

The Practice of Crime Scene Investigation

**INTERNATIONAL FORENSIC SCIENCE AND
INVESTIGATION SERIES**

Edited by James Robertson

Forensic Sciences Division, Australian Federal Police

Firearms, the Law and Forensic Ballistics

T A Warlow

ISBN 0 7484 0432 5

1996

**Scientific Examination of Documents:
methods and techniques, 2nd edition**

D Ellen

ISBN 0 7484 0580 1

1997

Forensic Investigation of Explosions

A Beveridge

ISBN 0 7484 0565 8

1998

Forensic Examination of Human Hair

J Robertson

ISBN 0 7484 0567 4

1999

**Forensic Examination of Fibres,
2nd edition**

J Robertson and M Grieve

ISBN 0 7484 0816 9

1999

**Forensic Examination of Glass and Paint:
analysis and interpretation**

B Caddy

ISBN 0 7484 0579 9

2001

Forensic Speaker Identification

P Rose

ISBN 0 415 27182 7

2002

The Practice of Crime Scene Investigation

J Horswell

ISBN 0 7484 0609 3

2004

Fire Investigation

N Nic Daéid

ISBN 0 415 24891 4

2004

**Fingerprints and Other Ridge Skin
Impressions**

*C Champod, C J Lennard, P Margot,
and M Stoilovic*

ISBN 0 415 27175 4

2004



INTERNATIONAL FORENSIC SCIENCE
AND INVESTIGATION SERIES

The Practice of Crime Scene Investigation

E D I T E D B Y

John Horswell



CRC PRESS

Boca Raton London New York Washington, D.C.

Library of Congress Cataloging-in-Publication Data

Catalog record is available from the Library of Congress

This book contains information obtained from authentic and highly regarded sources. Reprinted material is quoted with permission, and sources are indicated. A wide variety of references are listed. Reasonable efforts have been made to publish reliable data and information, but the author and the publisher cannot assume responsibility for the validity of all materials or for the consequences of their use.

Neither this book nor any part may be reproduced or transmitted in any form or by any means, electronic or mechanical, including photocopying, microfilming, and recording, or by any information storage or retrieval system, without prior permission in writing from the publisher.

All rights reserved. Authorization to photocopy items for internal or personal use, or the personal or internal use of specific clients, may be granted by CRC Press LLC, provided that \$1.50 per page photocopied is paid directly to Copyright Clearance Center, 222 Rosewood Drive, Danvers, MA 01923 USA. The fee code for users of the Transactional Reporting Service is ISBN 0-748-40609-3/04/\$0.00+\$1.50. The fee is subject to change without notice. For organizations that have been granted a photocopy license by the CCC, a separate system of payment has been arranged.

The consent of CRC Press LLC does not extend to copying for general distribution, for promotion, for creating new works, or for resale. Specific permission must be obtained in writing from CRC Press LLC for such copying.

Direct all inquiries to CRC Press LLC, 2000 N.W. Corporate Blvd., Boca Raton, Florida 33431.

Trademark Notice: Product or corporate names may be trademarks or registered trademarks, and are used only for identification and explanation, without intent to infringe.

Visit the CRC Press Web site at www.crcpress.com

©2004 by CRC Press LLC

No claim to original U.S. Government works
International Standard Book Number 0-748-40609-3
Printed in the United States of America 1 2 3 4 5 6 7 8 9 0
Printed on acid-free paper

This book is dedicated to:

Crime Scene Investigation and those who have chosen to work in this profession and to two special colleagues, Senior Sergeant Barry Cocks, AM South Australia Police (retired), and Detective Chief Inspector Alex Ross, London Metropolitan Police (retired), from whom I have learned a great deal about Crime Scene Investigation.

I would also like to pay special tribute to a colleague, Senior Constable Brian John Neiman (deceased), Northern Territory Police Forensic Services (1978–1989). He will always be remembered as a professional Police Officer who chose and excelled at Crime Scene Investigation.

Contents

Foreword

About the authors

Introduction

1 Crime scene investigation

JOHN HORSWELL

- 1.1 The crime scene
- 1.2 What constitutes a crime scene?
- 1.3 Forensic science
- 1.4 Physical evidence
- 1.5 Trace physical evidence
- 1.6 Class characteristics and similarity
- 1.7 Individuality
- 1.8 Value of forensic evidence
- 1.9 Scientific approach to a crime scene investigation
- 1.10 Crime scene investigation as a process
- 1.11 Assessment
- 1.12 Examination
- 1.13 Recording
- 1.14 Collection
- 1.15 Packaging
- 1.16 Collection guidelines for potential evidentiary material
- 1.17 Crime scene interpretation
- 1.18 Bibliography

2 Associative evidence – the Locard exchange principle

JOHN HORSWELL and CRAIG FOWLER

- 2.1 Background
- 2.2 The crime scene
- 2.3 Locard's exchange principle
- 2.4 Contact or transfer

- 2.5 Physical evidence categories
- 2.6 Discussion
- 2.7 Conclusion
- 2.8 Bibliography

3 The education and training of crime scene investigators: an Australian perspective

SUZANNE STANLEY and JOHN HORSWELL

- 3.1 Introduction
- 3.2 Diploma of forensic investigation
- 3.3 Degree level education and training
- 3.4 Competency-based training and assessment
- 3.5 Postgraduate forensic education and training
- 3.6 Training for investigators of volume crime
- 3.7 Crime scene investigator training in the AFP
- 3.8 Forensic awareness training
- 3.9 Conclusion
- 3.10 Bibliography

4 Crime scene investigation and third party quality systems accreditation: Australia's experience

JOHN HORSWELL

- 4.1 Background
- 4.2 Accreditation criteria
- 4.3 Court testimony monitoring
- 4.4 Crime scene investigator duties and competencies
- 4.5 Competency and proficiency testing
- 4.6 Internal competency and proficiency test instrument
- 4.7 Crime scene proficiency advisory committee
- 4.8 Crime scene proficiency test
- 4.9 Crime scene investigation
- 4.10 Acknowledgements
- 4.11 References

5 Management of crime scene investigation

JOHN HORSWELL

- 5.1 Background
- 5.2 Crime scene management
- 5.3 Scene control and coordination
- 5.4 Approaches to crime scene investigation
- 5.5 Scene security
- 5.6 Occupational health and safety
- 5.7 Examination records
- 5.8 Ongoing case management

- 5.9 Quality systems record management system for controlled documents
- 5.10 The ideal computerised system
- 5.11 Levels of access within a crime scene facility
- 5.12 Forensic science laboratory information management system
- 5.13 Forensic science LIMS overview
- 5.14 Programme features
- 5.15 Core system
- 5.16 Forensic functional modules
- 5.17 Customisation
- 5.18 Case profiling
- 5.19 Technical specifications
- 5.20 Summary
- 5.21 Bibliography

6 Application of forensic light sources at the crime scene CHRIS LENNARD AND MILUTIN STOILOVIC

- 6.1 Introduction
- 6.2 Basic light theory
- 6.3 Forensic light sources
- 6.4 Application at the crime scene
- 6.5 Conclusions
- 6.6 Note
- 6.7 Bibliography

7 Crime scene photography JOHN HORSWELL

- 7.1 Introduction
- 7.2 Background
- 7.3 Crime scene photography
- 7.4 Video recording of the scene
- 7.5 Digital photography
- 7.6 Legal aspects
- 7.7 Cited cases
- 7.8 Bibliography

8 Specialised photography and imaging GLENN PORTER

- 8.1 Introduction
- 8.2 Using linear scales in photographs
- 8.3 Distortion considerations
- 8.4 Close-up and photomacrography
- 8.5 Invisible radiation photography
- 8.6 Summary
- 8.7 References

9 Fingerprint identification

DALE CLEGG

- 9.1 Introduction
- 9.2 Historical application of fingerprints
- 9.3 The first fingerprint identification
- 9.4 Classification of inked fingerprint impressions
- 9.5 Fingerprint patterns
- 9.6 Ridgeology
- 9.7 Fingerprints and genetics
- 9.8 Fingerprints and the crime scene
- 9.9 Ninhydrin and DFO developers
- 9.10 Cyanoacrylate ester
- 9.11 Forensic light sources
- 9.12 Implications of a fingerprint identification
- 9.13 Forgeries
- 9.14 Conclusion
- 9.15 Bibliography

10 The ballistics expert at the scene

IAN PRIOR

- 10.1 Introduction
- 10.2 What happens when a firearm is discharged?
- 10.3 Types of propellant powder
- 10.4 What ballistics evidence could be located at a crime scene?
- 10.5 The importance of the ballistics specialist at the scene
- 10.6 Safety
- 10.7 Evidentiary value of the exhibits
- 10.8 Exhibit handling
- 10.9 Crime scene interpretation
- 10.10 Intelligence
- 10.11 Presentation of evidence
- 10.12 Crime scene interpretation
- 10.13 The ballistics specialist at the mortuary
- 10.14 Bibliography

11 The role of the pathologist at the crime scene

KEVIN LEE

- 11.1 General considerations
- 11.2 History of involvement in crime scene investigation
by medical practitioners
- 11.3 Investigation process
- 11.4 Functions at a crime scene

- 11.5 Safety issues
- 11.6 Equipment and dress
- 11.7 On location at the crime scene
- 11.8 Disturbance of evidence
- 11.9 Recording
- 11.10 Evidence collection
- 11.11 Timing of death
- 11.12 Changes after death
- 11.13 Forensic anthropology/archaeology
- 11.14 Aboriginal burials
- 11.15 Entomology
- 11.16 Blood spatter
- 11.17 Body removal
- 11.18 Leaving the scene
- 11.19 Revisiting the scene
- 11.20 Death types
- 11.21 Scene types
- 11.22 Conclusions
- 11.23 Bibliography

12 Establishing identity with odontology

DAVID GRIFFITHS

- 12.1 Background
- 12.2 History of odontology
- 12.3 How can dentistry assist at a crime scene?
- 12.4 Dental requirements at a crime scene
- 12.5 Identification of the unknown deceased
- 12.6 Identification of individuals
- 12.7 The dental post-mortem
- 12.8 Obtaining ante-mortem records
- 12.9 Bite marks
- 12.10 What constitutes a bite mark?
- 12.11 The role of the police
- 12.12 Treatment of the bite mark area
- 12.13 What to do if you suspect a bite mark is present?
- 12.14 Saliva sampling
- 12.15 Photography of bite marks
- 12.16 Production of photographic prints
- 12.17 Bite mark analysis
- 12.18 Areas where bite marks may be of particular use
- 12.19 Use of bite marks in assessing the degree
of force in an assault
- 12.20 Conclusion
- 12.21 Acknowledgements
- 12.22 Bibliography

13 Drug operations

KARL KENT and BRUCE NELSON

- 13.1 Introduction
- 13.2 Controlled delivery operations
- 13.3 Substitution
- 13.4 Illicit drug concealment
- 13.5 Drug importations and the forensic examination of the primary crime scene
- 13.6 Preliminary illicit drug identification
- 13.7 Pre-analytical illicit drug identification
- 13.8 Purity estimation by solubility testing
- 13.9 Mass measurement (drug bulk and samples)
- 13.10 Representative sampling of suspected illicit drug bulk
- 13.11 Preparation of concealment for a controlled delivery operation
- 13.12 Drug importation: forensic examination of the secondary crime scene
- 13.13 Role of the forensic drug laboratory
- 13.14 Occupational health and safety
- 13.15 Future directions
- 13.16 Conclusion
- 13.17 Bibliography

14 Clandestine drug laboratory investigations

JOHN WHITE

- 14.1 Introduction
- 14.2 Variables associated with illicit drug production and scientific investigation
- 14.3 Safety issues
- 14.4 Safety education and training programmes
- 14.5 Investigative aspects
- 14.6 Conclusion
- 14.7 Acknowledgements
- 14.8 Bibliography

15 Fire and explosion scene examination

PETER THATCHER and JOHN KELLEHER

- 15.1 Background
- 15.2 Scene security
- 15.3 Health and safety issues
- 15.4 Fire investigation
- 15.5 Scene recording
- 15.6 Scene examination: preliminary
- 15.7 Scene examination: location of probable starting point
- 15.8 Evidence of fire cause

- 15.9 Packaging
- 15.10 Other evidence
- 15.11 Accidental fires
- 15.12 Reporting
- 15.13 Explosion investigation
- 15.14 Explosion scene examination objectives
- 15.15 Explosion scene searching
- 15.16 Search patterns
- 15.17 Search techniques
- 15.18 Chemical analysis
- 15.19 Device reconstruction
- 15.20 Bibliography

16 The scientific requirements and outcomes of a sexual assault crime scene investigation

CARMEN I. ECKHOFF

- 16.1 Introduction
- 16.2 The crime scene
- 16.3 Exclusion or elimination samples
- 16.4 Medical examinations
- 16.5 The collection and examination of clothing
- 16.6 Summary
- 16.7 Bibliography

17 Botanical and soil evidence at the crime scene

JAMES ROBERTSON

- 17.1 Introduction
- 17.2 Scope of forensic botany
- 17.3 Soils, pollen and forensic science
- 17.4 Evidence and interpretation issues
- 17.5 Summary and conclusion
- 17.6 Case examples
- 17.7 Bibliography

18 The application of entomology to criminal investigations

JAMES F. WALLMAN

- 18.1 Introduction
- 18.2 Using insects in the investigation of death
- 18.3 Linking a suspect and the death scene
- 18.4 Insects as the cause of death
- 18.5 Post-mortem artefacts caused by insects
- 18.6 The role of insects in other criminal investigations
- 18.7 Collection and treatment of insect evidence

- 18.8 Acknowledgements
- 18.9 Bibliography

19 Physical comparative evidence

TED VAN DIJK and PAUL SHELDON

- 19.1 Background
- 19.2 Pattern recognition
- 19.3 The comparative process
- 19.4 At the scene
- 19.5 Shoemarks
- 19.6 Tyremarks
- 19.7 Toolmarks
- 19.8 Physical matching
- 19.9 Reporting the results of comparative examinations
- 19.10 Conclusion
- 19.11 Bibliography

20 Signal processing evidence

GRAEME J. KINRAID

- 20.1 Background
- 20.2 Format conversion
- 20.3 Audio enhancement
- 20.4 Tape authentication
- 20.5 Tape repair
- 20.6 Voice identification
- 20.7 Acoustic analysis
- 20.8 Image/video enhancement
- 20.9 Conclusion
- 20.10 Acknowledgement
- 20.11 Bibliography

21 Crime scene investigation: key issues for the future

JAMES ROBERTSON

- 21.1 Setting the 'scene'
- 21.2 What impact will emerging technologies have?
- 21.3 What type of people will we need and what implications will this have for training?
- 21.4 How do we ensure or assure quality?
- 21.5 How do we ensure law enforcement makes the best use of forensic science?
- 21.6 Conclusion
- 21.7 References

Foreword

I have enjoyed the privilege of being a police practitioner for some 35 years, together with the opportunity to practice for a short time as a barrister in both the criminal and civil jurisdictions. This combination of experience convinced me many years ago of the fundamental importance of forensic science in all its dimensions, and of the quality and integrity of its process. Crime scene investigation is, of course, at the absolute coalface of this process.

Throughout my career, either as a police officer or a lawyer, my experience has been that quality of the immediate crime scene response and examination is almost always a critical factor in a successful prosecution. Evidence missed so often is evidence lost, and evidence corrupted by incomplete or improper handling or examination cannot be sanitised.

The nature and diversity of the jurisdiction of the Australian Federal Police, which combines community policing (both in Australia and in Australia's external territories), and overseas deployments as part of the United Nations and other peacekeeping and policing activities, probably raises more potential forensic need and challenge than in almost any other law enforcement agency in the world. For this reason the Australian Federal Police has been at the forefront of forensic science development in Australia throughout its 22-year history.

The commitment of John Horswell to compiling this book, with the strong support of many forensic colleagues, is a reflection of his dedication to continuous improvement and development.

In support of this commitment, and to assist an objective assessment of the credibility of contributions such as this, it is perhaps important to recognise that the Australian Federal Police Forensic Services has, as part of its forensic team, former members of the Forensic Science Unit of the Australian National University who developed the 'Polilight®' and many of the physical and chemical enhancement techniques routinely in use today. Those people include Dr Chris Lennard and Mr Milutin Stoilovic whose work has made a very significant impact on field forensic science, and who are contributors to this book. The Forensic Science Unit was fully funded by the Australian Federal Police throughout its life. The Australian Federal Police continues to provide support and leadership in the development of the forensic sciences through active involvement and partnership with academics in teaching and research.

Forensic science is necessarily and importantly absolutely collegiate and collaborative dependent on quality, standards and integrity, irrelevant to jurisdictional boundaries and borders. The contributors to this book are an example of this collegiate. Several of

them have been involved over a long period in improvement of crime scene investigative standards through the development of the Associate Diploma in Forensic Investigation, later the National Diploma in Forensic Investigation, and the development of a degree programme for field forensic science. Many other tertiary education courses in forensic science, which can now be found in universities around Australia, have their origins in the leadership and initiative of many of the book's contributors. The development of quality systems accreditation for crime scene investigators, something which had never been attempted previously, is an example of this leadership.

Whilst many of the authors come from Australia the principles and the messages are universal. The case examples only serve to demonstrate this truth. We can all learn from each other and only by doing so will the standards and practice of forensic science improve.

Judicial and community confidence in forensic science is critical. It is a confidence, which law enforcement cannot afford to be shaken or threatened, and which must continuously be reinforced and enhanced. Many of the book's chapters directly contribute to the enhancement, and the range of subject matters covered provides a real insight into the dimensions and potential of crime scene examination.

This book is a blend of forensic science philosophy and practical, technical, 'how to' forensic science, with an emphasis on the critical coalface of the crime scene itself. I believe it will prove to be a valuable tool for all people interested not only in the world of forensic science, but also in the broader operation of our system of justice.

M. J. Palmer AO APM FAIM
Former Commissioner
Northern Territory Police and the
Australian Federal Police

About the authors

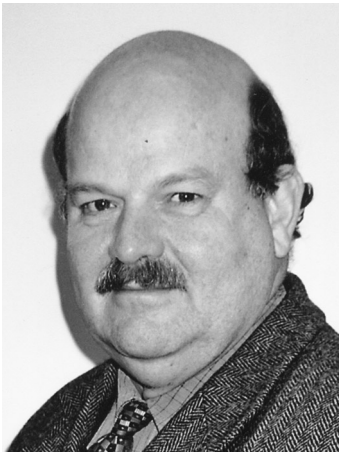

John Horswell, *Consulting Forensic Scientist, Forensic Executives, PO Box 6204, Upper Mt Gravatt, Queensland, 4122 Australia, Telephone 61 (0)402 564 467, formerly of the Forensic Services, Australian Federal Police, Canberra, Australia.*

John holds a Master of Science degree in Forensic Science from Strathclyde University, Glasgow, Scotland, a Forensic Science Society Diploma in Crime Scene Investigation and a Diploma in Business Management from the Australian Institute of Management.

Between 1965 and 1973 he was employed as a laboratory analyst conducting 'classical' chemical analysis with experience in the food, pharmaceutical, household product, industrial chemical and flexible packaging industries.

From 1974 to 1989 he was a forensic investigator with the Northern Territory Police. Since 1989 he has worked within Forensic Services of the Australian Federal Police (AFP), carrying out various roles, which included time as Director Training and Standards, Director Crime Scenes and ACT Forensic Teams Coordinator.

It was his vision, leadership and persistence which led to the introduction of the first tertiary and joint industry specific education and training programme in forensic science in Australia. Whilst with the AFP he again introduced such a programme for AFP practitioners Australia wide. Since this time there has been a national approach adopted and an explosion of forensic science programmes in the University sector in Australia. He was also responsible for Quality, for both Field and Laboratory Sciences across six sites in his role as Quality Manager.

John has studied forensic investigation with the South Australia, New South Wales, Queensland and London Metropolitan Police as well as fire investigation as a Churchill Fellow in the United States of America in 1984.

John is the founding Chair of the Crime Scene Proficiency Advisory Committee (CSPAC), a standing committee of the National Institute of Forensic Science and a National Association of Testing Authorities, Australia (NATA) proficiency test provider. He is a member of a number of scientific and management associations and is a Fellow of:

- The Royal Australian Chemical Institute;
- Australian Institute of Management;
- Institute of Quality Assurance (UK);
- Quality Society of Australasia; and
- Institution of Fire Engineers (UK).



James Robertson, *Australian Federal Police, GPO Box 401, Canberra, ACT 2601, Australia.*

James graduated with a BSc Agricultural Botany (Hons) in 1972 and PhD in 1975, both from the University of Glasgow. He lectured in forensic science at the University of Strathclyde from 1976 to 1985 where part of his responsibilities included courses in forensic botany. He moved to Australia in 1985 where he worked for nearly five years at State Forensic Science, Adelaide before taking up his present appointment as Director of Forensic Services for the Australian Federal Police. He has extensive experience in the analysis of cannabis and has research interests in developing DNA methods for profiling cannabis. He has published numerous papers across a wide range of topics

including applications of botany in forensic science and the forensic examination of soils. He is the series editor of the Taylor & Francis series in forensic science. He maintains an active involvement in academic forensic science by chairing a number of academic advisory groups. He is past Chair of the Senior Managers Australia and New Zealand Forensic Laboratories (SMANZFLL), chairs the ACT chapter of the Australian Academy of Forensic Sciences, and is the assistant editor of the academy journal. James is an adjunct Professor at the University of Technology, Sydney and at the University of Canberra.



Craig Fowler, *Principal Innovation and Incentives, Ernst & Young, 321, Kent Street, GPO Box 2646, Sydney, NSW 2001, Australia.*

Craig Fowler commenced his career in forensic science in the police laboratory of the British South African Police in Salisbury, Rhodesia.

Craig holds a Bachelor of Science degree in Chemistry and Biochemistry from the University of Rhodesia, Zimbabwe, a Master of Science degree in Forensic Science from Strathclyde University, Scotland, a Master of Business Administration in Technology Management from Deakin University, Victoria and a Doctor of Philosophy degree from Flinders University of South Australia. Craig's thesis concentrated on Human DNA Fingerprinting.

Craig worked for a number of years with State Forensic Science of South Australia commencing in the Forensic Biology Laboratory within the Institute of Medical and Veterinary Science in the early 1970s, the predecessor of the Forensic Biology Laboratory at State Forensic Science.

Craig is no longer working in forensic science, however, maintains an active interest in forensic science and in particular science and is currently a Principal of the Innovation and Incentive Practice Tax Division of Ernst & Young in Sydney.



Suzanne Stanley, *Coordinator, Federal Law Enforcement Training Centre, Australian Federal Police, GPO Box 401, Canberra, ACT 2601, Australia.*

Suzanne holds a BSc in Zoology (Hons) from the University of Western Australia (1972) and a PhD from the Australian National University (1979).

She commenced teaching at the Canberra Institute of Technology in 1985 and was Head of the Department of Forensic Science from 1997 to 2000. Suzanne was closely involved in the development of curriculum and learning resources for the National Diploma of Forensic Investigation and with the delivery and management of distance learning packages associated with this qualification. She developed and implemented the Bachelor of Applied Science (Forensic Investigation)

at the Canberra Institute of Technology, which is aimed at crime scene investigators.

Suzanne moved to the Australian Federal Police in 2001, where she is Head of the School of Forensic Investigation, which is part of the Australian Federal Police College. Her current responsibilities include managing the training for laboratory and field services members of AFP Forensic Services, as well as forensic awareness training for recruits and investigators in all areas of the AFP.

Suzanne is currently President of the ACT chapter of the Australian and New Zealand Forensic Science Society.



Chris Lennard, *Director, Operations Support (Chief Scientist), Forensic Services, Australian Federal Police, GPO Box 401, Canberra, ACT 2601, Australia.*

Chris holds a Bachelor of Science in Chemistry (1982) and a Doctor of Philosophy (1986) in Chemistry, both from the Australian National University, Canberra, Australia.

In 1986 Chris took up a postdoctoral position at the School of Forensic Science, University of Lausanne, Switzerland, where he later gained the position of Associate Professor in Criminalistics in 1989.

In 1994 he returned to Australia to take up position as Coordinator, Laboratory Services within Forensic Services of the Australian Federal Police. He is currently the Chief Scientist for the Australian Federal

Police Forensic Services with the responsibility for Research and Development, Quality Management – ensuring the service provided is based in science and adheres to system.

Chris has published extensively across a wide range of forensic topics, but fingerprint detection and enhancement have remained his major interest.

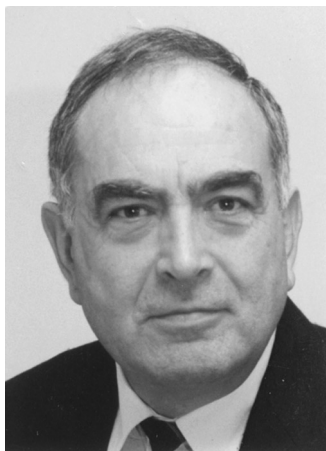

Milutin Stoilovic, *Forensic Physicist, Criminalistics, Laboratory Services, Forensic Services, Australian Federal Police, GPO Box 401, Canberra, ACT 2601, Australia.*

Milutin holds a Bachelor of Science in Physics (1966) and a Master of Science (1976) by research from the University of Belgrade. He studied solid-state physics concentrating on the luminescence phenomena for his Master's thesis.

Milutin migrated to Australia in 1980 and took up a position as Research Scientist within the Forensic Science Unit at the Australian National University in Canberra. The research, funded by the Australian Federal Police, included the development of a light source for latent fingerprint detection. From a prototype developed in 1982, a fully commercialised forensic light source became available in 1987.

In 1990 Milutin joined the Australian Federal Police as a Senior Forensic Scientist. He has travelled widely lecturing in Australia and many overseas countries, and although his work has broadened to include microspectrophotometry and X-ray fluorescence, he is still heavily involved in latent fingerprint research. He has published well over 30 scientific papers in the refereed literature on his speciality.

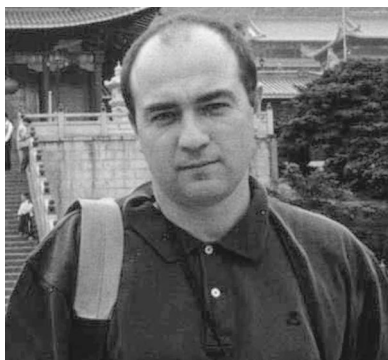

Glenn Porter, *Senior Lecturer in Forensic Science, University of Western Sydney, Locked Bag 1797, Penrith South DC, NSW 1797, Australia.*

Glenn Porter is a Senior Lecturer in Forensic Science at the University of Western Sydney and formerly with the Australian Federal Police. Glenn's expertise is forensic photography and he holds several qualifications in photography and science from various educational institutions including the Sydney Institute of Technology, University of Sydney and RMIT University.

Glenn has published papers in several journals and symposiums on aspects of forensic photography. He has lectured forensic photography and imaging techniques to university and on law enforcement training courses.

In particular, Glenn has extensively researched bite mark photography techniques through his study for a Master of Applied Science (Photography) degree. His thesis, published in 2002, is titled 'A Study into Bite Mark Evidence Recording Methodologies and their Validity in Bite Mark Evidence in Australia'. This study examined traditional and contemporary photography and imaging techniques used in bite mark identification.

Glenn's current doctoral studies, examine the complexities of photographic evidence and its effectiveness to record reality. His study investigates influences outside the standard physical recording mechanisms and explores consequences that distort and corrupt the real. These influences may strongly affect the reliability of photographic evidence.

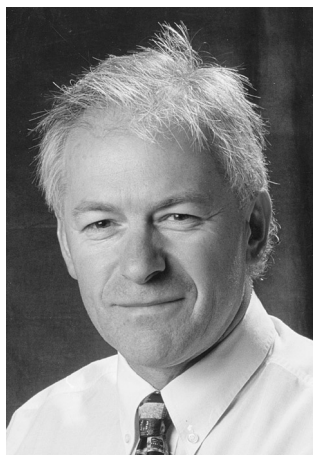

Dale Clegg, *Fingerprint Expert, Fingerprint Department, Nottingham Police Headquarters, Arnold, Nottinghamshire NG5 8PP, United Kingdom.*

Dale completed his fingerprint studies with the New South Wales Police in 1987 whilst serving in that State's Fingerprint Bureau. Dale holds a Certificate in Marketing from the New South Wales Technical and Further Education in 1990 and a Graduate Certificate in Police Management from Charles Sturt University in 1998. He has completed a number of fingerprint professional courses and is a Fellow of the Fingerprint Society.

Dale has served as a serving member with the New South Wales Police and the Australian Federal Police. He has also served as a staff member of both the Australian Federal Police and Nottinghamshire Constabulary.

He has a number of publications to his credit and has been involved in all categories of crime in the use of fingerprints in criminal investigation, including community crime, federal crime and international crime.



Ian Prior, *Former Federal Agent, Forensic Services, Australian Federal Police, GPO Box 401, Canberra, ACT 2601, Australia.*

Ian has been a serving member of the Australian Capital Territory and latterly the Australian Federal Police since February 1970.

He joined the former Scientific Branch of the Australian Capital Territory Police in November 1995 as a crime scene examiner with the view of developing a forensic ballistics capability.

Ian has studied firearms identification with all State and Territory Police Services in Australia and the production methods of the major firearm and ammunition manufacturing companies in Australia, South Korea, United States of America, Italy,

Switzerland, Austria, Germany, Belgium, France and the United Kingdom.

He is a member of the Association of Firearms and Toolmark Examiners and the International Wound Ballistics Association.

Ian Prior has received many awards for his service to the Australian community through his work as a Forensic Ballistics Expert within the Australian Federal Police including the Australia Day Medallion for his work in developing a world class forensic ballistics facility. The pinnacle of his achievements was the award of the Australian Police Medal for distinguished Police Service in the field of firearms identification, testing, training and control, and the safety of imported firearms, particularly in the implementation of national gun controls.

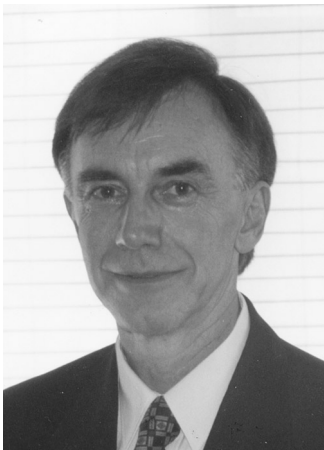

Kevin Lee, *Consultant in Pathology and Forensic Medicine, Newcastle Department of Forensic Medicine, PO Box 664J, Newcastle 2300, NSW, Australia.*

Kevin holds the degrees of Bachelor of Medicine and Bachelor of Surgery (1968), the Diplomas in Medical Jurisprudence, Clinical and Pathology (1974), Membership (1981) of the Royal College of Pathologists and Fellow of the same body (1993).

Dr Lee is currently a Senior Specialist Forensic Pathologist with the Royal Newcastle Hospital in New South Wales. He is an Honorary Senior Lecturer in the Department of Forensic Medicine, Monash University.

Kevin commenced pathology training in Zimbabwe (Rhodesia) in 1970, and in 1973 started a postgraduate study year at Guy's Hospital London as a Lecturer/Registrar. He returned to Africa in 1974, and was responsible for the majority of coronial work in the eastern part of the country, continuing on until the end of 1977. The workload had been predominantly civilian in nature, but with the escalating war, it gained a more military focus. He returned to Guy's Hospital in 1978 as a Lecturer in

Forensic Pathology. He moved to the Royal Darwin Hospital, Northern Territory 1983, becoming the forensic pathologist, and then going on to the Victorian Institute of Forensic Medicine in 1989. After two years he returned to Darwin as a senior specialist pathologist, becoming the Director of the Forensic Pathology Unit in 1996. In 1998 he moved to private consulting practice and now is a Forensic Pathologist at the Royal Newcastle Hospital.

His crime scene experience and interest began at the start of his training and he attended many crime scenes, mainly of suspicious deaths, homicides, suicides and road traffic accidents. His second stint in Africa also involved a large number of crime scenes. These included many related to the civil war, a large portion of which was multiple death scenes. His crime scene experience in England was of the normal civilian type, focusing mainly on homicides and suspicious deaths, and was much of the same type in Melbourne, as in Newcastle. In Darwin it involved the usual range of cases, but included a significantly higher proportion of deaths related to suicide, motor vehicle trauma, and apparent natural cause deaths. It also involved a number of multiple and serial homicides. Decomposition and post-mortem injuries were common complicating factors.

Kevin has an ongoing interest in crime scene investigation and has undertaken the Bloodstain Evidence Course with Herb McDonnell, as well as an Advanced Bloodstain Pattern Analysis Workshop at the Metropolitan Police Institute in Miami, Florida. He has published and presented many cases which have had a crime scene investigation element.



David Griffiths, *Consulting Forensic Dentist, Dental Surgery, Suite 6, 2nd Floor, Ethos House, Ainslie Avenue, Canberra, ACT 2601, Australia.*

Dr Griffiths is a Dental Surgeon in General Practice in the Australian Capital Territory. He was educated at The Grammar School, Shaftesbury in England and the University of Sydney. He has been a consultant in Forensic Dentistry to the Australian Federal Police since 1991 and has lectured extensively at tertiary level on forensic dentistry. He became the foundation Director of the Australian Capital Territory Forensic Dental Unit in 1992 and as an active campaigner for forensic science was instrumental in setting up a Branch of the Australian and New Zealand Forensic Science Society in the Australian Capital Territory, serving as its inaugural president between 1992 and 1996 when he became National President. In 2000, he was responsible for creating and implementing the Forensic Practitioners Register and currently serves as the Registration Board's Foundation Chair.



Karl Kent, *Coordinator, Field Services, Australian Capital Territory, Forensic Services, Australian Federal Police, GPO Box 401, Canberra, ACT 2601, Australia.*

Federal Agent Karl Kent has been a member of the Australian Federal Police for the last 16 years, with over 14 years of experience in forensic investigations. Karl has worked within a diverse range of areas within forensic services in support of AFP operations in NSW, SA and the ACT, and in training, quality management, and policy areas. Karl has a Bachelor of Science degree from the University of New South Wales and an Associate Diploma of Applied Science in Forensic Investigation from the Canberra Institute of Technology.

Since 2001 Karl has performed the role of Coordinator, Field Services ACT, where he coordinated the operations of specialist forensic investigation teams including crime scenes, fingerprints and firearms and ballistics primarily in support of ACT policing operations.

Federal Agent Karl Kent performed the role of Coordinator, Forensic and Disaster Victim Identification, for the investigation into the Bali bombings in 2002 and also established and coordinated the Forensic Major Incident Room during this operation. Karl is currently on a 12-month secondment to the Science Engineering and Technology Unit, National Security Division, Department of the Prime Minister and Cabinet.



Bruce Nelson, *Federal Agent, Team Leader, Joint Drug Intelligence Team, Forensic Services, Australian Federal Police, Sydney Office, 110 Goulburn Street, Locked Bag A3000, Sydney 2000, NSW, Australia.*

Federal Agent Bruce Nelson has been a member of the Australian Federal Police Sydney since 1979, serving a year as a uniformed Constable before commencing as a Trainee Document Examiner.

In 1980 Bruce became the AFP's regional photographer and instigated the Forensic recording of Drug-related Crime Scenes, a role then performed *ad hoc* by Investigators. During the early to mid-1980s Australia's shores were violated by emerging notorious organised crime figures, importing record quantities of cocaine, heroin and cannabis. With a rapidly increasing burden now placed on investigators, and the absence of scientific support, Bruce expanded the role of forensic services to include fingerprint examination, scientific photography and video recording of crime scenes.

With the quantity of drugs entering Australia and the problems faced with making 'live' deliveries to their intended recipients, a procedure of 'Drug Substitution and

Controlled Delivery' was developed. Bruce pioneered the practical aspects of this procedure. This involved the exact replication of a drug importation using inert substances, and the inclusion of a 'Controlled Delivery Sample' of the imported drug. The seizure was then reconstructed, methodology recorded, photographed and returned to the investigator for a 'controlled delivery'.

In 1984 Bruce was appointed Sergeant, in charge of the Physical Evidence Team, now increased in members and operating from Victoria, South Australia and Western Australia. He has contributed articles to many journals and produced a Physical Evidence Procedures Manual.

Bruce is currently Team Leader of the Forensic Services Joint Drug Intelligence Team, examining the physical aspects of drug importations and comparing them with other seizures, with a view to establishing links.

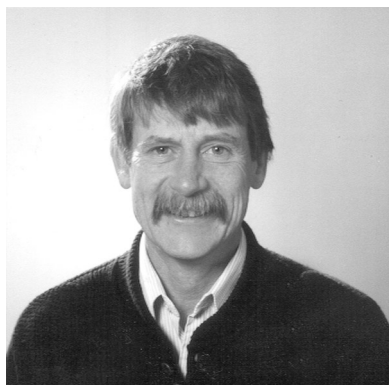

John White, Forensic Chemist, Victoria Police Forensic Science Centre, 1 Forensic Drive, Macleod, Vic. 3085, Australia.

John White holds the degree of M App Sci from the Royal Melbourne Institute of Technology. He has in excess of 20 years experience in the scientific examination of clandestine drug laboratories and presented associated papers to the 12th meeting of the International Association of Forensic Sciences in Adelaide, 1990 and the National Amphetamines Workshop in Adelaide, 1995.

He has represented the Victoria Police Forensic Science Centre (VFSC) on the National Amphetamines (Education and Training) Working Party, the National Best Practice Guidelines Committee (Clandestine laboratories: environmental health and safety), the National Psychostimulants Taskforce and both state and national technical advisory groups associated with legislative reform. He is currently Chair of the National Working Group on Toxic By-Products of Illicit Drug Laboratories, which reports to the Intergovernmental Committee on Drugs.

John White has prepared and directed a series of three national safety-training courses for specialist clandestine laboratory investigators (both law enforcement and forensic personnel) and directed two national forensic seminars for clandestine laboratory investigating scientists. In 1996, 1998, 2000 and 2001 he attended and presented to the International Technical Training Seminars and Workshops for Clandestine Laboratory Investigating Chemists.



Peter Thatcher, *Director, Forensic Services, Northern Territory Police, Fire and Emergency Services, PO Box 39764, Winnellie, NT 0821, Australia.*

Dr Peter Thatcher was educated at Monash and Melbourne Universities before joining the Norman MacCallum Police Forensic Science Laboratory in 1973. He worked in many areas including trace evidence, drugs analysis, arson residue analysis and forensic biology before forming the Fire Investigation Section in 1976.

In 1982, Dr Thatcher completed his doctoral thesis titled 'The Identification of Petroleum Residues in Arsons'. This study targeted the formation and identification of selected pyrolysis products in fire residues located at fire scenes. Over the next 20 years, Dr Thatcher conducted research, lectured extensively and contributed to books and journals in the field of fire investigation. He also investigated the causes of many fires both in Australia and overseas and, subsequently, presented evidence in a large number of these cases.

In 1986, Dr Thatcher was appointed to the position of Assistant Director (Chemistry) at the Victorian Forensic Science Centre and, while in this position, during the period 1986 and 1996, he assisted an Australian aide project in Papua New Guinea where he established the Papua New Guinea Forensic Science Centre.

In 1998, Dr Thatcher was appointed to the position of Director, Northern Territory Police, Fire and Emergency Services Forensic Science Centre.

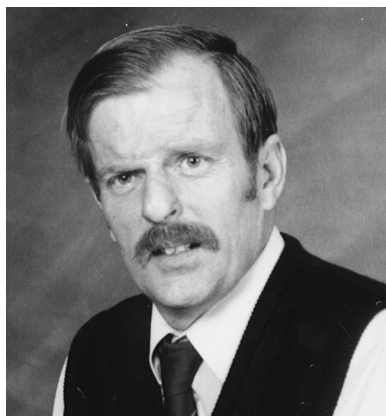

John Kelleher, *Forensic Chemist, Victoria Police Forensic Science Centre, 1 Forensic Drive, Macleod, Vic. 3085, Australia.*

John holds a Bachelor of Arts in Mathematics and a Bachelor of Applied Science in Chemistry and Physics from Monash Gippsland.

Between 1983 and 1988 John was a Chemist and Inspector of Explosives with the Explosives Branch, Department of Labour within the Government of Victoria. He was responsible for the examination and testing of explosives; explosive accessories and magazines; and the investigation of accidents and incidents including fires and explosions relating to the commercial and industrial use of explosives.

From 1988 John has been the Section Head, Fire and Explosion Investigation, Victoria Police Forensic Science Centre. He is the Team Leader and is responsible for the investigation of fire and explosion scenes, the examination of exhibits, and the presentation of his findings to Magistrates, County and Supreme Courts of Victoria.

He conducts research and development into methods of analysis and investigation particularly relating to explosives, training of police and laboratory personnel in fire and explosion investigation methods and procedures.

John is a Chartered Chemist (MRACI) and member of the Australian Institute of Physics.



Carmen I. Eckhoff, *Northern Territory Police, Fire and Emergency Services, PO Box 39764, Winnellie, NT 0821, Australia.*

Carmen holds a Bachelor of Science (Honours) from Flinders University of South Australia and has had ten years experience in medical pathology.

Carmen is currently a Senior Forensic Biologist within Forensic Services of the Northern Territory Police, Fire and Emergency Services Department. She has 11 years experience working as a Forensic Scientist specialising in Forensic Biology. Her duties include the application of serology and more recently, molecular biology,

to the investigation of crime.

She has extensive experience in the examination of items both in the laboratory and at crime scenes where biological expertise has been required. This includes the chemical enhancement of various types of stains and the interpretation of bloodstain patterns.

Carmen is a seasoned lecturer and presenter at Symposia and Workshops and has presented her findings to various courts of law in the Northern Territory and South Australia.



James F. Wallman, *Lecturer, Biological Sciences, Faculty of Science, University of Wollongong, Wollongong, NSW 2522, Australia.*

James is a Lecturer in the Department of Biological Sciences at the University of Wollongong where he has worked since 2001. Prior to that he lectured in the Department of Zoology and Environmental Biology at the University of Adelaide, from where he gained a BSc (Hons) degree in 1991 and a PhD in 1999. For these degrees he studied the systematics and biology of carrion-breeding blowflies and their application to forensic science, a topic that he continues to actively research. He acts as a consultant in forensic entomology to the state

police services of New South Wales and South Australia. He is a Fellow of the Royal Entomological Society and serves on the Executive of the NSW Branch of the Australian and New Zealand Forensic Science Society.



Ted Van Dijk, *Senior Sergeant, Officer in Charge, Physical Evidence Section, Forensic Services Branch, South Australia Police, 60 Wakefield Street, GPO Box 1539, Adelaide, SA 5001, Australia.*

Ted is a Senior Sergeant of Police and presently the Officer in Charge of the Physical Evidence Section, within the South Australia Police Department's Forensic Services Branch.

He has been a police officer since 1971. He holds a Science Technician's Certificate (Forensic Option) from the South Australian Institute of Technology (Adelaide University), and has specialised in the various physical comparison disciplines, particularly toolmark identification. The author of a number of chapters relating specifically to this discipline, Ted has also written the

'Introduction to Physical Comparative Examinations' (distant learning) module for the Diploma in Forensic Investigations. He is a member of both the Australian and New Zealand Forensic Science Society and the International Association of Identification.

Ted has presented evidence on a wide range of serious and major crime scene investigations as well as comparative identifications and is presently responsible for the training and management of the group providing this service in South Australia.

In 2001 Ted's contributions to forensic science nationally were recognised by the award of Australia's highest police award, the Australian Police Medal (APM).



Paul Sheldon, *Physical Evidence Section, Forensic Services Branch, South Australia Police, 60 Wakefield Street, GPO Box 1539, Adelaide, SA 5001, Australia.*

Paul is Sergeant of Police and presently a supervisor in the Physical Evidence Section, within the South Australia Police Department's Forensic Services Branch.

He has been a police officer since 1977 and a Crime Scene Investigator since 1984. He is currently a Team Leader responsible for the investigation of serious crime, coordinating the physical comparison function within the section and training less experienced members. He has made presentations to Australian and New Zealand Forensic Science Society Symposia

on shoe evidence and crime scene topics. From 2000 to 2002 he was the President of the Society's (ANZFSS), South Australian Branch.

He has presented evidence on a wide range of serious crime scene investigations as well as comparative identifications.



Graeme J. Kinraid, *Team Leader, Forensic Imaging, Forensic Services, Australian Federal Police, GPO Box 401, Canberra, ACT 2601, Australia.*

Graeme Kinraid, a native of New Zealand, trained with the New Zealand Police as a radio technician, obtaining his Radio Technician Certificate. Graeme went on to complete his New Zealand Certificate of Engineering in 1990.

In 1986 he started his career in Forensic Signal Processing when he took the position of Audio and Development Technician at New Zealand Police National Headquarters in the National Tape Laboratory, where he progressed to senior technical investigator.

From November 2000 until the present, Graeme has been the Team Leader of the Forensic Imaging Team within the Australian Federal Police's Forensic Services in Canberra, Australia, where as well as supervision of a small team, he continues to perform signal processing casework.

Graeme is one of the founding members of the Australasian Forensic Signal Processing Group established in 1996 under the auspices of Australia's National Institute of Forensic Science, the forerunner of the Senior Managers of Australia and New Zealand Forensic Laboratories Specialist Advisory Group on Electronic Evidence, which was formed in 1999.

Graeme is a Member of the Audio Engineering Society, the National Technical Investigators Association (USA), Australia New Zealand Forensic Science Society and Australasian Sound Recording Association.

Introduction

What I have attempted to achieve in this book is to provide police officers, crime scene investigators, including other field scientists, and those practising forensic science at the bench, a philosophical and practical grounding in forensic science, particularly crime scene investigation, as one of the most, if not, the most important disciplines within forensic science. The contributors to this book have provided an insight into their respective speciality areas, each presenting their subject as if they had carriage of the crime scene investigation.

Each chapter stands alone and has been organised in such a way that the selected topic is examined with a focus on the individual requirements for each speciality area. The monograph commences with a complete treatment of crime scene investigation and concludes with a discussion on the key issues for crime scene investigators for the future.

The book is 'Australian' in flavour as we believe that crime scene investigation has matured considerably in Australia during the last decade. Many of our initiatives are leading edge and are worthy of consideration by others. We have come a considerable distance with the introduction of education and training programmes, career paths and structures and third party quality systems accreditation, all centred around crime scene investigation.

I hope that this book will be seen as a 'beginning' and that others will develop the subject of crime scene investigation through evolution of further editions of this book.

Editor
Canberra, Australia

Crime scene investigation

John Horswell

1.1 The crime scene

Crime scene investigation in Australia is practised differently in all jurisdictions and the responsibility for scene investigation will include, a combination of, or all of, the following types of incidents and examinations:

- vehicle (car, bicycle, motor cycle, boat, aircraft) accidents;
- vehicle (number falsification and restoration, vehicle parts identification and head-light examination in vehicular accidents) identification;
- accidental (multitude of circumstances including misadventure) death;
- suicidal (multitude of circumstances) death;
- homicidal (multitude of circumstances) death;
- sudden (with or without suspicious circumstances) death;
- forced entry onto premises (houses, factories, shops, shopping malls, garages, garden sheds);
- forced entry into money containers (safes and automatic teller machines – ATMs);
- theft (including thief traps);
- fraud (scientific examination of documents excluding handwriting identification);
- sexual assault (touching, penetration, ejaculation – with or without violence);
- assault with a weapon (hammer, screw driver, axe, knife, firearm, piece of timber);
- difficult victim identification (mummification and putrefaction);
- disaster victim identification (dealing with multiple casualties);
- fire scene investigation;
- explosion scene investigation;
- drug investigations (importation of drugs, plantations, clandestine laboratories);
- firearms offences (scene examinations);

- physical comparisons (mechanical fit, footwear, tyretrack and toolmark impression identification); and
- identification and recovery of micro and macro physical evidence including the location, visualisation and recovery of fingerprints and other latent marks.

The location or 'locus' of an 'incident' is usually called the crime scene. In some 'incidents' it may be readily apparent that a crime has indeed been committed and it is a 'crime scene'. However, in many situations one of the initial and primary tasks of the crime scene investigator is to determine whether or not a crime has been committed. An obvious example is that of a deceased person. In many instances, it will be obvious that death was not due to natural causes. In other instances it may be far from obvious; hence, the primary role of the crime scene investigator is that of conducting a forensic investigation.

It is the responsibility of the senior investigating officer to ensure that the crime scene is investigated by appropriately skilled and qualified crime scene investigators and it is the responsibility of the relevant crime scene unit head to ensure s/he provides the appropriate resources. Resources should be based on the complexity and seriousness of the alleged incident. It is invariably useful for the police to have a major incident response plan, which recognises that the crime scene is the principal responsibility of the forensic support group. In the State and Northern Territory jurisdictions of Australia, relevant State and Territory Police have the responsibility for crime scene investigation, which is usually confined to that jurisdiction or to other jurisdictions where suspects have travelled to avoid apprehension. The skill and competency, education and training qualifications, and experiences vary considerably in Australia, and this would be even more so across international boundaries. There are some very competent crime scene investigators with very little formal training or educational background. They possess excellent practical skills but have too often had to be largely self-trained. In the 1990s senior crime scene investigators throughout Australia tried their best to solve this void with the development and introduction of a purpose-designed education and training programme, the National Diploma in Forensic Investigation. In the Federal Jurisdiction in Australia, this is not an issue. We have well-educated and well-trained crime scene investigators. For community-related crime, we have geographically defined jurisdictional boundaries such as, the Australian Capital Territory, the Territory of Jervis Bay, Norfolk and Christmas Island. It is our involvement in federal crime which has our crime scene investigators spread thinly across Australia, operating both nationally and internationally from facilities in Adelaide, Brisbane, Melbourne, Perth and Sydney. We now have a dedicated crime scene investigator in East Timor assisting that country with local community crime as well as looking at war crime issues and training local officers in crime scene techniques. Our (federal) specialists in Canberra also are called upon to travel extensively to crime scenes anywhere they are required. This applies particularly to fingerprint officers and crime scene investigators as primary responders or back up to local resources. In many other countries crime scene investigators receive formal training. A good example is the United Kingdom with their National Training Centre. However, all too often formal training is limited to short courses and, rarely, is a sound science base included in that training. This is a topic to which we return later. Suffice to say in this introductory chapter that the crime scene investigator of tomorrow will require a sound foundation in science allied to practical skills and competencies.

The role of quality systems and accreditation will be a key element in ensuring that appropriate standards are being met and maintained. This aspect is considered later as well.

1.2 What constitutes a crime scene?

Any place could become a crime scene and it is usually a place where a crime or an incident that may end in legal proceedings has occurred, and some of the incidents investigated by crime scene investigators in Australia have been mentioned earlier.

1.2.1 Primary crime scene

The primary crime scene is an area, place or thing where the incident occurred or where the majority or a high concentration of physical evidence will be found, e.g. where there has been a sudden suspicious death.

1.2.2 Secondary crime scene/s

Secondary crime scene/s are places or things where physical evidence relating to the incident may be found. The potential physical evidence will usually be transported away from the primary crime scene.

Some examples include:

- the deceased;
- the get away vehicle in crimes of armed robbery;
- the suspect;
- the suspect's environment;
- the suspect's vehicle; and
- the weapon used in the crime.

1.3 Forensic science

Before commencing a treatise on crime scene investigation it is useful to look at the key words and how the dictionary defines them. The following words are defined in the Macquarie dictionary (Delbridge *et al.*, 1988):

- Forensic – 1. pertaining to, connected with, or used in courts of law or public discussion and debate. 2. adapted or suited to argumentation; argumentative.
- Science – 1.a. the systematic study of man and his environment based on the deductions and inferences which can be made, and the general laws which can be formulated, from reproducible observations and measurements of events and parameters within the universe. b. the knowledge so obtained. 2. systemized knowledge in general. 3. a particular branch of knowledge. 4. skill; proficiency.
- Crime – 1. an act committed or an omission of duty, injurious to the public welfare, for which punishment is prescribed by law, imposed in a judicial proceeding

- usually brought in the name of the state. 2. serious violation of human law: steeped in crime. 3. any offence, especially one of grave character. 4. serious wrongdoing: sin.
- Scene – 1. the place where the action occurs. 2. any view or picture. 3. an incident or situation in real life. 4. an exhibition or outbreak of excited or violent feeling before others.
 - Examination – 1. the act of examining; inspection; inquiry; investigation. 2. the state of being examined. 3. the act or process of testing pupils, candidates, etc. as by questions. 4. the test itself; list of questions asked. 5. the statements, etc. made by one examined. 6. formation interrogation.
 - Investigation – 1. the act or process of investigating. 2. a searching inquiry in order to ascertain facts; a detailed or careful examination.
 - Investigator – 1. one who investigates. 2. a private investigator.

The contemporary view of forensic science is that it is the *application of science to the law*. The subject is further divided into many sub-disciplines; some of those commonly encountered are: criminalistics, forensic biology, fingerprints, forensic ballistics, forensic chemistry, toxicology, drugs of abuse, document examination and crime scene investigation.

You will note from the definitions found in the Macquarie dictionary that the words ‘crime scene examination’ and ‘crime scene investigation’ are interchangeable; however, contemporary use of the word ‘examination’ refers to the identification, recording and collection of obvious potential evidence and the use of the word ‘investigation’ not only refers to the identification, recording and collection of *all* potential evidentiary material but includes the interpretation of the circumstances surrounding the commission of the crime by reconstructing the incident to determine a sequence of events which may reveal a ‘modus operandi’. Investigation also includes the provision of high-level advice regarding other specialty areas of forensic science to investigating police.

Forensic science is based on two major premises. First, crime scene investigators, as forensic scientists, work on the basis of the so-called locard exchange principle. This is considered at length later. Second, in attempting to identify an individual, crime scene investigators work with the notion that in nature no two individuals are identical and as individuals we are all unique. It is in this second premise that the work of the crime scene investigator becomes intermingled with that of the police surgeon and/or forensic pathologist. The individuality of a person as determined by fingerprints is covered at length later, and other forms of identification are covered later in chapters covering forensic dentistry and forensic pathology.

1.4 Physical evidence

The value of physical evidence is measured by its usefulness in:

- verifying that a crime has been committed;
- identifying the person or persons responsible; or
- exonerating anyone who comes under suspicion.

To realise its full potential, the police, the field scientist, the laboratory scientist and the prosecutor must join together to produce a set of facts that make it unreasonable to believe any conclusion other than the one the facts support, even though anyone of the facts may be open to reasonable doubt.

In order to accomplish this important task, there are certain qualities of evidence that must be attained, and some minimum quantities collected before forensic science can be of assistance. It is important to mention at this juncture that, in the majority of cases, the police officers who protect and the crime scene investigators who search the crime scene, play a critical role in determining whether the expertise of the forensic science laboratory will be tasked in a particular case.

In all cases where circumstantial evidence plays a crucial role in identifying the suspect, the identification must come from seemingly unrelated items of information underpinned by supporting physical evidence. Several important concepts bearing on the quality and usefulness of physical evidence must be considered in all such cases.

Physical evidence is tangible and includes all physical things. Items considered, as potential physical evidence may exist in the following forms:

- macroscopic (gross);
- microscopic (minute and hard, if not impossible to see);
- living;
- inanimate (non-living);
- solid;
- liquid; and
- gas.

The crime scene investigator will have to consider the presence of physical evidence, but the absence of physical evidence maybe just as important in relation to the overall case (this is usually the case in verification of what is being stated by witnesses or complained of by complainants).

Physical evidence includes the inter-relationship between each item of physical evidence as they relate to the commission of the offence being investigated. It includes the object in its original state but includes objects, which may have changed during or following the commission of the crime. In summary, anything has the potential to be physical evidence.

1.5 Trace physical evidence

Because trace physical evidence is so small and frequently cannot be seen with the naked eye (i.e. without an eyeglass, microscope or microscope) it is difficult to find. There is less chance that the suspect has deliberately eliminated this form of evidence, as would be the case with larger objects, which might associate him/her with a particular crime scene.

The concept of the transfer of trace physical evidence is based on the work of Edmond Locard and is explored in detail in [Chapter 2](#).

However, to summarise the practical application of the work undertaken by 'Locard' and many since, it has been established from experience and research that the degree of transfer depends on:

- the force or pressure applied when two objects come into contact;
- the brushing or scrubbing action during contact;
- the smoothness or roughness of one or both contact surfaces; and
- the duration the items are in contact.

Research has also established that the likelihood of discovering transferred trace material, which has resulted from contact between two items, will depend on:

- the nature of the surface onto which the material has been transferred (e.g. cotton material will not retain transferred fibres for as long as a woollen garment);
- the elapsed time since the contact; and
- the nature and extent of movement of the object bearing the transferred material (e.g. has the garment been shaken, washed or dry-cleaned, which would increase the loss of surface material).

The methods of detection may not be sensitive enough to demonstrate this, or the decay rate may be so rapid that all evidence of transfer has vanished after a given time, even though a transfer has taken place.

1.6 Class characteristics and similarity

Class characteristics and similarity are those features that group things into a common class requiring further examination to see if there are indicators of similarity which allow screening before a more detailed examination is made. An example would be a shoemark, which exhibits class characteristics and similarities, in that it is the same pattern, size and for the nominated foot, left or right. The pattern may indicate an upper style as well, although today with so many shoes being mass-produced in many countries, many different styles of shoes bear the same pattern/heels.

1.7 Individuality

Individuality or uniqueness are those attributes that make one thing different from all others that are similar to it. The process of identification of any object is one of establishing the fact that it belongs to a large group or class. Determination of identity of an item depends on establishing that it is the only one of its kind within its class.

This subject is covered in more detail in the chapters on physical comparative evidence, fingerprints, forensic pathology and forensic dentistry.

On the other hand, in relation to the identification of persons, fingerprint comparisons and DNA profiles are the most likely to establish the individuality and therefore the identity of a person.

1.8 Value of forensic evidence

Paul Kirk (1953) in the 2nd edition of his book on Crime Investigation edited by Thornton (1974) proposed the following in relation to the value of forensic evidence:

It is factual evidence. Physical evidence cannot be wrong; it cannot perjure itself; it cannot be wholly absent. Only in its interpretation can there be error. Only human failure to find, study and understand it can diminish its value.

It is as true today as it was when Paul Kirk was practising forensic science.
Forensic evidence can:

- prove a crime has been committed;
- establish key elements of a crime;
- be the decisive element in determining guilt or innocence;
- provide the lead to the perpetrator of a crime;
- provide a link in a chain of circumstantial evidence;
- corroborate other evidence; and
- test the statements of complainants, witnesses or suspects.

The absence of physical evidence may also provide useful information.

The aim of a crime scene investigator should be not to overlook anything providing relevant information, which may contribute to solving the crime under investigation.

There are many forms of physical evidence that do not lend themselves to statistical evaluation as there is not the volume of data available that would support an estimate of the frequency in which a particular type of physical evidence might be encountered.

The value of this type of evidence must be estimated on the basis of experience. Even though statistical data is lacking, it is possible to relate the particular observation of an event or item to experience, and therefore form an opinion as to the value of the evidence.

1.9 Scientific approach to a crime scene investigation

A successful crime scene investigation is determined by the results obtained. A crime scene investigator must identify, collect and utilise every piece of physical evidence that may be present whilst realising that valuable evidence could be hidden among a myriad of valueless material. To be a successful field scientist the crime scene investigator must be methodical, logical and thorough and must understand:

- What physical evidence is?
- How to record, collect and preserve it?
- How to obtain from it the information it carries?
- How to interpret the information obtained?

The crime scene investigator who is not left to undertake a slow, methodical and thorough search of the crime scene could fail to conduct a thorough investigation if there is:

- inadequate collection of potential physical evidence at the scene;
- inadequate sample material from the suspect;
- inadequate sample material from the victim;
- too much haste;
- potential evidence is destroyed at the scene by carelessness;
- potential evidence is destroyed intentionally at the scene;
- potential evidence is destroyed by accident at the scene;
- preconceived ideas;
- premature conclusions;
- lack of information flow; and
- lack of communication with other members of the team.

In this respect it is important to consider the additional roles of ‘crime scene manager’ and ‘crime scene coordinator’. I will return to the function of each of these roles in [Chapter 5](#).

1.10 Crime scene investigation as a process

Crime scene investigations are carried out as a process and it is generally accepted that the following seven performance criteria represent crime scene investigation:

1. assessment
2. control
3. examination
4. interpretation
5. recording
6. collection
7. case management.

In both this chapter and Chapter 5 the reader will find all of these criteria covered in-depth. I have not followed the order here as there are a considerable number of issues to cover under each broad heading.

1.11 Assessment

Prior to attending the crime scene it is important to obtain the best possible assessment of the circumstances relating to the crime. It is important to receive a briefing from the senior investigating officer who has been appointed to conduct the investigation. From a forensic viewpoint a crime scene coordinator should be appointed. This person will remain the focal point of contact between all the players who will subsequently become involved in the forensic investigation. This person should be a senior crime scene

investigator who will be responsible for chairing all subsequent meetings with investigating police, who will be responsible for the coordination of all the aspects of the forensic investigation. This includes the application of human resources to multiple scenes.

The more details obtained about what happened, the easier it is to determine what resources are required to examine the scene and the significance which is to be placed on each aspect of the evidence.

I will discuss a homicide as the model crime scene as this is the most serious crime against the person.

Forensic investigators are in the same position as the investigator. They need answers to the same questions posed by investigators: Who? What? When? Where? How? and Why?

Some of the following questions can be answered at the homicide scene. Some will only be answered when investigators talk to witnesses and conduct background enquiries. Some will only be answered at the post-mortem examination. Regardless, information must flow between all those involved.

Who?

- Who is the deceased?
- Who reported finding the deceased?
- Who are the witnesses?
- Who are the suspect/s?

What?

- What happened?
- What crime, if any, has been committed?
- What were the actions of the deceased?
- What were the actions of others involved?
- What are the witnesses saying?
- What injuries, marks, clothing and personal property has been found on the deceased?
- What is the deceased's estimated time of death?
- What possible weapon/s have been used?
- What cause-of-death information can be gleaned from the deceased?
- What was the manner of death?
- What potential physical evidence has been left behind by any person involved in the incident who has since left the scene?
- What areas or items any person involved in the incident has touched?
- What areas or items have been damaged during the incident?

When?

- When was the deceased discovered?
- When was the deceased last seen alive?
- When were police notified?

- When did police arrive at the scene?
- Where could a transfer of material have occurred between:
 - (i) the persons involved in the incident; and
 - (ii) the surroundings and the persons involved and the persons and/or the surroundings to items involved in the incident?

Where?

- Where was the body discovered?
- Where did death occur?
- Where was the deceased last seen?
- Where did the injury or injuries occur?
- Where were the witnesses during the incident?
- Where is the potential physical evidence located?

How?

- How did the deceased get to the death scene?
- How long between injury and death?
- How did the deceased sustain the injuries?

Why?

- Why was the deceased at this location?
- Why did this incident occur?
- Why was this type of weapon used?
- Why did this death occur at the time it occurred?
- Why was the deceased found when s/he was?

The Who? What? When? Where? How? and Why? can be applied to any crime scene. Answers of course will come from a variety of sources, not just the scene. However, as many as possible can and should be answered during the primary and secondary scene investigations. Information flow and communications are vital during this process.

1.12 Examination

After the general survey of the crime scene the sequence in which evidence is to be collected and areas to be searched should be apparent. The collection and search should be systematic to ensure nothing is overlooked.

Priority should be given to:

- Any items which are in danger of being destroyed by wind, rain, vehicles, animals, tides and human movement.
- The collection of any evidence which will enable access to a deceased or any critical area of the crime scene, such as, along entry and exit paths.

- Those critical areas of the crime scene which may render the most evidence, or once processed, enable the removal of a body, or the remainder of the examination to begin.
- Any area, which may give a quick indication as to the identity of any suspect/s.
- Any areas which when processed will permit the release of scene guards and other resources.
- A general examination of the remainder of the crime scene for potential evidence.

1.12.1 Systematic and sequential approach to the search and recovery of potential evidence

In establishing the manner and sequence of collecting potential evidence, consideration must be given to the possible destruction of evidence and which approach will yield the best result in terms of useful information. Consultation with other specialists such as forensic scientists and forensic pathologists as to the sequence and method of collection may be necessary to ensure the best result; however, at the scene this may not always be possible.

Some examples are:

- Macroscopic evidence should be collected from an area before it is powdered for fingerprints.
- Bloodstains and forensic evidence should be collected from an area before searching for fingerprints.
- Sweepings from the floor need to be collected before adding fingerprint powder to the scene.
- Polished floors need to be examined first with oblique lighting to locate latent shoemarks/footprints.
- Visible fibres, hairs and other trace material should be collected from an area before applying general collection techniques, such as tapelifts, sweeping and vacuuming.
- Tapelift areas of interest before removing deceased persons (blood seepage can cause subsequent trace evidence difficulties if left to later).
- Collect sheets and blankets.

In searching critical areas, a search conducted in a clockwise or anti-clockwise direction from a fixed point or conducting a line strip search makes for a systematic examination.

A systematic approach reduces fatigue and ensures a more comprehensive search by minimising chance of losing potentially valuable evidentiary material.

Larger objects should be examined before smaller objects and all items should be packaged and labelled at the time of collection (see [Figure 1.1](#)).

1.13 Recording

The accurate recording of details of a crime scene, incident scene or of any subsequent examination is important for several reasons. It is important for the crime scene



Figure 1.1 The use of a 'cherry picker' to gain a general survey and overview of a death scene prior to commencing a detailed photographic survey and crime scene investigation – Photographer: Horswell

investigator, as it will provide the basis for statements and reports that the crime scene investigator has to compile at a later date. It will also provide investigators with information which they may not otherwise have knowledge of and will assist the court reconstructing the scene providing the most reliable evidence as to the condition of the scene, potential evidential material and their inter-relationships, and finally, may well provide the Court with a facsimile of the crime scene which would not otherwise be available. It will also provide witnesses with the ability to indicate the position of people or things within the crime scene at the time of the incident.

It is fair to say that crime scene investigators can never make too many notes during a scene investigation and they should always be compiled during the course of the examination, not at some time later. However, if it is not possible to do so then details should be recorded as soon as possible afterwards.

There are obvious and very good reasons for compiling contemporaneous and accurate notes:

- Notes made at the time of an examination are likely to be more reliable and accurate than notes made some time later.
- By making notes as s/he is working, the crime scene investigator is less likely to overlook minor details committed to memory.
- An accurate record of times and dates will be maintained. This will avoid discrepancies with the records of other investigators involved in the investigation.
- An accurate record is available for later reference during the investigation and when compiling statements for court.

- When giving evidence in court, the crime scene investigator may be permitted by the court to refresh his/her memory by referring to his/her notes taken during the investigation if these were made contemporaneously to the examination of the crime scene.

Obviously if the notes are made during the conduct of each stage of an examination, then there can be no dispute as to their accuracy.

1.13.1 Photographs

It is not proposed to deal with crime scene photography at all in this chapter except to say that it is an integral part of the crime scene investigation process. The photographic recording of crime scene will be dealt with in detail in a later chapter.

1.13.2 Notes

As mentioned above, it is essential to make notes as the crime scene investigator progresses through an examination, or as soon as possible afterwards. Because of this, the notes may not be in a logical sequence, but this does not matter. The sequence can be re-organised at a later stage, when writing the report or statement.

The main aim of writing notes is to provide an accurate and comprehensive record of events and observations, which will still be meaningful months and even years later. For this reason, it is preferable to write detailed notes at the time rather than attempting to save time by using abbreviations, which, although readily understood when being written, might be insufficient to refresh the crime scene investigator's memory from after several months.

On arrival at a crime scene, the following should be noted:

- date and time of arrival;
- names of persons at the scene on arrival;
- weather conditions;
- lighting conditions at night;
- what has happened – the incident;
- what has taken place – activity since incident;
- officer in charge of the case;
- scene guard;
- assistance provided at the scene; and
- other resources already requested.

The sequence of the crime scene investigator's actions following arrival will vary depending upon the situation with which the crime scene investigator is faced. If there is no requirement to immediately commence a particular examination, it is often advantageous to spend some time studying the crime scene noting all observations. Any movement through the crime scene noting observations can only be done if there is no risk of contamination or damaging possible evidence. There should be a pathway identified, which is used as a common approach path, into and out of the critical areas of the crime scene.

1.13.3 Plans

There are two types of plans, a sketch drawn by the crime scene investigator and a scale plan which an experienced crime scene investigator or a draughtsman can draw. Plans complement written notes and photographs, and are notes of the scene examination as well.

1.13.3.1 Sketch plan

A sketch enables the crime scene investigator to show the location of items and their relationship with other items. A sketch should be drawn for all serious and major crimes.

Although the sketch only needs to be freehand, it must be neat enough for the crime scene investigator or draughtsman to accurately interpret the data at a later date in order to draw a scale drawing.

There are several basic drawing types, which are commonly encountered in sketching crime scenes. The floor-plan view is the most common and is the easiest to complete. It depicts the location looking down from above. This should be used for both indoor and outdoor scenes. The exploded view or cross-projection method is similar to the floor-plan view and differs only in that the walls fold out to reveal items of evidence found on or in the walls. Isometric projection of walls as stand-alone drawings may be used to indicate items of evidence, such as bloodstain patterns found on walls at crime scene exhibiting extreme violence. Three-dimensional drawings, virtual reality and animated computer programs are now being used more and more in crime scene investigation.

1.13.3.2 Method of measuring crime scenes

- Accurately determine North with a compass and place it at the top of the plan.
- Determine what is to be included in the plan and the method of recording.
- Draw a rough sketch on which the measurements will be recorded.
- Work systematically throughout the scene recording dimensions, in the case of a room, and the location of important items within it.
- It is ideal that the person responsible for both the sketch plan and the scale drawing should be the person who records the measurements on the sketch plan.
- Use the progressive system of measurement where possible, for example, corner of room to the nearest point of window 3.0m and 3.5m to the other end of the window frame.
- In order to locate items within a room or open areas use either the coordinate or the triangulation method or a combination of both.
- The position of bodies and important items should be plotted prior to removal or collection, however, the position of 'fixed' objects may be recorded at a subsequent date thus enabling a quicker examination of the scene.
- If objects must be moved prior to plotting then mark their location prior to moving, for example, with chalk, felt marking pen, crayon or spray paint.
- Place the crime scene investigator's name, the case, date, time and location. If anyone assisted his/her name should also be included on the sketch.

The following two methods are suitable for measuring the crime scenes:

1. *Coordinate method.* This method uses the principles of measuring the distance of an object, such as a body, from two fixed points. One form of the coordinate method involves the use of a baseline, which is drawn between two known points. The baseline may also be a wall or drawn as a mathematical centre of a room, the exact dimension of which is known. The measurements of a given item are then taken from left to right along the baseline to a point at right angles to the item which is to be plotted.
2. *Triangulation method.* The triangulation method requires three measurements:
 - base;
 - shortest side of the triangle; and
 - longest side of the triangle.

An established base may be used, for example, the side of a house. Two measurements are then taken from either corner of that side of the house to the item to be plotted. When a crime scene is in an open area such as a beach, paddock or park, the triangulation method is usually employed, however, it is necessary to establish a base. This can be achieved with the aid of a magnetic compass to determine true North.

The use of terrestrial (outdoor scenes) photogrammetry and crime scene photogrammetry is another way of obtaining measurements from scenes. This method is one of the most accurate means of recording measurements at incident scenes. The method has been around now for some 40 years, however, not many police organisations have decided to spend the considerable amount of money required, for not only the camera equipment, but also the plotter that is required to interpret the photographic plates which is also an expensive item. In Australia, the New South Wales Police have such equipment and use it on the more serious or complicated incident scene plan drawing (see Figures 1.2 and 1.3).

1.13.3.3 *Scale plan*

Scale plans are employed to convey accurately by the size, shape and position of important potential evidence and other features of the crime scene. They are a valuable adjunct to scene photographs. Scale plans are also an aid in reviewing a crime scene with investigators.

The use of modern surveying equipment overcomes many of the problems encountered in preparing crime scene plans. Many practitioners are now putting these tools to good effect. See Scale plan 1.1.

1.14 **Collection**

1.14.1 *Quantity*

It is better to collect excess material than to have an examination fail because there is insufficient material for analysis. Where difficulty may be encountered in collecting minute traces of substances, specialist collection techniques should be employed.



Figure 1.2 The use of the terrestrial photogrammetry cameras at the scene of a hit-and-run accident – Photographer: Horswell



Figure 1.3 The use of the crime scene photogrammetry cameras at the scene of a double homicide – Photographer: Royds

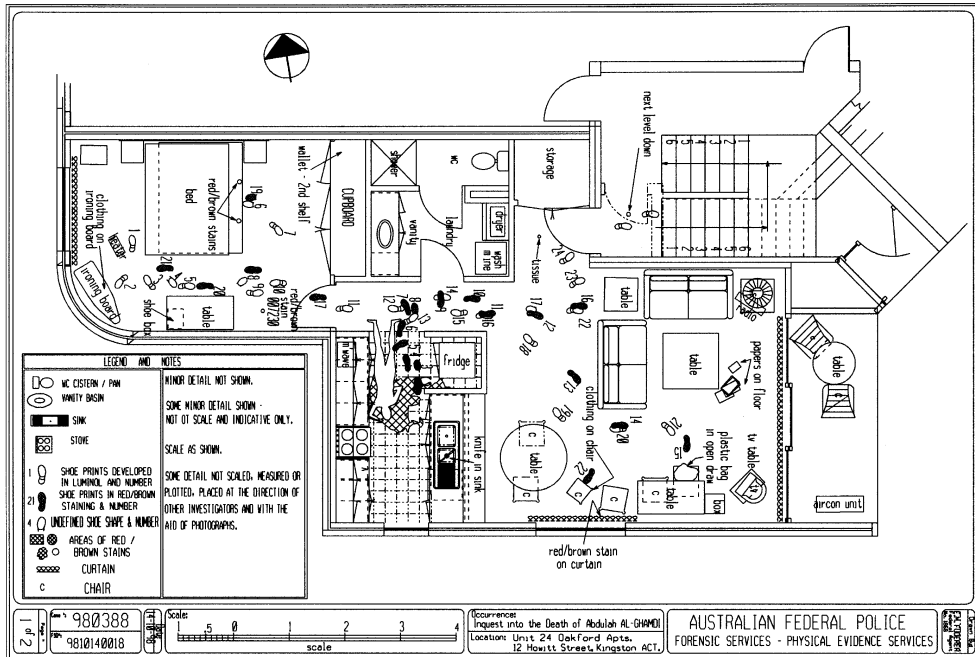

Scale plan 1.1 An example of a homicide scale plan drawing – drawn by Fuderer

However, if traces of evidence are on small items and there is a chance of loss, the trace sub-sample should be recovered and placed into a separate container. If the trace is a stain then the stain should remain on the item for assessment in the forensic science laboratory. This is particularly important where the item as a whole is vitally important. For example, a bloodstained knife.

1.14.2 Controls

In many cases involving stained material, for example, fire debris, it is necessary to submit unstained material for analysis to determine if the material itself interferes with the analytical procedures.

1.14.3 Reference material

In any comparison of the constituents of two substances, there should be sufficient reference samples provided. For example, if dust on clothing is suspected of being filling from a particular safe, a sufficient amount of the safe packing should be collected, packaged and submitted together with the items of clothing in order that a satisfactory comparison may be performed. The reference sample should be representative of the source from which the test sample originated. For example, it is useless attempting to compare a body hair found at the scene with a head hair from the suspect. Similarly,

the comparison of soil from a shoe with soil from the scene may be unsuccessful if the source of the two samples is separated by only a few metres.

The proper collection of items and trace material is essential in obtaining the greatest evidential value from an examination.

Special clothing should be worn during all scene and laboratory examinations. White cotton overalls or laboratory coats should always be worn as white cotton has the least evidential value as a fibre and is therefore suitable in preventing contamination of scenes or clothing with fibres from the examiner's clothing. There is also an occupational health and safety dimension to the use of appropriate clothing in protecting the examiner.

1.14.4 Collection case

Collection cases must be kept clean with equipment stored in an orderly manner. The principal collection items are listed with some of their uses:

- paper bags, envelopes and A4 white paper;
- various sized plastic containers;
- various sized plastic bags;
- compass which is used for the determination of North;
- measuring tape, 30 m cloth, 3 m steel and 2 m steel with separations painted in bold so as to be seen in photographs;
- rulers designed for footwear photographs;
- adhesive scales for inclusion in photographs where holding a rule is difficult or not practical;
- graph paper for rough sketching;
- 500 cm plastic ruler;
- clip board;
- adhesive tape for collection of trace material;
- brushes (paint) of various sizes used for the collection of trace particles such as paint, metals, vegetation and glass in localised and constricted areas;
- cotton (linen) used for the collection of whole blood for a stain card;
- dustpan and broom for sweeping debris from small areas;
- magnet covered in plastic which is used for collection of particles of iron and steel;
- probe used to manipulate small particles such as paint, fibres, residues, oils, greases;
- spatula for the collection of soil samples, whole or partly congealed blood and to mix casting material;
- scalpel for paint smears, visible fibres, vegetation and dried blood;
- swab for small particles which will be caught in the course fibres of the swab and when moistened with distilled water or injection water for the collection of trace blood and other body fluids for DNA PCR;
- tweezers (steel) for collecting trace material such as fibres, hair and vegetation; and
- tweezers (plastic) for items that may be damaged if metal tweezers are used and also employed in the recovery of blood stains using a small piece of moistened white cotton.

1.14.5 *Collection techniques*

A variety of techniques have been developed for the collection of trace material and other potential evidential material. Each technique is designed to prevent damage and contamination to the material.

The main collection techniques are:

- handpicking
- removal of the whole object
- pipetting
- tapelifting
- sweeping
- vacuuming
- swabbing
- scraping
- cutting
- casting.

Each technique is described in detail; however, they are not presented in any order of selection as their use is very much circumstance dependent.

1.14.5.1 *Handpicking*

Whenever examining crime scenes, garments, bodies or other articles, the initial emphasis should be directed toward the collection of gross and macroscopic items. These items can be recovered by hand or by the use of tweezers. Items large enough to see with the naked eye should be collected by handpicking. Materials such as hairs, large paint and glass fragments, and pieces of vegetation should be collected prior to the application of other collection techniques such as tapelifting, sweeping and vacuuming.

Handpicking has the advantage of establishing the position of the material on the item and requires no further time in searching, whereas tapelifts, sweepings and vacuumings have to be further searched to isolate small particulate matter of interest.

When collecting items by hand, consideration should be given to the potential for contamination by perspiration and where applicable gloves should be worn.

Various types of tweezers are available to cope with small particulate matter and a moistened fine hairbrush will recover paint particles.

It is essential that each item of collection equipment be cleaned between individual collections.

1.14.5.2 *Removal of the whole object*

When dealing with items that are large or items that have evidential material deposited on them it may not be appropriate to remove, or the evidence cannot be easily removed, then the whole object should be removed to the forensic science laboratory.

1.14.5.3 *Pipetting*

Pools of liquid can be easily collected by using a disposable pipette. This is particularly useful for fresh liquid body fluids.

1.14.5.4 *Tapelifting*

Tapelifting is a reliable method of collecting trace microscopic material from a variety of surfaces, and in particular garments and motor vehicle seats. Transparent adhesive tape no more than 7 cm in length is applied to the surface of the object. At the completion of the application the tape is placed over a clean piece of glass or rigid plastic and then placed into a clean-labelled plastic bag. Garments and other larger objects should be examined in segments, for example, the front and rear of a shirt as two discreet areas. Too much material should not be placed on one tape and the tape should only be used whilst the adhesive qualities remain.

The collection of material in this manner facilitates the examination of trace evidence using a macroscope and in particular, assists in sorting material of interest from a myriad of other insignificant material. When using adhesive tape from a dispenser the first five centimetres should be discarded to prevent contamination.

The method of tapelifting is used more widely in the forensic science laboratory, however, it does have its uses in the field.

1.14.5.5 *Sweeping*

This method is particularly useful in collecting material from a variety of areas including inaccessible sites or those where there is a mass of material. Sweeping is also a useful collection technique for the examination of motor vehicles where large amounts of debris can be present on the floor surfaces in the cabin or boot.

It is essential that the brush is clean and that separate brushes are used whenever contamination or cross-transfer is a consideration, for example, examining a scene and a suspect's vehicle. New paint brushes approximately 25 mm wide with non-painted handles along with new pans from dust pan and broom sets should be used on each occasion where sweeping is employed.

1.14.5.6 *Vacuuming*

The collection of microscopic material from garments, motor vehicles and other large objects by vacuuming, is another valuable means of collecting trace material. However, the circumstances in which it should be employed need to be considered carefully as the vacuumings collected are difficult to search involving long periods of time in the laboratory searching, usually under a stereoscopic macroscope. Furthermore, vacuuming can be too effective in that it can lead to the collection of a great deal of 'ancient history'.

This method requires a specialised nozzle for the vacuum cleaner. Nozzles are made from customised stainless steel. Plastic demonstration traps have also been employed in the field.

Material is collected by suction on a clean filter paper (stainless steel) or cotton material (plastic), which rests on a perforated plate located in the central compartment.

Some situations may warrant the use of an ordinary vacuum cleaner with a clean bag for collecting trace material, however, this is a last resort, as you could add material to your collection sample from traces, which remain in the vacuum hose if it has not been appropriately cleaned and dried.

When using the stainless steel and plastic traps, care must be taken to ensure that the nozzle, trap and suction end of the traps are cleaned prior to use. The nozzle should be washed in warm soapy water, rinsed with clean water and dried. Bottlebrushes are ideal to clean nozzle pipes.

A blank/control vacuuming should be run prior to the actual sampling run with a clean filter paper in place. This is then removed and bagged separately for later examination. Each sample run must also have a clean piece of filter paper and a new bag as a control and a new bag for the sample run if an ordinary vacuum cleaner is used and a trap nozzle is not available.

Once set-up ready for a sample run, the nozzle is applied to the area. For example, with a garment, in a series of strokes. Each area of the garment will be a discrete search area in its own right, for example, pockets, back and front of garment. Likewise localised regions of an object, vehicle or scene.

When not in use the nozzle should be cleaned and stored in a sealed plastic bag, clean and ready for use (see Figures 1.4 and 1.5).

For field use, the 3M[®] Company have produced what they describe as an International Service Vacuum, which is a small self-contained vacuum cleaning unit. To accompany this unit and for use by crime scene investigators, 3M Electronic Products

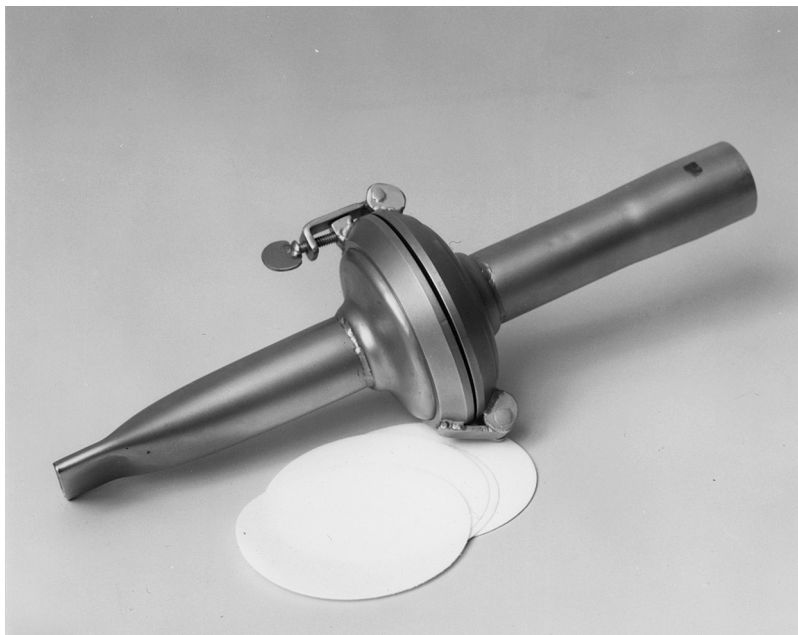

Figure 1.4 The forensic science laboratory stainless steel vacuum nozzle – Photographer: Horswell



Figure 1.5 The forensic science laboratory stainless steel vacuum nozzle opened view depicting debris trap – Photographer: Horswell

Division Law Enforcement Products have manufactured the Trace Evidence Collection Filter. It is a one-time use filter, which satisfies ‘evidence under seal’ and would satisfy an accreditation body’s interpretation of the International Standard ISO 17025.

Instructions for use

1. Open bag by detaching numbered receipt along perforation and retain receipt in the crime scene investigation notes.
2. Remove the clean filter unit from the evidence storage bag. Retain the evidence bag to store filter after evidence is collected.
3. Tamper-proof tape is used to join the filter halves. To ensure the integrity of collected evidence, do not remove the tape before use as removal of the tape seal before the evidence collection voids the filter use.
4. Remove the black end cap and round plug from the filter and retain for future use.
5. Attach the round end of the filter to the hose of the 3M Trace Evidence Collection Vacuum and use for evidence collection.
6. Replace black end cap and round plug to seal the filter and ensure the integrity of the evidence.
7. Record required information on the outside of the evidence bag.
8. Place the filter unit into the evidence storage bag and seal using the self-adhering strip.
9. Transport to the forensic science laboratory with other relevant potential evidence.

1.14.5.7 *Swabbing*

Dry swabs can be employed to collect minute particles. The fibrous nature of the swab end can be effectively used to collect particulate matter. The material can then be separated in the laboratory from the swab onto microscope slides for further microscopic examination.

Swabs moistened with distilled or injection water can be used to collect body fluids. Forensic biologists did prefer body fluids to be collected using cotton threads or small pieces of cotton material. The reason for this is related to the dilution and dispersion of the sample. For early electrophoretic techniques localised concentration was important and therefore the thread type swabbing method was preferred. Now with DNA PCR amplification, the dispersion and dilution of body fluids found on a moistened swab no longer present a problem.

1.14.5.8 *Scraping*

Some samples such as dried blood or paint smears need to be scrapped into a container. This can be achieved using new scalpel blades.

1.14.5.9 *Cutting*

It may be necessary to cut out and remove stained areas from larger items.

1.14.5.10 *Casting*

Particularly with impression footwear marks, and impression and scrape or sliding toolmarks it will be necessary to cast to remove the item and return to the forensic science laboratory.

1.14.6 *Preservation*

Items must be preserved so as they remain, as far as possible, in their original state so that they may be produced in court in the condition in which they were found. In some cases it is not possible to retain the exhibit intact. For example, in analytical procedures, the item may have to be altered or it may be totally consumed in the procedure.

The crime scene investigator should take all necessary steps to protect items collected from the following.

1.14.6.1 *Loss*

Small items such as hairs, fibres and paint flakes may be lost from packages, which are not properly sealed. Envelopes on their own are unsuitable for small samples as the particulate matter may be lost through corners of the envelope. Volatile liquids from fire scenes may evaporate if the containers are not airtight and impermeable.

1.14.6.2 *Deterioration*

Biological material such as wet blood or seminal stains may deteriorate rapidly. The rate of deterioration is usually weather/temperature dependent. 'Hot and wet' climate zones require the urgent identification, recovery and submission of biological material.

1.14.6.3 *Decomposition*

Biological material such as wet blood or seminal stains may decompose if they are stored in plastic for any length of time, therefore *never* consider the storage of wet blood-stained items in plastic.

1.14.6.4 *Damage*

Valuable shoe impressions and bloodstains in outdoor scenes must be protected and collected before wind or any rain that maybe present or approaching destroys them.

1.14.6.5 *Contamination*

Items, which are not properly packaged, may become contaminated by the introduction of foreign matter into the packaging.

1.14.6.6 *Tampering*

Items should be packaged securely and should not be left unattended. The crime scene investigator should guard against innocent tampering as well as that intended to destroy potential evidence. For example, a firearm left unattended with a fired cartridge case in the breech may arrive at the forensic science laboratory with several impressions on the firing pin if the firearm is not packaged appropriately and secured.

1.15 Packaging

The ideal method of collecting and subsequent packing of items for transport to the forensic science laboratory will vary considerably depending on the nature of the item concerned. Likewise the material from which a package is fabricated will also vary considerably.

1.15.1 Paper

Generally, the use of paper in the form of bags of various sizes is recommended. Paper bags are fabricated in various sizes and should be readily available. If using envelopes, an A4 white bond paper should be employed in the first instance for small items such as hairs, fibres, glass or paint. Place the item onto previously folded paper and then place this in an envelope. This will prevent the loss of items from envelope corners and the use of folded paper will simplify the subsequent examination under a microscope.

The placement of clothing and biological material in paper allows the item to breathe. If the item is placed in a plastic bag it could result in bacterial action encouraging the growth of mould. All items should be air-dried prior to packaging in paper.

Items stained extensively with blood or semen recovered from crime scenes should only be, first placed into paper and then protected by a plastic bag. However, the item must be removed from packaging on return to the forensic science laboratory and air-dried.

Items wet with volatile substances should be placed in nylon bags or new clean paint cans. Normal polyethylene bags are not suitable for the retention of volatiles.

1.15.2 *Infested material*

In some instances, material recovered from crime scenes or mortuaries for return to the forensic science laboratory or for long-term storage as property may be infested with pests such as fleas, lice, maggots or coffin beetles. Care must be taken when examining this material by wearing protective clothing and gloves. If possible always use a large open search bench. If insect infestation is present within the item there is at least two methods available to kill them:

- Place the material and container in a large plastic bag and seal it. Place the bag into a deep freeze until the insects are dead.
- Add a few drops of ethyl formate into the plastic bag containing the item and its container. Seal the bag and leave for approximately one hour or until the insects are dead.

Where blood or semen stains are present, samples from stains should be collected prior to freezing.

Consideration should also be given to entomological aspects of the case. Live specimens as well as dead specimens of insects may be required for examination.

Heavily contaminated clothing should be examined quickly. It should be photographed and any potential evidence recovered. Consideration should then be given to its destruction on OH&S grounds.

1.15.3 *Sealing containers*

The sealing of containers is necessary to keep items from being lost, contaminated or tampered with.

The container should be sealed with sealing tape and then with evidence tape. The crime scene investigator/collector should sign the evidence tape. Wax seals and special tamper proof evidence bags are another way of ensuring 'evidence is under seal'.

1.15.4 *Labelling*

The label should be completed at the time of collection or receipt of the item so that the item can be later identified in addition to initiating 'chain of custody'.

The purpose of a label is twofold:

- to identify the nature and source of the item; and
- to establish a chain of custody.

Ideally, a label should have the following information recorded on it:

- nature of contents;
- source (where found or from whom recovered);
- date and time;
- signature and printed surname of collector;
- sequential number; and
- a unique case identifying number.

Additionally, room should be available on the label to record the movement of the item and the label should be completed at the time of collection or receipt of the item.

If the item contained is from a person, use that person's name, for example, Trousers from John SMITH. Do not mark the item with the word 'Suspect' as this may lead to the exhibit being excluded from a trial. Some courts are of the view that to mark items in this way is 'unnecessary' and 'objectionable' because whenever an item is mentioned in evidence during the trial the jury are being told that the accused has been a suspect. This perhaps gives the impression that s/he was a suspect early in the investigation, which need not necessarily be the case. The jury may also wrongly hold the view that there may be more to know about the accused, which could be prejudicial. Obviously the word 'offender' or 'perpetrator' should never be used as this is a presumption of guilt.

The sequential number used should relate to the collectors item list and could be JH1, JH2, JH3, etc.

When making a subsequent examination of the items collected, any material removed should be given a number that relates to the original item. For example a pair of trousers is marked JH1 and hair is recovered from the trousers. This item should be marked JH1.1. In this way each sub-sample can be traced easily back to the original item source.

Where the item is something substantial, for example, a knife or clothing, then the exhibit itself should be marked as well as the container. It may be appropriate to tie a label with a piece of string to the item. If this is done then there can be no doubt about later identifying the item in the witness box, should the item be separated from its container.

If using plastic pots or vials, ensure that there is a corresponding mark on both the lid and the container to avoid any mixing up of the containers. The sequential number and unique case number are normally used for this purpose.

1.15.5 Chain of custody

The chain of custody refers to the documentation of possession of items from their recovery/collection through examinations to their tendering in court as potential items of evidence. This allows interested parties to trace who has had custody of the item at

a given time as well as being able to account for where the item has been whilst it has been in an individual's or organisation's custody.

Proximal containers, and if applicable, items should be labelled with a movement record of the container/item and the case file and/or exhibit movement log should also record the movement of the item.

1.15.6 Hazard labelling

It will be necessary to mark containers with appropriate hazard labels. Those that contain items, which are stained with body fluids, should be marked with a 'Biological Hazard' label and those that contain items that have been treated with chemicals to enhance fingerprints should be marked with a 'Chemical Hazard' label.

This would go some way to encourage court staff to resist the temptation to open all packages and dispense with containers prior to the item being tendered as an exhibit in Court.

1.16 Collection guidelines for potential evidentiary material

Once the crime scene has been thoroughly documented and the locations of the evidence noted, then the collection process can begin. The collection process will usually start with the collection of the most fragile or most easily lost evidence. Special consideration can also be given to any evidence or objects, which need to be moved. Collection should be conducted in a logical manner. Photographs should also continue to be taken if the crime scene investigator is developing latent images or revealing layers of evidence, which were not previously documented because they were invisible or hidden.

Most items of evidence will be collected in paper containers such as packets, envelopes and bags. Liquid items can be transported in non-breakable, leak proof containers. Fire debris evidence is usually collected in airtight, clean metal cans. Only large quantities of dry powder should be collected and stored in plastic bags. Moist or wet evidence (blood, plants, etc.) from a crime scene should be collected in paper bags at the scene and transported back to crime scene unit or forensic science laboratory. Once in a secure location, wet evidence must be removed and allowed to completely air-dry. That evidence can then be repackaged in a new, dry paper container. Under no circumstances should potential evidence be packaged in plastic and under no circumstances should staples be used to secure the bag/s. Remember moisture allows the growth of microorganisms, which can destroy or alter evidence. No more is this evident than in the tropics.

Any items, which may cross contaminate each other, must be packaged separately. The containers should be closed and secured to prevent the mixture of evidence during transportation. Each container should be labelled appropriately.

Each type of evidence has a specific value in an investigation. The value of evidence should be kept in mind by the crime scene investigator when conducting a crime scene investigation. For example, when investigating a crime s/he should spend more time on collecting good fingerprints than trying to find fibres left by a suspect's clothing. The reason is that fingerprints can positively identify a person as having been at the scene of a crime, whereas fibres could have come from anyone wearing clothes made out of the same material. Of course if obvious or numerous fibres are found at the point of entry,

on a victim's body, etc., then they should be collected in case no fingerprints of value are found. It is also wise to collect more evidence at a crime scene than not to collect enough evidence. A crime scene investigator usually only has one go at a crime scene, so s/he should make the most of it.

The following is a breakdown of the types of evidence encountered and how the evidence should be handled.

1.16.1 Bite marks

Bite marks are common in sexual assault cases and can be matched back to the individual who did the biting. Before attempting an examination moisten a piece of cotton with distilled or injection water and clean the surface. Submit to the forensic biology laboratory for trace DNA analysis. Bite marks should be photographed using a scale with normal lighting conditions, side lighting and UV light sources. Colour slide and print film as well as black and white film should be used. The more photographs under a variety of conditions, the better. Older bite marks, which are no longer visible on the skin, may sometimes be visualised and photographed using a UV light source. If the bite mark has left an impression then may be a cast can be made of it. Casts and photographs of the suspect's teeth and may be the victim's teeth will be needed for comparison. For more information see the chapter on Forensic Odontology.

1.16.2 Blood

1.16.2.1 Bloodstain pattern interpretation

In multiple homicide scenes or single homicide scenes involving more than one venue there can be large amounts of a variety of bloodstains. These will need to be interpreted to assist in the determination of the sequence of events and a variety of samples taken as one set of stains or more may belong to the suspect.

To photograph use a large format camera 6×6 cm minimum and photograph stains with both black and white and colour film. Take overview photographs of stains at 90° from each subject and then take close up views including measuring tape.

1.16.2.2 Bloodstains (wet)

Blood that is in liquid pools should be collected as whole blood and also on a piece of sterile cotton linen and allowed to air-dry thoroughly, at room temperature. It should be refrigerated as soon as possible and transported to the forensic science laboratory as quickly as possible. Delays beyond the period of drying stained linen may make the samples useless.

Do not heat stained material or place it in bright sunlight to dry. Hang clothing and similar articles in a drying room where there is adequate ventilation or in a purpose-built drying cabinet.

If not completely dry, label and roll in paper or place in a brown paper bag or box and seal and label container. Place only one item in each container. Do not use plastic containers/bags.

1.16.2.3 *Bloodstains (dry)*

If on clothing wrap the item in clean paper and place the article in a brown paper bag or box and seal and label container. Do not attempt to remove stains from the cloth.

On small solid objects, transport the whole stained object to the forensic science laboratory, after labelling and packaging.

On large solid objects, cover the stained area with clean paper and seal the edges down with tape to prevent loss or contamination. If impractical to deliver the whole object to the laboratory, scrape the stain onto a clean piece of paper, which can be folded and placed in an envelope. Do not scrape directly into evidence envelope. If necessary scrape blood from objects using a new scalpel blade fitted to a scalpel handle. Place each stain in a separate envelope seal and mark the envelope.

Never attempt to wipe dried stains from an object using a moistened cloth or paper.

1.16.2.4 *Blood samples from deceased persons (liquid)*

Request the forensic pathologist to obtain the sample directly from the heart or one of the major arteries and place one sample into a container containing fluoride/oxalate for blood alcohol determination and one in a plain vacuutainer. In rare cases when no liquid blood is available, ask pathologist to collect a section of deep muscle tissue and freeze for typing. Also, make sure that some bloodstained garment worn by the individual has been air-dried to serve as a secondary standard.

Refrigerate and do not freeze liquid blood samples and submit to the forensic biology laboratory as soon as possible.

1.16.2.5 *Blood samples from live individuals (liquid)*

For typing purposes, have sample drawn into vacuutainers and into fluoride/oxalate-seeded container for blood alcohol determination.

If the victim is injured to the extent that a transfusion is necessary, make an effort to obtain or begin the necessary approaches to obtain the pre-transfusion sample collected by the hospital. These samples are not retained for long periods by the hospital, so it is important to act promptly. Also, make sure that some blood-stained garment worn by the individual has been air-dried to serve as a secondary standard.

Refrigerate and do not freeze liquid blood samples and submit to the forensic biology laboratory as soon as possible.

1.16.3 *Burglary cases*

Tools used to gain entry into buildings, safes or other places often contain traces of paint, as well as other substances, such as plastic, safe insulation, etc. Care must be taken that such traces are not lost. If such transfers may be present, wrap the end of the tool containing the material in clean paper and seal with tape to prevent loss. In no case should attempts be made to set the tool into marks or impressions found. If this is done, transfers of paint or material can occur and any traces found later will have no significance as evidence.

Collect specimens of paint from all areas, which the tools may have contacted at the crime scene. These samples should include all layers present. Do not destroy the tool mark in collecting the paint. If possible, cut out around the mark, and send it to the forensic science laboratory.

The tool itself may contain paint or other coatings, tracings of which may be left at the crime scene. A careful search should be made for such matters, particularly in each tool mark. Collect and preserve all paint samples in separate containers.

A piece of A4 white bond can be used to collect and hold many paint samples. A satisfactory method is to tape one edge of the piece of paper to the side of the vehicle, building or safe just under the area where the sample is to be collected. Holding the paper open with one hand, and using a clean scalpel blade scrape paint loose and into the piece of paper. With the sample in the paper, the scotch tape can be removed and the open end of the paper folded several times. It can then be placed in an envelope, which can be marked and sealed.

Never place paint directly into envelopes unless large pieces of paper are enclosed. Most envelopes have unsealed cracks in the corners and loss or contamination can occur.

1.16.4 Cigarette butts

Cigarette butts found at a scene may provide information of one or more smokers. It may provide information as to one or more male and/or female smokers with the presence of lipstick. Fingerprints maybe present and with the advancement of DNA it is worthwhile submitting the butt to the forensic biology laboratory for DNA analysis. Collect individual butts with plastic tweezers, air-dry and package.

1.16.5 Clothing

Clothing maybe important because of its description, the stains present and trace material transfer that may have occurred. Photograph, note and describe. Remove clothing from suspects over clean white paper, air-dry and package. Remove any obvious trace material and package separately. Package clothing in paper bags.

1.16.6 Documents

All questioned documents involved in a particular investigation should be submitted to the laboratory for examination. This is important since questioned documents are identified by a comparison of similarities, plus an absence of divergences or dissimilarities. In order to make an identification, sufficient handwriting, typewriting or other evidence must be available on which to base an opinion. This means that all questioned material is needed, as well as sufficient exemplars or known specimens.

1.16.6.1 Exemplars

It is very important to have sufficient handwriting exemplars for comparison with the questioned document. One or two signatures on a suspect's driver's license, in many cases, do not contain sufficient individual characteristics on which to base a conclusion.

In some instances, such an examination may substantiate a suspicion and this should be considered as an investigational lead. To support this, it is necessary to obtain and examine additional standards.

Collected specimens that were made in business transactions such as receipts, promissory notes, credit and employment applications, letters, booking card and fingerprint form signatures are writings that, in most cases represent the individual's most normal writing. It is significant in many cases that these writings are of the same date as the questioned document. It is important to obtain request specimens from a suspect at the first interview; the suspect may be uncooperative at a later date.

The conditions surrounding the preparation of the questioned document should be duplicated as nearly as possible when the request exemplars are obtained. If yellow lined paper and blue ink were used to produce the questioned document, then the same or similar colour and type of paper and instrument should be used. If the suspect document is a threatening letter and the note is either handwritten or block-lettered, the same style should be requested from the writer. Have subjects write their names and addresses several times and brief personal histories. This should be removed and another sheet of paper furnished. Dictate the exact words and numbers, which appear on the questioned document. This should be done at least twelve times, removing the specimens from the writer's view as they are produced. If it is a check case, the specimens should be taken on blank checks or slips of paper of the same/appropriate size. The number of specimens necessary for identification in any specific case cannot be determined; therefore, at least twelve specimens should be obtained for each questioned document.

When securing typewritten exemplars, several copies of the questioned documents should be made on the suspected machine using light, medium and heavy touches.

At least one copy should be made with the ribbon removed from the machine, or the ribbons set on stencil, and the keys allowed striking directly on a sheet of new carbon paper, which should be inserted on top of the paper used for the specimen. This provides clear-cut exemplars of any machine's typeface, showing disfigurements in type characters. Always type the exemplars on the same type and colour of paper as that used on the questioned document.

1.16.6.2 Preservation of questioned documents

Under no circumstances should either the questioned document or the exemplars be marked, defaced or altered. No new folds should be made, nor should marks or notes be placed on such material.

Whenever possible, all documents should be protected by placing them in a plastic sleeve with an A4 cardboard support.

1.16.6.3 Charred documents

Where examination and decipherment of charred paper is involved, great care must be taken to prevent any additional crumbling or breaking apart of the burned material. Normally it should be placed on top of loose cotton in a box and delivered in person to the laboratory.

1.16.6.4 *Other questioned document evidence*

In addition to handwriting and typewriting comparisons and the decipherment of charred documents, many other examinations can be requested of the laboratory.

These include, but are not limited to:

- restoration or decipherment of altered, obliterated or erased writing;
- comparison of rubber stamps with questioned printing;
- identification of embossed or indented writing or typing;
- comparison of paper and commercially printed material, such as cheques, coupons, receipts and others;
- physical matching have cut or torn paper of various types; and
- identification of ink.

1.16.7 *Drugs of abuse*

The forensic science laboratory handles the analysis of drugs and pharmaceutical preparations, which may be involved in suicides, criminal cases or found in the possession of suspects, involved in various crimes.

Each sample of material recovered should be placed in a paper envelope, which should then be sealed and marked. Be sure to properly seal as loose material, particularly can leak and spill. Drugs that have strong odours or are slowly losing their strength through evaporation should be packaged in nylon bags in order to prevent further decay.

Pharmaceutical preparations found in prescription bottles should be left in these containers, which can be placed in a plastic bag, labelled and sealed. The information on the prescription label may be of assistance to the laboratory.

By means of chemical tests, most controlled substances and common drugs can be identified.

Many pills, tablets, capsules and other pharmaceutical preparations are very difficult to analyse and identify unless either large quantities are available for testing, or some clues are present as to the general type of material they contain. In all cases where prescriptions are involved the doctor's prescriptions may be of assistance. With this information, the laboratory will often be able to determine whether or not the contents of the containers are the same as the material described.

While controlled substances can be identified in routine cases, the forensic science laboratory does not normally attempt to identify all medicinal preparations, which may be encountered in criminal investigations. Unless specific instructions to the contrary are received, such materials are usually tested only for common preparations.

All evidence of this nature should be brought to the forensic science laboratory in sealed containers.

1.16.8 *Fabric, threads and fibres*

Such evidence is often found in fabric abrasions or caught in torn materials or other areas on hit-and-run vehicles. In some burglary cases, it may be found caught in torn screens, broken glass or other locations.

Examination of fibres can normally be conducted to determine the type or colour of fibre. Such examinations will sometimes indicate the type of garment or fabric from which they originated.

Fabric, fibres and threads can also be compared with suspects' clothing to determine whether or not they could have come from this clothing.

If fabric, threads or large fibres are found, they can often be picked up with the fingers and placed in a piece of A4 white bond paper, then in an envelope, which can be sealed and marked. Never place loose fibres directly into a mailing envelope since they can be lost from this type of envelope.

If the fibres are short or few in number, and if it is possible to do so, wrap the area or the entire item containing the fibres in paper and transport the whole exhibit to the laboratory.

Pick up fibres on tape only if the laboratory in your jurisdiction allows it and gives you its requirements. When fibres or threads are recovered, always send all clothing of persons from which they might have originated to the laboratory for comparison purposes.

In sexual offences, assaults and some other cases, it may be possible to indicate or demonstrate contact between two individuals or between one other individual and some other object, such as a car seat, by comparing fibres.

Such examinations are only of value when it is known no contact occurred between the two individuals or an individual and some other object prior to, or subsequent to, the offence. Extra care must be taken to keep each article of clothing of each individual or other object separated. Each garment should lie on a clean sheet of paper, and separately rolled up in the paper. If the clothing of one subject touches the clothing of another, or if it is laid down on the table or placed on the car seat contacted by the clothing of the other suspect, the comparisons may be of no value.

1.16.9 *Fingernails*

Broken fingernails have individual characteristics in the form of striations and these can be matched back to a suspect by comparative macroscopy. A broken fingernail found at a crime scene can be matched to the individual it came from many months after the crime has been committed. Broken fingernails should be placed in a piece of folded A4 white bond and then in a paper envelope. Known samples from both the suspect and victim may be needed for comparison.

1.16.10 *Fingerprints*

Fingerprints, including palm prints and bare footprints, are the best evidence to place an individual at the scene of a crime. Collecting fingerprints at a crime scene requires very few materials, making it ideal from a return-on-investment point of view. All non-movable items at a crime scene should be processed at the scene using grey powder, black powder or black magnetic powder. Photographs should be taken with scale and marker prior to lifting prints. All small transportable items should be packaged in paper bags or envelopes and transported to the laboratory for processing. Collecting prints at the crime scene should be every crime scene investigator's top priority. Fingerprints, palm and/or bare footprints will be required from the suspect as well as eliminations of a like nature will be required from the victim for identification and comparison.

1.16.10.1 Latent fingerprints

All latent fingerprint evidence should be marked in some distinctive manner, such as is the case with any other type of physical evidence. Precautions should be taken, when marking evidence, not to damage or destroy potential latent fingerprints.

Developed latents should be photographed without and then with an identifying mark and scale in order to both demonstrate where the latent was located in addition to being in a position to reproduce it 1:1 to enable an accurate comparison to be made.

Lifted, developed latents should also be marked or sealed in marked envelopes.

The primary precaution in all cases is the prevention of adding fingerprints to evidence, or of destroying those already present.

Most fingerprints submitted will be on paper, glass, metal or other smooth-surfaced objects. When articles containing latents must be picked up, touch as little as possible, and then only in areas least likely to contain identifiable latents, such as rough surfaces.

While gloves may be used to pick up such exhibits, any unnecessary contact should be avoided. Although using a cloth to pick up exhibits prevents leaving additional prints on the articles, the cloth will frequently wipe off or smear any prints originally present, unless great care is taken.

Large articles containing latents such as glass, metal articles and firearms should be placed on wood or heavy cardboard and fastened down with string to prevent shifting and contact with other objects in transit. Where such evidence is to be examined frequently, a pegboard should be obtained on which wooden pegs can be moved as desired to support exhibits and keep them from moving. Bottles and glasses may be placed vertically on a board and placed in the bottom of a box. The base of the bottle or glass can be surrounded with nails to hold it in place, and the top can be either inserted through a hole in a piece of cardboard or held in position with a wooden board nailed to the container's lid.

Papers and documents containing latent prints should be placed individually in a plastic or manila envelope. Such a container can be sandwiched between two sheets of stiff cardboard, wrapped and placed in a large envelope for transportation to the forensic science laboratory.

1.16.11 Firearms evidence

Never submit a loaded firearm to the laboratory. Unfired cartridges may be left in the magazine of a firearm, provided the magazine is removed. A firearm with the cartridge in the chamber should never be shipped by any method, even if the firearm is not cocked or is on safety.

Never clean the bore, chamber or cylinder before submitting a firearm, and never attempt to fire the firearm before it is examined in the forensic science laboratory.

Never pick up a firearm by placing a pencil or other object in the end of the barrel.

Record serial number, make, model and calibre of the firearm, and mark it in some inconspicuous manner before sending it to the laboratory. Marking firearms is important since duplicate serial numbers are sometimes found on different firearms of the same make and general type. Do not confuse model numbers, proofing marks/numbers or patent numbers with serial numbers.

Do not take the firearm apart and place in specific firearms carrying case, a strong cardboard or wooden box, well packed, to prevent movement in transit. If blood,

fingerprints or any other material, which may pertain to an investigation, is present on the firearm, place a clean paper around the firearm and seal it with tape to prevent movement of the firearm and loss of the sample during transportation to the forensic science laboratory.

1.16.11.1 Projectiles

Never mark projectiles. Wrap recovered projectiles in small plastic bags and place in separate rigid plastic containers.

Submit all evidence projectiles recovered to the laboratory. A conclusive identification may be possible on only one of several projectiles recovered even when they all appear to be in good condition.

Do not attempt to clean recovered projectiles before submitting them to the laboratory. Projectiles recovered from a body should be air-dried and wrapped in a small plastic bag and then placed in a rigid plastic container. Washing may destroy trace evidence.

1.16.11.2 Cartridge cases

Wrap recovered cartridge cases in a small plastic bag and then place in a rigid plastic container.

If an examination is required to determine if a shot shell or cartridge case was fired by a specific firearm, submit the firearm along with the fired cartridge cases and all recovered unfired ammunition.

Submit all evidence cartridge cases or shotgun shells recovered to the laboratory as some cases contain more identifying detail than do others.

Wrap each cartridge in a small plastic bag and then place into a rigid plastic container to prevent damaging the breech clock, firing pin or other markings by contact with other cartridge cases.

1.16.11.3 Powder and shot pattern

Submit clothing or other material showing evidence of gunpowder residue or projectile holes to the forensic science laboratory. The clothing should be carefully wrapped in clean paper and folded as little as possible to prevent dislodging powder particles. Photographs of the pattern will not suffice, as in most instances microscopic examination and chemical tests must be conducted on the exhibits themselves. Package each item separately. Infrared or other specialist laboratory photography may be required.

For gunpowder or shot pattern tests to have significance, it is essential to obtain ammunition identical in make, type and age to that used at the crime scene. This duplicate ammunition is necessary for firing in the firearm in question to determine the distance of the muzzle of the weapon from the victim or other object at the time the questioned projectile was fired.

1.16.11.4 Firearms discharge residue

Firearms discharge residue (FDR) is extremely fragile evidence and should be collected as soon as possible (preferably within 3 h of the discharge of firearm). Use the

laboratory-supplied FDR kits and carefully follow the directions. In the case of live subjects, if more than 6h have passed or if the subject has washed his hands, it is unlikely that meaningful results will be obtained. If a deceased person is to be sampled, whenever possible, the FDR collection should be performed prior to moving the body. If this is not possible, protect the hands with paper bags.

1.16.11.5 Serial number restoration

In many cases, obliterated serial numbers can be restored if too much metal has not been removed in erasing the number.

1.16.11.6 Ammunition

Always attempt to recover unused ammunition for comparison purposes when firearms are obtained as evidence. If not in the firearm itself, suspects often have additional ammunition in their cars, clothing, houses or other locations. It may be important for test purposes to duplicate exactly the make, type and age of the ammunition used in the crime. Other ammunition in the suspect's possession may be identical to that fired during the crime.

Unfired ammunition should not be marked. The box with the ammunition may be packaged and marked, and then transported to the forensic science laboratory.

1.16.12 Flammable fluids

The search for flammable fluids in arson cases should include a thorough examination of the entire fire scene. This should extend to areas where no burning occurs, since flammable fluids may have been placed in other locations where ignition failed.

Traces of flammable fluid may be found in cans at the fire scene in arson cases. Mattresses, rugs, upholstery, wallboard and other objects at the scene may also contain fluids, which can be separated and identified in the laboratory, even though these objects are partially burned. Wood upon which such fluids have been poured and ignited may still contain detectable traces of the liquid, if the wood has not been completely charred by the fire. Even where a large and hot fire has occurred, traces of such liquid are sometimes found where they have seeped into the ground through cracks in the floor or flowed under baseboards and sills.

While most flammable fluids commonly used have characteristic odours, some substances commonly available are almost odourless and quite easily escape detection. These include some alcohols, deodorised kerosene, charcoal lighter fluids and others.

If volatile liquids are found in open containers, pour a small amount of the material into a clean glass vial with an airtight seal so no loss will occur.

Do not use any rubber-lined lids or plastic containers.

Small samples of soil, wood, cloth, paper, etc. should be placed in small, clean metal cans and sealed immediately to prevent loss of additional volatile components by evaporation.

Large pieces of wood, upholstery, wallboard and similar exhibits, which will not fit in cans, should be placed in nylon bags. Be sure the forensic science laboratory has examined a sample of the plastic as a blank from each order before you use it.

When the exhibits themselves can be marked, this should be done. In all cases, the package or container should be marked.

Samples of flammable fluids normally present at fire scenes should also be submitted for comparison with any material recovered from partially burned substances.

Samples of flammable fluids in the possession of any suspects should be submitted for comparison purposes. This includes any clothing, rags or other materials, which have suspicious stains or odours. These should be packaged in the same manner as materials recovered at the fire scene. It is possible, in many cases, to isolate flammable fluids from various, partially burned articles through means of gas chromatographic analysis and other studies to determine the type of flammable fluid present.

1.16.13 Fracture matches

Fracture matches can positively link broken pieces at the scene with pieces found in the possession of a suspect. For example, headlight fragments found at the scene of a hit-and-run could be positively matched to a broken headlight (just like putting together a jigsaw puzzle) on a suspect's vehicle. Larger fragments should be placed in paper bags or envelopes. Smaller fragments should be placed in a paper packet and then placed in an envelope.

1.16.14 Glass

Windows are frequently broken in burglaries, headlights in hit-and-run cases and bottles or other objects may break or leave fragments on personal belongings of suspects involved in various types of crimes.

Shoes and clothing of suspects or other objects contaminated with glass should be wrapped in paper and submitted to the laboratory for examination.

All glass found at hit-and-run scenes should be recovered. The search should not be limited to the point of impact, since headlight glass may be dropped off at some distance away as the car leaves the crime scene. Glass from different locations should be kept in different containers. All glass should be collected because more than one type may be present. In addition, if just a few representative samples are saved, individual pieces that could be physically matched with glass remaining in the headlight shell of the suspected vehicle may be overlooked.

Place small glass fragments in plastic bags, and then in rigid plastic containers, pillboxes or film containers, which can be marked and completely sealed.

Place large glass fragments in boxes. Separate individual pieces with plastic bags, cotton or tissue to prevent breakage and damaged edges during shipment. Seal and mark the box containing them. If a broken window is small, send the whole window or all glass remaining to the laboratory. If the window is large, recover several samples from different areas of the window. If the evidence glass is large enough for physically matching the broken edges or comparing the fracture lines, hackle marks, surface abrasions or contamination, the whole broken window is necessary and should be collected.

1.16.14.1 Vehicle glass and headlights

All glass remaining in the shell should be recovered. If it is suspected that a new glass has been installed, this should be removed and a careful examination made for small chips remaining in the shell from the previous lens, which is broken. In such cases, also submit the new lens to the laboratory.

1.16.14.2 Other glass

When bottles or other glass objects are broken, recover all remaining glass. Collect headlights and taillights of motor vehicles as part of the investigation of vehicle accidents as it may be of importance to determine whether or not a headlight or taillight was illuminated at the time the covering envelope was broken.

Recovery of the filaments is of primary importance. These are quite small and their location may require a careful search. If recovered, they should be placed in a small plastic bag and then into a rigid plastic container and sealed with tape. Whether or not the large filaments are located, all remaining parts of the lamp socket, glass envelope or sealed beam headlight unit should be wrapped in paper and saved for further examination in the forensic science laboratory.

1.16.15 Hair

An examination of human hair can occasionally reveal the possible race of the individual from whom it came and the part of the body from which it originated.

Human hair can be compared to determine whether or not two samples could have had a common origin. The value of the forensic science laboratory examination of such specimens will depend upon the amount of hair recovered and the characteristics found in the examinations.

Recover all hair present. If possible, use the gloved fingers or tweezers to pick up hair, place in a piece of A4 white bond paper, which should then be folded and sealed in larger envelopes or paper bag. Label the outer sealed envelope.

If hair is attached, such as in dry blood, or caught in metal or a crack of glass, do not attempt to remove it but rather leave hair intact on the object. If the object is small, mark it, wrap it and seal it in an envelope. If the object is large, wrap the area containing the hair in paper to prevent loss of hairs during shipment.

In sexual assault cases, the victim's pubic region should be combed prior to collecting standards. The recommended method for collecting foreign material from hair is to comb the region using a cotton wool seeded comb. This method will recover foreign hair. Obtain known hair samples from the victim, suspect or any other possible sources for comparison with unknown specimens. This is achieved with cooperative victims and suspects by having them gather hair by plucking them from representative areas. A minimum of 25 hairs is desired. Do not cut the hair. This same method may be used to collect hairs from other parts of the body. When the person is a suspect, hair should be gathered from all parts of the body even though there may only be an interest in hair from the head at that particular time.

1.16.16 Insects

1.16.16.1 Flies

There may be a need to attempt an estimation of time of death and entomology can be of assistance in some instances. There are four (4) stages in the life cycle of a fly: eggs, maggots, pupae and adults (flies). To sample:

- Collect 60–80 individuals from each position, on, under and approximately 90–150cm from the decomposing body.
- Collect from hidden areas, beneath leaves and floorboards.

Place specimens in 70 per cent V/V ethyl alcohol in distilled water in a glass container.

Note: Pupae may be found in the form of brown capsules under the body or in soil under the body.

1.16.16.2 Maggots

Collect two samples, each containing 60–80 individuals. Place one sample with some flesh and the second sample in 70 per cent aqueous ethyl alcohol and/or in formalin in glass containers.

1.16.17 Hit-and-run cases

Paint may be transferred to clothing of pedestrian victims. Examine all areas, with particular attention being paid to areas showing pressure glaze, tears or other contact.

If found, do not remove the paint, but mark the garment, carefully wrap it by rolling it in paper and send it to the forensic science laboratory.

Such paint will at least show the colour of part of the responsible car. It must be remembered, however, that many modern cars have more than one colour and the paint transferred only represents the colour of the particular area on the car that made contact with the victim/s.

Rarely will an examination of paint transfer on clothing indicate the make and model of the vehicle involved, since only portions of the top oxidised layer on the cars are usually transferred. In addition, many vehicles are repainted using colours and types of paint, which may be different from those specified by the automobile manufacturer. The colour and type of paint selected by the car owner for repainting his vehicle may also be the same as that used by a different automobile manufacturer, which could cause confusion in the search for the responsible car.

Sometimes whole chips of paint will be transferred to the clothing. If these flakes contain several layers, and in particular if they come from a repainted car, such evidence may have great value when the responsible vehicle is located. Chips of paint may also be found on the ground near the point of impact in some cases.

Obtain samples for comparison from all areas showing fresh damage on suspected vehicles. This is very important since the paint may be different in type or composition in different areas, even if the colour is the same. If bending the metal slightly can flake off the paint, remove it in this manner. If not, scrape or chip the paint off, using a clean

knife blade. Carefully wipe the blade before collecting each sample. Collect all layers down to the metal. Place each sample in a separate container.

Cross transfers of paint commonly occur in hit-and-run cases of two or more vehicles. If loose paint chips are found, attempt to remove and place them in a rigid plastic container. If, however, the transfers are smeared on the surfaces, flake off chips or scrape paint from the vehicle, including the transferred paint, as well as the top layer of paint originally on the car. Keep all transfers recovered from different areas in separate containers.

When cross transfers occur, always collect contaminated samples from each vehicle from areas immediately adjacent to each transfer collected. This is of great importance, since such specimens permit the laboratory to distinguish between the transferred paint and the paint originally present on the vehicle.

1.16.18 Paint

As mentioned above paint evidence is frequently encountered in hit-and-run cases, on tools used by burglars, and occasionally in other types of cases. If possible collect the item (tool or vehicle) containing the evidence. Collect paint chips separately. Care should be taken not to fragment paint chips. Take reference samples of each colour ensuring they are scraped down to the base colour. Place into a piece of white A4 bond folded paper and then place into an envelope.

1.16.19 Saliva

Collect on a sterile gauze pad or swabs, allow to air-dry and package in paper. Do not use plastic containers. Submit to the forensic biology laboratory as soon as possible.

1.16.20 Seminal stains

Seminal stains are often, but not always, found on clothing, blankets and sheets. Allow any stains to air-dry, wrap in paper and package evidence in paper bags.

For sex offence cases, a physician should always examine the victim. A sexual assault evidence collection kit is used to collect evidence from the victim. It is very important that the instructions on the kit be followed with care in order to gain the greatest benefit from the collected evidence. Please refer to ASTM E 1843 Standard Guide for Sexual Assault Investigations, Examination and Evidence Collection and [Chapter 16](#).

Label all garments such as underpants, panties, or other exhibits and package each garment separately.

If damp, allow fabric to dry completely before packaging.

Handle fabrics with gloved hands as little as possible.

1.16.21 Shoeprints and tyretracks

Shoeprints and tyretracks can be matched positively to a pair of shoes or to tyres in a suspect's possession. Shoeprints and tyretracks can sometimes tell investigators what type of shoes or tyres to look for when searching a suspect's residence or

vehicle/s. Before any attempt is made at collecting shoeprints or tyretracks, one-to-one photographs should be made using a tripod, ruler and level. The flash should be held at about 45 degree angles from the surface containing an impression. Casts can be made of impressions using dental plaster of paris (calcium sulphate). Once hardened, the cast can be packaged in cardboard box and transported to the forensic science laboratory. When photographing prints on hard flat surfaces the flash should be used as side lighting. Shoeprints on hard flat surfaces can also sometimes be lifted like a fingerprint. Dust prints on certain surfaces can be lifted with an electrostatic dust print lifter.

1.16.22 Toolmarks

Toolmarks are encountered most frequently in burglary cases but may also be found in other types of crimes. The evidence consists of striations or impressions left by tools on objects at the crime scene and various types of tools found in the possession of suspects. In other cases, it is possible by means of physical and other comparisons to prove that parts of tools left at crime scenes were broken from damaged tools found in the possession of suspects. In many cases, it is possible to identify the specific tool, which made the questioned marks by means of a laboratory comparison of tools and marked objects. In some instances, it is also possible to prove that objects, which they contacted at crime scene, produced marks of various types on tools.

1.16.22.1 Preservation and packaging of tools

All areas on recovered tools which contain transferred paint, building material or other contamination should be wrapped in paper and packaged to prevent the prying blades or cutting edges from contacting any other surface or object.

Attempts should never be made to fit tools into questioned marks or to make test marks prior to the forensic science laboratory examination. If done, the questioned mark or tool may be altered and this may make any laboratory examination valueless. In addition, traces of transferred paint or other stains on the tool may be lost or additional material may be transferred to the tool.

Whenever possible, submit the whole object containing tool marks to the laboratory instead of just removing the area containing the mark. If this is not possible, carefully photograph and sketch the area containing the mark. Although this photograph will not be sufficient to allow the laboratory to perform a tool mark comparison with the tool, it will assist the laboratory to determine how the mark was made so that test marks can be more easily made.

A person who has had considerable experience in this work can make casts of toolmarks. Poor casts are useless for comparison purposes and some marks will be damaged if improper methods are used.

Pack the object containing tool marks so that no alteration or damage will occur during shipment. Small objects should be wrapped with clean paper and placed in envelopes, while important areas on larger objects can be protected with paper. Whole, large objects can be packed in cardboard cartons for transportation to the forensic science laboratory.

1.17 Crime scene interpretation

I would have to argue strongly that crime scene interpretation is a matter of experience. You cannot expect to interpret crime scenes unless you have had many years of experience and been exposed to the variety of offences and ways of committing offences, which is complemented by education and training, not the other way round. I say this regardless of the training in hypothesis testing and the application of the scientific method that scientists are taught indirectly during their science degree education. It is my unique experiences, not my background in education and training, although I believe this has instilled in me an objective approach to crime scene investigation, which has provided me with crime scene interpretative ability.

Regardless of the type of offence, the crime scene investigator approaches the scene in exactly the same way asking the following questions:

How did the suspect get to and from the scene?

Once known it is here that the crime scene investigator searches for evidence of vehicle, animal, footprints or shoemarks.

How did the suspect get into and leave a contained indoor scene?

The crime scene investigator searches the point of entry and exit of a scene, which is contained in a building or container of some nature looking for signs of forced entry and exit, looking for toolmarks, fingerprints, footprints, shoemarks, the deposition of blood, hair and fibres.

What material has the suspect left or taken from the scene and/or victim?

In looking at the potential for applying Locard's exchange principle crime scene investigators will consider the following:

Environmental

What vegetation, soil or other material is in the area surrounding the scene which may provide useful evidence if the material had transferred onto the suspect during his time at the scene?

In the case of buildings or containers, the crime scene investigator will have to consider, paint, glass, carpet fibres and any other unusual material that may be present within the scene. In particular, factories will contain an infinite amount of exotic materials that would strengthen any evidence of contact if these materials were proved to have transferred from scene to suspect.

What environmental material has been brought to the crime scene and deposited both within the scene and on any victim/s?

Victim

If there is a victim the crime scene investigator will have to consider body fluids, hair and fibres transferred to the suspect during the commission of the offence.

As mentioned earlier in this chapter, time of contact and material make-up along with the type of contact will have a bearing on any material deposited at the scene or on the victim, or taken away from the scene or victim.

The information gleaned from the above objective evidence along with any cause of death, if a victim is involved, will be combined with information gleaned from witnesses and investigating officers which will enable the scene to be interpreted.

Usually it is straightforward to interpret what has happened; it becomes a little more difficult when interpreting scenes involving the spillage of large volumes of blood and scenes of fires and explosions. It is these complex cases that crime scene investigators will not always be able to interpret. There is absolutely nothing wrong with this. You cannot prove hypotheses unless there is evidence to support your formulated hypotheses. There must be objective reproducible evidence to support your findings otherwise your evidence will not be accepted in court.

It is very easy to interpret a crime scene where there is plenty of physical evidence. If there is evidence of forced entry into a contained indoor scene, along with shoemarks on highly polished floors indicating the entry, with further shoemarks heading through and ultimately exiting through a rear door, it is easy to interpret that someone has forced entry onto premises walked through and out through a doorway. It will be the evidence in between the 'entry' and 'exit' that will indicate what the suspect has done whilst he has been on premises. Finding drawers and cupboards open in rooms along with a body located in one of the rooms will make interpretation fairly easy. It is when a building has been burnt to the ground and all available combustible material has been consumed then interpretation becomes difficult. Likewise in a large bombing incident the interpretation becomes difficult and an interpretation may not be able to be made until laboratory examinations have taken place. The PAN AM Flight 102 incident over Lockerbie in Scotland in 1989 is one such case where it took weeks of searching and months of laboratory examinations and analysis to come to any conclusions. This must have been one of the largest crime scene investigations ever undertaken.

So it does not matter if the case is a:

- breaking into and out of premises with intent to commit other offences;
- assault;
- homicide;
- sexual assault;
- vehicle accident;
- fire; or
- explosion.

An appropriately educated, trained, experienced and competent crime scene investigator will always consider and interpret crime scenes so as to obtain as much information to enable an interpretation of the events which have occurred to be made.

It is very rewarding indeed when a crime scene investigator provides evidence of interpretation in a homicide matter to a court of law knowing that there are only two people who know exactly what transpired at the scene, the 'suspect' who may not be talking and the 'victim', who is deceased. Enter a third person, the crime scene investigator who was not present and is able to provide the court with an accurate

interpretation backed up by evidence, this then to me, is the pinnacle of the profession of crime scene investigation.

1.18 Bibliography

- American Society of Testing and Materials (1997) *Standard Guide for Sexual Assault Investigation, Examination, and Evidence Collection E 1843*, ASTM 14.02, pp. 749–51.
- Delbridge, A. *et al.* (eds) (1988) *The Macquarie Dictionary*, 2nd edn, Macquarie University Press, Sydney.
- Kirk, P. L. (1953) *Crime Investigation*, John Wiley & Sons, New York, Chapter 1 Introduction.
- Fisher, B. A. J. (2000) *Techniques of Crime Scene Investigation*, 6th edn, CRC Press.
- Horswell, J. (2000) Major incident scene management, in Siegal *et al.* (eds), *Crime Scene Investigation, Encyclopedia of Forensic Sciences*, Academic Press, London, pp. 428–32.
- Horswell, J. (2000) Packaging, in Siegal *et al.* (eds), *Crime Scene Investigation, Encyclopedia of Forensic Sciences*, Academic Press, London, pp. 432–40.
- Horswell, J. (2000) Recording, in Siegal *et al.* (eds), *Crime Scene Investigation, Encyclopedia of Forensic Sciences*, Academic Press, London, pp. 443–7.
- Horswell, J. (2000) Suspicious deaths, in Siegal *et al.* (eds), *Crime Scene Investigation, Encyclopedia of Forensic Sciences*, Academic Press, London, pp. 462–6.
- Robertson, J. and Roux, C. (2000) Transfer and persistence, in Siegal *et al.* (eds), *Fibres, Encyclopedia of Forensic Sciences*, Academic Press, London, pp. 834–8.
- Roux, C. and Robertson, J. (2000) Significance, in Siegal *et al.* (eds), *Fibres, Encyclopedia of Forensic Sciences*, Academic Press, London, pp. 829–34.

Associative evidence – the Locard exchange principle

John Horswell and Craig Fowler

2.1 Background

The statement *every contact leaves a trace* attributed to Edmond Locard has long served as the foundation to associative evidence. This chapter examines the relevance and accuracy of this statement to modern forensic science. The authors also propose a general classification scheme for all transfer materials and re-examine the criteria relevant in assessing the significance of association by physical materials. The chapter concludes with a general discussion of the concepts of contact or transfer.

2.2 The crime scene

An extremely diverse array of materials may be located or associated with a crime scene. Each may have some potential for providing reliable forensic evidence. In order to maximise realisation of this potential, contemporary forensic science laboratories are staffed by scientists who individually have relatively narrow scientific specialities. As more sophisticated technologies are adopted into forensic science, so are the resources of these specialists greater enmeshed into solving their own technical problems. Consequently much of the forensic literature contains specialist technical information about new or improved methods. It is also common for international forensic conferences to be split into concurrent specialist sessions. For many forensic scientists, such a narrowed environment is not immediately conducive to maintaining a broad critical overview of the potential and limitation of all forensic disciplines.

Achieving and maintaining such an overview is especially important for new graduates of science who obtain employment in forensic science. They are normally employed for their specialist academic education, and in large laboratories are often functionally housed within specialist sections. These new graduates stand a better chance of a

generalist forensic education if they are employed in organisations, which operate as an integrated laboratory providing all forensic disciplines. Historically (Williams, 1980) the structure of forensic science services in Australia was, with some exceptions, fragmented. Today most laboratories are integrated, in that the laboratory-based disciplines are in a single organisation.

The field forensic disciplines are always in a police department, but there has also been a greater integration with the laboratory sciences. In Australia we now have the majority of field and laboratory sciences being managed within a police environment or, at the very least, occupying the same building and therefore being in very close proximity to each other.

Whatever the management model it is generally accepted that maximising the potential for forensic science to contribute to solving crime requires closer cooperation between the field and laboratory sciences.

In Australia we have been fortunate to have the National Institute of Forensic Science (NIFS, 1993) to assist in the coordination and facilitation of forensic science. The National Institute of Forensic Science here in Australia, since its inception, has directed resources towards education and training in the forensic sciences with a focus on field sciences. Now resources are being directed towards the training of established and newly recruited scientists.

In accepting that specialisation is necessary for both technical excellence and progress in forensic science, this will not in itself ensure a functional forensic science service. Individual scientists also require a broad appreciation of both science in general and forensic science in particular. This chapter allows consideration of some essential basic elements of forensic science. It is these elements, which unite specialist scientists as forensic scientists whilst providing the new recruit to forensic science the proper grounding in the academic aspect of associative evidence. More particularly it is hoped the discussion will provide a more reasoned framework of the principles by which associative evidence may be evaluated, than is presently afforded by the statement *every contact leaves a trace*.

2.3 Locard's exchange principle

It is during in-house training programmes, undergraduate and postgraduate education that forensic scientists, and crime scene investigators in particular, obtain their knowledge, and in part, their skills in the application of various scientific disciplines to forensic science. Within the early textual material the student will find a reference to 'Locard's exchange principle'. This has been variously quoted, but most often described as *every contact leaves a trace* (Walls, 1968; Califana and Levkov, 1978).

Edmond Locard (1877–1966) founded the Lyons Police Technical Laboratory in France during 1910. From these modest beginnings Locard later became the founder and director of the Institute of Criminalistics at the University of Lyons. In 1920 he published a book where in Chapter IV, titled *Traces and Stains*, at page 139 he stated:

J' ai longuement insisté sur les empreintes digitales parce qu'elles représentent le cas type de la preuve indiciale susceptible de mener, à elle seule, l'enquête judiciaire à sa fin. Mais il ne faut pas croire que par l'absence de cette trace, l'expert reste

désarmé. La vérité est que nul ne peut agir avec l'intensité que suppose l'action criminelle sans laisser des marques multiples de son passage. Je voudrais faire toucher du doigt l'extrême variété de ces traces, non qu'il puisse s'agir d'écrire ici un traité de l'expertise criminelle, mais dans le but de montrer la souplesse et le polymorphisme de la méthode. Les indices dont je veux montrer ici l'emploi sont de deux ordres: tantôt le malfaiteur a laissé sur les lieux les marques de son passage, tantôt, par une action inverse, il a emporté sur son corps ou sur ses vêtements les indices de son séjour ou de son geste. Laissées ou reçues, ces traces sont de sortes extrêmement diverses.

Translated into English:

I have stressed at length the importance of fingerprints as they represent the typical case of evidential proof susceptible of leading, on its own, the judicial investigation to its conclusion. But it should not be thought that, in the absence of this trace, the expert is disarmed. The truth is that nothing can act with the intensity associated with the criminal action without leaving a multitude of marks of its passage. I wanted to touch on the extensive variety of such traces, not to write a treatise on Criminalistics Investigation but with the aim of showing the flexibility and the polymorphism of the method. The material evidence, its exploitation is what I would like to discuss here, is of two orders: on the one hand, the criminal leaves marks at the crime scene of his passage; on the other hand, by an inverse action, he takes with him, on his body or on his clothing, evidence of his stay or of his deed. Left or received, these traces are of extremely varied types.

It is our view that the key words from which English-speaking authors have drawn the simplification *every contact leaves a trace* is quite plain in a translated version of Locard's (1920a) statement:

on the one hand, the criminal leaves marks at the crime scene of his passage; on the other hand, by inverse action, he takes with him, on his body or on his clothing, evidence of his stay or of his deed. Left or received, these traces are of extremely varied types.

In subsequent work conducted by Locard (1930, 1931–1932), he made no reference to his original work. This may have lead further authors expounding the exchange principle to rely only on the English translations of his work with dust (Locard, 1928, 1930), or merely that there has been a loss in meaning between the translations, originally published in both French and German, and then translated to English (Locard, 1920a,b, 1928, 1931–1932).

Locard took a detailed and dedicated approach to the analysis of dust and debris using microscopy and microchemical techniques; however, there is no comprehensively argued theory about contacts or transfer of evidence. The following statements are however attributed to Locard (1928, 1930):

The more one studies it, the more surprising it is to reflect that we have had to wait until the twentieth century to see such a simple idea applied – the deduction of the

movements and environments of a suspected person from the dust collected on his clothes. For the microscopic dusts which cover our clothes and our bodies are silent yet certain and reliable witnesses of each of our actions and contacts.

and

Yet upon reflection one is astonished that it has been necessary to wait until this late day for so simple an idea to be applied as the collecting, in the dust of garments, of the evidence of the objects rubbed against, and the contacts which a suspected person may have undergone. For the microscope debris that cover our clothes and bodies are the mute witnesses, sure and faithful, of all our movements and of all our encounters.

It is illuminating to follow the way Locard's work and writings have been subsequently recorded in the English forensic literature (Locard, 1928, 1930). There appears to have been some rather crude generalisation purely based on his English translated articles and hence an oversimplification of the concepts involved. For example Nickolls in his book of 1956 makes the following statement:

The basis of this reconstruction and of contact traces was laid down by Locard (1928) who stated that when two objects came into contact there is always a transference of material from each object on to the other.

Such a transference may be large or small, it may be readily detectable or it may be very difficult to detect. Nevertheless it occurs, and it is the business of the scientist to find and prove the transference wherever possible, however small this may be.

A reference to what Locard 'stated' is given, but the article (Locard, 1928) itself does not include such words. Of course we recognise that there may have been something lost in the translation.

Other authors use similar wording but do not quote their sources. Walls (1968) in his book made the statement:

Edmond Locard...laid it down as a guiding principle that *every contact leaves a trace*. Identification of the trace may thus provide evidence of the contact. Sometimes of course this task is beyond the present resources of science, but it is up to the scientist to reduce whenever he can the category of undetectable traces.

The authors of this chapter make sensible qualification by calling it a guiding principle. However other authors of more contemporary texts are much more cavalier in explaining 'Locard's principle'. For example in James *et al.* (1980) they make the following statement:

The one statement that perhaps most clearly epitomises the pursuits of the criminalist is that made by Edmond Locard who said '*every contact leaves a trace*'. Many years ago such a statement was merely a dream, but modern technology now

permits many contacts to be detected, and the future holds the promise of more to come. Certainly every contact leaves a trace; it is up to us to detect it. We hope you find a better appreciation of what a criminalist does, while exciting your ingenuity so that in the future you may well discover how to detect a new contact.

And Eltzeroth and Elzerman (1981) stated the following:

(Professor Edmond Locard, founder and Director, Institute of Criminalistics, University of Lyons, France) As professor Locard correctly stated '*every contact leaves its trace*'. It is practically impossible for an individual(s) to commit a criminal act without leaving some trace and evidence of his deed. Therefore the remaining clues to the criminal commission are to be discovered in physical evidence determinations.

Again no reference is made to the source of such wording. Other authors are more muted in explanation of Locard's contribution, injecting their own understanding. For example Kind and Overman (1972) stated the following:

Another pioneer was Edmond Locard (who) is chiefly remembered for his principle of interchange, formulated in 1910. He was the first man to theorise that when a man commits a crime, he always leaves something at the scene that was not there before, and carries away something that was not on him when he arrived.

And Kirk (1974) stated the following:

Wherever he steps, whatever he touches, whatever he leaves even unconsciously – will serve as silent evidence against him. Not only his fingerprints and his shoeprints, but also his hair, the fibres from his clothes, the glass he breaks, the tool mark he leaves, the paint he scratches, the blood or semen that he deposits or collects – all these and more bear mute witness against him.

Other authors are still more cautious avoiding reference to Locard and avoiding such categorical language as 'always' or 'every' but they don't say why. For example Fox and Cunningham (1973) stated the following:

When two objects come into contact, there will be a transfer of small amounts of material from one to the other. Therefore when a suspect comes into contact with the victim and objects at the crime scene, he leaves behind traces of himself and takes with him traces of the things he touched. Materials transferred in this way are normally referred to as trace evidence.

Though justifiable criticism can be made for quoting these statements out of textual context, they all contain a supposed principle of forensic science derived from Locard's work. Reading his earlier book reference there can be no doubt as to what Locard meant. However, if an author was to rely only on his later two papers then there is good reason to suggest he intended little more than saying *dust on people and their clothing*

is a reliable indicator of that persons actions and environment. Indeed Locard disclaimed any prize when in 1930 he wrote:

One may thus observe that in the study of dust in criminology, opportunities occur for all sorts of applications and discoveries. The main idea, which was embryonic for a long time, has been hatched in many places simultaneously, and no one can frankly attribute its paternity to himself.

This statement may suggest that the concept may go back earlier than his book.

Let us make it very clear that little concern is felt as to who actually formulated *Locard's Principle*. The concern is that such a *principle* in its present form should continue to be received in such an uncritical manner.

2.4 Contact or transfer

There are four areas of concern. The first three are scientific in basis and the fourth relates to how the principle is communicated:

- The use of the word contact is inappropriate.
- The principle is simplistic and a gross generalisation resting on an unproven assumption that every contact does in fact leave a trace.
- The principle is misleading as it incorporates no clear stated time frame over which it may apply.
- The principle in its present form is an inadequate basis to explain the concepts of transfer evidence to jurors and lawyers.

Contact implies the condition of touching. However a source and a receiver surface need not make contact with one another for transference of material to occur between them. For example, if glass from a smashed window is transferred directly to clothing, it need not be achieved by surface contact of garment and window but is often achieved by aerial transference. Evidence for example which drops from the pocket or trouser cuffs onto a receiver bed sheet surface is not by strict definition contact evidence but fibres transferred from the knee resting upon the bed sheet are. An arsonist's hair may be heat damaged, not by contact between hair and flame, but by transference of energy (rather than matter) from the flame to the hair.

Hence although there may have been reasons inherent in Locard's work, which made the use of the word 'contact', its continued use appears to be inappropriate. This is because modern forensic laboratories search for transfer materials, the predominant but not exclusive cause of which being direct contact between surfaces.

An issue related to this is the more modern sub-division of transfer evidence into *trace transfer evidence* or *physical (as distinct from biological) transfer evidence*. These descriptions reflect the differing technologies available for the analysis of such materials. The terms should not be allowed to develop the impression that transfers occur only in small amounts, or in restricted form, as this may narrow the vision of individual scientists in pursuing all available transfer evidence.

In continuing this critique, it would prove unprofitable to tackle the remaining general criticisms directly. Rather a far broader base of enquiry will be pursued. This allows scope for discussion of some general issues concerning the nature and significance of transfer evidence as well as some philosophical issues related to the practice of forensic science. Included in this will be points supportive of the criticisms generalised above and these will be highlighted as they occur.

2.5 Physical evidence categories

In general, physical materials may provide evidence of two different categories, although larger sub-divisions have been described. First they may *indicate* an 'offence' has occurred. This in general requires identification of a physical material. For example, identification of traces of flammable and combustible fuels at a fire scene, identification of alcohol in blood, identification of drugs in body viscera or as an illicit preparation. Second physical materials may associate people with an event. In this regard, the evidence may *implicate* an individual, or *eliminate* others or *corroborate* the evidence of witnesses, complainants and suspects. Corroboration need not necessarily be linked with human evidence. It may also be satisfied by transfers of different types of materials, particularly if this occurs as an 'interchange' or 'two-way' transfer.

Clearly evidence indicating an offence and evidence associating people with an event are complementary in the sense that the second may follow from the first. However, the circumstances of an event are often that an offence of some kind has clearly occurred and therefore there remains only the question of who is associated with the event.

Where should forensic scientists expend their resources to have the best chance of answering these questions and thereby provide useful evidence to the criminal justice system? The major problem is to personalise evidential materials leading to the association of a person (the suspect) with an event. Since the nature of such materials is unlimited, their general classification is helpful. Such a classification scheme should take general account of their potential for personalisation.

2.5.1 Primary material man

Primary material is derived from the naked person. If a suspect moves into and away from a crime scene he may transfer materials which personalise him; for example fingerprints, palm and foot prints and hair. These are derived from an external self. Occasionally a fragment of the person may be transferred.

Primary materials may also be derived from within the person. An individual moving into and away from a crime scene may transfer blood, semen, saliva, tissue bone, their voice or impressions of their teeth. The characters of the internal and external human, which personalise, are in general present by genetic determinate. Though people may dye or lose their hair, replace their teeth or disguise their voice, the most important personalising features, such as fingerprints, blood, tissue, semen and saliva, are all inviolate components of the person's being, unchangeable and unique.

2.5.2 Secondary material man

Secondary material is derived from people who are both clothed and in possession of tools. A suspect moving into and away from a scene may transfer or leave impressions of their clothing, shoes, tools, etc. The person has what may be generally described as immediate possessions, a layer of clothing and chosen utilities, tools, weapons, cars, pens/ink, etc. Crucially important in this distinction is that a suspect with secondary material gains these identifiers by personal choice. The person chooses their immediate possessions/utilities, which s/he may change, discard or disguise thus exercising personal control over them.

2.5.3 Tertiary material man

Tertiary material is derived by considering people in their total environment and examines those contaminants on the surface of the body, the immediate possessions and chosen utilities. A suspect moving into and away from a crime scene may provide some evidence, which personalise them. It may be what the person takes into and leaves at a scene is a hair from a domestic pet which is present on their clothing or paint/weld spatter from his daily working clothes or mud from his/her boots, characteristic of his/her own backyard. It may be in moving away from a scene the person takes with them carpet fibres on their shoes or pollen or industrial waste present as dust at the scene. Whatever, the crucial distinction is, the suspect is there by some adventitious cause and not personal choice. This is because although people may possess (by owning) cats or land, they do not choose to carry fragmented portions of these environments on their person. Nor do they choose to collect carpet fibres or industrial waste from a scene. It happens by accident. Most often, tertiary materials are derived from secondary possessions and utilities. Hence, Locard's forte in associating dust and debris with occupational trades and professions.

Class overlap of materials does occur under these definitions. For example, head hair, dependent on its cosmetic treatment, falls into both primary and secondary material categories. Overlap between secondary and tertiary material depends on the usefulness and immediateness of the suspect's possession. For example, horsehair deposited at a scene by a suspect may be because he works with horses or because he rode a horse to and from the scene. By strict definition such hair assumes either tertiary or secondary identity.

This categorisation of evidentiary materials into those that exist in people, those chosen by the person and those adventitiously present on them, describes the range of materials, which when transferred, may have some potential for identifying the person. It does not describe the reason for any transference. Any transference, which in fact occurs, normally does so unintended by the suspect and is, in general, simply a consequence of the person's actions.

2.6 Discussion

Having defined these categories, what are the implications for forensic scientists and in particular crime scene investigators?

Primary evidence formed of inviolate genetic determinate will provide the shortest and most permanent route to the identification of individuals. Fingerprints are the outstanding practical example. Kirk said of blood and semen:

The criminalist of the future may well be able to identify persons directly from the blood he shed or the semen he deposited.

Kirk would indeed be pleased that what he suggested in 1960 was indeed a reality by 1990 with the advances of DNA technology. Additionally, some primary materials such as hair and teeth are not permanent; however, both become personalised by human intervention and by genetic determinate.

The difference between primary and secondary materials is that a possessive link needs to be established between the materials and their owner, as well as showing transference of part of them. Clearly any linkage rests upon the nature and circumstances of each finding. For example, a boot print may match a boot, but does the boot fit the suspect's foot and was he wearing them at the time of the offence? A paint fracture match between scene and vehicle identifies the vehicle but not the driver; the suspect must be put behind the wheel of the motor vehicle at the time of the offence.

There is an important difference between materials, which are transferred *to* the victim or scene *from* the suspect as opposed to material transferred *from* the scene or the victim *to* the suspect. In the latter case, the suspect can in theory at least remove all evidence of their association with the scene and/or the victim. By discarding, for example, their clothing, and any weapons carrying the blood/hair/fibres of the victim, it might be possible for the suspect to remove all first, secondary and tertiary materials providing evidence of association. However, in the case of material transferred to the victim or the scene by the suspect, the suspect may in theory remove all potential for association by secondary or tertiary materials but not that of primary material. For example, the person can discard their clothing and shoes to eliminate comparison with fibres or prints on the victim or at the scene. The person may discard tyres on his vehicle to eliminate comparison of tyre tracks at a scene. However, only the suspect's suicide and biological degeneration would effectively eliminate comparison with fingerprints, blood or semen, the person left at the scene or on or in the victim. In this regard the potential of primary evidence exceeds that of second or tertiary evidence.

As secondary person chooses their possessions and utilities, they may be reluctant to completely discard them. In addition a sudden absence of these possessions might arouse suspicion. Hence a suspect may attempt to 'clean' their clothing or possessions of primary, secondary and tertiary material e.g. blood, fibres, soil. But even if this 'cleaning' is successful, it still leaves open the possibility of comparing the person's gross possessions with fragments or impressions of these which remain at the scene or on the victim.

Tertiary materials, which are obtained adventitiously, may be lost adventitiously as the suspect has no sense of possession over them. Therefore such evidential material, either being deliberately removed or unintentionally lost, is likely to be quickly replaced with other materials from subsequent environments.

Primary, secondary and tertiary material categories have differing capacities to either indicate an offence has occurred or to associate people with an event.

For example, the shedding of primary materials such as blood and semen is characteristic (though not definitive) of crimes against the person. Such materials may by their

presence and distribution indicate a crime has occurred. They may eliminate or implicate a suspect by their groupings. They may also corroborate a victim's statement of events.

By contrast, the transfer of fibres across fabric surfaces, as such, neither indicates an offence has not occurred nor eliminates suspects. It is however capable of corroborating an allegation of contact and thereby implicating a suspect. However, the transfer of fibres crushed into a vehicle paint surface goes further in indicating the nature of an event. Similarly other secondary materials, by their very nature, powerfully indicate an offence has occurred. Such is the case with traces of explosive or fire accelerants at a scene.

Evidence attained from tertiary materials is generally only corroborative of association. Soil and botanical materials are examples. However, in some cases the reconstruction of the circumstances of an event may be the core purpose of investigation rather than ascertaining whether an offence has occurred or who was responsible. For this purpose tertiary materials such as grass or soil may be as evidentially useful as primary materials such as blood or semen.

Materials, which associate people, serve as a more direct link between them than materials, which only suggest their common presence at a scene. It can always be argued that the people concerned were at the scene but at different times. For example, transfer of primary and secondary materials such as semen or clothing fibres between people is more telling of their association than the common presence on them of tertiary materials such as soil or carpet fibres located at the scene.

The circumstances of each case tend to dictate the level of evidentiary approach required. This is largely determined by the known or admitted relationship of the suspect with either the scene or the victim. Hence all three levels, primary, secondary and tertiary material may be appropriate in a 'stranger-stranger' rape but more than primary material is necessary to corroborate intercourse in, for example, a rape-in-marriage enquiry.

2.7 Conclusion

The principle of associating people and events by examining for the transfer of physical materials between them is valid. However, to express such a principle as simply as '*every contact leaves trace*' may not be desirable. If the principle were to be reformulated, a general examination of the elements, which underpin it, is necessary. One such element is the physical materials themselves. Three criteria for the general classification, based on their source have been proposed. These are those materials existing in man by genetic determinate, those chosen to be possessed and used by him and those adventitiously present on him. A number of implications arise from this particularly with regard to the materials crime scene investigators search for. Although the three level classifications of materials generally assumes a gradation by which they may personalise individuals, it must be stressed that in practice this does not necessarily provide a complementary gradation in the value of evidence obtainable. Materials either singly, or in combination, and arising from any classification level may in the circumstances of any particular case provide information of high evidential value. Therefore the potential of each cannot be ignored. Clearly from the perspective of the crime scene investigator, the important implication is the need to be aware of all possibilities for exchange of materials, physical, chemical or biological, which may later prove to be of practical evidential value.

2.8 Bibliography

- Califana, A. L. and Levkov, J. S. (1978) *Criminalistics for the Law Enforcement Officer*, McGraw-Hill.
- Divall, G. B. (1985) The application of electrophoretic techniques in the field of criminology, *Electrophoresis* (6) pp. 249–58.
- Eltzeroth, R. and Elzerman, T. (1981) *The Crime Scene Technician Manual*, The University of Illinois and Illinois Department of Law Enforcement, p. vii.
- Fox, R. H. and Cunningham, C. L. (1973) *Crime Scene Search and Physical Evidence Handbook*, US Department of Justice, Law Enforcement Assistance Administration, National Institute of Law Enforcement and Criminal Justice, p. 9.
- James, R. E., Meloan, C. E. and Saferstein, R. (1980) *Laboratory Manual for Criminalistics*, Prentice-Hall, p. xv.
- Kind, S. and Overman, M. (1972) *Science Against Crime*, Allidus, p. 23.
- Kirk, P. L. (1960) *Crime Investigation Physical Evidence and the Police Laboratory*, Interscience, p. 13.
- Kirk, P. L. (1974) in Thornton, J. I. (ed.) *Crime Investigation*, 2nd edn, John Wiley & Sons, New York, p. 2.
- Locard, E. (1920a) *The Criminal Investigation and Scientific Methods*, Ernest Flammarion, p. 139.
- Locard, E. (1920b) *L'Enquête criminelle et les Méthodes scientifiques*, Ernest Flammarion translation into English by Chris Lennard.
- Locard, E. (1928) Dust and its analysis an aid to criminal investigation, *Police Journal* (1), p. 177.
- Locard, E. (1930) The analysis of dust traces, *American Journal of Police Sciences* (1), pp. 128, 276–98, 401–18, 496–514.
- Locard, E. (1931–1932) *Traité de Criminalistique, 1-2 Les Empreintes et les Traces dans l'Enquête Criminelle*. Joannès Desvigne et Fils, Lyon, France et 3–4 *Les Preuves de l'Identité*, Joannès Desvigne et Fils, Lyon, France.
- National Institute of Forensic Science (1993) *Corporate Plan 1993–1995*, NIFS Melbourne, Australia.
- Nickolls, L. C. (1956) *The Scientific Investigation of Crime*, Butterworth, p. 39.
- Pounds, C. A. and Smalldon, K. W. (1977) *The Distribution of Glass Fragments in Front of a Broken Window and the Transfer of Fragments to Individuals Standing Nearby*, Central Research Establishment Research Paper (207).
- Svensson, A., Wendel, O. and Fisher, B. A. J. (1981) *Techniques of Crime Scene Investigation*, Elsevier, pp. 2–5.
- Walls, H. J. (1968) *Forensic Science*, Sweet and Maxwell, p. 11.
- Williams, J. (1980) *Australian Royal Commission into Drugs*, Australian Government Publishing Service, pp. C309–37.

The education and training of crime scene investigators: an Australian perspective

Suzanne Stanley and John Horswell

3.1 Introduction

The proper processing of a crime scene is the lynchpin of successful forensic investigations. The skills, knowledge and attitudes of crime scene investigators comprise both the strength and the potential weakness of an investigation. No matter how rigorous later laboratory analyses are, they are worthless if the evidence collected at the scene does not include samples of sufficient size, both for all the required analyses and to represent the natural variation that exists, if control and reference samples are not taken, or if the packaging, labelling and storage are inappropriate. Given that forensic investigation has evolved very rapidly in recent times and become more closely based in scientific concepts (for example, increasing miniaturisation and hence portability of equipment suggests that some biological and chemical analyses will be conducted at the crime scene within the foreseeable future), it is important to evaluate the education and training provided to crime scene investigators.

Australia provides an appropriate context in which to examine and evaluate a range of training options for crime scene investigators. There are eight police jurisdictions with a variety of approaches. Furthermore, there has been considerable focus on the reform of training in this area since the mid-1980s. One of the stimuli was the introduction of formal training for police recruits. Other stimuli included a series of Royal Commissions of Enquiry into forensic and general police investigative practices (Shannon, 1984; Morling, 1987; Wood, 1997). The Shannon and Morling Commissions strongly criticised the forensic practices used, which demonstrated weaknesses in both the understanding of scientific concepts and the use of scientific methodology. A major recommendation was for improved training for all aspects of forensic investigation. The Wood Royal Commission went further and recommended formal training and assessment of all police by independent tertiary education and training providers. Similar criticisms and recommendations have been made in other countries. For

example, the Kaufman Commission of Proceedings involving Guy Paul Morin (2000) in Canada recommended improved forensic science training for all levels of the justice system.

Historically crime scene investigation has been provided by police departments and their training grew out of traditional police training systems. It was largely informal with a short face-to-face introductory training period, together with an apprentice type system of on the job training using a buddy system. Access to this field was limited to sworn police officers. In recent years however, there has been a move toward both the formalisation of training for crime scene investigators and the civilianisation of the role. A variety of approaches have been adopted, reflecting a diversity of attitudes and resources in Australian jurisdictions. Nevertheless, some of the Australian approaches have been praised internationally and an analysis of the issues and outcomes may help other jurisdictions in developing a training framework for their crime scene investigators.

3.2 Diploma of forensic investigation

Formal customised training for crime scene investigators was introduced in Australia and officially adopted by police services during the early 1990s. Prior to this, interested individuals within forensic services typically undertook certificate level training, for example the Science Technician's Certificate and Police Studies Certificate in South Australia between 1968 and 1981, and the Forensic Science Certificate in the Northern Territory between 1981 and 1984 (Horswell and Petterd, 1989).

The Australian Federal Police diploma programme (Canberra Institute of Technology, 1992), developed, delivered and assessed in collaboration with the Canberra Institute of Technology, was the first of its kind in Australia, implemented in 1990 (Horswell, 1995). The New South Wales Police adopted a similar programme for its crime scene investigators in 1993 (Canberra Institute of Technology, 1993).

These programmes were considered successful (Ord, 1994) and with the formation of the National Institute of Forensic Science, the concept of a national approach was adopted. The National Institute commissioned a survey on the status of education and training in forensic sciences (Gaffy, 1993). The results of this survey overwhelmingly found that there was a need throughout Australia for specialist forensic science training. The following statement prefixes the recommendations in that report:

The following recommendations are made . . . in the hope that all administrators of those police services will see that with the development of national common core curricula, the first step only has been taken and that the opportunity for a truly national standard of training will be available for the first time in this country
(Gaffy, 1993)

All Australian police jurisdictions cooperated to develop a national curriculum in forensic science (Australian National Training Authority, 1995). The project began with the development of a profile that defined the role of investigators in each speciality and identified the competencies and underpinning knowledge and skills that were required (Brightman and Wardrop, 1993). Curricula for five specialisations were developed:

crime scene investigation, fingerprint identification, document examination, fire and explosion scene investigation, and firearms and toolmarks identification. Learning and teaching resources were also developed for many of the modules.

Approximately fifty per cent of the programmes consisted of underpinning knowledge and skills in science (chemistry, physics, biology, human anatomy and physiology), mathematics, statistics, computing and communications. The discipline-specific components for the crime scene specialisation included crime scene investigation and management, forensic photography, physical comparison evidence, legal studies and courtroom presentation skills, as well as forensic science and forensic medicine. Differences between states in terms of the competencies required were addressed by providing elective modules (Table 3.1).

The aims of these diploma programmes included the provision of graduates with the necessary knowledge, technical skills and attitudes to effectively manage and investigate a crime scene and implement quality assurance measures. They also aimed to develop a level of scientific awareness sufficient to enable them to communicate effectively with scientific or other experts, and present forensic evidence competently to courts of law (Australian National Training Authority, 1995).

The previous educational and training history of participants was considered in developing the approach and delivery strategy for the diploma, to ensure prior learning (and knowledge and skills gaps) was recognised, along with equity of access to the programme for learners. Most of the learners at the time were sworn officers with a variable and often, minimal understanding of scientific concepts (Horswell, 1995). Opportunities for bridging studies in mathematics and chemistry were provided. Science teachers were also given opportunities to work and study with forensic practitioners to ensure forensic applications of the science were recognised. Modules addressing scientific and mathematical concepts were then contextualised to forensic applications and interwoven with the learning of forensic discipline skills. This was done to ensure the participants learnt the necessary forensic skills in a timely manner and did not become bogged down in more abstract concepts. Later, this was modified further so that new recruits to forensic investigation received a short training course in essential basic skills to make them work-ready (e.g. photography, basic crime scene investigation) before they embarked on the diploma programme.

Given that most crime scene investigators worked shifts and were widely dispersed throughout Australia and within individual jurisdictions (States and the Northern Territory), it was often not feasible to have face-to-face classes. Distance learning resources were developed to reduce work disruption and facilitate equity of access to training. The distance learning was usually combined with short workshops to develop practical skills.

Despite the recognised high quality of the national diploma programme, only the crime scene investigation and fingerprint identification specialisations have been implemented to date. Furthermore, despite in principle support from all Australian jurisdictions for the national forensic diploma programme, it was only officially adopted by the Australian Federal Police, the New South Wales and Victoria Police, although individuals from other jurisdictions did enrol at their own initiative and expense. Western Australia and South Australia adopted a certificate level programme that did not include the science and maths components. There are several possible

Table 3.1 Modules in the National Diploma of Forensic Investigation (Crime Scene Investigation) (Australian National Training Authority, 1995). The Diploma was approximately 1400 nominal hours long, comprising 820 nominal hours of modules common to all five specialisations, and the balance in crime scene discipline core modules and electives. Additional electives were used by some states, e.g. Fire Investigation for New South Wales

Diploma of forensic investigation – common core modules

Module code	Common core modules	Nominal hours	Module code	Common core modules	Nominal hours
ABD206	Introduction to crime scene investigation	30	AAA750	Introductory chemistry	50
ABD207	Introduction to forensic investigation	40	AAA641	Laboratory mathematics	50
ABD200	Basic photography	50	AAB258	Introductory statistics	60
ABD203	Forensic photography	50	AAA632	Scientific database applications	25
ABD208	Legal studies	20	AAA631	Scientific spreadsheet applications	25
ABD201	Court presentation of evidence	70	NCS011	Client interaction	20
ABD202	Forensic biology	50	NCS005	Dealing with conflict	20
ABD204	Forensic physics	50	NCS015	Presenting reports	20
ABD205	Human anatomy and physiology	50	ABD209	Research skills	40
			AAA604	Practical project	100
				Total	820

Discipline core modules – crime scene investigation

Module code	Common core modules	Nominal hours	Module code	Common core modules	Nominal hours
ABD222	Crime scene investigation	70	ABD228	Forensic microscopy	20
ABD223	Crime scene management	50	ABD229	Forensic science	70
ABD227	Forensic medicine	60	ABD231	Physical comparisons	40
				Total	310

Elective modules – crime scene investigation

Module code	Common core modules	Nominal hours	Module code	Common core modules	Nominal hours
AAB257	Applied trigonometry	18	ABD232	Post blast examination	
ABD220	Bloodstain evidence	50	AAB259	Regression and analysis of variance	
ABD221	Clandestine laboratories	20	ABD234	Restoration techniques	
ABD239	Drug investigation	40	ABD236	Toolmark examination	
ABD224	Fingerprint science	70	ABD237	Vehicle identification	
ABD226	Footwear and tyre mark evidence	60	ABD238	Video	
ABD230	Forensic photogrammetry	70			

explanations for the limited implementation of the programme, the major one being financial limitations. Forensic services groups found it difficult to obtain funding from the police budget for the long training programme (four years part time). Another reason may have been the conflicting priorities in some jurisdictions for their sworn officers to complete a Diploma of Policing or similar police management studies, the completion of which was an expectation of the parent police organisation for promotion to higher ranks/levels. Unfortunately, little has been done in Australian jurisdictions to stream qualifications to allow parallel promotion for achievement of forensic qualifications similar to that pertaining to general policing qualifications.

3.3 Degree level education and training

Today, there is a growing trend towards both university-based recruit education and 'civilianisation' of forensic investigation. Many universities began to offer forensic science in their programmes during the 1990s, largely as attractors to increase enrolments. Senior forensic science practitioners lectured on the programmes and were impressed with the quality of the students to the extent that they began to advocate the employment of graduates as crime scene investigators. Entry into the Australian Federal Police and New South Wales Police Forensic Services now generally requires a degree qualification for unsworn staff. This requirement will inevitably extend to sworn officers if they are to have credibility in the courts.

Many tertiary education institutions throughout the world offer courses in Forensic Science. Within Australia, five institutions offer undergraduate degrees in Forensic Science – the University of Technology in Sydney, Canberra Institute of Technology and the University of Canberra, Flinders University in South Australia and Deakin University in Victoria. The Canberra Institute of Technology degree focuses on the field aspects of forensic investigation (i.e. crime scene investigation), although their students also have a strong background in a broad range of sciences. Although the other degrees focus more strongly on the laboratory-based sciences, graduates from these degrees also adapt well to crime scene investigation. Several other Australian universities also offer specialised forensic science units in undergraduate degrees.

Regardless of the reasons for universities offering forensic science programmes, they have provided the forensic science community with the opportunity to choose graduates with both a strong scientific background and forensic knowledge and skills that make such recruits work-ready more quickly. This provides both a financial and human resource incentive; by employing science graduates, considerable savings are made because the service does not have to pay for the science component of their education and training. Given that science graduates have most, if not all of the necessary underpinning knowledge and skills in science, maths and computing, training of recruits need only focus on their forensic applications and on jurisdiction-specific processes and procedures. Furthermore, the development of forensic programmes in university environments benefits forensic science by promoting research into forensic applications of scientific and technological innovations (Sensabaugh, 1998).

3.4 Competency-based training and assessment

In response to the training reform agenda of the 1990s, national competency standards and qualifications have been developed for forensic investigators within the public safety industry (Public Safety Industry Training Advisory Board, 2000). As with the original Diploma of Forensic Investigation, forensic industry representatives determined the competencies required and these were translated into a diploma level training package (Table 3.2). This movement towards training to meet nationally agreed minimum standards for forensic support is being paralleled in several countries (e.g. Blakey, 2000).

A criticism of the public safety training package for forensic investigation (and indeed for many training packages) is the lack of balance between education and training. Each competency specifies required underpinning knowledge and skills, but these are narrowly discipline-based and largely ignore basic scientific and mathematical knowledge and skills. This focus ignores the increasing dependence of problem solving in forensic investigation upon the understanding of scientific and mathematical concepts. A possible consequence of the emphasis on training relative to education is that basic scientific skills related to the scientific method and hypothesis testing will not be explicitly addressed (Caddy, 2000).

In practice, the Australian Federal Police, New South Wales and Victoria Police Services have continued their commitment to a strong scientific background for their crime scene investigators, and require them to study basic science at either diploma or degree level. If other jurisdictions interpret the training package narrowly and do not develop scientific concepts in their investigators, there will be a question as to the transferability of the Diploma of Public Safety (Forensic Investigation) qualification among jurisdictions. However, this seems to be increasingly unlikely, with South Australia and Western Australia now committed to the underpinning knowledge and skills contained within the original Diploma of Forensic Investigation curriculum.

Table 3.2 Diploma of Public Safety (Forensic Investigation) PUA50300. There are ten competency units within the qualification

Code	Units of competency
PUAFOR001A	Use and maintain forensic equipment
PUAFOR003A	Detect, record and collect physical evidence
PUAFOR002A	Maintain a safe forensic working environment
PUAFOR004A	Evaluate and document cases and facilitate analyses
PUAFOR005A	Prepare and submit forensic documentation
PUAFOR006A	Contribute to and comply with quality systems
PUAFOR008A	Process and interpret comparative evidence
PUAFOR010A	Evaluate items and conduct laboratory examinations analyses
PUALAW003A	Give evidence in a judicial or quasi-judicial setting
PUAMAN002A	Administer workgroup resources
PUATEA002A	Work autonomously

3.5 Postgraduate forensic education and training

Graduate level competencies have also been included in the Public Safety Training Package (Table 3.3). This package places a strong emphasis on management-related competencies that are appropriate to senior investigators with several years experience. However, there is a strong argument for a graduate qualification in forensic investigation for new forensic practitioners and for science graduates seeking to enter the industry. While there is a place for management units in such a graduate qualification, the development of forensic investigation and courtroom presentation skills and knowledge is more important for people seeking entry to the forensic industry. Consequently, we believe there is a case for postgraduate programmes and qualifications that only partly address the competencies listed in Table 3.3, in favour of content and outcomes relevant to new practitioners.

Griffith University in Queensland was the first to offer a graduate diploma and higher degrees in forensic investigation in Australia, in response to the decision by the Queensland Police Service to hire science graduates in its scientific section and provide them with education and training in forensic applications. Since then the University of Western Australia and La Trobe University have introduced postgraduate qualifications for crime scene investigators, and other educational institutions are considering similar moves.

Table 3.3 Core and elective units of competency in the graduate qualification in forensic investigation

Code	Units of competency – core
PUAFOR007A	Assess, control and examine incident scenes
PUAFOR013A	Conduct complex laboratory analyses or examinations
PUAFOR009A	Develop and maintain forensic discipline expertise
PUAFOR011A	Manage complex forensic investigations
PUAFOR012A	Coordinate multidiscipline forensic investigations
PUAPOL018A	Control and monitor service delivery
PUAMAN005A	Manage projects
PUAMAN006A	Manage and facilitate change
<i>Elective units of competency (five required)</i>	
PUAOPE004A	Conduct briefings/debriefings
PUAMAN007A	Manage financial resources
PUAMAN008A	Manage physical resources
PUAPOL013A	Create, maintain and enhance productive working relationships
PUAPOL014A	Manage performance/behavioural issues
PUAPOL015A	Manage operations
PUAPOL016A	Manage risk
PUAPOL017A	Plan and develop strategies to support organisational policy
PUAPOL027A	Manage information within specialised policing functions
PUATEA003A	Lead, manage and develop teams

3.6 Training for investigators of volume crime

There is a trend in some Australian jurisdictions, such as Queensland, South Australia and New South Wales, to divide crime scene investigators into two groups: scientific officers or senior investigators who possess a relevant diploma or degree qualification to investigate major and/or serious crime, and scenes of crime officers, who are primarily involved with the investigation of volume crime. Training of scenes of crime officers is generally limited to short courses in crime scene investigation, photography, fingerprint gathering, legal studies and court presentation skills. However, most of the scenes of crime officers recently recruited into the NSW Police Service have science or forensic science degrees and are unsworn members. Such trends reinforce the value placed on a general scientific education, both because of the knowledge and skills of recruits and the reduction in training costs. Science graduates are also more likely to be able to progress from scenes of crime officers to senior forensic investigators.

3.7 Crime scene investigator training in the AFP

The Australian Federal Police has a policy (since 1999) of employing only science graduates (and most are unsworn or civilians), who therefore have underpinning scientific knowledge, skills and attitudes. Their training has a dual focus – on the one hand to ensure that all forensic investigators (both laboratory- and field-based practitioners) understand and have basic skills in all areas of forensic services, and on the other hand, to develop appropriate specialist skills within each area.

Unsworn graduate recruits to Australian Federal Police Forensic Services receive an initial five-week training in basic crime scene investigation, photography, fingerprint examination, fire arms identification and safety testing, and drug investigation, as well as an overview of criminalistics and forensic biology. Many jurisdictions have a similar content for their forensic recruit training, although the drug investigation module is specific to the Australian Federal Police, which is responsible for investigations into the importation of illicit drugs into Australia. As a consequence of this general training, all forensic members are aware of the capabilities and limitations of each discipline and are able to contribute effectively to team-based investigations.

Trainees are posted to the workplace after the initial block of training but undergo further knowledge and skills development through a mix of distance and face-to-face learning over a period of approximately twelve months. This includes training in specialist photographic techniques, rules of evidence and courtroom presentation skills, as well as advanced techniques of crime scene investigation, physical evidence comparisons and drug investigation. Trainees are assessed on their knowledge, skills and attitudes through a mix of tests and assignments which measure the understanding of theoretical concepts, and on-the-job assessments of their competency in regard to practical skills and attitudes.

Specialist training in crime scene investigation and the examination of associated physical evidence is provided by a combination of experts within Forensic Services and from other police jurisdictions, tertiary institutions and private industry. Because the Australian forensic community is relatively small, specialist training is often facilitated through the National Institute of Forensic Science and the Specialist Advisory Groups

of the Senior Managers of Australian and New Zealand Forensic Laboratories. Specialist instructors teach groups from all Australian jurisdictions, thus facilitating the development of partnerships. Crime scene investigators specialise in aspects of crime scene investigation, including the investigation of fires and explosions and drug importations, as well as in types of physical evidence, including drug identification, shoeprints, tyreprints, firearms and toolmarks.

However, discipline-specific skill development is only one component of the training and education provided to forensic investigators. They must also be able to work in and lead teams, manage projects and communicate their findings to colleagues and courts of law. All scientific officers are trained in the management of forensic investigations, to promote an integrated multidisciplinary approach and ensure appropriate use of technology, prioritisation and sequencing of analyses.

Ongoing training in specialist forensic investigative techniques continues over time through a mix of distance and face-to-face learning.

3.8 Forensic awareness training

The report *Under the Microscope* by Her Majesty's Inspectorate of Constabulary (HMIC, Blakey, 2000) indicated a lack of forensic awareness amongst operational police officers in England, Wales and Northern Ireland. The effective use of forensic support relies not on it being used more often, but on it being used appropriately. Given that forensic support is a finite resource, and the consequent need for screening policies to avoid forensic attendance at non-productive scenes, it is essential that the first responders and investigators are aware of forensic capabilities in regard to both traditional technologies and recent advances in the analysis of physical evidence.

The effective use of forensic support relies not on it being used more often, but on it being used more appropriately. Recurrent forensic awareness training for investigators will promote an integrated approach to criminal investigation and will improve decision-making in regard to the need for specialist staff to be deployed to a scene (Blakey, 2000; Millen, 2000). The HMIC report recommends forensic awareness training, appropriate to their roles, be given to all police during initial training, during training for specialist roles, during managerial and supervisory training and as part of general refresher training.

3.9 Conclusion

Crime scene investigators have always had a role to play and the popular perception that they only provide technical support to laboratory analysts is short-sighted. Crime scene investigators require strong technical backgrounds to undertake the technical requirements of scene recording and evidence identification and visualisation. They require a strong understanding of the 'scientific' method (hypothesis testing and objectivity) and they require the ability to interpret the inter-relationships among physical evidence types and how they can be applied to scene interpretation.

Both 'laboratory' and 'field' groups should have equal status in a team that contributes to a holistic investigation and interpretation of an incident. Equal status will be facilitated if

crime scene investigators have the knowledge, professional skills and attitudes equivalent to a degree qualification. The trend towards employing unsworn or civilian members, as crime scene investigators of both volume and serious crime in Australia will be accompanied by a corresponding increase in the employment of science graduates in this area. A degree level qualification will also ensure that forensic investigators are able to approach their work from a perspective of scientific inquiry and ethical judgement and with scientific knowledge and skills. Graduates with forensic science degrees will be in high demand. While forensic services groups around Australia may only employ relatively few of these graduates, such programmes should be supported because the graduates should be work-ready more quickly, and discipline- and jurisdiction-specific training will be more cost-effective. Their skills will also be transportable to other investigational-type work that requires an inquiring mind.

3.10 Bibliography

- Australian National Training Authority (1995) *ACTRAC National Curriculum Project: Crime Scene Investigation*, Volumes 1 and 2, ANTA, Australia.
- Blakey, D. (2000) *Under the Microscope: Thematic Inspection Report on Scientific and Technical Support*, Her Majesty's Inspectorate of Constabulary, UK.
- Brightman, R. and Wardrop, J. (1993) *ACTRAC National Forensic Project: Skills Validation for Police Forensic Sciences Report to ACTRAC on Phase A of the National Forensic Project*, ANTA 1993.
- Caddy, B. (2000) Education and training the forensic practitioner for the new millennium, *Science and Justice*, **40**, pp. 143–6.
- Canberra Institute of Technology (1992) *ACT TAFE Associate Diploma of Applied Science in Forensic Investigation Curriculum Document*, CIT, Canberra, Australia.
- Canberra Institute of Technology (1993) *Associate Diploma of Applied Science in Forensic Investigation (New South Wales Police) Curriculum Document*, CIT, Canberra, Australia.
- Gaffy, B. (1993) *Report on the Status of Education and Training in Forensic Science*, National Institute of Forensic Science, Melbourne.
- Horswell, J. and Petterd, C. (1989) *Education in Scenes of Crime/Forensic Science*, NPRU, Volume 5, pp. 88–91.
- Horswell, J. (1995) Education and training of police in the forensic sciences: an Australian perspective, *Science and Justice*, **35**, pp. 15–18.
- Kaufman, F. (2000) *Commission on Proceedings Involving Guy Paul Morin*, Ministry of the Attorney General – Reports, Publication and News, Ontario, Canada.
- Millen, P. (2000) Under the microscope: a personal view, *Police Review*, 8 December, pp. 28–9.
- Morling, T. R. (1987) *Royal Commission of Enquiry into the Chamberlain Convictions. Report of the Commissioner The Hon., Mr Justice T R Morling*, Government Printer of the Northern Territory.
- Ord, R. (1994) *An Evaluation of the Associate Diploma of Applied Science in Forensic Investigation (Australian Federal Police)*, Canberra Institute of Technology and Australian Federal Police, Canberra.
- Public Safety Industry Training Advisory Board Ltd (2000) *Public Safety Training Package*, ANTA, Melbourne.
- Sensabaugh, G. F. (1998) On the advancement of forensic science and the role of the university, *Science and Justice*, **38**(3), pp. 211–14.
- Shannon, C. R. (1984) *Royal Commission Report Concerning the Conviction of Edward Charles Splatt*, D. J. Woolman, Government Printer of South Australia.
- Wood, J. R. T. (1997) *The Wood Royal Commission into New South Wales Police Service*, Volume 2, Reform, Premier's Department, NSW Government, Sydney.

Crime scene investigation and third party quality systems accreditation: Australia's experience

John Horswell

4.1 Background

During the early 1990s the senior managers of Australian and New Zealand Forensic Laboratories representing the forensic science management community in Australia and New Zealand, provided the vital leadership and impetus to the newly formed National Institute of Forensic Science of Australia for the formation of the Forensic Science Accreditation programme managed by the National Association of Testing Authorities, Australia through its Forensic Science Accreditation Advisory Committee.

The first third party forensic science laboratory accreditation programme in Australia relied somewhat on the experiences of the forensic science laboratory accreditation programme already in existence in North America, managed by the American Society of Crime Laboratory Directors Laboratory Accreditation Board, a programme the Society has been offering to laboratories throughout the world for a number of years. The first Australian programme consisted of the American programme's forensic science criteria as well as testing and calibration laboratory criteria from ISO Guide 25, which had been offered to participating testing and calibration laboratories throughout Australia, by the National Association of Testing Authorities, Australia for some years.

With the introduction of ISO 17025 and the National Association's new supplementary requirements for forensic science laboratories in Australia, management of Australian laboratories is now reviewing the necessity for continuation with the American accreditation for their respective laboratories.

It was, however, the foresight of the National Association of Testing Authorities' Forensic Science Accreditation Advisory Committee when formulating the classes and sub-classes of tests that would come under the umbrella of the National Association's Forensic Science Accreditation Program that, for the first time anywhere, an accreditation programme for forensic science would include crime scene investigation. Note the use of the word 'investigation' as it is indeed the view of the forensic community in Australia

that investigation is a key philosophy in the identification, recording and retrieval of potential evidence at scenes of crime. The difference between ‘examination’ and ‘investigation’ is where an examiner just identifies and collects those items, which are obvious, an investigator goes a step further and interprets as well. Indeed an examiner, without the ability to investigate, may miss vital potential evidence. An ‘examiner’ may not have the ability, through lack of skill or knowledge, to identify potential evidentiary material which would be identified by an investigator, with the skills and knowledge, during an interpretation of the events which have occurred relating to the crime scene.

The Field and Identification Specialist Advisory Group, a committee of the Senior Managers Australian and New Zealand Forensic Laboratories, consisting senior crime scene investigators, forensic ballistics specialists and fingerprint specialists, were tasked with coming up with an accreditation programme for crime scene investigators. The Specialist Advisory Group formed a smaller group of senior crime scene investigators into a committee titled the Crime Scene Accreditation Committee to work through the conceptual and development issues surrounding the proficiency testing of crime scene investigators.

4.2 Accreditation criteria

The National Association’s ISO 17025 (1999) supplementary requirements for accreditation in the field of forensic science application document require that crime scene investigators be competent in the application of the principles of crime scene photography, scene examination and exhibit handling, safety and have an appreciation of the capabilities of other disciplines.

Being part of the overall accreditation regime requires that even though a facility may go forward seeking accreditation for crime scene investigation only, it must conform with the Australian Standard ISO 17025 (1999) – general requirements for the competence of testing and calibration laboratories, and the National Association’s ISO 17025 – supplementary requirements for accreditation in the field of forensic science application document.

The specific aspects of the National Association’s programme as it applies to the discipline of crime scene investigation now follow.

4.3 Court testimony monitoring

The presentation of testimony is the culmination of the work performed by a forensic scientist. Accordingly, it is vitally important that the effectiveness of each examiner in the presentation of oral evidence be reviewed at least once annually. The following are acceptable methods by which monitoring may be carried out:

- observation of the testimony by a supervisor or a peer and completion of the pro forma testimony evaluation form; or
- the completion by officers of the court of a testimony evaluation form; or

- a member of the laboratory's technical management team or a supervisor may request responses by telephone from one or more officers of the court. The responses would be used to complete the testimony evaluation form.

The testimony evaluation form allows for personal impressions such as voice volume, tone and fluency, eye contact, demeanour and etiquette. The testimony of the witness is also evaluated for confidence, responsiveness to questions, preparation and subject knowledge, clarity and conciseness, objectivity and impartiality. The witness having referenced the case file, diagrams and photographs as well as the length of time the witness underwent evidence-in-chief; cross-examination and re-examination would be included in the evaluation.

The monitoring procedure must also prescribe the remedial action that is to be taken should the evaluation be less than satisfactory and each analyst/examiner must be given timely feedback from the evaluation.

It is a requirement of the accreditation programme that there is a documented procedure whereby the testimony of each analyst/examiner is monitored during each year testimony is given. Records of the actual monitoring must be kept for each examiner as a record of the evaluation having taken place (Horswell and Edwards, 1997).

See [Table 4.1](#) for an example of a court testimony monitoring form.

4.4 Crime scene investigator duties and competencies

The following is a summary of the main duties of a crime scene investigator. These seven criteria were used to develop the competency and internal proficiency testing instrument, and the external proficiency test, which form the crime scene component of the National Association's programme (Wright, 1994).

4.4.1 Initial assessment of the crime scene

- Assess health and safety risks and take adequate safety precautions.
- Ascertain the circumstances regarding the incident.
- Define/redefine the scene boundary to optimise the recovery of physical evidence.

4.4.2 Control of the crime scene

- Ensure that a log of all persons entering and leaving the scene is established and maintained.
- Preserve the scene during the examination.
- Advise those entering and leaving the scene of an access and exit path to minimise loss of evidence.
- Adopt appropriate procedures to prevent contamination and loss of evidence.

4.4.3 Examination of the crime scene

- Identify and apply an appropriate search pattern.
- Accurately record details of the scene.
- Locate physical and trace evidence.

Table 4.1 Example of a court testimony monitoring form

AUSTRALIAN FEDERAL POLICE						
FORENSIC SERVICES		Case Ref.				
<i>COURTROOM/WITNESS EVALUATION FORM</i>						
<i>The purpose of this questionnaire is to provide information that will help staff present more effective court testimony. Constructive evaluation of courtroom performance is encouraged.</i>						
Name of witness:		Date:				
Matter of:						
<input type="checkbox"/> Coronial: <input type="checkbox"/> Magistrates <input type="checkbox"/> Trial:						
		1	2	3	4	5
PERSONAL IMPRESSIONS:	1.	VOICE (volume, tone, fluency)				
	2.	EYE CONTACT				
	3.	DEMEANOUR				
	4.	DRESS				
	5.	ETIQUETTE				
TESTIMONY:	1.	CONFIDENT (forceful, direct)				
	2.	RESPONSIVE TO QUESTIONS				
	3.	PREPARED & KNOWLEDGABLE				
	4.	CLEAR & CONCISE				
	5.	OBJECTIVE				
		1	2	3	4	5
		CASE FILE (referred to in court?) YES/NO				
		COURTROOM AIDS (diagrams/photos) YES/NO				
LENGTH OF TIME:		EVIDENCE IN CHIEF				
		CROSS EXAMINATION				
COMMENTS:						
.....						
.....						
<i>Your comments would be appreciated on any of the above aspects of witness performance, which in your view could be improved. As a guide, "5" would be considered improvement needed, and "1" no improvement required. If appropriate, indicate how witness performance could be improved.</i>						
COMPLETED BY:		DATE:				

- Make appropriate arrangements to collect evidence from victims and suspects.
- Seek assistance from other specialists where appropriate.

4.4.4 Interpretation of the evidence at the crime scene

- Establish the possible significance of the evidence.
- Establish the possible sequence(s) of events where appropriate.
- Communicate the significance and interpretation of the evidence to the officer in charge of the incident.

4.4.5 Recording the crime scene and evidence

- Record time, date and location of the scene.
- Make a thorough and accurate record of the scene.

4.4.6 Evidence collection

- Collect and package exhibits in a manner, which will prevent contamination.
- Ensure exhibits are identified by appropriate labelling.
- Establish a record of exhibits collected.

4.4.7 Case management

- Ensure continuity and security of exhibits, items and records.
- Maintain liaison with the officer in charge of the case and other specialists.
- Prepare relevant statements, reports and other documentation.

4.5 Competency and proficiency testing

The emphasis inherent in internal and external proficiency tests is one of continual improvement. Proficiency testing is an integral part of an effective quality assurance programme, to monitor performance and to identify areas where improvement may be needed. Hence a critical element in the National Association's programme has been the development of proficiency tests for crime scene investigation.

4.6 Internal competency and proficiency test instrument

A proficiency-testing programme is an essential criterion for accreditation of a facility. Both the internal and external proficiency tests measure the capability of a facility's investigators, thus ensuring their competency and therefore the reliability of any results produced. Each crime scene investigator must complete an internal proficiency test (instrument) and each facility must complete an external proficiency test (CD-ROM) annually.

The instrument for internal competency and proficiency testing replicates what is required from a crime scene investigator undertaking the external (CD-ROM) proficiency test (Flogel, 1995).

See [Table 4.2](#) for an example of the competency and internal proficiency test instrument.

Table 4.2 Example of the competency and internal proficiency test instrument

**Australian Federal Police
Forensic Services**

***COMPETENCY AND PROFICIENCY TEST
CRIME SCENE INVESTIGATION***

This involves assessment at an actual crime scene.

A. INITIAL ASSESSMENT OF THE SCENE

The crime scene investigator should establish if the crime scene guard at the scene has:

DESCRIPTION	Achieved	Not Achieved	Not Applicable	Comment
1. Assessed hazards, physical, electrical, gas, chemical and biological				
2. Supplied first aid or medical attention as required				
3. Determined nature and size of the scene				
4. Determined entry and exit points that may have been used by suspect/s				
5. Removed all persons from the scene and recorded details of anyone who may have unintentionally or deliberately contaminated the scene				
6. Called for assistance (if required) to co-ordinate the scene				
7. Called any other experts (eg Fingerprints, police surgeon, forensic pathologist and plain clothes investigators) if required				
8. Defined the scene boundary with tape and guards				
9. Protected any endangered physical evidence				
10. Recorded details of all actions in an official notebook and maintained a log of persons who entered and left the scene				

Has the crime scene investigator:

DESCRIPTION	Achieved	Not Achieved	Not Applicable	Comment
1. Ascertained the circumstances of the incident				
2. Re-assessed scene boundary and protection				
3. Re-assessed health and safety risks				
4. Taken adequate safety precautions, additional checks and protective clothing				
5. Determined if anyone else may have entered or left the scene (eg ambulance officers, witnesses, other victims or suspects)				

B. CONTROL OF THE SCENE

Has the crime scene investigator:

DESCRIPTION	Achieved	Not Achieved	Not Applicable	Comment
1. Identified an appropriate entry point to the crime scene				
2. Monitored cordon(s)				
3. Ensured a log is maintained				
4. Arranged to obtain a copy of log of events recorded by the first officer				
5. Adopted appropriate procedures to prevent contamination and loss of evidence				
6. Ensured that the scene is adequately guarded				
7. Determined an entry and exit path for the investigator to commence examinations whilst minimising loss of evidence				

C. EXAMINATION OF THE SCENE

Did the crime scene investigator:

DESCRIPTION	Achieved	Not Achieved	Not Applicable	Comment
1. Demonstrate an appropriate search pattern such as lane, grid, zone or spiral <i>NB: At least one of these techniques must be demonstrated</i>				
2. Make detailed observations of the scene				
3. Consider and assess trace evidence during the search				
4. Consider possible contamination of evidence during the search				
5. Make arrangements to later search victims and/or suspects for evidence (if applicable)				
6. Assess the need for:				
a. Fingerprinting				
b. Forensic ballistics				
c. Forensic pathologist/police surgeon				
d. Video				
e. Photogrammetry/plan drawing				
f. Other experts or assistance				

Table 4.2 (Continued)

D. INTERPRETATION OF THE EVIDENCE AT THE SCENE

Has the crime scene investigator:

DESCRIPTION	Achieved	Not Achieved	Not Applicable	Comment
1. Assessed the significance of evidence at the scene				
2. Considered possible sequences of events				
3. Determined the most probable scenario				

E. RECORDING THE SCENE

Photography

Has the crime scene investigator:

DESCRIPTION	Achieved	Not Achieved	Not Applicable	Comment
1. Taken adequate photographs:				
a. General				
b. Mid-range				
c. Close-up				
d. Technical				
2. Taken adequate notes regarding:				
a. Times, dates, locations				
b. Description of scene				
c. Location of items				
d. Persons in attendance				
e. Lighting conditions				
f. Condition of locks, windows, doors				
g. Condition of items and objects				
h. Any other relevant details				

Plan

Has the crime scene investigator:

DESCRIPTION	Achieved	Not Achieved	Not Applicable	Comment
3. Arranged for appropriate plans:				
a. Completed a sketch plan which is a reasonable representation of the scene				
b. Taken adequate measurements for CAD/sketch plan				

F. EXHIBIT COLLECTION

Has the crime scene investigator:

DESCRIPTION	Achieved	Not Achieved	Not Applicable	Comment
1. Collected all relevant exhibits				
2. Packaged all items according to procedures				
3. Labelled all items collected in accordance with procedures				
4. Maintained a log of all items collected				

G. CASE MANAGEMENT

Scene Aspects

Has the crime scene investigator:

DESCRIPTION	Achieved	Not Achieved	Not Applicable	Comment
1. Maintained close liaison with first officer and investigator so as to process the scene effectively				
2. Maintained control				
3. Organised and planned the scene examination				
4. Evaluated options available				

Post Scene

Has the crime scene investigator:

DESCRIPTION	Achieved	Not Achieved	Not Applicable	Comment
1. Entered details of examination in the case management system				
2. Entered collected items in relevant recording system/s				
3. Obtained any other relevant paperwork for inclusion in the case folder				
4. Examined items for evidence potential in an appropriate manner to avoid contamination and/or cross contamination				
5. Assessed items for further laboratory examination including possible options				
6. Completed all relevant forms and reports for items requiring further examination and forwarded them to the appropriate laboratory				
7. Secured exhibits for further examination				
8. Attended at case conference				
9. Ensured continuity is maintained for all exhibits				
10. Ensured appropriate quality assurance procedures have been adopted				

Table 4.2 (Continued)

DESCRIPTION	Achieved	Not Achieved	Not Achieved	Comment
11. Prepared relevant statements and other documentation covering the following:				
a. Included an opening paragraph stating relevant qualifications and experience				
b. Presented the evidence in chronological order				
c. Explained the nature and extent of the examination				
d. Provided a detailed description of the scene				
e. Described details before presenting photographs in series				
f. Presented the information in a way that can be understood				
g. Labelled/captioned photographs appropriately				
h. Introduced exhibits appropriately				
i. Produced any charts, plans etc of scene				
j. Presented opinion evidence appropriately				

ADDITIONAL COMMENTS SECTION

Any other matters arising from this assessment which should be considered in the final assessment:

Has the crime scene investigator carried out additional specific procedures:

DESCRIPTION	Achieved	Not Achieved	Not Applicable	Comment
1.				
2.				
3.				
4.				
5.				
6.				
7.				
8.				
9.				
10.				
11.				
12.				
13.				
14.				
15.				

Crime Scene Investigator being assessed:.....
(name)

Assessor:
(name)

..... **Date:**.....
(signature)

Crime scene investigation, because of its subjective nature presented a definite challenge in developing a concept of how to test crime scene investigators. The initial committee of crime scene investigators after considerable thought and discussion came up with strategies in dealing with external proficiency tests for crime scene investigators covering:

- concept
- platform

- management
- development
- delivery.

The conceptual stage of developing external proficiency tests was a challenge for the crime scene committee and it was decided to produce the first proficiency test using video (analogue) format and at the same time task a media development company to develop the concept of CD-ROM (digital). It was also decided to set up an independent committee, the Crime Scene Proficiency Advisory Committee, which was tasked with managing the external proficiency-testing programme, leaving the marketing and distribution to the National Institute of Forensic Science, and a sub-group titled the Proficiency Test Working Party to develop the actual scenarios. The Crime Scene Proficiency Advisory Committee is a standing committee of the National Institute and is accredited by the National Association as a proficiency test provider.

4.7 Crime scene proficiency advisory committee

This committee was formed under the auspices of the National Institute of Forensic Science and comprises five senior crime scene investigators from throughout Australia. The committee is responsible for the development of all external proficiency tests relating to crime scene investigation.

4.8 Crime scene proficiency test

The committee develops one external proficiency test annually, which covers any or all of the following performance criteria:

- initial assessment of the crime scene;
- control of the crime scene;
- examination of the crime scene;
- interpretation of evidence at the crime scene;
- recording the crime scene and evidence;
- evidence collection; and
- case management.

The scenarios conceptualised by the committee are representative of those encountered in normal crime scene operations and reflect any jurisdictional-specific roles of crime scene investigators throughout Australia.

The scenarios are mock crime scenes, which allow crime scene investigators to carry out normal procedures in an as-near-to-the-real-thing-as-possible setting. These crime scenes are fabricated by the working party and photographed using still photography. The photographs were sequenced and overlapped using a special photographic camera mount on a tripod. They are then entered into the programme by stitching the images together to provide a panorama of the scene with the ability to move from one point in the scene to another allowing zoom ability for close-up views of evidential material

seeded within the mock scene. The resulting interactive CD-ROM programme is known as 'After the Fact[®]'. The concept of interactive CD-ROM technology is not new as it has been available in animated games for some time. The application, for this purpose, is a first anywhere in the world, which has been followed by others in Australia in relation to the recording of actual crime scenes for replication as virtual reality used during investigations and court room presentations. The concept has now surfaced in North America in relation to testing fire investigators.

After several draft versions the first CD-ROM external proficiency test was distributed to 110 facilities throughout Australia in August 1999.

There are three aspects to the crime scene proficiency test:

1. the crime scene;
2. the investigation tools; and
3. the written test.

Each aspect is fully explained in detail on the programme and it is important that any investigators representing the participating facility equate themselves fully with the functions of the programme before attempting the assessment phase.

'After the Fact[®]' allows the investigator to 'walk through' a virtual crime scene and provides for realistic scene processing including the following:

- photography;
- notes; and
- collection and packaging of evidence.

Questions, pre-developed by the committee and relevant to that particular scene, are presented to the investigator in accordance with the seven key performance criteria of crime scene investigation (Ashley, 2000).

4.9 Crime scene investigation

The identification, recording and retrieval of potential evidentiary material is practised worldwide by individuals with a variety of backgrounds who possess a variety of qualifications and who have undertaken a variety of education and training programmes.

Some countries employ bench scientists as crime scene examiners, some countries employ uniformed or plain-clothed police, who have very little training as crime scene examiners and some countries employ professional scientists as crime scene investigators.

I am pleased to say the jurisdiction I work in has recently embarked on employing graduate scientists who are then trained as crime scene investigators. I have been an advocate in the past for the provision of scientific and forensic education and training to police officers who carry out the functions of crime scene investigators. This has had varying degrees of success in Australia; however, it has particularly worked well in my own jurisdiction. I am not, and never have been, an advocate of the bench scientist undertaking crime scene investigation duties in addition to their bench duties, as I believe these are two very distinct vocational activities, Laboratory Science and Field Science.

Like all specialities, those that practice within a given speciality must practice and practice their discipline to maintain current competencies and be in a position to provide evidence to a court of law that they have the required expertise to present evidence of ‘interpretation’ or what is known in scientific circles as ‘hypotheses testing’. It is only by carrying out many and varied crime scene investigations will a crime scene investigator remain current and be in the position alluded to above. Having said this, I do believe there are instances when laboratory scientists should be called to scenes to assist their field scientist colleagues. This would normally relate to the way in which the laboratory scientist would want the item or sample collected and handled given a particular set of circumstances. There is always room for other specialists to assist at the scene, such as fingerprint and forensic ballistics examiners. To take away the ‘interpretation’ aspect of a crime scene investigator’s duties is to demean the practice of crime scene investigation and those dedicated individuals that practice in the discipline.

The value of accreditation in crime scene investigation cannot be understated. The old adage ‘rubbish in – rubbish out’ applies when there is not an appropriately educated, trained and equipped crime scene investigator undertaking crime scene investigation duties. There is another universally held view: ‘that it does not matter how well equipped or qualified the staff are at the forensic science laboratory, if the material they are asked to analyse or examine is not relevant to the case, was not appropriately collected or packaged, or, indeed was not collected at all, then the forensic science laboratory will not be able to “make it right” and provide useful information as the evidential value of such material is lost forever’.

It is only by routine quality systems auditing, proficiency testing the individual and the system, will the crime scene investigation facility be able, not only to say that they are delivering a quality product, but be able to prove it.

In my view a crime scene investigation facility must be staffed with appropriately educated and trained scientists, who carry out their field science discipline, by not only attending the very complex crime scene, but by attending the every day routine crime scene. The crime scene investigation facility should also possess quality systems forensic science accreditation which will indicate to the customer, courts and hence public, that the product they produce is a ‘quality’ product which is backed up by a ‘quality system’.

One last closing comment, third party quality systems accreditation, even though it is administratively hard work, is good management practice and common sense; however, it is said that common sense is not so common.

4.10 Acknowledgements

The work of the Field and Identification Sciences Specialist Advisory Group is acknowledged.

The work of current and former colleagues on the Crime Scene Proficiency Advisory Committee (CSPAC, 1999) is acknowledged.

The support of the staff of the National Institute of Forensic Science is also gratefully acknowledged both during the developmental stages and delivery stages of the CD-ROM proficiency tests.

4.11 References

- Ashley, W. (2000) *Interactive CD-ROM Training and Proficiency Testing – Learning from Experience*, A paper prepared and delivered at the CrimTrac 15th International Symposium on the Forensic Sciences – Crime scene to court, which was held on the Gold Coast Queensland.
- Crime Scene Proficiency Advisory Committee (CSPAC) (1999) *Standard Operating Procedures*.
- Flogel, P. (1995) Personal Communication – Competency Testing Crime Scene Investigators.
- Horswell, J. and Edwards, M. (1997) Development of quality systems accreditation for crime scene investigators in Australia, *Science and Justice*, **37**(1), pp. 3–8.
- National Association of Testing Authorities, Australia (1999) *ISO/IEC 17025 Application Document – Supplementary Requirements for Accreditation in the Field of Forensic Science*.
- Standards Australia (1999) *Australian Standard General Requirements for the Competence of Testing and Calibration Laboratories AS ISO/IEC 17025*.
- Wright, M. J. (1994) *Crime Scene Investigation*, Presentation to the Australian and New Zealand Forensic Science Society's International Symposium on the Forensic Sciences, Auckland New Zealand.

Management of crime scene investigation

John Horswell

5.1 Background

Crime scene investigation is a subject that encompasses:

- management and coordination of human and physical resources;
- the technical aspects of recording and recovery of potential evidentiary material; and
- the interpretation of what has occurred in the recent past.

5.2 Crime scene management

There are three critical operational stages of a criminal investigation. These are:

1. control and coordination of the criminal investigation;
2. the criminal investigation; and
3. the forensic investigation.

Normally the coordination of a major criminal investigation is delegated to a senior investigating office. Like Kirk (1953), I hold the view that any investigation is dual, involving individuals and material items. A senior investigator should be appointed to coordinate the gathering of all oral evidence from witnesses and suspects (individuals). Likewise, a senior forensic investigator should coordinate the overall forensic investigation (material items).

To manage major incident scenes and multisited crime scenes the crime scene coordinator must understand forensic science and criminal investigation.

The crime scene manager must surround him/herself with competent, skilled and qualified forensic investigators to carry out the task of conducting the crime scene investigation.

5.3 Scene control and coordination

Without proper control and coordination, information may not reach the crime scene investigator which may lead to his/her efforts being aimless, and the leads uncovered may never be passed onto investigators for follow-up action. This is most important when the crime scene is large and there are several crime scene investigators present processing the scene or where there are secondary scenes away from the primary scene. There must be a flow of information back and forth between investigator and crime scene investigator and vice versa. This is one of the functions of the crime scene manager. In relation to the management of crime scenes, I will discuss my interpretation of two terms as follows:

1. crime scene manager; and
2. crime scene coordinator.

5.3.1 *Crime scene manager*

This is a term applied to a senior crime scene investigator who has been given the role of managing a large and complex single crime scene.

5.3.2 *Crime scenes coordinator*

This is a term I apply to a senior crime scene investigator who has been given the role of coordination of several single simple and/or complex scenes all inter-linked and related and who takes on the role of chairing case management committee meetings when both forensic personnel and senior investigating police come together for case management meetings.

5.4 Approaches to crime scene investigation

The examination of a crime scene and subsequent collection of potential evidential material requires special skills, knowledge and aptitude. The manner in which a crime scene investigation is conducted may be a critical factor in determining the success of an investigation. The thorough examination of a crime scene requires a disciplined approach and systematic application of the various observation, recording and collection techniques as well as an in-depth knowledge of forensic science.

Examining a crime scene is often a demanding task, and in many instances, requires physical and mental stamina as well as team member and team leadership skills.

Forensic science has become a powerful aid to criminal investigation with courts placing much emphasis on the results. Accordingly, the manner in which evidence is located, recorded and collected, the observations made along with the results of tests

performed, will be vigorously examined and tested by the court before being admitted into evidence.

Therefore a systematic approach to crime scene investigation will ensure:

- good coordination between investigation and crime scene examination teams;
- an efficient, effective and thorough examination;
- less fatigue;
- orderly recording and collection of potential evidence; and
- effective observations and deductions.

5.5 Scene security

The first officers attending the scene will make an initial assessment of the crime scene. They will secure the scene to an extent based on the information available at the time. The crime scene manager, who will normally be a senior member of the crime scene investigation staff, must attend the scene at the earliest possible opportunity to take charge of the management of the crime scene. A crime scene investigator or a team of crime scene investigators who will undertake the crime scene investigation will normally accompany him. The size of the crime scene/s will dictate the amount of resources allocated to the particular incident. It is imperative that the crime scene manager has the authority to allocate the amount of resources required.

Once the crime scene is handed over to the crime scene manager, a re-assessment of the scene security should be made to ensure the scene security is adequate. There should be a formal protocol used for the handing over of a crime scene. This ensures control and the maintenance of the scene's chain of custody.

It is an essential element of any prosecution where forensic evidence is involved to prove the security of the scene and that it was maintained throughout the subsequent examination/investigation. Therefore the objective of securing the crime scene is:

- to prevent evidence being destroyed or contaminated;
- to ensure security of information – generally a media liaison officer or the senior investigating officer only releases information to the media;
- to ensure chain of custody of the scene is maintained as is necessary with any item of potential evidence;
- to remove from the scene all unnecessary persons including police officers and the media. It must be remembered that the more people present the greater the potential for contamination and destruction of evidence. Large numbers of persons present will also inhibit the proper processing of a crime scene; and
- to ensure that all evidence has been recorded and recovered. This may include securing the scene until the results of the post-mortem or scientific analysis are to hand.

There are a variety of methods for securing the crime scene. Some of these are:

- posting guards;
- rope or printed tape cordons;
- the strategic placing of vehicles;

- the use of markers, flags, signs;
- locking rooms or areas within buildings or using the external walls of a building as the barrier; and
- establishing safe walk areas (common approach path with tape or purpose-built raised stepping plates).

5.6 Occupational health and safety

The well-being of the crime scene investigator/s is the primary responsibility of the crime scene manager. He/she must be aware of fatigue and well-being of his investigators. Appropriate protective clothing and equipment should be made available. Breaks should be organised for the forensic investigator/s and refreshments should be on hand during those breaks. Scene guards should also be part of the crime scene operation regardless of the area they originate from. There should be an area designated where food and drink can be taken, equipment can be stored and rubbish can be accumulated.

All personnel on site should be briefed regarding:

- safety hazards;
- smoking and eating;
- the location of critical areas; and
- the use of telephones and toilets.

5.7 Examination records

In order to conduct a thorough systematic crime scene investigation there should be protocols developed for each activity. I will not enlarge on those here as each jurisdiction will have their own subtle differences; however, I will provide subject headings for each category of examination. There should be prepared check sheets, which will provide the crime scene investigator with comprehensive notes taken during the examination, and these pro forma records should be available for:

- crime scene log – activities undertaken at the scene including movements, who was in the scene on arrival, and who arrived and who left the scene and a summary of their activities whilst on site;
- formal ‘hand-over’ ‘take-over’ of the crime scene from the first police at the scene to the crime scene investigator to arrive or the crime scene manager;
- list of environmental conditions at the crime scene;
- list of conditions within the premises and the surrounding area;
- list of activities and observations at the crime scene;
- exhibit list;
- rough sketch of the crime scene;
- list of photographs taken at the scene;
- list of specialists attending and times they were involved in the examination; and
- initial findings from the crime scene investigation from all specialists attending the scene.

5.8 Ongoing case management

Once the scene work is completed, the emphasis changes to the coordination of further examinations and the communication and flow of information and results from forensic analysis/examinations to and from investigating officers and forensic examiners, and from investigating officers to forensic examiners. If it is not practical for the crime scene coordinator to chair further case management meetings then another senior crime scene investigator may be nominated to maintain that contact and coordination of the ongoing case management.

5.9 Quality systems record management system for controlled documents

Record management and the control of documents is an integral part of third party forensic science accreditation. Crime scene investigation is now an integral part of both the American Society of Crime Laboratory Directors-Laboratory Accreditation Board (ASCLD-LAB) and the National Association of Testing Authorities, Australia (NATA) and is likely to spread through the Mutual Recognition Agreements (MRAs) between other national accreditation bodies. It is therefore desirable that crime scene facilities have both 'systems' and 'technical' accreditation of their system conforming to the International Standard ISO/IEC 17025.

The use of a computerised programme to manage record management within a quality management system is the only systematic and comprehensive way to manage and control the quality management system (QMS) documentation and therefore control the quality system.

5.10 The ideal computerised system

The ideal computerised record management system, designed to manage records associated with a quality system, should be modular and consist of operational and support modules.

The operational modules required and needed to control the various aspects of the QMS are:

- document control
- auditing
- proficiency testing
- corrective and preventive action
- equipment
- suppliers
- customers
- training,

assisted by the following support modules:

- administration
- workload

- performance
- messaging.

5.10.1 Document control

Document control is one area where there is traditionally high demand for administrative support when using a manual system. A computerised program should automate many of the time-consuming activities undertaken within a manual system.

The computerised system should be set up in such a way so there is a principle administrator as the document administrator, with a management committee, such as a quality assurance committee (QAC) as the document approvers. Staff are able to access documents associated with the crime scene investigation facility on a read-only basis. The system should control and allow full records of requests for changes to be maintained. The draft document system should allow for documents to be updated and circulated to the QAC for review and approval. Any comments made by the QAC are maintained with the document and archived, therefore providing a full history.

5.10.2 Auditing

The audit module should allow for the inclusion of all associated activities with internal quality systems auditing. The program should take control of the audit cycle from scheduling through to completion. Checklists can be developed or referenced, and any audit findings remain tracked until addressed with an appropriate corrective action.

Extensive audit analysis should be available to determine if the audit coverage is adequate. In addition, analysis should be extended to review performance of individual audit areas and auditors, allowing for objective judgements relating auditing frequency and auditor consistency to be made.

5.10.3 Proficiency testing

The proficiency-testing module should allow for full records of proficiency testing to be maintained on the system. The proficiency-testing program for the year should be in a calendar within the program. This should contain details as to the provider of the proficiency test, the supervisor receiving the proficiency test, when the test was returned, when the results were received and discussed by the QAC. Any problems identified in proficiency testing should feed directly into the corrective action system.

5.10.4 Corrective and preventative action

A formal corrective/preventative reporting system is a requirement of ISO 17025, and is one of the first areas where inspectors/assessors look during their audits. The status of the corrective/preventative action system is an accurate reflection of the culture of the organisation and its acceptance of the spirit of quality improvement. The corrective/preventative action module of the program should be straightforward, and the analysis of the information from this module will assist in determining trends in problem occurrence.

5.10.5 Equipment

The equipment module should be designed to maintain a complete list of equipment and monitor when safety, calibration or maintenance checks are due, another requirement of ISO 17025. Equipment should be entered into the program and should include:

- serial number;
- date of purchase;
- maintenance schedule;
- calibration (if appropriate) schedule; and
- a unique identifier.

5.10.6 Suppliers

The approved suppliers list is another requirement of ISO 17025. The program should maintain the list of suppliers and products, as well as assist in a performance history and review of suppliers.

5.10.7 Customers

This module should track all customer feedback, either good or bad, through to resolution. Complaints should feed directly into the corrective/preventative action module ensuring that all issues are recorded in the one database. This further enhances the level of analysis that can be undertaken.

5.10.8 Training

The training module should maintain for each individual, a record of his or her qualifications, training and experience. It should allow for a specification for each position to be developed that typically includes the qualifications, training and experience required to carry out the role satisfactorily. The module should automatically generate a training gap when qualifications, training and experience of a member of staff are compared with the specifications for a given position. This should allow training to be planned and scheduled in advance.

5.10.9 Administration

This should be the controlling model where access is granted and where the structure of the organisation is maintained. This module should be set up first before proceeding to make entries and setting up other modules. Every time the structure changes or new staff are inducted, changes have to be made within this module.

5.10.10 Workload

The workload module should be designed to monitor actions that are outstanding within the quality system. Actions should be able to be viewed on an individual, department or organisation-wide level.

This module should also provide a list of all activities that have been carried out within the quality system over a period of time. This saves significant time when preparing for management review meetings.

5.10.11 Performance review

This module should allow for an extensive analysis of incidents. Analysis may be occurrence- or cost-driven, and can be used to highlight areas of concern, repeat problems and costly failures. Trend analysis and reaction time taken to address issues should also be measured and serve to highlight opportunities for improvements in overall performance.

5.10.12 Messaging

Communication breakdown is often a major source of issues within a quality management system. The program should overcome this problem with a messaging system, which keeps appropriate people informed of changes and actions within the system. Messages should be delivered via a local area network (LAN) e-mail messaging system. When an event is about to occur, all named people associated with the event, and any additional people deemed necessary, are informed. If messages are not actioned in a timely manner, reminders are sent or the issue may be escalated as necessary. The wording of all messages can be changed via the administration module.

5.11 Levels of access within a crime scene facility

In order to maintain security and prevent alterations to the system, there must be various levels of access within the system. In a crime scene investigation facility the following access is appropriate:

- All members of the crime scene investigation facility need access to make suggestions as to new forms, procedures, methods, and changes and improvements to these and the quality system, through the messaging system.
- Supervising crime scene investigators need additional access to input information regarding the distribution and movements of proficiency tests.
- Supervising crime scene investigators need additional access to input information regarding audits and the closing-off of continuous improvement forms.
- Trained auditors need access to make entries relating to audits.
- QA management committee (supervising crime scene investigators and manager of crime scene investigation facility) needs access to monitor all activities within the crime scene investigation facility.
- Administration – principle administrator needs overall complete access.

5.12 Forensic science laboratory information management system

The crime scene investigation facility that provides potential evidential material to a forensic science laboratory, even if that laboratory is part of another organisation,

should be able to link into the forensic science laboratories information management system by providing a data link up with an existing system to download information already in the appropriate format covering each of the following:

- each item should be bar coded;
- each item should be listed in order to commence the ‘chain of custody’;
- each item should have recorded with it what its significance is and what analysis/examination is required to be conducted; and
- an examination/analysis request form, which includes a summary of the case.

Whilst not endorsing any particular product I will provide the reader with an ideal concept of a forensic science laboratory information management system (FSLIMS).

5.13 Forensic science LIMS overview

Forensic science LIMS should be a modular software product designed for use by forensic laboratories on a LAN. The key components of this type of system would be: case management, evidence tracking and examination/analysis processing. Through the use of standard bar codes, all evidence would be tracked from the moment it is collected at the crime scene through to entering the forensic science laboratory (FSL) until it either leaves the FSL or is destroyed. This provides an auditable chain-of-custody for all potential evidentiary items.

Examination processing modules would be necessary for crime scene investigation and laboratory disciplines such as chemistry, biology (DNA), toxicology, drugs of abuse, fingerprints, physical comparisons (physical fits, footwear, tyretracks, mechanical failure, light globe for ‘on’ or ‘off’ interpretation and toolmarks), questioned documents, and ballistics. Management reports should be able to be produced from a variety of templates or tailored to a given laboratory’s specification.

5.14 Programme features

Included in every application would be the ‘core system’ which consists of case management, evidence tracking and administration with the process modules crime scene investigation, chemistry, biology (DNA), toxicology, drugs of abuse, fingerprints, physical comparisons (physical fits, footwear, tyretracks mechanical failure, light globe for ‘on’ or ‘off’ interpretation and toolmarks), questioned documents, and ballistics available to complement the core capability and be available as modules. A forensic science laboratory depending on the casework the laboratory offered to its customers could then select these modules. Each standard process module selected by the FSL should be able to be customised to specific laboratory needs. For example, a laboratory with only chemistry and fingerprints disciplines would select the chemistry and fingerprints modules. The software supplier should be able to tailor the selected modules and integrate them with the ‘core system’ to produce a client-specific forensic science LIMS application.

5.15 Core system

The core system should be the central component of any forensic science LIMS programme. It should consist of three major areas of functionality: case management, evidence tracking and administration. These are further described below.

5.15.1 Case management

Cases are initiated based on an attendance at the crime scene by crime scene investigators who would identify, select and record evidence and further make the request through the forensic science LIMS system for examination/s and/or analyses based on the type of potential evidence recovered. Basic information required in the system would be: crime scene investigator; date, time, and place of the crime scene investigation; investigating officer; police station/district; items of evidence with attached unique bar code numbers; types of examination/analysis requested of each items. On lodging the exhibits, the liaison officer would identify each discipline within the laboratory and the name of the individual supervising scientist for the area. There should be some type of alert system that informs the supervising scientist of the fact that a case has arrived and is awaiting his/her discipline's attention. The case would then be tracked through each discipline with the individual analyst being required to report on his/her examination/analysis through to the return of the items to the liaison officer. It is then the liaison officer's responsibility to dispose of the exhibits through destruction, return to investigating police or the transfer to court. The case management feature should provide workload monitoring and the ability to create, assign, re-assign and remove cases.

5.15.1.1 Quality assurance

There should be a quality assurance feature, which provides for both administrative and technical peer reviews of examination processes. This assists the forensic science laboratory, including a crime scene investigation facility, in satisfying this criterion within a forensic science laboratory accreditation programme, as well as contributing to the maintenance of high standards.

5.15.1.2 Court reports

A court report is the narrative description of the potential evidence received and the examinations/analyses conducted and the results obtained. At the conclusion of the examination process, the FSL analyst prepares a court report describing the analysis and subsequent results. These reports should be Microsoft Word™ documents that are stored in a document pool with the ability to query and retrieve.

5.15.1.3 Court processing

Court processing should manage all activities involving a court appearance. It should give FSL staff the ability to record such things as preparation time, travel time, time in court, testimony, court (name and location), court type, judge (name), prosecutor (name), subpoena number, defendants list and verdict/disposition (if known). This would in

turn provide FSL management with necessary management information as to staff workload and commitments.

5.15.1.4 Management reports

Included with each core system should be a set of standard management reports for statistical reporting on lab examination activity. Additional reports as needed should be developed to forensic science laboratory specifications and requirements.

5.15.2 Evidence tracking

Evidence tracking is an integral part of any forensic science LIMS application. A bar code is affixed to the container (plastic bag, paper bag, envelope, box, etc.) for each item of potential evidence. Each item of potential evidence is logged to a case by scanning the bar code, entering a description of the item, the name of the responsible party, and the date, time and place it was seized by the crime scene investigator. Additional information can be entered as the evidence item enters and moves through the FSL. The transfer of evidence to an outside laboratory for examination is also tracked by the system. All evidence is tracked for chain-of-custody from the moment it is logged into the system until it leaves the lab, or is destroyed. There should be an evidence destruction feature, which would record critical information regarding the actual destruction of an evidence item.

5.15.2.1 Tracking reports

A standard chain-of-custody report should be included as a part of evidence tracking. Other reports and trend reports should be identified by the FSL and developed as required.

5.15.2.2 Bar code management

Bar code labels for potential evidentiary material should be able to be prepared at crime scenes through the use of integrated bar code printing hardware and software. Bar code fields can be defined to specific FSL specifications and allocated to crime scene investigators printed on site. As an option, the FSL can have a commercial printer providing pre-printed bar code labels. Tight control on their issue to crime scene investigators would have to be assured.

5.15.3 Administration

This section should contain the functions, which include all security-related features such as:

- identification;
- password protection;
- access permissions; and
- password encryption.

5.16 Forensic functional modules

Forensic functional modules should represent specific functional options and requirements selected by each FSL management team to meet the individual requirements of their laboratory. Forensic functional modules would provide forensic science laboratory process tracking for any or all of the following disciplines:

- crime scene investigation;
- chemistry;
- biology (DNA);
- toxicology;
- drugs of abuse;
- fingerprints;
- physical comparisons (physical fits, footwear, tyretracks and toolmarks);
- questioned documents; and
- ballistics.

5.17 Customisation

There would be a need for customisation to a forensic science laboratory's unique specifications and its unique use of each of the functional modules.

The customer should also have the ability to modify (add, delete or change) such things as FSL code lists (drop-downs) for processes/analysis, instrumentation, crime scene investigators, laboratory analyst names, dates, case status, etc. to meet the needs of the respective laboratory. Additional drop-down lists should be able to be provided as required by each discipline or as an overall FSL requirement. The standard functional modules should be able to be integrated in any combination to accommodate forensic science laboratories from the smallest to the largest.

5.18 Case profiling

There should be a case profiling feature, which would provide the FSL and each discipline with the capability to query the court report files to identify past cases with similar examination results. For instance, a query for heroin, cut with glucose may be submitted or a blood DNA results from a crime scene. The case profiling search would return a summary of all court reports in the repository that contained the attributes requested. The examiner/analyst would then be able to click on a summary to view the entire report. This would save countless hours in searching for and linking cases that have similar findings.

5.19 Technical specifications

I leave the technical specifications for the management of both the QMS and FSLIMS to those who may develop such systems. Some systems are already on the market and

will, in the near future, fill a void that currently exists and be extended to cover the modules and disciplines I have suggested in this chapter.

5.20 Summary

Management of crime scenes is a matter of gaining control of the crime scene and then managing the coordination and application of resources. What follows must be a systematic and thorough approach to processing the scene. Serious crime scenes will vary in size and complexity, some requiring many crime scene investigators, others, smaller and less complicated, will require only one or two crime scene investigators.

Overall scene management and the maintenance of a two-way flow of 'information' and 'communication' are the essential ingredients to successful crime scene management. Regular case management meetings must be held to keep all stakeholders abreast of the latest available information. These must be recorded in the case notes and could be as formal as having a formal minute taker present.

Underpinning this there must be an effective case management system and the crime scene investigation facility should be quality 'systems' and 'technically' assessed to conform to the international standard ISO/IEC 17025 – 1999, *General requirements for the competence of testing and calibration laboratories*, and the quality system should also be appropriately managed through computerised systems.

5.21 Bibliography

- Azoury, M., Meirovich, L. and Refael, E. (1997) Computerised Management of a Forensic Analytical Laboratory, *MICROGRAM XXX*, **12**, pp. 297–304.
- Fisher, B. A. J. (2000) *Techniques of Crime Scene Investigation*, 6th edn, CRC Press.
- FORENSIC LIMS™ (2003) Management Systems Designers Inc. <http://filmsmsdinc.com>.
- Gael Quality (2002) *Marketing material for Q-PULSE™ Version 4.2*, Gael.
- Horswell, J. and Edwards, M. (1997) Development of quality systems accreditation for crime scene investigators in Australia, *Science and Justice*, **37**(1), pp. 3–8.
- Horswell, J. (2000) Major incident scene management, in Siegal *et al.* (eds), *Encyclopaedia of Forensic Sciences*, Academic Press, London, pp. 428–32.
- Horswell, J. (2000) Suspicious deaths, in Siegal *et al.* (eds), *Encyclopaedia of Forensic Sciences*, Academic Press, London, pp. 462–6.
- Kirk, P. L. (1953) *Crime Investigation*, John Wiley & Sons, New York, Chapter 1 Introduction.
- Management Systems Designers (2002) *Marketing Material for Forensic LIMS™*, MSD.
- NATA (2000) *ISO/IEC 17025 Application Document, Supplementary Requirements for Accreditation in the field of Forensic Science – Version 1*, National Association of Testing Authorities, Australia.

Application of forensic light sources at the crime scene

Chris Lennard and Milutin Stoilovic

6.1 Introduction

Specialised light sources, including lasers and high-intensity filtered lamps, have been employed for many years as an aid to crime scene examination. The term ‘forensic light source’ (or FLS) is commonly used to refer to an illumination system adapted for such use. Numerous forensic light sources, from a number of manufacturers, are now available on the market. When used correctly, an FLS can facilitate the search for a range of evidence types including footwear impressions, hairs and fibres, firearm discharge residues, lubricant stains, biological material (e.g. blood, semen, urine and saliva), and latent fingerprints.

An interest in the forensic application of lasers was initiated in 1977 when Dalrymple and coworkers reported on the detection of untreated latent fingerprints using photoluminescence techniques (Dalrymple *et al.*, 1997). The development of high-intensity filtered lamps, as more versatile, cost-effective alternatives to the laser, was subsequently pursued in the early 1980s in Australia, Great Britain and Canada. A non-laser FLS is sometimes referred to as an ‘alternate light source’ (or ALS).

The purpose of this chapter is to review the application of forensic light sources at the crime scene and describe how the effective use of such systems can lead to the detection of a wide range of evidence types. In order to understand the correct use of an FLS, however, a basic knowledge of light theory and illumination techniques is required. The first section of this chapter therefore contains an overview of relevant concepts.

6.2 Basic light theory

6.2.1 Introduction

The perception of colour and of photoluminescence emission represents the observation of physical phenomena due to the interaction of light with matter. Light is a form of

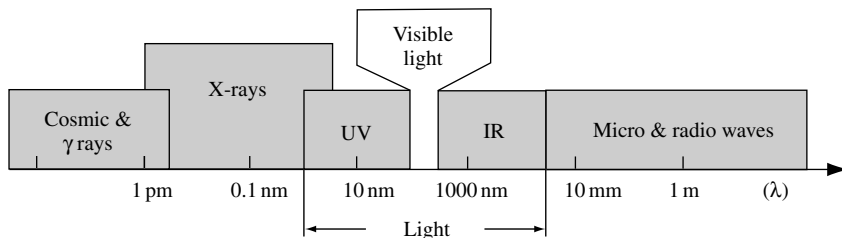

Figure 6.1 The electromagnetic spectrum. Light consists of three parts: UV, visible and IR. Visible light is a very small portion in this region

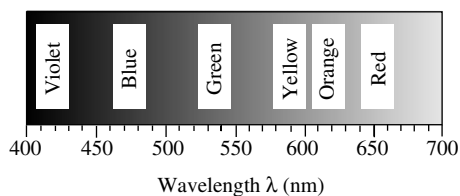

Figure 6.2 The spectrum of visible light showing the correlation between colour and wavelength

electromagnetic energy, part of a group that includes X-rays, microwaves and radio waves. (The term ‘electromagnetic’ refers to the fact that light energy has both electric and magnetic components.) The visible waves, which make up white light, form only a small part of the electromagnetic spectrum (Figure 6.1). The ability of our eyes to see ‘visible light’ is called colour vision and is similar to a filter that transmits only the radiation between approximately 400 and 700 nm. Radiation at 450 nm is observed as blue light, at 550 nm as green and at 650 nm as red. The mixture of electromagnetic rays between 400 and 700 nm is seen as white light (Figure 6.2).

The search for forensic evidence can sometimes require examination through the entire visible region (i.e. from 400 to 700 nm). It is important to understand that the human eye has limitations, the most important of which is restricted spectral sensitivity. From the spectral sensitivity curve (Figure 6.3), it can be seen that the human eye has the highest sensitivity around 550 nm (green/yellow region). Sensitivity is very low in the violet region, below 450 nm, and in the red region, above 650 nm. This should be taken into account when working at these wavelengths.

Sometimes quite useful forensic evidence is rejected as it does not ‘look good’ when observed with the naked eye. A typical example is a weak fingerprint in blood on a lightly coloured surface. Violet light can be used to enhance the print as blood has an absorption peak in this wavelength range. The human eye has a very low sensitivity in the violet region, and a fingerprint in blood may not ‘look good’ under these conditions. When photographed, however, an excellent image may be produced, as photographic film is very sensitive in this region. The film ‘sees’ the fingerprint very well under violet light, much better than the human eye.

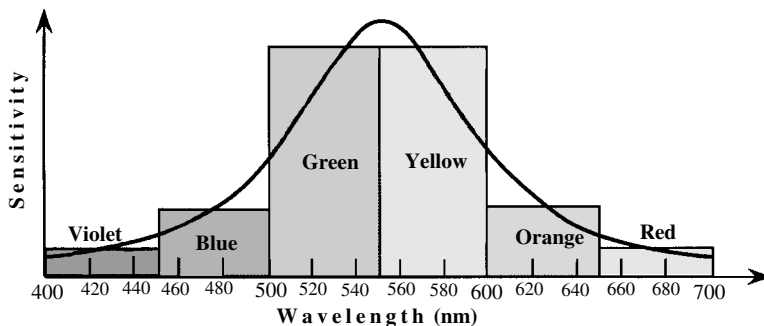

Figure 6.3 The spectral sensitivity of an average human eye

There are three principal modes of acquiring information from a surface or object using light. These are the *absorption mode*, the *diffused reflection mode* and the *photoluminescence mode*. The majority of illumination techniques used for evidence searching at a crime scene employ one of these three modes.

6.2.2 Absorption mode

The method of acquiring information from a surface based on colour difference (or ‘selective absorption’) is known as the absorption mode. A coloured object or stain can be readily visualised by enhancing the colour difference against the background substrate. A coloured band of light is chosen that is opposite to the colour of the object (or stain) in question. Enhancement will be achieved as the object will be ‘darkened’ due to selective absorption properties. For example, an orange stain on a blue surface can be enhanced by illuminating the surface with a blue band of light. The stain will appear dark against a light background. Alternatively, the surface can be illuminated with white light but visualised through a blue filter. The only requirement for enhancement is that the background and the object do not absorb at exactly the same wavelength (even if the colour is similar). The use of absorption and reflection properties of matter is the basis of ‘colorimetric’ techniques (techniques based on the measurement of colour). Such techniques are among the most practical, but are less sensitive than methods based on photoluminescence, which are described later.

As a general rule, the selection of a filter or a coloured incident light, to improve contrast, can be made with the aid of a colour wheel (Figure 6.4). Opposite (‘complementary’) colours on this wheel will darken the colour observed (i.e. increase the contrast) while adjacent colours will lighten the observed colour (i.e. reduce the contrast).

The absorption mode improves photographic contrast and is relatively simple to implement (Barker, 1999). It requires any white light source and a band pass filter compatible with an absorption band of the coloured object of interest. In simple terms, the band pass filter should be opposite in colour to the colour of the object, while being as close in colour to the background substrate as possible.

To illustrate the implementation of the absorption mode, consider a red fingerprint on a white surface. The simplest way to photographically enhance the print is to use the absorption mode. The absorption mode can be implemented in two ways: (i) with an

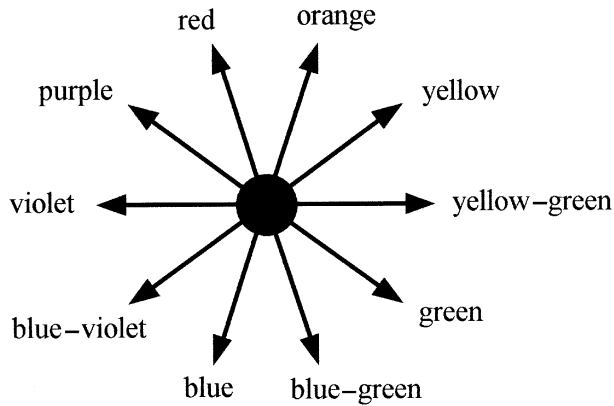

Figure 6.4 The ‘colour wheel’ can be used for the selection of a filter to improve contrast. Colours that are opposite on the wheel are complementary

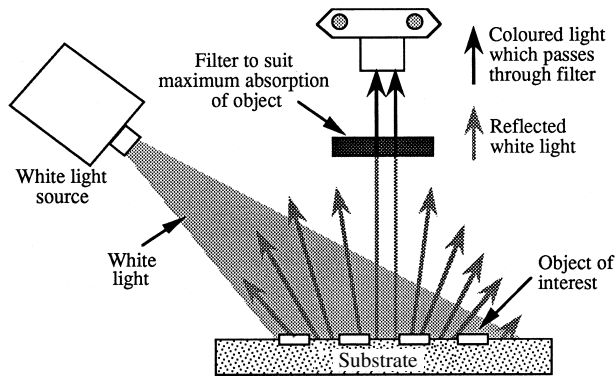

Figure 6.5 Schematic representation of the absorption mode with the appropriate filter used in front of the camera. This method can be used under full daylight or artificial light conditions

appropriate filter (a blue–green filter in this case) in front of the camera, or (ii) with the same filter in front of the light source. The filter used in front of the camera is known as the *barrier filter*. The method with a filter in front of the camera (Figure 6.5) can be used in all situations, even if daylight or artificial light is present. If an appropriate barrier filter is not available but is incorporated into the light source, the absorption mode can be implemented by using this band of light (Figure 6.6). In this latter case, the room must be darkened for optimum results.

Enhancement using the absorption mode may be unsuccessful if the surface is similar in colour to the object of interest. Changing the wavelength of the band of light may sometimes produce better results (a light source with fine tuning capabilities will be an advantage in such cases). If the colour of the object is pale, or the object appears transparent, the absorption mode may not offer satisfactory enhancement, and other modes should be exploited to achieve possible enhancement.

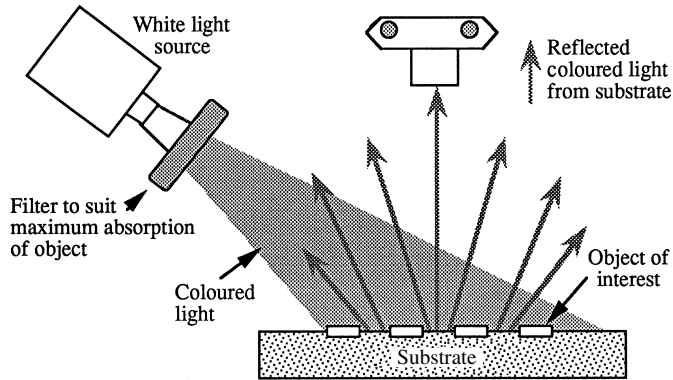

Figure 6.6 Schematic representation of the absorption mode with the appropriate filter in front of the light source. This method can only be used in dark or semi-dark situations

When working in the violet or red regions of the spectrum, it must be remembered that the human eye has low sensitivity at these wavelengths. Enhancement under such conditions may appear poor but will generally be significantly improved in any photographic images.

6.2.3 Diffused reflection mode

This method of acquiring information is based on diffused reflection from a rough object on a surface that is dark, or flat and shiny (Figure 6.7). When light is directed onto a rough surface, light is reflected back off the surface in all directions; this is known as *diffused reflection*. When light is directed onto a flat shiny surface, light is reflected at the same angle towards the normal as the angle of the incident light; this is known as *specular reflection*. In the case of a dark surface, the incident light will tend to be absorbed.

In the case of a rough object on either a dark or flat shiny surface, more diffusely reflected light from the object will reach the camera than reflected light from the

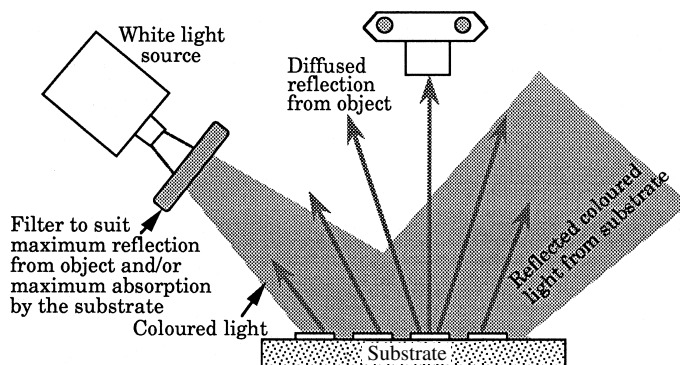

Figure 6.7 A schematic representation of the diffused reflection mode

surface. The object will therefore appear light against a dark background. This method can be used for the observation and photography of an object that is on top of, or indented into, a surface. Classical examples include a finger or footwear mark in blood on a dark or flat shiny surface, or a footwear impression in dust or greasy fingerprint on a smooth shiny surface. The light beam used for illumination should be directed at an angle to the surface (starting at 45° , then varying the angle as required) with the working area darkened.

In the case of a coloured object, a monochromatic light band of similar colour to the object should be used to enhance the diffused reflection. In the case of a coloured surface, a monochromatic light band with a colour opposite to the colour of the surface should be used to darken the surface (i.e. increase the contrast between the object and the surface). Oblique lighting (i.e. light beam almost parallel to the surface) is required in some cases (e.g. footwear impressions in dust or cyanoacrylate-developed fingerprints).

6.2.4 *Episcopic coaxial illumination*

Episcopic coaxial illumination is a special implementation of the diffusion reflection mode. The incident light is directed along the camera lens axis (i.e. perpendicular to the surface). This effect can be achieved by mounting a semi-transparent mirror (or flat piece of glass) in front of the camera at an angle of 45° towards the lens axis (Figure 6.8). The incident light beam is directed onto the mirror at an angle of 45° towards the mirror. To avoid 'hot' spots a diffuser is recommended in front of the light source. Part of the incident beam is reflected from the semi-transparent mirror and travels along the lens axis towards the exhibit. The other part of the incident beam passes through the mirror

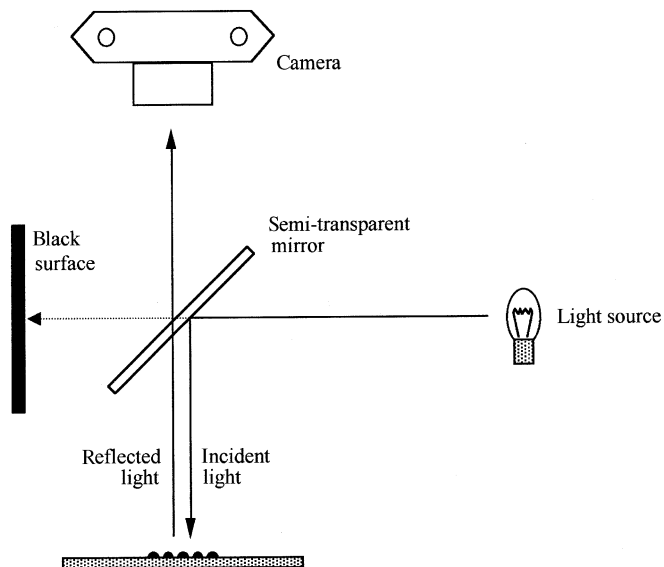

Figure 6.8 A schematic representation of episcopic coaxial illumination (Pfister, 1985)

and is trapped by a black surface. The incident light is reflected more from the flat surface (specular reflection) than from the ridges (diffused reflection) producing the opposite result to the conventional diffused reflection mode (i.e. a dark image against a light background). Episcopic coaxial illumination can be successfully used for photographing latent fingerprints, fingerprints in blood or cyanoacrylate-developed fingerprints on smooth shiny surfaces (e.g. glass, metal, plastic). The surface must be as flat as possible in order to obtain optimum results.

6.2.5 Photoluminescence mode

A photoluminescent object absorbs light at a particular wavelength and then re-emits the absorbed energy as light at a longer wavelength. Photoluminescence can occur as either ‘fluorescence’ (light emission only occurs during excitation) or ‘phosphorescence’ (light emission continues to occur for a short period after excitation). ‘Luminescence’ is a general term that incorporates phenomena such as thermoluminescence (light emission that results from the absorption of heat energy), bioluminescence (light emission from a biological process), chemiluminescence (light emission from a chemical process), as well as photoluminescence (light emission that results from the absorption of light energy). The correct term in the context of this chapter is therefore ‘photoluminescence’.

The photoluminescence mode is based on recording the photoluminescent emission from an object against a non-photoluminescent support. The sensitivity of detection is increased 100 fold or more compared to the absorption or diffused reflection modes. To implement the photoluminescence mode, two filters are necessary, one in front of the light source to suit the main absorption band of the photoluminescent object, and another in front of the eyes (or camera) to suit the emission wavelength (Figure 6.9). Under these conditions, the object will appear light against a dark background.

Due to the weak light emission that results, all observation and recording in this mode must be done under darkened conditions. In addition, the excitation source should be powerful and the barrier and excitation filters must be compatible (i.e. the barrier filter should not transmit any of the excitation light). Under ideal conditions, a photoluminescent object will produce a light image against a dark background (Figure 6.10).

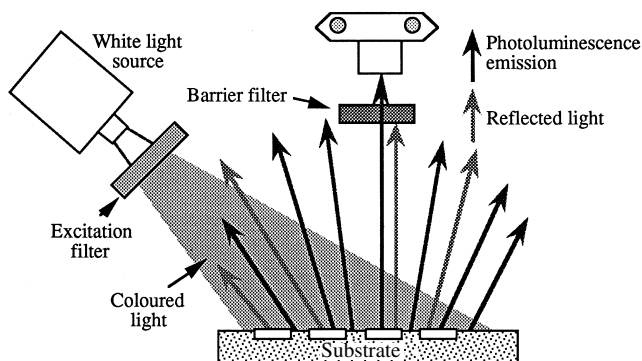

Figure 6.9 Typical arrangement for photoluminescence observation



Figure 6.10 A photograph of an 'ideal' photoluminescent fingerprint (light ridges against a dark background)

In reality, a substrate always shows some photoluminescence and the background may be more or less dark, but rarely black. The photoluminescence of the substrate has to be taken into account during recording, and conditions optimised, to obtain the best possible contrast.

The recording of photoluminescent objects is somewhat different to conventional photography. First, we are dealing with very weak light emission that is difficult to measure with conventional light meters. The low light levels require exposures much longer than one second, which is usually the longest automatic exposure time available with conventional cameras. Second, we are often dealing with small photoluminescent objects (e.g. fingerprint ridges) against a more or less dark background. When this weak light is averaged over 70 per cent of the frame (which most cameras use to measure the amount of light reaching the film) the camera's microchip reads this as being much fainter than is actually present. This can result in heavily overexposed images with blurred contours and loss of detail.

To avoid overexposure, the image frame should be composed in such a way that the photoluminescent object (e.g. fingerprint) occupies more than 70 per cent of the viewing field. Images should be recorded using a macro lens (for small objects) and an aperture setting of not less than f8 in order to obtain sharp photographic detail. When using a conventional camera, a minimum exposure time should be estimated, based on experience, and then a series of photographs taken, each time doubling the previous exposure time (e.g. 2, 4, 8, 16 and 32 seconds). Bracketing the exposures in this manner should provide at least one acceptable exposure.

Some cameras (e.g. Olympus OM-4) feature a light-off-the-film (LOTF) metering system. This metering system was developed for photography under very low light levels (e.g. starry nights). A LOTF camera has two metering systems, one for conventional photography (exposures up to one second) and another for low light photography (exposures over one second). The first light metering system is on all the time, but once the camera's microchip detects low light levels, it switches to the second light metering system. When the LOTF system is activated and the shutter opened, a light sensitive diode inside the camera measures the amount of light reflected off the film surface. The camera's microchip holds the shutter open until sufficient light has been received by the internal sensor. While not perfect, the system is well suited for the photography of

weak photoluminescent images requiring exposure times up to several minutes. A LOTF metering system alone is not a guarantee that correct exposures will always be obtained and it is therefore recommended that exposures be bracketed. This can be achieved by taking five exposures, with the exposure compensation dial on '0' (normal exposure), '+1' (2× exposure), '+2' (4× exposure), '-1' (½× exposure), and '-2' (¼× exposure).

As described earlier, the set-up for photography in the photoluminescence mode always incorporates a barrier filter to suit the emission band of the photoluminescent material. The film to be used should fulfil certain requirements – it should have adequate sensitivity, have a fine grain and exhibit a relatively 'flat' spectral sensitivity curve from at least 400 to 650 nm (preferably up to 700 nm). Colour film is generally not recommended, except to demonstrate the colour of the photoluminescence emission.

If high contrast is required, Kodak Technical Pan 2415 B&W film (or similar) is recommended. The spectral sensitivity of this film is quite wide, from 300 to nearly 700 nm. Light sensitivity can be varied from 25 to 400 ASA, and the contrast altered from very high to moderate, depending on the conditions and developer employed. The recommended sensitivity setting is 64 ASA, with development using Kodak HC-110 developer, dilution 'D', for 10 min at 20 °C.

For moderate contrast, Kodak T-Max 100 B&W film (or similar) is recommended. This film can be used from about 400 to nearly 650 nm, although a sharp fall in sensitivity occurs around 650 nm. For the photography of 'very red' photoluminescence emission (650–700 nm), the use of Kodak Technical Pan film is advised. T-Max film should be developed under the conditions recommended by Kodak. (Frair *et al.* (1989) proposed the use of Kodak T-Max 400 film for the recording of UV reflection and luminescence photographs.)

6.2.6 UV illumination techniques

A range of UV illumination techniques are available that can be generally classified as follows:

1. *UV-VIS photoluminescence* – illuminating the surface with UV light (short or long wavelength) while observing luminescence emission in the visible (VIS);
2. *UV-UV photoluminescence* – illuminating the surface with short-wavelength UV light (200–300 nm; UV 'B') while observing luminescence emission in the long-wavelength UV region (300–400 nm; UV 'A'); and
3. *UV reflection* – illuminating the surface with UV light (short or long wavelength) while observing light reflected in the same wavelength region (short- or long-wavelength UV).

Working with any UV illumination technique poses a number of hazards to the operator in addition to technical difficulties when recording results. The human eye is insensitive to UV light so any observation in the UV region cannot be achieved directly (a photographic or video camera is required). Due to its high energy, UV light can cause significant eye and skin damage so personal protection is required. Short-wavelength UV lamps generate ozone that can be hazardous to the operator. Glass absorbs short-wavelength UV light so any observation in this region cannot be achieved using conventional glass lenses – very expensive quartz components are required. (Glass also

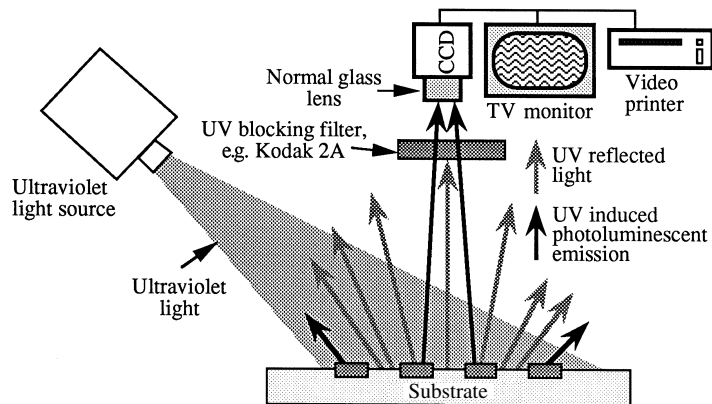

Figure 6.11 Typical set-up for the photoluminescence mode with excitation in the UV region and observation in the visible

absorbs a large proportion of long-wavelength UV light, so quartz objectives are also recommended when working in this region.) Conventional photographic film generally shows poor sensitivity below 400 nm. While these difficulties can be largely overcome, particularly with respect to recent technological advances, they have limited the widespread use of UV illumination techniques at the crime scene.

UV–VIS photoluminescence is the simplest mode to apply in that the observation of results is conducted in the visible region and therefore can be achieved with the naked eye. The technique can be used to locate items that are luminescent in the visible when illuminated with UV light. Optical brighteners used in textile fibres, paper and paint typically show strong photoluminescence emission under such conditions. Alternatively, the technique can be used to locate UV absorbing materials (e.g. blood) on highly luminescent surfaces. Photography (or video capture) should be conducted with a filter on the camera that transmits in the visible but blocks any reflected UV light (Figure 6.11).

UV–UV photoluminescence requires illumination of a surface with short-wavelength UV light. A photographic or video camera, fitted with a barrier filter that only transmits long-wavelength UV light, is required for image capture. It has been determined that a range of biological fluids (including latent fingerprint deposits) photoluminesce under such conditions. In general, photoluminescence emission in the UV is very weak and it is difficult to capture an image on conventional film or using a CCD camera. The problem can be overcome by either (a) using a CCD camera with image integration capabilities, or (b) using a light intensifier device in which case information is not acquired directly from the object but from the phosphor screen of the image intensifier.

UV reflection requires the use of either a short- or long-wavelength UV lamp and a photographic or video camera fitted with a barrier filter that only transmits in this region (i.e. either short- or long-wavelength UV) (Figure 6.12). It is important that only reflected light is recorded, not light re-emitted at longer wavelengths (i.e. photoluminescence emission). If light reflected in the short-wavelength region is being recorded, quartz objectives must be employed. Reflected UV techniques have been demonstrated to be effective for the visualisation of untreated fingermarks and footwear impressions, in addition to the recording of wounds or bruising on human skin.

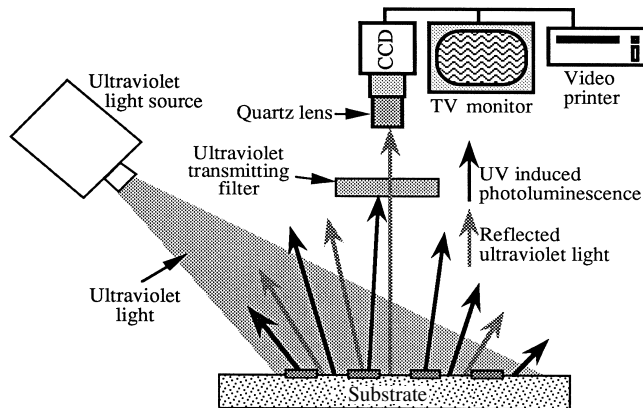

Figure 6.12 Implementation of the UV reflection mode

6.3 Forensic light sources

It is not the purpose of this section to compare the forensic light sources currently available on the market. Consideration will only be given to the basic requirements for a multipurpose light source designed for crime scene use. FLS needs to be portable, yet powerful enough for use under the non-ideal conditions typically encountered at a crime scene. To cover all potential crime scene applications, the light source must be versatile, offering a range of different light bands from the UV through to the red end of the visible spectrum. Ideally, these bands should be as narrow as possible (typically 30–50nm in width), while maintaining sufficient light intensity. This is particularly important if the photoluminescence mode is to be employed.

Since the late 1970s, lasers have been proposed for the detection and enhancement of a wide range of evidence types including latent fingermarks, footwear impressions, paint, fibres and biological stains (Creer, 1982). The LASER (Light Amplification by Stimulated Emission of Radiation) offers high light intensity and precisely delimited operating wavelengths (monochromatic laser lines). However, lasers tend to suffer from a lack of flexibility (for a given type of laser, only a limited number of wavelengths are available), and a relatively high cost (Watkin and Misner, 1990). Lasers were traditionally large, fixed laboratory instruments but are now available as portable units. During the 1980s, different research groups around the world independently developed non-laser light sources as more versatile, cost-effective alternatives to the laser (Stoilovic *et al.*, 1987; Watkin, 1987; Haylock, 1989). Comparisons between different light sources have been reported by a number of authors (Warrener *et al.*, 1983, Auvdel, 1988; Wilkinson and Watkin, 1994).

The 'alternate light sources' on the market are typically designed around a strong white-light source (e.g. xenon arc lamp) fitted with a range of filters that allow for the selection of a particular monochromatic band of light. The power of the light source and the characteristics of the filters (e.g. bandwidth and transmission at the centre wavelength) determine the light intensity. The quality of the filters (e.g. light

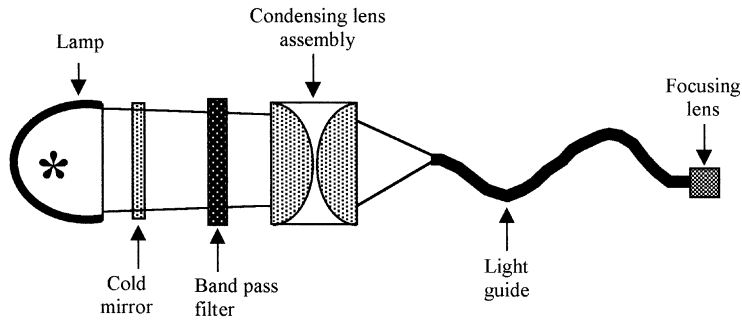

Figure 6.13 Schematic representation of an FLS

rejection outside the band pass region) is critical if optimum results are to be achieved. The use of high quality interference filters has the advantage that such filters can be tilted in the light path to shift the transmission band to shorter wavelengths. (This ‘fine-tuning’ capability can be particularly important in cases where background photoluminescence creates a contrast problem.) A schematic diagram of a typical non-laser FLS is given in Figure 6.13. The essential components are as follows:

1. Lamp – The lamp (light bulb) determines the initial power available and should be of a long-lasting type (e.g. arc lamp). The lamp output should adequately cover the UV and the entire visible spectrum. The minimum recommended power is 300 watts.
2. Cold mirror – A cold mirror is used to reject infrared radiation (heat) and transmit UV and visible light. The mirror should have a high transmittance in the UV and visible regions.
3. Band pass filters – Band pass filters determine the monochromatic bands of light that can be selected. The filters have to be of high quality, preferably multi-layer interference filters with an anti-reflective coating. The colour of a band is determined by the filter’s central wavelength (CW), while the half-bandwidth (HBW) and maximum transmission determine the purity and power. Requirements for higher purity of a band result in the lowering of the transmitted power. Therefore a compromise has to be made for each band.
4. Collimating lens assembly – The collimating lens assembly should focus the coloured light beam onto a small spot at the entrance of the light guide. The lens should be highly efficient with an anti-reflective coating.
5. Light guide – The light output should be delivered through a light guide so that the beam can be readily directed at an area of interest. Single-core liquid light guides (7–10 mm diameter) are favoured as they have a much higher transmission efficiency compared to fibre optic bundles. High transmittance is required from the UV through the entire visible region.
6. Focusing lens – A focusing lens at the end of light guide should be able to focus the light spot with sharp edges in order to achieve a uniform light field. Uniformity of

the light spot is of utmost importance for successful photography. It should be possible to focus the beam over a large area for rapid screening or over a small area (several square centimetres) for the photography of a small subject such as a photoluminescent fingerprint.

Before the recording of an object using illumination from an FLS, the light spot needs to be focused and its size correctly adjusted. The spot size is adjusted by varying the distance between the light guide and the object. The focusing can then be done with the lens attached to the end of the light guide. When photographing an object (e.g. fingerprint) it is important that the light spot covers the entire field of view of the camera, otherwise the automatic exposure will not be correct.

A dedicated forensic light source for crime scene applications should be able to provide a narrow band of intense light at any wavelength of interest to the investigator. The essential bands for an FLS are represented in Table 6.1. Other bands may be beneficial under particular circumstances. A list of recommended barrier filters and goggles is given in Table 6.2. Given the high intensity of light produced by modern light sources, suitable eye protection must be worn and precautions taken to ensure that the eyes are never directly exposed to the full intensity of the beam. Care must therefore be exercised when examining highly reflective surfaces using an FLS.

Table 6.1 Recommended output bands for an FLS

Central wavelength (nm)	Half bandwidth (nm)	Applications
White light	–	Visible fingermarks or stains, impressions in dust (oblique lighting), trace evidence on smooth surfaces (oblique lighting), general searching
350	50–80	latent fingerprints on UV luminescent surfaces, prints dusted with UV luminescent powder, semen, firearm discharge residues, textile fibres, paint flakes, lubricants
415	30–40	dried bloodstains, fingermarks in blood, semen stains, firearm discharge residues, textile fibres, lubricants
450	60–100	inherent fingerprint luminescence, general searching in the luminescence mode, semen stains, firearm discharge residues, textile fibres, lubricants
500	30–50	semen stains, firearm discharge residues, enhancement of metal salt treated ninhydrin prints (absorption mode)
550	30–50	semen stains, enhancement of ninhydrin prints (absorption mode)
600	30–50	enhancement of blood marks stained with amido black or fingerprints developed with iodine/benzoflavone (absorption mode)

Table 6.2 Recommended barrier filters and goggles for use with an FLS

Band pass filters	
Central wavelength (nm)	Half bandwidth (nm)
410–420	30–40
550–570	30–50
580–600	30–50
Long pass (cut-off) filters	
Edge wavelength (nm)	Colour
400–420	Clear
460–480	Yellow
490–520	Yellow
530–570	Orange
580–600	Red
620–650	Red
Goggles	
Edge wavelength (nm)	Colour
400–420	Clear
480–520	Yellow
560–580	Orange
600–650	Red

6.4 Application at the crime scene

6.4.1 General

A strong white light source can be used as a general search tool at a crime scene. Surfaces can be examined for visible evidence such as bloodstains, hairs and fibres, paint chips, and footwear impressions in dust. On smooth surfaces such as vinyl and wooden floors, kitchen benches and table tops, the use of oblique lighting (light beam nearly parallel to the surface) can be an effective search technique, particularly when performed under darkened conditions. Conventional evidence searching using a white light source has its limitations, however. Particular types of evidence are better visualised and recorded using specialised lighting techniques that may include selective absorption, photoluminescence and episodic coaxial illumination.

6.4.1.1 Absorption mode

When searching for evidence on coloured surfaces, it should be remembered that the use of coloured bands of light can significantly improve results. A band of light similar in colour to that of the surface will 'lighten' the surface making it easier to locate dark items of evidence (e.g. blood and hair). Alternatively, a band of light that is opposite in colour to that of the surface (selected using the colour wheel; [Figure 6.4](#)) will 'darken' the surface. This can be an advantage, for example, when using oblique lighting to locate impressions in dust. The best results are generally obtained when darkened conditions are employed.

6.4.1.2 *Photoluminescence mode*

As a search technique, the photoluminescence mode can be of significant use at a crime scene but darkened conditions (as dark as possible) are an absolute requirement if results are to be obtained. In addition, this mode requires patience and perseverance on the part of the crime scene examiner if all relevant surfaces are to be effectively scanned under this mode. Evidence such as semen and lubricant stains, textile fibres, firearm discharge residues and latent fingerprints are targeted by this method.

It is recommended to start scanning surfaces using a strong blue band from the light source (e.g. 450 nm) as an excitation beam. The operator should work in the dark, wearing yellow or orange goggles that act as cut-off (long pass) barrier filters. If a photoluminescent area (or item) of interest is located, it is wise to check other excitation bands on the light source to see if better photoluminescence can be induced (or to see if a photoluminescent background can be minimised). Sometimes the use of a band-pass barrier filter may be required to optimise results, particularly if the background emits strongly in the red. If a photograph is required (e.g. in the case of a photoluminescent finger mark), it is important that the best excitation/barrier filter combination is determined beforehand so that optimum results are obtained.

When working in the photoluminescence mode, excitation band/barrier filter compatibility is critical. The barrier filter should not transmit any significant amount of the excitation band otherwise weak photoluminescence emission from an item of evidence will not be detected. Similarly, weak photoluminescence emission cannot be observed if the scene is insufficiently darkened. After preliminary searching, it is recommended that portable items be returned to the laboratory for full examination under more ideal conditions.

6.4.1.3 *Episcopic coaxial illumination*

Some FLS manufacturers also provide a portable episcopic coaxial illumination accessory that can be used in conjunction with the light source. Such an accessory can be used for the location and recording of marks such as latent fingerprints (and fingerprints in blood) on smooth shiny surfaces such as glass, mirrors and polished timber. Best results are obtained on flat surfaces.

6.4.1.4 *UV illumination techniques*

Precautions must be taken when applying any UV illumination technique at the crime scene due to the dangerous nature of this form of radiation. The eyes must be protected at all times with UV absorbing goggles (or prescription glass). Bare skin must be covered when working with high intensities and long exposures times. Of the two forms of UV light, the short-wavelength region (200–300 nm; UV 'B') is more dangerous due to its higher energy. It is important to remember that, since UV light is not visible to the human eye, the user is not directly aware of its presence nor its intensity. When using a UV source at a crime scene, other examiners present must also be warned of the hazards and suitable precautions taken.

UV–VIS photoluminescence can be applied at the crime scene to locate items of evidence that absorb UV light and subsequently emit visible radiation. Examples

include some textile fibres (particularly those treated with optical brighteners or luminescent dyes), semen stains, and some firearm discharge residues. The technique can also be useful for the detection of non-luminescent marks (e.g. bloodstains) on luminescent surfaces (e.g. white painted surfaces). As with any photoluminescence technique, the crime scene must be darkened as much as possible if optimum results are to be obtained. When photographing the results, a filter must be fitted to the camera that rejects any reflected UV radiation and only transmits the visible emission.

UV–UV photoluminescence and UV reflection techniques require the use of an image capturing device that is sensitive to UV radiation. A number of portable units suitable for crime scene use have been developed and are available on the market. Surfaces can be scanned using these modes for the detection of latent fingerprints, footwear impressions and biological stains.

6.4.2 Footwear impressions

Two-dimensional footwear impressions in dust on smooth flat surfaces (e.g. ceramic tiles, vinyl and polished wooden floors) can be located and recorded using a strong white light source. A very oblique angle is required, with the light beam nearly parallel to the surface under examination (Figure 6.14). Light is diffusely reflected by the dust or other foreign material in the impression, giving a white image against a dark background. Best results are achieved if the scene is darkened. The technique is generally ineffective on rough, porous or textile surfaces (e.g. carpet).

While white light is best for general searching, a particular impression may be enhanced using a coloured band from the FLS, depending on the colour of the surface and the nature of the foreign material (dust, blood, etc.) making up the impression. It is generally recommended to use a light band that is opposite in colour to the surface; however, each coloured band available should be assessed to determine the most suitable for optimum contrast. Some success has been reported with the use of UV reflection techniques for the recording of footwear impressions on UV absorbing surfaces

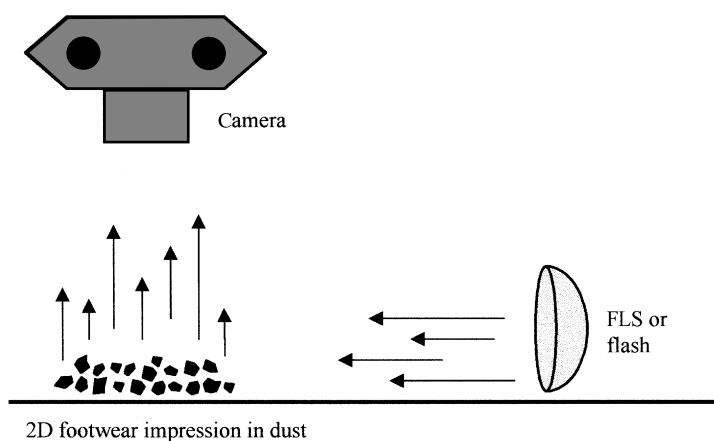

Figure 6.14 Use of oblique lighting to enhance two-dimensional footwear impressions in dust on smooth shiny surfaces (Adapted with permission from CRC Press, Bodziak, 1990.)

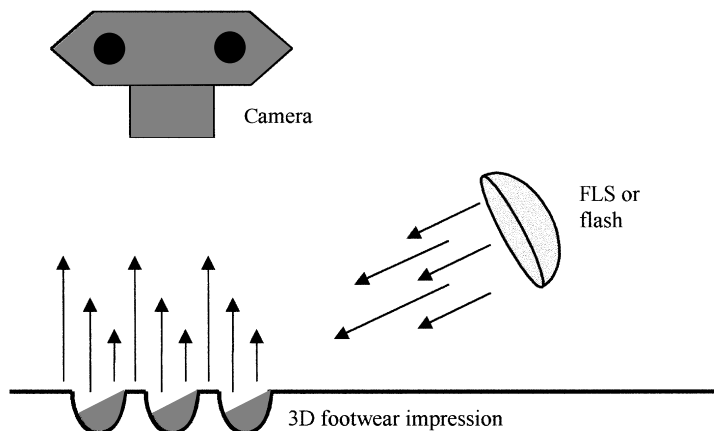

Figure 6.15 Use of oblique lighting to enhance three-dimensional footwear impressions in malleable material such as soil (Adapted with permission from CRC Press, Bodziak, 1990.)

(Krauss and Warlen, 1985; West *et al.*, 1990). If the impression is contaminated with a photoluminescent material (e.g. semen or lubricant), then the photoluminescence mode should be employed for photographic recording.

A footwear impression in blood may be enhanced using the UV–VIS photoluminescence mode (if the surface is luminescent under these conditions) or using a coloured band centred at approximately 415 nm as this is the wavelength of maximum absorption of dried blood. Alternatively, UV–UV photoluminescence may be employed if suitable UV imaging equipment is available.

For three-dimensional footwear impressions (in soil, for example), oblique lighting can be used to create shadows between the high and low areas of the imprint (Figure 6.15). The subsequent increase in contrast can assist with the recording of the fine detail contained in the impression. The deeper the impression, the higher above the ground the light source needs to be positioned. To capture all of the available details, a series of photographs should be taken with the light source at different angles and at various positions around the footwear impression (Bodziak, 1990). When photographing any footwear mark, it is critical that the plane of the film is parallel to the impression and a suitable scale placed in the field of view.

6.4.3 Fingerprint detection

As a general screening technique, a white light source should be employed to check all relevant surfaces at the scene for visible fingermarks. Oblique lighting may also assist with the detection of fingermarks in dust or greasy prints on smooth shiny surfaces. A general search of this nature will pinpoint areas for further examination using more specialised lighting conditions. It must be considered that not all prints detected under such conditions will respond to normal fingerprint detection techniques such as powdering or chemical treatment. It is therefore critical that any identifiable marks detected by optical means are photographed under optimum conditions before proceeding with conventional detection methods.

Visible fingermarks can occur when a surface is touched with fingers contaminated with a coloured material such as blood, ink or paint. Based on the colour of the contaminant, and the colour of the substrate, such fingermarks can be enhanced using the colour wheel (Figure 6.4) to select an appropriate wavelength band for illumination or observation. A versatile light source, offering a wide selection of light bands, can be a considerable advantage in that a relatively minor change in wavelength can sometimes significantly improve contrast.

Dried blood is a strongly absorbing material that has an absorption maximum at 415 nm (Stoilovic, 1991). A fingermark in blood can generally be enhanced in the absorption mode by either (a) using a white light source and a camera fitted with a 415 nm band pass filter, or (b) working in the dark with an FLS that provides a light band centred at 415 nm. If the surface also absorbs at this wavelength, better results may sometimes be obtained using another light band (e.g. 450 nm) where blood tends to diffusely reflect the radiation. (Further details on the detection and enhancement of blood marks can be found in the section of this chapter that deals specifically with blood.)

Indented (or moulded) fingerprints may occur in substances such as window putty. The photography of such impressions should be conducted using oblique lighting in the same way as for the enhancement of three-dimensional footwear impressions.

Latent fingermarks are the most difficult to detect in that, due to their very nature, they are essentially invisible under normal lighting conditions. The principal components of latent prints are the natural secretions (generally eccrine and sebaceous material) found on the inner surfaces of the hands.

Greasy fingermarks on flat shiny surfaces (such as glass, chrome-plated objects, mirrors, etc.) can often be detected using oblique lighting. However, the photography of such prints can be problematic. Episcopic coaxial illumination, using an FLS accessory provided by some manufacturers, can be very successful for the recording of this evidence.

An exhaustive search for latent fingermarks requires considerable patience and the skilled use of specialised lighting conditions. Some latent marks display inherent (natural) photoluminescence. This phenomenon, first reported by Dalrymple *et al.* (1977), prompted the use of high-powered lasers (e.g. 10 W argon-ion lasers) for the detection and enhancement of latent prints on a range of surfaces. In practice, only a small percentage of latent marks will display inherent luminescence, and this will typically be very weak, requiring a high intensity light source and ideal conditions for visualisation. A search for weakly photoluminescent marks must be conducted under darkened conditions – i.e. the crime scene must be made as dark as possible if optimum results are to be obtained. In addition, weakly luminescent marks can only be detected on surfaces that are not photoluminescent under the same conditions. Given that only a small percentage of latent fingermarks are photoluminescent, it is unlikely that this phenomenon is due to natural secretions. The photoluminescence emission is therefore more likely to be due to an environmental contaminant (e.g. lubricant, grease, food dye or ink residue). As a result, the optimum wavelength conditions can vary considerably between different marks.

The search for inherently luminescent fingermarks at a crime scene requires a high intensity FLS that can provide a strong light band in the blue region (e.g. 450 nm). The examiner, working in the dark, must wear suitable goggles (e.g. yellow or orange) that

absorb any reflected blue light but transmit any luminescence emission that occurs at longer wavelengths. Using the light guide of the FLS to provide a focused and relatively small spot size (typically less than 10 cm in diameter), the beam should be slowly moved over the surface of interest. A photoluminescent print will appear as light ridges against a dark surface as long as no significant background luminescence is present.

If a luminescent mark is located, different excitation bands should be evaluated to see if photoluminescence emission can be improved. If photography is justified, an appropriate barrier filter must be selected that optimises the contrast between the mark and the substrate. When selecting a barrier filter, it is critical that the transmission band of the filter does not overlap with the excitation band from the FLS. (This can be rapidly assessed by holding the barrier filter in front of the FLS light guide. If any light is transmitted, the two bands overlap and either a lower-wavelength excitation band, or a higher-wavelength barrier filter, is required.) Non-luminescent fingermarks can sometimes be detected on photoluminescent surfaces. The same searching techniques are employed as described above but, in this case, any detected marks will appear as dark ridges against a light background.

UV illumination techniques, requiring the use of a high-intensity UV source, can be very effective for the detection of latent fingermarks (Grasman, 1997). UV–VIS photoluminescence can sometimes detect non-luminescent marks on surfaces such as white painted walls that typically emit in the visible under UV excitation. As observation is conducted in the visible region of the spectrum, there are no special requirements other than UV absorbing goggles (or a UV absorbing barrier filter for photography). For both UV–UV photoluminescence and UV reflection techniques, a UV imaging camera is required if surfaces at the crime scene are to be searched for latent marks.

The detection of untreated latent prints using a commercially available reflective UV imaging system (RUVIS) has been described by a number of authors (West *et al.*, 1990; Keith and Runion, 1998). A latent fingerprint deposit diffusely reflects short-wave UV radiation. On a UV-absorbing surface, fingermarks can be visualised as light ridges against a dark background (i.e. more UV light is reflected from the ridges than from the surface itself). The position of the light source relative to the fingerprint is important; therefore, the examiner must be able to view the image in real time while adjusting the angle of incidence of the light beam and the distance between the UV light source and the object. This can be achieved using a UV image intensifier. Short-wave UV reflection photography of latent fingermarks has been described by Gui Qiang (1996).

UV–UV luminescence (i.e. short-wave UV excitation, long-wave UV emission) has been reported in recent years as a sensitive, non-destructive technique for the detection of latent fingerprint deposits and other bodily secretions (Bramble *et al.*, 1993; Springer *et al.*, 1994; Bramble, 1995, 1996; Ben Yosef *et al.*, 1998). An effective light source for this application was found to be a frequency quadrupled Nd:YAG laser operating at 266 nm. Johnson *et al.* (1991) determined that approximately 80 per cent of the observed photoluminescence emission in the long-wave UV region can be attributed to the tyrosine and tryptophan content of the fingerprint deposit. Despite the successful research in this area, further work is required to develop more flexible, field operable systems for routine crime scene application (Ben Yosef *et al.*, 1998).

6.4.4 Biological evidence

6.4.4.1 General

On most surfaces, blood stains can be detected using the absorption mode due to the fact that dried blood strongly absorbs at most wavelengths. Other dried body fluids, such as semen, saliva, urine and sweat, exhibit photoluminescence properties and are best detected using the luminescence mode. In this case, general searching of a crime scene must be conducted under darkened conditions using a strong blue light source (e.g. 450nm) and an appropriate barrier filter (e.g. yellow or orange goggles). Depending on the substrate and the nature of the biological stain, excitation at other wavelengths (e.g. violet or UV light bands) may produce better results. Interference problems may arise if the surface to be searched is also luminescent under the same conditions.

Auvdel (1987) compared the capabilities of UV and laser light sources for the luminescence detection of serial dilutions of semen, saliva and sweat on cloth substrates. The laser, in comparison with UV light, was shown to be more effective as a screening tool for the detection of body fluid stains. In a later article, Auvdel (1988) reported on a comparison between two different lasers and a filtered high-intensity arc lamp for the detection of semen, saliva and sweat deposits. It was determined that the filtered arc lamp had a better detection rate for the stains examined and had the additional advantage of increased portability over a high-powered laser.

Springer *et al.* (1994) reported that dry stains of blood, semen and saliva invisible to the naked eye could be detected using UV–UV photoluminescence. All three body fluids were found to be readily observed by their bright luminescence emission in the long UV upon illumination at 266nm using a frequency quadrupled Nd:YAG laser. However, the technique currently lacks feasibility for use at crime scenes due to the lack of proper portable light sources and detection systems. Research is under way to develop more portable units that could be adapted for field use (Ben Yosef *et al.*, 1998).

An important consideration when using UV illumination techniques for the detection of biological evidence is that short-wavelength UV radiation can compromise subsequent DNA profiling (Anderson and Bramble, 1997).

Craig and Vezaro (1998) found that bone and tooth fragments luminescence strongly when excited in the violet–blue–green region using a forensic light source. The luminescence emission is best viewed through orange goggles, with a search for bone and tooth fragments being conducted in a darkened environment.

6.4.4.2 Blood

Although dried blood has a broad absorption spectrum in the entire light region (UV–visible–IR), it exhibits a distinctive strong absorption maximum around 415 nm (Figure 6.16, Stoilovic, 1991). The location and recording of untreated blood marks can be performed using either the absorption or diffused reflection mode. The absorption mode is recommended for lightly coloured or luminescent surfaces, while the diffused reflection mode is recommended for dark or shiny surfaces.

For lightly coloured or luminescent surfaces, the absorption mode can be applied utilising the 415 nm blood absorption band. In this wavelength region, lightly coloured or luminescent surfaces will be seen as a bright background while any blood will

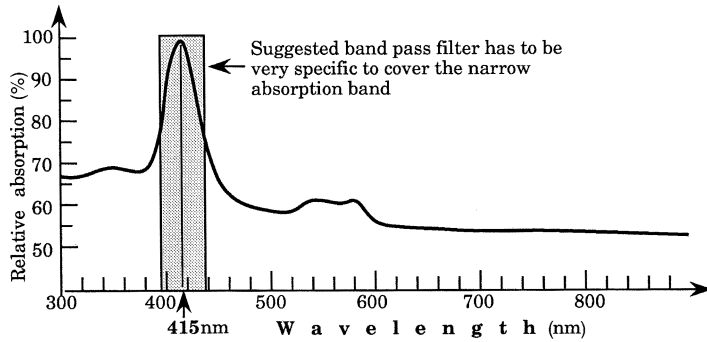

Figure 6.16 Absorption spectrum of untreated dry blood

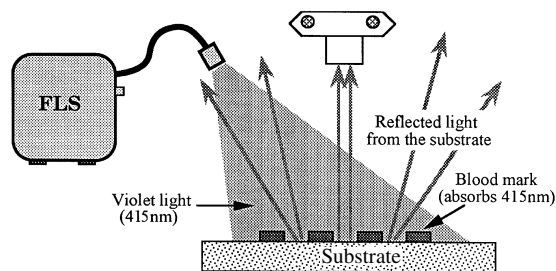

Figure 6.17 Recording of blood marks under darkened conditions

absorb strongly producing good contrast. If the scene can be darkened, a search for blood marks may be conducted using a light source providing a violet band centred at approximately 415 nm (Figure 6.17). It must be remembered that the human eye is relatively insensitive in the violet region and an adaptation time from 5 to 10 min is required before any detailed examination is performed.

Under conditions of full daylight or artificial light, the recording of blood marks on lightly coloured surfaces can be conducted using a white light source and a violet band pass filter, centred at approximately 415 nm, fitted to the camera (Figure 6.18).

In the case of a shiny or dark coloured surface, the diffused reflection mode should be employed (Figure 6.19). A wavelength band from the FLS is selected that will be diffusely reflected by the dried blood while being either strongly absorbed or specularly reflected by the surface. (A blue band centred at approximately 450 nm has been found to produce good results on a range of surfaces.) Working under darkened conditions, the blood mark is observed perpendicular to the surface, without any barrier filter. The incident angle of the light from the FLS should be varied to obtain the best contrast. Dried blood will appear light against a dark background. In the case of a coloured surface, selecting a light band opposite in colour to the substrate colour will generally enhance the contrast.

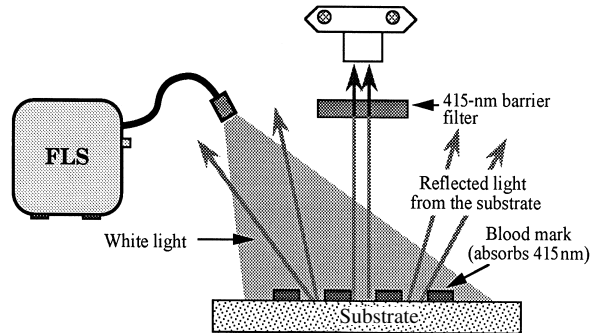

Figure 6.18 Recording of blood marks under conditions of full daylight or artificial light

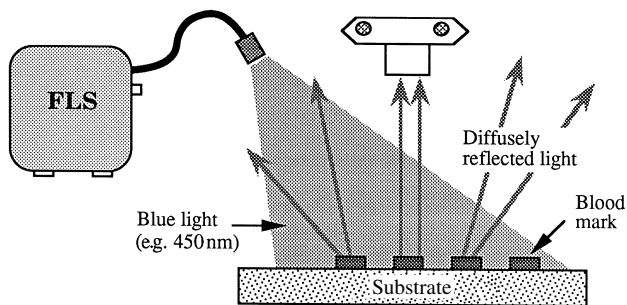

Figure 6.19 Diffused reflection mode for the recording of blood marks on shiny or dark coloured surfaces. This mode can be implemented only under darkened conditions

6.4.4.3 Semen

Untreated semen shows very strong photoluminescence qualities (Stoilovic, 1991). This property of semen stains, used in conjunction with a suitable FLS, can be exploited for the rapid screening of a crime scene or object. Photoluminescence spectra for untreated semen are given in [Figure 6.20](#) (Stoilovic, 1991). The photoluminescence can be excited over a broad range, from UV (300 nm) through to green (530 nm), with a maximum excitation around 400 nm. The emission maximum is dependent on the excitation wavelength. A recommended protocol for semen detection is given in [Figure 6.21](#). Note that this is a screening process only, and is not conclusive for the presence of semen. Further biological testing is required for confirmation of the presence of semen.

6.4.5 Miscellaneous evidence

6.4.5.1 Textile fibres

Textile fibres can be readily detected on smooth shiny surfaces (e.g. polished wooden or vinyl flooring) using oblique white light, with the light beam positioned nearly parallel to the surface. This technique works best if the scene can be darkened.

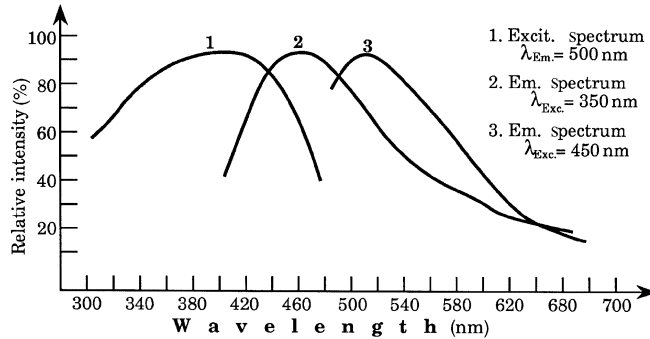

Figure 6.20 Excitation and emission spectra for a typical untreated semen stain.
 1. Excitation spectrum, 2. Emission spectrum (350 nm excitation), 3. Emission spectrum (450 nm excitation)

A large percentage of textile fibres photoluminesce under certain conditions, due to the presence of either optical brighteners (e.g. in white cotton) or fluorescent dyes or pigments. If the scene can be darkened, a search conducted with a UV light source can often detect textile fibres that may be relevant to the incident under investigation. Some fibres luminesce strongly under visible excitation, such as with a strong blue band (e.g. 450 nm) from an FLS. In this case, the operator must wear yellow or orange goggles as a barrier filter to detect any photoluminescence emission. Often fibres can be differentiated based on the colour of the emission as seen through the goggles. In this way, a specific search can be conducted after excitation/observation conditions have been optimised for the target fibre in question.

6.4.5.2 Firearm discharge residues

Most ammunition types, when discharged within a short distance from an object (up to approximately 1 m), will deposit relatively large unburnt or semi-burnt propellant particles on the target. These particles typically show weak photoluminescence properties. Examples of excitation and emission spectra for semi-burnt propellant particles from three brands of ammunition are given in [Figures 6.22](#) and [6.23](#). The detection of firearm discharge residues can therefore be conducted using the photoluminescence mode. Due to the weak nature of the photoluminescence emission, the scene should be made as dark as possible. A recommended protocol for the luminescence detection of propellant residues on a range of surfaces is given in [Figure 6.24](#). Surfaces should be examined with great care as such particles are readily lost or redistributed. A particular distribution of propellant particles may be significant and therefore photographs should be taken before collection of the item for transport to the laboratory.

6.4.5.3 Lubricants

The general search of a crime scene or object using a strong blue light source (e.g. 450 nm) and a suitable barrier filter (e.g. yellow or orange goggles) can sometimes

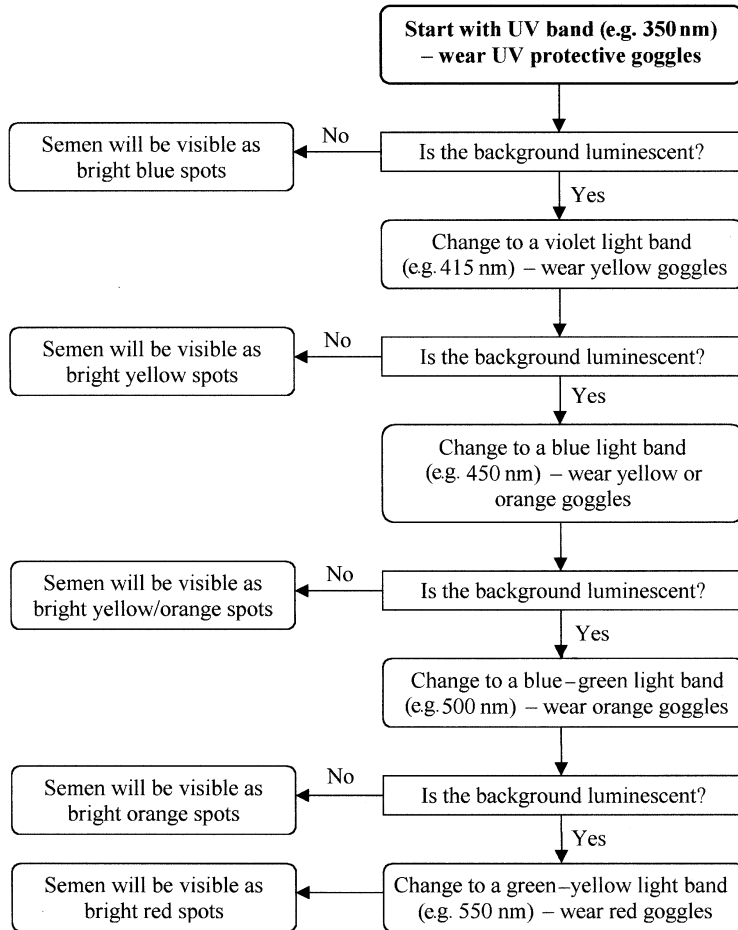

Figure 6.21 Recommended procedure for the detection of dry semen stains

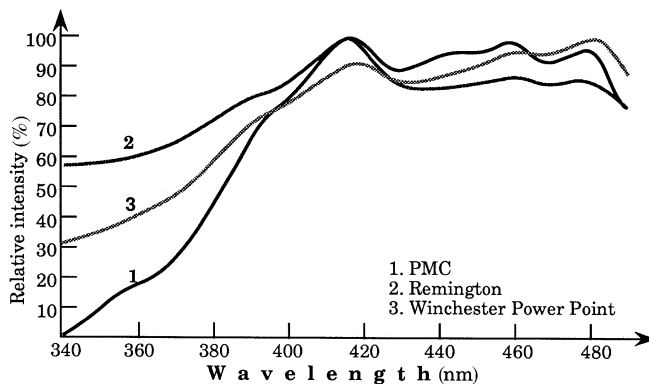

Figure 6.22 Typical excitation spectra for semi-burnt propellant particles

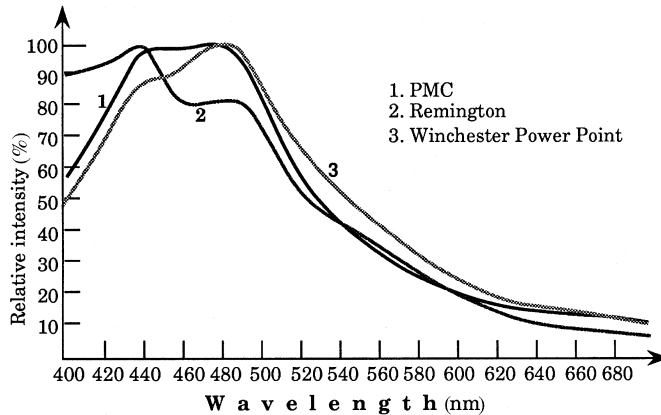

Figure 6.23 Typical emission spectra for semi-burnt propellant particles

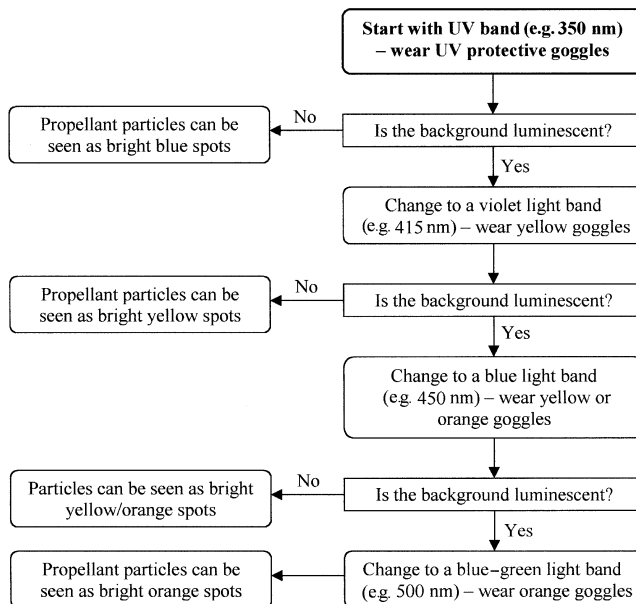

Figure 6.24 Recommended procedure for the detection of firearm discharge residues

reveal grease or lubricant stains. Such stains are generally photoluminescent under these conditions. If a luminescent stain is detected, excitation and observation conditions should be optimised (i.e. the intensity of the emission maximised) so that photographic recording or continued searching is more efficient.

6.5 Conclusions

A wide range of forensic light sources is now available on the market. Ideally, a light source for crime scene use should have adequate portability, a high intensity output,

and be versatile enough to provide a wide selection of wavelength bands. When used correctly, a light source of this type can provide a simple, effective and non-destructive method for the location and recording of numerous types of forensic evidence. Portable lasers, filtered arc lamps and UV light sources can all be employed as screening devices at a crime scene. The seriousness of the crime and the nature of the forensic evidence likely to be present should dictate the extent to which specialised illumination techniques are employed.

6.6 Note

The figures in this chapter, unless otherwise indicated, are reprinted with permission from the Australian Federal Police.

6.7 Bibliography

- Anderson, J. and Bramble, S. K. (1997) The effects of fingerprint enhancement light sources on subsequent PCR-STR DNA analysis of fresh bloodstains, *Journal of Forensic Sciences*, **42**, 303–6.
- Auvdel, M. J. (1987) Comparison of laser and ultraviolet techniques used in the detection of body secretions, *Journal of Forensic Sciences*, **32**, 326–45.
- Auvdel, M. J. (1988) Comparison of laser and high-intensity quartz arc tubes in the detection of body secretions, *Journal of Forensic Sciences*, **33**, 929–45.
- Barker, D. A. (1999) Contrast from the past, *Journal of Forensic Identification*, **49**, 589–93.
- Ben Yosef, N., Almog, J., Frank, A., Springer, E. and Cantu, A. A. (1998) Short UV luminescence for forensic applications: Design of a real-time observation system for detection of latent fingerprints and body fluids, *Journal of Forensic Sciences*, **43**, 299–304.
- Bodziak, W. J. (1990) *Footwear Impression Evidence*, New York: Elsevier.
- Bradford, B. (1997) High intensity light sources in the detection of markings on commercial vehicles, *Science and Justice*, **37**, 275–8.
- Bramble, S. K. (1995) Separation of latent fingerprint residue by thin-layer chromatography, *Journal of Forensic Sciences*, **40**, 969–75.
- Bramble, S. K. (1996) Fluorescence spectroscopy as an aid to imaging latent fingerprints in the ultraviolet, *Journal of Forensic Sciences*, **41**, 1038–41.
- Bramble, S. K., Creer, K. E., Gui Qiang, W. and Sheard, B. (1993) Ultraviolet luminescence from latent fingerprints, *Forensic Science International*, **59**, 3–14.
- Craig, E. A. and Vezaro, N. (1998) Use of an alternate light source to locate bone and tooth fragments, *Journal of Forensic Identification*, **48**, 451–8.
- Creer, K. E. (1982) Some applications of an argon ion laser in forensic science, *Forensic Science International*, **20**, 179–90.
- Creer, K. E. (1996) The detection and enhancement of latent marks using specialised lighting and imaging techniques, in Almog and Springer (eds), *Proceedings of the International Symposium on Fingerprint Detection and Identification*, pp. 25–35, Jerusalem: Israel National Police.
- Creer, K. E. and Brennan, J. S. (1987) The work of the serious crimes unit, in *Proceedings of the International Forensic Symposium on Latent Prints*, pp. 91–9, Washington: Federal Bureau of Investigation.
- Dalrymple, B. E., Duff, J. M. and Menzel, E. R. (1977) Inherent fingerprint luminescence – detection by laser, *Journal of Forensic Sciences*, **2**, 106–15.

- Frair, J. A., West, M. H. and Davies, J. E. (1989) A new film for ultraviolet photography, *Journal of Forensic Sciences*, **34**, 234–8.
- Fraval, H., Bennett, A. and Springer, E. (1996) UV detection of untreated latent fingerprints, in Almog and Springer (eds), *Proceedings of the International Symposium on Fingerprint Detection and Identification*, pp. 51–8, Jerusalem: Israel National Police.
- German, E. R. (1996) Reflected ultraviolet imaging system applications, in Almog and Springer (eds), *Proceedings of the International Symposium on Fingerprint Detection and Identification*, pp. 115–18, Jerusalem: Israel National Police.
- Grasman, H. J. (1997) New fingerprint technology boosts odds in fight against terrorism, *The Police Chief*, January, 23–8.
- Gui Qiang, W. (1996) Detecting and enhancing latent fingerprints with short wave UV reflection photography, in Almog and Springer (eds), *Proceedings of the International Symposium on Fingerprint Detection and Identification*, pp. 37–49, Jerusalem: Israel National Police.
- Haylock, S. E. (1989) The light fantastic, *Fingerprint Whorld*, **14**(56), 113–15.
- Johnson, G. A., Creaser, C. S. and Sodeau, J. R. (1991) Fluorescence spectroscopic and HPLC studies of intrinsic fingerprint residues, in Davies and Creaser (eds), *Analytical Applications of Spectroscopy II*, Proceedings of an International Conference on Spectroscopy, pp. 207–12, Cambridge: Royal Society of Chemistry.
- Keith, L. V. and Runion, W. (1998) Short-wave UV imaging casework applications, *Journal of Forensic Identification*, **48**, 563–9.
- Krauss, T. C. and Warlen, S. C. (1985) The forensic science use of reflective ultraviolet photography, *Journal of Forensic Sciences*, **30**, 262–8.
- Menzel, E. R. (1987) Laser fingerprint detection and development, in *Proceedings of the International Forensic Symposium on Latent Prints*, pp. 25–38, Washington: Federal Bureau of Investigation.
- Pfister, R. (1985) The optical revelation of latent fingerprints, *Fingerprint Whorld*, **10**(39), 64–70.
- Springer, E., Almog, J., Frank, A., Ziv, Z., Bergman, P. and Gui Qiang, W. (1994) Detection of dry body fluids by inherent short wavelength UV luminescence: preliminary results, *Forensic Science International*, **66**, 89–94.
- Stoilovic, M. (1991) Detection of semen and blood stains using Polilight as a light source, *Forensic Science International*, **51**, 289–96.
- Stoilovic, M., Warrenner, R. N., Margot, P. and Lennard, C. J. (1987) Design of a versatile light source for fingerprint detection and enhancement, in *Proceedings of the International Forensic Symposium on Latent Prints*, pp. 153–4, Washington: Federal Bureau of Investigation.
- Warrenner, R. N., Kobus, H. J. and Stoilovic, M. (1983) An evaluation of the reagent NBD chloride for the production of luminescent fingerprints on paper: I. Support for a xenon arc lamp being a cheaper alternative to an argon ion laser as an excitation source, *Forensic Science International*, **23**, 179–88.
- Watkin, J. E. (1987) Alternative lighting methods of detecting latent prints, in *Proceedings of the International Forensic Symposium on Latent Prints*, pp. 39–44, Washington: Federal Bureau of Investigation.
- Watkin, J. E. and Misner, A. H. (1990) Fluorescence and crime scenes in the 90s, *RCMP Gazette*, **52**(9), 1–5.
- West, M. H., Barsley, R. E., Frair, J. and Hall, F. (1990) Reflective ultraviolet imaging system (RUVIS) and the detection of trace evidence and wounds on human skin, *Journal of Forensic Identification*, **40**, 249–55.
- Wilkinson, D. A. and Watkin, J. E. (1994) A comparison of the forensic light sources; Polilight, Luma-Lite, and Spectrum 9000, *Journal of Forensic Identification*, **44**, 632–51.
- Yosef, N. B., Almog, J., Frank, A., Springer, E. and Cantu, A. A. (1998) Short UV luminescence for forensic applications: design of a real-time observation system for detection of latent fingerprints and body fluids, *Journal of Forensic Sciences*, **43**, 299–304.

Crime scene photography

John Horswell

7.1 Introduction

It is not my intention to provide the reader with a chapter on the use of cameras, as this is a separate subject, which is more than adequately covered in a book, which I have referenced in Section 7.9. It is assumed that the reader will already have some knowledge of photography.

It is not my intention to cover all aspects of Forensic Photography, as the reader will benefit from [Chapter 8](#). What I do want to do is to define crime scene photography and focus on how it is applied at the scene. I will complete the chapter with a discussion on the emerging use of digital cameras in crime scene recording.

7.2 Background

Cameras have been used in the policing and law enforcement environment since the inception of photography.

Crime scenes are photographically recorded so that the primary crime scene, including secondary crime scenes as well as suspects and victims, and items of potential physical evidence can be:

- *reassembled* during the investigative process;
- *reviewed* by investigators and the principle actors;
- *reinspected* by all stakeholders in the investigation and prosecution processes;
- *relocated* to the courtroom;
- *recreated* in the courtroom;
- *retold* by witnesses; and
- *reconstructed* by witnesses.

7.3 Crime scene photography

Photographs provide a detailed record of the condition of a crime scene illustrating the items present and their relative locations. For this reason, photographs should be taken before items are moved or interfered with, and should be taken from varying angles. Reconstruction of items within the scene to be photographed should not be attempted.

There may be items shown in the photographs, which were not mentioned, in the written notes taken at the time, and the photographs may help to refresh the crime scene investigator's memory on some aspect of the crime scene or its examination.

On the other hand however, during court hearings, defence counsel may, during cross-examination, question the crime scene investigator about objects shown in the photographs, and if there are no notes about the items it may prove embarrassing. For this reason, it is important not to rely too heavily on photographs; therefore, the crime scene investigator should ensure there are ample written notes as well.

The general survey procedure will help determine what photographs will be required and the sequence in which they are taken. As a rule the crime scene should be photographed after the general survey and before any further examination is made without reconstructing the scene in any way. The crime scene investigator should be able to demonstrate photographically how the scene existed prior to the commencement of the scene investigation.

The 6×6/6×7 cm or 120 roll film camera is ideal for recording toolmarks, shoe impressions and tyretracks. The Mamiya[®] Camera is a popular large format camera; however, these cameras are heavy and therefore better used with a tripod. This is also an excellent format for use during post-mortem examination for recording injuries that may be present on the deceased.

The 35 mm single lens reflex (SLR) camera is the workhorse of the crime scene investigator – a good all round camera for scene work and the recording of fingerprints.

During my 14 years as a crime scene investigator I used both the Mamiya[®] RB67 6×7 cm format camera and the Nikon[®] F3 SLR Camera. I know that there have been advances made on these early model cameras; however, for the broad photographic requirements of crime scene photography you would not find better all round robust cameras.

Before commencing the photographic aspect of the crime scene investigation it must be remembered that photographs should not include artefacts introduced by the crime scene investigator and other investigators. Briefcases, clipboards, photographic equipment bags, crime scene kits or the photographer's feet should not feature in any of the photographs.

Each crime scene will be different but the following should be considered:

- The photographic record should be comprehensive and should include the general layout of premises or features of an area. This will depend on the seriousness and circumstances of the crime.
- The photographic record should illustrate the relative position of rooms, the state of those rooms and the position of houses in streets in relation to the crime scene.
- Footprints, shoemarks, tyretracks and toolmarks should be photographed with a scale before casting. A close-up and positioning photograph should be taken.
- Photographs should be taken from a number of angles, or positions including those described by witnesses.

- A series of photographs should be taken from the point of entry to the point of exit.
- Detailed photographs should be taken of potential evidentiary material, such as, the body; injuries, weapons; trace material; cartridge case/s; damage and other relevant items.
- As the scene examination progresses, further photographs should include new potential evidentiary material found and visualised, or areas of importance which were previously concealed.

Before taking any photographs the crime scene investigator must answer the following questions:

- What am I going to photograph?
- Why should it be photographed?
- What do I want to demonstrate using photography?
- How can I record it as I see it?

Having made these comments it is necessary to cover all pertinent material. It is wiser to take too many photographs than too few. It must, however, be remembered that it is not necessary to have all the negatives printed. This should create no problem in court as long as the investigating officer is aware of the situation. It may also be necessary in some jurisdictions to advise the defence of their existence, and one way to cover this point is to have the investigating officer select the photographs he wants from proof sheets. The crime scene investigator should be prepared to defend his/her selection of the photographs later in court (see Table 7.1). See Figures 7.1–7.10 for some examples of crime scene photography.



Figure 7.1 Deceased showing tentative cuts to the neck and major chest wound which caused his death – note the map of Australia in reverse which was tattooed by the deceased whilst looking onto a mirror when he was a prisoner in goal

Table 7.1 Crime scene photographic log sheet

Sequential frame number	Case file number	Photographic view	Photographer's initials
1			
2			
3			
4			
5			
6			
7			
8			
9			
10			
11			
12			
13			
14			
15			
16			
17			
18			
19			
20			
21			
22			
23			
24			
25			
26			
27			
28			
29			
30			
31			
32			
33			
34			
35			
36			

Photographer
Number of Frames Taken
Date
Incident **Place**



Figure 7.2 Deceased as a result of suicide – note the firearm *in situ* and a blood droplet, which has fallen whilst the deceased was sitting upright



Figure 7.3 View of an undisturbed shallow grave holding the victim of a homicide. The victim was dragged some distance and buried as you see



Figure 7.4 View of a deceased person who had been buried in sand for a considerable number of years. In these cases finding the cause of death can be difficult if not impossible



Figure 7.5 View of a deceased who fell on caravan annex ties and remained there deceased



Figure 7.6 View of a deceased who committed suicide and remained unfound in the wet tropics for several days. You can see the decomposition, fly activity, and bloating



Figure 7.7 View of a deceased who was left unfound for five days in the hot dry inland of Australia. In this case mummification can be seen



Figure 7.8 View of a life subject who was shot in the back using a shotgun. Photograph of the X-ray shows shot distribution. This was crucial in determining distance between forearm and victim

7.4 Video recording of the scene

It is useful to video the crime scene, as it may become an invaluable briefing tool for investigators and others to view later as well as to introduce as potential evidence in court.

The recording of a crime scene by video should be undertaken in each serious and major crime. Experience has shown that the video of any crime scene should be taken without sound. The crime scene investigator or investigating officer, either in person or by means of what is referred to as a 'voice over', should guide the subsequent audiences that view the video, through it.

The video recording of what is referred to, as a 're-enactment' should be attempted only after the suspect has been interviewed and only after an invitation has been made which the suspect accepts with the video being taken whilst the suspect is under caution. Experience has shown this to be a very successful tool in presenting the prosecution case in court. The court will also be able to see if the suspect is under stress or duress at the time of the re-enactment video along with his/her general demeanour and that of the



Figure 7.9 View of an X-ray of a deformed humerus. You can also see shot pellets still lodged in the upper section. The subject was a difficult identification in that his remains were severely burnt in a 'bush fire'. This clinched his identification after numerous enquiries

interviewing officer. Experience has shown that powerful evidence can be gained from using this technique.

The video recording of a crime scene should be under the direct control and guidance of the crime scene investigator or crime scene manager as it is only these individuals who are aware of the current position regarding the processing by recording, search and recovery of potential evidentiary material at the crime scene.

7.5 Digital photography

Digital photography is not popular as an alternative to silver halide images at this time for recording crime scenes as the image can be altered. There are issues regarding the archiving of photographic images electronically. However, many systems are being developed with an inbuilt 'audit trail' to overcome the proof of authenticity. Software programs have also been developed, which, in all likelihood will still be here in years to come when the retrieval of stored images may be an issue. Having said this,

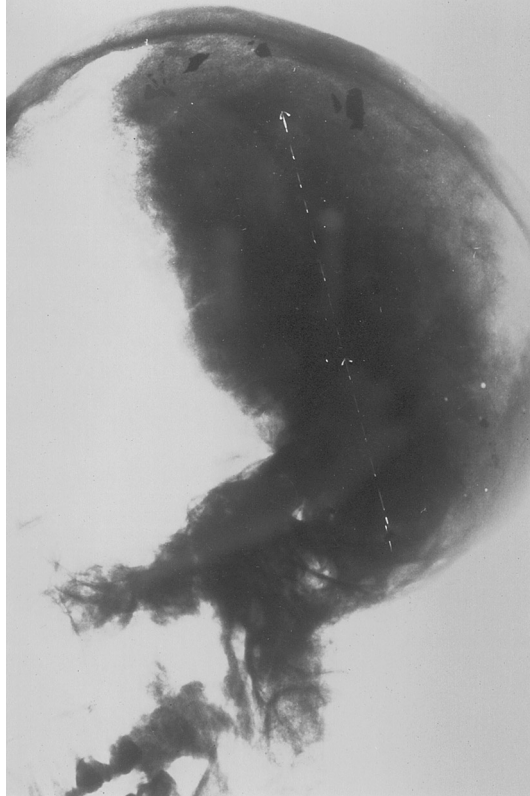

Figure 7.10 View of an X-ray of a deceased skull. What can be seen are the remnants of a lead projectile and the entry wound. The direction of travel can be reconstructed from photographs such as this

there is every likelihood that digital imaging will overtake the more traditional recording methods in the future.

This medium is also a useful investigative tool, which can facilitate in the movement or shipment of an image of an item from one place to another as an attachment to an e-mail message. It may also be used in the recording and movement of arrested person photographs. The Japanese National Police agency use digital images for arrested persons and for circulation of suspect persons throughout Japan.

This medium may also come into its own in the presentation of evidence in court. Courts are already using CD-ROM technology as a means of presenting evidence. This includes statements, photographs and drawings. In addition, virtual reality crime scene footage is also being used to present the crime scene to the court.

Crime scene investigators should be aware of the potential for use as an aid to a forensic investigation. As this book goes to press there are police jurisdictions in Australia using Digital Photography in Crime Scene Investigation, my former organisation is one of them. Other jurisdictions are following the lead. I am currently using this medium exclusively as a private practitioner. I look forward to reading any debate on this issue in coming courts cases.

7.6 Legal aspects

There have been a number of cited cases in Australia, which have laid the groundwork for the routine implementation of crime scene photography. As police organisations in earlier years have been very conservative, these cases have provided a platform and reference for the routine use of photography in crime scene investigation and ultimately the introduction of photographs into evidence in court proceedings.

7.6.1 *Graphic photographs of deceased persons*

In the matter of *Green v. the King* (1939) in the Supreme Court of Victoria, the learned judge, *Lowe J.* allowed several photographs taken during the scene investigation to be admitted into evidence. The photographs showed the bodies of two victims lying in the rooms at the time of their first discovery. The defence objected to the entry into evidence on the grounds that verbal descriptions by witnesses would serve the same purpose, and that the tendency of the photographs would be to inflame the minds of the jury and so operate to the prejudice of the accused. In allowing the photographs the learned judge stated that if, as was conceded, a verbal description of the positions of the bodies was permissible, he could see no ground upon which the photographic evidence recording those positions could be rejected.

In the matter of *Green v. the King* (1939) in the High Court of Australia, *Latham J.* in his judgement stated, inter alia, it was objected that certain photographs showing the bodies of the murdered women were admissible in evidence and should not have been shown to the jury. The learned judge could see no reason for holding that any of this evidence was inadmissible, and no principle of law was stated in which the application of would result in the exclusion of the evidence in question.

In the matter of *King v. O'Leary* (1946) in the Supreme Court of South Australia (Court of Criminal Appeal) *Mayo, Reed and Abbott JJ.*, in their judgement the learned judges held that photographs of the wounds inflicted were admitted in addition to oral medical evidence of their nature and effect. The second issue related to the depiction of injuries to the head and body of the deceased. The photographs were supported by medical evidence of two doctors and were merely prejudicial against the appellant. In allowing the photographs their Honours stated that the Crown relies on them to satisfy the jury that the deceased was indeed murdered by someone, and to demonstrate that that the injuries were inflicted intentionally. They went on further to say that there appears no reason why the body of the deceased itself should not have been produced for inspection if it was fairly relevant, and if so, a photograph of it would be equally admissible. In this matter for both issues there appears to be no grounds for drawing a distinction between oral and visual evidence.

In the matter of the *Queen v. Ames* (1964) in the Court of Criminal Appeal of New South Wales, *Herron CJ., Taylor and Moffitt JJ.*, on appeal from the District Court of New South Wales, a ground for appeal, inter alia, was that the learned trial judge erred in allowing the admission of photographic evidence.

The learned judges in their deliberations held the view that the photographs are gruesome, but this is to be expected whether the death was caused by murder or suicide. They did have some probative value, as distinct from an oral description of what they depicted and the state of the clothing. They depict the direction of the flow of blood on the clothing

and establish the presence of blood on the mouth and back, and on the upper of the clothing as against the front of the dressing gown. These features were said to be inconsistent with the appellant's version. As the Crown case was that the crime was finally committed in the hall, the position of the body and clothing and the condition of the latter as to blood were important and could be best proved by visual, as against oral evidence.

It is too late in the day to suggest that photographs should be no longer regarded as admissible in evidence because of the dangers of their being faked. The matter was discussed in somewhat general terms by this court in *Queen v. Travers* (1958) *SR (NSW)* 85 at pp. 98 and 109. See article, *Evidence – Use of Photographs and Gramophone Records* 14 *ALJ* 401, in which the author suggests that it is now a common practice to use photographs as evidence.

The learned judges came to the conclusion that the photographs taken of the deceased and her environs were properly admitted into evidence and as the matter was one within the discretion of His Honour, no ground was shown for interfering with this discretion or with his decision.

In the matter of the *Queen v. Jeffrey* (1966) in the Supreme Court of Victoria (Court of Criminal Appeal) *Barry, Smith and Gillard JJ.*, in their judgement on one of the grounds for appeal in that: the learned trial judge erred in admitting in evidence photographs that the defence requested be excluded on the grounds that they were of little or no probative value, yet were so horrifying or gruesome in nature as to be highly prejudicial to a fair trial of the accused.

In the judgement by *Smith J.*, it was argued by the appellant's council that the trial judge ought, in the exercise of his discretion, to have excluded from evidence five photographs showing the wounds, which had been inflicted on the deceased, and a photograph showing the skin from his penis lying in grass upon the ground. It was said that their inflammatory and prejudicial effect was very great and far outweighed any legitimate probative effect that they could have, over and above the description in words of the various wounds and of the place where the piece of skin was found. The learned judge went on to say that this was a case in which photographs of this kind served a legitimate purpose of substantial importance, which was not outweighed by their inflammatory tendency. The location of the wound in relation to each other, the marked variation in their sizes and the precise nature of the mutilation of the penis, were all matters of substantial importance in relation to the appellant's state of mind at the time of the killing, and they were matters which could be conveyed to the jury more clearly and accurately by photographs than by words. The photograph of the piece of skin confirmed evidence as to where it was found, which again was a point of importance in relation to the appellant's state of mind. *Smith J.*, considered that these photographs were rightly admitted in evidence.

In the matter of the *Queen v. Lowery and King* (1971) in the Supreme Court of Victoria (Court of Criminal Appeal) *Winneke CJ., Little and Barber JJ.*, at their trial the defendant's counsel objected to the admissibility of photographs which showed the deceased in the position in which her body was found in the scrub, and others of which, taken after she had been removed from that position, revealed some of the injuries inflicted upon her, and clearly described the manner in which she had been tied up.

The learned judges in their deliberations were of the view that photographs had value in showing the rather complex method of tying up and, moreover, on the evidence there could have been no doubt as to the circumstances in which the photographs were taken. They further stated that any initial shock, which may have been caused, would tend to

become exhausted as the jury became accustomed to the photographs as the trial progressed for a considerable time. In their collective view, the photographs admitted were plainly relevant and the learned trial judge exercised his discretion in admitting them, therefore it is impossible for an appellate court to say that his discretion miscarried according to well-established principles.

In the matter of the *Queen v. Harbach* (1973) in the Supreme Court of South Australia (Court of Criminal Appeal) *Bray CJ, Mitchell and Sangster JJ.*, held that photographs of the body of a murdered person, showing severe injuries to the head and face, were admissible in evidence although they were of an unpleasant nature.

7.6.2 Transition from black and white to colour photographs

I was an active crime scene investigator during the transition between black and white and colour photographs. As I recall there were much discussions at the time with the expectation that courts would out of hand reject colour photographs. I recall that the jurisdiction in which I worked at the time had a strategy in place if there was a significant challenge to colour photographs, and the strategy was that at the change over there was complete (with the exception of some specialist photographs) change to colour. What would have occurred was that if the court wanted scene photographs then they would have to be content with colour as there was no alternative on the menu. We were, as I recall, pleasantly surprised and relieved at the smooth transition between black and white and colour photographs. Colour today is the standard supported by specialist black and white photographs mainly used in the replication of marks.

7.6.3 Film re-enactments

In the matter of the *Queen v. Lowery and King* (1971) in the Supreme Court of Victoria (Court of Criminal Appeal) *Winneke CJ., Little and Barber JJ.*, at their trial the defendant's counsel objected to the admissibility of a film showing a re-enactment, however, the learned judge found that the accused voluntarily took part in re-enacting the events, and in the exercise of his discretion allowed it to be admitted into evidence and shown to the jury.

The learned judges in their deliberations were of the view that the applicants cooperated voluntarily and that the learned judge was right having refused to exclude the film in the exercise of his discretion. Having regard to the evidence of earlier warnings given to the applicant, to the evidence that the applicants had the advice of their solicitors, to the terms in which they were requested to cooperate in the making of the film and the absence of any evidence from him on the holding of a voir dire, the learned judge was amply justified in holding that the applicant acted voluntarily and also in exercise of his discretion in refusing to exclude the evidence.

7.6.4 Legal implications of photographic evidence

As can be seen from the stated cases there is no impediment from tendering photographs of deceased persons, scenes depicting deceased persons and close-up views of injuries as long as there is probative value in doing so. The learned trial judge has the discretion in deciding whether to admit or to reject photographic evidence. He is entitled to reject, if, in his opinion, they were prejudicial to the appellant. The discretion of

a judge has been fully discussed in *Kuruma Son of Kaniu v. the Queen* (1955) 1 All ER 236 (1955) AC 197, where the Privy Council applied an earlier decision of the Board in *Noor Mohamed v. the Queen* (1949) 1 All ER 365 (1949) AC 182, and a case in the House of Lords *Harris v. Director of Public Prosecutions* (1952) 1 All ER 1044 (1952) AC 694. The result of these decisions is that the test to be applied both in civil and a criminal case, though in the latter the judge always has a discretion to disallow evidence if the strict rules of admissibility would operate unfairly against an accused person, See the judgement of Lord Goddard CJ, in *Kuruma Son of Kaniu v. the Queen* (1955) 1 All ER 236 at p. 239 (1955) AC 197 at p. 204. One factor which, although not conclusive, is a guide to a trial judge in exercising his discretion, is if the probative value of the evidence is slight and would be outweighed by its prejudicial aspect or because it would be unfair to the accused in the circumstances.

7.7 Cited cases

Green v. the King (1939) in the Supreme Court of Victoria.

Green v. the King (1939) in the High Court of Australia.

King v. O'Leary (1946) in the Supreme Court of South Australia Court of Criminal Appeal.

Noor Mohamed v. the Queen (1949) in the Privy Council.

Harris v. Director of Public Prosecutions (1952) in the House of Lords.

Kuruma Son of Kaniu v. the Queen (1955) in the Privy Council.

Queen v. Travers (1958) in the Court of Criminal Appeal of New South Wales.

Queen v. Ames (1964) in the Court of Criminal Appeal of New South Wales.

Queen v. Jeffrey (1966) in the Supreme Court of Victoria Court of Criminal Appeal.

Queen v. Lowery & King (1971) in the Supreme Court of Victoria Court of Criminal Appeal.

Queen v. Harbach (1973) in the Supreme Court of South Australia Court of Criminal Appeal.

7.8 Bibliography

Clark, S. C., Ernst, M. F., Haglund, W. D. and Jentzen, J. M. (1996) *Photograph the Scene and the Body, Section 31 within Chapter 4 Investigating Deaths in The Medico Death Investigator*, Occupational Research and Assessment, Michigan.

Davis, P. (1995) *Photography*, 7th edn, McGraw-Hill, Boston.

Mamiya, *Mamiya® RB67 Camera Instruction Manual*.

Nikon, *Nikon® F3 SLR Camera Instructional Manual*.

Scientific Working Group on Imaging Technologies (SWGIT) (1999) *Definitions for the Use of Imaging Technologies in the Criminal Justice System*, Forensic Science Communications 1:3, Federal Bureau of Investigation.

Scientific Working Group on Imaging Technologies (SWGIT) (1999) *Definitions and Guidelines for the Use of Imaging Technologies in the Criminal Justice System Part II Guidelines*, Forensic Science Communications 1:3, Federal Bureau of Investigation.

Staggs, S. (1997) *Crime Scene and Evidence Photographer's Guide*, Staggs Publishing California.

Specialised photography and imaging

Glenn Porter

8.1 Introduction

The application of photography in crime scene investigation has been widely practiced by law enforcement agencies throughout the world since the development of photography itself some 150 years ago. A common misperception however, is that photography is simply a method of recording the scene and evidence. Imagine if the medical profession only used imaging and photographic techniques to record and classify patient's injuries and disease. How would doctors determine and set broken bones without the aid of X-rays, or diagnose pneumonia? Like the medical industry, the crime scene examiner and forensic practitioner can utilise special imaging and photographic techniques to enhance the depth of investigation and therefore increase the information recovered.

Fundamentally, photography and imaging have a function to record and preserve perishable and non-perishable evidence for further reference, examination or analysis. More specifically, photographs may be used as secondary evidence or in many cases as primary evidence. Examples of photographs used as secondary evidence are images taken to demonstrate to a court the bulk or quantity of a drug seizure, seized by police. Transporting large quantities of narcotics back and forth to court has significant logistic, storage and security issues. Photographs demonstrating the bulk of the seizure may successfully indicate the relative size of the contraband. In some cases, these quantities may exceed a tonne. An example of photographs used as primary evidence is when photography and imaging techniques have been employed to enhance or record evidence that cannot be normally seen under normal conditions. Photographs are also used as primary evidence if further analysis by a forensic expert has used the photographs as a source of analysis (Porter and Doran, 1998, 2000). Visual data is gained directly from the photograph. An example is bite mark identification by a forensic odontologist. The photograph of a bite mark found on an assault victim is compared with a dentition replica of a suspect (Porter, 2002). The analysis is made directly from the photograph

source rather than the physical bite mark. The application of photography to provide visual data for analysis requires careful consideration and accuracy.

Crime scene photography and imaging methodologies may be divided into the following categories:

- image documentation of the crime scene and items present at the scene, simply as a record with no accurate reference to scale and perspective. The photographs allow further reference by investigators who did or did not attend the crime scene. No accurate analysis may be made from these photographs alone;
- recording of the crime scene and items present at the scene using correct scale references and perspective controls. Photographs displaying these controls can be used as a reference and further analysis is possible by qualified forensic personnel to obtain possible evidence. These photographs may be considered as primary evidence rather than secondary evidence. Perishable items which may require further analysis (e.g. bite marks) should be considered as primary evidence and higher recording accuracy is required; and
- used as an investigation tool. Invisible radiation photography provides the recording of evidence not normally visible under standard viewing conditions.

This chapter discusses several specialised photographic and imaging techniques used in crime scene and forensic investigation. The author assumes that the reader already has established basic photography techniques.

8.2 Using linear scales in photographs

While photographs have the ability to record and display fine detail from most subjects, it very often fails to demonstrate the actual size of any subject, without some comparative object to visualise a sense of scale. An example of how this inability may confuse the viewer, are photographs of floating icebergs found in the waters of the polar regions. While these huge mountains of floating ice can range in size from a few metres to several kilometres, the viewer cannot comprehend their size unless there is some other subject within the image, of a known size to make a comparison. These additional subjects provide a scale to the viewer, which may offer some contrast to the actual size. In this example, a ship passing the iceberg or visible wildlife on the ice may represent a scale.

In crime scene photography, it is important that a scale of known size is introduced to the photograph. The easiest method of introducing scale is by placing a linear scale within the frame of the image. These scales have two functions: they provide the viewer with a bearing of size and they may also be used to provide further measurement or analysis. While placing a linear scale within the frame of a photograph may seem fundamental, this practice is widely misused. Incorrect use of linear scales often introduces distortion of size and may conceal important elements of the subject (Hyzer, 1986). Furthermore, erroneous use of linear scales in photographs that will be used to supply visual data for analysis or measurement will misrepresent the evidence and/or introduce image artefacts.

Linear scales are commercially produced in many different styles and sizes. They are also manufactured in a variety of materials including glass, plastic, vinyl and paper.

Inexpensive disposable types are also available for biological hazards, and have an adhesive backing to attach to items. There are linear scales designed for specific purposes in such applications as fingerprints, shoe impressions, bite marks and invisible radiation photography. The size of the linear scale including the scale deviations should be appropriate to the size of the specimen photographed. The accuracy of the scale is another important consideration. This accuracy may be calculated (and recorded for court evidence) by taking several measurements using a good quality vernier scale and applying a standard deviation calculation. Using linear scales of known error rates may assist in the preparation of data gained from the photographs (see Figure 8.1).

Some forensic institutions use linear scales which they have customarily made for their own organisation's needs. For example, these linear scales used in forensic pathology are designed to adhere to skin and are able to be easily cleaned of blood as well as being disposable for bio-hazardous reasons. Customising your own scales allows you to include features that are applicable to your own organisation. This may include the name of the organisation, appropriate measurement divisions and provide areas to include case numbers, dates and name of the forensic practitioner. Customising linear scales also provides a professional or corporate identity on all photographs taken from the institution. These linear scales must however be manufactured to high precision using a printing firm that understands these precision requirements. The accuracy should also be tested before accepting them into general practice. Office photocopied



Figure 8.1 Photograph of human skull with linear scale placed on the same plane as the dentition (photograph by Glenn Porter)

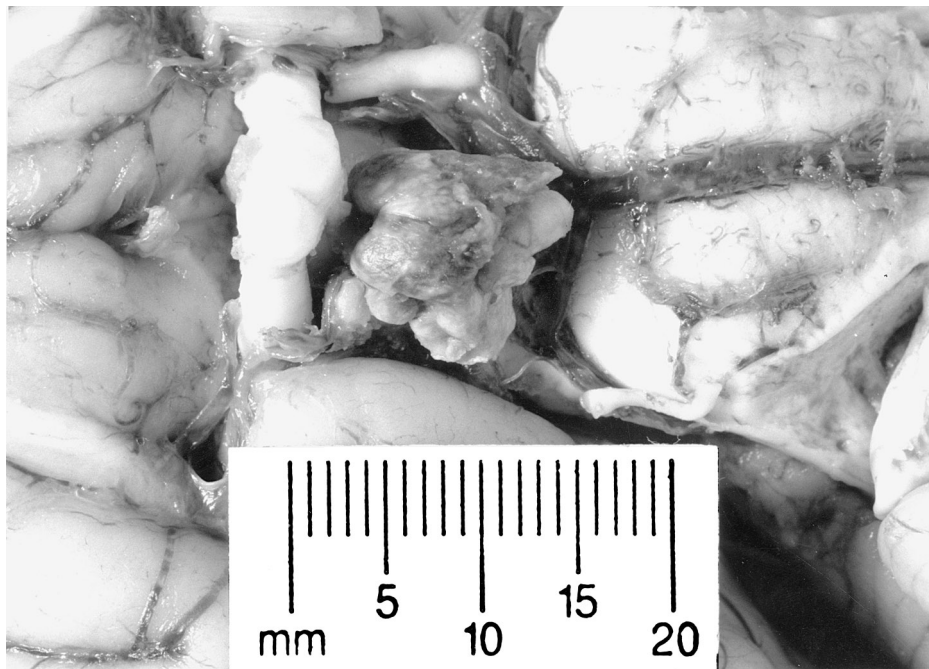

Figure 8.2 Close-up of an area of a Koala's brain with Hydrocephalus. Note the position and size of the linear scale (photograph by Glenn Porter)

linear scales do not offer accurate reproduction of the size of the original, even at 100 per cent reproduction mode. Third and fourth generation photocopied linear scales should be strongly avoided for accurate work (see Figure 8.2).

Using linear scales correctly provides sound professional practice and best evidence of the subject being photographed. Important considerations to ensure best practice include:

- use a linear scale of accurate scale divisions;
- know the error rate/s of all linear scales used and identify each scale by using a reference system;
- use a linear scale that is of an appropriate size to the subject being photographed (e.g. do not use a metre rule for a subject which is 10 cm);
- use a linear scale appropriate to the type of evidence being photographed. For example, use an 'ABFO No. 2' linear scale when photographing bite marks. This scale has been designed and authorised by the American Board of Forensic Odontology (ABFO) and is recommended for bite mark photography (Hyzer and Krauss, 1988);
- use a linear scale that displays metric measurements. Imperial measurements may be incorporated with the metric measurements, but never use imperial exclusively. The international scientific community developed common units of measurement

known as the *Système International d'Unités* or SI units. The SI unit of length is 'metre' and should be used in scientific practice;

- placement of the scale in relation to the subject, and camera angle is an important consideration. The position of the linear scale should avoid any distortion. Avoid covering any part of the subject with the scale; however, this is unavoidable in many circumstances;
- if the scale is used as an orientation tool for close-up photography, never change the angle of the scale between photographs from different viewpoints. Changing the position of the scale may cause disorientation of perspective;
- if the linear scale covers aspects of the specimen, take two photographs: one with the scale and one without. While this practice may seem frivolous, the placement of the linear scale may be seen as obstructive and an attempt to hide information. To avoid any criticism in court, always take a second shot without the scale. This practice is particularly important in the photography of wounds in forensic pathology;
- linear scales may also include reference information such as the case officer, case file number, date and other information; and
- beware of contamination risks of linear scales when photographing biological specimens and possible cross-contamination of trace elements from previous cases, etc. The use of disposable linear scale may be best practiced in these circumstances.

The use of linear scales in crime scene photography has a significant purpose when documenting evidence in an accurate manner. These principles should be adopted as general practice to promote best practice (see [Figure 8.3](#)).

8.3 Distortion considerations

Distortion in photography is the altered shape, size or perspective of the subject. The subject is considered 'distorted' when its image shape is different from that of its original. In reality, any two-dimensional photograph of three-dimensional subjects is a distortion of perspective. The use of shadow and highlight, and diminishing subject size provides the illusion of depth. Crime scene and forensic photography generally does not require this perception of depth. It is, however, highly preferable to maintain the integrity of the shape of the subject being photographed. Crime scene and forensic photographs must minimise image distortion.

While distortion is a 'natural' phenomenon of two-dimensional imaging, distortion may be exaggerated or minimised depending on the equipment used and imaging techniques. Distortion is also a lens aberration or defect found in some lens designs, particularly wide-angle lenses. Lenses may suffer from two types of lens distortion aberrations: 'pinchusion' and 'barrel' distortion. Pinchusion alters the image shape similar to the shape of a pinchusion with the sides bent towards the centre of the image. Barrel distortion is the opposite. The sides of the image bend towards the outer edge of the frame and take on a similar shape to a barrel, hence its name. Wide-angle lenses often suffer from barrel distortion. These lenses should be avoided, if possible, when accurate recording is required. This is often impractical when working in confined spaces or when wide shots are required. Lenses of symmetrical lens element design do not suffer from distortion aberration. Most 'macro' and large format lenses are of

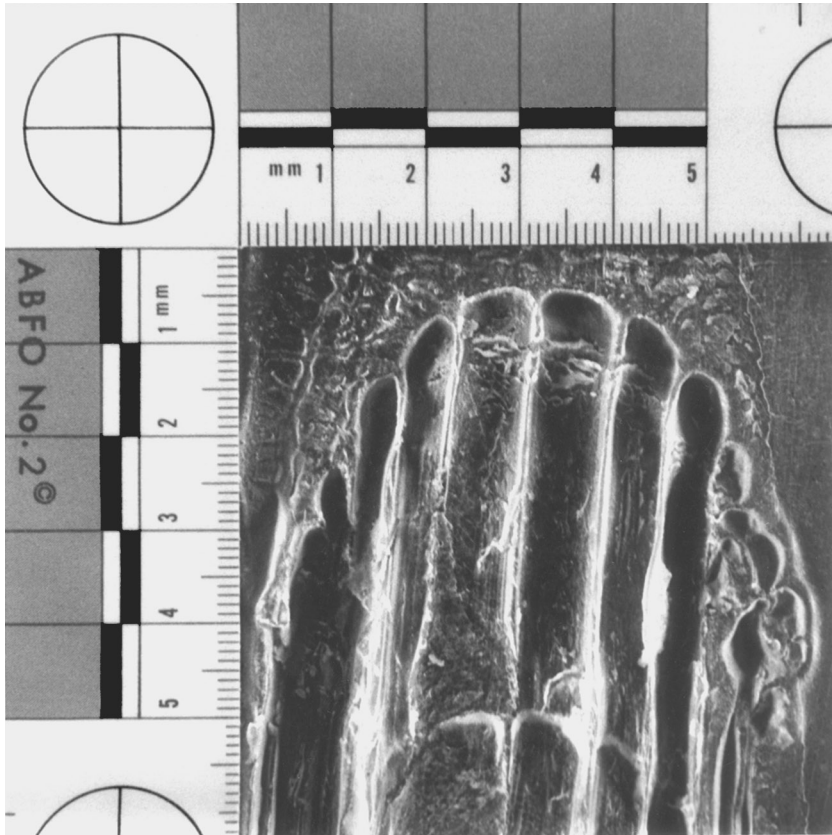

Figure 8.3 Using the ABFO No. 2 bite mark scale (photograph by Glenn Porter)

symmetrical design to maintain a distortion free image. Some modern macro lenses are now of asymmetric design with a ‘floating’ lens element to correct for distortion and provide a flat field image.

Distortion of size, better known as image perspective also has some implications in crime scene photography. Subjects, or parts of a subject, closer to the camera lens, record at a greater size, than subjects that are further from the camera lens. An example of this effect may be seen when a photograph is made of a cube shape object or box, from a 45° angle. The vertical line on the front edge of the box appears larger than the rear. The diminishment of size relationship between the front and rear edge gives the illusion of depth in the image, or producing a more realistic viewpoint or perspective. However if measurements are required from the photographs for physical evidence, the degree of distortion should be considered. Calculations of corrections have several varying factors including distance, magnification and lens focal length. Another cause of this type of distortion also occurs when the camera is tilted, up or down, or from side to side. Images produced when the camera is tilted, cause a convergence of vertical and/or horizontal lines.

Image distortion may occur from the following causes:

- subject is placed on a curved surface;
- subjects positioned at different distances from the camera lens;
- the camera's viewpoint;
- dimensional stability of film;
- camera lens suffering from distortion aberration;
- distortion aberration occurring in the enlarger lens; and
- distortion aberration of the lens/CCD with digital captures devices including film scanners and digital cameras.

When using linear scales to demonstrate the size of a subject, care must be exercised not to introduce size or perspective distortion. Perspective distortion results from a linear scale placed closer to the lens than the subject, resulting in the subject appearing artificially larger. Because focal length is a function of image magnification, short focal length lenses (wide angle lenses) are generally used at a closer working distance than longer focal length lenses (telephoto lenses). Shorter working distances exaggerate perspective distortion, and care should be exercised to minimise the distortion between the object and linear scale (Hyzer, 1994).

The following practices should be considered when using linear scales in crime scene photography:

- use an accurate linear scale;
- check linear scale against quality callipers;
- avoid using 'photocopied' linear scales due to accuracy concerns;
- consider the placement of the linear scale;
- avoid/minimise distortion errors;
- maintain sharp focus of linear scale;
- use an appropriate size scale according to the size of the subject; and
- where possible, take two photographs, one with and one without the scale.

Best practice in crime scene photography demands that the photographs be fault free and devoid of any deliberate image distortion. Practitioners should have an understanding of the effects of distortion and be capable of applying techniques to minimise image distortion. Considerations for minimising image distortion are:

- use lenses free of distortion aberration (macro lenses are highly corrected for distortion);
- maintain the camera's focal plane parallel to the subject plane;
- avoid perspective distortion; and
- arrange subject on a single plane, if possible.

As previously mentioned, image distortion is a natural occurrence when imaging three-dimensional subjects onto a two-dimensional medium. However, some three-dimensional subjects may be arranged on a two-dimensional plane. A logical example is when photographing a paper document. The document can be made completely flat with a sheet of glass with the camera placed directly above the document. Provided

the camera's focal plane is parallel with the document, the perspective is reduced to height and width only. If the complete subject is positioned at the same distance from the camera and would reproduce without any perspective distortion, provided the lens does not suffer from distortion aberration. When using linear scales, they should also be positioned on the subject plane, parallel to the camera's focal plane.

In many cases, absolute omission of all distortion when imaging three-dimensional subjects, using conventional techniques, is impossible. Good practice may reduce the effect of distortion to an insignificant factor so that the image can be regarded as distortion free. Special techniques such as scanning photomacrography reproduce three-dimensional subjects, at any angle with absolutely no perspective distortion. By moving the subject through a small narrow focused beam, the subject to lens working distance is kept the same, therefore maintaining a constant magnification throughout the subject. Images produced using these scanning methods are termed 'isometric' meaning 'no perspective'.

8.4 Close-up and photomacrography

Close-up and photomacrography, also known as 'macro' photography, is frequently used throughout crime scene investigation to record and preserve smaller sized items of evidence. Some specific evidence types using close-up and photomacrography include fingerprint identification, toolmark, shoemark and tyre-mark comparisons, and blood spatter examination and bite mark identification. The magnification range used to record the image describes close-up and photomacrography. General, or gross, photography has a magnification range up to X0.10, while close-up photography has a range between X0.10 and X1.0, and photomacrography from X1.0 to X50. The range of photomacrography may exceed to X50, however this range may only be achieved using photomicroscopes or low-powered microscopes. Photomacrography using conventional camera and macro accessories has a maximum range of 0.9 times due to the limitations of the optical system or the lens to subject distance becoming impossibly close.

Standard aspects of forensic photography must be observed when conducting close-up and photomacrography work. Linear scales should be used as previously described; only smaller sized scales should be used. Small linear scales designed for photomacrography are available from suppliers. It may be necessary to photograph the scale on a previous negative frame, using the same settings and magnification, rather than along side the subject. Orientation of the subject is also an important aspect of close-up and photomacrography of evidence. Orientation is necessary to demonstrate to the viewer, the location of the area photographed with increased magnification. It may also be necessary to take a series of photographs identifying the location of the area being photographed. These orientation photographs should display a logical sequence without confusing the viewer. Disorientation may result from dramatic change in camera angles and/or moving the linear scale placed near the subject to allow the scale more easily read in each photograph. Wound documentation is an example subject where orientation is an important consideration when recording the evidence.

Close-up photography may be conducted with minimum amount of camera equipment. Any lens, which has a close focusing range, will adequately record close-up range up to X1.0 or 1:1. Macro lenses generally have this facility; however, most general-purpose

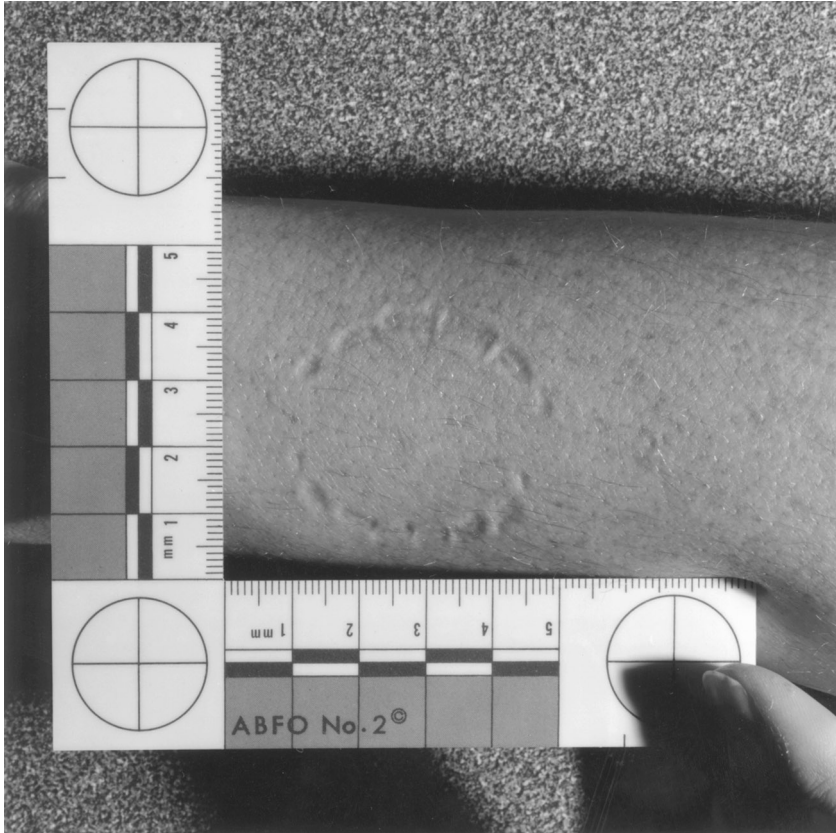

Figure 8.4 Bite mark photographed with linear scale on same plane as bite mark (photograph by Glenn Porter)

lenses do not allow the subject to be focused closer than approximately half a metre. Close range focusing may be achieved by applying camera accessories such as close-up filters, known as dioptre's. Dioptre's are easily attached to the front of the camera lens like any other photographic filter. Quality varies dramatically according to price).

Most camera systems, in all formats with interchangeable lenses, may be used for photomacrography with further macro accessories. There are several methods for achieving magnifications within the photomacrography range; they include:

- dioptre filters fitted on the front of the camera lens;
- extension tubes of various sizes attached between the lens back and camera body;
- bellows extension also attached between lens and camera body;
- reversal rings which attach the lens on the camera in reverse allowing a closer focusing distance; and
- adaptor rings to attach enlarger lenses to the camera body.

The most common methods normally used are extension tubes or bellows extensions; they are relatively easy to use and offer the best results, in resolution terms. Diopters are the most inexpensive method and do not require any increase of exposure; however, they offer lower resolution than the extension tubes or bellows. Reversal rings are not very common, and results are also low in quality. Attaching enlarger lenses to camera bodies offers high quality results because these lens types are designed for close-up range and are often well corrected for distortion. Operation of the camera function, however, becomes very difficult with enlarger lenses.

For optimum results, the camera lens should be specifically designed for use at shorter working distances. General camera lenses used in photography are all corrected for most lens aberrations at a working distance of infinity. The use of these lenses for photomacrography may result in a slight decrease of image quality and the likelihood of pinchusion or barrel distortion. Lenses termed 'macro' have been corrected for lens aberrations when used in a close range distance from the subject to the lens and are preferable for accurate forensic and crime scene photography. Traditionally, all macro lenses consisted of symmetrical lens element design to avoid any distortion aberrations and offer a flat field image. Some contemporary macro lenses are of an asymmetrical design with a floating lens element to assist corrections. On many zoom lenses, a 'macro' function offers the ability of the lens to focus the subject at a closer working distance, by displacement of the lens elements. This function should not be confused with 'macro' lenses; it has not been corrected for photomacrography work and normally produces low quality work. Photographic enlarger lenses used in the darkroom may be used as an alternative lens for photomacrography via a camera mount adaptor. Enlarger lenses offer similar advantages as macro lenses because they are also designed and corrected for their regular close work distance. While enlarger lenses offer good quality photomacrography images, lenses corrected for colour printing, known as apochromats, must be used. Some quality black and white enlargers lenses (achromats) are not apochromats because there is no requirement for them to be corrected for colour work. Lateral and axial chromatic aberration may result if achromat lenses are used for photomacrography.

The reproduction scale, or magnification, of the image is determined by dividing the image height by the actual object height. The magnification may be expressed as a fraction, ratio, factor or percentage (e.g. 2/1, 2:1, X2 or 200 per cent). The ratio and factor methods are most commonly used to describe the reproduction ratio or magnification. A magnification ratio of X1 or 1:1 is an image size equal to the object size or life size. Most macro lenses are capable of reproducing 1:1 magnification without any macro accessories. Magnifications greater than life size require macro accessories to enable closer focus distances.

Determining the reproduction scale requires the understanding of simple formulae and some nomenclature. In extreme magnifications, these formulae may save the photographer hours of trial and error by precisely calculating the necessary camera adjustments and parameters (Langford, 1977; Blaker, 1989).

Magnification formula:

$$M = \frac{I}{O} = \frac{v}{u}$$

To calculate subject to lens distance:

$$u = \left(\frac{1}{M} + 1 \right) f$$

To calculate the bellows extension length:

$$v = (M + 1)f$$

whereas:

M = magnification (reproduction scale)

I = image height

O = object height

v = 'v' distance (distance from rear noble point of lens to film plane)

u = 'u' distance (distance from subject to lens)

f = lens focal length

Depth of field is always a limiting factor in photomacrography. Greater the magnification, the smaller the depth of field which may result in the subject not displaying an overall sharp image. Using small apertures increases the depth of field until the effective aperture becomes so small that diffraction causes a loss of overall sharpness or resolution. A technique called scanning photomacrography can maximise the depth of field at any magnification. Application of this technique requires the subject to move through a narrow slit of light as it exposes onto film. The depth of field need only be greater than the width of the beam of light.

An adjustment or increase of exposure is required when using bellows extensions (and extension tubes) in photomacrography. The lens f /stop is calculated when the lens is focused on infinity. The f /stop indicated on the lens is not necessarily the correct indicated aperture when conducting photomacrography with bellows extensions and will vary depending on the focal length of the lens and the magnification or degree of bellows extension. To obtain the correct exposure and/or adjustment, it is necessary to calculate the 'effective aperture' or corrected 'exposure factor' to avoid underexposed images.

Exposure factors to obtain exposure adjustment:

$$E = \frac{v^2}{f^2}$$

$$E = (1 + M)^2$$

whereas:

M = magnification (reproduction scale)

E = exposure factor

v = 'v' distance (distance from rear noble point of lens to film plane)

f = lens focal length

When using single lens reflex cameras, the second formula is the easiest to use. By using a linear scale and the known size of the frame or negative format, magnification may be easily calculated.

Table 8.1 Diffraction limits for most camera formats

Diffraction limits	
Camera format	Minimum f /stop and/or effective aperture
35 mm	$f/22$
6 × 6 cm	$f/45$
5" × 4"	$f/64^{1/2}$

Table 8.2 Minimum f /stops at set magnifications to prevent significant diffraction

Smallest possible f /stop without significant diffraction							
Infinity		Magnification					
Camera format	Min. aperture	X0.5	X1	X2	X4	X6	X8
35 mm	$f/22$	$f/16$	$f/11$	$f/8$	$f/4^{1/2}$	$f/2.8^{1/2}$	$f/2^{2/3}$
6 × 6 cm	$f/45$	$f/32$	$f/22$	$f/16$	$f/8^{1/2}$	$f/5.6^{1/2}$	$f/4^{2/3}$
5" × 4"	$f/64^{1/2}$	$f/45^{1/2}$	$f/32^{1/2}$	$f/22^{1/2}$	$f/16$	$f/11$	$f/8^{1/3}$

An important image quality component using photomacrography is often overlooked resulting in poor image results. The effective aperture must remain within the acceptable diffraction limit range. Most lenses are manufactured with a range of f /stops, which operate within the parameters of diffraction. These lenses are referred to as 'diffraction limited'. However when performing photomacrography, the effective aperture, the calculated f /stop for exposure adjustment, must also remain within the diffraction limits. These diffraction limits are established using Abbe's equation and influenced by the permissible circle of confusion of each camera format, wavelength and diffraction (Porter, 2002).

Practitioners of photomacrography must consider the effects of diffraction and maintain an effective aperture within the diffraction limit range. Table 8.1 establishes these limits and the effective aperture may easily be calculated once the exposure compensation or factor has been determined. For example, if the indicated exposure was $f/22$, the magnification was 3:1 or 3 times, the exposure factor is X16 or 4 stops. If the camera is set at $f/22$, the effective aperture is $f/90$, four stops less than the original f /stop. Using the effective aperture of $f/90$ with a 35 mm format camera would exceed the diffraction limit range and the image would suffer from significant diffraction resulting in a loss of overall sharpness. Table 8.2 indicates the minimum apertures available at different magnifications and camera formats.

8.5 Invisible radiation photography

Human vision has a spectral range of approximately 400–700 nm. This range expanding from blue to red wavelengths is commonly referred to as the 'visual' spectrum and

comprises of all the colours of a rainbow, and when combined produces white light. All these colours may however be seen individually when dispersed through a prism causing each colour to refract at different rates due to the relationship of wavelength energy and refractive index of the transparent medium. Positioned at either side of the visual spectrum is ultraviolet and infrared. Human vision does not have the ability to see in these ranges of light or radiation below 400nm and above 700 nm. There have been however known cases, albeit uncommon, where some people have displayed sight below the 400 nm and into the long-wave ultraviolet spectrum. These cases are extremely rare and have usually resulted after damaging the eye lens and/or suffering from a cataract.

Specialised photography and imaging techniques may record subjects illuminated by ultraviolet or infrared radiation, allowing the recording of aspects of the subject that are not seen by human vision. Photography using these techniques and displaying characteristics that are normally invisible is hence termed 'invisible radiation'. Invisible radiation is a significant technique used to gain physical evidence that is not physically seen under normal white light or by human vision. Several published forensic science papers have well documented the value of obtaining evidence from subjects that did not appear under normal conditions, while uncovering valuable evidence using invisible radiation techniques. One case in particular was a bite mark that was recorded five months after the attack, providing valuable physical evidence using ultraviolet radiation techniques (David and Sobel, 1994).

Invisible radiation photography is not just the application of light outside the visible spectrum, but also more importantly, the application of the invisible spectrum while excluding the visible. By effectively minimising or eliminating the visible wavelengths, exposure in the invisible range is more apparent which results in subjects displaying information from the invisible spectrum only. Exposure in the invisible range may be achieved by:

- the use of filters either over camera or light source, or both; and
- the use of a monochromatic light source.

Monochromatic lighting is the application of a light source with a narrow spectral bandwidth. This may be achieved by using filters over the light source or using specialised lighting equipment. Several specialised lighting equipment are available (e.g. Polilight) that have built-in interference filters that allow easy application of a range of selective wavelengths, by simply selecting the required wavelength band. While specialised lighting equipment offers many advantages when working in a narrow spectral range, they are usually very expensive. Invisible radiation photography can also be successfully conducted with simple lighting equipment like portable flash. Filtration of the camera lens also selectively transmits the required spectral wavelength only.

Invisible radiation photography necessitates the combination of three elements in photography, all related to spectral sensitivity, distribution or transmission (Williams, 1992). To ascertain the actual recorded spectral or wavelength range, the spectral sensitivity of the film or recording material in the camera should be examined. Spectral sensitivity curves are supplied by film manufactures and represent the sensitivity of the emulsion to the spectrum. Black and white films are available in different spectral

sensitivity, ranging from blue sensitive, orthochromatic (sensitive up to green wavelengths) and panchromatic which is sensitive up to all colours of the visual spectrum but does not exceed past red. Infrared film has an extended spectrum sensitivity, which exceeds past red and into the infrared range. Most monochrome films are sensitive to the ultraviolet spectra. The spectral distribution of the light source is the second aspect of consideration when determining the recording range. The spectral transmission of the filter and lens is the third consideration. Each spectral curve is then combined to display the actual useable spectral range using a specific film, light source, filter and lens combination (Williams and Williams, 1993).

Another consideration when photographing in the ultraviolet range is the focus shift required when achieving sharply focused images. The shorter wavelength of ultraviolet and the longer wavelength of infrared cause an adjustment in the focal length of the lens, which must be corrected by a slight shift of the focus. Most lenses have an infrared focus shift indicator (usually a little red dot) located on the lens barrel and adjusts the focal length by approximately 1 per cent. After normal focusing the lens, the focus is then shifted to the indicator, which will correct for infrared photography. This indicator is normally calculated for gross photographic applications. This indicator is not considered accurate for shorter working distances, testing at set parameters is therefore recommended.

The wavelength of ultraviolet light is shorter than infrared and it may be assumed that the focus correction would be in the opposite direction to infrared. While this argument seems logical, it is believed due to contemporary lens design and lens element combinations and corrections, the focus shift for most lenses for ultraviolet is in the same direction as infrared (Nieuwenhuis, 1991). It is important to note that the degree of focus shift for both ultraviolet and infrared photography varies depending on the distance of the subject to the lens and/or magnification. Using a large depth of focus may assist in minimising focusing errors. However, this is often not practical; invisible radiation photography is often conducted under effectively low illumination when you consider the requirements of the filters. Testing for the required focus shifts should be carried out at the distances commonly used by the practitioner, for each different lens used.

8.5.1 Ultraviolet photography

The ultraviolet spectrum ranges from 14 to 400nm and is divided into two separate regions: short-wave (14–310nm) and long-wave ultraviolet (310–400nm). Glass absorbs all ultraviolet wavelengths below 320nm making short-wave ultraviolet impossible with glass lenses. Special quartz lenses are available for ultraviolet photography, which have a lower absorption of ultraviolet down to approximately 250nm. These lenses are extremely expensive and do not offer a lot of practical advantages due to other ultraviolet absorption conditions in photography such as: glass filters, gelatin filters, gelatin layers and ultraviolet absorption layers on film emulsions, which all absorb levels of ultraviolet radiation.

When conducting ultraviolet photography, it is important that the work is conducted in a safe manner. Prolonged exposure to ultraviolet radiation may cause skin irritations or sunburn, conjunctivitis and in extreme cases skin cancers. The effects of overexposure to ultraviolet are not obvious until several hours after. Similar to sunburn effects, the

damaged is not noticed until the evening. Safety precautions include wearing clothing that covers most of the exposed skin, minimising the length of exposure and wearing special ultraviolet protection glasses to avoid eye irritations.

There are two distinctive methodologies for ultraviolet photography: reflected ultraviolet photography and fluorescence ultraviolet photography. These techniques are quite different in approach; therefore, it is best to discuss the techniques separately.

8.5.2 Reflected ultraviolet photography

Reflected ultraviolet photography may be used to detect invisible wounds on human skin, determine fraudulent documents, detect skin disease and record secretive ultraviolet markings on bank notes and legal documents plus many other applications. This form of invisible radiation simply records the subject by exposing the reflected ultraviolet from the subject, while excluding all other wavelengths.

To conduct reflected ultraviolet photography, you must first use a light source that has a ultraviolet content. This can be determined by examining the spectral distribution curve of a selected light source. Tungsten lighting generally has a low blue and ultraviolet content and is not suitable for ultraviolet photography. Second, the remaining spectrum must be filtered out so exposure is exclusively ultraviolet radiation. There are two methods of filtration for reflected ultraviolet photography, filter the light source or use a filter on the camera lens. The filter must transmit ultraviolet wavelengths while absorbing other visible wavelengths. There are currently several filters available for reflective ultraviolet photography including Kodak Wratten 18A (Kodak, 1968, 1990; Williams and Williams, 1993).

The simplest method for reflected ultraviolet is the use of electronic flash with a ultraviolet-transmitting filter placed on the camera lens. This method may also be conducted under normal ambient light, rather than filtering the light source. Reflected ultraviolet photography using filtered light sources must be conducted in total darkness. Film exposure should be calculated by testing standard combinations of film and developer, filter/s and light source. In most cases it is necessary to push the film speed to provide adequate exposures. It is also interesting to note that regular film speeds may not be an indication of the film's sensitivity at this range. Some slower speed films may have a higher sensitivity in the ultraviolet range (Friar and West, 1989) (see [Figure 8.5](#)).

8.5.3 Ultraviolet fluorescent photography

Luminescence is an energy phenomenon, which occurs when certain materials are exposed to shorter-wavelength radiation, they emit a wavelength longer than the original. Ultraviolet radiation is the most common excitation source for this type of imaging; blue wavelengths may also be used successfully depending on the characteristics of the material being photographed. When subjects are excited by ultraviolet or blue wavelengths, their fluorescence emission is in the visible spectrum ranging from blue, green, yellow or red, depending on the excitation and the properties in the material.

Fluorescence occurs when reflected excitation radiation is removed, leaving only the emission radiation of a longer wavelength to expose the film. Some materials naturally fluoresce which is called *autofluorescence*, while other materials have little or no fluorescence. Fluorochrome dyes may be added to non-fluorescent materials to induce

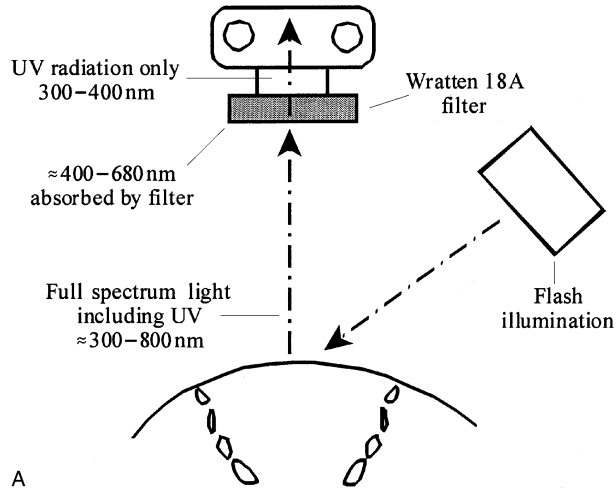

A

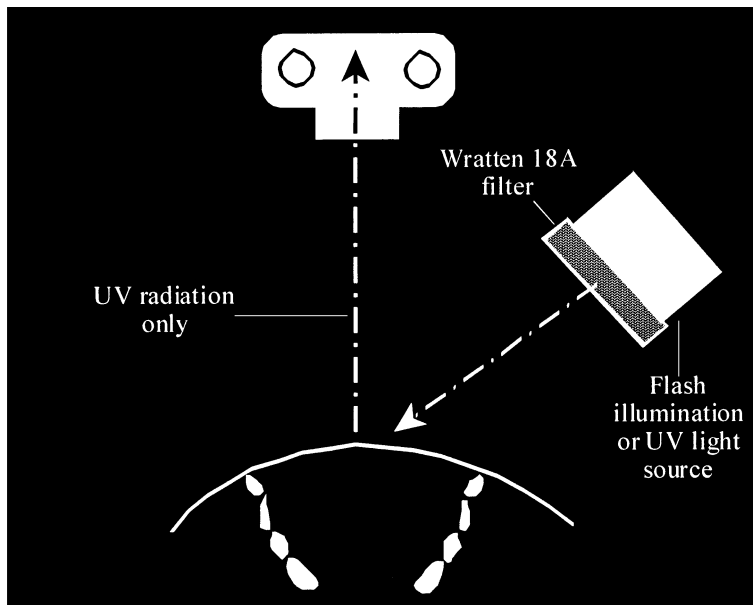

B

Figure 8.5 Diagrams illustrating ultraviolet reflected method. A, using a ultraviolet transmission filter (Wratten 18A) on camera. This method may be conducted in normal daylight conditions. B, illustrates reflective ultraviolet photography method with ultraviolet transmission filter of light source, in this case a portable electronic flash. This method must be conducted in total darkness. (adapted from Friar & West, 1989)

fluorescence. This technique is called *secondary fluorescence* and is commonly used in fingerprint photography and ultraviolet photomacroscopy (see Figure 8.6).

Fluorescent photography is conducted using a monochromatic excitation light source, usually ultraviolet (350 nm) or blue (450 nm) and a barrier filter placed over the camera lens. Monochromatic lighting may be achieved by using a light source specially

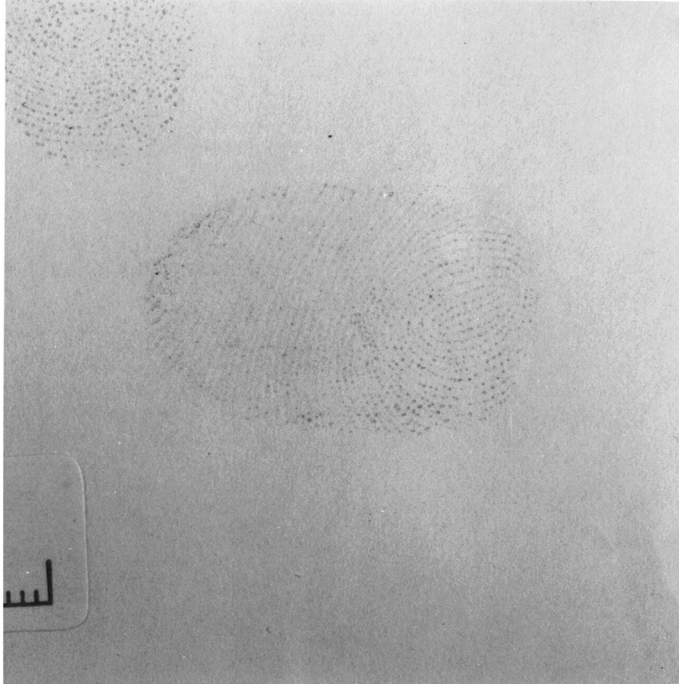

A



B

Figure 8.6 A – Fingerprint under standard white light, B – same fingerprint using ultraviolet fluorescent photography with secondary fluorescence (photographs by Glenn Porter)

designed to produce monochrome light, or use ultraviolet transmission filters placed over a light source, which contains a high output of ultraviolet light. Several manufacturers produce barrier filters specially designed for fluorescence photography. The colour of the barrier filter will depend on the colour of the fluorescence of the material being photographed, and the desired contrast between the subject and the background. Fluorescent photography must be conducted without any additional ambient light. Exposure may be determined again by testing; however, exposure meters may also be used because the fluorescence is in the visible spectrum. The spectral sensitivity of the meter may need to be considered however, particularly if the subject is fluorescing in an orange to red colour. Most light meters are not very sensitive to the red spectrum. Unlike ultraviolet reflected and infrared photography, fluorescent photography requires no focus shift. When exposing the subject to the excitation source causing it to fluoresce, care should be taken to minimise exposure due to *quenching*. Quenching is the loss of fluorescent activity due to prolonged exposure by the excitation source.

Fluorescent photography may be used in fingerprint photography, document examination, detection of invisible body fluids (spermatozoa, saliva, etc.), photomacroscopy and the detection of stress fractures in engineering material. Fluorescent viewing of a crime scene for the detection of and collection of body fluid samples is also possible using a ultraviolet/blue monochromatic light source while wearing barrier filter glasses.

8.5.4 Infrared photography

Infrared photography has many uses as a pictorial and scientific photographic technique. Many pictorial photographers use infrared with some components of the visual spectrum (red), to create an artistic effect on landscape photographs. In a scientific application, there is more interest in using only the infrared spectrum and the visual spectrum is completely filtered out. Most films are not sensitive to infrared; therefore it is necessary to use a special purpose film, which has an extended sensitivity into the infrared spectrum. Infrared films have undergone a dye sensitisation procedure during manufacture of the film to increase its spectral sensitivity. Some panchromatic films also have an extended red sensitivity.

The longer wavelength of infrared offers the ability to penetrate the surface of most subjects and record information below the surface. Medical photographers have used these principles to photograph and record superficial veins, tumours and pigment lesions of skin as non-invasive exploratory examination of the patient (Williams and Williams, 1994). Scientific and forensic applications include the detection of art fraud by recording the original artist's markings below the surface of the paint, the detection of diseased plants, aerial surveys of forestry areas for cannabis plantations and comparison of inks in document examination (Kodak, 1980).

Two infrared techniques are available: reflected infrared which is the most common application and infrared luminescence. Both techniques are somewhat restricted to using only a small portion of the infrared spectrum due to the spectral sensitivity range of infrared film. Currently the maximum spectral range is up to 900 nm using Kodak High Speed Infrared film. Some specialist digital CCD arrays have a higher infrared range; however, these cameras are not available in general photography applications.

To use infrared for invisible radiation, any light source that has a high infrared content may be used; however for best results, the light source should be of large size in

relation to the size of the subject (Williams and Williams, 1994). An infrared transmission filter that absorbs all other visual spectra while transmitting infrared is placed on the camera, and Kodak Wratten 87 series filters are designed for infrared photography. Film exposure is determined by conducting exposure testing because no light meter has the spectral range or sensitivity to measure infrared. A focus shift is also required to obtain correct focus.

Infrared luminescence is a technique that offers a fluorescence emission in the near infrared range between 700 and 2000 nm. A monochromatic light source should have a shorter wavelength than near infrared or 700 nm. A 650-nm red monochromatic excitation filter is often used which is just inside the visual spectrum; however the fluorescence emitted from the material is in the invisible infrared spectra. The Kodak Wratten 89 filter series is recommended as a barrier filter for infrared luminescence, particularly the Wratten 89B (Cantu and Prough, 1988).

8.5.5 Invisible radiation photography using digital cameras

Law enforcement and forensic institutions around the world are quickly recognising the advantages of digital photography. The immediate result, electronic transportation of images and the savings in consumable costs are just some advantages. Practicing invisible radiation photography with digital cameras, uses the same techniques described in the previous sections. The spectral sensitivity of the sensor, however, replaces the spectral sensitivity considerations of film.

Electronic sensors, such as CCD arrays and CMOS chips, respond to light differently than film. During the manufacture of film, film becomes sensitive to ultraviolet in the first stages of manufacture and the spectral sensitivity is increased by the introduction of certain chemicals or dyes. Electronic sensors seem to work in the reverse; they are more sensitive in the higher wavelengths such as infrared and less sensitive to ultraviolet. The biggest problem however, is the camera manufacturer's ability to reduce the spectral response outside the visible spectrum using filters over the sensors. General photography does not require the sensors to be sensitive in the ultraviolet and infrared regions, in fact it often reduces the quality of the image, particularly chromatic aberration from the lens and sensor-wells themselves. Future advancements in digital technology may also narrow the spectral response further, to improve image quality for more general photography purposes. There is only a very small forensic market for manufacturers to modify the sensors spectral sensitivity for invisible radiation photography. It is unlikely a digital camera will be manufactured for this special purpose.

The application of digital cameras for invisible radiation largely depends on the spectral sensitivity of the camera sensor. This will vary between each sensor, camera make and model, and future camera advancements. In general terms, film may remain the best recording device for reflective ultraviolet photography, while digital capture would have some distinctive advantages for reflective infrared photography, provided the sensors are sensitive to infrared or infrared is not filtered out on the sensor. Digital cameras that have the ability to record infrared, do not have the excessive film grain problem like infrared film. Extended red sensitivity films have an acceptable degree of graininess; however, these films are generally only sensitive to 750 nm and do not use much of the infrared spectrum. Infrared films that are sensitive to 900 nm do display excessive graininess, which reduces the resolution of the image. High-speed infrared

photography without the high degree of graininess is an advantage that may be provided by digital cameras.

Ultraviolet fluorescent photography records in the visual spectrum and could be achieved by film and digital capture. While ultraviolet radiation excites the specimen to fluoresce, the barrier filter filters out the reflected ultraviolet while the visible light is transmitted through the filter and recorded. Problems may occur with some digital cameras using this technique. Digital cameras generally have difficulties with excessively long exposures. The image suffers from noise which is a similar effect to film graininess. Specimens with low levels of fluorescence or specimens that have been quenched, produce low illuminance levels making digital capture difficult. However, specimens that have introduced secondary fluorescence, generally provide higher levels of exposure or illuminance. Fingerprint techniques is a good example of this type of fluorescence.

8.6 Summary

This chapter has exposed the underpinning theory behind scales and measurement, distortion, close-up and photomacrography, invisible radiation, ultraviolet, reflected ultraviolet, fluorescent and infrared photography. The practitioner should practice these techniques as in both the author's and editor's view, these techniques are not employed in enough crime scene and forensic investigation cases.

8.7 References

- Blaker, A. A. (1989) *Handbook for Scientific Photography*, 2nd edn, Focal Press, Boston, London.
- Cantu, A. A. and Prough, R. S. (1988) Some spectral observations of infrared luminescence, *Journal of Forensic Sciences*, **33**(3), pp. 638–47.
- David, T. J. and Sobel, M. N. (1994) Recapturing a five-month-old bite mark by means of reflective ultraviolet photography, *Journal of Forensic Sciences*, **39**(6), pp. 1560–7.
- Friar, J. and West, M. H. (1989) *Ultraviolet Forensic Photography*, Kodak Tech Bits, No. 2.
- Hyzer, W. G. (1986) Discriminate and indiscriminate use of distance scales, *Photomethods*, September, pp. 10–11, 50.
- Hyzer, W. G. (1994) The last word on depth perception in photographs, *Photo Electronic Imaging*, **37**(2), pp. 42–3.
- Hyzer, W. G. and Krauss, T. C. (1988) The bite mark standard reference scale – ABFO No., *Journal of Forensic Sciences*, **33**(2), pp. 498–506.
- Kodak (1968) *Ultraviolet & Fluorescence Photography*, Kodak Publication No. M-27.
- Kodak (1980) *Applied Infrared Photography*, Kodak Publication No. M-28.
- Kodak (1990) *Photographic Filters Handbook*, Eastman Kodak.
- Langford, M. J. (1977) *Basic Photography*, 4th edn, Focal Press.
- Nieuwenhuis, G. (1991) Lens focus shift required for reflected ultraviolet and infrared photography, *Journal of Biological Photography*, **59**(1), pp. 17–20.
- Porter, G. (2002) *A Study into Bite Mark Evidence Recording Methodologies and their Validity in Bite Mark Evidence in Australia*, Master of Applied Science (Photography) thesis, RMIT University.
- Porter, G. and Doran, G. (1998) The application of forensic photography for facial identification methods, *The Imaging Science Journal*, **46**(3–4), pp. 175–6.

- Porter, G. and Doran, G. (2000) An anatomical and photographic technique for forensic facial identification, *Forensic Science International*, **114**, pp. 97–105.
- Williams, A. R. (1992) *Clinical Photography with Invisible Radiation: Notes on Techniques and Applications, with Selected Bibliography*, RMIT University notes.
- Williams, A. R. and Williams, G. F. (1993) The invisible image – a tutorial on photography with invisible radiation, part 1: introduction and reflected ultraviolet techniques, *Journal of Biological Photography*, **61**(4), pp. 115–32.
- Williams, A. R. and Williams, G. F. (1994) The invisible image – a tutorial on photography with invisible radiation, part 3: reflected infrared photography, *Journal of Biological Photography*, **62**(2), pp. 51–62.

Fingerprint identification

Dale Clegg

9.1 Introduction

Throughout the twentieth century, fingerprints have become widely used in the identification of individuals. This is particularly so in forensic investigation and the compilation of criminal records. When a crime is committed, there is much in the way of physical evidence that may be left at the scene by the offender. For nearly 100 years, through the application of powders, the impression of an individual's fingerprint has proven an easily collected example of this physical evidence. In recent years, many improvements have been made in the methods of visualising fingerprint impressions with the use of chemical reagents and a variety of high intensity light sources, such as lasers and other available alternatives.

There has been a demonstrated increase in the awareness, and application, of the variety of detail available in the ridges of the inner surface of the hands (palmar surfaces). This detail goes beyond the traditional ridge endings and bifurcations to include sweat pores, the shapes appearing on the ridge edges, scars and creases. The study and application of this detail in personal individualisation has, in recent times, become known as Ridgeology or, in the context of this chapter, *Forensic Ridgeology*.

The following pages will discuss the use of fingerprints in their forensic application and will include a description of the formation of the minute detail that can be used to individualise each of us. The areas of skin on the palmar surface of the hands are generally referred to as *friction ridge (d) skin*. It must be noted that the skin located on the sole of the foot (plantar surface) is also suitable for this individualisation as there is no biological, physiological or physical difference between these two areas of friction ridge skin (Moenssens, 1971, p. 263). We will however, in this discussion, direct most of our attention to the palmar surfaces.

9.2 Historical application of fingerprints

Historically, it would appear that mankind has held a degree of fascination for the friction ridge skin that appears on the palmar surfaces of the body. From finger marks placed in wax seals, on clay pottery, on contracts in ancient China and Japan, to cave drawings depicting the narrow swirling lines which form the many and varying patterns which we call fingerprints (Browne and Brock, 1953; Moenssens, 1971; Lambourne, 1984; Ashbaugh, 1996). It is unclear as to whether the use of fingerprints was accidental or more for spiritual reasons, although there would appear to have been a significant awareness of the uniqueness of fingerprints in oriental cultures as far back as 700 AD, as detailed by the ridgeology consultant, David Ashbaugh (1996, pp. 10–13).

An early recorded use of a palm print impression in a murder trial during the Roman Empire is provided by Andre Moenssens (1971, pp. 2–3). He refers to the works of B. C. Bridges, a fingerprint author and historian, which describes the following account of the incident:

The Roman Advocate, born in the year A.D. 35, successfully defended a blind boy accused by his stepmother of murdering his own father by showing that a set of bloody hand prints along a wall could not have been made by the defendant, but had been planted by the true criminal, the stepmother.

No claim was made that the bloody fingerprint was compared and identified applying modern fingerprint comparison techniques. It was more likely the value of the evidence being the difference in palm print size of the boy's compared with that of his stepmother's.

Throughout the last 300 years a number of studies of the friction ridge skin have been published (Malpighi, 1668; Grew, 1684; Purkinje, 1823 [cited by Browne and Brock, 1953]; Mayer, 1788 [cited by Moenssens, 1971; Ashbaugh, 1996]). Many of these studies were of an anatomical and physiological nature. The first practical application of the use of fingerprint impressions has been attributed to Sir William Herschel. Herschel was an English administrator in India who, in 1858, placed the handprint of Radyadhar Konai on a contract requiring him to supply road-making material. Herschel continued the practice of obtaining inked finger and palm impressions throughout the later half of the nineteenth century. It was primarily these impressions, which assisted in establishing the persistence of the friction ridge skin detail throughout the life of an individual.

9.3 The first fingerprint identification

The first practical application of fingerprint identification in a murder case, using fingerprint comparison techniques, has been attributed to Juan Vucetich. Vucetich was a Dalmation immigrant to Argentina who developed an extensive interest in fingerprints and, in 1892, established the identity of an individual through the use of fingerprints in the following case:

In the Buenos Aires provincial town of Necochea the two sons of Francesca Rojas were found murdered, and she had a throat wound. She accused a near neighbour

of this grisly crime, and he was arrested, although he protested his innocence. Fortunately, the police officers examining the crime scene noticed what appeared to be fingerprints in blood on a door adjacent to the place where the bodies had been found. Portions of the door bearing these marks were cut out and sent to La Plata identification bureau together with the fingerprints of the accused man and the woman Rojas. It was quickly confirmed that the marks were in fact fingerprints, and that the woman had made them. Faced with this damning evidence, Francesca Rojas confessed to the murder of her sons and was sent to prison.

Lambourne (1984: pp. 58–9)

9.4 Classification of inked fingerprint impressions

Towards the end of the nineteenth century, Juan Vucetich had devised a system of classifying inked fingerprint impressions, which he introduced in Argentina. A system still in use in many South American countries. At the same time, an Englishman working in India, Sir Edward Henry independently devised another classification system, which he documented and published (Henry, 1900). This classification system became the basis of filing and retrieving fingerprints throughout the western world and, albeit with some modifications, is still in use in most of those countries. Numerical values applied to the various pattern types, combined with ridge counting and tracing of the fingerprint patterns, form the basis of this classification system. The use of inked fingerprints has provided a reliable means of identifying persons and allowing the accurate recording of criminal convictions. Without such comprehensive records forming a 'database', the value of obtaining fingerprints from the crime scene would be greatly reduced. Such fingerprints are often referred to as 'latents' or 'finger marks'. Latents will be further discussed.

During the commission of a crime, the perpetrator will rarely leave a complete set of finger marks at the scene. It was therefore only a matter of time before a classification system was devised for searching single finger impressions. One of the original members of the New Scotland Yard Fingerprint Bureau, Detective Collins, attempted such a system that proved frustratingly inadequate as the fingerprint collection grew. In 1925, Detective Chief Inspector Battley, also of Scotland Yard, began to devise a more workable system with the assistance of Detective Sergeant Cherrill. In 1930, Battley published his book entitled *Single Fingerprints* (Lambourne, 1984). His system of single fingerprint classification was used extensively for many years.

The last 20 years of the twentieth century witnessed the introduction of computers in the storage of inked fingerprint impressions and searching of crime scene finger marks. It is expected that improvements in technology will see even greater improvements in the electronic capturing and searching of finger and palm prints.

9.5 Fingerprint patterns

9.5.1 *General considerations*

While the ridges cover the entire palmar surface, it is on the ends of the fingers and thumbs, or distal phalanges, where the most commonly encountered patterns will

appear. It is these patterns, which are used in the process of classifying, searching and filing. Although impressions left by an individual may be from any area of the palmar surfaces, the distal phalanges are those, which are commonly observed. Four common pattern types are widely recognised as being the basis for describing the ridge patterns on the distal phalanges. Sir Edward Henry indicated the four types as:

1. arch
2. loop
3. whorl
4. composite.

A brief definition and example of these is provided for reference.

9.5.1.1 Arches

Ridges in arch patterns generally flow from one side of the finger to the other without any form of recurve that would create a 'delta' point (Figure 9.1a). See Figures 9.1(b–g) for examples of a delta point.

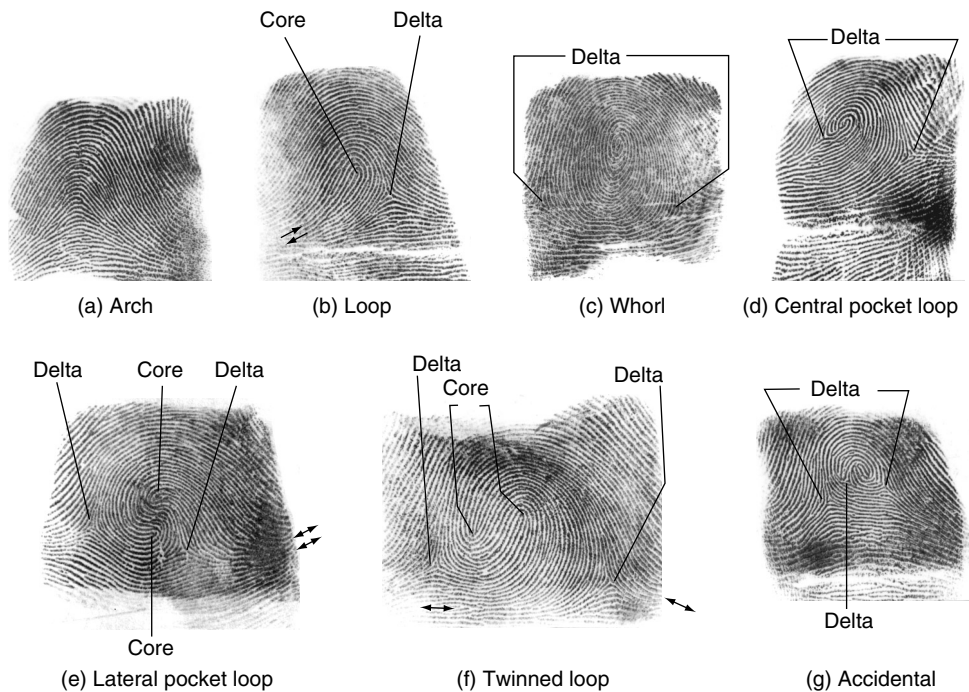

Figure 9.1 Different types of fingermarks indicating the presence and positioning of the 'core' and the 'delta'

9.5.1.2 Loops

Ridges in a loop pattern flow from one side of the finger with at least one of these ridges recurving and exiting the finger on the side from which it came (Figure 9.1b). This recurve will generally create one delta point and there may be only one such recurving ridge, or many. If, in the example provided, we place a line between the delta point and the 'core' of the pattern, which will be on or near the innermost recurve, it can be seen there are nine intervening ridges. Further examples of the 'core' are provided in Figures 9.1e and 9.1f.

9.5.1.3 Whorls

Ridges in whorl patterns flow from the side of the finger, with some completing a full circuit creating two delta points (Figure 9.1c). The ridges completing the circuit may be circular or elongated.

9.5.1.4 Composites

Composites include patterns in which various combinations of the arch, loop or whorl are found in the same finger impression. These are subdivided into central pocket loop (Figure 9.1d), lateral pocket loop (Figure 9.1e), twinned loop (Figure 9.1f) and accidental (Figure 9.1g). In the example of an accidental, it can be seen there are three delta points. This is a common occurrence in this subdivision. It can also be seen in the lateral pocket loop that the ridges forming the two loops exit on the same side of the impression while in the twinned loop, these ridges exit from opposite sides.

9.5.2 Identification methodology

9.5.2.1 The premises of fingerprint identification

Fingerprint identification relies on the premise that detail contained in the friction ridges is unique and unchanging. The premises, or fundamental principle of fingerprint identification, have best been stated in their clearest form by David Ashbaugh (1996, p. 61). These premises are:

- Friction ridges develop on the foetus in their definitive form before birth.
- Friction ridges are persistent throughout life except for permanent scarring.
- Friction ridge patterns and the details in small areas of friction ridges are unique and never repeated.
- Overall friction ridge patterns vary within limits, which allow for classification.

Ashbaugh notes that the fourth premise does not relate directly to identification, as the detail contained within the ridges forming the patterns is not in itself utilised in the classification process. In the day-to-day terminology of the fingerprint environment, the detail contained within the friction ridges is referred to as 'characteristics'. These characteristics may also be referred to as 'minutiae', 'Galton detail' (after one of the fingerprint pioneers of the late 1800s), or 'points'. Whichever term may be applied, the detail generally being referred to in such application are the many bifurcations and ridge endings which may be observed within the general ridge pattern.

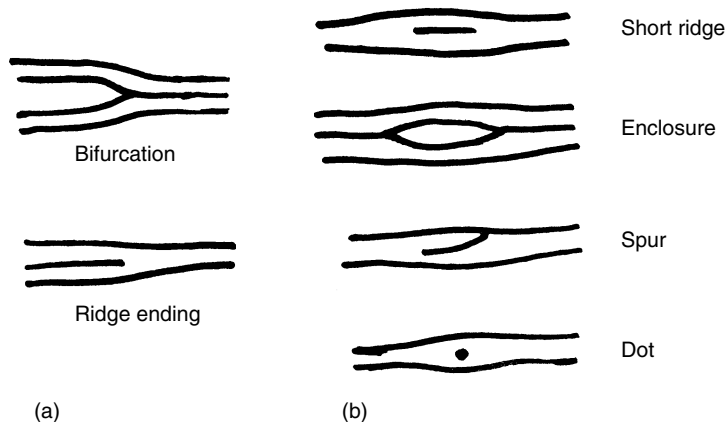

Figure 9.2 Characteristics within a fingerprint which are used in the identification process

9.5.2.2 *Bifurcations and ridge endings*

On close observation of the ridges flowing over the palmar surfaces and the varying pattern types, which they may form, it can be seen they do not flow continuously. Many of the ridges terminate or bifurcate throughout the area of ridge skin being observed. Figure 9.2a provides an example of these ridge ending and bifurcation characteristics in their literal sense.

These bifurcations and ridge endings often form configurations that in themselves may be termed characteristics. Examples of these are provided in Figure 9.2b. As it can be seen in these examples, a ‘short ridge’ can be seen to be two ridge endings, while an ‘enclosure’ is the configuration of two bifurcations. A ‘spur’ on the other hand is the configuration of both a bifurcation and a ridge ending, while a ‘dot’ is argued by some to be two ridge endings, whilst others would argue it is a unique characteristic in its own right. Such arguments are of academic value only, and have no bearing on the value of the particular characteristic in the fingerprint comparison process.

These bifurcations and ridge endings are the ‘traditional’ characteristics used in the fingerprint comparison process. The term ‘traditional’ is used to differentiate these characteristics from the additional and sometimes small detail that may be observed along the ridges, and utilised in the identification process of friction ridge skin. This detail together with creases, bifurcations and ridge endings, forms the basis for the study of Ridgeology. At this point, we will examine the use of traditional characteristics as they are used in the identification process as these represent the detail currently used by most fingerprint practitioners on a daily basis.

9.5.3 *Establishing identity with ‘traditional’ characteristics*

Should one and the same person have made two friction ridge skin impressions, their identification may be established through the location of sufficient ridge endings and bifurcations being found to be in true relative position and coincidental sequence. To achieve this, an examination of one of the impressions, generally the crime scene

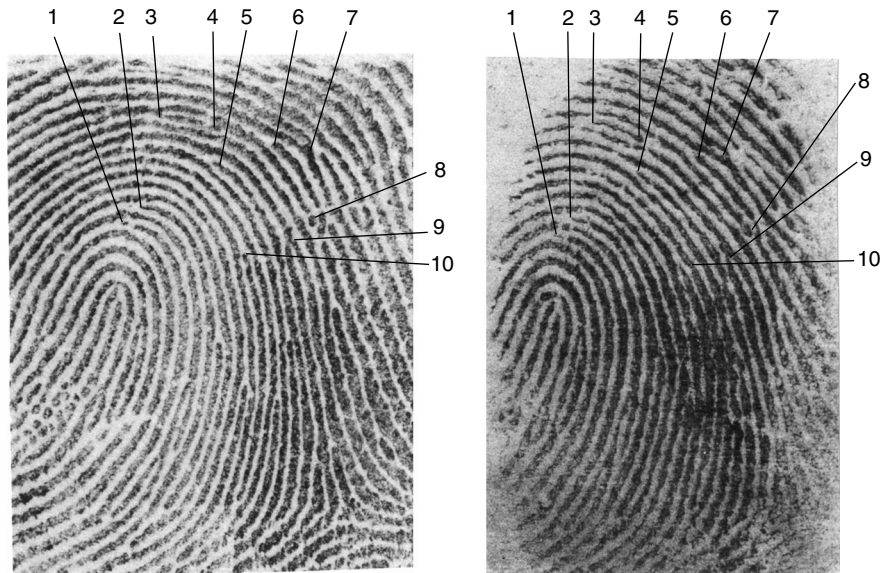

Figure 9.3 Comparison of an inked fingerprint with a recovered developed latent fingerprint. Each observable characteristic has been given a number 1–10

mark if this is the case, will be commenced. A determination is made by the examiner as to where, from the palmar surface, the finger mark may have originated. One or may be two characteristics may be observed and compared with characteristics appearing in the second impression. Once such characteristics are located to the satisfaction of the examiner, a further examination of the first impression will be made in an effort to locate a further characteristic. Again, the second impression will be examined to locate that characteristic. Having done this, the examiner will ensure the characteristics observed are in the correct sequence meaning that the same number of intervening ridges must separate each of the characteristics. In addition, their relative position to each other must be considered. An example of the process can be seen in Figure 9.3.

In the two impressions appearing in Figure 9.3, it can be seen that the marked characteristics are in relative position with one another. It can also be seen that the number of intervening ridges between points 1 and 2, is one in each impression. Likewise, there are seven intervening ridges between points 2 and 3. This process is continued throughout an examination until the examiner is either satisfied that an identification has been established, or that the impressions are not identical.

As an exercise, continue counting the intervening ridges between the marked points. The following is a selection against which you may compare your own findings:

- Points 4 and 10 = five intervening ridges.
- Points 8 and 3 = nil intervening ridges (trace the ridge from point 8 and you will arrive at point 3).
- Points 1 and 7 = twelve intervening ridges.

9.5.4 Numeric standards

Since the introduction of the use of fingerprints by police forces, fingerprint examiners have relied primarily on the ridge endings and bifurcations used in the manner discussed. This has resulted in the creation of numeric standards. That is to say, standards were set establishing how many characteristics should be present, in relative position and sequence, before fingerprint identification could be positively established for presentation at court. Different countries throughout the world set various standards requiring a pre-determined number of characteristics to be present. A variety of numeric standards existed which include 7, 8, 10, 12 and 16. Each country had their own reason for their preferred standard although many were based on statistical models which demonstrated the probability of no two people having the same fingerprint.

In 1973 the International Association for Identification (IAI) met for their annual conference in Jackson, Wyoming, USA. A statement declaring 'no valid basis exists at this time for requiring that a predetermined minimum of friction ridge characteristics must be present in two impressions in order to establish positive identification', was subsequently adopted by all North American fingerprint identification examiners (IAI: Report of the Standardisation Committee, 1973: cited by Ashbaugh, 1996: p. 1). This began a philosophy whereby an opinion of identification was not based on the number of characteristics present in two impressions.

The New South Wales Police, in Australia, followed this direction in the early 1980s and in doing so broke away from the national standard which, at that time, was 12. The Australian Federal Police and the Northern Territory Police (Australia) soon adopted a non-numeric philosophy also. In 1998, it was agreed that the national standard in Australia be accepted as non-numeric; however, state jurisdictions are at liberty to maintain 'office policy' regarding minimum standards.

The United Kingdom currently maintains a numeric standard of 16 ridge characteristics, which is considered by many to be extremely conservative. This standard was recently challenged through a report prepared by Evett and Williams in 1989, which, however, was only released during a meeting in Ne'urim, Israel, in June 1995. The report was soon published in the *Fingerprint Whorld* (1995). The following resolution was agreed upon and unanimously approved by members at that meeting; no scientific basis exists for requiring that a predetermined minimum number of friction ridge features must be present in two impressions in order to establish positive identification (Ashbaugh, 1996: p. 5).

Note the significant difference in the resolution, 'no scientific basis exists...', compared with the IAI declaration which commenced, 'no valid basis exists...'

The numeric standard, which currently exists in the United Kingdom, has been reviewed which has resulted in the recommendation that it be removed.

9.6 Ridgeology

9.6.1 Structure of friction ridge skin

To assist in understanding Ridgeology, a description of the structure of friction ridge skin may be a point at which to commence. This skin is comprised of two primary layers being the inner or dermal layer, and the outer or epidermal layer. Within the epidermal

layer can be found five sublayers, the inner most layer being the basal. This layer connects to papillae pegs that can be visualised on the outer surface of the dermis. The basal layer generates cells that migrate to the surface of the skin. This migration, amongst other functions, enables the persistence of the detail visible in the friction ridges. From within the dermal layer, sweat ducts, from the eccrine gland, twist their way to the tops of the friction ridges whereby small sweat pore openings may be seen.

The friction ridges themselves are constructed by ridge units, which may vary in size, shape and alignment and, 'are subjected to differential growth factors, while fusing into rows and growing' (Ashbaugh, 1996: p. 58). This author makes the observation that the ridges are three-dimensional, creating uniqueness in the forming of the friction ridges, even in a very small area. Random forces through differential growth also affect the location of the sweat pore openings on a ridge unit. The detail associated with the sweat pores and the minute detail located on the ridge edges are significantly smaller than the traditional characteristics. It is however the collective formation of this minute detail, through differential growth, which determines the position of the ridge endings and bifurcations and how they are observed.

9.6.2 Poroscopy

Poroscopy is the method of establishing identity by a comparison of the sweat pores along the friction ridges and was extensively studied by the French criminologist, Edmond Locard. His studies examined the sweat pores and applied measurements in microns, whereby he found their size varied from 88 to 220micra (Moenssens, 1971: p. 281). Locard demonstrated the value of poroscopy in the criminal trial of Boudet and Simonin in 1912, in which he marked up some 901 separate sweat pores and more than 2,000 in a palm print recovered from the crime scene.

Other such cases involving much lower numbers of sweat pores have been documented in more recent times (Clegg, 1994; Ashbaugh, 1997). At [Figure 9.4](#) the sweat pore detail in this latter case is offered as an example of how it may be used collectively with the traditional characteristics available. The position of these sweat pores are marked '>', while the traditional characteristics are not marked. The case in question centred on a fragmentary fingerprint located on a stamp that was in place on a letter. This letter contained a small quantity of an illicit drug that had been forwarded to Australia from Mexico. Confronted with the evidence, the individual who was the subject of the investigation admitted to the offence, resulting in no opportunity in presenting the evidence in court.

9.6.3 Edgeoscopy

The term 'edgeoscopy' surfaced in an article prepared by Salil K. Chatterjee that appeared in *Finger Print and Identification Magazine* in 1962 (Ashbaugh, 1996). Chatterjee suggested the use of ridge edges in conjunction with other friction ridge detail that may be present, and assigned names to seven common edge characteristics which included convex, concave, peak, pocket and angle. Several examples of the detail to which Chatterjee was describing have been traced and indicated in [Figure 9.5](#). It can be seen that there are many more features than those marked.

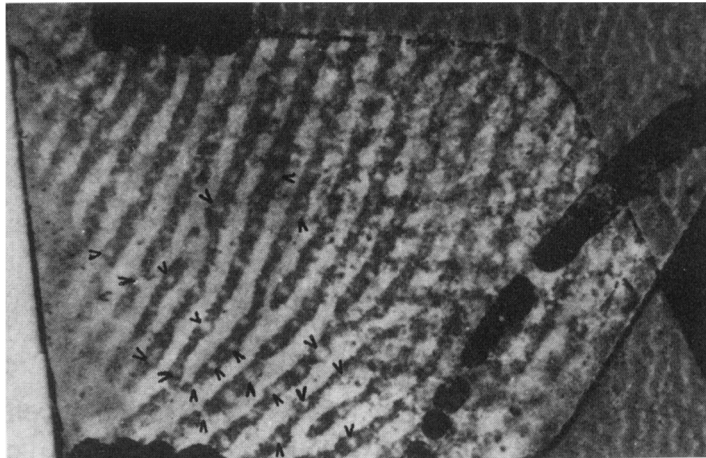

Figure 9.4 Sweat pores

9.6.4 Additional palmar surface detail

Further detail that may be utilised by the fingerprint examiner includes scarring, usually of a permanent nature, and flexion creases. In examining the palm area of the hands, the predominant flexion creases can be seen to be the point where the skin folds when you commence to make a fist of your hand. The persistence of these creases was demonstrated by Sir William Herschel through the comparison of two impressions of his own left hand that were taken 30 years apart (Ashbaugh, 1996: p. 125). This author also describes two murder trials in which flexion crease identifications have been presented in North America (pp. 130–3). In each case, the accused was convicted although it was not suggested this evidence was the only evidence available to the prosecution.

Permanent scarring is created by injuries that may be inflicted upon the inner extremities of the epidermis effectively damaging the dermal papillae to which it is attached. Once

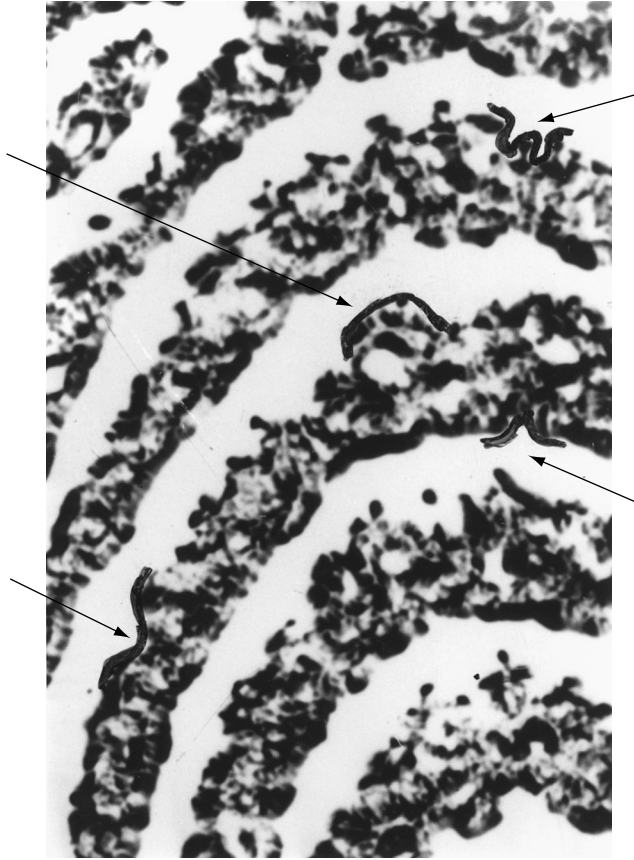

Figure 9.5 Tracings to the edges of the fingerprint, indicated by arrows which are the unique characteristics seen in edgeoscopy

such a scar is created, it too becomes a permanent feature of the particular area of friction ridge skin. This permanence allows for such scars to be utilised in the identification process when it appears in two impressions being compared. For an example of this type of scarring see [Figure 9.6](#) and examine the similarity of the detail along the scar. These two impressions were taken nine years apart and the scarring in question has in fact existed, unchanged, for 38 years.

The increased acceptance and application of all the detail contained within an area of friction ridge skin is eliminating the reliance, by practitioners, on a predetermined number of traditional characteristics being present to establish identity. This path is being encouraged through recommendations from reports such as that of Evett and Williams following their review of the 16 points standard in England and Wales, and by the increasing number of practitioners around the world who have given their support to *Forensic Ridgeology*. A further recommendation for having no predetermined numeric standard has been published in a recent text aimed at forensic scientists and the legal fraternity (Robertson and Vignaux, 1995).

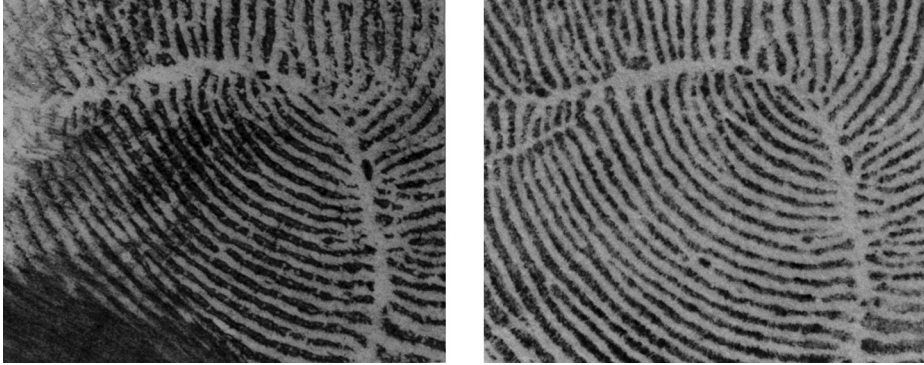

Figure 9.6 Scars of the type which are used for comparison purposes

9.7 Fingerprints and genetics

The first point to be made in this section is that the friction ridge detail appearing on the palmar and plantar surfaces of identical, or monozygotic twins, will be as different and varied as will be encountered in each of us. While it must be remembered that it is the detail located within, and along the ridges, which enables us to individualise areas of friction skin, the patterns the ridges form may well be influenced by genetic factors. There are a number of studies published by individuals that resulted from the study of the development of friction ridge skin. David Ashbaugh refers to these people as the ‘Scientific Researches’ (1996). Included in these are the works of Harold Cummins and Charles Midlo (1943), and Alfred Hale (1952). These studies were lengthy so no attempt to disseminate their contents will be made in this discussion; however, a brief and very simplified account of their outcome is provided.

In the development of a human foetus, volar pads form and become evident around the sixth week. It was described by Cummins that the placement of the volar pads conformed to a morphological plan (Cummins and Midlo, 1943: p. 178). The placement and shape of these pads, which are raised areas on the hand, may influence the direction of the friction ridge flow, which in turn creates the particular pattern types that we may see. Examples of this, it is believed, would be high centred pads creating ‘whorls’, whilst intermediate pads with a trend are believed to form ‘loops’ (Ashbaugh, 1996). It is important to remember that while genetics may influence the pattern formation and general flow of the ridges, the location of ridge endings, bifurcations, and other detail contained within each ridge, is the result of differential growth at the developmental stage.

9.8 Fingerprints and the crime scene

9.8.1 *What is a fingerprint?*

In simple terms, a fingerprint may be described as an impression of an area of friction ridge skin left upon a surface. Being able to visualise this fingerprint is the essence of its value to enable any comparison to be undertaken. The simplest form of achieving this

is the tried and proven method of applying a thin coating of printer's ink to the tops of the ridges and placing the finger or palm onto a white paper surface. This is the process that most police forces apply in obtaining the finger and palm impressions of a person charged with an offence. Electronic scanning devices are becoming more popular in use by law enforcement, although costing has hindered their general introduction. Concerns have also been expressed as to the ability of this equipment to record the finer detail contained within the friction ridges although improved technology is overcoming these concerns, and will continue to do so. A further concern is the legalities of producing electronically generated copies of person's prints at court. Measures such as audit trails or built-in mechanisms preventing digital alteration will address these concerns.

Visualising a finger mark left on a surface is somewhat more complex than obtaining an inked fingerprint. Such finger marks may fall into one of four categories as follows:

1. Latent – hidden (or difficult to see) until developed by the use of a powder, chemical or optical device.
2. Visible – in dust, dirt, blood, grease or other medium, which contrasts with the background.
3. Moulded – in soft mediums such as putty or plasticine.
4. Etched – into various soft metals by acids contained in the perspiration.

There are various terms used by fingerprint practitioners when referring to fingerprints located at a crime scene or on an object, some of which have been mentioned in this discussion. This may include but is not limited to, 'fingerprint', 'crime scene mark', 'finger mark' or 'latent print'. Latent print, when used in this context, refers to any friction ridge impression located at the crime scene, or on an item. The types of finger marks described at 2, 3 and 4 are self-explanatory and perhaps require no further discussion; however, a case study involving a 'visible' finger mark will now be offered.

9.8.2 Jane Doe murder

In December 1991, the victim of a vicious murder was found in a suburb of Sydney, Australia. The New South Wales Police Service commenced an intensive investigation; the first step being to identify the victim of the crime, which in itself took some months. During the following post-mortem, a number of items were removed from the victim including her clothes, some hairs, sand, and two double-sized pages from the *Sydney Morning Herald* newspaper, dated 10 December 1991. These newspaper pages were removed from the victims mouth and were about the size of a man's fist. Detective Senior Constable Colin Terry of the NSW Fingerprint Section was in attendance and obtained a set of inked fingerprints from the deceased. He also took possession of the newspaper pages.

On return to the fingerprint office, the victim's fingerprints were searched on the National Automated Fingerprint Identification System (NAFIS) with a negative result. Constable Terry then began an examination of the newspaper by carefully unfolding the large pages. At this point he observed three finger marks in a medium which appeared to be blood. As these finger marks were not that of the unidentified victim, a search was initiated resulting in no identification. The police were now in possession of finger marks, which they believed were those of the murderer, although this fact was not

confirmed until April 1992. Through the patient efforts of investigating police, the victim was identified which provided them with a suspect, the victim's boyfriend. This person had departed for England in apparent haste, within days of the body being found.

On obtaining the fingerprints of this suspect from existing records, a comparison of the finger marks was carried out which resulted in a vital identification. The prosecution, much of which was refuted through legal argument and conjecture by defence representatives, produced additional evidence. At the conclusion, the evidence which the Judge relied on most was the finger mark on the paper. The defence of the accused was that he had had a fight with his girlfriend at which point he punched her in the nose causing it to bleed. They were packing at the time in preparation for moving house and he used some of the newspaper to wipe her blood from his hands. However, the judge could not accept the coincidence that these same pages of newspaper were found lodged in the victim's throat some two weeks later. This, and a conversation had by the accused with British Police at the time of his arrest in England, on warrant, overcame any reasonable doubt in finding the accused guilty. It was interesting to note that the accused exercised his right not to have the matter heard before a jury (see Fay (1998) for the story).

9.8.3 Latent finger marks

'Latent' finger marks, as previously mentioned, are those, which require some form of developing to be visualised. How latent deposits come to be, and their subsequent development, will now be explained. The pore openings located on the tops of the ridges play an important role in the deposit of a true latent finger mark. The secretion from these pores is generally found to contain approximately 98.5 per cent water, with the remainder comprising organic acids, salts, neutral fats and cholesterol, and extracts with epithelium (Moenssens, 1971: p. 29). The normal rate of secretion of perspiration through the ducts on the friction ridges may be found to be approximately 62.5 mm^3 per hour, per fingertip, and contains no significant quantity of oil.

This perspiration will flow the length of the friction ridges and when an area of these ridges comes into chance contact with a surface, an impression of the ridges may be deposited. In addition to the presence of perspiration, contaminants such as sebum may be present. Sebum is an oil, which is secreted by the sebaceous glands that are located adjacent to hair follicles, which in itself explains their absence on the palmar surfaces. Through normal contact of the hands with areas of the body where sebum may be present, contamination may occur. These sebum-enriched latent finger marks are generally the ideal form of latent mark. Other contaminants may be encountered through the handling of many greasy surfaces, should such an external medium collect on the tops of the friction ridges. Again when these ridges contact a given surface an impression of the friction ridges may be deposited.

Should this surface be non-porous in nature, the application of a fine powder, generally with a soft haired brush, will physically adhere to this deposit allowing us to visualise the detail of the source friction ridges. In selecting the colour of powder, the fingerprint technician will have regard for the background surface colour in an effort to achieve maximum contrast. The now developed finger mark will either be lifted with the use of adhesive lifting tape and placed onto an appropriate coloured backing card, photographed with a suitable camera, or both processes may be undertaken. As the

developed print becomes evidence, it is necessary that the technician accurately records the location of the finger mark and maintains a satisfactory continuity trail of that evidence.

Should the surface be of a porous nature, powders will generally fail to provide a satisfactory result. A number of non-porous surfaces like that of some plastics, varnished timber and some metal surfaces react similarly with powders providing generally poor results. Throughout the latter half of the twentieth century, extensive scientific research was conducted in the development of techniques, which may be used in the processing of porous and non-porous surfaces, with a view to visualising finger marks.

Many of the techniques reported require the use of chemical reagents and are therefore more sensitive than dry powders in their application. While there are many such processes, some of which are complex, we will concentrate our discussion on the more common techniques in use by most fingerprint practitioners.

9.8.4 *Duration of a latent finger mark*

It is regularly asked whether it can be said how old a finger mark, found at a crime scene, may be. To date, there is no scientific means by which this can be answered; however, many fingerprint technicians, through years of experience, may offer an opinion as to whether a mark is 'fresh' or 'old'. As a true latent friction ridge deposit is primarily water, evaporation may occur quite rapidly if exposed to wind or heat. The duration of the mark may however be aided by contaminants such as sebum or a similar medium. Such oils may remain stable for some time depending on location and whether they are subject to external influences like rain, sunshine or heat. The amount of matter deposited in the mark, and the type of surface on which it is placed, will also have a bearing on durability. Several studies conducted have been unable to provide conclusive value through their results.

Other factors, as may be provided by the victim of a crime, may assist in establishing duration of a finger mark. An example of these factors may simply be that the item in question was just purchased and recently removed from its packing case, or that a window sill has just been repainted. In both cases it would be expected that any finger marks must have been deposited since those events.

A case reported by Sergeant Dean Greenlees, a fingerprint officer in South Australia, centred on finger marks located on the outside of a window at a vacant premises which had been burgled (1994). A finger mark was searched on the NAFIS resulting in an identification of a South Australian Police Officer. Following an internal investigation it was revealed the officer in question had attended the house some two years previously to assist the occupant of that time, who had locked himself out, to gain entry. On the night of that event the officer was working with a Police Cadet with whom he had never worked since that time. Unidentified finger marks, which were not suitable for searching on NAFIS, were subsequently identified as being those of the cadet. The marks were two years old yet in the opinion of most that had the opportunity to examine them, they were characteristically fresh. Such an example reinforces the need for fingerprint practitioners to qualify their opinion regarding duration of finger marks, and to remain mindful of the need to keep objectivity in addressing such an issue.

9.9 Ninhydrin and DFO developers

Ninhydrin reacts with the amino acid components of eccrine gland secretions to produce a purple product known as Ruhemann's purple (Margot and Lennard, 1994: p. 71). Their primary use is for visualising finger marks on paper and other porous surfaces. DFO also reacts with these components although if going to be used in conjunction with ninhydrin, must be used prior to ninhydrin treatment. In both cases, the items to be examined must be exposed to the reagents, preferably by immersion, brush or spray. Methods of using these reagents in a dry state have also been considered.

In the wet state, ninhydrin requires air-drying over 24–48 h with a preferred humidity greater than 80 per cent, or may be accelerated in a humidity cabinet, although allowing the items to become wet may well destroy any finger marks present. DFO requires the application of dry heat for the development to take place. It is generally not possible to visualise DFO-developed finger marks at this time. How this can be done will be addressed when discussing forensic light sources. Finger marks on paper may be developed after many years from the time of their placement provided the paper has not been subjected to wetting.

9.10 Cyanoacrylate ester

Cyanoacrylate esters are colourless monomeric liquids generally sold as 'superglue' (Margot and Lennard, 1994: p. 61). The 'glue' is subjected to heat, in a chamber, causing it to vaporise at which point it selectively polymerises on the ridge deposits to form a hard, white polymer. Latent deposits high in sebum content appear to react particularly well using this method. This process is for use on non-porous surfaces such as glass, metals and plastics. As the process produces white finger marks, there is often a need to further treat items in an effort to adequately visualise the developed marks. How this visualisation may be carried out will also be discussed in forensic light sources.

9.11 Forensic light sources

Recent years have seen the application of lasers to assist in the visualisation of finger marks. As these lasers are costly and limited to the one wavelength, alternative high intensity forensic lights have been designed and produced which enable quality results while providing a range of narrow band wavelengths. The forensic applications of these light sources are many, however in the context of our discussion, we will examine their common use in finger mark visualisation.

DFO-developed finger marks, which may not be visible in normal room light, can be visualised in a photoluminescence mode, made possible by such a light source. The desired wavelength is selected as the excitation source, and directed at the item being examined. This area is then viewed through a chosen band pass filter at which point any finger mark, which has reacted with the DFO, may be visualised. An inherent

problem, which may be encountered with this process, is that many papers maintain a degree of luminescence, due to various manufacturing processes, negating the process' effectiveness.

In the process of finger mark development using 'superglue', it was stated that the ridge deposit would develop white. If this is on a light-coloured or multicoloured surface a fluorescent stain may be applied. After staining, the excess is gently washed away under a running tap and the item allowed to dry. Using the light source in the same manner as previously described will allow visualisation of any finger marks developed as a result of the process. In both examples given, the use of appropriate camera filters in conjunction with the forensic light source will enable the developed finger marks to be photographically recorded.

9.12 Implications of a fingerprint identification

The mere fact that a finger mark found at a crime scene, or on an item, has been identified is not in itself proof of guilt. Should a person have legitimate access to either the scene or the item in question, then the weight of the identification may be greatly reduced. This is often the direction the defence may take when representing accused persons in court, not unlike the defence in the previously mentioned Jane Doe case. On the other hand should an individual deny all knowledge of the crime scene including ever being present, then the detection of his finger mark may become quite convincing in the eyes of the court.

It is not always the identification itself, of a finger mark, that may assist in proving beyond reasonable doubt the involvement of an individual in a criminal act. A case in Nottingham, England involved a number of fraudulent claims for items such as travel, at a local Royal Air Force base. These forms were made available in an administration office for signing by the respective RAF members enabling them to receive their claims. One such member decided to start signing on behalf of others and successfully obtained their funds. Mr Robert MacShane from the Nottinghamshire Constabulary Fingerprint Bureau was asked to examine the fraudulent documents that resulted in the development of the suspected individuals palm print. The print in question was the side of the right palm and appeared in the same location and position on each of the forms. When confronted with this, the suspect said he must have inadvertently touched these forms when he was locating his own. Mr MacShane conducted some tests by overlaying his own hand as if he were signing the forms and found that his own palm took the same position and location as those developed. At that time he did not know whether the suspect was right or left handed.

The RAF, when informed of this, provided Mr MacShane with a number of claim forms which the accused had rightfully submitted. These were subjected to ninhydrin processing resulting in all forms bearing the suspects palm print, in the same location and position on the form, as it may be expected to be placed while signing. Consistency of the position of this person's palm print, being on all the forms examined, became quite valuable to the prosecution. The matter was contested, but this evidence, along with other evidence offered at the court martial, resulted in the accused being convicted (personal account provided by Mr MacShane).

9.13 Forgeries

The question of forgeries is serious and will not be hastily discounted by the experienced fingerprint technician. What is a forged fingerprint? The term 'forgery' would imply the fingerprint in question has been copied, which may certainly be the case if using a rubber mould, or stamp of an individual's finger. Forgery often refers to the lifting of a finger mark, using some form of adhesive medium and placing it at a crime scene or on an object to be examined. The mark may be lifted after powdering, or as a true latent deposit should it be sufficiently visible. The lifting of a mark, particularly if it is powdered first, may lift material in the surrounding area, which may in turn be transferred to the new surface. The surrounding material transferred may be easily seen to be foreign to the receiving surface. Adequately trained technicians should be carefully observing all finger marks that are developed for the presence of such anomalies. Should rubber moulds or stamps be used, it may not be possible for all the ridge detail, pores, edges, etc. to be duplicated. It has been observed that when using such a medium, small air bubbles may appear in the duplicated mark. A further consideration is that friction ridge skin maintains a high degree of elasticity resulting in no two impressions being placed down in exactly the same manner. If a rubber stamp were to be used at a crime scene and placed down several times to ensure it was located, no natural variation of the friction ridges would be observed as duplication of the elasticity of friction ridge skin may be difficult to achieve.

There are many issues to consider when contemplating the forgery of a fingerprint. Where will the mark be sourced? Is it in fact the mark of the person needed? Where to place the mark to be certain it will be located? Can the technician be relied upon to locate the mark? Will the quality of the mark be such that the technician will consider it worthy of recovery? How will the examiner know who to compare it to? There would surely be more certain and easier methods of 'framing' an individual, if someone was motivated to do so.

The suggestion of forgeries, particularly in court, would generally be directed by defence lawyers towards the fingerprint technician. Certainly having the necessary knowledge, combined with the guarantee of locating and identifying the mark, would make such an exercise much simpler. At some point however, during proceedings where forgery is alleged, the integrity of the fingerprint examiner(s) will have to be relied upon. This places a great onus on all fingerprint practitioners to police the profession ensuring this behaviour does not occur, and when it does, to publicly denounce those involved. Unfortunately, the situation of a fingerprint technician fabricating fingerprint evidence has occurred on more than one occasion. A recent example involving the New York State Police was published in *Scientific Sleuthing Review* (Greive, 1993). A fingerprint member of this police service was found guilty of fabricating fingerprint evidence that resulted in many people serving lengthy periods in gaol. These events lead to an extensive investigation and drew much attention of the media in the United States such as *60 Minutes*: 28 March 1993. It is the responsibility of all fingerprint practitioners to ensure such situations do not occur in the future.

9.14 Conclusion

A historical review of fingerprints has been provided, combined with a discussion of their practical use by law enforcement agencies. With the dozens of textbooks available,

relevant to the subject, combined with ongoing publications of new texts, we have only scratched the surface in these few pages of what may well be the greatest practical means of volume identification of individuals. The ease of locating a finger mark, to the relatively quick, reliable method of identification, has enabled fingerprints to become the foundation stone of personal identification in the forensic science arena throughout the twentieth century.

The most significant step forward for the science is the removal of predetermined numeric standards and the increasing acceptance and use of all available ridge detail located in the friction ridge skin on the palmar and plantar surfaces. Whether this study is to be known as Ridgeology, or some other name, it will elevate the standing and professionalism of the fingerprint practitioner through the twenty-first century. More importantly, in some jurisdictions, it will make available to the courts more evidence of identification than is currently being presented.

Several finger mark detection techniques have also been briefly discussed; however, it must be stated in conclusion, that there are many other specific techniques available as a result of the work produced by the scientists and practitioners whose research is ongoing in this field.

9.15 Bibliography

- Ashbaugh, D. (1996) *Quantitative – Qualitative Friction Ridge Analysis. An introduction to basic and advanced Ridgeology*, Published in draft: Ridgeology Consulting Services: Canada.
- Ashbaugh, D. (1997) Friction ridge identification based on pore structure – a case study, *Fingerprint Whorld*, **23**(87), pp. 7–11.
- Browne, D. and Brock, A. (1953) *Fingerprints – fifty years of scientific crime detection*. Harrap: London.
- Clegg, D. (1994) Poroscopy in practice, *Journal of Forensic Identification*, **44**(1), pp. 15–20.
- Cummins, H. and Midlo, C. (1943) *Finger prints, palms and soles. An introduction to dermatoglyphics*, Research Publishing: Mass., USA.
- Evett, I. W. and Williams, R. L. (1995) A review of the sixteen points fingerprint standard in England and Wales, *Fingerprint Whorld*, **21**(82), pp. 125–43.
- Fay (Barry), C. B. (1998) The Jane Doe Murder Mystery, *Australian Police Journal*, **52**(2), pp. 61–101.
- Greenlees, D. (1994) Age determination – case report, *Fingerprint Whorld*, **20**(76), pp. 50–2.
- Greive, D. (ed.) (1993) Fingerprint identifications rocked to the core: seeing is not observing, *Journal of Forensic Identification*, **43**(6), pp. 669–74, Reprinted from *Scientific Sleuthing Review*, Starrs and Midkiff (senior eds), **17**(2), pp. 7–9.
- Hale, A. R. (1952) Morphogenesis of volar skin in the human foetus, *The American Journal of Anatomy*, **91**(1), July.
- Henry, E. R. (1900) *Classification and uses of finger prints*, Routledge (for His Majesty's Stationary Office): London.
- Lambourne, G. (1984) *The fingerprint story*, Harrap: London.
- Margot, P. and Lennard, C. (1994) *Fingerprint detection techniques*, 6th revised edn, Institut de Police Scientifique et de Criminologie: Lausanne, Switzerland.
- Moenssens, A. A. (1971) *Fingerprint techniques*, Chilton: Philadelphia.
- Robertson, B. and Vignaux, G. A. (1995) *Interpreting evidence, evaluating forensic science in the courtroom*, Wiley: Chichester, UK.
- Terry, C. (1992) Personal Communication, Fingerprint Section, New South Wales Police, Australia.

The ballistics expert at the scene

Ian Prior

10.1 Introduction

The term *Ballistics expert* is a term not often used or referred to by the *forensic firearms examiner*. This term is used by: Counsel when calling on ballistics expert opinion evidence; investigating police; media groups or loosely coined by laymen. The objection to the term, by the forensic firearms examiner, is that it attracts connotations that the ballistics expert immediately knows everything about *all* arms and *all* ammunition. This, of course, is a ridiculous assumption, but by the time the forensic firearms examiner presents evidence, about a particular matter in court, s/he will know everything possible about the exhibits presented and their performance. Most forensic ballistics practitioners would prefer to be called *forensic firearms examiners*, and rightly so.

The word *forensic*, in its application to any applied science, suggests a relationship to the courts of justice and legal proceedings, derived from the Latin word *forum* – a market place – where men gathered for public disputation.

The word *ballistics* can be used to specify the scientific study of the motion of projectiles, derived from the Latin word *ballista* – an ancient military appliance for hurling projectiles at an enemy.

Therefore, *ballistics* may be divided into three units of study:

1. internal
2. external
3. terminal.

Internal ballistics is the study of the properties and performance of the projectile while still moving through the barrel of the firearm.

External ballistics is the study of the projectile movement, performance and attributes after exiting the muzzle of the barrel.

Terminal ballistics is the study of the effect of the projectile on:

- hard surface contact – splat and ricochet;
- hard and soft surface penetration; and
- soft tissue wounds.

However, the *forensic firearms examiner* studies the identification of firearms and ammunition used or involved in the commission of crime and the performance of projectiles. The traditional police forensic firearms trainee is usually coupled with an experienced forensic firearms examiner (mentor) who, under a *buddy-system* or *master–apprentice* type relationship, coaches the trainee through on-the-job training along with a menu of external courses and professional site visits so as s/he will eventually become accepted by the courts to give *expert opinion evidence*. It is the court system that bestows the status of ballistics expert, once the examiner has been tested, through cross examination under *voir dire*, on the qualifications and experience necessary to be able to give the subject opinion evidence and be accepted as an expert in that field for that given case before the courts. (*Expert n.* A person who has extensive skill or knowledge in a particular field.) Hence the terms *ballistics expert* or *forensic ballistics expert*, by common usage, whether correctly or incorrectly, have come to mean one and the same thing in the mind of the general public.

For this exercise I will reluctantly use the term *ballistics expert* in the common context, but not to be confused with the *ballistics expert* sometimes called by defence counsel to rebut all or part of the prosecution's *forensic ballistics expert* opinion evidence. The defence experts may have an intimate knowledge of some attribute of the subject exhibits' function or performance and will most unlikely be full-time forensic examiners or have the facilities to research and identify, totally across the subject. These defence experts may refer to themselves as *ballisticians*. However, some may be retired police officers, once employed as forensic ballistics examiners and have established themselves into the defence circuit to technically re-examine cases.

Crime scene, by the very simplistic term denotes a place where a crime has been committed. Crime scenes can be classified as *primary* or *secondary*. As an example, an Armed Robbery in a local bank, where shots have been fired and money stolen. The interior and immediate exterior of the bank would be classified as the *primary* crime scene. The robbers leave the scene in a stolen get-away car, which is later, located, abandoned. The car contains balaclavas, gloves, fired cartridge cases and other items of significance. That car and the immediate location would be classified as the *secondary* crime scene.

10.2 What happens when a firearm is discharged?

The discharge of a firearm can be aptly described as *dynamic*. For example, using a common military service handgun, a Colt brand, .45 ACP calibre, self-loading pistol, Government Model 1911, and follow the process:

- The shooter takes the pistol in the master hand. With the non-master hand pulls the slide to the rear, cocking the hammer in the process. The shooter then releases the slide, which travels forward under recoil spring tension; the breech face strips a live

round of ammunition from the magazine and inserts it in the chamber. The pistol is now in 'battery'.

- The shooter squeezes the pistol grip, disengaging the grip safety catch. With the finger being withdrawn with the application of approximately 30 Newtons Force to the trigger, through mechanical geometry, a series of disconnectors and sears trip the bent on the hammer allowing it to fall, under great inertia from the hammer spring, to strike the rear of the spring loaded firing pin.
- The firing pin travels forward through the guide in the breechblock and strikes the rear of the cartridge case primer, crushing the priming compound (for this vintage cartridge, usually lead styphnate) against a captured anvil within the primer. This sensitive compound, in the crushing, shearing force, sets off fuel and oxidiser, producing a jet of extremely hot flame through a flash hole in the base of the brass cartridge case, enveloping the propellant (powder) charge – in this instance – of approximately 6 grains in weight (there are 7,000 grains per pound weight).
- The 230 grain, full metal jacket bullet (lead core with copper jacket) passes through the forcing cone (between chamber and barrel proper) and engages the 6 rifling grooves cut into the land (bore) of the 5 inch barrel. The left-hand twist of the rifling grooves grip the projectile and imparts a spin on the bullet as it exits the muzzle at a velocity of 850 feet per second (fps)=259 m/s, delivering an energy of 384 foot pounds (fpME).
- During early flight – on muzzle exit – the bullet initially yaws as the spin fights the velocity and then stabilises into true trajectory. The bullet at this stage has a coating of residue and grease carried from the barrel and the firing process. It will leave that grease (bullet wipe) on the target, at the entry wound or impact point. Following the bullet will be unburnt (charred but not consumed) powder particles and gun shot residue (GSR), or firearms discharge residue (FDR) – which is the residue of the priming compound in the firing process (typically *lead*, *barium* and *antimony*) in quantities that may indicate the various commercial mixtures of ammunition makes and types. Also present may be metallic particles from the projectile, the cartridge case or the barrel of the firearm. All of these trace elements will be carried down range.
- In the mean time, the fired cartridge case has reacted violently against the breech face, forced by the chamber pressures. It pushes the slide backwards against the recoil spring as it travels along the rails of the frame. The fired cartridge case is gripped by the extractor claw recessed in the breech face and is dragged backwards out of the chamber. The claw holds onto the fired cartridge case, travelling backwards until it violently strikes a solid and static ejector rod.
- The fired cartridge case is then ejected from the ejection port of the pistol. The ejected fired cartridge case carries with it FDR, which is sprayed over the shooter's hand. When the slide reaches the end of travel, it cocks the hammer. Under recoil spring tension the slide then travels forward, stripping a fresh round from the magazine, placing it in the chamber ready for firing on the application of force on the trigger. The pistol has returned to 'battery'.
- While all this happens the pistol has been subjected to a phenomenon known as recoil. The laws of science state that for every force there is an equal and opposite force, true, but the recoil in pistols is influenced by the weight of the pistol and the application of resistance in the shooter's grip. Needless to say, the pistol reacts with the muzzle-up-attitude, using the shooter's wrist as a fulcrum.

10.3 Types of propellant powder

There are two types of propellant powder:

1. black powder made up of potassium nitrate (saltpetre), charcoal and sulphur; and
2. smokeless powder, which is either single or double base:
 - single base=primarily nitrocellulose; and
 - double base=a mixture of nitrocellulose and nitroglycerine in combinations to give specific burning rates.

The smokeless powder granules are enveloped by the primer flash creating instantaneous powder ignition and a controlled build-up of pressure. Because the burning of the powder is confined within the cartridge case walls – held together by the chamber walls of the barrel – they produce a heavy gas which expands rapidly, creating a force in all directions. The force, which is identified as chamber pressure – and in this instance in the region of 16,000 Copper Units of Pressure (CUP)=approximately 20,000 pounds per square inch absolute (psia) – presses against the case head and drives the cartridge back against the breech face. It pushes out the walls of the case, tight against the sides of the chamber. Seeking to escape the confines of the case, the pressure force builds to the point where it unseats the projectile (bullet) and drives it with increasing speed (velocity), down the length of the barrel.

10.4 What ballistics evidence could be located at a crime scene?

Using the above example, but not exclusively, the following exhibits should be present at the crime scene:

- the bullet or projectile is the firearms component that does the damage, whether it is lodged in a human being or it has deflected off a solid mass or has overpenetrated;
- the fired cartridge case will have been ejected and is there for the finding;
- FDR has been propelled down range and on the shooter's hands;
- charred propellant powder has been discharged from the barrel of the pistol, which may be found on the target dependent on muzzle to target range;
- bullet wipe may be present around the entry holes (wounds);
- the pistol; and
- ammunition still in the magazine or closely associated.

To break away from the above example of the Colt pistol and opening up the variety of items of potential evidential value that may be located at a crime scene with an explanation as to the lack of some expected items at the scene in shooting incidents, cognisance must be taken of the fact that not all firearms are generic. The inventive minds of firearms designers and manufacturers challenge the ballistics expert.

If a shotgun had been discharged at the crime scene, one could expect to find a pattern of shot damage at the terminal point of contact. Because the shot needs to be pushed from the barrel of the shotgun, then a wad or wads would be present. Some wads – over powder – are mono and some composite, either in plastic, felt, paper, cardboard or a

combination. Some of the older variety of shotgun cartridges or those from some 'Eastern Bloc' countries may employ an over shot wad, rather than the modern type plastic hull crimped over the shot charge. Those, disk shaped, over shot wads may hold intelligence on the stamped markings indicating the manufacturer, distributor, shot size, gauge and weight of charge load.

Should a revolver have been discharged at the scene, it would be unlikely to find any ejected fired cartridge cases as they are captured within the cylinder of the handgun – unless of course a full cylinder of rounds had been fired and the shooter dumped the fired cases and then reloaded. If that were the case, the fired cartridge cases would be located in a heap, or at least close together, rather than being violently ejected and scattered as if a self-loading pistol had been used.

It would be unlikely to recover any fired cartridge cases at the scene if a single discharge from a single shot or repeating firearm had been fired, or in the case of a 'drive-by shooting', where the fired case had been ejected inside a moving vehicle. Of course, should the vehicle later be recovered, the cartridge case may be located at the *secondary crime scene*.

The recovery of FDR on a suspect is dependent on the type of firearm used in the commission of the crime. Should a centre fire self-loading firearm be discharged then the chances of FDR recovery is higher than that of a locked breach (bolt action) rim-fire rifle. However, FDR and charred propellant are usually available – depending on crime scene conditions – down range.

Unfired ammunition may be available from:

- having been dropped by the offender;
- having been ejected, due to malfunction clearance of the weapon;
- normal residence at the scene and was used in the commission of the crime; or
- an original source at another location.

In the violent and dynamic action of discharging a firearm, one cannot overlook the possibility of a firearm component breaking in one form or another. If the weapon has been well used or abused then the chance of a breakage is higher than one that has been well cared for. For example, the extractor claw of the weapon might break during extraction/ejection and therefore, it should be available for recovery from the scene and later physically matched to the remainder of the firearm/part should the weapon be recovered. Sometimes the firearm is used as a physical assault weapon prior to or after discharge. Those profile marks left by the firearm, as in *pistol-whipping* a victim, are available for interpretation. In fact, the very violent act of using the firearm as a club could break pieces such as sights or stocks. All pieces should be available for collection, physical matching and interpretation.

10.5 The importance of the ballistics specialist at the scene

Overall, police services have invested considerable resources to train and place *ballistics experts* in forensic science laboratories to investigate firearms-related crime. One of the most valuable resources, so we are reminded, is the trained human resource. In the realm of forensic science, that statement is true.

Some jurisdictions advocate the practice that forensic firearms examiners, attached to forensic science laboratories, attend and control all firearms-related crime scenes. Those firearm specialists perform most functions of recording the scene total through notes, photography, plan drawing (note sketching) and exhibit handling. They call in assistance as and when required. This practice is not to be criticised, as it appears to work quite well when the required infrastructure is established and controlled through quality crime scene management. However, in the interest of jurisdictions where the crime scene examiner is the first forensic officer at the crime scene and takes control, then this chapter will afford an indication of the ballistics expertise and intelligence base available to him/her and the investigators.

Not only will the crime scene examiner consider calling-in a ballistics expert to a major and serious crime scene where a firearm has been used, he would also consider using the expertise of the pathologist, fingerprint experts, biologists, botanists and any other forensic scientist who may be able to assist in the examination, evidence collecting/handling and crime scene interpretation.

10.6 Safety

The ballistics expert should be called to the scene of a crime – where a firearm has been used or suspected to have been used – for a number of obvious and not-so-obvious reasons. The most important is of course *Safety*. Firearms are inherently dangerous and more so at the scene of a crime.

After the scene has been faithfully recorded, by way of sketch plans, still photography and video recording, and before any unnecessary disturbance or movement takes place, in the interest of health and safety, the firearm at the scene must be proved safe. In doing so the ballistics expert will record the condition of the safety catch, the condition of exposed hammer/s. Taking all precautions to guarantee the integrity of the exhibit and any trace elements or fingerprints, unload the weapon, separating and recording the ammunition whilst noting any indentations or marks underneath the firearm, which may aid in the interpretation of events.

For example, a case where a police medical officer was called to the scene of an obvious suicide by gunshot – to the head of the deceased – to pronounce life extinct. He had arrived just prior to the ballistics expert and obviously with more pressing engagements on his mind became forceful to the crime scene examiner to allow him to enter the scene *poste haste* so that he could perform his function. Had the examiner allowed that to happen, the medical officer would have been killed.

The deceased had used a self-loading .22 calibre rifle to self-inflict the fatal injury, sitting on a chair with the finger still on the trigger, rigour mortis had set in prior to him being discovered. The barrel of the rifle was pointing directly at any person approaching the body, or in fact leaning over the body. The deceased had loaded the magazine of the rifle with extra ammunition and hence, being a self-loading action (semi-automatic) the rifle had reloaded after the fatal shot, the safety catch, naturally was in the ‘fire’ condition. Had any person touched the body, the solid-state finger – through the effects of rigour mortis – would have pressed on the trigger and discharged the rifle.

10.7 Evidentiary value of the exhibits

Some exhibits are of obvious value, others are not so obvious.

Crime scenes vary in location, topography and surface. They can range from a domestic residence, bushland, car parks, commercial and industrial sites, roadways, shopping centres, plazas and the list goes on. Consequently, exhibits may be confused with material that is normal to that environment and will take a trained eye to evaluate. Some exhibits, such as cardboard wadding from older varieties of shotgun cartridges or deformed, small lead shot may not be obvious to crime scene examiners, not totally familiar with the subject. Similarly, ricochet marks may not be obvious.

10.8 Exhibit handling

The ballistics expert is best trained to handle and package exhibits relative to firearms and ammunition examinations.

While the crime scene examiner records, controls and coordinates the crime scene, it will become apparent in the progression of time, through consultation with other specialists, that exhibits may be collected and packaged for later examination. The coordination will realise that different specialists may subject certain exhibits to multi-discipline examinations. Such questions will arise – should the firearm be fingerprinted prior to ballistics examination? The crime scene examiner, fingerprint expert and ballistics expert should agree on the continuity process of exhibits prior to them being handled or removed. It is not prudent that the ballistics expert takes samples of FDR. It may be argued that he could be contaminated with FDR due to the nature of his normal duties. The crime scene examiner or attending forensic scientist should take the FDR samples on advice from the ballistics expert. Those samples should be secured away from any ballistics contamination. The coordination is critical. The evidentiary value of such examinations will be weighed and the sequence decided upon.

When the ballistics expert, handles and packages the exhibits that eliminates other members in the continuity chain, thus streamlining the evidentiary production in court. It allows the expert to leave the crime scene at the appropriate and agreed time, with the exhibits, to commence examinations with the view to delivering early intelligence to the investigators. In a major incident, the crime scene may take days for the crime scene investigator/s to clear. It is an advantage for the various specialists to handle and package items, leave the scene and start the examination process expediently.

10.9 Crime scene interpretation

The ballistics expert, with his knowledge of firearms, ammunition and projectile performance, is best placed to interpret the crime scene where firearms have been used.

A very pertinent phrase was coined many years ago, and ballistics experts often repeat it to crime scene investigators and detectives, during lectures and at the scene . . .

Things are not always as they might first appear

Interpretation of the violent and dynamic circumstances that have taken place within the crime scene is a necessary step in the reconstruction of events. An intelligent step in understanding the events leading up to, during and after the commission of the crime. Important, not only in the consequential presentation of the evidence in court, but a tool in the investigation and the questioning of witnesses and suspects. As part of the crime scene investigation package, specialists will examine and form opinions. It is critical that dialogue takes place at the scene and speculation be discouraged in the light of cold hard facts.

The ballistics expert may throw light on where the offender was standing at the time the shot/s were fired, from either the angle and distance of the ejected fired cartridge cases and/or the trajectory of the projectile, the recovered shot wads or ejected live rounds. From any broken part/component recovered, he should be able to tell the effect that it had on the circumstances and the performance of the firearm. All this will assist in the subsequent examination of the fired or unfired exhibits. From unfired cartridges at the scene, he may be able to tell if the firearm or the ammunition suffered a malfunction at that point, or it may have been excitement on the offender's part, that a live round was worked through the action and ejected unintentionally. In collaboration with other learned specialists, the association of ejected fired cartridge cases, projectile trajectory and blood splash/spray patterns, it will be important to know the location of the offender and the victims when the shot was fired.

When the pathologist attends the scene, it is important that the ballistics expert explains the performance and capabilities of the firearm, the ammunition involved and the expected wound ballistics the deceased would have suffered. If the wounds are contrary to this advice, then the interpretation of the scene is paramount. Perhaps the projectile had struck a solid object prior to wounding or in fact may have penetrated some other object interfering with the flight – projectile path – and projectile performance. The bullet being slowed down, diverted or damaged can cause this. Cognisance should be taken of the fact that perhaps a silencer may have been fitted to a firearm at the time of discharge. From interpretation of the observations of witnesses or markings available this may in fact be a vital link and explanation of possible events.

Unless the ballistics expert and pathologist view the scene with the deceased *in situ* then what is observed at the mortuary can become an unnecessary puzzle. The defensive action of the deceased, at the time of the shooting, by holding an arm in front of the face can be explained and may be quite critical to the elements of a criminal charge. The deceased, in fear and in confrontation with the offender, may have placed an arm or hand across the face in a normal defensive action. Then a shot was fired at the deceased, the bullet passing through the hand/arm and then penetrating the face/head causing death. When the body is laid out at the mortuary for post-mortem examination, with the arms beside the body, the wounds become disassociated and may remain unexplainable as they appear to be two separate bullet wounds. It is only after visiting the scene and reconstructing events do these puzzles become clear.

10.10 Intelligence

The professional, timely and accurate information delivered to the investigators is a valuable aid. The intelligence supplied to investigators at the scene, could and most

likely will be the subject of sworn information for a search warrant and if not accurate could lead to unfortunate results. For example, a *self-designated ballistics expert* – a crime scene examiner – openly declared to investigators that a fired cartridge case, located at the murder scene, had been fired in a .243" calibre Winchester brand rifle. His sole intelligence was based on the fact that the recovered fired cartridge case was head stamped .243 Win – W.W. The investigators rushed to the home of the prime suspect looking for a .243 Winchester brand rifle. They found a rifle in .308" calibre of Sako brand. Leaving that rifle with the prime suspect, they returned to regroup and review the intelligence.

Had a ballistics expert been called to the scene he could have explained to the investigators that .243" Winchester ammunition was originally developed as a *wildcat cartridge* using the .308 Winchester cartridge (7.62×51 mm NATO) as the base, necking the throat down to .243"(6 mm). The cartridge was so popular and successful that the Winchester Western (hence W.W. on the head stamp) ammunition manufacturers produced the round commercially for sporting, hunting use. Because Winchester was the first to commercially develop and produce the round, they called it the .243 Winchester Cartridge. It can of course be fired in other manufacturer's rifles, chambered for that cartridge. Other ammunition manufacturers, such as Remington, manufacture that cartridge, but they honour the origin and head stamp accordingly: e.g. .243 Winchester–Remington.

10.10.1 Things are not always as they first might appear

In this example, the throat of the .243" case had sustained damage that indicated to the trained eye of the ballistics expert, who was later consulted, that indeed the subject case had been fired in a .308" Winchester calibre rifle. The necked down case had, on discharge, been fire-formed back to almost original dimensions of .308", suffering loss of annealing and some minor splitting at the shoulder. The smaller 6mm projectile, when later located, displayed classic signs of having *skidded* down the larger diameter .308" calibre (7.62 mm) barrel. What had happened, of course, was that the offender had mistakenly loaded a .308 calibre rifle with a sub-calibre .243 cartridge in the domestic heat of the moment. The investigators had located the subject, .308 Sako rifle, but on intelligence at hand left it with the suspect who, later turned out to be the offender.

10.10.2 Things are not always as they first might appear

Cartridge designation appears confusing. Manufacturers use obscure nomenclature when naming calibre and cartridge size and use. However confusing it may appear, ballistics experts understand and can explain. A few are listed:

- **30/30 Winchester**
First marketed in early 1895 for the model 1894 level action rifle. Denotes a cartridge in .30" calibre, loaded with 30 grains weight of smokeless powder; and in comparison; and
- **30/06 Springfield**
A United States military cartridge of 30 calibre, adopted for military service in 1906 (hence '06), however the cartridge before military adoption was called the

30–45 cartridge because it was of 30 calibre and loaded with 45 grains weight of smokeless powder. In Europe, this cartridge is known as the 7.62×63 mm cartridge and in global military terms '*Ball, calibre 30, M1*'.

In comparison now consider a:

- **45/70 US government**

A .45 calibre cartridge developed for the Springfield 'Trapdoor' rifle loaded with 70 grains weight of black powder and adopted for military purposes in 1873. The list goes on.

Generally the European manufacturers list the calibre bore in metric terms and the length of the cartridge case in millimetres i.e. 7.62×63 mm (30/06 Springfield). The military, and in particular NATO, designate the same cartridge in various nomenclature.

In 1952 the Winchester sporting cartridge *.308 Winchester* was introduced. It was officially adopted by the US Government in 1954 for the M14 rifle and designated *T-65* and later the *7.62 mm M59* (Ball), *M61* (Armour Piercing) and *M62* (Tracer). Later, when NATO adopted the cartridge it was known as the 7.62×51 mm NATO.

1957 saw the experimental military cartridge for the Armalite AR-15 rifle. It became known as the *5.56 mm ball cartridge M193*. The Remington ammunition manufacturers later turned out the same cartridge in a sporting configuration and called it the *.223" Remington*. NATO later adopted the cartridge loaded with a slightly heavier bullet and designated it the *NATO SS109*.

There is very little rhyme or reason for the designations. When one thinks he has worked it out, faith can be destroyed in the next demonstration. For example, the *.38 special* calibre revolver cartridge, common to most police services, is not *.38"* calibre, in fact, but measures *.357"*. Therefore, as is almost inevitable in contemporary cartridge trends, when the case was lengthened by 1/10th of an inch to magnum loadings, it was designated the famous *.357 magnum*. The term *Magnum* in Latin means 'larger or of greater capacity'. Of course, the *.38 special* cartridge can be fired in a *.357 magnum* revolver, but not conversely.

This, therefore, raises the subject of interchangeability of ammunition. A subject known to the ballistics expert and considered at each issue of information to the investigators. In common terms, a *.22* rim fire calibre rifle or handgun may be able to load and fire cartridges designated: *.22 BB Cap*, *.22 CB Cap*, *.22 Short*, *.22 CB Short*, *.22 CB Long*, *.22 Long*, *.22 Long Rifle*. Similarly, a *.25* calibre self-loading pistol may be able to load and fire cartridges designated: *.25 Automatic*, *.25 Auto*, *.25 ACP*, *.25 CAP*, *6.35 mm Auto*, *6.35 mm Browning (Auto)*. As previously discussed, the *.357 magnum* revolver can load and fire *.38 Short Colt*, *.38 Long Colt*, *.38 Special* and *+P* variations, and of course the *.357 magnum*. This list is by no means comprehensive, rather an indication of the interchangeability of cartridges through parent firearms.

10.11 Presentation of evidence

It is desirable, in the sequential presentation and continuity of evidence, that the ballistics expert had been present at the crime scene.

The judicial presentation of evidence through *evidence-in-chief* and the consequential *cross-examination* of the ballistics expert is naturally enhanced if the expert has been at the crime scene. There would appear a gap in the evidence should the ballistics expert be only called upon to remotely examine the firearm/ammunition. The expert's obvious knowledge of evidence value, firearm/ammunition performance and crime scene interpretation should be presented. If that evidence is not forthcoming the very intelligent question, *why?*, may be asked.

The ballistics expert can present a more meaningful answer to hypotheses raised by defence in cross-examination than the non-specialist.

10.12 Crime scene interpretation

A crime scene where a firearm has been used bears witness to violence and dynamics. One of the most important considerations for the first crime scene examiner at the scene is to preserve and record accurately. That preservation will enable an intelligent interpretation of the actions of the offender and victim. The accurate interpretation will corroborate reliable witness statements or rebut any untrue claims of the suspect.

Accurate interpretation will corroborate a recorded re-enactment should the offender pursue this avenue at the suggestion of the investigators or should the court, during the hearing, decide to visit the scene.

Crime scene interpretation depends upon a concentrated effort by a number of experts from different fields. These may include: the coordinating crime scene examiner calling on his general experience; The ballistics expert calling on his specific experience in firearm function, ammunition performance, the dynamics, exhibit identification and value; The fingerprint expert interpreting his findings; the forensic scientist to cover the interpretation of blood splash patterns, toolmarks/shoeprints and the like; the forensic pathologist to view the deceased, injuries and interpret; and any other forensic expert that may assist particularly to the perceived events.

For example, in March 1984, in the Canberra suburb of Richardson, a young family – husband, wife and two small children – were murdered. Police broke into the family home after neighbours became concerned that the family had not been seen for a number of days and through a window, one neighbour saw the hot plates on the electric stove glowing red hot. A gruesome scene greeted the first police on the scene. One child, in bed, had been shot through the head and his throat had been cut. One bedroom contained the bodies of the other three family members, stacked on top of each other and a child's cot placed over the top of them. The house and the stacked bodies had been soaked in volatile fluid. The electric hot plates on the stove had been left *on* in the *high* position and crumpled newspaper sheets placed over the hot plates. Fortunately the newspaper did not catch on fire.

The evidence inside the house, once interpreted, demonstrated that:

- the child, in bed, had been shot through the temple with a .22 calibre firearm which had been fitted with a silencer that had made contact with the skin at the time of discharge;
- the mother, nursing the youngest child, had been shot in the face whilst seated in a chair in the lounge room;

- the father had been shot (not fatal) whilst seated in another lounge chair and he had retreated through a doorway leading to a dining room. The offender had circled through another entrance to the dining room, met the father head-on and fired another two shots into his head from close range, killing him there;
- the youngest child was shot in the face, at point blank range, with a firearm of .22 calibre fitted with a silencer;
- the offender had dragged the three bodies along a hallway into a rear bedroom and stacked them on top of each other;
- the offender then tried to clean up the bloodstains and blood stain patterns;
- the offender, in his attempts to clean up the carpets, removed the glass top on the coffee table and placed it against the wall;
- all of the shots fired had been discharged in a .22 calibre self-loading rifle of 'Stirling' brand, manufactured in the Philippines;
- the ammunition used was of 'Federal' brand, made in the USA and of a type that was sub-sonic in velocity (target loadings);
- the firearm sustained a broken extractor claw during the incident;
- the offender splashed kerosene throughout the house;
- the offender turned on the hot plates on the stove and crumpled newspaper sheets over them;
- the offender tried to wash clean-up cloths and himself in the kitchen sink; and
- from the wife's diary entry, that evening, the offender – a family friend – was in the house.

All of this intelligence was gathered by the specialists at the scene, coordinated by crime scene investigators. Further information gathered from officers attending, lead to the identification of the offender, who showed no remorse nor did he offer any admissions or denials. Not only was he convicted of these crimes but the intelligence of his *modus operandi* lead police to investigate further incidents involving the previous unsolved deaths of two other females of the same family, resulting in the offender being found guilty of their murders, as well.

10.13 The ballistics specialist at the mortuary

One could argue that the post-mortem examination of the deceased at the mortuary is an extension of the crime scene. When the body is carefully removed from the primary crime scene and placed within the sterile and secure forensic mortuary, this leads to a comfortable examination environment that should promote teamwork between the forensic pathologist, the crime scene investigator and the ballistics expert.

The major factors that will influence a comprehensive post-mortem examination of a deceased who died as a result of gunshot wounds and therefore provide all relevant information are:

- full photographic and video survey of the deceased;
- facial photograph for identification purposes;
- close-up photographs of entry and exit wounds;

- close-up photographs of any other injuries such as defence or other types of wounds;
- full diagrammatical record of positions of wounds;
- matrixed full length body X-rays;
- preservation of clothing for FDR and proximity testing;
- preservation of the deceased's hands for FDR sampling at the scene and sampling prior to the post-mortem examination;
- undisturbed, preserved and excised entry wounds;
- the interpretation of entry v. exit wounds;
- three cavity internal examination;
- fingerprints taken of deceased;
- dental charting as another form of identification;
- blood for DNA profiling; and
- blood/urine/vitreous humor for blood alcohol determination.

10.14 Bibliography

- Bady, D. B. (1973) *Colt Automatic Pistols*, Borden, Alhambra, California.
- Doyle, J. E. (1993) *Physical Evidence Handbook*, 5th edn, Wisconsin Department of Justice.
- Fisher, Barry A. J. (2001) *Techniques of Crime Scene Investigation*, 6th edn, CRC, Boca Raton.
- Hatcher, J. S., Jury, F. J. (Lt. Col. Ret.) and Weller, J. (1977) *Firearms Investigation Identification and Evidence*, 2nd edn, Stackpole, Harrisburg, Pennsylvania.
- Warlow, T. A. (1996) *Firearms, the Law and Forensic Ballistics*, Taylor & Francis, London, England.
- Wilber, C. G. (1977) *Ballistic Science for the Law Enforcement Officer*, Charles C. Thomas, Springfield, Illinois.

The role of the pathologist at the crime scene

Kevin Lee

11.1 General considerations

11.1.1 Background

Forensic pathologists have a background in medical training and experience. They have generally undergone training in the area of anatomical and histopathology. Most have then undergone further training in clinical forensic medicine and forensic pathology, but in some instances, have trained specifically in forensic pathology. They then have special skills, and, to quote the Brodrick Report (1971):

Every police force needs to be able to call on the services of a specially experienced pathologist to help in the investigation of murder and other serious crimes against the person. Ideally, this person should be a pathologist with a sound training in [anatomical pathology] who has added to this general knowledge some additional skills, most notably the ability to detect, and give authoritative testimony about, unusual features of a dead body and the surrounding circumstances which may well be of evidential value.

As forensic pathologists not only have training in the medical arena, but also have knowledge and experience of both the scientific and legal processes of investigation, they are uniquely situated in the field of death investigation. It can be argued that a suspicious death or a homicide cannot be considered as fully and thoroughly investigated unless a pathologist has attended the scene.

11.1.2 Availability

A forensic pathologist should be available to respond to a crime scene call on request, and most forensic departments do have an on-call system for these occasions. These

calls have a tendency to occur more frequently outside normal working hours, and particularly at weekends.

It is best if the pathologist who attends the scene is the one who carries out the autopsy, particularly in the more complex cases. This is not always feasible, particularly in a busy or understaffed department. However, the information gleaned at the scene should be passed onto the other pathologist, prior to the autopsy. It is obviously of benefit if it later avoids having two pathologists in court, with potential time wastage or conflict.

11.2 History of involvement in crime scene investigation by medical practitioners

Although there are references to crime scene attendances involving doctors which date back many hundreds of years, these doctors were not specialised practitioners in the field. It is only in the last 200 years that lectures have been given in the English language in this subject. Much of the examinations were thus carried out in an ill-trained and fragmentary manner.

One of the earlier cases described in detail involved a homicide investigated in America in 1859. This was originally considered a suicidal death; the alleged method being by cut throat. A doctor reviewed the physical evidence at the death scene, and he found that the lack of bleeding on the bedding was not consistent with the throat having been cut prior to death (MacDonell, 1993).

The introduction of the book written by Dr Edouard Piotrowski in 1895 on aspects of blood stains states *inter alia*:

The clearest description of the scene of the crime plays no smaller a role than the autopsy. Each supplements the role of the other.

From this, it is clear that even a century ago, doctors working in the field of death investigation had a good understanding of the need to correlate the findings of scene and autopsy, in order to arrive at a comprehensive picture.

However, it is only since the relatively recent specialisation of doctors as pathologists, and then as forensic pathologists, that the medical role at the death scene has enlarged to its present extent. In those areas where forensic pathologists are not providing the bulk of the autopsy service, this role is still relatively small.

11.3 Investigation process

A trained forensic pathologist has knowledge of the scientific process of investigation, as well as the legal process as it applies in the court environment. The view that the forensic pathologist exists purely to examine bodies and establish the cause of death in suspicious cases is held predominantly by lawyers, but it is also held by other investigators, and even by other doctors. This is a very narrow and limiting picture of their responsibility. On many occasions, it is the judgement of the forensic pathologist that determines whether a death is in fact the natural cause, accident or suicide, which it

appears to be, or whether it should in fact be a criminal investigation. Part of this determination derives from an examination of the crime scene.

The term 'crime scene' in this context is taken to refer to any scene where an incident or death has taken place. It could therefore refer to a death that is not obviously suspicious, and it does not necessarily involve any criminal activity.

An important function of the scene investigation is to be able to identify the relatively large proportion of cases that are not criminal in origin. This can abort a homicide investigation before the investment of a large amount of time and other resources. This can save much public money, even if it is usually not that of the pathologist's employing authority.

11.4 Functions at a crime scene

Scene examination by a pathologist has some or all of the following functions, depending on the circumstances:

- certifying the fact of death;
- gathering of initial impressions;
- giving input to the direction of the investigation;
- partaking in a complex on-site examination;
- examining and interpreting blood spatter;
- producing a crime scene report which is specific to the cause and manner of death; and
- giving scene evidence in a court of law in relation to the cause and manner of death.

This cannot take place unless there is a multidisciplinary approach to crime scene investigation. Trained forensic pathologists would be the first to recognise that crime scene investigation is a discrete discipline within forensic science, and crime scene investigators are educated, trained and experienced forensic scientists. They do all the recording at scenes, evidence recovery and interpretation. Having said this there is nothing to prevent input from a multidisciplinary team at a scene. What we have to avoid is unnecessary duplication and differing interpretations being made and offered as evidence in court.

As a result of their early involvement in cases, forensic pathologists should have a wide appreciation of death investigation, and they are thus a significant element of the team involved in the inquiry. A two-way flow of information should continue throughout the scene examination. The initial information derived from the police investigation is passed to the pathologist, and the pathologist in turn passes back a series of pathology findings, which may relate to the cause or time of death, or other aspects. At the same time, any doubts regarding the case should be aired.

After examination of the body, the general crime scene and possibly blood spatter, the forensic pathologists should have a basic understanding of the situation. They should thus be in a position to give some preliminary conclusions for the benefit of the other investigators. These may include the time and manner of death, as well as the mode of death. Obviously as this information is given prior to the autopsy, it has to be provisional, and the pathologist must give this caveat about the conclusions. Over-interpretation

is tempting, but must be avoided. Forensic pathologists should understand that police investigators will pursue a line of enquiry until it is eventually found to be false.

The pathologist's understanding of the case, and of the environment from which the body comes, will prevent the autopsy from being carried out in an information vacuum. The information is used during the autopsy to formulate more detailed and accurate conclusions. These are given verbally by the pathologist at the end of the autopsy, and in full detail in the written report later when all other examinations and analyses, such as histopathology and toxicology, have been completed, and these results are to hand.

On occasion, crime scene information that appeared to be of little relevance at the time gains major significance at the time of a court hearing. A fully trained forensic pathologist will be expected to consider and evaluate this sort of material at the beginning, as there will be little opportunity to re-examine the scene later. As was put by a trial judge in a nineteenth-century Scottish case: *'a medical man, when he sees a dead body, should notice everything'*.

11.4.1 Principles

Much of crime scene examination is based on the work of Dr Edmund Locard, which is covered in an earlier chapter.

Depending on its nature, potential evidence might be missed if searched for at the scene, but conversely may be lost during removal or transport. It is thus critical to consider how to best manage the case, and plan all evidence gathering accordingly. For example, in a rape murder, it is reasonable to take vaginal and anal swabs if the area is easily accessible without disturbing the body. However, if the genital region is poorly accessible, badly lit and partially clothed, then more evidence is liable to be lost than gained.

11.4.2 Basic process

Although there may be a strong temptation to examine the body immediately on arrival at the scene, the pathologist should never approach it until invited by the senior crime scene investigator present, and then only by the indicated access path. If the forensic pathologist is the first doctor at the scene, then they should certify the fact of death. This is most likely to occur in remote locations and in circumstances where the body is clearly deceased, as in cases of advancing decomposition. It is otherwise more likely that another practitioner will have certified the fact of death. To carry out this certification, they should cause minimal disturbance of the scene, and then leave the body alone.

The forensic pathologist may then mesh in with the other aspects of the investigation, and take their place in the chain of individuals having access to the immediate area. Normally, they will spend the majority of their time observing and documenting the body and scene, but doing relatively little.

A number of factors are considered early on in crime scene examination by the police investigators. These include locating the entry and exit points, and locating footprints and tracks both in the central and peripheral areas. When examining the peripheral area, they look for objects that are out of place, and consider what other potential evidence may be present. As this should be an ordered process, it is better for the forensic pathologist

to keep away from potential interference of this phase, unless specifically invited to approach.

The forensic pathologist's primary focus must relate to the body itself, and those features of the scene that relate to the death. It is also important for them to remember that they are in the unusual situation of being able to inadvertently damage or interfere with much of the other potential evidence at the scene, just by overstepping their bounds.

However, if questions relating to wider medical aspects arise at the scene, or health and safety becomes an issue, then these should be dealt with in a suitable manner.

11.4.3 Coordination and cooperation

The forensic pathologist may be involved in the investigation of a death from the very beginning, and does not have the narrow role sometimes envisaged by some. They have contact not just with coroners and the other coronial staff, but also with uniformed police, crime scene investigators, photographers, specialist investigators and others. The media frequently portray forensic pathologists as individual and idiosyncratic investigators. In reality however, they can only function effectively if they act as team members, and take an equal part as one of the investigative team.

This requires in the first instance that they are subject to exactly the same conditions as other investigators at the crime scene, in that they do not enter it until invited, and that they do not interfere with crime scene aspects that do not concern them.

The person in control of the scene may vary, but in some states, the ideal situation is that it is under the management of the senior crime scene investigator. All persons, including pathologists, should be under the supervision and control of that investigator, and they should remain outside the actual scene until the crime scene investigator's arrival. They should expect to log on and to log off as other investigators do.

Pathologists who attend crime scenes should not try to take control of the scene. This may occur due to poor communication and it will lead to a lower standard of crime scene investigation. This problem can only be resolved by education, training and experience of all the individuals involved, so that they each understand where their own contribution begins and ends.

It is not one of the functions of the pathologist to gather or to document the physical evidence, unless forced by circumstances of remote locality or other practical difficulties. However, they will not infrequently observe an item of trace evidence either on the body or elsewhere. This should be brought to the attention of the relevant crime scene investigator, who is best able to deal with the material.

11.4.4 Other aspects

Because of the unusual position of the pathologist as doctor, scientist and investigator, as well as expert witness, they will commonly be placed in a position of being requested to assist in the examination or interpretation of some of these wider aspects of the scene. In many instances, they may advise on specimen collection. At the same time, it may be possible for the pathologist to provide specific assistance to minimise damage and interference with trace or other evidence by suggesting options.

It is also important to minimise post-mortem damage to the body, and a pathologist is well equipped to supervise or assist in moving or bagging the body to produce the least interference with the evidence.

A significant function of the pathologist may be to suggest a role for other specialist investigators at the scene, by recognising the limits of their own expertise. These other investigators include specialists such as botanists or entomologists, who could help with estimation of the time of death.

The pathologist will often require extra recording of environmental factors. This includes the positions of blinds, settings of heaters and their timers, lighting conditions, types and numbers of pets, contents of toilets, weather conditions, or tidal changes. Often, these are relevant only to specific scene types, particularly where there is time of death and decomposition issues.

11.5 Safety issues

11.5.1 General

Generally speaking, crime scenes tend to be relatively safe from the point of view of biological hazard despite the potential problems. This is because the normal slow and deliberate investigation process, and the avoidance of contamination of exhibits, are methodologies that will coincidentally reduce the risk of danger.

However, some scenes are inherently more dangerous, in that there is both an increased risk of injury or skin penetration and increased biological hazard, particularly viral. For example, scenes involving drug-related deaths may have blood-contaminated needles in clothing or bedding, apart from those needles which have been intentionally concealed elsewhere at the scene. Motor vehicle crashes are environments that have multiple sharp metal or glass edges and can be associated with relatively large volumes of blood.

11.5.2 Viral disease

It is estimated that there are over 250,000 chronic carriers of each of Hepatitis B and C in Australia. Other hepatitis viruses may be present in blood, including Hepatitis G, but this has not been identified as a cause of significant illness. Carriers of viral hepatitis tend to be over-represented in the death scene population.

The most important factors are that only a minute amount of blood is required for an infective dose, and that the virus is very resistant to damage. This means that dried blood flakes and stains are as infectious as fresh blood. It must be remembered that diseases such as Hepatitis B are readily transmitted by access of the virus to the mucous membranes, particularly the eyes and mouth. Either direct transfer of blood from fingers to mucous membranes, or indirect droplet or dust contamination of blood particles to the eyes can occur relatively easily. This is a further reason for never eating and drinking at a crime scene. Contact with broken skin is yet another possible route of entry of the virus, apart from any trauma sustained at the scene itself.

The human immunodeficiency virus (HIV) is a delicate virus, and does not retain its infective potential anywhere near as successfully as the Hepatitis B virus. However, the

relatively few cases of infection, which have occurred outside the usual modes, indicate that care must still be taken, especially with regard to penetrating wounds such as needle stick injuries. Although most body fluids have been shown to contain at least small levels of the virus, blood is by far the most significant fluid.

11.5.3 Other disease

Bacterial diseases such as tuberculosis are again on the increase. It is becoming significantly more common in high risk groups, such as AIDS patients, and people who are living rough. The bodies when seen at the scene may show no external evidence of their diseased status. Other less common conditions, such as Creutzfeldt-Jakob disease, can theoretically be picked up at crime scenes, but this is extremely unlikely.

11.5.4 Precautions

The pathologist may be in a position to identify potential hazards to other personnel, because of their general medical knowledge, and as they also frequently can interpret medical notes or identify medications that may be present at the scene.

However, as it is usually not feasible to accurately identify which scenes have infectious potential. The simplest and most logical answer is to regard all scenes as being potentially of high risk, and act accordingly. Obviously, for operational reasons, it is not always possible to follow the guidelines exactly, but they should be followed as closely as is practicable.

Henry C. Lee (1989) has published a series of crime scene precautions with special reference to viral diseases. To paraphrase them:

- all blood and body fluids are to be considered infectious, whether wet or dry;
- rubber gloves should be worn when handling blood specimens, body fluids, materials and objects exposed to contamination. Dispose of gloves after a single use;
- gowns, masks and eye protectors should be worn when blood or body fluids may soil clothing, or if procedures may involve extensive exposure to blood or body fluids;
- always be alert for sharp objects. When handling syringe needles, knives, broken glass, broken metal, or any other sharp object possibly bearing blood, take the greatest care to prevent a cut or puncture of the skin;
- all needles, knives and other sharp instruments should be handled with caution and placed in puncture-resistant containers;
- avoid all hand-to-face contact including eating, smoking and drinking;
- good personal hygiene is the best protection against infectious disease. Wash hands with soap and water after each case;
- contaminated hands and skin must be washed immediately and thoroughly;
- be aware of the integrity of your skin. Keep all wounds carefully bandaged whilst at work. Use a bandage that provides a complete and impermeable cover. Change the bandage if it becomes soiled; and
- contaminated surfaces should be cleaned with 1:10 dilution of household bleach in water. An alcohol pad or soap and water can then be used as a cleaning solution, and this will remove the odour of bleach.

11.6 Equipment and dress

11.6.1 Clothing

In those crime scenes where protective overalls with hoods and boots are available, the pathologist should, along with others at the scene, cover their everyday clothing.

A number of crime scenes will occur in a comfortable indoor environment, but a greater proportion will occur in an area that lacks most of the facilities normally required. A working pathologist will soon become familiar with the need to be dressed suitably to carry out their functions efficiently in their region. It is wise for the car boot to contain a variety of clothing suitable for likely eventualities. This includes hat, coat, raingear, boots and whatever else may appear useful. A pathologist who is not appropriately dressed will be uncomfortable, and unable to function properly, especially in a protracted case. It is useful to remember that final access to the scene is often by foot, and as it may include rocky paths, rope ladders or winches, it is best if the clothing is of a practical nature.

11.6.2 Accessories

Similarly to clothing, the pathologist will need to have accessories that will allow continued efficiency at a crime scene. This will vary enormously with the site, but may include sunglasses, sunscreen, insect repellent, and food or drink. An overnight stay at the scene may require a sleeping bag or tent, although a new body bag may well suffice. The more detail of the scene that is available before departure, the more likely it is that the correct material will be taken. Even a set of earplugs for a noisy aircraft may be of great value for allowing travel that is more restful.

11.6.3 Equipment

Most pathologists will accrete a crime scene bag over a period of time, which contains the equipment that they normally would want to use when at a scene. This bag should contain pens, pencils, paper, template reports, ruler, magnifying glass, syringes, needles, specimen bottles, labels, thermometer, forceps, scalpels, gloves, aprons, torch, dictating machine, spare batteries and any other material normally used.

In some environments, particularly remote ones, it may be found necessary to carry out relatively extensive dissection at the scene, as for example when a body is enmeshed in wreckage. The equipment carried should be enough to cope with this eventuality.

11.7 On location at the crime scene

11.7.1 Arrival

After arrival at the crime scene, the pathologist will be allowed to access the area of the body itself, either by following the directions of the crime scene investigator, or by following a taped access route. The body is generally accessed by walking directly up to it, with the constraints previously described. Depending on the form of scene, the pathologist may be provided with disposable overalls at this stage.

The pathologist should do relatively little at most scenes. It is always useful to first stand and examine the body and its immediate surroundings for a few minutes. At the more complex scenes, this stage may take a considerable time before anything else is done. This especially applies in those cases where close access to the body, or any disturbance of it, is liable to damage potential evidence. Here, an access plan must be formulated before any damage occurs. This has to be a team plan involving all relevant investigators, allowing for differing priorities. As evidence is noted, it should be documented.

11.7.2 View points

In most cases a view from ground level is adequate, but it is sometimes valuable to have a view from a higher eye point. Indoors, this can be done with a stepladder. At outside scenes, it is sometimes useful to use the roof of a police vehicle to gain an improved view, and occasionally the use of a cherry-picker hoist will provide considerable insights. This occurs especially in those cases where a body may have been dragged or dumped at a site. Complex blood spatter patterns on grass or other surroundings may be far more easily seen and interpreted from this kind of vantage point. Drag marks or other evidence of disturbance are often more clearly identified.

11.8 Disturbance of evidence

11.8.1 Outside of own area

The temptation at a crime scene to casually handle a firearm, pick up a suicide note, or sift through other property at the scene is often strong. However, it is much wiser for the pathologist to keep their hands in their pockets, unless invited to examine material at the scene. It is difficult to explain to a court why something has moved position between photographs, or why the pathologist's fingerprints were found on a weapon. The author has seen an instance of a large blood- and tissue-stained bottle being brought over to the crime scene investigator, and his being asked if this might be the murder weapon. In this instance, a coroner was the offending party, but pathologists are not immune.

The chances of inadvertently disturbing evidence are minimised if the pathologist develops the habit of continually checking with the crime scene investigator in charge: Is it alright for me to . . .

11.8.2 Bloodstains

Little more need be said than to quote an instance from the early nineteenth century (Smith, 1948):

In judging from marks of blood in the room, we must take care that we are not unconsciously misled by the accidental dispersion of this liquid by persons going in and out or touching the body. The following case . . . will show the necessity for extreme caution. A young man was found dead in his bedroom with three wounds

on the front of his neck. The physician who was first called to see the deceased had unknowingly stamped in the blood with which the floor was covered, and had then walked into an adjoining room, passing and repassing several times; he had thus left a number of bloody footprints on the floor. No notice was taken of this at the time; but on the following day, when the examination was resumed, the circumstances of the footprint were particularly attended to, and excited a suspicion that the young man had been murdered. The suspected person was arrested, and would have undergone a trial on a charge of murder . . .

11.8.3 Other

The forensic pathologist will eventually develop a wide appreciation of aspects of crime scene investigation outside their own field. It is critical to remember that any insights that they may have regarding a subject outside their own must be considered in that light. It is reasonable to point out a feature of interest to another investigator, but it is not acceptable to try to take over that part of the investigation and disturb the evidence. The corollary is that pathologists should readily accept input from others, but not allow themselves to be unduly influenced.

11.9 Recording

11.9.1 Requirements

It has to be remembered that in many instances the defence, during a trial, could make considerable advantage of any inconsistency between the reports produced by the different scene investigators. Therefore, the actual form of the scene report itself varies greatly between jurisdictions. However, like the autopsy report, the scene report should be completed in such a way that another pathologist is able to assess the findings to produce an independent opinion.

11.9.2 Sketch plan

Pathologists vary in their approach to this aspect of the investigation. The type of plan should be dependent not only on the kind of case, but also on what other resources are available.

In the most simple cases, a plan is hardly necessary, except as a convenient method of noting features which otherwise do not easily fit with other parts of the documentation. This might include such aspects as the position of a telephone or the location of a ceiling fan.

In the most complex cases, those where a detailed plan has been prepared by a specialist unit and is available for the pathologist's use, then little extra need be added, apart from minor points of clarification.

11.9.3 Detail

The situation needing the most detailed plan by the pathologist is that where the scene is relatively complex, but is difficult to adequately describe in words. In particular, if

there are many features of relevance to the pathologist, which may be of lesser importance to the other investigators, then these will have to be documented in detail by the pathologist.

A significant factor to remember is that the plan is not only the pathologist's aide memoire for a possibly distant court appearance, but as part of the documentation, it may be submitted as evidence. It should therefore be considered in the same way as any other piece of documentary evidence, and be suitably labelled and annotated.

It is of value to have a template which can be used on all occasions, that has a number of headings that refresh the memory, and can diminish the chances of failing to document an observation. A number of these sheets can be used for a complex scene.

11.9.4 *Written description*

The description is most commonly done using a battery-operated tape recorder. This has the advantage of being easy and convenient, allowing the production of contemporaneous notes. In some jurisdictions the tapes are retained after transcription, and may be submitted as evidence. This means that all dictated material should thus be relevant to the investigation, to avoid possible later embarrassment. Voice-operated machines are convenient to use, but have the disadvantage that they are more prone to record irrelevant material.

The amount of detail that is recorded is once again very much dependent on the type of case, and the pathologist must always consider the potential outcome.

11.9.5 *Photography*

Pathologists frequently wish to take their own set of photographs of the scene in order to best identify features of most interest and relevance to them. However, it is generally desirable that only one set of photographs is taken of the scene, in order to avoid potential conflict in court, as two sets of photographs may show alterations or give different perspectives.

The best solution is for the pathologist to clearly identify to the photographer, and video team if appropriate, exactly what aspects of the scene are of importance to them. It is important to remember that although the photographer may have to speak to the provenance of the photographs used in court, it will usually be the pathologist who gives evidence on their subject matter. It can be extremely difficult and frustrating if the photographs do not clearly show the crucial information or the use of an inappropriate lens produces avoidable distortions. The pathologist thus needs some knowledge of photography for the best results to be available to the court.

In those cases where an evidence clash will not occur, pathologists may still take their own photographs. The availability of compact digital cameras has made photographic documentation of crime scenes by the pathologist an easy, convenient and cheap method. This is of great value in the completion of reports, and is also an excellent method of information transfer during the course of the investigation. Macro-photographs using flash can illustrate features on the LCD preview screen which may be difficult or impossible to appreciate under ambient lighting.

11.9.6 Video

This is generally not of any great value for documenting injuries or other findings on the body itself, as this function can be best performed by still photography. On the other hand, it can be of considerable value to illustrate the general surroundings of the body. This is especially true if the scene is cramped, complex or is one with difficult access. The footage should be in continuous form, rather than vignettes, so that a full circumferential view is gained. Individual segments that record aspects of interest are also useful, but cannot be regarded as a substitute for a full view. The pathologist may find the video to be of great value in court, especially when trying to describe a complex scene to a jury and explain how conclusions were drawn.

11.9.7 Measurement

As the crime scene investigator will be measuring the scene, and this is what will be given in evidence, it is important for the pathologist not to produce possible inconsistencies by taking their own measurements. The dimensions which are most likely to be made relate to body positions, areas of blood pooling, lengths of blood trails or distances to weapons. The pathologist should thus specifically request that any measurements required for their purposes are made by the crime scene investigator.

If any scene dimensions are noted by the pathologist, either on their charts or in the reports, it is best to make it clear that these figures are approximate, so that the measurements which are to be relied on are those of the crime scene investigator.

11.9.8 Conflict with crime scene examiners

As has been referred to, a most likely source of conflict is on the subject of measurements, and the difficulties that this may subsequently produce in court. There are obviously many other possible areas of difficulty. Recognition by the pathologist that the successful outcome of a case depends to a large measure on teamwork should resolve any possible discord.

Part of this teamwork involves recognition both of the limits of one's own experience and expertise, and that of another investigator's field. One should not go beyond one's own limits, but must be able to recognise boundaries, and know when not to step into another investigator's domain (Young *et al.*, 1994). Training in parts of this is available, especially in fields of investigation such as sudden infant death syndrome (Iyasu *et al.*, 1994).

11.10 Evidence collection

11.10.1 What

Crime scene investigators may decide to take samples from the body whilst it is still at the scene. This may involve 'picking' off individual items, or 'taping' the body by pressing adhesive tape across parts of the skin or clothing to collect loose hairs, fibres or particulate matter. These may otherwise be easily lost by moving or disturbing the

body. This sampling process should be done at a suitable and mutually convenient stage of the investigation.

Depending on circumstances, usually those relating to time, distance and incipient decomposition, it may be advisable for the pathologist to take some toxicology specimens at the scene. Venous blood, vitreous humour and urine can easily be sampled by using a syringe. These specimens can then be cooled or refrigerated immediately, whereas the body may have a period of many hours before being sampled at its destination. In hot environments, this may make a significant difference to the quality of the samples.

11.10.2 How

Part of the object is to assess the body and the scene, whilst causing minimal disturbance to the evidence on the body or clothing. Body regions that have a particularly high likelihood of containing easily disturbed evidence include the hands and head. These areas must be protected.

A recommended method is for each hand to be enclosed in a plastic bag, which is then fastened at the wrist, by either tape or string. A similar bag is placed and fixed over the head. One disadvantage of this method is that the enclosed parts are liable to sweat in the bags, the resulting condensate causing deterioration of the evidence. For this reason, unlined paper bags may prove to be more practical. The decision should be made in the light of the particular circumstances, particularly regarding the body and environmental temperatures, as well as the presence of blood, or the threat of rain.

Apart from any biohazard risk, as previously discussed, the pathologist should be wearing rubber gloves to reduce the chances of evidence contamination. These may require to be changed frequently, and double gloving may be a practical consideration.

11.10.3 When

Once the visible surface of the body has been examined, it can then be moved to look at the sides and under surface. This should be done with caution so that no weapon, other object or trace evidence is disturbed. There can be no set routine, as each case has its own individual aspects. Frequently, a convenient method is to roll or carry the body onto the body bag, which has already been placed next to the body. Conversely, the flap of the bag may be passed under the body. Once the body has been moved, then the entire underlying area can be searched thoroughly.

This order may have to be modified according to circumstances, particularly relating to bad weather descending on an outdoor crime scene.

11.10.4 Who

The people involved may include the pathologist and various forensic officers. This should be discussed by the pathologist and the rest of the team. In most cases, it is clear where the responsibility lies. A collaborative effort is most likely to maximise the benefit. Sometimes, the pathologist may have to take the forensic samples themselves if there is no crime scene officer to deal with them. They should remain within their area of expertise, and take particular care about labelling.

This collaboration should extend to the packing of specimens, which is at least as important a topic as the collection. Specimens that stay wet will rapidly deteriorate, and become unfit for examination. If they remain in plastic bags they will become mouldy, but plastic bags may have to be used at the scene to transport wet material from the scene.

11.11 Timing of death

This is a particularly difficult area, despite the considerable effort invested in the subject. The timing of death is imprecise, with the degree of error increasing with the interval since death. Some of the difficulty relates to the fact that death is not a single biological event, but a process, and this process can be divided into segments. The 'time of death' as construed in an investigation refers to somatic death, or failure of the body as a whole. It relates to either cardiorespiratory arrest or brain death, which occur at much the same time, when outside the setting of an intensive care unit.

11.11.1 General

Immediately after the occurrence of somatic death, the body will be in a state of flaccidity, but many individual functions will still be present to some extent. For example, the eyes can react to some drugs, the muscles can react to electrical stimulation, or tissues can survive if transplanted. These features will disappear over a variable period, as irreversible tissue degeneration commences.

Much of the estimation of the time of death is a matter of experience, especially as it relates to local conditions. A pathologist used to death scenes in a hot humid climate will be at a considerable disadvantage in a cold dry climate for some time, until 'acclimatised'. Some local factors may also be of value. For example, if a suicide victim in a hot sunny climate is found in a car parked in the sun, when shade is available, death is more likely to have occurred during the hours of darkness.

It is generally true to say that the timing of death is of investigational rather than evidential value. It is common for the police investigation to hinge on the time of death, particularly during the earlier stages. This is usually not a problem, if the limits are made clear to the investigators. However, although this estimation may be clearly stated by the pathologist to have little evidential value, there still may be considerable discussion in court, especially if a defence of alibi arises.

11.11.2 Range

The methods used to ascertain the time of death will vary according to the apparent time interval since death. Multiple methods tend to give a better result, or else indicate some problem with the methods used. The most important point is for the forensic pathologist to give a range for the time of death, rather than to give a specific time. This range should become progressively wider with the increasing passage of time since death.

There will be only very rare occasions where the pathologist notes that an impact on a digital watch has reset it to its default start time and date, thus giving the time of the fatal impact to the second.

11.11.3 Factors

There are numerous factors influencing the changes after death, and on many occasions, they cannot all be known. These factors should be allowed for as much as possible when attempting to estimate the time of death. Some of the relevant factors include:

- environmental temperature range and wind speeds;
- body covered or uncovered, and clothed or unclothed;
- relative stability of conditions;
- access and types of insects or animals;
- immersion or burial;
- heat or cold as a factor in the death itself; and
- cause of death, such as septicæmia causing rapid decay.

11.11.4 Methods

The methods used vary with the time of death, from temperature and biochemistry determinations in freshly dead bodies, to botanical methods such as ageing of tree roots in long-standing burials. The less commonly used factors will require input from other disciplines.

11.11.4.1 Temperature

It is obvious that bodies cool after death, and temperature-related methods have been used for a long time. The basic premise is that death causes effective cessation of metabolism, and thus body heat is no longer maintained. The central body temperature then drops over a period to reach that of the environment.

A difficulty concerns assumptions about the body temperature at the time of death. It is unlikely to be exactly 37°C, and could be much higher, as after strenuous exercise, or much lower, as after a long agonal period. Evidence for either of these should be looked for at the scene.

The rate of loss of heat depends primarily on total body mass and body insulation. Another major factor is the insulation efficiency of clothing, which varies greatly, depending on whether it is wet or dry. Wind and rain are thus factors. The actual temperature outdoors may change dramatically over a few hours, and may be extremely variable over the relevant time interval. Even indoors, there are difficulties, with significant temperature variations. Air conditioning or central heating can provide a stable environment, but sometimes this is switched on by the first investigators, prior to their commencing investigation. The local environment may be critical to consider, such as a cool day, but with a sun-exposed body in a closed car. In addition, very large numbers of maggots can warm the body many degrees, rendering body temperature measurements irrelevant.

The author has seen a case of a body being discovered with a core temperature of 3.5°C, less than four hours after last being seen alive. It was discovered on a windy and icy roadway, the deceased's clothing having been soaked with vomit and urine. At the other end of the scale, a body was examined with a core temperature of 37°C, about

2½ days after death. The ambient temperature was 36°C and the overnight minimum temperatures had not dropped below 30°C.

The core temperature of the body must be determined, not the external skin temperature. A hand-held thermocouple probe with a digital read-out is valuable, as mercury-in-glass thermometers are often too fragile for scene work. The most common technique is to make a sub-hepatic stab, marking the site to prevent confusion at the autopsy. Some authorities suggest taking rectal temperatures, but this is not recommended, as it usually requires interference with clothing, and it may contaminate the ano-genital area before the case is realised to have a sexual element. Deep ear canal or nasal temperatures are also being established as routine methods, as they require little disturbance of the body. The time of death is calculated by applying one of the algorithms found in the standard texts. The simplest one, which makes many assumptions, is:

$$\text{Time in hours} = 40 - \text{core temperature } (^\circ\text{C})$$

The nomograms produced by Henssge (1988) are more valid, as they include a number of correction factors, as well as confidence limits.

Feeling the body to gain an idea of its temperature has been used since time immemorial, but has an extremely wide range of error, as the superficial loss of temperature is far more variable than that of the core. Furthermore, the subjective nature of this examination varies widely, both with the relative warmth of the examiner's hand, and with their experience of dead bodies.

11.11.4.2 *Rigor mortis*

This is the best-known change that occurs after death, and has long been used to estimate the time since death. It is a normal muscle contraction, but one which persists, because of the lack of adenosine triphosphate (ATP) which is needed for relaxation. The levels of tissue ATP thus influence its onset. Rigor can be described as appearing at around 3 h, becoming complete at around 8 h, and passing off over the next 48 h, but timing is extremely variable.

A well-rested individual would be expected to have much higher tissue ATP levels than someone dying after a protracted altercation, and rapid onset of rigor in persons dying in combat is well recognised. Body temperature will also influence the rate of tissue consumption of ATP, bodies in hot conditions remaining in rigor for much shorter periods than those in the cold will. These factors can be identified at the scene.

Crime scene investigation should include an evaluation of rigor by the pathologist. This should include both the degree and extent of the condition. Any conclusions reached will have to be based on personal experience as well as the wide variations possible. However, rigor mortis is so variable that it provides little useful information in most cases, tending only to produce argument in court.

11.11.4.3 *Hypostasis*

The settling of blood into the dependent parts of the body, under the influence of gravity, is a variable process, depending to some extent on the mode of death. It may appear at around the time of death, for example in cases of elderly people dying slowly; conversely,

it may not appear at all, as in cases of death due to haemorrhage. These factors can be considered at the scene.

It is usually described as appearing as a blotchy purple hue at around 1–3 h after death, becoming confluent over the next few hours and maximal by 12 h. It is mobile at an early stage, and will reappear on the dependent parts if the body is moved. It becomes ‘fixed’ at around 6 and 12 h, and thus does not move on rearranging the body, although there are many exceptions. It finally disappears with the onset of putrefaction. This calendar is imprecise, but can give some indication of the time since death.

Hypostasis is of greater value in determining whether a body has been moved some time after death to a new site, by having a pattern inconsistent with the posture as found.

11.12 Changes after death

11.12.1 Decomposition

This phase corresponds to the beginning of the final dissolution of the body, as a combination of breakdown from enzymic and bacterial action. The tissues soften and liquefy, and like other post-mortem changes, are dependent on factors such as temperature and other outside influences. As the time frame is relatively long, the degree of variability becomes ever greater, reducing the accuracy of estimation. Because of the increased number of variables in this area, there is a greater need for pathologists to attend these crime scenes.

Artefacts are produced by a variety of animals, varying from small insects to large carnivores, depending on the circumstances. These must be recognised by the pathologist, most easily by observation at the scene (Patel, 1994). Even domestic dogs can produce extensive damage to bodies, consuming tissue, preferentially targeting ante-mortem injuries. They will also disarticulate bodies, as will larger carrion birds. These aspects must be considered, in that this animal damage can influence the rate of decomposition, and thus potentially alter estimates of time since death.

Decomposition represents a complex area, the pathologist’s involvement varying greatly. At the more complex end of the scale, other specialists will be involved in determining details of the body and its surrounds (Spennemann and Franke, 1995). Ground penetrating radar, for example, can provide evidence of disturbance of the ground below the surface layers (Miller, 1996).

11.12.1.1 Putrefaction

Putrefaction is the usual end process of post-mortem changes, leading to skeletonisation. It is an extremely variable process, depending not only on the degree of protection of the body by clothing or shelter, but also on the access of insects and other animal life. The major factors involved are temperature and humidity, with higher levels increasing the rate of putrefaction. Complete skeletonisation can occur in under a fortnight in the most favourable conditions for its development; whereas bodies in ice fields can be preserved almost intact. The 5,000-year-old body found in the Otzal Alps in 1991 was first investigated as a forensic case (Spindler, 1994).

The products of decomposition leach into the soil, and these can provide potentially useful information. Scene examination may thus include the sampling of soil for products of decomposition (Vass *et al.*, 1992). If these products are not beneath the body, this may be an indication of its having been moved, probably by animals. Detection of this first area is of value, as this may be the site of evidence that has separated from the body.

Determination of time of death by considering putrefaction can thus be very difficult, and requires knowledge of the local circumstances that might apply. A description of all relevant features is necessary, in order that experts in other fields may be able to contribute. For example, even a feature such as post-mortem tooth loss may provide an indication of the interval since death (McKeown and Bennett, 1995).

11.12.1.2 *Mummification*

This process requires a dry environment to allow drying out of the body. It is seen mainly in those circumstances where heat is a factor, such as in desert areas. Small children may be mummified in places such as clothes-drying cupboards. The process can begin within hours of death in parts like the fingertips, but usually takes a matter of weeks to become complete. The leathery exterior then acts as protection against other damage. Once mummified, the body is virtually immune to further deterioration, apart from that caused by some species of beetles.

As the mummified body changes so slowly, it may be very difficult to determine the time of death. The pathologist should engage the help of other experts in these cases. Crime scene examination in these cases is still valuable, as many other forms of evidence are well preserved by the conditions.

11.12.1.3 *Adipocere*

Adipocere is a product of decomposition where fatty acids are produced from body fat by bacterial action. The tissues are converted to a pale partly fatty waxy material, often with a strong cheese-like smell.

It is a relatively unusual finding at crime scenes, as it requires a damp cool environment, and its formation is a rather slow process. It is most commonly seen in bodies that have been buried near the water table, or submerged in water. Although starting to develop within days, it is rarely identifiable after less than a month, and it usually becomes visible after 3–6 months. It may continue to increase for a year or two. Under anaerobic conditions, it may remain stable for decades. It should therefore be used with caution in estimating the post-mortem interval. Significant soft tissue detail may be preserved, although it is relatively fragile.

11.12.1.4 *Skeletonisation*

This last phase, as already noted, is extremely variable in its onset. If decomposition is aided by animal damage, which removes skin and some soft tissue, this will speed the process greatly. Evidence of animal activity should be looked for, either as tooth marks on bone, disarticulation or animal tracks. Disarticulation is a gradual and to some extent, an ordered process, with smaller and simpler joints separating first, and larger, deeper and more complex joints such as the lumbar spine, separating later. An unusual order of

separation may be an indicator of a local factor, such as an injury. A fresh skeleton will be noted to have connective tissue tags, especially around the joints, and a distinct smell of putrefaction may still be evident on the bones or in the underlying soil. At a later stage, the bones will still be oily, and with a progressively weaker organic smell. This smell will often be lost after around a year. Bleached or soil-stained bones are older, and crumbly bones may be many years old. This has to be taken in conjunction with the scene findings. Bones exposed to strong sun, wind and rain may be crumbling after only a couple of years, whereas those in a protected location, such as a shallow cave, may appear in good condition after decades.

The bones should be considered at the scene, from the point of view of whether any fractures may be ante-mortem or post-mortem. Post-mortem fractures may be related to animals, in which case teeth marks are usually evident, or they may be part of the burial process. The general appearance of the scene may give significant insight into this aspect.

11.13 Forensic anthropology/archaeology

This is an area with blurred boundaries, but most pathologists feel competent to deal with the more straightforward cases. The use of specialised anthropological techniques is more appropriate for complex cases (Reichs, 1992). This especially applies in the investigation of mass graves, which although defined as graves with two or more bodies, is commonly taken as those with numerous bodies. The presence of a number of bodies in a grave, especially where the burials may have occurred in phases, have been buried at varying stages of decomposition, or have been disturbed for some reason, can be particularly taxing to exhume.

Archaeological methods are slower and more complex than those used in most cases of a forensic nature, but they are capable of producing significantly better results, and they should be used where applicable. This could be any burial site, but especially applies to old graves and mass graves. The processes of trenching the site, excavating the grave by pedestaling the remains, using wooden implements, and exposing all remains prior to any removal, are all of value. In particular, they can provide detailed information relating to the time and process of burial, as well as the changes that occur afterwards (Spennemann and Franke, 1995a,b). It is important to avoid digging directly down onto the remains from above. This will prevent the production of post-mortem damage due to the excavators digging through or standing on yet uncovered remains. It is also less cramped, and more conducive to a good excavation. If the persons carrying out the burial have tamped the remains down, they can produce a similar pressure pattern, which may then be correctly interpreted.

11.14 Aboriginal burials

One area of specific difficulty in Australia relates to the examination of aboriginal remains. It is a legal requirement that if remains are discovered that relate to traditional burials then they are to remain *in situ*, and be transferred to the care of the traditional owners. This can prove to be a dilemma, as it is often necessary to carry out a significant amount of investigation to determine the situation. The forensic pathologist will usually have some idea of the situation, from the site and description, prior to arriving at the

scene. Local custom should be known, such as whether bodies are buried sitting or lying, or oriented in a certain direction. The presence of specific methods, such as wrapping in bark, should also be known. There may be background information about the possibility of burial sites in the area. From the point of view of attempting to determine the time since burial, the site can be investigated in the same general way as any other.

The pathologist should have a clear picture within a short time of starting. Minimal disturbance of the remains may then be sufficient to determine that they are of aboriginal origin, represent a normal rather than clandestine burial and appear old enough to be of no interest to the coroner. Sometimes a more extensive review or excavation of the site is needed to determine the facts surrounding the remains, to the satisfaction of all interested parties.

A number of features, which can be found in several areas of the skeleton, may be used to determine the aboriginality of skeletal remains. In the interests of minimal disturbance of the remains, the skulls should be examined first, as they are the best source of information, and a determination can generally be made without having recourse to any complex methods. The pathologist should have a good working knowledge of the relevant anthropological features. Documentation of the remains should include a description as well as photography of the features used for differentiation.

11.15 Entomology

A considerable variety of insect species may visit, feed from or live on bodies. Their types and numbers are of importance, in that they provide insights into the time of death by their numbers, development and succession of types. They may indicate the presence of wounds. If the insect species are 'incorrect', in the sense that they do not appear to match the circumstances, it may indicate that the body has been moved from another site. The type of the original site may be indicated by those species that are present. Once the body is disturbed by investigation, some insects will leave, so this aspect must be considered at the scene.

Flies will appear within a very short time of death, often within minutes. They are attracted to blood, and will consume it avidly. They may then produce regurgitation spatter. These are seen as round or ovoid droplets of slightly altered blood, which may look a little older or browner than other blood at the scene. The pattern of droplets often relates to an object above the spots, on which the flies have alighted. On occasion this can be quite easily confused with fine blood spatter. Sometimes heavy deposits of these blood spots are seen along the bottom edges on windows, such as inside motor vehicles.

As flies are diurnal, sometimes the presence or absence of egg masses within the body orifices gives an indicator as to the time interval in a recently dead body.

If a body has significant maggot infestation, it is worth considering the body from the aspect of which areas of it might be a suitable and protected site for egg laying. Most commonly, these are the natural body orifices, but injuries are chosen if they are accessible. The presence of large numbers of maggots in an otherwise unusual site may thus be the first indicator of a wound. The maggots will move if disturbed, so this aspect is best considered at the scene.

Specimens of fly larvae may be taken by the pathologist, but this is better left to an entomologist, or at least be done with their guidance. Artefactual shrinkage of maggots

by the use of incorrect preservative solutions can produce an underestimate of growth time (Tantawi and Greenberg, 1993). Other insects may also be collected, as their presence or succession may provide further information of value to the investigation (Schoenly and Goff, 1992). For example, in the case of bodies found in water the presence of aquatic or other insects in clothing may help (Haskell *et al.*, 1989). Inappropriate insects may provide further information. Maggots which are found on a buried body generally indicate that the body has been disposed of only after hatching has taken place.

Entomology is covered more fully in [Chapter 18](#).

11.16 Blood spatter

Blood spatter is a common form of physical evidence at a death scene, and is often of major relevance. It is not a field in which all forensic pathologists feel confident, as in some jurisdictions it is regarded as totally within the domain of the forensic scientist and in others, the crime scene investigator. It should be reasonably regarded as a shared topic, one understood by all players, as each expert has an individual slant on the subject, and can thus provide separate insights. It is important to avoid evidence clashes, as previously mentioned.

Examination and documentation of blood spatter, including what, where and how much, allows interpretation of the type and form of bleeding, and may provide a reconstruction of the incident and some surrounding circumstances. The form of report produced tends to vary with different departments, but usually is incorporated into the general scene report.

Blood loss itself is due to breaches of blood vessels, and this may be due to natural disease processes or trauma. Typical examples of natural disease-causing problems at crime scenes include bleeding from a varicose skin ulcer, which is at ankle or shin level, and bleeding from lung cancer, which produces coughed-up blood. Both of these may be associated with widespread blood deposition. Commonly, these kinds of cases are associated with some degree of cleaning up or self-help, of a type consistent with a solitary life style.

The type of loss is dependent on the kind of blood vessels involved. Veins return blood to the heart, operate at low pressure and flow is at a constant rate. A breach causes an ooze or pour of blood. On the other hand, arteries operate at high pressure and have a pulsatile flow. This produces a very variable flow rate, and a breach causes a spray or spurt of blood. The normal blood pressure peak and trough is 120/80 mmHg at rest, but can be as high as 180–200 mmHg with strenuous activity or stress, excluding any disease process. Obviously, this level may be expected in violent deaths. As veins and arteries commonly run parallel to each other, both types of vessels may be damaged at once. The size of vessel is also important, as small vessels will produce little blood, whereas the major vessels can bleed catastrophically. An arbitrary level of 200 ml has been defined as the cut-off between a small and a large volume. The pathologist can rarely estimate the volume directly at the scene with any great degree of accuracy. The estimate may have to be done indirectly by crime scene examiners, such as by weighing areas of soaked carpet, and comparing this with dry areas.

An abrasion or superficial laceration involves large numbers of very small to small vessels. This produces a diffuse ooze from the whole area, and neither a pour nor a spray

of blood would be expected. Incision of a superficial artery, such as in the wrist, involves larger vessels, with a small area of origin. This produces mainly a spray of blood due to pumping or spurting. A stab of a deep artery, as in the thigh, may mean involvement of a larger deep vessel. Here the presence of overlying tissues will interfere with the production of a spray, and the blood exits as a rapid pour, usually without spurting. However, there is usually still a clearly pulsatile element.

The size of blood spots relates to the impulse of dispersal. Low impulse bleeding, such as venous bleeding, will produce large blood spots. A medium amount of impulse, such as produced by the use of a blunt instrument, will produce finer spots. High impulse dispersal, as in firearm injuries for example, will produce a fine spray. This can be used in interpretation, as in the case of a crewman missing after an on-board explosion. There were several areas of very fine blood spray near the relevant hatch cover, and also on a broken ship's railing. This clearly indicated that the deceased had been hit by the swinging hatch cover, and had broken the railing by force of his impact with it, during the course of being thrown overboard.

Some knowledge of the injury pattern will produce the best results in interpretation. For example a slash of the neck might be expected to produce arterial spurts from large superficial vessels. A stab of chest could produce a rapid flow, but if the stab is small or angulated, producing a degree of sealing, there may be little external bleeding. For example, multiple heart and aortic stabs with a skewer have been seen to produce only occasional external drops of blood. A stab of the lung may have the combination of direct bleeding from the stab and the expiration of blood mixed with air. Projected bleeding can also occur from mouth and nose following a gunshot wound of the head.

During the bleeding process, the blood may be around the injury itself, and be capable of making contact impressions, or may have been projected away from the injury, and no longer be on the body at all. This blood may be around the body, and situated on bedding, furnishings, walls or carpet. The type of patterning will provide the pathologist with insights of where and how the deceased had moved.

The blood may be on objects at the scene such as a weapon or a vehicle. The position, patterning and extent may indicate which part of the object caused the injury, and in turn, this may indicate the position of the deceased at the time of sustaining this injury.

There may be minimal blood present at the scene, or what appears to be an inadequate amount, in view of the injuries. This may indicate that this is a secondary scene, and that the primary scene must be searched for elsewhere.

If the body is missing or is not in a condition to show injuries, then the reverse processes may have to be applied, as the scene has to be used to establish what injuries were present. An example of this related to a burnt body, with few apparent injuries, found in a room that had multiple bloodstains. A more complex case involved a trawler with a missing seaman. The physical evidence consisted of no more than 200 small blood spots and bloodstains. The interpretation of these spots in relation to possible injuries, activity and movement satisfied a jury that the suspect's versions of events could not be true.

When considering blood spatter, the pathologist should remember that not all blood arrives directly at its final site. For example, vertical dripping of blood from a chest injury will tend to fall on the ground between the feet. If the deceased remains fairly static, then blood will pool between the feet. Blood splashing into this pool will

produce a fine spatter of blood at low level, with the last drops producing the greatest effect. This may outline the feet on the floor, and will also be present on the inner borders of the feet and the tops of the feet. The blood on the feet may subsequently be transferred elsewhere. The target surface is of major importance, and the effect is far less on a carpet than it would be on tiles, due to the reduced pool effect. Another significant aspect relates to blood which has been deposited from an injury onto a weapon, and is then cast off by the centrifugal force of swinging the weapon again. This may leave blood trails on ceilings or on high walls.

Individual drops of blood will behave differently on impact with different surfaces, even at the same impact speed. A fall onto a smooth surface, such as glass, will not cause break-up of the drop. It will spread more with a greater velocity of impact, or greater height of fall, and the border of the drop may then exhibit scallops. Porous surfaces such as carpet or clothing tend to absorb blood, so there may be no real spread, and the drop may not break up. An irregular surface such as brick or a road surface will cause a drop to break up. This produces a stain with an irregular border. At one end of the scale, the effect is small, and there are radial spines only. There is a greater effect when higher impulse is involved, or there is a more irregular surface. This produces a radial spread of small satellite drops. The height of fall cannot be determined from drop diameter, as the volume of a drop is variable.

The pathologist must remember that relatively few drops land at right angles to a target surface, and this is the only time that circular drops are formed. An oblique impact will form elliptical drops, and as the angle decreases so the ellipse will lengthen. The more sharply pointed end of the drop indicates its direction of travel. This effect is commonly seen with drops spraying on walls. A comparison of drop width to length allows impact angle to be determined by the use of basic trigonometry. If a number of drops are assessed, then an interpretation may be made by looking for areas of origin of bleeding. This can be done using strings, or a computer software package, such as 'No More Strings'. The area of origin of bleeding can be correlated with pathological findings (*Law enforcement technology*, 1995) relating to movement, position or the order of sustaining injuries, so that this can be compared with the accused's version of events (Ristenbatt and Shaler, 1995). If the target surface is not fixed, and could have been moving at the time of impact, interpretation of direction is unwise, as the estimation can only give the relative, and not the absolute, movement between the two.

Elliptical drops may also be seen if the drops are coming from a moving person. The angle of the drops indicates the direction of movement. This effect is minimised in the case of drops falling from the upper part of the body, as they are slowed by air resistance, and the fall thus becomes more vertical. Other variants of drops may be seen. An example is of mixed blood and air, such as may be expelled after a lung wound, is seen to have small clear areas representing air voids. Similarly, blood may be mixed with fat globules. The fat will remain after the blood dries.

Blood when first shed is slippery and many bloodstains resulting from contact at this time show evidence of sliding contact. Clotting is a physiological process that converts the liquid blood into a solid coagulum. This process normally takes some minutes, and the resulting clot is still of a slippery nature. Blood exuding from a dead body may appear different to bleeding from a live individual, in that the bleeding separates into serum and red cells, producing a stain with clear and dark regions. If fresh blood is allowed to dry over a period of a few minutes, it then becomes tacky or sticky. It will

then exhibit a different contact pattern if disturbed at the scene, as could occur during a protracted assault, or in an attempt to clean up. Drops may also leave an annulus if they are partially cleaned away at this stage, only the liquid central part being wiped away. The rate of drying is influenced by temperature, humidity, thickness, surface and airflow. Drying of undisturbed blood over a period of hours may cause it, when on smooth surfaces, to dry and flake. These flakes are flat or rolled, reddish brown and inconspicuous. A surface such as plastic laminate or a vinyl floor may be found with little blood remaining on it, as it has blown away.

The assessment of the evidence of bloodstains by the pathologist should allow a considerably more detailed assessment of the crime scene. One aspect to consider includes the amount of activity that appears to have occurred, and whether or not this was in the form of a struggle. This may also reveal if there was time or ability to summon help or first aid. The pattern of blood spatter may have areas of blood-free shadowing, on a wall for example, thus indicating the position of another party. This may shed light on the issue of whether blood might be expected to be found on any assailants. The amount of blood found on them is often significantly less than might be imagined from the amount of blood found at the scene. The amount of blood that may be found on 'innocent' bystanders may also be an issue that has to be considered at this time (see Figures 11.1–11.7).



Figure 11.1 Victim of stabbing escaped the scene before collapsing. Note the blood smears on the body from the scuffle, the blood trails on the legs from the injury, blood on the feet from the blood-wetted floor, the collapse point to the right of the body and the seepage towards the drain. The total distance travelled of around 15 m was consistent with the severe injury



Figure 11.2 Victim of massive blunt force injury to head. Note position of body after ambush from behind, and lack of evidence of movement. Slow blood seepage has occurred from head injuries. Assailant admitted blow to deceased causing collapse, followed by many blows whilst on the floor



Figure 11.3 Victim of stabbing. Note the blood smears on the body from the scuffle, the blood trails on the legs from the injury situated on the upper trunk, blood on the carpet from dripping, and lighter blood dripping with skeletonisation and wipe marks on the tiled floor in the next room



Figure 11.4 Blunt force trauma while victim was asleep. Note medium impulse blood spatter on wall indicating multiple impacts, as later confirmed by autopsy and suspect

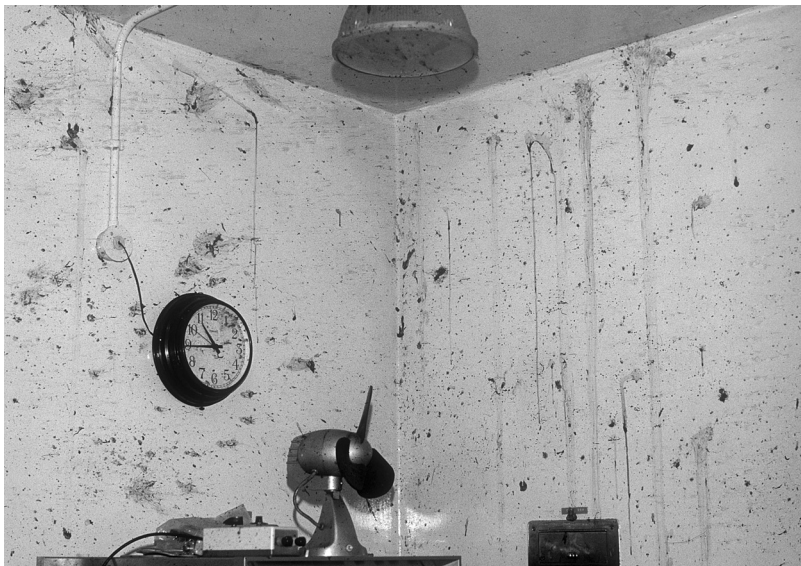

Figure 11.5 Room after suicidal explosion death, indicating blood spatter as well as impact of larger fragments of brain and other tissues. The area of origin was towards the left-side of the photo



Figure 11.6 Part of scene of assault with steel bar. Note complex blood spatter, including hair swipes, finger wipes, medium impulse blood spatter from varying directions, blood on iron bar, and impact damage to plaster by bar. Deceased showed multiple facial and lower jaw fractures



Figure 11.7 Note finger impression, grip on pipe and multiple medium impulse blood spatters of varying directionality

11.17 Body removal

11.17.1 Factors

When the pathologists have completed the examination, they should then ensure that the body is transferred to the mortuary with minimal disturbance or loss of evidence. The surroundings of the body must be preserved as much as possible. Part of the pathologist's role is to provide advice on how to best move and transport the body. The removal itself should be carried out, assisted or supervised by the pathologist. At the least, the task should be handed over to a competent and well-trained assistant.

11.17.2 Evidence preservation

The pathologist will usually be working with forensic officers who will collect the trace evidence. However, this is not always the situation, so the pathologist must then collect this material. It is important for them not to exceed their own limits of expertise and training. Hairs and fibres adhering to the body or clothes and loose objects must be taken and suitably labelled.

As the hands and head are likely sites of evidence retention, it is recommended that each hand should be enclosed in a bag, with a similar bag placed over the head, as described above.

11.17.3 Methods

A number of body bags are available on the market, and the pathologist should have input into the type to be used in their area. A large, wide D-shaped opening renders the move much easier. A flat bag, although cheaper, often requires more force to place the body in it, and a bag with sidewalls is better. In cases where difficult terrain or multiple vehicle transfers are frequent, a six-handled body bag is very practical. Another option is to use large plastic sheet, wrapping the edges over the body and securing it with adhesive tape. Sheets are convenient if the body can be easily moved from the scene.

There is no set removal routine, as each case has to be treated on its own merits. One convenient method is to open the bag or sheet next to the body, and either roll or carry the body onto it. Alternatively, the unzipped bag may be passed under the body, as it is being gently lifted.

Fluid-absorbing pads may be placed under the body to minimise spread of leakage of blood or other body fluids, especially in trauma cases. In cases of biohazard or decomposition, the body should be double bagged. This particularly applies if air transport is to be used.

Damage produced during the removal should be minimised, although this is sometimes difficult. The pathologist must always note and interpret damage which is unavoidably produced during removal.

This particularly occurs if the body is in poor condition to start with, as for example, significantly decomposed. Badly burnt and charred bodies may be brittle and easily crumble or split at the joints. The pathologist should consider factors such as the possible need for dental identification, and take measures to specifically protect the teeth and jaws from transit damage. This is most easily done by the use of cyanoacrylate glue

and then bubble wrap. Sometimes a physical support such as cardboard box fitted around the head may give the best protection for the journey to the mortuary.

The body should not normally be undressed at the scene, as it is usually a less than ideal site for a number of reasons. However, it may be necessary on occasion. For example, if the body has injuries likely to bleed heavily on movement, evidence such as blood patterns on clothing will be lost. Cases where there is difficult or protracted transport will also tend to degrade this surface evidence. The aim must be to produce minimal disturbance of the body, to minimise trace evidence loss. If possible, undressing should occur when the body is already on the plastic sheet or bag.

The bag or sheet may be submitted to the forensic laboratory after the body has been removed, in order to look for trace evidence that may have been dislodged in transit.

11.17.4 Chain of evidence

The transport of the body from scene to mortuary is the responsibility of the coroner or the police. This may be carried out through the agency of a contract undertaker. The body and its contained evidence must form part of the normal continuous chain of evidence that would be expected for any case. Once the body has been bagged and is ready for transport, the person in physical charge of it will frequently be a member of the coroner's staff, or a police member.

Quite often the pathologist is the person taking charge of the body, and will stay with it until its delivery at the mortuary. This is particularly convenient in circumstances of complicated transport, such as with use of small boats or light aircraft. In addition, this arrangement leaves little room for courtroom argument on chain-of-evidence matters (see [Figure 11.8](#)).

11.18 Leaving the scene

Before leaving the scene, the pathologist should log off, but not before discussing the case with the other investigators. The pathologist should also ensure they take all other material relating to them. This includes evidential pathology-related specimens, such as blood or urine samples. To save later embarrassment, a final check for equipment should also be made.

Discarded gloves and other rubbish should never be left lying at the scene, as apart from the lack of professionalism and the production of potential confusion, much of the material is likely to be a biohazard. It should either be left in the area that has been reserved for contaminated scene rubbish at the operation's base, or be taken back to the mortuary.

11.19 Revisiting the scene

If the pathologist feels that a later return to the scene may be valuable, it is best to discuss the matter with the officer in charge of the scene, as the scene will need to be secured. A final decision may be made during or after the autopsy. If the case appears somewhat unclear after the autopsy, then a further examination will frequently resolve difficulties.



Figure 11.8 Body found in mangrove swamp after being missing for three days. Note concrete blocks chained to waist, and extensive post-mortem animal damage, caused by fish, crocodiles and crabs. Body removal difficult due to post-mortem change and necessity to retain weights. Death due to blunt trauma

The author has recently reviewed an outdoor scene over a year after the autopsy, resolving the nature of an injury never interpreted by the original autopsy pathologist.

11.20 Death types

All experienced pathologists have dealt with cases which appeared to be obvious accidents, suicides, homicides or natural deaths, and which have later been established to belong to one of the other groups. Most commonly, this reclassification happens at the crime scene, but it may only occur at the autopsy. A number of factors need to be considered in order to determine the situation, such as:

- power of movement;
- evidence of movement;
- movement for how long;
- state of the deceased; and
- pathology of the deceased.

11.20.1 *Body position*

This is easy to document, and may provide useful information relating to the incident, especially regarding the suddenness of collapse, or intent to carry out a specific activity (Spitz, 1989).

11.20.2 Environment

Often this area tends not to be considered carefully enough. Especially in cases of natural death or deaths in elderly persons, environmental factors may have an insidious effect on the victim. Typical examples of this would be an either relatively cold or hot environment, with hypothermia or hyperthermia being part of the cause of death. Lack of detailed consideration of this can lead to incorrect conclusions, or even a failure to evaluate the possibilities (McGee, 1989). Inappropriate removal of clothing by persons suffering from hypothermia is often a useful indicator.

11.20.3 Natural causes

These cases are generally easy to identify and investigate, and frequently the forensic pathologist will not be asked to attend such a scene. In many instances, there is clear evidence of significant disease process. This may include an environment that contains numerous forms of medication, prescription forms, equipment or references to doctors or hospitals. The deceased person is commonly found in bed in a normal position of repose. The deceased person may also show clear evidence of disease process on external examination.

It is more common to attend a scene in which bleeding has been part of the cause of death. As this bleeding may have occurred over a period, the scene is often heavily bloodstained, usually with most of the blood in the bathroom area, especially the toilet. There may be evidence of some cleaning up. The body may be unclothed or part clothed, with bloodstained clothing nearby. There maybe a considerable quantity of blood on the body itself, the distribution depending on the origin of bleeding. If the blood has been coughed up, much of the blood will be in the form of widespread fine drops, many with air bubbles. If it has been vomited up, it is usually in larger pools, often with evidence of low-level splashing. The blood is usually dark and may contain 'coffee grounds', due to partial digestion. Rectal bleeding is usually on underclothing and around the toilet bowl area. It maybe fresh blood, or in the form of dark tarry material. Bleeding from varicose ulcers of the lower leg and ankle area is particularly associated with widespread bleeding, with a large terminal blood pool. Some form of bandaging may be present.

If the process that causes death is one that causes mental confusion, such as a cerebrovascular accident, hyperthermia or hypothermia, then a number of injuries may have been sustained during this phase. This may be associated with a disturbed scene that includes broken or damaged items. Most commonly, this is seen in elderly people who have lived alone. The injuries are usually minor, and tend to be of the pattern associated with multiple light impacts. These cases may be easily regarded as being suspicious due to the level of disorder and the number of injuries.

11.20.4 Suspicious

Many deaths are considered to be suspicious on the basis of the way in which the body is found. This may be confirmed or disproved during the first part of the scene examination. As mentioned in [Section 11.20.7](#), a useful feature which indicates a suspicious scene is that it is too tidy. This can extend from the scene which has been totally cleared

of all relevant material, such as an autoerotic death where the family may have even dressed and placed the body in bed, to those where an assaulted body has been washed or cleaned. If the clean-up is done very well, then suspicion may not occur at the scene. It may not even occur at the autopsy, as in a series of 'professional' euthanasias reviewed by the author.

Bodies may be found in very unusual positions, thus attracting suspicion. Examples would include persons with natural disease who have collapsed over items of furniture, and thus been found folded over chairs or tables. They may occasionally be found in a standing position, almost invariably in a situation where they can be propped up by furniture or other objects until rigor mortis occurs. Bodies may even be found in positions such as the knee elbow position, leading to suspicion of sex-related deaths.

11.20.5 Accident

Accidental deaths may sometimes be relatively difficult to identify at the scene, particularly in a domestic setting. An electrocution scene (Zhang and Cai, 1995), especially one involving a low voltage, is related to the environmental conditions. These factors must be identified. It is difficult in those cases where the body may be in a bath for instance, as there are no heat effects, and the skin changes are minimised (Goodson, 1993).

Some industrial accidental deaths may occur in circumstances where defective equipment may be removed or concealed prior to the arrival of investigators, so that electrocution has to be considered even if there is no immediately obvious source of injury.

Carbon monoxide poisoning can sometimes be recognised at the scene (Risser *et al.*, 1995), particularly if the levels are high. This not only sets the investigation in the correct direction, but it can also flag a potential hazard for investigators or others who may use the locale. The same principle applies in other poisonings, such as in methane asphyxia (Byard and Wilson, 1992). It has also been shown that overall accuracy in drug death investigation is dependent on crime scene examination (Shai, 1994).

11.20.6 Suicide scenes

These may be relatively simple to investigate. All pathologists will be familiar with the commonly repeated patterns; for example the woman in bed with empty pill bottles nearby, a glass with tablet slurry in it, a suicide note and photographs of loved ones. The man in the garden shed with a gunshot wound to the head is equally familiar. The difficulties appear in those cases where there has been a set-up scene, made to make a homicide look like a suicide. In some instances, there may be clear evidence of criminal involvement, as in a case of a body being found naked and dead across a railway line in cold weather, circumstances that would make suicide extremely unlikely to have occurred. However, the Tanner case in Victoria in 1984 involved a 'suicidal' gunshot death that involved two entry wounds of the head, as well as one of each hand, but the case was not further investigated at the time. Sometimes, a genuine suicide may embrace unusual methods or aspects, such as drug overdose death that involves a phase

of manic activity before collapse, and the victim is found with numerous injuries in a very disordered scene. A detailed scene investigation is the only solution to resolving this type of case (Avis, 1993).

11.20.7 Homicide scenes

In general, these are easily identified as being homicides, but sometimes an extensive clean up of the scene has been made, usually by the assailant, in an attempt to mislead the investigation. If the scene is too tidy, then this too should lead to a high level of suspicion. A typical example would be that of a domestic incident where the body has been cleaned up, dressed suitably, and then placed in a bed. Often the body is placed as if it has been 'laid out', and is not in a normal position of sleep or repose. The bedding maybe unnaturally tidy. The body itself maybe only partly clean, there maybe some blood traces present on it, or the clothing maybe on inside out. There may still be signs of an incident, such as blood droplets at the level of the skirting board. The pattern of hypostasis or position of limbs set by rigor mortis may be inconsistent with the position at the scene.

Investigation of 'gentle' homicides can be difficult to clarify, such as cases of euthanasia involving plastic bags, which are removed after death. There maybe only subtle findings present, such as a vague noose mark of the throat, or hair flattening by the plastic bag. As usual, pathologists should voice their suspicions to other investigators, so that a search will be made for the relevant evidence. Homicide scenes in which there is relatively little scene disturbance may indicate that the offender is someone who is used to the scene, and normally has access to it.

Blood present at the scene may appear from its patterning to not have come from the deceased. This aspect is most likely to be seen in a complex scene, and must be considered, with the pathologist drawing attention to it as necessary. It is a relevant factor in placing another individual at the scene, particularly if the accused has sustained injuries and there is later a court discussion relating to interpretation of a 'fair fight'.

11.20.8 Serial offences

Common factors in crime scenes should always be considered, as it is part of the pathologist's role to identify features that may point to serial or multiple offenders. The crime scene location or type, body position, clothing disturbance or the relationship of the body to the crime scene are all factors to be considered. Consideration should be given to objects such as potential ligatures or blindfolds. It is important to be able to differentiate whether the victim was killed at the scene or was dumped there. Offender profiling is not a part of the pathologist's role, but successful profiling does require some significant factual input from pathologists. This will include, amongst other things, a pathology-based interpretation of the crime scene that has resulted from its complete examination.

11.20.9 Deaths in custody

It was established by The Royal Commission into Aboriginal Deaths that where a case was a homicide or suspicious death, and this included a death in custody, then the autopsy should be performed by a forensic pathologist. Partly this is because deaths in

custody can be among the most complex of cases to investigate. Not only does society require that any death occurring under these situations is fully investigated, but there are frequently side issues, which may mean that unwarranted suppositions or allegations are made by various parties. These deaths frequently occur in a setting of acute or chronic alcoholism, or drug- and alcohol-related activity. Tricyclic drug overdose and phenothiazine therapy (Laposata *et al.*, 1988) may lead to a state of excitement, as may the use of a number of drugs of abuse. Deaths related to these may occur in a custody setting, and any injuries that are present have to be considered in the light of their possible ramifications. It is important to consider that trauma is commonly present, and that this may occur before, during or after being taken into custody.

Scene examination in the case of a death in custody usually involves a death that has occurred in a police vehicle, police lock-up or prison cell. It is relatively unusual to examine the scene in those settings that involve a psychiatric ward or some other medical area. As allegations of violence carried out by custody staff are by no means infrequent, it is important to examine the area in the context of whether it is possible to sustain injury at the site where death occurred. One advantage of these sites is that it is generally possible to keep them secured as a crime scene until after the autopsy has been completed. It is also necessary to determine if the body actually appears to have died in the place which has been nominated, as it is frequently moved by persons attempting to render assistance. As almost every 'known fact' at such a scene is liable to be contested at a court hearing, added attention to detail is always worthwhile. Although determination of the time of death, as previously discussed, is fraught with difficulty, extra effort directed towards this may prove valuable in cases where a death has occurred between cell checks.

11.20.10 Drowning scenes

These vary considerably in complexity. At one end, there is the more straightforward scene where a body is found in a bath, spa or domestic swimming pool, and where many of the required details are known or can be identified. These would include evidence of the use of alcohol or drugs, and physical hazards nearby. At the other end, there are the more difficult cases, where a body may be located in a river, a lake or the sea, and little can be deduced from the scene. Here it is necessary to determine, if possible, whether the body has drifted into the area or death has occurred at the site of discovery. Folded clothing at the waters edge tends to indicate a suicide. The presence of mud on the body and in the clothing can be helpful for comparison purposes. Vegetable matter such as waterweeds in the hands can be compared with that at the scene. In all cases, high level of suspicion has to be maintained, as water is commonly used for the disposal of bodies, and homicidal drowning is not unusual.

11.20.11 Children

The early childhood period is still associated with a relatively high sudden death rate, which could be due to anything from natural causes to homicide. Because of the peculiarities of children, the autopsy findings maybe minor, no matter what the cause of death. There is thus a relatively greater need for scene examination, in order to attempt to differentiate one cause from another (Byard *et al.*, 1994a,b).

11.20.11.1 Abuse

Child abuse is a complex area in which frequently there are repeated incidents of unwitnessed trauma, and a pattern of injury that is not consistent with the history as given by the carers. Examination of the scene is often of great value, although in most instances, the body has already been removed. Many of the injuries found at autopsy are difficult to interpret, so it is particularly useful to know about the type of bedding, furniture, flooring and household contents, in order to make a useful interpretation (Wagner, 1986; Botash *et al.*, 1996). Items such as belts and hairbrushes may account for otherwise uninterpretable injury patterns. As in deaths in custody, a retrospective examination of the scene can be helpful. This may be particularly useful after review of the previous medical history, because of the frequency of repeated episodes of trauma.

11.20.11.2 Sudden infant death syndrome

As sudden infant death syndrome (SIDS) is a diagnosis of exclusion, by definition, crime scene examination must be part of the investigation (Beal and Byard, 1995; Willinger, 1995). The point has been made that the socio-economic groups most likely to have SIDS deaths are themselves likely to have a high rate of accidental and other forms of death (Bass *et al.*, 1986). However, there is still some disagreement with this aspect (Guntheroth *et al.*, 1994). Because of the connection between these two groups, there is a greater need to examine the scene, and sometimes a need to reconstruct the scene to determine the feasibility of any explanation.

Other aspects of the scene to be considered include investigation of heat balance to determine the role of hyperthermia or hypothermia (Ponsonby *et al.*, 1992). Even the role of rebreathing may need to be considered as a cause of suffocation (Kemp *et al.*, 1993).

11.20.11.3 Accidents

This area extends almost imperceptibly from each of the two previous sections. For example, accidental asphyxia can occur in young children in a variety of sleeping situations. As the autopsy findings are minimal, they may only be differentiated from SIDS by an adequate level of crime scene examination. There is no other effective way of identifying an environment that puts a child at risk (Byard *et al.*, 1994a, 1996). One particularly difficult area to resolve is that of overlaying, where a parent, usually alcohol- or drug-affected, lies on the child. A clear description or re-enactment maybe very hard to arrange, although worthwhile. The patterns of hypostasis and congestion may be the most useful findings.

11.21 Scene types

General features for a forensic pathologist to consider in attempting to gain a preliminary impression of the death are:

- whether or not the scene is neat, or shows either acute or chronic disorder. It is sometimes difficult for a pathologist to accept the condition of a scene as being

possibly normal for some people. It is for this reason that scene attendances should not just be limited to the more complex or high-profile cases, as a wide general background is required in order to make a balanced judgement;

- the food type and its condition and amount are of value in attempting to assess the general standard of lifestyle and disease potential;
- the type and amount of alcohol present at the scene, as well as the empty containers, will provide further significant information regarding lifestyle, disease and possible circumstances of the incident;
- the type and amount of medications are of particular value in deaths due to natural causes, but the presence of inappropriate medications may provide information relating to drug abuse; and
- the general appearance of the scene will provide indications of the lifestyle, as well as the general physical condition of the deceased, as well as the potential for accident. Sometimes, clear indications of the psychological state of the deceased can be seen.

11.21.1 Shootings

Apart from the normal documentation of the scene, it is necessary to consider a number of specific matters. The pathologist must determine if the victim has moved during the course of the shooting, or has shown signs of activity afterwards. This can be done by noting the position of the body, the accessibility of the entry sites in the current body position, the presence of bullets or markings near the exit sites, and blood or tissue spatter patterns.

There is usually little back spatter, but there may be considerable forward spatter, especially with more powerful weapons. It is worth bearing in mind that there may also be significant spatter extending from gas splits in the skin, and this could be at right angles to the main bullet track.

11.21.2 Sharp force

11.21.2.1 Knife

As mentioned above, the possibility of movement has to be considered. The volume of blood coming from an injury will depend on factors such as its type, situation and coverings, but if these are held in mind, then useful information can be gathered in order to reconstruct the incident. A knife or other sharp weapon is unlikely to cause damage to the scene, except in the most violent incidents, but it may be wiped or cleaned on the victim's clothing or on furnishings, leaving a bloody outline.

11.21.2.2 Axe

Because of the type of injury produced, these scenes tend to be very bloody. As there is a tendency to inflict multiple blows, there may also be evidence of the way in which these injuries were inflicted, as left by the spatter patterns. These patterns will frequently include cast-off spatter, as well as medium impulse spatter. There may even be loose fragments of soft tissue, bone or teeth. There may be damage to the scene, particularly near to the body, due to missed hits.

11.21.3 Blunt force

11.21.3.1 Instrument

As in the instance of axe injuries mentioned above the use of a blunt weapon in homicide may produce a particularly bloody scene, and the pathologist should look for evidence of multiple impacts. Damage to the scene, such as gouges in walls, may help to reconstruct either the placing or sequence of the blows. Blood spatter patterns are of particular importance.

11.21.3.2 Fists and feet

Assaults by kicking or stamping maybe associated with considerable contamination of the crime scene. This maybe in the form of low-level blood spatter, which may be evident up to a metre or so above ground level. Evidence of the type and position of an earlier phase of the assault is to be looked for, and blood pools that are separate from the final position of the body indicate periods of immobility. The ground surface has to be considered from the point of view of its being the possible anvil opposite some of the injuries, and thus help to interpret the assault. Footprint patterns may help to provide information as to whether bare or shod feet were used.

11.21.4 Asphyxia

11.21.4.1 General

Asphyxial deaths can be of any mode, and as many of the changes are minor or subtle, they need to be identified as early as possible during the course of the investigation (Hicks *et al.*, 1990). In a case of a euthanasia death seen by the author, the only crime scene evidence consisted of flattened head hair and a faint oblique mark on the neck. These were each related to the plastic bag that had been removed before the death was reported. These signs would not have been appreciated, or even present, if the body had not been seen *in situ*.

A study by Risser *et al.* (1995) found that around 40 per cent of unintentional carbon monoxide poisonings were not recognised at the scene, with the detection rate diminishing with the increasing age of the deceased. The reduction in the required lethal carboxyhaemoglobin concentration with age contributes to this. In addition, room heaters may contribute to deaths other than purely by carbon monoxide poisoning, as there may also be oxygen depletion, sometimes on a background of intercurrent disease.

11.21.4.2 Sexual

Despite a considerable increase in knowledge of this subject, it is still one which can lead to difficulty at the crime scene due to its unusual nature. The complexity of some scenes renders them likely to be misinterpreted, and regarded as requiring the involvement of others, although they are generally solitary activities (Byard *et al.*, 1990; Boglioli *et al.*, 1991) One particularly difficult aspect relates to deaths that do involve sexual partners, where elucidation of the case can be particularly difficult (Hazelwood *et al.*,

1982). An example of this involved an asphyxial death in a woman found dead in a hotel room, where her partner detailed the 'accidental' circumstances. These circumstances were later found to be similar to those of another of his sexual partners who had been found dead in a hotel.

Sexual asphyxia is generally described as a method involving only males, the relatively few female cases being liable to be confused with homicides, or else not recognised at all (Byard and Bramwell, 1988).

Common features for the pathologist to consider are the high incidence of nudity or cross-dressing, evidence of sexual activity, repetitive behaviour, sex toys, sexually oriented or pornographic literature and the presence of possibly complex equipment or devices.

11.21.4.3 Ligature

Ligature-related deaths are most commonly suicidal in nature. A number are accidental, particularly in the sexual asphyxia group, and in children intentionally playing with ligatures, or in the totally accidental cases as in small children. A relatively small percentage of these deaths are homicidal in nature. Crime scene attendance by the pathologist is of value, as there may be relatively little in the autopsy itself to resolve the case. The general features of the scene should be examined, and the type, site and position of the ligature should be carefully considered, as should any suspension point.

11.21.4.4 Traumatic

Most of these cases are relatively straightforward, in that it is the general, rather than the specific features of the scene that apply. They are often industrial accidents, and may involve tasks such as ditch digging or grain silo filling. Another group involves those people who are crushed in large and often panicking crowds such as at sporting events or riots. Items to consider at the scene include examination of the ground surface, and irregularities such as stairs, fences and grills, in the proximity of the body or bodies, as they may produce patterns that are identifiable at autopsy. Children or adolescents tunnelling in sand at the beach represent another subgroup. There is little that is specific in these cases.

11.21.5 Drug related

The pathologist's main interest is to identify the likely role of drugs not just as a potential cause of death, but also as an explanation of activities or other findings at the crime scene. The presence of syringes, needles, foils, spoons and other general paraphernalia is of value in general terms. More important is the presence of a tourniquet still around or under an arm, a syringe still within a vein or a blood trickle from an injection site, each of which indicates lack of movement after injection.

The position of the body maybe of great relevance, as it may indicate an immediate collapse after drug administration, such as being found lying backwards across a chair, with both head and feet being found on the ground. As most deaths

have an asphyxial element, hypostasis is usually prominent and provides confirmation of the position. It is always worth considering any findings that are out of context, as they may indicate suspicious features, such as the presence of other drug users who were present at the material time, or more rarely, a homicidal drug overdose.

Oral drug overdose scenes are either suicidal or accidental. Those of suicidal type are often associated with alcohol taken as a congener, and open bottles may be nearby, as well as glasses with mixed alcohol and drug residues. These are often massive overdoses, and numbers of empty bottles or stripped-open foil tablet packs may be found nearby or in a rubbish bin. Accidental drug overdoses are usually of lower doses, and containers may be found lying about, or in pockets. These cases may be found in an environment suggesting recreational activity, such as use of a spa or swimming pool, or sexual activity.

11.21.6 Fire

The position of the body may indicate what kind of activity or escape attempts were made. Artefactual changes from heat contractures must be considered at this time. The degree of burning will influence the method and type of recovery. A relatively lightly burnt body will need no special precautions, whereas a severely charred body will be liable to fragment or shed evidence. This particularly occurs if the body is linked with other bodies or material due to pugilistic contractures. The body should not be moved until the possible relevance of other nearby material has been assessed.

The body may be seriously damaged during the course of scene examination. This maybe because it has not been identified as a body. At the time of the author's arrival at a burnt-out house supposed to contain a body, a fire officer was found to be standing on the body itself.

11.21.6.1 Domestic/industrial

Many domestic fires occur in the context of children playing with matches or failure of domestic heating units. The scene should be examined from the point of view of trying to assess whether the death has occurred during sleep, or whether attempts at escape have been made by the victims. Industrial fires may involve particularly high temperatures of long duration, due to the presence of large quantities of flammable materials, so trauma to the body is likely to be severe, and extreme care in removal is obligatory.

11.21.6.2 In vehicle

As the degree of heat damage corresponds both with the temperature reached and the duration of burning, a vehicle fire may be associated with extensive body damage. The position of the bodies as found has to be considered, bearing in mind the probable development of a post-mortem pugilistic attitude. In addition, as many fires occur after a crash, the body may already be in an unusual position prior to the fire. The role of ante-mortem trauma has to be interpreted by the pathologist, as well as the

fact that heat contractures may be occasionally confused with active movement by eyewitnesses.

11.21.7 Explosion

Explosion scenes may extend from those where only a gram or two of explosive material is involved, to those involving tonnes of material. The pathologist's approach will vary accordingly. Where a small quantity of material is involved, the pathologist should attempt to assess if there was any movement of the body from its original site to the point at which it is found. Blood and tissue spatter is most valuable here. The crime scene findings must be correlated with the burns and particulate damage later identified at the autopsy. The presence and role of any primary or secondary projectiles must be assessed. The author was involved in the investigation of an explosion on board a ship, where a crewman caused an explosion that blew him overboard. The body was not recovered, but damage to a hatch cover and the ship's rail, both with deposition of high-impulse blood spatter and small tissue fragments, indicated the extreme nature of the trauma that must have been sustained.

Fragmentary body remains may be all that is recovered following a large explosion. As these may be covered with cement dust or other building materials, recognition of these remains at the scene may prove to be difficult, but this task is usually easier for a pathologist than other investigators.

11.21.8 Motor vehicle crashes

Motor vehicle crashes are generally accidental, but some may be of other modes, and this is best appreciated by a scene examination that includes the relevant vehicles. In a case seen by the author of a shot driver being found after an accident, the rifle being found in the car, investigators at first felt that the discharge was a result of the collision. The bullet trajectory through the head and then the vehicle rendered this explanation highly unlikely. The author noted that the (tall) driver's seat had been adjusted to the full forward position, allowing steering with the knees, and freeing the hands to use the firearm. Suicidal intent was later confirmed.

11.21.8.1 Multiple vehicle

Crashes involving multiple vehicles may involve vehicle ejection of some occupants, with the exact vehicle and seating position being more easily identified after scene examination. Impact points can be identified on roadways.

11.21.8.2 Road user status

The scene and vehicle investigation can provide useful information regarding direction and force of impacts. For example, a vehicle, which had heavy damage along the passenger side, had an almost undamaged driver's compartment. The accused driver nominated a passenger as being the actual driver. This interpretation was incompatible with the position of the dead occupants at the scene, as well as the trauma that they had sustained. His relative lack of injury confirmed this interpretation.

In an accident such as a rollover, driver status may be determined from the position of injuries from ground contact. The elbow or side of head may pass outside the driver's window, contacting the ground surface. Scene and vehicle examination can provide valuable information about this. In particular, damage to windows will allow an interpretation as to whether or not an occupant could be ejected or partly ejected. Damaged parts of the vehicle interior may also provide useful indications of the position of occupants. For example, a damaged 'A' pillar would be frequently associated with head injury of the relevant occupant, and a heavily damaged glove box area would be associated with the presence of a front seat passenger.

Scene examination in the case of pedestrian or cyclist fatalities can be of particular value, in that it will allow interpretation of factors such as whether the road user was travelling with the flow of traffic, or attempting to cross it. It will also allow an interpretation of all of the forms of injury that might be expected to be found at autopsy. In the case of hit-and-run accidents, the scene examination may be of particular value in attempting to interpret the kind of vehicle which may have been involved. The scene will clearly indicate whether the deceased has passed over a vehicle and been thrown off, has been rolled underneath the vehicle, or may have been clipped by a projecting load. The position of a bicycle will provide further information.

Very occasionally vehicle deaths may be of homicidal type as in the Crabbe case (Horswell and McLeod, 1996), where five persons were killed by the driver of a road train. In this type of case, it may obviously be necessary to interpret the positions of the victims with even greater care than usual.

11.21.9 Air crashes

Forensic pathologists are most likely to be involved in the investigation of light aircraft crashes, as they are numerically the most common. Investigation of these requires many of the same processes that are used above, in that although crashes are generally accidental, some maybe of other modes. It is thus important to determine the type of crash as part of the process of determining why and how it occurred.

The physical status of the pilot is of great relevance, as they may have been incapacitated by disease, drugs or alcohol. Although this status is determined at the autopsy, it requires reference to who was in the pilot's seat. Determination of seating position can best be carried out by having regard to the structures within parts of the aircraft, as well as the seatbelt configuration.

Light aircraft crashes are frequently associated with a heavy facial impact to the instrument panel, leaving very specific patterning, which will identify the side. Seatbelts for passengers are usually only of lap type, whereas those for pilot and copilot will have a sash (often of narrower belting) available, although this is not always used, as it may be a separate belt. Many aircraft will disintegrate on impact, ejecting the occupants, their position or impact tracks sometimes reflecting their position within the aircraft. It is most important in these cases to document bodies and body parts prior to any removal. Low-speed accidents, especially those involving helicopters, may be associated with a period of survival with or without incapacitation, and the scene should be considered from this aspect.

Examination of the scene will indicate the basic form of the accident, such as whether it is high or low speed, small or large angle, or an in-flight disintegration. This information is generally gained from other investigators.

The pathologist's role is to assess the likely sources and types of injury at the scene, which can then be correlated with the later autopsy results. The autopsy may also then be used to resolve specific questions arising during the investigation, such as relating to injury produced by the rudder bar or joystick, or external objects such as tree branches or powerlines.

11.21.10 Mass disaster

Many of these cases involve commercial aircraft, ships or oil-rigs. Depending on the variety of the mass disaster, the remains which are recovered may be fragmentary, burnt or decomposed. They might also show evidence of other practical complexities, such as contamination by fuel oil. As the case maybe that of homicide, accident or occasionally even suicide, the investigational difficulties maybe major. Specific difficulties relate to commingled remains and the mixing up of property, which renders identification particularly difficult. Documentation of the scene is critical in these cases, and the remains should not be disturbed until this is done.

Part of the function of the scene pathologist is to work very closely with the rest of the team, and identify whether apparent human remains are in fact what they seem to be. The processes used are those now established for disaster victim identification. The details are beyond the scope of this chapter, but the overall aims are those of any other scene investigation.

11.21.11 Domestic deaths

11.21.11.1 Epilepsy

These deaths can be difficult to resolve, and although many epileptic deaths occur in the context of a medical history, they may occur in well-controlled individuals. Some will occur in those who do not have a relevant history. Many of these deaths occur in bed, presumably during sleep. Family members usually find the bodies. They are frequently facedown in a pillow or other bedding, and may have a little bloodstained mucus around the face and nose. They are very congested and may have emptied their bladders into the bedding. If the fitting has occurred elsewhere than a bed, there maybe evidence of injuries sustained during the clonic phase, usually in the form of repeated abrasions. The relevant furniture or other wounding object would be expected to be nearby. It must be remembered that urine may have evaporated before the body is found, so that staining must be looked for on clothing and floor coverings.

11.21.11.2 Bathroom

Deaths in the bathroom represent a particular problem, as there is frequently a combination of high humidity or moisture, and an electrical supply. Wet surfaces may dry prior to discovery of the body, and even a plugged bath may empty over a few hours.

The presence of wet surfaces will contribute to a number of falls, especially in the elderly and infirm. Depending on the situation, this may also lead to drowning in the bath.

The use of overheated water may precipitate collapse due to natural causes, or may produce burns sufficient to cause death. The heated water may well have run out by the time that the body is discovered. It is important to remember that many individuals who are feeling unwell will use the bathroom, and therefore death from causes not specifically linked to the area may occur there.

The pathologist must think of these factors, and consider the contents of the toilet bowl, rubbish bin, bathroom cabinet and hand basin in attempting to assess these deaths.

11.21.11.3 Electrical

From the pathologist's perspective, electrical deaths may range from very simple to extremely complex to investigate. Most deaths occur with domestic voltages and available currents of no more than a few amps. In those instances where the conductors are clearly visible, as in cases involving amateur repairs or suicide attempts, there are usually obvious sites to consider for contact areas, and these will usually not be clothed. Electrical equipment, tools or a made-up suicide kit, which often includes a timer and warning messages, would be expected to be present.

The combination of electricity and water is particularly dangerous, and is usually seen in bathroom incidents, as above. The difficulty facing the pathologist is that the body may have no burns or minimal burns in these circumstances, as there may be no local skin heating. Scene examination will assist in allowing an assessment of likely burn areas, or attracting attention to the source of other possible injuries that may aid in the interpretation of the case.

11.21.12 Falls

11.21.12.1 Domestic

Falls in the domestic setting are often associated with a degree of infirmity or poor maintenance of the home. The victims tend to be elderly, and have usually fallen from a standing height. The degree of injury is usually relatively minor. There maybe other injuries present, depending on the exact circumstances. For example, a fall in front of an electric fire may be associated with extensive but localised heat damage, sometimes to the extent of 'spontaneous human combustion'.

11.21.12.2 Other

Falls in other areas may be from a standing height, but are far more likely to involve a significant drop, usually in the circumstances of alcoholic intoxication, or a recognisably risky activity. Both of these circumstances can normally be elucidated easily during the scene examination. Part of the pathologist's function is to determine the track followed by the victim in those circumstances where there have been multiple impacts.

11.22 Conclusions

The functions of forensic pathologists are not limited to their merely carrying out autopsy examinations. They have a wide range of skills and expertise that extend into a variety of medical, scientific and legal areas. They can therefore be an extremely valuable resource in the wider aspects of death investigation.

The pathologist is there to examine the body and scene, to preserve the evidence, then to remove the body from the scene. They should be in a position to formulate a provisional opinion about the death, and pass this on to the other investigators. Frequently, much of the responsibility of deciding if the history of events relating to the death meshes with the observed facts is taken by the pathologist, rather than by the rest of the investigation team.

If the circumstances of death are important or disputed, their reconstruction by the pathologist then becomes a major task. Some of the scene information used by the pathologist will be of a type that is not normally detailed by the other crime scene investigators. It may be necessary to correlate injuries with articles found at the scene, and to decide if the injuries are ante-mortem, post-mortem or artefactual in origin. Only then can their significance be determined. This detailed reconstruction cannot be done at the scene, as it also requires autopsy information.

Some of the more important conclusions to reach revolve around whether or not a crime has been committed, and then what form of crime it may be. In a homicide case, it is necessary to collect facts that will allow the investigators, and then the courts in their turn, to know who the victim was, and how, when and where they died. Other wider questions relating to motives or offender traits may also be at least partially answered.

11.23 Bibliography

- Avis, S. P. (1993) An unusual suicide. The importance of the scene investigation, *American Journal of Forensic Medicine and Pathology*, **14**(2), 148–50.
- Bass, M., Kravath, R. E. and Glass, L. (1986) Death-scene investigation in sudden infant death, *New England Journal of Medicine*, **315**(2), 100–5.
- Beal, S. M. and Byard, R. W. (1995) Accidental death or sudden infant death syndrome?, *Journal of Paediatrics and Child Health*, **31**(4), 269–71.
- Boglioli, L. R., Taff, M. L., Stephens, P. J. and Money, J. (1991) A case of autoerotic asphyxia associated with multiplex paraphilia, *American Journal of Forensic Medicine and Pathology*, **12**(1), 64–73.
- Botash, A. S., Fuller, P. G., Blatt, S. D., Cunningham, A. and Weinberger, H. L. (1996) Child abuse, sudden infant death syndrome, and psychosocial development, *Current Opinion in Pediatrics*, **8**(2), 195–200.
- Brodrick (1971) *Report of the Committee on Death Certification and Coroners* (Cmnd. 4810), 22.18.
- Byard, R. W. and Bramwell, N. H. (1988) Autoerotic death in females. An under diagnosed syndrome?, *American Journal of Forensic Medicine and Pathology*, **9**(3), 252–4.
- Byard, R. W. and Wilson, G. W. (1992) Death scene gas analysis in suspected methane asphyxia, *American Journal of Forensic Medicine and Pathology*, **13**(1), 69–71.
- Byard, R. W., Beal, S. and Bourne, A. J. (1994a) Potentially dangerous sleeping environments and accidental asphyxia in infancy and early childhood, *Archives of Diseases of Childhood*, **71**(6), 497–500.

- Byard, R. W., Bourne, A. J. and Beal, S. M. (1996) Mesh-sided cots – yet another potentially dangerous infant sleeping environment, *Forensic Science International*, **83**(2), 105–9.
- Byard, R. W., Carmichael, E. and Beal, S. (1994b) How useful is post-mortem examination in sudden infant death syndrome?, *Pediatric Pathology*, **14**(5), 817–22.
- Byard, R. W., Huckler, S. J. and Hazelwood, R. R. (1990) A comparison of typical death scene features in cases of fatal male and autoerotic asphyxia with a review of the literature, *Forensic Science International*, **48**(2), 113–21.
- Dees, T. M. (1995) Simplifying blood spatter analysis at the crime scene, *Law Enforcement Technology*, **22**(8), 42–4.
- Goodson, M. E. (1993) Electrically induced deaths involving water immersion, *American Journal of Forensic Medicine and Pathology*, **14**(4), 330–3.
- Guntheroth, W. G., Spiers, P. S. and Naeye, R. L. (1994) Redefinition of the sudden infant death syndrome: the disadvantages, *Pediatric Pathology*, **14**(1), 127–32.
- Haskell, N. H., McShaffrey, D. G., Hawley, D. A., Williams, R. E. and Pless, J. E. (1989) Use of aquatic insects in determining submersion interval, *Journal of Forensic Sciences*, **34**(3), 622–32.
- Hazelwood, R. R., Dietz, P. E. and Burgess, A. W. (1982) Sexual fatalities: behavioural reconstruction in equivocal cases, *Journal of Forensic Sciences*, **27**(4), 763–73.
- Henssge, C. (1988) Death time estimation in casework. 1. The rectal temperature time of death nomogram, *Forensic Science International*, **38**, 209–36.
- Hicks, L. J., Scanlon, M. J., Bostwick, T. C. and Batten, P. J. (1990) Death by smothering and its investigation, *American Journal of Forensic Medicine and Pathology*, **11**(4), 291–3.
- Horswell, J. and McLeod, G. (1996) The Queen v. Douglas John Edwin Crabbe: murder: Ayers Rock Inland Motel Bar carnage, *Australian Police Journal*, **50**(2), 53–60.
- Iyasu, S., Hanzlick, R., Rowley, D. and Willinger, M. (1994) Proceedings of ‘workshop on guidelines for scene investigation of sudden unexplained infant deaths’, *Journal of Forensic Sciences*, **39**(4), 1126–36.
- Kemp, J. S., Kowalski, R. M., Burch, P. M., Graham, M. A. and Thach, B. T. (1993) Unintentional suffocation by rebreathing: a death scene and physiologic investigation of a possible cause of sudden infant death, *Journal of Pediatrics*, **122**(6), 874–80.
- Laposata, E. A., Hale, P. and Poklis, A. (1988) Evaluation of sudden death in psychiatric patients with special reference to: forensic pathology, *Journal of Forensic Sciences*, **33**(2), 432–40.
- Lee, H. C. (1989) Precautions for infectious diseases: Aids and Hepatitis B, in Eckert and James (eds), *Interpretation of Bloodstain Evidence at Crime Scenes*, Elsevier, The Netherlands.
- MacDonell, H. L. (1993) *Bloodstain Patterns*. Laboratory of Forensic Science, Corning, New York. Golos Printing, New York.
- McGee, M. B. (1989) An unusual case of accidental hypothermia due to cold water immersion, *American Journal of Forensic Medicine and Pathology*, **10**(2), 152–5.
- McKeown, A. H. and Bennett J. L. (1995) A preliminary investigation of post-mortem tooth loss, *Journal of Forensic Sciences*, **40**(5), 755–7.
- Miller, P. S. (1996) Disturbances in the soil: finding buried bodies and other evidence using ground penetrating radar, *Journal of Forensic Sciences*, **41**(4), 648–52.
- Patel, F. (1994) Artefact in forensic medicine: postmortem rodent activity, *Journal of Forensic Sciences*, **39**(1), 257–60.
- Piotrowski, E. (1895) *Concerning Origin, Shape, Direction and Distribution of the bloodstains Following Head Wounds Caused by Blows*, The Institute of Forensic Medicine of the K. K. University in Vienna, Vienna.
- Ponsonby, A. L., Dwyer, T., Gibbons, L. E., Cochrane, J. A., Jones, M. E. and McCall, M. J. (1992) Thermal environment and sudden infant death syndrome: case-control study, *British Medical Journal*, **304**(6822), 277–82.

- Reichs, K. J. (1992) Forensic anthropology in the 1990s, *American Journal of Forensic Medicine and Pathology*, **13**(2), 146–53.
- Risser, D., Bonsch, A. and Schneider, B. (1995) Should coroners be able to recognize unintentional carbon monoxide-related deaths immediately at the death scene?, *Journal of Forensic Sciences*, **40**(4), 596–8.
- Ristenbatt, R. R. and Shaler, R. C. (1995) A bloodstain pattern interpretation in a homicide case involving an apparent ‘stomping’, *Journal of Forensic Sciences*, **40**(1), 139–45.
- Schoenly, K. and Goff, M. L. (1992) Early M A BASIC algorithm for calculating the postmortem interval from arthropod successional data, *Journal of Forensic Sciences*, **37**(3), 808–23.
- Shai, D. (1994) Problems of accuracy in official statistics on drug-related deaths, *International Journal of Addiction*, **29**(14), 1801–11.
- Smith, S. (1948) *Taylor’s Principles and Practice of Medical Jurisprudence*, 10th edn, Churchill.
- Spennemann, D. H. and Franke, B. (1995) Archaeological techniques for exhumations: a unique data source for crime scene investigations, *Forensic Science International*, **74**(1–2), 5–15.
- Spennemann, D. H. and Franke, B. (1995) Decomposition of buried human bodies and associated death scene materials on coral atolls in the tropical Pacific, *Journal of Forensic Sciences*, **40**(3), 356–67.
- Spindler, K. (1994) *The Man in the Ice: The Discovery of a 5,000-Year-Old Body Reveals the Secrets of the Stone Age*.
- Spitz, W. U. (1989) The case of the sitting corpse. Accident or homicide?, *American Journal of Forensic Medicine and Pathology*, **10**(3), 242–4.
- Tantawi, T. I. and Greenberg, B. (1993) The effect of killing and preservative solutions on estimates of maggot age in forensic cases, *Journal of Forensic Sciences*, **38**(3), 702–7.
- Vass, A. A., Bass, W. M., Wolt, J. D., Foss, J. E. and Ammons, J. T. (1992) Time since death determinations of human cadavers using soil solution, *Journal of Forensic Sciences*, **37**(5), 1236–53.
- Wagner, G. N. (1986) Crime scene investigation in child-abuse cases, *American Journal of Forensic Medicine and Pathology*, **7**(2), 94–9.
- Willinger, M. (1995) SIDS prevention, *Pediatric Annals*, **24**(7), 358–64.
- Young, D. B., McCormick, G. M., Norris, D. K. and Mashburn, J. P. (1994) Death investigations involving personal computers, *American Journal of Forensic Medicine Pathology*, **15**(2), 118–21.
- Zhang, P. and Cai, S. (1995) Study on electrocution death by low-voltage, *Forensic Science International*, **76**(2), 115–19.

Establishing identity with odontology

David Griffiths

12.1 Background

The use of dental records to identify the unknown corpse is a technique which has its origins in history, and the use of dental characteristics as a means of identification predates fingerprint identification by a considerable period.

In recent years, growing awareness within the dental profession of the valuable role they can play has led to a proliferation of forensic dental training and forensic dental units. As this training has become more widespread and forensic dental services more freely available, police services and the judiciary are starting to recognise the valuable role that dentistry can play in investigations, and more use is being made of the vast dental expertise available.

Forensic dentistry has in the past been mainly identified with mass disaster victim identification (DVI), sometimes to the detriment of the other areas where dentistry can be extremely valuable. The modern role of the forensic dentist can be divided into the following categories:

- identification of the unknown body;
- identification of victims in mass disasters;
- bite mark analysis and comparison;
- identification of skeletal remains; and
- age determination.

The principal role of the forensic odontologist remains the identification of the unknown body in simple civil cases where no crime is suspected. These cases are generally low profile and only when a mass disaster or a high profile case such as the 'Backpacker Murders' occurs does press coverage bring dentistry to the public notice.

Bite mark analysis and comparison while practised widely overseas still enjoys a slightly mixed reputation in Australia. Despite this the value of bite mark evidence should not be neglected as it can be a valuable indication of the degree of violence in an assault and has definite value in the elimination of suspects.

The identification of skeletal remains has advanced beyond the simple comparison of dental records to the dentition of the remains with the development of techniques such as video superimposition and computer imaging so that the forensic dentist can now offer a modern and effective means for the identification of skeletal remains.

Age determination by dental means currently tends to be limited to the young basically from birth to the age of about 21 years. It relies heavily on the eruption dates and the degree of formation of developing teeth.

12.2 History of odontology

12.2.1 Identification of the unknown body

Far from being a new science, there are recorded cases of forensic odontology being used to identify bodies as early as 49 AD. In a well-recorded case, the wife of the Emperor Claudius, Agrippinila, had her main rival for Claudius' affections, Lollia Polina, murdered. Lollia's head was then brought back to Agrippinila who identified her main rival by the mal-positioning of several of her front teeth.

In Europe, his page identified Charles the Bold, the last Duke of Burgundy, whose badly mutilated corpse was recovered after the battle of Nancy in 1477. There being no male heir this ended the power of the Duchy of Burgundy forever. The main feature in this identification was the absence of several front teeth.

In 1776, America's Paul Revere, well known as a patriot, silversmith and lesser known as a dentist, was one of the first people to identify a body by using its dental records.

At the beginning of the twentieth century in Southern America, the German Chargé d'affaire in Chile and his wife were believed to have been murdered and then incinerated. Forensic odontology was able to prove that while indeed the wife was present, the other body was certainly not that of the Chargé d'affaire. He was later arrested with his secretary at a beach resort.

Nor did Australia fail to feature in the history of odontology. In the now famous 'Pyjama Girl Case', the case was eventually solved by identification of the victim by dental records. The reason the case took so long to solve was that the victim was originally unidentified because of a discrepancy between the ante-mortem records and the post-mortem results.

In 1935 in Britain, Dr Buck Ruxton murdered and then surgically dismembered his wife and housemaid. Dr Ruxton went to considerable trouble to destroy fingerprints and more significantly teeth before dumping the bodies. He was most unfortunate in that the remains of the two women were linked with the missing persons report filed by the housemaid's mother because of one in a million chance. Identification was achieved using a superimposition technique where an ante-mortem photograph was matched with a radiograph taken of their skulls. This is probably the first recorded case of superimposition and was adjudged sufficient at that time for Dr Ruxton to hang.

In 1945 in Europe, the Russian Armies advancing across the wasted Berlin discovered what was believed to be the body of Adolf Hitler. The body of Hitler and later on Martin Bormann was identified from dental records seized during the advance through Berlin.

With the advent of computer technologies, matching of skeletal remains to photographs has proved to be very valuable. A noticeable case being the identification of the Russian Royal Family by Russian Forensic Odontologists in the late 1980s.

12.2.2 Disaster victim identification

One of the most harrowing jobs facing both police and rescue workers is the mass disaster. Often many hundreds of bodies are present, and many grieving relatives are terribly concerned whether they will be able to take their loved ones back and give them the proper burial that their religion requires. It is in this field that dentistry has proved most valuable. Some 449 guests perished in a hotel fire in Vienna late last century. This is the first case of dental records being used to attempt identification. The founding father of modern forensic odontology, Oscar Amoedo brought forensic dentistry to prominence in 1897 when he identified many of the 126 victims of a fire in Paris by dental means. With the advent of methods of mass transport, be it trains, buses or aircraft, there exists an ever-increasing possibility of major disaster.

There have been several cases in the post-war period of aircraft accidents. Most noticeably Tenerife where over 600 passengers and crew were killed and required identification. Most of these bodies were severely burnt.

The crash of an Air New Zealand DC10 into Mt Erebus in Antarctica left more than 200 bodies, and dental records played a major role in the subsequent identification process.

The case of the Turkish Airlines DC10, which crashed at Orly in Paris, resulted in massive fragmentation of the victims, with 370 bodies providing 20,000 fragments. In this situation dental records played a significant but reduced role in identification. After 3 months over 4 tonnes of body parts remained in a Paris morgue awaiting identification.

More recently the Lauda Air Boeing 767 crash in Thailand presented some 270 bodies requiring identification.

The difficulty of comparing dental records both post- and ante-mortem in this type of situation has led to the use of computers. The first large-scale use of computers was during a flood disaster in Colorado and since that time computers are being used increasingly to try and match victims to dental records in mass disasters.

12.2.3 Bite mark analysis

One of the most contentious areas of forensic odontology is the identification of a person by the mark they leave on something they have bitten. This is regarded as one of the newest areas of forensic odontology and has met with a mixed reception by the legal system of Australia. It is however not a new technique. In the middle ages in Europe there existed a problem with legal documents in that a significant proportion of the populous were illiterate. The only way they could attest to a document was by making the traditional 'X' or mark. This was not sufficient in many cases to allow for

proper identification at a later date. The problem was circumvented by getting the person attesting the document to bite into a piece of sealing wax which was attached to the document therefore leaving an indelible impression of their teeth. As can be clearly seen, should there be a requirement to verify the document later all that was required was to place the piece of sealing wax in the persons mouth and should it fit their teeth they were indeed the person who originally attested that document.

In assault cases in North America and Europe, it has become routine for victims to be assessed for bite marks. In one of the more famous cases in North America, the serial killer Ted Bundy was identified by the marks he left in one of his victims whom he bit many times in frenzy. The evidence was judged to be sufficiently reliable for Bundy to be executed.

In Australia in the case of *R v. Lewis* in the Northern Territory, a full court of criminal appeal found dental evidence as to identification by bite mark to be inadequate, and in this country since that time bite mark evidence has not been widely accepted. This is unfortunate because while one may accept that identification of an individual by the mark they may leave is erroneous under law, there still exists a particularly fine opportunity for eliminating people from an investigation. In the case of an assault in which one of several people may be guilty, it is quite possible to eliminate all but one person from the investigation by comparing the teeth of the suspects to the marks left in the victim. This is particularly true in the case of child abuse where an abused child is likely to have been bitten by one of the custodial adults.

12.2.4 Age determination

One of the earliest attempts to determine the age of skeletal remains was made in France. Louis the XVII was the last hope of the French Monarchists to restore the status quo after the French Revolution. Louis having been held by the Revolutionaries was alleged to have died and was buried in unconsecrated ground in an unmarked grave. For many years the Monarchists attempted to find the grave and the remains of Louis. On one particular occasion they were so convinced that they had the remains that an attempt was made to age the person at death. This was one of the earliest instances of trying to age a body by the use of teeth. The technique was used to great effect during the examination of mass war graves in the Ukraine but tends to be limited in most cases to young children under the age of 21 and relies heavily on the eruption times and development of teeth. There have been some recent developments where the number of dentinal or cemental rings on a tooth can be examined by electron microscope, and this is believed to give a reliable indication of someone's age. Reports suggest that this may be effective in determining age at any stage during life.

12.3 How can dentistry assist at a crime scene?

The most common crime scene where a forensic dentist will be required is that where a corpse is present. An area in which the dentist may be particularly useful is where either advanced decomposition or massive disfigurement of the corpse means that identification by relatives is either inadvisable or unlikely. In the case of skeletal remains, dentistry normally offers the best chance of identification (see [Figures 12.1](#) and [12.2](#)).



Figure 12.1 Advanced decomposition. The body was recovered after fourteen days in a well-heated residence. The necks of the teeth display 'pink' tooth discolouration. Identification was accomplished dentally (Dr David Griffiths)

In the case of a violent assault, the presence of a bite mark may well indicate the need to call the forensic dentist. It should be noted that an early call-out to investigate a bite mark is essential because of the propensity of bite marks to fade with time and the presence of saliva around the bite mark which provides a valuable means of DNA matching if sampled before it degrades.

As with all expert areas involved in forensic science the forensic dentist regards his role as the most important and therefore requires the scene to be preserved for his first examination. Unfortunately with the demands of crime scene investigation by police, and demands of other experts, the dental evidence is often treated with less respect than odontologists would wish.

This section of the chapter will deal with the ideal dental requirements, in other words what a forensic dentist would wish to happen when asked to examine a crime scene.

12.4 Dental requirements at a crime scene

It is an often neglected but considerably more valuable exercise than one would believe for the crime scene to be examined by the forensic dentist. An early call-out was mentioned before, especially for bite marks but often even a simple scene such as a suicide should be examined by the dentist because many things that seem unremarkable to the untrained eye can in fact point the forensic dentist in the right direction for an identification.



Figure 12.2 Death by drowning. While the general facial form is recognisably human, the fine features have been destroyed by the build-up of gases in the tissues (reproduced with permission, Associate Professor C. G. Griffiths, NSW Forensic Dental Unit)

A dentist, for example, will regard the recovery of a single avulsed tooth as much more significant than someone merely concerned with recovery of a decomposed body. A single tooth may hold the key to identification but may be overlooked in a normal course of events.

In a recent case in Canberra, where a suicide victim had little in the way of identifying features about his body or his teeth except a marked abrasion at the neck of the teeth which indicated a particularly severe and savage method of tooth brushing. When examining the scene it was discovered that the only grocery items in the flat were a bag of frozen peas and 12 tubes of toothpaste. This indicated to the dentist that the person had a particular fetish about cleaning his teeth and this tied in particularly well with the wear observed post-mortem and while not sufficient to identify the corpse added to



Figure 12.3 Effects of Fire. The victim was incinerated in a motor vehicle. The anterior teeth have been extensively fire affected and required stabilisation before transport to the mortuary

the overall evidence of identification being painstakingly assembled by the police. An untrained person may have regarded the presence of a large number of tubes of toothpaste as unremarkable and not commented on it (see Figures 12.3, 12.3A and B).

There are no special requirements for photography from a dental viewpoint of the crime scene; the standard photographs taken at the scene will normally suffice. However there is a particular requirement for the removal of the remains to a mortuary. It is essential that all the remains from the site arrive at the mortuary so they may be examined.

In the case of fragmentation of bodies from some form of high velocity impact, a careful search must be conducted of the entire area as even a single tooth may prove to be the vital piece of evidence and lead to identification. Any such item found should be photographed in situ, carefully tagged with identifying number and bagged and

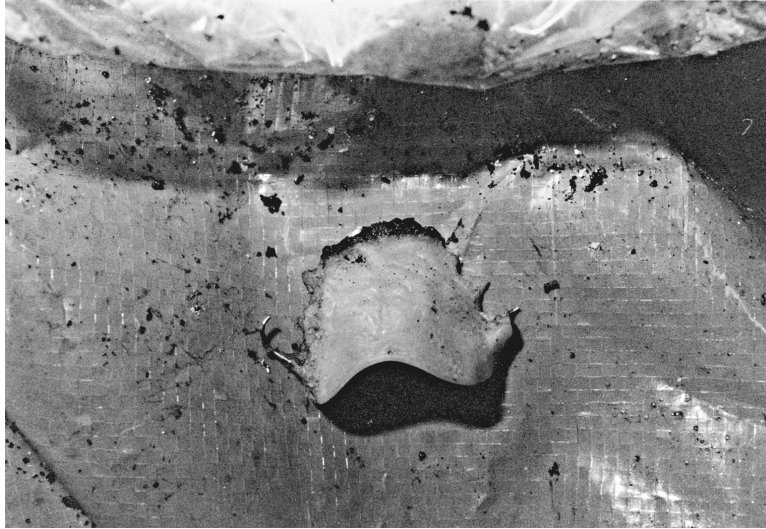

Figure 12.3A Partial upper acrylic denture recovered from the victim. While the anterior teeth have been destroyed in the fire, the bulk of the denture has survived, and details of the palatal rugae can be seen on the denture surface



Figure 12.3B Mandible resected from the victim. Despite extensive charring of the lower border of the mandible, the posterior teeth are intact and if adequate ante-mortem records exist a dental identification is still possible

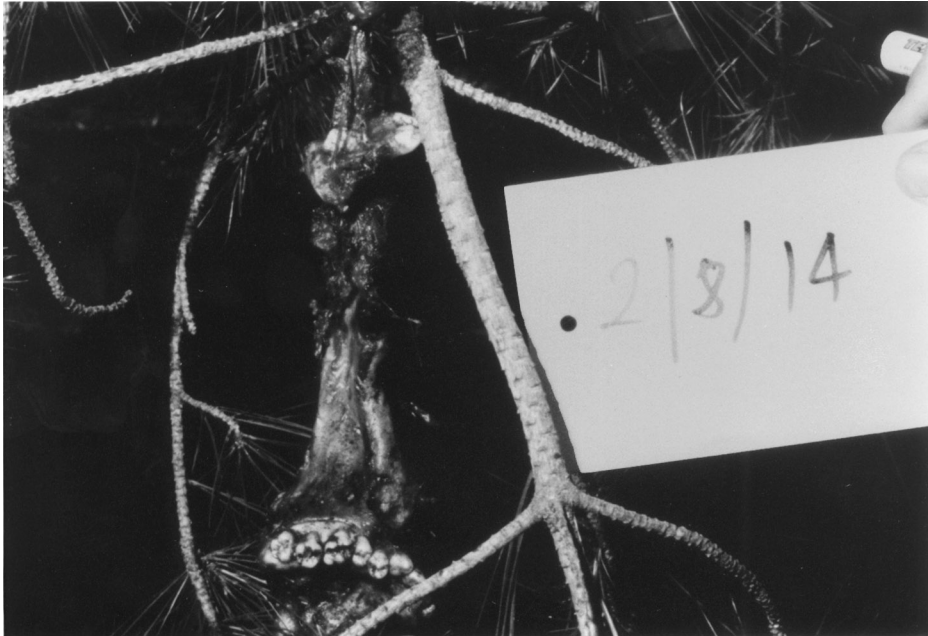

Figure 12.4 Fragmentation of the body following a high-speed aircraft crash. This was the largest dental structure recovered from the two victims who provided a total of 276 body parts. Identification of this victim was achieved dentally. Note the correct positioning of the body reference number

recorded. In the case of skeletal remains, there is a tendency for the teeth, particularly the anterior teeth, to have loosened due to degradation of supporting tissues, and rough handling of the cadaver may lose these teeth (see Figure 12.4).

In the case of a badly burnt corpse, the teeth will generally survive the fire; however, they will become brittle and any rough handling is likely to dislodge teeth, cause them to fragment or cause loss of restorations, which may become critical later on in the identification process.

Griffiths and Bellamy suggest a protocol for preserving the badly burnt remains as follows: Where there is any doubt at all about the integrity of the remains before transportation the teeth should be fixed in place by dripping cyano acrylate cement such as loktite 420 on to the teeth with care being taken to avoid the fumes. The remains should then be carefully wrapped in bubble plastic and the whole package secured with packing tape and then covered with a plastic sample bag.

The preservation of such remains is often a highly skilled task and wherever possible a forensic dentist should be called to the scene to assist police during the body recovery procedure. Small tooth fragments, which may have become dislodged, may only be found and connected with the right previous owner by a forensic dentist, particularly in multiple cases.

In the case of bite marks in living tissue, a forensic dentist should be called to examine the marks as soon as possible. In any bite mark, there is always a deposition of saliva.

This saliva provides an excellent source of genetic material and can be used for DNA matching to the perpetrator. The value of saliva is highly time-dependent and unless sampling is carried out quickly it is likely that this evidence will be lost.

The photographic requirements for bite marks are very exact and will be discussed in a later section. These should not be attempted without reference to an odontologist.

12.5 Identification of the unknown deceased

Before dealing with the precise procedure followed by forensic odontologists in identifying an unknown body, it is worthwhile examining the cases where a forensic odontologist will be required and some significant features of these cases. By far the most common is simple unknown body in which the cause of death is not in dispute but identification is. This may be because of a body discovered with no other identifying features or marks, or may well be that the body is too badly decomposed or disfigured to allow relatives to view it.

The basis of a dental identification is that the teeth and the jaws are among the most durable structures in the human body. There have been cases of recognisable teeth and of jaw skeletal remains discovered at archeological sites more than one million years old. Long after fingerprints and other physical features and usable genetic material have disappeared, the teeth remain as a sole means of identifying the remains.

Another area in which dental identification is useful is in the case of fragmentation of a body. This generally occurs in a high-speed accident such as a plane or a motor vehicle crash. This fragmentation of course also affects the jaws but generally sufficient teeth and jaw structure will be recovered to make an attempt at dental identification a valuable exercise. Identification of the fragmented body normally ends up as a cooperative effort between finger print experts, odontologists and examiners of personal effects and clothing found at the scene.

Where forensic odontology plays its most significant role in the identification of a burnt victim. In all but the most severe fires, the teeth will generally survive intact. Palamara *et al.* (1990) state that the teeth can withstand prolonged heating up to 1600°C. The tongue, possibly due to asphyxiation, will swell and protect the interior surfaces of the teeth. The muscles of the cheeks will contract and protect the outer surfaces of the posterior teeth, and the lips initially will similarly contract and protect the outer surfaces of the anterior teeth. In severe fire, the lips may be burnt off and the anterior teeth become subject to the direct heat of the fire. These teeth will generally craze and dehydrate but very rarely will they totally disappear. The same is true of artificial teeth such as dentures. Often in these cases the only possible means of identification is dental.

12.6 Identification of individuals

The individuality of the human dentition and its restoration after disease forms the corner stone of the identification of the individual from their dental state.

It is not essential for the individual to be deceased before such identification can be made; fugitives from justice have been apprehended after their dental records were circulated to dental surgeries.

Human beings develop 20 primary or deciduous teeth, which erupt between the ages of six months and two years and are then progressively lost from the ages of 6–12 years. They are succeeded by 32 secondary or permanent teeth, which erupt from the ages of 6–21 years. The crown of each tooth, the visible portion in the oral cavity, has five surfaces, four relatively smooth and one chisel shaped in the case of incisors, pointed in canines and deeply fissured in molars and premolars. The fissured areas, or biting surfaces of the posterior teeth, are the most prone to dental caries and with the modern emphasis on dental health will generally have been restored to make good the ravages of disease. Each restoration is specific to the fissure pattern of the tooth and the extent of the caries. Caries will often extend onto the smooth surfaces where the adjacent teeth contact. The pattern of the decay is specific to the individual and is dependent on the anatomy of the teeth, the quality of saliva, diet and oral hygiene. The specificity of the decay pattern is necessarily reproduced in the restorations in the individual's mouth, and this individuality of the pattern of restorations provides the primary means of identification to the odontologist. The individuality of restorations is further enhanced by the variety of restorative materials available. In common use in modern dentistry is dental amalgam, a silver–tin–mercury compound, and tooth-coloured resins such as glass ionomer cement and composite resins, which are used for the direct restoration of teeth, and porcelain, gold and some composite resins that are fabricated in a laboratory prior to placement in the mouth. Severely compromised teeth may be restored with jacket crowns fabricated from porcelain, porcelain fused to gold, porcelain fused to non-precious metal, gold, non-precious alloys, stainless steel and various tooth-coloured resins. Missing teeth may be replaced with fixed prostheses, attached to adjacent teeth or supported by a titanium osseointegrated implant, constructed from any of the materials used to restore a severely compromised tooth or removable prostheses which may consist of a base made from cobalt chrome alloy, gold, acrylic resin and, from earlier times, vulcanite to which are attached mass-produced teeth made of porcelain or acrylic resin.

Taking into account the individuality of decay patterns in teeth and the many types of restorative materials available, it can be seen that a restored dentition can be regarded as uniquely individual and a comparison of dental records (if adequately kept) to a dentition is capable of providing identification. There are 160 tooth surfaces in the intact human adult dentition, and Keiser-Neilson (1980) has determined that 2.5 billion possibilities exist in the production of a single dental chart.

The advent of modern dentistry has led to a greater number of people seeking dental care and many more records becoming available. This has proved to be somewhat of a mixed blessing because as dentistry embraces the new preventive era, dental caries is becoming less common and restorations less frequent, but radiographs taken as part of a normal dental examination play an increasingly important role in identification in that they provide a record of the pattern of bony trabeculae in the jaws, the anatomy of the tooth roots, nutrient canals in bone, the anatomy of the maxillary sinuses and the presence of any treatment rendered to the roots of the teeth.

12.7 The dental post-mortem

This generally takes place at the same time or immediately after the medical post-mortem. The dental post-mortem is used to establish the precise pattern of the teeth present and

the presence of any dental restorations. The technique varies depending on the quality and condition of the remains. What is essential is that a clear view of the teeth and their supporting structures be obtained. This may in some cases mean that the mandible and the maxilla have to be resected and taken away for examination apart from the remainder of the body. This resection, if skillfully done, may still render the corpse available for viewing by relatives at a later stage. Where access and vision is not a problem the examination may be carried out leaving the jaws *in situ*. The initial phase of the examination is a thorough investigation of the teeth present and a note of the teeth absent. With the teeth present a careful charting of restorations present noting the type of restoration, the material used, the position of the restoration and any peculiar feature such as an unusual carving of shape into the restoration is carried out. At this stage, the crime scenes investigator will often be asked to take intra oral photographs of the restorations and in particular of any unusual or particularly characteristic restoration. As well as completing the full chart of the teeth and restorations present, the dentist at this stage is looking for any particular feature such as a gold crown or some complex restoration that may make the identification simpler (see Figure 12.5).

Once the teeth have been thoroughly checked and charted, the jaw is then examined radiographically. Initially radiographs are taken of all posterior teeth so the detail under the restorations and between the teeth can be seen, and further radiographs are taken to display the root structures of all teeth. These radiographs are there purely as a reference



Figure 12.5 Members of the ACT Forensic Dental Team in action conducting a dental examination of a murder victim who was doused in petrol and ignited. The mandible has been resected because the heat-affected tissue made normal opening of the mouth impossible

and will be repeated later should ante-mortem records come to light. It is important that all stages of the dental post-mortem are recorded photographically.

12.8 Obtaining ante-mortem records

In Australia it is a requirement that all dentists keep adequate records of treatment afforded to their patients and of their patients' dental condition. Once a suspected identity is available, these records are then requested from the dentist by the police acting for the coroner, and when available are delivered by the police to the forensic dentist who then transcribes the records onto a standard Interpol dental identification form and then compares this to the results achieved at the dental post-mortem examination. It should be noted that these records should be surrendered by the dentist on request and should be the full and complete original records not photocopies and not a written report by the dentist of what his records contain. These records may be obtained by subpoena if necessary.

Where ante-mortem radiographs are present and identification looks likely the post-mortem radiographs are repeated, often many times, to reproduce the exact alignment of the X-ray tube and the exact alignment of the X-ray film that was used to create the ante-mortem radiographs, and thus give a radiograph which may be overlaid with the ante-mortem record therefore establishing an indelible identification.

With the advent of fluoridation and much-improved oral hygiene in many western countries it is not uncommon for teenagers and young adults to have no dental restorations. Identification therefore is normally done radiographically and in many cases people in their late teens will have had an orthopantomograph (OPG) taken to establish the presence of third molar or wisdom teeth.

Such a radiograph contains great detail of the bony structures of the jaws, detail of the root structure of the teeth and detail of the anatomy of the maxillary sinuses. Should such a radiography be available from the ante-mortem records, the remains are subjected to the same radiographic technique as 'small' film radiographs until the post-mortem radiograph is an exact match to the ante-mortem radiograph. It is interesting to note that in North America the use of an OPG is routine for members of the armed services and is coming to be routine within the Australian armed services as well.

Once a dentist has established identity by comparing his post-mortem examination to ante-mortem records, he will complete a report that will be forwarded to the coroner for consideration. It is up to the coroner in most jurisdictions to decide whether identification is adequate and to release the remains for suitable burial or disposal.

There are some unusual features of teeth and jaws that often lead to identification in an otherwise apparently impossible case.

People who have suffered a fracture, particularly of their lower jaw, may often have had the fracture repaired with some form of fixed titanium plate. These plates often contain a manufacturer's logo or symbol and checking back to the manufacturer can lead to a list of surgeons or dentists who would use this technique, and records may be obtained from them.

There are occasions where people may have tattooed themselves either on the lips, the tongue or even on the gum tissue itself. These tattoos will often be remembered by friends or relatives and should of course be carefully photographed. One unusual feature

is the so-called amalgam tattoo. This is where a fragment or fragments of amalgam, which have become dislodged during a tooth extraction, are incorporated in the extraction socket and remain as a black mark under the healed tissue. These marks are highly distinctive and will often have been recorded on the person's ante-mortem records.

One interesting feature sometimes seen during dental post-mortem is a pink discolouration of the teeth often coming from the gum area up towards the biting surface of the teeth. For many years this was thought to indicate some form of poisoning or evidence of asphyxiation. It is now recognised that this is a normal post-mortem change that normally occurs seven to nine days after death and is caused by red blood cells which are too large to pass into the dentinal tubules of a tooth intact in life degrade post-mortem, and the degradation products percolate through into the dentine causing a characteristic discolouration. It can on occasions be a valuable tool in establishing time of death where there is some doubt.

12.9 Bite marks

Just as teeth can be used to identify a person so can the marks left by those teeth in an object be used to identify an individual. Over the past few years, forensic dentists have become quite adept at identifying bite marks in objects and relating that back to the person who has actually inflicted the mark (see Figure 12.6).

Bite mark analysis is unfortunately a very sensitive area, particularly in Australia, and two adverse findings in legal cases have resulted in this very valuable form of evidence not receiving the attention that is its due. Of all dental evidence the bite mark is the one which is most time and handling affected. Unfortunately often the role of the police

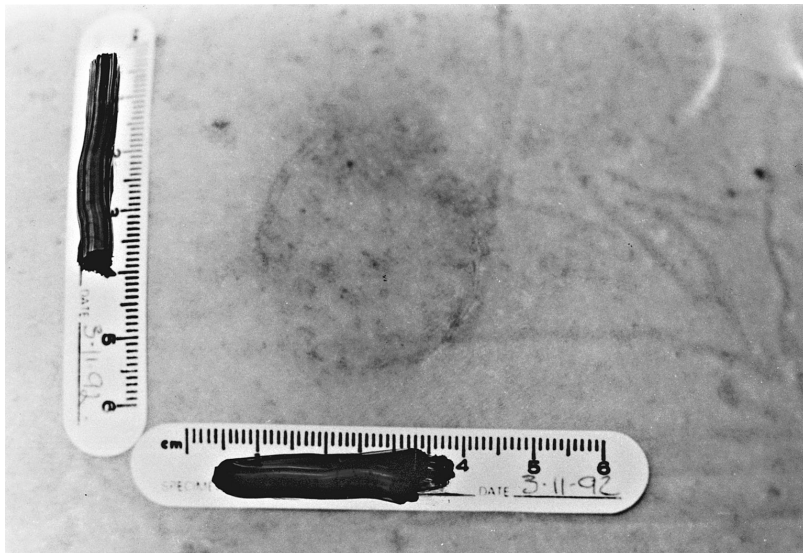

Figure 12.6 Bite inflicted in the back of a victim during a drunken brawl. Two of the suspects were eliminated dentally, the third confessed when confronted with the dental evidence

medical personnel, before the dentist is called, influences dramatically the quality of the bite mark. If bite mark evidence is to become accepted in Australia, as it is in many other parts of the world, it is important that both police and medical personnel be aware of a bite mark and be aware of its significance and the correct mode of handling such a mark.

It is important that anyone examining a crime scene be aware of the significance of bite marks and where bite marks may be found. The most common area where bite marks are found and most mentioned in literature is the bite mark on the human flesh. However many very valuable identifications have been carried out from bite marks left in inanimate objects. The case of the IRA gunman who bit an apple at the scene of a crime and was later identified by the marks left on the apple is one of the better-known cases. In many break-ins nowadays offenders will help themselves to a snack often leaving behind marks of their teeth in pieces of chocolate, bread, cheese and fruit. Properly handled these objects can provide an identification of the perpetrator.

12.10 What constitutes a bite mark?

There is a mystique surrounding bite marks particularly those inflicted upon humans. This mystique has tended to hide the simplicity of a bite mark. There is certain revulsion in society of people who are bitten or who bite. This revulsion could well have its origins in the human fear of cannibalism and has tended to colour the perception and the treatment of bite marks in human victims. However, taken in their simplest form, bite marks are merely marks left in an object by a tool. Most crime scene examiners are well and truly familiar with the handling procedures for tool marks. It is therefore of some regret that they treat bite marks in such a different way. If one regards the teeth as simple tools, which in fact is all that they are, then the mark left by the tooth or teeth is a tool mark and is capable of being analysed.

Careful examination of a bite mark pattern will show marks left by the actual teeth but may also show pressure marks caused by the lips, tongue and cheeks. The whole injury pattern caused by these components is part and parcel of the overall bite mark (see [Figure 12.7](#)).

Signs or factors that indicate the presence of a bite mark may include an ovoid or elliptical pattern, the presence of tooth edge marks and a linear interrupted abrasion pattern consistent with a complete or partial dentition. There are however many agents which can produce marks very similar to bite-mark-electrocardiogram pads, children's toys, shoe heels and even jewellery (Harvey, 1976), and where such a pattern is present it is important that it be assessed by a competent person, normally a forensic dentist, to ensure that a bite mark is present.

Before discussing how to analyse the bite mark and what can be gained from it, it is important to discuss the role of the people who see the mark before the dentist.

12.11 The role of the police

Generally the first trained person to sight a bite mark is the general duties policeman called to the scene. It is essential that this person be able to identify a potential bite



Figure 12.7 Bite inflicted on a victim's leg during an assault. No suspects were apprehended. Note the use of linear scales positioned horizontally and vertically in close proximity to the bite mark

mark at the earliest opportunity either by personal observation or by careful history taking from the victim or any witnesses, and care should be taken to note any report of a defensive bite mark which may have been inflicted on the assailant. It is a sad fact of life that the majority of general duties police do not understand the significance of a bite mark nor could they identify a bite mark in most instances. It therefore generally devolves to the crime scene personnel to identify bite marks and given the time lapse between the crime and the attendance of the crime scene examiner it is crucial that crime scene personnel be aware of the correct treatment of suspected bite as much usable evidence will be lost before the dentist can attend.

In an ideal world the police role would be as follows.

12.11.1 First on the scene (normally general duties)

- Examine victim for bite marks physically or by careful questioning of witnesses.
- If a bite is suspected immediately isolate and protect the area from any contamination.
- Inform crime scene investigators that there is a suspected bite who will outline the steps taken to protect the bitten area.
- Do not touch the area until a crime scene investigator arrives. If the ambulance service is involved impress upon them the importance of protecting the bitten area until saliva sampling has been done. This of course is often much harder than it sounds because the initial inclination of the ambulance service is to render some form of first aid to what is obviously a laceration or abrasion.
- It is advisable to inform the forensic dentist at this stage, as the best evidence will be obtained if both the crime scene investigator and the forensic dentist communicate and carry out the examination and follow-up as a team.

12.11.2 Role of crime scene examiner

- Ascertain from the attending general duties officer if a check has been carried out for bite marks. If a check has not been made it should be carried out immediately. If a bite mark is present arrange for immediate saliva sampling either by self, any medical, para-medical personnel present or immediately contact the duty dentist.
- Ascertain the exact position of bitten portion of the victim, when the bite occurred and take suitable photographs of the area with the victim in the position in which they were bitten. This is particularly important because human flesh will distort in different positions and if a usable photograph is to be taken these photographs must be taken in the position the bite was inflicted.
- Contact the consulting forensic dentist as soon as possible to report a suspected bite mark.
- Arrange suitable follow-up photographs as requested by the forensic dentist.
- Wherever possible arrange for a forensic dentist to view the bite mark *in vivo* at the earliest opportunity.

Unfortunately this world of ours is not ideal and at the moment police standard operating procedures tend to lead to a lot of bite mark evidence being ignored or lost. It is up to the individual at the scene to assess whether or not priority should be given to the bite mark and often the individual called upon to make that assessment is neither equipped nor qualified to make a decision that a forensic dentist would regard as acceptable. The good dictum is if in doubt call for assistance (see [Figure 12.8](#)).

12.12 Treatment of the bite mark area

The bite mark must always be regarded as transient and as such given priority over more durable evidence. Adequate photographs must be taken at the earliest opportunity and if saliva is present the area should be protected until saliva testing can be carried out.



Figure 12.8 Bite inflicted on the forearm of a police officer during an arrest. The suspect claimed that the mark was self-inflicted to 'fit him up'. Dental examination proved this not to be the case

Contamination of the area both in the forensic and hygienic sense should be prevented. A bite mark in a corpse is likely to last considerably longer than a bite mark in living flesh and therefore can be given a lower priority in the investigation.

Bite marks in foodstuffs may be long lasting or may deteriorate very rapidly. It is important that foodstuffs be assessed early, and appropriate preservation measures taken to ensure that the mark is not lost or degraded in any way.

12.13 What to do if you suspect a bite mark is present?

Given the psychological significance of being bitten most victims will put the bite fairly high on their list of priorities and it is likely they will state very early on in an

interview that they have been bitten. This has become more likely in the modern era of high profile infections such as Hepatitis B, Hepatitis C and human immunodeficiency virus (HIV). Many victims of bites will be deeply concerned and distressed by the possibility of infection being transmitted by the bite. Given that the presence of antibodies to HIV cannot be demonstrated for three months after the initial infection often the only way to allay a victim's fears is to catch and blood test the offender and this alone should cause bite marks to be given a high priority in any investigation.

If there is reason to believe that a person has been bitten they should then be examined for the typical ovoid or elliptical mark.

The first question to be asked when examining this area is: could this be a bite mark? And if so is there any other creditable explanation for its presence?

The second question to be asked is if this is a bite mark is its position consistent with the nature of the crime.

Bite marks may be found on the breasts, face abdomen, shoulder, upper extremities, buttocks, female genitalia, male genitalia, legs, ear, nose and neck (Harvey, 1976). Some studies list similarities but in slightly different order of frequency (Vale and Noguchi, 1983). In simpler terms in a sexual assault on a female, the most likely areas to be bitten are the neck, the breasts and the genitalia.

In a homosexual assault on a male the bite mark is more likely to be on the back. In the cases of simple assault the bite may be found on the arms, the hands and not infrequently in the case of a bar room brawl, nose or the ears.

At this stage it is worth asking if this bite could have been self-inflicted. There have been many cases where victims have bitten themselves and then alleged that an assailant inflicted the damage. The suspected bitten area should then be examined for the presence of saliva.

Saliva presence can be demonstrated in many ways; however, a simple visual examination is normally all that is available at a crime scene particularly where human victims are involved. The amount of saliva deposited in a bite mark is relatively small, as little as 0.3 ml. This can be distributed over a relatively large area of tissue (Clift and Lamont, 1974). Saliva is basically 0.7 per cent solids and 99.3 per cent liquid. This consists of soluble protein antigens and inorganic chemicals, there may be some lip mucous that contains amylase, secreted antigens with epithelial cells also present. Seventy per cent of the population secretes factors in their saliva. Periera (1971) has demonstrated that in many cases a perpetrator's blood group can be determined from a saliva sample, and other factors present can be used for DNA profiling; therefore the importance of saliva should not be underestimated in a bite mark, and every attempt should be taken to preserve the area and have it sampled at the earliest opportunity.

In the case of a bite inflicted through clothing the outer garments in particular should be examined carefully as these are the areas most likely to have been affected by saliva deposition.

12.14 Saliva sampling

Collection of saliva samples is a skilled task and should be performed wherever possible by the forensic dentist or a trained virologist. Examiners of crime scenes will be

aware that the art of the possible does not often appear in their field and often they will be the only person available to take a saliva sample within the critical time frame. The best sample from the viewpoint of the analyst is the most concentrated one and any attempt to sample saliva should aim to achieve the most concentrated sample possible. Care should be taken to avoid any contamination from the victim's blood, should an open wound be present. Many sterile materials may be used to collect a sample such as surgical sponges or gauze but the 'Rizla' style cigarette papers have been the easiest to obtain and use. With the advent in many jurisdictions of buccal swabbing for DNA sampling the sterile swabs used for this purpose provide an excellent medium for saliva swabbing of a suspected bite mark. With any medium, care must be exercised to avoid contact between the medium and the investigator's skin thus avoiding the sample being contaminated with factors from the investigator.

Using cigarette papers, an acceptable technique is to extract a single paper from the packaging using tweezers and cut that paper into small sections approximately 1 cm², some sources recommend the cutting of different shapes of paper to signify different areas of swabbing. The cut paper should be moistened, simple tap water is acceptable, and then carefully swabbed over the target area ensuring that both sides of the paper are used and that the tweezer position is changed regularly to ensure complete impregnation of the paper. The paper should then be air-dried by placing it on a glass microscope slide or the outside of a specimen bottle before being placed and sealed in the specimen bottle because the group antigens collected have been shown to decompose more rapidly in a moist environment (Periera, 1971). The procedure should then be repeated on a non-bitten area of the victim, a sample of the victim's saliva obtained by the same technique and a control prepared by moistening a piece of paper with the same tap water and allowing it to air-dry in the same way as the earlier samples. Scrupulous attention must be paid to labelling each sample as it is obtained ensuring that the label records the site of each sample, the date, time, the victim's name and the identity of the person taking the sample. Where different shapes of paper have been used for different areas, a note should be included informing the analyst of the significance of the different shapes and care must be exercised to only use a specific paper shape for each different site to avoid confusion in the laboratory. The technique for using the now commonly available swabs is identical in essence but care needs to be exercised in handling the recapping of the swab to avoid contamination and the shaft of the swab should be broken on recapping to prevent accidental reuse.

12.15 Photography of bite marks

A bite mark in any flesh has a finite life and it is essential that the mark be accurately recorded at the earliest opportunity. Most people assume that a bite mark is an indentation left in the flesh by the pressure of the teeth. By the time a crime scene examiner is asked to photograph a bite mark these indentations are likely to have disappeared. Indentations inflicted during a bite will normally only last a few hours in living flesh (Harvey, 1976). However, a bite mark of sufficient severity will disrupt the underlying capillary bed and this capillary bed will cause a unique and individual bruising pattern related to the position of the teeth. It is normally this bruising pattern that is photographed and used for analysis.

Of particular interest is the fact that this bruise may develop over several days and it is important that after the initial photographs are taken that adequate follow-up is maintained. Cameron *et al.* (1973) demonstrated that a bite mark up to 12 months old which leaves no visible sign may be visualised using medium wave length ultraviolet light.

The photography of bite marks presents particular problems for photographers. The bite mark is generally found on curved surfaces, which are often fairly reflective, and the position of the bitten area at the time of the bite radically alters the shape of the bite.

Successful photography therefore depends on the following. Positioning the bitten area to copy exactly its position when the bite was inflicted, minimisation of bloom from the camera flash and reproduction of the bitten area in life size in the final photographs.

The following technique (with some minor variations) should produce usable results:

1. Take standard colour photographs of the area surrounding the bite mark to show normal anatomical features so the mark can be located accurately in relation to the rest of the body.
2. Ascertain the position of the bitten area when the bite was inflicted.
3. Place the area to be examined in that position.
4. Place adhesive flexible linear scales marked with the victim's name and the date as close as possible to the bite mark, these scales should be placed both vertically and horizontally.
5. Take colour photographs of the bite mark ensuring that the camera is kept perpendicular to the main axis of the bite mark. As far as possible there should be an attempt to record the bite mark in real size.
6. Repeat step 5 using only ambient light i.e. with the flash unit disconnected.
7. Repeat steps 5 and 6 using black and white film.
8. Review the victim after 24 and 72 h to assess the detail of bruising appearing. If this detail is clear, repeat steps 5, 6 and 7. Remembering that the bite mark often shows more detail several days after it was inflicted. Where a flexible scale is badly distorted by the curvature of the target area, a small metallic adhesive disc of standardised size may be substituted.

12.16 Production of photographic prints

Prints should be produced on a scale of 1:1 to allow direct comparison with the dental models obtained from the alleged perpetrator. Discard any prints where the scale is distorted. Where a metallic disc has been used the prints should be produced to show the disc in real size and shape.

12.17 Bite mark analysis

There are two facets to bite mark analysis that will be carried out by the forensic dentist. The first part is a careful analysis of the mark left in the victim. Here the odontologist will be looking for any particularly unusual features – missing teeth, malpositioned teeth, teeth with an unusual wear pattern that have caused an unusual amount of damage and the relationship between the upper and lower teeth. The size of the dental arch will

be assessed as a simple size assessment which may give an indication of whether one is looking for a male or female suspect. In a particularly unusual bite it is possible for good indications to be given to the investigating police as to what they should be looking for in a suspect.

In the case of an IRA gunman his bite was sufficiently unusual for the police to be given not only a description of his teeth but also a general description of his body and his facial shape.

The second part of bite mark analysis is the analysis of the alleged perpetrators. When a suspect is in custody and has given the required informed consent the forensic dentist will examine the suspect's teeth and then take moulds of the teeth using a standard dental impression technique. This technique is neither significantly invasive nor harmful to the suspect. These moulds, which may be taken in an irreversible alginate material or sometimes a red impression compound which is merely softened in warm water then bitten, are processed by pouring liquid plaster into them which gives an accurate positive copy of the suspect's teeth. Then analysis can start. Initially the forensic odontologist will mark the prominent areas of the teeth that would be expected to leave a recognisable mark. These marks are then transferred to an acetate sheet and compared with the bite mark photographs. For an adequate comparison to be done points of concordance should be examined and there should be at least ten points concordance present and no points of discordance before a reasonable match can be claimed. In an ideal situation if the suspect has been apprehended early enough and the bite mark remains either in the victim or in food stuffs, the models should then be applied directly to the mark giving a good three-dimensional view of the match. Courts are much more likely to accept the careful comparison of the models of the teeth to the actual mark than they are using a system which is purely two-dimensional using photographs.

In the case of *R v. Lewis* (1987) in the Northern Territory bite mark evidence was very heavily criticised. One of the major criticisms was the use of a two-dimensional acetate system in comparing a three-dimensional bite mark.

Other methods of comparison do exist. Some use has been made of stereoscopic techniques and more recently the use of electron microscope analysis of striations in the teeth can be compared back to striations found in a substrate. This is more typical of the normal tool mark examination that most crime scene examiners would be familiar with.

It is to be hoped that bite mark evidence will gain acceptance again in this country and come to occupy its rightful place in the forensic examination as a most valuable tool. However unless bite marks are given the correct priority and the correct treatment at every stage of an investigation this expectancy will be a long time in coming.

12.18 Areas where bite marks may be of particular use

It should never be forgotten that while the courts might not accept bite mark analysis as a positive identification tool it is still widely accepted for elimination and therefore the role of bite marks should not be ignored on the grounds that courts may not accept identification by bite mark. Elimination of all but one suspect will identify the offender as adequately as a direct identification. The attitude of ignoring bite marks on the grounds that the courts will not accept identification by bite mark can be seen to be a misguided one.

It is an unfortunate fact of life that child abuse cases are being reported more frequently in our society and one of the more common forms of abuse being discovered is that of the bitten child. In a case such as that, there are normally only two suspects, the custodial adults. It is unfortunately not uncommon for each adult to blame the other for inflicting the marks and any other damage on the child. Given only two suspects it is normally possible to eliminate one by bite mark analysis therefore pointing very clearly to the offender. This particular aspect of bite mark analysis has not received the due attention from the judiciary because in many cases when confronted with the identification, the perpetrator will plead guilty (see Figure 12.9).



Figure 12.9 Bite inflicted on an infant as part of more serious assault. The size difference in the marks left by the upper and lower dental arches can be clearly seen. No linear scales are present and this failure in technique made positive identification of the assailant impossible, but one of the two suspects (the custodial adults) had a gross misalignment of their teeth and was eliminated from enquiries. Given this evidence the offender pleaded guilty



Figure 12.9 (Continued)

12.19 Use of bite marks in assessing the degree of force in an assault

For a bite mark to remain recognisable after the initial indentations disappear there must be a disruption of the capillary bed underlying the skin. The teeth and sometimes pressure from the lips and tongue have caused this disruption. The most basic form of recognisable bite mark is the 'love bite' where the teeth are applied relatively gently to the flesh and suction then used to force the flesh up in between the teeth. They normally consist of abrasion marks from the teeth, pressure marks from the lips where a seal has been achieved and pressure marks from the tongue. When slightly more pressure is applied in a bite the capillary bed will be significantly more disrupted by the pattern of the teeth. To actually disrupt the capillary bed requires considerable force in the bite and will inflict considerable pain on the victim.

The next degree is where the flesh has actually been ruptured by the teeth and is more properly a laceration than a bite mark and requires considerable force to inflict. The most severe form of a bite mark is one which is applied with sufficient force to actually remove flesh. It is not uncommon for noses and ears to be bitten off in pub brawls and in cases of particularly savage sexual assault it is not unknown for the victim to lose a nipple.

When examining a bite mark if an obvious mark is detected it can be deduced that a high degree of force was used to inflict it and significant pain was inflicted upon the victim.

This evidence may be of considerable help to the courts when assessing the ferocity and intensity of an assault.

12.20 Conclusion

The forensic uses of dentistry are rapidly gaining acceptance with police forces worldwide and the growing expertise of the dental profession in both training and delivery means that forensic dentistry is an area that the prudent crime scene investigator cannot afford to overlook particularly since dentistry has travelled well beyond its humble origins as a secondary means of establishing identity. In the context of crime scene investigation, dentistry should now be afforded a much higher priority when an assault has taken place, child abuse is suspected, a bite mark in any substrate is present and in the identification of human remains where visual identification is unreliable or inadvisable.

Dentistry as a tool in crime scene investigation will continue to gain a wider acceptance and every crime scene investigator would be well served by acquainting themselves with the range and scope of services available.

12.21 Acknowledgements

My grateful thanks and heartfelt appreciation are given to Associate Professor Chris Griffiths of the NSW Forensic Dental Unit who has fostered and nurtured my interest over the years and who has played a much larger role than he can imagine in establishing forensic dentistry in the Australian Capital Territory.

Thanks are also due to Dr James Robertson and Mr John Horswell of Forensic Services, Australian Federal Police without whose encouragement and support forensic dentistry in the ACT would have been stillborn.

12.22 Bibliography

Averill, D. C. (ed.) (1991) *Manual of Forensic Odontology*, Colorado Springs: American Academy of Forensic Sciences, Chapter 4, pp. 126–75.

Bellamy, G. (1990) *Bite Mark Evidence and Interpretation*, Presentation at the 1990 Forensic Dental Identification Course, Sydney, May.

- Brondum, N. and Simonsen, J. (1987) Postmortem red discolouration of teeth: a retrospective investigation of 26 cases, *American Journal of Forensic Medicine and Pathology*, **8**, 127.
- Cameron, J. M. and Sims, B. G. (1974) The tooth and age determination, in *Forensic Dentistry*, Edinburgh: Churchill Livingstone, pp. 23–45.
- Cameron, J. M., Grant, J. H. and Ruddick, R. (1973) Ultraviolet photography in forensic medicine, *J. Forc. Photog.*, **1**.
- Ciapparelli, L. and Hughes, P. (1992) Bite marks in tissue and in inanimate objects: analysis and comparison, in D. H. Clark (ed.), *Practical Forensic Odontology*, London: Wright, pp. 149–77.
- Clark, D. H. (1984) Postmortem pink teeth, *Med. Sci. Law*, **24**, 130–4.
- Clark, D. H. (1992) *Practical Forensic Odontology*, in D. H. Clark (ed.), London: Wright.
- Clark, D. H. (1992) Saliva swabbing, bite mark examination procedures: victims and suspects, in D. H. Clark (ed.), *Practical Forensic Odontology*, London: Wright, Chapter 10, pp. 135–6.
- Clement, J. G. (1993) Forensic dentistry, in Freckelton and Selby (eds), *Expert Evidence*, North Ryde: Law Book Company, Chapter 34.
- Clift, A. and Lamont, C. M. (1974) Saliva in forensic odontology, *Journal of the Forensic Science Society*, **14**, 241–5.
- Griffiths, C. G. (1990) *Aircraft Accidents and Dental Identification*, Presentation at the 1990 Forensic Dental Identification Course, Sydney, May.
- Harvey, W. (1976) *Dental Identification and Forensic Odontology*, London: Kimpton, p. 91.
- Keiser-Neilson, S. (1980) *Person Identification by Means of the Teeth*, Bristol: J. Wright.
- Middleton, A. (1987) *History of Forensic Dentistry*, Presentation at the 1987 Forensic Dental Seminar, Sydney, May.
- Palamara, J., Olsson, C., Phakey, P. P., Clement, J. G., Rachinger, W. A. and Holden, J. (1990) *The Ultrastructure and Phase Transitions in Human Bone and Tooth Tissue-Heat Treated in the Temperature Range 200 to 1600 deg C*, Presentation at the 1st International Conference on Burns and Fire Disasters, Palermo, September.
- Periera, M. (1971) Possibilities and limitations of saliva tests in forensic odontology, *British Dental Journal*, **130**, 161.
- R v. Carroll (1985) *Australian Criminal Reports*, **19**, 410.
- R v. Lewis (1987) *Australian Criminal Reports*, **29**, 267.
- Vale, G. L. and Noguchi, T. T. (1983) Anatomical distribution of human bite marks in a series of 67 cases, *Journal of Forensic Sciences*, **28**, 61–9.

Drug operations

Karl Kent and Bruce Nelson

13.1 Introduction

One of the roles of a crime scene investigator in supporting national operations of the Australian Federal Police (AFP) is the forensic investigation of illicit drug-related importation offences. This requires a need for their specialist skills and experience in the physical evidence aspects of *Controlled Operations*. These operations are now managed through specific legislative requirements. It is not our intention to cover all the legal or investigative aspects of these operations in this chapter; however, the nature of the drug-related crime scenes encountered and associated procedures and methods employed are revealed and discussed.

13.2 Controlled delivery operations

A controlled delivery operation in respect of importation of illicit drugs can be defined as:

The controlled movement by law enforcement officers of seized illicit drugs from the point of detection through to distribution, in an effort to identify those persons responsible for the importation.

This technique was developed, at least to some extent, through frustration encountered by law enforcement agencies where only drug couriers themselves were being arrested for drug importation offences. Such couriers often only play an extremely small part in the organised criminal activity surrounding the importation and subsequent distribution of illicit drugs.

In Australia until 1996 the basis to conduct such operations came not from legislation but from the Single Convention of Narcotic Drugs, 1961 to which Australia was

a signatory. The status of this investigative technique is that there exists no element of *agent provocateur* or *entrapment*, as the importation offence has already been committed prior to the controlled delivery operation taking place. This legal position is certainly *true* for controlled delivery operations, which commence *after* the illicit drugs have been imported. These operations may be referred to as *internal Controlled Operations*.

This argument was not considered valid by the High Court of Australia in *R v. Ridgeway* (1995) for the situation where a controlled delivery operation was commenced prior to the drugs entering Australia (known as an *external Controlled Operation*). In this case it was held that where law enforcement officials break the law by committing an element of the offence for which the defendant is being prosecuted, then as a general rule a court should exercise discretion to *refuse to allow evidence of that element* of the offence to be admitted.

This High Court decision resulted in the implementation of the Crimes Amendment (Controlled Operations) Act 1996. This Act makes provision that any evidence resulting from such conduct by law enforcement officials in *Controlled Operations* is *not* excluded from subsequent prosecution under the principles enunciated in the *Ridgeway* case. This Act details requirements for the AFP to report to the Minister on application for Certificates authorising *Controlled Operations* and provides for strict reporting requirements for the results of those operations.

The AFP has developed guidelines to provide a procedural framework for *Controlled Operations*. In these guidelines the Field Services Teams of Forensic Services carry the responsibility for Pre-analytical Illicit Drug Identification (PIDI), representative sampling for subsequent quantitative analysis, mass measurement and the substitution process. These are all the forensic investigation aspects of illicit drug-related operations, which we will limit ourselves to discussing in this chapter.

13.3 Substitution

There exist two types of *Controlled Operations*, those in which a substitution is conducted and those where it is considered not possible to substitute the illicit drugs. A substitution in respect of illicit drugs may be defined as:

The removal of the majority of an illicit drug substance from its concealment and replacing it with a non-toxic substance which closely resembles in appearance the original illicit drug substance.

A substitution is performed wherever possible to limit the opportunity of the illicit drugs entering the community should the control of the operation be lost by law enforcement officers. Due to the highly unpredictable nature of such operations the risk of a loss of control varies considerably from operation to operation.

The list of material which may be used in substitution for controlled delivery operations is only limited to one's imagination, combined with common sense and resourcefulness. The very wide range of illicit drugs and their packaging materials make it virtually impossible for any facility to keep sufficient stock of all substitute materials. However, based on experience and the more common concealments and illicit drug forms

currently encountered, a list of typical substitute materials and packaging may be formulated.

Substitute materials are chosen to be similar in as many ways as possible to the illicit drug that is to be substituted, and the packaging materials used. Consideration must be given to occupational health and safety issues when dealing with both drugs and substitute materials.

To achieve a quality result in this task the material used must be inert and the crime scene investigator must consider:

- colour
- size
- shape
- consistency
- density, mass per unit volume.

Detailed information on materials used and preparation processes can be obtained by authorised law enforcement agencies on request.

13.4 Illicit drug concealment

It is not possible to describe each type of illicit drug concealment that has been detected for they are far too numerous to address here. The illicit drug industry is such a profitable one, that concealment is becoming increasingly more technical in design and therefore more difficult to detect. However, there are a number of typical concealment types that we will consider here.

13.4.1 *The suitcase*

There is a range of suitcase types, which are commonly used to conceal illicit drugs. Each suitcase must be considered on its own merits and may vary considerably in quality of manufacture.

13.4.1.1 Hard samsonite suitcases

These suitcases are constructed of a hard thermosetting plastic material, with illicit drug packages being concealed under the false lid and bottom sections. These false sections are sometimes constructed of fibreglass or a material similar to the original suitcase and may be pop-riveted and/or glued into position underneath a fabric inner lining.

13.4.1.2 Soft sided suitcases/carry bags

In these items illicit drugs are concealed inside lining materials or underneath a cardboard or plastic false bottom section.

13.4.1.3 *Composite suitcases*

These suitcases are constructed with a soft vinyl outer covering, with the sides of the base and lid consisting of a laminar construction of wood or cardboard. These sections are generally attached to a lightweight aluminium frame, also having a fabric inner lining. Illicit drug packages are generally concealed in between the laminar structure of the side sections of the base and lid.

13.4.1.4 *Moulded plastic base and lid suitcases*

These cases have their base and/or lid constructed from a moulded plastic material, which is pop-riveted to an outer vinyl covering. The illicit drug material is concealed in the honeycomb like cross-section of the moulded plastic base or lid.

13.4.2 *Impregnations and suspensions*

Impregnation of illicit drugs into substrate materials being solids or liquids is a commonly encountered concealment technique. Of the illicit drugs concealed in this manner, cocaine hydrochloride is by far the most common concealed drug encountered. This is primarily due to its high solubility in water or other liquids.

Cocaine hydrochloride has been successfully impregnated into most fabrics, dissolved in liquids such as alcohol, paint products and shampoo, and also chemically bonded within polymer resins (methyl methacrylate). Such concealments vary in actual cocaine yield, but the yield may be greater than 50 per cent by weight/volume. The limitation of these concealments is generally not the solubility of cocaine hydrochloride but rather the difference in weight between the genuine and impregnated item (see [Figure 13.1](#)).

Heroin hydrochloride is more difficult to impregnate into material or other substrate materials due to its lower solubility. However, it has been effected in fabrics. The fabric generally demonstrates increased stiffness and small white spots may be observed.

The most commonly encountered impregnated material in dosage amounts is lysergic acid diethylamide (LSD) with the liquid being absorbed onto blotting paper squares or what are known as tabs. LSD may, due to its exceptionally high solubility in water or other solvents, be impregnated easily into a range of other substrate materials including foodstuffs. Methylamphetamine in its liquid form is often mixed within other liquids to conceal it, and has also been reported as being detected in paper tab form.

13.4.3 *Body packs*

This is a very common concealment used by persons entering the country via ports, where illicit drug packages are attached to the body. The packages are attached using adhesive tape to the legs (upper and/or lower) or a fabric body belt to the lower abdomen or lower back. These packages vary in size; however, the wrappings are generally some form of plastic and adhesive tape (see [Figure 13.2](#)).



Figure 13.1 Cocaine hydrochloride suspension in shampoo

13.4.4 Internal concealments

A dangerous form of concealment of illicit drugs is that of the internal concealment, where the packages are concealed within a person's body cavities. There are essentially three methods encountered:

- orally taken (swallowed) for later excretion;
- placed inside the anus as you would with a suppository, for later excretion; or
- placed in the vagina, for later removal.

Such internally secreted packages vary in size, shape and number. However, an orally taken package is approximately 30mm in length and 10mm in diameter. An anal or vaginal concealed package may be up to 50mm in length and 25mm in diameter. The wrappings



Figure 13.2 Example of a body pack containing 1.5 kg heroin powder

of these packages usually consist of plastic, surgical glove fingers, PVC tape and multilayers of condoms. The largest number of internally concealed packages currently exceeds 300; however 60–100 is typical. A medical practitioner using X-ray or ultrasound equipment generally confirms this type of concealment (see Figures 13.3 and 13.4).

13.4.5 Parcel post

The parcel post package is a frequently encountered form of illicit drug concealment in respect of importation investigations. There exists a very wide range of concealments in this category.

The most typical concealment is that of a simple envelope containing a letter in which is concealed a plastic or foil package containing a cannabis product. However, there are many objects which are sent through the mail system, audio and video cassettes,

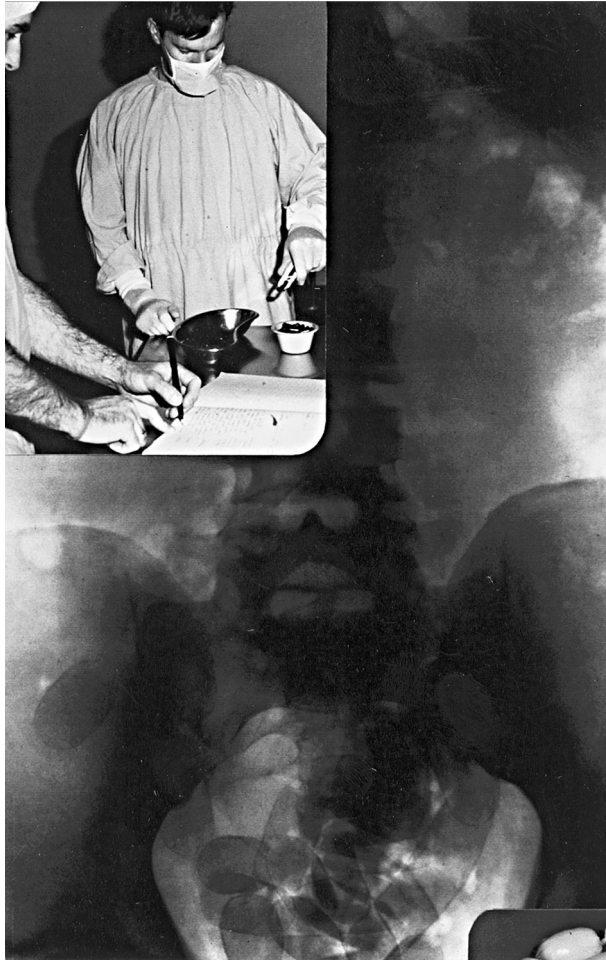

Figure 13.3 X-ray of internally concealed packages

compact disc cases, magazines, foodstuffs, cardboard boxes, paintings, etc. all of which have been found to serve as concealments for the full range of illicit drug substances.

13.5 Drug importations and the forensic examination of the primary crime scene

Where an illicit drug importation is effected, the primary crime scene exists at the point of detection. In Australia this is usually at an Australian Customs Service (ACS) storage facility, examination area or at the Customs barrier itself. This scene is limited in scope as it consists primarily of the drug concealment used, its contents including packaging materials, and the illicit drugs. These materials present a valuable source of forensic evidence, which may also be utilised to provide criminal intelligence. Thus every effort



Figure 13.4 The medical procedure conducted on a courier to save his life after internally concealed packages containing heroin had ruptured inducing coma

should be made by crime scene investigator/s to detect and record this information. The standard crime scene investigative process is applied, which is initial assessment, control, scene examination, interpretation of physical evidence, recording, collection and preservation of all physical evidence, and case management.

On initial attendance at the scene the crime scene investigator obtains as much information as possible from the investigating police and Customs officers regarding the initial condition of the drug concealment. This information is critical if a controlled delivery operation is being considered. Facts regarding who has had physical contact with the concealment are also important to determine levels of contamination or destruction of potential forensic evidence. The crime scene investigator should also seek advice regarding the identity of possible suspects and the geographic origin of the concealment.

Finally, the investigating case officer is asked to provide other relevant facts regarding the importation including:

- if a controlled delivery operation is to be conducted and if so sight the authorisation and discuss anticipated time frames for the controlled delivery operation;
- suspected illicit drug type;
- available intelligence;
- if there is to be an installation of technical devices;
- the presence of booby traps or improvised explosive devices; and
- if substitution of the drug is required to go ahead.

The AFP approach to this work is 'holistic'. When the seizure comes to our notice it is treated as a 'crime scene' and not just as a 'drug' matter. Therefore a general survey is then conducted of the concealment to identify all potential sources of forensic evidence

and the priorities assessed regarding the collection of such evidence. This evidence includes fingerprints, physical comparisons, documents, hairs and fibres, DNA and other trace evidence materials. This is done with the view that the primary crime scene will be altered irrevocably once the illicit drugs are removed from the concealment. It is critical that fingerprint examination of drug wrappings is considered prior to the removal of the illicit substance. This is due to the excessive handling of the packaging material in this removal process and the resulting destruction of any fragile latent fingerprint deposits on non-porous surfaces.

The concealment is recorded in its current state using digital video and still photography, sketch plans and written notes. Where possible the construction techniques and sequence of construction are also interpreted at this stage. Consideration is also given to other specialists and specialised equipment, which may be required for the examination. This includes protective clothing and other occupational health and safety equipment.

Where practicable the gross weight (mass) of the concealment is measured and recorded. This evidence has often proved critical at a later stage during the prosecution. Control of the crime scene is now considered. In drug-related matters, the continuity of the drugs and packaging materials cannot be overemphasised. All persons present during the examination must be recorded and a log of departures and arrivals to and from the examination area established. Ideally a continuous video recording of the entire examination process and persons present should be conducted.

The concealment is then dismantled in order to remove the suspected illicit drugs and packaging. This process is conducted using extreme care to minimise any unnecessary destruction to the concealment with a view to the possible substitution and reconstruction of the concealment to its original condition. To this end non-destructive examination procedures such as X-ray and ultrasound techniques are often employed as tools to obtain improved information regarding concealment construction, and the location of any suspected substances.

Dismantling is always conducted in a logical sequence with each step of the process painstakingly recorded using notes, still photography and video. This is to ensure that the full details of the process can be easily explained to the court at a later time and is critical in establishing the credibility of the controlled delivery process. When similarly concealment items are encountered identical dismantling steps are adopted to ensure consistency, quality of final product and adherence to established methodology.

The gross weight of the suspected illicit drugs and their packaging is measured and recorded. Each item is assigned an identification number for future reference including a drug seizure number, an item number and further indices to indicate layers of packaging.

Where large or complex concealments are examined (particularly in the case of shipping container concealments) it is often necessary to form a production line dismantling process, with staff identified to conduct discrete tasks. This process is recorded using notes and photography. The dismantling method is outlined on a whiteboard, so that new team members can be introduced, rotated or briefed.

13.6 Preliminary illicit drug identification

It is critical that reliable preliminary identification of suspected illicit drug substances recovered from a concealment be obtained as quickly as possible. This information is then

utilised to obtain a Certificate under the Crimes Amendment (Controlled Operations) Act 1996 to authorise the actions of Federal Agents conducting the operation.

Crime scene investigators are responsible for providing advice to investigating police regarding the identity of suspected illicit drug seizures with a standard of confidence of '*Highly Probable*' (>80 per cent). To achieve this, crime scene investigators perform presumptive screening tests and pre-analytical illicit drug identification procedures, which are supported by specific training programmes. The information provided by crime scene investigators is also used by Federal Agents to base operational tactical decisions, including search warrants, arrest processes and bail applications.

These preliminary identification techniques are, due to their destructive nature, unsuitable for use where trace quantities of illicit drugs are suspected. All the observations, results and conclusions of this examination are recorded on the prescribed illicit drug identification worksheets. This information is also reported to the court in any subsequent prosecution. The following is a brief explanation of the preliminary illicit drug identification procedures conducted on illicit seizures.

13.6.1 Physical characteristics

The physical characteristics of all illicit drug seizures including packaging, size, shape, density, colour, consistency, mass, odour, designs or other identifiable features are recorded. In addition further physical examinations are conducted in order to identify cannabis products and LSD, this includes botanical and UV examinations.

13.6.1.1 Botanical examination

A morphological and microscopical botanical examination of suspected cannabis seizures (with the exception of burnt or liquid products) is conducted. This examination is to identify the most characteristic features of cannabis products being abundant glandular trichomes and cystolithic hairs, which are present on the surface of the fruiting and flowering tops.

13.6.1.2 Long-wave ultraviolet examination

Suspected LSD seizures are observed under long wavelength UV radiation to identify a characteristic blue fluorescence.

13.6.2 Presumptive illicit drug identification tests

Presumptive illicit drug identification test or colour tests are used to indicate the presence of a particular illicit drug in a suspected substance. Such colour tests can be regarded only as 'qualitative' or as a presumptive chemical test. This produces a result that *indicates* a particular illicit drug substance *may* be present in the bulk material. These tests are not used to provide any information regarding the concentration or purity of the illicit drug substance.

Crime scene investigators in conducting presumptive colour tests, in accordance with the prescribed methods, use the following reagents. These methods are well documented in the literature and are not dealt with here in any depth.

13.6.2.1 *Marquis reagent*

For presumptive identification of opiates, amphetamines and ring-substituted amphetamines: concentrated sulphuric acid + 37 per cent formaldehyde, in a 9:1 ratio.

13.6.2.2 *Scott's reagent (modified)*

For presumptive identification of cocaine and cocaine base (crack): 2 per cent w/v cobalt thiocyanate solution in glycerine.

13.6.2.3 *Ehrlich's reagent*

For presumptive identification Ergot alkaloids including LSD: 10 per cent w/v para-dimethylamine benzaldehyde in methanol and concentrated orthophosphoric acid.

13.6.2.4 *Duquenois-Levine reagent*

For presumptive identification of THC in cannabis and cannabis products including resin and oil: 2.5 per cent v/v acetaldehyde, 4 per cent w/v vanillin in ethanol (95 per cent).

13.6.2.5 *Simon's reagent*

For the presumptive identification of amphetamines and methylamphetamines, and MDA and other ring-substituted amphetamine derivatives:

Solution 1: 2 per cent w/v sodium carbonate solution.

Solution 2: 10 per cent v/v acetaldehyde solution is added to 1 per cent w/v sodium nitroprusside solution.

Detailed methods have been developed for the preparation of samples for presumptive and pre-analytical testing of material from suspected illicit drug concealments in the form of aqueous suspensions (for aqueous, alcohol and detergent-based solutions) and impregnations (into absorbent substrates such as fabrics). It is not intended to describe these methods within this chapter as such techniques are well documented as basic chemistry procedures.

13.7 Pre-analytical illicit drug identification

Crime scene investigators who undertake this type of work use thin layer chromatographic (TLC) techniques to provide a pre-analytical identification of suspected substances. Clark and Moffat (1986) define TLC as:

A method of chromatography in which a mobile phase moves by capillary action across a uniform thin layer of finely divided stationary phase (adsorbent) bonded to a plate.

Each illicit drug substance moves across the plate at different rates depending upon their mobility in the absorbent material. This mobility is determined by the solubility of the substance in the mobile phase, pKa values, and their capability of hydrogen bonding. In this way different drugs can be separated from mixtures or identified by the distance travelled along the plate over a given time (Clark and Moffat, 1986).

A range of TLC systems exist which can be utilised to perform drug separation and identification procedures. The system currently used by crime scene investigators is identified as the CO1 system and uses Silica Gel G plates (silica gel bonded to a glass plate, both 20 and 5 cm types). The mobile phase consists of cyclohexane:toluene:diethylamine in a 75:15:10 ratio. The TLC plates are stored in desiccators on a shelf over silica gel.

Known drug standards are run against unknown suspected materials. Both standards and unknowns are dissolved in methanol (2–3 drops in 1–2 mg of substance) with a 1–2 µl sample volume applied to the plate using micropipette disposable applicators. Each sample track on the plate is marked at 10 mm intervals and labelled with the appropriate item number, drug standard or solvent blank reference. The plate is also labelled with the drug seizure number, date and the initials of the crime scene investigator conducting the test.

Each plate is placed into a TLC tank containing the mobile phase solvent, the level of which is underneath the samples/standards origin line (about 10 mm from the base of the plate). The solvent is allowed to move up the plate until the solvent front is about 5–10 mm from the top of the plate. The plate is removed from the TLC tank and the final position of the solvent front is marked. The plate is then air-dried.

The TLC plate is visualised using short wave UV radiation (254 nm). The sample and known standards appear as dark spots against a bright green fluorescent background. A check is made at this point to ensure that no spots appear on the solvent blank track, which would indicate contamination had occurred, and a new test would need to be conducted. Each spot visualised using this method is outlined using a pencil. The plate is then photocopied and the copy is attached to the preliminary illicit drug identification worksheet.

The photocopy is used to directly compare the relative position (Rf) values of each sample to the known standards.

Each sample and standard spot is then developed using either Marquis reagent (all spots except suspected cocaine, cocaine standards or adulterants) or Scott's reagent for suspected cocaine or cocaine standards. The use of the colour test directly applied to the plate is used as a secondary confirmatory test to ensure correct identification of any illicit drug substance on comparison to drug standard Rf relative values.

The TLC plates are then neutralised by washing under running water and then discarded. The mobile phase is discarded into waste organic solvent containers for later disposal.

13.8 Purity estimation by solubility testing

Chloroform solubility tests are conducted for the purpose of estimating the purity of illicit drug seizures. Purity (*P*) is estimated to lie within the following ranges:

$P < 10$ per cent
 $10 \text{ per cent} < P < 50$ per cent
 $P > 50$ per cent

Three millilitres of chloroform is added to a test tube. 0.3 g of the suspected illicit drug is added to the test tube, and the level of the substance in the chloroform is marked on the tube. The tube is then shaken and then let stand for about five minutes. The level of any undissolved solid is marked. Most cutting agents will demonstrate a low solubility in chloroform. Thus a clear solution indicates that the purity is probably greater than 50 per cent. If insolubles are present then the purity may be estimated based upon the relative quantity of impurity measured against the initial level of the powder. This test is conducted as an indicator of drug purity only, and is designed to assist the investigating officer in making tactical decisions concerning any subsequent controlled delivery operation.

13.9 Mass measurement (drug bulk and samples)

Whilst the measurement of mass may seem a trivial task, in drug-related investigations evidence of the mass of the illicit drug substance is critical. This evidence determines the seriousness of the offence and thus the penalty handed down by the court to a convicted offender. In these circumstances it forms a vital component of physical evidence, and must be conducted in accordance with appropriate scientific standards.

Basic Newtonian physics tells us when an item is placed on a balance pan it is pulled towards the centre of the earth under the influence of gravitational force (or weight force) of F (Newtons). This force is equivalent to mass m (kg) multiplied by the acceleration due to gravity g (ms^{-2}). The restoring electromagnetic force imposed by the balance places the item in a state of equilibrium such that its mass can be determined.

The item itself possesses a fundamental mass, which does not change. However, the acceleration due to gravity does vary by about ± 0.3 per cent due to variation in the distance of the earth's surface from its centre. Due to this variation of gravitational forces mass balances must be calibrated whenever they are installed or moved. Mass balances must also be regularly calibrated to ensure precision and reliability due to temperature variations, ageing electronic and mechanical components, ageing of magnetic circuits, and power fluctuations, which may affect balance electronics.

The calibration, use and maintenance of balances is a subject which will not be covered in any further depth in this chapter suffice to say there has been considerable written on this subject in other fora.

The legal terms used in Australia of *gross weight* and *net weight* may require some explanation. *Gross weight* describes the mass of a substance suspected to contain illicit drugs including the mass of its wrappings or packaging. *Net weight* is used to describe the mass of the substance suspected to contain illicit drugs.

Both random and systematic errors are estimated by crime scene investigators for each measurement of gross and net weight. This information is included in the original notes made during the examination.

13.10 Representative sampling of suspected illicit drug bulk

Crime scene investigators are required to remove representative samples from the bulk of any suspected illicit drug seizure. They determine what constitutes the removal of a representative sample from the bulk material for submission to the drug laboratory for both qualitative and quantitative chemical analysis. The sampling process is recorded using notes, photography and video.

Sampling procedures adopted by crime scene investigators are based on those used by Australian Government Analytical Laboratories' (AGAL) analysts and are in accordance with the United Nations Division of Narcotic Drugs Recommended Methods for Testing. Where practicable a safety factor of two has been introduced to further ensure representative sampling does occur. It is not intended in this chapter to detail these procedures as they are quite extensive and the United Nations publication is readily available to forensic science laboratories.

Where practicable representative samples are withdrawn from all illicit drug seizures where an AFP investigation is initiated. The process of representative sample extraction is dependent upon the form in which the illicit drug is present in its respective substrate and its packaging. Illicit drugs can exist in a number of physical forms. A common range has been identified as:

- powders/granules
- capsules/tablets
- compressed powders/blocks/pellets
- liquids/solutions
- suspensions
- impregnations
- tickets/tabs
- oils
- resinous material
- plant material
- traces.

Detailed methods for removing representative samples for each form of illicit drug substance have been developed and are considered to be the minimum sampling requirements. Formal guidelines are being developed internationally by SWG DRUG and nationally by the Senior Managers Australian and New Zealand Forensic Laboratories (SMANZFL) Drug Specialist Advisory Group. It is recognised that there will exist certain operational situations where sampling occurs that do not comply with these guidelines. In these circumstances detailed notes are required regarding the reasons for the deviation.

13.11 Preparation of concealment for a controlled delivery operation

Once the identity of a suspected drug seizure has been identified, an operational decision is made as to whether a controlled delivery operation is to be conducted. The AFP have developed National Guidelines to assist Federal Agents for operations of this type. These

guidelines contain specific provisions and describe the role and function of crime scene investigators present during the preparation of a concealment for the operation. Each stage of this process is recorded using photography, notes, sketches and video.

13.11.1 Non-substituted controlled delivery operation

In some rare cases, insufficient time exists for a substitution of the drug to take place for a particular seizure. In these instances the concealment is dismantled only to a stage such that preliminary drug identification and representative sampling can be conducted.

Tracer materials such as fluorescent creams and powders, aniline, methylene blue, ethyl violet and brilliant green powders, are used by crime scene investigators. Such tracer materials are placed inside the concealment in order to contaminate any resulting secondary crime scene or suspects. Samples of these materials are kept for comparative analysis with samples recovered from the scene.

The concealment is reconstructed to resemble as much as possible its original condition. The concealment is also marked covertly such that it can be identified at some later time. This stage is crucial as it is often the case that those receiving the drug concealment possess a detailed knowledge of its concentration. If unexpected alterations are detected by the offenders at an early stage of the controlled delivery, the operation may be compromised as will the safety of any law enforcement entry teams.

13.11.2 Controlled delivery operation with substitution

The drug concealment is dismantled and the bulk of the suspected illicit drugs is removed, identified and representatively sampled. Crime scene investigators then prepare substitute drugs and packaging materials. Tracer substances are incorporated into the substitute materials with samples of such substances, and the substitute materials kept for later comparative analysis if required.

Substitute packaging material can also be a valuable source of physical evidence by the secondary crime scene. It is often the case that the substitute drug materials will have been moved from their packaging and lost or destroyed by suspects. In these cases perhaps only substitute packaging materials may be located at the secondary crime scene. For this reason adhesive tape endings and other substitute packaging materials are kept for later comparison and identification if necessary.

A *Controlled Delivery Sample* of illicit drug is removed from the original drug bulk material. A controlled delivery sample can then be defined as:

A sample removed from the illicit drug bulk for the purposes of inclusion in the substituted drug concealment. This is conducted to ensure a minimum trafficable quantity of illicit drugs is retained within the concealment in order to meet operational or legislative requirements.

The decision to include controlled delivery samples including their mass and number, in a controlled delivery operation, rests with the Federal Agent given the responsibility for that operation. Crime scene investigators can provide advice regarding the size and number of controlled delivery samples where required. Each controlled delivery sample of illicit drugs is covertly marked for later identification and recovery.

The concealment is then reconstructed to resemble its original condition, now containing substitute drugs and packaging materials, and a controlled delivery sample/s. The concealment is covertly marked such that it can be identified at any subsequent secondary crime scene.

13.12 Drug importation: forensic examination of the secondary crime scene

The secondary crime scene on completion of a controlled delivery operation is often a complex scene, which contains a wide range of relevant potential physical evidence, which must be identified. Unlike the primary crime scene, this scene is not limited in scope to the drug concealment itself. In fact, what is important to establish is the probable sequence of events after the concealment was introduced to the scene. For this reason the standard crime scene investigative process must be applied of initial assessment, control, scene examination, interpretation of physical evidence, recording, collection and preservation of all physical evidence, and case management procedures.

If the concealment has been opened and the substitute material removed it is critical that the persons responsible for this process are identified. This evidence may be vital in establishing the level of knowledge possessed by suspects that the concealment did in fact contain illicit drugs. Suspect/s' hands and clothing should be thoroughly searched for any evidence of tracer or substitute material, and relevant samples obtained and recorded. If the concealment required the use of tools to effect removal of the contents, such tools should be identified and recovered. These tools can then be the subject of future physical comparisons with associated marks on the concealment and also latent fingerprint examination.

Floor and table areas within identified critical areas of the scene should be swept, vacuumed or swabbed to recover possible traces of illicit drug, substitute or tracer materials. Toilets, sinks and associated plumbing should also be thoroughly examined for the presence of this evidence. All substitute materials and controlled delivery samples are re-identified, recorded and recovered. Substitute packaging materials are also recovered and their condition and location recorded.

It is sometimes the case that insufficient emphasis is placed upon this scene as a source of valuable forensic evidence. This is generally due to time limitations imposed by legislative requirements or search warrant provisions. There is little doubt that given the stiff penalties applied to convictions regarding drug importations, that these scenes should be viewed as serious crime scenes requiring a thorough forensic investigation.

13.13 Role of the forensic drug laboratory

The forensic drug laboratory conducts confirmatory tests on the seized drugs and includes the following examinations and analyses:

- qualitative and quantitative chemical analysis of the seized drug to establish identity for prosecution purposes;
- training and competency assessment of crime scene investigators with a drug role;
- supply reagents for the TLC analysis conducted by crime scene investigators;

- proficiency test provider; and
- advisory role and provider of certificates of analysis and reports as required.

13.14 Occupational health and safety

Illicit drug seizures of the quantity and concentration encountered at the importation level present a significant health and safety risk to crime scene investigators involved in their examination.

Not only ingestion of high purity drugs but also the handling of associated chemicals involved in preliminary illicit drug identification, pose serious potential health risks.

For this reason crime scene investigators working in this field conduct their examinations whilst wearing appropriate protective clothing and using appropriate equipment. Such equipments will include:

- fume cupboards;
- extraction hoods;
- cross-flow bench ventilation;
- solvent and corrosive cabinets;
- disposable overalls, gloves and shoe covers;
- eye wear protection and face shields;
- breathing masks and self-contained breathing apparatus;
- specialised OH&S kits and procedures to assist in the recovery of internally secreted concealments;
- chemical spill kits;
- sharps and syringe containers; and
- a range of disinfectants.

13.15 Future directions

The emergence of new technologies over the last few years will have a dramatic effect on the way in which suspected drug seizures can be recorded and analysed. There is also a strong need from our law enforcement clients, for forensic science to provide a more proactive intelligence-driven approach to illicit drug investigations, and to identify the potential source of these seizures. This need has seen the emergence of drug profiling methods for heroin, cocaine, cannabis and amphetamine type substances. These profiling results are included in information databases relating to other physical aspects of the seizures, such as wrappings, and other packaging materials, logos and concealment methods.

13.15.1 *Field-based instrumental analyses methods*

13.15.1.1 *Fourier transform infrared spectroscopy (FTIR)*

A new generation of field-portable FTIR technology has emerged which promises to perform semi-quantitative on-site analyses for illicit drugs and drug precursors. It is very

likely that this technology will soon replace the current methods that rely upon TLC which comparatively are time-consuming and have a number of inherent OH&S risks.

The 'Travel-IR' portable FTIR spectrometer, manufactured by Sens-IR in the USA and marketed in Australia by Perkin Elmer, has already been evaluated by AFP Forensic Services. The instrument is fitted with a diamond attenuated total reflectance (ATR) accessory that can be used to analyse a wide range of sample types.

Samples were obtained from the AGAL, consisting of AFP illicit drug seizures intercepted during the year 2001. The comparison of spectra obtained from heroin and MDMA illustrated the ability to definitively identify illicit drugs that have different molecular structures. Even though most drug seizures were mixtures, the illicit compounds remained identifiable for the range of drug purities tested. Further analysis is required to examine different drug mixtures, in particular the range of adulterants that are commonly found in street drug seizures, to assess the effectiveness of the portable FTIR to perform qualitative field-based analyses for illicit drugs and drug precursors.

13.15.1.2 Gas chromatography ion scan and gas chromatography mass spectrometry

Remarkable technological advancements have also seen the emergence of field portable GC ion scan and GCMS instruments. These instruments also promise to serve in the arsenal of instrumental techniques that could be utilised by forensic specialists to identify suspect substances in the field. A good deal of preliminary research is already well underway for the implementation of this technology in the forensic science environment. The combination of these technological advances are likely to dramatically reduce the time frame required to provide accurate preliminary identification to law enforcement. In the future this may well allow laboratory-based analyses to focus upon more strategic issues such as drug profiling.

13.15.1.3 Digital imaging

The use of digital imaging technology has already impacted upon all areas of forensic investigation, at the crime scene and in the laboratory. From August 2002 all AFP crime scene investigators will be using digital imaging as their primary imaging tool. Silver halide technology will have been effectively replaced by the CCD and the compact flash card. The result of this technology will again serve to reduce turn around times, and provide more information more rapidly to investigating police.

As with the implementation of all new technology such change will be accompanied by detailed methods and procedures as safeguards to ensure the integrity of this evidence.

13.15.1.4 Australian Illicit Drug Intelligence Programme (AIDIP)

In 1997 the Australian Government announced, as part of the National Illicit Drug Strategy (NIDS) and Tough on Drugs Program, the National Heroin Signature Programme. Funds were provided to the AFP to establish a strategic partnership with AFP Forensic Services and the AGAL, through its Australian Forensic Drug Laboratory (AFDL). The

purpose is to examine and interpret the chemical and physical aspects of heroin importations into Australia.

This programme is made up of four elements:

Signature 1 – HPLC. This involves the use of high pressure liquid chromatography (HPLC). This technique gives quantitative results for eight major compounds relating to heroin.

Signature 2 – GCMS. This involves the use of gas chromatography mass spectrometry (GCMS). This technique enables the determination of the area of production through the identification of 30 specific chemical markers, e.g. ‘plant cholesterol’ for South East Asian heroin.

Signature 3 – ICPMS. This involves the use of inductively coupled plasma mass spectrometry (ICPMS). This technique enables the identification of trace elements and is complementary to Signature 2.

Signature 4. The recording of the physical aspects of heroin seizures including point of entry, means of entry, concealment method, wrapping, packaging, drug form, markings/logos, shape, colour, odour, tool marks and weight.

The AFP established a joint drug intelligence team (JDIT) to support the NHSP in researching linkages between the chemical profiling of Signatures 1, 2 and 3 and the physical characteristics recorded by Signature 4.

The outcome of the JDIT is to establish a proactive approach to linking scientific information, data and operational intelligence. This in turn provides a collaborative intelligence database for interrogation by law enforcement and associated agencies, at a tactical and strategic level. In 2003, the programme expanded to include Signature Programmes for Amphetamine Type Substances and Cocaine.

13.16 Conclusion

Crime scene investigators who work in the federal jurisdiction of Australia provide a diverse range of forensic services to investigating Federal Agents, which includes both traditional crime scene investigation and, in addition, perform a unique role in drug operations. The more unique aspects of this work has been discussed. Controlled operations are a valuable tool to support the outcomes identified in the Australian Government, National Tough on Drugs Strategy, Supply Reduction programme. Many successful cases have been published in the mass media and also in police journals such as the AFP platypus.

The impact of new technology and the focus on intelligence-led policing strategies are transforming the role of the crime scene investigator in this environment. The challenge for forensic science has been to develop a new breed of crime scene investigators who possess the necessary scientific and technical skills to match these new roles.

A wide range of tools and materials are used in the deconstruction and reconstruction of illicit drug concealments and the AFP will provide further details to authorised law enforcement agencies upon request.

13.17 Bibliography

- Anon. (1984) *Skill Requirements and Basic Equipment for Narcotics Laboratories*, Division of Narcotic Drugs, United Nations, Vienna.
- Anon. (1986) *Recommended Methods for Testing Heroin*, Division of Narcotic Drugs, United Nations, Vienna.
- Anon. (1986) *Recommended Methods for Testing Cocaine*, Division of Narcotic Drugs, United Nations, Vienna.
- Dodsworth, A., Annie, L. A. and Pomeroy, M. (2002) *The Use of Field-Portable FTIR Technology for the Preliminary Analysis of Illicit Drugs and Drug Precursors*, A poster presentation at the 16th Australian and New Zealand Forensic Science Society's International Symposium on the Forensic Sciences held in Canberra between 13 and 17 May 2002.
- Evans, I. and Nelson, B. (2002) *National Heroin Signature Program*, A poster presentation at the 16th Australian and New Zealand Forensic Science Society's International Symposium on the Forensic Sciences held in Canberra between 13 and 17 May 2002.
- Forensic Services (2002) *Physical Evidence Section, Field Services Procedures Manual*, Australian Federal Police 2002.
- Government of Australia (1996) *Crimes Amendment (Controlled Operations)*, Parliament of the Commonwealth of Australia.
- Kerr, D. (1995) *Crimes Amendment (Controlled Operations) Bill, Explanatory Memorandum*, Parliament of the Commonwealth of Australia.
- Ridgeway v. The Queen (1995) Appeal to the High Court of Australia, **129** ALR 41; **69** ALJR 284.
- Weijenburg, R. (2000) *Cocaine Trafficking Towards and Within the European Union*, INTERSEC **10**(2), pp. 39–42.

The successful cases in which some of the techniques described in this chapter have been applied are described in detail in the following publications:

- Bennett, B. R. (1992) Operation Trumpet, *Platypus*, **35**, pp. 18–20, Australian Federal Police.
- Beveridge, J. (1993/1994) Operation Soy, *Platypus*, **42**, pp. 2–3, Australian Federal Police.
- Clark, E. C. G. and Moffat, A. C. (1986) *Clarks Isolation and Identification of Drugs*.
- Gillman, P. and Haman, P. (1987) *The Duty Men, The Inside Story of the Customs*, BBC, London.
- McQuillan, J. (1996) *Women of Substance*, ELLE October, pp. 47–50.
- Simpson, S. (1989) Operation Toggle, *Platypus*, **25**, pp. 13–15, Australian Federal Police.
- Simpson, S. (1995) Operation Flute, *Platypus*, **46**, pp. 20–1, Australian Federal Police.
- Torr, J. (1993/94) Operation Dogwood, *Platypus*, **42**, pp. 7–8, Australian Federal Police.

Clandestine drug laboratory investigations

John White

14.1 Introduction

During the past decade USA, Canada, Europe and Australia have each witnessed increasing trends in the use of illicitly produced drugs and substantial increases in the scale and diversity of illicit drug manufacturing laboratories. New Zealand has also experienced a considerable increase in illicit drug manufacture, with emphasis on 'home-bake' heroin (Bedford and Nolan, 1992), Cannabis L extracts (and products) and more recently amphetamines (Norris, 1995; Coxon, 1997–present).

Laboratories, which are established for the purpose of manufacturing illicit drugs and/or chemically related substances subject to legislative control, may be referred to as clandestine drug laboratories ('clanlabs'). Chemically related substances can include chemical precursors and drug intermediates.

Chemical precursors are key chemicals, which enter into chemical reaction with other essential chemicals, and as a result, become incorporated into the chemical structure of the finished drug product. Examples include phenyl-2-propanone and pseudoephedrine in the manufacture of amphetamines.

While some procedures employed in the manufacture of illicit drugs may involve relatively simple one-step chemical reactions, others may involve multiple steps, in which case drug intermediates are obtained. Generally, illicit operators prior to undertaking further stages in the production process attempt some isolation and purification of intermediates.

Legislative aspects of precursors, drug intermediates and drugs have been presented elsewhere (White, 1993) and will not be further expanded upon.

14.2 Variables associated with illicit drug production and scientific investigation

A dynamic and diverse range of manufacturing processes are currently applied to illicit drug production, as operators attempt to circumvent drug legislation and the reporting requirements associated with chemical and equipment purchases.

In general, illicit drug manufacturing processes can be categorised according to the following types:

- *Extraction*: Processes whereby naturally occurring drugs are isolated from raw plant materials using a wide range of chemicals, particularly solvents. Under these conditions the chemical structure of the drug remains unaltered, and examples include morphine from opium; hash oil from Cannabis L and cocaine from coca leaf. Currently there is a trend to extraction of drugs including pseudoephedrine and ephedrine from pharmaceutical products, as a preliminary step to the manufacture of methylamphetamine.
- *Conversion*: Processes, which aim at converting one form of a drug into another more desirable and/or saleable form. The fundamental chemical structure of the drug remains unchanged, and examples include cocaine hydrochloride to cocaine base ('crack') and refinement of methylamphetamine to a crystalline form ('ice').
- *Synthesis*: Chemical materials are combined through a chemical manufacturing process(es) to produce the desired drug type. Examples include methylamphetamine from phenylacetic acid, phenyl-2-propanone, pseudoephedrine or ephedrine; methylenedioxymethylamphetamine (MDMA, 'Ecstasy') from safrole; phencyclidine from piperidine; and heroin from morphine.

More specific details of synthetic-manufacturing processes are reported in the forensic literature (Frank, 1983; Frank and Sobol, 1990; White, 1993) and in a wide range of forensic journals.

While 'clanlabs' are generally characterised by the presence of relevant chemicals and manufacturing equipment, specific features can be extremely variable (White, 1993). As a result, illicit drug laboratories cannot be stereotyped (Frank and Sobol, 1990).

The type of drug manufactured can vary from amphetamines and other psychostimulants including methylenedioxymethylamphetamine (MDMA) and methylenedioxyamphetamine (MDA) through heroin, cocaine, Cannabis L products, phencyclidine, fentanyl, gamma-hydroxybutyrate (GHB) hallucinogens including lysergic acid diethylamide (LSD) to 'designer drugs'.

The term 'designer drug' has been coined to describe those drugs which are often manufactured from common chemical reagents and which are exempt from legislative control because of their unique chemical structure and skilfully marketed under attractive exotic names (Henderson, 1988).

It is important to note that a number of different drug types may in fact be manufactured at a single 'clanlab' site. The selected location for manufacture is highly variable as 'clanlabs' can be established virtually anywhere. Locations include private residences, garages and outhouses, motel and hotel rooms, flats and commercial establishments. 'Clanlabs' can be disguised behind legitimate business activities or secluded in

remote rural settings or in attics, basements or underground. Alternatively, they may be mobile and located in trailers, trucks, caravans, houseboats, etc.

Since there may be several chemical processes involved in the manufacture of a single drug type, it is also possible that these processes may be separated and undertaken at separate locations.

Most common manufacturing processes require a source of heat, and this may be supplied from a range of equipment including electric heating mantles, hot plates, oil baths or gas cylinders connected to gas ring burners. However, recently developed 'cold' methods have been encountered.

Cooling water is also frequently required, and in remote rural settings, this is obtained from dams or tanks or through recirculation of ice-cooled water.

A number of different methods of varying complexity can be available for the production of a single drug type. Drug-manufacturing procedures ('recipes') can be obtained directly from the published scientific literature or alternatively, be passed on through a range of underground publications, the Internet, or through verbal or written instructions from associates.

It is also common practice for the manufacturer of an illicit drug(s) to commit a method(s) to memory as a result of experience gained through practice.

Manufacturing processes can be relatively straightforward, requiring only crude, makeshift chemical processes, or involve sophisticated technology and a number of advanced scientific concepts and procedures.

Process selection can reflect the illicit demand for a particular drug type, the operator's competency in chemistry, a desire to avoid chemicals which are subject to legislative control, likely to arouse suspicion when purchased, likely to create fire or other health hazards, or difficult to obtain.

While most illicit operators generally attempt some form of separation and/or purification of stable drug intermediates and final products, a range of impurities are frequently detected in reaction mixtures and illicitly produced drugs obtained from 'clanlab' sites. The presence of impurities distinguishes illicitly produced material from pharmaceutical-grade counterparts and can often benefit forensic specialists in characterising the method of manufacture.

Manufacturing equipment varies from crude arrangements employing common kitchenware and appliances to sophisticated chemical apparatus, which is either purchased or 'home-made'. Selection depends on the expertise and ingenuity of the operator(s), the scale of production or the operator's desire to avoid purchasing chemical equipment, which could arouse suspicion. There is a trend to large-scale 'home-made' metal apparatus in Victoria, in addition to the scientific glassware traditionally used.

Scale of production can vary from small-scale production for 'home-use' to large-scale commercial undertakings with the capacity to produce large kilogram quantities for established illicit markets.

Expertise of the operator varies from the complete novice, through qualified scientists to highly experienced operators. One could reasonably expect that a novice will simply follow verbal and/or written instructions until familiar with a process. More experienced operators should appreciate chemical principles involved in a process and thus be able to improvise to enhance the scale and efficiency of production and the purity of the finished product.

Experience is also reflected in the chemical process selected, the degree of sophistication of the manufacturing equipment, the nature of scientific literature and handwritten notes available, the ability to produce 'designer drugs' or the ability to adapt a process should particular chemicals be unavailable.

Law enforcement personnel detect illicit drug laboratories as a result of planned investigation or through accidental discovery. In either event, intervention can result in the discovery of non-operational laboratories including packaged, fire-affected and previously used sites or, alternatively, fully operational 'clanlabs' covering the diverse range of possible production stages. The nature of available scientific evidence can therefore vary extensively depending on the time of intervention.

14.3 Safety issues

Since 1990, there has been a substantial increase in the number, nature and scale of 'clanlabs' detected throughout Australia.

Influencing factors include increased marketing and demand for illicit drugs, focused law enforcement supply reduction strategies aimed at confiscating illicit drugs at the source (i.e. the 'clanlab'), increased national and international awareness and cooperation between both law enforcement and forensic services, increased cooperation between law enforcement and legitimate commercial suppliers of chemicals and chemical equipment leading to the introduction of a 'Code of Conduct', and the use of a wide range of law enforcement techniques and procedures aimed at enhancing detection.

With increasing rates of detection, more investigators throughout Australia and New Zealand are now entering potentially hazardous 'clanlab' environments.

Clandestine laboratory operators generally have little or no scientific education and little appreciation for their own safety, the safety of others (neighbours, investigators, end-users) and the environment. As such, a combination of disarray, drug-related, poisonous, corrosive, flammable/explosive chemicals and potential ignition sources (including naked gas flames and 'home-made' heating appliances) are frequently encountered at 'clanlab' sites.

In the mid-1980s a clandestine laboratory situated in rural Victoria caught fire, reportedly causing extensive burns to the operator. This incident would possibly have resulted in serious injuries to investigators should they have entered the premises immediately prior to the fire, and in a more recent case, a fire severely damaged a suburban residence and an operator was again reportedly injured.

A significant number of structural fires continue to result from the accidental ignition of flammable solvents and vapours associated with illicit drug production in the United States (Kirk, 1990).

Heat generated in 'clanlab' fires can also result in chemical conversion reactions, posing additional threats to investigator's safety. For example, when red phosphorus (itself a pyrotechnic) is heated, it can convert to highly reactive white phosphorus. Red phosphorus may also be converted to highly toxic and explosive phosphine gas under certain reaction conditions.

In addition to the above, the majority of 'clanlab' chemicals and reaction mixtures are usually located in unlabelled, open containers. Since the chemical nature of these substances is often unknown to investigators at the time of entry into a 'clanlab', so too

are the potential health and safety risks associated with inhalation, skin-absorption and ingestion.

Experience gained in the United States and elsewhere, clearly demonstrates that, as stricter controls are placed on the supply of commonly employed chemicals/equipment, determined 'clanlab' operators seek out and adopt highly novel manufacturing procedures, often with dire health and safety consequences.

In Australia, the application of hazardous chemical processes is on the increase and can present additional safety risks for investigators. Of growing concern is the generation of highly toxic gases including hydrogen sulphide ('rotten egg gas'), hydrogen chloride and hydrogen iodide, and the potential to produce phosphine. Also, the application of reductive processes involving highly flammable hydrogen gas, and use of chemicals (including benzene and safrole), which are reportedly carcinogenic, present an additional hazard.

While the application of novel manufacturing processes may at first be region-specific, once mastered, 'underground' scientific procedures rapidly traverse state and international boundaries. This trend away from conventional procedures means that investigators are becoming increasingly reliant on rapid information exchange with colleagues at state, national and international level.

14.4 Safety education and training programmes

As a means of protecting the health and safety of investigators, the Office of Training, United States-Drug Enforcement Administration (US-DEA) provides safety/investigative training for specialist 'clanlab' investigators.

Under current US-DEA protocols, investigators cannot enter suspected 'clanlab' sites without essential safety certification training, comprehensive medical assessments and ongoing medical monitoring.

Since 1992, the VFSC has received a series of grants from the National Drug Crime Prevention Fund (NDCPF), an initiative of the National Drug Strategy, to study US-DEA training philosophy and programmes as a prerequisite to preparing and presenting safety training courses to meet Australia's specific needs. These 'train the trainer' courses, for specialist drug law enforcement and forensic personnel, place the onus on attendees from the Australian states/territories and New Zealand to develop and introduce appropriate safety training programmes in their respective regions. Due emphasis is placed on National Best Practice Guidelines for Environmental Health and Safety (Brammer *et al.*, 1994). These Guidelines are currently being re-drafted into a more prescriptive National Action Plan for Clandestine Drug Laboratories.

The above series of national safety/investigative training courses aims at protecting the health and safety of investigators through deployment of safety certified personnel (both law enforcement and forensic science specialists) at suspected 'clanlab' sites. These investigators should receive regular medical monitoring and be proficient in the selection, use and maintenance of personal protective clothing, respiratory protection and air-monitoring equipment.

Adherence to safe operating procedures, in accordance with National Best Practice Guidelines, is essential to the safe conduct of clandestine laboratory investigations.

14.5 Investigative aspects

In the case of an accidental discovery of a clandestine laboratory, the aim is to rapidly convert the unplanned event into a planned investigation. Under these circumstances, local police are expected to immediately remove any suspect(s) from the premises, isolate and maintain a safety perimeter at the site, preserve the scene and notify both the lead state agency (drug squad) and the appropriate forensic 'clanlab' service. Based on forensic assessment and advice, it may be necessary to consider evacuation of neighbours and have local fire and ambulance services either on standby or in attendance.

To maximise the safety of all concerned, local police should not handle, move, disconnect, deactivate or operate anything within the laboratory environment. On arrival, the lead agency, in close consultation with forensic 'clanlab' specialists, should take responsibility for site control and the ensuing investigation.

Despite the dynamics and diversity of illicit drug production, planned 'clanlab' investigations generally follow a set format of phased investigatory procedures, with key elements comprising intelligence gathering, planning, entry, safety assessment, evidence processing, exit and follow-up (Podkowa and Skinner, 1994). This delineation enables specialist investigators to follow standard operating procedures aimed at addressing investigative and safety issues during each phase.

The highly chemical nature of illicit drug production dictates heavy reliance of law enforcement personnel on the impartial authoritative judgements of specialist forensic 'clanlab' investigators at each phase of an investigation, in the forensic laboratory and in the courts.

During the intelligence phase, forensic specialists are frequently requested to assess and provide expert opinions based on chemical intelligence obtained through informers, the 'Code of Conduct' with legitimate commercial suppliers of chemicals and/or equipment and from other sources.

At this stage suspected 'recipes' and/or suspected 'clanlab' samples (comprising chemicals, chemical reaction mixtures or powdered drugs) may be submitted for the purpose of forensic examination and expert advice.

Depending on the nature of available intelligence, forensic experts may be able to formulate opinions regarding the possibility of illicit drug production, drug type(s) involved, likely manufacturing process(es) and potential hazards, potential scale of production, possible stage of production, further chemicals/equipment required to complete a process and estimated time for completion of the process.

The above authoritative advice can impact appreciably on further law enforcement involvement, particularly in regard to resource allocations and appropriate time for intervention.

Based on available chemical intelligence information, forensic specialists may be able to advise law enforcement teams of specific scientific safety considerations during the planning and entry phases of an investigation.

Once law enforcement personnel have secured a suspected 'clanlab', forensic specialists should be readily available to assist the appointed site safety officer with site safety assessment. The site safety officer should be responsible for establishing a record of those entering/exiting the site, for establishing hot, warm and cold safety zones and the decontamination station. Those entering and/or exiting the site (including suspects) should pass through decontamination.

Site safety assessments should only be conducted by safety-certified personnel wearing designated levels of personal protective clothing and respiratory protection. Forensic specialists should assist the site safety officer by monitoring the air inside the laboratory to determine oxygen and flammability levels and the nature and levels of toxic chemicals present in the atmosphere. Results should be recorded on appropriate forms. During this phase, operational drug-manufacturing processes are deactivated (Frank and Sobol, 1990), potential chemical and physical hazards are identified, rated and systematically remedied, and the laboratory is ventilated when deemed appropriate. Physical changes associated with site safety considerations should be recorded.

Site safety assessment is an ongoing requirement, which continues throughout the remaining phases of the investigation.

The site safety officer consults appropriate expertise during the safety assessment phase and then determines when the crime scene investigators can begin the evidence-processing phase. Whenever practical, forensic 'clanlab' specialists should attend and take responsibility for examining chemically related materials suspected of use in illicit drug manufacture. General forensic crime scene examiners should assist with overall scene searches and in the identification of evidence, which may be related to other enquiries.

In Victoria, forensic 'clanlab' specialists routinely attend suspected 'clanlab' sites. Initially, they will record relevant site details and oversee photographic and/or video recording of relevant chemical items *in situ*. Appropriate care should be taken to protect supporting personnel and equipment from chemical contamination.

Ideally, fingerprint examinations should take place inside the laboratory; however, for safety reasons, this may not be possible and items may need to be carefully transferred to the warm zone under scientific supervision. At large-scale illicit laboratories it is far more efficient to employ two fingerprint examiners.

As fingerprinting of individual chemically related items is completed, these items can be photographed against identifying labels. The forensic specialists can assist drug squad property officers in describing and recording scientific items and respective locations. An option, which is currently employed in Victoria, is to convey all scientific evidence to a sampling and transfer station at the Victoria Police Forensic Science Centre (VPFSC). Fingerprinting is then undertaken in a controlled environment under direct supervision of one of the forensic specialists.

Legal definitions of manufacture need to be considered when determining the relevance of scientific materials, since definitions may be jurisdiction specific. Any suspected precursors, essential chemicals, reaction mixtures and finished products (in both liquid and solid forms) should be taken for subsequent forensic analysis. The results of subsequent scientific tests, including the characterisation of impurities, can be used to establish the manufacturing process.

Under occupational health and safety legislation, it may be necessary to retain samples for analysis and arrange for supervised transportation and destruction of the bulk of material by qualified hazardous waste contractors. Preliminary scientific tests may be performed on solids, liquids and gases at the site, to assist the sampling process. Results of these tests should be recorded. Whenever samples are taken these should be clearly labelled and may be photographed in company with the parent item. Scientists should be responsible for maintaining supplies of appropriate sample tubes and containers required for safe transfer and transport of items retained for scientific testing.

The total volumes and/or masses of suspected precursors, essential chemicals, mixtures and drugs should also be recorded. This is particularly important in regions where prima facie traffic and commercial quantity provisions apply to legislation. These quantities, together with the capacity of equipment, can also be used in estimating the scale of production and the manufacturing potential of an illicit laboratory.

Relevance of scientific equipment and 'recipes' can be assessed following forensic analysis of chemically related items. Forensic document examiners may also be requested to examine any handwritten notes and other documentation. Further descriptions of forensic analysis, together with reporting and court testimony issues, have been reported in the literature (Frank and Sobol, 1990; White, 1993).

On completion of the processing phase, forensic scientists often assume a number of advisory roles throughout the exit and follow-up phases. Compliance with both occupational health and safety and dangerous goods legislation is essential and the forensic scientist can generally advise on safe packaging, transport, storage and destruction requirements.

When premises and/or surrounding environs are heavily contaminated with hazardous chemical wastes, forensic scientists need to consult with local health authorities and the environmental protection authority.

14.6 Conclusion

Effective health and law enforcement strategies aim at reducing the supply of illicit drugs at the source (i.e. the clandestine laboratory), with a reliance on forensic specialists to provide a broad range of scientific advice regarding legislative, 'Code of Conduct', health, safety, intelligence and training issues. In addition, forensic experts are required to impartially examine suspected 'clanlab' sites, collect and examine a complex range of relevant materials and present authoritative expert evidence in the courts.

The dynamic and diverse nature of illicit drug production traverses state and national boundaries, challenging health, law enforcement and forensic services and highlighting the need for continuous state, national and international cooperation.

14.7 Acknowledgements

The author wishes to acknowledge the Office of Training, United States-Drug Enforcement Administration (US-DEA), Quantico, Virginia, USA, for outstanding input into the training of clandestine drug laboratory specialists (both law enforcement and forensic personnel) throughout Australia and New Zealand. Specific thanks go to Special Agents Debbie Podkowa and Mike Cashman and to Forensic Chemists Harry Skinner, Roger Ely and Terry Dal Cason.

The author also clearly acknowledges the National Drug Crime Prevention Fund, an initiative of the National Drug Strategy, for funding the national safety training courses for clandestine laboratory investigators.

14.8 Bibliography

- Bedford, K. R. and Nolan, S. L. (1992) *Personal Communication*, Institute of Environmental Science and Research, Auckland, NZ.
- Brammer, M., Barnsley, R., England, B., White, M. J., *et al.* (1994) in Dolan, J. (ed.) *National Best Practice Guidelines for Environmental Health and Safety: Clandestine Drug Laboratories*, An initiative of the National Drug Strategy Committee developed by the National Investigation and Safety Workshop Group and resourced by the National Drug Crime Prevention Fund, Australia.
- Coxon, A. (1997–present) *Personal Communication*, Institute of Environmental Science and Research, Auckland, NZ.
- Frank, R. S. (1983) The clandestine drug laboratory situation in the United States, *Journal of Forensic Sciences, JFSCA*, **28**, 18–31.
- Frank, R. S. and Sobol, S. P. (1990) Clandestine drug manufacturing laboratories, in Maehly and Williams (eds), *Forensic Science Progress*, 4, pp. 1–23, Springer-Verlag, Berlin.
- Henderson, G. L. (1988) Designer drugs: past history and future prospects, *Journal of Forensic Sciences, JFSCA*, **33**, 568–75.
- Kirk, P. L. (1990) Chemical fires and hazardous materials, in De Haan, J. D. (ed.), *Kirk's Fire Investigation*, 3rd edn, pp. 261–4, Brady, A Prentice Hall Division, New Jersey.
- Norris, R. (1995) *Personal Communication*, Institute of Environmental Science and Research, Auckland, NZ.
- Podkowa, D. and Skinner, H. (1994) *Personal Communication*, United States Drug Enforcement Administration, Dept of Justice, USA.
- White, M. J. (1993) Scientific aspects of illicit drug manufacture, in Freckelton and Selby (eds), *Expert Evidence*, 3, pp. 7-901–7-1081, Law Book Company, New South Wales, Australia.

Fire and explosion scene examination

Peter Thatcher and John Kelleher

15.1 Background

Fires and explosions are phenomena with a similar chemical and physical basis for ignition and propagation. Therefore, it is not surprising that explosions often result in fires and, conversely, fires can result in major or minor explosions. Both types of incidents have the potential to result in major incidents involving loss of life and severe property damage.

As a result, scene investigations are often dangerous, protracted and conducted under intense media exposure.

Regardless of which service attends the scene initially, the objectives must be to tend to those requiring assistance and to reduce the potential for further injury and/or damage. Unfortunately, this can often endanger valuable physical evidence.

It is therefore important that members of the emergency services are aware of, and use, techniques which are not only effective, but avoid unnecessary damage to the structure and surrounds.

15.2 Scene security

Once a scene is rendered safe, the examination for evidence of cause can commence. This can range from a comparatively simple task where the scene or damage is minimal, to the most complex problem involving searching grids, large numbers of searchers, sieving apparatus, etc.

In the case of explosions, the secured area must comprise both the primary recovery zone and the buffer zone. The primary recovery zone will extend to the position of the furthest projected fragment or point of blast damage (whichever is the greatest), while the buffer zone should exceed this distance by one half, in order to allow for initial underestimation and to limit the potential for damage to, or removal of, physical evidence.

In some cases, particularly where there are directional aspects to the explosion, the secured area might not be circular. Also, it may be appropriate in some circumstances, to limit the size of the buffer zone or to reduce it at selected points. This could be justified if, for example, a small reduction in the buffer zone would allow a railway line to operate or where the effects of an explosion have been partially confined in a structure.

In the case of fires, the scene boundaries are somewhat easier to define. For fires in structures, the entire building should be preserved because evidence of secondary fires or unactivated time-delay ignition devices could be present. Similarly, for fires in ships, vehicles, caravans, etc. the scene boundaries are generally obvious after considering the damage and circumstances.

15.3 Health and safety issues

Prior to any scene examination, a safe work environment must be established (see Figure 15.1). For scenes involving explosions where it is not immediately obvious that the cause was accidental, trained bomb technicians must render the scene safe and



Figure 15.1 The clearing and searching of fire and/or explosion scenes requires individual assessment and appropriate action. However, in each situation, the potential for contamination and disturbance must be carefully considered. In this particular instance, the potential for sample contamination with petroleum products was high but unavoidable given the amount and nature of the materials which needed removal prior to the examination of the diagnosed fire starting point

determine whether other devices or loose explosives may be present. In both fire and explosion scenes, the danger of structural collapse must always be considered.

Protective clothing, including helmets and suitable footwear, is essential. In the case of footwear, leatherwork boots or rubber boots with steel sole inserts are necessary if injuries from nails, etc. are to be avoided.

A major hazard in the examination of fires and explosions in structures is the threat of injury caused by falling masonry. While a safety helmet will protect the head, there is still considerable risk to the back and shoulder areas, particularly during excavations.

Similarly, damaged flooring presents a safety hazard. While the danger of falling through floors is obvious, there is an increased hazard when cellars and basements are present. Also, after fire fighting operations, these subterranean rooms can fill with water thus posing an additional hazard for investigators encumbered with protective clothing.

Once the examination commences, specialist expertise will be required to investigate the cause of the incident. However, these investigators must always be aware of the possible presence of more orthodox scene evidence such as point-of-entry evidence, shoe impressions, fingerprints, blood stains, etc. As a consequence, all fire and explosion scene investigators should have general crime scene training and experience in addition to their particular field of expertise. This makes an appropriately qualified and experienced crime scene investigator ideal for development in fire and explosion scene investigation.

15.4 Fire investigation

Most fire scenes are investigated to ascertain the starting point of the fire and the fire cause. Other interested parties, such as insurance agencies may be interested in property and contents damage while scientific investigators could have an interest in the fire characteristics and behaviour and would therefore investigate the structure, materials, flammability, etc. Because this chapter is written in the context of crime scene investigation, the remainder of this section will concentrate on the starting point and cause aspects of fire investigation.

15.5 Scene recording

The importance of accurate scene recording of fire scenes, as with all (potential) crime scenes, cannot be overemphasised. Records will normally include notes, sketches, photographs and, under certain circumstances, video taping. It is important that both still photographs and video are obtained over scene from either a plane, helicopter or 'cherry picker'. The choice of which is very much scene-dependent.

The style used for notes and sketches can be according to personnel preferences, so long as all relevant information is included.

A most convenient method of recording the damage is to construct a 'Fire Travel Map'. To do this, the severity of damage is represented by a series of cross-hatched lines across a plan of the premises, with an increase in the density of cross-hatching illustrating an increase in the severity of damage. Included in this map will be holes in the flooring and other aspects of the damage, which are considered relevant to the fire intensity and travel.

Depending on the complexity and/or severity of the fire damage, it may be convenient to construct individual maps in the form of overlays for the roof, walls and floor. If these maps are constructed accurately, fire loads and starting points are often graphically illustrated.

15.6 Scene examination: preliminary

Before proceeding to a detailed examination of the scene, a preliminary examination should be conducted. This should commence with an inspection of the exterior of the structure and serves several purposes. First, valuable information concerning the structure, which is not easily obtainable from the damaged interior, can be recorded and assessed. This includes building materials and mode of construction, both of which influence flammability and therefore fire behaviour, which determines fire travel.

Second, some of the recognised fire travel indicators, such as lowest point of burning, are more obvious on the exterior of the structure and noting this can often assist in locating the starting point of the fire without excavating the entire interior of the structure.

The preliminary examination should also include general photographs of the damage. These photographs should depict *all* the external damage. If the structure is large (a factory, warehouse, school, etc.), arrangements should be made to photograph the roof from above the structure if possible. These photographs often illustrate, quite graphically, fire loads and starting regions, which are not easily seen from inside the structure.

Assuming that all local policies and procedures have been met, the scene is now ready for a detailed inspection.

15.7 Scene examination: location of probable starting point

The examination will generally commence at a region of least or no fire damage, and will proceed towards areas of most intense damage whereupon the sector will be complete. Upon reaching this area, the examination should then recommence, again at an area of least or no damage and proceed until the sector is completed. During this examination, the 'Fire Travel Map' should be continually updated. Again, relevant photographs should be taken of significant damage. Occasionally, there are areas that are significant due to their lack of damage. These areas should be similarly recorded and photographed.

Generally, the area sustaining the most damage will be diagnosed as the approximate starting point. There can, however, be very significant exceptions to this, which can be explained by fire load, flammability, fire fighting (or lack of) operations, weather conditions, etc. If this situation exists, then the justification for the interpretation must be detailed and the areas extensively photographed because this is the basis for most disagreement occurring amongst individual fire investigators.

Notwithstanding the exceptions mentioned above, orthodox fire investigation techniques are primarily based on the premise that the most damage will occur where a fire has burnt for the longest period. The longest period must relate directly to the

starting of the fire and this then logically justifies the premise and also the procedure outlined briefly above which is used to diagnose the starting point of the fire.

The actual 'fire travel indicators' such as lowest point of burning, deepest burning, number of fire seats, holes in flooring, etc. are well documented in many books devoted to practical fire investigation and do not need further description here. However, it is important to note that these indicators have explanations other than those commonly accepted and applied as evidence of fire travel. For example, a fire, which has started above floor level and has spread to the ceiling, may cause curtains to burn and fall to the floor.

This will then represent the lowest level of burning but certainly not the starting point of the fire. Therefore, these 'indicators' must be regarded as no more than that.

Also, and this is particularly the case for large and complex fire scenes, several of the 'fire travel indicators' may be contradictory. Obviously, in this situation a 'fire travel indicator(s)' has been either misinterpreted or is irrelevant to the situation for some reason.

A further complication arises because fire investigators have individual preferences as to the significance of particular 'fire travel indicators'; that is to say, greater reliance is placed on particular 'indicators' than others. There can be no general agreement on this: It is a personal decision based on expertise. The significance of spalling in concrete is a good example where investigators debate the significance of this 'indicator'. As a result, fire scenes can be interpreted differently by different fire investigators, but in most instances a common fire starting point will still be diagnosed.

15.8 Evidence of fire cause

15.8.1 *Samples containing petroleum residues*

After the diagnosis of the probable starting point, a search is undertaken for the probable fire cause. In the case of deliberately lit fires, and particularly those, which have been assisted with flammable liquids, this is often a fairly easy task. Tongue-and-groove burning in floorboards, liquid 'splash' burns in carpet (see Figure 15.2), heavy sooting, holes in floors with a 'V' shape cross-section, characteristic petroleum-type odours and unexplained containers are all indicators of the possible involvement of a flammable liquid and, by inference, a deliberately lit fire (see later discussion on reporting).

Adequate samples of approximately 0.5 square metres should be taken for subsequent testing at the laboratory. A larger sample size may be necessary if it is suspected that only a very small amount of hydrocarbons may be present. In the case of timber, soil or debris, approximately 2.5 kilograms should be sampled, again depending on the degree of damage.

Such a conclusion could be based on an observation that the sample is so heavily burnt that only a small amount of hydrocarbons could be expected to remain or that the sample is relatively undamaged suggesting that if flammable liquids were present, and then only a small amount must have been present.

Because pyrolysis products can be coextracted along with any fuel residues in the laboratory (as will natural products such as lanoline from woollen carpet underlay, terpenes and pinenes from wooden floorboards, etc.) the identification of fuel residues can be quite complicated. Therefore, it is advisable to take reference samples of material



Figure 15.2 Burn patterns in carpet is the most valuable indicator of the involvement of flammable liquids in fires. However, there are several other potential causes for these patterns including, burning materials falling to the floor, 'shadowing' by items on the floor and burning characteristics of some types of carpet materials. In this example, all alternatives other than the presence of a flammable liquid were eliminated, and the sample was subsequently found to contain petrol

from areas where it can be positively established that no petroleum fuels had been present before the fire.

15.9 Packaging

The method of packaging of samples are an individual decision. Some laboratories still use glass jars and, although these do provide an excellent seal, they are bulky and heavy and are obviously fragile. Other laboratories use cans. The disadvantages of these containers are their bulk and unreliable seals. Also, when glass and other debris scratch the inner surface of the cans, corrosion can cause holes in a very short time.

An advantage, however, is the fact that they can be easily modified at the laboratory to become part of the extraction procedure. In fact, samples need not be removed at all from cans if certain types of extraction techniques are used.

Most agencies now use synthetic bags for collecting samples. The construction of the bags varies depending on availability but mostly a type of 'oven/freezer bag' is used. Unfortunately, nails, etc. present in samples easily tear these bags. This can be overcome

by inserting a polyethylene bag into the ‘oven/freezer bag’ prior to sampling. In this situation, the ‘oven/freezer bag’ provides the impermeable barrier while the polyethylene bag provides the strength. Note that polyethylene bags alone are not suitable because hydrocarbon vapours can easily permeate polyethylene.

15.10 Other evidence

Should the cause of the fire, or the circumstances surrounding it become suspicious during the investigation, then consideration should immediately be given to the possible point of entry and any associated evidence. This could include the necessity for the attendance of a fingerprint examiner or other specialist crime scene investigator. At this stage, the scene has become far more generalised and, although fire investigation expertise is still vital to the examination, other areas of expertise have also become necessary.

Other obvious evidence of intent, e.g. the presence of time-delay ignition devices, is also occasionally revealed. The range of such devices extends from very simple candle-based devices to sophisticated electrical- or chemical-based devices (see Figure 15.3).



Figure 15.3 The use of commonly available materials to construct home-made incendiary devices is often regarded as of nuisance value only. In this particular device, constructed with ‘pool chlorine’ and brake fluid, the destructive force and resultant incendiary effects are dramatically illustrated

If multiple devices have been used, damage can be intensive and extensive, and great care must be used in examining the debris in the area of the diagnosed starting point. On occasions, multiple devices have been employed that have been constructed without consideration of a common ignition time. As a result, some fires will be extinguished (or self-extinguish) before other devices have ignited. This then gives a good indication of what should be present in the debris, and searching can become somewhat more focused.

In these situations the devices are usually based on a burning candle, cigarette or other item with an unreliable burning rate. With this in mind, great care must be taken when offering opinions of the burning times of candles, etc. which is sometimes necessary where investigation into an alibi is required.

15.11 Accidental fires

When fires are caused accidentally or are the result of some degree of negligence, relevant evidence and opinions are usually less obvious than is the case with intentionally lit fires. In fact, there is often no evidence other than the 'fire travel indicators' which are indicators of fire travel, not fire cause. In such situations, only opinions can be given concerning possible or probable fire causes. Because opinion evidence is the realm of the expert, and because fire causes cannot be diagnosed without an inspection, it logically follows that fire scene examinations must be conducted by 'experts'.

Of course, fires can be deliberately lit in such a way that a careful scene search will not reveal any direct evidence as to the cause.

A simple example is the deliberate ignition of available materials with a cigarette lighter. In this instance, the diagnosis of the probable cause, in the absence of any physical evidence, is usually by means of elimination of all other possible causes. Solving the fire in this way is logical and scientifically justified.

Similarly, fires of electrical origin are often diagnosed by circumstantial evidence, i.e. the position of the seat of the fire, the presence of electrical wiring and componentry in this area, the apparent time of burning, etc. Often, no samples will be taken, as their relevance is unclear. This is particularly so in the case of fused wiring. Even though it is a comparatively simple task to determine whether a particular piece of wiring was fused by an electrical overload or by the heat generated by a fire, the fact that the fusing caused the fire, or the fire caused an electrical short circuit which caused the fusing is often indeterminable. As a consequence, most serious fire scenes in buildings, which are supplied with electricity, will have electrical wiring, which has been fused by an electrical short circuit, whether or not the fire is electrical in origin.

Some recent studies suggest that oxygen levels in the fused wiring will provide answers to this dilemma. Although this could possibly provide another 'fire travel indicator' for consideration, the method does require sophisticated metallurgical examination and the interpretation is certainly not beyond dispute.

Other fires, such as those caused by malfunctioning machinery do occur. Hopefully, no fire cause diagnosis will be offered in the absence of a sound theoretical basis, and in some instances, this diagnosis can be supported, but not necessarily confirmed, by off-site testing. In the case of large machines, this may be entirely impractical, and the

opinion will be based on a theoretical basis supported by the fire starting point and the elimination of all other explanations.

A similar logic applies to fires, which occur as a result of self-ignition ('spontaneous combustion'). Again, there must be some physical evidence uncovered which explains the biological and/or chemical activity that has occurred and which resulted in the production of sufficient heat to cause the fire. For the well-recorded example of fire in haystacks, it is relatively easy to track the progress of the fire back into the interior of the stack and eliminate any other cause by the sheer inaccessibility of the starting point. This, coupled with the well-recorded, heat-producing biological activity (and subsequent chemical activity) in grass and hay, determines that any such fire can only be the result of self-ignition. Other examples involving drying oils and paints, etc. are less obvious but the principle remains the same.

15.12 Reporting

All agencies will have reporting requirements, which are based on many factors ranging from legislation to the aesthetics of presentation. However, there are some philosophical aspects of reporting which should always be considered.

The information provided in this section should allude to the fact that most fire investigation is purely opinion based. Although there may be laboratory results, which support the conclusions, the diagnosis of both the starting point and the cause of the fire, nevertheless, are opinions. This should be reflected in any reports, statements, etc. which refer to the fire cause, and a clear distinction must be made between fact and opinion.

Similarly, unless there is indisputable proof of intent, there should be no reference to intent or insinuations of intent. This proof could be in the form of a time-delay ignition device or multiple and unconnected seats of fire, but the presence of fuel residues, although certainly suspicious in nature, is not in itself proof of intent because other explanations for their presence are possible although, perhaps, less likely.

As a consequence, if the expression '...the fire was started...' is used, the writer must be acutely aware of the inferences so contained. On most occasions, the expression '...the fire started...' is more accurate and certainly less biased.

Any opinions as to intent are more appropriately addressed during examination in a conference or courtroom situation when qualifications and alternative explanations can be expressed.

15.13 Explosion investigation

Explosion scenes, particularly bomb (improvised explosive device) scenes, are possibly the most challenging scenes encountered by the crime scene investigator. In addition to the complexity created by physical effects similar to those encountered in a natural disaster, most of the critical evidence is fragmented or distorted. The scientific and technical demands of device reconstruction and explosive residue analysis require as much or more expertise as other types of major criminal investigation. Most scenes will

therefore be investigated by a team of investigators, all of whom are experts in their individual fields.

A typical team for a scene investigation could comprise:

- team leader
- post-blast consultant
- forensic chemist
- photographer
- crime scene searchers
- evidence recorder.

In less significant incidents, these roles may be combined, so that the team will be considerably smaller. Conversely, in a major incident, this may represent the composition of one of many sub-teams, with additional specialists co-opted as necessary. These additional specialists may include:

- engineers
- surveyors
- architects
- pathologists
- audio-visual operators
- biologists.

Although the roles of these team members are to some degree self-explanatory, three roles require further elaboration.

Post-blast consultant: This person will be experienced in the use of explosives, particularly in the use of explosives against target structures. They must be familiar with the effects of a wide variety of explosive types, military, commercial and improvised, and be able to discriminate rapidly between direct explosive effects and the results of fire, impact or structural collapse.

Since an explosion is not necessarily the result of the detonation of a high explosive charge, the consultant must have a good knowledge of other explosion mechanisms, such as fuel-air and mechanical explosions, and be able to clearly identify the distinguishing features of these in the immediate aftermath of the incident. The post-blast consultant will advise the team leader as to the explosion type and where appropriate, the charge size, possible explosive type and charge placement.

Forensic chemist: The major role of the forensic chemist is to collect appropriate samples for laboratory analysis, to enable the explosive components to be identified. This is a task, which is ideally conducted by the explosives chemist who will perform the analysis, since that person has the best knowledge of what sample collection techniques, control samples and sample sizes are appropriate.

Crime scene searchers: Since in explosion scenes, the physical condition of significant evidence may be drastically altered, it is important that the searchers be able to recognise a fragment of bomb casing, to distinguish between detonator lead wires and household wiring, and identify unconsumed explosives, to list several requirements. The circumstances

of many explosions will also be that disaster victim identification procedures will be in operation, and they should be well versed in these also. Crime scene investigators who are tasked with this role must be ‘bomb scene examiner’ trained and experienced.

15.14 Explosion scene examination objectives

As a consequence of the trauma and confusion present at the scene of a major explosion, working under the pressure of media exposure and public concern, the explosion scene examination team must have clear objectives and remain focused on those objectives. These objectives may be expressed as:

- determination of the cause of the explosion;
- collection of evidence as to the nature of the explosion;
- provision of scientific and technical advice to the incident investigators (i.e. to the senior investigating officer in charge of a criminal investigation, as distinct from the scene investigators); and
- reconstruction of any improvised explosive device.

15.15 Explosion scene searching

The post-blast consultant must gain a rapid overview of the whole scene, with particular emphasis on the type of damage to structures, the progressive nature, if any, of blast effects, the extent of fragment damage and of fire damage. The most significant fact to be determined in a major explosion is whether the incident resulted from a dispersed or a concentrated explosive.

Dispersed explosions are characterised by:

- absence of an obvious blast seat;
- extensive fire damage subsequent to the explosion;
- minimal fragmentation; and
- widespread low-blast pressure effects, such as ceilings lifted, window frames pushed out and walls pushed over.

Identification of some or all of these indicators may enable an explosion to be rapidly classified as a dispersed explosion. While this may still be a criminal act, it may also be an industrial accident, a gas leak or other fuel spillage, and public concern may be allayed. In these circumstances, the explosive effects are, to some extent, incidental to the fire effects, and the investigation will essentially proceed as for a more conventional fire investigation.

Concentrated explosions are characterised by:

- shattering damage, such as holes blown in brick walls, frames broken rather than bent or split;
- penetration of relatively substantial material by high velocity fragments;

- cratering of the ground or floor;
- blast-affected materials, with gas wash and thinning effects characteristic of intimate contact with high explosives; and
- target-related factors, which may influence the probability of a terrorist or criminal attack.

Concentrated explosions, whether fully confined, as in the case of a pipe bomb or item of military ordinance, or unconfined, as may be the case with commercial explosives, present a radically different view to the initial inspection, provided the evidence has not been obscured by a subsequent fire.

15.16 Search patterns

Given that the explosion has been determined to be a concentrated explosion, the team leader should plan a search to use the physical features of the scene to best advantage.

In a building, the individual rooms or floors make natural, albeit irregular, grid zones. In an outdoor setting, roads and paths, fences, property boundaries and building lines provide zone markers. Depending on the scene, it may be appropriate to further grid the more critical areas.

The scene investigation team or teams will be assigned grids to search, with consideration given to the sequence of searching. There are competing considerations in assigning grid priorities, namely:

- clearly, grid sections close to the explosion centre are likely to contain more significant evidence;
- structural damage is likely to hinder investigation of these inner sections;
- inner sections cannot be cleared until enough distant sections have been searched to permit access to the interior areas.

In these circumstances, it is most appropriate to search a sequence of grid zones, which will provide rapid access to the explosion centre, to permit clearance work to be undertaken; while clearance is underway further outer zones can be searched.

It is important that the team leader not be bound by a predetermined search formula, but rather, weighs individual cases on their merits. While speed is of assistance to investigators, thoroughness is in the long term equally or more valuable. Regardless of the exact search sequence, it must be planned, comprehensive and the evidence obtained must be preserved and labelled appropriately.

15.17 Search techniques

The team assigned to a particular area will ensure that the area has been recorded photographically and usually, audio-visually, before work commences. All the items in the grid section should be removed individually, and examined for explosion-related

material. If an item can be identified as native to the scene, has no signs of being in close proximity to a high explosive charge and does not contain any fragments, it can be cleared from the scene. Items, which do not meet these criteria, should be subjected to a further examination by the post-blast consultant.

Items, which are passed to the evidence recorder to be held for further examination, are:

- items suspected of being foreign to the scene;
- items with signs of proximity to a high explosive charge;
- items suspected of being explosive related, such as fragments of fuse; and
- items suspected to contain fragments.

All evidence collected is handled in accordance with standard crime scene handling procedures, with the following exceptions:

- paper and nylon bags will be inappropriate for many samples, in view of the sharp edges encountered in explosion debris; and
- the advice of the forensic chemist should be sought in relation to sampling for explosive residues.

Deceased persons or parts of deceased persons collected from the scene may well contain fragments. It is not uncommon for significant sections of bomb casing to be the cause of death. These bodies or parts of bodies should be escorted to the mortuary; an experienced crime scene investigator should attend to consult with the pathologist regarding recovery of fragments.

15.18 Chemical analysis

The forensic laboratory will examine items from the scene for explosive residues. Residues may be found on fragments, even fragments recovered from bodies, on shreds of fuse, on dust from the crater, on furniture or floor coverings close to the blast, etc. Close consultation between the team leader and forensic chemist will assist in focusing the search.

15.19 Device reconstruction

Armed with device fragments from the scene, information as to size and placement of the charge from the post-blast consultant, and advice from the chemist as to the filler material, the team leader and/or post-blast consultant can begin the process of reconstruction. This is a time-consuming and painstaking task, but will be of enormous assistance in both the investigative and judicial phases of the investigation. It may be of assistance to test devices thought to be similar, and to compare fragment sizes, blast effects and residues.

15.20 Bibliography

- Ackerman, J. A. *et al.* (1995) *The Investigation and Prosecution of Arson*, 2nd edn, California District Attorneys Association.
- Barnes, R. C. (1991) *Investigation of Bomb Incident*, Presentation to the 10th International Conference on Terrorist Devices and Methods, Deepcut, United Kingdom.
- Benson, R. (1988) *Ragnar's Guide to Home and Recreational Use of High Explosives*, Paladin Press, Boulder, Colorado.
- Cooke, R. A. and Ide, R. H. (1985) *Principles of Fire Investigation*, The Institution of Fire Engineers, Leicester.
- De Haan, J. D. (1991) *Kirk's Fire Investigation*, 3rd edn, Prentice Hall, New Jersey.
- FBI Laboratory Division, *Suggested Guidelines for Establishing Evidence Response Teams*, Washington DC, United States Department of Justice.
- Johannson, C. H. and Persson, P. A. (1970) *Detonics of High Explosives*, Academic Press, London.
- Lecker, S. (1985) *Improvised Explosives: How to Make Your Own*, Paladin Press, Boulder, Colorado.
- Meyer, R. (1987) *Explosives*, 3rd edn, VCH Publishers, New York.
- National Fire Protection Association (2001) *921 Guide for Fire and Explosion Investigations*, NFPA, Quincy.
- Palmer, K. N. (1973) *Dust Explosions and Fires*, Chapman and Hall, London.
- Yallop, H. J. (1980) *Explosion Investigation*, The Forensic Science Society, Harrogate.
- Yinon, J. and Zitrin, S. (1993) *Modern Methods and Applications in Analysis of Explosives*, John Wiley, New York.

The scientific requirements and outcomes of a sexual assault crime scene investigation

Carmen I. Eckhoff

16.1 Introduction

This chapter is primarily concerned with the investigation of the crime scene and an overall emphasis is placed on the coordination and investigative potential of a multi-disciplined approach.

The crime scene investigation of a sexual assault can be crucial to the successful outcome of the case. A thorough scene examination maximising the recording and recovery of physical evidence often provides circumstantial information, which can significantly influence the effectiveness of any subsequent scientific and medical examinations. Potentially, the results from all the disciplines can provide a focus for the investigation and have a profound effect on any subsequent forensic examination of the incident.

The requirements and responsibilities of a crime scene examiner at a sexual assault crime scene are no different to those at most other crime scenes, particularly those involving violence. In addition to their own skills in toolmarks or shoe impressions, for example, crime scene examiners must be familiar with the expertise and requirements of other specialists, particularly those who provide evidence, based on fingerprints and deoxyribonucleic acid (DNA), for identification purposes.

The investigation of sexual assault is complicated by the fact that the victim's account is often contradictory to the account of the other person(s) present, that is, the suspect. The victim's account is not always reliable because he/she could be traumatised, under the influence of drugs, or the report could be the result of spite, vindictiveness or intimidation.

Furthermore, any scientific results will not necessarily validate the allegation, and in fact, can equally support the suspect's account. It might be argued that this is the case in any scientific investigation of an offence but it is generally conceded that this situation is more common in sexual offences than any other specific crime.

As a consequence of the numerous possible technical, scientific and medical explanations, the contentious issue of consent cannot always, or immediately, be resolved. This places increased pressure on the scene and laboratory examinations. Therefore, it is crucial that the crime scene is preserved and that the crime scene examiner ascertains exactly what has allegedly occurred in the scene prior to any examination. Also, as is the case with most crime scenes, before the examination commences, the following points must be considered:

- allegations that have been made by the victim, suspect/offender or other person(s);
- whether the victim or any other person has interfered with the scene either intentionally or inadvertently;
- the alleged point of entry and exit of the offender(s). This point is often not an issue in the case of sexual assault because the presence of the suspect(s) can be at the invitation of the victim; and
- the recent sexual history of the victim. This must be established, particularly for the interpretation of any laboratory results.

16.2 The crime scene

16.2.1 Recording and resource assessment

Upon arrival at the scene, the crime scene examiner must assume total responsibility for all aspects of the crime scene. This includes recording the scene by means of notes, sketches, photographs and video and the collection of items of potential evidentiary value. The basic scene recording must be completed prior to the movement or recovery of any item, although, as with all crime scenes, additional recording will undoubtedly be necessary during the examination.

Consideration should always be given to the drawing of a sketch-plan of the scene. This will not necessarily be to scale, although sufficient measurements must be taken to allow a plan to be drawn, to scale if it is ever required. At this stage, consideration should be given to other specialist examinations including fingerprints or bloodstain-pattern interpretation. Should other specialists be needed, there must be negotiation concerning the requirements of all personnel involved and when they should have access to the scene. Regardless of the outcomes of the discussions, items of potential evidence must be photographed *in situ*.

The involvement of multiple specialists has the potential to generate enormous amounts of evidence. Therefore, it is essential that a post-scene examination conference be held as soon as possible. The conference should include all the experts and the investigators. In this way, subsequent scientific examinations can be prioritised, and investigators updated on preliminary scene observations and conclusions.

16.2.2 Scene screening tests

Large or immovable items such as carpets can be examined at the scene using the 'Polilight' or more specific screening techniques such as 'Luminol' and 'Acid Phosphatase'. The 'Polilight' is a versatile, portable light source that allows the user to

illuminate surfaces using light of a selected wavelength. Under some circumstances, seminal fluid will fluoresce, and blood absorbs and appears as a black stain when exposed to a specific wavelength of light. (Blood is best viewed at 415–20 nm, while semen stains can be detected at 450 nm.) More specific screening tests involve spraying entire areas with chemicals and observing the reaction. They can be useful in the identification of areas that should be sampled for more detailed analyses in the laboratory.

‘Luminol’ is a presumptive test for the presence of blood. Its use will identify any bloodstains by producing an intense luminescence in a darkened environment.

‘Acid Phosphatase’ reagent is used to indicate the presence of acid phosphatase activity in semen. The presence of seminal fluid is indicated if the colour change occurs within a minute of the reagent being added to the stain.

Experience in the interpretation of the tests is essential for meaningful interpretation. Care must be taken when using these chemicals to avoid potential health hazards. The reagents used to prepare ‘Luminol’ are all irritants. Furthermore, it is documented that ‘Luminol’ and the dye component in the ‘Acid Phosphatase’ reagent have mutagenic properties, i.e. could cause mutations.

16.2.3 *The collection of evidence*

For occupational health and safety reasons and to prevent contamination, the crime scene examiner must wear gloves at all times. Consideration should also be given to wearing disposable overalls including hoods and footwear coverings. It is preferable that the crime scene examiner changes gloves between the handling of each item; however, the regularity at which it occurs is dependent on the situation and protocols followed by each jurisdiction.

Any item with damp or wet stains must be air-dried before packaging. This can be accomplished by pegging the item onto a clothesline, while ensuring that the usual continuity and security procedures are followed. If not done, it is highly probable that putrefaction and degradation of biological material, including DNA that could be present, will occur. Subsequently items of biological interest must be packaged in individual bags. The use of paper bags prevents the item(s) sweating.

As previously mentioned, the issue of consent might not be resolved by a thorough crime scene and laboratory examination, where the emphasis is on the detection of stains of seminal or blood origin. Unfortunately, any medical examination can also be of limited assistance, although injuries to areas other than the genitals might provide useful evidence (refer Section 16.4). There are many other considerations such as the use of condoms and/or the use of drugs like ‘Rohypnol’ (Flunitrazepam, more commonly known as the ‘date rape’ drug) that should be taken into account during the investigation of a sexual assault crime scene. These items might be present at a crime scene but their significance and therefore, the need for collection might well be determined by pre-scene discussions.

16.3 Exclusion or elimination samples

The advent of DNA analysis has significantly increased the potential of more items and samples to provide valuable evidence. To maximise the potential of any DNA that might be present, it is essential that the crime scene examiner is familiar with the

requirements of the collection, storage and significance of DNA samples. A fundamental comprehension of the basic chemistry of DNA is also needed.

Many sexual assaults occur in dwellings, vehicles and public places, such as parks, halls or public transport facilities. Therefore, there is the complication of excluding innocent persons who have had legitimate access to the scene and might have had such access for a considerable time. As a consequence, other information concerning coinhabitants and visitors must also be investigated, and samples for DNA analysis might need to be taken from these people for exclusion purposes. An accurate account of the victim's recent sexual history could also determine that additional exclusion samples are necessary.

In addition to samples taken from the victim and other persons, items that possibly have been handled or otherwise touched by a suspect should be swabbed for DNA analysis and/or fingerprinted. This could assist in the identification of the suspect and/or could help to verify the victim's account of the incident.

16.4 Medical examinations

Arrangements for a medical examination of the victim must be made immediately. This is because a nexus can often be established between the observations made at a crime scene and the results from a medical examination. How and when the medical examination is conducted is determined by the condition of the victim and jurisdictional procedures, but regardless, the victim's medical examination should occur as soon as possible after the alleged sexual assault is reported. This is imperative, as it is very common for sexual assault victims to feel the need to wash themselves repeatedly. Therefore, to maximise the recovery of evidence, it is important that the victim does not douche or shower prior to the medical examination.

The development of specific guidelines for medical examinations has given rise to the adoption of some form of sexual assault medical protocols by each jurisdiction. In some instances, specific cultural and religious considerations are necessary. They should be established and addressed well before they are required.

A competent medical examination with suitable protocols will maximise the potential of any laboratory analyses through the collection of specific and crucial samples. These samples often include high vaginal, low vaginal, vulval, rectal or penile swabs and smears. Any samples taken are dependent on the circumstances established during the medical examination and the victim's (and suspect's) statements. Injuries to suspects, victims or other persons must be determined and documented. This information can be of assistance when screening the scene for traces of blood and when scientists are examining the items recovered from the scene for similar purposes. Bite marks should be photographed, swabbed for DNA analysis and measured for dental comparisons.

It should be stressed that even when all the results to date are considered, the issue of consent might not be clarified.

16.5 The collection and examination of clothing

The examination of the victim's, and possibly the suspect's, clothing is an essential part of the scientific investigation. The clothing must be collected as soon as possible and

before it is washed. Each item must be dried and individually packaged to avoid contamination.

For evidence of sexual assault, clothing worn by the victim must be tested for the presence of semen. The presence of seminal fluid, and in particular spermatozoa, is of maximum importance because it is irrefutable evidence of sexual activity. The rich source of DNA contained in any spermatozoa heads can provide evidence of identification. However, with the increasing prevalence of vasectomised males, there has been a need to develop more involved confirmation testing. In these cases, the presence of seminal fluid is verified using more time-consuming tests designed to confirm known components of semen, e.g. P30 or PSA (prostate-specific antigen). Although it is also possible to obtain DNA from seminal fluid in the absence of spermatozoa, it is less successful.

An examination of the clothing for evidence other than seminal fluid and perhaps, blood might provide important circumstantial evidence depending on the allegations. For example, if consensual sexual intercourse is alleged, the presence of tears to the clothing might well prove vital, in refuting the consensual claims, as will evidence of broken clips, missing buttons, grass stains or soiling.

Alternatively, the absence of such damage might well provide important evidence that there was no offence, and any activity was consensual. However, this evidence could also prove the allegation that the victim was forced to undress under a threat of violence.

An examination of clothing and, in fact, any item removed from the crime scene, may well reveal items such as fibres, glass or vegetation, known colloquially as 'trace evidence'. In cases containing trace evidence suitable control samples must be collected and contamination avoided at all costs.

At the completion of the scene and medical investigations, it is often possible to provide a reasonably accurate account of what actually occurred. However, until the laboratory results are available, the explanation remains unconfirmed.

16.6 Summary

The technical, scientific and medical requirements of sexual offence investigations indicate that these cases have a complexity not often seen in other types of investigations. The actions of the crime scene examiner may have profound ramifications on the interpretation of events and the potential of the other disciplines to provide crucial evidence.

16.7 Bibliography

- Crowley, S. R. (1999) *Sexual Assault: The Medical-Legal Examination*, Appleton and Lange.
- De Forest, P. R., Gaensslen, R. E. and Lee, H. C. (1983) *Forensic Science – An Introduction to Criminalistics*, McGraw-Hill Inc.
- Fisher, B. A. J. (2000) *Techniques of Crime Scene Investigation*, 6th edn, CRC Press.
- James, S. H. and Eckert, W. G. (1999) *Interpretation of Bloodstain Evidence at Crime Scenes*, 2nd edn, CRC Press.

- Osterburg, J. W. and Ward, R. H. (1992) *Criminal Investigation – A Method for Reconstructing the Past*, Anderson Publishing Co.
- Rofin Australia (1992) *Polilight Manual – Version 7*.
- Siegel, J. A., Saukko, P. J. and Knupfer, G. C. (2000) *Encyclopedia of Forensic Sciences*, Volumes 1, 2 and 3, Academic Press.
- White, P. (1998) *Crime Scene to Court – The Essentials of Forensic Science*, The Royal Society of Chemistry.

Botanical and soil evidence at the crime scene

James Robertson

17.1 Introduction

As a young academic entering the field of forensic science I was fortunate enough to get a copy of the Biology Methods Manual published by the (then) Metropolitan Police Forensic Science Laboratory. The nine chapters included one on 'Urine and Faeces', one on 'Foodstuffs', one on 'Fibres and Hairs' (including a section on plant fibres), one on 'Botanical Applications' and one on 'Paper'. Being a biology manual it did not include the botanical aspects of illicit drugs. A third or more of the content of the manual was botanical!

Indeed at the interview for my position at the University of Strathclyde I was asked how I would cope with the examination of clothing from a rape case involving an elderly lady who had defaecated during the assault. To the obvious delight of the 'interviewer' I was enthusiastically invited to look at the items in question (or perhaps smell would be more accurate) as I was shown around the laboratory post-interview. Botany was alive *but* within only a few years the expertise, which resided in only a small number of individuals, had all but disappeared. As the levels of information available from biological materials increased exponentially, especially with the developments of DNA through the 1990s, the role of forensic botany has, if it is possible, further declined. Does this mean that there is no value in forensic botany beyond the obvious identification of cannabis? Or is it simply that the lack of skill in core forensic laboratories has resulted in the potential for this type of evidence being ignored or missed at the crime scene? What is the point of collecting material if it is not going to be examined?

In this short chapter the focus is on the special aspects, which need to be considered by the forensic investigator when dealing with botanical materials. By necessity this will include an introduction to forensic botany covering its potential scope. As plants will often be intimately associated with soils the forensic aspects of soil collection will

also be considered. It is assumed that the reader will be familiar with the general requirements of best practice crime scene examination and will apply these.

17.2 Scope of forensic botany

The types of samples which can be (used to be!) encountered in forensic botany include:

- vomit, stomach contents and faecal matter;
- wood;
- poisonous plants;
- cannabis and other plants used as illicit drugs;
- plant fibres used in paper and textiles; and
- general plants, pieces, parts or fragments of plants.

17.2.1 *Vomit, stomach contents and faecal matter*

The analysis of stomach or gastric contents as an aid to establishing time of death used to be quite common. It relied on the ability to identify partly digested residues of foods (plant or animal) and to assess in quite broad parameters when the deceased had last eaten. It is now generally considered that such analysis for time of death is of limited value. However there may still be individual circumstances in which it is important to establish what was eaten by an individual.

The analysis of vomit is essentially the same as for stomach contents except that the material to be recovered may be partly or wholly dried by the time it reaches the forensic laboratory. It is not uncommon for people to vomit during a violent situation.

Faecal material will contain only the remnants of foodstuffs most resistant to the digestive process. Once again it is quite common for people involved in a violent situation to defaecate. It is also not unusual for burglars to defaecate intentionally as a further ‘insult to injury’.

In the case mentioned in the introduction, using chemical testing it was possible to establish the presence of faecal stains on clothing from the suspect. Examination and comparison of solid material in these stains and of faeces from the victim’s clothing, revealed the presence of a mixture of a low grade wheat product, beans, and material consistent with being remnants of sausage skins. It was later established that the elderly victim had earlier eaten a meal of sausage, beans and potato chips and was in the habit of eating a wheat-based biscuit (digestive biscuit). [Figure 17.1](#) shows the cell types found in wheat and beans, seeds or fruits.

The examination of food or other plant residues requires a knowledge of the microscopic appearance of a wide variety of foods, an understanding of how these are present in raw and cooked foods and the effects of the digestive process.

Forensic botanists involved in this type of analysis used a mixture of basic microchemical tests and microscopic analysis involving transmission light microscopy and polarising light microscopy. The latter is especially useful in visualising starch grains (which are highly characteristic of particular starchy foods) provided the starch grains have maintained structure integrity. A characteristic so-called Maltese cross is seen

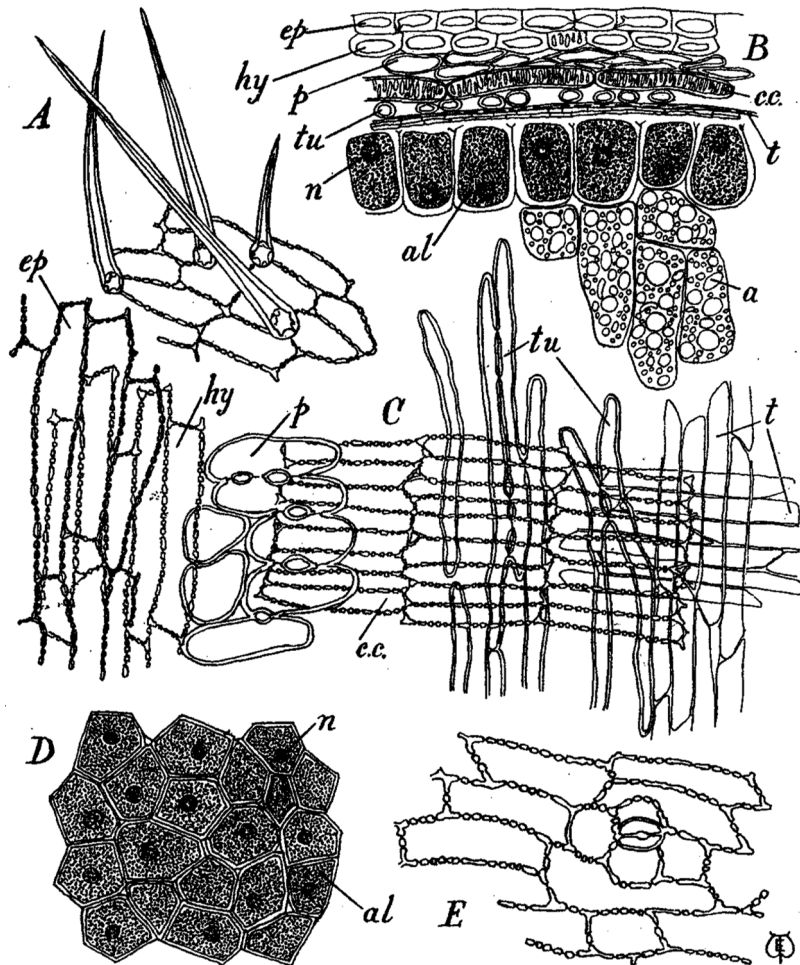

Figure 17.1(A) Microscopic structure of wheat bran (*Triticum aestivum*, Law). A, Fragment of epidermis from apex of the caryopsis, showing typical trichomes. B, Transverse section through the pericarp, testa and outer part of endosperm. C, Surface view of the layers of the pericarp and testa. D, Aleurone layer in surface view. All $\times 200$. a, starch; al, aleurone; cc., cross-cells; ep., epidermis; hy., hypodermis; n, nucleus; p, parenchyma of the pericarp; t, testa; tu, tube cells (from Greenish, 1923)

when starch granules are examined under polarising microscopy. [Figure 17.2](#) shows examples of starch granules, and [Table 17.1](#) summarises the features of some commonly occurring starch granules.

It is beyond the scope of this chapter to consider in detail the types of information relied upon by the forensic botanist conducting this type of work. Texts are invariably old, often out of print and information was generally not available in a systematic way aimed at, or suited for, forensic application. Often the key skill was to recognise the broad type of plant material and then go through a process of using reference works and

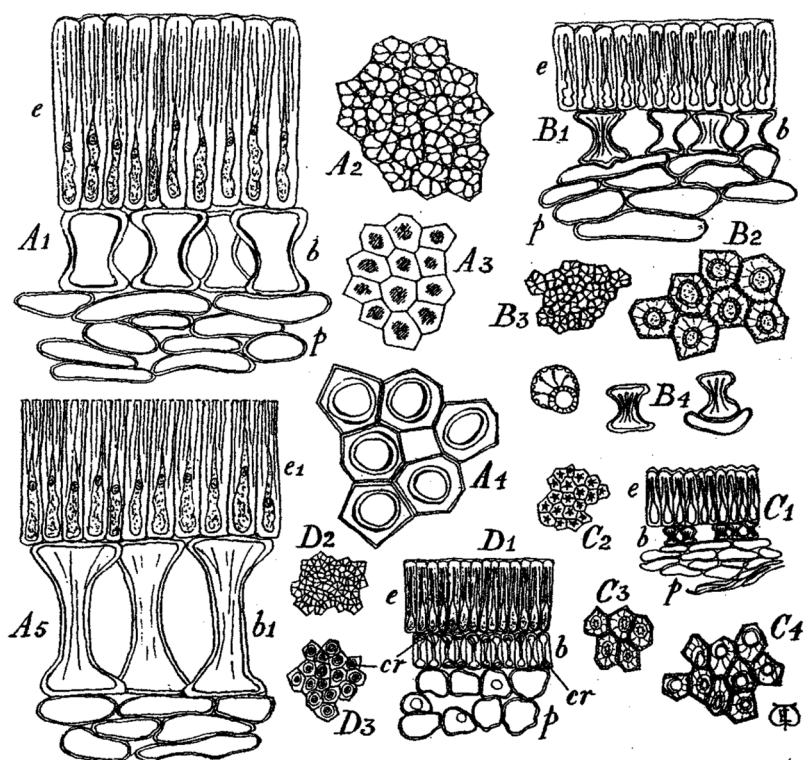
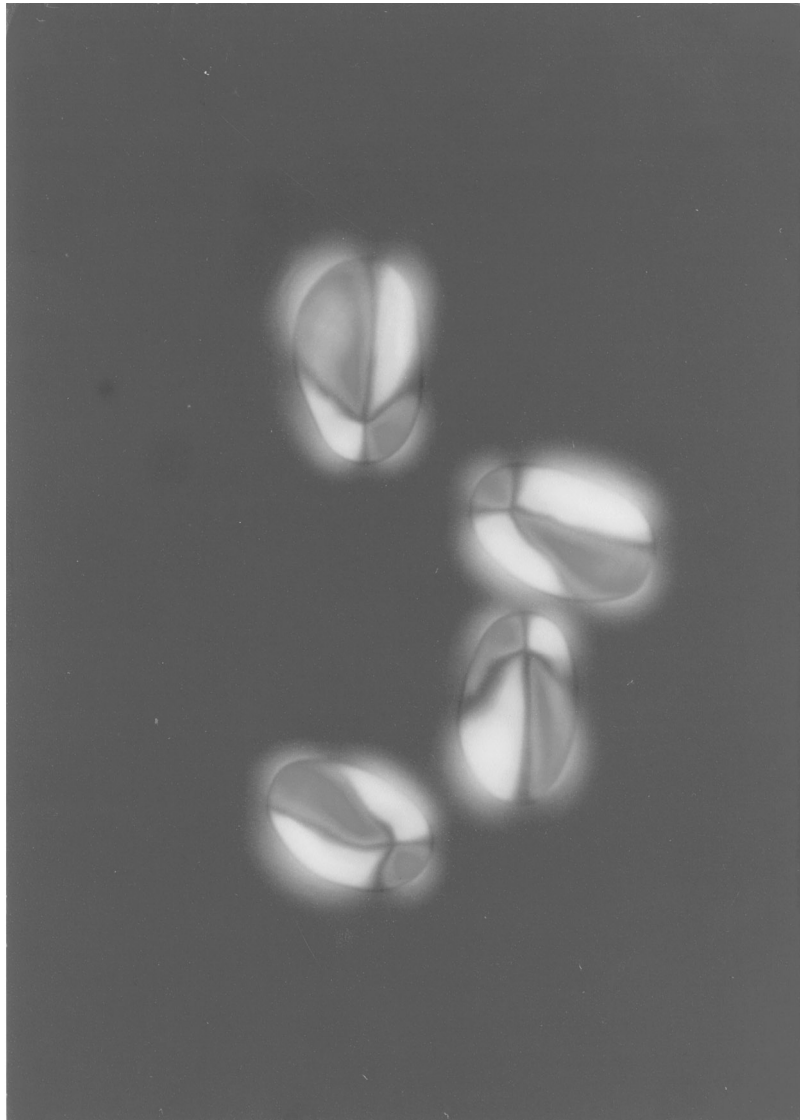

Figure 17.1(B) Microscopic structure of leguminous seeds, all $\times 350$. A, Field bean (*Vicia faba* L.). A1, transverse section of the testa. A2, palisade epidermis upper end surface view. A3, the same lower part in surface view. A4, bearer cells in surface view. A5, transverse section of the testa near the hilum. B, Grey pea (*Pisum sativum* L.). B1, transverse section of testa. B2, hypodermis (bearer cells) surface view. B3, epidermis surface view. B4, isolated bearer cells. C, Lentil (*Ervum lens* L.). C1, transverse section of the testa. C2, epidermis in surface view. C3, bearer cells from above. C4, bearer cells from below. D, Haricot bean (*Phaseolus vulgaris* L.). D1, transverse section of the testa. D2, surface view of epidermis of testa. D3, hypodermis in surface view. b, hypodermis of bearer cells; b1, hypodermis of bearer cells near the hilum; cr, prism of calcium oxalate; e, palisade epidermis; e1, lower part of the palisade epidermis; p, parenchyma (nutrient layer of the testa) (from Greenish, 1923)

preparing known samples for comparison. The work relied heavily on individual experience and on what the individual had previously seen. Attempts to develop a more systematic analytical approach using manual- and computer-based keys have been made only in those areas where the materials had some commercial or academic interest, for example, with woods or powdered vegetable drugs.

In summary, there would be few, if any, individuals in current practice in a forensic laboratory with the background and knowledge to conduct examinations of this type of material. Hence, in those cases where this type of evidence may be useful it is likely the expertise will reside in an academic institution. However, the existence of generalist



A

Figure 17.2 Examples of starch granules showing 'Maltese Cross' appearance. *A*, potato starch, *B*, maize starch. Photographed with first order red plate under polarised light $\times 40$ objective magnification

skills in microscopic examination of plant fragments and, in particular, food fragments is also a very rare skill to locate in today's academia.

The collection of vomit, faeces or stomach contents depends on their presentation. Liquid or wet samples should be collected in sealable plastic containers. If kits are available for the collection of internal drug concealments these are highly suitable. Otherwise guidelines should be strictly followed for handling biohazard material.

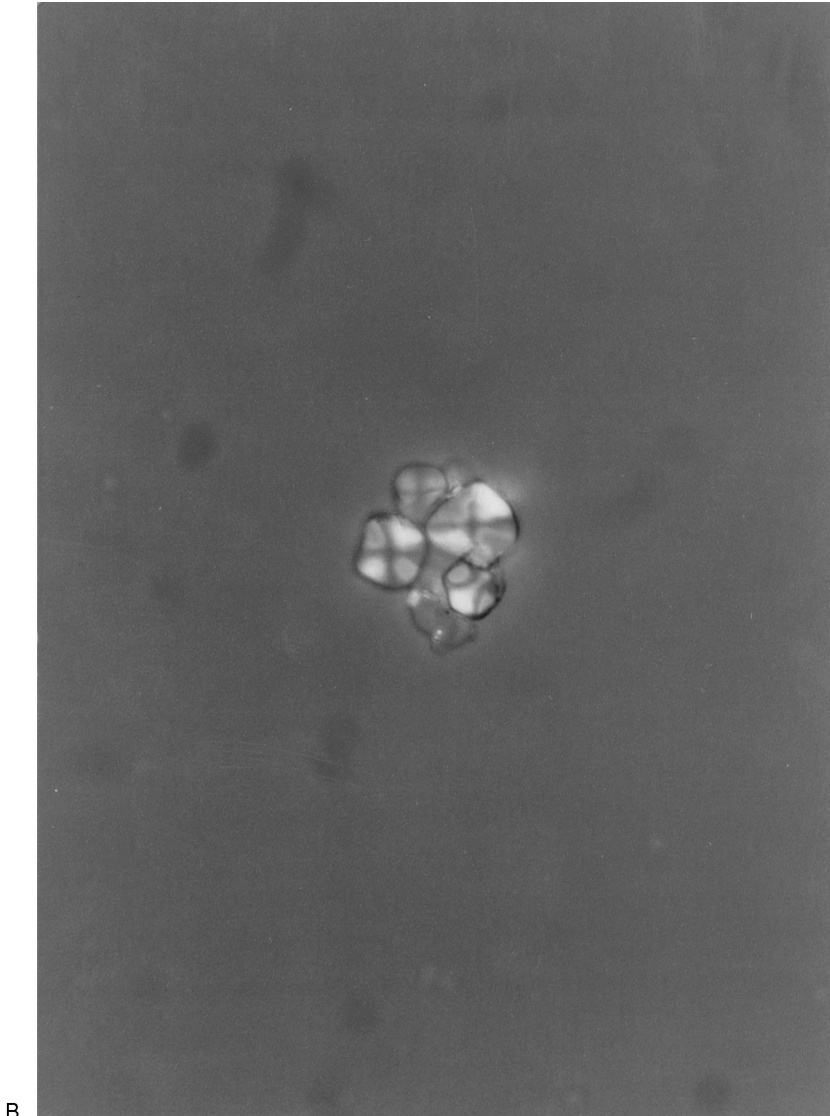

B

Figure 17.2 (Continued)

Samples should be labelled accordingly. Where the material is in a dry or semi-dry condition the item should be treated like any other item of physical evidence. It should be packaged to prevent loss of potential evidence remembering there may be other potential evidence present with a higher probative value. If it is not possible to fully dry them in a suitable environment prior to packaging, items should be refrigerated, *but* not frozen. The laboratory scientist may wish to sample material before it is fully dry. Clearly, with this type of sample speedy delivery of items is critical.

Table 17.1 Examples of commercial starches (from Wallis, 1957)

Name and source	Shape	Hilum	Striations	Dimensions	Aggregation	Polariscope, etc.	Remarks
¹ Wheat. <i>Triticum sativum</i> (= <i>T.aestivum</i>)	Lenticular. Outline circular, or oval sub-reniform	A central point appearing as a line when a grain is on its edge	Concentric. Faintly marked in commercial starch	Smaller grains 0 to 5 to 10 microns. Larger grains 16 to 20 to 25 to 50 microns. More than 400 grains per milligram of 40 microns and over	Mostly simple. Very few compound grains of 2 to 4 components	Faint Maltese cross. Grains on their edges show a clearly defined 'cross' thus >----<	Attacked quite slowly by 0.9 per cent KOH
Maize or corn <i>Zea mays</i>	Polyhedral or sub-spherical	A central triangular or 2-5 stellate split	None in polyhedral grains. Rare in the rounded grains	5 to 10 to 15 to 25 microns	In commercial starch, all simple	Well-marked cross	
² Rice. <i>Oryza sativa</i>	Polyhedral	A central point	None	3 to 5 to 8 to 12 microns	Ovate compound grains, 2 to 150 components. Size 7 to 20 microns × 12 to 30 microns	Well-marked cross	
Potato. <i>Solanum tuberosum</i>	Ovoid; irregularly ovoid or sub-spherical. Somewhat flattened	A point at the narrower end. Usually eccentric 1/3-1/4	Concentric. Well marked; some rings darker than others	Rounded 10 to 35 microns. Ovoid 30 to 100 microns	Small number of compound grains of 2 to 3 components	Well-marked cross	Rapidly gelatinised by 0.9 per cent KOH

Table 17.1 (Continued)

Name and source	Shape	Hilum	Striations	Dimensions	Aggregation	Polariscope, etc.	Remarks
Arrowroot. West Indian. <i>Maranta arundinacea</i>	Ovoid to ellipsoid, with tuberosities	A cleft, resembling wings of a bird in flight, at the broader end	Faintly marked	7 to 30 to 45 to 75 microns	All simple	Well-marked cross	Almost unaffected by 0.9 per cent KOH
Arrowroot. East Indian <i>Curucuma angustifolia</i> and <i>C. leucorrhiza</i>	Flattened. Rectangular-ovoid with a terminal projection	A point in the terminal projection	Numerous, faint and transverse	Length 15 to 30 to 60 to 140 microns, Breadth 25 to 35 microns. Thickness 7 to 8 microns	All simple	Well-marked cross	
Sago. <i>Metroxylon rumphii</i> , <i>M. sagu</i> and <i>M. laeve</i>	Simple grains, mostly ovoid, some sub-spherical. Components of compound grains, muller-shaped	A 2 to 5 rayed split. Central or eccentric 1/2 to 1/5	Concentric	Large components 50 to 65 to 80 microns. Small components 10 to 20 microns	Mostly compound with 2 to 4 components. Usually one large and 1 to 3 small	Well-marked cross. Some grains are gelatinised	
Tapioca. <i>Manihot utilissima</i> and other species	Mostly sub-spherical. Separated components, muller-shaped	Round, linear or stellate. Central or up to 1/2 eccentric	Concentric	Large components 25 to 35 microns. Small components 5 to 12 or 25 microns	Mostly compound, 2 to 8 components, mostly 2, 3 or 4	Well-marked cross. Some grains are gelatinised	

Notes

- 1 Barley. *Hordeum sativum*. Resembles wheat starch, but is rather more irregular in outline and slightly smaller. No grains over 40 microns. Rye. *Secale cereale*. Resembles wheat starch, but is slightly larger and the hilum is a split with 3–5 rays. Rapidly gelatinised by 0.9 per cent KOH.
- 2 Oat. *Avena sativa*. Resembles rice, but always shows some spindle-shaped or lemon-shaped forms.

17.2.2 Wood

Wood is a ubiquitous material. Samples made of wood may present in forensic investigations in a number of ways. These may include pieces of timber or timber products used as weapons, timber from doors or windows from break and entries or sawdust/wood shavings from older style safes where it is present as ballast. The latter was the mainstay of the forensic botanist even into the 1980s. The requirement for forensic laboratories to examine wood shavings or sawdust has largely disappeared because today's criminal finds it easier to rob a petrol station or a supermarket than to blow up a safe and because few businesses now deal in cash to pay salaries. Nonetheless, many, if not most, of the larger and certainly older safes will have wood ballast. (A safe consists of two metal boxes. The space between the larger and smaller boxes is filled with insulation material or ballast. In older safes sawdust mixed with other substances is prevalent as ballast.)

Botanically wood is divided into two broad groups, softwood and hardwoods. These can be distinguished by very obvious differences in the major cell types present. Whilst the anatomy of wood is quite complex it is well described for all commercial species. There are numerous physical- and computer-based identification keys and programs – their use requires a quite detailed knowledge of the botanical features found in wood. This *is* quite a specialised field, and the relevant expertise would not be commonly found in today's forensic laboratory.

The same approach and knowledge is required to identify larger items made of wood, although at this somewhat more macro level there are keys for the identification of woods using a hand lens. In essence today the identification of a wood sample would probably require the use of a scientist in wood research institute. A word of caution! Scientists used to looking at wood or timber are very good at identifying timber by eye or with the aid of a hand lens. For forensic purposes an identification must be based on a full examination using appropriate identification keys. Identification usually requires information gained by examining three types of sections, a transverse cross-section, tangential and radial longitudinal sections. [Figure 17.3](#) shows sections of typical wood species. Wood ballast presents as very small fragments often of 1 mm or less. Hence, their examination involved preparing sections using a freezing microtome. These could be suitably stained and their microscopic features recorded. With very small particles of wood it may not be possible to obtain all three sections even with the aid of a freezing stage microtome.

There are no special crime scene factors for the collection of wood samples beyond that normally used for macro samples or for small to trace samples. It is important to think about what might be available for transfer and in what form. The collection of appropriate known samples, and later of possible reference samples, can require some specialist involvement. For example, care should be taken to ensure samples are representative. It is not unknown for a wooden window to have a repaired section comprising a different timber, especially in older properties as a wider range of commercial timbers were used in building construction than is the case today.

The possibility of physical fits with wood should also be considered. Once again wood or timber may be associated with other potential evidence, for example, paint, which may have higher probative value. It should be possible to collect samples which are suitable for examination of more than one evidence type.

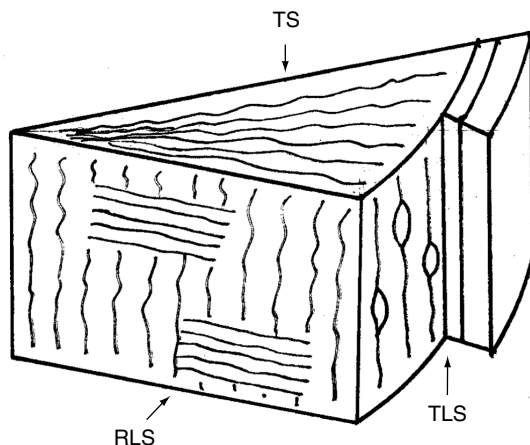

Figure 17.3 Diagram showing cross-sections of wood

17.2.3 Poisonous plants

Far more plants are poisonous than would be generally recognised by the lay person. In most developed countries, when poisoning occurs it is more often than not the result of accidental ingestion due to either a lack of knowledge or a misidentification. I include in this category the ingestion of mushrooms. Specifically there have been a number of cases where death has occurred as a result of people misidentifying what they think are edible mushrooms. In some countries it may be more common for plants to be used in suicides where commercial and pharmaceutical drugs are not as readily available.

Where plants have been used in poisoning it has been more usual for the perpetrator to prepare some form of extract. A recent case in Canberra involved the offender poisoning her husband by preparing an extract of leaves of Oleander, a quite common garden shrub. Where extracts with plant toxins are used identification is carried out by a toxicologist through chemical testing. If the plant has been eaten, the examination, comparison and identification process is the same type as for stomach contents.

From a crime scene investigator's viewpoint the collection of appropriate known and reference samples may require the involvement of a specialist scientist. Where there is a time gap before it is possible to collect such samples (for example, in long-term poisoning or where the immediate cause of illness is not detected) it may not be possible to collect plant material at the same growth stage. This would be most obvious with mushrooms.

17.2.4 Cannabis and other plants used as illicit drugs

By far the most common plant material still examined in forensic laboratories is cannabis. Occasionally, in Australia, the forensic scientist may be asked to examine

poppy plants. In other countries extensive cultivations of poppy and of Erythroxyton species (from which cocaine is extracted) are common.

The identification of cannabis plant material is straightforward although requiring specialist knowledge. The combination of microscopic features of cannabis is unique. Excellent descriptions of the microscopic features of cannabis are to be found in older pharmacy books reflecting the fact that cannabis used to be commonly used as a medicinal drug. Figures 17.4 and 17.5 show the microscopic detail of cannabis parts and at a cellular level. Increasingly many laboratories have adopted a minimalist botany approach relying on chemical tests (colour spot tests and thin layer chromatography). Erythroxyton also has characteristic botanical features as do poppy plants. Identification to species level is more difficult. A species is the lowest unit of plant classification. For example, *Cannabis sativa* where ‘*Cannabis*’ is the Genus and ‘*sativa*’ the species. Individual plants within a species are able to breed amongst themselves but not with plants from other species. In fact life is more complex than this, and even within a species there are levels of genetic variation – this is a point to which I will return later in this chapter!

To avoid semantic debate over identification of *Cannabis* species many countries have written their legislation placing prohibitions at the level of the genus *Cannabis*. It is generally accepted that there is only one species, *sativa* with a number sub-species and forms.

Before considering crime scene aspects of cannabis and other plants, there are other botanical species which are abused throughout the world which will not be considered here in detail. Included in these are various forms of *Psilocybe* species or magic mushrooms! The identification of mushroom species usually relies on a mix of botanical and chemical analysis.

From a crime scene perspective the forensic investigator is only likely to be involved in more serious cases involving cultivation. These may involve outdoor scenes, the use of glass houses and increasingly indoor settings with non-soil-based hydroponic cultivation.

The general principles of crime scene examination apply and it is important to recognise that these scenes are not just about identifying the suspected illegal plants. The whole range of other forensic evidence needs to be considered. This may help to establish the presence of persons at the scene. *In these types of scene particular caution needs to be exercised with regard to booby traps, ranging from razor blades placed in plant stalks to shotguns rigged to trip wires, to bombs.* Unless the site has been declared cleared by operational police (often specialist operations teams) then *extreme* caution should be exercised by forensic personnel.

At the appropriate time specific aspects relating to the plant ‘crop’ should be considered. As a minimum it is good practice to fully record the scene using video (if appropriate), still photographic techniques and producing a plan of the site. In my experience, where non-specialists undertake this task all too often the quality of images is not good enough if, at some stage, a more detailed assessment of the crop is required.

This type of specialist assessment is not the normal role of the crime scene investigator unless they have relevant competencies and experience. The competencies will include botanical training to identify male and female cannabis plants, to assess the state of maturity and form an opinion (where appropriate) on likely yields from a particular crop situation. Without being prescriptive this assessment would include factors

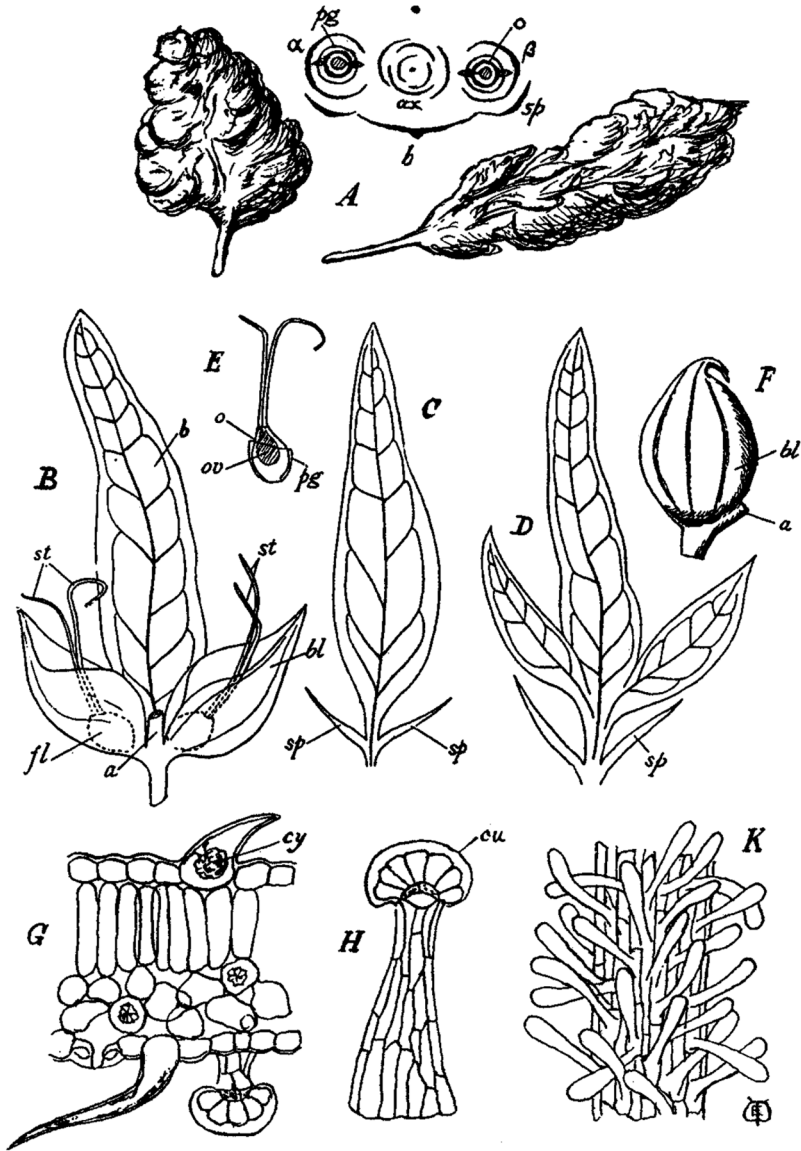
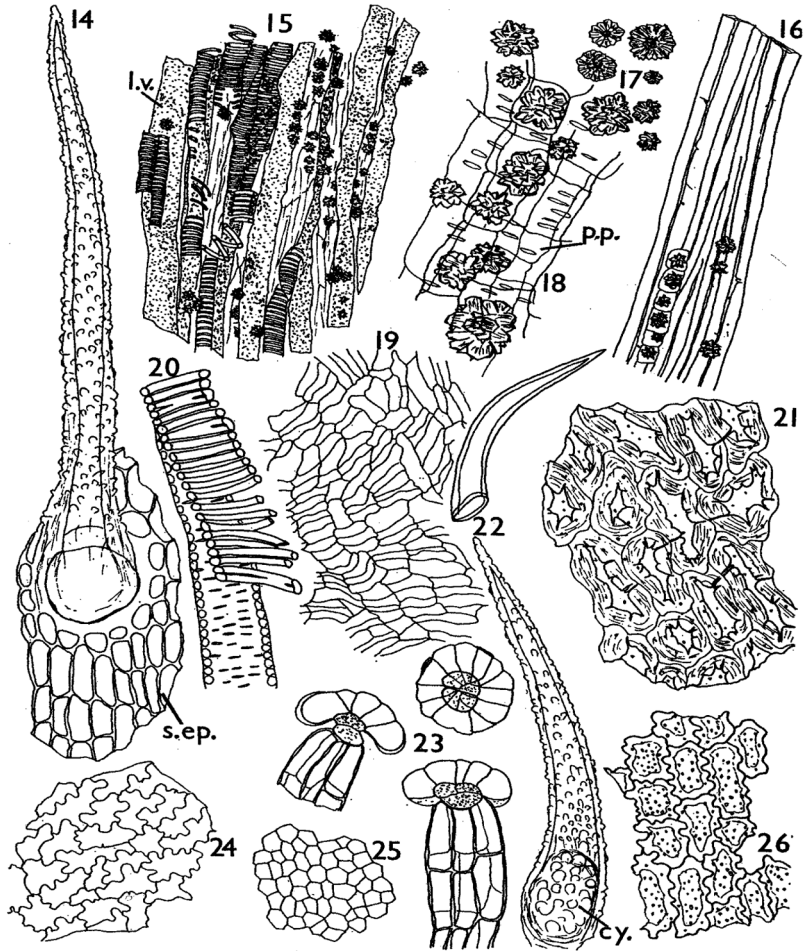

Figure 17.4 Structure of cannabis (Indian hemp). A, habit sketches and floral diagram of female inflorescence. B, bract and its pair of bracteoles, each with a female flower in the axil, $\times 4$. C, simple lanceolate bract, $\times 4$. D, a ternate bract, $\times 4$. E, pistillate flower, $\times 4$. F, full grown fruit surrounded by its bracteole, $\times 4$. G, transverse section of a bract, $\times 150$. H, glandular trichome, $\times 150$. K, part of a stigma, $\times 75$. ax, axillary shoot; b, bract; bl, bracteole; cu, cuticle; cy, cystolith; fl, flower; o, ovary; ov, ovule; pg, perigone; sp, stipule; st, style and stigma; α and β , the two bracteoles (from Wallis, 1960)



1. Upper epidermis of a bract in surface view showing glandular trichome (g.tr.) and part of the underlying palisade (pal.) with some of the cells containing crystals of calcium oxalate.
2. A multicellular, multiseriate glandular trichome.
3. Lower epidermis of a bract in surface view showing anomocytic stomata, a small trichome (g.tr.) and a sessile gland (s.g.).
4. Covering, non-cystolith trichomes.
5. Part of stigma showing papillae.
6. Upper epidermis of a bract in surface view showing covering trichomes containing cystoliths (cy.) and part of the underlying palisade.
7. Detached heads from the showing faint cuticular striations, a small multicellular glandular trichomes.
8. Small glandular trichomes.
9. Part of a papilla from a stigma.
10. Lower epidermis of a bracteole in surface view showing anomocytic stomata, covering non-cystolith trichomes (c.tr.) and calcium oxalate crystals in the underlying mesophyll.
11. Part of a bract in sectional view, showing calcium oxalate crystals in the palisade.
12. A multicellular, multiseriate glandular trichome attached to an epidermis.
13. Upper epidermis of a bracteole in surface view showing beaded walls and cluster crystals of calcium oxalate in the underlying mesophyll.

Figure 17.5 Microscopy of cellular detail of cannabis (from Jackson and Snowden, 1968)



14. Part of the epidermis of the stem (s.ep) in surface view, with an attached warty-walled covering trichome.
15. Laticiferous tissue (l.v.) from the stem in longitudinal view, with associated vessels and parenchyma containing cluster crystals of calcium oxalate.
16. Part of a group of pericyclic fibres from the stem, with associated parenchyma containing cluster crystals of calcium oxalate.
17. Cluster crystals of calcium oxalate.
18. Pith from the stem in longitudinal view showing pitted parenchyma (p.p.) and large cluster crystals of calcium oxalate.
19. Elongated parenchyma of the perigone
20. Annularly and reticulately thickened vessels from the stem.
21. Sclerenchymatous layer of the pericarp in surface view from above.
22. Covering trichomes, one warty walled and calcium oxalate containing a cystolith (cy.).
23. Fragments of multicellular, multiseriate glandular trichomes.
24. Sinuous-walled parenchyma of the perigone.
25. Polygonal straight-walled parenchyma of the perigone.
26. Sclerenchymatous layer of the pericarp in surface view, from below.

Figure 17.5 (Continued)

such as number of plants, potential of site to nurture a number of plants, water and nutrient availability, time of year – climatic factors, or for an indoor cultivation lighting and temperature conditions. Provided it is supported by appropriate data it is possible to predict a range of potential yield for a site. This is useful in some jurisdictions for sentencing purposes. I stress this type of assessment should *not* be attempted without the necessary competencies, experience and background data.

17.2.5 Plant fibres used in paper and textiles

Carroll (1993) discusses the botanical aspects of paper examination in an excellent introduction to botany in forensic science. The forensic analysis of paper is a multi-faceted activity, *one* element of which can be the botanical identification of fibres present in paper. These fibres can come from a variety of plant materials, although most commercial paper is made of fibres from wood sources.

From a crime scene investigator's perspective 'paper' usually will mean documents. The scene examiner should be aware that part of the examination carried out by a document examiner may involve some analysis of the paper. Collection of relevant known samples is important. Except in those unusual cases, where it is not possible to write guiding principles, there are no specific issues for crime scene investigators with respect to paper.

Botanical fibres are also found in textile usage. This includes ropes and cordage. Although natural fibres have been replaced in many applications by man-made fibres, many ropes, twines, etc. are still made of botanical fibres. Wiggins (1999) deals with ropes and cordage in Chapter 3 of Robertson and Grieve (1999). The classification of textile fibres is covered in Chapter 1 by David and Pailthorpe whilst Robertson deals with natural fibres (including botanical fibres) in Section 5.3 of the same book, 'The Forensic Examination of Fibres'. Once again the forensic examination of textiles, including ropes and cordage, is somewhat specialised.

From a crime scene investigator's perspective textile fibres, in the context of clothing or other fabrics, should be dealt with as part of the general crime scene. For ropes and cordage there may be specific factors to consider. Ropes and cordage will often be knotted and sometimes used in suicide or murder as a ligature or to bind a victim. Great care should be taken to fully record the detail of knots, and these should in general be left alone. If it is necessary to cut the rope it is critical that the ends are marked and protected to stop damage or contamination of other items through fibres falling from the cut ends.

Where rope has been used to secure a victim the crime scene investigator may attend a scene or scenes relating to a suspect or suspects. The sampling of ropes or cordage found at such a scene needs to focus not only on collecting any ropes present but also on the possibility of physical fits and the presence of cutting implements as it is possible to have tool marks on cut ends. Samples need to be, as usual, large enough and representative.

17.2.6 General plants, pieces, parts or fragments of plants

We live surrounded by plants and by plant debris. Even the barest alleyway will have some plant material whether it is a weed growing out of a crack in the road, moss or algae on a rock, or dried seeds blown in by the wind.

Many seeds are actually adapted to transferring during contact and sticking to the surface of animals, humans, clothing, etc. Hence, plants whole, in parts or fragments are pretty much ubiquitous. Every forensic scientist knows plant material is found on clothing in many types of case and, at least in some laboratories, the 'trace' botanical material will be collected *but* in most this is where the trail ends.

The ubiquitous nature of plants and the difficulty in individualising by traditional morphological approaches, are the underlying reasons for plant fragments being generally ignored. It is only in those cases where the plant fragment may be critical that effort is expended *but* all too often with very limited probative value. This issue is considered in more detail in [Section 17.4](#).

The present purpose is to look a little further at the scope of such evidence.

The diversity of plant life is enormous. Major subgroups of the plant kingdom include mosses, ferns, conifers, and all of the flowering plants in their many forms. The various forms of algae and diatoms belong to a separate kingdom in modern classification schemes. Fungi and lichens belong to a third kingdom.

This diversity in turn means that the type of morphological structures and their anatomy is enormously varied. Added to this is that in some higher plants the seeds or fruits are adapted to attaching themselves to 'passing' animals for dispersal. Given this diversity it would not be possible for any one type of botanist to be a specialist across the entire range of plants. For this reason taxonomists (taxonomy is the systematic classification of organisms) specialise, usually dealing in quite specific and delineated areas or taxa. Taxonomists typically produce classification schemes which can be used to classify or identify a particular species. Mostly these 'identification' schemes have relied upon the use of dichotomous (two choices) keys. The use of such keys assumes a detailed knowledge of the relevant plant morphology (external structure) and sometimes anatomy (internal structure). It also usually assumes access to whole plants at the specific stages of development.

Major centres of taxonomic study have access to large collections of so-called 'voucher' specimens of plants in herbaria. Hence, the taxonomist can access relevant materials for direct comparison with a questioned sample.

The task of a botanist working in a forensic situation is to attempt to identify (usually) fragments or specific parts (such as seeds) from plants. This requires a generalist approach as the early key is often to recognise the broad grouping to which the recovered material belongs. If the botanist has some specialist knowledge of this group then it may be possible to identify to a more specific level. Where the scene of the incident is known and appropriate known samples are available, this is extremely useful. First, identification of the actual plants at the scene is invariably made easier and second, it is then possible to compare the 'fragment' recovered from the case item with the relevant part of the known plant. In some cases, the reverse may apply where the botanist is able to suggest a type of ecological site based on the plant species present. Although the basics of plant examination are the same worldwide, knowledge of the local flora and habitat is *vital*.

Returning briefly to the use of identification keys, with a few exceptions these are not especially useful for the forensic botanist. Demmelmeier and Adam (1995) discuss some specific examples where keys may be of value.

In summary the forensic botanist needs to be first and foremost a generalist and in many cases will need to consult with a specialist in the type of plant present in the

particular case. As such specialists may have very limited experience of the legal system this interaction works best where there is a genuine partnership between the specialist, the crime scene investigator and the lawyer.

From a crime scene investigator's perspective it is most likely that the scene will be an outdoor setting although indoor settings should not be excluded. The types of cases in which botany is most likely to be encountered will be sexual assault and/or murder cases. In some cases, the body may be in a shallow grave or simply covered with plant debris. A rather specific type of outdoor scene is where a body is located partly or fully submerged in water or near water where drowning is suspected.

The analysis of microscopic algae in or on the bodies of deceased persons has been used in forensic examinations to provide evidence of drowning. These algae invariably include diatoms which have silica skeletons with highly characteristic microscopic appearance. As with many types of forensic evidence there are issues regarding the interpretation of what the presence of diatoms means in the context of a specific case (see Peabody, 1980). However, used appropriately diatom analysis can provide useful evidence. The subject is alive and well as shown by the publication during the preparation of this chapter of a paper on 'algal colonisation of submerged carcasses in a mid-order woodland stream' (Casamatta and Verb, 2000).

The study and identification of diatoms, although relatively straightforward requires specialist knowledge as does the collection of samples for analysis.

In a sexual assault, the victim may be able to identify the location in general or highly specific terms. It is not unknown for there to be quite obvious signs of disturbance to vegetation. In some cases the evidence can be quite compelling (see [Figures 17.6](#) and [17.7](#)). In an early case in my own life in forensic science I encountered an interesting, if painful, example where the suspect had sexually assaulted a young lady near some blackberry bushes to which the detached 'thorn' found on his scrotum testified! In other cases there may be debris left at the scene indicating a more general location.

In the case of a body found in a grave, shallow or otherwise, the scene should be treated as a forensic archaeological examination. It is particularly important not to rush to get to the body which in any event is not going anywhere fast.

Common sense should apply, as well as following normal best practice, in fully recording the scene; each 'layer' as it is uncovered should be recorded and sampled. It may be that the plant evidence of value is what was present several months before. It may be that the offender has carried away fragments which will have persisted in a car boot on a blanket, rug or on footwear. Consideration should be given to involving a specialist forensic botanist to oversee the collection of samples. It is critical that photographs of vegetation are not so generalist that they do not show sufficient detail to allow a specialist to tell what was present (at least in general terms) at some later stage. The photographs may be the only record of what was growing at a particular time.

If it is not possible to have a forensic botanist present, the guiding rule should be: collect more not less. Plant material should be placed in either cardboard boxes or in paper bags and preferably *not* in plastic bags. If the material is damp it can be placed for the short term in plastic but must be dried as soon as possible. Finally, the possibility of a physical fit between the scene and suspect samples should be considered.

In discussing plants from an outdoor scene these will often be associated with soil. This is the subject of the next section.



Figure 17.6 Outdoor scene of sexual assault: obvious flattening of vegetation on a railway embankment indicating precise scene location



Figure 17.7 Outdoor scene of sexual assault: no obvious precise location but debris at scene indicates general location

17.3 Soils, pollen and forensic science

The purpose of this section is to develop the obvious link between plant and soil in forensic investigation. The reader is referred to the bibliography for a number of key references in which the forensic examination of soil is dealt with in more detail. As was discussed in [Section 17.2.6](#) there will be many situations where, if plant material is present then so will soil. Indeed even in the absence of obvious plant fragments soil has a botanical 'potential'. Specifically, but not restricted to, pollen analysis has significant potential to be used more often than would currently be the case. Bruce and Dettmann (1996) discuss the potential for the use of pollen (palynological) analyses of Australian surface soils. Their results show that specific assemblages of pollen can be reliable indicators of vegetation communities.

Another interesting example of the use of pollen analysis is with cannabis seizures (Stanley, 1992). Being resinous and sticky, the surfaces of cannabis plants are particularly effective in trapping passing particles. In this report, pollen analysis was used to establish geographic origin based on the pollen species present. There have been number of applications of this type of analysis to assist investigators determine the possible site of harvested cannabis plants. Perhaps it is not a surprise that the application of forensic palynology is directly correlated with the presence of an individual having an interest in applying their skills to forensic purposes. In this regard there have been many published examples of the use of pollen analysis in New Zealand thanks to the work of Mildenhall, Horrocks and others (see bibliography for some examples).

Bruce and Dettmann (1996) refer to 'surface soils'. This is an interesting qualification to 'soils' and accurately describes the normal presentation of soil to the forensic scientist. Demmelmeier and Adam (1995) also discuss the issue of what is soil from a forensic perspective. Soil is formed by physical, chemical and biological weathering of the uppermost layers of rock. Soil scientists classically classify soils based on the types of particles present. However, from a forensic perspective, soil is more like dust. It is a mixture of soil and debris which is often a good indication of its environmental surroundings. Whilst the soil scientist typically collects sub-layers or horizons, the forensic scientist is most often only interested in the surface or first few centimetres below the surface. The potential range of analytical techniques which could be used to look at this 'dust' is extensive and, no pun intended, the surface has not yet been scratched; for example, the potential to look at the soil microflora. Typically forensic laboratories which do examine soils (of which there are decreasingly few) focus on macro appearance, particle size and if the specialist knowledge is available, mineralogy. Perhaps more attention should be paid to the initial microscopic examination where it may be possible to recover plant fragments and/or seeds.

From a crime scene investigator's perspective sampling for soil presents some specific issues. As Wanogho *et al.* (1985) have shown there can be significant differences in particle sizing in soil samples collected from the same site separated by only a small distance. Furthermore, the composition of surface dust may change over quite short time periods due to environmental or physical influence or intervention.

Hence, the initial collection of soil samples can usually only be general unless it is very clear where the incident has occurred. In the latter case, very careful consideration is needed in determining what samples to collect. There are no rules of thumb which

can be followed *but* more is better than less. With caked soil on a vehicle, care should be taken to not disturb layering when taking samples as analysis of layers may yield significant history. In general I do not favour plastic bags or containers for the collection of soil samples. Folded clean paper is preferred which can be readily unfolded for later examination. This can then be placed in a sealable plastic bag. In some circumstances it may be necessary to use a vacuum such as inside a motor vehicle *but* this should be a last resort as it produces mixed debris, which can make subsequent analysis more difficult and very time-consuming.

17.4 Evidence and interpretation issues

The blunt reason why forensic botany no longer finds general or widespread application is the *generally* low potential significance of findings. This is notwithstanding those special cases, of which there are many, where the evidence is critical to a particular case. In an era in which forensic science is doing ‘more with less’, but perhaps ‘less with more’, the focus is on numbers driven by DNA analysis.

Where it is not possible to place numbers on the analytical results, forensic examinations are under pressure. The use of probability theory and in particular the Bayes approach, is an attempt to address this issue. But perhaps the future will lie in the increased application of DNA for plant analysis.

A number of studies have been reported on the use of DNA analysis for the identification of, or comparison of, cannabis samples (see Jagadish *et al.*, 1996 and references cited). There are few other published examples of the use of DNA analysis for forensic botany. The potential is enormous.

In *DNA Fingerprinting in Plants and Fungi* (Weising *et al.*, 1995) some 841 references are quoted, and four appendices list species which have been subjected to various forms of DNA analysis. So-called RAPD (random access polymorphism) analysis was the most popular approach by the mid-1990s but the balance has changed in the last five years towards other approaches. There are a number of reasons for this change. The benefit of RAPD’s analysis is that it can be applied to any species without detailed knowledge of its genome. However, RAPDs has a number of disadvantages the most critical of which, for forensic application, is the difficulty in ensuring the necessary level of reproducibility and overall robustness.

When one considers the global effort required to analyse the human genome, a single species, the scope of the problem for many hundreds of thousands of species is obvious. The first plant species to have its genome fully ‘typed’ is *Arabidopsis*, a weed species used in botanical research with a very small genome. Clearly, the enormous effort required will see work directed at species of commercial or academic research interest. Notwithstanding, one can be confident of very significant advances in the years ahead. Depending on the species it will probably be possible to obtain a genetic profile or signature which will go well beyond species level. It may be possible to get to a level of ecological population. This opens up very exciting possibilities. In the past, the ‘rare cases’ have usually involved ‘rare species’ being present which of course by the very nature of that rarity, makes these cases rare!

It would be much more useful if it was possible to identify a relatively common species but also show that it came from a limited geographic area or population,

defusing the usual argument that the plant could have been picked up anywhere. Current work on cannabis using an STR (short tandem repeat) approach is aimed at producing a robust approach for comparison of cannabis seizures (Gilmore *et al.*, 2003).

It should be stressed that, even if this DNA vision is realised, many of the issues confronting forensic botanists and crime scene examiners will not disappear. The principal issue facing the crime scene examiner, as *with any type* of evidence, is what to collect. As in all types of crime scene investigation this involves detailed consideration of the specific circumstances. There is no formula-driven approach which can be used. The hope is that this chapter will have increased the awareness of the crime scene examiner to the potential value of botanical examinations beyond cannabis identification. For that value to be realised the most critical phase is collecting the 'right' known and reference samples. In some cases this will more or less be relatively straightforward. The crime scene investigator should call in expert advice and assistance if in doubt as to what to collect. It is more than merely picking up a few bits and pieces of vegetation at a scene! The scene examiner needs to be particularly focused on how the material available for potential transfer presents. Whilst there is value in collecting appropriate fresh material to assist the expert identify the species present in, say, leaf litter, it is the actual leaf litter which will be available for transfer. The possibility of physical fits and other evidence at a scene has been stressed throughout.

Finally, in order to apply DNA analysis to plants, *all* of the preliminary testing will still have to be conducted, i.e. visual examination, searching, sorting and selecting samples for morphological and anatomical examination. The use of low magnification and high magnification microscopy will still be core techniques. DNA will only be able to be applied where the analyst has a good idea of the type and identity of the plant material.

17.5 Summary and conclusion

In this chapter I have outlined the range and scope of forensic botany. There are of course many other examples not covered in this chapter. There is a potentially exciting future to enhance the evidential value of botanical samples through the future use of DNA analysis. This will only be achieved *if* the crime scene investigator is open to the possibilities for forensic botany to contribute and to collect the necessary known and reference materials. Mostly there is nothing unique from a crime scene investigation viewpoint for forensic botany as, generally speaking, these contact, physical materials are transferred or picked up at *normal* scenes. Hence normal scene work is involved. Awareness *to* the environment is the key. In many cases it will be within the scope of the crime scene investigator to record and take appropriate samples from the scene. The key here is to ensure photographs record not only the overview but also any necessary detail. The focus of the collection process should be twofold, first, what is necessary to identify the materials available for transfer, and second, how does the material present for transfer. Sampling needs to meet the basic requirements of being large enough (sufficient) and of being representative. There are some special requirements to be followed in dealing with

gravesites. The key is that, if in doubt, seek expert assistance – it may be necessary to use academic or industry scientists. The role of the crime scene investigator here is critical as these individuals cannot be expected to appreciate all facets of a forensic approach. In an effective relationship there will be no sense of inappropriate role protection.

Plant materials should be carefully selected and packaged with the primary aim being the preservation of (what may be) moist plant material. Unless there are factors which make the use of paper not possible this is to be preferred to plastic. Even plant material, which looks to be dry can sweat inside plastic and quickly deteriorate. For small samples a sheet of paper folded into a boat shape and then placed in a plastic bag works well. Vacuuming should be used, if at all, as a final search technique. Whilst vacuuming is a quick way to cover large areas it may further fragment plant material, and any special analysis (where was the sample? how was it attached?) is lost.

In many outdoor scenes plants and soils go together. Soil in the forensic context is the surface or close to the surface layer and can be a complex mixture of debris, dust and ‘soil’ particles reflecting the environment. Soil can vary over short distances and this can make the collection of known and reference samples difficult. Soils can again be collected in paper boats. For both plant debris and soil, care should be taken to avoid loss and contamination through the use of poorly sealed or constructed bags. It may be necessary for the specialist to later collect further samples.

Forensic botany and soil analysis is too infrequently used in forensic investigation. The aim of this chapter is to increase knowledge and understanding about its potential uses and about the role of the crime scene investigator in ensuring botanical materials are available for subsequent analysis.

17.6 Case examples

Case example 1

Sclerolaena (nindylis or copperburrs) is a genus of plant which occurs through the arid and semi-arid parts of Australia. These plants have hardened fruits with spikes and, therefore, are readily retained in clothing. The position and number of spikes on the fruit are used to identify the plant species level. Diagrammatic keys of the fruits may be studied and the species readily identified perianth (or fruit) was located, it being identified by its spikes as *Sclerolaena johnsonii*. A bag holding many kilograms of cannabis seeds was seized in Adelaide. The bag also contained ‘foreign’ plant fragments including some *Eucalyptus* fruits and some common weed fragments. The distributions of the identified fragments were found to overlap indicating a cannabis cultivation site in the upper part of South Australia and into the north-west corner of New South Wales. Additionally, a *Sclerolaena terianta* (a fruit) was located, it being identified by its spikes as *Sclerolaena johnsonii* (see Figure 17.8). The restricted distribution of this species determined that the cannabis site was in a particular part of New South Wales, in the geographical vicinity of a large cannabis cultivation under investigation. Soil collected from seized cannabis plant material in Adelaide corresponded to the crop-site reference soils samples, strengthening the prosecution allegations of a conspiracy to trade.

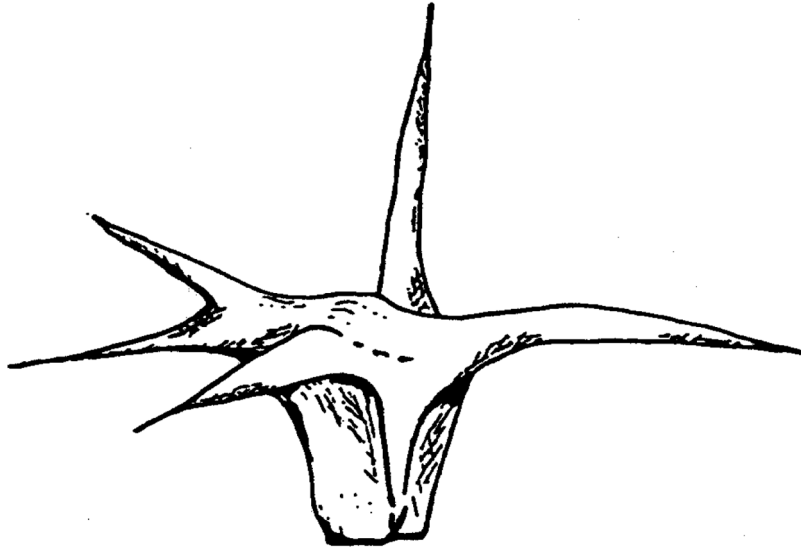

Figure 17.8 The fruiting perianth of *Sclerolaena johnsonii* (from Carroll, 1993)

Case example 2

The Morling Royal Commission (1987) reported the findings of the inquiry into the convictions of Lindy and Michael Chamberlain.

Botanical facets of the investigation into Azaria Chamberlain's death highlight many of the points raised regarding identification of fragmentary material and its subsequent interpretation. Plant fragments were recovered from the baby's jumpsuit located at the base of Ayers Rock, and these were identified as belonging to eight different species. The principal fragments present were from *Parietaria debilis* which is ecologically restricted to rocky shaded areas such as found at the base of the rock. This plant does not grow in the sand dune country (the campsite) nor in the plains lying between the sand dunes and the rocky areas. Other species identified during the investigation could have also originated from near the base of the rock or in the nearby plains, but not in the sand dunes. Plant fragments from species typical of the dunes and plains were not well proportionately represented in the recovered plant materials.

The Crown thrust was that a dingo could not be involved in the transport of that clothing. This was based upon the argument that a dingo would be non-selective as to which plant species would be collected on the baby's clothing. Therefore, clothing carried by a dingo from the dune area to the base of the rock would be expected to have representative and proportionate vegetative fragments from the dunes, plains and rocky environs. As the rocky area vegetation was disproportionately over-represented, this therefore implied human intervention.

When evidence was given at the trial not all of the plant material recovered had been able to be identified. For the Morling Royal Commission (1987), two experts re-examined the fragments and identified another three species. Although, largely agreeing with earlier findings and the evidence given in the trial, the identification of those extra

species pointed to the plains and sand dune environments. Furthermore, evidence on the road usage by dingoes in carrying their prey was adduced at the Commission.

This was sufficient to indicate to the Commission that the botanical evidence did not exclude possible involvement by a dingo in carrying the baby to the rock from the campsite.

Other factors, such as the density of the vegetation, growth habit of individual plants, their tendency to fragment and to subsequently cling to clothing, needed to be considered.

The case illustrates the importance of maximising the information obtained from trace material by pursuing the best possible identifications. Sometimes, subtle differences in the totality of this information may alter the overall thrust of the evidence. It also shows the necessity for expert and counsel to consider the question of interpretation of materials found which could not be identified (from Carroll, 1993).

Case example 3

The conviction in South Australia of Charles Edward Splatt for the murder of an elderly woman in her Woodville home relied almost entirely on trace evidence linking Splatt and his environment with the bed upon which the deceased was found. In the subsequent Royal Commission (1984) all aspects of the original evidence were questioned. One element of the trace linkages was the presence of fragments of seeds on the bedsheet. Splatt was known to keep an aviary and to feed his birds with a seed mix made on site. The Crown case was that fragments of seed which had fallen into the turnups (cuffs) of the trousers worn by Splatt had become dislodged during the violent assault and murder of the deceased. In the trial, evidence was led that five species of seed were identified out of eight species found at the aviary.

This evidence was heavily criticised at the Royal Commission on a number of grounds including:

- The identification was based on the appearance of starch granules in the seed fragments – this identification was overstated in that it was inappropriate to be as specific as to species.
- The starch granules in the seed fragments had a character appearance when microscopically viewed under crossed polars – it was said this meant they could not have come from an alternative source such as a biscuit or cookie product – this was based on starch losing the characteristic polarisation effect when it is subjected to heat and gelatinises; in fact in some cooked products such as biscuits starch can retain its polarisation appearance.
- The known sample collected from the aviary of Splatt consisted of whole seeds, and no samples were collected from the debris on the floor of the aviary – this meant that no examination was conducted to compare the fragments on the bedsheet with the type of fragment left after the birds had eaten the seeds, i.e. what it was alleged was available in the trouser turnup for transfer.

The seed fragments were but one of seventeen trace material said to link Splatt and the murder scene. All were criticised to a greater or lesser extent by Justice Shannan in his final report which led to the release of Splatt (Shannan, 1984).

The case illustrated

- the need to collect samples reflecting how they present for transfer as well as samples for use in establishing identity;
- that a forensic examination is first and foremost an exercise in comparison and not identification – the identity of the species present is meaningless unless there is comparability in appearance and, finally;
- the need to consider possible alternative explanations and sources – biscuits were suggested at an early stage; the specialist botanist involved had no knowledge of food products or processing and dismissed this as an alternative.

Case example 4

On 4 July, W. Michael, who had been missing since 28 June, was found stabbed in a cornfield. His hands were bound with a shoestring. Some blades of grass were found in the knot. In one hand, the victim was clasping some blades of grasses and corn. The victim was wearing only socks. His shoes were found some distance away, lying in the grass. One shoestring was missing. A lot of soil was adhering to the tread pattern of the shoes.

During inquiries in order to explain the events concerning the crime, traces such as fibres, the soil and vegetation traces became relevant. Investigation of these could be used to answer the following questions:

- Did the grass blades in the victim's hands and in the knot of the wrist binding originate from the place where the shoes were found?
- Were the blades of corn pulled out at the place where the victim was found?
- Was the soil wet when it stuck to the shoes and how long is it likely to have remained when the shoes were worn afterward? (Until the day after the disappearance of W. Michael the weather was very dry.)
- Did the soil on the shoes originate from the place where the victim was found?

Examinations

The traces from the binding around the wrists and from the hand of the victim were composed of the Gramineae – *Anthoxanthum odoratum*, *Festuca ovina*, *Trisetum flavescens* and *Arrhenatherum elatius* and of three blades from *Triticum sativum* which were not fully ripe.

A considerable amount of loamy soil on the soles and heels was found. The soil was firmly pressed into the grooves and filled them completely. The raised portions of the soles were mostly free, however, in some positions, the soil overlapped the raised portions. Enclosed in the soil and homogeneously mixed with it were plant fragments from *Poa trivialis*, *Holcus lanatus*, *Alopecurus pratensis*, *Agrostis tenuis*, *Dactylis glomerata*, *Achillea* species and *Atriplex* species.

On the upper part of the shoes (around the laces) and inside the shoes, plant particles were also found. All the identified plant species have been listed according to the origin, as shown in [Table 17.2](#).

Table 17.2 Plant species and their origins

Material	Place where the victim was found	Place where the shoes were found	Wrist binding	Enclosed in the soil from the shoes	Upper surface of the shoes	Inside the shoes
<i>Alopecurus myosuroides</i>	+++					
<i>Apera spica-venti</i>	++					
<i>Dactylis glomerate</i>		++				+
<i>Festuca rubra</i>		+++				
<i>Arrhenatherum elatius</i>	+++	+		+	++	
<i>Anthoxanthum odoratum</i>	+++	++			++	
<i>Festuca ovina</i>		+++	++		+	++
<i>Trisetum flavescens</i>		++	+		+	++
<i>Achillea species</i>		++		+	+	+++
<i>Gallium verum</i>		+++				++
<i>Poa trivialis</i>				+++	+++	+++
<i>Holcus lanatus</i>				++	+	++
<i>Alopecurus pratensis</i>				+	+	++
<i>Agrostis tenuis</i>				++		++
<i>Atriplex species</i>				+		
<i>Avena pubescens</i>						+

(Reproduced with permission from Demmelmeier and Adam, 1995)

Findings

The comparison of the grass species from the wrist bindings and from the hands of the victim with the grasses from the place where the shoes were found showed that all components of the recovered samples could be found in the comparison material. Therefore, in all probability the wrists were bound at that location.

The wheat from the hand of the victim was of the same species and was at the same stage of growth as the wheat in the cornfield. It is not likely that it originated from another place. The soil adhering to the shoes was mainly pressed into the grooves of the sole and partly overlapped the raised portions of the sole. The instep areas were relatively clean. Such deposits normally arise from walking through a moist (but not wet) loamy soil without sinking in too far. The soil traces that partly overlapped the raised portions of the sole showed that only a short distance was walked after picking up the soil.

The plant particles that were found enclosed in the soil differed in species from those found at the places where the victim and his shoes were found. The morphological comparison of the soil showed differences in particle size distribution and in colour. It is therefore not possible that the soil was transferred at the scene of the crime. The enclosed plant particles suggested that they may have originated from a nearby foot-path where grasses were growing. Such a foot-path led to the scene of the crime. The origin of the other plant species that were found on the upper surface and inside the shoes, which is the same as those from the place where the shoes were found can thus be explained.

From these results, it can be postulated that the victim was walking along the foot-path towards the scene of the crime on the day after his disappearance at the earliest. He was bound at the place where the shoes were found and then transported without shoes to the place where he was found dead.

Case example 5

On 24 April 1976 two children were playing on the nature strip in suburban Alice Springs in Central Australia. A four-wheel drive mounted the kerb; hit a tree and one of the children, injuring her seriously. The driver failed to remain at the scene and decamped prior to police arrival.

A witness noted the vehicle's registration number, and a suspect was spoken to about the accident in a record of interview four hours later.

In an answer to a question regarding the leaves and other plant material stuck in the grill and other crevices in the front of the vehicle he stated he had not been near the tree in question but had been 'scrub bashing' in the hills north of Alice Springs.

Following the record of interview the driver was charged with culpable driving, dangerous driving and failing to stop after an accident.

The traffic member in charge of the enquiry caused a forensic examination to be carried out on the vehicle and botanical specimens, among other potential evidence was recovered from the front of the vehicle. These items along with control samples were sent to the forensic science section of the Northern Territory police in Darwin, Australia.

As botany is a specialised science with very few botanists being employed in forensic science laboratories, a specialist was consulted at the Northern Territory Primary Industries Branch.

Examinations

The samples of leaves were identified using the reference Herbaria and books. The majority of samples submitted for botanical examination were found to come from the species *Ceratonia siliqua* (carob) a species, which was commonly cultivated within the Alice Springs Township.

Findings

The botanist was able to present this evidence in the Alice Springs Court of Summary Jurisdiction and along with evidence that the species *Ceratonia siliqua* does not occur in the wild in Alice Springs caused the person charged to change his plea, and he accepted the consequences of his actions.

Conclusion

This case demonstrates the proper use of forensic botanical evidence by astute traffic and crime scene investigators (Crossan, personal communication; *Police v. Kevin, D.*).

17.7 Bibliography

The purpose of this bibliography is to provide a number of specific, but mainly, general references covering aspects discussed in the text of this chapter. The list is not intended to be comprehensive but rather to provide a starting point for the reader interested in further pursuing forensic botany.

- Andrasko, J. (1981) Soil, in Maehli and Strömberg (eds), *Chemical Criminalistics*, Berlin: Springer-Verlag.
- Apling, E. C. (1980) The optical microscope in foods analysis, in *Development in Food Analysis Techniques – 2: Applied Science*.
- Barefoot, A. C. and Hankins, F. W. (1982) *Identification of Modern and Tertiary Woods*, Oxford: Clarendon Press.
- Bock, J. H., Lane, M. and Norris, D. (1988) Identifying plant food cells in gastric contents for use, in *Forensic Investigations – A Laboratory Manual*, US Dept of Justice.
- Brazier, J. D. and Franklin, G. L. (1961) Identification of hardwoods – a microscopic key, *Forest Products Research Bulletin*, No. 46.
- Bruce, R. G. and Dettmann, M. E. (1996) Palynological analysis of Australian surface soils and their potential in forensic science, *Forensic Science International*, **87**, 77–94.
- Bryant, V. M., Jones, J. G. and Mildenhall, D. C. (1990) Forensic palynology in the United States of America, *Palynology*, **14**, 193–208.
- Carroll, D. (1993) Botany in forensic science, in Freckleton and Selby (eds), *Expert Evidence*, Sydney: The Law Book Company.
- Casamatta, M. S. and Verb, R. G. (2000) Algal colonization of submerged carcasses in a mid-order woodland stream, *Journal of Forensic Sciences*, **45**, 1280–5.
- Catling, D. L. and Grayon, J. (1982) *Identification of Vegetable Fibres*, London: Taylor & Francis.
- Chun, J., Lee, J., Cole, M. and Linacre, A. (2000) Identification of members of the genera *Panaeolus* and *Psilocybe* by a DNA test. A preliminary test for hallucinogenic fungi, *Forensic Science International*, **112**, 123–33.
- Crossan, T. *Personal Communication*, Traffic Section Northern Territory Police, Alice Springs.
- David, S. K. and Pailthorpe, M. T. (1999) Classification of textile fibres: production, structure and Properties, in Robertson and Grieve (eds), *Forensic Examination of Fibres*, 2nd edn, London: Taylor & Francis.
- Demmelmeier, H. and Adam, J. (1995) Forensic investigation of soil and vegetable materials, *Forensic Sciences Review*, **7**, 119–42.
- Eyring, M. B. (1997) Soil pollen analysis from a forensic point of view, *Microscope*, **44**, 81–97.
- Faegri, K. and Iversen, J. (1989) *Textbook of Pollen Analysis*, Chichester: John Wiley & Sons.
- Gilmore, S., Peakall, R. and Robertson, J. (2003) Short tandem repeat (STR) DNA markers are hypervariable and informative in *Cannabis Saliva*: implications for forensic investigations, *Forensic Science International*, **131**, 65–74.
- Gordon Cook, J. (1984) *Handbook of Textile Fibres, Natural Fibres*, 5th edn, Durham: Morrow.
- Greenish, H. G. (1923) *The Microscopical Examination of Foods*, London: Churchill.
- Gregory, M. (1980) Wood identification: an annotated bibliography, *IAWA Bulletin*, **1**, 3–41.
- Horrocks, M. and Walsh, K. A. J. (1998) Forensic palynology: assessing the value of evidence, *Rev. Paleobot. Palynol.*, Special edn: *New Frontiers in Palynology* 1 × 1PC, **103**, 69–74.
- Horrocks, M. and Walsh, K. A. J. (1999) Fine resolution of pollen patterns in limited space: differentiating a crime scene and alibi scene seven metres apart, *Journal of Forensic Sciences*, **44**, 417–20.
- Horrocks, M. and Walsh, K. A. J. (2001) Pollen on grass clippings: putting the suspect at the scene of the crime, *Journal of Forensic Sciences*, **46**, 947–9.

- Jackson, B. P. and Snowdon, D. W. (1968) *Powdered Vegetable Drugs*, London: Churchill Ltd.
- Jagadish, V., Robertson, J. and Gibbs, A. (1996) RAPD analysis distinguishes *Cannabis sativa* from different sources, *Forensic Science International*, **78**, 113–21.
- Jane, F. W. (1970) *The Structure of Wood*, 2nd edn, London: A & C Black.
- Jolliffe, G. H. and Jolliffe, G. O. (1979) Computer-aided identification of food materials, in Vaughan, J. G. (ed.), *Food Microscopy*, London: Academic – Press.
- McCrone, W. C. and Delly, J. G. (1973) *The Particle Atlas*, Ann Arbor, MI: Ann Arbor Science.
- Metropolitan Police Forensic Science Laboratory (METLAB) (1978) *Biology Methods Manual*.
- Mildenhall, D. C. (1990) Forensic palynology in New Zealand, *Rev. Palaeo-Bot., Palynology*, **64**, 227–34.
- Moffat, A. C. (1980) Forensic pharmacognosy – poisoning with plants, *Journal of the Forensic Science Society*, **20**, 103–10.
- Morling, J. R. (1987) *Royal Commission of Inquiry into Chamberlain Convictions*, Legislative Assembly of Northern Territory.
- Murray, R. C. (1982) Forensic examination of soil, in R. Saferstein (ed.), *Forensic Science Handbook*, New Jersey, NJ: Prentice Hall.
- Murray, R. C. and Tedrow, J. C. F. (1992) *Forensic Geology*, New Brunswick, NJ: Prentice Hall.
- Norris, D. O. and Bock, J. H. (2001) Method for examination of fecal material from a crime scene using plant fragments, *Journal of Forensic Identification*, **51**, 367–77.
- Peabody, A. J. (1980) Diatoms in forensic science, *Journal of the Forensic Science Society*, **17**, 81–8.
- Pollanen, M. S. (1997) The diagnostic value of the diatom test for drowning, II. Validity: Analysis of diatoms in bone marrow and drowning medium, *Journal of Forensic Sciences*, **42**(2), 286–90.
- Pollanen, M. S., Cheung, C. and Chiasson, D. A. (1997) The diagnostic value of the diatom test for drowning, I. Utility: A retrospective analysis of 771 cases of drowning in Ontario, Canada, *Journal of Forensic Sciences*, **42**(2), 281–5.
- Police v. Kevin, D. (1976) *Culpable Driving and Other Charges*, Northern Territory Court of Summary Jurisdiction at Alice Springs.
- Robertson, J. (1999) Protocols for fibre examination and initial preparation, in Robertson and Grieve (eds), *Forensic Examination of Fibres*, 2nd edn, London: Taylor & Francis.
- Shannan (1984) *Royal Commission Concerning the Conviction of Edward Charles Splatt*, Government Printer, South Australia.
- Shoyama, Y., Kawachi, F., Tanaka, H., Nakai, R., Shibata, T. and Nishi, K. (1998) Genetic and polyploid analysis of *Papaver* species and their F1 hybrid by RAPD, HPLC and Elisa, *Forensic Science International*, **91**, 207–17.
- Stanley, E. A. (1992) Application of palynology to establish the provenance and travel history of illicit drugs, *Microscope*, **40**, 149–52.
- Summer, M. E. (2000) *Handbook of Soil Science*, Boca Ratan: CRC Press.
- Thornton, J. L. (1986) Forensic soil characterisation, in Maehli and Williams (eds), *Forensic Science Progress*, Vol. 1, Berlin: Springer-Verlag.
- Vaughan, J. G. (1979) *Food Microscopy*, London: Academic Press.
- Wallis, T. E. (1957) *Analytical Microscopy*, 2nd edn, London: J & A Churchill.
- Wallis, T. E. (1960) *Textbook of Pharmacognosy*, 4th edn, London: Churchill.
- Wanogho, S., Gettingby, G., Caddy, B. and Robertson, J. (1985) A statistical method for assessing soil comparison, *Journal of Forensic Sciences*, **30**, 864–72.
- Watling, R. (1983) Hallucinogenic mushrooms, *Journal of the Forensic Science Society*, **23**, 53–66.

- Weising, K., Nyboun, H., Wolff, K. and Meyer, W. (1995) *DNA Fingerprinting in Plants and Fungi*, Boca Raton, FL: CRC Press.
- Wiggins, K. G. (1999) Ropes and cordage, in Robertson and Grieve (eds), *Forensic Examination of Fibres*, 2nd edn, London: Taylor & Francis.
- Winton, A. L. and Winton, K. B. (1932) *The Structure and Composition of Foods*, Volumes 1 and 2, New York: John Wiley.

The application of entomology to criminal investigations

James F. Wallman

18.1 Introduction

Forensic entomology is the scientific study of insects involved in matters pertaining to the law. It is best known for its use in the investigation of crimes, especially violent crimes such as murder. This sub-speciality of forensic entomology, called medico-criminal entomology (Catts and Goff, 1992), is the subject dealt with here. Other forensic involvement by insects may include contamination of foodstuffs (stored products entomology) or infestation of buildings and gardens in the urban environment (urban entomology) (Lord and Stevenson, 1986).

This section explores how and why information gleaned from insects is useful in criminal investigations. It also provides guidelines for the collection of forensic entomological evidence at the scene of a crime and elsewhere.

18.2 Using insects in the investigation of death

18.2.1 *Insects and carrion*

Animal carcasses form highly specialised, ephemeral environments inhabited by characteristic communities of arthropods. As a carcass decomposes, the composition of its arthropod community changes in a sequential manner, a phenomenon known as succession. Insects are the animals most responsible for the breakdown of carrion. This is because the adults and, more particularly, the larvae of certain species have a voracious appetite for rotting animal tissues. By feeding on such tissues these important insects reduce considerably the time taken for nutrients to be released and thus made available to other components of the ecosystem (Putman, 1983).

Because of their abundance and ubiquity, carrion-breeding blowflies are the primary insects in carcasses. They invade a body often only minutes after death to lay, depending on the species of blowfly involved, either eggs or live-born larvae. The larvae, commonly known as maggots, pass through three instars, or stages, of development. Following this, they undergo a process called pupariation, in which their cuticle, or skin, hardens to form a case-like puparium. Within the puparium the third-instar larva becomes a pupa, which then metamorphoses into an adult fly. Upon completing their development, the adult flies emerge from their puparia and disperse to continue the life cycle. For further information on the biology of blowflies see Erzinçlioglu (1996).

In general, the flies of greatest forensic importance belong to the families Calliphoridae, Sarcophagidae, Muscidae and Piophilidae. Other families may be involved, but either less commonly, or less usefully (Smith, 1986). Different groups of species use a carcass at different times during its decomposition, and may be labelled primary, secondary or tertiary, depending on the timing of their arrival (Fuller, 1934; Norris, 1959). The activity of each group of species renders the carrion unsuitable for continued occupation by itself, but more suitable for the next set of species which was unable to use the carrion in its previous form. In general, calliphorids are primary and secondary invaders of carrion, while sarcophagids are secondary, and muscids and piophilids are tertiary invaders.

Beetles also play an integral role in the ecology of carcasses because, like the flies, they rely on the carrion to provide a nursery for the development of their progeny. Beetles that are important forensically belong to the families Staphylinidae, Histeridae, Silphidae, Cleridae and Dermestidae, among others (Smith, 1986).

Insects not only invade carcasses on dry land, but also those immersed in freshwater. Insects of the kinds mentioned above may be present in an immersed carcass if it is floating or parts of it are protruding from the water (Payne and King, 1972). However, an exclusively aquatic carrion fauna also exists that differs considerably from the terrestrial carrion fauna, particularly in its diversity (e.g. Vance *et al.*, 1995). It appears to be dominated by larvae of flies of the family Chironomidae (Haskell *et al.*, 1989; Keiper *et al.*, 1997).

18.2.2 Estimating time since death

Most commonly, medicocriminal entomology uses insects to estimate the period that has elapsed since a person's death (also known as the post-mortem interval). Pathological methods for determining the post-mortem interval become increasingly inaccurate over time, and after about 72 h. insects are often the only means of determining it with any precision, e.g. see Kashyap and Pillay (1989).

There are two main methods for estimating time since death entomologically – determination of the stage of faunal succession in the corpse and determination of the age of blowflies found in it.

18.2.2.1 Stage of faunal succession in corpses

Since the composition of the insect fauna in a body changes successively, it is possible in principle to determine the stage in the successional sequence which the faunal assemblage represents and thus to arrive at the likely age of the corpse.

On land, as already mentioned, this assemblage has as its most common components an array of flies and beetles of various families. Soil mites, which are not insects, but arachnids, have also been shown to be useful because of their association with corpses found outdoors (Goff, 1991).

For this technique to be reliable it should be recognised that the fly, beetle and other arthropod species that invade carrion have particular geographic distributions and environmental and seasonal preferences. Thus, the actual species of forensic value will differ depending on the locality and the time of year. It is therefore impossible to generalise about the details of insect succession in corpses (Erzinçlioglu, 1983).

18.2.2.2 Age of blowflies in corpses

The second method for determining time since death is to identify and determine the age of particular insects, usually larval blowflies, in the body.

The first task here is to identify the blowfly species, based on knowledge of their immature and adult stages (e.g. Wallman, 2001a,b). It is then necessary to infer the minimum period that they could have been present, judging from their stage of development. The rate of development is controlled primarily by temperature (Higley and Haskell, 2001).

The thermal environment in a carcass will change during the time that larvae remain there. At the outset, they will be influenced by the air temperature and by the temperature of the body itself. Heat from the sun may also be a contributing factor (Shean *et al.*, 1993). Moreover, considerable heat may be produced later by the metabolic activities both of the larvae themselves (Cianci and Sheldon, 1990; Turner and Howard, 1992), and of bacteria in the decomposing body and rotting vegetation beneath or around it, so that, in total, the temperature to which the larvae are exposed may considerably exceed the air temperature. This may help them to develop at their optimum rate (Catts, 1992).

The time since death may equal the estimated minimum period spent by flies in a corpse, since blowflies often arrive at a body within a few hours or even minutes after death. However, oviposition by flies could occur *before* death if a wounded or soiled person was lying unconscious or helpless for some time before dying, e.g. see Goff *et al.* (1991). Such invasion of living animals by fly larvae is called myiasis (see Hall and Wall, 1995). Conversely, oviposition may have been *delayed*. There are two possible reasons for this:

1. The body was protected from insect infestation. This may have come about because the corpse was inside a building or automobile, or because it was wrapped in material of some sort, or covered with soil and/or vegetation, e.g. see Erzinçlioglu (1985) and Goff (1992). Under such circumstances, the actual *lack* of insects associated with the corpse may be revealing. Of course protection from insects may also have occurred while the body was being transported from the scene of the death to the scene of discovery.
2. Flies were incapable of ovipositing on the corpse or of seeking it out because it was exposed at night or when the climatic conditions were unsuitable (it may have been raining or was too hot or cold). Although flies are generally only active during the day, Green (1951) and Greenberg (1990b) have shown that some species are

capable of nocturnal oviposition under certain circumstances. Cold and extreme heat inhibit oviposition, but the temperatures at which this occurs vary between species (Erzinçlioglu, 1996). The temperature conditions required for flies to take to the wing and search out a body may be partly determined by the thermal environment in which they developed or that which they recently experienced as adults since emergence (Wallman, personal communication).

Blowflies can also be invaluable in determining the season of death in cases involving skeletonised remains. This is because the puparia from which the adults emerged are extremely durable. Under certain conditions they may be identifiable even after tens of thousands of years (Gautier and Schumann, 1973; Coope and Lister, 1987). Season of death may then be inferred if the species identified is known to be active only at certain times of the year, e.g. see Nuorteva (1987).

Aside from using insects to determine time since death, there are five other main ways in which the association of insects with deaths may be important.

18.2.3 Movement of a body after death

At times, the species collected from a corpse may not appear to be characteristic of the fauna in the locality where it was discovered. It is then a possibility that the body was originally infested in another locality in which those species naturally occur, and subsequently moved (Erzinçlioglu, 1989b).

When a corpse is relocated this way, insects that had been feeding on it may remain at the death scene. Human DNA may be extracted from such insects, proving the prior existence of the body or even identifying it (Wells *et al.*, 2001; DiZinno *et al.*, 2002).

18.2.4 Manner and cause of death

Information concerning the manner and cause of death may also be inferred from the evidence of flies. The location and pattern of larval infestation in a body may suggest that death occurred as a result of damage to a specific area, even when the associated wounds and tissue damage have been consumed (Lord, 1990; Erzinçlioglu, 1992).

Fly larvae have also been shown to accumulate poisons and drugs from the corpses on which they are feeding. Toxicological tests on the living tissues of larvae can detect these substances in their bodies just as in the decomposing tissues of the corpse. This field of study is known as entomotoxicology. Despite its potential for the identification of poisons used in a murder, no cases of this kind have been reported. So far, entomotoxicology has been applied only in cases concerned with suicide or accidental drug overdose, e.g. see Beyer *et al.* (1980). Drugs have also been isolated from fly puparia and beetle exuviae (Miller *et al.*, 1994).

It is important to note that the presence of drugs may alter the rate of development of some species of fly larvae and that it may also affect the time they subsequently spend as pupae, e.g. see Goff *et al.* (1997). This effect may be crucial, since it can influence the estimation of time since death profoundly. For example, if drugs shortened the time of development of larvae in a body, the estimate of time since death based on temperature data would be greater than it should. Such an error could lead to a miscarriage of justice. Entomotoxicology has been reviewed by Goff and Lord (1994, 2001).

18.3 Linking a suspect and the death scene

Insects and other arthropods may also be valuable for establishing a link between the suspect and the scene of a death. Arthropods present on clothes may suggest, perhaps rather tenuously, that a person has been in a particular locality (Erzinçlioglu, 1989b), and evidence of their bites can serve the same purpose (Webb *et al.*, 1983; Prichard *et al.*, 1986). A more certain connection could potentially be demonstrated by identifying human DNA extracted from a blood-sucking arthropod, such as a louse, that had fed on a suspect and was later collected from the victim or the death scene (Lord *et al.*, 1998).

18.4 Insects as the cause of death

Insects have been the actual cause of death in some criminal cases (Smith, 1986). The stings of bees and wasps may be fatal, especially to people with a particular sensitivity or allergy (Smith, 1993). Other arthropods such as spiders, scorpions and ticks may also be deadly (Cloudsley-Thompson, 1993; Varma, 1993) and have similar potential for use in homicides. Keh (1985) and Leclercq (1969) have discussed the use of dead insects, especially beetles of certain kinds, as sources of poisons.

18.5 Post-mortem artefacts caused by insects

Marks left by insects in feeding on corpses may be misinterpreted as injuries sustained at or before the time of death. Fly larvae may produce small holes in the skin of corpses by burrowing their way through it. These may be mistaken for injuries caused by shotgun pellets (Perper, 1993). Ants and cockroaches may cause small erosions on the skin which could be wrongly interpreted as ante-mortem abrasions. Specifically, marks made by ants feeding on the neck of a body may resemble fingernail abrasions produced during manual strangulation. Superficial skin defects caused by insects during feeding have also been mistaken for cigarette burns (Perper, 1993).

Insects, by their activities, may alter patterns formed by human blood that has been shed during a murder or other violent crime. Insects themselves may also produce blood patterns by the regurgitation or defecation of partially digested and undigested blood. Such artefacts may potentially confuse the forensic interpretation of bloodstain evidence at crime scenes (Brown *et al.*, 2001).

18.6 The role of insects in other criminal investigations

The potential application of insects and other invertebrates to forensic science is not limited to the investigation of deaths.

The investigations of crimes of many sorts can be aided by the connection that arthropods may provide between a suspect and the crime scene, e.g. see Greenberg (1985).

Blowfly larvae have also been used to establish evidence of child abuse (Benecke and Lessig, 2001) and could equally well demonstrate criminal neglect of the mentally

disabled and the elderly. Insects have also been pivotal in proving the geographical origin of imported cannabis, leading to establishment of the guilt of those found in possession of the drug (Crosby *et al.*, 1986).

Finally, there is considerable scope for the use of insects in determining the movement of vehicles that have been involved in crimes. Dead insects adhere to the fronts of cars when they collide with them, or may become trapped in the treads of their tyres (Smith, 1986).

18.7 Collection and treatment of insect evidence

The collection of entomological evidence at the scene of a crime is best done by a forensic entomologist. There are often subtle entomological and meteorological aspects of the situation that would not be noticed or appreciated without appropriate training and experience.

Several publications have dealt with aspects of collecting insects as forensic evidence. The emphasis in these has generally been on evidence associated with corpses. For a very full treatment of this subject see Haskell and Williams (1990), Haskell (1990) and Haskell *et al.* (2001). Information on this topic may also be found in Lord and Burger (1983), Meek and Andrews (1983), Smith (1986), Erzinçlioglu (1989a), Rodriguez and Lord (1993) and Morris (1995).

The following protocol applies to the collection and treatment of all entomological evidence, not just that associated with corpses. Law enforcement authorities should ensure that it is adhered to as far as possible on occasions when it is not feasible for a forensic entomologist to do the work.

18.7.1 General procedures

Collect detailed written and photographic evidence, recording:

- the geographical location;
- the habitat or environment;
- the nature of any medium on which specimens are found, e.g. a dead body;
- the appearance of this medium, e.g. in the case of a body, presence of physical damage, presence and extent of clothing, extent of decomposition;
- the nature and position of insects on the medium; and
- the nature and position of insects surrounding the medium.

Collect representative samples of all the insect life history stages (eggs, larvae, pupae and puparia, and adults) that can be found.

Kill and preserve eggs in 80 per cent ethanol, along with any immature stages of insects other than the larvae of flies.

Samples of fly larvae should be killed immediately, preferably in boiling or near-boiling water (~70°C+). Other killing agents cause larvae to shrink, making the accurate estimation of their age difficult (Tantawi and Greenberg, 1993). Hot water can be brought to the scene of collection in a thermos and conveniently boiled using an electrical water heater plugged into the socket of the cigarette lighter of a car. If boiling

water cannot be obtained, kill the larvae in 80 per cent ethanol. Ensure that a record is kept of the procedure that has been used. Preserve the larvae in acetic alcohol (3 parts 90 per cent ethanol:1 part glacial acetic acid). If glacial acetic acid is unavailable, larvae may be stored in 80 per cent ethanol, but this is undesirable, since it often results in their internal tissues turning black. Glacial acetic acid prevents this.

Take a further representative sample of larvae (at least several dozen where possible) and keep them alive and moist in a well-aerated container. Deliver these to the forensic entomologist as soon as possible. If there is any delay, keep the larvae cool by placing their container on ice or in a refrigerator. It is crucial in the case of carrion-feeding larvae that any meat on which they are placed is protected from further infestation by adventitious flies. It is also important to separate the predaceous larvae of such species as *Chrysomya rufifacies* and *C. albiceps* ('hairy maggots') from the larvae of other species ('smooth maggots'), otherwise they may kill them and thus destroy potentially important evidence.

Kill and preserve representative samples of all adult insects other than moths in 80 per cent ethanol. Place moths alive in a vial stoppered with tissue or cotton wool to prevent their movement. Collect flying adult insects with a net.

Place all specimens in containers that are clearly labelled with the time, date, geographical location, part of the medium or its surroundings from which the specimens came, and with the name of the collector.

18.7.2 Additional procedures at the death scene

Record the following temperatures using a thermometer shielded from direct sunlight:

- temperature of the air around the body, measured at several levels from the ground up;
- temperature at the surface of the body;
- temperature at the interface between the body and the ground;
- temperature at the centre of any aggregations of fly larvae in or adjacent to the body; and
- temperature of the soil at several levels from the surface down, measured at a distance several metres from the body and, once the body has been removed, at a point corresponding to where it lay.

When the body is partly covered by soil or vegetation record also the temperature at several points in the soil or vegetation surrounding the body into which larvae may have moved to pupate.

If the body is indoors, or inside a motor vehicle, record the air temperature both inside and outside this structure.

Also record the relative degree and period of exposure of the body to direct sunshine and shade and, if possible, the relative humidity. Note the time at which all temperature measurements are made.

Detailed climatic data are also required from the rough time when death is likely to have occurred (often corresponding to the last reported sighting of the deceased) until the time of discovery of the body. Since these data will rarely have been recorded

exactly where the body was found, the data will need to be obtained from the nearest meteorological station. For comparison with the data from the meteorological station, collect parallel data, if possible, from both this and the scene of death for several days after the discovery of the body.

18.7.2.1 Collection of specimens on the body

Look for fly egg masses in shaded interstices, such as between the torso and limbs, in the skin creases of the neck, at the hairline and between skin and clothing. They may also occur around body openings and wounds.

Fly larvae will most likely be found in the nasal openings, ears, mouth and eyes, and at the site of any traumatic injury. If the body is unclothed, the anal and genital areas may also be infested. Aim at collecting a sample of several hundred larvae, ensuring that it is as representative as possible of the total population. In particular, collect in separate containers from any aggregations for which the temperature was recorded.

Collect larvae of all sizes, not just the largest. This is important for two reasons:

1. As discussed by Erzinclioglu (1990), and further documented by Wells and King (2001) and VanLaerhoven and Anderson (2001), females of some egg-laying blowfly species, such as *Calliphora vicina*, may deposit one of the several hundred eggs they lay at a more advanced stage of development. In such species, the eggs are fertilised only one at a time in the reproductive tract. After the first egg has been fertilised there may be a delay before the female can locate carrion on which to oviposit. Depending on the length of this delay, the larva to hatch from the first egg may be considerably older, and thus larger, than the others. Consequently, if the larvae on the body belonged to one such egg-laying species, it would be more accurate to base the estimate of time since death, not on the oldest larval stage, but on the stage that is present in the largest numbers. This stage would represent the progeny resulting from the eggs that were fertilised during egg laying. There is evidence that in certain species the same phenomenon involves the first egg hatching while still within the female, causing a first-instar larva to be deposited ahead of the remaining eggs (Dear, 1985). Future studies are required to test this.
2. As already mentioned, drugs present in the body may alter the development of the immature stages of certain species. Thus, the larvae considered to be the oldest may not necessarily be so. If a drug known to affect the growth of immature blowflies is detected in the body, the larvae thought to be the oldest will need to have their age adjusted if they are known to have ingested the drug. Sometimes only some of the larvae on the body will have been feeding on drug-contaminated tissue, as was shown to be likely in the case of the body of a person who had snorted cocaine just before death (Lord, 1990).

In view of these observations it seems that the best estimate of time since death can only be derived from the largest larvae if (1) these larvae belong to live-bearing species and (2) no growth-affecting drugs have been found in the body, or the largest larvae have been shown conclusively not to have ingested such drugs.

18.7.2.2 Collection of specimens in close vicinity to the body

The larvae of many fly species crawl away from carrion when they are ready to pupate. The distance travelled varies according to species (Greenberg, 1990a). Search the area within a radius of at least 6 m from the body for 'wandering' larvae. If the body is indoors, examine the perimeter of the room containing the corpse and any adjacent rooms. Larvae shy away from light. Consequently, if the body is indoors or inside a motor vehicle, search dark recesses, such as the folds of sheets and the pile of carpets. If outdoors, examine soil and vegetation carefully. Also inspect all of the above places for puparia, which may additionally be found on the surface of the body and within folds of clothing. If the fly puparia contain pupae, place a sample in a well-aerated container, while others should be placed directly into 80 per cent ethanol. The container holding the live pupae should be kept cool if there is to be a delay in delivering it to the forensic entomologist. If puparia do not contain pupae, they should be placed into 80 per cent ethanol, taking care to also collect the operculum (lid) of the pupal case, which may help in identification.

18.7.2.3 Collection of specimens beneath the body and in the surrounding ground

Adult and immature insects often remain on or in the ground after the body has been removed. This is especially so if the body is outdoors. Collect 100 cc samples of the soil and vegetation from the area directly beneath the body, as well as from 1 m away for comparison. Place these samples in plastic bags or containers. Do not preserve them in liquid. Keep the samples cool if there will be a delay in delivering them to the entomologist.

18.7.2.4 Collection of specimens from buried and immersed remains

Insect evidence associated with buried remains is best collected in conjunction with a physical anthropologist. Many specimens, especially puparia, may be in the soil surrounding the body and it may only be possible to locate them by sieving.

Preserve specimens of aquatic fauna from immersed remains in 80 per cent ethanol, and also keep some alive in water-filled containers. Insects (and other arthropods) take time to drown after immersion in water. The presence of dead specimens on a corpse can therefore help to estimate the period of immersion (Smith, 1986; Singh and Greenberg, 1994).

18.7.3 Additional procedures at the time of autopsy

Frequently, insect evidence will need to be collected at the autopsy, either because none was collected at the scene of death, or because only superficial collecting was possible there without significantly disturbing the body. Attention should be paid to the following points:

- insects often remain inside the body bag used to transport the body. This should therefore be thoroughly examined for specimens;

- if the body has been placed in a mortuary cooler prior to the autopsy, ensure that a record is kept of the period and temperature of refrigeration;
- while most of the temperature readings that need to be taken in the field are not relevant to the scene of the autopsy, the temperatures of larval aggregations in the body are still important and should be noted; and
- in the mortuary the body can be examined more closely than is possible in the field. This makes it possible to carry out a search for very small insects such as fleas, lice and mites. If present, fleas may be found among the clothing, lice at the base of scalp and pubic hairs, and mites especially among the eyelashes. Such animals may be useful because they will remain on a body for only a certain period after death. Their presence (or absence) may therefore help to refine the estimation of time since death (Keh, 1985).

Because of the potentially profound effect of drugs on estimates of time since death, enquire at the time of the autopsy whether such drugs are to be tested for. If they are not tested for, it cannot be ruled out that they are present and may have affected the estimate of the post-mortem interval.

18.8 Acknowledgements

I thank Drs D. A. Duckhouse and K. R. Norris for their valuable comments on the manuscript.

18.9 Bibliography

- Benecke, M. and Lessig, R. (2001) Child Neglect and Forensic Entomology, *Forensic Science International*, **120**, 155–9.
- Beyer, J. C., Enos, W. F. and Stajic, M. (1980) Drug analysis through analysis of maggots, *Journal of Forensic Sciences*, **25**, 411–12.
- Brown, R. E., Hawkes, R. I., Andreson Parker, M. and Byrd, J. H. (2001) Entomological alteration of bloodstain evidence, in Byrd and Castner (eds), *Forensic Entomology: the Utility of Arthropods in Legal Investigations*, pp. 353–78, Boca Raton, Florida: CRC Press LLC.
- Catts, E. P. (1992) Problems in estimating the postmortem interval in death investigations, *Journal of Agricultural Entomology*, **9**, 245–55.
- Catts, E. P. and Goff, M. L. (1992) Forensic entomology in criminal investigations, *Annual Review of Entomology*, **37**, 253–72.
- Cianci, T. J. and Sheldon, J. K. (1990) Endothermic generation by blow fly larvae *Phormia regina* developing in pig carcasses, *Bulletin of the Society of Vector Ecologists*, **15**, 33–40.
- Cloudsley-Thompson, J. L. (1993) Spiders and scorpions (Araneae and Scorpiones), in Lane and Crosskey (eds), *Medical Insects and Arachnids*, pp. 659–82, London: Chapman and Hall.
- Coope, G. R. and Lister, A. M. (1987) Late glacial mammoth skeletons from Condoover, Shropshire, England, *Nature*, London, **330**, 587.
- Crosby, T. K., Watt, J. C., Kistemaker, A. C. and Nelson, P. E. (1986) Entomological identification of the origin of imported cannabis, *Journal of the Forensic Science Society*, **26**, 35–44.
- Dear, J. P. (1985) Calliphoridae (Insecta: Diptera), *Fauna of New Zealand*, **8**, 1–86.

- DiZinno, D. D. S., Lord, W. D., Collins-Morton, M. B., Wilson, M. R. and Goff, M. L. (2002) Mitochondrial DNA sequencing of beetle larvae (Nitidulidae: Omosita) recovered from human bone, *Journal of Forensic Science*, **47**, 1337–9.
- Erzinçlioglu, Y. Z. (1983) The application of entomology to forensic medicine, *Medicine, Science and the Law*, **23**, 57–63.
- Erzinçlioglu, Y. Z. (1985) The entomological investigation of a concealed corpse, *Medicine, Science and the Law*, **25**, 228–30.
- Erzinçlioglu, Y. Z. (1989a) Editorial: Entomology, zoology and forensic science: the need for expansion; Protocol for collecting entomological evidence, *Forensic Science International*, **43**, 209–11.
- Erzinçlioglu, Y. Z. (1989b) Entomology and the forensic scientist: how insects solve crimes, *Journal of Biological Education*, **23**, 300–2.
- Erzinçlioglu, Y. Z. (1990) On the interpretation of maggot evidence in forensic cases, *Medicine, Science and the Law*, **30**, 65–6.
- Erzinçlioglu, Y. Z. (1992) Proceedings of the BAFM meeting held in Tunbridge Wells on 6 July 1991, 1. Forensic entomology, *Medicine, Science and the Law*, **32**, 43–4.
- Erzinçlioglu, Y. Z. (1996) *Blowflies*, Slough: The Richmond Publishing Co. Ltd.
- Fuller, M. E. (1934) The insect inhabitants of carrion: a study in animal ecology, Council for Scientific and Industrial Research, Australia, *Bulletin*, **82**, 1–63.
- Gautier, A. and Schumann, H. (1973) Puparia of the subarctic blowfly *Protophormia terraenovae* (Robineau-Desvoidy, 1830) in a skull of a late Eemian (?) bison at Zemst, Brabant (Belgium), *Palaeogeography, Palaeoclimatology, Palaeoecology*, **14**, 119–25.
- Goff, M. L. (1991) Use of Acari in establishing a postmortem interval in a homicide case on the island of Oahu, Hawaii, in Dusabek and Bukva (eds), *Modern Acarology*, Volume I, Proceedings of the VIII International Congress of Acarology, Ceske Budejovice, Czechoslovakia, 6–11 August 1990, The Hague, Netherlands: SBP Academic Publishing.
- Goff, M. L. (1992) Problems in estimation of postmortem interval resulting from wrapping of the corpse: a case study from Hawaii, *Journal of Agricultural Entomology*, **9**, 237–43.
- Goff, M. L., Charbonneau, S. and Sullivan, W. (1991) Presence of fecal material in diapers as a potential source of error in estimations of postmortem interval using arthropod development rates, *Journal of Forensic Sciences*, **36**, 1603–6.
- Goff, M. L. and Lord, W. D. (1994) Entomotoxicology. A new area for forensic investigation, *The American Journal of Forensic Medicine and Pathology*, **15**, 51–7.
- Goff, M. L. and Lord, W. D. (2001) Entomotoxicology. Insects as toxicological indicators and the impact of drugs and toxins on insect development, in Byrd and Castner (eds), *Forensic Entomology: the Utility of Arthropods in Legal Investigations*, pp. 331–40, Boca Raton, Florida: CRC Press LLC.
- Goff, M. L., Miller, M. L., Paulson, J. D., Lord, W. D., Richards, E. and Omori, A. I. (1997) Effects of 3,4-methylenedioxymethamphetamine in decomposing tissues on the development of *Parasarcophaga ruficornis* (Diptera: Sarcophagidae) and detection of the drug in post-mortem blood, liver tissue, larvae, and puparia, *Journal of Forensic Sciences*, **42**, 276–80.
- Green, A. A. (1951) The control of blowflies infesting slaughterhouses. 1. Field observations on the habits of blowflies, *Annals of Applied Biology*, **38**, 475–94.
- Greenberg, B. (1985) Forensic entomology: case studies, *Bulletin of the Entomological Society of America*, **31**, 25–8.
- Greenberg, B. (1990a) Behavior of postfeeding larvae of some Calliphoridae and a muscid (Diptera), *Annals of the Entomological Society of America*, **83**, 1210–4.
- Greenberg, B. (1990b) Nocturnal oviposition behaviour of blow flies (Diptera: Calliphoridae), *Journal of Medical Entomology*, **27**, 807–10.
- Hall, M. and Wall, R. (1995) Myiasis of humans and domestic animals, *Advances in Parasitology*, **35**, 257–334.

- Haskell, N. H. (1990) Entomological collection techniques at autopsy and for specific environments, in Catts and Haskell (eds), *Entomology and Death: A Procedural Guide*, pp. 98–110, Clemson, South Carolina: Joyce's Print Shop.
- Haskell, N. H. and Williams, R. E. (1990) Collection of entomological evidence at the death scene, in Catts and Haskell (eds), *Entomology and Death: A Procedural Guide*, pp. 82–97, Clemson, South Carolina: Joyce's Print Shop.
- Haskell, N. H., Lord, W. D. and Byrd, J. H. (2001) Collection of entomological evidence during death investigations, in Byrd and Castner (eds), *Forensic Entomology: the Utility of Arthropods in Legal Investigations*, pp. 81–120, Boca Raton, Florida: CRC Press LLC.
- Haskell, N. H., McShaffrey, D. G., Hawley, D. A., Williams, R. E. and Pless, J. E. (1989) Use of aquatic insects in determining submersion interval, *Journal of Forensic Sciences*, **34**, 622–32.
- Higley, L. G. and Haskell, N. H. (2001) Insect development and forensic entomology, in Byrd and Castner (eds), *Forensic Entomology: the Unity of Arthropods in Legal Investigations*, pp. 287–302, Boca Raton, Florida: CRC Press LLC.
- Kashyap, V. K. and Pillay, V. V. (1989) Efficacy of entomological method in estimation of postmortem interval: a comparative analysis, *Forensic Science International*, **40**, 245–50.
- Keh, B. (1985) Scope and applications of forensic entomology, *Annual Review of Entomology*, **30**, 137–54.
- Keiper, J. B., Chapman, E. G. and Foote, B. A. (1997) Midge larvae (Diptera: Calliphoridae) as indicators of postmortem interval of carcasses in a woodland stream: a preliminary report, *Journal of Forensic Sciences*, **42**, 1074–9.
- Leclercq, M. (1969) *Entomological Parasitology*, Oxford: Pergamon Press.
- Lord, W. D. (1990) Case histories of the use of insects in investigations, in Catts and Haskell (eds), *Entomology and Death: A Procedural Guide*, pp. 9–37, Clemson, South Carolina: Joyce's Print Shop.
- Lord, W. D. and Burger, J. F. (1983) Collection and preservation of forensically important entomological materials, *Journal of Forensic Sciences*, **28**, 936–44.
- Lord, W. D. and Stevenson, J. R. (1986) *Directory of Forensic Entomologists*, 2nd edn, Washington DC: American Registry of Professional Entomologists.
- Lord, W. D., DiZinno, J. A., Wilson, M. R., Budowle, B., Taplin, D. and Meinking, T. L. (1998) Isolation, amplification, and sequencing of human mitochondrial DNA obtained from human crab louse, *Phthirus pubis* (L.) blood meals, *Journal of Forensic Sciences*, **43**, 1097–100.
- Meek, C. L. and Andrews, C. S. (1983) Role of the entomologist in forensic pathology, including a selected biography, *Bibliographies of the Entomological Society of America*, **1**, 1–10.
- Miller, M. L., Lord, W. D., Goff, M. L., Donnelly, B., McDonough, E. T. and Alexis, J. C. (1994) Isolation of amitriptyline and nortriptyline from fly puparia (Phoridae) and beetle exuviae (Dermestidae) associated with mummified human remains, *Journal of Forensic Sciences*, **39**, 1305–13.
- Morris, B. (1995) Forensic entomology, in Freckleton and Selby (eds), *Expert Evidence*, pp. 5291–381, North Ryde, NSW: The Law Book Company Limited.
- Norris, K. R. (1959) The ecology of sheep blowflies in Australia, in Keast, Crocker and Christian (eds), *Biogeography and Ecology in Australia*, Monographia Biologicae, **8**, 514–44.
- Nuorteva, P. (1987) Empty puparia of *Phormia terraenovae* R.-D. (Diptera: Calliphoridae) as forensic indicators, *Annales Entomologici Fennici*, **53**, 53–6.
- Payne, J. A. and King, E. W. (1972) Insect succession and decomposition of pig carcasses in water, *Journal of the Georgia Entomological Society*, **7**, 153–62.
- Perper, J. A. (1993) Anatomical considerations, in W. U. Spitz (ed.), *Medicolegal Investigation of Death*, 3rd edn, pp. 14–49, Springfield, Illinois: Charles C. Thomas, Publisher.
- Prichard, J. G., Kossoris, P. D., Leibovitch, R. A., Robertson, L. D. and Lovell, W. F. (1986) Implications of trombiculid mite bites: report of a case and submission of evidence in a murder trial, *Journal of Forensic Sciences*, **31**, 301–6.

- Putman, R. J. (1983) *Carrion and Dung: Decomposition of Animal Wastes*, London: Edward Arnold (Publishers) Limited.
- Rodriguez, W. C. and Lord, W. D. (1993) Forensic entomology and its use in the determination of time since death, in W. U. Spitz (ed.), *Medicolegal Investigation of Death*, 3rd edn, pp. 65–70, Springfield, Illinois: Charles C. Thomas, Publisher.
- Shean, B. S., Messinger, L. and Papworth, M. (1993) Observations of differential decomposition on sun exposed v. shaded pig carrion in coastal Washington State, *Journal of Forensic Sciences*, **38**, 938–49.
- Singh, D. and Greenberg, B. (1994) Survival after submergence in the pupae of five species of blow flies (Diptera: Calliphoridae), *Journal of Medical Entomology*, **31**, 757–9.
- Smith, K. G. V. (1986) *A Manual of Forensic Entomology*, Ithaca, New York: Cornell University Press.
- Smith, K. G. V. (1993) Insects of minor medical importance, in Lane and Crosskey (eds), *Medical Insects and Arachnids*, pp. 576–93, Chapman and Hall, London.
- Tantawi, T. I. and Greenberg, B. (1993) The effect of killing and preservative solutions on estimates of maggot age in forensic cases, *Journal of Forensic Sciences*, **38**, 702–7.
- Turner, B. and Howard, T. (1992) Metabolic heat generation in dipteran larval aggregations: a consideration for forensic entomology, *Medical and Veterinary Entomology*, **6**, 179–81.
- Vance, G. M., VanDyk, J. K. and Rowley, W. A. (1995) A device for sampling aquatic insects associated with carrion in water, *Journal of Forensic Sciences*, **40**, 479–82.
- VanLaerhoven, S. L. and Anderson, G. S. (2001) Implication of using development rates of blow fly (Diptera: Calliphoridae) eggs to determine postmortem interval, *Journal of the Entomological Society of British Columbia*, **98**, 189–94.
- Varma, M. R. G. (1993) Ticks and mites (Acari), in Lane and Crosskey (eds), *Medical Insects and Arachnids*, pp. 597–658, Chapman and Hall, London.
- Wallman, J. F. (2001a) A key to the adults of species of blowflies in southern Australia known or suspected to breed in carrion (corrigendum in *Medical and Veterinary Entomology*, **16**, 223), *Medical and Veterinary Entomology*, **15**, 433–7.
- Wallman, J. F. (2001b) Third-instar larvae of common carrion-breeding blowflies of the genus *Calliphora* (Diptera: Calliphoridae) in South Australia, *Invertebrate Taxonomy*, **15**, 37–51.
- Webb, J. P., Loomis, R. B., Madon, M. B., Bennet, S. G. and Greene, G. E. (1983) The chigger species *Eutrombicula belkini* Gould (Acari: Trombiculidae) as a forensic tool in a homicide investigation in Ventura County, California, *Bulletin of the Society of Vector Ecologists*, **8**, 141–6.
- Wells, J. D., Introna, F., Di Vella, G., Campobasso, C. P., Hayes, J. and Sperling, F. A. H. (2001) Human and insect mitochondrial DNA analysis from maggots, *Journal of Forensic Sciences*, **46**, 685–7.
- Wells, J. D. and King, J. (2001) Incidence of precocious egg development on flies of forensic importance (Calliphoridae), *Pan-Pacific Entomologist*, **77**, 235–9.

Physical comparative evidence

Ted Van Dijk and Paul Sheldon

19.1 Background

Physical comparative evidence relates to two or more objects that by virtue of their physical characteristics are able to be compared. The extent of this physical comparison may establish that the two objects had been in contact with each other at some time, or that some other relationship exists between the two. Within this broad evidence group are those evidence types which are commonly referred to as 'marks' and physical or mechanical fits. The term 'marks' is generally understood to involve marks left at crime scenes by shoes and tools, whilst the term 'physical or mechanical fits' is generally used to describe fracture or 'jigsaw' fits or fracture matching. To obtain a complete understanding of marks and physical fits, it is necessary to look at their position and relationship within the concept of physical comparative evidence.

A brief perusal of forensic journals, books and presentations would show that the term physical comparative evidence (or physical comparisons) is not commonly used. It would not be surprising, if two criminalists, when asked to give a definition of physical comparative evidence, would give two different interpretations. One criminalist may include shoemarks and toolmarks whilst omitting physical matching evidence, whilst the other may leave out toolmarks and include physical matching. One would suspect that neither may consider fingerprints as forming part of the definition. These differing viewpoints are understandable, when we look at the diversity of practitioners that deal with different types of physical comparative evidence around the world.

Crime scene investigators have routinely examined some physical matching and shoemark evidence, whilst ballisticians examine the toolmark evidence, fingerprint practitioners examined fingerprints, podiatrists and odontologists relate 'marks' to their particular area of comparative interest, whilst forensic scientists may have examined physical matching evidence, as part of their analysis. This spread of expertise has not necessarily resulted in a lack of appreciation of the principles involved, but rather

a lack of understanding of how the principles and concepts in one field are either similar or identical to those in other fields. Appreciation of this similarity will enable practitioners to look for opportunities to improve their own discipline by virtue of examining and comparing procedures, processes and the reporting methods that other fields employ. This is not proposing that one expert must deal in all fields of evidence. To the contrary, it is by practitioners developing an overall perspective, which will enable them to continue performing their particular expertise independent from one another.

Rather than list evidence types that are, or are not, part of physical comparisons, the recognition of such evidence should be by definition. *Physical comparisons are those evidence types which involve the visual comparison of features existing in one item with features present in another.* The presence of such features enables an identification or an association to be drawn between the two. This definition includes the well-known evidence types of shoemarks (where the sole pattern found at a scene is compared to a shoe) and toolmarks (where a mark in a window frame at a crime scene is compared to a tool). It also includes fingerprints (where fingerprints found on the point of entry at a crime scene are compared to a suspect's fingerprints) and any other evidence that involves the comparison of physical features in one item to another.

19.2 Pattern recognition

'Physical comparisons is', by definition, an all encompassing term which does not explain how or why one item can be compared to another. It was Biasotti who identified that all physical comparisons have the same objective, this being the identification of one physical object with another physical object through the recognition of a unique pattern (i.e. Biasotti uses the term 'pattern' rather than 'physical features'). Using this *pattern recognition* concept as a basis, Biasotti then demonstrates that there are only two types of physical phenomena which permit complementary patterns on two separate objects to be compared, *pattern transfer* and *pattern fit*.

Pattern transfer relates to marks that occurred when an object 'transferred a pattern' from one or more of its surfaces to another object. This could occur once or repeatedly at different times at different locations. They were also sub-divided into either:

- *Two-dimensional*: Being impressions made by any implement, shoe or other object which left a two-dimensional impression, e.g. a shoe sole or finger impression on a piece of glass or a fabric impression on the paint of a motor vehicle.
- *Three-dimensional*: Being impressions made by any implement, shoe or object which left a three-dimensional impression, e.g. a shoe sole impression in soil or a toolmark left in a window frame.

Pattern fits (also referred to as physical matching) are a large group where the pattern being examined on one item can be 'fitted' into the pattern evident on another. This group predominantly contains 'fracture' matches, but a closer examination of this group reveals that it can readily include another type of 'pattern fit'. As a result the 'pattern fit' grouping has been further divided (although Biasotti did not do so) into sub-groups based upon how the pattern fit is achieved. The sub-groups are:

- *Pattern match*: Cases that involve the comparing of items side by side. Examples of these are: the comparing of a video tape picture of a robbery offender to clothing from a suspect and the comparing of two broken items where the fractured surfaces do not fit (for whatever reason) but a conclusion of association could still be made, based on the ‘unique’ pattern existing in both.
- *Fracture fit*: Cases that involve the fitting together of broken objects to demonstrate that at one time they formed part of an unbroken object. An example of this is fitting together a piece of car headlight from a hit-and-run accident scene with the broken headlight from the suspect vehicle.
- *Pattern continuity*: Cases that involve the matching of a pattern adjoining each other demonstrating that the pattern continues from one to the other. An example of this is matching extrusion marks on plastic pipe found at different drug crop sites (see Figure 19.1).

If Biasotti’s concept of pattern recognition is accepted as a means of recognising physical comparative evidence, a reader can now appreciate that all forms of ‘marks’

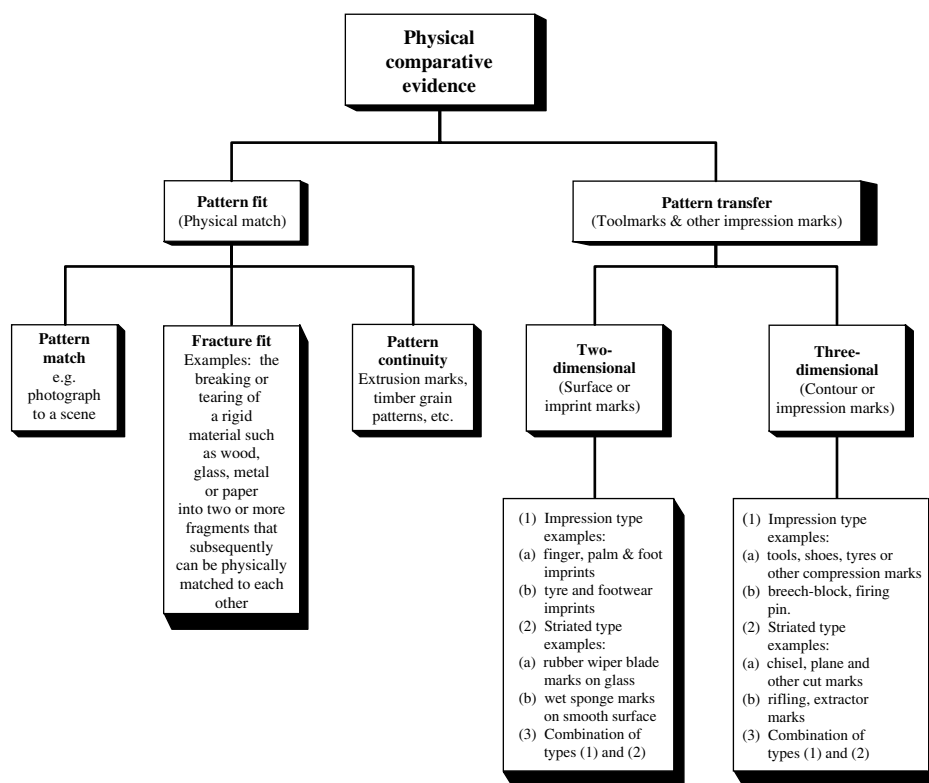

Figure 19.1 A generic classification of contemporary comparative analysis examinations which utilise various forms of pattern recognition to demonstrate an association between separated objects (revised from Biasotti)

i.e. toolmarks, shoemarks, fingerprints, physical fits and a wide range of other evidence types, subject to physical comparison are encompassed.

19.2.1 Case studies

The above discussion is best illustrated through a number of case studies which highlight the variety of physical comparative evidence that has been demonstrated to be useful in an investigation.

Case study 1

An impression is left by the shoe uppers on an assault victim's face. This is an example of a two-dimensional pattern transfer (see Figure 19.2).

Case study 2

A screwdriver found on a suspect was compared with a striated mark located at the scene of a burglary. This is an example of a three-dimensional pattern transfer, i.e. the blade tip transfers a pattern of the tip contour to the window surface (see Figure 19.3).

Case study 3

A can opener found at the suspect's premises was compared with striated/impressed marks found on pieces of metal recovered from a bomb scene. This is an example of



Figure 19.2 Impression on the forehead of an assault victim, showing a lace expression from the uppers of the boot he was kicked with

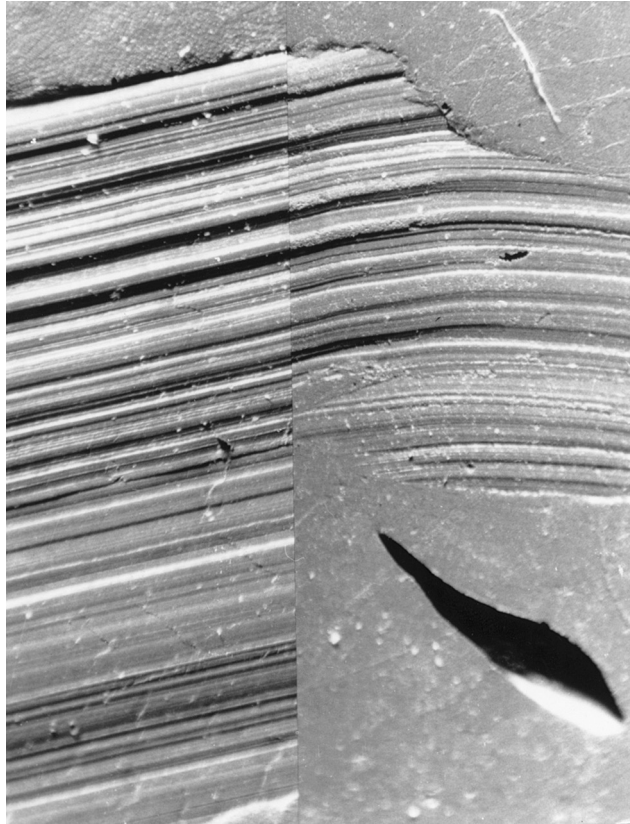

Figure 19.3 A matching striated tool mark comparison with the test impression from the 'suspect' screwdriver on the left and the scene impression on the right

a three-dimensional pattern transfer, i.e. the feeder wheel from the can opener transfers a pattern from the wheel teeth to the underside of the can rim (see [Figure 19.4](#)).

Case study 4

A photograph of a drug crop was located in possession of a person suspected of being involved in the cultivation of the crop (see [Figure 19.5A](#)). The same location as depicted on the photographs was found by investigators (minus the crop). A photograph was taken from a similar position and angle to demonstrate the corresponding 'pattern' of the background tree line (see [Figure 19.5B](#)). This is an example of a pattern match.

Case study 5

Pieces of motor vehicle indicator lens located at an accident scene were fracture matched to the remains of a broken indicator in a suspect vehicle (see [Figure 19.6](#)).

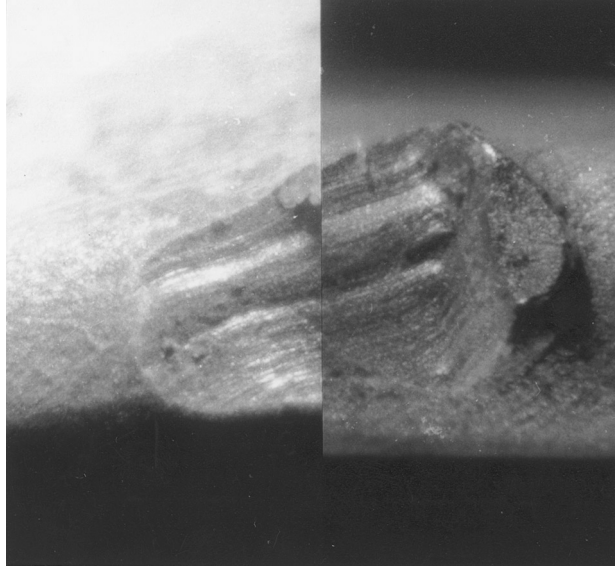

Figure 19.4 A toolmark comparison involving a combination of striation and impression. The marks are produced by the feeder wheel of an electronic can opener on the underside of can rim. The crime scene piece (on the left) was recovered from a bomb scene and the test impression (on right) made from a can opener seized from the suspect's address



Figure 19.5A A photograph recovered by police from a suspect's home. A marijuana crop cultivation is visible in the foreground



Figure 19.5B A photograph taken by police at the location where the crop (seen in [Figure 19.5A](#)) was alleged to be situated. The crop is now gone but note the corresponding tree line in Figures 19.5A and B

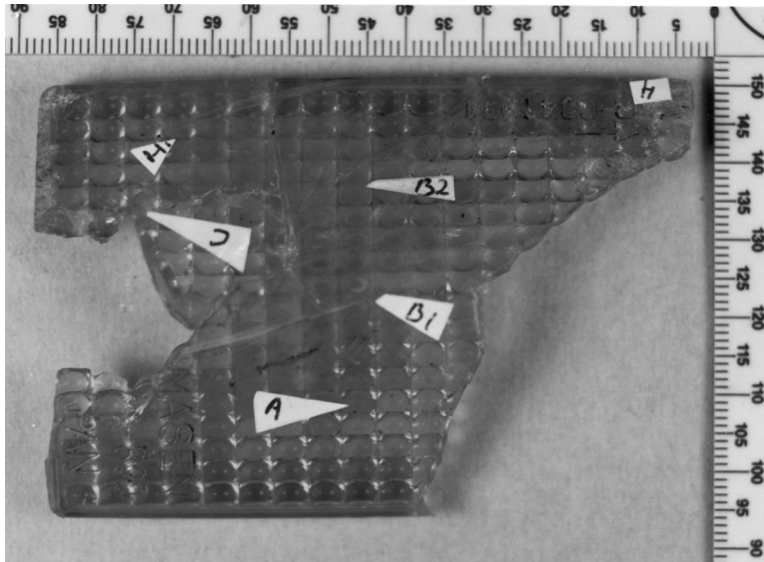

Figure 19.6 A fracture fit for pieces of a broken vehicle indicator lens in a hit-and-run case. Note the labelling indicating the different origins of each piece

Case study 6

A 'paint chip' from a destroyed painting, compared to an actual-sized photograph of the original painting, in a fraud case. This is an example of a pattern continuity, i.e. the brush strokes are continuous from the painting through the paint chip and into the painting again (see Figure 19.7).



Figure 19.7 This case involved the alleged stealing of paintings in a house burglary. A photograph (from an art book) of one of the 'stolen' paintings was produced to actual size and forms the background in this figure. Two small pieces of broken timber were found at the crime scene. These pieces contained a coloured pattern formed by brush strokes. These pieces were able to be matched to a particular part of the painting displayed and are positioned on top of photograph at the matching area. This evidence supported that the paintings were not stolen but destroyed and were part of an attempted fraud

Case study 7

The deformed face of a boltcutter blade corresponds to the deformed shape of a cut padlock hasp. This is an example of a pattern transfer (impressed toolmark) (see Figure 19.8).

These case studies and Biasotti's 'pattern recognition' concept demonstrate that crime scene investigators need to appreciate that physical comparative evidence involves more than just shoemarks, toolmarks and physical fits. They need to be continually on the lookout for all types of associative evidence where pattern recognition may be utilised.

19.3 The comparative process

This chapter is not intended to delve into the intricacies of comparing physical evidence. A discussion on the comparison of shoemark evidence can be found in Chapter 5 of

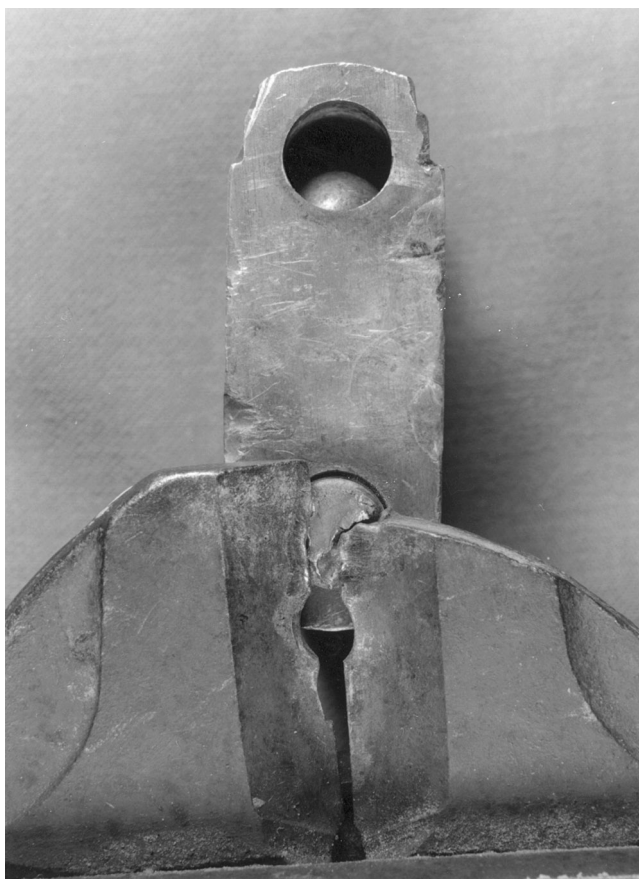

Figure 19.8 A demonstration of matching features from the blades of a pair of boltcutters and a hasp from a padlock. The damage to the blades would have occurred during the attempt to cut the 'hardened' padlock hasp

Cassidy's *Footwear Identification*, and similar theories relating to all types of evidence are discussed in Tuthill's *Individualisation: Principles and Procedures in Criminalistics*. One of the principles of identification is that the value of any evidence is guided by the quality of the 'scene' impression. This is to say, that a poor quality impression at a crime scene will not yield the same value of evidence as a good quality one. If the quality of scene impressions is further degraded by poor quality recording or collection, then this will further degrade the value of the evidence. An understanding of the comparative process will result in crime scene investigators appreciating what effect their collection techniques have in the resultant value of the evidence.

Both Cassidy and Tuthill refer to the identification process of *analysis, comparison and evaluation*.

In the analysis phase, all of the objects being compared are comprehensively documented and observations made of their physical attributes. Size, shape, colour, thickness and any possible identification features capable of being compared are recorded in notes, sketches and photographs.

During the analysis phase, the concept of *class v. individual characteristics* is also explored. Class characteristics being those attributes that are present in a range of similar objects whilst individual characteristics are unique to the specific object. As a result, matching attributes that are class characteristics will *not exclude* other similar objects, whilst matching attributes that are individual will *exclude* other similar objects.

In the comparison phase, these attributes are compared to each other. Similarities (as well as dissimilarities) are noted. In the *evaluation* phase the significance of any similarities or dissimilarities will be assessed.

This brief discussion, on the comparison of physical evidence, clearly develops a nexus between the collection and evaluation of physical comparative evidence. Crime scene investigations using good collection techniques will maximise the value to be obtained from physical comparison evidence.

19.4 At the scene

The examination of crime scenes is not a haphazard action but rather a methodical search for evidence. Each crime scene, is in fact subjected to a systematic 'process' by which the available, relevant evidence is identified and collected. This process (Wright, 1994) is categorised by seven steps or stages. These being: assessment, control, preservation, examination, recording, interpretation and collection. In the following pages these stages are discussed in terms of all physical comparative evidence.

Following this discussion, the most common physical comparative evidence of shoemarks, tyre marks, tool marks and physical matching are discussed in more detail.

19.4.1 Assessment

Upon arrival the crime scene investigator will need to assess the availability of physical comparative evidence. If other police or other persons are present, they may assist with important information of what has occurred. Following this, a careful 'walkthrough' of the scene is desirable. At this time, the crime scene investigator should ascertain if any

persons have entered the crime scene (e.g. ambulance officers) and the extent of their entry and activity within the scene. These persons may also assist in identifying other related scenes (vehicles, etc.) that may also require examination.

19.4.2 Control

Following an assessment of the scene the crime scene investigator may need to place cordons around the scene or parts of it. If cordons are already in place, the crime scene investigator may need to alter that cordon. At this time, the crime scene investigator should also organise an access corridor for entry and exit into the scene.

19.4.3 Preservation

At this stage the crime scene investigator will need to assess if any physical evidence may be lost as a result of the weather (wind, rain, etc.) and then take any necessary steps to prevent any such loss. This loss of evidence can also result from other causes e.g. bystanders, vehicles, time, etc. all of which the crime scene investigator will need to anticipate and take the necessary action to avoid such loss. In general terms, exterior evidence should take preference over protected interior evidence for this reason. Due to the wide variety of scenes and prevailing conditions it is not possible to list all possible eventualities in this chapter. Sufficient to say the crime scene investigator has the responsibility to protect evidence, and an ability to foresee contaminating factors will be an advantage.

19.4.4 Examination

The search for evidence at a scene should be in a methodical and organised manner. This search will be visual at first but may require the use of different lighting or other assistance, e.g. chemical enhancement of blood stains. An attempt should be made to exclude evidence present before or after the offence. If there is uncertainty on this point, the evidence should be processed and excluded at a later time.

19.4.5 Recording

General photographs of the scene should be taken. Photographs should be taken of evidence at the scene *in situ* (how it was found), as a result photographs should precede any handling or collection. These photographs should be comprehensive and should accurately record the position of the object in relation to other items or landmarks. Where necessary close-up photographs should be taken showing details. Identification labels and measuring scales should be used where the photographs are to be used in evaluation of that evidence, e.g. shoemarks.

Detailed notes should be taken relating to observations made of the evidence. Include descriptions, time/dates, location, lighting, how collected, condition of marks, etc. Where suitable, sketch plans should be made to indicate the position of relevant evidence. Notes should be made in relation to how evidence was deposited, e.g. shoe-marks in soil were made when person jumped from top of fence. This will assist in later

evaluation when attempting to reproduce similar shoemarks. Detail is necessary to describe when, why, how, where and what.

19.4.6 Interpretation

The crime scene investigator should endeavour, where possible, to interpret scene evidence. For example, toolmarks on a window may not appear consistent with occurring when the window was forced, or shoemarks in/on or under bloodstains would indicate whether they were made before or after the blood was deposited. The position, size and shape of toolmarks will indicate not only the type of tool but also the method in which it was used. This would become important during later evaluation of the toolmark evidence.

In all situations, the CSI should compare victim, witness and suspect statements with what is present at the scene to corroborate or refute them. Where no such statements are available due to lack of witnesses, then the crime scene investigator should attempt to identify possible scenarios. These interpretations must be based on observable features and may involve terminology of what ‘*may have*’, ‘*could have*’ or ‘*is likely to have*’ occurred.

19.4.7 Collection

Techniques and containers that do not contaminate or destroy evidence should be used. Objects or the packaging should be labelled with sufficient detail to identify that object and its origin, at a later date. Items should be packaged separately to avoid cross-contamination. The chain of evidence should be kept on all items that are collected. The basic philosophy of collection is to retain the item in its original condition.

Specific evidence types of shoemarks, tyreremarks, toolmarks and fracture fits are now dealt with in more detail.

19.5 Shoemarks

Readers of this chapter are strongly recommended to refer to Bodziak *Footwear Evidence*, Chapters 1–5, where shoemark evidence is discussed in detail. Use of this reference will assist in standardising the approach by all crime scene investigators to this vital evidence. The following discussions on shoemark evidence should be read in conjunction with Bodziak.

Shoe impressions will be present at many scenes. The suspect may leave footwear impressions in the surface soil or on carpet, papers or other surfaces or items.

Establish boundaries as soon as possible after arriving at the scene with consideration to the areas where a person may have entered or left by foot. These areas should be cordoned off, and immediate attention should be given to this evidence. Shoemark evidence can easily be damaged or destroyed as a result of poor scene management.

19.5.1 Extraneous shoemarks

Relevant shoemark evidence can easily be ‘masked’, prior to the arrival of the crime scene investigator, by the inadvertent actions of police, witnesses and emergency services. It is important that the crime scene investigator is able to distinguish these ‘extraneous’ shoemarks from those of importance to the scene being investigated. These ‘extraneous marks’ cannot be ignored and need to be explained.

If the crime scene investigator as part of his/her assessment of the scene, recognises that such extraneous ‘shoemarks’ may be present, the crime scene investigator needs to obtain eliminations from all witnesses and/or police personnel who may have entered a scene. (It may be easier and less time-consuming to ascertain these at the scene rather than following up at a later time.) Such eliminations ideally will take the form of a photograph of the shoe sole pattern (for every ‘witness’ or police officer), as well as a sample (i.e. test impression) of each shoe.

19.5.2 Suspects

Timeliness in the collection of any ‘suspect’ shoes will ensure the maximum comparative value being obtained from a subsequent shoemark comparison. Early collection of shoes will prevent unnecessary wear changing the shoe sole, which may confuse or lessen any further comparison and may prevent disposal of the shoe.

Ownership of ‘suspect’ shoes must be clearly established at the time of collection. Later comparison may link the shoe with a particular scene impression. Any suspects should, therefore, be identified with the shoe. Investigating police may need to be reminded of this. Alternatively, the expertise of a forensic podiatrist may be utilised to provide evidence that a shoe has been worn by a particular person. (A forensic podiatrist utilises similar comparative processes to relate the shape of a person’s foot to the impressions left on the inner soles of shoes.)

Shoes should be packaged in paper bags rather than plastic to reduce odours and prevent biological evidence from being contaminated by decomposition.

19.5.3 Recording

Comprehensive notes relating to shoemark impressions should be made, including:

- exact location of shoemark;
- description and dimensions of sole pattern;
- alignment of shoemark (e.g. toe/heel);
- medium in or on which the shoemark has been made;
- direction and distance of any trails present; and
- detailing the type of action required to produce the shoemark (e.g. kicking, running, etc.) and include an assessment of weight bearing in the impression, in respect to left/right or toe/heel in the medium involved.

Taking measurements within a trail of stride length, foot angle, heel width and heel angle may assist in providing information about the walking pattern of the person

responsible. (For further information in relation to stride length, foot angle, heel width and heel angle refer to Cassidy *Footwear Identification*, pp. 113–121.)

Photographs of individual marks must be taken prior to collecting evidence and preferably with the aid of a tripod. The following should be considered when photographing shoemarks:

- General photography should show the position of the shoemark in relation to an identifiable object or location. Markers (A, B or 1, 2, etc.) are ideal for identifying specific marks.
- If the shoemark can be returned to the laboratory without any significant loss of detail, general, *in situ*, close-up photographs should be taken and the mark should be collected.
- Every effort should be made to ensure the camera is perpendicular to the shoemark. A series of photographs taken at varying angles to accommodate a shoemark on a curved or angled surface may be necessary.
- Two sides (which join) should have a measuring device alongside. Every effort should be made to ensure the measure is on the same level as the shoemark. Where possible use rigid measuring devices.
- An identifying marker should be placed in the photograph with at least the date, location, shoemark number and photographer's initials visible.
- Photographs should be taken using a large format camera (e.g. 6×7 cm) to assist with detail when enlarging negatives.
- For impressed marks at least three different oblique light angles should be used, preferably one from each end and others which may be relevant. An upright marker should be placed in the photograph to assist with future attempts to reproduce light angles.
- Resist using any flash light source. If it is used ensure it is held a good distance from the impression to reduce uneven illumination.

Trails, particularly those over extended areas, must be recorded in such a manner that courts will be able to understand the significance of them. Two ways of doing this are:

1. marking the trail with large markers or white plaster so that it is visible from an aerial photograph/video recording; and
2. using a video recording taken while following the trail.

19.5.4 Interpretation

Detailed scene examination of shoemark evidence may enable the crime scene investigator to interpret what could have occurred at the scene. This interpretation may corroborate witnesses, victims or suspects or alternatively directly implicate persons in some criminal act or particular course of action. This interpretation directly relates to the amount and types of shoemark evidence that is available at the scene. Areas of possible interpretation are as follows:

1. location and direction of travel of different persons at scene;
2. sequence of various impressions being deposited;

3. type of action required to produce impression, e.g. kicking, jumping, etc.;
4. identifying the person responsible for making a trail by:
 - recognising individual walking idiosyncrasies, e.g. limp or unusual foot pathology;
 - comparing walking patterns of various individuals;
 - whether a person is carrying a heavy item;
 - possible location of any injury, e.g. blood being deposited to left or right whilst walking along;
 - possible time frame in which the shoemarks were deposited.

(For further information in relation to walking patterns refer to Cassidy *Footwear Identification*, pp. 113–121.)

19.5.5 Collection

Where there are a large number of relevant shoemarks they should all be recorded by notes and general photographs, and a number should be selected to photograph and collect in detail. Select shoemarks which:

- show the best detail for both class and individual characteristics;
- show each of the sole patterns present;
- show at least one left and one right from each sole pattern; and
- directly relate to some significant incident.

Where the impression can be physically collected suitable photographs must be taken prior to collecting the impression. Impressed marks should always be cast with an approved casting material such as dental stone or plaster. Residual impressions such as dust or powder can be lifted using adhesive lifting materials or the electrostatic dust lifter. Take care to prevent damage or loss of detail in any impression that is collected.

19.5.6 Enhancement

Not all shoe impressions found at scenes of crime are suitable for recording. Often they require some form of enhancement. There are a number of factors that will affect the type of enhancement required, including:

- the situation and attendant circumstances, e.g. seriousness of offence and portability of surfaces involved;
- the nature of surfaces involved; and
- the type of residue that may be involved.

Crime scene investigators must select a series of techniques, commencing with the less destructive methods and working towards the more destructive methods in an

attempt to obtain maximum enhancement of the impression. Enhancement techniques fall into three main groups:

1. *Photographic techniques*: These are the least destructive and include the use of camera filters and different lighting.
2. *Physical enhancement*: These include the use of electrostatic dust lifting and fingerprint and magnetic powders.
3. *Chemical enhancement*: These are generally the most destructive and will cause some change in the impression.

It is important to have a stage by stage photographic record of the impression before and after each type of enhancement. If there is loss of detail at any stage the photograph already obtained will be the best possible record of the impression. Enhancement is covered in more detail in [Chapter 6](#).

19.6 Tyemarks

A tyre impresses into surfaces and residues in the same manner in which a shoe does. As a result, many aspects of tyre examination procedures, such as location, collection and recording relate directly to shoemark procedures and so the following sub-paragraphs should be read in conjunction with the previous shoemark discussion.

McDonald's *Tire Imprint Evidence* is used as a reference work for the examination and comparison of tyemarks.

19.6.1 Scene

Often, although an offender commits a crime on foot, the person's entry/egress from the scene may involve the use of a vehicle. Crime scene investigators should be aware of this to prevent any loss of tyre mark evidence by an incorrect assessment or placement of scene cordons.

19.6.2 Suspect

As a result of contact between a tyre and road surfaces, the tread pattern will exhibit wear and unique individual characteristics in the same manner as shoes. As a result of the large number of wheel rotations and distances travelled in vehicles, the wear and individual characteristics will change much quicker than on a shoe. The need to locate 'suspect' vehicles (to compare with a scene impression) as soon as possible after an incident is very important.

19.6.3 Recording

Comprehensive notes and photographs must be made of tyre mark evidence. Some of the information that is required is as follows:

- brand, size, type and tread pattern of all road wheels;
- wheelbase measurements (front axle to rear axle);
- wheeltrack measurements – measured outside to outside and outside to inside on left and right tyres on same axle;
- condition of tyre, e.g. amount of wear; and
- sequence in which the impressions were deposited.

The tyre pattern should be recorded with a small sketch illustrating the number and width of the grooves, stud pattern and element shape (entire circumference of tyre).

19.6.4 Interpretation

It may be possible to ascertain the direction of travel, the position of a wheel on a vehicle and the acceleration or deceleration of that vehicle based on the following:

- the locality of the tyre marks;
- observations by witnesses;
- flattening of grass or surface material;
- direction of spray of a surface material, e.g. fast acceleration on a gravel road;
- the arc of any tyre marks, e.g. a vehicle turning on a beach or dirt area;
- the location of skid or scuff marks; and
- the sequence in which tyre marks were left, e.g. rear wheel marks running over front.

19.6.5 Collection

To obtain an impression of a full rotation of a tyre (if it is available at the scene) may require casting a 2–2.5 m impression. The fragile nature of long narrow casts may make it necessary to cast the impression in 2 or 3 sections. Strengthening the cast with sticks or wire may be necessary.

The two main methods of obtaining test impressions are:

- using a tray containing soil and pushing the vehicle through the soil (not driving); ensure that the tyre is marked so that a full revolution can be measured. This can then be cast after having been photographed (both done in sections due to the length);
- inking the tyre; and with paper or cardboard on the ground make the impression by pushing the vehicle.

19.6.6 Examination

Prior to identification examination it may be necessary to collect trace evidence from the vehicle. This evidence, e.g. soil, vegetable matter or mud, may not only be present on the tyre but also inside the wheel arch and body surrounds. This can be collected by direct sampling or by placing clean paper under the area and then prying samples off the vehicle and onto the paper.

19.7 Toolmarks

A toolmark is any mark which results from the forcible contact of an implement with a softer surface.

Toolmark identification is a discipline primarily concerned with determining if a toolmark was made by a particular implement. While a range of marks may be left by various implements, toolmarks which have particular value in the identification discipline are:

- impressed
- striated or
- a combination of the two.

Refer to Van Dijk in *Expert Evidence*, Chapter 85, pp. 8-2535–8-2536.

The definition of a toolmark is so broad that it can encompass a wide variety of physical evidence encountered in criminal investigations, including marks produced by the following:

- screwdrivers
- jemmy bars
- bolt cutters
- multigrips
- pliers
- tin snips
- knives
- axes
- hammers
- steel marking stamps.

Based on the premise that the working surface of any implement will have numerous individual imperfections, the marks produced by that implement (i.e. the transfer of a pattern) may be able to be related back to that specific implement.

The extent to which toolmark identification work may be taken is determined by the following:

1. The condition of the toolmark or the implement (i.e. damage through either corrosion, storage or handling).
2. The nature and quality of the toolmark is dependent on the:
 - surface on which the mark has been left;
 - character (type and condition) of the implement used;
 - relative hardness of the two contacting surfaces;
 - magnitude of the force applied; and
 - relative motion of one surface to the other.
3. Recognition of toolmark evidence is reliant on a crime scene investigator's:
 - appreciation of the toolmark definition;
 - recognition of types of marks likely to be encountered; and
 - the application of sound scene management procedures.

4. Examination of marks on surfaces is aimed at:
 - identifying the class of implement used, i.e. size, shape, type, etc.;
 - determining their suitability for further examination based on their condition, type of surface, etc.; and
 - assisting the investigators in their search for a particular class of implement.

19.7.1 Breaking scenes

At scenes where the premises has been forcibly entered, a thorough search should be made for toolmark evidence on:

- wire fencing
- galvanised roofing
- padlocks
- chains
- doors
- door frames
- windows
- locks
- safes
- filing cabinets
- money tins or like receptacles.

(This list is by no means exhaustive.)

19.7.2 Recording

Record the following using both sketches and notes:

- dimension and shape;
- accurate location within the scene;
- the type of surface on which the mark has been left;
- the angle and direction of application; and
- the presence of foreign trace material (e.g. paint, rust, etc.).

This detail is recorded in an attempt to identify the class characteristics within the mark/s with a view to assisting in the initial stages of an investigation (e.g. flat-bladed screwdriver with a tip of 10 mm and a widest point of 12 mm).

19.7.3 Photographs

Photographs of toolmark evidence should incorporate the following:

1. General and mid-range photographs which show:
 - the marks in relation to the scene;
 - the relationship between several marks;

- identification labels which can relate back to notes, sketches and casts; and
 - casts in place before removal.
2. Close-up photographs which:
- employ oblique lighting (approximately 45° to the mark);
 - include at least two separate close-up photographs in which the oblique lighting has been moved through at least 90°;
 - utilise a tripod and large format camera;
 - incorporate identification and scale markers; and
 - are taken perpendicular to the mark (i.e. film plane parallel to the mark).

19.7.4 Collection

Toolmarks located at and related to a crime scene must be recorded, photographed and collected in a form suitable for subsequent identification and comparison work. The procedures which follow must be used at all scenes involving toolmarks.

Retention of the object on which the impression has been left is the preferred method of collecting toolmark evidence. If possible, the whole item should be packaged or the portion of the item retaining the mark removed.

19.7.5 In situ

The following guidelines should be adopted when collecting *in situ* toolmark evidence:

- use standard crime scene procedures for labelling and packaging physical evidence;
- collect all useful marks available;
- clearly distinguish any scene mark in a section bearing a toolmark which has been cut from a larger section, from any marks caused by removing the section;
- consider using oil or other protectant on toolmarks which may be subject to corrosion or damage (with due consideration for other trace material); and
- collect and package separately any loose foreign trace material associated with the toolmark, to prevent its loss. (It may be possible to physically match or compare this material with a specific implement.)

19.7.6 Casting

If *in situ* collection of toolmark evidence is not appropriate a cast of the impression must be taken. Mikrosil® is the standard casting medium used throughout Australia, and the following guidelines for its use should be adopted:

- collect loose paint located in the toolmark impression, including any foreign paint or rust, etc. prior to casting;
- mix sufficient casting medium to initially cover the mark and the surrounding area (Mix only small amounts of Mikrosil® at any one time to ensure control. It can be layered to thicken the cast, readily bonding with the previous layer.);

- rub a thin layer of mixed Mikrosil® into the toolmark impression to minimise the trapping of air bubbles and then spread the remaining mixture over this thin layer;
- press a small prepared section of cardboard firmly onto the back surface before the cast has set. The cardboard will adhere to the cast and can be used for labelling;
- indicate the relationship between the scene and the mark, if appropriate (use arrows on the cardboard to indicate interior versus exterior, floor versus ceiling, etc.);
- photograph the casts in place;
- package the cured casts into separate plastic bags or boxes; and
- collect control paint samples from the object retaining the toolmark impression after removing the casting medium, if applicable.

19.7.7 Suspect implements

When suspect implements are recovered the crime scene investigator must record the details relating to their seizure, including:

- original location;
- property receipts;
- ownership; and
- chain of evidence.

The implement must be suitably packaged and labelled with particular attention to:

- suitably recording and preserving foreign trace material adhering to it;
- protecting metal surfaces to prevent corrosion or damage; and
- avoiding cross-contamination between scene and implement.

Suspect implements *must never* be placed into or against the scene impression.

19.8 Physical matching

Evidence suitable for physical matching may be located in various forms. Crime scene investigators must have a broad appreciation of the potential value of this type of evidence and be ready to assist investigating officers in the identification, recording and collection of such evidence. A search for physical matching evidence may extend beyond the original scene boundaries.

Standard procedures for searching for, recording and collecting evidence are to be adhered to with particular emphasis on the following:

- all items which could be the subject of physical matching examinations must be collected;
- items from different sources must be clearly identified as such. (If fifty pieces of broken headlight glass from the scene are to be fracture matched to ten pieces located in the suspect vehicle, the source of each individual piece must be

identified. In this example it would be easier to mark the ten ‘vehicle’ pieces with a permanent marking pen or similar. All unmarked pieces would then be identified as coming from the scene.);

- the original location of items must be recorded in notes, supported with photographs;
- items should be packaged to avoid further damage;
- depending on the circumstances, items from one source may be grouped together as one exhibit; and
- consider the possibility that the items being collected may be required for other forensic investigation, such as fingerprint, blood grouping or fibre transfer examination.

If the items to be examined have been collected by police investigators, at the time of reception crime scene investigators must ensure:

- the chain of evidence is secure and accurate (many physical fits cases have been lost on this point);
- the integrity of the various sources has been maintained; and
- a physical match will have probative value for the case.

19.8.1 Examination

All items are initially examined, while maintaining the integrity of the items from their various sources, with attention to the following:

- the presence of any other forensic evidence. This evidence (fingerprints, blood or other trace material) will need to be processed in accordance with general crime scene procedures. Liaison with other specialist and forensic personnel will determine the sequence of these examinations; and
- the sources of all items must be marked or identified.

Items from the various sources are then examined to determine their suitability for physical matching, depending on:

- class characteristics being compatible (i.e. similar composition, colour, design, pattern, etc.); and
- condition of the various items (size, damaged edges, corrosion, etc.).

19.8.2 Fracture fits

Following analysis, examination of the items from various sources can be commenced with a view to demonstrating that the cut, broken or torn ends from one source can be physically fitted to the corresponding cut, torn or broken ends of the other. The standard method is to simply abut the items and, if necessary, photograph the physical fit. The stereo binocular microscope may be needed for small items (photographs must be taken in these cases).

If the outer surface of a fracture fit is not an obvious fracture fit, it may be appropriate to use a casting medium. The cast of the fractured surface of one item can then be

directly compared with the fractured surface of the other and similarities in shape and contour can be recorded (noted and photographed).

When a fracture fit is achieved, a microscopic examination for minute characteristics which can be seen to continue from one item into the other, should be conducted. These characteristics should be noted and photographed.

19.8.3 *Pattern matching and pattern continuity*

Pattern matching and pattern continuity evidence usually involves the matching of photographic evidence to either a scene or specific objects. As there are numerous variations of physical matching evidence encountered, specific examination/comparison procedures are difficult to define; however, generally the conditions under which the original item was produced should be duplicated (i.e. camera position and lighting similar to how it was when the original photograph was taken).

Armed hold-up suspects may be identified and arrested on the basis of photographs taken on bank film. These images are often poor quality and may be enhanced using various photographic or computer techniques. It may be possible to compare information in the photographs, e.g. clothing (style, pattern, distinctive features, tears, stains, etc.), hair style, carry bags, etc. with the suspect's features and items found on the suspect or at the suspect's premises.

Where the suspect agrees to be photographed for comparison purposes you should first examine the bank film photographs then:

- determine the angle of the photograph in relation to the camera position and the position of the suspect;
- reconstruct the position of the camera and the position of the suspect – take a series of photographs at different angles and make judgements regarding the position of the suspect's head or body relative to the camera; and
- photograph the suspect's clothing – lay out the clothes in studio conditions and photograph them from different aspects.

19.9 Reporting the results of comparative examinations

Physical comparisons are generally carried out to determine if one object can be related to another specific object, by means of class and individual characteristics. As such the examination and evaluation is a progression from exclusion through to identification. If different class characteristics are identified (between the two) an examiner will be able to report that the 'questioned' item can be excluded. If comparable individual features are identified then the number of such individual features, as well as their nature (shape, size, location, etc.) will assist the examiner in determining the extent of the identification. On many occasions an examiner may have sufficient detail to identify the 'questioned' item as being 'capable of' producing the 'mark', but insufficient to positively 'exclude all other similar items'. Over many years, there has been extended

debate on ‘reporting methodologies’ adopted by various comparative disciplines. It is sufficient to state that such reporting will fall into one of four groups:

1. not suitable for comparison (i.e. the items have insufficient detail for further analysis). This finding should not be used as a means of reporting on ‘inconclusive’ results as described below;
2. excluded on the basis of different class (and sometimes individual) features;
3. inconclusive (This finding may have significant value, as it does not preclude the questioned item, but recognises that some (class or individual) features are present, but insufficient to establish identity or exclusion). The reporting of this conclusion is the subject of ongoing debate, but is argued to be a valuable and legitimate finding when expressed in unambiguous terms; or
4. identification (more correctly referred to as identity). This finding excluding all other items, even those with similar class characteristics. (Again this finding is a major topic of debate both within scientific and legal circles – particularly as it conflicts with the Bayesian approach to statistics.)

Whilst the reader has to recognise these reporting concepts, detailed discussions on this topic are beyond the scope of this chapter.

19.10 Conclusion

Part of a crime scene investigator’s duties is to recognise physical evidence capable of being associated between the crime, victim and any suspects. This chapter is intended to assist crime scene investigators appreciate the basic concept of pattern fit and pattern transfer and to allow for the recognition of a far wider range of items capable of being compared. The application of this pattern recognition concept has resulted in many unusual types of evidence being used to assist in criminal investigations. Whilst not exhaustive some of these have been:

- photographs in possession of suspects used to prove the previous existence of a marijuana crop, at a specific location;
- comparing the ‘cut’ edges of aluminium foil and paper in ‘heroin’ deals;
- impressions left on ‘heat sealed’ plastic bags compared back to the heat sealer;
- minute paint particles located on a jemmy bar matched back to the window sill;
- photographs of armed robbery offenders being compared to clothing found in possession of suspects;
- can opener feeder wheel being compared to marks found on bomb components; and
- shoe impressions found on the skin of victims being compared to shoes from suspects.

These are in addition to the ‘standard’ range of shoemark, toolmark and physical matching evidence encountered by crime scene investigators routinely.

By understanding the pattern recognition concept and applying it to a wider range of physical evidence which may be located at crime scenes and by:

- applying good crime scene recording techniques;
- where possible collecting items *in situ*; and
- ensuring sound chain of custody is maintained.

Crime scene investigators will greatly increase the value of their role and involvement in the investigative process.

19.11 Bibliography

- Biasotti, A. A. (1980) Firearm and toolmark identification – a forensic science discipline, *Association of Firearm and Toolmark Examiners Journal*, **46**.
- Bodziak, W. J. (2000) *Footwear Impression Evidence: Detection, Recovery, and Examination*, 2nd edn, CRC, Boca Raton.
- Cassidy, M. J. (1980) *Footwear Identification*, Canada, Canadian Government Publishing Centre.
- McDonald, P. (1989) *Tire Imprint Evidence*, Elsevier, USA.
- South Australian Police (1996) *The Crime Scene and Forensic Procedures Manual*, SAPOL.
- Tuthill, H. (1994) *Individualisation: Principles and Procedures in Criminalistics*, USA Lightning Powder Co. Inc.
- Van Dijk, T. M. (1993) Toolmark identification, in Freckelton and Selby (eds), *Expert Evidence*, 3, pp. 8-2501–52, Law Book Company Ltd.
- Wright, M. J. (1994) *Crime Scene Investigation*, Presentation to the Australian and New Zealand Forensic Science Society's International Symposium on the Forensic Sciences, Auckland, New Zealand.

Signal processing evidence

Graeme J. Kinraid

20.1 Background

For the purposes of the book, this chapter outlines the signal processing field to the crime scene investigator in their crime-solving role with investigators.

Forensic signal processing uses electronic equipment to examine and process signals reproduced from electronic recording media, either audible or visual.

Forensic signal processing has been in existence for some years; however, by comparison to traditional forensic science fields, such as fingerprints, it is seen as a relatively new field. In the early years, signal processing services were predominantly used by the covert or intelligence areas. The security issues of those areas required the field to maintain a very low profile in order to protect against countermeasures. Today, signal processing has become more widely known and accepted because of the wider use of similar technologies in other electronic equipment, such as telephone and satellite systems.

Over time the established laboratories have expanded their services to incorporate a much broader range of activities. This is due to the considerable investments in the specialised equipment, the development of the technical examiner's skills, and through advancements in technology. Many agencies have recognised the greater scope possible in this specialist field and its crime solving potential. As a result it is increasingly more common to see this field aligned to a forensic science function, rather than perhaps their origins in training units or surveillance areas.

During the early years of signal processing, the field was very much based around the development of purpose-built instruments designed for specific applications. There have been some very clever individuals, who have taken these early concepts, developed

and designed them into practical and useful tools. In some cases the concepts were identified or theorised decades before the existence of the technology capable of implementing them.

The modern personal computer, its continuing improvement and increases in computing power/speed have revolutionised the field and influenced equipment development. It appears likely that we will continue to see an ever-increasing trend towards software solutions, using the computer's generic power, rather than using custom-made boxes and dedicated processing chips.

The services offered in forensic signal processing laboratories are very much dependent on their history, client requirements, resourcing, age of existing equipment and expertise of the technical examiners. I would strongly recommend and encourage you to contact the relevant group in your organisation to determine what services they can provide.

20.2 Format conversion

Most fully equipped signal processing laboratories will have a variety of playback equipment, to cope with most of the common recording media formats used by the public or clients.

One of the more straightforward services that can be provided is to convert from one recording format to another.

This can be necessary for a number of reasons:

- for convenience because the original recording is on an uncommon format or carrier, for which a playback machine is difficult to obtain;
- to preserve the evidence on a format that does not degrade as easily as the original format;
- so that the evidence can be circulated more widely without risk of accidental or intentional damage;
- to provide a copy that can replay the audio in a more accessible manner, for example compact disc; and
- to avoid confusion caused by different counters being used on different playback devices.

Some laboratories may also offer fast copying facilities using specialised copying machines. This is often limited to the compact cassette and compact disc formats, where direct copies are made onto the same format (see [Figure 20.1](#)).

20.3 Audio enhancement

One of the most common signal processing services is referred to as audio enhancement. The principle of audio enhancement is that electronic equipment and techniques are used to enhance or improve the intelligibility and/or the quality of the conversations on audio tape recordings.

Unlike the music production recording studio, or on the Hollywood movie set, in law enforcement the audio conversations are regularly captured under hostile conditions.



Figure 20.1 A typical cassette fast copier

It is hostile in that there is less opportunity to control the recording environment, such as adjusting the microphone position, asking the participants to speak up for the microphone, or asking for words to be repeated. By the very nature of the recording environment these recordings are often of poor quality.

Ever since audio recordings began, there has been a desire to replicate sound as close as possible to reality, 'as if you were there'. All recording systems have their limitations, particularly when the microphone cannot be positioned within centimetres of the sound source, that is, the mouth. Often the microphone must be placed or concealed further away from the 'wanted' conversations.

The microphone is purely a transducer that transforms changes in air pressure to electrical signals, thereby capturing audible sounds. Therefore, it does not discriminate between wanted and unwanted sounds.

In a closed room environment many noises may already exist, for example air conditioning units, fans, radio, TV or similar. These are commonly referred to as *additive noise*, as these sounds are in addition to the wanted sounds. The adverse effect on the recording is that these unwanted noises can distract, or may even be louder than the wanted sounds – 'the criminals planning the crime'.

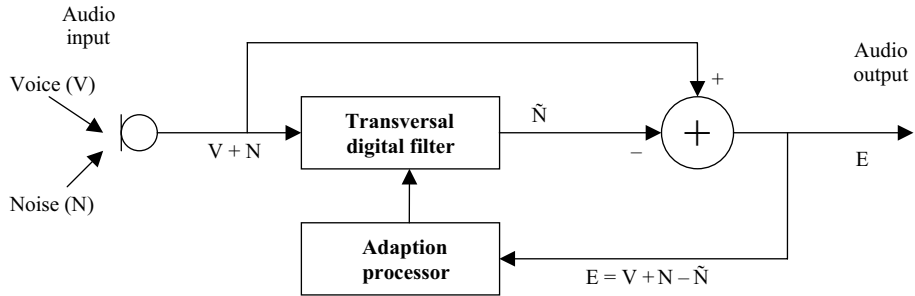

Figure 20.2 Functional diagram of an adaptive predictive deconvolution filter (with permission from Digital Audio Corporation)

The nature of sound is that it travels in a three-dimensional wave front from the sound source. When it meets another surface in the room it will be reflected, absorbed or a combination of the two, depending upon the surface sound properties. If reflected another sound path or a number of sound paths will be created and in time will arrive at the microphone. This type of effect is often called *convolutional noise* because of the convolving effect within the room when the sounds arrive at the microphone.

In the ideal situation these indirect sounds would arrive at the microphone much later in time than the direct path and at a significantly lower intensity or volume in order for them not to have an adverse effect on the recorded audio. Needless to say, the situation the technical examiner is faced with is less than ideal. For example, there may *not* be a direct sound path, or there may be numerous indirect sound paths arriving at different times at the microphone, making it difficult to interpret words being said. An added complication is that this may not occur consistently due to changing conditions within the room, for example, movement of people.

Impulse noise interference is often caused through electrical noise being induced into equipment wiring or systems – this is a difficult type of noise to attempt to reduce.

The technical examiner will have a number of tools in the toolbox to improve the recordings. Some of these tools such as equalisers and band-pass filters can be found in most recording studios. There are also other tools designed for specialist enhancement and in some cases these may only be available to law enforcement agencies.

The functional diagram shown in Figure 20.2 shows an adaptive predictive deconvolution filter that can be used in the reduction of additive and convolutional noises.

20.4 Tape authentication

If a technical examiner ever needs any inspiration, or a reminder of the significant impact that their work can lead to, you only need to mention Watergate.

In the Watergate inquiry, Chief Judge John J. Sirica of the US District Court in Washington DC, appointed a panel of six scientists to investigate the interruption on a taped conversation from the White House between President Nixon and former Chief

of Staff Haldeman. The advisory panel report of 31 May 1974 found that the 18½-minute segment had been over-recorded by another recorder, different to the recorder that had recorded the other conversations on the tape. President Nixon resigned from office on 9 August 1974.

The advisory panel's report became one of the founding documents for most experts to base their procedures for the examination of tape recordings and recorders when attempting to establish authenticity.

The authenticity process is very involved and has a number of stages to it. One of the important tasks is to playback the recording and then to listen critically to determine and identify unusual sounds or significant events that require further investigation.

Other tasks that may be required are:

- physical examination of the tape for physical edits or tampering of the tape and originating recorder (see Figure 20.3);
- waveform analysis for unusual electrical events as opposed to acoustic events;
- sound level analysis for unusual noise level changes; and
- examination of the magnetic patterns on the tape for unusual events or for measurement purposes.

The above is not intended to be a definitive list of the examinations (that may or may not be used), but merely as an indicator of the complexity of the examination process.

In conducting the authenticity examinations, the technical examiner is tasked with attempting to find unique indicators to prove or disprove hypotheses. This may be to:

- link an exhibit recorder and recording;
- determine if the recording is continuous;
- determine if it has been subjected to tampering or alteration; or
- determine if it is the original or a copy.

The examination result is very much dependent on the individual circumstances of the case. It may be possible to find a range of results from strong indications supporting or rejecting the hypotheses, to an absence of evidence neither supporting nor rejecting.

Today, with ready access to computer audio and video editing software, the question can be posed that it is more difficult to detect the 'doctoring' of tapes. The answer is yes, it is more difficult to detect. However, like the proposition that a person could commit

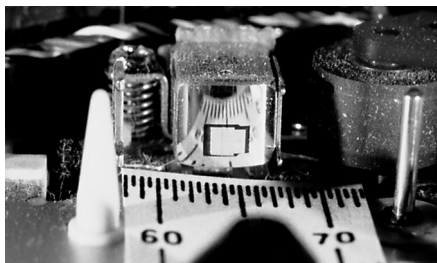

Figure 20.3 A typical micro-cassette tape recorder head

the 'perfect' murder, reality is that inevitably there may be an element of imperfection or unique occurrence that can be detected.

From my own experiences this has certainly been the case, and on occasions the audio fraudster may have tried to be too clever. One incident I recall, noises were added to the voices (probably using a computer editing program). I can only surmise that this was done in an attempt to help support the hypothesis that the recording was made accidentally. However, due to the nature of the noise content, further analysis revealed that it could never have occurred on the recording in the way that it appeared. Some of the participants in the conversations later corroborated this.

If an authentication is to be carried out, it is important for the original recording to be examined, and preferably with the original recorder available to make test (known as exemplar) recordings.

20.5 Tape repair

As a crime scene investigator you may come across incidents where a tape recorder, or recording tape or disc is discovered in a less than ideal condition. This can be because an attempt has been made to intentionally damage it, or due to accidental damage through using faulty playback equipment, or it has been exposed to the elements (wind, rain, dust, snow, etc.) for an extended time.

It is obviously important to attempt to salvage as much of the remains as possible, in the best condition practicable. In most cases the best way to ensure this, is to store the remains in a container or in conditions that will not further degrade the material. Consider the example of an item discovered submerged in saltwater. The item is likely to be affected once exposed to air, therefore the best option in that case is to transfer the item directly to freshwater, distilled water if practicable.

Once secured the technical examiner can clean or treat the item in an appropriate way to recover any potential evidence. If for instance an audio tape was cut into many pieces, the segments could be reassembled back into the original order either physically or reconstruction electronically using a computer editing system.

The most requested service of this category is where a tape has snapped, and both ends are inside the plastic shell and cannot be replayed. This is often a straightforward task, opening the plastic shell, splicing the two tape ends together and closing the shell again. The repair may not be perfect and repeated replay over the splice could cause damage to replay equipment and the original tape. So it is highly recommended that after completing the repair, the tape should be copied ([see Figure 20.4](#)).

20.6 Voice identification

Many papers have been written on this topic with a variety of views depending on the perspective of the writer. In the 1970s the voiceprint or voice spectrogram was used in courtrooms to prove identification through the uniqueness of individual voices. Using a computer to analyse the sounds, a graphical display would plot the frequencies contained within these voice sounds (phonemes) that make up words. This was not found



Figure 20.4 Cassette tape splicing

to be reliable enough to prove identification and is generally not used solely in evidence for the courts. These days some agencies still use the voiceprint but often as an indicator and is not used in evidence or as primary evidence.

Research has been conducted internationally over a considerable number of years into computerised or automated speech identification. The systems using neural networks or gaussian modelling appear to be showing the most promising results, but the research work continues.

Through this research and testing, to date a number of speech recognition systems have been developed that can recognise words (with training), but cannot reliably identify individual voices. The biggest stumbling block for most computerised identification systems is the presence of noise, which is typical of those recordings received in a forensic science situation.

The most successful systems in current use have been around for many years using one of the most powerful computing systems known – the human brain. As humans we perform voice identifications every time we answer the telephone, meet people or overhear conversations. Usually within a matter of a few words we can accurately identify who is speaking, if we know them very well. After a few more words we can often identify those we have not spoken to for months or even years.

Even when we have never spoken to a person before, we can usually ascertain their sex, estimate their age, and often identify dialects or countries of origin. This is not surprising when considering this skill has been learned and refined by humans over thousands of years.

Voice parade or voice lineup is an identification tool, which has gained acceptance by the courts. The voice lineup is a similar process to the traditional visual identification parade, except the identification is only by sound and not visually. Samples of a number of different voices including that of the suspect are recorded onto a compact disc or tape. The recording is then replayed to someone who knows the suspects voice well or the victim. They are then asked if they can recognise any voices present.

20.7 Acoustic analysis

The crime scene investigator's advice can be sought to assist the police officers investigating the crime. There can be many possible leads or questions that need answering or testing of hypotheses as a result of a crime scene investigator's foresight or due to explanations given by suspects during questioning.

One area that can be considered is sound, to answer the questions such as:

- 'Surely someone would have heard the victim shouting?'
- 'The door was closed, I could hear angry voices but I couldn't hear what they were saying.' – but could they? why not?
- 'I had the TV turned up, I couldn't hear a thing' – is that right?
- 'A gunshot in the middle of the city, nobody heard it – that can't be right can it?'
- 'Mrs X. was over here, heard two shots and Miss Y. was there, she heard eight shots, we found two empty shells near Mr Z.' Did we have more than one offender? Did we have someone on the grassy knoll?
- 'The police shot at the offender twice, and then he fired back later, it's all been caught by the TV crew who were there' – who fired first?

The technical examiner can analyse original recordings made at the time. From this it may be possible to establish the sequence of events, based on critical listening and measurements. In conjunction it may be helpful to perform an acoustic reconstruction of the 'events' at the crime scene. This reconstruction can be recorded by placing microphones at specific positions. In listening to this recording of reconstructed events, a layperson, such as a jury member, can be virtually placed at the crime scene.

In the presence of concrete buildings the sounds of the gunfire will reflect off hard surfaces. These reflections or echoes can often confuse listeners, who then provide conflicting accounts of the quantity of shots and the direction from which the shots were fired. The difference in these accounts is often exacerbated when the listeners are in different locations.

Consider the example of the assassination of US President John F. Kennedy in the Dealey Plaza, Dallas, Texas on 22 November 1963. Over the years there has been much debate and controversy over whether a second assassin shot from the grassy knoll. On the day of the assassination two recordings were made by the Dallas Police Department of the radio channel traffic. These recordings were made onto Dictabelt and Gray Audograph recorders.

Unlike today's tape recorders that use magnetic tape, these recordings were made on a plastic disc that are similar to a poor quality phonograph record. At the time of the actual assassination the microphone press-to-talk switch on one of the police radios was jammed ON, potentially capturing sounds relating to the assassination. There have been some assertions that radio transmission was from a motorcycle that was part of the presidential motorcade. However subsequent review of the recorded sounds, compared with those, one would have expected to be recorded in the motorcade, suggests that the notion the motorcycle transmission came from within the Dealey Plaza is unlikely.

20.8 Image/video enhancement

TV programmes and cinema movies portray the capabilities of audio, image and video enhancement in a light, often far from technical reality. The effectiveness of closed circuit television video systems is limited by their resolution. You may have watched movies that show the investigator zooming in from what was originally the size of a flea on-screen, to a full screen image that contains full detail. This is pure fantasy. The flea image in reality may have only been a few pixels or blocks of image. Unfortunately these fictional scenes often unrealistically raise the expectations of investigators and those in the legal profession.

The diagrams in Figure 20.5 form a useful guide that can be used to demonstrate to the layperson the limitations of video and closed circuit television (CCTV) systems.

To further explain the actual effect, the images shown in Figure 20.6 demonstrate the effect of enlarging images from the proportions as shown in Figure 20.5.

Whilst there are a number of interpolation filters that can create new pixels based on the surrounding pixels, the process can never add extra detail that was not originally

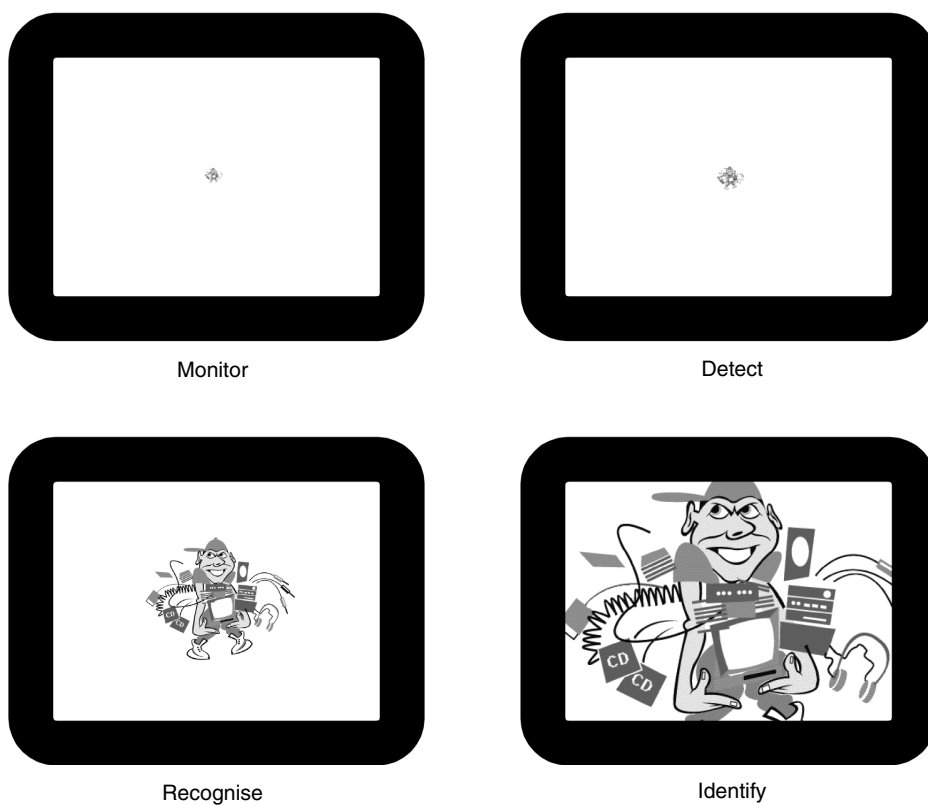

Figure 20.5 With permission from J. Aldridge, Home Office, Police Scientific Development Branch

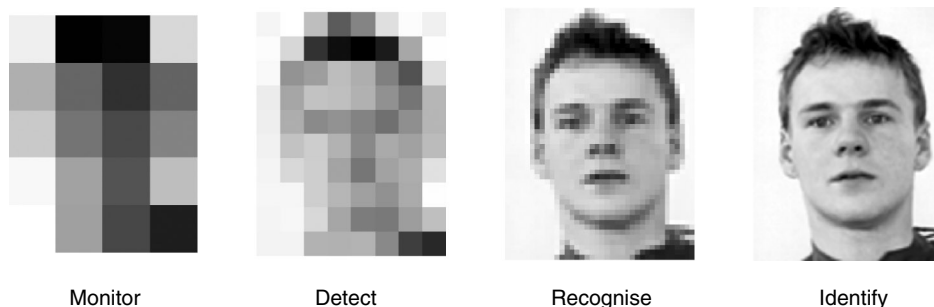

Figure 20.6 With permission from J. Aldridge, Home Office, Police Scientific Development Branch

captured. The images for monitor and detect are classic examples of where the quality of the image cannot be improved to assist identification.

Frame averaging is a useful technique to assist in the identification of number plates or models of parked cars under low light or dark conditions. The technique uses multiple frames of stationary images of the same view. In low light conditions the images are susceptible to noise. However the noise, being random in its nature, does not appear in the same place in each frame. So when the frame averaging process is applied the noise is reduced and the common stationary images in all the frames stand out.

Image processing is not only used in law enforcement. A lot of research and work is being done in universities and companies all over the world in a very diverse range of applications. A couple of examples are the automated grading of apples and the monitoring of drivers in motor vehicles for fatigue. It is this variety of usage and application that will inevitably lead to further innovations and developments for forensic science.

20.9 Conclusion

The crime scene investigator is often the first contact point for higher level forensic science services. By having a wider appreciation of the available forensic signal processing services the crime scene investigator can enhance their role.

Forensic science is likely to benefit from the increasing design and application of signal processing technology used in our community. Some products are purposely designed for use in forensic science while others may be applied to suit. Forensic signal processing is a very dynamic field. This is due to the increasing development of new recording media, signal carrier systems and processing techniques, which in turn is driven by consumer and industry demands.

20.10 Acknowledgement

Thanks to Jim Aldridge (PSDB, UK), Dean Catoggio (VFSC, Australia) and Digital Audio Corporation (USA) for their assistance.

20.11 Bibliography

- Aldridge, J. (1994) *CCTV Operational Requirements Manual*, Publication 17/94, Home Office, Police Scientific Development Branch.
- Bolt, R. H., Cooper, F. S., Flanagan, J. L., McKnight, J. G., Stockham Jr, T. G. and Weiss, M. R. (1974) *The EOB Tape of June 20, 1972: Report on a Technical Investigation Conducted for the U.S. District Court for the District of Columbia by the Advisory Panel on the White House Tapes*, US Government Printing Office.
- Catoggio, D. (2001) *Big Brother and Trends in Forensic Examination of Audio Visual Evidence*, Presentation to 7th Indo-Pacific Association of Law Medicine and Science congress, Melbourne 21 September 2001.
- Elliott, S. J. and Nelson, P. A. (1990) The active control of sound, *Electronics & Communication Engineering Journal*, August 1990, 127–36.
- Koenig, B. E. (1983) Acoustic gunshot analysis, the Kennedy assassination and beyond (Part1), *FBI Law Enforcement Bulletin*, **52**(11), November 1983, 1–9.
- Koenig, B. E. (1983) Acoustic gunshot analysis, the Kennedy assassination and beyond (Conclusion), *FBI Law Enforcement Bulletin*, **52**(12), December 1983, 1–9.
- Koenig, B. E. (1988) Enhancement of forensic audio recordings, *Journal of the Audio Engineering Society*, **36**(11), 884–94.
- McKnight, J. G. and Weiss, M. R. (1976) Flutter analysis for identifying tape recorders, *Journal of the Audio Engineering Society*, **24**(9), November 1976, 728–34.
- Widrow, B., Glover Jr, J. R., McCool, J. M., Kaunitz, J., Williams, C. S., Hearn, R. H., Zeidler, J. R., Dong Jr, E. and Goodlin, R. C. (1975) *Adaptive Noise Cancelling: Principles and Applications*, Proceedings of the IEEE, Vol. 63, No. 12, 1692–716.

Crime scene investigation: key issues for the future

James Robertson

21.1 Setting the 'scene'

In the foreword to this book the former Commissioner of the Australian Federal Police, Mick Palmer, observed that in his 35 years experience of law enforcement the quality of the immediate crime scene response and investigation was almost always a critical factor in a successful prosecution.

Few would find cause to disagree with Commissioner Palmer but how well are we doing in ensuring the necessary 'quality' is being met?

In a global sense there is no single or simple answer to the above question. The situations faced by those tasked with the investigation of crime scenes reflect the demographic, geographic and law enforcement challenges of each jurisdiction. What can be said is that, in many parts of the world, crime scene investigation is carried out by personnel who do not have tertiary science qualifications and most work out of a police organisation. By itself this need not equate to a lack of quality. However, a lack of the necessary training and/or resources essential for quality is all too often the reality.

In the laboratory setting forensic science managers and organisations have long recognised that an essential part of the quality equation is to have a quality system, which meets accreditation standards. Many countries have their own accreditation agency and the United States based American Society of Crime Laboratory Directors-Laboratory Accreditation Board (ASCLD-LAB) has accredited laboratories in a number of countries and has recently included crime scene investigation within their accreditation programme. However, Australia was the first to have a formalised quality assurance *and* proficiency testing system for crime scene investigators or field forensic scientists. This is now well established and is an integral test class within Australia's National Association of Testing Authorities (NATA), Australia's Forensic Science Laboratory Accreditation Programme. NATA carries out assessments of laboratories and facilities ensuring conformance to the international standard, ISO 17025.

In some countries laboratory-based science qualified staff attend more serious crime scenes although usually supported by scenes of crime, photographic and/or fingerprint personnel. In the United Kingdom most (if not all) police forces have established scientific support groups and increasingly staff have science qualifications. The United Kingdom also has an excellent centralised training school, which provides competency-based training for scenes of crime officers (SOCOs). However, even in a country with what is, by any standard, a large and sophisticated forensic science capability and capacity, a 1996 report on 'Using Forensic Science Effectively' (UFSE) found that:

- scientific support was usually managed separately to the investigative process and was rarely seen as an integral part of it;
- forensic science was almost always used reactively, except in the most serious crime, and did not readily support intelligence-driven initiatives;
- forensic science usage was not an interactive process; and
- awareness of scientific support was poor, and often insufficient for purposes.

This report jointly published by the UK Association of Chief Police Officers (ACPO) and the Forensic Science Service (FSS) was seen as a blueprint for the more effective use of forensic science. Regrettably in July 2000 a review of its impact and implementation found *'not only that the advice of UFSE had frequently not been acted upon but also that, even more regrettably, the failure to respond was a product of ignorance of its contents'*, not an encouraging outcome. The report concluded that the document and its guidance should have been a cornerstone of a more professional and strategic exploitation of forensic science.

Perhaps one exception to the above has been the uptake and use of DNA technology combined with DNA intelligence databases. This has resulted in significant changes in police investigative practices and is a major force for forensically driven, intelligence-led policing. However, this has also had its costs. The exponential increase in the caseloads for forensic biology, and the demand on DNA analysis, has had an impact more broadly on forensic laboratories and has placed enormous demands on laboratory forensic science.

In 1999 a United States review of status and needs for the forensic sciences identified a number of areas where current methods could be improved or where developments were occurring. These were:

- small, rugged, chemical analysis instruments for on-site preliminary or confirmatory analysis in investigations involving drugs, explosives and hazardous material (to these we might add today DNA);
- sample location, identification, capture and stabilisation technology 'in a kit', suitable for recovery of trace particulate, liquid, chemical and biological evidence;
- portable and remote hazardous material's detectors for alerting/protecting crime scene personnel;
- micro-robotic platforms to support scene visualisation, safety assessments and sampling; and
- computerised crime scene mapping supported by global positioning systems (GPS) and multimedia capture technologies for three-dimensional crime scene visualisation, memorialisation and location of evidence.

In identifying the key issues for the future I am attracted to the comments of Dr Geoff Garrett, the CEO of Australia's Commonwealth Science and Industry Research Organisation (CSIRO), when he said '*strategy is not about rolling forward from the present; it's rolling back from the future... we don't need a crystal ball, we need a wide angle lens because the future is all around us and it's happening now!*' (Anon., 2001).

The environment and issues, which will shape crime scene examination of the future, are with us now.

Some of the significant questions, which will require answers, are:

- What impact will emerging technologies have?
- What type of people will we need and what implications will this have for training?
- How do we ensure or assure quality?
- How do we ensure law enforcement makes best use of forensic science?

21.2 What impact will emerging technologies have?

The simple answer to this question is that emerging technologies will transform the face of crime scene investigation in the next 5–10 years.

This truly is an area where we do not need a crystal ball but rather a wide-angle lens. Whilst it might not be possible to predict with 100 per cent accuracy the actual instruments which will be available or the precise timeframe – these will be determined more by market and business realities than scientific or technological limitations – it is easy to predict that there will be the emergence of an ever increasing variety of field useable instruments. The desire of the customer, in general law enforcement agencies, to have quick, preferably real time answers, will be a major driver for the uptake of field technology.

To name but a few examples of the type of technology we can expect:

- Digital image capture is a reality being introduced or used in many countries across the world – we are at the very start of the digital age and can expect, (as with computers) a doubling in 'capability' about every year. Where this will take us is hard to say but it is not inconceivable that the crime scene examiner of 2005 will 'wear' a digital video camera recording the scene, zooming in on specific evidence, with local and global positioning, automatic production of 3D diagrams and voice generated note taking. Of course all of the above is already possible but not yet in a highly convenient package! Traditional photographs will have very limited use if they survive at all.
- Field digital capture of latent marks with real time searching – again already possible in a limited way.
- Field analytical instrumentation made available by developments in miniaturisation of components and fuel cell technology to power these devices. Micro channel capillary electrophoresis is likely to be a key technology, but micro gas chromatographs and mass spectrometers are also likely to be important. Such instruments are again beginning to become available. In my own laboratory we are evaluating field portable gas chromatography (GC), Fourier transform infra red (FTIR) spectroscopy and explosives capability. However, these instruments are still

largely based on old technology. The trend will be to smaller and smaller instruments with increasing sensitivity.

- DNA testing in the field will become a reality as biochip technology develops. DNA biochips already exist but, once again, they will become smaller, self-contained complete analytical packages. It will be possible to conduct analysis in real time and search databases from the field.

The emergence of field portable analytical instrumentation will not see a lesser need for the laboratory for a number of very practical reasons. It will not be possible or desirable to analyse everything in the field. This may be for practical, security and scientific reasons. It can be expected that the more complex and difficult analysis will still be conducted in the laboratory. For example, it will be possible to identify illicit drugs in the field, it may be possible to quantify in some circumstances but it will not be possible to carry out higher-level drug profiling analysis. However, what it may enable is, through rapid analysis, small seizures of drugs to be dealt with in much the same way as alcohol is dealt with in many countries, i.e. on the spot analysis. For those who find this hard to come to terms with, one need only ask an older colleague how blood samples were analysed in almost all laboratories prior to the introduction of substantive breath testing devices. If it were possible to analyse accelerants in the field would there be a role left or reason to analyse accelerants in the laboratory? and how much better to test in the field to help determine the seat of a fire, with the additional benefit of a decrease in the risk of accelerant loss from the time of collection to the time of analysis?

21.3 What type of people will we need and what implications will this have for training?

Having started my career in the forensic sciences as an academic, moved to Australia to a 'bench' science role and then onto the management of a fully integrated forensic service I have experienced probably the full range of attitudes and opinions about what is, and what is not, forensic science. All too often crime scene investigators (by whatever name – *and* all too often semantics are used to blur the real issues) are viewed as the three 'Ps' *pickers, packers* and *posters!* Laboratory-based personnel have seen themselves as the scientists and 'field' personnel as technicians, technicians being characterised by the 'monkey see, monkey do' approach. The reality is of course more complex and, truthfully, around the world the people doing crime scene investigations have not helped as they also do not see *themselves* as scientists.

In my own organisation my crime scene group were sworn police members, few of whom had formal science qualifications. In order to address this lack of formal training the Australian Federal Police instigated a formal para professional subdegree level educational programme in the late 1980s. This diploma included core science components with specialist modules developed to cover forensic areas. From an Australian Federal Police perspective the thinking behind this was that our examiners were expected to apply science principles and reasoning to their work and use, increasingly, scientific equipment such as specialist light sources. It was our view that the examiner should understand the basic biology, chemistry and physics used in, for example, the detection

of fingerprints. Without this basic knowledge the examiner could indeed fall into the trap of being a '*monkey see, monkey do*' follower of basic protocols. Of course in real life no protocol can cover every potential situation. A scientific approach involves critical thinking and the ability to modify a core method to address a specific situation. It should be self-evident that such an approach lies at the very heart of crime scene investigation.

Some 10 years after the initial introduction of the diploma the Australian Federal Police supported the development of a degree programme in field forensic science. We also moved to graduate recruitment. This was a logical progression, as we do not see ourselves as being in the business of 'educating' scientists. In parallel we have altered our approach to the induction of our new staff to a 'training' approach based on a mix of technical competencies, practical application of science principles to crime scene investigation, ethics and philosophy, and evidence presentation.

Although there has been a national approach to these issues in Australia there are jurisdictional differences. These are probably greater today than in the mid-1990s and this has to an extent been driven by the need to respond to more crime scenes due to DNA. There is considerable pressure to attend more crime scenes on the basis that the more scenes attended the more success there will be from the collection of samples for DNA testing and, perhaps also, fingerprinting.

The question has been raised as to whether or not it is necessary to have fully trained crime scene examiners attend 'minor' or 'volume' crime where the focus is on the collection of samples for DNA and perhaps routine searching for latent fingerprints. In the previously mentioned report of Her Majesty's Inspector on Science and Technical Support an example is quoted where Northamptonshire is employing scenes of crime officers (SOCO) aides to undertake low-level examinations such as vehicle crime. This is seen as a cost-effective approach. The report recommends that there needs to be a fresh approach to ensure that volume crime such as vehicle theft is properly dealt with.

Although the specifics of crime may vary around the world, burglary, home invasions and vehicle theft are universal. In many countries there is increasing public pressure, translating into political pressure, to deal with these problems.

The answer for some groups and organisations has been to have different levels of crime scene investigator. For myself I have never seen the logic in this approach. For example, what happens when there is a serious physical assault? Should the 'lower' crime scene investigator do nothing and wait to see if the victim dies? *because* there is a rule that this type of crime belongs to the serious crime scene group? It may be possible to separate out some categories of non-violent crime for a 'new' approach but the issue is not as simple as it may appear. However, it is clear that a very major issue for the managers of forensic science *now*, and increasingly in the very near future, is how to manage the practical and political challenges posed by volume crime.

Much is made of intelligence-led policing with potential DNA databases leading the way. The paradox is that we may be forced to revert to a lower level of crime scene investigator to meet the practical demands created by DNA and an increased focus on 'minor' crime scenes.

Crime scene investigation is real forensic science, *and* at least the more complex and major incidents demand a scientific approach requiring personnel with appropriate basic science and specialist training. It would be a tragedy for the future if this was to be lost in short-term 'fix it' solutions to deal with the challenges posed by volume

crime. Strong leadership and management by the forensic community will be required if appropriate standards are to be developed and maintained. It would help if more crime scene investigators had the confidence to view themselves as forensic scientists *and* if laboratory scientists would also recognise this self-evident fact.

The emergence of field technologies as discussed earlier in this chapter will demand that the personnel using these instruments must have tertiary science qualifications. These instruments cannot be used as 'black boxes' if their full potential is to be realised. Scientific support managers, or crime scene managers by whatever name, need to be considering now future recruitment and training strategies to meet this changing paradigm. For my own organisation I see no science boundary in the future between field and laboratory science. The only boundary and challenge will be management of staff throughout a career in broader forensic science.

21.4 How do we ensure or assure quality?

Limiting my comments to the scope of this chapter, key issues for the future, the question begs a second question, is there a lack of quality in current crime scene practices?

Of course there is no simple answer to this second question. On a global scale standards of practice must vary across the spectrum in terms of capability, and how well this 'capability' is practised. As I commented on in setting the scene, crime scene investigation has been characterised by not being covered by a formal assessment framework for quality in the way laboratory services is *in some countries*. As mentioned at the beginning of this chapter, Australia was the first country to include crime scene examination in its forensic accreditation programme. Internal and external proficiency testing programmes have also been developed as enabling elements of the accreditation programme. The American Society of Crime Laboratory Directors-Laboratory Accreditation Board (ASCLD-LAB) has recognised this key forensic science discipline and has had crime scene investigation as a discipline area in its accreditation programme since 2000.

Regardless of the existence or not of formal accreditation programmes, and it is highly likely further programmes will emerge in the future, crime scene should have written operating protocols and methods with appropriate quality oversight including proficiency testing. It can be expected that the crime scene environment previously characterised by a lack of formal externally assessed and validated standards, will move quickly in the next few years to join laboratory services in having formal, third party and externally assessed quality systems.

This need will be increased as more sophisticated field instrumentation becomes available. It will be critically important that crime scene protocols are well crafted to recognise the need that they are soundly based in science and are also flexible enough to apply in real life. A crime scene investigation, except in the simplest cases, requires on-the-spot assessment, decision-making and sometimes an innovative approach. Provided this is done applying scientific principles, and fully recorded, this should meet quality standards. It can also be expected that there will be an increased need for, and demand for, proficiency tests for field-testing. The development of a novel approach to the provision of such tests in the Australian context is described elsewhere in this book.

21.5 How do we ensure law enforcement makes the best use of forensic science?

The whole service must recognise that the use of forensic support is integral to reducing crime and work to make that a reality.

(Blakey, 2000)

There is a need to change the dominant culture in law enforcement agencies, which views scientists and 'techos' as a curious, if albeit frequently necessary, adjunct to the main game of crime fighting. A more wholehearted engagement with the science community must be actively promoted... this engagement in turn, should inform strategic planning by law enforcement agencies.

(Anon., 2000)

It is one thing to recognise that there is room for improvement in the use of forensic science in support of law enforcement but more difficult to identify the underlying reasons and find ways to bring about changes. Better education of law enforcement officers, as to what forensic science can and cannot do in support of police investigation, would be a good starting point as the lack of accurate knowledge about forensic science must inhibit its proper uptake and use. In my own organisation we have created a School of Forensic Science within our Police College. One role of the school is to ensure all police training includes relevant forensic input. A less formal, but equally important role is to improve communication between the operational police and the forensic scientist. Crime scene personnel have a very important role to play as they are usually the first forensic people operational police have to deal with. However, it is of equal importance that senior police have commitment to ensuring forensic support is properly utilised. To this end forensic science contributes to the Australian Federal Police's Management of Serious Crime (MOSC) course. Here the need for timely proactive engagement with forensic science is stressed. As forensic support is not a free resource (whether or not there is formal charging) we also stress the need to consider the relative costs of forensic support to other methods of investigation. On the long term, the key to forensic science being best used by law enforcement has to lie in showing that the use of forensic support makes economic sense.

Many organisations around the world are no doubt engaging in the same dialogue and activities as my own organisation but it is pleasing to note that the Australian Federal Police has embraced the concept of science and technology which impacts on our strategic planning.

In jurisdictions in which the various elements of the forensic sciences are housed in different agencies and where there is formal charging, the challenges are probably greater in ensuring a coherent, enhanced and cooperative adoption of forensic support.

21.6 Conclusion

One of the major challenges facing governments is to decide whether or not forensic science should be core government business and to what extent the commercial paradigm is appropriate for forensic science. In turn the leaders in the forensic community need

to develop a much sharper focus on measuring the cost benefit of using forensic science. The game in the foreseeable future is unlikely to be one of bidding for an increased public purse but rather of trying to have existing resources directed to increased forensic support. This is only likely to happen if there are demonstrable benefits, quantitative and/or qualitative.

Crime scene or applications of forensic science in the field are likely to become the growth sector of forensic science. Organisations and individual leaders will need to address the issues raised in this chapter and others if the benefits of enhanced technologies are to be captured and realised for the community.

21.7 References

- Anon. (2000) *Science, Crime Prevention and Law Enforcement*. Report of the Prime Ministers Science, Engineering and Innovation Council (PMSEIC).
- Anon. (2001) Team Australia – New CSIRO Chief Geoff Garrett describes his vision for Australia. *Australasian Science*, **22**, 14–15.
- Blakey, D. (2000) *Under the Microscope: Thematic Inspection Report on Scientific and Technical Support*, Pub. Home Office, UK.