

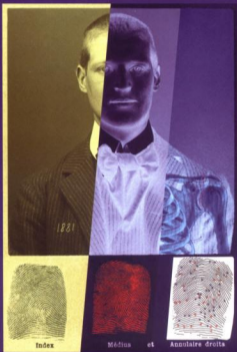

INTERNATIONAL FORENSIC SCIENCE
AND INVESTIGATION SERIES

Fingerprints and Other Ridge Skin Impressions



**CHRISTOPHE CHAMPOD,
CHRIS LENNARD, PIERRE MARGOT,
and MILUTIN STOILOVIC**

Fingerprints and Other Ridge Skin Impressions

As the most comprehensive reference available on fingerprint science, **Fingerprints and Other Ridge Skin Impressions** gathers together and analyzes the latest findings and techniques related to fingerprint detection and identification. A recognized team of authorities brings together the scientific and legal aspects of this discipline into one easily accessible resource. Chapters cover all aspects of the subject, including the formation of friction ridges on the skin, the deposition of latent prints, the detection and enhancement of such marks, the recording of fingerprint evidence, and fingerprint identification itself. Recent advances in statistical interpretation, fingerprint detection techniques, and computer technology are also discussed in detail.

Features

- Presents more comprehensive fingerprint information than any other book available
- Offers up-to-date, in-depth knowledge of fingerprint detection and identification issues
- Includes appendices with the most recent statistical data on fingerprint patterns and minutiae
- Provides flowcharts that guide the selection of proper sequences of detection techniques

This practical techniques manual is an ideal text for practitioners working in the field of fingerprint detection and identification, as well as anyone studying forensic science at the undergraduate and postgraduate levels. There is also sufficient background material for legal and law-enforcement professionals in need of an introduction to the critical subject of fingerprinting.

CRC PRESS

www.crcpress.com





INTERNATIONAL FORENSIC SCIENCE
AND INVESTIGATION SERIES

Fingerprints and Other Ridge Skin Impressions

**CHRISTOPHE CHAMPOD,
CHRIS LENNARD, PIERRE MARGOT,
and MILUTIN STOILOVIC**



CRC PRESS

Boca Raton London New York Washington, D.C.

Library of Congress Cataloging-in-Publication Data

Fingerprints and other ridge skin impressions / Christophe Champod ... [et al.]
p. cm.

Includes bibliographical references and index.

ISBN 0-415-27175-4

1. Fingerprints. 2. Fingerprints--Identification. 3. Criminal investigation. 4. Forensic sciences. I. Champod, Christophe.

HV6074.F564 2004

363.25'8—dc22

2003067458

This book contains information obtained from authentic and highly regarded sources. Reprinted material is quoted with permission, and sources are indicated. A wide variety of references are listed. Reasonable efforts have been made to publish reliable data and information, but the author and the publisher cannot assume responsibility for the validity of all materials or for the consequences of their use.

Neither this book nor any part may be reproduced or transmitted in any form or by any means, electronic or mechanical, including photocopying, microfilming, and recording, or by any information storage or retrieval system, without prior permission in writing from the publisher.

The consent of CRC Press LLC does not extend to copying for general distribution, for promotion, for creating new works, or for resale. Specific permission must be obtained in writing from CRC Press LLC for such copying.

Direct all inquiries to CRC Press LLC, 2000 N.W. Corporate Blvd., Boca Raton, Florida 33431.

Trademark Notice: Product or corporate names may be trademarks or registered trademarks, and are used only for identification and explanation, without intent to infringe.

Visit the CRC Press Web site at www.crcpress.com

© 2004 by CRC Press LLC

No claim to original U.S. Government works

International Standard Book Number 0-415-27175-4

Library of Congress Card Number 2003067458

Printed in the United States of America 1 2 3 4 5 6 7 8 9 0

Printed on acid-free paper

Preface

Our aim with this book was to place, under the same roof, two distinct but intertwined aspects of the use of fingerprinting for personal identification and criminal investigation: (1) the aspects associated with the visualization, detection, and recording of friction ridge skin impressions and (2) the issues regarding the identification or individualization of unknown marks when compared with known prints. In 1978, Robert Olsen (1978) published one of the rare books where both aspects were covered with equal weight. Two of us published an overview of fingerprint detection techniques, putting significant emphasis on detection sequences (Margot and Lennard 1994); however, the identification process was only briefly covered. In recent years, we have all been involved in various research projects on fingerprint detection techniques as well as identification issues. We have tried to reflect these dual aspects through our mandate to regularly update the forensic community on the field for the triennial Interpol Forensic Science Symposiums in Lyon (Margot and Lennard 1993; Champod and Margot 1997b, 1998; Meuwly and Margot 2001). We have observed a field that is in rapid progress on both detection and identification issues and, in light of the recent debate on the admissibility of fingerprint evidence in U.S. courts, we have decided to bring together both sides of this discipline within the same volume and to give them the evenhanded critical analysis they deserve.

Our chapters are arranged as follows:

In [Chapter 1](#), we give a brief overview of the current state of knowledge on the morphogenesis of friction ridge skin. Our objective is to embed the identification process on a firm ground of understanding of biological uniqueness. We are particularly grateful here to Prof. Michio Okajima, who has shared with one of us his time, extensive knowledge, and photographic material during a wonderful summer afternoon in Tokyo in 1996.

In [Chapter 2](#), we investigate the nature of the identification process. We have tried to step beyond the well-known ACE-V protocol, which does not completely fulfill the requirements — as described by van Koppen and Crombag (2000) — of (a) a fully articulated descriptive model, (b) a detailed and systematic account of the variation of the features, and (c) a transparent decision model. Consequently, we put some effort into making explicit the available knowledge, with special emphasis on the documented selectivity of fingerprint features. We have also made a deliberate attempt to reconcile the two main approaches to the identification process: an approach based on an empirical numerical standard (a predefined number of points) and a holistic approach. We believe that most of the antagonism of this debate fades away when an appropriate perspective is adopted on the concept of identification standards: a sound professional framework founded on a sound corpus of scientific data, high standards of quality management, proficiency testing, performance monitoring, and blind testing.

Chapter 3 presents the knowledge of chemistry, optics, and photography that is necessary to develop skills and understanding in detection techniques. We felt that it was important to draw special attention to the use of filters, optical enhancement techniques, and also digital image processing. Following the creation of the School of Forensic Science (Institut de Police Scientifique) at the University of Lausanne in 1909, Prof. R.-A. Reiss taught pioneer forensic scientists to maximize and secure the recovery of evidential marks through the expert use of photographic techniques (Reiss 1903). The importance of the recording process can never be overstressed.

In Chapter 4, the major fingerprint detection techniques are reviewed according to the type of surface encountered. The chapter starts with information regarding the composition of fingermark residue, allowing an understanding of the nature of the components targeted by the detection techniques and the added value of detection sequences as opposed to a single treatment. It is not intended to provide an exhaustive account of all optical, physical, or chemical techniques that have been proposed in the literature, but rather to provide a consistent and optimized set of techniques that have shown good potential in operational casework.

Chapters 5 and 6 bring the book to its conclusion. They provide the reader with an insight into fingerprint-related matters such as age determination, forgeries, and the management of errors. We also made an attempt at setting a standard nomenclature.

In developing this book, we have made some choices that the reader needs to be aware of. First, we decided to give no account of the history of the use of fingerprinting in criminal investigation. We consider that the chapter from John Berry and the relevant section in David Ashbaugh's book are very complete accounts for fingerprint examiners (Ashbaugh 1999b; Berry and Stoney 2001). In addition, recent publications have covered these historical aspects and brought to the table important sociological perspectives (Cole 1998, 1999, 2001), reaffirmed the contribution of Dr. Henry Faulds (Beavan 2001), and documented the essential development of the method in India during the 19th century and its influence in Britain (Sengoopta 2003).

Although the reader will find significant material in the above references, we strongly felt the need to complement this view by presenting a European perspective that remains largely unknown and poorly documented. Among the active forensic scientists during the transition period between anthropometry (Bertillon) and dactyloscopy (Faulds, Galton, Henry, and Vucetich), little credit is generally given to Dr. Edmond Locard and Prof. R.-A. Reiss. Locard (who later became head of the forensic science laboratory in Lyon) heralded from the famous medico-legal school of Lyon under the direction of Prof. A. Lacassagne. This group of researchers pioneered the optimization of detection techniques for bloodstains and fingermarks (Florence 1885, 1889; Coutagne and Florence 1889; Frécon 1889). The early work of Galton became well known in France in 1891 through the publication of de Varigny (1891). Locard (1903) was immediately impressed by the simplicity and efficiency of dactyloscopy, but was still hesitant to replace bertillonage. A thesis by France's Yvert (1904) gave Locard all the arguments necessary to push dactyloscopy forward. Locard then engaged himself in the review of all the systems of personal identification available at that time, covering Bertillon's anthropometry as

well as the various dactyloscopic systems proposed worldwide (Locard 1906). This first book by Locard is a key contribution in the development of fingerprint science, providing a fair and comparative assessment of anthropometry and the dactyloscopic systems of Vucetich, on the one hand, and Galton-Henry on the other. By 1909, Locard was convinced of the superiority of fingerprinting over anthropometry as a worldwide means of personal identification (Locard 1909). The between-user variability of recorded measurements was indeed one of the weakest points of anthropometry.

The main debate at that time revolved around the efficiency of the classification system. Bertillon's system offered a versatile means of classifying hundreds of thousands of cards, whereas, at that time, fingerprints suffered from a lack of standardization. That view was held by Bertillon himself, followed by R.-A. Reiss (1909a, b, c). There was no doubt that fingermarks offered a fantastic tool for criminal investigation (as Faulds first suggested), but the application of fingerprinting as the only record for personal identification was initially viewed with skepticism. Bertillon is often portrayed as a dogmatic opponent to the development of fingerprint identification. We believe that the reality is more subtle. Bertillon in fact embraced fingerprints very early and recorded fingerprints on the anthropometric cards from 1894. Around 1900, Bertillon worked on the development of easy and efficient detection techniques for revealing fingermarks at crime scenes. Indeed, Bertillon is known for one of the first identifications, that of a murderer, based on marks secured with powder at the crime scene; the Scheffer's case (October 10, 1902) is known as the earliest conviction (March 15, 1903) for homicide in Europe that relied on fingerprint evidence (Sannié 1950). In 1903, Bertillon produced a classification system very close to the Vucetich system, and he suggested using fingerprints as a subsidiary (to anthropometry) classification system.

Bertillon did indeed publish the now-infamous prints modified to display what could be viewed as 16 points in agreement (Bertillon 1912), but this publication was never intended by Bertillon to be a warning or a barrier against fingerprint evidence (Champod et al. 1993). Bertillon was forward-looking and, despite his strong character and dedication to his anthropometric system, he contributed enormously to the development of fingerprinting as a new tool for identification purposes. The slow development of dactyloscopy is certainly due to the lack of international standardization regarding a classification system, whereas Bertillon's system was applied uniformly in the identification bureaus. This state of affairs was deplored by all the main actors during the sixth conference on criminal anthropology in Turin, Italy, in 1906, but we had to wait until the first conference devoted to *police judiciaire* in Monaco in 1914 to see some international resolution toward standardization (Roux 1926). (The proceedings of this meeting were published much later due to the First World War.) It is fair to say that international exchanges are still not fully optimized today. Although it is difficult to cover the development of fingerprinting in all countries, the work of Heindl (1927), a famous German dactyloscopist, deserves a special mention here. Heindl's book remains the most complete reference for its time (Heindl 1927).

The second option chosen for this book was to avoid a chapter on the development and use of automatic fingerprint identification/recognition systems

(AFIS/AFRS). Nowadays, these systems are used operationally as very successful and decisive sorting devices, but they have no impact on the identification process itself. In other words, the identification of an unknown fingermark remains unaffected by whether or not the potential corresponding prints have been put forward to the fingerprint expert through a “standard” police inquiry or following a search within a database of millions of fingerprint records. Of course, this is not to say that automatic techniques have no impact on fingerprint matters; they represent decisive tools for the criminal justice system, moving fingerprint bureau practices from a few “cold hits” a week to dozens a day. In addition, we believe that automated processes will contribute significantly to the validation of the field in the very near future. Interested readers should refer to the historical accounts by Foote (1977) and Moore (1991). Surveys describing relevant research and the implementation of automated systems have recently been published, respectively, by Peterson (1996) and by Jain and Pankanti (2001), and recent books and dissertations portray a very active research community (Hong 1998; Jain et al. 1999b; Prabhakar 2001; Bazen 2002; Maltoni et al. 2003). Fingerprint technology cannot be separated from other biometric systems that are receiving very close attention nowadays (Jain et al. 1999a), and in the future, we will undoubtedly see the development of integrated systems combining multiple characteristics (e.g., fingerprints, DNA, face, and voice).

Finally, we would like to express our gratitude to all those who have provided assistance and advice in the elaboration of this book. Our special thanks go to Alexandre Anthonioz, David Ashbaugh, Les Bush, Nicole Egli, Eric Sapin (author of the photographs illustrating [Chapter 3.6](#)), Kasey Wertheim, and James Robertson. Our thanks also to our respective families for their patience and understanding while this book was being put together.

Lausanne, Switzerland, and Canberra, Australia

Contents

Chapter 1 Friction Ridge Skin

- 1.1 Structure of the Skin
- 1.2 Morphogenesis of Friction Ridge Skin — Primary Dermal Ridge Development
- 1.3 Factors Affecting the General Pattern and the Configuration of Minutiæ
- 1.4 Morphogenesis of Friction Ridge Skin — Secondary Dermal Ridge Development and Dermal Papillae
- 1.5 Summary of the Stages of Friction Ridge Skin Morphogenesis — Relationship with Durability or Permanency and Uniqueness

Chapter 2 The Friction Ridge Identification Process

- 2.1 Analysis
- 2.2 Comparison
- 2.3 Evaluation
 - 2.3.1 Historical Milestones
 - 2.3.2 Current Views and Practices
 - 2.3.3 Transparency of the Individualization Decision
 - 2.3.4 Range of Conclusions in the Field
 - 2.3.5 Statistics as a Key to Transparency
- 2.4 Verification

Chapter 3 Chemistry, Light, and Photography

- 3.1 Standard Weights and Measures
- 3.2 Chemistry Theory
- 3.3 Light Theory
 - 3.3.1 Introduction
 - 3.3.2 Wave Theory
 - 3.3.3 Particle Theory
 - 3.3.4 White Light and Colored Light
 - 3.3.5 Spectral Sensitivity of the Human Eye
 - 3.3.6 Absorption and Reflection of Light
 - 3.3.7 Photoluminescence
 - 3.3.8 Optical Filters
 - 3.3.9 Absorption Mode
 - 3.3.10 Diffused Reflection Mode
 - 3.3.11 Episcopic Coaxial Illumination

- 3.3.12 Photoluminescence Mode
- 3.3.13 Time-Resolved Imaging
- 3.3.14 Ultraviolet Illumination Techniques
- 3.4 Forensic Light Sources and Their Application
- 3.5 Photography
 - 3.5.1 Introduction
 - 3.5.2 Image Formation
 - 3.5.3 Photosensitive Materials and Image Sensors
 - 3.5.4 Black and White Film (35 mm)
 - 3.5.5 Sensitometry
 - 3.5.6 Camera Lenses
 - 3.5.7 Shutter and Diaphragm
 - 3.5.8 Resolution
 - 3.5.9 Depth of Field
 - 3.5.10 Photography in the Photoluminescence Mode
- 3.6 Digital Imaging
 - 3.6.1 Introduction
 - 3.6.2 Data Compression
 - 3.6.3 Image Processing Techniques
 - 3.6.4 Legal Requirements
 - 3.6.5 Standard Procedures for Fingerprint Imaging
 - 3.6.6 Case Example

Chapter 4 Fingerprint Detection Techniques

- 4.1 Types of Fingerprint Evidence
 - 4.1.1 Visible Fingermarks
 - 4.1.2 Latent Fingermarks
- 4.2 Surface Characteristics
 - 4.2.1 Porous Surfaces
 - 4.2.2 Nonporous Surfaces
 - 4.2.3 Semiporous Surfaces
- 4.3 Optical Detection Techniques
 - 4.3.1 Absorption
 - 4.3.2 Luminescence
 - 4.3.3 Diffused Reflection
 - 4.3.4 Ultraviolet Imaging
- 4.4 Detection Techniques for Porous Surfaces
 - 4.4.1 Ninhydrin
 - 4.4.2 Ninhydrin Analogs
 - 4.4.3 Diazafluorenone (DFO)
 - 4.4.4 Physical Developer (PD)
 - 4.4.5 Multimetal Deposition (MMD)
 - 4.4.6 Recommended Detection Sequence
- 4.5 Detection Techniques for Nonporous Surfaces
 - 4.5.1 Fingerprint Powders

- 4.5.2 Small-Particle Reagent
- 4.5.3 Cyanoacrylate Fuming
- 4.5.4 Vacuum Metal Deposition (VMD)
- 4.5.5 Recommended Detection Sequence
- 4.6 Miscellaneous Techniques for Latent Fingerprint Detection
 - 4.6.1 Iodine/Benzoflavone
 - 4.6.2 Dimethylaminocinnamaldehyde (DMAC)
 - 4.6.3 Osmium Tetroxide (OsO₄) and Ruthenium Tetroxide (RTX)
 - 4.6.4 Silver Nitrate
- 4.7 Fingerprint Detection on Semiporous Surfaces
- 4.8 Fingerprint Detection on Human Skin
 - 4.8.1 Powdering
 - 4.8.2 Transfer Techniques
 - 4.8.3 Physico-Chemical Methods
 - 4.8.4 Recommended Detection Sequence
- 4.9 Fingerprint Detection on Adhesive Surfaces
 - 4.9.1 Gentian Violet
 - 4.9.2 Sticky-Side Powder
 - 4.9.3 Cyanoacrylate Fuming
 - 4.9.4 Recommended Detection Sequence
- 4.10 Fingerprint Detection on Firearms and Cartridge Cases
 - 4.10.1 Cyanoacrylate Fuming
 - 4.10.2 Gun Blue
 - 4.10.3 Miscellaneous Techniques
- 4.11 Enhancement of Fingermarks in Blood
 - 4.11.1 Optical Techniques
 - 4.11.2 Protein Stains
 - 4.11.3 Diaminobenzidine (DAB)
 - 4.11.4 Miscellaneous Techniques
 - 4.11.5 Recommended Detection Sequence
- 4.12 Fingerprint Detection at the Crime Scene
- 4.13 Effect of Fingerprint Detection Techniques on Subsequent DNA Profiling
- 4.14 Laboratory Safety
 - 4.14.1 Hazardous Substances
 - 4.14.2 Light Sources

Chapter 5 Issues Related to the Exploitation of Fingerprint Evidence

- 5.1 Terminology
- 5.2 Use of Finger Impressions
 - 5.2.1 Print-to-Print Comparison
 - 5.2.2 Trace-to-Record or Trace-to-Print Comparison
 - 5.2.3 Trace-to-Trace Comparison
 - 5.2.4 Combining Evidence Types

- 5.3 Relevance
- 5.4 Age Estimation of Latent Marks
- 5.5 Forged and Fabricated Fingerprint Evidence
 - 5.5.1 Forgeries Committed by Law-Enforcement Personnel
 - 5.5.2 Forgeries Committed by Criminals
 - 5.5.3 Detection of Forged Marks
- 5.6 Errors
 - 5.6.1 Error Types
 - 5.6.2 Quality Assurance

Chapter 6 Conclusions

- 6.1 Fingerprint Detection
- 6.2 Fingerprint Identification

Appendix 1 Statistical Data for General Fingerprint Patterns

Appendix 2 Statistical Data on Minutiæ

- A2.1 The Model
- A2.2 Minutiæ Considered
- A2.3 Sample and Data Acquisition
- A2.4 Statistical Findings
 - A2.4.1 Minutiæ Density
 - A2.4.2 Localized Relative Frequencies of Minutiæ Types
 - A2.4.3 Relative Orientation of Minutiæ
 - A2.4.4 Length of Combined Minutiæ

Appendix 3 Fingerprint Detection Sequences

- A3.1 General
- A3.2 Recommended Fingerprint Detection Sequences
 - A3.2.1 Porous Surfaces
 - A3.2.2 Nonporous Surfaces
 - A3.2.3 Semiporous Surfaces
 - A3.2.4 Adhesive Surfaces
 - A3.2.5 Fingermarks in Blood
 - A3.2.6 Human Skin
 - A3.2.7 Crime Scene

Appendix 4 Preparation and Application of Reagents

- A4.1 Amido Black (AB)
 - A4.1.1 Surfaces
 - A4.1.2 Preparation
 - A4.1.3 Application

- A4.2 Cyanoacrylate — Basic Yellow 40 Stain
 - A4.2.1 Surfaces
 - A4.2.2 Preparation
 - A4.2.3 Application
- A4.3 Cyanoacrylate — Rhodamine 6G Stain
 - A4.3.1 Surfaces
 - A4.3.2 Preparation
 - A4.3.3 Application
- A4.4 Diaminobenzidine (DAB)
 - A4.4.1 Surfaces
 - A4.4.2 Preparation
 - A4.4.3 Application
- A4.5 Diazafluorenone (DFO)
 - A4.5.1 Surfaces
 - A4.5.2 Preparation
 - A4.5.3 Application
- A4.6 Dimethylaminocinnamaldehyde (DMAC)
 - A4.6.1 Surfaces
 - A4.6.2 Preparation
 - A4.6.3 Application
- A4.7 Gentian Violet
 - A4.7.1 Surfaces
 - A4.7.2 Preparation
 - A4.7.3 Application
- A4.8 Gun Blue
 - A4.8.1 Surfaces
 - A4.8.2 Preparation
 - A4.8.3 Application
- A4.9 Indanedione
 - A4.9.1 Surfaces
 - A4.9.2 Preparation
 - A4.9.3 Application
- A4.10 Iodine/Benzoflavone
 - A4.10.1 Surfaces
 - A4.10.2 Preparation
 - A4.10.3 Application
- A4.11 Multimetal Deposition I (MMDI)
 - A4.11.1 Surfaces
 - A4.11.2 Preparation
 - A4.11.3 Application
- A4.12 Multimetal Deposition II (MMDII)
 - A4.12.1 Surfaces
 - A4.12.2 Preparation
 - A4.12.3 Application
- A4.13 Ninhydrin
 - A4.13.1 Surfaces

- A4.13.2 Preparation
- A4.13.3 Application
- A4.14 Ninhydrin — Metal Salt Treatment
 - A4.14.1 Surfaces
 - A4.14.2 Preparation
 - A4.14.3 Application
- A4.15 Physical Developer (PD)
 - A4.15.1 Surfaces
 - A4.15.2 Preparation
 - A4.15.3 Application
- A4.16 Ruthenium Tetroxide (RTX)
 - A4.16.1 Surfaces
 - A4.16.2 Preparation
 - A4.16.3 Application
- A4.17 Silver Nitrate
 - A4.17.1 Surfaces
 - A4.17.2 Preparation
 - A4.17.3 Application
- A4.18 Small-Particle Reagent (SPR)
 - A4.18.1 Surfaces
 - A4.18.2 Preparation
 - A4.18.3 Application
- A4.19 Sticky-Side Powder
 - A4.19.1 Surfaces
 - A4.19.2 Preparation
 - A4.19.3 Application

References

1 Friction Ridge Skin

The aim of this chapter is to provide a brief summary of the basic elements of friction ridge skin morphogenesis and their relationship to friction ridge skin variability. More extensive accounts for latent fingerprint examiners can be found in Ashbaugh (1999b), Wertheim and Maceo (2002), and Bush (2002). These contributions, with their associated references, constitute the essential material required to gain an understanding of the biological basis for friction ridge pattern variability. They complement and extend the work undertaken by earlier pioneers such as Wilder and Wentworth (1932) and Cummins and Midlo (1961).

Two cornerstones to the use of fingerprints as a mean of personal identification are the permanence (persistence or durability) and the uniqueness of friction ridge skin. Both of these foundations have been extensively challenged and confirmed through 100 years of fingerprint identification practice, but their scientific basis lies within biological research.

Unless examiners have a good understanding of friction ridge skin morphogenesis (the biological development of form), the basic tenet for individuality is often resolved by using standard, shallow statements such as “nature never repeats itself.” We cannot accept that the justification for individualization essentially revolves around the tautological argument that every entity in nature is unique. The selectivity of friction ridge skin should be fully understood from a biological perspective and then applied in assessing latent fingermark comparisons.

1.1 STRUCTURE OF THE SKIN

Skin is an essential organ of the human body. Finger, palm, and sole areas of the epidermis display a series of friction ridges taking various forms and shapes. These volar areas of the skin are known to display friction ridge skin. Depending on the surface considered, we generally refer to them as fingerprints, palmprints, and soleprints. It is postulated that the essential function of having friction ridge skin is to increase grip.

The skin is usually divided into two distinct layers. The outer layer ([Figure 1.1](#)), called the epidermis, is a stratified epithelium of five sublayers, listed as follows from bottom to top:

- Basal generating layer (*stratum germinativum*)
- Spinous layer (*stratum spinosum*)
- Granular layer (*stratum granulosum*)
- Transitional hyalin layer (*stratum lucidum*)
- Horny cornified layer (*stratum corneum*)

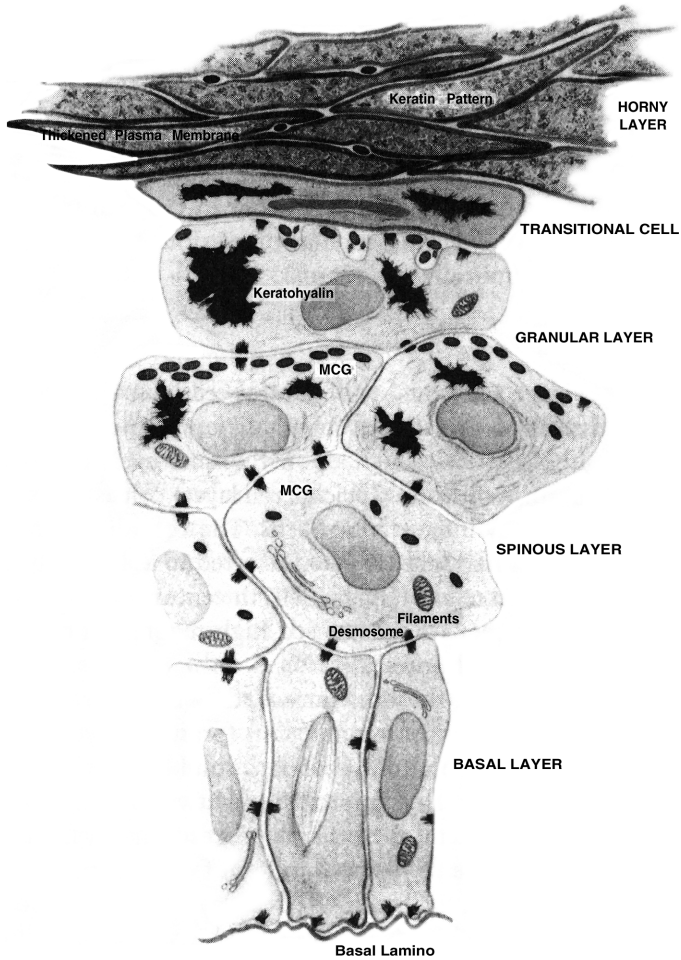

FIGURE 1.1 Structure of the epidermis from basal lamina to horny layer. (Reproduced from Montagna, W. and Parakkal, P.F. [1974], *The Structure and Function of Skin*, 3rd ed., London: Academic Press. With permission.)

The layer under the epidermis is called the dermis and is 15 to 40 times thicker than the epidermis and constitutes the primary mass of the skin.

The cornified layer exposed to the environment is made up of 15 to 20 layers of flat dead cells that are regularly shed through abrasion and replaced by keratinization. All these cells originate from initial cuboidal-shaped cells formed on the basal layer (cells just above the basal lamina) that migrate through the epidermal layers up to the horny layer. The cells move upward simultaneously with surrounding cells. The basal cells do not migrate and remain firmly attached to the generating layer. During this process, cells change shape, reduce their activity, and take up keratin (a water-repellent protein). All cells of the epidermis therefore originate from the basal layer at the interstice between the dermis and the epidermis. The

permanency of the friction ridge pattern is largely due to this generative process, whereby the cells constituting the epidermis (and thus its shape) are produced on the inner protected basal layer just above the dermis. Only damage to the basal layer will result in permanent scars on the epidermis.

1.2 MORPHOGENESIS OF FRICTION RIDGE SKIN — PRIMARY DERMAL RIDGE DEVELOPMENT

The morphogenesis of friction ridge skin starts during the very first weeks of gestation. In fact, we can only speak of estimated gestational age (EGA).

The hand starts to develop from 5 to 6 weeks EGA. The first fingers appear around 6 to 7 weeks. At that time, volar pads appear on the palm (interdigital pads first, followed by thenar and hypothenar pads). Volar pads are transient swellings of mesenchymal tissue under the epidermis on the volar surfaces of the fetus. Volar pads appear on each finger at 7 to 8 weeks (Figure 1.2). These pads remain clearly visible until 10 weeks, when the growth of the hand overtakes the pads, rendering them not visible by week 16 EGA. This phenomenon is often described as the “regression” stage of the volar pads. It is between weeks 11 and 20 that the major development of friction ridge skin occurs. The volar pads provide the bedding for that development.

At around 10 weeks EGA, cells on the basal layer start to proliferate. Prior to ridge development, the embryonic epidermal surface — the periderm — is three or four cell layers thick and smooth on its outer surface (Figure 1.3). The location of

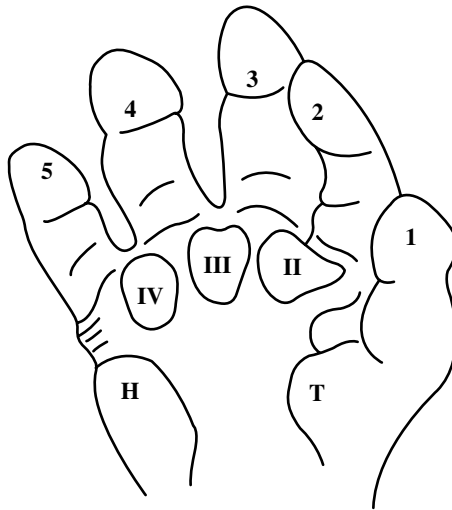

FIGURE 1.2 Volar pads as they appear on the surface of the hand. The first to appear are the second, third, and fourth interdigital pads (II to IV), followed by the apex finger pads. (Reproduced from Ashbaugh, D.R. [1999b], *Qualitative-Quantitative Friction Ridge Analysis — An Introduction to Basic and Advanced Ridgeology*, V.J. Geberth, Ed., Boca Raton, FL: CRC Press. With permission.)

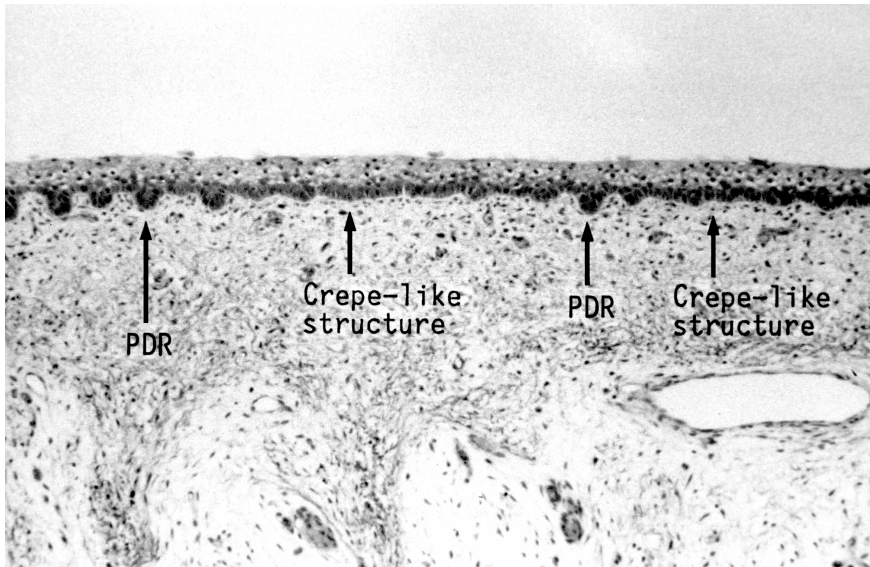

FIGURE 1.3 Cross-sectional view of the skin of a fetus at the initial stages of primary ridge development, showing the primary dermal ridge (PDR) and the crepe-like structure. (Image obtained from M. Okajima. With permission.)

the initial proliferations seems coincident with sweat gland development, but it could also be associated with the arrangement of superficial dermal nerves (Merkel cell clusters and Meissner corpuscles) organized in an approximately two-dimensional hexagonal grid that orchestrates the spacing and general arrangement of the papillary ridges (Dell and Munger 1986). These cells, each associated with a sweat gland, multiply rapidly and fuse into ridges called “ledges” (Hale 1952). These ridges, called primary dermal ridges, are still immature and will start to mature by developing downward within the dermis. Individual dermal ridges are not yet differentiated on the areas surrounding these focal areas; rather, the dermis presents a primordial crepe-like appearance (Figure 1.3). The latter is predictive of the basic orientation of the ridge structure to be manifested there later (Okajima and Newell-Morris 1988).

The first obvious manifestation of friction ridge skin is primary ridges on the dermis with fully formed minutiae (ridge endings or bifurcations). The configuration can be viewed as a series of ridge units (each associated with a sweat pore) that have fused together into ridges of various lengths — lengths being defined by the number of ridge units between two minutiae, the smallest ridge being a single ridge unit.

When the surface of the dermis is examined at its various stages of development, ridges start to be visible from the apex of the volar pad (core of the fingerprint), the distal periphery (tip of the finger), and the distal interphalangeal flexion crease area. These three fronts of ridges develop at different speeds until they ultimately converge to cover the dermal surface (Figure 1.4 and Figure 1.5). Such pattern development may follow the molecular mechanism proposed by Turing (1952), called the reaction-



FIGURE 1.4 Image of the dermal surface of the index finger of a fetus (11 weeks EGA). Note the initial development of the ridges on the apex of the finger. Dark staining indicates primary ridges.



FIGURE 1.5 Dermal surface of the index finger of a fetus (11 weeks EGA), showing the development of ridges from various development fronts. Dark staining indicates primary ridges.

diffusion system, which can develop periodic patterns from an initially homogeneous state. Many models — as we will discuss later — have since been proposed in mathematical biology to account for patterning phenomena in morphogenesis based on this mechanism, and a computer model has been used to generate fingerprint patterns.



FIGURE 1.6 Dermal surface of the index finger of a fetus (14 weeks EGA), showing the final friction ridge pattern.

1.3 FACTORS AFFECTING THE GENERAL PATTERN AND THE CONFIGURATION OF MINUTIÆ

The general pattern taken by the ridges seems to be dependent on following inter-related factors (Bonnievie 1924; Cummins 1926; Penrose 1969; Babler 1987):

- Shape (symmetry) and size of the volar pads (Penrose hypothesized that the flow of the ridges follows the lines of curvature of the skin on the volar pad [Penrose and O'Hara 1973]; research in mathematical biology confirmed this hypothesis [Smith 1979; Mardia et al. 1992])
- Timing between the regression of the volar pads and the onset of primary ridge formation
- Relative speed of the three development fronts
- Bone morphology (Babler 1991)

It is important to recognize that the basic form of the general pattern is set before the initial development of the primary dermal ridge (Figure 1.7). Wertheim and Maceo (2002) have provided detailed examples of the various general patterns associated with the behavior of the above-mentioned variables, with excellent animations at the following Web site: <http://www.clpex.com/animation.htm>.

It is well documented that the general pattern taken by ridges is indirectly inherited (Holt 1968). Relative frequencies of general pattern types have been extensively studied in various populations (Mavalwala 1977) and in relation to numerous chromosomal deficiencies and diseases (Wertelecki et al. 1979; Loesch 1983; Plato

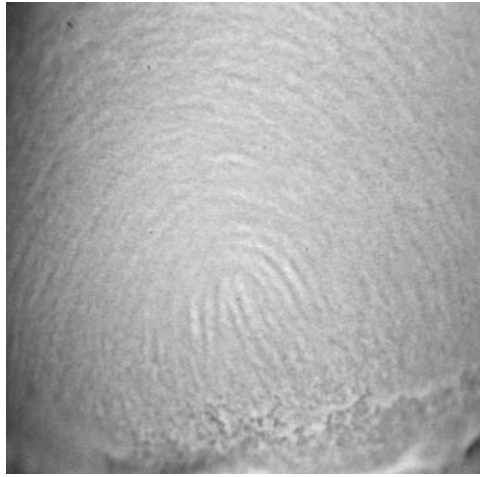

FIGURE 1.7 Dermal surface of the index finger of a fetus (11 weeks EGA), showing the initial development of dermal ridges in the center as well as the crepe-like appearance on the other regions setting the general pattern.

et al. 1991; Durham et al. 2000). This research area (often without a direct relationship to forensic science) is named *dermatoglyphics*. The general pattern taken by the ridges offers some selectivity, but the main contribution to selectivity stems at this stage from the configuration of the minutiae (types and relative position).

The exact random process governing minutiae formation is still unknown. Hale (1952) suggested that, due to the growth of the surface, ridges separate and create room for the formation of new ridges. It is postulated that ridge endings are formed when a new ridge is formed between two existing ridges, with bifurcations resulting from ridge units developing on the side of a host ridge. Alternatively, minutiae and the full ridge structure might be formed at the outset of the proliferation but remain transient until becoming clearly visible through the maturation on the dermis. Very little research is available to articulate more precisely the stochastic process of minutiae generation. Nevertheless, we are attracted by theories of mathematical biology (Meinhardt 1982; Murray 1993) offering models for various pattern formation in nature such as zebra's stripes or stripes on tropical fishes (Kondo and Asai 1995; Meinhardt 1995). Building on mathematical biology, Sherstinsky and Picard (1994) used a Turing's reaction-diffusion model (Turing 1952) to design restoration and enhancement algorithms for fingerprints. Another paper by Kosz (2000) mentioned such methods to model (and then compress) fingerprint patterns and especially minutiae. Some researchers are even suggesting the use of computer-generated fingerprint images (Figure 1.8) to test automatic fingerprint recognition systems (Capelli et al. 2000).

Most of the research effort in dermatoglyphics has been focused on studying general patterns and various ridge counts, but it also offers very good insight into the morphogenesis. The fact that these features are under genetic control is well documented (Chakraborty 1991). However, valuable research has been carried out



FIGURE 1.8 Image of fingerprint generated using the program SFinGE developed by Cappelli et al. (2000) and available on-line at <http://bias.csr.unibo.it/research/biolab/sfinge.html>.

looking at minutiae distribution for clinical use. Forensic research pertaining to minutiae and their statistical behavior is presented in [Chapter 2](#). Okajima studied the occurrence of basic minutiae on prints from twins in various populations and noted higher correlations on the number of minutiae for monozygotic twins as opposed to dizygotic twins. More minutiae are observed on prints from males compared with prints from females, but no bilateral difference (right vs. left) was observed (Okajima 1966, 1967). Correlations between the presence or absence of pattern area and number of minutiae have also been investigated (Loesch 1973). Dankmeijer and coworkers (1980) confirmed that the number of minutiae was correlated to the finger number and pattern type, but no bilateral difference was noted. From these results, it appears that the number of minutiae is a hereditary trait. Dermatoglyphic studies on the various types of minutiae are limited, but they tend to show that the frequency of bifurcation (forks) depends on the sex and the digit number, hence suggesting the existence of a genetic role (Okajima 1970, 1977). However, the number of minutiae tends to be uncorrelated to the frequency of bifurcations (forks) (Okajima 1984).

1.4 MORPHOGENESIS OF FRICTION RIDGE SKIN — SECONDARY DERMAL RIDGE DEVELOPMENT AND DERMAL PAPILLAE

Although the general pattern and minutiae are fully determined by the primary dermal ridge development, which is set very early in the development process, the primary dermal ridges continue to develop within the dermis until 15 to 16 weeks. Their size

and progression within the dermis are fully related to the development of the size of the fetus (assessed by the crown-to-rump length) (Babler 1987). At that time (16 weeks), the pattern is permanently set. In a cross section of the skin (Figure 1.9), we can see the downward penetration of primary dermal ridges within the dermis, with a proliferation of cells under a groove being the initial manifestation of a sweat gland.

Between 15 and 17 weeks EGA, secondary ridges commence to develop between primary ridges and mature until 24 weeks (Babler 1991). Secondary ridges increase the surface area of attachment to the dermis (Figure 1.10). Primary ridges do not develop any further in the dermis at that time (24 weeks).

Further maturation leads to the formation of bridges between the apex of primary dermal ridges and secondary ridges, cordoning off sections of dermal ridges referred to as papillae pegs (Hale 1952) or dermal papillae. Their differentiation is composed of microridges and compartments that develop with advancing age. The papillae are formed for the purpose of increasing the anchorage, exchange, and surface area at the dermal–epidermal interface. Some of them will accommodate the insertion of Meissner corpuscles (allowing the detection of tactile stimuli) (Okajima 1979).

At 24 weeks EGA, the development of the dermis is finalized. The epidermis is gradually formed by cell development from the dermis into five layers (as shown in Figure 1.1). The friction ridge pattern in its final stage is a projected image of the structure on the dermis. The primary deeply formed dermal grooves correspond to the ridges on the epidermis, and the furrows coincide with the secondary dermal

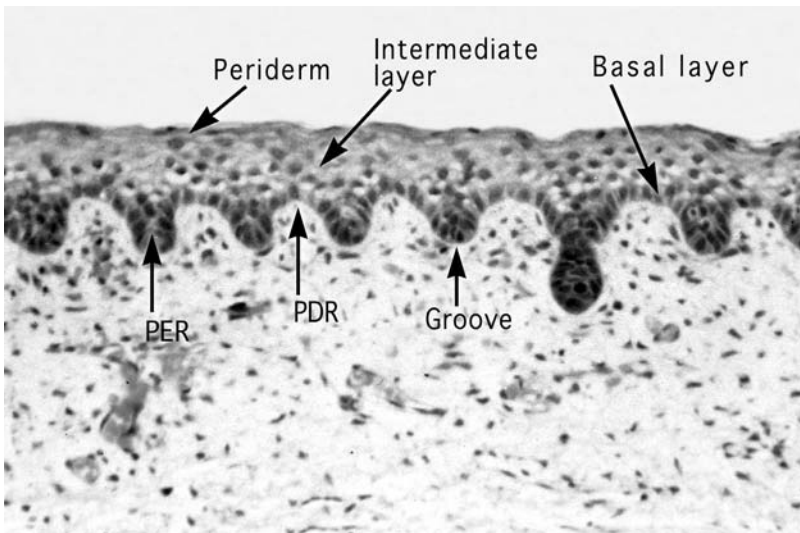

FIGURE 1.9 Cross-sectional view of the skin of a fetus at the initial stages of primary ridge development. PER stands for “primary epidermal ridge.” PDR stands for “primary dermal ridge.” “Groove” is the term used by Okajima to denote the penetration into the dermis, the term “ridge” being reserved for the friction surface of the dermis. The proliferation of cells under the second dermal groove from the right is the precursor of a sweat gland. (Image courtesy of M. Okajima.)

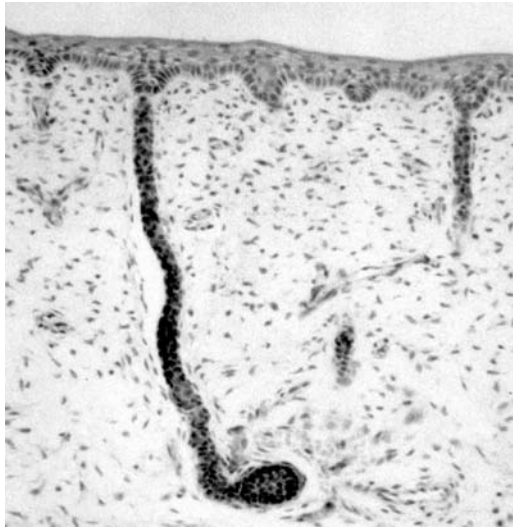

FIGURE 1.10 Cross-sectional view of the skin of a fetus at the final stages of primary and the initial secondary dermal ridge development. The sweat duct connecting the groove of the primary dermal ridge and the eccrine gland is clearly visible. (Image courtesy of M. Okajima.)

ridges. The dermal papillae are therefore arranged in a double row (parallel to the primary ridge) and define the shape and form of the epidermal friction ridge. Each sweat duct on the epidermis is connected to an eccrine sweat gland via a canal of cells. Research has shown that dermal papillae evolve with age, tending to multiply in order to anchor the skin structure (Figure 1.11) (Okajima 1979).

Incipient (called also secondary or subsidiary [Ashbaugh 1992]) ridges follow the same development process but, due to timing constraints, remain only partially developed. Although these ridges received some attention from an anthropological perspective (Wendt 1956), it has been shown recently that, during the course of a lifetime, new incipient ridges can develop (although never disappear). It is postulated that this development corresponds to a compensation for the degenerative change (loss of sensitivity) that occurs with age or activity (Stücker et al. 2001). It has been found that these ridges are associated with Meissner corpuscles (Kyeck 2003).

Flexion creases also share the same principles of morphogenesis (Ashbaugh 1991b; Kimura 1991). Their development starts between 7 and 9 weeks EGA.

1.5 SUMMARY OF THE STAGES OF FRICTION RIDGE SKIN MORPHOGENESIS — RELATIONSHIP WITH DURABILITY OR PERMANENCY AND UNIQUENESS

Okajima (1975a, b, 1982) presented a series of useful sketches to summarize the friction ridge skin morphogenesis process (Figure 1.12, Figure 1.13, and Figure 1.14). These sketches show that the friction ridge skin on the epidermal surface is

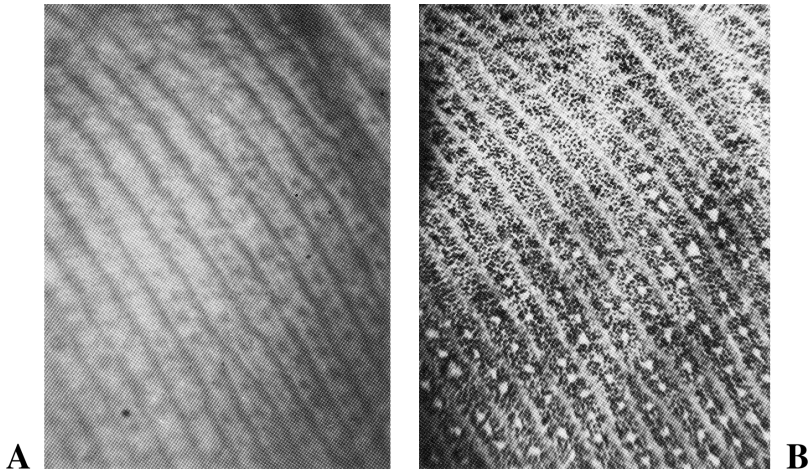

FIGURE 1.11 Views of: (A) the epidermal surface (ridges on a dark background) of an 82-year-old man with orifices for sweat gland ducts and (B) the dermal surface of the same volar section. (Reproduced from Okajima, M. [1979], Dermal and epidermal structures of the volar skin, in *Dermatoglyphics — Fifty Years Later*, Vol. XV, No. 6, W. Wertelecki, C.C. Plato, and N.W. Paul, Eds., New York: Alan R. Liss, pp. 179–198. With permission.)

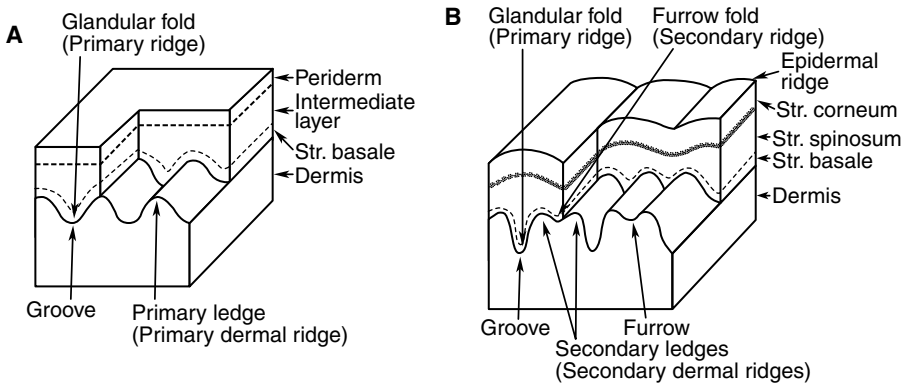

FIGURE 1.12 Diagrams illustrating ridge differentiation: (A) primary development and (B) secondary development. (Reproduced from Okajima, M. [1982], A methodological approach to the development of epidermal ridges on the dermal surface of fetuses, in *Progress in Dermatoglyphic Research*, Vol. 84, C.S. Bartsocas, Ed., New York: Alan R. Liss, pp. 175–188. With permission.)

the consequence of a constant proliferation of cells from a basal generating layer, a blueprint, on the very top of the dermis. The configuration of the ridges (with the minutiae) mimics, as a mirror image, the configuration defined by the dermal primary and secondary ridges. On the epidermis, the ridges will display sweat ducts (pores) spaced almost evenly — but to varying degrees — along the ridges. Each pore corresponds originally to a ridge unit associated with a sweat gland. The shape and

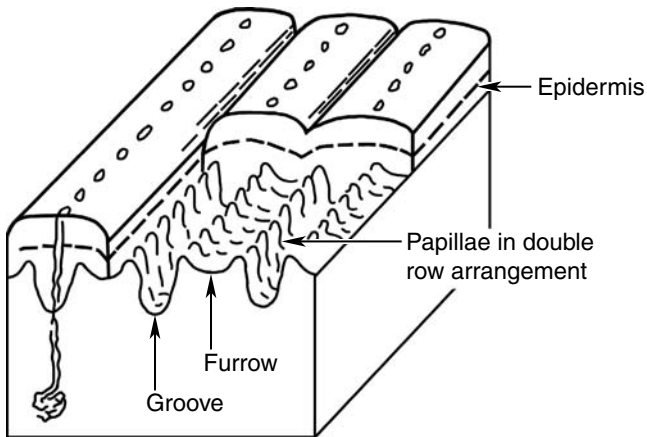

FIGURE 1.13 Diagram of the final dermal surface, illustrating the dermal papillae and the corresponding mirror-image epidermal development. (Reproduced from Okajima, M. [1975b], Technical aspects of dermatoglyphic examination in primates, in *Contemporary Primatology: Proceedings of the Fifth International Congress of Primatology*, S. Kondo, M. Kawai, and A. Ehara, Eds., New York: S. Karger, pp. 49–53. With permission.)

structure translated on the surface by each ridge unit depends on the shape and structure on the dermis obtained following the maturation process. The forms of the pores and ridge edges add to the selectivity of friction ridge skin. The relationship between the friction ridge arrangement of the dermis and the friction ridge skin on the epidermis is the basis for the durability of the fingerprint pattern. Early anecdotal evidence of permanency can be found in the work of Sir William Herschel used by F. Galton (1892). However, a detailed knowledge of the structure of the skin permits an understanding as to why the fingerprint pattern is reproduced to the exact image of the dermis. Superficial damage to the epidermis will have no bearing on the pattern (if we allow its restoration), with visible scars only being acquired when the dermis is damaged.

With the sum of stochastic processes dictating, in turn, the general pattern, the configuration of ridges (with their minutiae) and their shapes and structures is such that chance duplication is considered to be impossible. We have here the fundamental premise of the individuality of friction ridge skin. Ashbaugh (1991c, pp. 82–83) summarized the premise of friction ridge skin uniqueness very elegantly:

The friction ridges are constructed of ridge units. The number of ridge units that make up a ridge is established at random. Where one ridge starts and stops, the factors that designate its length are completely dependent on differential growth. The location of the ridge unit where a branching develops is also established at random. Due to the plethora of genetic and physical variances the ridge units are subjected to during ridge formation and the number of units involved, the paths of friction ridges are unique to that area of friction skin.

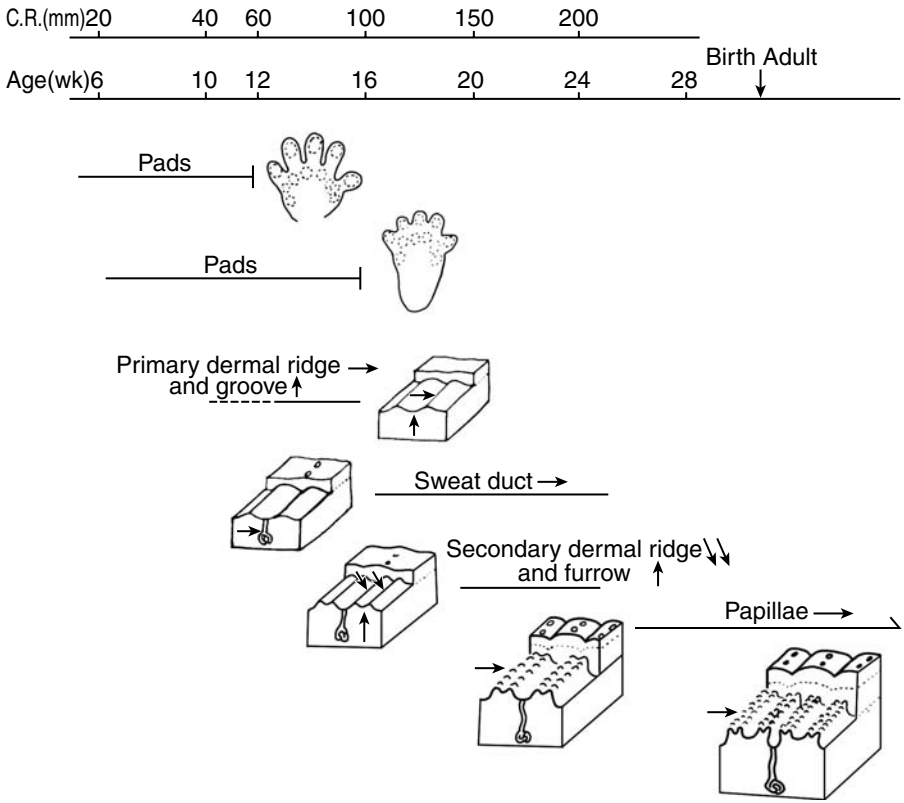

FIGURE 1.14 Diagrammatic representation of dermal ridge morphogenesis based on published studies. C.R. is crown rump. (Reproduced from Okajima, M. [1975a], Development of dermal ridges in the fetus, *J. Medical Genet.*, 12, 243–250. With permission.)

The ridge units are not only subjected to differential growth factors while developing into rows and growing, they are also subjected to a random growth factor in relation to their shapes. Therefore, ridge units may vary in shape, size, alignment, and whether they fuse to the next ridge unit or not. For example, some units are thinner than others, some have bulges on one side, and some misalign with the next ridge unit or fail to develop to maturity. Friction ridge surfaces are three-dimensional and, due to the variables along the friction ridge surface, they are unique, even in a very small area. The location of the pore opening on a ridge unit is also established by random forces through differential growth. The random placement of pore openings on the friction ridge is another factor that enhances the uniqueness of friction skin.

2 The Friction Ridge Identification Process

Friction ridge identification procedures have been widely discussed in the literature and in other forums. Good literature coverage of the issues has been given by Cowger (1983), Grieve (1988, 1990a), Ashbaugh (1999b), and Wertheim (2000). The Internet is also a valuable source of information regarding the identification process. Edward German's site (<http://www.onin.com/fp>) is a reference on these matters, covering the basic concepts and a discussion of some known cases of wrong identifications. Finally, the acceptability of fingerprint evidence as being scientific in nature has been subject to a *Daubert* hearing in the U.S. (*U.S. v. Mitchell*, U.S. District Court for the Eastern District of Pennsylvania, Criminal No. 96-00407). This hearing led both parties to present their views on the underlying principles of fingerprint identification. The *Mitchell* case has been followed by more than 20 *Daubert* hearings in the U.S. (the most recent being *U.S. v. Llera Plaza*, U.S. District Court of the Eastern District of Pennsylvania, Criminal No. 98-362-10,11,12), with unprecedented press coverage (e.g., the article by Specter [2002]) as well as strong reactions from a lawyer (Faigman 2002) and a social scientist (Cole 2000). The outcome of all hearings was that fingerprint evidence passed the *Daubert* test. Judicial notice was given to the fact that fingerprints are permanent and unique. All the documents associated with these hearings can be found on German's Internet site. We also would like to draw attention to the excellent paper by Epstein (2002), the federal defender in both the *Mitchell* and *Llera Plaza* cases.

Useful protocols and flow charts have been published as step-by-step descriptions of the comparative identification process (Smith et al. 1993; Olsen and Lee 2001). The flow charts presented by Olsen will serve as a reference for this chapter as well as the protocol published by Drews (2002). The aim of this chapter is to encapsulate the detailed procedure within the generic methodology or protocol known as "ACE-V," as adopted by Ashbaugh (1991a) in the early 1990s and presented by Tuthill (1994), and more recently discussed during the *Daubert* hearings as the state-of-the-art methodology for the identification process. The Royal Canadian Mounted Police (RCMP) should be recognized as the organization that developed (Huber 1959, 1972) and adopted the ACE-V protocol to fingerprints. The ACE-V (analysis, comparison, evaluation, and verification; [Figure 2.1](#)) methodology is outlined in the following four sections. An initial critical analysis can be found in Clark (2002).

2.1 ANALYSIS

This initial step calls for an analysis of the recovered mark to assess (a) the reality of its ridge formations and (b) their clarity. The analysis is focused solely on the

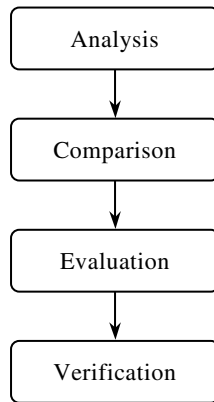

FIGURE 2.1 ACE-V methodology in a flow diagram.

unknown mark in order to determine, in total objectivity (without having access to a reference print), what information is visible and reliable, taking into account the clarity of the image and considering the effects of pressure, distortion, media, and development techniques. We will distinguish three levels of information that can be recorded: level 1, level 2, and level 3 as proposed by Ashbaugh (1999a). These three levels describe features visible in the mark without any *a priori* assessment of the selectivity of the features. [Table 2.1](#) provides a short definition for each level.

Note that some practitioners are suggesting a distinction into three levels according to the magnification required to visualize the features (Wertheim 2000). Level 1 features are visible without magnification, level 2 features require 5× to 10× magnification, whereas the visualization of level 3 features benefits from higher magnification. Hence, depending on its size and clarity, features of an incipient ridge may fall into level 1, 2, or 3. In our view, the convention used to divide between categories of features has no significant impact on the following discussion. These three levels are illustrated in [Table 2.2](#). [Figure 2.2](#) shows Mairs's family tree of transitional fingerprint patterns (Mairs 1933b).

During the analysis phase, it is expected that the examiner has categorized all the features that are visible in the mark, with an assessment of their reality and the conditions under which the mark has been left. The examiner should annotate the mark accordingly, displaying, when visible, the flow of the ridges, the minutiae, and the level 3 features. This process may be seen as very time-consuming, and it is acknowledged that some quicker analysis may be carried out on marks of high clarity, but that this process is essential for all poor-quality marks.

When the features visible in the mark have been identified, the examiner can assess the mark's intrinsic value, i.e., its capacity to define a unique source. Indeed, some practitioners will retain for the comparison stage only marks displaying features allowing, in their opinion, an individualization following a comparison with the appropriate known material. Others will retain all marks suitable for a comparison, keeping in mind that a mark may be insufficient for identification but decisive for exclusion. Even if, in theory, all marks could be retained for the comparison

TABLE 2.1
Definition of the Three Levels of Friction Ridge Skin Features

Level	Definition
Level 1	<p>Level 1 refers to the overall pattern formed by the flow of papillary ridges on the papillary surface. Traditionally, the general pattern formed on the fingertips has been classified into generic classes. Various classification schemes were developed in the early days of dactyloscopy, aimed at offering a classification system to enable a ten-print card search. The most widespread classification systems are by Vucetich (1904) and by Galton (1892) and Henry (1900), distinguishing arches (and tented arches), loops, and whorls. We have to recognize that any partitioning scheme is a simplification of the continuum of papillary flow patterns that fingerprints may possess, as emphasized by Mairs (1933a, b) (Figure 2.1). This continuum is also recognized among the computer scientists who are developing the automatic fingerprint identification system. (AFIS) . After devoting much effort at mimicking an exclusive fingerprint classification system based on a small number of classes, scientists are now focusing their efforts on capturing the full spectrum of general forms (Cappelli et al. 1999).</p> <p>In addition to the forms taken by the flow of the ridges, some measurements can be classed as level 1 features, such as ridge counting and ridge tracing. Both of these measures were implemented within classification systems to increase the discriminative power of the systems. They are well described, for example, in the FBI’s manual on fingerprint science (U.S. Department of Justice and FBI 1984).</p> <p>The general flow of papillary ridges on the palm has been the subject of a recent and important publication (Tietze and Witthuhn 2001). This work allows examiners to gain an understanding of the various flow structures that friction skin ridges form in palmar areas. Examiners can use this knowledge to quickly reposition unknown palm marks.</p>
Level 2	<p>Level 2 refers to major ridge path deviations, also known as minutiae, points of identification, or Galton characteristics. Basic forms are ridge endings, bifurcations, and dots (Olsen 1981). Additional types of minutiae (combinations of the basic minutiae) have been identified in the literature as being more specific than their basic components. For these features, the nomenclature in the literature is not standardized (Saviers 1987, 1989), and it is safer to work with illustrations.</p> <p>Occasional features such as warts, scars, creases, and wrinkles are also referred to as level 2, incipient, or subsidiary ridges (Ashbaugh 1992) and flexion creases (Ashbaugh 1991b).</p>
Level 3	<p>Level 3 refers to intrinsic or innate ridge formations: the alignment and shape of each ridge unit, pore shape, and relative pore positions are level 3 features.</p>

stage, practitioners have adopted various working policies to cope with the workload and thereby reduce the number of required comparisons. A flow chart of the above process is given in Figure 2.3.

Addressing the questions outlined in the flow chart (Figure 2.3) requires a deep knowledge of the factors affecting the transition from the three-dimensional friction

TABLE 2.2
Illustrations of the Three Levels of Friction Ridge Skin Features

Level **Illustration**
 Level 1 Mairs’s family tree is illustrated in [Figure 2.2](#); basic general patterns are illustrated below:

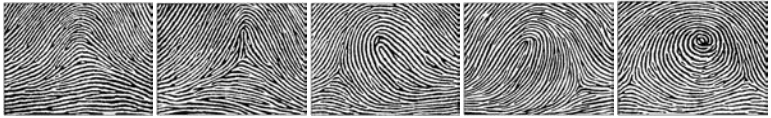

Simple arch Tented arch Right loop Left loop Whorl

Level 2 Ridge endings, bifurcations, and dots are the basic minutiae (ridges are shown in black); all other types are combinations of these:



Ridge ending

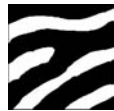

Bifurcation



Dot

Below are illustrations of wrinkles, creases and warts, and scars:



Level 3

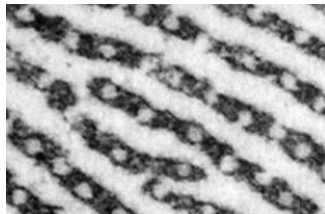

Inked impression showing succession of pores and specific shapes of edges (friction ridges are in black ink)

skin structure to a mark (most of the time, a two-dimensional outcome). Ashbaugh (1999b, p. 172) refers to this transition as the “clarity bridge.” It is essential to realize that the transfer process from a three-dimensional organ to a two-dimensional mark

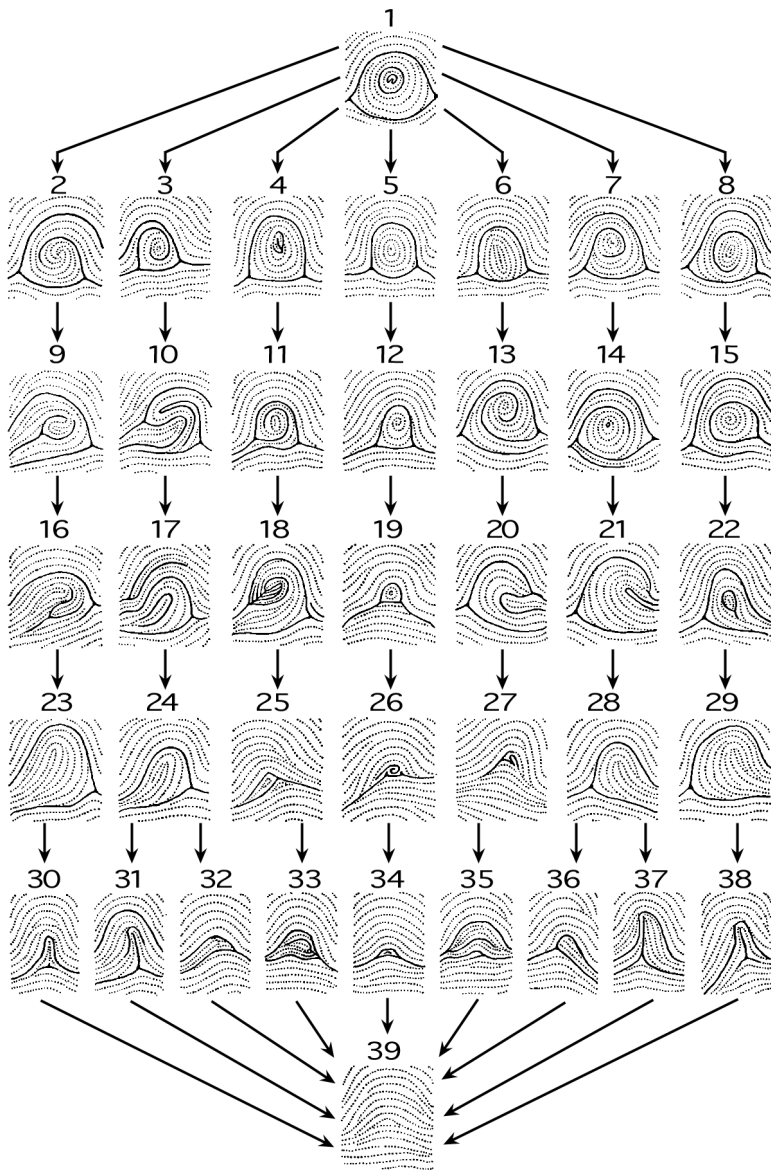

FIGURE 2.2 Mair's family tree of general transitional patterns from the whorl (1) to the arch (39). (Reproduced from Mair, G.T. [1933b], Finger prints indexed numerically: a finger print family tree [Part II], *Finger Print Identification Mag.*, 15 [5], 16–18. With permission.)

necessarily results in a loss of information. Tackling these issues requires that the examiner have a detailed knowledge of the circumstances under which the mark has been secured. The observed mark will depend not only upon the friction ridge skin that came into contact with the receiving surface, but also upon the medium (latent, bloody, other contaminants), the surface (smooth, rough, contaminated), the contact

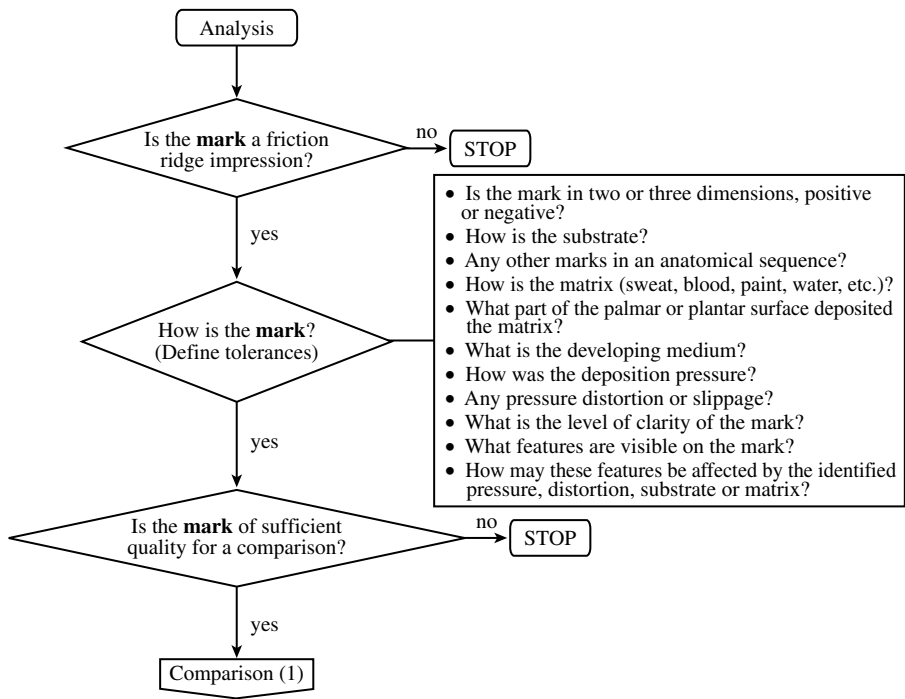

FIGURE 2.3 Flow diagram of the analysis stage.

pressure, the duration of contact, distortion, and the fingerprint development technique employed. Little has been published on this topic (Singh 1963), with assessment relying heavily on the examiner's experience. However, Ashbaugh (1999b) has presented numerous cases that will help any examiner with this process. The procedure requires the examiner to assess not only the clarity and visibility of the mark, but also the tolerances that need to be taken into account during the comparison phase. These tolerances must allow for the mechanisms and constraints of the deposition process. The analysis phase therefore involves the collecting of information concerning the crime scene mark(s). Questions of the following type are hopefully answered (adapted from Mary Beeton [formerly Drews]; <http://www.ridgesandfurrows.homestead.com/identification.html>):

- Where was the mark found?
- What was used to enhance the print (e.g., black powder, white powder, ninhydrin, or perhaps the impression was made in dust and then photographed)?
- How has the surface from which the print was lifted affected the appearance of the lift?
- How has the enhancement process affected the appearance of the friction ridges?

- What type of distortion is present (many different kinds may be apparent in one lift)?
- How does the clarity or lack of clarity affect the amount of detail that is present in the unknown print?
- How does the clarity or lack of clarity affect the level of tolerance for any ridge formation discrepancies that may exist between the unknown and the known print in the comparison phase?
- Is there sufficient quality and quantity of information to proceed to the comparison step in the identification process?

2.2 COMPARISON

Basically, the comparison process is an iterative comparison between the unknown mark and a known print, focusing successively on level 1, level 2, and level 3 features (when they have been identified in the mark) and taking into account the tolerances dictated by the quality of the mark. As the clarity of the unknown mark is generally inferior to the quality of the known print, when both images are compared (especially when looking at the print then at the mark), our suggestive brain tends to compensate for any differences. Ashbaugh reiterates the capacity of our brain to reconstruct poor-quality images based on our prior representation of the reality (Ashbaugh 1991a). This phenomenon may lead an examiner to believe that some features are concordant between a mark and a print, whereas their visibility can only be ascertained in the print and not in the mark. Knowledge of the known material may provide the examiner with expectations that may distort his/her judgment on the visibility of features in the mark, leading to inappropriate, expectation-led observations (Norby 1992). To ensure maximum objectivity during the comparison process, the examiner should avoid any prior knowledge of the known print under examination. For that reason, the analysis stage is essential, and the comparison process should in theory be focused primarily on features that have been identified previously, during the independent assessment of the mark. In any case, the comparison should always begin with an observed feature in the mark that serves as a control measure to be tested against the known print. The comparison process, as outlined in the flow charts in [Figure 2.4](#) and [Figure 2.5](#), should be unidirectional from the mark to the print.

The outcome of the comparison process could be a charted comparison between the two images, emphasizing the concordances but also the differences revealed between the mark and the print. All available areas of the mark should be compared at the various levels identified and within the tolerances defined during the analysis.

2.3 EVALUATION

After the comparison between a mark and a print, the examiner faces a set of observations from which an inference about the identity of source must be drawn. An exclusion decision logically follows when discrepancies are observed that cannot be explained other than by the hypothesis of different sources. Such discrepancies

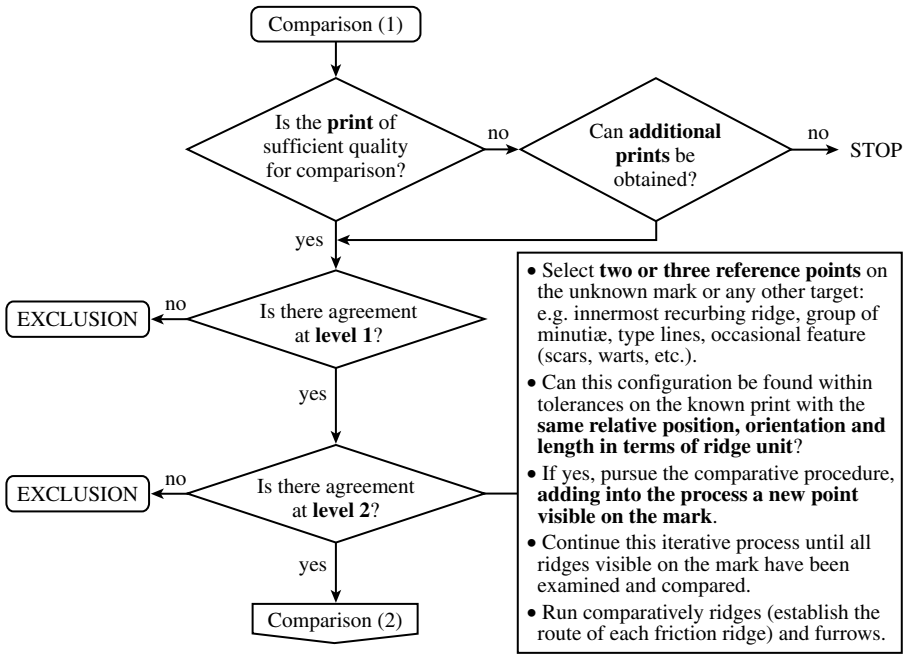

FIGURE 2.4 Flow diagram (part 1) of the comparison stage.

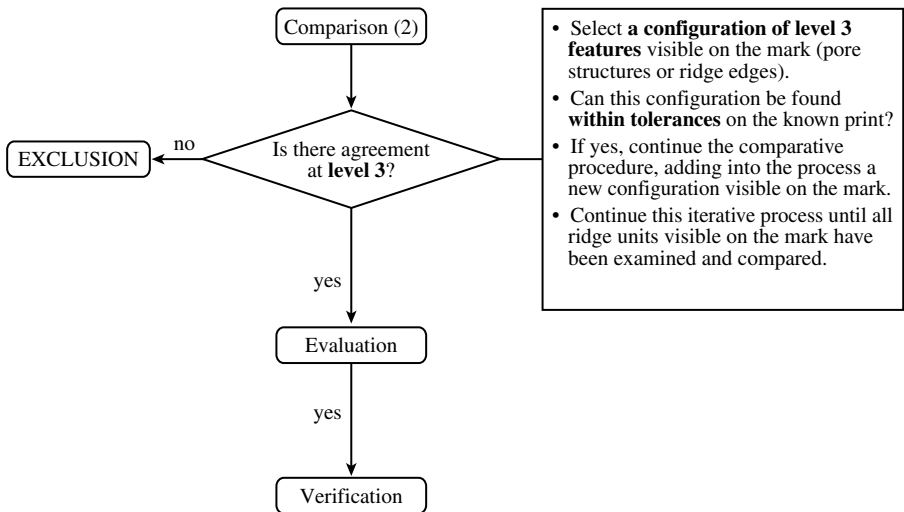

FIGURE 2.5 Flow diagram (part 2) of the comparison and identification stages.

can be observed at any level of the comparison between the mark and the print. In theory, one significant dissimilarity is enough for the examiner to declare an exclusion (Thornton 1977), irrespective of the number of concordances that have been revealed before the dissimilarity is noted. In practice, the difficulty lies at

defining what a significant difference is (Thornton 1997b). The number of documented case reports discussing the assessment of differences in a comparison is limited (Puri 1962, 1964; Ferguson 1992). The ability to distinguish between distortion and dissimilarity is essential and relies mainly on the examiner's experience (Leo 1998). In fact, consideration of the clarity of the mark dictates the level of tolerance defined during the analysis process. The greater the clarity, the lower is the tolerance, and vice versa. An ideal way of gathering reliable experience for interpreting differences is through the setting up of controlled experiments where marks of known donors are deposited and revealed under various conditions. The study of such sets allows a calibration of the examiner and could even lead to an assessment of the examiner's proficiency.

Exclusion decisions are obvious deductions when, for example, the dissimilarity at level 1 or level 2 is unambiguous thanks to a mark of excellent clarity. However, we should keep in mind the possibility of a wrong exclusion due to a hasty examination (without a proper analysis phase) focused on level 1 detail (Saviano 2003). As soon as the mark lacks clarity, and distortion induces possible differences at all levels, the assessment is much more difficult. Due to the popular belief that a wrong exclusion is more acceptable than a wrong identification, the exclusion process has received little attention. As Bertillon (1912) rightly pointed out, the examiner should in fact be more focused on dissimilarities than on concordances.

When no significant differences (the concept of significant being defined by the tolerances obtained from the analysis stage) have been noted between the mark and the print, the value of the match has to be assessed. The concept of identification is closely related to the selectivity of the features at the various levels, taking into account the level of tolerance set initially. The term *identification* as used here generally denotes individualization. Individualization is probably what distinguishes forensic science from other scientific endeavors (Kirk 1963). Tuthill (1994, p. 21) defined individualization as follows:

The individualization of an impression is established by finding agreement of corresponding individual characteristics of such number and significance as to preclude the possibility (or probability) of their having occurred by mere coincidence, and establishing that there are no differences that cannot be accounted for.

In the fingerprint field, the term *identification* is used synonymously with *individualization*. It represents a statement of certainty that a particular mark was made by the friction ridge skin of a particular person. This is the sense in which we will use the word *identification* throughout this book.

In the literature, this problem of identity of source is often treated by distinguishing "class" characteristics from "individual" characteristics. Level 1 features would normally be referred to as class characteristics, whereas levels 2 and 3 deal with individual characteristics. Leaving aside the conclusion of exclusion of a common source drawn when significant differences are observed, the identification process is then articulated as follows:

1. A comparison between a recovered mark and a known print that leads to agreement in class characteristics only (without significant differences) will lead to an inconclusive statement.
2. Only when sufficient agreement of individual characteristics are observed, in conjunction with class characteristics, can a conclusion of positive identification or individualization be drawn.

The task of distinguishing between these two categories is critical if wrong individualizations are to be avoided. However, the problem of inferring identity of source is more complex than this simple dichotomy. It has to be recognized that the distinction between “class” and “individual” characteristics is just a convenient, oversimplified way of describing selectivity. Selectivity is a measure on a continuum that can hardly be reduced to two categories without more nuances. The term *individual characteristic* is particularly misleading, as a concordance of one minutia (leaving aside any consideration of level 3 features) would hardly be considered as enough to express uniqueness. The problem with this binary categorization is that it encourages the examiner to disregard the complete spectrum of feature selectivity that ranges from low to high. It is proposed, then, that selectivity at each feature level be studied without any preconceived classification of its identification value. Indeed, nothing should prevent a specific general pattern — such as, for example, an arch with continuous ridges from one side to the other (without any minutiae) — from being considered as unique, since no such pattern has been observed to date.

Table 2.3 defines selectivity for the three levels of friction ridge skin features. With an awareness of the selectivity of the features considered during a comparison, we can now return to the evaluation process.

Following a comparison between a mark (recovered, for example, in association with a crime) and a known print (control print associated with a suspect), suppose that the examiner observes a complete agreement between the mark and the print without any significant discrepancy. Considerable confusion exists among laymen, indeed also among fingerprint examiners, on the use of words such as *unique*, *identical*, *same*, and *identity*. Although the phrase “all fingerprints are unique” has been used to justify fingerprint identification opinions, it is no more than a statement of the obvious. Every entity is unique; no two entities can be “identical” to each other because an entity can only be identical to itself. Thus, to say that “this mark and this print are identical to each other” is to invoke a profound misconception: the two might be indistinguishable, but they cannot be identical. In turn, the notion of “indistinguishability” is intimately related to the quantity and quality of detail that has been revealed. The question for the fingerprint examiner is not, “Is this mark and that print identical?” The proper question is, “Given the detail that has been revealed and the comparison that has been made, what inference might be drawn in relation to the propositions that I have set out to consider?” We have, then, to distinguish between the source variability that we have explored under the term *selectivity* (information derived from good-quality prints) and the expressed variability in the mark, which can be partial, distorted, or blurred (Stoney 1989). Hence we remain skeptical when facing arguments such as “nature never repeats itself” (McRoberts 1996) to ascertain the value of fingerprint identifications. Such a

TABLE 2.3**Selectivity of the Three Levels of Friction Ridge Skin Features**

Level	Selectivity
Level 1	The contribution of the general pattern (and basic measures such as ridge counting or ridge tracing) as a means of differentiation is well known through widespread experience with fingerprint classification systems. Extensive statistical data can be obtained from these collections. For example, we can observe that ulnar loops are more frequent than simple arches. Some published data are available to examiners for each finger taken individually or for groups of fingers (e.g., Cowger 1983). More up-to-date and case-specific data can be obtained through appropriate queries submitted to an AFIS system. Level 1 features have also been the subject of extensive studies dealing with the distribution of these features according to sex, race, or various genetic syndromes. Such studies represent the core of a discipline known as dermatoglyphics (see Chapter 1). In Appendix I , the reader will find the statistics for general patterns obtained from the FBI collection as per 1993 (according to the NCIC [National Crime Information Center] classification scheme). Data on palmar level 1 features have been published by Tietze and Withuhn (2001). The authors provide extensive statistical data on the relative frequencies of defined general patterns.
Level 2	The selectivity of level 2 features, especially the selectivity of minutiae configurations, was the main argument in favor of the adoption of fingerprinting as a mean of personal identification (over Bertillon's anthropometry) at the turn of the 19th century. Galton was probably the first to apply statistical analysis to minutiae (Galton 1892; Stigler 1995). Statistical data are a solid ground for exploring the selectivity of level 2 features (see Appendix 2). Most past studies have been reviewed by Stoney (2001). Stoney (1985) extended the work of previous authors and was followed by Champod (1996; Champod and Margot 1997a). This selectivity is also corroborated by the enormous experience of practitioners over more than a century, especially when we consider manual "cold" searches in large databases. The knowledge stems then from the stochastic morphogenesis of fingerprint patterns (see Chapter 1) and the success of AFIS systems at retrieving potential candidates based on complete unknown prints or partial questioned marks (see also the recent paper by Pankanti et al. [2001]). For fingerprint examiners, level 2 details in combination (without discrepancies) have individualizing power.
Level 3	The extreme selectivity of pore forms and pore relative positions was first postulated by Locard (1912, 1913), who later received a very favorable echo in the U.S. (Wilder and Wentworth 1932). The possibility of using edge structures to discriminate between fingerprints was first proposed by Chatterjee and Hague (1988) but was also mentioned by Locard. All related aspects were initially merged under the term <i>ridgeology</i> by Ashbaugh (1982a), but it is fair to say that today ridgeology has a much wider mandate, covering all aspects of the identification process without being restricted to level 3 features (Ashbaugh 1999b). Experience is the first basis for support of the high selectivity of these features. Additional knowledge comes from morphogenesis data (see Chapter 1) and a number of statistical studies. Ashbaugh (1982b) was the first to propose a model to express pore variability, and this model has been refined recently by Stosz, Roddy, and coworkers (Stosz and Alyea 1994; Roddy and Stosz 1997, 1999). However, it must be recognized that, at present, the amount of structured data relative to pores and edge structures is limited. As with level 2 features, fingerprint examiners consider combinations of level 3 features (without discrepancies) as having individualization capabilities.

paradigm may add to our knowledge on the variability of the source, but it does not address the crucial issue of the clarity or representation of the mark. This takes us back to the “clarity bridge” and to the importance of the analysis phase.

The ultimate question is often expressed as follows (provided that no difference has been observed): “how many similarities are required to conclude to an identification?” The aims of this section are (a) to explore this question by reviewing in detail international views and practices and (b) to update earlier reviews by Kingston and Kirk (1965) and the FBI (Anon. 1972) and Champod (2000a).

2.3.1 HISTORICAL MILESTONES

The first rules establishing the minimum number of minutiae necessary for fingermark identification can be attributed to the famous Frenchman Edmond Locard (1911, 1912). Locard suggested a tripartite rule, which followed from the discovery of poroscopy. It can be summarized as follows (Locard 1914):

1. If more than 12 concurring points are present and the fingermark is sharp, then the certainty of identity is beyond debate. (The imperative requirement for the absence of significant differences is implicit.)
2. If 8 to 12 concurring points are involved, then the case is borderline, and the certainty of identity will depend on:
 - The sharpness of the fingermark
 - The rarity of its type
 - The presence of the center of the figure (core) and the triangle (delta) in the exploitable part of the mark
 - The presence of pores
 - The perfect and obvious identity regarding the width of the papillary ridges and valleys, the direction of the lines, and the angular value of the bifurcations

In these instances, certainty can only be established following discussion of the case by at least two competent and experienced specialists.

3. If a limited number of characteristic points are present, the fingermark cannot provide certainty for an identification, but only a presumption proportional to the number of points available and their clarity.

Locard based his tripartite rule on various sources of information: the discovery of poroscopy, the limited (at that time) practical experience gathered by the identification bureaus around the world, and the statistical evaluation by Balthazard (1911), Galton (1892), and Ramos. (Galdino Ramos published statistical work in a book entitled *Da Identificação* [Rio de Janeiro, 1906] that we were unable to locate.) This approach persists throughout the extensive writings of Locard (1931). His considerations (principally the first two) were largely taken up by the most eminent fingerprint researchers of the first half of the century, notably Wilder and Wentworth (1932), Cummins and Midlo (1943), Heindl (1927), and Bridges (1963).

2.3.2 CURRENT VIEWS AND PRACTICES

On the fringe of this early view, the practice of fingerprint identification is nowadays confined to two distinct positions:

1. The empirical criterion is based solely on a quantitative threshold expressed by the number of concordant minutiae between the mark and the known print.
2. The holistic criterion is a combined assessment of quantitative and qualitative aspects of the corresponding features.

In 1998, the Interpol European Expert Group on Fingerprint Identification (IEE-GFI), created with the mandate to assess the feasibility of formulating a European fingerprint standard, came to the same conclusion (Interpol 2000). Although these two schools may appear drastically opposed, we feel compelled to stress that any quality standard will be found to be either a defined empirical criterion or a defined holistic criterion. Quality will be achieved by the publication and endorsement of transparent and detailed procedures describing the identification process and associated quality assurance measures. We believe that, as soon as the identification process is encapsulated within a strict regime of documented procedures and quality control measures, then the whole debate between these two schools (empirical vs. holistic) will disappear. The driver toward quality is, we believe, transparency.

2.3.2.1 Predetermined Minimum Number of Minutiae — An Empirical Standard

The majority of European fingerprint experts favor a purely quantitative approach, ignoring in the decision process the potential contribution of concordant qualitative aspects (such as level 3 features), by fixing a numerical standard — a minimum number of minutiae necessary to establish an identification. The numerical standard represents a lower limit; above this value, the identification is beyond doubt regardless of the type of minutiae that are discerned. The interpretation of the concept of a numerical standard may vary from agency to agency (or even from examiner to examiner), as illustrated by a few examples (Table 2.4) based on Almog (1986), a recent review by Interpol (Interpol 1995), and an updated table published in *Fingerprint Whorld* (Anon. 2002).

Despite the systematic use of a numerical standard, various countries (e.g., Finland, Greece, Holland, Israel, and Portugal) have developed methods to bypass the rigid threshold when particularities (such as visibility of pores, ridge structures, or rare combinations of minutiae) are observed during the comparison. The adoption of a range from 8 (or 10) to 12 points was found to be a way to relax an otherwise rigid threshold. In 1983, an addendum was even made to the “16-point standard” in the U.K., stating that in extremely rare cases an expert with long experience and high standing in the profession can offer an opinion on an identification that does not meet the nationally accepted standard.

TABLE 2.4
Overview of Some Empirical Standards and Their Origins

Country	Points Criterion	Origin
Italy	16–17	The criterion is based on the questionable probabilistic calculation by Balthazard dating back to 1911 (Balthazard 1911). The minimum standard is expressly mentioned from jurisprudence referring to Balthazard’s work (Pirone 1976, 1991). The jurisprudence is constant (according to decisions from 1954 to 1989). This situation is quite paradoxical because Sorrentino, head of the School of Police Science in Rome in the 1950s, was advocating against the consideration of a predetermined minimum number of minutiae (Sorrentino 1948, 1952, 1956).
Germany, Sweden, Holland, Switzerland	8–12	This criterion is in agreement with Locard, even though sometimes, in practice, there is a clear tendency to respect a 12-point rule (Walder 1976). The practice in Germany is a generalization of Locard’s first two rules (Section 2.3.1), asking the examiner to fully balance the quantity of minutiae with qualitative aspects of the mark (visibility of pores, specificity of the minutiae, etc.). Hence if, for example, the mark displays poor level 1 features, the examiner may reach an identification conclusion only after having noticed more than 12 concordant minutiae without discrepancy (Steinwender 1958b). Holland is operating on an analogous regime between 10 and 12 points.
U.K. (before 2001)	16	The origins of this standard (adopted by New Scotland Yard in 1924) dates back to an erroneous interpretation of a paper published by Bertillon in 1912 (Bertillon 1912; Champod et al. 1993). Up to a recent date, the numerical standard was virtually impossible to circumvent and had been adopted nationally in 1953 and confirmed in 1984. If simultaneous impressions were available, the identification was allowed if there were at least 10 points in each mark. The purpose of the standard was to guarantee a high level of quality and faultlessness in the matter of fingerprint identifications (Lambourne 1984, 1986). The 16-point standard, however, has proved to be inadequate as an ultimate safeguard against error, as attested by the recent disclosure of erroneous identifications (Grieve 1999b).
South Africa	7	According to Sherratt (1979)
Belgium, Finland, France, Israel, Ireland, Greece, Poland, Portugal, Romania, Slovenia, Spain, Turkey, Japan, South American countries	12	Criterion probably derived from the consideration of Locard’s first rule (Section 2.3.1)

Note: The empirical standards may be different for the identification of simultaneous marks in anatomical sequences or for marks showing separate parts.

2.3.2.2 No Predetermined Numerical Standard — A Holistic Approach

In 1970, a commission of experts from the International Association for Identification (IAI) was established to study the question of the relevancy of a fixed numerical standard for fingerprint identification (Anon. 1970, 1971). The work of this committee led to a review of the state of empirical and scientific knowledge at that time (Santamaria Beltran 1953; Osterburg and Bloomington 1964; Gupta 1968). As a result of this process, excellent review papers were published by Hess (1971a, b, c, d). Hess stressed the fact that some types of minutiae were more selective than others (for example, a double bifurcation in the periphery of the pattern is six times less frequent than two separate bifurcations). Qualitative features (such as level 3 features) may be added to minutiae in the decision process. Finally, the absence of any minutiae may be as decisive as their presence. It would be very exceptional to observe a core area or a delta area where the ridges do not display any minutiae. The observation of such a particularity would provide strong support for an identity of source.

To conclude the work of this ad hoc committee, the following resolution was adopted by the IAI in 1973 (Anon. 1973, p. 8):

[The International Association for Identification], based upon a 3-year study by its Standardisation Committee, hereby states that no valid basis exists for requiring a predetermined minimum number of friction ridge characteristics that must be present in two impressions in order to establish positive identification.

Another powerful argument against any numerical standard stems from knowledge of the morphogenesis of the papillary lines (see [Chapter 1](#)). The various stresses involved in this process (regression of the volar pads, development of size, meeting of multiple development fronts) induce a stochastic formation of minutiae (in terms of form and positioning). Around the 25th week of gestation, the development of papillary lines is finished on the dermis and has been projected onto the epidermal layer of the skin. From that moment, a final differentiation occurs on the papillae pegs, which dictates the form of the gland ducts and ridge edges. This final stage produces a strictly individual pattern. The nature of this papillary individuality prevents any justification for a predefined minimum number of ridge characteristics that must be in agreement (without significant differences) in order to conclude to an identification. Indeed, the extent of specific features is much broader than minutiae alone.

In 1995, during a conference on fingerprint detection and identification techniques hosted by the Israel National Police in Ne'urim, Israel, 28 fingerprint experts and scientists (representing 11 countries) unanimously approved a slightly actualized variation of the IAI 1973 resolution (Margot and German 1996):

No scientific basis exists for requiring that a pre-determined minimum number of friction ridge features must be present in two impressions in order to establish a positive identification.

The individualization process cannot therefore be reduced to counting minutiae; each identification represents a unique set of circumstances, and the judgment of the value of concurring features between a mark and a print depends on a variety of conditions that automatically exclude any minimum standard. It is not justifiable (or even scientific) to reduce the issue of fingerprint individuality to numbers of corresponding minutiae alone. The identification process is a holistic assessment, balancing both quantitative (number of minutiae) and qualitative aspects (general pattern, type of minutiae, pores, edges) visible in the mark. This qualitative/quantitative approach is at the heart of Ashbaugh's view of the identification process (Ashbaugh 1999b), which he previously placed under the term *ridgeology*. This quality/quantity balance is also well described by Vanderkolk (1999, 2001).

Of course, when simultaneous marks are available (e.g., marks left by fingers in anatomical sequence), the full information can be used, provided that the analysis stage established the fact that the marks were associated. A good description of the process for dealing with simultaneous impressions is given by Ostrowski (2001).

In practice, most fingerprint examiners recognize that the counting of matching points up to a number determined by policy does not precede the identification. On the contrary, it is usually the case that the expert reaches a state of personal conviction about the identification, based on a wide spectrum of features, before the point count is conducted. As indicated in [Table 2.5](#), various countries have adopted the practice endorsed by the IAI/Ne'urim resolution.

The review undertaken by a committee in the U.K. has been a determining factor in the recent move toward the adoption of the IAI resolution by other countries. In 1989, Evett and Williams conducted a collaborative study among 130 fingerprint examiners in England and Wales. They sent to each participant ten mark/print comparisons (nine associations and one exclusion), asking each examiner to mark the number of concordant minutiae and to express an opinion with respect to the identification. No misidentification was reported. But, when examining genuine pairs of prints, examiners varied widely in the number of points of comparison they found. In the case of one print, the number varied from 11 to 40. In other words, some examiners would not have gone to court with this pair of impressions, although most would have done so (Evett and Williams 1995). A comparable survey was undertaken in Switzerland in 1997, leading to worrisome results, especially with regard to false exclusions. Evett and Williams' study led to the following main conclusions:

- The dogma adopted by numerous fingerprint examiners that fingerprint identification is an "exact" science is a misconception. The essence of science is inductive inference. Inference is a mental process that cannot be exact (or deductive). Fingerprint identification is scientific in that sense (Evett 1996).
- The precision implied by any number (12, 16, etc.) is also a lure. The determination of individual minutiae or features is highly subjective. The use of any rigid numerical standard favors the process of gleaning sufficient points ("teasing the points") to reach the magic number (Tiller 1983).
- As a means of achieving quality, a numerical standard alone is poor. The way forward is to concentrate on professional standards rather than on

TABLE 2.5**Overview of Some Holistic Approaches and Their Origins**

Country	Comments
U.S. and Canada	Since 1973, following the IAI resolution.
Scandinavian countries (Finland, Sweden, Denmark, Iceland, and Norway)	To our knowledge, Norway was the first European country to move toward the abandonment of the 12-point numerical standard. The other Scandinavian countries followed.
U.K. (from 2001)	In 1988, a committee was formed by the ACPO (Association of Chief Police Officers) and the Home Office to undertake a review of the origin and relevancy of the 16-point standard. Following this review (Evelt and Williams 1995), the committee recommended abandonment of the numerical standard. Since 1996, a project group (ACPO National Fingerprint Evidence Standard Project Board) worked at implementing the change from the 16-point practice to no numerical standard. This was also in the light of new rules for disclosure, and the establishment of appropriate quality assurance mechanisms and procedures as well as training requirements. A 1999 appeals court decision <i>R v. Buckley</i> (1999) 163 JP 561 (Moenssens 2002) paved the way toward the abandonment of the numerical standard by discussing and allowing a comparison with only eight minutiae. The practice without a numerical standard was implemented beginning June 11, 2001. The change was well received by courts and legal writers (O'Doherty 2001).
Australia	In 1996, the "12-point rule" adopted in 1975 was abandoned in favor of the IAI resolution. A working party was formed to examine various issues such as a National Fingerprint Accreditation Board (NFAB) for education and competency assessment and other quality assurance issues. In 2000, the NFAB adopted a resolution excluding any numerical standard, making this policy uniform across Australia.
Switzerland	Taking advantage of the debate in the U.K. and in Australia, and following the Ne'urim declaration, a committee has undertaken to manage the change toward a nonnumerical practice. In 1997, after a survey analogous to the one undertaken in the U.K., the abandonment of the 12-point numerical standard was adopted by the heads of the fingerprint bureaus as a long-term objective. Current practice is, however, still focused on a 12-point rule.

rules about numbers of minutiae. A quality management scheme is required that includes training, certification testing, performance testing, file audits, and blind trials.

2.3.3 TRANSPARENCY OF THE INDIVIDUALIZATION DECISION

When a fingerprint expert concludes to an identification, he or she indeed reaches a decision threshold. However, this threshold is highly subjective, whether the criterion is a minimum number of concordant minutiae or, in addition to this quan-

titative element, qualitative factors are taken into account. As Ashbaugh (1999b, p. 103) stated, “The opinion of individualization or identification is subjective.”

With the extensive use of probability-based DNA evidence and the evolving requirements for the admissibility of scientific evidence in the U.S., older identification fields such as fingerprints are being subjected to more rigorous scrutiny and are under the pressure of a growing demand for “scientific” data to underpin the identification process (Saks and Koehler 1991; Jonakait 1994; Saks 1994, 1998). Even forensic scientists are calling for the acquisition of statistical data (Menzel 1997; Thornton 1997a). A natural evolution of this trend is the claim that the fingerprint identification discipline is not rooted in science (Stoney 1997). That was the line of argument taken by the defense during the recent *Daubert* hearings in the U.S. To us, the crux of the matter would appear to be more on the transparency of the process than on its scientific merits.

Courts traditionally welcomed the apparent transparency of a numerical standard with open arms, and the fingerprint has become the gold standard by which other types of evidence are measured. However, we must recognize that the apparent transparency afforded by “x points” was an illusion. As previously mentioned, there was never any scientific justification for the number chosen; furthermore, what is considered a “point” by one expert might not be a “point” to another.

We applaud the contribution that Ashbaugh (1999b) has made to the establishment of fingerprint identification as an applied science. These are the studies and arguments that form the body of scientific knowledge that any expert can draw on when explaining fingerprint individuality in court. However, when it comes to the core issue of drawing inference from a comparison, Ashbaugh (1999b, p. 103) states:

Finding adequate friction ridge formation in sequence that one knows are specific details of the friction skin, and in the opinion of the friction ridge identification specialist that there is sufficient uniqueness within those details to eliminate all other possible donors in the world, is considered enough.

Here we arrive at the core of the matter. It is the expert who forms the opinion that there is “sufficient uniqueness ... to eliminate all other possible donors in the world.” Ashbaugh does not clarify how this inference is to be drawn. It has been argued that the decision process must be inductive (Champod 1999, 2000b), as already rightly underlined by Kwan (1977), whose thesis is an essential contribution to forensic science. The expert is, however imprecisely, forming a view about the entire world when he cannot possibly have considered more than a subsample. The quotation from Ashbaugh therefore illustrates two points:

1. The opinion is based on inductive reasoning. (It follows inevitably that it must be probabilistic.)
2. The process by which the expert arrives at an opinion is ultimately obscure. The process relies undoubtedly on extensive and reliable experience, but it is not fully articulated.

The point is that Ashbaugh evokes the need to eliminate all other possible donors in the world, but does not say how this can be done. Essentially, this is because it cannot be done. Certainly it cannot be done by scientific means but, even leaving science to one side, no one person can attain and retain comprehensive knowledge of the prints of every person in the world. It has to be an inference, be it scientific (which it cannot be) or otherwise. The conclusion has to be, as Stoney (1991) eloquently put it, “a leap of faith”; as such, it is ultimately obscure. Indeed, Stoney (1991, pp. 197–198) gave a very illustrative description of this process for fingerprint examination:

Beginning with a reference point in one pattern, a corresponding point in a second pattern is sought. From this initial point the examiner then seeks neighbouring details that correspond in their form, position and orientation. These features have an extreme variability, that is readily appreciated intuitively, and which becomes objectively obvious upon detailed study. When more and more corresponding features are found between two patterns, scientist and lay person alike become subjectively certain that the patterns could not possibly be duplicated by chance. What has happened here is somewhat analogous to a leap of faith. It is a jump, an extrapolation, based on the observation of highly variable traits among a few characteristics, and then considering the case of many characteristics. Duplication is inconceivable to the rational mind and we conclude that there is absolute identity. The leap, or extrapolation, occurs (in fingerprinting) without any statistical foundation, even for the initial process where the first few ridge details are compared.

The conclusion of certainty derives from the examiner’s personal conviction that the chance of a match between the crime mark and any person other than X is so small that it can be ignored. Effectively, the expert sets a personal threshold that rounds the probability assigned to the identification to 100%. This position appears, through custom and practice, to be acceptable to courts in all situations where statistical analyses are not possible: fingerprints, handwriting, toolmarks, footwear impressions, etc. The fingerprint expert’s reasoning is based on the idea that the probability that another person would match the mark is so small that it can be discounted. Greater transparency in this process could be obtained if a match probability were to be assigned by means of a database constructed from a suitable survey. But — in a fingerprint field dominated by categorical opinion and the refusal of any corroborative statements — any discussion about a probabilistic approach is rejected on principle (see [Section 2.3.4](#)) by the fingerprint profession (Stoney 1997). To progress toward transparency, our duty is twofold: first, we need to explore the framework of conclusions used in the field (see [Section 2.3.4](#)), and second, we need to discuss probabilistic data pertaining to fingerprints (see [Section 2.3.5](#)).

2.3.4 RANGE OF CONCLUSIONS IN THE FIELD

The present state of affairs, then, is that fingerprint experts have taken the position not to report opinions in terms of probabilities. The examination of a fingermark retained for comparison leads either to a categorical opinion of identification or exclusion, or the mark is judged as insufficient to reach any conclusion. This has

been termed the doctrine of “positivity”; see, for example, Manners (1996) or Knowles (2000), with a reply by Taroni and Margot (2000). All comparisons that fall outside the extremes of definite inclusion and definite exclusion are classified as “inconclusive.” In a case where, perhaps because of the limited quality (or clarity) of a mark, the weight of evidence is not sufficient to convince the expert of a categorical opinion, there may be corroborative evidence of less weight that might still provide useful guidance to the court. A report containing such phrases as “inconclusive,” “consistent with,” “points consistent with,” or “the investigated person cannot be excluded as the donor of the mark” fails to offer an expression of the value of the evidence. If, for the sake of the argument, a practice is adopted based on a numerical standard of 16, it is clear that an inconclusive conclusion for a comparison showing 14 concordant minutiae (and no discrepancy) provides stronger evidence than an inconclusive conclusion regarding a comparison with 3 concordant points. It would be preferable that the terminology used by the fingerprint expert renders explicit these contrasted values in a more effective way than “inconclusive.” This concept is recognized to be central to the reporting of other fields of forensic science, such as the examination of handwriting, toolmarks, footwear impressions, etc. In this sense, Locard’s third directive (see [Section 2.3.1](#)) is fundamental and permits the placement of fingerprint evidence in the same line as for other types of transfer traces.

The idea that fingerprint evidence could provide a presumptive link preceded Locard, notably in a case work dating back to the beginning of the century performed by Reiss at the Institut de Police Scientifique et de Criminologie (IPSC) in Lausanne, Switzerland. At present, very few identification bureaus in Switzerland leave this possibility open. However, according to a recent European survey conducted by Interpol (1995), some countries are leaving open the possibility to use fingerprint evidence as corroborative evidence. For example, in Belgium, when between 8 and 12 points of agreement are noted between a questioned fingermark and a fingerprint (without discrepancies), it is stated that “the fingerprint could be at the origin of the fingermark in examination.”

Steinwender, a German fingerprint expert, was the first to widely publish his refusal to consider fingerprint evidence as anything but absolute proof (Steinwender 1958a, b, 1960). This point of view was largely followed by Bridges (1963), the FBI (Anon. 1972), and Olsen (1978), and then by the whole profession. In 1979, during the annual IAI conference in Phoenix, AZ, the assembly unanimously approved Resolution VII prohibiting members from giving testimony on qualified identifications (likely, possible, probable, etc.) (Anon. 1979). Identification, according to the IAI, can only be negative, impossible, or certain. This resolution opened the way for a large debate (Champod 1995) before it was revised and accepted at the annual IAI meeting in Ottawa, ON, in 1980 (Anon. 1980). At this meeting, the IAI experts rejected the idea of using fingerprints as corroborative evidence in the following terms (Resolution VII Amended or Resolution V):

[The delegates of the IAI] state unanimously that friction ridge identifications are positive, and officially oppose any testimony or reporting of possible, probable or likely friction ridge identifications found on hands and feet.

This approach means that, in countries using numerical standards (e.g., Switzerland), a fingerprint comparison with 12 concordant minutiae is an identification, whereas a comparison presenting only 11 points has no probative value and will not be presented in court. Such a rule can easily lead to difficult situations when, for example, a suspect arrested and identified in one country on the basis of an identification with 12 points is to be judged in a neighboring country where 16 points are explicitly required. This example highlights all the difficulties but also the challenge of harmonizing forensic science at the international level (Sprangers and Nijboer 2000).

There appear to be three arguments that are constantly used by practitioners against probabilistic considerations. The first argument stipulates that probabilities cannot be used in the field because of the individuality of friction skin arrangements. It generally takes the following form (Vanderkolk 1993; Grieve 1999a; Wertheim 2000):

Any probabilistic statement would imply a possibility for duplication. But biological uniqueness prevents any duplication. Hence probabilities do not apply to fingerprints.

It is axiomatic that no two fingerprints are identical; indeed, no two entities of any kind can be identical to each other. The crux of the matter is not the individuality of the friction skin ridges but, rather, the ability of the examiner to recognize sufficient information for the disclosure of identity from a small, distorted latent fingerprint fragment that may reveal only limited information in terms of quantity or quality (Grieve 1990b). It is the examiner's capacity to reveal individuality from a papillary impression that is at question, and not the individuality of the skin surface that produced it. This concept encapsulates a continuum of values, in that an expressed feature in a mark may have the capacity to distinguish sources at various degrees, depending on its clarity. These various degrees of a mark have a probabilistic nature.

The second argument is that probabilistic opinions should be avoided until a dedicated tool for assessing match probabilities is made available to the examiner (Ashbaugh 1999b). Whereas a cautious approach is to be commended, it presents a peculiar state of affairs. An opinion of individualization means that the known individual is singularized with regard to the world population. But, paradoxically, a fraction of a second earlier in the comparison process, when the information gathered is judged by the examiner as insufficient to individualize, it is suggested that the examiner cannot give any opinion. In other words, the leap of faith is presented as a transition from a state of an absence of knowledge to a state of certainty. This approach is incompatible with the logic of the inference of identity of source. If examiners are able to provide opinions regarding individualization, they should also have an equal capacity to position themselves with reliability in cases where the volume of information is viewed as insufficient for an identification.

The third argument is that the admission of probabilistic statements would weaken the value of fingerprint evidence (Hazen 2002). The perception is that the fingerprint pursuit should remain absolute, accepting no shades of gray. But this is more a cultural view than one that has derived from any scientific reasoning. No doubt, most fingerprint experts see probabilistic arguments as a threat that could undermine the profession. That is not the intention. There is no dispute concerning

the power and utility of fingerprint examination. Indeed, a probabilistic approach seeks to expand the potential of the pursuit.

Some will no doubt argue that judges expect fingerprint evidence to be unequivocal and without compromise. This idea is false. It is obvious that all judges would prefer indisputable forms of proof, but judges would also wish to be informed of any evidence that can lead them closer to the truth. Fingerprints have already been considered by jurists from a probabilistic point of view (Finkelstein and Fairley 1970; Tribe 1971) and, indeed, from a Bayesian point of view, as advocated today to interpret most forensic types of evidence (Aitken 1995; Robertson and Vignaux 1995). For jurists, fingermarks can be perfectly classed with all other forms of evidential material in the judicial system (Eggleston 1983). This issue has also been addressed by the Court of Appeal of New Zealand (*R v. Buisson* [1990] 2 NZLR 542 [CA]). The court not only ruled that no numerical standards exist for an identification, but also stated that much useful evidence was being kept out of the courts based on decisions made by experts.

This reporting practice in the fingerprint field is a policy that is opposed to the scientific principles governing the interpretation of scientific evidence (Robertson and Vignaux 1994; Champod 1995; Stoney 1997). As Tuthill (1994, p.61) puts it, "It is simply one of the aberrations that have been developed within the discipline of fingerprint identification." The evidential value of fingerprints cannot be so extreme and clear-cut; there is an increasing scale that runs from exclusion to identification. In fact, there is no logical reason to suppress gray levels between white (exclusion) and black (identification). Evidence becomes relevant when it tends to make the matter at issue more or less probable than otherwise (Lempert 1977). Even if there is no certainty, evidence should not be ignored; the term *inconclusive* does not offer an adequate nuance. There is no logical reason to avoid probability statements. The refusal to give qualified opinions is a policy decision, even if the distinction between the arguments (policy based or scientific) is not so clear in the literature. We strongly argue against the dogmatic statement proposed recently by the North American working group on fingerprint identification (SWG-FAST) (McRoberts 2002, p. 312):

Probable, possible, or likely identification are outside the acceptable limits of the science of friction ridge identification.

Champod and Evett (2001) recently wrote in support of a probabilistic approach. The proposal did generate some reaction in both camps (Crispino 2001; McKasson 2001). Because we believe that probabilities and inductive reasoning indeed have a place in the field of fingerprint identification, it is worth reviewing several statistical studies pertaining to this field (see Section 2.3.5), as they represent the key toward transparency.

2.3.5 STATISTICS AS A KEY TO TRANSPARENCY

One of the most frequent questions posed to statisticians regarding fingerprints is of the kind, "If a comparison between a mark and a print shows a given set of

features in agreement without discrepancies, could you demonstrate statistically the identity of the source?" The quick answer is no. As Stoney (1991) puts it, "You cannot achieve individualization through statistics." All that statistics can do is provide (a) a model for assigning a match probability in a given case and (b) guidance on setting that match probability in some kind of relevant population framework, the latter leading to some kind of inference as to the probability of the mark and the print being from the same person. But statistics can do no more than provide a probability. It is for others to decide on whether that probability is small enough to conclude identity of source. For a complete discussion, see Champod (2000b).

Some may argue that the random match probabilities for fingerprints are so small that, whatever the framework, the probability of the identification will be so close to 100% that there is no need to disclose a specific number to the court. During the recent *Daubert* hearing in the *U.S. v. Mitchell* case, the FBI provided calculations based on experiments carried out on an AFIS system. (The model is described in Stoney 2001.) For complete fingerprints, a random match probability of 10^{-97} was claimed. For partial marks, the match probability was given as 10^{-27} . Such figures, at first sight, appear to relegate the argument that we are presenting to the status of nitpicking. The figure of 10^{-97} transcends reality to the extent that it is amazing that it was admitted into evidence. It is entirely unsupported. This extraordinary number was obtained by a model-based formula that took the probability density of extreme points of a postulated probability distribution. Wayman (2000) has pointed out the weakness of this argument.

We should not have unrealistic expectations of statistical studies, and the quoting of extravagantly extreme numbers is, ultimately, not productive. It follows that it is not possible to prove that a given mark must have been left by a particular region of friction ridge skin. The process is, as we have said, essentially inductive, and absolute certainty is not logically and philosophically attainable through mathematical methods. Nevertheless, this limitation does not prevent statistics from offering a highly powerful tool for assessing fingerprint evidence. Limited statistical investigations (Galton 1892; Henry 1900; Balthazard 1911) were made at the time that fingerprints were gaining acceptability. These studies were far too small and were based on unrealistic assumptions to provide anything more than peripheral support for the technique. These earlier models assumed that each type of minutiae appeared evenly on the fingertip surface, each with the same probability and independently one from the other. The limitations of these assumptions were quickly brought to light (Anon. 1911; De Ryckere 1912; Sannié and Guérin 1940), and other, more sophisticated models were proposed (Roxburgh 1933a, b; Amy 1946, 1947, 1948). Research was then devoted to models where the assumption of equal probability between the types of minutiae was relaxed (Santamaria Beltran 1953; Gupta 1968; Osterburg et al. 1977; Lin et al. 1982a, b; Edzhubov 1996). But all failed initially to recognize the fact that minutiae were not evenly distributed on the papillary surface, and that some zones (like the center or the delta) are more rich in minutiae than peripheral regions. Kingston (1964) was the first to propose a probabilistic model addressing both issues. He was followed by Sclove (1979, 1980), Stoney (1985; Stoney and Thornton 1986, 1987), Champod (1996;

Champod and Margot 1996, 1997a), and more recently, Pankanti et al. (2001). These studies cover research on level 2 features and especially minutiae. Studies on pore arrangements have also recently been carried out (Roddy and Stosz 1997, 1999) and remain peripheral.

Statistical studies on minutiae provide extremely valuable knowledge, but they cannot yet be deployed for large-scale, case-specific calculations. As underlined by Stoney (2001), none of the proposed models has been subjected to extended empirical validation studies.

Up until now, no statistical models have incorporated the various factors of individuality (general pattern, major ridge deviations, ridge edges, or pores). The models are simplifying the complexity by adopting a restricted atomistic view of the overall factors, with emphasis on the study of the statistical behavior of minutiae. However, the imperfection of any model — in the sense that it does not capture all the elements of the holistic approach — does not preclude its use in the fingerprint science if its robustness has been extensively demonstrated and the model has been subjected to scientific scrutiny. Statistical data, even gathered through myopic models, can only help the discipline work toward more reliable and transparent methods of assessing evidential value.

The most extensive study to date has been carried out on a sample of around 1000 fingerprints from distinct individuals (Champod 1996; Champod and Margot 1996, 1997a). This study provides valuable knowledge concerning the statistical behavior of various types of minutiae, for example:

- The probability of observing a given number of minutiae on a given area of ridge skin
- The relative frequencies of various types of minutiae and how these frequencies depend on minutiae location within the fingerprint pattern
- The relative frequencies of minutiae orientations in the ridge path
- The relative frequencies of lengths of combined minutiae

However, the studies undertaken up to this point in time do not provide a robust tool for assessing match probabilities associated with all configurations of features on all fingers and for all general patterns. This is because:

- The actual models employed do not capture the spatial relationship between minutiae.
- The robustness of the independence assumptions at the core of each model has not been fully explored.
- The studies are focused on the estimation of the match probability, with a weak account for tolerances due to distortion or clarity of the marks, including connective ambiguities.
- The effect of other variables such as the general pattern, the finger number, the sex, or the ethnic origin of the source have rarely been addressed.
- None of the proposed models has been subjected to an extended empirical validation.

The gap between DNA statistics and fingerprint statistics is huge, emphasizing the need for further research. Ultimately, the benefits from statistics applied to the fingerprint identification field will include (Champod 2002):

1. A new body of scientific research that will empirically support the extreme variability of the features that are used by latent print examiners during the examination process. This will provide another method of justifying opinions of identity in court.
2. A way to assess the statistical value of marks declared insufficient for identification. A model should allow probabilities to be assigned to partial marks, e.g., assessing the chance of finding another finger showing a limited number of matching features.

In the meantime, as proposed by Kingston (1970), such studies provide valuable data to verify the subjective judgments of experts concerning the rarity of given fingerprint features. Osterburg and Bloomington (1964) explored the discrepancies that can be observed between examiners in assessing the relative frequencies of various types of minutiae. Such variations have to be minimized, and statistical surveys provide an excellent baseline. Results from the study by Champod (1996) are provided in [Appendix 2](#) and offer current statistical knowledge from level 2 features on loops and whorls. This provides some basis for the interpretation of the identification potential or value of potential marks.

2.4 VERIFICATION

We are emphasizing the subjective nature of the fingerprint evaluation stage. The highly subjective recognition process exploits the extraordinary power of the human eye–brain combination, and the ability of the examiner is crucial (Wertheim 1996). But this is not to say that fingerprint identification is unreliable. Nevertheless, such subjective judgments should be monitored in a structured and disciplined environment. There are various ways to achieve this, and each has been explored by the fingerprint profession (see, for example, the initiatives under the SWGFAST group [McRoberts 2002]):

- Selection processes for fingerprint examiners
- Quality assurance program and standard operating procedures
- Program of collaborative studies, proficiency tests, and internal/external audits

These initiatives would allow forensic scientists to convince the court of their expertise, not by referring to years of service or thousands of comparisons completed, but by presenting a detailed portfolio recording their proficiency in a long series of independently conducted proficiency tests. Reliability therefore stems from training standards, competency assessment, and proficiency testing.

In addition, a principal safeguard against error is obtained through independent verification procedures for each comparison, by at least two experienced examiners.

This form of peer review is a fundamental part of any scientific process. This procedure should be documented, and the processes to resolve any disagreement should be declared and applied. A practical difficulty is to ensure that this verification process is done blindly, avoiding any confirmation bias.

To conclude this chapter, it is clear to us that, at present, the whole identification process is dominated by dogmatic positions rather than by a structured and documented approach. We have mentioned the benefits that a statistical approach can bring to the field, but we also insist on the need for fully documented procedures ensuring transparency. We would like to see the development of a corpus of standard operating procedures detailing:

- The identification process, from analysis to verification (with a clear descriptive model of the features used and an explicit inferential model)
- The process of note-taking from analysis to verification
- The procedures used to handle disputes and/or errors
- The processes for casefile auditing and proficiency testing of fingerprint experts, and the potential associated actions

We understand that the Interpol European Expert Group on Fingerprint Identification [IEE-GFI] is currently working toward this end (Zeelenberg 2003).

The fingerprint profession needs to operate with an ethical and unbiased culture, in a free environment offering adequate reward mechanisms. Training, continuous education, and appraisal systems should all be in place. We will elaborate more on this in [Chapter 5](#), which deals with errors in fingerprint identification. And finally, we call for the development of well-supported research programs directed at all aspects of fingerprint identification.

3 Chemistry, Light, and Photography

For a complete understanding of fingerprint detection techniques and their application, a good knowledge of chemical and physical phenomena (including a study of light and its interaction with matter) is required. The aim of this chapter is to give some general background theory that will aid the reader in comprehending the development methods described in this book. In addition to basic chemistry and light theory, the chapter also includes a discussion on forensic light sources (FLS), general photography, and digital image enhancement.

3.1 STANDARD WEIGHTS AND MEASURES

The science of measurement is known as metrology. From three fundamental quantities — length, mass, and time — all other mechanical quantities (e.g., area, volume, acceleration, and power) can be derived. A comprehensive system of practical measurement should include at least three other bases, taking in the measurement of electromagnetic quantities, of temperature, and of intensity of radiation. Accordingly, the 11th General Conference of Weights and Measures, held in Paris in 1960, adopted a number of quantities and units as the bases upon which was established the International System of Units (SI units). The SI units constitute an international decimal system of weights and measures derived from and extending the metric system of measurement. The seven basic units, from which other units are derived, are as follows (with their respective symbols):

1. Length, the meter (m)
2. Mass, the kilogram (kg)
3. Time, the second (sec)
4. Electric current, the ampere (A)
5. Luminous intensity, the candela (cd)
6. Amount of substance, the mole (mol)
7. Thermodynamic temperature, the Kelvin (K)

A prefix is used to specify a multiplier for a measurement unit (Table 3.1). For example, a kilometer is equal to 1000 m (10^3 m), and a millimeter is equal to one-thousandth of a meter (10^{-3} m). Our eye can distinguish details down to about 250 μm (10^{-6} of a meter) (called visual acuity), while the light microscope can permit the visualization of biological structures smaller than 1 μm (such as the details on the surface of a grain of pollen; this is called the optical resolution). Modern electron microscopes can obtain images of structures up to even 100,000 times smaller, thus

TABLE 3.1**Standard Prefixes for the Designation of Decimal Multiples or Fractions of Base Measurement Units**

Multiplier		Prefix	Length		Weight		Volume	
1,000,000,000	10^9	giga	gigameter	(Gm)	gigagram	(Gg)	gigaliter	(Gl)
1,000,000	10^6	mega	megameter	(Mm)	megagram	(Mg)	megaliter	(Ml)
1,000	10^3	kilo	kilometer	(km)	kilogram	(kg)	kiloliter	(kl)
1	10^0	—	meter	(m)	gram	(g)	liter	(l or L)
0.1	10^{-1}	deci	decimeter	(dm)	decigram	(dg)	deciliter	(dl)
0.01	10^{-2}	centi	centimeter	(cm)	centigram	(cg)	centiliter	(cl)
0.001	10^{-3}	milli	millimeter	(mm)	milligram	(mg)	milliliter	(ml)
0.000001	10^{-6}	micro	micrometer	(μm)	microgram	(μg)	microliter	(μl)
0.000000001	10^{-9}	nano	nanometer	(nm)	nanogram	(ng)	nanoliter	(nl)
0.0000000001	10^{-10}	—	angstrom	(\AA)	—	—	—	—
0.000000000001	10^{-12}	pico	picometer	(pm)	picogram	(pg)	picoliter	(pl)

permitting us to distinguish atoms whose diameter barely exceeds one ten-millionth of a meter (10^{-10} m, sometimes called $1 \text{ \AA} = 1 \text{ angström}$) (Figure 3.1).

3.2 CHEMISTRY THEORY

All solid matter is composed of pure elements or combinations of elements called compounds. An element is a substance that cannot be decomposed into simpler substances by chemical or physical treatment. Examples of common elements are carbon, hydrogen, oxygen, and nitrogen. There are currently 112 known chemical elements; however about 20% of these do not exist in nature (or are only present in trace amounts) and are known only because they have been synthesized in the laboratory. The known chemical elements are typically displayed in the form of a table — the periodic table (Figure 3.2) — that groups the elements according to similar structure and properties.

All elements are composed of very small units called atoms. All the atoms of a single element are the same as each other in terms of their size, weight (with the exception of isotopes), and chemical properties, but are different from those of every other element. Each element can be represented by a symbol that is short notation derived from the element's scientific name (e.g., S for sulfur, C for carbon, O for oxygen, and Si for silicon). Sometimes the symbol is derived from the Latin name (e.g., Au for *aurum*, gold; Fe for *ferrum*, iron; and Na for *natrium*, sodium) or from other linguistic roots (e.g., W for *wolfram*, tungsten; from the German name “Wolf Rahm”).

Every atom consists of a central core (or nucleus) of subatomic particles called protons (positively charged) and neutrons (neutral or uncharged) in various numbers, surrounded by a cloud of negatively charged electrons circulating around the nucleus like planets around the Sun (Figure 3.3). It is these electrons, and the ease with which they may be shared with (or donated to) other atoms, that determine the chemical reactivity of the element. The lightest of all atoms, hydrogen, has a diameter

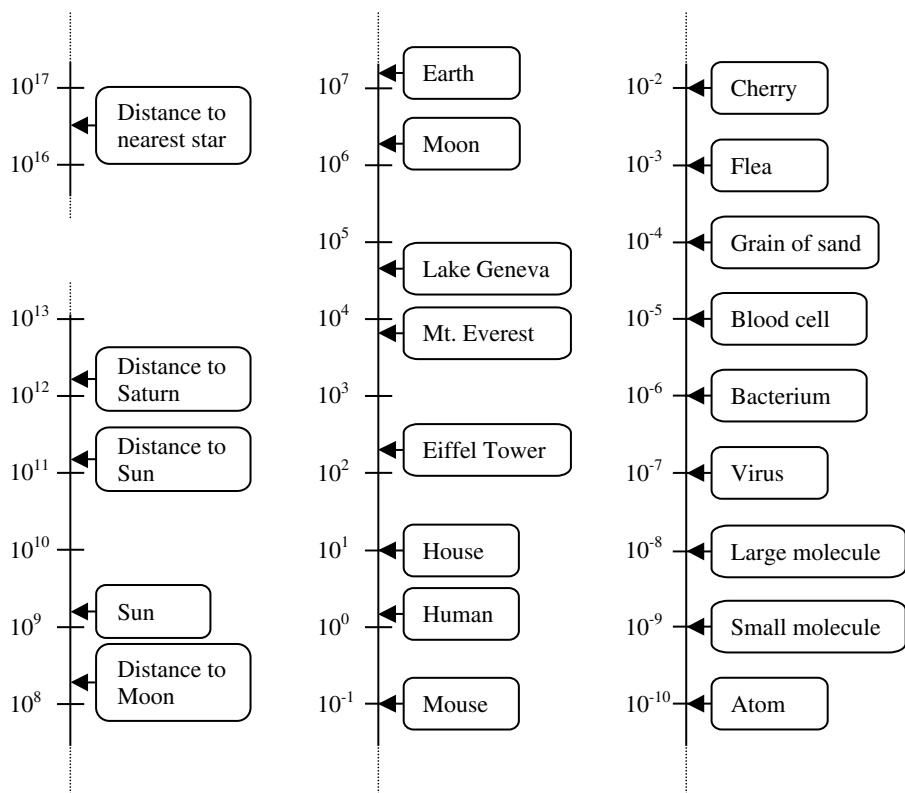

FIGURE 3.1 Scale of dimensions (in meters).

of approximately 1×10^{-10} m (0.1 nm; one angström [\AA]) and weighs 1.7×10^{-24} g. The diameter of an atom is 10,000 times larger than that of its nucleus.

Each element has a unique atomic number that indicates the number of protons present in the nucleus of each atom of that element. In their normal, uncharged state, each atom of an element has an equal number of protons and electrons. For example, carbon has the atomic number 6, indicating that there are six electrons and six protons in its atomic structure. Atoms with the same atomic number but different atomic masses differ in the number of neutrons contained in their nuclei, and these are called isotopes. Isotopes have identical chemical properties, yet they can have very different nuclear properties. The nuclear properties of an atom include possible radioactivity, magnetic properties, and weight. The element potassium (K, atomic number 19), for example, has two natural isotopes, ^{39}K (nucleus contains 19 protons and 20 neutrons) and ^{40}K (nucleus contains 19 protons and 21 neutrons). They form exactly the same compounds, but ^{40}K is radioactive and decays into another element. Because isotopes have the same number of protons, all of the isotopes of a given element occupy the same place in the periodic table of elements (Figure 3.2). Most elements have stable isotopes.

PERIODIC TABLE OF THE ELEMENTS

1	H hydrogen (1.008)																	2	He helium (4.003)																
3	Li lithium (6.94)	4	Be beryllium (9.01)																	5	B boron (10.81)	6	C carbon (12.01)	7	N nitrogen (14.01)	8	O oxygen (16.00)	9	F fluorine (19.00)	10	Ne neon (20.18)				
11	Na sodium (22.99)	12	Mg magnesium (24.31)	← TRANSITION ELEMENTS →																13	Al aluminium (26.98)	14	Si silicon (28.09)	15	P phosphorus (30.97)	16	S sulfur (32.06)	17	Cl chlorine (35.45)	18	Ar argon (39.95)				
19	K potassium (39.10)	20	Ca calcium (40.08)	21	Sc scandium (44.96)	22	Ti titanium (47.90)	23	V vanadium (50.94)	24	Cr chromium (52.00)	25	Mn manganese (54.94)	26	Fe iron (55.85)	27	Co cobalt (58.93)	28	Ni nickel (58.71)	29	Cu copper (63.55)	30	Zn zinc (65.38)	31	Ga gallium (69.72)	32	Ge germanium (72.59)	33	As arsenic (74.92)	34	Se selenium (78.96)	35	Br bromine (79.90)	36	Kr krypton (83.80)
37	Rb rubidium (85.47)	38	Sr strontium (87.62)	39	Y yttrium (88.91)	40	Zr zirconium (91.22)	41	Nb niobium (92.91)	42	Mo molybdenum (95.94)	43	Tc technetium (98.91)	44	Ru ruthenium (101.07)	45	Rh rhodium (102.91)	46	Pd palladium (106.4)	47	Ag silver (107.87)	48	Cd cadmium (112.41)	49	In indium (114.82)	50	Sn tin (118.69)	51	Sb antimony (121.75)	52	Te tellurium (127.60)	53	I iodine (126.90)	54	Xe xenon (131.30)
55	Cs caesium (132.90)	56	Ba barium (137.34)	57*	La lanthanum (138.91)	72	Hf hafnium (178.49)	73	Ta tantalum (180.95)	74	W tungsten (183.85)	75	Re rhenium (186.2)	76	Os osmium (190.2)	77	Ir iridium (192.2)	78	Pt platinum (195.09)	79	Au gold (196.97)	80	Hg mercury (200.59)	81	Tl thallium (204.37)	82	Pb lead (207.19)	83	Bi bismuth (208.98)	84	Po polonium (209)	85	At astatine (210)	86	Rn radon (222)
87	Fr francium (223)	88	Ra radium (226.03)	89**	Ac actinium (227)																														
* LANTHANIDES				58	Ce cerium (140.12)	59	Pr praseodymium (140.91)	60	Nd neodymium (144.24)	61	Pm promethium (145)	62	Sm samarium (150.35)	63	Eu europium (151.96)	64	Gd gadolinium (157.25)	65	Tb terbium (158.93)	66	Dy dysprosium (162.50)	67	Ho holmium (164.93)	68	Er erbium (167.26)	69	Tm thulium (168.93)	70	Yb ytterbium (173.04)	71	Lu lutetium (174.97)				
** ACTINIDES				90	Th thorium (232.04)	91	Pa protactinium (223)	92	U uranium (238.03)	93	Np neptunium (237.05)	94	Pu plutonium (244)	95	Am americium (243)	96	Cm curium (247)	97	Bk berkelium (247)	98	Cf californium (251)	99	Es einsteinium (254)	100	Fm fermium (257)	101	Md mendelevium (258)	102	No nobelium (259)	103	Lr lawrencium (260)				

FIGURE 3.2 Periodic table of the elements.

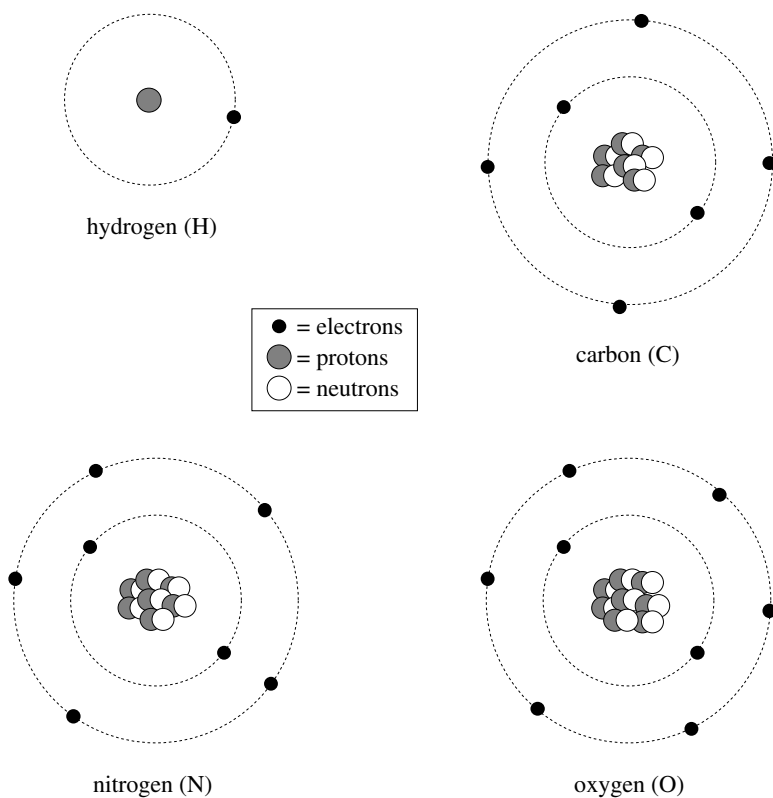

FIGURE 3.3 The atomic structures of hydrogen, carbon, nitrogen, and oxygen.

The term *atomic weight*, or *atomic mass*, refers to the mass of a fixed number of atoms of an element. The standard scientific unit for dealing with atoms in macroscopic quantities is the mole (abbreviated to mol), which is defined arbitrarily as the amount of a substance with as many atoms or other units as there are in 12 grams of the carbon isotope ^{12}C (carbon-12). The number of atoms in a mole is called Avogadro's number, the value of which is approximately 6×10^{23} . The atomic mass of an element, commonly expressed as atomic mass units (amu), is the number of grams in one mole of the element. (Neutrons and protons have relative weights of approximately one amu, whereas an electron is only about $1/2000$ as heavy.) The atomic mass of a given element, as indicated in the periodic table (Figure 3.2), is the weighted average of the different isotopes that naturally occur for that element. For example, chlorine has two common isotopes, ^{35}Cl and ^{37}Cl , and a weighted average atomic mass of 35.5 amu. Therefore, 35.5 g of chlorine will contain approximately 6×10^{23} individual chlorine atoms, being a mixture of the two common isotopes. (Chlorine is a mixture of approximately three parts of chlorine-35 for every one part of the heavier chlorine-37 isotope.)

In their uncharged state, atoms have an equal number of protons and electrons. An imbalance between the number of protons and electrons in an atom results in

the formation of an ion, which can be either positively charged (i.e., a cation; more protons than electrons) or negatively charged (i.e., an anion; more electrons than protons).

The atoms of nearly every element can combine with other atoms to form molecules by chemical interaction. For example, a molecule of water (H₂O) is formed by the interaction of two atoms of hydrogen (H) with one atom of oxygen (O). A molecule can be defined as the smallest unit of a compound that retains the chemical characteristics of the original substance. The molecular weight of a pure compound such as water is calculated by taking the sum of atomic weights for the elements present. For example, the molecular weight of carbon dioxide (CO₂) — one atom of carbon (atomic weight of 12) plus two atoms of oxygen (atomic weight of 16) — is 44. Therefore, 44 grams of carbon dioxide will contain approximately 6×10^{23} individual CO₂ molecules.

When two atoms come into contact and share electrons, a combined electron cloud enveloping both atoms results, and a chemical covalent bond is said to have been formed. Depending on the number of electrons that have been shared, the covalent bond that is formed may be either single (one pair of electrons), double (two pairs of electrons), or triple (three pairs of electrons).

If an atom completely loses one or more electrons to another atom (i.e., the “bonding” electrons are no longer shared but are completely taken by one of the atoms), then an ionic bond results. Sodium chloride (NaCl), common table salt, is an example of an ionically bonded compound that can be represented as Na⁺Cl⁻. In the case of NaCl, each atom of chlorine has taken one electron from a sodium atom, resulting in a negatively charged chlorine atom and a positively charged sodium atom, with the atoms being held together in the final compound by the natural attraction between positively and negatively charged bodies.

Because of the specific number and arrangement of electrons around the nucleus of each atomic element, that element will prefer to combine with other atoms in particular ratios. For example, oxygen and carbon atoms may combine to give either carbon dioxide (CO₂), which constitutes about 0.03% of the air we breathe, or carbon monoxide (CO), the toxic gas emitted by imperfect combustion such as from a car’s exhaust system. Gases such as hydrogen, oxygen, and nitrogen do not exist for very long as single or free atoms and prefer to be in combination with other atoms. For example, two atoms of hydrogen (H) will combine with each other to form a relatively stable diatomic molecule (i.e., having two atoms) of hydrogen gas, represented by the chemical formula H₂. When hydrogen is oxidized, two diatomic molecules of hydrogen combine with one diatomic molecule of oxygen to form two molecules of water. The chemical reaction can be written as follows:

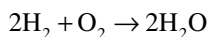

Compounds can be represented by their numerical or empirical formulas — such as H₂O, CO₂, and O₂ — or by structural formulas in which lines are used to represent the sharing of electrons by the atoms of a molecule (Table 3.2). The lines represent the forces or bonds between the atoms of elements making up the molecule. A single

TABLE 3.2
Some Empirical and Structural Formulas

Chemical Name	Empirical Formula	Structural Formula
hydrogen	H ₂	H—H
oxygen	O ₂	O=O
nitrogen	N ₂	N≡N
carbon dioxide	CO ₂	O=C=O
water	H ₂ O	$\begin{array}{c} \text{O} \\ / \quad \backslash \\ \text{H} \quad \text{H} \end{array}$
ammonia	NH ₃	$\begin{array}{c} \text{H} \\ \\ \text{N} \\ / \quad \backslash \\ \text{H} \quad \text{H} \end{array}$
methane	CH ₄	$\begin{array}{c} \text{H} \\ \\ \text{H}-\text{C}-\text{H} \\ \\ \text{H} \end{array}$
ethane	C ₂ H ₆ (CH ₃ CH ₃)	$\begin{array}{c} \text{H} \quad \text{H} \\ \quad \\ \text{H}-\text{C}-\text{C}-\text{H} \\ \quad \\ \text{H} \quad \text{H} \end{array}$
ethanol	C ₂ H ₆ O (CH ₃ CH ₂ OH)	$\begin{array}{c} \text{H} \quad \text{H} \\ \quad \\ \text{H}-\text{C}-\text{C}-\text{OH} \\ \quad \\ \text{H} \quad \text{H} \end{array}$
ethylene	C ₂ H ₄ (CH ₂ CH ₂)	$\begin{array}{c} \text{H} \quad \text{H} \\ \backslash \quad / \\ \text{C}=\text{C} \\ / \quad \backslash \\ \text{H} \quad \text{H} \end{array}$
acetylene	C ₂ H ₂ (CHCH)	H—C≡C—H

line indicates that one pair of electrons is shared (i.e., a single bond), two lines indicate two shared pairs (i.e., a double bond), and three lines mean three pairs (i.e., a triple bond). In this way, the structural formula shows not only how many atoms are in a molecule, but in what order they are arranged and the nature of the chemical bonds between them, thus providing a great deal of information in a small space. Rings of carbon atoms containing $2n + 2$ carbons (i.e., 4, 6, 8, 10, etc.) and having alternating single and double bonds (also called π -bonds) are termed aromatic rings. An example of an aromatic ring is benzene (C₆H₆), which forms the basis of many organic compounds and can be represented by any of the structures depicted in [Figure 3.4](#).

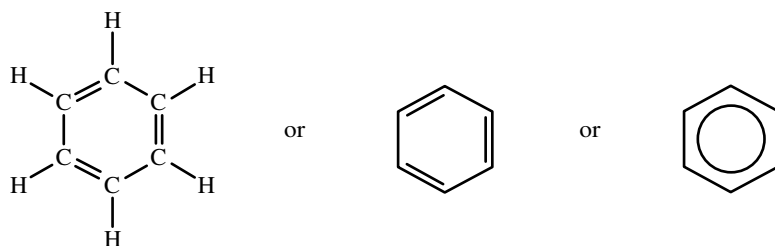

FIGURE 3.4 Different graphical representations for a benzene ring (C_6H_6).

Matter can exist in one of four states:

1. *Solid* — the position and distance between the particles (atoms or molecules) is fixed
2. *Liquid* — the particles interact with each other and the distance between them is more or less stable (limited movement)
3. *Gas* — the particles move freely, changing distance and position among themselves
4. *Plasma* — where, at high temperature, the substance is entirely ionized to form “naked” atomic nuclei and free electrons that are in thermal motion

Within a solid, very strong bonding forces keep the atoms in a lattice structure; individual atoms are unable to move but can vibrate around a fixed position. The degree of atomic vibration increases with increasing temperature. Within a liquid, the bonding forces between the molecules are weaker, with no lattice structure in place, but sufficient to keep the molecules together. The limited movement of molecules results in elastic collisions where there is an exchange of kinetic energy, the energy being directly proportional to the temperature (i.e., increasing kinetic energy with increasing temperature). Within a gas, the bonding force between individual molecules is weak and insufficient to keep the molecules together. Gas molecules tend to disperse and occupy all the available space, with free movement of molecules within this space. Elastic collisions, with an exchange of kinetic energy, occur as for liquids (energy proportional to temperature).

The compounds that are based on carbon are so numerous and so vital to life processes that they are considered a chemistry in themselves. The study of carbon-containing compounds (with the exception of carbonates and cyanides) is called organic chemistry. All other compounds, based on combinations of elements except carbon and generally having a mineral origin, fall into the general category of inorganic chemistry.

3.3 LIGHT THEORY

3.3.1 INTRODUCTION

All living organisms on Earth obtain their energy needs directly or indirectly from sunlight. Light plays such an important role in human existence that optical phe-

nomena have been studied since the earliest times. Cavemen, watching the flickering flames of a fire, thought that the yellowish light was a magical, mysterious spirit. The ancient Greeks knew that when a ray of light is reflected from a mirror, the angle of incidence is equal to the angle of reflection. Various theories of light have been formulated throughout the centuries. Today, it is known that light is a form of energy that is dualistic in nature, having both wave and particle properties. When light interacts with macroscopic objects (bulk matter), it is regarded as a beam of electromagnetic waves. When light interacts with microscopic objects (e.g., atoms or molecules), it is regarded as a beam of energy particles known as photons.

The perception of color and of photoluminescence emission represents the observation of physical phenomena due to the interaction of light with matter. To explain and to efficiently employ the observed phenomena, it is essential that some fundamental properties of light be understood. Light is a form of electromagnetic energy, part of a group that includes x-rays, microwaves, and radio waves. (The term *electromagnetic* refers to the fact that light energy has both electric and magnetic components.) Visible radiation, which makes up white light, forms only a small part of the electromagnetic spectrum (Figure 3.5).

3.3.2 WAVE THEORY

In the early 19th century, Thomas Young found strong evidence to support the wave theory of light. The electromagnetic wave model was subsequently established. Electromagnetic energy propagates in the form of waves that can be described by their wavelength λ (measured in units of nanometers [nm], 10^{-9} m) or their frequency ν (oscillations per unit time, measured in units of hertz [Hz]) (Figure 3.6). The frequency ν can be calculated from the wavelength λ using the formula $\nu = c/\lambda$ where c , the speed of light, is a constant (c is approximately 300 million m/sec).

3.3.3 PARTICLE THEORY

Max Planck and Albert Einstein, Nobel Prize winners in physics, proposed that light, which usually travels in waves, sometimes behaves as if it were made up of a stream of small energy particles or *photons* traveling at the speed of light (Figure 3.7). Light is always emitted or absorbed as a number of whole photons. The intensity of a light source is equal to the number of emitted photons per second.

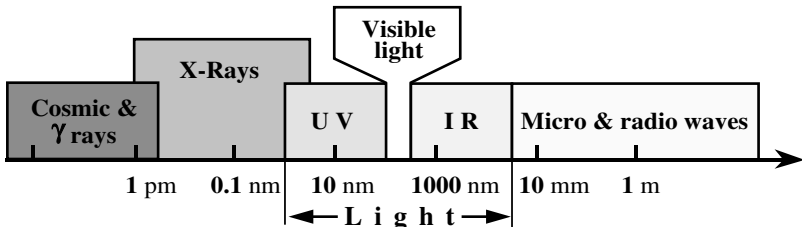

FIGURE 3.5 The electromagnetic spectrum. Light consists of three parts: ultraviolet (UV), visible, and infrared (IR). Visible light is a very small portion in this region.

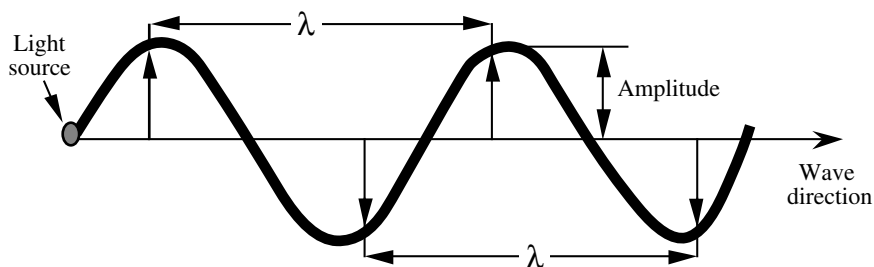

FIGURE 3.6 Wave theory. Schematic representation of a light wave. The distance between the two nearest points in the same phase is known as the wavelength λ .

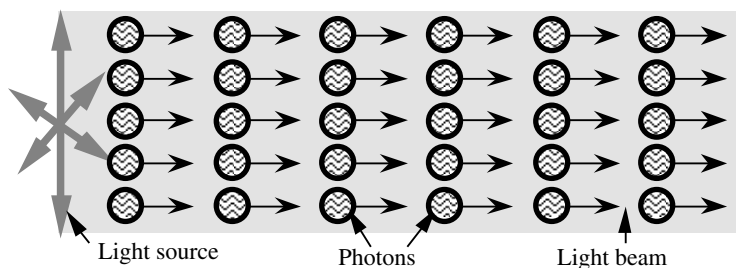

FIGURE 3.7 A beam of pure energy particles, called photons, traveling at the speed of light.

During light interaction with matter, a photon may be totally absorbed by an atom or molecule of that matter. The atom (or molecule) gets excited to the extent of energy equal to the energy of the absorbed photon. The energy, ϵ , of a photon can be calculated using the following equation, where h is a universal constant (Planck's constant), ν is the light frequency, λ is the wavelength, and c is the speed of light.

$$\epsilon = h\nu = \frac{hc}{\lambda}$$

As can be seen from this equation, the energy of a photon (ϵ) is inversely proportional to the wavelength (λ) of the corresponding light wave. Therefore, the shorter the wavelength, the higher is the energy of the corresponding photon. The longer the wavelength, the lower is the energy of the photon.

3.3.4 WHITE LIGHT AND COLORED LIGHT

Newton carried out a series of experiments in which a beam of white light was passed through a prism. He found that the prism separated white light into a band representing all the colors of the rainbow, from violet to red, and he concluded that

white light consists of a mixture of various colors. The colors — identified as violet, indigo, blue, green, yellow, orange, and red — represent the visible spectrum. The human eye only sees “visible” light, which is any electromagnetic radiation falling within the wavelength range of approximately 400 to 700 nm. Color perception is related to wavelength; for example, radiation at 450 nm is observed as blue light, at 550 nm as green, and at 650 nm as red. When each color (wavelength) of the visible spectrum is present with the same relative intensity, we have white light (Figure 3.8). If each color (wavelength) in the visible region is not present at the same intensity — such is the case when some colors are absent — then we have colored light. (Black is the “color” perceived by the brain when no visible light is present, but this does not preclude the presence of nonvisible radiation such as ultraviolet, infrared, or x-rays.)

Colored light can be polychromatic (many colored) or monochromatic (single colored). When only one single wavelength is present, we have pure monochromatic light. When a narrow range of colors (visible wavelengths) is present, we have a monochromatic *band* of light (Figure 3.9). It is obvious that the narrower the band, the purer the color will be (i.e., more monochromatic). A band of light is defined by its central wavelength (CW) and its bandwidth (BW).

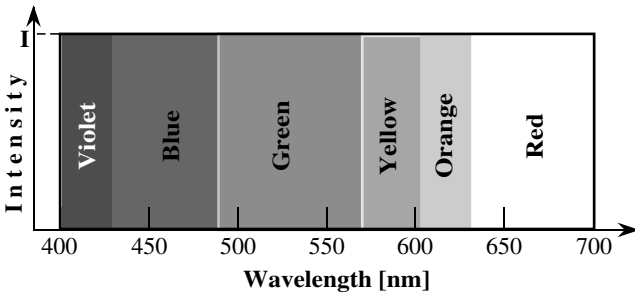

FIGURE 3.8 When each color (wavelength) of the visible spectrum is present with the same relative intensity, we have white light.

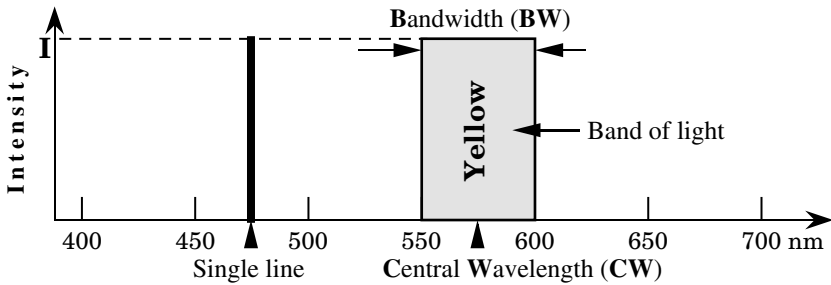

FIGURE 3.9 When a narrow range of colors (visible wavelengths) is present, we have a monochromatic band of light.

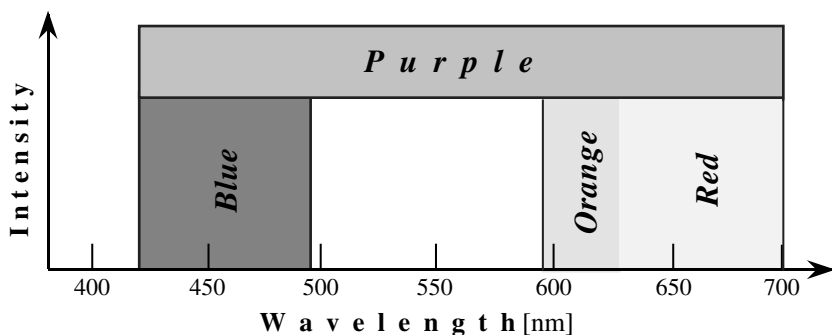

FIGURE 3.10 A blue band combined with an orange/red band will produce polychromatic light that will be perceived by the human eye as being purple in color.

Light that is composed of two or more monochromatic bands is referred to as polychromatic. For example, a blue band combined with an orange/red band will produce polychromatic light that will be perceived by the human eye as being purple in color (Figure 3.10). Incidentally, this is the color of fingerprints developed with ninhydrin.

3.3.5 SPECTRAL SENSITIVITY OF THE HUMAN EYE

The search for forensic evidence can sometimes require examination through the entire visible region (i.e., from 400 to 700 nm) as well as, in some cases, nonvisible regions such as the ultraviolet and infrared. It is important to understand that the human eye has limitations, the most important of which is restricted spectral sensitivity. From the spectral sensitivity curve (Figure 3.11), it can be seen that the human eye has the highest sensitivity at around 550 nm (green/yellow region). Sensitivity is very low in the violet region, below 450 nm, and in the red region, above 650 nm. This should be taken into account when working at these wavelengths. Similarly, when recording marks, the specialist needs to be aware of the spectral sensitivity of the photographic film being used, which may differ considerably from that of the eyes.

Sometimes quite useful forensic evidence is rejected, as it does not “look good” when observed with the naked eye. A typical example is a weak fingermark in blood on a lightly colored surface. Violet light can be used to enhance the mark, as blood has an absorption peak in this wavelength range. The human eye has a very low sensitivity in the violet region, and a fingerprint in blood may not “look good” under these conditions. When photographed, however, an excellent image may be produced, as photographic film is very sensitive in this region. The film “sees” the fingermark very well under violet light, much better than the human eye.

3.3.6 ABSORPTION AND REFLECTION OF LIGHT

At a macroscopic level, a light beam directed onto a surface is either reflected, absorbed, or transmitted. For example, if the material is transparent, most of the

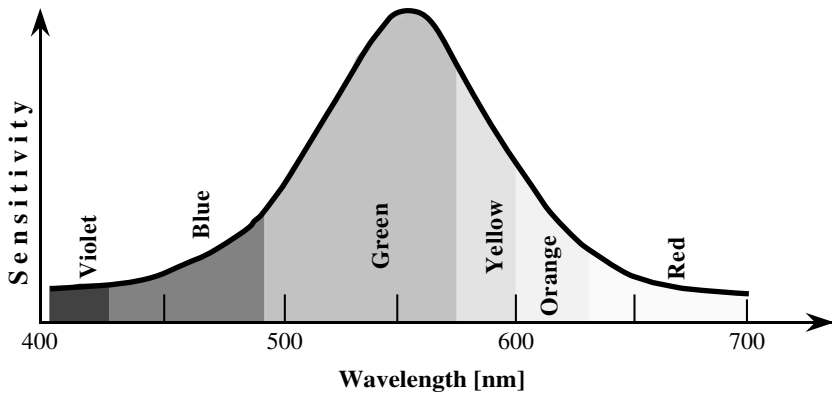

FIGURE 3.11 The spectral sensitivity of an average human eye.

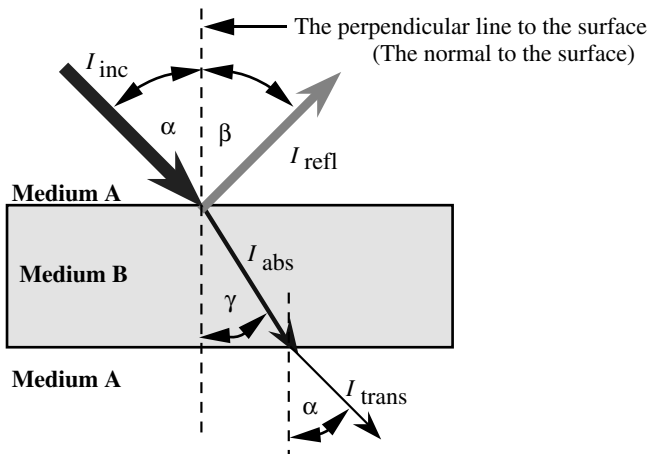

FIGURE 3.12 Transformation of incident light after irradiation of an object.

light is transmitted, some is absorbed, and the rest is reflected. The total energy of the system is conserved so that the irradiating intensity I_{inc} is equal to the sum of the reflected intensity I_{refl} , the absorbed intensity I_{abs} , and the transmitted intensity I_{trans} (Figure 3.12).

For a nontransparent surface, $I_t = 0$ and all light not absorbed is reflected. The reflected light is the light seen by our eyes (or camera or photosensitive detector), which gives us a colored image of the object observed. If the object appears white under white light, then the surface reflects all of the wavelengths of the visible spectrum to an equal extent: there is no selective absorption and the surface will appear to be the same color as the incident light.

One of the fundamental laws of reflection is that the angle of incidence of the light beam (α in Figure 3.12) is equal to the angle of the reflected light (β). This angle is measured with respect to a line perpendicular to the surface (normal to the surface) at the point of incidence. For a perfectly flat, shiny surface (e.g., a mirror),

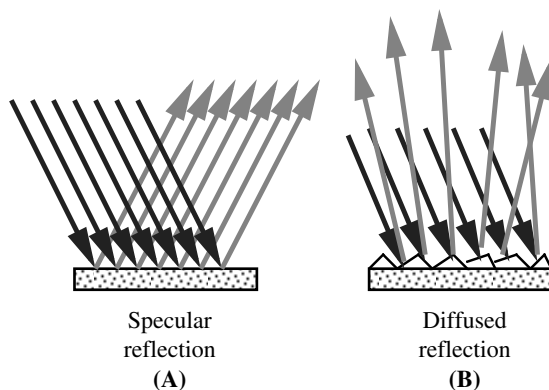

FIGURE 3.13 (A) Specular reflection from a flat surface. (B) Diffused reflection from a rough surface.

all rays will be reflected in the same direction. This is termed *specular reflection* (Figure 3.13A). A rough surface gives randomly oriented reflected rays (due to the random orientation of the normals to the surface), producing what is termed *diffused reflection* (Figure 3.13B).

When the incident light is white but the reflected light is colored, we have the phenomenon of *selective absorption*: certain wavelengths are absorbed or transmitted while others are reflected — our eyes only perceive the latter. For example, if an object appears red under white light, all wavelengths have been absorbed except for the red, which is reflected and perceived. Under a green or blue light, the same object will appear black (all incident light is absorbed), while under a red light it will appear red (all incident light is reflected). It must be noted that in this latter case (red incident light), a white object will also appear red, since most of the incident light is reflected. As a result, a red object cannot be distinguished from an identical, but white, object under red lighting. This phenomenon is recognized in police circles when it comes to describing the color of an object under different lighting conditions. For example, a yellow car seen at night under artificial light will be difficult to distinguish from a similar white car observed under the same conditions.

3.3.7 PHOTOLUMINESCENCE

Luminescence is a general term that incorporates phenomena such as thermoluminescence (light emission that results from the absorption of heat energy), bioluminescence (light emission from a biological process), chemiluminescence (light emission from a chemical process), as well as photoluminescence (light emission that results from the absorption of light energy). The correct term in the context of this book is therefore *photoluminescence*.

When light interacts with matter, a photon of light may be absorbed by a molecule (or atom) of that matter (Figure 3.14). After absorption of the photon, the molecule has an excess of energy, equal to the energy of the absorbed photon, and

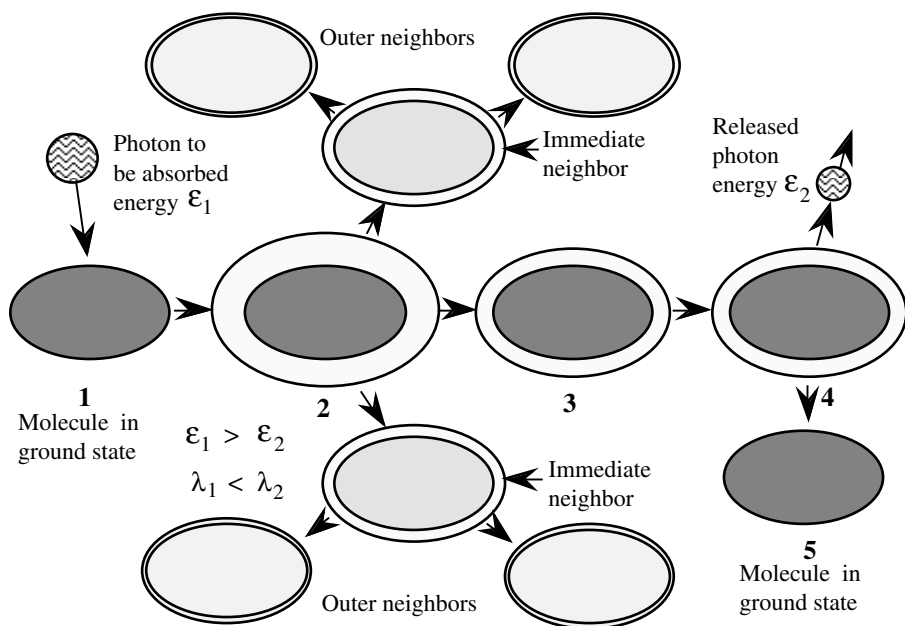

FIGURE 3.14 Absorption and emission of a photon — photoluminescence. (1) A molecule in its normal (ground) state just before absorption of a photon. (2) The molecule becomes excited by the amount of absorbed energy. It immediately shares some of its extra energy with its nearest neighbors. Shared energy spreads out to other molecules. (3) The molecule is less excited by the amount of the shared energy. (4) The molecule releases (emits) its extra energy in the form of a photon. (5) The molecule returns to its ground state.

is no longer in its normal (ground) state. The molecule (or atom) is promoted to a higher energy (excited) state. The molecule tends to rapidly return to its ground state (the state before absorption of the photon) by releasing the excess energy in some form. This process is complex, and necessary simplification/schematization highlights parts of the phenomena that are useful in fingerprint detection. To release the excess energy, the molecule may undergo a chemical change, may transfer the energy to other molecules through collision or vibration (producing heat), or emit the energy as another photon (Figure 3.14).

All these processes compete with each other, and a return to the ground state seldom occurs through a single pathway. Our particular interest is the process of emission of another photon. Before emission of another photon takes place, some faster processes, in which the molecule loses part of its extra energy, are occurring. The molecule shares a part of its extra energy with immediate neighbors. Shared energy spreads out to other molecules in the form of increased vibration (increased heat). The molecule then emits the remainder of its extra energy in the form of a secondary photon (Figure 3.14). The process involving the emission of a secondary photon upon absorption of a primary photon is called “photoluminescence.”

The energy of an emitted photon is smaller than the energy of an absorbed photon by the amount of shared energy. This means that the photoluminescence

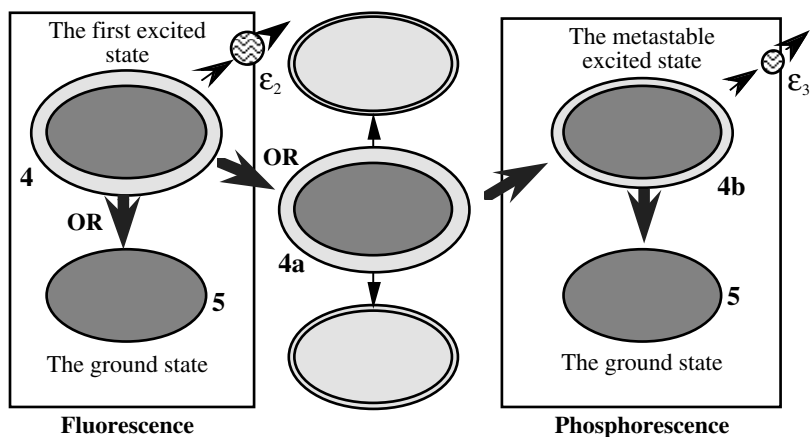

FIGURE 3.15 The molecule in stage 4 (first excited state) has two possibilities of returning to the ground state: directly, or indirectly by further sharing its extra energy. The latter process takes longer and leads to phosphorescence emission.

emission has a longer wavelength (lower energy) compared with the absorbed light that was used to excite the molecule (the “excitation” light). It is said that the photoluminescence emission is “red-shifted” in comparison to the excitation light. Emission can proceed either directly (Figure 3.15A) or indirectly, i.e., when a smaller amount of extra energy is further shared and the molecule falls into a “metastable” state (Figure 3.15B). Direct emission is known as “fluorescence,” while emission through a metastable state is known as “phosphorescence.” Because it is the result of a direct transition, the fluorescence process is fast, and fluorescence emission occurs only during exposure of the matter to the excitation light. When the excitation light is removed, fluorescent emission ceases.

In the phosphorescence process, the molecule is in a lower excited state than the first excited state due to energy loss during transition to the metastable state. This means that phosphorescence is red-shifted in comparison to fluorescence emission, or further red-shifted in comparison to the excitation light. The nature of the metastable state is such that the molecule stays much longer in this state, and transition does not take place immediately as with fluorescence. Phosphorescence emission continues for a fraction of a second to several seconds (sometimes minutes) after the excitation light has been removed, and it is known as “afterglow.” Only some photoluminescent compounds have the property of phosphorescence; most of them exhibit only or mostly fluorescence. The general term *photoluminescence* covers both fluorescence and phosphorescence processes.

In summary, a photoluminescent material absorbs light at a particular wavelength and then reemits the absorbed energy as light at a longer wavelength. Photoluminescence can occur as either fluorescence (light emission only occurs during excitation) or phosphorescence (light emission continues to occur for a short period after excitation). Elsewhere in this book, where the general term *luminescence* is employed, this should be taken to mean “photoluminescence.”

3.3.8 OPTICAL FILTERS

There are three principal modes of acquiring information from a surface or object using light:

- Absorption mode
- Diffused reflection mode
- Photoluminescence mode (based on the detection of a photoluminescent material)

The majority of illumination techniques used for forensic examinations employ one of these three modes. The implementation of these optical enhancement methods is heavily dependent on the use of optical filters. An optical filter is a device designed to select specific colors (wavelengths) of light from the range of colors (wavelengths) available.

Filters can be classified, according to their transmission characteristics, as either short pass, long pass, or bandpass. A *short pass filter* is designed to transmit shorter wavelengths while rejecting longer wavelengths (Figure 3.16). The mid-point between transmitted and rejected regions is called the edge wavelength (EW). The edge wavelength (in nanometers) is labeled on each filter as the characteristic of that filter. The transmission is limited on the left side (shorter wavelengths) by the substrate of which the filter is made. For example, if a glass substrate is used, the transmission falls sharply below 380 nm. A *long pass filter* is designed to transmit longer wavelengths while rejecting shorter wavelengths (Figure 3.17).

A *bandpass filter* is designed to transmit over a wavelength range while rejecting all other wavelengths (Figure 3.18). In this way the bandpass filter creates a monochromatic band of light. The combination of a long pass filter and a short pass filter with overlapping transmission bands will result in a bandpass filter. The basic characteristics of a bandpass filter are as follows:

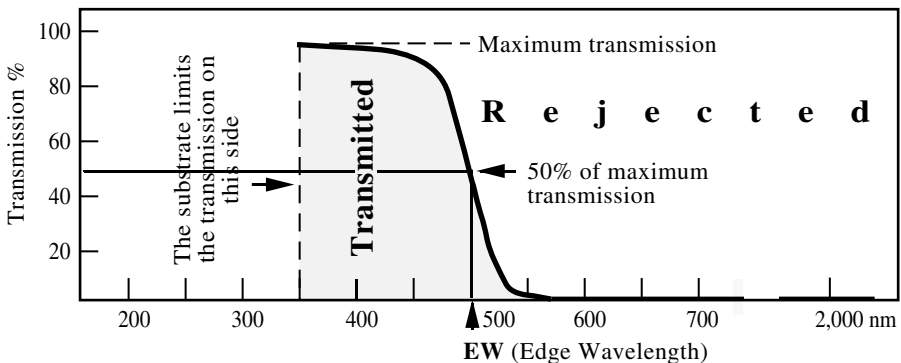

FIGURE 3.16 Typical transmission characteristics of a short pass filter.

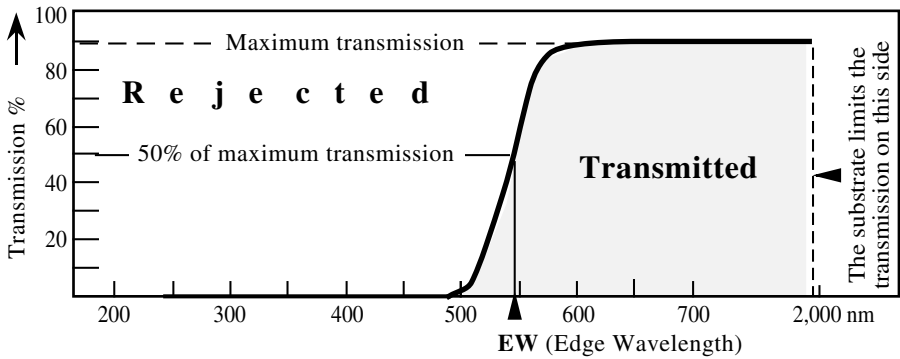

FIGURE 3.17 Typical transmission characteristics of a long pass filter.

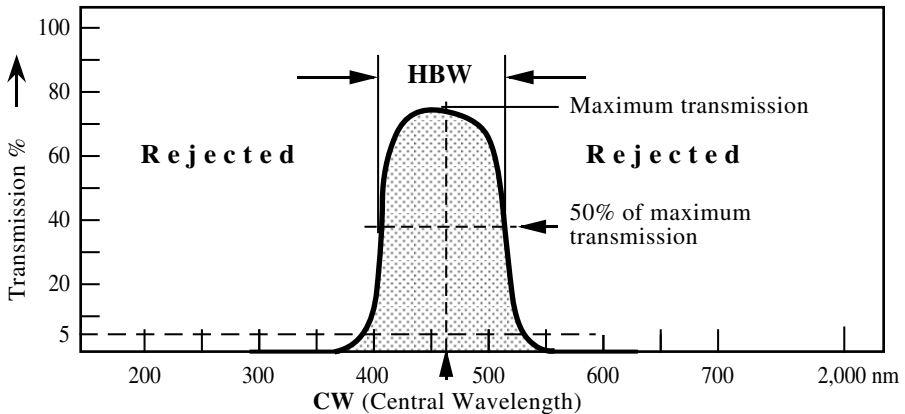

FIGURE 3.18 Typical transmission characteristics of a bandpass filter.

- *Central wavelength (CW)* — the wavelength that corresponds to the midpoint of the band as measured at 50% of maximum transmission
- *Half-bandwidth (HBW)* — the width of the transmission band measured at 50% of maximum transmission
- *Passband* — the width of the transmission band measured between the 5% transmission points on each side of the band
- *Blocking region* — the attenuation of transmitted radiation in specified spectral regions outside the passband. Blocking is specified by the percentage of transmitted light. For a good filter, transmission should not be higher than 0.0001% ($10^{-4}\%$) in this region.

When the transmission band of a long pass filter is compared with that of a relevant bandpass filter, it can be seen that the long pass filter transmits significantly more light (energy) but is less selective (Figure 3.19). This should be taken into account when selecting an observation filter (barrier filter) for a particular applica-

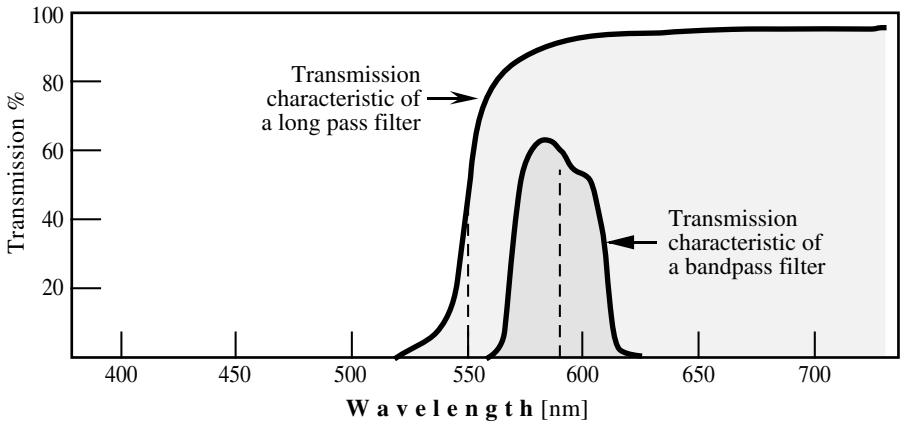

FIGURE 3.19 Transmission characteristics of a long pass filter (KV550) compared with transmission characteristics of a bandpass filter (IF590/40).

tion, especially in cases where a colored or photoluminescent background prevents the recording of satisfactory results.

With regard to the process of wavelength rejection, there are two different types of optical filters: *energy absorbing* and *energy reflecting*. Energy absorbing filters are based on the absorption of some wavelengths by colored matter present in the filter. When a light beam passes through a colored substance, certain wavelengths are absorbed and the rest are transmitted (Figure 3.20). Since light is pure energy, and the energy conservation law applies, the absorbed light is converted into heat. The filter must dissipate this absorbed energy at the same rate as it receives it; otherwise, the temperature of the filter increases. Increased temperature can cause destruction of the filter. The manufacturing of energy-absorbing filters is relatively simple and inexpensive. A suitable colored matter is embedded into glass, gelatin, plastic, or dissolved in a liquid. The two major disadvantages of these filters are: (a) often it is difficult or impossible to find a colored matter to suit particular wavelength requirements; and (b) due to heat buildup, they cannot be used with high-intensity light. Energy-absorbing filters can be successfully employed as barrier filters in front of the eyes or a camera.

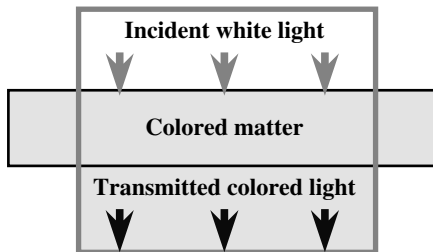

FIGURE 3.20 White light filtered through an energy-absorbing filter.

A typical example of an energy-reflecting filter is the *interference filter*. Interference filters are made by deposition of alternating thin layers of material with high and low refracting index under high vacuum. There are several types of interference filters with regard to the materials that are used in the manufacturing process, e.g., metal-dielectric-metal, metal-dielectric, and all dielectric. The two types of all-dielectric filters, known as “soft coated” and “hard coated,” are the most commonly used filters. Hard-coated filters are manufactured by using metal oxides; they are insensitive to moisture, hard wearing, and very long lasting. Soft-coated filters are manufactured by using zinc sulfide (refractive index = 2.35) and cryolite (refractive index = 1.35). To obtain a good “square” transmission characteristic with an upright rejection ratio out of the transmission band, it is required to deposit many alternate thin layers of zinc sulfide and cryolite on a glass substrate under high vacuum (Figure 3.21). Both zinc sulfide and cryolite are colorless, and therefore the absorption of light within the filter is minimal. The required wavelength band is obtained by the interference of transmitted light through the filter. The range of transmitted wavelengths depends only on the thickness of the filter layers. By varying the layer thickness, an interference filter can be designed and manufactured to give specific filter characteristics. The number of layers influences the shape of the transmission curve. Better-quality interference filters, with a multilayered construction, have transmission curves that display a better defined pass band (much sharper cut-off–cut-on edges).

An interference filter transmits or reflects light, while absorption is negligible. This property of interference filters allows them to be used with high-intensity light without significant risk of overheating and filter damage. All three types of filters mentioned in the previous section (bandpass, short pass, and long pass) can be made in the form of interference filters. However, due to the complex manufacturing process required, interference filters are very expensive.

The standard transmission characteristics of an interference filter refer to the case where the incident light beam is perpendicular to the filter’s surface (Figure 3.22A). In this case, the normal to the filter’s surface and the incident light beam are parallel and it is said that the angle of incidence is 0° . When the incident angle increases (i.e., when the filter is tilted with respect to the light beam), the central wavelength is shifted toward shorter wavelengths due to a longer light path through the filter layers

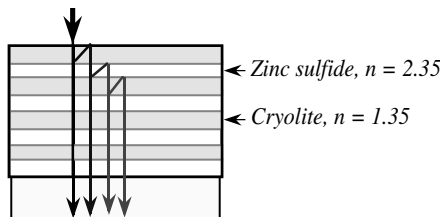

FIGURE 3.21 An interference filter is made from many alternate layers of zinc sulfide and cryolite. Beams with different light paths through the filter interfere with each other, which leads to only certain wavelengths appearing in the transmitted light.

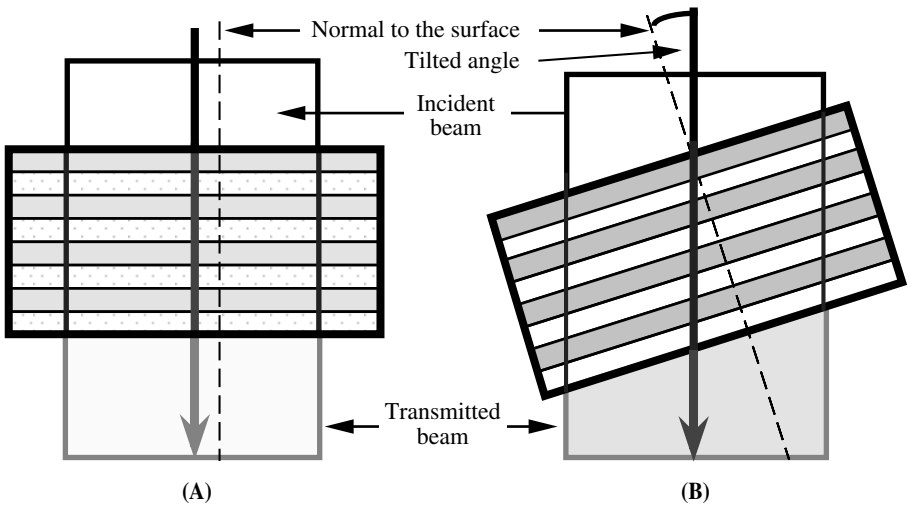

FIGURE 3.22 (A) Conventional use of an interference filter compared with (B) down-tuning, where the filter is tilted with respect to the incident beam. The light path through the filter layers becomes longer, resulting in a shift of the band toward shorter wavelengths.

(Figure 3.22B). The shift depends on the transmitted wavelength and is proportional to the incident angle. The shape of the transmission curve and the transmission intensity do not change significantly during the “down-tuning” process. A maximum wavelength shift of about 30 nm (visible region) can be achieved for an incident angle of 45° (Figure 3.23). This fine-tuning property of interference filters can be of significant benefit in some forensic applications (e.g., for attenuating background interference when recording weakly luminescent fingerprints).

3.3.9 ABSORPTION MODE

The method of acquiring information from a surface based on color difference (or selective absorption) is known as the absorption mode. Selective absorption can be

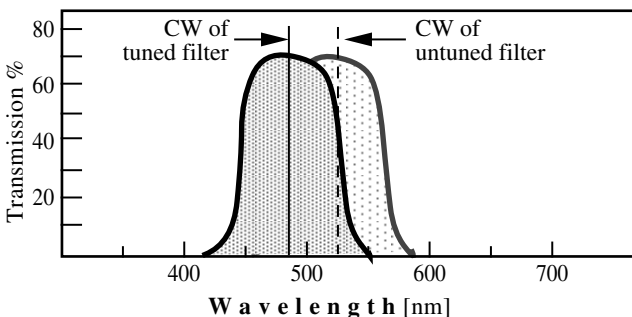
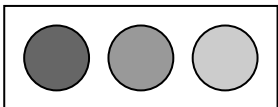
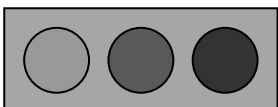
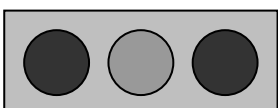
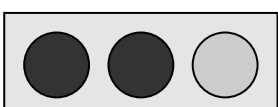

FIGURE 3.23 Tilting of an interference filter results in the shifting of its passband toward shorter wavelengths (wavelength down-tuning).

demonstrated by considering how colored spots — blue, yellow, and red — on a white background will appear under different bands of colored light or when visualized through different bandpass filters (Table 3.3).

A colored object or stain can be readily visualized by enhancing the color difference against the background substrate. A colored band of light is chosen that is opposite to the color of the object (or stain) in question. Enhancement is achieved because the object is “darkened” due to selective absorption properties. For example, illuminating an orange stain on a blue surface with a blue band of light can enhance the orange stain. The stain will appear dark against a light background because the blue light is absorbed by the stain but reflected by the surface. Alternatively, the surface can be illuminated with white light but visualized through a blue filter. The only requirement for enhancement is that the background and the object do not absorb at exactly the same wavelength (even if the color is similar). The use of absorption and reflection properties of matter is the basis of colorimetric techniques (i.e., techniques based on the measurement of color). Such techniques are among the most practical, but they are less sensitive than methods based on photoluminescence, which are described later. For a fingerprint, approximately 100 ng of reactant product is necessary to obtain a significant colorimetric signal.

TABLE 3.3
Absorption Mode Demonstrated Using Three Colored Spots (Blue, Yellow, and Red) on a White Substrate

Observation Conditions	Appearance	Effect
White incident light (no observation filter)	 blue yellow red	White substrate will appear white (reflects all colors). Blue spot will appear blue (reflects blue, absorbs all other colors). Yellow spot will appear yellow (reflects yellow, absorbs all other colors). Red spot will appear red (reflects red, absorbs all other colors).
Blue incident light (no observation filter) or white incident light with observation through a blue bandpass filter	 blue yellow red	White substrate will appear blue. Blue spot will appear blue, Yellow spot will appear black (absorbs blue, no reflected light). Red spot will appear black (absorbs blue, no reflected light).
Yellow incident light (no observation filter) or white incident light with observation through a yellow bandpass filter	 blue yellow red	White substrate will appear yellow. Blue spot will appear black (absorbs yellow, no reflected light). Yellow spot will appear yellow. Red spot will appear black (absorbs yellow, no reflected light).
Red incident light (no observation filter) or white incident light with observation through a red bandpass filter	 blue yellow red	White substrate will appear red. Blue spot will appear black (absorbs red, no reflected light). Yellow spot will appear black (absorbs red, no reflected light). Red spot will appear red.

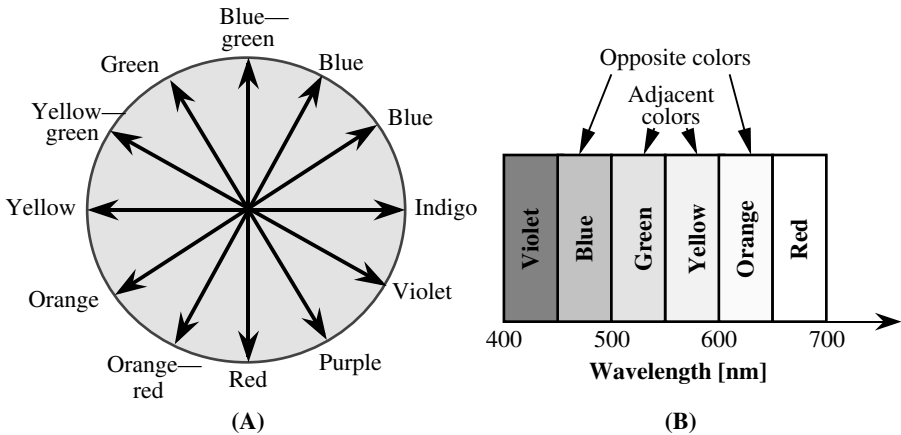

FIGURE 3.24 The color wheel can be used for the selection of a filter to improve contrast. Colors that are opposite on the wheel are complementary.

As a general rule, the selection of a filter, or a colored incident light, to improve contrast can be made with the aid of a color wheel (Figure 3.24). Opposite (complementary) colors on this wheel will darken the color observed (i.e., increase the contrast), while adjacent colors will lighten the observed color (i.e., reduce the contrast). The absorption mode improves photographic contrast and is relatively simple to implement (Barker 1999). It requires any white light source and a bandpass filter compatible with an absorption band of the colored object of interest. In simple terms, the bandpass filter should be opposite in color to the color of the object while being as close in color to the background substrate as possible.

To illustrate the implementation of the absorption mode, consider a red fingerprint on a white surface. The simplest way to photographically enhance the print is to use the absorption mode. The absorption mode can be implemented in two ways: (a) with an appropriate filter (a blue–green filter in this case) in front of the camera, or (b) with the same filter in front of the light source. The filter used in front of the camera is known as the barrier filter. The method with a filter in front of the camera (Figure 3.25) can be used in all situations, even if daylight or artificial light is present. If an appropriate barrier filter is not available but is incorporated into the light source, the absorption mode can be implemented by using this band of light (Figure 3.26). In this latter case, the room must be darkened for optimum results.

Enhancement using the absorption mode may be unsuccessful if the surface is similar in color to the object of interest. Changing the wavelength of the band of light can sometimes produce better results. (A light source with fine-tuning capabilities will be an advantage in such cases.) If the color of the object is pale, or if the object appears transparent, the absorption mode may not offer satisfactory enhancement, and other modes (or chemical treatment to modify the colorimetric properties of the object) should be exploited to achieve possible enhancement.

A ninhydrin-developed fingerprint, when viewed under white light, will appear purple in color. Some wavelengths will be absorbed by the print, while other are

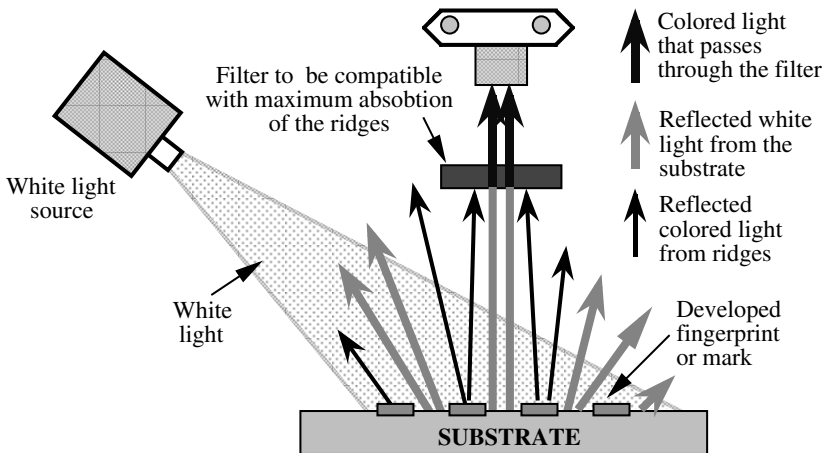

FIGURE 3.25 Schematic representation of the absorption mode with the appropriate filter used in front of the camera. This method can be used in all situations in the presence or absence of daylight or artificial light.

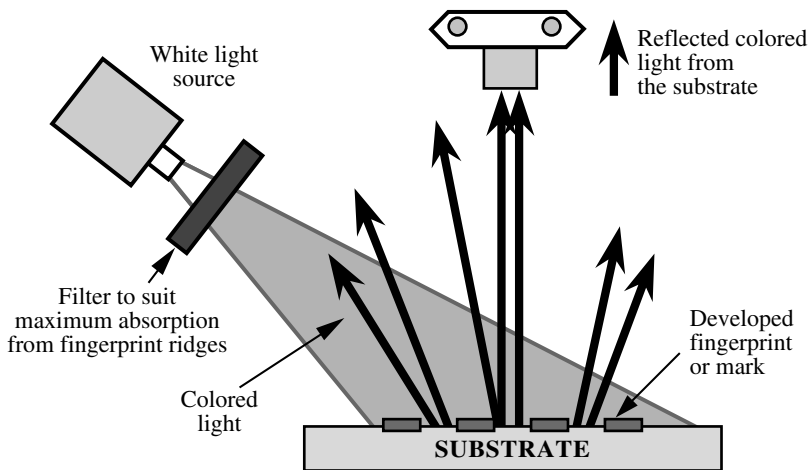

FIGURE 3.26 Schematic representation of the absorption mode with the appropriate filter in front of a light source. This method can be used only in dark or semidark situations.

reflected. The combination of reflected wavelengths (principally in the blue and red regions) is perceived by the human eye as being purple in color. The purple color is due to a compound known as Ruhemann's purple, which is formed when ninhydrin reacts with a latent fingerprint. The absorption characteristics of Ruhemann's purple need to be taken into consideration if the best contrast is to be obtained using the absorption mode.

A typical absorption spectrum for a ninhydrin-developed fingerprint is depicted in [Figure 3.27](#). It can be seen that there are two absorption bands: a narrow band with a maximum at around 410 nm (violet region) and a broad major band with a

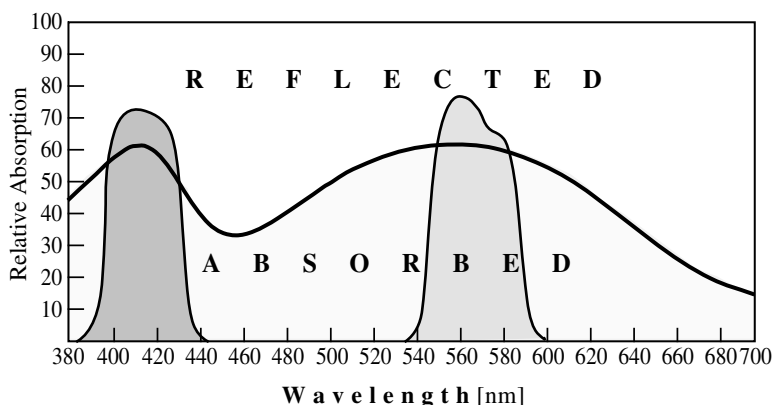

FIGURE 3.27 A typical absorption spectrum for a ninhydrin-developed fingerprint. There are two absorption bands: a narrow band with a maximum at around 410 nm (violet region) and a broad major band with a maximum at around 560 to 580 nm (green–yellow region).

maximum in the region of 560 to 580 nm (green–yellow region). The best contrast can be obtained by using a bandpass filter in front of the camera, or in front of the light source, that suits one maxima (560 to 580 nm) or the other (410 nm) in the absorption spectrum.

When working in the violet or red regions of the spectrum, it must be remembered that the human eye has low sensitivity at these wavelengths. Enhancement under such conditions may appear poor but will generally be significantly improved in any photographic images.

3.3.10 DIFFUSED REFLECTION MODE

This method of acquiring information is based on diffused reflection from a rough object on a surface that is dark or that is flat and shiny (Figure 3.28). In such a case, more diffusely reflected light from the object will reach the camera than reflected light from the surface. The object will therefore appear light against a dark background. This method can be used for the observation and photography of an object that is on top of, or indented into, a surface. Classical examples include a finger or footwear mark in blood on a dark or a flat and shiny surface, a footwear impression in dust, or a greasy fingerprint on a smooth shiny surface. The light beam used for illumination should be directed at an angle to the surface (starting at 45°, then varying the angle as required), with the working area darkened.

In the case of a colored object, a monochromatic light band of similar color to the object should be used to enhance the diffused reflection. In the case of a colored surface, a monochromatic light band with a color opposite to the color of the surface should be used to darken the surface (i.e., increase the contrast between the object and the surface). Oblique lighting (i.e., light beam almost parallel to the surface) is required in some cases (e.g., footwear impressions in dust or cyanoacrylate-developed fingerprints).

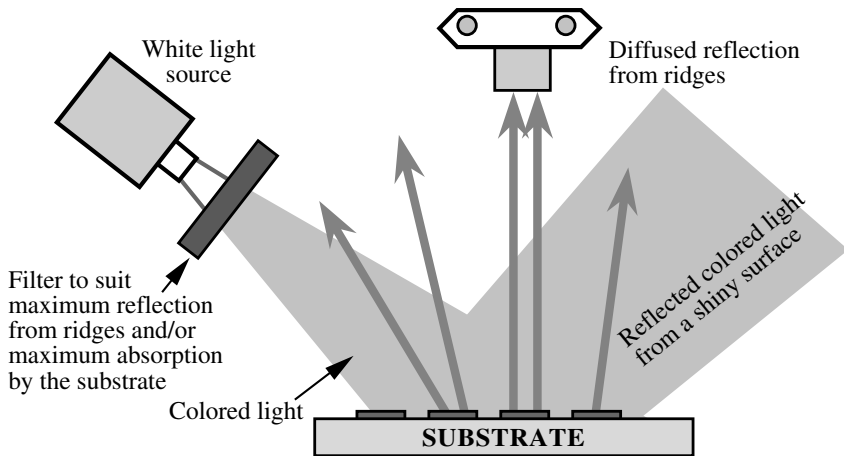

FIGURE 3.28 A schematic representation of the diffused reflection mode.

Used in the transmission mode, this technique is the basis of dark-field illumination in light microscopy. The phenomenon is observed when the incident light rays are diffused and refracted differently by a sample on a transparent surface such as glass. A fingerprint on glass, with transmitted oblique lighting, will be observed as light ridges against a dark background (Figure 3.29).

This method, already documented 100 years ago (Reiss 1903), can be used to efficiently image marks on glass surfaces. Diffused transmission techniques can also be utilized for the fast screening of cyanoacrylate-developed prints on clear plastic bags. The light beam from a forensic light source is directed onto one side of the bag, with examination done from the other side. Care should be exercised to ensure that the eyes are not exposed to the direct beam from the light source!

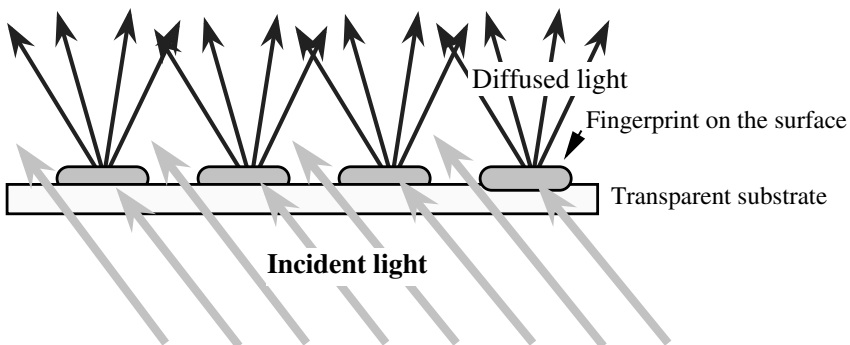

FIGURE 3.29 The diffused reflection mode as applied to a transparent substrate. Note that the incident light is directed at an angle from underneath the object.

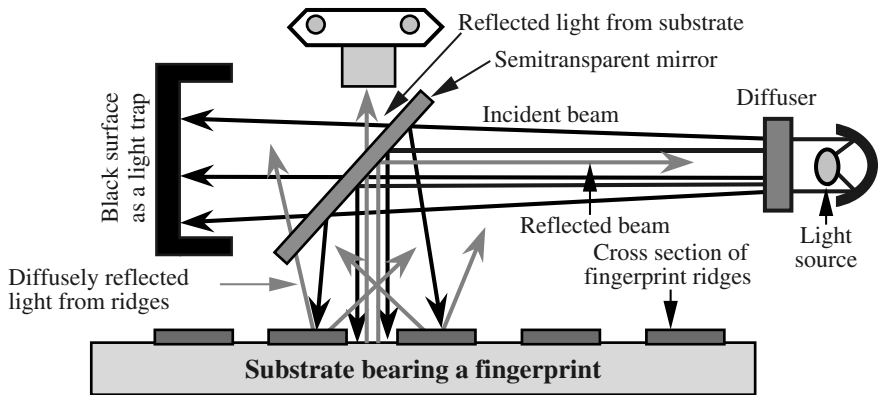

FIGURE 3.30 A schematic representation of episcopic coaxial illumination. (From Pfister, R. [1985], The optical revelation of latent fingerprints, *Fingerprint Whorl*, 10, 64–70. With permission.)

3.3.11 EPISCOPIC COAXIAL ILLUMINATION

Episcopic coaxial illumination is a special implementation of the diffusion reflection mode. The incident light is directed along the camera lens axis (i.e., perpendicular to the surface). This effect can be achieved by mounting a semitransparent mirror (or flat piece of glass) in front of the camera at an angle of 45° toward the lens axis/light path (Figure 3.30). The incident light beam is directed onto the mirror at an angle of 45° toward the mirror. To avoid “hot” spots, a diffuser is recommended in front of the light source. Part of the incident beam is reflected from the semitransparent mirror and travels along the lens axis toward the exhibit. The other part of the incident beam passes through the mirror and is trapped by a black surface. The incident light is reflected more from the flat surface (specular reflection) than from the ridges (diffused reflection), producing the opposite result to the conventional diffused reflection mode (i.e., it results in a dark image against a light background). Episcopic coaxial illumination can be successfully used for photographing latent fingerprints, fingerprints in blood, or cyanoacrylate-developed fingerprints on smooth shiny surfaces (e.g., glass, metal, plastic) (Pfister 1985; Ziv and Springer 1993). The surface must be as flat as possible to obtain optimum results.

3.3.12 PHOTOLUMINESCENCE MODE

Photoluminescence emission is always very weak compared with the excitation light, and it is shifted toward the red end of the spectrum (Figure 3.31). If white light is used for excitation, weak photoluminescence emission cannot be seen, as it is swamped by the incident light.

The chemical compounds of interest to us usually have one main absorption (excitation) band and will absorb only those wavelengths (colors) that match this band. White light can be reduced to the wavelengths of interest by placing a bandpass

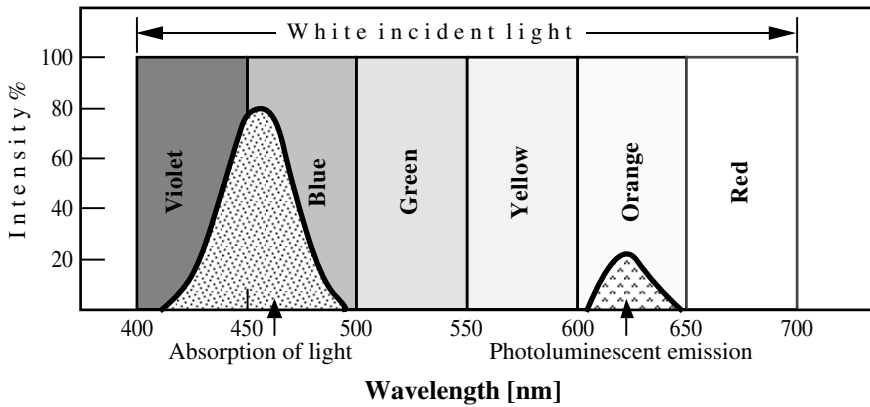

FIGURE 3.31 Absorption and emission curves for a theoretical photoluminescent material with white incident light.

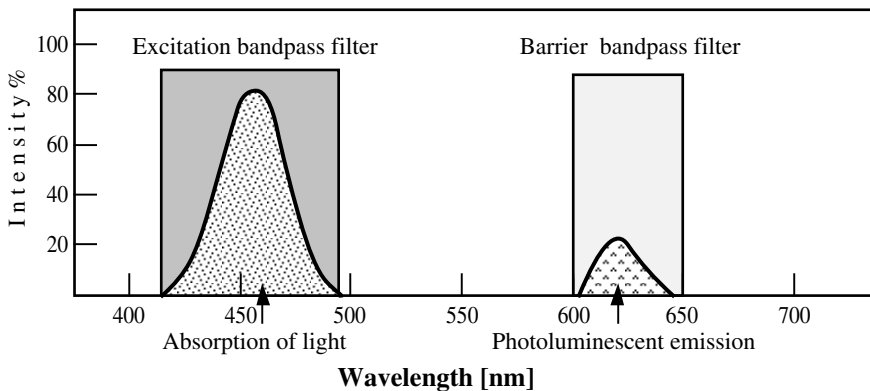

FIGURE 3.32 Absorption and emission curves for a theoretical photoluminescent material with choice of appropriate excitation and barrier filters.

filter in front of the light source. The bandpass filter should match the absorption band (Figure 3.32).

A barrier filter is then required in front of the eyes (or camera) that will reject the very strong excitation light reflected from the surface while transmitting the weak photoluminescence emission. The barrier filter should therefore match the emission band without overlapping with the excitation band (Figure 3.33). This method of gathering information based on the photoluminescence emission of a material is known as the photoluminescence mode.

In practice, the choice of appropriate filters is made according to excitation and emission spectra of the photoluminescent compound of interest (Figure 3.33). An excitation spectrum shows the change in emission intensity vs. excitation wavelengths for a fixed emission wavelength. In general, this spectrum corresponds to the absorption spectrum of the compound. The emission spectrum shows the change

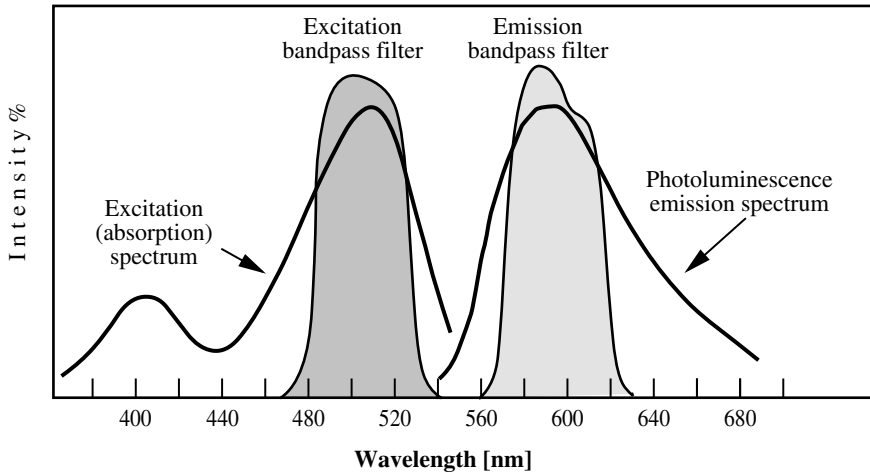

FIGURE 3.33 Excitation and emission spectra for a ninhydrin-developed latent fingerprint post-treated with cadmium nitrate (as an example) with the choice of appropriate filters for excitation and emission.

in emission intensity vs. emission wavelength for a fixed excitation wavelength. Excitation and emission spectra for a given material are often displayed on the same graph.

To implement the photoluminescence mode, two filters are necessary: one in front of the light source and another in front of the eyes (or camera) (Figure 3.34). The only exception to this is when a monochromatic light source (e.g., laser or forensic light source [FLS]) is employed. In this case, only a barrier filter is required. Due to the weak light emission that results, all observation and recording in this mode must be done under darkened conditions (as dark as possible). In addition, the excitation source should be powerful, and the barrier and excitation filters must

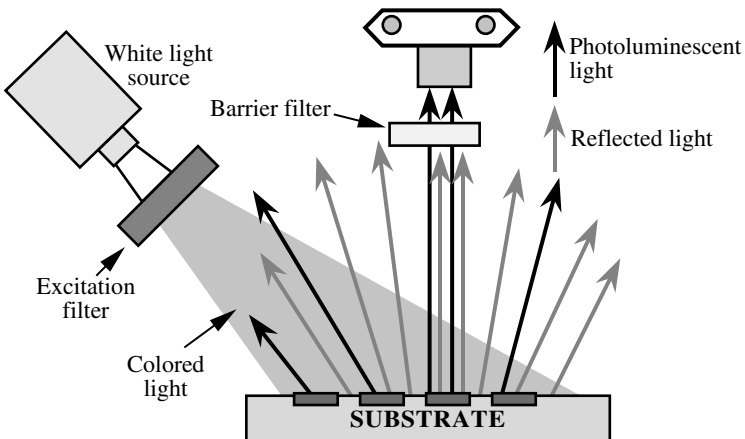

FIGURE 3.34 Arrangement for photoluminescence observation.

be compatible (i.e., the barrier filter should not transmit any of the excitation light). Under ideal conditions, a photoluminescent object will produce a light image (luminescent) against a dark background (nonluminescent). In reality, a substrate always shows some photoluminescence, and the background may be more or less dark, but rarely black. The photoluminescence of the substrate has to be taken into account during recording, and conditions must be optimized to obtain the best possible contrast.

The intensity of photoluminescence emission depends on temperature. As the temperature decreases, some of the competing processes mentioned above (e.g., energy loss by molecular vibration) are attenuated, thus enhancing the photoluminescence pathway. Sometimes this enhancement is dramatic, as is the case for the Ruhemann's purple–cadmium complex. At room temperature, photoluminescence of the complex is negligible, while at the temperature of liquid nitrogen (77 K or -196°C), photoluminescence is very strong and has an excellent practical application for the enhancement of weak ninhydrin-developed latent fingerprints.

The main advantage of the photoluminescence mode is its sensitivity. When used under optimum conditions, picograms ($\text{pg} = 10^{-12} \text{ g}$) of a substance can be detected, while in the absorption mode (colorimetric techniques), detection limits are typically in the nanogram range ($\text{ng} = 10^{-9} \text{ g}$). It is for this reason that significant research has been conducted over the last 20 years directed at the development of luminescence techniques for the detection of latent fingerprints.

3.3.13 TIME-RESOLVED IMAGING

The photoluminescence mode offers enhanced sensitivity compared with other modes employed for latent fingerprint detection and recording. However, this is the case only if the luminescence emission from the fingerprint is stronger than the luminescence of the background. When the luminescence of the fingerprint is equal to or weaker than the luminescence of the background, the extraction of fingerprint detail is generally no longer possible. Menzel has suggested a number of methods that exploit phosphorescence (delayed fluorescence) as a solution to this problem (Menzel 2001): time-resolved and phase-resolved imaging. (The latter is still being developed and may not be easy to apply.) To date, we do not have a routine fingerprint reagent that develops luminescent fingerprints with significant phosphorescence. However, the basic principles of time-resolved imaging are of interest.

Let us assume that a developed fingerprint shows some phosphorescence properties (i.e., it continues to emit light for some time after removal of the excitation source). In most cases, the background exhibits fluorescence properties only (i.e., it stops emitting light as soon as the excitation source is removed). All we need in this situation is to watch the fingerprint at a time when the light source is off. A classical phosphoroscope (Figure 3.35), a device used for phosphorescence measurements, can be used to achieve these conditions.

The exhibit is placed within a large cylinder with two opposite slots. When the cylinder rotates, the exhibit is exposed to a light flash at one time, and the phosphorescence emission is picked up by a camera some time later. The limitation of the phosphoroscope approach is that a large cylinder is needed to accommodate large

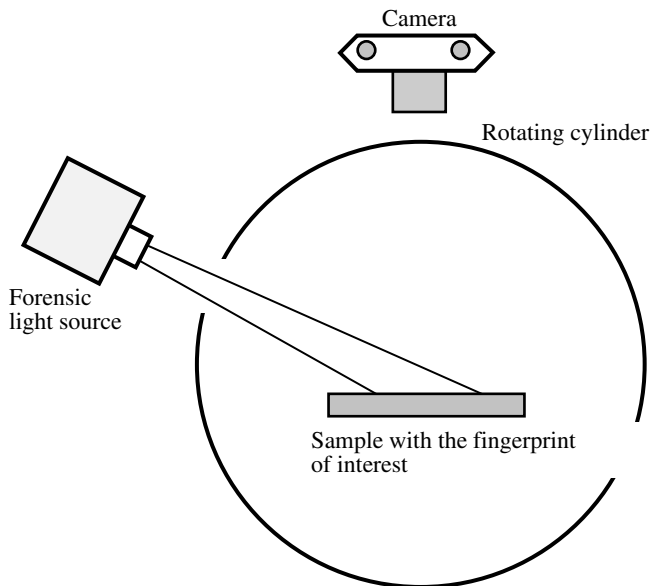

FIGURE 3.35 A phosphoroscope can be used for the recording of a phosphorescent fingerprint.

exhibits. Menzel (2001) has suggested as an alternative a pulsed laser and an electronically gated video camera, with the camera opening its shutter in between laser pulses. Another option for gathering phosphorescence emission is to use two alternatively driven fast liquid-crystal shutters (Figure 3.36), one placed in front of the light source and the other in front of the camera.

3.3.14 ULTRAVIOLET ILLUMINATION TECHNIQUES

A range of ultraviolet (UV) illumination techniques are available that can be generally classified as follows:

UV-VIS photoluminescence — illuminating the surface with UV light (short- or long-wavelength UV) while observing luminescence emission in the visible (VIS)

UV-UV photoluminescence — illuminating the surface with short-wavelength UV light (200 to 300 nm; UV B) while observing luminescence emission in the long-wavelength UV region (300 to 400 nm; UV A)

UV reflection — illuminating the surface with UV light (short- or long-wavelength UV) while observing light reflected in the same wavelength region

Working with any UV illumination technique poses a number of hazards to the operator, in addition to technical difficulties, when recording results. The human eye is insensitive to UV light, so any observation in the UV region cannot be achieved

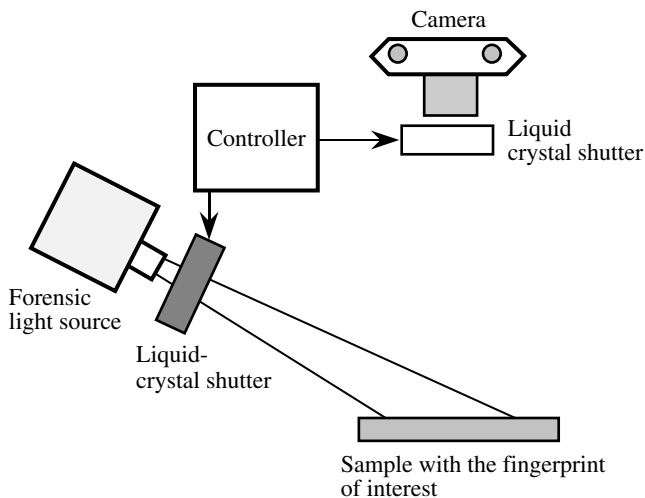

FIGURE 3.36 Two alternatively driven fast liquid-crystal shutters, one placed in front of the light source and the other in front of the camera, can be used to gather phosphorescence emission.

directly (a photographic or video camera is required). Due to its high energy, UV light can cause significant eye and skin damage, so personal protection is required. Short-wavelength UV lamps generate ozone that can be hazardous to the operator. Glass absorbs short-wavelength UV light, so any observation in this region cannot be achieved using conventional glass lenses, thus requiring the use of very expensive optical components (quartz, fluorite, etc.). (Glass also absorbs a large proportion of long-wavelength UV light, so quartz optical components are also recommended when working in this region.) Conventional photographic film generally shows poor sensitivity below 400 nm. While these difficulties can be largely overcome, particularly with respect to recent technological advances, they have limited the widespread use of UV illumination techniques at the crime scene.

UV–VIS photoluminescence is the simplest mode to apply, in that the observation of results is conducted in the visible region and therefore can be achieved with the naked eye. The technique can be used to locate items that are luminescent in the visible spectrum when illuminated with UV light. Optical brighteners used in textile fibers, paper, and paint typically show strong photoluminescence emission under such conditions. Alternatively, the technique can be used to locate UV-absorbing materials (e.g., blood) on highly luminescent surfaces. Photography (or video capture) should be conducted with a filter on the camera that transmits in the visible but blocks any reflected UV light (Figure 3.37).

UV–UV photoluminescence requires illumination of a surface with short-wavelength UV light. A photographic or video camera, fitted with a barrier filter that only transmits long-wavelength UV light, is required for image capture. It has been determined that a range of biological fluids (including latent fingerprint deposits) can photoluminesce under such conditions (Bramble et al. 1993; Springer et al.

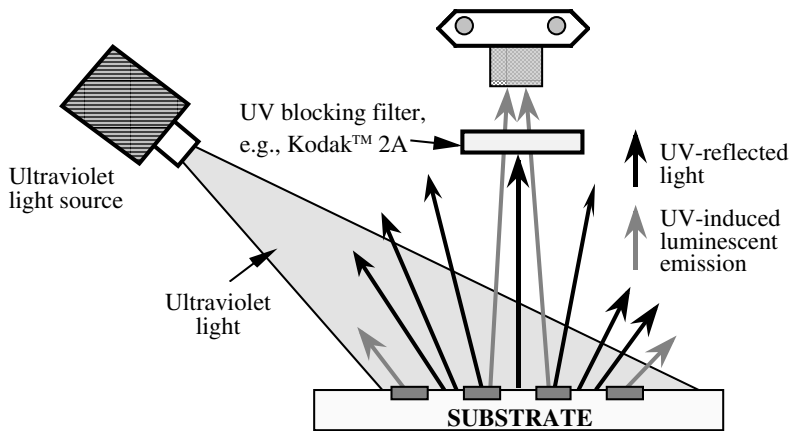

FIGURE 3.37 Typical setup for the photoluminescence mode with excitation in the UV region and observation in the visible region.

1994). In general, photoluminescence emission in the UV is very weak, and it is difficult to capture an image on conventional film or using a CCD (charge-coupled device) camera. The problem can be overcome by either (a) using a CCD camera with image integration capabilities, or (b) using a light-intensifier device, in which case information is not acquired directly from the object but from the phosphor screen of the image intensifier.

UV reflection requires the use of either a short- or long-wavelength UV lamp and a photographic or video camera fitted with a barrier filter that only transmits in this region (i.e., either short- or long-wavelength UV) (Figure 3.38). It is important that only reflected light is recorded, not light reemitted at longer wavelengths (i.e., photoluminescence emission). If light reflected in the short-wavelength region is being recorded, quartz objectives must be employed. Reflected UV techniques have been demonstrated to be effective for the visualization of untreated fingerprints and footwear impressions, in addition to the recording of wounds or bruising on human skin (West et al. 1990).

3.4 FORENSIC LIGHT SOURCES AND THEIR APPLICATION

Specialized light sources, including lasers and high-intensity filtered lamps, have been employed for many years as an aid to fingerprint enhancement and crime scene examination in general. The term *forensic light source* (or FLS) is commonly used to refer to an illumination system adapted for such use. Numerous forensic light sources, from a number of manufacturers, are now available on the market. When used correctly, an FLS can facilitate the search for a range of evidence types including footwear impressions, hairs and fibers, firearm discharge residues, lubricant stains, biological material (e.g., blood, semen, urine, and saliva), and latent fingerprints (both pre- and post-treatment).

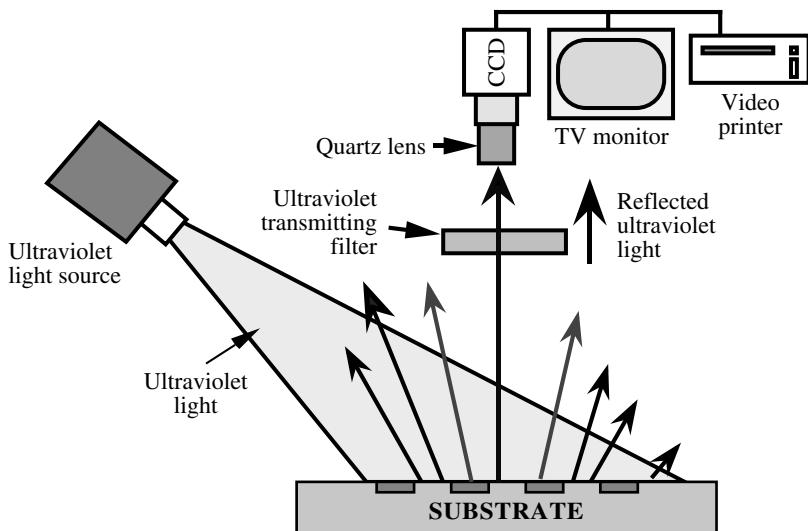

FIGURE 3.38 Implementation of the UV reflection mode.

An interest in the forensic application of lasers was initiated in 1977 when Dalrymple and coworkers (1977) reported on the detection of untreated latent fingerprints using photoluminescence techniques. The development of high-intensity filtered lamps as more versatile, cost-effective alternatives to the laser was subsequently pursued in the early 1980s in Australia, Great Britain, and Canada. A nonlaser forensic light source is sometimes referred to as an alternate light source (ALS).

It is not the purpose of this section to compare the forensic light sources currently available on the market. Consideration will only be given to the basic requirements for a multipurpose light source designed for forensic use. An FLS needs to be portable, yet powerful enough for use under a range of conditions. To cover all potential forensic applications, the light source must be versatile, offering a range of different light bands from the ultraviolet through to the red end of the visible spectrum. Ideally, these bands should be as narrow as possible (typically less than 50 nm in width) while maintaining sufficient light intensity. This is particularly important if the photoluminescence mode is to be employed.

Since the late 1970s, lasers have been proposed for the detection and enhancement of a wide range of evidence types, including latent fingermarks, footwear impressions, paint, fibers, and biological stains (Creer 1982; Menzel 1987). The laser (light amplification by stimulated emission of radiation) offers high light intensity and precisely delimited operating wavelengths (monochromatic laser lines). However, lasers tend to suffer from a lack of flexibility (for a given type of laser, only a limited number of wavelengths are available) and a relatively high cost (Watkin and Misner 1990). Lasers were traditionally large, fixed laboratory instruments but are now available as portable units. During the 1980s, different research groups around the world independently developed nonlaser light sources as more

versatile, cost-effective alternatives to the laser (Stoilovic et al. 1987; Watkin 1987; Haylock 1989). Comparisons between different light sources have been reported by a number of authors (Warrener et al. 1983; Auvdel 1988; Wilkinson and Watkin 1994).

The forensic light sources on the market are typically designed around a strong white-light source (e.g., xenon arc lamp) fitted with a range of filters that allow for the selection of a particular monochromatic band of light. The power of the light source and the characteristics of the filters (e.g., bandwidth and transmission at the center wavelength) determine the light intensity. The quality of the filters (e.g., light rejection outside the bandpass region) is critical if optimum results are to be achieved. The use of high-quality interference filters has the advantage that such filters can be tilted in the light path to shift the transmission band to shorter wavelengths. (This fine-tuning capability can be particularly important in cases where background photoluminescence creates a contrast problem.) A schematic diagram of a typical nonlaser FLS is given in Figure 3.39. The essential components are as follows:

- *Lamp* — The lamp (lightbulb) determines the initial power available and should be of a long-lasting type (e.g., arc lamp). The lamp output should adequately cover the UV and the entire visible spectrum. The minimum recommended power is 300 W.
- *Cold mirror* — A cold mirror is used to reject infrared radiation (heat) by reflection and transmit UV and visible light. The mirror should have a high transmittance in the UV and visible regions. If infrared output is required, then the cold mirror needs to be bypassed. A cold mirror may not be necessary if hard-coated filters are employed.
- *Bandpass filters* — Bandpass filters determine the monochromatic bands of light that can be selected. The filters have to be of high quality, preferably hard-coated multilayer interference filters with an antireflective coating. The color of a band is determined by the filter's central wavelength (CW), while the half-bandwidth (HBW) and maximum transmission determine the purity and power. Requirements for higher purity of a band result in the lowering of the transmitted power. Therefore a compromise has to be made for each band.

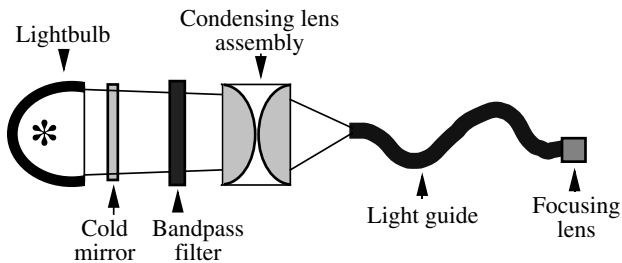

FIGURE 3.39 Schematic representation of a forensic light source.

- *Collimating lens assembly* — The collimating lens assembly should focus the colored light beam onto a small spot at the entrance of the light guide. The lens should be highly efficient, with an antireflective coating.
- *Light guide* — The light output should be delivered through a light guide so that the beam can be readily directed at an area of interest. Single-core liquid light guides (7 to 10 mm diameter) are favored, as they have a much higher transmission efficiency compared with fiber-optic bundles. High transmittance is required from the UV through the entire visible region.
- *Focusing lens* — A focusing lens at the end of the light guide should be able to focus the light spot with sharp edges in order to achieve a uniform light field. Uniformity of the light spot is of utmost importance for successful photography. It should be possible to focus the beam over a large area for rapid screening or over a small area (several square centimeters) for the photography of a small subject such as a photoluminescent fingerprint.

Before the recording of an object using illumination from an FLS, the light spot needs to be focused and its size correctly adjusted. The spot size is adjusted by varying the distance between the light guide and the object. The focusing can then be done with the lens attached to the end of the light guide. When photographing an object (e.g., fingerprint), it is important that the light spot covers the entire field of view of the camera; otherwise, the automatic exposure will not be correct.

A dedicated forensic light source for crime scene applications should be able to provide a narrow band of intense light at any wavelength of interest to the investigator. The essential bands for an FLS are represented in [Table 3.4](#).

Other bands may be beneficial under particular circumstances. A list of recommended barrier filters and goggles is given in [Table 3.5](#). Given the high intensity of light produced by modern light sources, suitable eye protection must be worn and precautions taken to ensure that the eyes are never directly exposed to the full intensity of the beam. Care must therefore be exercised when examining highly reflective surfaces using an FLS, and manufacturers' recommendations should be carefully observed.

3.5 PHOTOGRAPHY

3.5.1 INTRODUCTION

The word *photography* comes from two ancient Greek words: *phôtos*, for “light,” and *graphein*, for “writing.” Photography can therefore be described as “writing with light.” When a photograph is made, light or some other form of radiant energy, such as x-rays, is used to record a picture of an object or scene on a light-sensitive surface. The two types of light-sensitive surfaces currently in use are based on: (a) the photochemical reaction of a light-sensitive material (classical photography), and (b) the photoelectrical effect on a light-sensitive chip (digital photography). Light is the essential ingredient in all forms of photography, and therefore the physical

TABLE 3.4
Recommended Output Bands for a Forensic Light Source (FLS)

Central Wavelength (nm)	Half-Bandwidth (nm)	Applications
White light	—	Visible fingerprints or stains, impressions in dust (oblique lighting), trace evidence on smooth surfaces (oblique lighting), general searching
350	50–80	Latent fingerprints on UV-luminescent surfaces, prints dusted with UV-luminescent powder, semen stains, firearm discharge residues, textile fibers, paint flakes, lubricants
415	30–40	Dried bloodstains, fingerprints in blood, semen stains, firearm discharge residues, textile fibers, lubricants
450	60–100	Inherent fingerprint luminescence, general searching in the luminescence mode, semen stains, firearm discharge residues, textile fibers, lubricants
500	30–50	Semen stains, firearm discharge residues, enhancement of metal-salt-treated ninhydrin prints (absorption mode)
550	30–50	Semen stains, enhancement of ninhydrin prints (absorption mode)
600	30–50	Enhancement of blood marks stained with amido black or fingerprints developed with iodine/benzoflavone (absorption mode)

principles of the technique are governed by the physics of light. A number of good textbooks exist (e.g., Jacobson et al. [2000]) that give a thorough treatment of the material outlined in this section. Only the more critical parameters are summarized here for the benefit of fingerprint detection specialists.

3.5.2 IMAGE FORMATION

An image can be formed on a flat surface using either a pinhole (Figure 3.40) or a lens (Figure 3.41). A pinhole forms an image using a single ray from each object point. The number of rays coming from the object is therefore drastically reduced, resulting in a very faint and somewhat blurred image due to diffraction effects. Very sensitive photographic media and/or long exposure times are needed to record such an image. Much better images can be obtained using a lens. Lenses can focus light rays, producing much sharper images. Due to a much larger aperture (lens opening equal to the approximate diameter of the lens), light throughput through the lens is several thousands times higher than that of a pinhole.

A simple lens suffers from a number of limitations, called “aberrations,” that prevent the formation of a perfectly focused image. Two of the most important limitations are spherical and chromatic aberrations. Spherical aberration is the phenomenon whereby perimeter rays bend more (i.e., focus at shorter distances) than axial rays (Figure 3.42). The spherical aberration effect can be reduced by masking

TABLE 3.5
Recommended Barrier Filters and Goggles for Use with a
Forensic Light Source (FLS)

Bandpass Filters	
Central Wavelength (nm)	Half-Bandwidth (nm)
410–420	30–40
550–570	30–50
580–600	30–50

Long Pass (Cutoff) Filters	
Edge Wavelength (nm)	Color
400–420	clear
460–480	yellow
490–520	yellow
530–570	orange
580–600	red
620–650	red

Goggles	
Edge Wavelength (nm)	Color
400–420	clear
480–520	yellow
560–580	orange
600–650	red

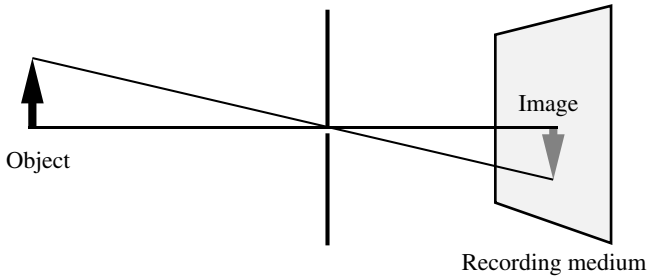

FIGURE 3.40 Formation of an image using a pinhole.

the perimeter rays through the introduction of a diaphragm in front of the lens (Figure 3.43). Chromatic aberration is the phenomenon whereby shorter wavelengths bend more (i.e., focus at shorter distances) than longer wavelengths (Figure 3.44).

Although modern camera lenses are made of many sophisticated components, aberrations can only be reduced (not eliminated), and the effects may still be apparent in some situations. It is important to be aware of the limitations imposed by these aberrations and to take precautions, where possible, to limit their effects.

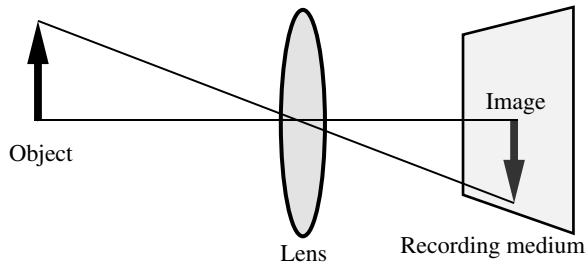

FIGURE 3.41 Formation of an image using a lens.

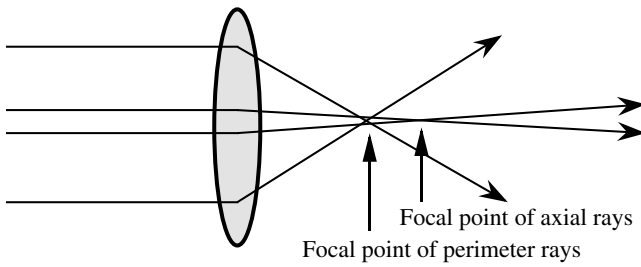

FIGURE 3.42 Schematic representation of spherical aberration.

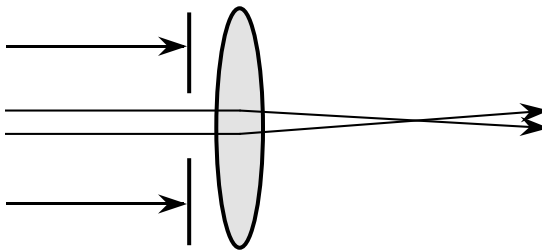

FIGURE 3.43 A diaphragm in front of the lens reduces the lens aperture, thus reducing the spherical aberration effect.

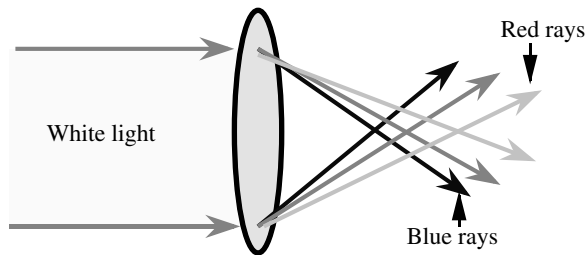

FIGURE 3.44 Schematic representation of chromatic aberration.

3.5.3 PHOTSENSITIVE MATERIALS AND IMAGE SENSORS

Many substances are light sensitive, but silver halides (silver combined with elements of the halogen group: bromine, chlorine, and iodine) offer properties that made them materials of choice for conventional photography. The process involves the use of complex emulsions of silver halides, and other chemicals, suspended in gelatin. A transparent and inert support (e.g., glass or plastic film) is uniformly coated with this gelatin mixture, and an excellent light-sensitive medium is achieved once the gelatin hardens. When the medium is exposed to light, silver halide crystals suspended in the emulsion undergo chemical changes to form what is known as a latent image — an invisible image that can be developed. The light exposes nuclei of metallic silver on the silver halide grains that are subsequently amplified up to a billion times during development to produce a visible image. Film resolution comes from the random distribution of the silver halide grains through the emulsion layer. Grain size is generally not homogeneous, but the grains are extremely small, with the largest grains being only about 2 μm in diameter (grain size is generally in the range 0.03 to 1.5 μm).

When the photographic medium is processed in a chemical agent called a “developer,” particles of metallic silver form in areas that were exposed to light. Once an image is developed, a “fixer” is used to remove all unreacted silver halides. Intense exposure to light produces a high concentration of silver particles, while weak exposure causes few to form. The relation is linear over a certain range of exposures, but with very low- or very high-intensity light, exposure deviation is observed, and this is called reciprocity-law failure. The linear range is the useful range of a film; however, this range may be modified by development conditions that can be adapted in order to obtain contrast within a specific imaging zone.

The image produced in this manner is called a “negative” because the tonal values of the object photographed are reversed (i.e., areas that were relatively dark appear light, and areas that were bright appear dark). The tonal values of the negative are reversed again in the photographic printing process. This is achieved by shining light through the negative onto another light-sensitive medium (usually photographic paper), which is then developed and fixed.

A certain quantum of energy is required to sensitize the silver halide particles, and the energy needed is in the UV–violet–blue region of the electromagnetic spectrum. (It is for this reason that older films were not sensitive to yellow or red.) In order to approach the spectral sensitivity of the human eye, dye molecules are introduced that reduce the relevant energy levels required for silver halide sensitization, and a colored (yellow) layer is used to filter the excess UV–blue radiation reaching the sensitive crystal layer. Similarly, infrared-sensitive films will contain other dyes that will bridge the energy gap and shift the spectral sensitivity toward the red–infrared (IR) region of the spectrum. The use of IR-sensitive film will result in incorrect tonal reproduction, but it may lead to the detection of marks barely visible to the naked eye.

Color photography is much more complex than black-and-white photography. Today’s color light-sensitive materials are made as three layers of dye-sensitized silver compounds, each one sensitive to either red, green, or blue radiation (RGB; primary colors). During the development process the silver is bleached out and

removed, leaving the color dyes behind. Any color in the visible spectrum can be obtained by combination of these three primary colors.

As well as the conventional two-step photographic process, where the first image produced is a negative, a one-step process also exists. A positive latent image is created when higher light intensities produce lighter tones and lower light intensities produce darker tones, forming an image that looks the same as the subject. When the latent image is developed and fixed, a photographic positive is obtained in one step. For example, color-reversal film, when processed, produces a positive transparency in which the colors match those of the original subject. Positive transparencies can be viewed by the transmitted light from a light box, or they can be mounted as a color slide for projection.

Instant or self-processing film, such as that produced by Polaroid, is available for taking both color and black-and-white photographs. With this type of film, the chemicals necessary to develop the latent image on the emulsion and produce a finished print are included in the film itself. The chemicals, present in the form of microcapsules, are automatically activated when the film is removed from the camera. Development may take place very rapidly — within a matter of seconds — depending on the particular make of film and the ambient temperature. Although this “instant” photography may be satisfactory in many situations, the quality of these photographs is inferior to those obtained by two-step image formation.

Digital images are created by light falling on an electronic receptor, generally a charge-coupled device (CCD) that converts light into an electrical signal that is then processed by a computer to form an image. CCDs are made up of individual picture elements (pixels) that generally present a square shape of uniform size to the incoming light. The resulting image is a mosaic of minute blocks of color. CCDs with large numbers of pixels generally produce higher resolution images than those with lower pixel counts. The size of each pixel determines the sensitivity of the CCD chip: CCDs with large pixels can gather more light per pixel and therefore have a higher light sensitivity than CCDs with smaller pixels. Chips with larger pixels also have a greater dynamic range (exposure latitude) than those with small pixels. Overall image quality is therefore determined by both the total pixel count of the CCD and the size of the individual pixels. Professional digital cameras employ large image sensors (CCDs) with large pixels, while consumer digital cameras typically have very small CCDs with small pixels (Brown 2000). Linear CCD arrays generally replace two-dimensional arrays for scanning devices and professional backs for some studio cameras.

For the recording of digital images, a number of different file formats exist (e.g., TIFF, JPEG, GIF, and many others), which can lead to difficulties in transferring images from one platform to another. The need for standards and intersystem compatibility demanded by users has led manufacturers to adopt widely accepted formats. File sizes can be very large, particularly with high-resolution images, and digital images can quickly overload storage media. Data compression techniques are generally required for efficient storage and rapid transfer capabilities. Forensic imaging applications generally require compression techniques where no data loss occurs (i.e., a decompressed image should be identical to the original image), resulting in a need for large storage capacities.

3.5.4 BLACK AND WHITE FILM (35 MM)

The features and quality of modern black-and-white films make them suitable for both general and enhanced fingerprint photography. This type of film is therefore considered in more detail in this section. A 35-mm film is created when a photo-sensitive silver halide emulsion is spread, in the form of a thin translucent gelatin layer, on one side of a 35-mm-wide acetate or polyester strip. The other side of the strip is covered with a layer of dyed gelatin (dark green, gray, or brown) that is removed during the development process. The treated strips are perforated along each edge so that the camera sprockets can advance the film after each shot (Figure 3.45). The standard image size for this film is 36 mm (width) by 24 mm (height).

Although the silver halide crystals are very small and not visible to the naked eye, they pack randomly over each other, creating agglomerates. These agglomerates are visible in an enlarged photograph as a grainy structure in the film. Many modern films are manufactured in a way to reduce the size of these agglomerates. Such films may require special developers and development conditions to further reduce the graininess.

The film speed (sensitivity) is an important characteristic of the film and is indicated by an ISO number that combines two previous standards: ASA and DIN. The speed of the film is determined by regulated procedures created by the American Standards Association (hence ASA) using a linear arithmetic scale and/or by the German industrial norms (DIN, Deutsche Industrie Normen) using a logarithmic scale. In 1974, the ISO (International Standardization Organization) standards were formulated by adopting the American ASA system and the German logarithmic DIN system, usually given with a degree symbol (e.g., DIN 22° [ASA 125]). The typical ISO film sensitivity sequence is as follows:

... 40/17°, 50/18°, 64/19°, 80/20°, 100/21°, 125/22°, 160/23°, 200/24°, 250/25°, 320/26°, 400/27°, 500/28°, 640/29°, 800/30°, 1000/31°...

It can be seen that the film speed sequence progresses in intervals of one-third. The effect of this is that every third number in the series is doubled. The speed number is directly related to sensitivity (i.e., film rated as ISO 200/24° is twice as fast as film rated as ISO 100/21°), and sensitivity doubles as the ASA value doubles or when the DIN value increases by 3°.

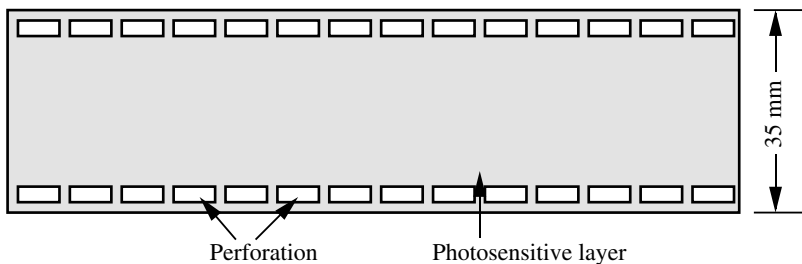

FIGURE 3.45 A strip of 35-mm film.

The two characteristics of speed and graininess are generally correlated, and it is very important to consider the relationship when choosing a film. In principle, the slow films (below ISO 80/20°) have a fine grain, produce very sharp images with high contrast, and cannot tolerate large exposure variations (i.e., have a narrow dynamic range). The fast films (above ISO 400/27°) have a coarse grain, produce soft images, and can tolerate large exposure variations (i.e., have a wide dynamic range). Mid-range films — 100/21° to 400/27° — combine medium grain with good sharpness and contrast, and can tolerate good exposure variations. However, improvements in film technology and development procedures may change not only the dynamic range, but also graininess and contrast.

An image is produced on a film by exposing the film to light, with the length of this exposure being the exposure time. The amount of light that falls on the film (exposure) depends on the intensity of the light and the exposure time. The amount of light needed to produce a useful image is inversely proportional to the film speed (i.e., the faster the film, the shorter the exposure time) and should fall within the linear range of the sensitometric curve (see Section 3.5.5). Underexposure produces pale images, reduced contrast and sharpness, and a loss of detail. Overexposure also reduces the sharpness of an image and may render the film useless. During overexposure, an extra amount of light travels sideways through the emulsion layer and/or reflects from the back of the film, producing a “halo” effect. Overexposure of this type is known as an “irradiation” or “burning in” effect and must be avoided at all cost.

Under normal conditions, film exposure obeys the reciprocity law, which states that the exposure effect remains constant as long as the product of exposure time and intensity of light is constant. This means that if light intensity is reduced by half, then the exposure time should be doubled. With extreme light conditions (e.g., low light levels or extremely bright light), requiring exceptionally longer (more than 10 sec) or shorter (less than 1/10,000 sec) exposure times, the emulsion acts with reduced sensitivity, producing reciprocity-law failure. To compensate for this effect, the exposure time should be increased, or a larger diameter lens (with higher light throughput) should be employed.

For fingerprint work, many fingermarks will show adequate contrast with the surface and will give reasonable results using photographic conditions within the manufacturer’s working range. Nevertheless, there are often less-than-ideal cases where deviations from standard working procedures may increase the dynamic range of the film and help improve overall results (e.g., by choosing to increase contrast in certain ranges of the film). Unfortunately, the professional training required to apply such techniques is often lacking within most fingerprint bureaus.

3.5.5 SENSITOMETRY

The inherent sensitivity to light of the various films, CCD sensors, and the human eye may differ considerably. It is worthwhile documenting sensitivity data for the different materials used within a service (fingerprint bureau, forensic science laboratory, crime scene imaging, etc.). This can then be compared with the spectral data from different detection techniques to ensure that the film or sensors in use properly

record the wavelengths of light coming from a mark. Color films will usually be manufactured to have a color balance mimicking the sensitivity of the eye, but this is not generally the case for black-and-white films. Film and CCD camera manufacturers generally have comprehensive technical data that can be obtained on request or that is available via the Internet.

Sensitometry can be used to measure objectively the response of an imaging system to light. Film manufacturers demonstrate the response of a film via a standardized response curve, plotting the density (units of blackening) against exposure to light (amount of light per unit time) expressed logarithmically. This so-called characteristic curve helps determine certain qualities of the light-sensitive material employed. The time needed for a certain amount of light to give a reproducible density in the recording medium is an indication of sensitivity (film speed). The slope of the linear portion of the curve (when an increase in light exposure reproduces a proportional change in density) is called the Gamma (γ). When this slope makes an angle of 45° with the horizontal axis, $\gamma = 1$, and the contrast of the image is comparable to the visual differences in the original scene. When this angle increases, a small increase in light exposure is expressed by a larger density difference in the image. This is an indication of the contrast of the light-sensitive material. The higher the contrast, the lesser is the detail in the image (at the extreme, all gray zones will be changed into black or white). It is usual for photographic films to work with a γ of 0.7, the image being of less contrast than the object, with a large range of gray zones to give fine detail. Desired contrast can then be introduced when processing the primary image. The length of the linear portion of the curve is an indication of exposure latitude (i.e., the range over which an increased exposure does not simultaneously limit detail in the image highlights).

Depending on purpose, the photographer will be able to select films with specific characteristic curves (high contrast, high speed, low contrast, etc.), and may change the characteristic curve by changing development conditions or signal treatment. Film manufacturers describe all these characteristics extensively in their technical data. It must be noted that modern films have been developed that do not have a linear γ and whose contrast can be changed on the upper or lower part of the curve. This can be used to advantage in the imaging of poor-quality marks.

Sensitometric curves will vary with wavelength (color), and it is important to know the response of the light-sensitive material in the wavelength range employed, especially when filtered light is being used, which is common with advanced fingerprint detection techniques. The manufacturer's information generally will not cover UV or IR sensitivity to the same extent as for the visible range. As a result, experimentation may be necessary when imaging marks in these domains.

To date, there is no standard method for characterizing the light sensitivity of digital cameras, but sensitometric parameters can be determined using calibrated gray scales; the camera CCD is used as a photometer, and the output in pixel value for each step of the gray scale can be plotted from 0 (black) to 255 (white). As there is an instantly visible response when using a digital camera, an image taken outside the useful exposure range will be obvious and can be taken again. In addition, contrast can be modified by treating the primary image with image-processing software such as Adobe *Photoshop*®.

3.5.6 CAMERA LENSES

Camera lenses are often referred to in generic terms such as *wide-angle*, *normal*, and *telephoto*. These terms refer to the “focal length” of the lens, which is typically measured in millimeters. Focal length is defined as the distance from the center of the lens to the image it forms when the image source is at infinity. In practice, focal length affects the field of view, magnification, and depth of field of a lens. In 35-mm photography, lenses with focal lengths from 20 to 35 mm are considered wide-angle lenses. They provide greater depth of field and encompass a larger field (or angle) of view but provide relatively low magnification. Extreme wide-angle, or fish-eye, lenses provide fields of view of 180° or more. Lenses with focal lengths from 45 to 55 mm are referred to as normal lenses because they produce an image that approximates the field of view of the human eye. Lenses with longer focal lengths, called telephoto lenses, constrict the field of view and decrease the depth of field while greatly magnifying the image. For a 35-mm camera, lenses with focal lengths of 85 mm or more are considered telephoto. A fourth generic lens type, the zoom lens, is designed to have a variable focal length, which can be adjusted continuously between two fixed limits. These lenses allow continuous control of image scale between the two limits.

In fingerprint work, there is a further lens type that should be used in most cases — the close-up macro lens, which usually has a focal length of approximately 50 mm. This allows close-up photography. It is standard practice to use extension rings to come even closer to the mark that is being documented. This allows full-size reproduction using the whole image field (for single fingerprint photography), permits more concentrated print illumination (more effective use of the light source), guarantees maximum resolution, and particularly for luminescent prints, limits light dispersion, thus resulting in a sharper image.

3.5.7 SHUTTER AND DIAPHRAGM

The shutter is a mechanical device in the camera that, on command, opens the light path toward the film for a preselected time (shutter speed) so that the film can be exposed. The shutter speed determines the exposure time and is given in numbers that represent the reciprocal value of the shutter opening time in seconds. Common camera shutter speeds are given in Table 3.6.

When the shutter is open, the light flux through the lens and onto the film is controlled by a diaphragm consisting of several overlapping metal or plastic leaves that control the lens aperture (A = active lens diameter). The diaphragm is usually

TABLE 3.6
Common Shutter Speeds

Shutter speed	1	2	4	8	15	30	60	125	250	500
Exposure time (sec)	1	—	—	1/8	1/15	1/30	1/60	1/125	1/250	1/500

mounted within the lens itself. The relative aperture, defined as the ratio between the focal length of the lens and the aperture, is used to represent the amount of light reaching the film. The relative aperture is known as the “*f*-number” or “*f*-stop” (for “stopping down,” reducing the amount of light), and a series of consecutive *f*-numbers (*f*-stops) is represented on a knurled ring on each lens. Each consecutive number in this series represents half the amount of light as the previous one (i.e., increasing the *f*-number decreases the diaphragm opening). The maximum relative aperture (the first number in the series) depends on the lens characteristics, maximum aperture (diameter), and focal length; therefore, each type of lens has its own series. An example of an *f*-numbers series is given in the Table 3.7.

A proper exposure is obtained by adjusting the shutter speed and the diaphragm aperture. These settings are directly proportional: a one-increment change in shutter speed is equal to a change of one *f*-stop. A one-stop adjustment in exposure can refer to a change in either shutter speed or aperture setting; the resulting change in the amount of light reaching the film will be the same. Thus, if the shutter speed is increased, a compensatory increase must be made in aperture size to allow the same amount of light to reach the film.

The aperture of a camera lens, given as the ratio “1:maximum *f*-number,” is generally written on the front of the lens. The focal length is the maximum *f*-number multiplied by the lens diameter. For example 1:1.4 for a 50-mm lens means that the focal length of the lens is 1.4 times the lens diameter. The ratio between focal length and *f*-number is known as the speed of the lens (or relative light-gathering power). For example, a lens *f*/2 is twice as fast (i.e., capable of capturing twice as much light) as a lens *f*/2.8.

3.5.8 RESOLUTION

The resolution of a camera system represents the ability of that system to reproduce two closely spaced points as separate images. The resolution depends on the optical system of the camera and the recording medium.

According to wave optics, the image of a distant small point origin produced by a lens is not a point, but, rather, a typical diffraction pattern consisting of a small disk (known as an Airy disk) surrounded by alternating dark and progressively fainter light rings, known as Airy rings (Figure 3.46A). In the case of two closely spaced distant point origins, there will be two closely spaced diffraction images (Figure 3.46B). As two point origins approach each other, their diffraction images overlap until they blend into one image (Figure 3.46C).

TABLE 3.7
A Series of Common *f*-Numbers

<i>f</i> -number (<i>f</i> -stop)	1	1.4	2	2.8	4	5.6	8	11	16	22
Amount of light (%)	100	50	25	12.5	3.13	1.56	0.78	0.39	0.2	0.1

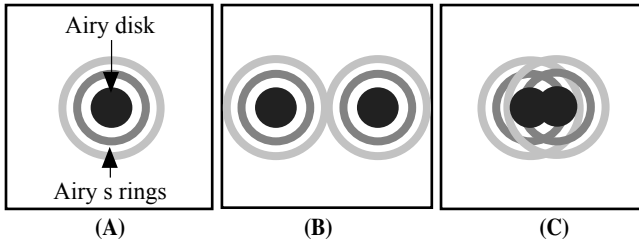

FIGURE 3.46 Image of a distant small point origin produced by a lens, typical diffraction pattern consisting of a small disk (known as an Airy disk).

According to Rayleigh’s criterion, two images are just resolved when the center of one Airy disk falls in the middle of the first minimum of the Airy pattern of the other point origin. The minimum distance between the centers of Airy disks represents the theoretical resolution limit for the image (RL_{image}) and it is approximately given by the following formula:

$$RL_{\text{image}} = 1.22 d \frac{\lambda}{A}$$

where d is the image distance from the lens, A the lens aperture diameter, and λ the wavelength of light.

It can be seen that resolution increases with decreasing wavelength of light (i.e., better resolution can be achieved by using light of shorter wavelengths) and/or increasing the aperture of the optical system (i.e., increasing the diameter of the lens).

The reciprocal value of the resolution limit is known as the resolving power (RP):

$$RP_{\text{image}} = \frac{1}{RL_{\text{image}}} = \frac{A}{1.22 d \lambda}$$

More importantly, the resolution of a camera system depends on the recording medium used in the camera. In the case of conventional film, resolution is limited by the average distance between the two nearest grains embedded in the emulsion. If the average distance between two nearest grains is $5 \mu\text{m}$, the resolution limit is twice this distance, i.e., $RL = 10 \mu\text{m}$ (Young 1984). In the case of a digital camera, the distance between the two nearest pixels will determine the resolution limit. Take for example a 4-megapixel camera chip that contains an array of 2272×1704 RGB pixels packed onto a chip of size 1×1.8 in. (2.5×4.5 cm). To find the distance D between two nearest red (or blue, or green) pixels (there are $1/3$ of 2272 red pixels = 757), we can perform the following simple calculation:

$$D = \frac{4.5 \text{ cm}}{757} \approx 59 \mu\text{m}$$

Thus the resolution limit of the red pixels is approximately 120 μm , over ten times worse than for the film.

It is common for a camera system to use resolving power expressed in resolvable lines per millimeter. Let us calculate resolving power for the two recording media discussed above:

$$\begin{array}{ll} \text{Film:} & \text{CCD:} \\ \text{RP} = \frac{1}{\text{RL}} = \frac{1}{0.01 \text{ mm}} = 100 & \text{RP} = \frac{1}{\text{RL}} = \frac{1}{0.12 \text{ mm}} = 8.3 \end{array}$$

The actual resolving power of a digital camera system is three times better in the case of white light (RP for RGB = $3 \times 8.3 = 25$), but it is certainly reduced if a bandpass filter is used in front of the camera. The resolving power of the camera system comprises the resolution limit of the lens system and the resolution limit of the recording medium, and it will be limited by the larger resolution limit of the two.

There are physical measurements that can be made on optical systems to determine their limits of resolution taking into consideration wavelength (color), aperture, and refractive index of the medium. However, for all practical purposes, the use of resolving power test charts is the most straightforward process. These charts are made of sequences of bar arrays of varying sizes, the smallest detectable array giving a measure of the smallest distance separating two objects that can be discriminated by the optical system. This conveniently combines film, development, and optical qualities of the imaging system and can be considered as a practical indication of image quality.

3.5.9 DEPTH OF FIELD

The “depth of field” (or “zone of focus”) refers to the area from near to far in the picture in which objects will be sharply focused. The depth of field is inversely proportional to both the camera–object distance and the lens aperture (i.e., the closer the object, the smaller the depth of field; and the smaller the aperture, the larger the depth of field). This aspect is of utmost importance in close-up photography, such as the recording of fingerprints, when the camera–object distance is typically less than 20 cm. The depth of field is so shallow that any unevenness in the object surface can result in part of the fingerprint being out of focus at larger apertures (e.g., f -stop 4). To increase the depth of field in such close-up photography, it is recommended to use f -stop 8 or higher. On all SLR (single lens reflex) cameras, the lens ring contains a depth-of-field scale that shows the approximate sharp-focus zone for the different aperture settings. This scale is not valid if an extension ring is employed.

3.5.10 PHOTOGRAPHY IN THE PHOTOLUMINESCENCE MODE

In the case of latent fingermarks developed with a photoluminescence technique, the photoluminescence mode produces light-emitting ridges that appear white in a black-and-white photograph (Figure 3.47). With weakly developed fingermarks, photoluminescence from the ridges is very faint, and the camera shutter must be left open for several seconds to several minutes for successful photography.



FIGURE 3.47 Latent fingerprint developed with a photoluminescence technique.

The recording of photoluminescent objects is somewhat different than conventional photography. First, we are dealing with a very weak light emission that is difficult to measure with conventional light meters. The low light levels require exposures much longer than 1 sec, which is usually the longest automatic exposure time available with conventional cameras. Second, we are often dealing with small photoluminescent objects (e.g., fingerprint ridges) against a more or less dark background. When this weak light is averaged over 70% of the frame (which most cameras use to measure the amount of light reaching the film) the camera's microchip reads this as being much fainter than is actually present. This can result in heavily overexposed images with blurred contours and loss of detail.

To avoid overexposure and to maximize resolution, the image frame should be composed in such a way that the photoluminescent object (e.g., fingerprint) occupies more than 70% of the viewing field. Images should be recorded using a macro lens (for small objects) and an aperture setting of not less than $f/8$ in order to obtain sharp photographic detail. When using a conventional camera, a minimum exposure time should be estimated, based on experience, and then a series of photographs taken, each time doubling the previous exposure time (e.g., 2, 4, 8, 16, and 32 sec). Bracketing the exposures in this manner should provide at least one acceptable exposure.

Some cameras (e.g., Olympus OM-4) feature a light-off-the-film (LOTF) metering system. (Note that the OM-4TI was the last conventional film camera that Olympus produced. Olympus now manufactures only digital cameras.) This metering system was developed for photography under very low light levels (e.g., starry nights). A LOTF camera has two metering systems, one for conventional photography (exposures up to 1 sec) and another for low-light photography (exposures over 1 sec). If the camera's microchip detects low light levels with the first light metering system, it switches exposure control to the second light metering system. When the LOTF system is activated and the shutter opened, a light-sensitive diode inside the

camera measures the amount of light reflected off the film surface. The camera's microchip holds the shutter open until the internal sensor has received sufficient light. While not perfect, the system is well suited for the photography of weak photoluminescent images requiring exposure times up to several minutes. A LOTF metering system alone is not a guarantee that correct exposures will always be obtained, and it is therefore recommended that exposures be bracketed. This can be achieved by taking five exposures, with the exposure compensation dial on "0" (normal exposure), "+1" (2× exposure), "+2" (4× exposure), "-1" (0.5× exposure), and "-2" (0.25× exposure).

The setup for photography in the photoluminescence mode must always incorporate a barrier filter to suit the emission band of the photoluminescent material. The film to be used should fulfill certain requirements: it should have adequate sensitivity, have a fine grain, and exhibit a relatively flat spectral sensitivity curve from at least 400 nm to 650 nm (preferably up to 700 nm). Color film is generally not recommended, except to demonstrate the color of the photoluminescence emission.

If high contrast is required, Kodak Technical Pan 2415 black-and-white film (or similar) is recommended. The spectral sensitivity of this film is quite wide, from 300 nm to nearly 700 nm. Light sensitivity can be varied from 25/15° to 400/27° ISO, and the contrast altered from very high to moderate, depending on the conditions and developer employed. The recommended sensitivity setting is 64/19° ISO, with development using Kodak HC-110 developer, dilution D, for 10 min at 20°C.

For moderate contrast, Kodak T-Max 100 black-and-white film (or similar) is recommended. This film can be used from about 400 nm to nearly 650 nm, although a sharp fall in sensitivity occurs around 650 nm. For the photography of very red photoluminescence emission (650 to 700 nm), the use of Kodak Technical Pan film is advised. T-Max film should be developed under the conditions recommended by Kodak. (Frair and coworkers [1989] proposed the use of Kodak T-Max 400 film for the recording of UV reflection and luminescence photographs.)

Note that the information in this section is rapidly becoming out of date, but it is presented here because some offices still use analog techniques for image recording and may need another two to three years before changing to digital techniques. With photographic negatives, there was a need for results with reasonable sensitometric balance that could only be checked much later in the process (i.e., after development, enlargement, etc.), the risk being that the whole process would need to be repeated (when at all possible) if results were unsatisfactory. This is now largely obsolete, since results can be observed in real time and current imaging sensors are much more sensitive than conventional film. Furthermore, an observed signal can be accumulated over long periods of time if required.

3.6 DIGITAL IMAGING

3.6.1 INTRODUCTION

Digital imaging technology is quickly replacing traditional film-based photography for the recording of forensic evidence such as fingerprints. The ability to enhance

digital images will continue to advance as hardware costs fall while resolution, processing speeds, and software technologies improve.

Detail present in an image may not be discernible to the human eye, but it can be extracted using digital enhancement procedures. Digital recording systems and advancements in information technology also permit the remote capturing of images, with subsequent transmission of such data to any destination in the world. With such technology, when applied in the forensic arena, comes the responsibility of ensuring that the original image is protected from any alteration. Any enhancement must be confined to a copy of the original image, with each step in the enhancement process being documented and repeatable. Procedures must be adopted that safeguard the original evidence and maintain an unbroken “digital image chain of custody” that demonstrates the production of an enhanced image (Berg 1996, 2000). In this respect, modern digital cameras automatically incorporate metadata into the image, which are like tags giving information that documents the resources used when taking the image. EXIF (exchangeable image file) is a standard developed by JEIDA (Japan Electronic Industry Development Association) for storing interchange information in image files. The file format incorporates technical information related to the image recording process at the time of image capture (date, time, geographical location [GPS data], lens, exposure time, diaphragm, resolution, size, etc.; see <http://www.exif.org>). Under some conditions, these “tags” may stay with each image through the various treatments that are applied. This follows standards that have been proposed through international agreement (e.g., Dublin Core Metadata Initiative; see <http://www.dublincore.org>).

The term *resolution* refers to the amount of discernible detail in a digital image. A digital image is composed of an array of discrete picture elements known as pixels. Spatial resolution, also referred to as spatial density, is a measure of the number of pixels in a digital image. The term *samples per inch* (spi) is used to describe image capture resolution, *pixels per inch* (ppi) to describe display resolution, and *dots per inch* (dpi) to describe hard-copy output resolution (Berg 1996, 2000). Higher-resolution images contain more information and therefore require more storage space and more image processing power than lower-resolution images.

Once a digital image has been captured, it needs to be saved in an appropriate digital image file format. An image file format defines a particular data storage protocol. There are probably over 100 different file formats for digital images. Some of these file formats are unique to specific programs, while others are general formats that extend over several platforms. Standard file formats allow for the exchange and manipulation of digital images by image processing systems from different manufacturers. The two things to consider when discussing file formats are the *representation scheme* (how the computer interprets data to reproduce it) and the *compression scheme* (how the computer utilizes memory to store the image). The simplest bitmap image files will have two or three parts: the header, bitmap data, and optionally, the footer. The header contains important information to prepare the computer for the data that follows. Bitmap data make up the bulk of the file and consist of values for each pixel in the image. The computer reads these values and, using the information from the header, reproduces them in the proper place in the image. The footer is an optional addition to the format.

Off-the-shelf personal computers, image-capture devices, and affordable software packages can be combined to form a digital enhancement system that can be used to significantly improve weak or obstructed evidence (German 1991; Dalrymple and Menzies 1994). (Section 3.6.6 provides an example of this process.) This can be achieved because the digitization of an image affords the operator much greater control over each individual picture element (pixel) than is possible with a conventional photographic (analog) image. The computer is able to differentiate between 256 separate values of gray in a grayscale image (8-bit images have pixel values from black [0] to white [255]). In addition, it is possible to separate images into different color ranges (RGB — red, green, blue) and treat the tonal range for each color individually before combining the various signals together. By comparison, the human eye can only differentiate approximately 32 separate gray values.

3.6.2 DATA COMPRESSION

Compression manages the image data so that less space is required to store the image. Most compression schemes fall into one of two categories: lossless and lossy. Lossless compression means that no data is irreparably altered in the process of shrinking and expanding a file. Lossy compression, on the other hand, does change the original data. In most cases, the changes are insignificant, and rarely can the naked eye make them out even when magnified to several times normal size. However, lossy compression can result in degradation of image quality and, in some cases, the introduction of artifacts. The advantage of lossy over lossless is that lossy schemes usually offer much better compression ratios.

Some of the more common cross-platform file formats for the storage and manipulation of digital images include the following:

Bitmap (BMP): This is a widely recognized format made popular by Microsoft Windows and IBM OS/2. It supports several data types ranging from black-and-white all the way up to 24-bit true color. Although the BMP format supports compression, most programs do not take advantage of it.

Tagged image file format (TIF): This file format was released in 1986 from a joint venture between Aldus Corporation (now merged with Adobe) and Microsoft (Berg 1996). TIF is a standard file format for most imaging programs, supporting all data types from monochrome up to 24-bit true color, as well as many color models and compression schemes. An even more powerful aspect of TIF is that its files can move easily between platforms (e.g., DOS, Windows, UNIX, and Macintosh), making it an ideal format for storing image data. The lossless TIF format is recommended for recording of all prints.

JPEG file interchange format (JPG): The JPEG (Joint Photographic Experts Group) format was developed to create a standard for sending images over digital communication lines. Although it is a lossy compression method, most digital images compressed with it show little or no degradation, thus it is becoming one of the most popular ones in use today. The JPEG format is best suited for digital photographs and other natural-looking images. It

is not as good for precise artwork such as line art. This is because some averaging takes place during compression, and edges may become blurred. In photographs, this is not so noticeable because such sharp edges are rare. JPEG uses a lossy compression method to achieve compression ratios of up to 100 to 1. This is far better than 10 to 1, which may be the best that most other compression methods produce. This format supports grayscale and true color data types, while black-and-white data types do not reproduce well and are not supported. One interesting feature of this format is that you can vary the degree of compression. This makes it possible to select a level of data retention vs. space savings that is best for a particular application.

3.6.3 IMAGE PROCESSING TECHNIQUES

Mathematical operations can be readily performed on digital images. Individual pixel values can be modified by addition, subtraction, or multiplication, for example. The dynamic range of some characteristics can be changed (mostly extended) to improve certain qualities. Image brightness or contrast can be adjusted, as can color balance. Two or more images can be combined to produce a composite image. Digital filters can be applied to an image to produce effects such as blurring, sharpening, and contour enhancement. Pixel-by-pixel modification of an image is also possible, but this can be tedious and time-consuming. Image geometry can also be modified (e.g., adjusting size/scaling, rotating/changing orientation, inverting images/mirror image) (Russ 2001). The use of subtraction is well documented (Dalrymple and Menzies 1994; Comber 2003). Watling (1994) showed the benefits of using color acquisition.

Sometimes valuable forensic information in an image (such as a fingerprint) is obscured by background interference. Sophisticated background suppression techniques can be employed to remove repetitious substrate patterns. The fast Fourier transform (FFT) is a useful software routine that converts a spatial image to the frequency domain. The converted image, or power spectrum, gives a representation of the image that makes it relatively easy to recognize and eliminate periodic background noise (Kaymaz and Mitra 1992, 1993; Sherlock et al. 1992; Watling 1993; Bramble and Jackson 1994; Bramble and Fabrizi 1995; Bullard and Birge 1996; Moler et al. 1998). FFT methods should be used with great care and appropriate expertise. Methods to remove nonperiodic patterns have also been proposed (Capel et al. 1998).

3.6.4 LEGAL REQUIREMENTS

New imaging technologies are raising questions as to the validity and acceptability of “photographic” evidence presented in court. There are generally two types of images used in evidence, those that are visually verifiable and those that are analyzed and treated (enhanced). The first category is usually without problem; whatever the technology used, these are images that document a state, such as crime scene photographs, and are used to describe or illustrate statements. This does not mean

that manipulation cannot be made, but this is mostly independent of the technology employed. On the other hand, images that are analyzed and transformed in some way may generate questions as to the validity of the evidence highlighted by this treatment. Is the evidential image a transformation that has been fabricated to support a speculative position, or is it highlighting latent information that constitutes evidence? Standard operating procedures are required to provide quality assurance and compatibility with legal requirements by offering the opportunity to track (and reproduce) the whole analysis and transformation process.

In a similar fashion to traditional photography, the primary image taken with a digital camera is a set of highly structured data that constitutes a “data folder” that is vulnerable, analogous to the latent image recorded on photographic film. This primary image needs to be “fixed” onto a physical support (in the same way as developer and fixing agents are required to obtain a negative in standard photography). This can be done using a replicating tool that will duplicate this primary image as a nonopened file on a nonmodifiable support (such as a numbered CD-WORM [write once read many]). Some users recommend two such records on separate systems. The number and index of such records should be kept in separate and protected files (Blitzer and Jacobia 2002). This will be called the original (or master) image that is a complete and faithful replicate of the primary captured image, in the same file format. This constitutes a string of highly structured and complex digital data that can then be copied an unlimited number of times without loss of quality.

An original, noncompressed image should be kept in archives. Copies for data treatment, which can be opened and edited, are working copies that should be incrementally recorded with a documentation trail that details each treatment step. The final image is the image used for demonstration purposes; this is printed, inserted into reports, or projected on a screen.

A complete script of all treatment steps should be recorded (e.g., engraved on a CD-ROM, preferably duplicated, with one copy kept in archives) and retained with the case notes, thus offering the possibility for the whole process to be independently verified. This is a professional approach that should satisfy scrutiny by the courts. Blitzer and Jacobia (2002) have extensively covered the problems associated with digital images as evidence in their recent publication.

When employing new recording technologies, one worry concerns the permanence of records or of systems capable of reading these records. At present, the lifetime of a new technology can be as short as 3 to 5 years, and planning by management has to take into account technological evolution and compatibility of systems over an extended period of time. Successive generations of software and hardware may need to be retained. This is one difficulty with rapidly evolving technologies that few agencies have foreseen and few have planned for.

3.6.5 STANDARD PROCEDURES FOR FINGERPRINT IMAGING

While standard operating procedures for digital imaging can vary significantly between agencies, they should always account for the appropriate filing of original images. An example of an image treatment sequence is presented in [Section 3.6.6](#). This example illustrates a possible stepwise routine to be used for fingerprint imaging

and image treatment using Adobe *Photoshop*[®]. It is imperative that a record be kept of the software version used in the treatment of the data. The size of the evidential mark and its image must be documented prior to treating the image, and the minimum requirements allow for the development and use of scripts that will help manage the entire process.

For efficiency gains, a script should allow for the visualization and return to individual treatments applied, the recording of each separate treatment step (including a record of all relevant parameters/settings), and the automatic batch treatment of images that need identical processing. The use of scripts ensures the consistent application of standard protocols and ensures reproducibility. Scripts also allow for the efficient management and treatment of the large files that are required, for quality assurance purposes, in forensic science applications. The reason for this is that:

1. Script execution uses relatively short machine time (much shorter than the opening of each individual variant in a series of treated images).
2. Page setup for reporting can be handled in the same way.

Within any given service (fingerprint bureau, forensic science laboratory, crime scene imaging, etc.), all treatment steps should be structured to take into account the complete process from capture of the original image through to the end product. This can be viewed as an arborescence or a treelike stepwise and/or hierarchical incremental and/or iterative process. An illustration of this is provided through the case example that follows. The complexity and the almost infinite possibilities offered by digital imaging in forensic science make this a whole new specialty, requiring well-trained professionals and documented quality assurance processes.

3.6.6 CASE EXAMPLE

This example relates to an extremely serious case. A fingermark had been detected on the nonadhesive side of a brown plastic tape a number of years ago (initial treatment unknown). An image was taken at the time on black-and-white film under standard white light illumination. When the case was reopened years later in 2003, the images from the negative showed poor detail (Figure 3.48A). After scanning and numerical treatment, details could be dramatically improved (Figure 3.48B).

The object from which the initial image had been recorded was still available, and new images were taken using an S2Pro[®] from Fuji[™]. Optically, the best results were obtained under blue light (450 nm, Polilight[™]), and both the background and the mark were intensely luminescent (Figure 3.49A). Recording was not made in the luminescence mode (using a barrier filter), as this would have limited the signal treatment to a specific wavelength range.

The case treatment illustrated in this example is based on a protocol established by Eric Sapin, photography specialist at the School of Forensic Science, University of Lausanne (Switzerland). Figure 3.50 and Figure 3.51 illustrate the arborescence and the four major steps in the structured treatment of the image.

Part of the EXIF file in the “informations” folder illustrates the metadata from the camera itself. The initial image previously mentioned (Figure 3.49A) does not

seem to contain much useful data. However, by separating each color (RGB) layer, adjusting the dynamic range according to the “sensitometric” type curves illustrated (and recorded in the background) (Figure 3.49B, Figure 3.49C, and Figure 3.52) for each layer, reducing the importance of the red layer (0%), enhancing another layer (green 80%), and so on, one can appreciate the data contained in each of these layers.

The RGB layers are finally recombined, after treatment, to give a grayscale picture whose contrast curve can be further modified to reach the best possible detail and contrast for the detected mark (Figure 3.53).

A stencil (equivalent to a transparency with circles and arrows) can be combined with the image to highlight visible minutiae and evaluate the quality of the mark, prior to comparison with reference prints (Figure 3.54A). Finally, the image can be inserted within the format used for reporting in the given organization (Figure 3.54B).

This case example demonstrates the complexity involved and the professionalism required to master the complete spectrum of digital imaging possibilities, which, if used properly, may give exceedingly good results.

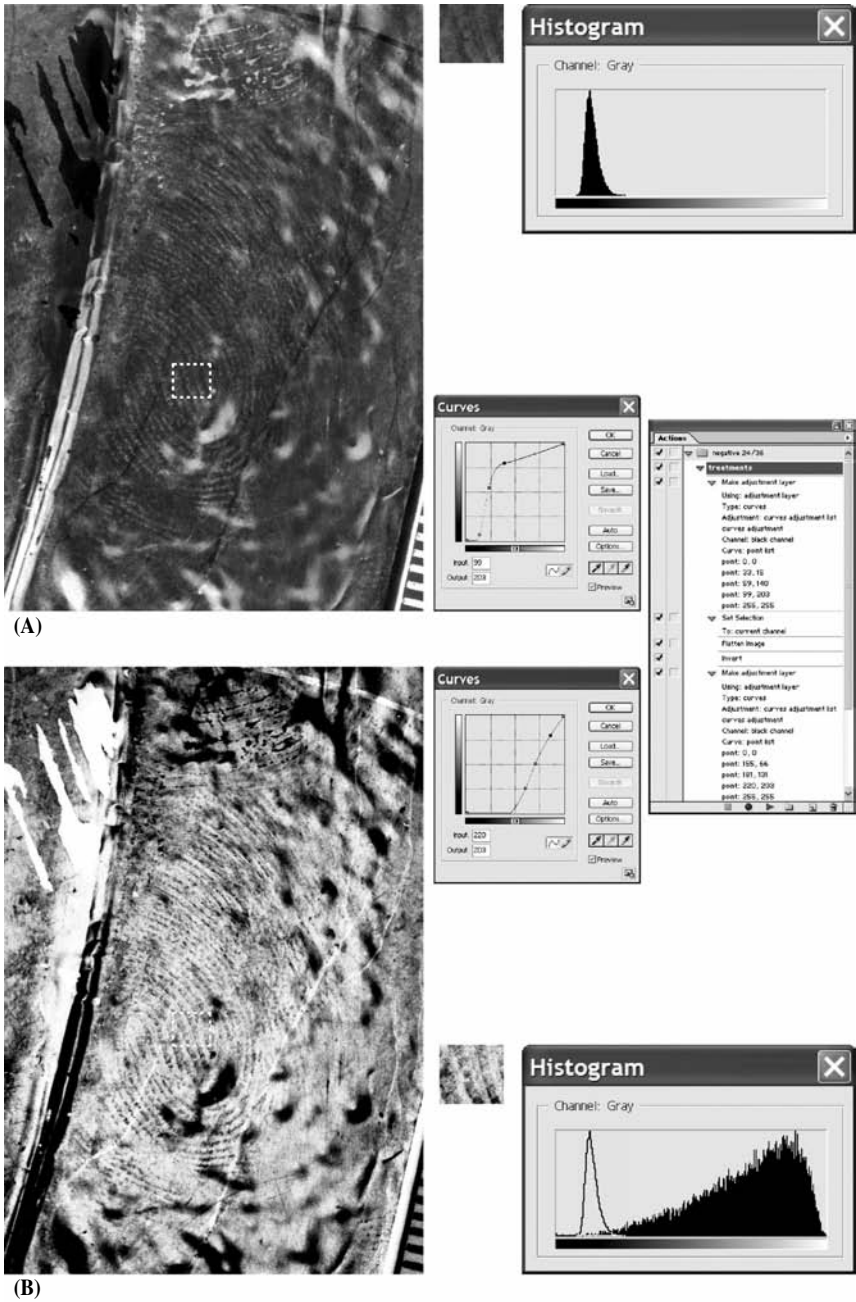
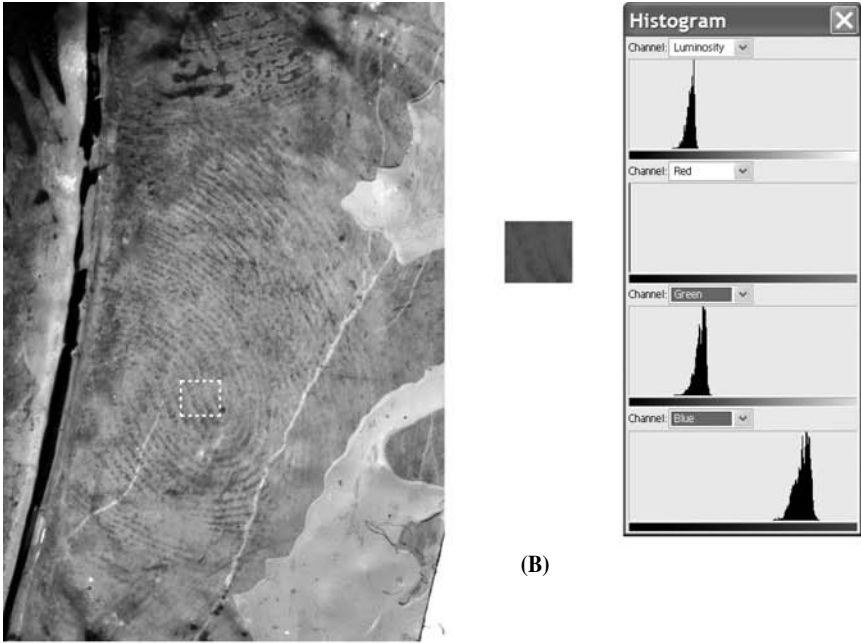
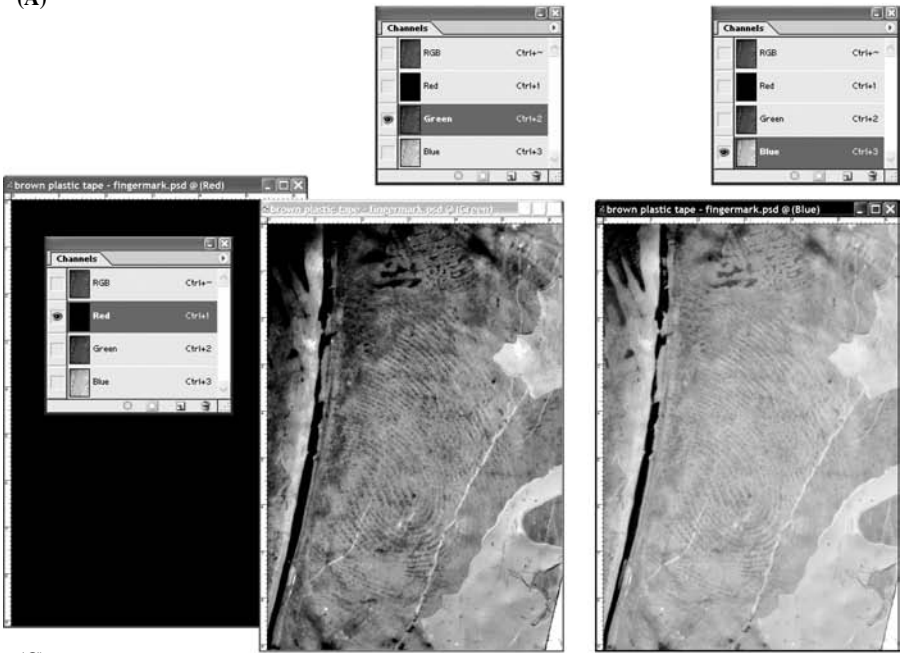

FIGURE 3.48 (A) Case example — image from negative. Highlighted square is used to demonstrate the change in tonal density. (B) Results of the image enhancement on the case picture.



(B)

(A)



(C)

FIGURE 3.49 (A) Image of trace under blue light — raw original image. (B) State of separate color channels defining the image. (C) Illustration of the signals in each separate layer.

Organization of archive and work files

Whether the work is hybrid (from negatives, scans, slides) or purely digital, it is necessary to organize one's files to :
Save original images

- Systematically recorded in the original format coming directly from digital cameras, scanners, data bases, etc on two physically separated discs.
- No treatment is made on these files except indexing according to the case.
- Use the information file as a "working notebook." This is like laboratory note keeping and it is up to the user how it should be organized or to create a specific model if meta-data appears in the subfile.

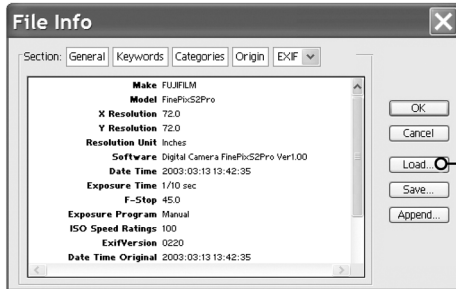

(A)

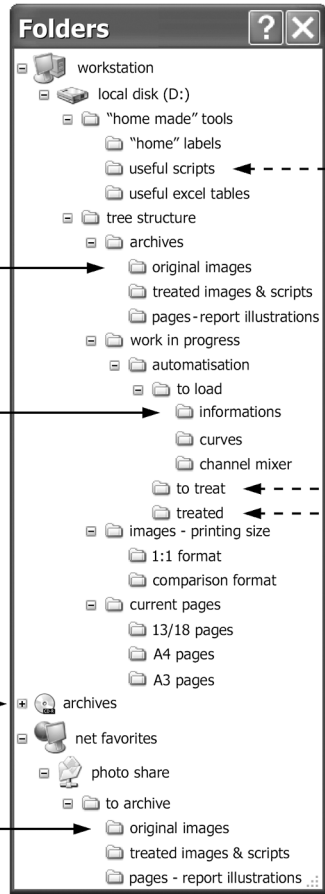

Treat image files

- The original files which come from digital cameras or scanners are transformed.
- Before treatment they are changed into format *.psd at 400 dpi, RVB mode or grayscale, 8 bits, this operation can be automatized for batches, using a transformation script.

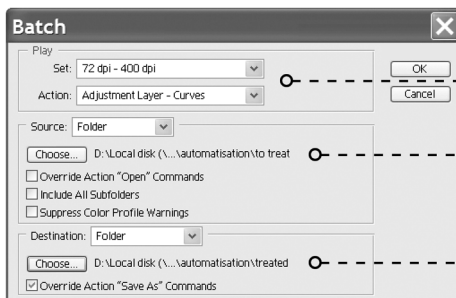

(B)

- The files that will be treated are moved momentarily in a file: to treat.

- The script is executed and the new file is recorded in the file: treated.

- Each type of transformation has its own script which is saved in archives : "home made" tools\useful scripts. This script will be indexed so as to reveal its operations and loaded on the range of scripts that will be used before starting the automatic work or the batch treatment.

- To accelerate the treatment of images, various treatment templates are programmed: curves, channel mixer, or others if necessary.

FIGURE 3.50 (A) Standard protocol for organization of the image files (original image and images for treatment). (B) Image file transformation protocol and management of image versions.

Save image treatments and treated images

- For each image, all treatments are recorded in a script. The file *.atn is indexed like the original image and this recording becomes the working notebook of image treatments done on the original image. New Adjustment Layers are used to correct pictures.

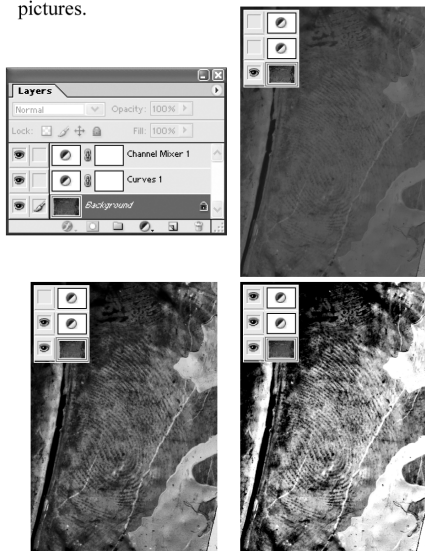

- The process that can be applied to a whole series of images can be momentarily recorded (curves *.acv) in a file and loaded for the next treatment.

- Treated images and their script are saved like original images on two physically separate discs.

(A)

Prepare the page set-up of photographic illustrations

- Treated images will be sized, changing the number of pixels to fit the presentation.
- Use a calculation method to change size.
- This work can be automatized, going through the folders: to treat, treated.
- Page set-up scripts for different formats, image sizes, trace types, comparison types, logo integration. Scripts will also generate rulers, micro-rulers, grey level charts, or color charts as well as guiding-marks, which will allow perfect superimposition for transparencies.

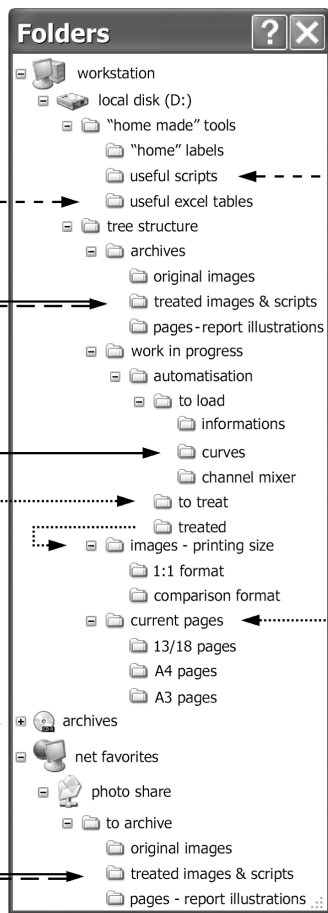

- Realize pages in form of two folders or two files:

- One where each different treatment stage is kept in order to correct pages until the last limit.
- The other under the form of a page where layers are flattened, ready for printing, to accelerate the printing.

- Indexation should distinguish these two files. These final pages at a lighter format are archived on two physically separated discs.

(B)

FIGURE 3.51 (A) Image treatment protocol and treatment chain management. (B) Final image for demonstration purposes is treated to fit size:portfolio organization according to laboratory standard.

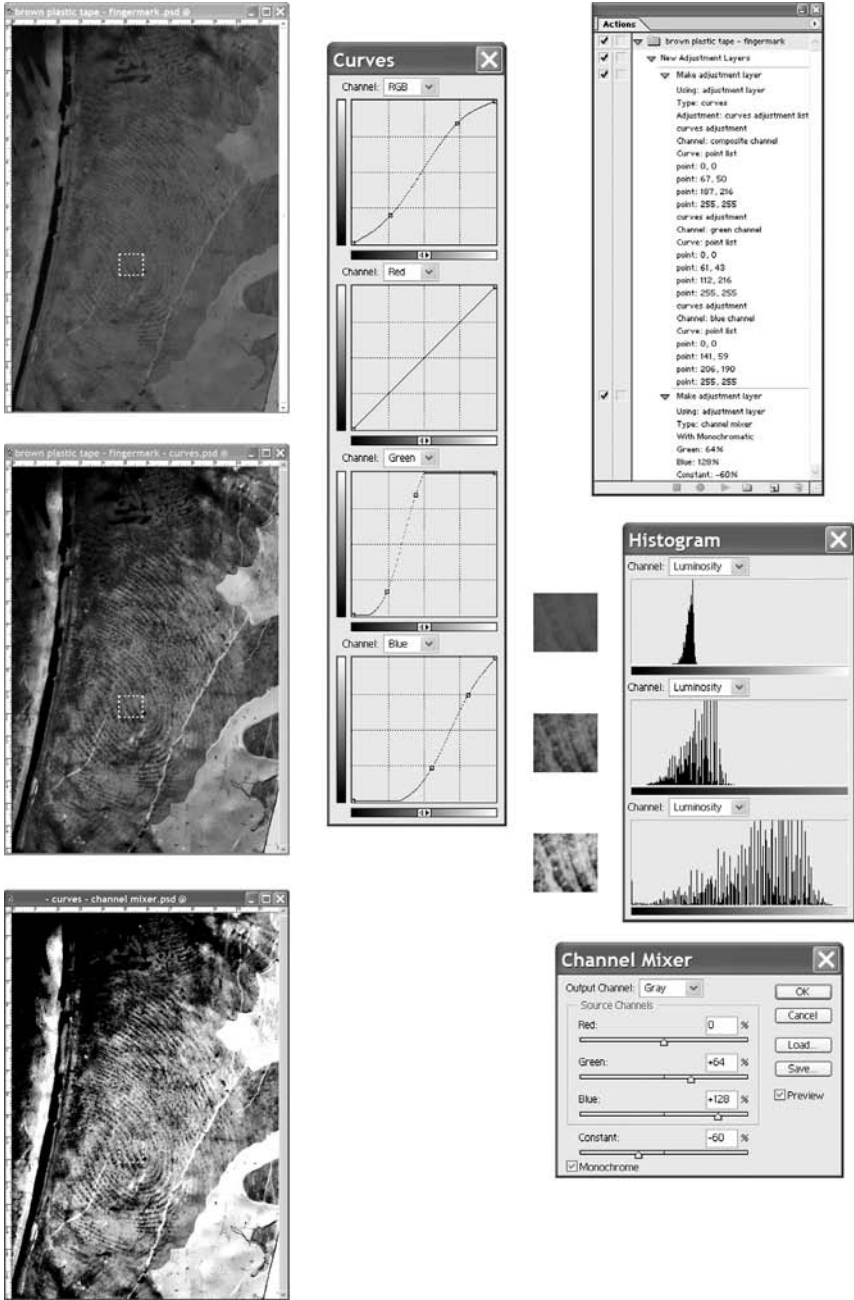

FIGURE 3.52 Comparison of the original image (top) with the intermediate image (center) and the final image (bottom) demonstrates the influence of treatment on each color layer and the result obtained after combining individually modified layers. The right-hand side of the figure shows the protocol, three histograms illustrating the change levels, and the channel mixer, which was obtained in gray.



FIGURE 3.53 Final treated image (black and white).



FIGURE 3.54 (A) Overlay of highlighted minutiae and (B) 1:1 size used for reporting.

4 Fingerprint Detection Techniques

4.1 TYPES OF FINGERPRINT EVIDENCE

There are two general categories to describe the fingerprint evidence that may be found at a crime scene or on an item related to a criminal matter: visible fingerprints and latent fingerprints. These categories are not mutually exclusive, since an item or surface can carry both visible and latent marks. Any search for fingerprint evidence must take into consideration the possible presence of both types of fingerprint. For example, a visible fingerprint (e.g., a blood mark) should not be enhanced to the exclusion of any latent fingerprints that may also be present on the item or surface under examination.

4.1.1 VISIBLE FINGERMARKS

Visible fingerprints, as the term suggests, are visible without any particular treatment. Such marks may be:

- Positive, where an image is formed by fingerprint ridges contaminated with a colored substance such as blood, ink, paint, etc.
- Negative, where the fingerprint ridges remove surface material such as dust and soot
- Indented (molded/plastic), caused by the contact of the finger with a malleable substance (putty, candle wax, wet paint, etc.) that subsequently retains a three-dimensional image of the print

The fingerprint is visible as long as there is sufficient contrast between the mark and its support; it may be necessary to use colored or oblique lighting to observe weakly visible marks. Fingerprints in blood are a common example, and these can be enhanced using specific optical techniques or by the application of an appropriate staining procedure or chemical treatment. On some metal surfaces such as aluminum and brass (e.g., cartridge cases), corrosion processes may take place between the metal and some salts and acids in the fingerprint residue to produce a visible fingerprint (Bobev 1995).

Indented fingerprints may be difficult to visualize or record photographically, and good lighting techniques are usually required (oblique lighting, for example); powdering (to improve contrast) or casting may sometimes be advantageous. Silicone casting material, as used for recording toolmarks, can be successfully employed in some cases.

4.1.2 LATENT FINGERMARKS

The term *latent* literally means “present and capable of becoming though not now visible, obvious, or active” (from Latin *latent-*, *latens*, from present participle of *latere*, to lie hidden; Merriam-Webster’s Collegiate Dictionary, 2002). The latent fingerprint is the most common form of fingerprint evidence and also the one that poses the most problems: it is present but invisible. The application of an optical (e.g., UV [ultraviolet] imaging), physical (e.g., powdering), or chemical treatment (e.g., ninhydrin) is required in order to visualize a latent fingerprint. This is where a detailed knowledge of the human secretions, and of the environment in which the samples have been stored, are essential in order to choose the optimum techniques for fingerprint development — the techniques that will give the best chance of fingerprint detection. It is interesting to note that certain detection techniques, still valid today, were originally proposed for the study of perspiration fluids and secretions before fingerprints became used for personal identification. Aubert (1877–78), for example, had already published in 1878 the reaction between alkaline salts in the sweat and silver nitrate and the absorption of iodine vapor by sebaceous secretions.

The latent fingerprint, deposited by the ridge of the finger or palm, is a complex mixture of natural secretions and contaminants from the environment. Three types of glands are responsible for the natural secretions of the skin: the sudoriferous eccrine and apocrine glands, and the sebaceous glands. These three types of glands have well-defined functions, and the composition of their secretions varies in consequence. The sudoriferous glands are distributed all over the body and produce the sweat that is more than 98% water. The secretory body of each gland is in the form of a long coiled tube situated in the subcutaneous layers of the skin. The glands traverse the epidermal layers to open at the summits of the papillary ridges to form “sweat” or sudoriferous pores. The sweat is produced by the cells of the secretory body, without loss of cell cytoplasm in the case of the eccrine glands, in contrast to apocrine glands. This explains the differences in chemical composition between these two types of secretions.

The palms of the hands and the soles of the feet produce only eccrine gland secretions, whereas the apocrine glands are located in the groin, in the armpits, in the perianal regions (where they generally open at the hair follicles), the lips of the vagina, the glands of the penis, and the mammary areolae. These belong to the apocrine glands. The sebaceous glands are found on the chest and the back (where they are associated with hair roots), and on the forehead. These glands secrete an oil (the sebum) that serves to protect the skin and hair against water, to act as a lubricant, and also to help absorb fat (lipid) soluble substances.

As the ridges of the hands are covered exclusively by eccrine glands, eccrine gland secretions are present to some degree in every latent fingerprint at the moment of deposition. Contamination by sebaceous gland secretions is also very common, due to activities such as combing the hair and touching the face, whereas that from the apocrine glands is infrequent but may be important in certain crimes (e.g., crimes of a sexual nature).

The major chemical constituents of the natural secretions are given in Table 4.1 (Knowles 1978; Ramotowski 2001). Secretions from eccrine and apocrine glands are mixtures of inorganic salts and water-soluble organic components that result in a water-soluble deposit (WSD). Secretions from sebaceous glands consist of a semisolid mixture of fats, waxes, and long-chain alcohols that result in a non-water-soluble deposit (NWSD). The chemical composition of these natural secretions has been extensively reviewed by Ramotowski (2001).

Latent fingerprints deposited by children have been found to have a different chemical composition than deposits from adults (Buchanan et al. 1996; Bohanan 1998; Mong et al. 2001). Children leave considerably less residue on a surface, as little as 1/20 that of adults, and the lipid portion of their latent prints is more volatile in nature (Mong et al. 2001). As a result, latent fingermarks from children tend to degrade more rapidly than prints left by adults (Bohanan 1998). No gender differences in chemical composition of fingerprint residue have been highlighted (Asano et al. 2002).

TABLE 4.1
Main Chemical Constituents of the Glandular Secretions

Source	Location	Constituents	
		Inorganic	Organic
Eccrine glands	All over the body, but the only type of glands on the palms of the hands and the soles of the feet	Chloride Metal ions (Na ⁺ , K ⁺ , Ca ²⁺) Sulfate Phosphate Bicarbonate Ammonia Water (>98%)	Amino acids Proteins Urea Uric acid Lactic acid Sugars Creatinine Choline
Apocrine glands	In the groin and the armpits; associated with hair follicles around the genitals and mammary glands	Iron Water (>98%)	Proteins Carbohydrates Sterols
Sebaceous glands	All over the body, except on the palms of the hands and the soles of the feet; highest concentration is on the forehead and on the back; associated with hair roots	—	Glycerides (30–40%) Fatty acids (15–25%) Wax esters (20–25%) Squalene (10–12%) Sterol esters (2–3%) Sterols (1–3%)

Adapted from: Knowles, A.M. (1978), Aspects of physicochemical methods for the detection of latent fingerprints, *J. Physics Ser. E: Sci. Instruments*, 11, 713–721; and from Ramotowski, R.S. (2001), Composition of latent print residue, in *Advances in Fingerprint Technology*, 2nd ed., H.C. Lee and R.E. Gaensslen, Eds., Boca Raton, FL: CRC Press, pp. 63–104.

4.2 SURFACE CHARACTERISTICS

Few studies have considered the interaction between the friction ridge skin, the secretions, and the surface at the moment of deposition, or the later interaction between the deposited material and the substrate. Thomas (1978) reviewed fingerprint physics, with an emphasis on the mechanics of latent print formation, and the results of microscopic observations that shed some light on the interaction of fingerprints with flat surfaces. More recently, Bobev (1995) considered latent fingerprint formation as a physico-chemical process on the border or contact area between the ridged skin and the print-receptive surface. When the fingers touch a solid surface, secretions are transferred, depending on a number of factors, including:

- Temperature of the surface (sebaceous material adheres better to a surface that is cooler than the human body)
- Surface structure (the rougher the surface, the greater are the adhesive forces)
- Electrostatic forces on the print-receptive surface

Surface phenomena play an important role, and Bobev (1995) presented a number of observations made on different surfaces under different environmental conditions.

In general, all surfaces bearing latent fingermarks can be divided into three groups: porous, semiporous, and nonporous (Table 4.2). Properties of an unknown surface have to be considered before any attempt is made to develop latent fingermarks. This may mean evaluating a proposed detection sequence on test samples of the same type of surface before proceeding with the treatment of evidential items.

4.2.1 POROUS SURFACES

Any surface that tends to absorb the latent fingerprint deposit very quickly can be classified as a porous surface (e.g., paper). The water-soluble deposit (WSD) is taken into the first few layers of the surface within seconds of deposition (Figure 4.1). During absorption, water evaporates, leaving a mixture of residues behind, including amino acids, urea, and chlorides (sodium chloride in particular). An image of the latent fingermark is produced in the form of residual, water-soluble components. How deeply the latent fingermark deposit penetrates into the surface depends very much on the environmental conditions, in particular the relative humidity, and the degree of porosity of the surface. Once absorbed into the surface, the latent image based on the WSD will be relatively well preserved under normal conditions, cannot be rubbed away, but can be easily destroyed (washed away or diffused) with water.

As the fingermark ages, the amino acids will remain relatively stable provided that the porous substrate is stored under normal environmental conditions (relative humidity <80%). Other components such as urea and sodium chloride, however, will tend to migrate continuously, depending on the environmental conditions (relative humidity in the first instance). The higher the relative humidity, the faster is the migration. Under normal conditions (relative humidity <80%), minimal diffusion will be evident over the first week after deposition. Older marks will tend to show

TABLE 4.2**Types of Surfaces and Their Interactions with the Latent Fingerprint Deposit**

Types of Surfaces		
Porous	Semiporous	Nonporous
Porous surface absorbs the WSD very quickly (within seconds) after deposition The NWSD stays on top of the surface for a longer period (a half day to a day) A small amount of the NWSD stays on the surface for a significant period	Semiporous surface absorbs the WSD slowly after deposition (minutes to h) The NWSD stays on top of the surface much longer (a day to several days) A small amount of the NWSD stays on the surface for a significant period	Nonporous surface does not absorb any part of the latent fingerprint deposit The WSD and NWSD, as an emulsion mixture, stays on top of the surface for a very long time (until degraded) Latent deposits remain on the surface and are very fragile (marks are easily smudged)
Typical examples: paper cardboard some fabrics (e.g., cotton) untreated wood, etc.	Typical examples: certain types of plastic waxed surfaces certain types of wall paints and wallpapers varnished wood, etc.	Typical examples: certain types of plastic glass metal surfaces glazed ceramics glossy paints, etc.

Note: WSD = water-soluble deposit, NWSD = non-water-soluble deposit.

significant diffusion of urea and chlorides, thus producing blurred images with respect to these components.

The non-water-soluble deposit (NWSD), a semisolid complex mixture of fats, waxes, and alcohols, remains longer on the surface of the substrate (Figure 4.1). Mobility of the NWSD depends primarily on the ambient temperature. At around 20°C, mobility is relatively slow and the NWSD stays on top of the surface for several days. Above 35°C, however, mobility increases significantly and the NWSD is quickly diffused. Under normal conditions, a small amount of the NWSD will remain on top of the surface for a significant period (years). This small amount will not attract fingerprint powders, but it can be detected using more sensitive techniques such as physical developer.

4.2.2 NONPOROUS SURFACES

Any surface that does not absorb any component of the latent fingermark deposits is classified as a nonporous surface. Classical examples of nonporous surfaces are polyethylene (polythene) plastic bags, glass, and shiny metal surfaces. An emulsion consisting of water-soluble and non-water-soluble components of the latent fingerprint deposit remains on top of the surface for a significant period of time (Figure 4.2) unless it is removed (rubbed off) from the surface or has degraded through age or environmental effects. As all of the deposit remains on the surface of a nonporous

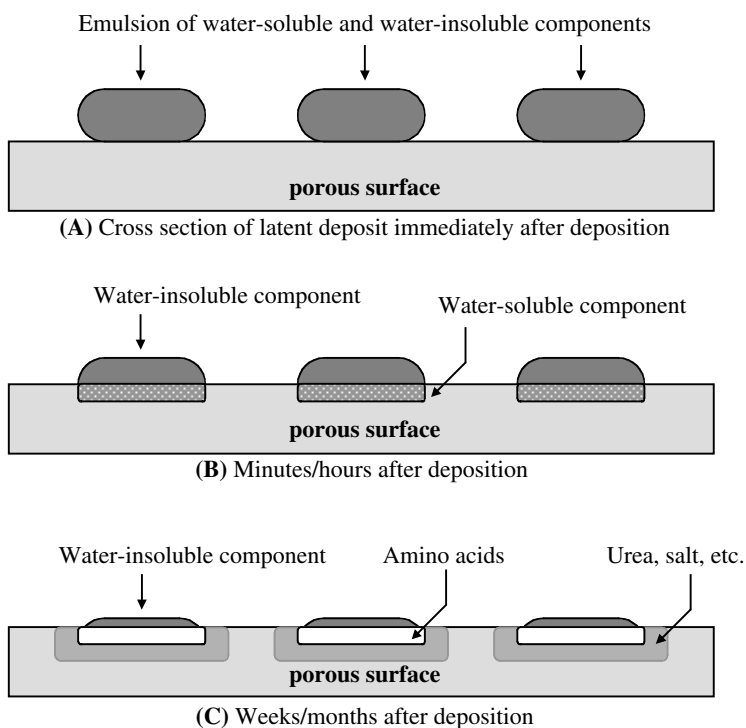

FIGURE 4.1 Aging of a latent fingerprint on a porous substrate (e.g., paper).

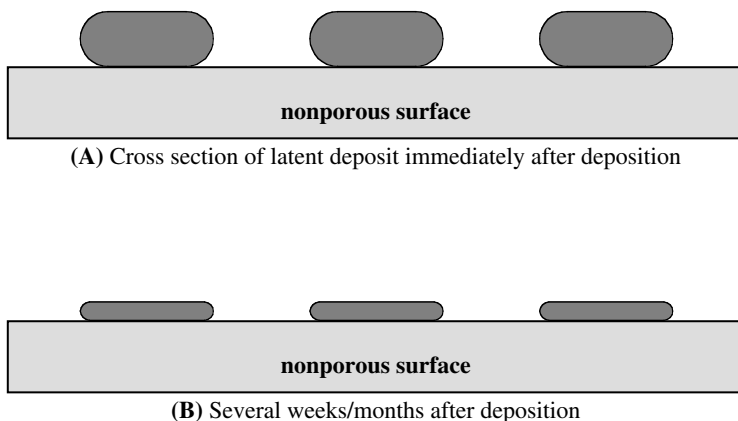

FIGURE 4.2 Aging of a latent fingerprint on a nonporous substrate (e.g., glass).

substrate, the latent marks are very fragile, and care must be taken when handling or packaging such items. In addition, such marks are readily removed by the action of organic solvents. While water will tend to remove any water-soluble material, the water-insoluble component will be unaffected.

4.2.3 SEMIPOROUS SURFACES

Any surface with intermediate characteristics that does not fit well into the porous or nonporous groups is generally classified as semiporous. Typical examples of this type of surface are some painted surfaces, polymer banknotes, and waxed wrapping paper. The surface absorbs the water-soluble component, but more slowly than for porous surfaces. The non-water-soluble component remains on top of the surface much longer than it does on a porous surface, but not as long as for a nonporous surface.

4.3 OPTICAL DETECTION TECHNIQUES

Optical detection methods have the advantage of being nondestructive with respect to the latent fingerprint deposit. As a result, these techniques do not preclude the later application of conventional fingerprint development procedures. The simple observation of an object under white light may disclose a visible fingerprint that can be photographed without any further treatment. The contrast in marks contaminated with a colored material such as blood can be significantly enhanced using selective absorption techniques. On the other hand, more complex optical detection methods can reveal otherwise invisible marks that may not be developed by other techniques. A fingerprint detection sequence should therefore always commence with an optical examination using different illumination techniques as dictated by the surface type and any likely fingerprint contamination.

4.3.1 ABSORPTION

The absorption mode can be useful for the enhancement of visible fingerprints. If the fingers are contaminated with a colored material, deposited fingerprints may have characteristic absorption properties that can be exploited to improve contrast. For example, dry blood has a strong absorption peak at 415 nm. This characteristic absorption can be used to optically enhance fingerprints in blood. Similarly, a colored fingerprint that is the result of a particular detection technique (e.g., ninhydrin treatment to produce a purple print) can be optically enhanced using selective absorption.

When enhancing colored marks, consideration must be given not only to the color of the fingerprint but also the color of the surface. The color wheel ([Figure 3.24](#); see [Section 3.3.9](#)) should be used to select an illumination wavelength that will darken the print (favor absorption) and lighten the surface (favor reflection). As an example, a blue fingerprint on a red surface can be significantly enhanced if viewed under orange-red illumination (e.g., around 600 nm), as this color will be strongly absorbed by the print but totally reflected by the surface. Alternatively, white light illumination can be used and the fingerprint viewed through an orange-red filter. Only the light reflected by the surface will be transmitted through the filter, thus giving the impression of a light background.

4.3.2 LUMINESCENCE

Lasers have, since the late 1970s, been proposed for the detection of untreated fingermarks on nonluminescent surfaces (Dalrymple et al. 1977). Four principal types of lasers have been employed to detect inherently luminescent fingerprints — the argon ion, the copper vapor, the Nd:YAG, and the tunable dye laser. According to Menzel (1980, 1985, 1999), positive results have been obtained on many surfaces, including metal (e.g., firearms), human skin, and polystyrene foam. It must be noted that the high success rates originally reported for this technique could not be achieved in practice, and good results have mostly been obtained with fingermarks contaminated by luminescent products picked up from the environment (Salares et al. 1979; Creer 1996).

Despite the relatively low success rate of the technique in actual casework, a search for inherently luminescent fingerprints should always precede the application of a destructive detection method. The evidential object should be illuminated at different wavelengths using a suitable high-intensity light source (not necessarily a laser) while observing through appropriately filtered goggles. A good starting point is to use high-intensity blue light (e.g., a filtered light source operating at 450 nm) while wearing yellow/orange goggles. Such an examination must be conducted under darkened conditions (total darkness if possible); otherwise, weakly luminescent marks will not be detected.

4.3.3 DIFFUSED REFLECTION

Light tends to be diffusely reflected from a latent fingermark deposit. This property can be used for the detection of latent marks on smooth, shiny surfaces such as glass, plastic (e.g., credit cards), and polished metal. Oblique lighting on shiny surfaces can sometimes reveal latent fingermarks, fingermarks contaminated with material such as dust, or fingermarks already developed by other techniques (e.g., powdering or cyanoacrylate fuming). Under these conditions, marks will be visible as light images against a dark background due to the light diffusely reflected from the fingerprint ridges.

Episcopic coaxial illumination is a specific optical setup that is particularly effective for this application (Pfister 1985). The technique involves the use of a semitransparent mirror to observe the reflection of light perpendicular to the surface (see [Section 3.3.10](#)), with illumination, reflection, and observation being along the same coaxial path. The light is diffused by the fingerprint deposit but specularly reflected by the surface, and therefore the fingerprint is visible as dark ridges against a light background. As well as detecting untreated latent marks, the technique can also give excellent results for the enhancement of prints developed by techniques such as cyanoacrylate fuming and vacuum metal deposition (Lennard and Margot 1988; Ziv and Springer 1993; Bullock et al. 1994).

4.3.4 ULTRAVIOLET IMAGING

Japanese workers (cited by German [1987]) originally proposed the optical detection of latent fingermarks by shortwave UV reflection. This technique requires

the use of a UV-sensitive CCD (charge-coupled device) camera (equipped with a quartz lens) and a source of UV light (West et al. 1990). The Hamamatsu company has marketed, for several years, a complete Reflected UV Imaging System (RUVIS) for the detection of trace evidence, including fingerprints, footwear impressions, and bite marks on skin. Less expensive units have recently become available, including the KrimeSite™ Scope marketed by Sirchie® and the SceneScope™ marketed by the SPEX Forensic Group. This unit has been evaluated by Saferstein and Graf (2001), who confirmed that the detection of latent fingermarks by RUVIS was a practical and worthwhile undertaking, particularly on smooth, nonporous surfaces.

The technique is based on the contrast between the surface, which may absorb or reflect UV light, and the fingerprint deposit that absorbs some UV radiation and diffusely reflects the remainder. The technique may therefore give either light ridges on a dark background or dark ridges on a light background, depending on the nature of the surface and the composition of the fingerprint deposit (Wang 1996). The type of UV lamp employed and the angle of incidence of the UV illumination are both critical factors for obtaining satisfactory results.

Keith and Runion (1998) found that the routine casework application of real-time shortwave UV imaging was a valuable supplement to conventional white light and forensic light source examinations. The authors indicated that RUVIS can be extremely helpful when working with cyanoacrylate-fumed, dye-stained surfaces that luminesce excessively when excited with a forensic light source at wavelengths between 400 and 580 nm.

The Serious Crimes Unit (SCU) in London has routinely used reflection techniques in both the long- and shortwave UV region on a range of surfaces (Creer 1993, 1996). In addition, they have reported that the illumination of latent prints on paper using the 266-nm radiation from a frequency-quadrupled Nd:YAG laser, with photographic detection of their UV luminescence (emission in the long-wave UV region of 300 to 400 nm), can produce images with good ridge detail (Bramble et al. 1993). In a laboratory evaluation, they recorded a detection rate of 69% for latent fingermarks sampled from 34 individuals. Johnson and coworkers (1991) concluded that the aromatic amino acids tyrosine and tryptophan account for about 80% of the UV luminescence from finger sweat extracts. Fraval et al. (1996) provided some confirmation. Creer (1993) reported that the technique is far from being of practical use in routine work, as approximately 2 h are needed to search for fingermarks on an A4 sheet of paper by the procedure described. In addition, almost all of the fingermarks detected by UV luminescence could be enhanced by conventional chemical treatment. Springer et al. (1994) have confirmed that a range of different body fluids, including blood, semen, and saliva, can be readily detected by shortwave UV luminescence.

The design of an illumination-imaging system for the observation of shortwave UV luminescence, based on a portable mercury-xenon lamp and a cooled CCD camera, has been described (Ben-Yosef et al. 1998). The system was evaluated for the detection of latent fingermarks and various body fluid stains. Of the eccrine-rich latent marks examined in the study, only a small number (around 10%) exhibited significant luminescence.

Some surfaces, such as white glossy paper, absorb UV light and produce a strong luminescence emission in the visible spectrum due to the presence of optical brighteners. The illumination of such surfaces with UV light can sometimes reveal latent marks, particularly if such marks are contaminated with UV-absorbing material. Marks of this type will be seen as dark images against a bright luminescent background (Creer 1996). No special equipment other than a UV lamp is required.

4.4 DETECTION TECHNIQUES FOR POROUS SURFACES

4.4.1 NINHYDRIN

4.4.1.1 General

Ninhydrin reacts with primary and secondary amines (including amino acids, proteins, and peptides) to give a dark purple product known as Ruhemann's purple (RP) (Figure 4.3). As the eccrine component of a latent mark deposit contains amino acids, this reaction can be exploited as a means of developing fingerprints on porous surfaces such as paper and cardboard. The use of ninhydrin as a fingerprint detection reagent was first proposed in 1954 by Odén and von Hofsten (1954). Since then, ninhydrin has become the most popular technique for fingerprint detection on porous substrates.

Eccrine glands secrete a range of different amino acids that may ultimately be present in a latent fingerprint deposit (Hamilton 1965; Ramotowski 2001) (see Table 4.3 and Figure 4.4). Ninhydrin is a nonspecific amino acid reagent in that it reacts in the same manner with different amino acids. In this way, each amino acid present in the latent fingerprint deposit will contribute to the developed fingerprint image. Amino acids are stable compounds that, due to an affinity for cellulose, do not migrate to any significant extent through dry paper substrates. As a result, very old latent marks can be developed with ninhydrin (the development of 40-year-old marks has been recorded), and the revealed marks are normally of good quality. In addition, the amino acid composition of the eccrine secretion appears to remain relatively constant. Due to these qualities, the use of amino acid reagents (ninhydrin and ninhydrin analogs, including 1,8-diazafluoren-9-one [DFO]) constitutes an effective chemical technique for the development of latent fingerprints on paper surfaces.

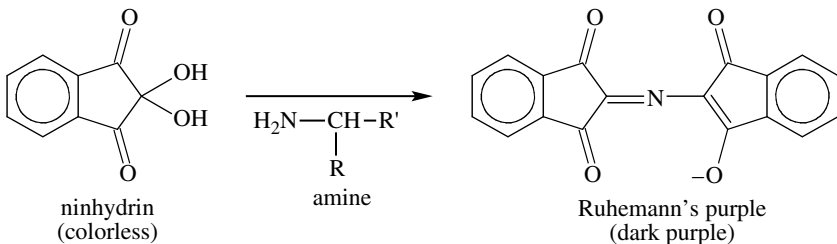

FIGURE 4.3 Chemical reaction between ninhydrin and a primary or secondary amine, resulting in the formation of a dark purple product known as Ruhemann's purple.

TABLE 4.3
Quantities of Major Amino Acids Found in a Single Wet Thumb Print

Amino Acid	Amount (μmol)	Serine Ratio
Serine	0.106	100
Glycine	0.071	67
Ornithine	0.034	32
Alanine	0.029	27
Aspartic acid	0.023	22
Threonine	0.018	17
Histidine	0.018	17
Valine	0.013	12
Proline	0.011	10
Leucine	0.011	10
Lysine	0.011	10

From: Hamilton, P.B. (1965), Amino-acids on hands, *Nature*, 205, 284–285; and from Ramotowski, R.S. (2001), Composition of latent print residue, in *Advances in Fingerprint Technology*, 2nd ed., H.C. Lee and R.E. Gaensslen, Eds., Boca Raton, FL: CRC Press, pp. 63–104.

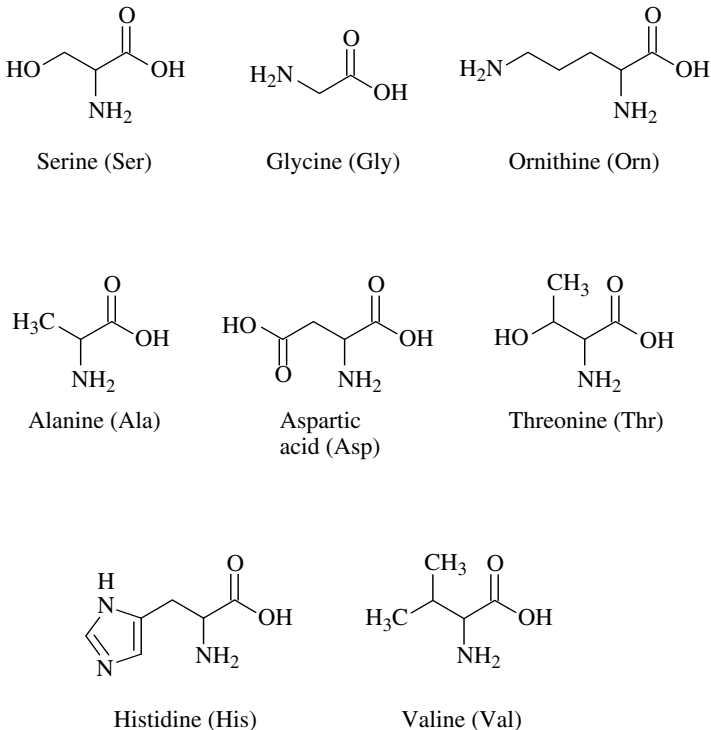

FIGURE 4.4 Structures of the major amino acids found in a typical latent fingerprint deposit.

The ninhydrin reaction is much more complex than the simplified process depicted in Figure 4.3. The mechanism for the reaction with amino acids is given in Figure 4.5 (Grigg et al. 1986; Lennard 1986; Wilkinson 2000a). Ninhydrin reacts in its triketone form to produce an intermediate imine. Subsequent decarboxylation gives an amine that reacts with a second molecule of ninhydrin to produce Ruhemann's purple. Due to this complex mechanism, reaction conditions must be tightly controlled if the optimum yield of Ruhemann's purple is to be obtained. The reaction rate will depend on temperature, relative humidity, and pH (acidity). It has been shown that an optimum reaction rate will be obtained under slightly acidic conditions, around pH 5 (Lamothe and McCormick 1972).

Paper items are generally treated with ninhydrin by briefly dipping in a solution of the reagent (typical concentration 0.5% w/v in a mixture of organic solvents). As an alternative to dipping, the reagent can be applied with a brush or spray. The items are then air-dried and the development allowed to proceed at room temperature over 24 to 48 h. The reaction is the most efficient when the relative humidity is between

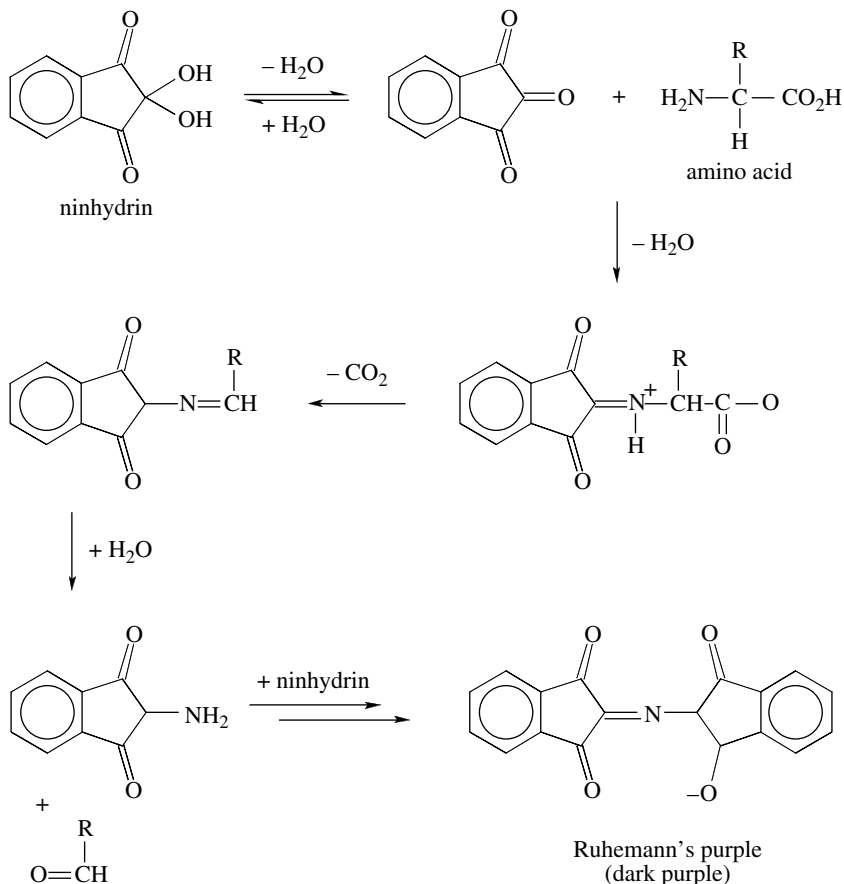

FIGURE 4.5 Mechanism for the reaction between ninhydrin and an amino acid.

50 and 80%. Heating the items to accelerate development is generally not recommended as this can lead to a background coloration that is due to a reaction between ninhydrin and the substrate itself. If rapid results are required for operational reasons, special-purpose ninhydrin development cupboards can be employed where the temperature and humidity are precisely controlled (80°C with 65% relative humidity; development time approximately 5 min [Kent 1998]). While the ninhydrin technique can develop latent fingerprints on a wide range of porous substrates, some paper surfaces (e.g., certain types of banknote paper) react strongly with the reagent, and its use is limited in such cases.

A ninhydrin-developed fingerprint is dark purple in color due to the formation of Ruhemann's purple along the ridge impressions. The absorption spectrum of Ruhemann's purple on paper (Figure 4.6A) shows two absorption maxima: a narrow band centered at 415 nm (violet region) and a broad, main band centered around 560 nm (green–yellow region). Photography of ninhydrin-developed latent prints is best achieved using the absorption mode. To achieve the best contrast when photographing ninhydrin-developed prints, the main absorption band of Ruhemann's purple (i.e., 560 nm) should be exploited. This is achieved using white light illumination and a green–yellow bandpass barrier filter in front of the camera (e.g., central wavelength [CW] = 540 to 580 nm; half-bandwidth [HBW] = 40 to 50 nm; Figure 4.6B). In cases where a colored background prevents good contrast from being obtained under these conditions, it is possible to utilize the 415-nm Ruhemann's purple absorption band (Figure 4.6). Some forensic light sources are fitted with a violet filter (e.g., CW = 415 nm; HBW = 40 nm) that can be used for this purpose. Photography should be conducted in a darkened room with the prints illuminated with the violet band from the light source. No barrier filter is required on the camera in this case.

4.4.1.2 Ninhydrin Formulations

Amino acid reagents such as ninhydrin are generally made up in a solution that contains the reagent itself, a small amount of polar solvent (generally ethanol or methanol) to keep the reagent in solution, acetic acid (to ensure that the reaction takes place under slightly acidic conditions), and a carrier solvent that makes up the bulk of the solution. Other solvents may be added to increase the stability of the working solution. Ideally, the carrier solvent should be volatile (to quickly evaporate from treated surfaces), nontoxic, nonflammable, nonpolar (to minimize ink running on treated documents), and cost effective.

The solvent 1,1,2-trichlorotrifluoroethane (sold under various names such as Arklone P, Fluorisol, Freon 113, CFC113, etc.) has generally been favored as the ideal carrier solvent for fingerprint reagents. The first such formulation was NFN (nonflammable ninhydrin), proposed by Morris and Goode in 1994 and widely used since that time (Morris and Goode 1975). Unfortunately, due to its harmful effects on the Earth's ozone layer, CFC113 is no longer manufactured, and its use is now prohibited in most countries. This is a direct result of the 1987 Montreal Protocol that placed restrictions on substances that deplete the ozone layer.

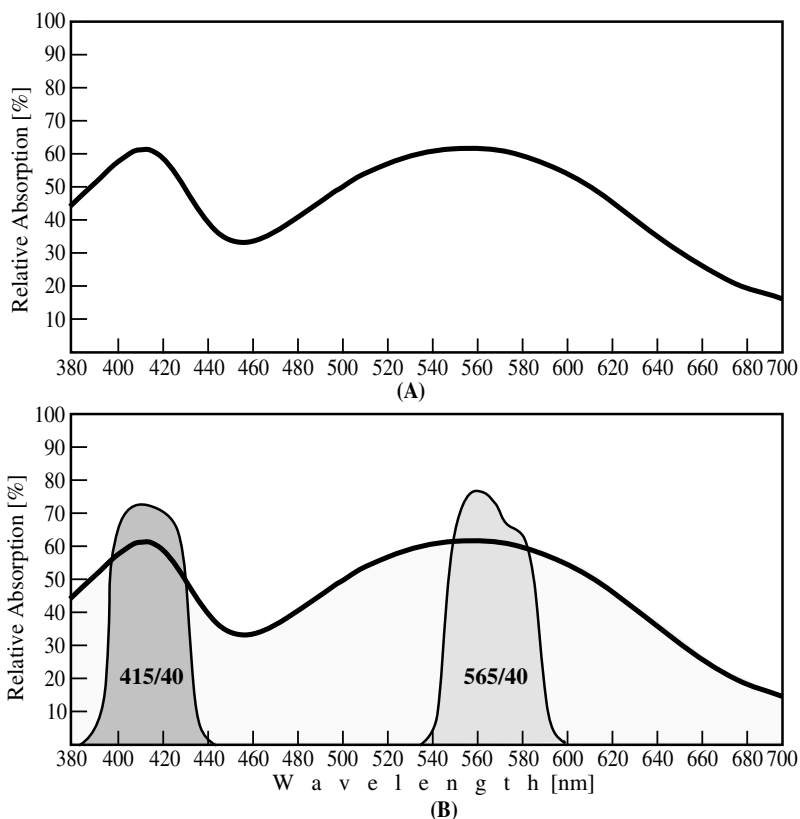

FIGURE 4.6 (A) Relative absorption of spectrum of a ninhydrin-developed fingerprint on paper; (B) Recommended bandpass filters for observation in the absorption mode.

Research into replacements for CFC113 has been underway since the early 1990s. Jungbluth (1992, 1993) reported good results with the solvents Genesolv 2020 (a mixture of dichlorofluoroethane and dichlorotrifluoroethane) and Genesolv 2000 (dichlorofluoroethane; HCFC 141b). However, both of these solvents are based on hydrochlorofluorocarbons (HCFC) that are also in the process of being phased out due to their ozone-depleting potential (albeit lower than that of CFC113). A number of authors have reported success with formulations based on hexane, heptane, or petroleum ether as carrier solvents (Watling and Smith 1993; Hewlett and Sears 1997). The flammability of such solvents, however, means that they are not a safe alternative for most operational laboratories. Formulations based on these solvents should only be used if laboratory facilities are adequate (e.g., availability of fume cupboards certified for flammable liquid use).

To date, the two most promising replacement solvents for CFC113 have proved to be the hydrofluoroether (HFE) 1-methoxynonafluorobutane (HFE7100) from 3M, and the hydrofluorocarbon (HFC) 1,1,1,2,3,4,4,5,5,5-decafluoropentane (HFC4310mee; Vertrel XF) from Dupont (Kent 1996). These solvents have a zero ozone depletion potential (ODP) and are nonflammable (Table 4.4). Operational

TABLE 4.4
Chemical Properties of CFC113 (Arklone, Fluorisol) and a Number of Alternative Carrier Solvents

	CFC113	HFC4310	HFE7100	HFE71DE	Heptane	Cyclohexane
Other names	arklone, fluorisol	Vertrel XF	—	hydrofluoroether azeotrope	—	—
Chemical name	1,1,2-trichlorotrifluoroethane	decafluoropentane	methyl nonafluorobutyl ether (1-methoxynonafluorobutane)	50% methyl nonafluorobutyl ether 50% 1,2-dichloroethylene	—	—
Boiling point (°C)	48	54	61	41	98	81
Density (g/cm ³)	1.56	1.58	1.52	1.37	0.68	0.78
Flash point (°C)	none	none	none	none	-3.9	-18.3
Exposure (8-h avg. in ppm)	600	200	750	750/200	500	300
Ozone depletion potential (ODP)	0.8	0	0	0	0	0

trials have indicated that ninhydrin formulations based on either of these two carrier solvents perform at least as well as, if not better than, CFC113-based formulations (Hewlett et al. 1997; Hewlett and Sears 1999; Petrucio 2000; Rajtar 2000). While HFE7100 and HFC4310mee are the currently recommended carrier solvents, their high cost (around U.S.\$1000 per 20-l drum) may be problematic for some laboratories.

4.4.1.3 Secondary Metal Salt Treatment

Fingermarks developed with ninhydrin can be further enhanced by treatment with a zinc (Zn) or cadmium (Cd) metal salt solution. This treatment results in a color change, orange for zinc and red for cadmium, that is due to the formation of a 1:1 coordination complex between the Ruhemann's purple (the product from the ninhydrin reaction) and the metal salt (Lennard 1986; Lennard et al. 1987) (Figure 4.7). These complexes show stronger absorption properties than Ruhemann's purple itself, and this may be useful in the absorption mode when the background color leads to poor contrast after initial ninhydrin development.

Absorption spectra for the RP-Zn and RP-Cd complexes are shown in Figure 4.8A. Post-treatment with zinc nitrate changes the purple color of ninhydrin-developed prints to orange, with the maximum absorption shifted to around 490 nm. Enhancement photography of zinc post-treated prints can therefore be achieved in the absorption mode with a 490-nm bandpass barrier filter in front of the camera (or using illumination from a forensic light source operating at this wavelength) (Figure 4.8B). Post-treatment with cadmium nitrate changes the purple color of ninhydrin-developed prints to red, with the maximum absorption shifted to around 505 nm. Enhancement photography of cadmium post-treated prints can therefore be achieved in the absorption mode with a 505-nm bandpass barrier filter in front of the camera (or using equivalent illumination from a forensic light source) (Figure 4.8C).

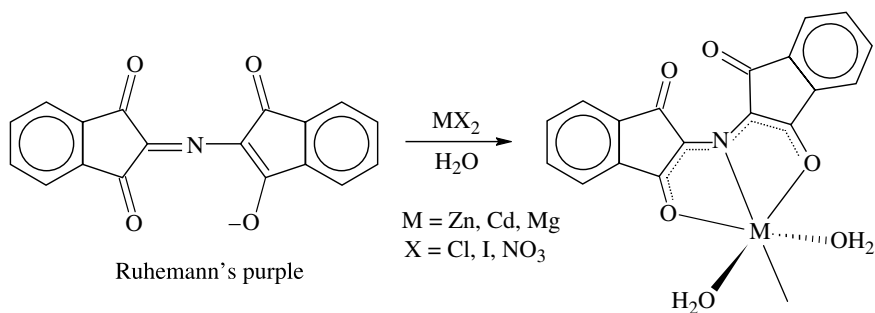

FIGURE 4.7 Treatment of Ruhemann's purple with certain metal salts results in the formation of a coordination complex. (From Lennard, C.J., Margot, P.A., Sterns, M., and Warrenner, R.N. [1987], Photoluminescent enhancement of ninhydrin developed fingerprints by metal complexations: structural studies of complexes formed between Ruhemann's purple and Group IIb metal salts, *J. Forensic Sci.*, 32, 597–605. With permission.)

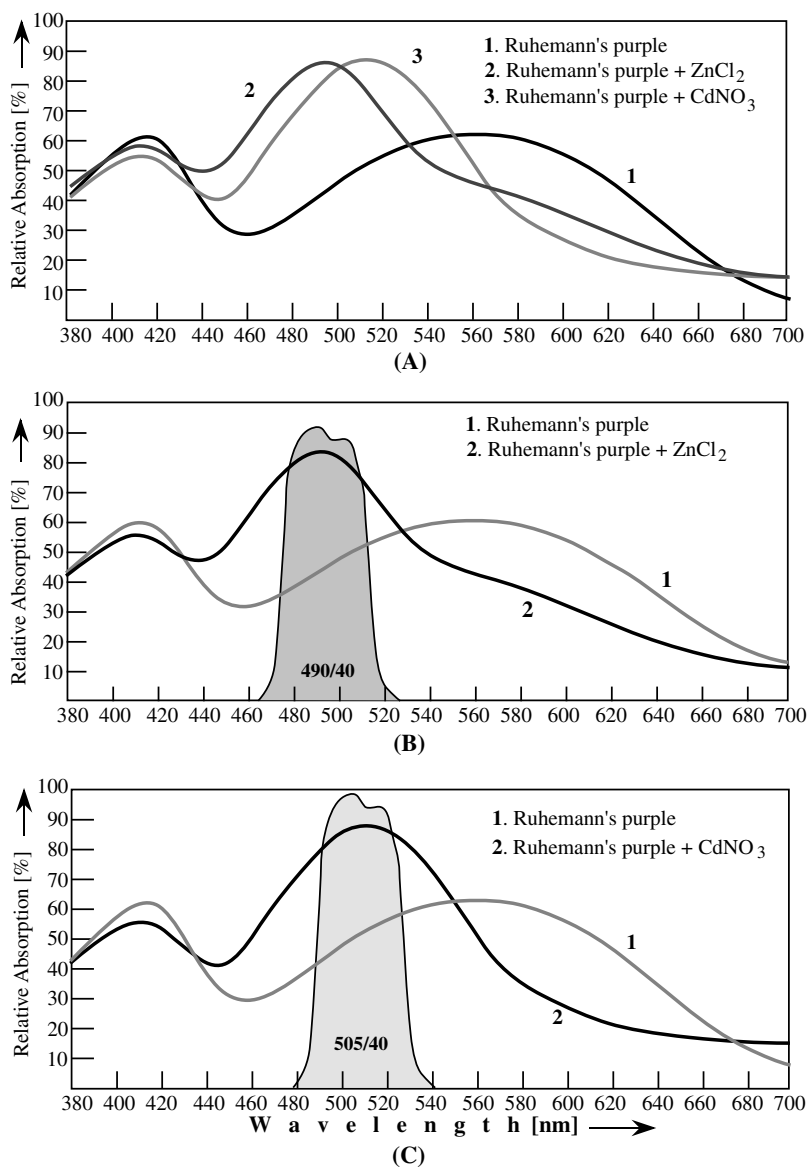

FIGURE 4.8 (A) Relative absorption spectra of Ruhemann's purple and its complexes with zinc and cadmium; (B) Recommended bandpass filter for observation in the absorption mode in the case of the zinc complex; (C) Recommended bandpass filter for observation in the absorption mode in the case of the cadmium complex.

Of more significance than the color change is the luminescence that is produced by zinc or cadmium post-treatment. The luminescence emission, which is very weak under normal conditions, is significantly enhanced at low temperature. This can be conveniently achieved by cooling the prints with liquid nitrogen (-196°C ; 77 K).

Typical luminescence spectra for a ninhydrin-developed fingerprint post-treated with zinc nitrate are shown in Figure 4.9A. Typical luminescence spectra for a ninhydrin-developed fingerprint post-treated with cadmium nitrate are shown in Figure 4.10. Considerable enhancement of ninhydrin-developed fingerprints can be obtained by exploiting the luminescence properties of these complexes (Herod and Menzel 1982; Kobus et al. 1983; Stoilovic et al. 1986).

If the relative humidity is low (<50%), exposure to the breath or to steam may be necessary to complete the reaction, particularly in the case of cadmium treatment. (As shown in Figure 4.7, water is a necessary component for the formation of the coordination complex.) Early research indicated that treatment with a cadmium salt is preferred, since the complex formed is more stable than the corresponding zinc complex, and the final result is less dependent on the conditions used for the

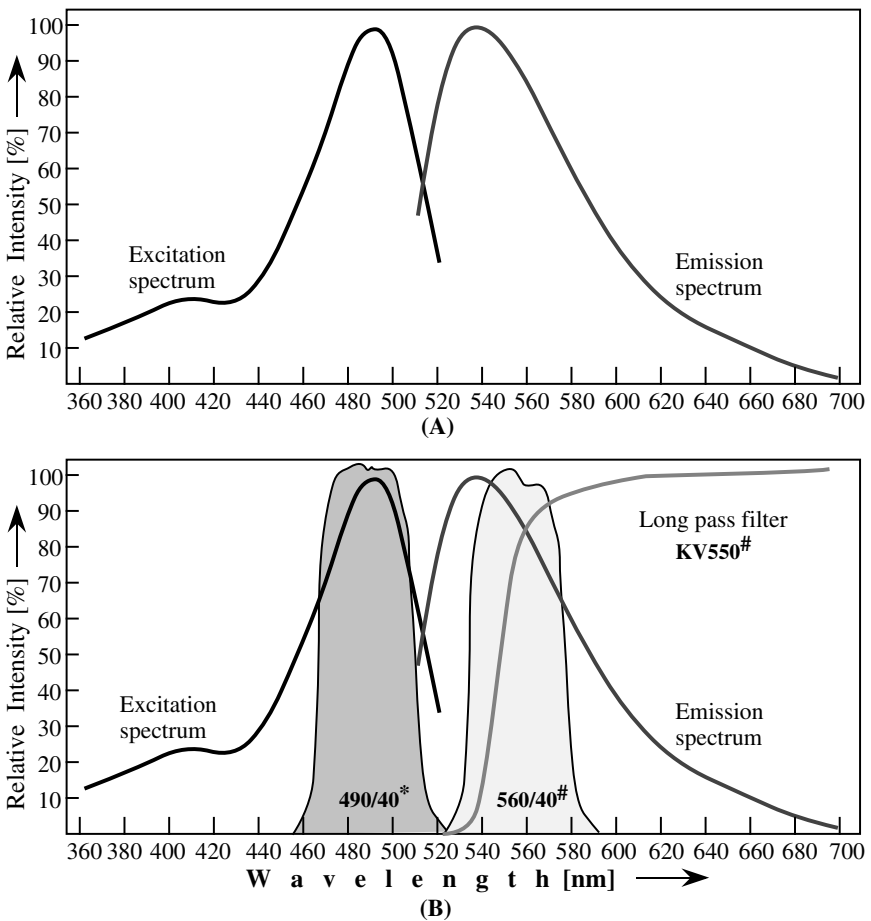

FIGURE 4.9 (A) Luminescence spectra recorded at liquid nitrogen temperature for a ninhydrin developed print post-treated with zinc nitrate; (B) Recommended filters for excitation (*) and observation (#) in the luminescence mode.

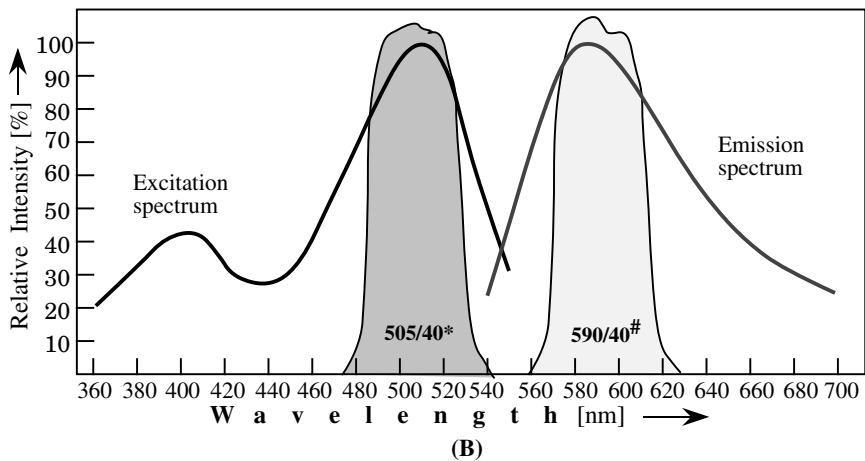
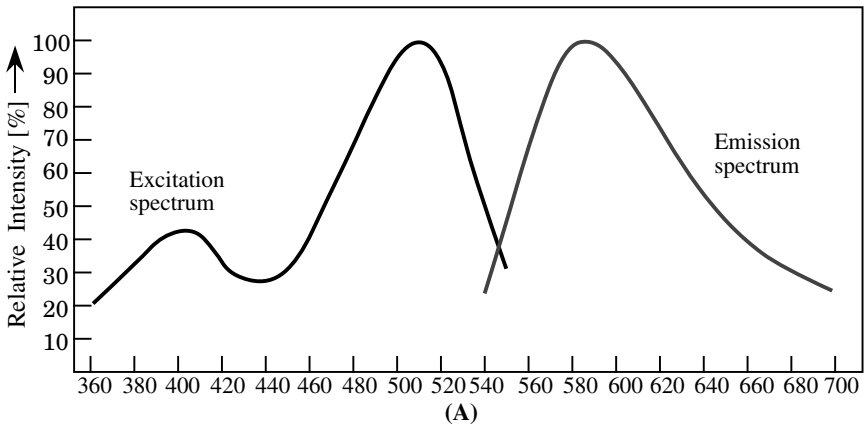

FIGURE 4.10 (A) Luminescence spectra recorded at liquid nitrogen temperature for a ninhydrin developed print post-treated with cadmium nitrate; (B) Recommended filters for excitation (*) and observation (#) in the luminescence mode.

ninhydrin development (Stoilovic et al. 1986). However, the high toxicity of cadmium salts must be taken into consideration. Zinc treatment can sometimes lead to the formation of a red complex, particularly if strong ninhydrin development has occurred and/or moisture levels are too high. It has been established that the red complex is in fact a 2:1 RP-Zn complex that can be formed under certain reaction conditions (Davies et al. 1995). The formation of a red complex in treated prints on paper has been associated with reduced luminescence yield and hence poor fingerprint enhancement (Kobus et al. 1983; Liberti et al. 1995).

After metal salt treatment, the sample is inspected under a forensic light source operating at a suitable wavelength. To favor the luminescence, the sample is cooled to liquid nitrogen temperature (-196°C), which is achieved by placing the sample in an insulated container (such as a polystyrene foam tray) and covering it with a thin layer of liquid nitrogen (Figure 4.11). The complex formed with zinc(II) has a

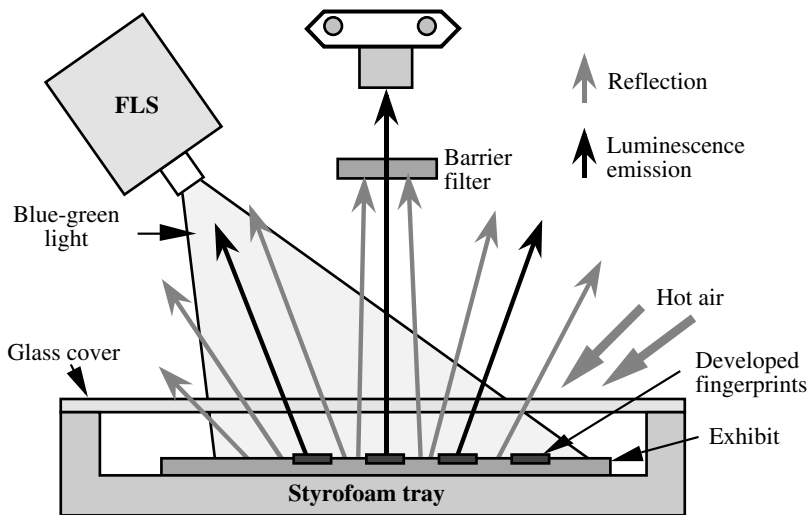

FIGURE 4.11 General luminescence mode set-up for the recording of ninhydrin developed prints post-treated with a metal salt (zinc or cadmium).

maximum absorption in the blue–green ($\lambda = 490 \text{ nm}$), while the complex formed with cadmium(II) absorbs in the green ($\lambda = 505 \text{ nm}$). The luminescence emission occurs in the green–yellow for the first complex ($\lambda = 550 \text{ nm}$) and in the orange for the second ($\lambda = 590 \text{ nm}$). Filters that transmit these wavelengths are placed in front of the camera (or the eye) to record the resulting luminescence. Best results are obtained using high-quality interference filters with a half bandwidth of approximately 40 nm. The fingerprint luminescence is often weak, and therefore photographic recording generally requires long exposure times (from a few seconds to several minutes).

Menzel and Mitchell (1990) investigated the complex formed between Ruhemann’s purple and europium chloride. The organo–rare earth complex that results (EuRP_2 , orange in color) exhibits europium(III) luminescence at 615 nm with a lifetime of 0.4 msec. This emission, excited in the long-wave UV region (330 to 360 nm), has a lifetime that is much longer than that of the usual background luminescence. Terbium–Ruhemann’s purple complexes, studied by Mekkaoui Alaoui and Renzel (1994), are best excited in the range 310 to 330 nm and have an emission maximum at 545 nm with an emission lifetime of 1.3 msec. These properties make lanthanide complexes suitable for time-resolved luminescence imaging, which can result in the extraction of useful fingerprint detail even on highly luminescent surfaces (Mekkaoui Alaoui and Renzel 1993; Murdock and Menzel 1993). With current technology, however, time-resolved imaging remains an expensive and relatively complicated procedure that has not found routine application.

4.4.2 NINHYDRIN ANALOGS

Ninhydrin analogs are amino acid–specific reagents that are structurally similar to ninhydrin itself, but where different functional groups have been introduced with

the purpose of improving fingerprint detection capabilities. The requirements for an ideal replacement for ninhydrin are good initial color, superior luminescence properties (preferably without the need for metal salt treatment or cooling with liquid nitrogen), low cost, good solubility in a range of solvents (preferably nonpolar), and low toxicity (Ramotowski et al. 1997). Excellent reviews on the synthesis and applications of ninhydrin and its analogs have been published by Joullié et al. (1991) and Almog (2001).

Almog and colleagues, in Israel in the early 1980s, were the first to explore the potential of ninhydrin analogs and thereby inspire other research groups around the world (Almog et al. 1982). Some of the more promising compounds that were synthesized at that time included benzo[f]ninhydrin (Almog et al. 1982) and 5-methoxyninhydrin (Lennard et al. 1986, 1988) (Figure 4.12). These reagents develop latent fingerprints on paper with a sensitivity similar to that of ninhydrin but, after metal salt treatment, offer considerably stronger luminescence emission, even at ambient temperature. This is particularly an advantage on surfaces that are luminescent at liquid nitrogen temperature (such as manila paper and yellow envelopes). The different spectral characteristics of marks developed with these compounds also permit better selectivity on certain surfaces where there is an interference with ninhydrin (Table 4.5). For example, the red-shifted absorption and emission from benzo[f]ninhydrin-developed marks can be particularly useful on cardboard and yellow paper, as these surfaces are highly luminescent at the same wavelengths as the RP-zinc(II) and RP-cadmium(II) complexes. Both benzo[f]ninhydrin and 5-methoxyninhydrin are now commercially available, but they are expensive alternatives to ninhydrin itself (Table 4.5). Almog and coworkers (2000) concluded that, due to high cost and low solubility, the advantages displayed by benzo[f]ninhydrin were insufficient to justify routine use.

More recently, the synthesis of a number of amino-substituted ninhydrin analogs has been reported (Almog et al. 1991). Of these, the compound 5-aminoninhydrin (Figure 4.13) showed some promise as a fingerprint reagent, producing strong room temperature luminescence in developed marks, even without secondary metal salt treatment. However, Pounds and Allman (1992) found that the reagent produced a highly luminescent background that tended to obscure developed marks. Sulfur-containing groups at position 5 were subsequently investigated and were found to

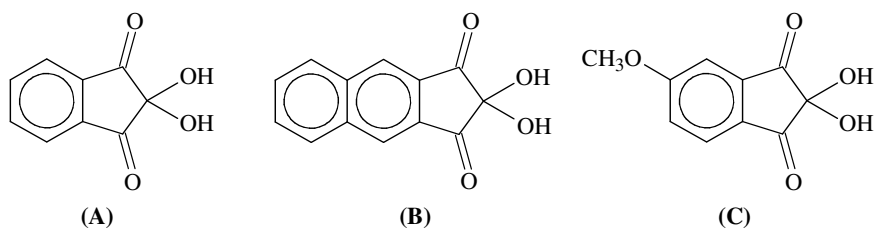

FIGURE 4.12 Chemical structures for (A) ninhydrin and the ninhydrin analogs, (B) benzoninhydrin, and (C) 5-methoxyninhydrin.

TABLE 4.5**Spectroscopic Data from Developed Marks and Approximate Costs for the Reagents Ninhydrin, Benzoninhydrin, and 5-Methoxyninhydrin**

	Ninhydrin	Benzoninhydrin	5-Methoxyninhydrin
Approximate cost (U.S.\$ per gram)	<\$1	\$500	\$250
Zinc complex:			
Excitation	490 nm	530 nm	505 nm
Emission	550 nm	590 nm	540 nm
Cadmium complex:			
Excitation	505 nm	550 nm	520 nm
Emission	590 nm	635 nm	585 nm

exhibit excellent properties as fluorogenic reagents for fingerprint detection on paper (Almog et al. 1992). Preliminary experiments indicated that 5-methylthioninhydrin (Figure 4.13B) showed a sensitivity that markedly exceeded that of ninhydrin and even that of 5-methoxyninhydrin.

A number of analogs composed of extended aromatic rings, bi-ninhydrins, and sulfur-containing compounds were synthesized by Joullié's group at the University of Pennsylvania (Cantu 1993). The sulfur-containing analogs 5-methylthioninhydrin, thieno[f]ninhydrin, and 5-(2-thienyl)-ninhydrin (Figure 4.13B, C, and D) were found to be very sensitive reagents for latent fingerprint detection, particularly after metal salt treatment. It was suggested that these analogs were at least as sensitive as DFO (and in some cases more sensitive) for the detection of fingerprints on paper. Similar results were independently reported (Pounds and Allman 1992). However, Hark and coworkers (1996) indicated that the estimated cost of manufacturing analogs such as 5-(2-thienyl)-ninhydrin would likely limit their widespread distribution and use.

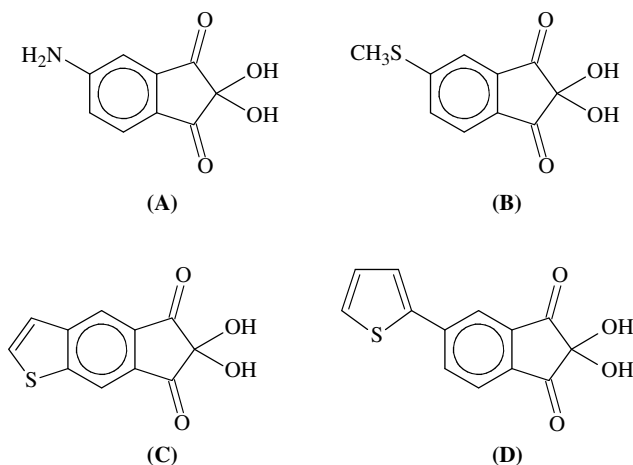

FIGURE 4.13 Chemical structures for the ninhydrin analogs (A) 5-aminoninhydrin, (B) 5-methylthioninhydrin, (C) thieno[f]ninhydrin, and (D) 5-(2-thienyl)-ninhydrin.

Cantu and coworkers (1993) compared ten amino acid reagents (ninhydrin, eight ninhydrin analogs, and DFO) in their ability to visualize spots of the amino acid glycine on paper. The evaluation considered parameters such as color development, luminescence, luminescence after zinc(II) treatment, and background interference. The role of acetic acid in the reagent formulations was also evaluated. Of the reagents tested, the analog thieno[f]ninhydrin was found to be the most sensitive visualizing reagent when zinc(II) treatment was employed. The study also confirmed that Ruhemann's purple combines with zinc(II) in a 1:1 ratio under normal circumstances.

Nitrophenylninhydrin, benzo[f]furoninhydrin, and six ninhydrin analogs containing oxygen, sulfur, and selenium substituents at position 5 were evaluated as fingerprint development reagents by Kobus and coworkers (2002). The analogs all showed good color development, but this was not superior to that obtained with ninhydrin itself. The reaction product obtained with benzo[f]furoninhydrin showed strong room temperature luminescence following zinc complexation. Of the compounds evaluated by this group, the benzo[f]furo analog (Figure 4.14) showed the greatest potential as a fingerprint reagent, with results comparing favorably with those obtained with DFO.

In 1997, Ramotowski and colleagues from the U.S. Secret Service and the University of Pennsylvania introduced 1,2-indanediones as a new class of amino acid visualizing compounds (Ramotowski et al. 1997; Hauze et al. 1998). Several substituted 1,2-indanediones as well as the unsubstituted 1,2-indanedione parent compound (Figure 4.15) were evaluated for their ability to detect glycine spots of varying concentration on paper. Results were compared with those obtained using DFO. Most of the 1,2-indanediones evaluated produced a light pink initial color as

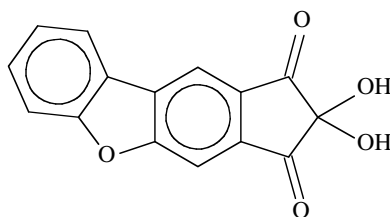

FIGURE 4.14 Structure of benzo[f]furoninhydrin.

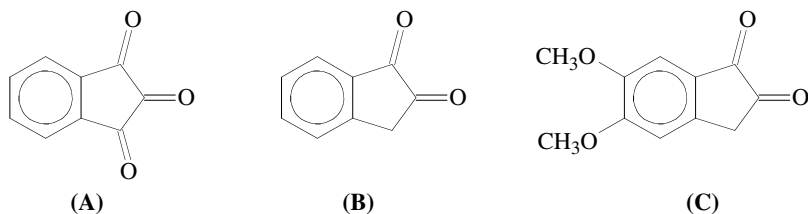

FIGURE 4.15 Chemical structures for (A) ninhydrin in its anhydrous form, (B) 1,2-indanedione, and (C) 5,6-dimethoxy-1,2-indanedione.

well as a strongly luminescent reaction product (at room temperature), in some cases without secondary metal salt treatment. The most effective compound appeared to be the 5,6-dimethoxy derivative (Figure 4.15C). The luminescence produced by this compound (without zinc salt treatment) was comparable to DFO, while the zinc-treated sample showed a significant advantage over DFO luminescence.

Almog and coworkers (1999) synthesized and evaluated unsubstituted 1,2-indanedione and a number of mono- and dimethoxy- derivatives as fluorogenic reagents for fingerprint detection on paper. The authors found that 1,2-indanedione, with its ease of preparation, good solubility in nonpolar solvents, and high sensitivity relative to DFO, made it a good candidate for use as a routine fingerprint reagent. An independent evaluation reported by Roux and colleagues (2000) confirmed this view. More recently, Wiesner and colleagues (2001) treated a large number of actual exhibits (used bank checks) and found that 1,2-indanedione developed 46% more identifiable prints than the sequence DFO–ninhydrin. It was found that acetic acid in the formulation did not improve the results and, in fact, had a detrimental effect on print clarity. Optimal development conditions were found to be 100°C for 20 min with 60% relative humidity. Indanedione is now commercially available, and it has been adopted for operational use by the Division of Identification and Forensic Science (DIFS), Israel Police. The Florida Department of Law Enforcement has also validated the technique for routine use (Kasper et al. 2002).

Wilkinson (2000a) conducted spectroscopic studies on 1,2-indanedione using nuclear magnetic resonance (NMR) spectroscopy and mass spectrometry (MS). These studies indicated that when 1,2-indanedione is dissolved in methanol, a stable hemiketal is formed similar to that proposed for DFO when it is dissolved in methanol. In contrast to DFO, where reactivity to amino acids appears to be enhanced by hemiketal formation, the reactivity of 1,2-indanedione toward amino acids is diminished. Alcohols, particularly methanol, should therefore be avoided when formulating 1,2-indanedione as a fingerprint reagent (Wilkinson 2000a; Wiesner et al. 2001).

4.4.3 DIAZAFLUORENONE (DFO)

The compound 1,8-diazafluoren-9-one (DFO) (Figure 4.16) is an amino acid-sensitive reagent that gives a reaction product that is pale purple in color (lighter than the color obtained with ninhydrin). The advantage of the reagent is that, without any secondary treatment, developed marks show a strong room temperature luminescence (Pounds et al. 1990). Heat is required for the reaction to proceed, but results are obtained within a very short period of time (less than 30 min). The chemical reaction involved is believed to be similar to the reaction between ninhydrin and the amino acids present in the fingerprint deposit. Grigg and coworkers (1990) trapped and characterized a number of reaction intermediates and were able to detail a possible reaction scheme (Figure 4.16). The final reaction product proposed by this group has since been identified by x-ray crystallography (Wilkinson 2000b).

The development process is simple and rapid: the document is dipped in a solution of DFO, dried, and then heated at 100°C for 20 min. As an alternative, Stoilovic (1993) has shown that 20 to 30 sec at 160°C or 10 sec at 180°C (e.g., using

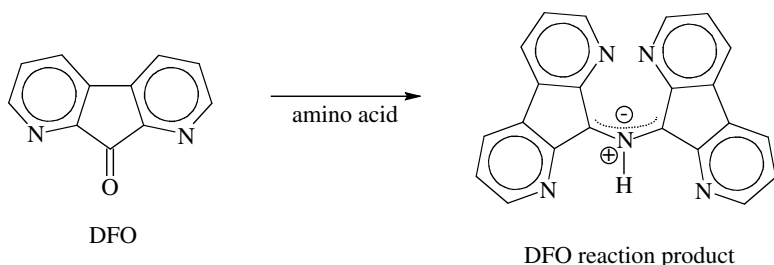

FIGURE 4.16 Suggested reaction between DFO and an amino acid to produce a luminescent product. (Wilkinson, D. [2000b], Study of the reaction mechanism of 1,8-diazafluoren-9-one with the amino acid l-alanine, *Forensic Sci. Int.*, 109, 87–103. With permission.)

an ironing press) produces superior development (at least twice the fingerprint luminescence with less background development). The color of DFO-developed latent fingerprints is faint, and only strong latent fingerprints will develop a good color sufficient for photography in the absorption mode. The absorption maximum is around 560 nm. Detection of DFO-treated prints is much more sensitive in the luminescence mode. Weak prints can often be further enhanced by repeating the DFO process (i.e., re-treatment with DFO solution and reheating).

DFO-developed latent marks produce excellent photoluminescence without any post-treatment or cooling. The excitation spectrum is very broad and covers the region from 430 to 580 nm, with maxima at 460, 530, and 560 nm (Figure 4.17A). The best luminescence can be produced by excitation between 540 and 570 nm (i.e., the main excitation region). If excitation at the main maximum produces a highly luminescent background, one of the other two excitation bands (530 nm or 460 nm) can also be used for excitation. The emission band is quite broad and covers the region between 560 and 620 nm (Figure 4.17). It must be noted that the luminescence is at its maximum immediately after the heating process and then decreases slightly with time due to the absorption of ambient humidity. The luminescence can be restored to its original intensity by reheating the prints. Secondary metal salt treatment has only a minimal effect on the luminescence of DFO-treated prints, although it has been shown that metal complexes are formed (Conn et al. 2001).

Operational trials on casework material have shown that DFO reveals approximately two to three times more latent fingermarks than ninhydrin (McComiskey 1990; Pounds and Allman 1991). However, a high-powered light source with appropriate filtration is required for the visualization of developed marks. If such a light source is not available, the advantages of using DFO over ninhydrin may be lost, as weak fingerprints will not be detected (Hardwick et al. 1993). Fingermarks developed with DFO can be further treated with ninhydrin.

Hardwick and coworkers (1993) modified the original DFO formulation (Pounds et al. 1990) to obtain a solution that is easier to produce and stable for several months. Their suggested formulation, however, is based on the ozone-depleting solvent CFC113. Masters and coworkers (1991) proposed the use of a petroleum ether/xylene formulation. Didierjean and colleagues (1998) evaluated a DFO formulation based on HFE7100 as the carrier solvent to replace CFC113. Their

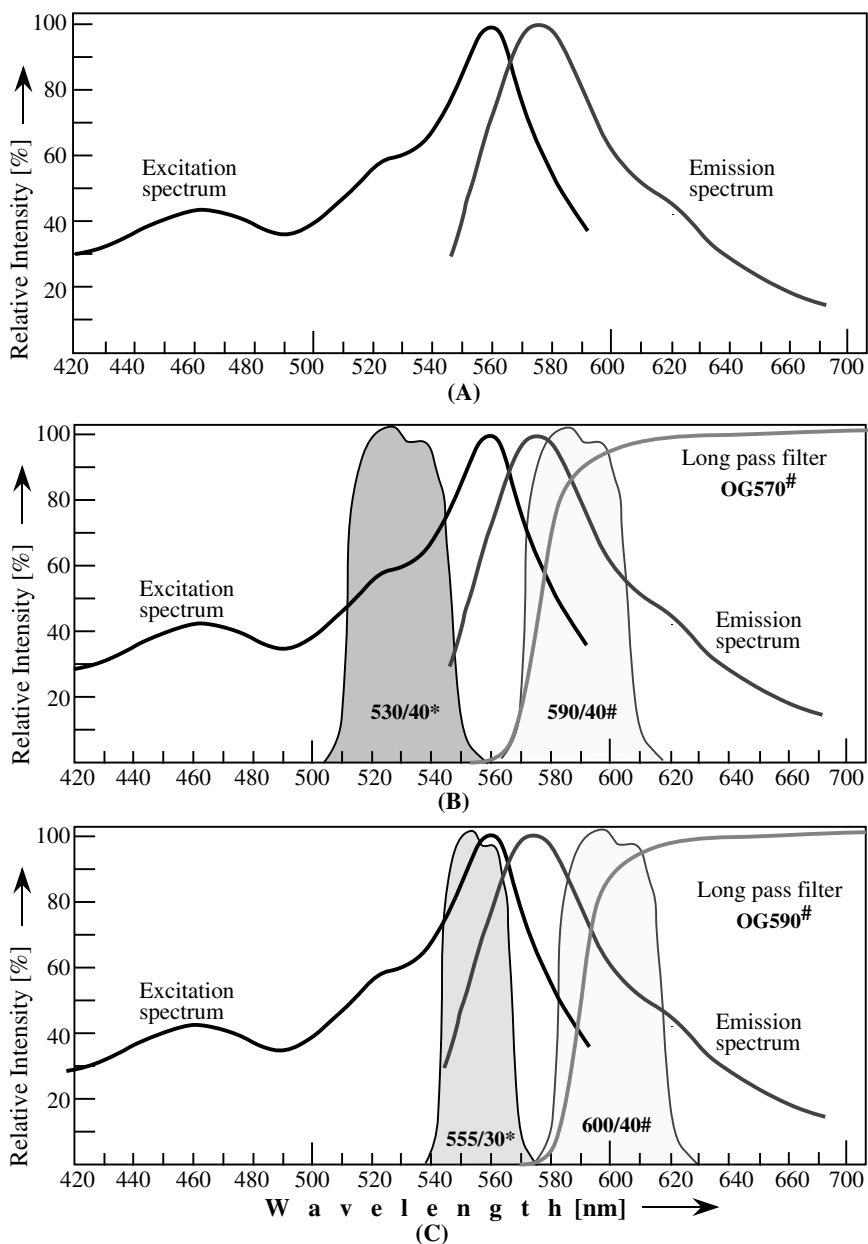

FIGURE 4.17 (A) Luminescence spectra for a DFO developed fingerprint on paper; (B, C) Recommended filters for excitation (*) and observation (#) in the luminescence.

proposed formulation is reported to be stable at room temperature for several weeks after preparation, with fingerprint detection results at least as good as those obtained using a CFC113-based solution. A similar formulation has been proposed by the Police Scientific Research Branch (Kent 1998). Wilkinson (2000b) confirmed that

methanol is an important component of the DFO formulation, as this appears to result in the formation of an unstable hemiketal that is the reactive species.

Bratton and Juhala (1995) reported the application of DFO in the dry state for the development of latent marks on papers. The technique does not use any petroleum ether, heptane, or Freon in the working solution. The technique involves the application of DFO from DFO-soaked filter papers and processing with a steam iron filled with a 5% acetic acid solution before heating in a mounting press at 100°C for 10 min. The authors reported that the “DFO-dry” procedure provides the same luminescence intensity as conventionally applied DFO, without ink running, damage to documents, or background-induced luminescence due to the DFO solution.

4.4.4 PHYSICAL DEVELOPER (PD)

Physical developer (PD) is a fingerprint processing technique for porous surfaces that was developed in the 1970s by the Atomic Weapons Research Establishment (AWRE) under contract to the Police Scientific Development Branch (PSDB), U.K. (Hardwick 1981; Goode and Morris 1983). The technique is sensitive to water-insoluble components of the latent fingerprint deposit, and therefore PD can be effective even if the surface has been wet. Fingermarks developed by this procedure are visible as dark gray to black images due to the deposition of silver metal along the print ridges.

PD, based on a photographic physical developer, is an aqueous solution containing silver ions, a ferrous/ferric redox (reduction/oxidation) system, a buffer (citric acid), and a cationic surfactant (generally *n*-dodecylamine acetate). The ferrous (Fe^{2+}) ions in solution reduce the silver (Ag^+) ions to silver metal (Ag^0), with ferric (Fe^{3+}) ions being present to hold back the reaction (Figure 4.18). Citric acid is required to complex with the ferric ions and to maintain a low pH. The action of the surfactant is to inhibit the premature deposition of silver metal by trapping randomly generated silver particles, as they are formed, within positively charged spheres of surfactant molecules known as micelles (Figure 4.19). The micelles repel the positive silver ions in solution, thereby blocking further silver formation (Jonker et al. 1969; Cantu 2001; Cantu and Johnson 2001). The PD solution is therefore a delicate balance of ferrous, ferric, and silver ions stabilized by the presence of citric acid and a surfactant.

When a document is placed in the PD reagent, silver slowly deposits from solution. This deposition generally is heavier on areas of surface contamination such as fingerprint residue. Developed marks generally appear as dark gray images against a light gray background. A conclusive explanation as to why the stabilized PD reagent can selectively develop latent marks on paper has yet to be found, although several theories have been expressed (Cantu 2001; Cantu and Johnson 2001).

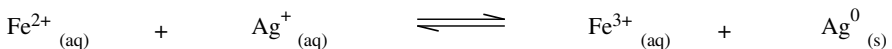

FIGURE 4.18 The redox (reduction/oxidation) reaction that is the chemical basis of the physical developer (PD) process.

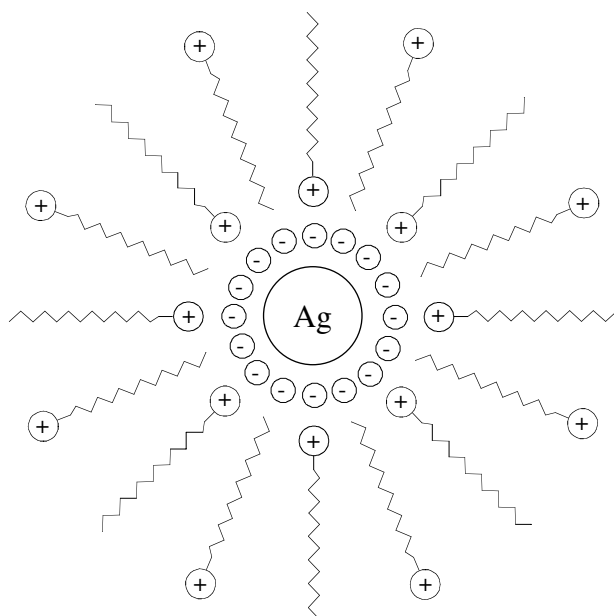

FIGURE 4.19 In the PD reagent, cationic surfactant molecules form positively charged micelles, each encapsulating a negatively charged silver colloid (silver colloid surrounded by negatively charged citrate ions). These positively charged micelles stabilize the reagent by repelling nearby silver ions and other micelles. (From: Cantu, A.A. [2001], Silver physical developers for the visualization of latent prints on paper, *Forensic Sci. Rev.*, 13, 29–64; and from Cantu, A.A. and Johnson, J.L. [2001], Silver physical development of latent prints, in *Advances in Fingerprint Technology*, 2nd ed., H.C. Lee and R.E. Gaensslen, Eds., Boca Raton, FL: CRC Press, pp. 242–247. With permission.)

Development time can be anywhere from 10 to 60 min, and items must be removed from the solution when good contrast is obtained, as overdevelopment cannot be reversed. Some paper substrates that have alkaline binders and fillers react strongly with PD. An acid prewash, typically using a solution of maleic acid, can be used to neutralize alkaline papers and thus improve the PD development of marks (Ramoto-wski 1996b, 2000; Cantu 2001; Cantu and Johnson 2001).

Contrary to ninhydrin and DFO, the PD reagent is sensitive to components in the latent mark that are not soluble in water (i.e., sebaceous secretions or water-soluble materials trapped within a water-insoluble emulsion). On wet paper or paper that has been wet, PD is one of the only techniques that can permit the satisfactory development of latent fingermarks. The reagent can also be used as a treatment after DFO or ninhydrin if these techniques fail to reveal useful marks on paper surfaces that have not been wet. PD is complementary to amino acid reagents, and it can therefore reveal ridge detail not detected by more conventional techniques.

PD-developed marks can, in some cases, be further enhanced by re-treatment with the PD reagent and/or treatment with a sodium hypochlorite solution (dilute household bleach). Treatment with bleach solution lightens the background and

darkens the print due to the formation of silver oxide (Phillips et al. 1990; Cantu 2001; Cantu and Johnson 2001). This can be particularly effective for improving contrast on dark surfaces such as brown paper. The application of radioactive ^{35}S toning has also been explored for the elimination of complex background patterns such as those encountered on paper banknotes (Goode and Morris 1983). This process involves the conversion of the silver metal deposited by the PD reagent into radioactive silver sulfide. Autoradiography is then used to image the radioactive marks. While this toning process can be particularly effective, its use is restricted to specialized laboratories that are authorized to handle radioactive materials. A scanning electron microscope (SEM) can also be used to improve the contrast in PD-developed marks using the backscatter electron image mode (Nolan et al. 1984). This method is, however, limited to small samples that can be placed in the SEM sample chamber.

The PD technique presents some major inconveniences: it is delicate and time-consuming to prepare (good-quality reagents and clean glassware must be employed); it is relatively expensive; the working solution has a short shelf life (generally less than 2 weeks); and the process is destructive (documents are permanently stained and no further fingerprint treatment is possible). Despite these reservations, PD is a sensitive technique that can give results where other techniques fail. Research is currently under way within the U.S. Secret Service to develop a copper-based physical developer (to reduce overall reagent costs) and to render PD-developed marks luminescent (Ramotowski and Cantu 2001).

4.4.5 MULTIMETAL DEPOSITION (MMD)

Multimetal deposition (MMD), developed by Saunders (1989), involves a two-step process, the first being immersion of the item in a colloidal gold solution (pH approximately 2.7). Colloidal gold, consisting of negatively charged gold particles due to the adsorption of citrate ions, is prepared by treating a solution of tetrachloroauric acid (gold chloride) with sodium citrate and a detergent. The negatively charged colloidal gold particles are attracted to organic residues that contain positive groups at low pH. (The use of colloidal gold is an established technique in biochemistry for the detection of proteins and peptides.) Gold subsequently deposits on any fingerprint residue on the item being treated. Weak marks will be barely visible at this stage, while stronger marks may be pale salmon pink in color. The second step involves the treatment of fingerprints developed by the colloidal gold process with a modified physical developer (MPD) solution. The bound colloidal gold provides nucleation sites around which silver precipitates from the MPD solution. This step greatly amplifies the visibility of treated marks that, after this second treatment, can vary in color from light gray to almost black.

Many types of surfaces — porous or nonporous, wet or dry — can be treated by this technique (e.g., wet and dry paper, plastic, glass, expanded polystyrene, and both sides of adhesive tape). Fingerprints in blood can also be enhanced by the treatment. Allman and coworkers (1992) found that MMD showed promise in developing marks on nonporous substrates that in the past have proved difficult (for example, masking tape, beer bottle labels, and plastic gloves).

The MMD process has been further optimized by Schnetz and Margot to improve its sensitivity and specificity (Schnetz 1999; Schnetz and Margot 2001). The optimized process, known as MMDII, recommends the use of silanized glassware (see [Appendix 4, Section A4.12.2.1](#)) and 14-nm colloidal gold particles (the original formulation resulted in 30-nm particles). In addition, a physical developer based on silver acetate and hydroquinone is preferred over the original formulation based on silver nitrate and a ferrous/ferric redox system. Jones (2002) confirmed that MMDII produces superior fingerprint detail compared with the original MMD formulation and found that it was particularly effective on a number of semiporous surfaces (latex and nitrile gloves, expanded polystyrene, and waxed paper).

MMD (and MMDII) may prove useful on surfaces where more conventional techniques are ineffective. However, MMD suffers from some of the disadvantages of conventional PD: the reagent is delicate and time-consuming to prepare and apply, the chemicals required are expensive, and the process can only be used at the end of a detection sequence.

4.4.6 RECOMMENDED DETECTION SEQUENCE

The recommended sequence of techniques for fingerprint detection and enhancement on porous surfaces is given in [Figure 4.20](#). This and the other detection sequences in this book should be considered as only a general guide that will give satisfactory results in 70 to 80% of cases. Different situations and surfaces will necessitate the consideration of modified sequences or the application of other techniques.

All detection sequences should start with an optical detection step that involves an examination of the surface under different lighting conditions. For example, white light examination may reveal visible fingerprints, while an examination in the luminescence mode may reveal inherently luminescent marks that might go undetected by other techniques. Potentially identifiable marks detected at any point in a sequence of examinations should be recorded photographically before proceeding with the next treatment.

If the porous surface (paper, cardboard, etc.) is or *has been* wet, then the water-soluble component of the latent print deposit will no longer be available for fingerprint detection. For example, the amino acids will have been washed away or diffused, hence the application of an amino acid reagent such as DFO or ninhydrin would serve no purpose. In this case, the preferred treatment is with physical developer (PD). While multimetal deposition (MMD) could be used instead of PD, comparative studies have indicated that more consistent results are generally obtained with conventional physical developer. However, if a particular paper surface is found to be unsuitable for PD treatment, then MMD should be evaluated as a potential alternative.

DFO is generally considered to be the best routine technique for the luminescence detection of latent marks on paper surfaces. Conventional ninhydrin processing, or application of a ninhydrin analog, can follow the DFO treatment. In some cases, particularly on paper surfaces that exhibit a high background luminescence, DFO treatment is ineffective, and better results may be obtained with ninhydrin.

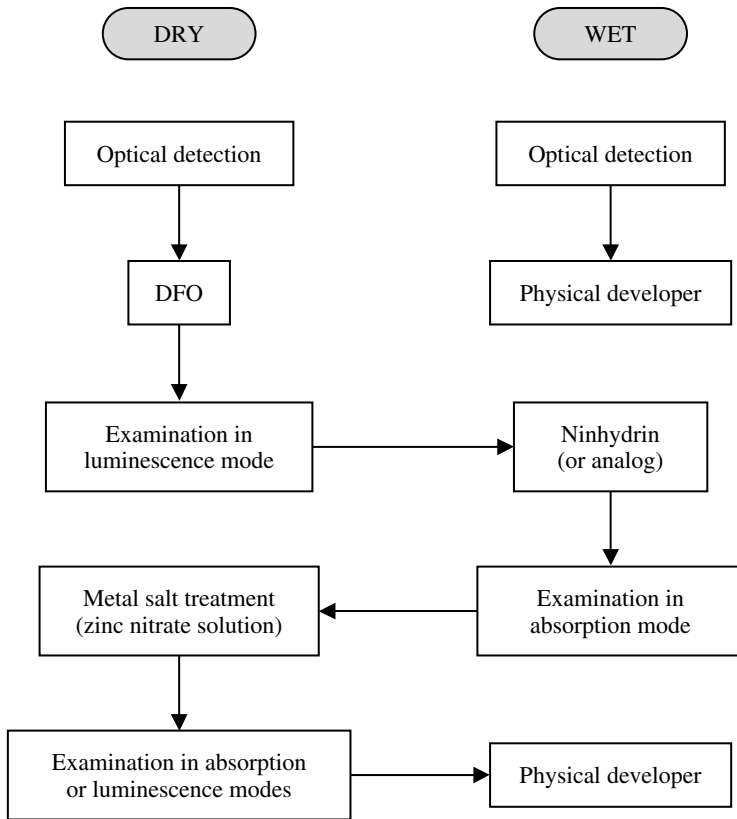

FIGURE 4.20 Recommended sequence of methods for detection of latent fingerprints on wet and dry porous surfaces (e.g., paper, cardboard). A porous surface that has been wet (even if received dry) should be treated as a wet surface.

Pounds and Allman (1991) reported that conventional ninhydrin processing can result in up to 10% more fingerprints than those already detected by DFO treatment.

With the introduction of DFO, the secondary metal salt treatment of ninhydrin-developed marks has become of less value as a luminescence enhancement process. The reason for this is that, if DFO is ineffective on a particular surface due to background luminescence, then luminescence enhancement through metal salt treatment will be equally ineffective. Despite this, the metal salt treatment of ninhydrin-developed prints may provide additional detail in some cases, particularly in the absorption mode where improved contrast is often obtained.

Ninhydrin analogs such as 1,2-indanedione, while not yet considered routine techniques, show particular promise and can be used to replace both ninhydrin and DFO in the reagent sequence.

Apart from radioactive detection, no technique has been shown to be effective after PD and, as a result, it should be the last reagent used on porous surfaces. PD is sensitive to the sebaceous (water insoluble) component of the latent mark, while ninhydrin and DFO are sensitive to the amino acid (eccrine, water soluble) compo-

nent. Since the proportions of these two components in the latent mark are not correlated and vary widely for different donors, PD is often an effective complementary reagent for the enhancement of marks already developed with DFO and/or ninhydrin. In a number of casework examples, the authors have developed identifiable marks with PD that were not detected by ninhydrin/metal salt treatment.

While PD is generally recommended as the final technique in this sequence, MMD (and particularly MMDII) may give better results on some paper surfaces. Experience and experimentation will generally dictate when MMD should be considered.

Thermal and carbonless papers need special consideration due to the nature of the substrate (Stimac 2003). Dye capsules are generally damaged or react with the polar solvents used as carriers for fingermark reagents. Various options are available on these surfaces, including vapor-based reagents such as DMAC (see [Section 4.6.2](#)), modified ninhydrin formulations that involve dissolution in nonpolar solvents (Takatsu et al. 1991), reformulating ninhydrin stock solutions using HFE-711PA[®], or using 1,2-indanediones (Stimac 2003). Excellent results have also been reported when ninhydrin is sublimed under reduced pressure (Schwarz and Frerichs 2002). No comparative analysis has been undertaken to this point in time.

4.5 DETECTION TECHNIQUES FOR NONPOROUS SURFACES

4.5.1 FINGERPRINT POWDERS

The traditional fingermark detection technique for treating smooth nonporous surfaces is powdering. Fingerprint powders are generally reserved for crime scene use on fixed surfaces or on objects that cannot be readily transported back to the laboratory. The process is a physical one, with powder particles adhering to the humid, sticky, or greasy substances in the latent fingerprint deposit. The application of powder is relatively simple and inexpensive, and little experience is necessary to obtain satisfactory results. Prints developed by powdering can also be conveniently lifted using adhesive tape or gel lifters. Despite these advantages, powdering is an insensitive detection method and only relatively fresh fingerprints will normally be developed. The reason for this is that, over time, the fingerprint deposit dries out and loses its stickiness. Difficulties also arise with certain surfaces that give high backgrounds when treated with a fingerprint powder. Powdering is not suitable for porous substrates, as the fingerprint deposit is quickly absorbed into the surface. Among the multitude of powders and brushes available, the choice is often made according to experience or personal preference. When the choice of a powder is not clear, it is recommended that different powders be tested on an identical surface before proceeding with the evidential object.

Fingerprint powdering has been used as a detection technique since the early 1900s. Over this period, many fingerprint powder formulations have been in use, with each formula generally consisting of a colorant for contrast and a resinous material for good adhesion (Lee and Gaensslen 2001a). Metallic oxides, sulfides,

and carbonates have commonly been used as colorants, offering a wide range of possible colors for different applications. Lead- and mercury-based formulations were once quite common but are now rarely employed because of their toxicity. In addition to the numerous powder formulations that are available, fingerprint brushes come in various styles that are generally distinguished by the types of fibers used to make them (e.g., synthetic fibers, natural fibers, glass fibers, etc.). The powder technique for latent fingerprint detection has been reviewed by Sodhi and Kaur (2001).

The most often used fingerprint powder, recommended by Thomas (1973, 1975, 1978), is aluminum powder (also known as “argentorum”). James and coworkers (1991a) confirmed that this is indeed the most effective powder for fingerprint detection. Aluminum flake, employed as a metallic paint pigment, is manufactured by passing aluminum grit through a ball mill, where stearic acid is added as a milling agent. The final product is composed of flat, platelike particles of aluminum (5 to 10 μm long and about 0.5 μm thick) containing from 3 to 5% w/w stearic acid. The research group was able to produce an even more efficient fingerprint powder by increasing the stearic acid content to about 10% w/w. It was found that this modified aluminum powder gave a lower background and thus better contrast in developed fingerprints.

The use of fluorescent powders (that are typically luminescent under UV illumination) has advantages on reflective or multicolored surfaces where contrast may be a problem with conventional powders. A wide range of fluorescent powders is available on the market, and again the choice generally comes down to experience and personal preference. Background colors and substrate luminescence should be taken into consideration when selecting an appropriate fluorescent powder.

Magnetic powders, generally made by mixing coarse iron grit with either aluminum or copper flake powder, are applied using a magnetic wand. The coarse magnetic particles form the “brush,” while the fine powder develops the prints. The use of magnetic powders avoids the brushing, and hence destruction, of fragile latent fingermarks (James et al. 1991b). However, the technique is difficult to apply on vertical surfaces. James and coworkers (1991c) found that an improved magnetic powder could be produced by passing the iron grit through a ball mill to give iron flakes with diameters in the range 10 to 25 μm and stearic acid contents of 3 to 5% w/w. These flat, platelike iron particles are more efficient for fingerprint development than the iron grit normally employed in commercial magnetic powders (James et al. 1993). New magnetic applicators have also been produced that incorporate powerful rare-earth magnets rather than conventional permanently magnetized steel rods (James et al. 1992). The new applicators, used in association with magnetic flake powders, provide a rapid and efficient means of developing prints over large surface areas. In addition, the magnetic flake attached to the fingerprint residue (and possibly the support itself) can be completely removed by touching the surface with a clean rare-earth magnetic applicator. In this manner, relatively smooth surfaces can be cleared of virtually all traces of powder after fingerprint development. Optimized magnetic flake powders and applicators are now commercially available, with field trials indicating that this new powdering technology can

develop marks in some cases where conventional fingerprint powders do not work (Milne 1996; Moorcroft 1996).

4.5.2 SMALL-PARTICLE REAGENT

Latent fingerprints may be made visible by immersion in an aqueous suspension of an insoluble powder followed by rinsing with water. The powder suspension is commonly referred to as small-particle reagent (SPR), and the technique is essentially a wet powdering method. The powder suspension is sensitive to the sebaceous (water insoluble) components of the latent fingerprint and can be used on a wide range of nonabsorbent surfaces. SPR is effective on surfaces that are wet, a condition that excludes the use of conventional powders or reagents sensitive to the eccrine (water soluble) components of the latent print. Treatment with the suspension is by immersion or vaporization (using a handheld garden spray, for example); the sample is then rinsed with water to remove any excess reagent.

Conventional SPR is a suspension of dark gray molybdenum disulfide particles (Goode and Morris 1983), the fine crystalline structure of which is critical for effective fingerprint development. The results obtained using molybdenum disulfide from different sources are strongly influenced by variations in this structure. Good results have been obtained using Rocol AS Powder and Molibond. Molybdenum disulfide obtained from other sources should be tested and compared with SPR of known quality.

In 1989, Haque and coworkers (1989) proposed the use of a suspension of iron oxide powder in place of molybdenum disulfide. While the use of iron oxide powder may improve contrast in some cases, comparative tests indicated that the modified SPR lacked sensitivity and selectivity compared with the original formulation (Irrausch 1990).

Franck and Almog (1993) proposed a white SPR formulation based on zinc carbonate powder. This formulation is designed for use on dark surfaces. As with molybdenum disulfide, it was found that the dimensions of the zinc carbonate particles had a significant influence on the quality of the fingerprint development. Aerosol sprays containing this white SPR formulation have been developed in Israel and have given excellent results in the field. More recently, Springer and Bergman (1995) reported the development of a fluorescent SPR. This was achieved by the addition of an ethanol solution of basic yellow 40 (BY40) to the SPR stock solution. Prints developed with BY40 SPR can be visualized in the luminescence mode with excitation at 450 nm and observation using a 550-nm cutoff barrier filter.

4.5.3 CYANOACRYLATE FUMING

4.5.3.1 Conventional Cyanoacrylate Fuming

Cyanoacrylate esters (generally the ethyl ester) are colorless, monomeric liquids sold commercially as rapid, high-strength glues (e.g., “Superglue”). Cyanoacrylate liquid forms a vapor that reacts with certain eccrine and sebaceous components in a latent fingerprint. The vapor selectively polymerizes on the fingerprint ridges to form a hard, white polymer known as polycyanoacrylate (Figure 4.21). Greasy

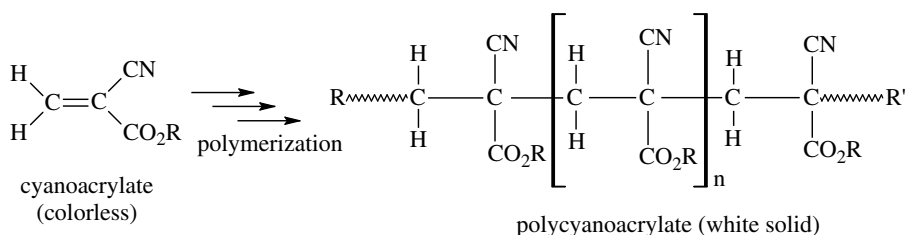

FIGURE 4.21 Cyanoacrylate polymerization reaction that results in the formation of a hard white polymer known as polycyanoacrylate.

fingerprints (i.e., prints with a high sebaceous component) appear to be particularly sensitive to cyanoacrylate vapor, although the glue also reacts with the moisture and some water-soluble (eccrine) components in the deposit (Lewis et al. 2001). The cyanoacrylate fuming technique, effective on most nonporous substrates such as glass and plastic, was first devised by the Criminal Identification Division of the Japanese National Police Agency in 1978 (Lee and Gaensslen 1984). Since then, cyanoacrylate fuming has become the most widely used process for the laboratory development of fingerprints on nonporous surfaces.

Numerous methods for cyanoacrylate (CA) treatment have been proposed, and many commercial units are now available on the market. Simple homemade systems can be constructed at minimal cost. These generally consist of a chamber, such as a glass aquarium, that can be sealed up to contain the cyanoacrylate vapor generated by means of a suitable heat source (e.g., modified soldering irons or a temperature-controlled hot plate). Items to be treated are suspended or placed in the chamber, and a small quantity of liquid cyanoacrylate is heated to around 80 to 100°C to produce sufficient vapor. A container of water may also be placed in the tank to ensure sufficient humidity for the development process, as low humidity tends to produce weakly developed prints that show poor contrast. Excess heat should be avoided and fingerprint development regularly inspected to avoid overdevelopment. It is good practice to place a control fingerprint, on a glass microscope slide for example, next to the objects to be treated. When the control print is sufficiently developed, the objects should be removed from the tank and checked for ridge detail.

Commercial cyanoacrylate chambers show advantages over homemade systems but are generally quite expensive. Advantages include better temperature control, more efficient vapor circulation leading to more even development, and automatic removal of the cyanoacrylate vapor when the process is finished. Some systems also have humidity control.

Cyanoacrylate vapor is classified as an eye and respiratory tract irritant, therefore exposure to the vapor should be minimized (Hughes 1993). Mock indicated that, if the glue is heated to temperatures above approximately 220°C, toxic hydrogen cyanide gas may be formed. Therefore, whenever heat is used to generate cyanoacrylate vapor, care must be taken to ensure that elevated temperatures of this magnitude are avoided. Cyanoacrylates are also reported to have a flashpoint just over 90°C, which means that CA vapors could ignite under certain circumstances (Mock 1985).

Masters (2002) reported that cyanide gas is formed when cured (polymerized or hardened) cyanoacrylate is heated above 205°C.

Portable fuming wands, first proposed by Weaver and Clary (1993), have been investigated for field use, and a number of commercial systems are now available. The fuming wand is based on a butane torch on which is placed a commercially manufactured cartridge containing solidified cyanoacrylate. When ignited, the torch heats the cartridge, and cyanoacrylate vapor is rapidly released. The fumes are directed onto the item to be processed until developed prints become visible to the naked eye. A comparison of this system with conventional chamber development indicated that the portable wand gives inferior results and is generally not recommended (Froude 1996). Fingerprint development with a portable wand can be difficult to control, typically leading to uneven development or overdeveloped prints. Another portable fuming device known as a Handy Fumer™ was evaluated by Geller and coworkers (1998) and was found to give results comparable with those obtained using a conventional fuming cabinet. Tissier et al. (1999) described a portable case that can be used to generate cyanoacrylate vapor that, in turn, is fed through a hose into a motor vehicle that requires fingerprint processing. The vapor generator can also be used to provide cyanoacrylate fumes for plastic tents built around items requiring treatment. More recently, commercial cyanoacrylate generators have become available (e.g., the SUPERfume™ portable cyanoacrylate fuming kit manufactured by Mason Vactron Ltd., U.K.), providing a safe and reliable means of applying the cyanoacrylate fuming process in the field.

Relatively small surfaces, or a particular area of an object, can be treated with cyanoacrylate by a relatively simple procedure proposed by Jian and Dao-An (1991). A solution of cyanoacrylate ester is prepared by mixing liquid cyanoacrylate glue with diethyl ether in proportions from 1:1 to 1:2. A piece of filter paper of appropriate size is then soaked with the cyanoacrylate–ether solution and allowed to dry for several minutes. The treated filter paper (saturated with cyanoacrylate ester) is then placed on the surface under investigation. Any latent fingerprints in close proximity to the paper will be developed by the cyanoacrylate fumes that are emitted. Depending on the surface and the quality of the prints, the filter paper is left in place from 5 to 60 min. The authors claim that the technique has been used in more than 1000 cases since 1987, and good results are reported on surfaces such as plastic, metal, silk fabric, currency, leather, and skin (Jian and Dao-An 1991).

Burns and coworkers (1998) analyzed cyanoacrylate-fumed fingerprints by Fourier transform infrared (FTIR) spectrometry as a nonsubjective means of estimating polymer deposition. The greatest degree of polymer deposition that was observed in the study was the result of prior exposure of the latent prints to ammonia followed by fuming with methyl cyanoacrylate vapor. Base activation and/or rehumidification as a pretreatment step for developing otherwise unresponsive latent prints with cyanoacrylate vapor warrants further investigation.

4.5.3.2 Vacuum Cyanoacrylate Fuming

A vacuum cyanoacrylate (VCA) fuming technique was first developed by Watkin for the National Research Council of Canada (Watkin and Misner 1990; Campbell 1991b).

Development is achieved by placing the evidential objects in a large metal chamber, together with a small quantity of liquid cyanoacrylate glue; then the pressure is reduced to approximately 200 mtorr (i.e., 0.2 torr, compared with standard atmospheric pressure of 760 torr) using a rotary pump. At this pressure, the evaporation of the cyanoacrylate is accelerated and the development time subsequently reduced. The contents of the chamber are kept under reduced pressure, in the presence of cyanoacrylate, for about 20 min; then air is admitted and the objects checked for fingerprint development.

The vacuum cyanoacrylate method is claimed to give more uniform fingerprint development than the traditional cyanoacrylate procedure. In addition, fingermarks developed by the vacuum process tend to show sharper ridge and pore detail (Neri 1992; LeRoy 1993; Bentsen et al. 1996). There is also less risk of fingerprint overdevelopment, and the operator is not exposed to cyanoacrylate vapor. Under vacuum, CA vapor spreads quickly to all parts of the chamber, hence fingerprints can be developed on surfaces that are not exposed directly to the fumes, such as the inside of sealed plastic bags, making it unnecessary to open and suspend such items. This can be of significant practical benefit when large quantities of plastic wraps (e.g., from drug seizures) require processing. Certain items, such as cans and bottles of soft drink, cannot be treated by vacuum CA fuming, as they may explode when placed under reduced pressure. Also, any object that is wet must be thoroughly dried before being placed in the VCA chamber.

Prints developed by VCA tend to be translucent and only weakly visible to the naked eye. Care must therefore be taken to avoid overlooking weak prints. To obtain good contrast, enhancement of VCA-developed prints with a luminescent stain is generally required. Scanning electron micrographs of prints developed in a conventional heat/humidity CA chamber indicate that the CA polymer formed under these conditions is fibrous in appearance. On the other hand, the polymer formed under vacuum has a smooth, more continuous appearance (Watkin et al. 1994). These observations explain why prints developed by VCA fuming do not appear as white as prints fumed in a conventional CA chamber. Lewis and coworkers (2001) have reported that the formation of a translucent polymer can be attributed to the dehydration of the fingerprint deposit under vacuum during processing.

The VCA fuming process does not generally require the heating of the cyanoacrylate glue to achieve adequate fingerprint development. However, Grady (1999) has reported that CA fuming using heat and vacuum can produce more uniform results, particularly on highly irregular surfaces, with no danger of overdevelopment or background interference. This modification to the VCA procedure also reduces fuming times without compromising the excellent ridge detail that is a characteristic of vacuum development.

The original vacuum cyanoacrylate chambers manufactured by the National Research Council of Canada were priced at around U.S.\$10,000 each. A range of commercial units is now available from several manufacturers. A number of authors have also provided information on the construction of inexpensive homemade systems (Jorgensen 1991; Mills 1993; Yamashita 1994; Harvey et al. 2000).

There is some debate concerning the perceived benefits of vacuum cyanoacrylate fuming, with some authors claiming that the technique offers no obvious advantage over a system operating at atmospheric pressure (Kent and Winfield 1996). The

general view, however, is that the operational advantages (no suspension of items necessary; better ridge detail obtained) outweigh the disadvantages (luminescent stain required; higher cost of equipment). The use of VCA is therefore recommended when the necessary equipment is available.

4.5.3.3 Enhancement of CA-Developed Prints

Solid cyanoacrylate polymer does not have any significant absorption band from the near ultraviolet through the visible to the infrared, but diffusely reflects most wavelengths over this range. The choice of illumination therefore depends on the color of the particular exhibit, i.e., the illumination band should be opposite to the color of the exhibit's surface. This results in light ridges against a dark background. White light and/or the 450-nm band from a forensic light source are recommended for the initial examination of CA-developed fingerprints. No barrier filter or goggles are required for this examination, and quite often it is necessary to use oblique light for the detection of developed prints. On white or multicolored surfaces, the coaxial illumination method can be very effective for searching and photography. In the case of plastic bags, an embroidery hoop can be used to produce a flat surface. Enhancement of cyanoacrylate-developed prints can also be achieved using a reflected ultraviolet imaging system (RUVIS).

The contrast produced by fingerprints developed with cyanoacrylate can be enhanced by the application of a colored or luminescent stain. To obtain the best results with these stains, the cyanoacrylate development must be precisely controlled and overexposure rigorously avoided. In addition, to limit the risk of washing cyanoacrylate-developed prints off the surface with the staining solution, the prints should be left overnight to allow the white polymer to harden on the fingerprint ridges before application of the stain. The choice of a particular staining technique will depend on the color and luminescence properties of the surface to be treated. If in doubt, tests should be conducted on a similar surface before treatment of the evidential article.

Staining involves treating the CA-developed prints with a stain formulation that contains a colored or luminescent material dissolved in a solvent mixture. The solvents used in the stain solution are critical in that they must soften the CA polymer to allow penetration of the stain itself without damaging the fingerprint image. In most cases, the article needs to be rinsed with water after stain application in order to remove excess stain (i.e., de-stain the background). Colored stains such as gentian violet can be used to enhance CA-developed prints, but their use is generally restricted to lightly colored surfaces. The use of luminescent stains is preferred for all nonluminescent surfaces, as the process is more sensitive and can produce results on dark or multicolored surfaces. However, the use of a luminescent stain requires the use of an appropriate light source for luminescence visualization. The most popular luminescent stains for this application include rhodamine 6G, Ardrex 970-P10, and basic yellow 40.

Rhodamine 6G is a multipurpose luminescent compound that has a particularly high quantum yield (luminescence efficiency). Luminescence spectra for CA-developed prints stained with rhodamine 6G are represented in [Figure 4.22A](#). The

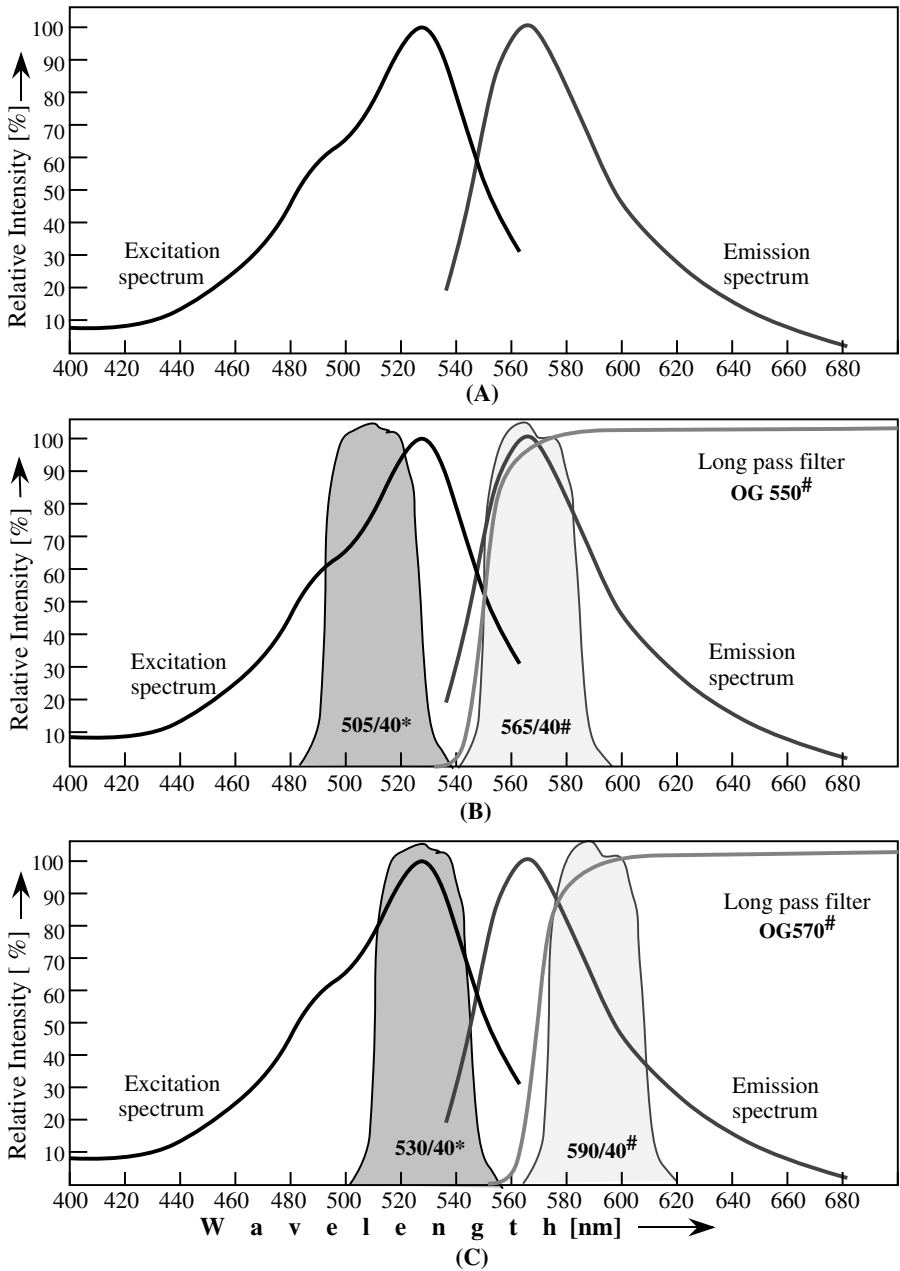

FIGURE 4.22 (A) Luminescence spectra for a cyanoacrylate-delivered fingerprint stained with rhodamine 6G; (B, C) recommended filter combinations for excitation (*) and observation (#) mode.

excitation spectrum is relatively broad, with excitation maxima at 490 and 530 nm. The emission spectrum comprises a single band with a maximum at 565 nm. Treated prints can generally be visualized using an excitation in the 450- to 550-nm range (Figure 4.22B and C), with observation in the 550- to 600-nm region. Two filter combinations are suggested in Figure 4.22 and, in general, either will produce an excellent result. There may be special circumstances where one particular filter combination works better than another (e.g., if there is interference from background luminescence). Prints treated with rhodamine 6G are only weakly luminescent under UV light. Initial reports suggesting that rhodamine 6G is carcinogenic have proved to be largely unfounded according to information provided by Masters (1990, 1992). Rhodamine 6G is not a human carcinogen, although it is toxic.

Ardrox 970-P10 is a fluorescent penetrant sold by Ardrex Limited, Canada. The product is a highly luminescent oily liquid that can be diluted to give an efficient staining solution for CA-developed prints (Lennard and Margot 1988; McCarthy 1990; Olenik 1992; Gamboe and O'Daniel 1999). Ardrex-treated prints can be visualized using an excitation in the 250- (UV) to 500-nm range, with observation in the 450- to 650-nm region. An advantage with Ardrex is that a simple UV lamp (short or long wavelength) can be used for the detection of treated prints. The UV-excited luminescence is stronger than that observed with rhodamine 6G or basic yellow 40.

Basic yellow 40 (BY40, Panacryl Brilliant Flavine 10 GFF, Maxilon Flavine 10 GFF) is a nontoxic dye currently being used in a number of countries including the U.K. (Kent 1986; Hardwick et al. 1990). It is reported to produce half the emission intensity of rhodamine 6G. Luminescence spectra for CA-developed fingerprints stained with basic yellow 40 are represented in Figure 4.23A (together with a recommended filter combination B). The excitation spectrum is broad, with a maximum at 445 nm. The emission spectrum is relatively narrow, with a maximum at 495 nm.

Many other luminescent stains have been evaluated as stains for the enhancement of CA-developed prints. Examples include: basic red 28 [$\lambda_{\text{ex}} = 495 \text{ nm}$, $\lambda_{\text{em}} = 585 \text{ nm}$] (Mazzella and Lennard 1995), safranin O [$\lambda_{\text{ex}} = 520 \text{ nm}$, $\lambda_{\text{em}} = 560 \text{ nm}$] (Hardwick et al. 1990), [4-(4-methoxybenzylamino-7-nitrobenzofurazan)] (MBD) (Cummings et al. 1990), Nile red (Day and Bowker 1996), and thenoyl europium chelate [$\lambda_{\text{ex}} = 350 \text{ nm}$, $\lambda_{\text{em}} = 614 \text{ nm}$] (Misner et al. 1993; Wilkinson and Watkin 1993; Lock et al. 1995). A number of authors have also proposed the use of mixed-dye solutions that may have advantages on some surfaces (Cummings et al. 1993; Mazzella and Lennard 1995; Olenik 1997).

Stain solutions cannot be applied to some surfaces (e.g., certain semiporous surfaces), as the substrate itself strongly absorbs the stain, and de-staining with water is ineffective. In addition, no enhancement is obtained with luminescent stains if the surface itself is highly luminescent. In such cases, fingerprint powders can be used to improve the contrast in CA-developed prints. Black magnetic powder is recommended due to its easy application and the excellent ridge clarity that can be obtained. After powdering, the enhanced prints can also be lifted, which is an advantage on multicolored or curved surfaces. Luminescent powders can be used as an alternative to conventional powders, offering much greater

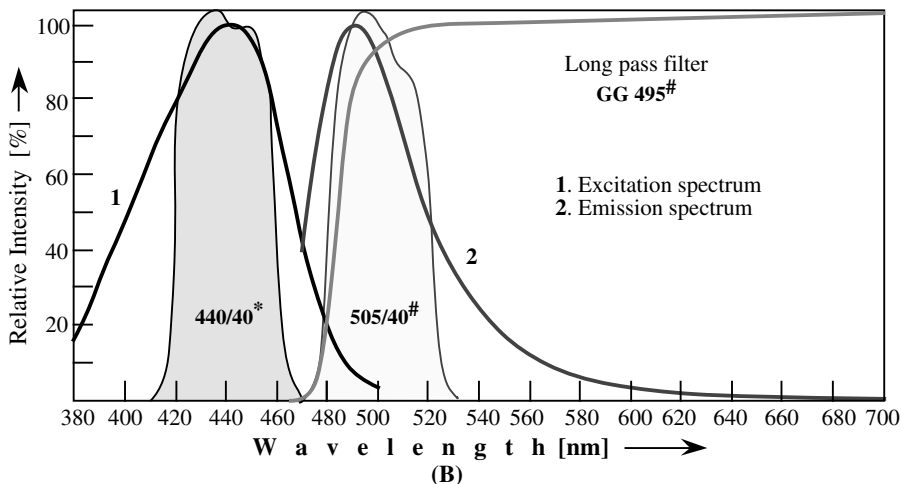
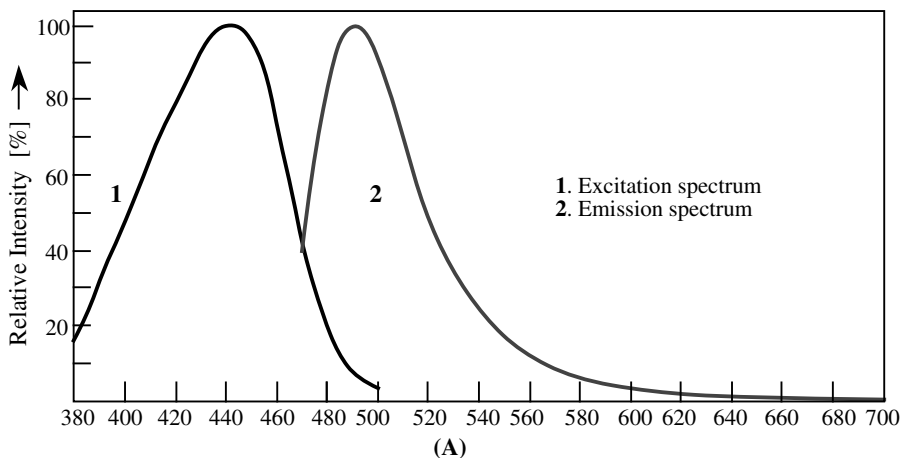

FIGURE 4.23 (A) Luminescence spectra for a cyanoacrylate-developed fingerprint stained with Basic Yellow 40; (B) Recommended filter combination for excitation (*) and observation (#).

sensitivity (as long as the surface itself is not luminescent) but requiring the use of an appropriate light source. In a recent study, Brennan and coworkers (2001) found that the spray application of a silicone casting material could be used to replicate CA-developed prints on some surfaces. This may be an option if other enhancement processes are unsuccessful.

4.5.4 VACUUM METAL DEPOSITION (VMD)

Fingerprint contamination on a surface can hinder the deposition of metallic films following metal evaporation under vacuum. This phenomenon has been known for a long time, but it is only relatively recently that it has been applied to the detection

of latent fingerprints (Theys et al. 1968; Kent et al. 1976; Thomas 1978). It is now accepted that vacuum metal deposition (VMD) is an extremely sensitive and useful technique for fingerprint detection on a variety of surfaces, and it can be employed in conjunction with other development techniques (such as cyanoacrylate fuming).

Gold is evaporated under vacuum to form a very thin layer of metal on the surface under examination (this layer is invisible to the naked eye). A second layer of zinc or cadmium (the latter is rarely used because of its toxicity) is deposited in the same manner. The gold film is uniformly deposited across the surface of the sample and penetrates the fingerprint deposit. The zinc is deposited preferentially on the exposed gold but does not penetrate the fingerprint deposit. The ridges are therefore left transparent, while the background becomes plated with a layer of zinc (Figure 4.24). Excellent fingerprint detail can be obtained in this way, with best results generally being obtained on nonporous surfaces such as plastic and glass. Fresh fingerprints (<48 h old) have also been developed on cloth and paper banknotes using this technique.

Under normal circumstances, VMD treatment produces negative marks, as zinc deposits on the background substrate and not the print ridges themselves. A phenomenon of reverse development, when zinc deposits onto the print ridges and not the background, has been reported by many authors, but until recently, its cause had not been conclusively identified (Kent et al. 1976; Grant et al. 1996; Masters and DeHaan 1996). Jones and coworkers have extensively studied the VMD development of latent marks on a range of different polymer substrates (Jones et al. 2001a, 2001b; Jones 2002). It was determined that reverse development would only occur on certain polymer types (such as low-density polyethylene), and then only under specific VMD conditions. The quality of VMD development was found to depend to a significant extent on the polymer type and the amount of deposited gold. The amount of deposited gold therefore needs to be accurately controlled. No one set of VMD conditions will result in good fingerprint development in all situations. Pretreatment of items by CA fuming will also affect the quality of VMD development, with CA pretreatment being particularly beneficial for certain polymer types (such as polyethylene terephthalate [PET] and polyvinyl chloride [PVC]). Guidelines have been developed for optimizing the VMD development of latent marks on various polymer substrates (Jones et al. 2001b).

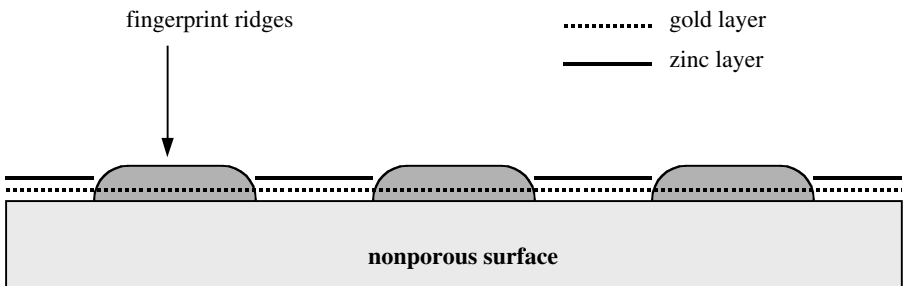

FIGURE 4.24 Principle of fingerprint development by vacuum metal deposition.

Vacuum metal deposition can sometimes reveal fingerprint detail when all other techniques have failed. Excellent results have also been obtained using VMD after cyanoacrylate development followed by luminescent staining (Yong 1986; Yong et al. 1986; Taroni 1990; Taroni et al. 1990; Murphy 1991). Misner (1992), working for the Royal Canadian Mounted Police, compared the relative performance of VMD and vacuum cyanoacrylate fuming for the detection of latent fingerprints on low-density polyethylene. Although only a relatively small sample size was employed, the study suggested that VMD is a more sensitive fingerprint detection technique, particularly with older marks (79% success rate for VMD, compared with 62% for VCA treatment). According to Misner, the high capital costs associated with vacuum metal deposition negates its widespread use in Canada. Cyanoacrylate combined with the use of a luminescent stain remains the technique of choice for routine casework, with VMD being reserved for major cases. Batey and coworkers (1988) have summarized the VMD technique and provided a number of examples to illustrate how VMD has proved to be extremely useful in several high-profile cases.

Masters and DeHaan compared VMD and CA fuming for the detection of aged latent marks that had been deposited on glass slides (Masters and DeHaan 1996). VMD was found to be more sensitive for the detection of older marks (>24 months old) than CA fuming alone. For fresh latent marks (<2 months old), VMD and CA fuming showed similar sensitivity. The authors concluded that cyanoacrylate fuming followed by VMD treatment may yield more identifiable detail than either technique alone, but care must be taken to avoid losing ridge detail already developed.

In a preliminary study, Flynn and coworkers (1999) determined that vacuum metal deposition was one of the few techniques that could reliably detect aged latent marks on polymer banknotes. A more extensive study completed in 2002 confirmed these results, with an optimized fingerprint detection sequence being established (Jones 2002; Jones et al. 2003). Polymer banknotes represent a semiporous surface that does not respond well to conventional fingerprint detection techniques. Fingerprint powders or cyanoacrylate fuming alone will generally only detect latent marks on this surface that are less than 1 week old. On the other hand, VMD treatment, applied after CA treatment and before the application of a luminescent stain, can develop latent marks that are more than 6 months of age.

4.5.5 RECOMMENDED DETECTION SEQUENCE

The recommended sequence of techniques for fingerprint detection and enhancement on nonporous surfaces is given in [Figure 4.25](#). Where possible, a wet nonporous surface should be allowed to dry at room temperature and then treated as a dry surface. If fingerprint detection is required while the surface is still wet, then — after a general examination — a small-particle reagent (SPR) should be applied.

A dry nonporous surface can undergo a detailed examination using different optical techniques. This is generally followed by cyanoacrylate fuming as the routine laboratory technique for processing nonporous surfaces such as plastic and glass. The diffused reflection mode (e.g., using episcopic coaxial illumination) can be very effective for the recording of superglue-developed marks. Further enhancement can be achieved using a luminescent stain followed by observation and recording in the

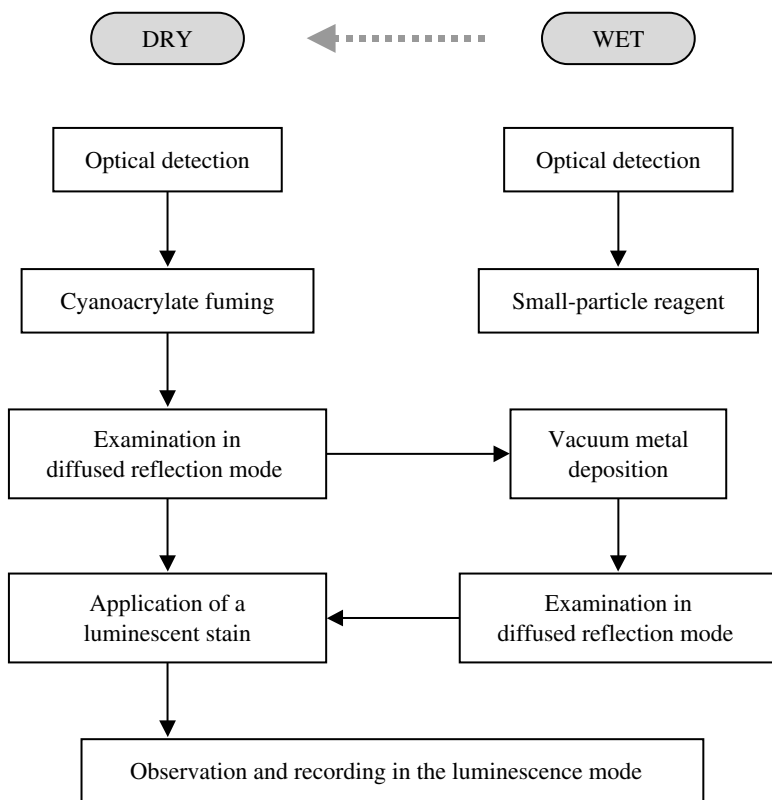

FIGURE 4.25 Recommended sequence of methods for the detection of latent fingerprints on wet and dry nonporous surfaces (e.g., plastic, glass, gloss-painted surfaces). Where possible, wet surfaces should be allowed to dry at room temperature before proceeding.

luminescence mode. The enhancement of cyanoacrylate-developed marks with a luminescent stain is unsuccessful on some surfaces due to either background luminescence or luminescence quenching. In such cases, vacuum metal deposition (VMD) can be used after the cyanoacrylate treatment and before the application of the luminescent stain to eliminate these background effects.

Some authors have suggested that VMD should be applied before cyanoacrylate fuming (e.g., the sequences proposed by Kent [1998]). Other studies, however, have presented the operational advantages of using VMD as an enhancement process for cyanoacrylate-treated items (Jones 2002). Not all laboratories have access to VMD, while cyanoacrylate fuming is a widespread technique. With the sequence proposed in Figure 4.25, all labs can conduct routine CA processing with only certain items being submitted to a central laboratory for VMD enhancement. Provided that items are not overdeveloped with cyanoacrylate, VMD processing is not precluded and is, in fact, enhanced in most cases. Jones and coworkers have demonstrated that the cyanoacrylate preprocessing of some polymer surfaces results in better VMD development (Jones et al. 2001a; Jones 2002).

4.6 MISCELLANEOUS TECHNIQUES FOR LATENT FINGERMARK DETECTION

4.6.1 IODINE/BENZOFLAVONE

Iodine treatment is one of the oldest known techniques for the development of latent fingermarks. Iodine vapor is absorbed by the lipids (sebaceous material) present in the latent fingermark deposit to produce a brownish image of the mark. It is a reversible physical process rather than a chemical reaction that, in principle, does not exclude the later application of other techniques. While the technique is simple, rapid, and economic, fingermarks developed with iodine are difficult to record because the contrast is generally poor and transitory (due to the reevaporation of iodine) unless the marks are chemically fixed. The technique can be applied to a wide range of porous and nonporous surfaces (such as paper, wood, plastic, and glass), but, due to its limited sensitivity, marks older than 3 to 5 days are unlikely to be detected. In addition, iodine vapor is toxic and corrosive; prolonged exposure to iodine fumes must be avoided. Because of these limitations, iodine vapor treatment is now rarely used as a routine fingerprint detection technique.

Two simple systems can be used for the development of fingermarks using iodine vapor:

1. Small items can be exposed to iodine vapor in an enclosed glass chamber (or similar transparent container). The vapor is provided by a few crystals of iodine placed at the bottom of the chamber (iodine readily sublimates at room temperature), and the exposure time is determined by visual assessment of the fingermark development.
2. To treat specific areas or large immovable surfaces, portable iodine fuming pipes are commercially available or can be easily constructed using standard laboratory equipment. Iodine vapor is generated by gently passing air through a hand-warmed glass pipe containing iodine crystals. The continuous supply of iodine vapor using this system allows rapid fingermark development over relatively large surfaces.

The application of iodine followed by transfer to a silver plate has had limited success for the detection of fresh latent fingermarks on skin and leather, but the results are difficult to reproduce and depend on factors difficult to control (Adcock 1977; Gray 1978; Arndt 1985). To apply the technique, marks are fumed with iodine until brown marks are observed. These marks are then immediately transferred to a highly polished silver plate by firm contact over approximately 5 sec. The transferred marks are then visualized by exposure of the silver plate to a strong white light source or UV lamp. This results in the formation of a dark image of the latent print against the shiny surface of the silver plate. It is recommended that preliminary tests be performed on fresh control marks before using this technique in actual casework.

Fingermarks developed with iodine fade quickly and usually show poor contrast; it is therefore advantageous to chemically fix the marks by the application of a reagent that will increase both the contrast and the stability. Several reagents have

been proposed, but the best results have generally been obtained using a solution of 7,8-benzoflavone (α -naphthoflavone). The solution can be applied with a pipette or by immersion. Marks fumed with iodine and fixed with 7,8-benzoflavone are generally dark blue–purple in color and relatively stable (Mashiko and Hizaki 1977; Haque et al. 1983). Wilkinson and coworkers (1996a, b) evaluated a range of fingerprint detection techniques on human skin and found that iodine fuming followed by the spray application of a 7,8-benzoflavone solution gave the most consistent results.

The use of a mixed solution of iodine and 7,8-benzoflavone has been suggested for the development of latent fingerprints at the crime scene on surfaces such as wallpaper, emulsion-painted walls, and aged gloss-painted surfaces. The solution can be applied with a spray, a paintbrush, or a paint roller, and it has been used with good success by the Serious Crimes Unit (SCU) of Scotland Yard. A few minutes after application of the reagent, treated marks become visible as dark blue ridges. Using a technique originally proposed by Haque and coworkers (1983), Pounds and Hussain (1987) have developed a system that is relatively simple to apply. Because the mixed reagent is not stable, it is prepared on-site by mixing a solution of iodine with a solution of 7,8-benzoflavone just before use. The technique is particularly effective for revealing fresh marks less than a week old. Marks more than about a week old are less efficiently developed. A more recent study indicated that the spray technique is more effective for revealing fingerprints at the crime scene (on the surfaces mentioned above) than either ninhydrin or iodine/benzoflavone solution applied with a brush (Pounds et al. 1992). Developed marks need to be photographed immediately, as they will fade over time.

4.6.2 DIMETHYLAMINOCINNAMALDEHYDE (DMAC)

Because urea is a major component of the eccrine secretion, the urea-sensitive reagent 4-dimethylaminocinnamaldehyde (DMAC) received significant attention in the 1970s as a possible technique for latent fingerprint detection (Sasson and Almog 1978; Goode and Morris 1983). A solution of DMAC can be used to develop latent fingerprints on porous surfaces such as paper. The reaction is rapid, giving a dark red reaction product that also has luminescence properties (Menzel 1980). The rapidity of the reaction, the relative abundance of urea in the latent mark, and the low concentration of urea in most paper surfaces are principal advantages of the technique. Unfortunately, urea migrates rapidly through porous substrates, and blurred images are generally the rule for DMAC-developed marks older than a few days. Sasson and Almog (1978) described the scope and limitations of the reagent and concluded that its main advantage was for the quick development of relatively fresh fingerprints (up to 72 h old).

More recently, Brennan and coworkers found that, when DMAC was used as a fuming agent, good ridge detail could be developed on a wide selection of substrates, and the technique can be included in routine sequential examination procedures. Items can be treated by exposure to the fumes generated by heating DMAC crystals to between 150 and 200°C (Brennan et al. 1995; Brennan 1996). After treatment, the items are then left to stand overnight at ambient temperature and humidity.

Developed marks are initially visualized under white light and then in the luminescence mode with excitation in the 450- to 530-nm range and observation using a 550-nm cutoff filter. Fingermarks more than 4 months old have been developed using this procedure. In addition, tests have indicated that DMAC fuming can be effectively employed in sequence with DFO, ninhydrin, and physical developer. DMAC vapor-phase treatment shows particular promise for the detection of fingermarks on problematic surfaces such as thermal paper.

A DMAC dry-transfer process has also been reported as an alternative to the fuming process (Ramotowski 1996a). In a study conducted by Francis (2002), dry-transfer sheets were prepared by treating sheets of clean copy paper in 0.25% w/v DMAC in methanol. The sheets are allowed to air dry and are then sealed in a plastic bag and stored in a refrigerator. Exhibits are treated by placing them between dry-transfer sheets in a cold press for up to 1 h. Developed marks are left overnight and are then examined in the luminescence mode (Figure 4.26). Excellent casework prints have been achieved using this technique on thermal paper.

4.6.3 OSMIUM TETROXIDE (OsO_4) AND RUTHENIUM TETROXIDE (RTX)

Osmium tetroxide (OsO_4) is a volatile oxidant that reacts with the double bonds present in the unsaturated organic components of the fingerprint deposit (sebaceous gland secretion) to give a black product. The treatment is by simple exposure of the object to the vapor given off by crystals of the reagent in an enclosed glass container (as for iodine development). Development time ranges from 1 to 12 h, and dark gray–black fingermark images are formed (Olsen 1978). Good results have been achieved on both porous and nonporous surfaces, but the technique is particularly useful on porous surfaces such as paper banknotes that react strongly with ninhydrin. However, osmium tetroxide exposure can be fatal if the compound is inhaled, swallowed, or absorbed through the skin. The reagent must therefore be used with great care and only in specialized laboratories!

Ruthenium tetroxide (RuO_4) has also been proposed as a sensitive technique for fuming latent marks. The reaction with fatty substances in the fingerprint deposit is the same as for osmium tetroxide. However, unlike osmium tetroxide, ruthenium tetroxide does not become gaseous at or near room temperature. Previous fuming methods called for a potentially hazardous application of heat in order to volatilize the crystals (RuO_4 decomposes explosively at 108°C) (Olsen 1978). More recently, Japanese workers proposed a safe procedure for the generation of RuO_4 vapor: RTX (ruthenium tetroxide) (Mashiko et al. 1991). Equal volumes of 0.1% ruthenium(III) chloride hydrate solution and 11.3% ceric ammonium nitrate solution are mixed together at room temperature in a closed container; ruthenium tetroxide fumes are generated chemically by the oxidation of ruthenium chloride. Any latent marks that come into contact with these fumes are developed as dark gray images over about 10 to 20 min, depending on the surface. (Longer development times may be required for surfaces such as wood or aluminum.) The developed marks have a similar aspect to those obtained by OsO_4 treatment. RTX works well when sebaceous material is present in the latent fingermark, but it is generally ineffective on eccrine secretions. A 4% sodium hypochlorite solution clears RTX-developed marks.

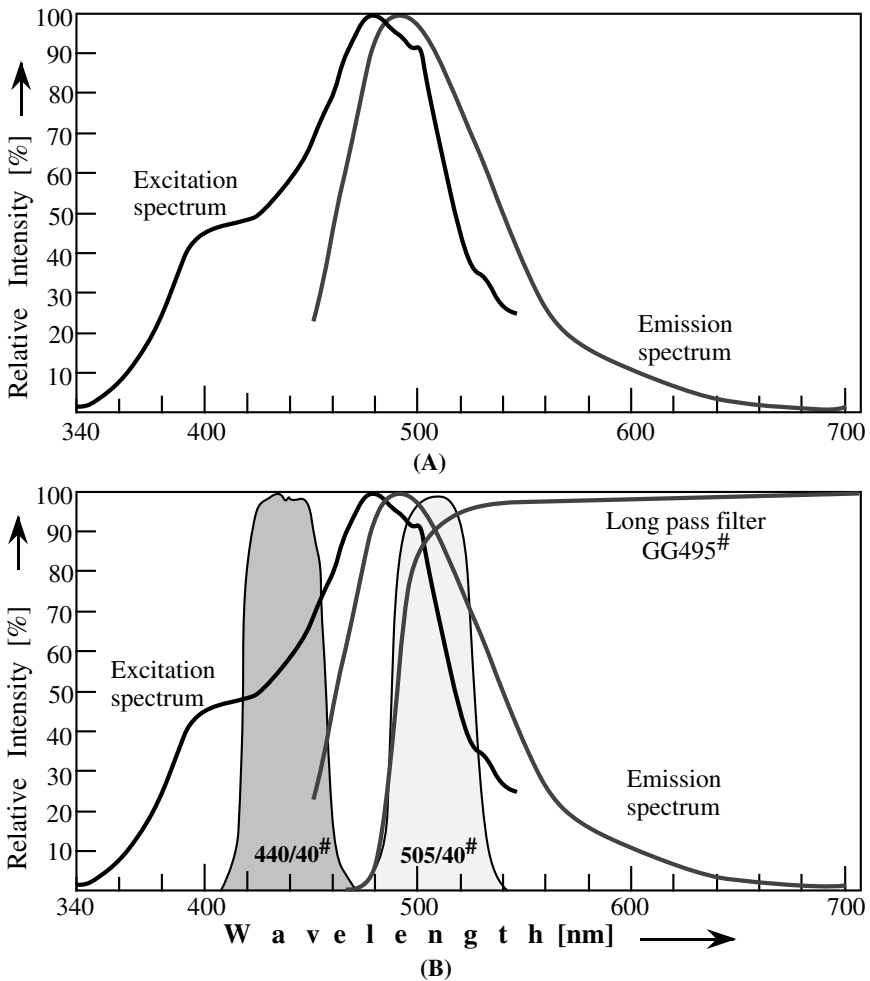

FIGURE 4.26 (A) Luminescence spectra for a DMAC-developed fingerprint; (B) Recommended filter combination for excitation (*) and observation (#).

Small objects can be enclosed in a glass or plastic container and treated with the RTX fumes generated by the mixing of the two solutions. Relatively large surfaces, such as doors, can be fumed using several milliliters of each solution added to a plastic wash bottle. By gently squeezing the wash bottle, the RuO_4 fumes that are produced can be directed from the nozzle toward the surface under investigation. (It may nevertheless take a significant time to develop marks over a large area by this procedure.) Using either of these methods, marks can be developed on both porous and nonporous surfaces. Another method by which fingerprints can be developed by RTX is by direct immersion of the object in the mixed solution. This procedure is very efficient in that fingerprint development is practically immediate

(Benzoni 1994). The direct immersion technique works best for nonporous surfaces, as porous surfaces tend to give a high background reaction.

Mashiko and coworkers (1991) have reported good results with the RTX technique on a variety of surfaces including paper, plastic, and human skin. Other authors have reported only limited success using RTX to develop latent marks on skin (Hébrard and Donche 1994; Wilkinson et al. 1996a). The method is simple and relatively rapid, and no special lighting is required to record developed marks. RTX shows particular promise for fingerprint detection on a number of difficult surfaces, including thermal paper, expanded polystyrene, adhesive surfaces (such as adhesive tape), untreated wood, PVC, and certain types of glossy paper where conventional techniques do not perform adequately.

In 1998, Mashiko and Miyamoto (1998) proposed a modification to the RTX procedure that employs a developing solution made up of ruthenium tetroxide dissolved in a hydrofluorocarbon solvent (such as tetradecafluorohexane) at a concentration of 0.25% w/v. The result is a deep yellow, transparent, nonflammable reagent that does not dissolve any of the sebaceous components in the fingerprint deposit. The fumes from the solution have an ozonelike odor. The solution is sprayed directly onto the surface of interest, and treated latent marks soon appear as brownish-black images. Where contrast is insufficient, the reagent can be reapplied. As an alternative to spraying, items can be treated by direct immersion in the solution. Regardless of the application method, RTX must be used with great care, as it is reported to be toxic by inhalation or skin contact (Blackledge 1998).

4.6.4 SILVER NITRATE

Silver nitrate reacts with the chloride component of the latent fingerprint (eccrine secretion) to form light-sensitive silver chloride. Upon exposure to light, silver chloride, which is white in color, is decomposed to silver metal (Figure 4.27), producing a black image of the fingerprint. The technique is effective on most paper surfaces and untreated wood. However, loss of fingerprint detail tends to be observed with relatively old marks (>1 week) developed with silver nitrate due to the diffusion of chlorides through the substrate. This phenomenon was proposed by Angst (1962) as a method for determining the age of a fingerprint on paper. Although simple to apply, the method is destructive, causing a strong background reaction that results in a darkening of the substrate with time. Silver nitrate is also an expensive chemical reagent.

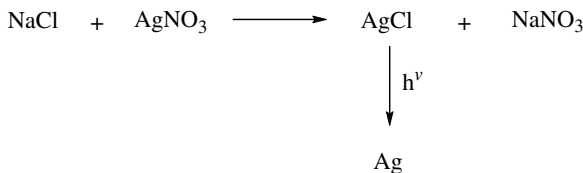

FIGURE 4.27 Silver nitrate reacts with chloride in the print deposit to form silver chloride. In the presence of light (h^ν), silver chloride decomposes to silver metal.

A typical working solution is 2% (w/v) silver nitrate in methanol. The solution may be applied by immersion or with a spray. After treatment, the article is exposed to a UV light source (sunlight, arc lamp, or UV lamp) until the best contrast between the developed fingerprints and the substrate is observed. Developed marks should be photographed immediately and treated items stored in the dark. Price and Stow (1998) have recommended the use of a stopping solution to slow down the background discoloration that occurs on items processed with silver nitrate. The silver nitrate technique can sometimes be effective for improving the contrast in weak ninhydrin-developed fingerprints. This can be particularly effective on raw wood. Dilute physical developer (PD) can be used to intensify weak silver nitrate-developed marks (Lennard and Margot 1988).

4.7 FINGERMARK DETECTION ON SEMIPOROUS SURFACES

Fingerprint detection techniques generally fall into two groups: those that work best on porous surfaces (e.g., DFO, ninhydrin) and those that work best on nonporous surfaces (e.g., cyanoacrylate fuming, VMD). Intermediate, semiporous surfaces are sometimes problematic. Such surfaces include waxed paper, glossy paper, matte-painted substrates, and some rubber/latex gloves. Single techniques that may be successful on such surfaces include iodine/benzoflavone spray and multimetal deposition (MMD). For example, Jones (2002) found that MMDII was particularly effective on surfaces such as latex and nitrile gloves, expanded polystyrene, and waxed paper. Otherwise, the best general approach is to use a combination of techniques applied in a logical sequence. One such sequence is depicted in [Figure 4.28](#). Given the unusual nature of some semiporous surfaces, tests should be conducted on a similar surface before proceeding with the treatment of an evidential item.

4.8 FINGERMARK DETECTION ON HUMAN SKIN

Human skin is probably the most difficult surface on which to develop latent fingerprints. The major problem lies in the fact that the same secretory compounds found in the latent fingerprint deposit, and exploited for latent fingerprint detection, also exist on the surface of the skin. This results in a very poor signal-to-noise ratio. In addition, while the eccrine/sebaceous emulsion that constitutes a latent fingerprint deposit may essentially solidify on a cold surface, this same deposit will remain liquid and diffuse rapidly when deposited on warm skin. Despite these obvious difficulties, certain cases warrant an attempt to detect marks on skin. For example, a case of manual strangulation would justify an attempt to develop marks on the neck of the victim.

Many techniques have been proposed in the literature for revealing latent prints on human skin (Shin and Argue 1976; Delmas 1988; Allman and Pounds 1991b; Bettencourt 1991; Hébrard and Donche 1994; Sampson 1996, 1997; Sampson et al. 1998). Some of the suggested detection methods are described here, and all have

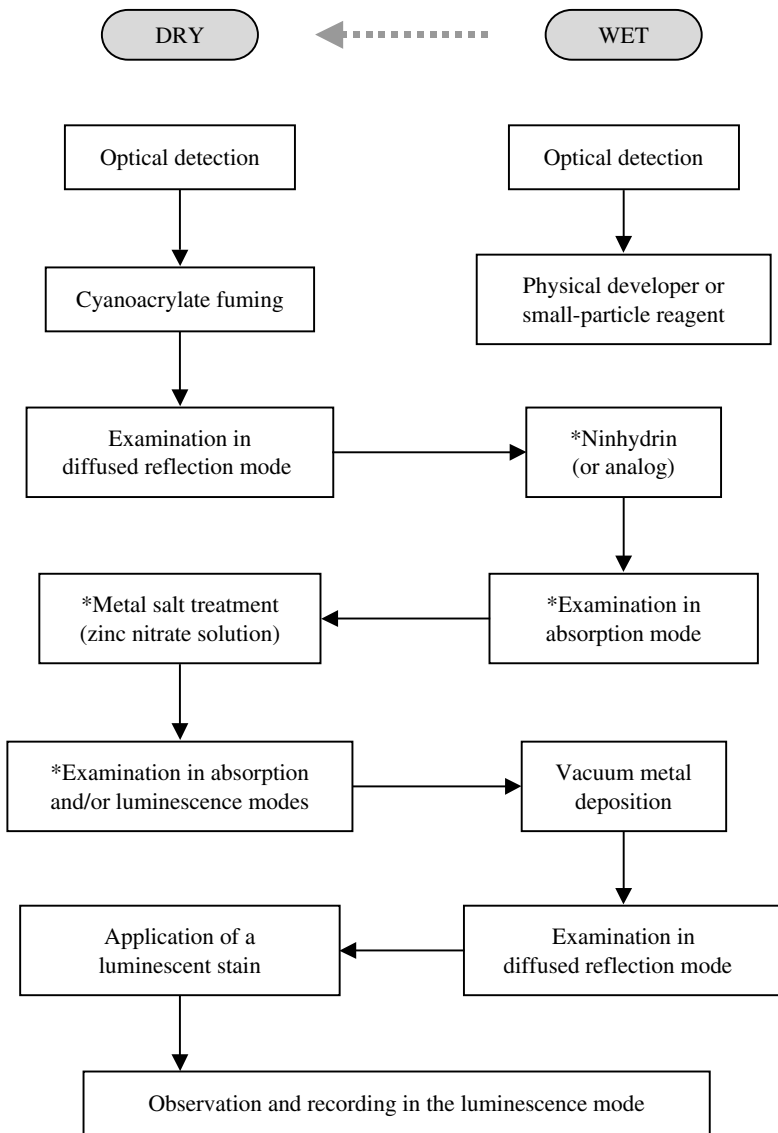

FIGURE 4.28 Recommended sequence of methods for the detection of latent fingerprints on wet and dry semiporous surfaces (e.g., wax paper, glossy paper). Where possible, wet surfaces should be allowed to dry at room temperature before proceeding. (*Skip if item has been wet.)

been shown to produce results under ideal laboratory conditions. However, there have been very few reported successes in actual cases, and it is generally considered that only very fresh marks of good quality (less than a few h old) or contaminated with a foreign material have any real chance of being detected. It has been estimated that the probability of recovering an identifiable fingerprint on the skin of a cadaver

is around 15 million to 1 (Sampson 1996). While certain cases justify a search for fingermarks on skin, it is important to remain realistic as to the chances of success on this surface. Human skin will always remain a difficult substrate for fingermark detection and, despite the research that has already been undertaken, further studies are required if higher success rates are to be obtained in the future.

4.8.1 POWDERING

The application of magnetic powder has been successful in several cases according to Haslett (1983). Any developed prints are photographed before being lifted using fingerprint lifting tape. Hébrard and Donche (1994) concluded that the direct powdering of fingerprints on skin should only be envisaged if the marks have already been localized.

Fingermarks on skin can sometimes be revealed by dusting with fine lead powder followed by application of an x-ray detection technique. The method is highly specialized, and both lead powder and x-rays are extremely hazardous to the health. Details of the technique can be found in the literature (Graham and Gray 1966; Graham 1969; Winstanley 1977).

4.8.2 TRANSFER TECHNIQUES

One approach to developing marks on skin is to transfer the latent fingermarks onto another surface before processing. A commonly cited technique is the transfer of latent marks onto glossy paper (Kromekote™ cards, for example). Unexposed but fixed photographic paper can also be used. After transfer, the marks can be processed with magnetic powder (or any other suitable powder or development technique).

Glass is one of the best surfaces on which to detect latent fingermarks. For this reason, Sampson (1992, 1995) proposed the use of a clean glass sheet as a support for the lifting of latent fingermarks from skin (glass recovery investigative technique [GRIT]). After the transfer procedure, various techniques (physical or chemical) can be applied to reveal any ridge detail (episcopic coaxial illumination, cyanoacrylate, etc.).

Hoyser (1992) suggested an alternative GRIT technique. In this case, marks are lifted from the skin surface onto a sheet of plastic film. (The sheet should be relatively thick but pliable enough to easily conform to most body contours.) The transferred marks can then be fumed with cyanoacrylate or dusted with conventional powder. Guo and Xing (1992) indicated that latent prints can be lifted from human skin using a semirigid polyethylene terephthalate (PET) sheet. The plastic sheet is electrostatically charged by vigorous rubbing and then pressed onto the surface of interest. Any dust present in the latent mark will be attracted by the static electricity in the charged sheet. The transferred marks are visualized on the plastic sheet by oblique lighting. The authors claim good results using this method for the detection of latent marks over a week old on skin.

Laboratory experiments on live subjects and cadavers, under ideal conditions, have indicated that only very fresh prints (<15 min) can be consistently detected using these transfer techniques (Hébrard and Donche 1994). The value of these

procedures must therefore be questioned, even though more optimistic results have been reported in other studies. For example, Reichardt et al. (1978) detected fingermarks after 1.5 h; Hammer (1980) and, later, Hamm (1988) claimed to have revealed four exploitable fingermarks using the Kromekote™ process on the forearm of a victim 18 h after the commission of the crime.

When ridge detail is visibly impressed into the skin (in the case of strangulation, for example), this can be photographed using oblique lighting. A silicone casting material can then be used to lift the mark in a similar way as for tool marks. Other techniques (as listed here) can then be applied to the impression in order to obtain additional ridge detail. Immamura and Asahida (1981) cite a case where this casting procedure was successfully applied on a person murdered by strangulation.

4.8.3 PHYSICO-CHEMICAL METHODS

4.8.3.1 Iodine/Silver Plate Transfer and Iodine/Benzoflavone

A portion of the skin is fumed with iodine vapor over approximately 30 sec. The possible presence of a latent fingermark is indicated by the formation of a brownish stain (no ridge detail can normally be discerned at this stage). A highly polished silver plate is then pressed directly against this processed area. The plate is removed after a few seconds and exposed to strong light (direct sunlight, UV lamp, arc lamp, etc.). A dark brown image of the lifted mark is formed on the silver plate (Adcock 1977; Gray 1978). The results are variable, and contradictory opinions are expressed in the literature concerning the performance of this technique. Hébrard and Donche (1994) determined that fingermarks deposited on warm cadavers that were subsequently kept in a cold room (6°C) gave the best results. Exploitable prints could even be developed up to 14 h after deposition (according to other reported studies: from 2 to 108 h after deposition).

Wilkinson and coworkers (1996a) compared the iodine/silver plate transfer process with iodine fuming followed by treatment of the skin surface with a solution of 7,8-benzoflavone. This latter treatment produces a dark blue reaction product that can be clearly seen against the skin. The iodine/silver-plate transfer process only developed partial ridges and proved very awkward when searching for marks on bony regions of the body. On the other hand, the iodine/benzoflavone technique showed great promise. The technique demonstrated excellent selectivity, providing that care was taken to ensure that excess iodine was allowed to evaporate from the background skin before the application of the benzoflavone solution. The authors of that study reported that iodine fuming followed by benzoflavone treatment consistently developed fresh marks deposited on skin and that further research on the use of this technique was warranted (Wilkinson et al. 1996a).

4.8.3.2 Cyanoacrylate

Skin fragments or body parts can be treated in a conventional cyanoacrylate tank. If a complete body must be processed, then this can be placed in a tent constructed

from plastic sheeting and subsequently fumed with heat-generated cyanoacrylate vapor (commercially available cyanoacrylate pads can also be used). After cyanoacrylate processing and photography of any ridge detail, the skin surface can be treated with a luminescent stain (rhodamine 6G or BY40, for example). The skin is then examined using a suitable light sources (laser or filtered arc lamp). If necessary, the surface can be washed with water or methanol to reduce background luminescence. As an alternative to the application of a luminescent stain, marks developed by cyanoacrylate fuming can be enhanced by the application of black magnetic powder (Fortunato and Walton 1998).

The advantage of this technique is that any latent marks that may be present can be rapidly fixed at the crime scene before the cadaver is transported and placed in a cold room. (In the case of a body that has already been kept in a cold room, water condensation over the skin surface normally excludes any fingerprint development by cyanoacrylate fuming.) Secondary treatment can be conducted at a later stage in the laboratory. Delmas (1988) has reported the cyanoacrylate development of exploitable fingerprints on three bodies (out of five) after 5 h; Hamilton and Dibattista (1985) cite a success in an actual case involving a 5-year-old child; Misner et al. (1993) have reported on successful experiments involving the detection of fingerprints on six cadavers after 24 h.

4.8.3.3 Ruthenium Tetroxide (RTX)

Mashiko and coworkers have reported good results on skin using ruthenium tetroxide (RTX) (Mashiko et al. 1991; Mashiko and Miyamoto 1998). Tests conducted by Dolci (1992) indicated that the technique can successfully develop latent marks on skin up to at least 8 h after their deposition. However, the results obtained by Hébrard and Donche (1994) indicate that adequate ridge detail can only be obtained for fingerprints deposited using very light fingertip pressure on the skin. This observation therefore implies that the chances of success with this technique, when used in actual casework, are very low. The RTX technique can be applied after the iodine/silver-plate transfer method.

4.8.4 RECOMMENDED DETECTION SEQUENCE

The processing of a cadaver for fingerprint evidence should ideally be conducted where the body is found, as any movement or unnecessary time delay is likely to further reduce the likelihood of success. On live subjects, the rapid diffusion of latent fingerprints into the hydrolipid layer on the skin surface normally excludes any chance of detection.

Fingerprint detection on human skin first requires a meticulous examination of the skin surface under different lighting conditions (white light, UV, monochromatic light [laser or filtered lamp], etc.) in order to detect any weakly visible or luminescent marks (caused by contamination of the fingers, for example). Any detail should be recorded photographically before proceeding with any other treatment.

The fingerprint detection sequence on cadavers (Figure 4.29) will be determined by the time delay and whether or not the body has been stored in a cold room. A delay of more than 24 h since the time of death will seriously reduce the chance of success and precludes the application of cyanoacrylate fuming (due to the body's elimination of water through the pores in the skin). Similarly, a body kept in a cold room will tend to be excessively moist due to water condensation; this also precludes cyanoacrylate treatment. When significant finger pressure has been employed by the aggressor (strangulation, for example), fingerprints may be visible on the cadaver. These marks can be lifted (or a silicone cast produced in some cases) before applying the iodine/silver-plate technique. RTX may be applied as a final treatment, but this is rarely successful when heavy fingertip pressure is involved. When no fingerprints are visible, cyanoacrylate

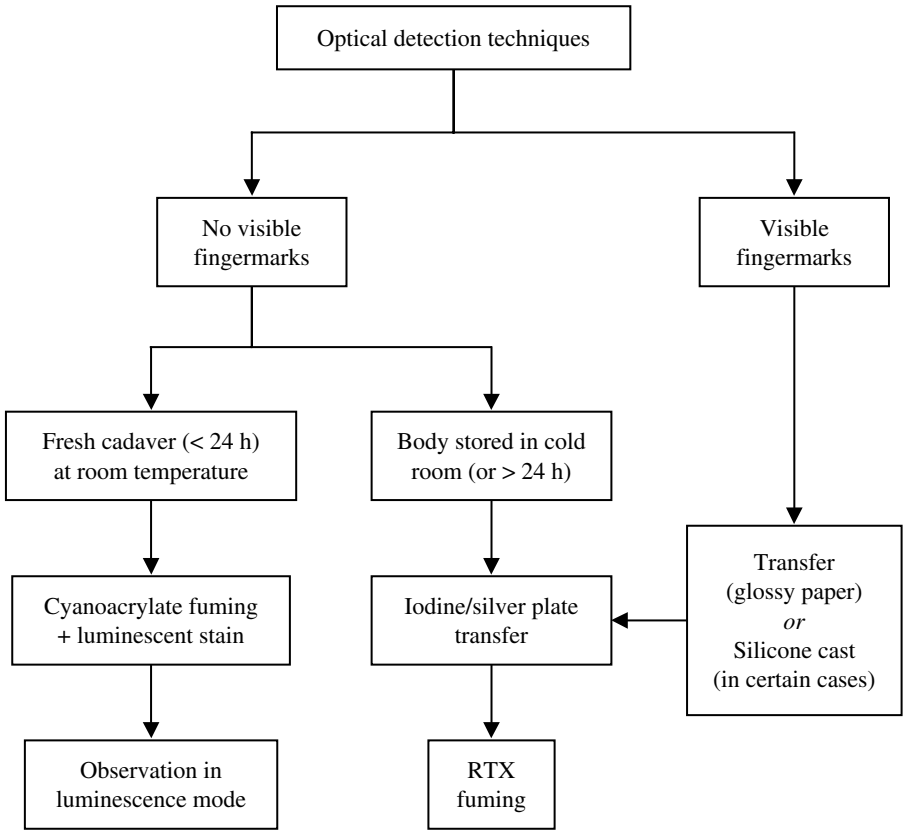

FIGURE 4.29 Recommended sequence of methods for the detection of fingerprints on human skin. (From Hébrard, J. and Donche, A. [1994], Fingerprint detection methods on skin: experimental study on 16 live subjects and 23 cadavers, *J. Forensic Identification*, 44, 623–627. With permission.)

can be employed in the case of fresh cadavers (<24 h) that have not been placed in a cold room. Otherwise, the only possibility remaining is the iodine/silver-plate technique followed by RTX.

As for the other detection sequences that have been presented in this chapter, this sequence is only one of many possible combinations that may be effective in a given set of circumstances. The sequence should be used as a general guide only, and the use of other techniques, such as powdering or iodine/benzoflavone, must also be considered. Experience and experimentation will dictate the sequence of techniques that should be applied in any specific case.

4.9 FINGERMARK DETECTION ON ADHESIVE SURFACES

Adhesive surfaces, such as the sticky side of self-adhesive tape, can be very productive for fingermark detection due to their receptive nature (essentially pulling secretions and skin debris off the fingertip surface when touched) and the fact that it is difficult to manipulate adhesive tape while wearing gloves. A number of techniques have been proposed for treating adhesive surfaces, the most notable being gentian violet (crystal violet) staining solutions and, more recently, sticky-side powder. Midkiff and coworkers have extensively reviewed the range of techniques available for the development of latent marks on adhesive tape (Midkiff 1994; Midkiff and Codell 1995; Midkiff et al. 1997).

One of the operational difficulties associated with the treatment of adhesive surfaces such as adhesive tape is the fact that such materials often have to be separated from another surface, or themselves, before processing. Various techniques have been proposed in the literature for separating or unraveling sections of adhesive tape (Choudhry and Whritenour 1990; Campbell 1991a; Stimac 2000). Suggested methods have included freezing, heating, and the application of a solvent. Care should be exercised with the application of such methods to limit any unnecessary damage to the latent marks that may be present. It has recently been shown that the use of the product Un-Du® (a heptane-based adhesive neutralizer) to remove stamps and labels will not adversely affect the detection of latent fingermarks on these surfaces (Schwartz et al. 2003).

4.9.1 GENTIAN VIOLET

Gentian violet (crystal violet) is a fat-soluble stain that is extremely effective for the examination of the adhesive surface of pressure-sensitive tapes such as clear Sellotape, paper masking tape, and PVC insulation tape. The conventional procedure involves treating the adhesive side of the tape with a solution of gentian violet that contains phenol to assist the absorption of the stain by the sebaceous material in the print deposit. Treatment can be by dipping, by floating the tape (adhesive side down) on the stain solution, or by application with a pipette. Excess reagent is then removed by washing with water. The sebaceous component of the fingerprint deposit is stained dark purple by this process, and therefore prints become visible as dark purple ridges against a lightly stained background. The

degree of background staining is dependent on the nature of the tape and any contamination present. Paper-backed tapes or labels may stain heavily and should be tested before treatment. The procedure can be extended to darkly colored tapes using a lifting technique in which marks developed with gentian violet are transferred to a clean gelatin surface. This is achieved by firmly pressing the adhesive surface of the tape, after treatment with the stain, onto a fixed and washed sheet of photographic paper; diffusion of the stain into the gelatin occurs rapidly (Wilson and McCloud 1982; Kent 1986).

Extreme caution must be used when handling solutions that contain phenol, as this compound is highly toxic and carcinogenic. Gloves must be worn and the processing conducted within a fume hood. Phenol-free gentian violet formulations have been proposed (Gray 1996), but it is generally considered that the formulation containing phenol gives superior results (Tuthill 1997).

Gentian violet staining produces a dark purple coloration; therefore, observation of treated marks is generally conducted in the visible region. Ziv and Springer (1993) reported that coaxial illumination can be a useful optical enhancement procedure for marks developed with gentian violet on the adhesive side of self-adhesive tape. Bramble and coworkers (2000) studied the deep red to near-infrared luminescence characteristics of gentian violet-treated latent marks. The luminescence data recorded in their study was used to optimize a relatively inexpensive viewing system for the observation and capture of the luminescence emission. Given the additional sensitivity offered by the luminescence mode, the authors found that the system permitted the visualization of both treated marks on dark surfaces and weakly developed marks on light surfaces.

As an alternative to gentian violet, Menzel (1989) proposed the use of basic fuchsin (rosaniline chloride). This stain was evaluated by Howard (1993) for the processing of black electrical tape. The staining procedure is similar to that of gentian violet, but the developed marks are luminescent when visualized under a forensic light source (observation conditions are as for rhodamine 6G). Using both water- and methanol-based stain formulations, results were found to be comparable with those produced using gentian violet or cyanoacrylate/rhodamine 6G. Midkiff and Codell (1995) used an aqueous solution of basic fuchsin (0.015 g per 100 ml) and reported good results on a range of adhesive tapes.

4.9.2 STICKY-SIDE POWDER

Sticky-side powder, a suspension of black fingerprint powder in a detergent solution, is an extremely simple but effective technique for the detection of latent fingermarks on the sticky side of adhesive tape. The technique was developed in Japan in the early 1990s and is now widely employed throughout the world (Yamashita et al. 1993; Burns 1994). To prepare the suspension, equal parts of Photoflo® detergent (Kodak) and water are mixed with a small amount of black powder until a consistency similar to thin paint is achieved. This suspension is then painted onto the adhesive surface using a soft brush (e.g., camel-hair fingerprint brush). After 10 to 15 sec, the adhesive surface is gently rinsed under running tap water. Treated marks are dark gray to black in color. The process can be repeated if development is weak.

Burns (1994) reported good results on a range of adhesive surfaces including the adhesive side of duct tape, masking tape, surgical tape, paper-backed labels, clear plastic tapes, and reinforced packing tapes. Gray (1996) evaluated the sticky-side powder technique and found that it generally outperformed gentian violet on the adhesive surfaces tested (although it should be noted that a phenol-free aqueous solution of gentian violet was employed in the study).

Bratton and Gregus (1996, 1997) evaluated a number of detergent/powder combinations and found that a formulation based on Lightning Black™ Powder and Liqui-Nox™ glassware detergent was the most effective on a broad range of adhesive tapes. It was determined that this method was superior to both the original sticky-side powder formulation and conventional gentian violet processing. The authors suggest that this should be the method of choice for adhesive surfaces and that attempts to apply other methods first may render the powder method ineffective. Sneddon (1999) explored the use of the Liqui-Nox™/black powder method for processing the adhesive side of duct tape. It was confirmed that excellent results could be obtained and that the powder suspension produced better overall results on this surface compared with results obtained with gentian violet.

The standard sticky-side powder method yields poor results on black electrical tape due to insufficient contrast. Martin (1999) reported that white or ash gray powder could be used instead of black powder in the sticky-side formulation for use on black electrical tape. This simple alternative was found to produce excellent results on the adhesive side of this tape. Parisi (1999) also reported success using powder suspensions produced by mixing fluorescent or white fingerprint powders with Liqui-Nox™ and water. This approach has obvious advantages on dark adhesive surfaces, where black powder gives poor contrast. As suggested by Kimble (1996), a range of conventional fingerprint powders can be used in suspension to develop latent marks on adhesive surfaces. The use of titanium dioxide has recently been proposed for the preparation of white sticky-side powder for the detection of latent marks on dark adhesive surfaces (Wade 2002).

4.9.3 CYANOACRYLATE FUMING

Morris (1992) proposed the use of low-level superglue fuming followed by staining with basic yellow 40 as an alternative to gentian violet for processing the adhesive side of tape. Similarly, Isaac (1993) compared a number of techniques and reported that cyanoacrylate fuming, followed by either rhodamine 6G or MBD staining, can be very effective for developing marks on a range of self-adhesive tapes.

Midkiff and Codell (1995) evaluated several techniques and found that cyanoacrylate fuming alone gives highly variable results, depending on the type of tape. Differences in the type, thickness, or consistency of the adhesive are believed to account for the observed variability in fingerprint development. Some tapes were found to be easily overdeveloped, resulting in a loss of fingerprint detail and poor contrast.

4.9.4 RECOMMENDED DETECTION SEQUENCE

Detection techniques applied to an adhesive surface must be used in sequence with methods that will also develop latent marks on any nonadhesive surfaces that are

also present. For example, the processing of adhesive tape must take into consideration the detection of latent fingermarks on both the nonadhesive and adhesive sides of the tape. Typically, any latent marks present on the nonadhesive side of the tape should be developed and photographed before proceeding with the treatment of the adhesive surface.

A recommended sequence for the detection of latent fingermarks on adhesive surfaces is given in Figure 4.30. While MMD is not included in this sequence, its use may be considered in some cases, as it is capable of developing marks on both adhesive and nonadhesive surfaces as well as for both porous and nonporous backings. The choice of a technique for the adhesive surface itself (e.g., adhesive side of adhesive tape) will depend on experience and experimentation. Certain adhesive tapes, for example, respond better to a particular technique. No one technique performs better than the others on all adhesive surfaces. For any given case, therefore, tests should be conducted in a systematic manner to determine the most appropriate method to apply.

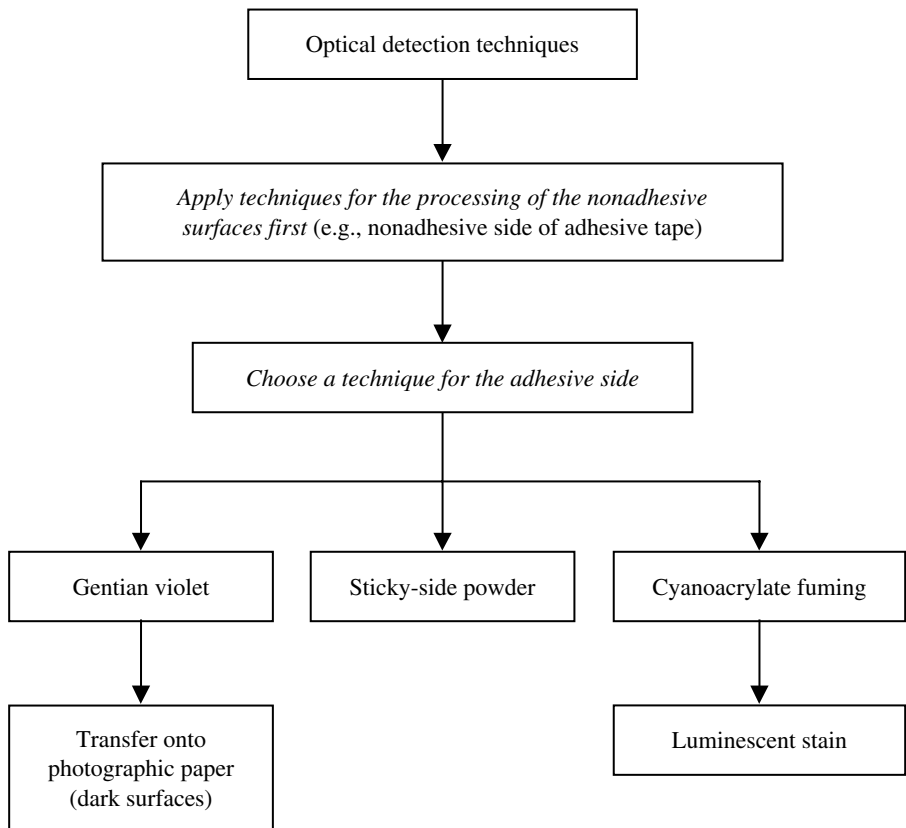

FIGURE 4.30 Recommended sequence of methods for the detection of latent fingermarks on adhesive surfaces.

4.10 FINGERMARK DETECTION ON FIREARMS AND CARTRIDGE CASES

The detection of latent fingerprints on fired cartridge cases is problematic, and low success rates are generally encountered in actual casework. The cartridge case surface itself is not the cause, as marks can be developed on unfired rounds using a range of techniques. The possible reasons for low success rates on fired rounds have been reviewed by Wiesner and coworkers (1996) and include the following:

- Friction between the surface of the cartridge case and surfaces of the firearm at different stages of the firing process (e.g., loading of the magazine, the introduction of the live round into the chamber, and the ejection of the empty case after firing)
- High temperature and pressure generated within the cartridge case at the moment of firing
- Exposure of the surface of the cartridge case to the combustion gases and discharge residues generated at the moment of firing

Studies conducted on each of these effects indicated that, while each factor plays a role, the main cause of fingerprint deterioration is the friction between the surface of the cartridge case and the chamber at the moment of ejection (Wiesner et al. 1996). At the moment of firing, the diameter of the cartridge case increases due to the high internal pressure that is generated. As a result, friction is more pronounced on ejection of the fired round rather than upon introduction of the live round prior to firing. Given the smearing of latent marks that can result from this friction, low success rates will tend to be encountered regardless of the detection techniques employed.

While a range of detection techniques can be applied, it should be appreciated that latent marks on brass cartridge cases may sometimes spontaneously develop over time due to a process of differential tarnishing (Saunders and Cantu 1996). A careful visual examination should therefore be conducted, and any ridge detail recorded, before proceeding with any other treatment.

Fingerprint detection on the firearms themselves can also present difficulties, depending on factors such as the nature of the surface (e.g., metal, wood, or plastic), any surface finish or pattern, surface contamination (e.g., gun oil and discharge residues), and how the firearm has been handled and packaged. Barnum and Klasey (1997) have reviewed the reasons why it can be difficult to obtain identifiable prints from firearms. Despite the inherent problems, the authors claim that, in their experience, identifiable marks are encountered almost 10% of the time.

4.10.1 CYANOACRYLATE FUMING

Sampson (1993) investigated the application of cyanoacrylate fuming for the detection of latent marks on both brass and nickel cartridge cases. Nickel cartridge cases were found to yield good overall results, while the results achieved on brass cartridge cases were generally poor. Donche and Musy (1994) found that the results obtained

with cyanoacrylate on plastic shotgun cartridges was generally satisfactory, while the technique gave limited results on metallic casings.

Bentsen and coworkers (1996) evaluated a range of techniques on fired cartridge cases, including both atmospheric-pressure and vacuum cyanoacrylate fuming followed by treatment with a luminescent stain. It was determined that both cyanoacrylate systems were effective, although the vacuum method gave sharper ridge definition. Of the luminescent stains evaluated, BY40 was found to give better overall results.

Klasey and Barnum (2000) evaluated vacuum cyanoacrylate fuming for fingerprint detection on a range of different firearms. Prints developed with the vacuum process were found to be not as white as those developed under atmospheric conditions. However, overdevelopment of fingerprint evidence was avoided, making this a good first choice for processing firearms. Virtually none of the test marks in this study were enhanced by a second treatment by vacuum cyanoacrylate fuming. However, subsequent atmospheric-pressure cyanoacrylate fuming enhanced some of these marks.

4.10.2 GUN BLUE

While most fingerprint detection techniques are dependent on a reaction with the fingerprint deposit, the gun blueing process involves a reaction with the substrate. The principal active ingredients in gun blue include selenious acid (H_2SeO_3) and a cupric salt in an acid solution. Both selenious acid and cupric ions can oxidize certain metals (e.g., zinc, aluminum, and iron). When these two components are reduced in the presence of such metals, a black copper-selenide coating is formed (Migron and Mandler 1997; Cantu et al. 1998). This coating will only form on a clean metal surface; no deposit will occur if the surface is contaminated with a greasy or oily material, as is the case when a sebaceous fingerprint is present. Dilute gun blue solution can therefore be used to treat certain metal surfaces, such as brass cartridge cases, to reveal latent marks as transparent images against a dark background.

A selenious acid process reported by Bentsen and coworkers (1996) involved the immersion of cartridge cases in a 0.4% aqueous solution of selenious acid until optimum ridge detail is observed. Treated cartridge cases are then rinsed thoroughly with water and dried. Developed marks can be preserved by dipping the cartridge cases in clear varnish to prevent further surface oxidation (alternatively, the surface can be coated with protective oil). Developed marks should be photographed immediately, as further oxidation can destroy ridge detail. The results are dependent on the composition of the cartridge case; selenious acid treatment was reported to be ineffective on aluminum- and nickel-coated brass cases. While the method is highly sensitive, propellant by-product contamination can limit results on some spent cases (Bentsen et al. 1996).

Saunders and Cantu (1996) evaluated several techniques for developing latent marks on both unfired and fired cartridge cases. Treatment with dilute gun blue solution gave better overall results compared with cyanoacrylate fuming. However, superior results were obtained with cyanoacrylate fuming followed by gun blue treatment compared with gun blue solution alone. (This suggests that a possible

sequence for processing cartridge cases would be as follows: cyanoacrylate fuming → selenious acid → luminescent stain.) The authors were unable to develop any ridge detail on oily or dirty cartridges, even after the application of degreasing or washing techniques.

Both etching and blueing techniques were evaluated by Schütz and coworkers (1999) and the results compared with those obtained with multimetal deposition (MMD). (Etching involves the acid-based dissolution of the metal surfaces, whereas blueing involves both an acid-based dissolution and the formation of a dark metal complex.) The best efficiency for latent fingerprint detection on brass cartridge cases was generally observed with gun blue treatment, particularly for sebaceous fingerprints. However, on aluminum cartridge cases, better results were obtained with MMD. Only the modified physical developer step of the MMD treatment appeared to contribute to the fingerprint detection. Lacquered steel cartridge cases were problematic, and the authors recommended cyanoacrylate fuming for this surface.

Cantu and coworkers (1998) determined that a mixture of acetic acid and hydrogen peroxide could be used to remove excess gun blue deposit from metal cartridge cases that had been overdeveloped by gun blue treatment. It was also found that the acidified hydrogen peroxide solution could be used to visualize latent marks on cartridge cases by an etching process and that such marks could be enhanced by subsequent gun blue treatment.

Vouk (1996) has warned that the use of gun blue solution for the detection of latent marks can result in a loss of detail in the individual toolmarks left on the cartridge case by the firearm. Such markings on a cartridge case should therefore be recorded by a firearms examiner before proceeding with the gun blue treatment.

4.10.3 MISCELLANEOUS TECHNIQUES

Migron and coworkers investigated palladium deposition techniques for the development of latent fingerprints on brass cartridge cases (Migron et al. 1996, 1998; Migron and Mandler 1997). Treatment is by immersion in an aqueous solution of either dipotassium hexachloropalladate or disodium tetrachloropalladate for 40 sec, followed by rinsing in distilled water. The reaction with the metal surface is a displacement process that involves the oxidation of zinc and, to a lesser extent, copper, resulting in the deposition of palladium. A dark metallic deposit forms on the exposed metal surface (including the fingerprint valleys), while the ridges remain golden-brass in color (Migron and Mandler 1997). A number of experiments were also conducted where iodine was used to etch the metal surface of the cartridge to sensitize it for subsequent palladium deposition. This etching step was found to significantly improve fingerprint visualization (Migron et al. 1996; Migron and Mandler 1997).

Overall, the palladium deposition technique was found to be a very promising method for fingerprint detection on unfired cartridge cases. The technique is relatively simple to apply, producing good fingerprint detail in a reproducible fashion. However, while application of the method on spent cartridge cases gave an indication that latent fingerprints were still present after firing, the developed images were rarely of good quality. It was confirmed in a further study that, under laboratory conditions, substantial parts of latent fingerprints on some cartridge cases could

remain intact after firing. In such cases, metal vapor deposition and the careful use of illumination can enable fingerprint visualization. The authors also proposed a model for the structural changes to latent fingerprints due to the firing process (Migron et al. 1998).

4.11 ENHANCEMENT OF FINGERMARKS IN BLOOD

Fingerprints in blood are often encountered in cases of violent crime where the offender's hands are contaminated with the blood of the victim. A fingerprint identified as being from the suspect, deposited in the blood of the victim (as suggested by DNA profiling evidence) constitutes very powerful evidence. Every effort should therefore be made to enhance any fingerprint in blood, for fingerprint identification purposes, without compromising the possibility of obtaining a DNA profile from the blood (see [Section 4.13](#)). Nondestructive optical enhancement procedures should be employed before proceeding with another treatment. Where possible, heavily bloodstained areas that are unlikely to yield ridge detail should be sampled for DNA profiling purposes before processing the surface for fingerprint evidence.

There are a number of blood- or protein-specific enhancement techniques (e.g., amido black and diaminobenzidine) that will not develop any latent fingerprints that may be present and are likely, in fact, to destroy such marks. This must be taken into consideration when processing an item for fingerprint evidence. An appropriate sequence of methods is required that will both develop any latent fingerprints that are present and enhance any fingerprints in blood. A sequence that exploits only the blood-contaminated prints will be to the detriment of any latent marks that may also be present on the evidential item.

In some cases it may be of interest to determine whether a fingerprint in blood is from a finger contaminated with blood or is a latent fingerprint already on the surface that has been developed by the blood. Creighton (1997) conducted a number of experiments where blood was allowed to flow over a series of latent impressions. The results suggested that preexisting latent impressions would not develop into visible fingerprints in blood by incidental or direct contact with blood. The observed effect was that the latent deposit tended to repel the blood. Further studies were conducted by Huss and coworkers (2000), who confirmed that: (a) blood will not visualize a previously deposited eccrine fingerprint and (b) blood may reveal a previously deposited sebaceous (greasy) fingerprint, although the print will be reversed, as blood will tend to be repelled by the ridges and hence accumulate in the furrows.

4.11.1 OPTICAL TECHNIQUES

Although blood has a broad absorption spectrum in the entire light region (UV–visible–IR), it exhibits a strong and narrow absorption maximum at 415 nm ([Figure 4.31A](#)) (Stoilovic 1991). The enhancement of untreated blood marks can be performed in either the absorption or reflection modes. The absorption mode is recommended for lightly colored or luminescent surfaces, while the diffused reflection mode is recommended for dark or shiny surfaces. Optical enhancement techniques

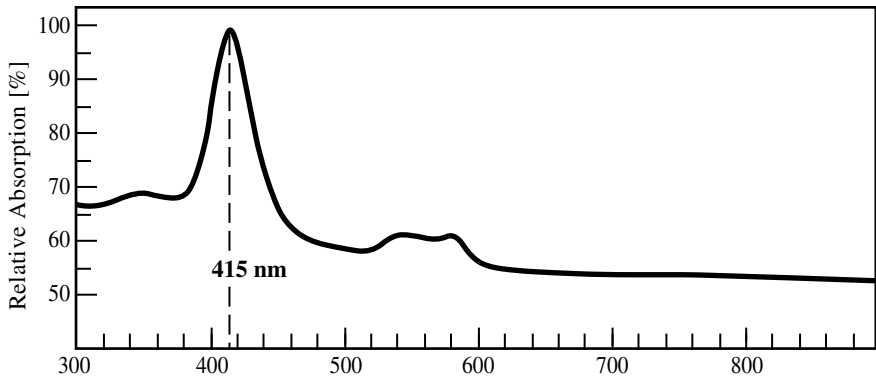

(A)

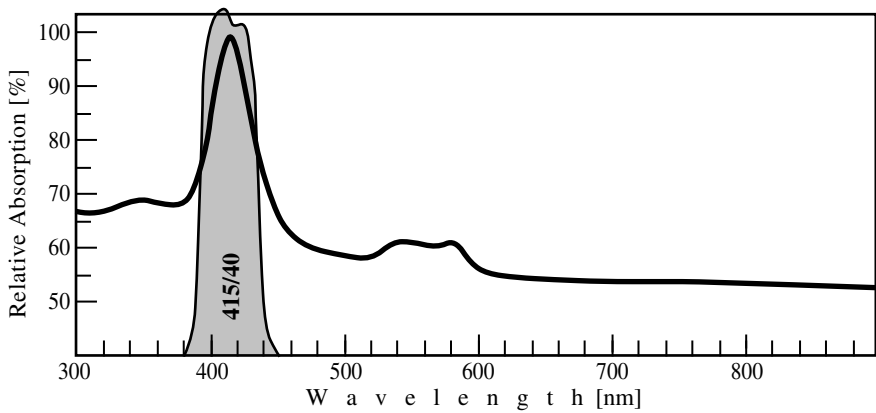

(B)

FIGURE 4.31 (A) Relative absorption spectrum of dry blood, showing a strong absorption peak at 415 nm. (B) Recommended bandpass filter for observation in the absorption mode.

are generally nondestructive, and therefore their use is strongly recommended before proceeding with any chemical treatment.

To employ the absorption mode for blood enhancement, a forensic light source is required that provides a strong band of light at around 415 nm (HBW approximately 40 nm) (Figure 4.31B). Under dark conditions, blood marks will appear almost black under such illumination due to the strong absorption of dry blood at this wavelength. Good contrast will therefore be obtained on lightly colored or luminescent surfaces. Note that the human eye is relatively insensitive in the violet region (400 to 420 nm), and any perceived enhancement will generally be much better when captured on film or via a CCD camera. If enhancement is required in full daylight (or artificial light), then the camera needs to be fitted with a 415-nm bandpass filter.

While dry blood strongly absorbs violet light, other wavelengths tend to be diffusely reflected. It is this characteristic that can be employed for enhancing blood

marks on dark or shiny surfaces. An illumination wavelength is chosen that is outside the violet region; for example strong blue light at 450 nm produces good results in most cases. Working under dark conditions, the blood mark is observed perpendicular to the surface, without any barrier filter, while the incident light angle is varied until the best contrast is obtained. The incident light will either be strongly absorbed or reflected by the surface, depending on whether the surface is dark or shiny. The blood mark will diffusely reflect the light, and hence the mark will appear as a light image against a dark background. In the case of a colored substrate, selecting an illumination band that is opposite to the substrate color will generally enhance the contrast.

Springer and colleagues have reported that UV luminescence techniques (short-wave UV excitation; observation in the long-wave UV region) can be particularly effective for detecting and enhancing marks in blood, semen, and saliva (Springer et al. 1994). Care must be exercised with such techniques, however, due to the danger associated with the use of shortwave UV light and the possible detrimental effect that it may have on subsequent DNA profiling.

4.11.2 PROTEIN STAINS

Before proceeding with any chemical treatment such as the application of a protein stain, blood marks need to be “fixed” to prevent the blood from washing away or diffusing. Two effective blood-fixing agents are methanol and 5-sulfosalicylic acid solution (Hussain and Pounds 1988; Sears and Prizeman 2000). The average fixing time is generally 5 min, although heavy deposits should be fixed for longer periods, 15 min or more, before applying the enhancement process.

The protein stain amido black (naphthol blue black B; acid black 1) has long been a recommended treatment for fingermarks in blood on both porous and non-porous surfaces (Kent 1986; Hussain and Pounds 1988; Sears and Prizeman 2000). Such marks are generally treated by immersion in a solution of amido black. After approximately 30 sec in the staining solution, the sample is washed successively in three different solutions to clear (de-stain) the background, thereby improving the fingerprint contrast. Treated marks are visible as dark blue ridges against a light blue or colorless background (depending on the nature of the support). The conventional amido black formulation is methanol based and may not be suitable on some surfaces or as a crime scene technique. Sears and Prizeman (2000) investigated alternative formulations and proposed a new ethanol/water-based system. This new formulation is suitable for application both in the laboratory and in the field. Warrick (2000) has described a case where marks in blood on cotton fabric were stained with amido black and then digitally enhanced, ultimately leading to the identification of a suspect in a murder investigation.

Coomassie blue is also a protein stain, giving results comparable to amido black. The same staining procedure is employed, and treated marks are blue but of a lighter color than that obtained with amido black. McCarthy and Grieve (1989) compared amido black with both Crowle’s stain and coomassie blue. It was concluded that, of the three protein stains evaluated, amido black is generally the best choice for treating fingermarks in blood and that cyanoacrylate preprocessing is not deleterious for most substrates that are subsequently processed with amido black. Cyanoacrylate

preprocessing on nonporous surfaces is recommended, as it can preserve latent impressions that are not subsequently visualized by the staining technique.

Sears and coworkers (2001) conducted a systematic evaluation of a range of protein stains — including fuchsin acid (Hungarian red) (Velders 1997) — for the enhancement of fingermarks in blood on surfaces typically encountered at crime scenes. Of the stains tested, two were found to show potential and warrant further investigation through operational trials. The first of these, acid violet 17 (coomassie brilliant violet), is an absorbing stain that produces a visible enhancement of blood marks; this stain may serve as a possible replacement for amido black. The second candidate, benzoxanthene yellow, was found to induce a luminescence in weak blood deposits on nonporous surfaces. This property may be an advantage on dark, non-luminescent, nonporous surfaces, where absorbing stains such as amido black are less effective.

4.11.3 DIAMINO BENZIDINE (DAB)

Work by Allman and Pounds (1991a, 1992a) has shown that the reagent diaminobenzidine (DAB) is a sensitive alternative to protein stains for the enhancement of blood marks both in the laboratory and at the crime scene. The reaction between diaminobenzidine and hydrogen peroxide is catalyzed by the peroxidase activity of blood (heme) to give a dark brown insoluble product. In contrast to protein staining, the reaction shows good specificity for blood and produces little background coloration; no de-staining of the surface is required. Before treatment, the blood marks are first fixed with a solution of 5-sulfosalicylic acid over several minutes. After being rinsed with water, the marks are then developed with a buffered solution of DAB over approximately 4 min. The revealed impressions are then rinsed with water and allowed to dry. The method is therefore quite rapid, with blood enhancement achieved in less than 10 min. Diaminobenzidine is considered safe to use, unlike the carcinogenic parent compound benzidine and some of its derivatives. The technique is particularly effective on porous surfaces, where protein stains tend to give a high background coloration. As a crime scene technique, application of DAB can be via reagent-saturated paper towels. This can be effective on a variety of surfaces, including doors and painted or wallpapered walls.

Sahs (1992) evaluated diaminobenzidine for the enhancement of blood marks and also proposed a DAB-MBD combined process. In this modified procedure, MBD (a luminescent stain proposed for the enhancement of cyanoacrylate-developed prints) is added to the sulfosalicylic acid fixing solution. While Sahs reported that results were inconsistent, luminescence was induced in some blood marks after treatment with the modified fixing solution. The addition of MBD to the fixing solution did not have any observable detrimental effect on the subsequent DAB reaction. However, marks enhanced with DAB were no longer luminescent; intermediate results must therefore be recorded before proceeding.

4.11.4 MISCELLANEOUS TECHNIQUES

Caldwell and coworkers (2000) proposed the use of ABTS [2,2'-azino-di-(3-ethylbenzthiazolinesulfonate) diammonium salt] as an effective alternative to DAB for

the enhancement of fingermarks in blood on porous surfaces. The authors found that the bright green color of the oxidized ABTS was an advantage on certain colored surfaces where the dark brown color of DAB-treated prints showed poor contrast. For blood marks on glass, better results were obtained with DAB. Treatment with ABTS did not interfere with subsequent DAB processing, indicating that the two techniques can be used in sequence if desired.

The amino acid reagent DFO has been found to be particularly effective for the treatment of fingermarks in blood on porous surfaces such as paper (Stoilovic 1991). Such marks, after development with DFO, show a strong room-temperature luminescence. In addition, the application of DFO (or ninhydrin) to blood marks does not preclude the later use of a protein stain such as amido black. DFO or ninhydrin preprocessing on porous surfaces is always recommended, as latent marks not contaminated with blood will not be revealed by a staining procedure. (Reagents such as DFO or ninhydrin cannot be employed after the application of a protein stain.)

A number of heme-reacting chemicals have been proposed for the enhancement of blood marks. These include reagents such as leucomalachite green, phenolphthalein, fluorescein, and tetramethylbenzidine (Lee 1984a, b; Shipp et al. 1994; Cheeseman and DiMeo 1995). In general, heme-reacting chemicals are extremely sensitive, being able to detect blood down to extremely low concentrations. This added sensitivity may be an advantage in some circumstances. The transfer of fingermarks in blood, enhanced by either leucomalachite green (LMG), leucocrystal violet (LCV), or diaminobenzidine (DAB), has been investigated (Jaret et al. 1997). It was found that fixed black-and-white photographic paper could be successfully used to transfer blood marks treated with LMG or LCV. This may be an advantage on dark surfaces, where contrast is poor, or for marks located in areas that are difficult to photograph. The transfer of DAB-enhanced impressions was not successful.

Dark surfaces are certainly a challenge for the detection of bloody fingermarks. Bergeron (2003) recently reported very good success using a methanol-based suspension of titanium dioxide, without any detrimental effects on the DNA profile.

4.11.5 RECOMMENDED DETECTION SEQUENCE

A recommended sequence of methods for the detection and enhancement of fingermarks in blood is given in [Figure 4.32](#). Depending on the nature of the surface, other techniques should be included at appropriate points within this sequence to ensure that any latent fingermarks are also detected and enhanced.

4.12 FINGERMARK DETECTION AT THE CRIME SCENE

Fingermark detection at the crime scene should logically begin with a detailed visual examination of all appropriate surfaces. The application of different optical techniques, using various light sources (strong white light, UV lamp, laser or filtered arc lamp, etc.), can reveal latent fingermarks or enhance weakly visible marks. Small objects or pieces of evidence should be removed from the crime scene, with all the normal precautions (proper packaging, labeling, etc.), for optimum fingermark treat-

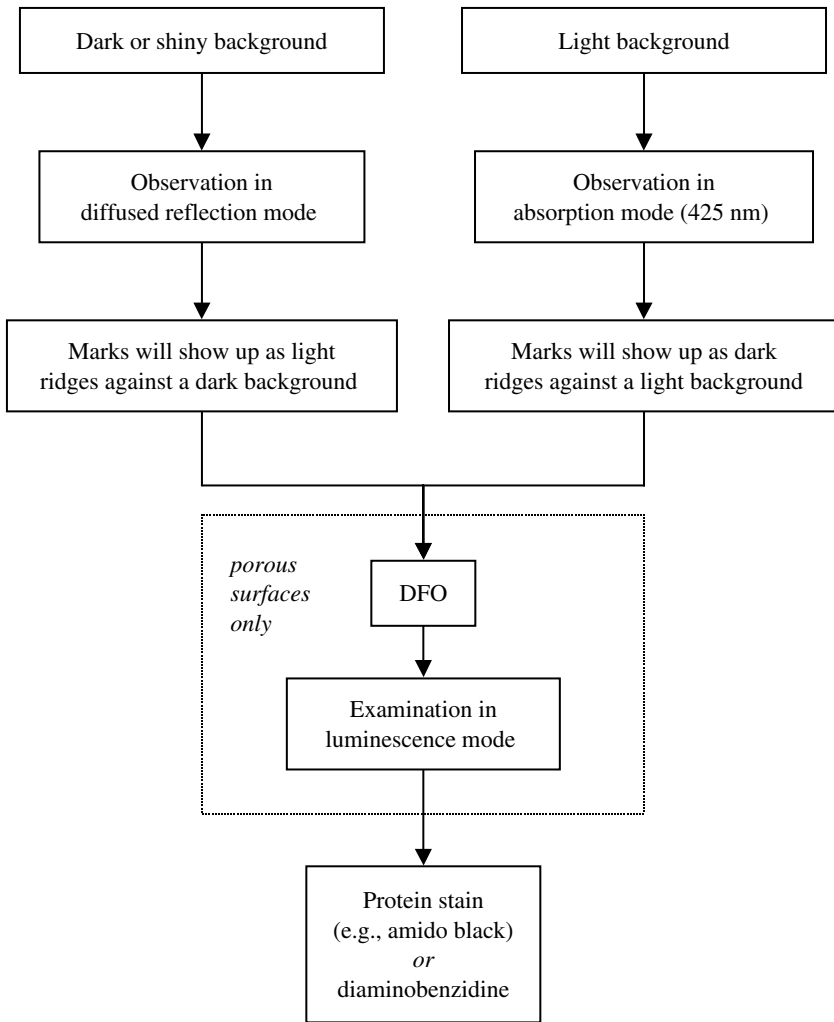

FIGURE 4.32 Recommended sequence of methods for the detection and enhancement of fingermarks in blood.

ment back at the laboratory. Nontransportable objects and fixed surfaces should then be processed using a suitable detection sequence.

Allman and Pounds (1992b) have elaborated a sequence of reagents for developing both latent and blood marks on various surfaces (both porous and nonporous) at the crime scene (Figure 4.33). This sequence was constructed after experiments performed on a range of different surfaces that may be encountered at a crime scene (including paper, wallpaper, wood, gloss paint, emulsion or matt paint, glass, polyethylene, and metal). After visual examination of the surface, the combined iodine/benzoflavone solution is applied with an air brush or paint spray (Pounds

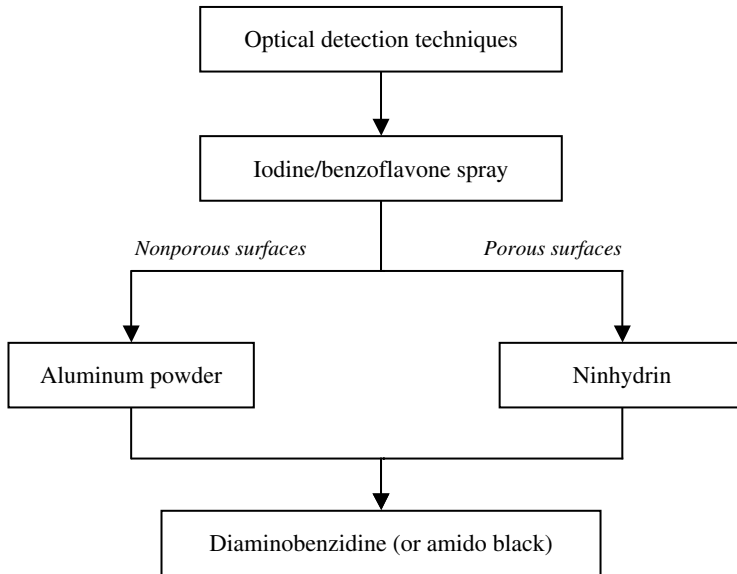

FIGURE 4.33 Recommended sequence of methods for the exploitation of latent and bloody fingerprints at the crime scene. (From Allman, D.S. and Pounds, C.A. [1992b], Sequence of Reagents To Be Used To Develop Fingerprints at a Scene of Crime, Technical CRSE No. 747, Central Research and Support Establishment, Home Office Forensic Science Service, Aldermaston, U.K. With permission.)

et al. 1992). Depending on the nature of the surface, marks can be further treated with either aluminum powder (nonporous surfaces) or ninhydrin (porous surfaces). While these authors preferred aluminum powder due to its high sensitivity, other powders may be employed depending on the personal choice and experience of the scene examiner. Powdered marks can be lifted in the conventional way even after the iodine spray treatment. Because ninhydrin reacts with the amino acid fraction of the latent fingerprint, while iodine is absorbed by the fatty components, additional fingerprints may be developed by the use of ninhydrin subsequent to iodine/benzoflavone. However, Allman and Pounds (1992b) reported that the iodine spray generally reveals marks equal in quality to those developed with aluminum powder, and it is consistently better than ninhydrin at detecting marks on porous surfaces such as wallpaper.

After powdering or ninhydrin, fingerprints in blood can be enhanced with either diaminobenzidine (DAB) or amido black. If blood is known to be present, fingerprint powder should be applied with care: excessive brushing may affect the integrity of a blood mark and excessive powder may decrease the effectiveness of the blood reagent. Because blood grouping and DNA profiling can be adversely affected by the enhancement procedures, samples required for biological testing should be taken prior to treatment with DAB or amido black (and preferably before the application of any fingerprint reagent).

4.13 EFFECT OF FINGERPRINT DETECTION TECHNIQUES ON SUBSEQUENT DNA PROFILING

DNA profiling techniques have become increasingly more sensitive and are now an integral component of the criminal investigation process. The recovery and analysis of DNA is not only possible when there is visible biological material present, such as blood and semen stains, but also where items may have been touched and trace amounts of DNA deposited. In this latter case, the deposited DNA is as a result of the skin cells that are naturally shed from the epidermis. The valuable evidence that may be obtained via DNA profiling cannot be ignored, and the fingerprint technician must therefore take into consideration the possible effects that fingerprint detection techniques may have on subsequent DNA analysis. While numerous studies have been undertaken on the profiling of DNA from blood marks that have undergone fingerprint examination, few studies are available where the recovery of DNA from treated latent marks has been considered.

Lee and coworkers (1989) subjected dried bloodstains on cotton cloth to fingerprint enhancement procedures that included cyanoacrylate fuming, iodine, rhodamine 6G, gentian violet, ninhydrin, silver nitrate, and laser light illumination (488 to 514 nm). The bloodstains were subsequently DNA profiled using a restriction fragment length polymorphism (RFLP) procedure. While high-molecular-weight DNA was recovered in nearly all cases, reagents such as silver nitrate appeared to reduce the DNA yield, and iodine fuming led to noticeable DNA degradation. In a similar study, Shipp and coworkers (1993) studied the effects of forensic light source illumination (argon ion laser and alternative light source, operating at different wavelengths) and cyanoacrylate fuming. It was found that none of the conditions evaluated were detrimental to the DNA pattern obtained by RFLP analysis.

Presley and coworkers (1993) considered the analysis of DNA from saliva present on envelopes, stamps, and cigarette butts that had been treated with ninhydrin, DFO, or physical developer (PD). DNA analysis was conducted by polymerase chain reaction (PCR)-based typing of the HLA DQ alpha region. No detectable DNA was recovered from the samples processed with PD. The authors suggested that either the chemicals used in the PD reagent had a degrading effect on the DNA, or the DNA was diluted by the PD processing to the extent that insufficient DNA remained for recovery. On the other hand, ninhydrin or DFO treatment did not adversely affect subsequent DNA recovery and profiling.

RFLP and PCR-STR (short tandem repeat) DNA typing was performed by Stein and coworkers (1996) on bloodstains and saliva on various supports after treatment with common fingerprint detection techniques, including black powder, ninhydrin, cyanoacrylate fuming, and gentian violet. It was determined that the fingerprint treatments did not adversely affect DNA extraction, quality, or profiling. Casework success has been reported where a PCR-STR result was obtained from the blade of a knife that had already been processed with cyanoacrylate and black powder (Newall et al. 1996).

Andersen and Bramble (1997) described a study designed to investigate the effects of different light sources used for fingermark enhancement on the subsequent PCR-STR analysis of bloodstains. While four out of the five light sources evaluated

had no significant effect on subsequent quadruplex PCR analysis, exposure of the bloodstains to shortwave UV for more than 30 sec precluded successful DNA typing. A study reported by Roux and coworkers (1999) investigated the effects of a range of common fingerprint detection techniques on bloodstains deposited on a number of surfaces. DNA typing performed using PCR amplification (DIS80 and CTT primers) was adversely affected by magnetic fingerprint powder, multimetal deposition (MMD), and UV radiation. The remaining fingerprint detection techniques evaluated had no significant effect on the analysis of DNA using the PCR-CTT system.

A study reported by von Wurmb and coworkers (2000) investigated whether or not cyanoacrylate (CA) fuming had an effect on the relative efficiency of three different forensic PCR systems: mtDNA, Y-STR determination, and the Profiler Plus™ kit. Results obtained from blood and saliva stains on glass slides indicated that the amount of specific PCR products is reduced when typing CA-treated samples. However, no difference in genotyping results was observed. Frégeau and coworkers (2000) evaluated a range of blood enhancement reagents (amido black, Crowle's double stain, DFO, Hungarian red, leucomalachite green, luminol, and ninhydrin) to determine their effect on the subsequent Profiler Plus PCR-STR analysis of fresh and aged blood marks on various porous and nonporous substrates. The study revealed that, while DNA typing was still reliable after fingerprint processing, some loss of biological material can take place, particularly with techniques that require de-staining steps, such as amido black, Crowle's double stain, and Hungarian red. Caution is therefore recommended in cases where the amount of biological material is limited.

Studies reported by Zamir and coworkers (2000a, b) have looked at the effects of different fingerprint detection techniques on subsequent PCR-STR profiling. Previous treatment of envelopes and stamps with DFO was found to have no adverse effect on subsequent DNA profiling using STR loci after phenol-chloroform extraction. DNA was successfully extracted from adhesive tapes and profiled after the tapes had undergone fingerprint processing using a forensic light source, cyanoacrylate fuming, basic yellow 40 staining, and crystal violet staining. STR profiles can be successfully obtained from envelopes and stamps previously treated with 1,2-indanedione provided that the DNA extraction is conducted as soon as possible after the fingerprint treatment (Azoury et al. 2002). SPR treatment also has not caused adverse effect on DNA profiling (Zamir et al. 2002).

4.14 LABORATORY SAFETY

4.14.1 HAZARDOUS SUBSTANCES

During any work involving the manipulation of chemicals, all reasonable precautions should be taken to prevent accidental or long-term exposure. Appropriate training must be provided to staff to ensure that there is general knowledge in the workplace regarding the hazards associated with particular chemicals and the safe work practices to be adopted. The laboratory itself must also be properly equipped with appropriate storage and handling facilities for any hazardous materials in use. Pro-

protective clothing (laboratory coats, safety glasses, and disposable gloves, for example) must also be provided, with usage enforced.

Occupational Health and Safety (OH&S) checklists are available in the specialized literature and should be used in the course of regular safety audits. Typical requirements include the following (CCH Australia Ltd. 1992):

- Inventory of all chemicals stored in the laboratory is up to date.
- Material Safety Data Sheets (MSDS) are available for all hazardous substances stored or used in the laboratory.
- All chemicals and containers are clearly labeled (with hazard warning symbols where appropriate).
- Chemicals are stored in compatible containers.
- Leakage of chemicals onto storage shelving is controlled.
- Storage of flammable material in domestic refrigerators is prohibited.
- Storage areas are separated depending on chemical compatibility (e.g., solvents separated from corrosives, fuels separated from oxidizing materials, etc.).
- Procedures are in place for handling hazardous materials.
- Personnel handling chemicals are required to wear protective equipment (gloves, glasses, aprons, etc.) when needed, in accordance with the appropriate MSDS.
- Personnel are trained in the operation and use of safety and emergency equipment where provided.
- Occupants of the laboratory are aware of what to do in the event of an emergency involving a chemical spill.
- Dry-powder fire extinguishers are readily available.
- Chemical spill kits are readily available.
- Emergency eye wash and safety showers are readily available.
- Basic first-aid kits are readily available.
- The laboratory has adequate ventilation.
- Fume cupboards are available for the handling of hazardous volatile substances.
- Biohazard cabinets are available for the handling of items contaminated with biological material.
- Eating, drinking, smoking, and the application of makeup is prohibited in the laboratory area.
- Appropriate hand-washing facilities are available for staff.
- Chemical waste is disposed of in a responsible manner and in accordance with local legislation.

Material Safety Data Sheets for hazardous chemicals are available directly from the manufacturer or distributor. The laboratory should have a complete collection of these documents, representing all hazardous materials stored and used in the workplace. The MSDS collection must be accessible to all laboratory users, and staff should be encouraged to review the data sheets before handling any hazardous substance. Each MSDS should contain the following information (Masters 2002):

- Name and contact details of the manufacturer
- Identity of the substance (the chemical name, chemical formula, and common name for each component of the material)
- Physical and chemical properties
- Physical hazards (including any potential for fire and explosion)
- Reactivity and incompatibility data
- Health hazards (including routes of entry, symptoms of exposure, permissible exposure or threshold limits, acute and chronic effects of exposure, and first-aid procedures)
- Precautions related to safe handling and storage (recommended personal protective equipment, ventilation requirements, procedures for dealing with a leak or spill, and waste disposal information)

All chemicals, including purchased or prepared reagents, must be stored in appropriate containers that are clearly labeled. Labels should include the chemical name and any appropriate hazard warning symbols and/or hazard warning keywords (e.g., *flammable*, *toxic*, *corrosive*, etc.). For prepared reagents (e.g., ninhydrin solution), the label should give the name of each component, the concentration of each component, the name of the person who prepared the reagent, the date of preparation, and the expiry date. A standard classification scheme for dangerous goods is given in [Table 4.6](#) (CCH Australia Ltd. 1992).

The following materials are commonly encountered in the fingerprint laboratory, and the specific hazards listed should be noted:

Acetic acid — causes burns; avoid inhalation of vapor and contact with the skin; flammable

Cyanoacrylate vapor — avoid prolonged exposure; long-term effects of exposure to this vapor are not well documented

Cyclohexane, *diethyl ether*, *petroleum ether*, and *ethyl acetate* — highly flammable solvents; vapors can create explosive mixtures with air

Dichloromethane and *chloroform* — chlorinated organic solvents are toxic by inhalation; carcinogenic

Ethanol and *methanol* — flammable; methanol is toxic

Fingerprint powders — prolonged inhalation should be avoided; use a dust mask if possible

Gentian violet (crystal violet) — toxic by inhalation and contact with the skin

Halogenated carrier solvents (e.g., HFE, HFC, CFC, HCFC) — create a heavy vapor that can displace air in enclosed spaces; risk of asphyxiation; good ventilation required

Iodine — toxic by inhalation; corrosive

Liquid nitrogen — cryogenic material with a temperature of -196°C ; skin and eye protection required; do not pour down the sink

Phenol — toxic by inhalation, contact with the skin, and ingestion; causes burns; carcinogenic; use extreme caution

Reagents used for fingerprint development — generally stain the skin; may cause inflammations; and are harmful if swallowed (e.g., ninhydrin, DFO)

Silver nitrate — toxic and corrosive

TABLE 4.6
Dangerous-Goods Classification Scheme

Class	Description
1. Explosives	Substances that are manufactured or used to produce explosions or pyrotechnic effects, or are explosive by reason of their chemical nature
2. Gases	
2.1 Flammable gases	Gases that ignite on contact with an ignition source
2.2 Nonflammable, nontoxic gases	Gases that within themselves are not flammable when exposed to an ignition source
2.3 Toxic gases	Gases that are liable to cause death or serious injury to human health if inhaled
3. Flammable liquids	Liquids that ignite on contact with a source of ignition
4. Flammable solids	Solids that can be easily ignited by external sources such as sparks and flames
5. Oxidizing agents and organic peroxides	
5.1 Oxidizing agents	Substances that, although not necessarily combustible themselves, may increase the risk and intensity of fire in other materials (may cause a fire when brought into contact with combustible materials)
5.2 Organic peroxides	May react dangerously with other substances; may be sensitive to impact or friction; may explode under long exposure to fire or heat
6. Toxic and infectious substances	
6.1 Toxic substances	Substances that are liable to cause death or serious injury to human health if swallowed, inhaled, or by skin contact
6.2 Infectious substances	Substances that are known, or reasonably believed, to cause disease in plants or animals
7. Radioactive substances	Materials or combinations of materials that spontaneously emit radiation
8. Corrosive substances	Substances that possess, in their original state, the common property of being able to severely damage living tissue; can also damage or destroy other materials, especially metals
9. Miscellaneous dangerous goods	Substances that present a danger not covered by other classes; generally present a relatively low hazard or an environmental hazard

From CCH Australia Ltd. (1992).

4.14.2 LIGHT SOURCES

Lasers and other high-intensity light sources (such as filtered arc lamps and ultraviolet systems) are now an integral part of fingerprint detection and enhancement procedures. While the different forensic light sources on the market differ in output power and operating wavelength, they all pose potential health hazards that must be taken into consideration. Direct or reflected beams can cause permanent skin and eye damage, and appropriate safety measures must be employed. Adequate skin and eye protection must be enforced when working with these systems, with particular reference to any recommendations given by the manufacturer.

Damage to the eye can be avoided through the use of appropriate viewing filters, safety glasses, goggles, or face shields. Most light-source manufacturers provide such equipment. High-intensity light should never be viewed directly at short distances, even for a fraction of a second, without eye protection (Hardwick et al. 1990). In addition, high-intensity light can burn the skin, so gloves and long-sleeve laboratory coats should always be worn.

Ultraviolet radiation poses a particular hazard due to its high energy and the fact that it is invisible to the naked eye. It is the UV component of sunlight that causes sunburn and skin cancer. When working with UV lamps, safety goggles/glasses that filter UV wavelengths must be employed. For the examination of reflective surfaces, use of a UV-protective face shield is recommended (Masters 2002).

5 Issues Related to the Exploitation of Fingerprint Evidence

Technical issues related to automated fingerprint identification systems and associated computer technologies for database searching are important, but they need separate treatment because such systems are only tools for the extraction of relevant information from a large amount of data. (See, for example, the book chapters by Moore [1991] and Jain and Pankanti [2001].) On the other hand, there are many professional issues that directly affect dactyloscopists in their daily activities, such as the information content (not simply the identification potential) of friction ridge skin impressions, the relevancy of traces (their age, the potential for forgeries and their detection), identification errors, and training and education requirements for fingerprint specialists. These issues, which are rarely covered in any detail in the general literature, are addressed in this chapter. Some of these issues are difficult to address, and some are controversial, but they are introduced to show that the field is not stale and that there is room for further discussion and advancement. Certainly, many questions raised may not have complete or satisfactory answers, but we hope that the mere fact of raising the issues will prompt relevant research and development efforts.

5.1 TERMINOLOGY

The use of ridge skin patterns for the purpose of identification has gone through rapid developments throughout the 20th century, resulting in sometimes conflicting opinions as to who preceded whom and what the proper terminology was supposed to be. Although it might be quite clear what is meant within the specialist language in a given geographical/sociocultural environment, differences have led to inconsistent uses and abuses, misunderstandings, and a flourishing of words to express or specify aspects of the “science of fingerprinting.” Terminology has ranged from *finger prints* (Galton 1892) to *icnophalangometry* (Vucetich 1904 [reported by Locard 1931]); *dactyloscopy* (Latzina [reported by Locard 1931]); *lophoscopy* (Lambert 1990); *cretoscopy*, *ridgeoscopy*, *ridgeology* (Ashbaugh 1982a); *poroscopy* (Locard 1913); *chiroscopy*, *pelmatoscopy* (referred to by Locard [1931]); *friction ridge skin* (Cowger 1983); etc. In addition, terms such as *stains*, *prints*, *traces*, or *marks* could be used without distinction to express the cause of the trace (pattern, details) and the trace itself (marks and their characteristics). These terms have mostly been created (neologisms) and are based on some descriptive aspects of the subject

matter, sometimes even without reference to a more or less universal etymological root. In scientific circles (botany, zoology, etc.), it is habitual to use a Greek or Latin descriptive root that can have universal acceptance and will give a general key for similarly constructed words. The further advantage of this is that these roots are found in all modern Indo-European languages and can be readily translated.

The most general and universal term is therefore *lophoscopy*, from the Greek root *lophos*, meaning “crest” or “ridge,” and *skopein*, meaning “study” or “examination.” Both roots are commonly encountered, the first in the naming (taxonomy) of plants (e.g., *Lophophora*, a kind of cactus with crests) and animals (e.g., *Bilophosauria*, a dinosaur with two crests), the second to describe instruments used to observe or examine (e.g., *microscope*, used to study small objects). In use in France and Belgium (according to Interpol), *lophoscopy* is translated (official European Council translation) into “ridge pattern analysis” in English and would correspond to the “ridgeoscopy” of Ashbaugh. *Ridgeoscopy* as a term has the merit of clarity in English, but it is etymologically heterogeneous, mixing both English and Greek roots. It is therefore advocated that *lophoscopy* be adopted as the generic term defining the study of ridges. This was adopted by the International Criminal Police Organisation (ICPO) (Lambert 1990).

Similarly, *dactyloscopy* has been coined from *dactylos* (a Greek root meaning “digit” or “finger”) and was proposed by a journalist (Dr. Francisco Latzina) who published a report in the journal *La Nacion* (Buenos Aires [reported by Locard 1931]) after visiting Vucetich. He used the term *dactiloscopia* (in Spanish), referring to what Vucetich was calling *icnofalangometria*. *Dactyloscopy* has since been adopted in most languages (*la dactyloscopie* [Spanish and French], *die Daktyloskopie* [German], etc.), but English has remained faithful to the “finger print” of Galton. Unfortunately, with the advent of modern analytical chemistry, DNA technology, biochemistry, etc., the term *fingerprint* has been so widely employed that it is impossible to make a database search (Internet, scientific indexes, etc.) for “finger-print” without finding thousands of references that have nothing to do with the study of fingers (or of fingerprints, for that matter!). It is time to adopt a unique identifier, *dactyloscopy* being the obvious choice. Some fingerprint specialists erroneously use the term *dactylography* (“writing with fingers”), which is widely used for “typewriting.” This latter word introduces additional confusion and should be avoided. *Dactyloscopy* has such a wide usage that it covers all aspects of detection, comparison, and identification of finger impressions and is equated in many countries with the misnomer of “fingerprint science.” A dactyloscopic file/card is a ten-print card, and a monodactyloscopic file is a classification based on a one-finger-specific print file (e.g., right thumb prints only).

Finally, ridge skin is not found only on fingers, and *chiroscopy* is the proper descriptor for the study of palms (the root *chiros* is found in *chiropractic*, meaning “healing by using palms” or “massages,” and in *chiromancy*, meaning “divination using the crease lines of palms” or “palmistry”). Crease or flexion lines of the palm can also be used for comparison or identification, and these belong in the realm of chiroscopy, even if few reports exist since the work of Claps in 1931 (referred to by Locard [1931]). Specialists mostly use crease lines as landmarks for orienting palm prints. Similarly, “palmatoscopy” is the study of the soles of the feet. (There

are few widely used words with *pelmatos* as a root, except in the area of foot medicine [podiatry]).

Poroscopy (from the root *poros*, meaning “pore”), first described by Locard [1913], is usually discussed in relation to ridge skin, and rightly so, since pores protrude and open on the surface of ridges. Nevertheless, it may have wider application, as pores are present everywhere on the skin surface, and it may be possible to map (like an astronomical map, using the expression of Locard) other skin surfaces that have been in contact with an object (see discussion of *dermatoglyphics* below). In fact, cases are known where such a mapping has been used as evidence in court, although this is fraught with difficulties and remains rather an academic exercise.

This nomenclature, which clearly defines the object of study (ridges) and its localization (fingers, palms, or soles of the feet), was already clearly established at the beginning of the 20th century. It is now proposed that such a nomenclature be widely adopted to avoid further confusion. The proposed terminology is listed in Table 5.1.

The term *dermatoglyphics* (from the roots *derma*, meaning “skin,” and *gluphein*, meaning “engrave”) was introduced by Cummins (1926) as the science of the study of skin patterns as a clinical instrument. Used commonly at the time in the study of the morphogenesis of skin patterns, this term is not quite synonymous with *lophoscopy*. *Dermatoglyphics* is a more generic term that covers other skin patterns, such as the netlike arrangements seen at the back of the hands, patterns that, incidentally, are being thoroughly researched in China for their identification potential.

A further confusion in terminology concerns the distinction between a “finger print” and a “finger mark.” The first term should clearly be employed for a record or comparison print taken for identification, exclusion, or database purposes (sometimes referred to as a “known” print), whereas the second should only concern traces left (unknowingly) by a person on an object (sometimes referred to as the “unknown,” “latent,” or “questioned” mark). Almost by definition, the mark implies a lesser quality impression that includes latent, partial, distorted, reversed (tonally or laterally), or superimposed impressions.

TABLE 5.1
Proposed Terminology

Proposed Terminology	Equivalent	To Avoid
Chiroscopy	Ridge pattern analysis of palms	—
Dactyloscopy	Ridge pattern analysis from fingers; fingerprinting	Science of fingerprinting
Dactyloscopist	Fingerprint specialist	—
Dermatoglyphics	Skin pattern analysis	—
Lophoscopy	Cretoscopy; ridgeology, ridge pattern analysis; ridgeoscopy	Science of fingerprinting
Pelmatoscopy	Ridge pattern analysis from the soles of the feet	—
Poroscopy	Study of pores	—

5.2 USE OF FINGER IMPRESSIONS

Fingerprints are not recorded for a systematic identification of the population, although this has been advocated in the past. The gathering of systematic records for a national register (national database) was first introduced by law in Argentina on July 20, 1916, but this led to violent opposition, and the law was suspended on May 28, 1917, and the register destroyed. Ecuador introduced a national register in 1924 without apparent opposition, and such registers were advocated throughout the world but were rejected on the basis of human rights (privacy laws, individual rights, etc.).

On the other hand, registers of offenders are widely employed. Other registers, restricted to certain sections of the population, exist in some countries (e.g., migrant/refugee registers). Access to these databases is usually narrowly defined for specific purposes, such as to avoid multiple requests for refugee status under false pretense at different border entry points, etc. Many countries also have registers for military, security, special agents, and law enforcement personnel to aid in the identification of casualties in military actions or for the identification of marks inadvertently left on the scene of a crime. (It is not uncommon for up to 30% of marks found at crime scenes to have been made by police officers, according to Mark [1996]). All such registers are subject to specific laws within the frameworks of local legal systems. Similar laws have been introduced for DNA records, and in some instances, the laws regulating the taking of fingerprint records have been extended to include other biometric markers such as DNA, offender photographs, and descriptive characteristics (remnants of the anthropometric system of Bertillon [1885]). Systematic records of newborn babies and other such practices have not found wide support and are mostly not applied.

Other uses cover the proof of identity by the application of a fingerprint (usually a thumb or an index print) on identification documents such as passports and identity cards (there is always a legal basis for these applications) or, in the last few years, as a morphometric or biometric means of identification in access control systems for computers, doors, safes, etc. (Shenk 2003). Recent interest in automatic access control is leading to the creation of records or files whose legality is often not established. Such database construction occurs on the basis of agreement or consensus decision only. Registers of this type may become the source of prints useful for identification purposes in large-scale disaster victim identification (DVI) or for the investigation of specific computer crimes (unauthorized access, fraudulent file modifications, etc.).

Finger impressions have been suggested as a replacement for signatures on civil documents, bank checks, or works of art, but reports of such applications are mostly anecdotal. Historically, this usage of fingermarks was widespread in Asia (China, India) (Xiang-Xin and Chun-Ge 1988; Li 2003), leading to later developments by both Herschel (1887 letter from India called Hoogly Letter) and Faulds (1890).

5.2.1 PRINT-TO-PRINT COMPARISON

Print-to-print or print-to-record comparisons do not create special difficulties. The quality of prints and the amount of information available (finger number, position, central pattern, deltas, ridge counts, not to mention a multitude of minutiae) make the process of exclusion very easy, with often only a cursory glance at the comparison prints being required. The process of identification is hardly more difficult to the trained observer, even if this is now largely machine-processed using automated fingerprint identification systems (AFIS), with remote operation possible using live-scan input stations. Such a comparison is mostly required in a procedure of confirmation (e.g., that the print on an identification document, or in a register of habitual offenders, corresponds to the print of the person under control, going through customs, or arrested in the course of an investigation). It must be noted that the quality of the print is mostly not at issue here, and sometimes this leads to sloppy print taking; the amount of information available is generally such that even if parts of the prints are not clear, or are obliterated, the identification process is not significantly impeded. Unfortunately, this is often a neglected aspect of print taking that affects the identification process when comparison is made with imperfect impressions found at crime scenes. Quality control in the taking of reference prints should therefore be an essential part of specialist training, and utmost care should be taken to have the highest standard prints for storage in AFIS databases.

5.2.2 TRACE-TO-RECORD OR TRACE-TO-PRINT COMPARISON

Forensic science is the art of working with imperfect data/samples/information. A trace is by essence a mark or material indicative of a source and/or action. The production of the trace is a limiting process: imperfections can be minimal to the point where the trace is deemed comparable to the reference material, or they can be great enough that it is difficult to even identify the possible source type for the trace. In dactyloscopy, a trace could be a smudge that may or may not be the mark of a finger, or it may be possible to identify the trace as a fingermark but without ridge detail. The position of a fingermark may give information on the event, probable handedness of the donor, etc. A general ridge pattern may be visible, with an approximate indication of ridge count, or ridge detail may be visible without knowing from which part of the ridge skin it originated (e.g., a partial mark that could be from a finger, a palm, or a foot sole). There may be sufficient information to determine which finger is responsible for a mark (e.g., the right index in a normal anatomical sequence), but with little detail other than a possible pattern and approximate ridge count. Finally, it may be possible to identify which finger is responsible for the mark and, with sufficient ridge detail, to determine the identity of the person whose finger made the trace.

Whatever sample or information is available at the crime scene, however imperfect, there may still be exclusion value important in the resolution of the case. The process of identification is discussed elsewhere ([Chapter 2](#)), but there is always a

need to evaluate — at the scene — the pertinence or the relevance of the mark to the case or to the investigation, or to the activity of the criminal who the investigator is trying to identify.

5.2.3 TRACE-TO-TRACE COMPARISON

Problems linked with the quality of the traces are compounded in this case because each trace can suffer from all the faults that a single trace may have. Depending on position and pattern types, it may be possible to determine whether one or more authors committed the crime, which part of the action can be identified with one author, and a partial reconstruction of the events. This is the usual primary observation made at the scene. More importantly, a trace may be identified at more than one crime scene, thereby creating a link between otherwise separate events. This provides the investigator with one of the strongest pieces of information one could obtain in the analysis of serial and high-volume crimes. Trace-to-trace comparisons therefore have a very high operational value when investigating such crimes (e.g., serial burglaries [Ribaux and Margot 1999]) and should be considered as a potential investigative tool. However, preliminary results show that, unlike with DNA — where each trace contains the total information from the source — the number of instances with partial-print matches is usually low (Aguzzi 2002; Anthonioz et al. 2003).

Out of 1001 identifications (of 867 authors) using AFIS in Switzerland in 2001, only 11 criminals (mostly burglars) were identified at several crime scenes through fingermarks. Ten of these cases were checked, and no mark-to-mark match was found. It must be noted that, in practice, not all marks found are submitted for AFIS searching. Typically, only the best mark in an anatomical sequence or good-quality marks — only about half the marks obtained — are filed in the database, thus reducing the potential use of fingerprints in serial and volume crime investigation.

5.2.4 COMBINING EVIDENCE TYPES

One issue that is bound to influence the work of fingerprint experts is the advent of extremely sensitive DNA methods (Findlay et al. 1997; van Oorshot and Jones 1997; Gill 2001) that can be successfully applied to determine a DNA profile on smudged or superimposed marks. Such marks may be identified to be from the criminal because of their positions at the crime scene, but they may lack ridge characteristics of sufficient quality for dactyloscopic treatment. Increased sensitivity in DNA technology creates the risk of profiling nonpertinent biological traces (background noise) (Lowe et al. 2002; Wickenheiser 2002), but applied to traces such as smudged fingermarks, it is bound to bring about valuable results in a reasonable percentage of marks (Schulz and Reichert 2002). One requirement, however, is that the fingerprint detection and enhancement process does not adversely affect the DNA analysis (see [Section 4.13](#)). It must be stressed that research on contact DNA is in its early days, and contamination issues have to be considered very carefully (Sutherland et al. 2003).

One issue might become the comparison of marks of less than perfect quality combined with incomplete DNA profiles to give an overall value for the evidence collected. This is an issue that most fingerprint specialists view with suspicion. Their skepticism is focused on the loss of the “positivity” that has pervaded the field for almost a century, rather than seeing a new lifeblood for a whole range of marks that were otherwise deemed insufficient to be used in evidence. The issue of combining less than perfect fingerprint evidence with other evidence types has already been raised (Champod 1995), but without much support from fingerprint specialists. The resistance probably arises from a perceived loss of control over one’s discipline through the introduction of new dimensions that may require a different and more complex training and education program for identification specialists than in the past.

5.3 RELEVANCE

The determination of relevance usually comes from proper documentation of where the mark was found in relation to the event, on which surface, and when and how the scene was preserved. This aspect of proper trace evidence management and documentation has an essential impact in criminal investigations. If the trace (a fingermark) is identified to a person that had no reason to be at the crime scene at the time of the incident, it becomes essential to know if it was on a mobile or a fixed surface; whether the location, orientation, and position could fit the perceived event; etc. Allegations questioning the validity of the evidence — that the trace was not found where it is alleged to have been found, that case notes were mixed from two or more scenes by overworked personnel, or that the mark was placed there before (or after) the event under investigation — can usually be laid to rest through proper case management and documentation. Poorly handled contested cases can create massive amounts of work to reconstitute the source of a trace (e.g., going back to the scene, documenting surface patterns to match with lifted marks, etc.). If the relevance of a mark is contested and unsuccessfully demonstrated, doubts can be cast on the value of the evidence.

There are three very important parameters that have to be discussed in relation to the relevance of evidence based on lophoscopy: the first concerns the date or the age of the evidence; the second concerns false traces (forged, fabricated, planted, etc.); and the third concerns the errors, or error rates, in deciding on an identification. The remainder of this chapter focuses on these three parameters.

5.4 AGE ESTIMATION OF LATENT MARKS

An estimation of the age of a particular trace is of both theoretical and practical importance, as it can indicate whether or not that trace is related to the offense under investigation. Numerous studies have been carried out aimed at developing techniques capable of determining the absolute (true) age, or at least the relative age, of particular items of evidence (Margot 2000). Examples include the dating of inks and documents, blood samples, footwear and tool marks, firearm discharge residues, and, of course, fingermarks. For all of these traces, attempts at determining an approximate age can be both a difficult and controversial matter (Howorka 1989;

Baniuk 2000). A recent review of the state of the art for fingerprint age determination has been published by Wertheim (2003).

Intuitively, a fresh fingerprint will show better ridge detail than an equivalent fingerprint that has been exposed to environmental conditions over a certain period of time. One must consider, however, the parameters that influence this loss in fingerprint detail. The aging process involves the drying out of the latent mark, resulting in:

- Dulling of the sweat–grease deposit
- Loss of stickiness
- Narrowing of the fingerprint ridges
- Loss of continuity along the fingerprint ridges

The rate of dehydration of the latent mark will depend on many factors, including the amount of fatty material contained in the deposit, the temperature and relative humidity, air currents, exposure to the sun, the nature of the surface (porous or nonporous, rough or smooth), etc. (Figure 5.1) (Holyst 1987). In addition to the dehydration of the latent mark, a loss of legibility may result from the effects of dust, atmospheric pollution, precipitation, bacterial action, oxidation and decomposition of the deposit, diffusion of the fingerprint material through the surface, and so on.

As far as the age of fingerprints is concerned, there are very few systematic studies published in the literature. In 1961, Angst (1962) proposed a technique for determining the age of latent fingerprints on paper. His method was based of the use of silver nitrate (Section 4.6.4) to evaluate the diffusion of the chloride component of the fingerprint through the paper support. He claimed that an age determination could be performed by studying the fingerprint images produced both on the recto and verso sides of the document after silver nitrate treatment, and then comparing these images with those produced under controlled conditions. Despite his detailed study of fingerprint aging on paper, the technique suffers from obvious drawbacks, notably those related to the use of silver nitrate as a detection technique. The diffusion of chlorides through a document will obviously depend on the structure and composition of the paper and the degree of humidity. It would be impossible to reproduce the exact conditions under which a document has been stored. In addition, and as with all fingerprint age determination techniques, *the quality and composition of a particular latent mark at the time of its deposition is unknown*. More recent aging studies on fingerprint residues using thin-layer and high-performance liquid chromatography (Duff and Menzel 1978; Dikshitulu et al. 1986) are of academic interest but do not propose a realistic solution to the age determination problem.

One of the most complete studies on fingerprint aging is probably that described by Holyst (1987), which forms the basis of the age-estimation technique used by the dactyloscopy department in Warsaw (Baniuk 1990). In this study, extensive tests were carried out on fingerprints deposited on various nonporous surfaces (glass, metal, and plastic) that were subsequently aged both indoors and outdoors. A large number of factors, including temperature, humidity, dust concentration, and exposure to water, were taken into account. The studies revealed that traces keep longest on glass, whereas their survival on plastics is short because of the material's electrostatic

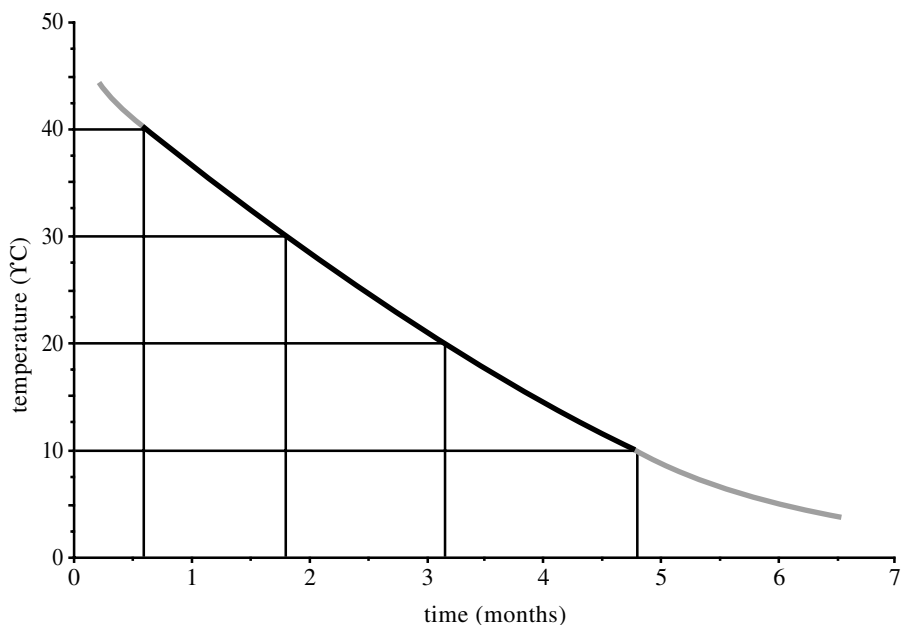

FIGURE 5.1 A typical fingerprint dehydration curve relating temperature to average drying time (in months) under controlled conditions (relative humidity = 50%).

charge, which attracts dust. A distinction was made between sweat marks (i.e., high eccrine component) and sweat–grease marks (i.e., high sebaceous component), with the latter preserving about five times as long (Table 5.2). The publication is of particular value as it shows that temperature, humidity, dust content in the air, and the type of object carrying the trace are factors of considerable impact on the aging process.

Holyst listed the following conclusions at the end of his article:

- Greasy marks are about five times more durable than sweaty marks.
- Latent fingermarks conserve best on smooth, nonporous surfaces.
- The lifetime of a latent mark depends on many factors, including temperature, humidity, precipitation, dust levels, and atmospheric pollution.
- The average lifetime of a fingermark kept indoors is about 15 times that of a similar mark kept outdoors.
- The aging process is not regular but depends on: accelerating factors such as high temperature, low humidity, and exposure to light and dust; and decelerating factors that include low temperature and high fat (sebaceous) content in the latent mark.
- To avoid errors in the determination of a fingermark's age, factors including the conditions of deposition (contamination of the fingers, fingertip pressure at the time of deposition, contact time, etc.) and conservation (temperature, humidity, dust, exposure to light, etc.) must all be considered.

TABLE 5.2**Average Lifetime of Sweaty and Greasy Latent Fingermarks on Different Nonporous Surfaces**

	Outdoors (days)			Indoors (weeks)		
	Glass	Metal	Plastic	Glass	Metal	Plastic
Sweaty fingermarks (high eccrine content)	5.8	4.2	3.3	12.2	10.1	7.5
Greasy fingermark (high sebaceous content)	25.8	20.5	19.5	73.2	47.6	28.2
Comparison between sweaty and greasy marks (row 2 divided by row 1)	4.5	4.8	5.9	5.9	4.7	3.8

Source: Holyst, B. (1987), *Kriminalistische Abschätzung des Spurenalters bei Fingerpapillarlinien*, *Archiv für Kriminologie*, 179, 94–103.

Baniuk (1990) has described the technique for fingermark age determination employed by the dactyloscopy department of the main police headquarters in Warsaw, Poland. Poland is probably the only country where a department of the police's criminal investigation bureau routinely analyzes the age of fingermarks. Their method is based on the study of fingermarks on smooth nonporous surfaces, both indoors (enclosed spaces) and outdoors (open spaces). The basis for inferring the age of a fingermark at the crime scene is as follows:

- Reconstruction of the conditions under which the evidential traces were formed
- Comparative examination of evidential traces with fingermarks of the suspect (accused) that have undergone experimental aging in a given environment
- Knowledge and experience of an expert in skin physiology and in the mechanism of formation and aging of fingermarks

According to Baniuk, more than 100 expert opinions have been given over a 10-year period by the dactyloscopy department in Warsaw, in which:

- In 85% of cases, due to the expert's opinion, the version given by the accused concerning the time when the fingerprint traces were left at the scene was rejected.
- In 10% of cases, the version given by the accused was confirmed, as a result of which he was acquitted by the court.
- In 5% of cases, there was no basis on which to formulate a precise opinion regarding the age of a fingermark (i.e., the available data did not make it possible to either confirm or reject one of the two preceding variants).

The estimation of fingerprint age has become a true discipline in Poland, with results based on probabilities. This has recently been disputed by Marcinowski (2000), who feels that the absence of categorical conclusions creates doubts rather than clarification. Marcinowski argues that “fingerprint science” can only be seen as science if it can offer absolute and categorical conclusions. A strong rejoinder by Baniuk (2000) rejects this dogma that categorical opinions are the tenet of scientific discovery and affirms the probabilistic nature of scientific discovery that allows for a range of useful conclusions. This view is consistent with the debate discussed in [Chapter 2](#) concerning conclusions of identity.

Additional information concerning the estimation of the age of a latent fingerprint can be found in the form of case reports, some of which have been published in the literature. These are mostly based on limited empirical experiments that do not allow for a general estimation and are often designed without much knowledge of fingerprint chemistry and/or physics. For example, O’Brien (1984) describes the case of a double murder that occurred in New Zealand in 1981. A young couple was murdered while asleep in their bedroom. At the scene, fingerprint evidence was collected from 71 different locations. A suspect was apprehended, and his fingerprints were found to be identical with marks collected from eight different locations at the murder scene, including a mark on the outside of the back door. In the opinion of the fingerprint experts involved, this mark was “very fresh.” The defense’s explanation for the fingerprint evidence was that the suspect had left these marks when he was an occupant of the property over six months before the murders had been committed. Extensive tests were subsequently carried out on good-quality test marks deposited on both the inside and the outside of the back door in question. It was concluded that fingerprints placed on the outside of the back door would not remain in good condition for more than a few weeks. On the other hand, some test marks on the inside of the door remained in excellent condition even after 40 days! Via the painstaking identification of nearly all the prints from the 71 locations, it was possible to show that none of the marks belonged to any of the persons known to have been in the house up to the end of the suspect’s occupancy (with the exception of the suspect himself). Experimentation showed that the chances of the offender’s marks surviving from his previous occupation, while those of his family and friends did not, were almost nil. The chances of eight marks surviving such a time were impossible. The accused was found not guilty of murder on grounds of insanity.

Schwabenland (1992) described a case of double murder where a suspect’s thumb mark had been developed on an empty aluminum beer can using black magnetic powder. The beer can had been found in an open field, close to the bodies of the two victims. Both victims appeared to have died within the previous 24 h. The suspect admitted to having been at the scene with the two victims (where they had eaten fried chicken and drank some beers) but claimed that the occurrence had been one week previously. It therefore appeared important to determine the age of the thumb mark found on the beer can in question. Testing was subsequently conducted on marks deposited on similar beer cans. Control marks were aged under conditions chosen to simulate those presumed to have influenced the evidential mark (for example, the amount of sunlight exposure and the fact that the suspect’s fingers had probably been contaminated with grease from the fried chicken). Schwabenland

had concluded, from the results of his experiments, that clear marks, comparable to the evidential thumb mark, could only be detected up to 48 h after deposition. He found that marks of this quality could not have resulted after outdoor exposure for one week. The results therefore refuted the suspect's version of the events. Schwabenland claimed that his experiment was a major factor in California's Fifth District Court of Appeal trial that led to the defendant being found guilty on two counts of second-degree murder.

The case report described by Schwabenland was subsequently reviewed by McRoberts and Kuhn (1992), who concluded as follows:

Conceptually, what the author was attempting to accomplish is worthwhile. Unfortunately, the guidance he followed and the approach he utilised lacked a thorough consideration of all the recognized factors for a complete and integrated study. Any examiner considering similar experiments should be cautioned to consider all relevant factors, follow scientific protocols, and limit conclusions to the extent supported by the study. *The scientific certainty and acceptability must be gained within the field of Friction Ridge Skin Identification prior to presenting testimony in a court of law* [emphasis added].

In addition to these criticisms, it was also determined that Schwabenland's experiment had never been mentioned in the trial under discussion, despite what the author had claimed in his article (Anon. 1992).

Almog (1992) has also reported a case in Israel where a fingerprint age estimation was required. A lady was found dead in her Jerusalem apartment, and the pathologist estimated that she had been murdered the day before she was found. The principal suspect had had a romantic relationship with the deceased, and his fingerprints were found in two places in the apartment where the murder took place: on a porcelain tile in the kitchen and on a white painted door in the laundry. The suspect claimed that these fingerprints had been left there from his last visit, which was seven or eight months prior to the murder. According to the accused, he had not visited the apartment or seen the deceased since that time. The field technician, based on his experience, estimated that the evidential marks (that he had developed with aluminum powder) were "fresh." In addition, it was stated that the victim was obsessively clean and that it was not plausible that fingerprints would be left in such prominent places for seven or eight months. The Jerusalem Division of Identification and Forensic Science conducted laboratory tests on fingerprints deposited on a clean porcelain tile and on a door, both taken from the victim's apartment. It was found that good-quality marks deteriorated to a point that no detail remained after four months. The evidential marks, however, showed good contrast and resolution of the ridge patterns as well as a massive adherence of powder, all indicating the "freshness" of the marks. On the basis of the fingerprint evidence, in addition to evidence relating to bite marks found on the back of the victim, the accused was found guilty.

Despite these documented cases, there are no presently known scientific tools available for determining the age of a fingerprint deposit. As a result, it is generally considered that the determination of the age of a latent finger or palm mark on a

particular piece of physical evidence is not possible. Midkiff (1993) has reviewed what little information is available concerning fingermark aging, and he underlined the need for continued research in this area. He even goes so far as to suggest that attorneys should contest the value of fingermarks as a means of proving the guilt of an individual. One of the easiest ways of countering dactyloscopic evidence is to establish previous legitimate access to the place at which the fingermarks were found.

An age estimation should never be based solely on the quality of a developed mark (for example, Involdstad [1976] reported developing a good-quality fingermark on one page of a book that had not been touched for over 30 years). In some cases, however, it may be conceivable to put limits on the age of a particular mark using results from well-designed aging experiments. In order to justify such an estimation, aging studies should be conducted corresponding as closely as possible to the case under investigation (type of surface, temperature, humidity, sunlight, etc.). Obviously, the same fingerprint detection technique should be employed as was used to develop the evidential mark. As some parameters are impossible to determine and control (for example, the quality and composition of the latent fingermark at the moment of deposition), these should be critically evaluated. In addition, and as an indirect method of age determination, best use should be made of various types of background information that may identify the time a trace was formed. In this way, it may be possible to identify the maximum age of a particular finger mark (Cowger 1983). For example, if it can be shown that a particular surface is thoroughly cleaned at least once a week, then a mark found on that surface could not be more than a week old. In the case of a fingermark on a manufactured item, the date of manufacture (if it can be determined) will obviously indicate an upper limit for the age of the mark. This relies on the search for anachronisms (as is done in questioned documents examination) — material evidence that precludes the possibility of an evidential item being placed outside a certain time frame. Any allegation to the contrary must then be false.

Current research on the chemical composition of fingerprint residues (Bramble 1995; Jacquat 1999; Jones et al. 2000) and their chemical degradation over time, such as the kinetics of decomposition and oxidation, should help determine useful aging markers (Jones 2002), although surface effects may play a more significant role than originally expected.

5.5 FORGED AND FABRICATED FINGERPRINT EVIDENCE

Planted or fabricated evidence can completely change police conclusions concerning the scenario of a crime. Documented cases of fingermark forgery are known since the beginning of the 20th century. Now DNA is being subjected to the same threat with the blind trust given to this type of evidence (however it was recovered). There is an obvious resistance to admit the possibility of police investigators and the courts being fooled. Little research has been done to establish the extent of the phenomenon

and how to detect it. Forgery covers reproduction, modification, or alteration with the intent to deceive. It includes counterfeiting, which is imitating with the intention that the imitation will be deceptively believed to be genuine.

Some fingerprint experts consider the phenomenon of fingerprint forgery only as an annoying curiosity; others, however, see it as a serious potential problem. The cases that do exist are few and far between, and documentation is rarely comprehensive, with many unsubstantiated allegations. When describing cases of this type of forgery, some sources omit important details, while the reliability of other sources raises questions. Information retrieval and evidence collection on this subject is not simple. Although the number of well-recorded and properly documented cases of fingerprint forgery is relatively small, there are reasons to believe that the real number of cases is higher and probably cannot be accurately estimated.

Cases of fingermark forgery fall into two main groups:

1. Forgery committed by law enforcement officers, police specialists, and fingerprint experts
2. Forgery committed by a criminal (or on behalf of the criminal)

In both instances, the intent is to frame or direct the attention on a person that has not left fingermarks where they were reportedly recorded. There is a third category of fingerprint imitation/modification, where scientists and experts attempt to reproduce alleged or admitted modus operandi by forgers. This is generally for research purposes or in order to detect forgeries and determine ways to avoid being fooled by them.

5.5.1 FORGERIES COMMITTED BY LAW-ENFORCEMENT PERSONNEL

In the early days of dactyloscopy, publications on the topic of fingerprint forgery were rare. The field was still fairly novel with, very often, passionate experts, and it had not yet developed to the industrial level we have today. Fingerprint identification was a craft, rewarding when successful, and acknowledged as a help for police investigators, but still marginal compared with traditional policing and evidence gathering. The earliest reported case of forgery is one made by a government official in 1903 to prove a suspect's contact with a crime scene (the manner of forgery is not documented).

This highlights the temptation for officials who deal with finger traces on a daily basis to "help" solve difficult or high-profile, emotive cases to demonstrate one's own importance, for reward, etc. This is observed throughout the century, the world over, with cases in America, Europe, and Asia. It is telling that the first report comes from India, where fingerprints had been used extensively in contracts, official deals, etc. (Hooghly Letter [Herschel 1887]). Probably a longer history of forgery could be found in China, since fingerprints had been used to prove authorship, as "official" and judicial seals/signatures, since the sixth century (at least) under the T'ang Dynasty. It would be rather strange if no instances of forgery were found in historical documents there, even if there was a certain "magical" dimension given to the act of signing by fingerprint.

With recent reports (Wertheim 1998; Geller et al. 2001) and the multiplication of documented cases, it is difficult to know whether more forgeries are occurring, or simply more are being reported. What can be safely said is that technical evidence is required more often than ever. Pressure on officers/experts is thus increasing, and a lack of ethics and control might lead the weakest to “prove” their worth and demonstrate their efficiency by helping put “good” suspects behind bars (much like the fireman who sets a fire so that he can demonstrate courage and self-sacrifice in putting it out). It makes for rewarding statistics and promotion opportunities, and obvious “bad characters” are kept in check. It may also be a (bad) response to the increased political pressure on police to obtain results while following “human rights” principles in their investigations, thus resulting in fewer admissions of guilt by suspects.

Reported cases from the U.S. have had a significant impact among dactyloscopists because of the openness with which these cases were discussed and because of the wide audience the relevant professional journals have across the world. The De Palma case and the Trooper Harding case are sensational stories that have left traces within the profession (Geller et al. 1999) and led to integrity-assurance measures focused on personnel requirements (selection, hiring and retention, dismissal of problem employees, and a commitment to ethics and integrity), structural adjustments (independence of the identification unit to avoid external and operational pressure), and the need for proper documentation and continuity of evidence (Wertheim 1998).

5.5.2 FORGERIES COMMITTED BY CRIMINALS

The number of documented cases of forgeries committed by criminals is very limited. This may be due to the successful stratagems adopted by criminals or, more probably, due to the lack of preparation, time, and perhaps intelligence to adopt a successful strategy of fooling investigators. The majority of cases concern confidence tricks or illusion-based trickery used to obtain financial gains. The planting of evidence to incriminate an innocent person is exceedingly rare due to the lack of opportunities to obtain a “model” for the forgery (unless there is a spontaneous opportunity). Any attempt at forgery would likely remain largely undetected, as was shown through limited experiments with specialists (Cummins 1938), and especially because, in many countries, the trust in fingerprint evidence is so high that it is almost never disputed.

5.5.3 DETECTION OF FORGED MARKS

Most forged marks will be found on smooth, plain, and easily accessible surfaces. The aim of the forger is for the mark to be readily found and for it to be of good quality, so that it is used as evidence. Performed by law enforcement personnel, the staging is relatively easy, with improperly documented lifts either mislabeled or taken from known prints allegedly lifted from the crime scene. Such activities can be difficult to even suspect let alone detect. High print quality — forgeries are almost always present as a single, clean mark — and a lack of proper photographic docu-

mentation could raise suspicion. The key issue here is that photographic documentation of the scene should be systematic, with illustrations of the marks prior to lifting, thus documenting the material on which the mark was found and ensuring a proper chain of evidence (labeling of lifts, use of proper case management, bar codes, etc.). Professional practices such as these should make forgery a difficult and risky activity with a high chance of discovery if contested.

The criminal who would like to direct suspicion toward another individual will have less opportunity to access good-quality prints. The temptation will therefore be to employ some form of cast as a template. This can give surprisingly good results, as was shown by Groenendal (1996), and more recently by Matsumoto (2002), who showed that this technique can fool biometric access systems.

5.6 ERRORS

To err is human, but humans hate to be found at fault. Fingerprint specialists are no different, and the usual stance is to lay the responsibility for a mistake on individuals rather than identifying the risks that everyone faces when confronted with evidence requiring an interpretation. Reports of errors in the fingerprint field are few, demonstrating that fingerprint evidence is reliable and has helped satisfactorily resolve many criminal cases. This has been demonstrated time and again throughout a century of practice, and no one can credibly cast doubt on the value of fingerprint evidence. The doctrine of infallibility became the hallmark of fingerprint identification, which in turn became the icon for all other types of identification evidence with a high power of discrimination (approaching 100%). This has led to the misnomers “DNA fingerprinting,” the “fingerprint” region of an infrared spectrum, “voiceprints,” and “shoeprints,” to name just a few. Many of the scientists who handled fingerprints at the beginning were well aware of the risks of matching a mark to a print when the mark was less than perfect, and they recognized the probabilistic nature of identifying the source of a mark as being the same as the source of a print. This is the basis of Locard’s third rule and the arguments discussed in [Chapter 2](#) concerning the process of identification and its subjectivity in determining identity. Court acceptance without much scrutiny in adversarial legal systems has led to an almost blind faith in fingerprint evidence (Saks 1998). This may also be so in other legal systems, although the door is open for judges in inquisitorial systems to use one of the major principles of European continental law — “la libre appréciation” or “freedom of appreciation,” which implies that judges have a free hand in determining the value of each piece of evidence submitted to them. Further, they have an obligation to review and integrate — in order to critically accept or reject even what might be seen as rock-solid evidence by specialists.

Nevertheless, mistakes have been documented, and results from proficiency testing have shown less than satisfactory performance, stupefying a profession that, in most cases, still prefers to single out black sheep rather than admit that mistakes are an integral part of all human activities. Errors have occurred and will continue to occur; the rarer the occurrence of error, the more difficult it is to detect. Admission of this paves the way for the establishment of control mechanisms that should limit the number of errors, detect errors before their release, and correct those that are

identified. This is a sign of maturity for any human endeavor. Recently, closer attention has been given to wrong identifications, and these are documented and discussed on the Internet (<http://www.onin.com/fp/problemidents.html> and <http://www.cplex.com/>). We recommend that all fingerprint examiners study these cases carefully.

There have been many important changes in the last 20 years that have brought to the fore the possibility of mistakes in the field of dactyloscopy. For most of the 20th century, with manual searches and local offender collections, identification bureaus were rarely at the forefront of the investigation, and cold hits were rare occurrences. Identification was generally a matter of confirming the results of an investigation by bringing solid physical evidence to otherwise mostly circumstantial combinations of elements collected from witnesses, observations, and other traditional police sources. At the beginning, most specialists were also enthusiasts, confident in the value of their trade and quite happy, in some cases, to demonstrate that the investigation had gone astray by showing that the evidence marks were not made by the main suspect! This meant mostly routine identification procedures, confirming or consolidating cases. In many instances, this led to a lackluster situation for dactyloscopists, who were perceived as secondary assistants of “true” or “real” investigators. This led, in some instances, to the punishing of bad investigators by placing them in fingerprint bureaus where they might make good technicians after some intensive retraining. This was never formally acknowledged and was certainly not the case overall, but it had a significant impact on the work of many identification services.

What brought about change was the introduction of AFIS. Suddenly, access to large national collections was possible even for very small units. Cold hits became common, and the trade changed from a backroom craft to an industrial production line that created new pressure and new approaches. The development of new detection methods also brought in more marks over a broad range of quality. This increase in scale created a need for a change in organization, for more checks and controls, and for new training schemes. Proficiency tests, which were mostly resisted by the profession until the first reports of errors came out in the open, and surveys, such as those discussed in [Chapter 2](#), demonstrated the subjectivity of the process of identification using fingerprint patterns and ridge details.

The awareness and acceptance of the possibility of errors, even if extremely limited in occurrence, is already a sign of progress and is an insurance against more widespread errors. In the future, we hope to see disputes handled and resolved in a framework of agreed procedures, specified at the outset of the comparison process, rather than through the use of *post hoc* empty statements such as “fingerprint comparison is a matter of opinion.”

5.6.1 ERROR TYPES

One always imagines errors whereby a person is identified as the author of a mark found at a crime scene when in fact the mark was made by someone else’s finger. This is the dreaded false identification, such as those reported at the U.K. National Fingerprint Conference in October 2001 (Ritchie 2002) and those that have occurred

over the last 15 years on both sides of the Atlantic. This is the most feared error because it can have serious consequences for the innocent person, who may have difficulty defending his innocence, especially in view of possible past criminal records.

There is a second type of error that deserves much more scrutiny because of the “no harm done” attitude toward it. This is the mark that can be used for exclusion purposes but is erroneously discounted. It is our contention that there are many marks that have exclusion power (i.e., capable of excluding the possibility that it was made by a certain individual’s fingers) but are branded as inconclusive, when indeed they have much value in exonerating potential suspects. This is one of the values attributed to DNA but is equally valid for fingerprints. Proficiency testing has shown that this error is not uncommon, and it is our contention that such errors are just as serious as the false identifications. Such errors demonstrate a certain lack of understanding of the principles of identification as they should be professionally applied. This is an issue that rests with the teaching and training of specialists.

5.6.2 QUALITY ASSURANCE

The changes of perspective from a craft to an industry, and from a confirmatory role to an investigative- and intelligence-led activity, introduce new demands on the overall quality of the service provided by dactyloscopy. Three main areas need to be considered:

1. Fingerprint examiners/specialists
2. Processes
3. Results or products

All three aspects need periodic review, both internally and externally.

5.6.2.1 Fingerprint Examiner

5.6.2.1.1 Recruitment

Little has been done in the past to consider specific recruitment requirements for dactyloscopists. Even now, in most countries and jurisdictions, the recruitment of future sworn police officers is made on the basis of standard police work rather than on identification skills or, for civilians, on the basis of standard administrative skills. Initial recruitment should be based on two important skills:

- Observation skills — the capacity to extract shapes and forms from complex designs, to connect similar patterns and details, and to discriminate dissimilar ones. Although this is something that can be trained, individuals with such qualities can rapidly become dependable identification specialists.
- Technical skills — efficiently detecting and recording traces and marks requires a basic knowledge of chemistry and physics, as well as aptitudes at image treatment (e.g., photography and digital imaging). This requires

a certain level of education, at least at laboratory technician or basic scientific degree level, which can be reached through an appropriate education program.

Certain qualities such as patience, curiosity, and critical thinking should also be favored.

Clearly, there is a need to set up tests based on such selection criteria. Then, as a standard procedure in law enforcement structures, selected candidates can be further checked for personality, honesty, integrity, commitment, and pride. Various agencies have developed selection criteria along the above lines, such as the image-recognition recruitment test as used by the National Identification Bureau in the Netherlands.

5.6.2.1.2 Education and Training

There is no unique or fail-safe education model valid for all circumstances; human diversity and nature help develop new skills and create new knowledge and working methodologies. However, an ideal education model would include sound foundations in science and technology (chemistry, physics, mathematics, computing), both theoretical and practical, in order to understand detection methods and the recording of evidence using advanced techniques. Additional requirements include a basic knowledge of the laws of the country and a thorough knowledge on the use of physical evidence in the legal system (criminal law, criminal procedure, laws of evidence) in order to understand the requirements of the courts. Specific education should cover crime types (criminology, criminal psychology), methods of investigation starting from the scene of the crime, the evidence types that can be collected, systematic methods for crime scene investigation, documentation requirements, and the systematic stepwise and professional treatment of detected evidence. Training should be imparted through multiple full-scale mock investigations, starting with simple collection and documentation of evidence to the full treatment of complex scenes. Each case should be fully completed by the individual. By controlling the evidence before (setting up the scenario) and after the investigation (check completeness, quality, and recording), it is possible at all stages to evaluate the progress of candidates and ensure a competence level that satisfies the highest expectations. A basic knowledge of general forensic science ensures that identification procedures are not applied to the detriment of other evidence types. By having full control over collection, the trainee is made aware of the relative position of traces; the way marks were placed; and the handedness, position, and finger type that made each mark. This evaluation is essential, and adequate documentation provides a comprehensive chain of custody, with scene images recording the surface type on which the evidence has been collected. Such training provides good insurance against tampering, mixing, or mislabeling traces, or even planting evidence.

The correct application of laboratory techniques, enhancement procedures, and imaging methods — with specific care taken to have the highest sensitivity and the highest selectivity for a particular situation — ensure that the best possible marks are documented. Only then does the identification process begin, i.e., searching through databases and comparing evidential marks with suspects' prints. It is not

sufficient to be able to observe comparable features; the specialist has to be able to highlight them, make them evident to others (judges, juries, lawyers), and discuss the weight that is attributed to these features and why. The specialist must be able to describe the whole identification process starting from initial observations through to the subjective appraisal described in [Chapter 2](#).

Such an education and training program may take several years to complete, but it ensures a solid foundation upon which the identification process and the courts can rely. This is the basis of the training program developed at the University of Lausanne in Switzerland, which is further completed with an additional year of training on other evidence types.

Specialists trained in this manner quickly adapt to real-life cases and are highly regarded in their professional environments and by the courts. Lophoscopy needs professionals who have a sound foundation and knowledge well above the strict drills and experience that are the key elements of most training programs.

5.6.2.1.3 *Portfolio and Competency Assessment*

Each examiner should have a personal portfolio highlighting career development and achievements, internal assessments, and periodic evaluations, both internal and external, to demonstrate competence and potential for career advancement. The Council for the Registration of Forensic Practitioners in the U.K. is adopting a proposal made by the U.K. Fingerprint Task Force to assess the competence of fingerprint examiners. This mostly follows and encapsulates certification requirements elsewhere (International Association for Identification, national registers) and need not be detailed here (Kershaw 2001).

5.6.2.2 **Processes**

This section addresses the internal management structures to be set up in agreement with local regulations and organizational needs. The following are necessary requirements to guarantee transparent quality assurance measures.

A set of written case-handling procedures should detail basic requirements for scene work (documentation, detection, photographic records, evidence collection, labeling rules, chain-of-custody requirements), laboratory work (enhancement, imaging, documenting), identification and checking procedures, and reporting (including the necessity for written statements of exclusion).

Concerning verification procedures, over 90% of identifications are generally not problematic. Consequently, we do not believe that systematic double-blind checks are necessary; they are time consuming and unnecessarily consume significant personnel resources. More important is that potentially *problematic* marks be checked routinely, and the verification structure should cater to this need. The primary responsibility lies with the specialists themselves to have these marks checked independently (i.e., the supervisor chooses another examiner to go through the whole identification procedure, without knowledge of conclusions reached by the first examiner). All contested identifications should also be checked and analyzed independently as a matter of course.

Proficiency tests should ensure that the general quality is up to the standards required. This avoids the systematic, time-consuming, routine double-checks that introduce bad working habits (such as complacency). Proficiency tests also reinforce individual responsibility and increase the motivation of each specialist. The occasional and rare errors should only arise from problematic traces, and these should be identified through the independent verification process.

Managers should be ready for a full audit if doubts are cast on any one aspect of the work produced by the service and should be amenable to changes due to weaknesses identified by this process. Any identified error should lead to such an audit, with corrective measures proposed when the problem is identified. Rather than systematically identifying a scapegoat or a black sheep for good conscience and convenience, efforts should be made to identify and rectify the root cause (e.g., reviewing the staff selection process, education requirements, training and competency-testing program, etc.).

5.6.2.3 The Product

Various measures of performance have been proposed in the past, mostly coming from the industrial management of processes (number of marks collected, number of marks identified, number of exclusions). Such measurements are useful management tools but may introduce undue pressure that could have serious consequences in the judicial process. Meaningful performance indicators are usually more difficult to set up than simply calculating numerical values. For example, a difficult but pertinent mark identified in a complex case may not change the numbers dramatically, but it may be a significant event (and a significant performance indicator) for a given specialist.

Identification is not an industrial item; it requires competence, qualifications, trust, and responsibility. External pressure may introduce bias and encourage sloppy work to fit requested target numbers while decreasing job satisfaction and generating negative attitudes toward work. There is a delicate balance that relies heavily on the personalities of the individuals chosen to manage such service delivery. Audits or reviews may show deficiencies in this respect, and corrective measures may include a change of manager.

6 Conclusions

To conclude this book, we would like to outline and explore what the future may hold for the area of fingerprint detection and identification. We will concentrate first on the detection side and then on identification.

6.1 FINGERPRINT DETECTION

It is clear from what is contained in the preceding chapters that there has been a proliferation of research and an extremely rapid development in the field of fingerprint detection over the last 25 years. This has followed from a renewed understanding of the value of fingerprints as a form of evidence by major laboratories and research institutions such as the U.K. Forensic Science Service (FSS; including their Serious Crime Unit), the Police Scientific Development Branch (PSDB, U.K.), the Division of Identification and Forensic Science (DIFS, Israel), the U.S. Secret Service, and the School of Forensic Science at Lausanne University (IPS — Institut de police scientifique). Such a revival is of immense benefit to practicing dactylogrists, increasing the standing of their work.

It is difficult to foresee what new techniques will make a future impact in the field of latent fingerprint detection. Some of the more recent advances, including the use of the ninhydrin analog diazafluorenone (DFO), indanediones, and multimeral deposition, have rapidly proved to be viable alternatives to conventional techniques. Overall, we would like to see the development of methods that can:

- Offer increased sensitivity and signal-to-noise ratio
- Be readily deployed at crime scenes
- Be introduced in sequences of detection techniques or in sequence with other forensic investigation methods (e.g., DNA profiling)
- Simplify the detection process by reducing the number of steps or allowing automation
- Reduce the overall cost of fingerprint processing
- Avoid the use of hazardous chemicals

The potential for advancement in the fingerprint detection field is foreseen in the following areas:

- Any optical device or imaging technique that permits rapid, noninvasive detection should be given research priority. Recent advances in chemical

imaging systems, for example, have offered new methods for detecting latent marks prior to any treatment (Roux 2003).

- Physical nondestructive methods, such as the use of high-voltage-induced plasmas, may also permit the creation of luminescent species in the fingerprint deposit to increase the sensitivity of detection, even if preliminary results do not yet indicate a significant revolution in fingerprint detection (Meylan et al. 1990; Halahmi et al. 1997).
- Further research on powdering processes (in either dry or liquid state) could lead to an improved understanding of this detection method and increased detection sensitivities. The U.S. Secret Service is currently funding research on magnetic nanoflake powders (Ramotowski and Cantu 2001).
- Several research groups have worked at developing a one-step fluorescent cyanoacrylate technique (Yong 1986; Weaver and Clary 1993; Spring et al. 1995). Only limited success has been achieved to date, and further research is required given the potential benefits from such an approach.
- The detection of fingermarks on human skin represents a significant challenge that remains analogous to the quest for the “holy grail.” Further research is required if success rates on this surface are to be improved.
- While indanediones now offer increased sensitivity for the detection of latent fingermarks on paper substrates, the improvement in sensitivity over reagents such as DFO is, at best, only marginal. Continued research into additional ninhydrin, DFO, and indanedione analogs is likely to result in only incremental improvements in detection limits. Any significant improvement in detection sensitivity using chemical reagents is likely to require a completely different approach that, as yet, has not been identified.
- Microchip techniques show promise as a means of increasing knowledge of the chemistry of the fingerprint deposit and the identification of potential chemical markers (Valussi 2003).

6.2 FINGERPRINT IDENTIFICATION

When it comes to identification issues, it is clear that the criminal justice system is approaching fingerprint evidence with a much more critical eye than in the past. Certainly, the highly debated introduction of DNA evidence and its systematic comparison with fingerprint evidence has promoted such renewed critical interest. We welcome this regain of interest, as it will force the profession to analyze its foundations critically. Judge Louis H. Pollak, in his opinion in *U.S. v. C.I. Llera Plaza, W. Martinez Acosta and V. Rodriguez* (Cr No. 98-362-10,11,12 – March 13, 2002), invited research in the area (pp. 49–50) in the following way:

With those findings in mind, I am not persuaded that courts should defer admission of testimony with respect to fingerprinting – which Professors Neufeld and Scheck term “[t]he bedrock forensic identifier of the 20th century” – until academic investigators financed by the National Institute of Justice have made substantial headway

on a “verification and validation” research agenda. For the National Institute of Justice, or other institutions both public and private, to sponsor such research would be all to the good. But to postpone present court-utilization of the “bedrock forensic identifier” pending such research would be to make the best the enemy of the good.

We agree with him and would like to see the development of strong research initiatives on the statistical aspects of fingerprint evidence. For research focused on level 2 features, the following lines are particularly appealing:

- Refine the available statistical models (such as that presented by Champod [1996]) by incorporating consideration of the arrangement of minutiae. Also, there is a need for validation on extensive databases.
- Use extensively the power of automated fingerprint identification systems to explore the statistical behavior of fingerprint features. More systematic analysis of within- and between-source variability using marks of varying numbers of features could provide valuable data to support the identification process. The approach taken by Daugman on iris recognition is an excellent example (Daugman 1999; Daugman and Downing 2001; Daugman 2003). However, the output of automatic systems will have to be expressed in a form that truly represents the weight of the evidence. We believe that using a likelihood ratio is the key here (Champod and Meuwly 2000). Such research could also pave the way toward the more extensive use of fingerprint evidence as a probabilistic intelligence tool.
- Explore the potential contribution of mathematical morphology to explain the friction ridge skin arrangement. Validating available generating models (Cappelli et al. 2000; Kosz 2000) against real fingerprint data is a promising line of research.

We also invite research on level 3 features. This is an area where the systematic description of the features is not fully available, and knowledge about within- and between-source variability is very sparse. Finally, creases and secondary (incipient) ridges have not been considered from a statistical perspective. A structured collection of data would certainly help to validate the judgment of latent fingerprint examiners.

The above considerations deal mainly with the source-attribution issue. However, it is fair to say that fingerprint examiners are asked more often to comment and provide guidance on other issues such as timing (fingerprint age estimation) and activities associated with the deposition of finger marks. Fingerprint examiners have traditionally been reluctant to comment on issues other than identification, but we foresee a growing demand from the criminal justice system for advice on “activity” issues. To systematically approach such questions as, “When was that mark deposited?” “Which was first — the fingermark or the blood?” “What manipulation led to the observed distribution of marks?” the scientist is not equipped with an adequate body of background research. We have discussed the age estimation question in [Chapter 5](#), and it is obvious that further research is required. The issue of order of deposition has been recently explored (Huss et al. 2000), but further work would be beneficial.

Appendix 1

Statistical Data for General Fingerprint Patterns

Data obtained from the FBI fingerprint collection have been collated by the National Institute of Standards and Technology (NIST). The collection has been sorted according to the finger number (finger #1 to finger #5 for the right hand [thumb to auricular — the little finger, as the one most easily inserted in the ear (*Oxford English Dictionary*)], and finger #6 to finger #10 for the left hand) and the NCIC (National Crime Information Center) classification. These data can be found at <http://www.der-matoglyphics.com>.

An explanation of the NCIC codes is given in [Table A1.1](#).

Rules for the general pattern classification, ridge count, and ridge tracing can be found in the description of the Galton/Henry classification used by the FBI (U.S. Department of Justice and FBI 1984). A very good guide is also available on the Internet at <http://brazoria-county.com/sheriff/id/fingerprints/>.

For each finger, the distribution of the general patterns in terms of total counts and relative frequencies (rounded to three decimal places) is given in [Table A1.2](#) and [Table A1.3](#) for male and female fingerprint forms, respectively. The data in [Table A1.2](#) are based on 17,951,192 ten-print forms from male donors. The data in [Table A1.3](#) are based on 4,313,521 ten-print forms from female donors.

TABLE A1.1
NCIC Classification Scheme

Pattern Type	Subgroup	NCIC Fingerprint Code
Arches	Plain and tented	AA and TT
Loops	Ulnar loop	Two numbers indicating the actual ridge count; an ulnar loop with ridge count of 7 will be entered as 07
Loops	Radial loop	50 + actual ridge count of the loop; if the ridge count is 13, the radial loop will be classified as 63
Plain whorl	Inner, meeting, and outer ridge tracing	PI, PM, and PO
Central pocket loop whorl	Inner, meeting, and outer	CI, CM, and CO
Double loop whorl	Inner, meeting, and outer	DI, DM, and DO
Accidental whorl	Inner, meeting, and outer	XI, XM, and XO
Missing/amputated finger	Preexisting condition	XX
Scarred/mutilated pattern	Preexisting condition	SR

TABLE A1.2

NCIC Classification Statistics Based on 17,951,191 Ten-Print Forms from Major Donors

NCIC Code	Finger #1	Finger #2	Finger #3	Finger #4	Finger #5	Finger #6	Finger #7	Finger #8	Finger #9	Finger #10
1	24067 (0.009)	158099 (0.009)	157907 (0.009)	69856 (0.004)	47762 (0.003)	33360 (0.002)	11726 (0.007)	140339 (0.008)	69750 (0.004)	61146 (0.003)
2	62517 (0.003)	339878 (0.019)	373189 (0.021)	181419 (0.011)	175929 (0.01)	90434 (0.005)	281799 (0.015)	318948 (0.018)	175942 (0.01)	193293 (0.011)
3	82889 (0.005)	351074 (0.02)	444137 (0.025)	234080 (0.013)	314759 (0.018)	132926 (0.007)	284801 (0.016)	361747 (0.02)	218048 (0.012)	297660 (0.017)
4	105770 (0.006)	369869 (0.021)	546777 (0.03)	318187 (0.018)	464229 (0.026)	167079 (0.009)	339295 (0.018)	434885 (0.024)	290656 (0.016)	438978 (0.024)
5	126655 (0.007)	327320 (0.018)	569584 (0.031)	337307 (0.019)	599537 (0.032)	203479 (0.011)	334989 (0.019)	438625 (0.024)	305718 (0.017)	501943 (0.028)
6	153326 (0.009)	286084 (0.016)	540178 (0.03)	307756 (0.017)	637564 (0.036)	246464 (0.014)	328542 (0.018)	412280 (0.023)	284086 (0.016)	517440 (0.029)
7	176251 (0.01)	287564 (0.016)	571383 (0.032)	302458 (0.017)	653399 (0.036)	293372 (0.016)	361113 (0.02)	467143 (0.026)	298106 (0.017)	552524 (0.031)
8	211197 (0.012)	332561 (0.019)	717546 (0.04)	330615 (0.02)	687023 (0.038)	357762 (0.02)	445325 (0.025)	625069 (0.035)	391809 (0.021)	686161 (0.037)
9	232763 (0.013)	441989 (0.025)	736208 (0.041)	353698 (0.02)	709543 (0.04)	401993 (0.022)	638400 (0.036)	672635 (0.037)	428482 (0.024)	752895 (0.045)
10	248963 (0.014)	456414 (0.025)	1022382 (0.057)	365333 (0.02)	815229 (0.045)	422325 (0.024)	666734 (0.037)	757053 (0.044)	474840 (0.026)	899488 (0.05)
11	327467 (0.022)	396499 (0.022)	1141366 (0.064)	393221 (0.022)	893517 (0.05)	705494 (0.039)	545141 (0.033)	1142739 (0.064)	538326 (0.03)	1041116 (0.056)
12	446899 (0.025)	509524 (0.028)	1112046 (0.062)	475979 (0.027)	1046780 (0.058)	803142 (0.045)	682891 (0.038)	1127595 (0.063)	677736 (0.038)	1306708 (0.073)
13	391622 (0.022)	483877 (0.027)	1161866 (0.065)	701306 (0.039)	1139957 (0.063)	642662 (0.036)	619626 (0.034)	1208000 (0.067)	1029935 (0.057)	1412633 (0.079)
14	473208 (0.026)	397575 (0.022)	1091501 (0.061)	703338 (0.039)	1206933 (0.067)	742321 (0.041)	460725 (0.026)	1163214 (0.065)	1022666 (0.057)	1425599 (0.079)
15	449216 (0.025)	325842 (0.018)	917488 (0.051)	565289 (0.031)	1181509 (0.066)	641954 (0.036)	347853 (0.019)	997113 (0.056)	765277 (0.043)	1331742 (0.074)
16	739801 (0.041)	278787 (0.016)	754109 (0.042)	735237 (0.041)	1146558 (0.064)	1077461 (0.06)	273928 (0.015)	840128 (0.047)	970744 (0.054)	129848 (0.072)
17	783353 (0.044)	190701 (0.011)	505285 (0.028)	639565 (0.036)	969442 (0.054)	891777 (0.055)	166264 (0.009)	587605 (0.033)	613071 (0.045)	1009457 (0.056)
18	644161 (0.036)	114041 (0.006)	305964 (0.017)	532776 (0.026)	786724 (0.044)	626307 (0.03)	86941 (0.005)	387822 (0.02)	677042 (0.038)	72478 (0.004)
19	628882 (0.035)	66177 (0.004)	171652 (0.01)	408056 (0.023)	557438 (0.03)	589675 (0.033)	44192 (0.002)	214688 (0.012)	507728 (0.028)	467305 (0.026)
20	627174 (0.035)	40952 (0.002)	99377 (0.006)	355759 (0.02)	374011 (0.021)	506460 (0.028)	241611 (0.012)	123055 (0.007)	425056 (0.024)	306769 (0.017)
21	491488 (0.027)	19701 (0.001)	46581 (0.003)	239495 (0.013)	217588 (0.012)	377280 (0.021)	10462 (0.001)	62725 (0.003)	287645 (0.016)	16334 (0.0009)
22	539102 (0.03)	9022 (0.001)	19627 (0.001)	140756 (0.008)	116987 (0.007)	266693 (0.015)	4515 (0.001)	27971 (0.002)	173234 (0.01)	78816 (0.004)
23	403673 (0.022)	4175 (0.001)	2598 (0.001)	88456 (0.005)	58164 (0.003)	178284 (0.01)	1999 (0.001)	12656 (0.001)	111008 (0.006)	37439 (0.002)
24	224212 (0.013)	1095 (0.001)	3674 (0.001)	61566 (0.003)	27186 (0.002)	112330 (0.006)	1098 (0.001)	5731 (0.001)	78069 (0.004)	17466 (0.001)
25	175812 (0.01)	842 (0.001)	1373 (0.001)	34388 (0.002)	11974 (0.001)	67262 (0.004)	476 (0.001)	2294 (0.001)	45174 (0.003)	7564 (0.001)
26	115284 (0.006)	321 (0.001)	580 (0.001)	17256 (0.001)	4819 (0.001)	38363 (0.002)	262 (0.001)	946 (0.001)	24212 (0.001)	3215 (0.001)
27	70387 (0.004)	147 (0.001)	215 (0.001)	9630 (0.001)	1930 (0.001)	20226 (0.001)	128 (0.001)	382 (0.001)	14474 (0.001)	1420 (0.001)
28	42255 (0.002)	76 (0.001)	103 (0.001)	5441 (0.001)	981 (0.001)	10588 (0.001)	79 (0.001)	175 (0.001)	9179 (0.001)	637 (0.001)
29	22933 (0.001)	41 (0.001)	50 (0.001)	2829 (0.001)	294 (0.001)	5230 (0.001)	48 (0.001)	91 (0.001)	5382 (0.001)	353 (0.001)
30	13588 (0.001)	26 (0.001)	1949 (0.001)	1949 (0.001)	182 (0.001)	190 (0.001)	13 (0.001)	96 (0.001)	428 (0.001)	105 (0.001)
31	6363 (0.001)	16 (0.001)	21 (0.001)	906 (0.001)	51 (0.001)	1107 (0.001)	36 (0.001)	49 (0.001)	2122 (0.001)	100 (0.001)
32	3193 (0.001)	12 (0.001)	11 (0.001)	608 (0.001)	21 (0.001)	506 (0.001)	17 (0.001)	36 (0.001)	1613 (0.001)	69 (0.001)
33	1503 (0.001)	3 (0.001)	9 (0.001)	341 (0.001)	9 (0.001)	190 (0.001)	13 (0.001)	30 (0.001)	595 (0.001)	27 (0.001)
34	719 (0.001)	2 (0.001)	7 (0.001)	210 (0.001)	2 (0.001)	104 (0.001)	6 (0.001)	9 (0.001)	599 (0.001)	19 (0.001)
35	310 (0.001)	1 (0.001)	4 (0.001)	125 (0.001)	6 (0.001)	48 (0.001)	7 (0.001)	13 (0.001)	412 (0.001)	21 (0.001)
36	150 (0.001)	1 (0.001)	3 (0.001)	73 (0.001)	21 (0.001)	73 (0.001)	21 (0.001)	11 (0.001)	237 (0.001)	15 (0.001)
37	73 (0.001)	0 (0.001)	3 (0.001)	21 (0.001)	1 (0.001)	12 (0.001)	5 (0.001)	4 (0.001)	106 (0.001)	14 (0.001)
38	29 (0.001)	1 (0.001)	3 (0.001)	16 (0.001)	0 (0.001)	5 (0.001)	1 (0.001)	4 (0.001)	77 (0.001)	10 (0.001)
39	17 (0.001)	0 (0.001)	1 (0.001)	12 (0.001)	0 (0.001)	1 (0.001)	1 (0.001)	4 (0.001)	35 (0.001)	4 (0.001)
40	9 (0.001)	0 (0.001)	1 (0.001)	11 (0.001)	1 (0.001)	5 (0.001)	1 (0.001)	7 (0.001)	40 (0.001)	10 (0.001)
41	7 (0.001)	0 (0.001)	11 (0.001)	9 (0.001)	16 (0.001)	15 (0.001)	13 (0.001)	22 (0.001)	33 (0.001)	30 (0.001)
42	311 (0.002)	39333 (0.025)	17043 (0.01)	2644 (0.001)	824 (0.001)	413 (0.001)	128475 (0.007)	36341 (0.002)	3364 (0.002)	847 (0.001)
43	773 (0.004)	215260 (0.012)	30187 (0.002)	6509 (0.001)	1958 (0.001)	915 (0.001)	293857 (0.016)	60305 (0.003)	5986 (0.003)	1473 (0.001)
44	1010 (0.005)	239894 (0.013)	27236 (0.002)	8432 (0.001)	2734 (0.001)	1284 (0.001)	325475 (0.018)	49237 (0.003)	5831 (0.002)	1382 (0.001)
45	1331 (0.006)	251618 (0.014)	21498 (0.001)	11358 (0.001)	3527 (0.001)	1727 (0.001)	343821 (0.019)	35081 (0.002)	6080 (0.001)	1344 (0.001)
46	1541 (0.007)	198596 (0.011)	15687 (0.001)	40177 (0.001)	4056 (0.001)	2083 (0.001)	272173 (0.015)	21011 (0.001)	6098 (0.001)	1624 (0.001)
47	1818 (0.01)	182323 (0.008)	12639 (0.001)	16486 (0.001)	4561 (0.001)	2595 (0.001)	187531 (0.01)	12881 (0.001)	6233 (0.001)	1342 (0.001)
48	2288 (0.012)	112261 (0.006)	12261 (0.001)	16741 (0.001)	4588 (0.001)	3085 (0.001)	147516 (0.008)	9164 (0.001)	6117 (0.001)	1329 (0.001)
49	2829 (0.015)	107113 (0.006)	13205 (0.001)	14278 (0.001)	4749 (0.001)	3353 (0.001)	129393 (0.007)	7409 (0.001)	6798 (0.001)	1368 (0.001)
50	3148 (0.018)	128890 (0.007)	13018 (0.001)	20296 (0.001)	4531 (0.001)	4052 (0.001)	120141 (0.007)	6017 (0.001)	5203 (0.001)	1236 (0.001)
51	3460 (0.02)	127130 (0.007)	17336 (0.001)	19607 (0.001)	4386 (0.001)	4545 (0.001)	92601 (0.005)	7157 (0.001)	5605 (0.001)	1177 (0.001)
52	4577 (0.026)	116128 (0.006)	17759 (0.001)	17028 (0.001)	3353 (0.001)	3705 (0.001)	70265 (0.004)	8853 (0.001)	6413 (0.001)	966 (0.001)
53	5162 (0.03)	165309 (0.009)	15228 (0.001)	13995 (0.001)	2865 (0.001)	6282 (0.001)	91803 (0.005)	5570 (0.001)	3622 (0.001)	904 (0.001)
54	4667 (0.03)	185107 (0.01)	15233 (0.001)	14543 (0.001)	2064 (0.001)	5387 (0.001)	86300 (0.005)	5585 (0.001)	3523 (0.001)	751 (0.001)
55	5265 (0.03)	185107 (0.01)	14103 (0.001)	10142 (0.001)	1447 (0.001)	5804 (0.001)	98920 (0.005)	5410 (0.001)	2297 (0.001)	566 (0.001)
56	4958 (0.03)	187306 (0.01)	11968 (0.001)	5914 (0.001)	899 (0.001)	6930 (0.001)	4933 (0.001)	4101 (0.001)	1248 (0.001)	113 (0.001)
57	5966 (0.04)	201744 (0.011)	10619 (0.001)	4595 (0.001)	573 (0.001)	5383 (0.001)	11636 (0.006)	4679 (0.001)	1521 (0.001)	286 (0.001)
58	6509 (0.04)	176202 (0.01)	8523 (0.001)	2947 (0.001)	295 (0.001)	5969 (0.001)	105947 (0.006)	3940 (0.001)	634 (0.001)	186 (0.001)
59	4677 (0.04)	142483 (0.008)	7113 (0.001)	1802 (0.001)	144 (0.001)	4883 (0.001)	87465 (0.005)	3306 (0.001)	498 (0.001)	59 (0.001)
60	4278 (0.04)	110548 (0.006)	5568 (0.001)	1055 (0.001)	83 (0.001)	4402 (0.001)	36385 (0.004)	2611 (0.001)	339 (0.001)	113 (0.001)
61	4035 (0.04)	90926 (0.005)	4310 (0.001)	668 (0.001)	63 (0.001)	4198 (0.001)	59959 (0.003)	2195 (0.001)	230 (0.001)	52 (0.001)
62	3129 (0.04)	62405 (0.003)	3225 (0.001)	358 (0.001)	29 (0.001)	2486 (0.001)	40177 (0.002)	1703 (0.001)	117 (0.001)	29 (0.001)
63	2583 (0.04)	40956 (0.002)	2446 (0.001)	198 (0.001)	15 (0.001)	3558 (0.001)	25508 (0.001)	1304 (0.001)	69 (0.001)	21 (0.001)
64	1908 (0.04)	25992 (0.001)	1734 (0.001)	100 (0.001)	10 (0.001)	2174 (0.001)	16532 (0.001)	874 (0.001)	49 (0.001)	10 (0.001)
65	1306 (0.04)	16854 (0.001)	1208 (0.001)	47 (0.001)	5 (0.001)	1610 (0.001)	10250 (0.001)	619 (0.001)	30 (0.001)	7 (0.001)
66	887 (0.04)	10461 (0.001)	799 (0.001)	38 (0.001)	6 (0.001)	1111 (0.001)	5943 (0.001)	466 (0.001)	14 (0.001)	7 (0.001)
67	601 (0.04)	6278 (0.001)	538 (0.001)	14 (0.001)	3 (0.001)	764 (0.001)	3040 (0.001)	325 (0.001)	11 (0.001)	4 (0.001)
68	345 (0.04)	3658 (0.001)	397 (0.001)	14 (0.001)	6 (0.001)	493 (0.001)	1882 (0.001)	225 (0.001)	9 (0.001)	5 (0.001)
69	217 (0.04)	2533 (0.001)	278 (0.001)	11 (0.001)	3 (0.001)	324 (0.001)	1096 (0.001)	99 (0.001)	5 (0.001)	3 (0.001)
70	121 (0.04)	1579 (0.001)	174 (0.001)	5 (0.001)	1 (0.001)	184 (0.001)	628 (0.001)	91 (0.001)	4 (0.001)	0 (0.001)
71	86 (0.04)	1290 (0.001)	154 (0.001)	8 (0.001)	0 (0.001)	108 (0.001)	496 (0.001)	8 (0.001)	0 (0.001)	0 (0.001)
72	34 (0.04)	4086 (0.002)	2446 (0.001)	6 (0.001)	5 (0.001)	80 (0.001)	212 (0.001)	28 (0.001)	6 (0.001)	3 (0.001)
73	601 (0.04)	6278 (0.001)	538 (0.001)	14 (0.001)	3 (0.001)	764 (0.001)	3040 (0.001)	325 (0.001)	11 (0.001)	4 (0.001)
74	1306 (0.04)	16854 (0.001)	1208 (0.001)	47 (0.001)	5 (0.001)	1610 (0.001)	10250 (0.001)	619 (0.001)	30 (0.001)	7 (0.001)
75	887 (0.04)	10461 (0.001)	799 (0.001)	38 (0.001)	6 (0.001)	1111 (0.0				

TABLE A1.3
NCIC Classification Statistics Based on 4,313,521 Ten-Print Forms from Female Donors

NCIC Code	Finger #1	Finger #2	Finger #3	Finger #4	Finger #5	Finger #6	Finger #7	Finger #8	Finger #9	Finger #10
1	9304 (0.002)	47886 (0.011)	44982 (0.01)	25112 (0.006)	21403 (0.005)	12406 (0.003)	39362 (0.009)	47758 (0.011)	27618 (0.006)	29720 (0.007)
2	23975 (0.006)	89841 (0.023)	103227 (0.024)	62741 (0.015)	74681 (0.017)	33517 (0.008)	83424 (0.019)	103235 (0.024)	86149 (0.015)	88510 (0.021)
3	31518 (0.007)	100427 (0.023)	120687 (0.028)	76997 (0.018)	121633 (0.028)	44724 (0.01)	86464 (0.02)	111189 (0.026)	78239 (0.018)	126046 (0.029)
4	39800 (0.009)	103419 (0.024)	140961 (0.033)	94407 (0.022)	162749 (0.038)	57822 (0.013)	92544 (0.021)	122504 (0.028)	93035 (0.022)	161938 (0.037)
5	46910 (0.011)	97644 (0.023)	146025 (0.034)	96144 (0.022)	184848 (0.043)	68697 (0.016)	104001 (0.022)	121560 (0.028)	92146 (0.021)	170039 (0.041)
6	57109 (0.013)	95773 (0.022)	151430 (0.035)	91247 (0.021)	198070 (0.045)	83870 (0.019)	96177 (0.022)	122643 (0.028)	87007 (0.02)	171794 (0.04)
7	65274 (0.015)	99889 (0.023)	186017 (0.038)	80768 (0.021)	153963 (0.045)	97153 (0.023)	130401 (0.024)	134547 (0.033)	90501 (0.021)	175291 (0.041)
8	77219 (0.018)	108181 (0.025)	199216 (0.046)	100876 (0.02)	200233 (0.046)	115326 (0.027)	114966 (0.027)	169534 (0.038)	108873 (0.025)	198787 (0.046)
9	85057 (0.02)	150105 (0.035)	202730 (0.047)	103696 (0.024)	203899 (0.047)	126483 (0.029)	162817 (0.038)	171769 (0.04)	119483 (0.028)	210672 (0.049)
10	90495 (0.021)	160259 (0.037)	229721 (0.059)	121114 (0.028)	242246 (0.056)	199104 (0.046)	127022 (0.029)	295934 (0.068)	147174 (0.034)	262831 (0.061)
11	135005 (0.031)	139869 (0.031)	333261 (0.077)	134411 (0.03)	272526 (0.063)	214351 (0.05)	141832 (0.033)	259181 (0.056)	161591 (0.037)	302531 (0.07)
12	154482 (0.036)	158784 (0.037)	288862 (0.067)	204884 (0.047)	282707 (0.068)	166701 (0.039)	115346 (0.027)	262480 (0.061)	251220 (0.058)	308311 (0.071)
13	134441 (0.031)	146359 (0.034)	300551 (0.07)	192451 (0.045)	248317 (0.058)	215865 (0.05)	40234 (0.009)	146820 (0.034)	196221 (0.046)	237221 (0.055)
14	157148 (0.038)	118402 (0.027)	272750 (0.063)	210571 (0.049)	284717 (0.068)	179102 (0.042)	84833 (0.02)	246827 (0.056)	145728 (0.057)	295957 (0.069)
15	143972 (0.033)	92467 (0.021)	219778 (0.05)	156960 (0.037)	267954 (0.062)	147260 (0.034)	58461 (0.014)	192088 (0.045)	166947 (0.039)	260784 (0.06)
16	217955 (0.051)	72893 (0.017)	162267 (0.038)	192451 (0.045)	248317 (0.058)	215865 (0.05)	40234 (0.009)	146820 (0.034)	196221 (0.046)	237221 (0.055)
17	212146 (0.048)	45740 (0.011)	103792 (0.024)	187713 (0.039)	198424 (0.046)	174719 (0.041)	21965 (0.005)	95715 (0.022)	162210 (0.038)	173326 (0.04)
18	165482 (0.037)	26552 (0.006)	60474 (0.014)	144300 (0.033)	149107 (0.035)	101972 (0.024)	10897 (0.003)	56990 (0.013)	134988 (0.031)	119335 (0.028)
19	146229 (0.034)	14459 (0.003)	31988 (0.007)	109338 (0.025)	97667 (0.023)	85341 (0.02)	5963 (0.001)	30966 (0.007)	100323 (0.024)	72705 (0.017)
20	130014 (0.03)	8030 (0.002)	16557 (0.004)	89707 (0.021)	64681 (0.015)	65189 (0.015)	20554 (0.001)	16754 (0.004)	79543 (0.018)	45931 (0.01)
21	93986 (0.022)	3717 (0.001)	7232 (0.002)	61093 (0.014)	35386 (0.008)	43130 (0.01)	1042 (0)	7836 (0.002)	53933 (0.013)	22888 (0.005)
22	63984 (0.018)	1641 (0)	3131 (0.001)	39196 (0.009)	17248 (0.004)	26732 (0.006)	478 (0)	3360 (0.001)	34360 (0.008)	10871 (0.002)
23	55421 (0.013)	749 (0)	1282 (0)	24433 (0.006)	8081 (0.002)	15705 (0.004)	205 (0)	1405 (0)	22304 (0.005)	4901 (0.001)
24	29297 (0.007)	250 (0)	493 (0)	15560 (0.004)	3583 (0.001)	8610 (0.002)	111 (0)	563 (0)	14767 (0.003)	2296 (0)
25	18808 (0.004)	144 (0)	209 (0)	8905 (0.002)	1497 (0)	4421 (0.001)	69 (0)	200 (0)	9360 (0.002)	886 (0)
26	10556 (0.002)	61 (0)	77 (0)	4900 (0.001)	529 (0)	2093 (0)	26 (0)	94 (0)	5355 (0.001)	343 (0)
27	5590 (0.001)	25 (0)	41 (0)	2650 (0.001)	206 (0)	971 (0)	19 (0)	38 (0)	3213 (0.001)	151 (0)
28	2905 (0.001)	19 (0)	25 (0)	1632 (0)	89 (0)	511 (0)	22 (0)	33 (0)	2088 (0)	52 (0)
29	1373 (0)	8 (0)	14 (0)	845 (0)	36 (0)	211 (0)	11 (0)	15 (0)	1227 (0)	34 (0)
30	692 (0)	3 (0)	6 (0)	603 (0)	32 (0)	160 (0)	7 (0)	16 (0)	85 (0)	17 (0)
31	277 (0)	3 (0)	5 (0)	217 (0)	2 (0)	4 (0)	4 (0)	4 (0)	444 (0)	5 (0)
32	141 (0)	2 (0)	1 (0)	169 (0)	2 (0)	12 (0)	2 (0)	5 (0)	330 (0)	4 (0)
33	56 (0)	2 (0)	8 (0)	80 (0)	1 (0)	2 (0)	1 (0)	6 (0)	181 (0)	2 (0)
34	20 (0)	1 (0)	2 (0)	51 (0)	1 (0)	1 (0)	1 (0)	4 (0)	115 (0)	0 (0)
35	8 (0)	2 (0)	2 (0)	30 (0)	1 (0)	2 (0)	0 (0)	2 (0)	69 (0)	1 (0)
36	7 (0)	0 (0)	0 (0)	15 (0)	0 (0)	0 (0)	0 (0)	31 (0)	3 (0)	0 (0)
37	1 (0)	0 (0)	0 (0)	8 (0)	0 (0)	0 (0)	0 (0)	2 (0)	1 (0)	1 (0)
38	1 (0)	0 (0)	1 (0)	1 (0)	0 (0)	0 (0)	0 (0)	1 (0)	5 (0)	2 (0)
39	1 (0)	0 (0)	0 (0)	0 (0)	0 (0)	0 (0)	0 (0)	4 (0)	0 (0)	0 (0)
40	3 (0)	2 (0)	1 (0)	2 (0)	1 (0)	1 (0)	5 (0)	2 (0)	1 (0)	1 (0)
41	3 (0)	2 (0)	4 (0)	4 (0)	2 (0)	1 (0)	4 (0)	3 (0)	3 (0)	3 (0)
42	4 (0)	2 (0)	4 (0)	2 (0)	1 (0)	1 (0)	1 (0)	1 (0)	1 (0)	1 (0)
43	5 (0)	2 (0)	4 (0)	6 (0)	2 (0)	2 (0)	1 (0)	2 (0)	3 (0)	3 (0)
44	5 (0)	2 (0)	4 (0)	6 (0)	2 (0)	2 (0)	1 (0)	2 (0)	3 (0)	3 (0)
45	5 (0)	2 (0)	4 (0)	6 (0)	2 (0)	2 (0)	1 (0)	2 (0)	3 (0)	3 (0)
46	5 (0)	2 (0)	4 (0)	6 (0)	2 (0)	2 (0)	1 (0)	2 (0)	3 (0)	3 (0)
47	5 (0)	2 (0)	4 (0)	6 (0)	2 (0)	2 (0)	1 (0)	2 (0)	3 (0)	3 (0)
48	5 (0)	2 (0)	4 (0)	6 (0)	2 (0)	2 (0)	1 (0)	2 (0)	3 (0)	3 (0)
49	5 (0)	2 (0)	4 (0)	6 (0)	2 (0)	2 (0)	1 (0)	2 (0)	3 (0)	3 (0)
50	5 (0)	2 (0)	4 (0)	6 (0)	2 (0)	2 (0)	1 (0)	2 (0)	3 (0)	3 (0)
51	11 (0)	20323 (0.005)	2860 (0.001)	693 (0)	238 (0)	183 (0)	33950 (0.008)	10467 (0.002)	1627 (0)	415 (0)
52	264 (0)	40729 (0.009)	4521 (0.001)	1712 (0)	615 (0)	462 (0)	7012 (0.016)	16264 (0.004)	2935 (0.001)	740 (0)
53	412 (0)	40455 (0.009)	3551 (0.001)	2246 (0.001)	841 (0)	727 (0)	71439 (0.017)	12474 (0.003)	2988 (0.001)	768 (0)
54	541 (0)	36039 (0.008)	2400 (0.001)	2714 (0.001)	936 (0)	512 (0)	66130 (0.015)	8271 (0.002)	3268 (0.001)	781 (0)
55	660 (0)	27682 (0.006)	1717 (0)	3280 (0.001)	993 (0)	1188 (0)	49740 (0.012)	4998 (0.001)	3413 (0.001)	692 (0)
56	846 (0)	19742 (0.005)	1427 (0)	3026 (0.001)	1062 (0)	1519 (0)	35099 (0.008)	3278 (0.001)	3261 (0.001)	756 (0)
57	961 (0)	16295 (0.004)	1399 (0)	4040 (0.001)	1021 (0)	1193 (0)	27015 (0.006)	2431 (0.001)	3191 (0.001)	719 (0)
58	1168 (0)	14925 (0.003)	1480 (0)	4190 (0.001)	979 (0)	2165 (0.001)	22413 (0.005)	2170 (0.001)	3266 (0.001)	696 (0)
59	1325 (0)	19771 (0.005)	1421 (0)	3938 (0.001)	1240 (0)	2387 (0.001)	24561 (0.005)	2016 (0.001)	2882 (0.001)	662 (0)
60	1563 (0)	19951 (0.005)	1831 (0)	4487 (0.001)	789 (0)	2720 (0.001)	23811 (0.005)	2273 (0.001)	2610 (0.001)	602 (0)
61	1790 (0)	18371 (0.004)	1797 (0)	3040 (0.001)	568 (0)	3408 (0.001)	16876 (0.004)	2114 (0)	2153 (0)	542 (0)
62	1931 (0)	24096 (0.006)	1503 (0)	2203 (0.001)	450 (0)	3635 (0.001)	24435 (0.006)	1949 (0)	1676 (0)	410 (0)
63	1664 (0)	26108 (0.006)	1459 (0)	1994 (0)	302 (0)	3174 (0.001)	20871 (0.006)	1822 (0)	1630 (0)	306 (0)
64	1640 (0)	26555 (0.006)	1263 (0)	1332 (0)	196 (0)	3170 (0.001)	29059 (0.007)	1720 (0)	1147 (0)	219 (0)
65	1463 (0)	26146 (0.006)	1032 (0)	724 (0)	96 (0)	2891 (0.001)	27956 (0.006)	1523 (0)	696 (0)	131 (0)
66	1675 (0)	26197 (0.006)	924 (0)	509 (0)	67 (0)	3484 (0.001)	30114 (0.007)	1421 (0)	523 (0)	81 (0)
67	1349 (0)	22390 (0.005)	743 (0)	322 (0)	32 (0)	3075 (0.001)	26183 (0.006)	1200 (0)	321 (0)	56 (0)
68	975 (0)	19314 (0.004)	401 (0)	195 (0)	24 (0)	2338 (0.001)	22038 (0.005)	999 (0)	321 (0.001)	75 (0)
69	753 (0)	13858 (0.003)	405 (0)	99 (0)	7 (0)	2070 (0)	17137 (0.004)	778 (0)	119 (0)	21 (0)
70	722 (0)	11293 (0.003)	364 (0)	59 (0)	7 (0)	1783 (0)	14105 (0.003)	678 (0)	74 (0)	17 (0)
71	528 (0)	7900 (0.002)	263 (0)	37 (0)	1 (0)	1038 (0)	9072 (0.002)	446 (0)	47 (0)	0 (0)
72	353 (0)	5298 (0.001)	169 (0)	18 (0)	1 (0)	1317 (0)	5938 (0.001)	345 (0)	23 (0)	5 (0)
73	288 (0)	3336 (0.001)	109 (0)	11 (0)	1 (0)	726 (0)	3577 (0.001)	238 (0)	11 (0)	2 (0)
74	160 (0)	2139 (0)	77 (0)	10 (0)	1 (0)	469 (0)	2295 (0.001)	174 (0)	12 (0)	1 (0)
75	110 (0)	1383 (0)	83 (0)	6 (0)	2 (0)	342 (0)	1355 (0)	106 (0)	6 (0)	0 (0)
76	52 (0)	881 (0)	46 (0)	1 (0)	1 (0)	215 (0)	704 (0)	78 (0)	3 (0)	0 (0)
77	32 (0)	526 (0)	24 (0)	1 (0)	0 (0)	126 (0)	430 (0)	55 (0)	6 (0)	2 (0)
78	21 (0)	306 (0)	29 (0)	0 (0)	0 (0)	72 (0)	247 (0)	34 (0)	2 (0)	1 (0)
79	13 (0)	234 (0)	12 (0)	0 (0)	0 (0)	31 (0)	157 (0)	15 (0)	3 (0)	0 (0)
80	6 (0)	182 (0)	12 (0)	2 (0)	1 (0)	32 (0)	108 (0)	10 (0)	1 (0)	0 (0)
81	5 (0)	89 (0)	8 (0)	0 (0)	0 (0)	12 (0)	37 (0)	6 (0)	1 (0)	0 (0)
82	4 (0)	17 (0)	3 (0)	0 (0)	0 (0)	7 (0)	30 (0)	4 (0)	1 (0)	0 (0)
83	3 (0)	26 (0)	3 (0)	0 (0)	0 (0)	4 (0)	20 (0)	1 (0)	0 (0)	0 (0)
84	0 (0)	2 (0)	2 (0)	0 (0)	0 (0)	1 (0)	6 (0)	3 (0)	0 (0)	0 (0)
85	0 (0)	1 (0)	0 (0)	0 (0)	0 (0)	0 (0)	1 (0)	0 (0)	0 (0)	0 (0)
86	0 (0)	2 (0)	1 (0)	0 (0)	0 (0)	1 (0)	5 (0			

Appendix 2

Statistical Data on Minutiæ

The main statistical findings from the study by Champod are presented in this appendix (Champod 1996; Champod and Margot 1996).

A2.1 THE MODEL

The study aimed at exploring the validity of a statistical model to compute match probabilities associated with level 2 features reduced to minutiæ. The postulated model suggests that the probability of a configuration of minutiæ, $\Pr(C)$, can be computed using the following equation:

$$\Pr(C) = \Pr(N) \cdot \Pr(T) \cdot \Pr(S) \cdot \Pr(D) \cdot \Pr(A)$$

where

$\Pr(N)$ = probability of a given number of minutiæ on the surface considered

$\Pr(T)$ = probability of the observed types of minutiæ (obtained by the multiplication of the probability of each minutia type)

$\Pr(S)$ = probability of the orientations of the minutiæ (obtained by the multiplication of the probability of the orientation for each minutia)

$\Pr(D)$ = probability of the length of minutiæ (when applicable, obtained by the multiplication of the probability of each minutia length)













$\Pr(A)$ = probability of the arrangement of the minutiæ

The probabilities for the number, type, orientation, and length of minutiæ — $\Pr(N)$, $\Pr(T)$, $\Pr(S)$, and $\Pr(D)$, respectively — have been studied.

A2.2 MINUTIÆ CONSIDERED

Two types of minutiæ are considered as fundamental points: ridge endings and bifurcations. From these two basic forms, it is possible to consider compound minutiæ resulting from the specific arrangement of these two fundamental points. Compound minutiæ are described in [Table A2.1](#). For each instance of combined

TABLE A2.1
Minutiæ Considered in the Study

Minutiæ	Illustration	Particular Case
Ridge ending		
Bifurcation		
Island (short ridge) and point or dot (particular case)		
Lake (enclosure)		
Opposed bifurcations and cross		
Bridge		
Double bifurcation and the trifurcation		
Hook (or spur)		
Bifurcation opposed with an ending		

minutiæ, maximum distance is used as a threshold to distinguish between the combined type and two distinct fundamental points.

A2.3 SAMPLE AND DATA ACQUISITION

The sample available for the study breaks down in [Table A2.2](#). The algorithms used (fully described by Champod [1996]) involved the following steps:

1. From an 8-bit gray-scale image of the fingerprint scanned at 800 dpi, a binary image is obtained by applying an adaptive threshold.
2. The image is then reduced to a skeleton and checked by an operator for its reliability.

TABLE A2.2
Breakdown of the Sample According to General Pattern and Ridge Count (RC)

Description	Number
Ulnar loops from right index finger (ridge count i: RC = 3–6)	217
Ulnar loops from right index finger (ridge count o: RC = 12–16)	104
Ulnar loops from right middle finger (ridge count i: RC = 3–6)	185
Ulnar loops from right middle finger (ridge count o: RC = 12–16)	180
Ulnar loops from left middle finger (ridge count i: RC = 3–6)	118
Whorls from right middle finger (ridge tracing meet)	173

3. The skeleton is then searched (walked through) for basic and combined minutiae. Decisions on categories are deterministically based on the number of branches and leaves and their angles.
4. For each detected minutia, its Cartesian coordinates from the core and the number of ridges from the core are recorded as well as the orientation defined relative to the vertical axis and the length of the minutiae (for combined minutiae only).

A2.4 STATISTICAL FINDINGS

A2.4.1 MINUTIAE DENSITY

It was found that the density of minutiae on the prints varied considerably — consistent with latent fingerprint examiner’s expectations — the delta and core area being more dense in terms of minutiae than the rest of the pattern. The process was modeled using a Poisson distribution of parameter λ being based on the density and depending only on the position of the minutiae on the print. [Table A2.3](#) shows the average density estimations according to the main positioning on the print.

This may seem obvious to fingerprint examiners, but this is the first time that the extent of this variation has been quantified. Also, modeling this distribution through a Poisson process allows us to predict the probability $\Pr(N)$ and, hence, not only the chance of a positive number of minutiae in a given area but also the absence of minutiae in a given area. This highlights the fact that the absence of minutiae over an extensive surface (an open field of uninterrupted ridges) also provides selectivity.

A2.4.2 LOCALIZED RELATIVE FREQUENCIES OF MINUTIAE TYPES

From the core of the fingerprint pattern, minutiae frequencies were analyzed within a ridge count radius of about 13. Further zones in the periphery (ridge counts from 11 to 25 from the core) were investigated above the core. It was observed that regions corresponding to the core or the delta presented more compound minutiae than the periphery of the print. So, when assessing the relative frequency of minutiae, the location on the fingerprint pattern has to be considered. The frequencies were shown not to vary with finger number, depending instead on the complexity of the pattern

(presence of one or two deltas). The independence assumptions postulated in the model were shown to be robust for most minutiae types except the short ridge.

TABLE A2.3
Average Minutiae Densities on the Core/Delta Area and Outside These Focal Points

Region Considered	Density of Minutiae per mm ²
Core/delta area	0.49
Out of core/delta area	0.18

Table A2.4 and Table A2.5 summarize the findings for the 804 loops and the 173 whorls, respectively.

A2.4.3 RELATIVE ORIENTATION OF MINUTIAE

Relative orientations were studied in 45° sectors about the core, excepting the delta areas (where the relative orientation was ill defined). Orientation was defined with reference to the vertical axis; minutiae creating ridges to the right were defined as positive, and minutiae creating ridges to the left were classified as negative. The results showed that negative orientation was more frequent for ulnar loops on the right hand and that the reverse was true for the ulnar loops on the left hand. In fact,

TABLE A2.4
Actual Counts and Relative Proportions of the Various Types of Minutiae Recorded in Three Areas of 804 Loops

Minutiae Type	Within Delta		Outside Delta		Periphery
	Zone	Zone	Zone	Zone	
Ridge ending	2763	(0.374)	6842	(0.455)	7070 (0.584)
Bifurcation	1002	(0.135)	3301	(0.22)	2515 (0.208)
Island	993	(0.134)	2313	(0.154)	1667 (0.138)
Lake	331	(0.045)	518	(0.034)	146 (0.012)
Opposed bifurcations	40	(0.005)	208	(0.014)	49 (0.004)
Bridge	523	(0.071)	231	(0.015)	121 (0.01)
Double bifurcation	688	(0.093)	716	(0.048)	v52 (0.004)
Hook	665	(0.09)	579	(0.039)	451 (0.037)
Bifurcation opposed with ridge ending	390	(0.053)	321	(0.021)	39 (0.003)

the relative orientations depend crucially on the presence of one or more deltas. As soon as this mirroring effect was taken into account for the loops, the orientation were shown to depend slightly on the minutiae type but were not affected by the

TABLE A2.5**Actual Counts and Relative Proportions of the Various Types of Minutiæ Recorded in Three Areas of 173 Whorls**

Minutiæ Type	Within Delta Zone		Outside Delta Zone		Periphery	
Ridge ending	1383	(0.422)	1308	(0.529)	1371	(0.635)
Bifurcation	595	(0.181)	521	(0.211)	393	(0.182)
Island	482	(0.147)	354	(0.143)	274	(0.127)
Lake	193	(0.059)	30	(0.012)	18	(0.008)
Opposed bifurcations	49	(0.015)	25	(0.01)	8	(0.004)
Bridge	62	(0.019)	18	(0.007)	17	(0.008)
Double bifurcation	197	(0.06)	105	(0.042)	7	(0.003)
Hook	223	(0.068)	79	(0.032)	62	(0.029)
Bifurcation opposed with ridge ending	96	(0.029)	33	(0.013)	10	(0.005)

finger number. Orientation results were obtained for 804 ulnar loops ([Table A2.6](#)) and 173 whorls ([Table A2.7](#)).

A2.4.4 LENGTH OF COMBINED MINUTIÆ

The length (in millimeters) of combined minutiæ was studied for given intervals (D1 to D5) defined in [Table A2.8](#), depending on their type. The results in [Table A2.9](#) show that, as soon as some conditioning was adopted for the short ridges (a function of their position within the delta pattern area), the length showed good independence behavior in the face of the number or orientation of the points.

TABLE A2.6**Actual Counts and Relative Proportions of the Orientations of Minutiæ Recorded in Three Areas of 804 Loops**

Minutiæ Type	Above Delta	Opposite Delta	Beside Delta
Ridge ending +	661 (0.31)	486 (0.33)	429 (0.17)
Ridge ending -	1461 (0.69)	967 (0.67)	2038 (0.83)
Bifurcation +	427 (0.41)	224 (0.21)	197 (0.22)
Bifurcation -	619 (0.59)	847 (0.79)	710 (0.78)
Other minutiæ +	126 (0.39)	23 (0.21)	83 (0.22)
Other minutiæ -	200 (0.61)	89 (0.79)	297 (0.78)

TABLE A2.7
Actual Counts and Relative Proportions of the Orientations of Minutiæ Recorded in Three Areas of 173 Whorls

Minutiæ Type	Above Left Delta		Above Right Delta	
Ridge ending +	113	(0.16)	407	(0.7)
Ridge ending -	612	(0.84)	176	(0.3)
Bifurcation +	47	(0.18)	185	(0.71)
Bifurcation -	215	(0.82)	74	(0.29)
Other minutiæ +	21	(0.38)	14	(0.27)
Other minutiæ -	35	(0.63)	37	(0.73)

TABLE A2.8
Definition of the Interval D1 to D5 in Function of the Type of Combined Minutiæ

	D1	D2	D3	D4	D5
Island	0-0.65	0.66-1.27	1.28-1.90	1.91-2.54	2.55-3.18
Lake	0-0.96	0.96-1.90	1.91-2.85	2.86-3.81	3.82-4.76
Other combined minutiæ	0-0.44	0.45-0.89	0.90-1.33	1.34-1.79	1.80-2.22

TABLE A2.9
Actual Counts and Relative Proportions of the Length of Minutiæ According to Their Type

	D1	D2	D3	D4	D5
Island (outside delta zone)	2563 (0.76)	333 (0.1)	211 (0.06)	142 (0.04)	143 (0.04)
Island (within delta zone)	442 (0.59)	96 (0.13)	75 (0.1)	79 (0.11)	58 (0.08)
Lake	272 (0.25)	418 (0.39)	195 (0.18)	116 (0.11)	71 (0.07)
Other combined minutiæ	267 (0.11)	497 (0.21)	517 (0.22)	530 (0.23)	536 (0.23)

Appendix 3

Fingerprint Detection Sequences

A3.1 GENERAL

The application of more than one technique or reagent for the detection of latent fingerprints can often increase the number of prints found or improve the quality of those already developed. However, it is imperative that reagents be employed in a systematic, predetermined order (Lennard and Margot 1988). The incorrect choice or application of one method can preclude the later use of another technique or lessen its effectiveness. Goode and Morris (1983) and the Home Office PSDB (Kent 1986, 1998) have proposed an extensive range of reagent sequences for the detection of latent prints on various surfaces. A number of systematic approaches to fingerprint development have also been suggested by Lee and Gaensslen (1988, 2001b). In addition, Allman and Pounds (1992b) reported on a recommended sequence of reagents for the development of both latent and blood marks at the crime scene. Ribaux and coworkers (1993) presented a computer-based approach to assist in the choice of a fingerprint detection sequence. The computer program, based on expert system technology, calculated an appropriate sequence of techniques based on a number parameters supplied by the user. Factors such as surface porosity, color, luminescence, fingerprint age, and whether or not the surface is or has been wet determined the choices made by the system. Unfortunately, the prototype system was never commercialized.

The proposed sequences for fingerprint detection and enhancement on particular surfaces, as presented in this book, should be considered as general recommendations only that will give satisfactory results in 70 to 80% of cases. Different situations and surfaces will necessitate the consideration of modified sequences or the application of other techniques. Operational laboratories should adapt sequences of this type to their own needs, based on available resources and conditions (techniques and instruments at hand, time limitations, etc.). In serious cases, where all possible means must be exploited regardless of cost or time, specialized laboratories should be contacted to apply more sophisticated fingerprint detection procedures (for example, vacuum metal deposition, radioactive enhancement, or computer image analysis).

A fingerprint detection sequence should, in all cases, commence with a nondestructive optical examination (such as with a forensic light source) before the appli-

cation of any other treatment. Standard safeguards should be employed, and prints developed at any stage in a sequence should be photographed under optimum conditions before proceeding. In this respect, the possibilities offered by modern digital image recording and enhancement should also be taken into consideration.

The use of exhaustive reagent sequences, as presented here, provides the greatest chance of latent fingerprint detection. This approach is recommended in all cases where the results obtained by one technique are insufficient. A relevant sequence should be followed until no further possibilities remain. Only then is it true to say that there are no detectable fingerprints.

A3.2 RECOMMENDED FINGERPRINT DETECTION SEQUENCES

A3.2.1 POROUS SURFACES

A3.2.1.1 Examples

Paper, cardboard, raw (untreated) wood.

A3.2.1.2 Recommended Sequence

[Figure A3.1](#) shows the recommended sequence of methods for the detection of latent fingermarks on wet and dry porous surfaces. A porous surface that has been wet (even if received dry) should be treated as a wet surface.

A3.2.2 NONPOROUS SURFACES

A3.2.2.1 Examples

Glass, plastic, metal, gloss-painted surfaces.

A3.2.2.2 Recommended Sequence

[Figure A3.2](#) shows the recommended sequence of methods for the detection of latent fingermarks on wet and dry nonporous surfaces. Where possible, wet surfaces should be allowed to dry at room temperature before proceeding.

A3.2.3 SEMIPOROUS SURFACES

A3.2.3.1 Examples

Glossy paper, wax paper, matte-painted surfaces.

A3.2.3.2 Recommended Sequence

[Figure A3.3](#) shows the recommended sequence of methods for the detection of latent fingermarks on wet and dry semiporous surfaces. Where possible, wet surfaces should be allowed to dry at room temperature before proceeding.

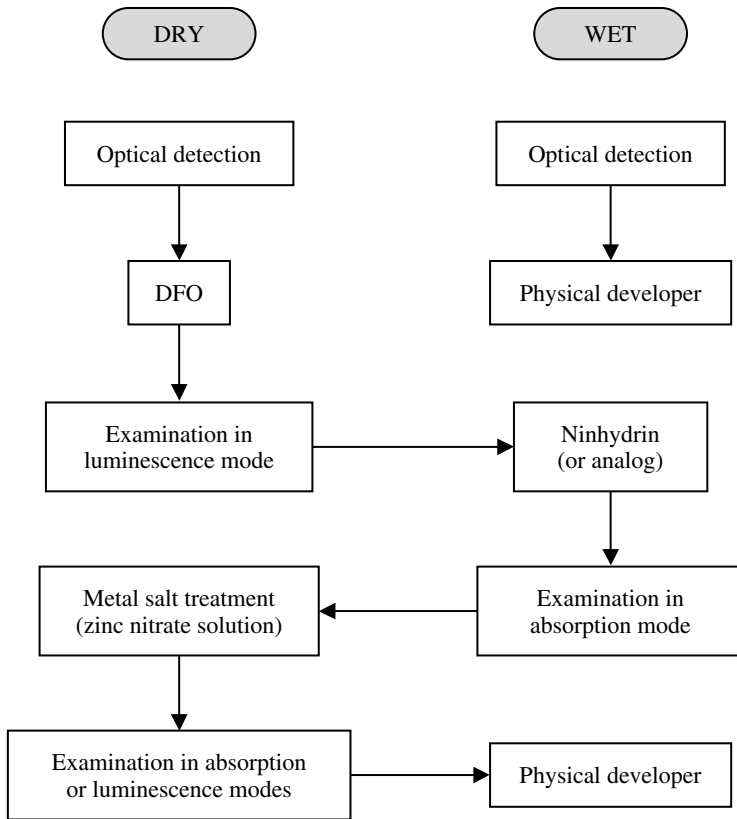

FIGURE A3.1 Recommended sequence of methods for detection of latent fingerprints on wet and dry porous surfaces (e.g., paper, cardboard). A porous surface that has been wet (even if received dry) should be treated as a wet surface.

A3.2.4 ADHESIVE SURFACES

A3.2.4.1 Examples

Adhesive side of self-adhesive tape, adhesive labels, etc.

A3.2.4.2 Recommended Sequence

Figure A3.4 shows the recommended sequence of methods for the detection of latent fingerprints on adhesive surfaces.

A3.2.5 FINGERMARKS IN BLOOD

A3.2.5.1 Examples

Fingermarks in blood, deposited on porous, semiporous, and nonporous surfaces.

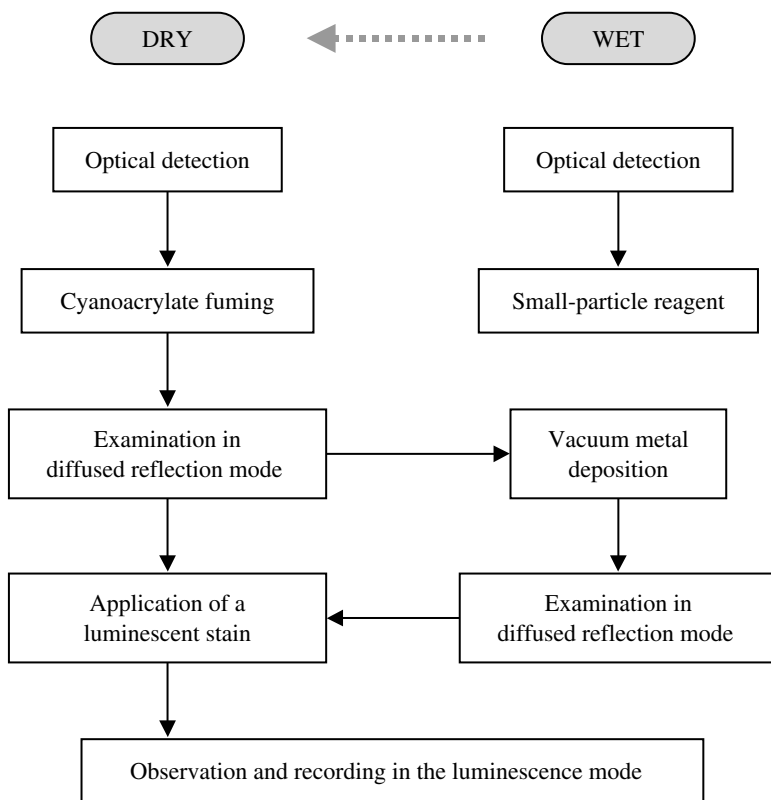

FIGURE A3.2 Recommended sequence of methods for the detection of latent fingerprints on wet and dry nonporous surfaces (e.g., plastic, glass, gloss-painted surfaces). Where possible, wet surfaces should be allowed to dry at room temperature before proceeding.

A3.2.5.2 Recommended Sequence

Figure A3.5 shows the recommended sequence of methods for the detection and enhancement of fingerprints in blood.

A3.2.6 HUMAN SKIN

A3.2.6.1 Examples

Fingerprints deposited on human skin (generally cadavers, as the chance of success on warm skin is extremely low).

A3.2.6.2 Recommended Sequence

Figure A3.6 shows the recommended sequence of methods for the detection of fingerprints on human skin.

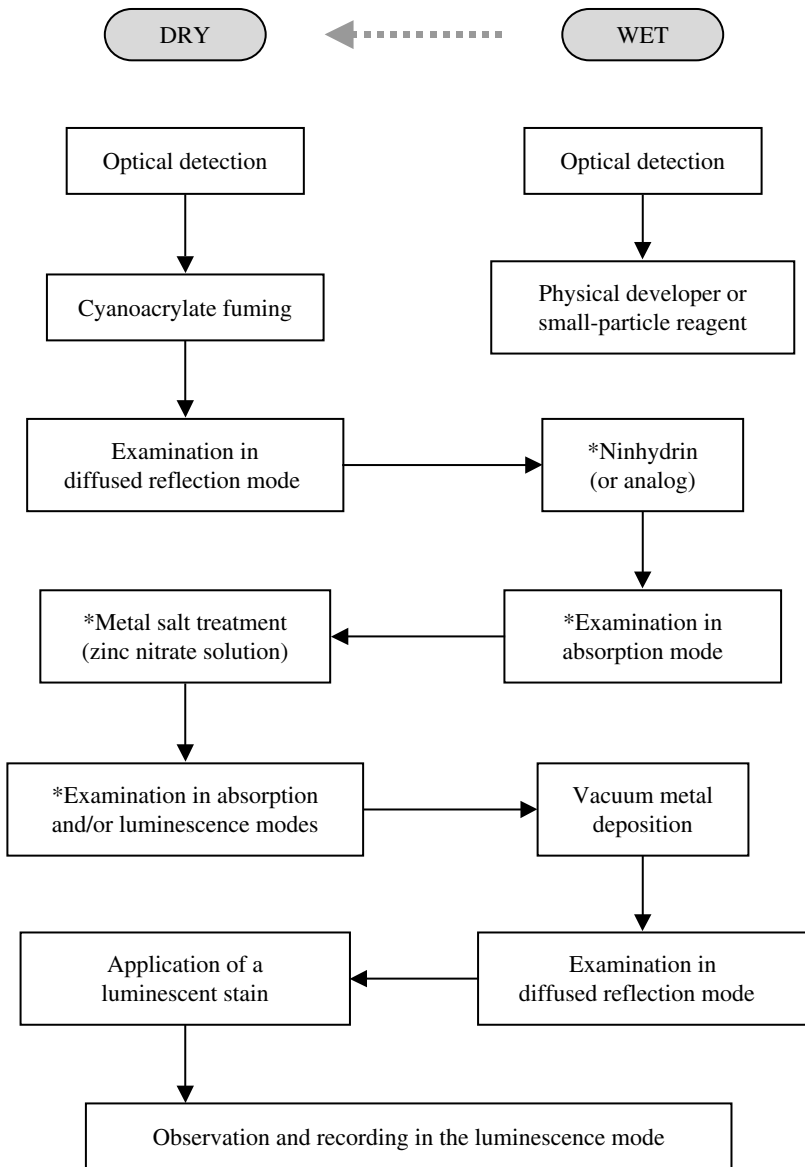

FIGURE A3.3 Recommended sequence of methods for the detection of latent fingerprints on wet and dry semiporous surfaces (e.g., wax paper, glossy paper). Where possible, wet surfaces should be allowed to dry at room temperature before proceeding. (*Skip if item has been wet.)

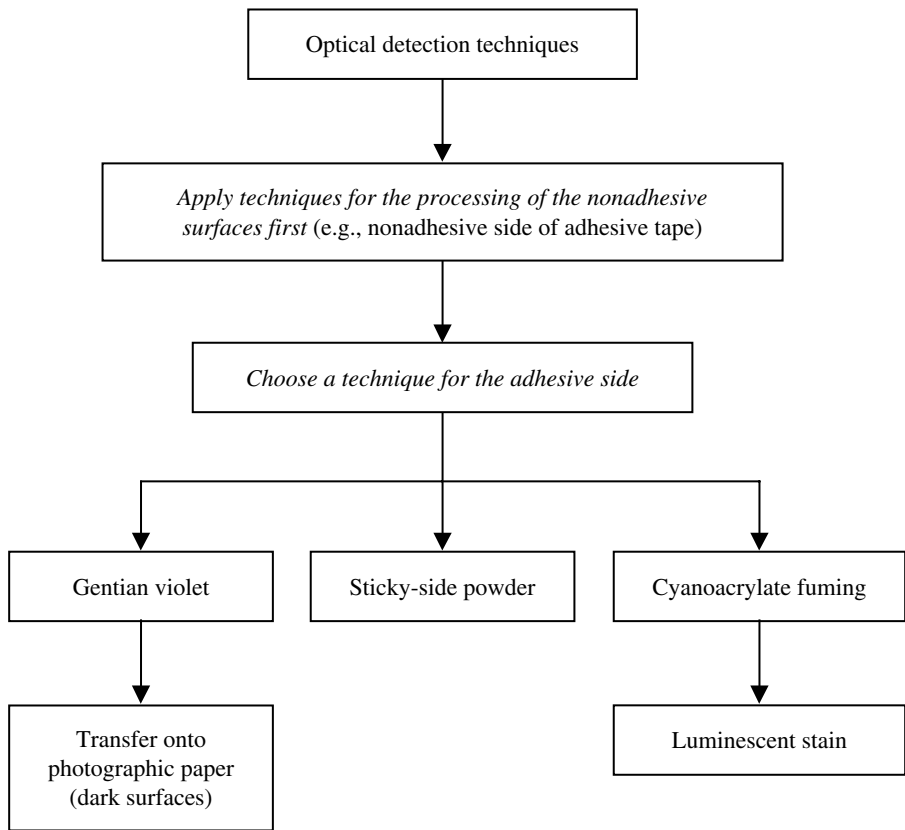

FIGURE A3.4 Recommended sequence of methods for the detection of latent fingerprints on adhesive surfaces.

A3.2.7 CRIME SCENE

A3.2.7.1 Examples

Fingermarks on fixed surfaces (porous and nonporous) at the crime scene.

A3.2.7.2 Recommended Sequence

Figure A3.7 shows the recommended sequence of methods for the exploitation of latent and bloody fingerprints at the crime scene.

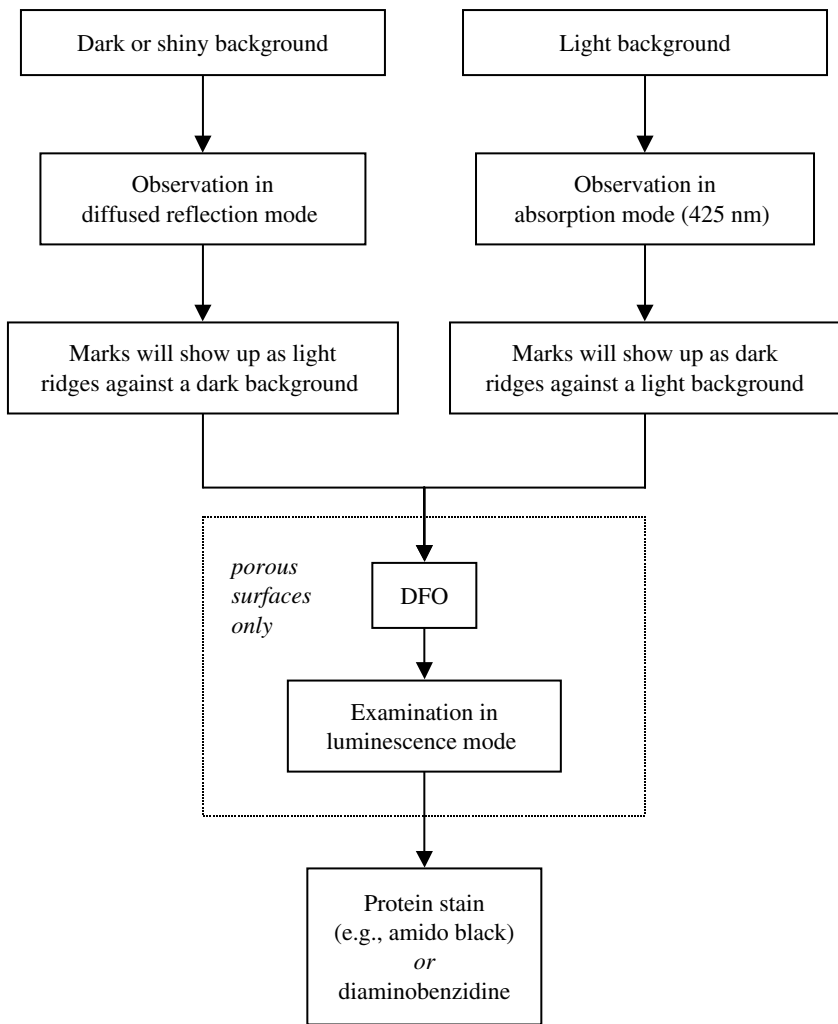

FIGURE A3.5 Recommended sequence of methods for the detection and enhancement of fingermarks in blood.

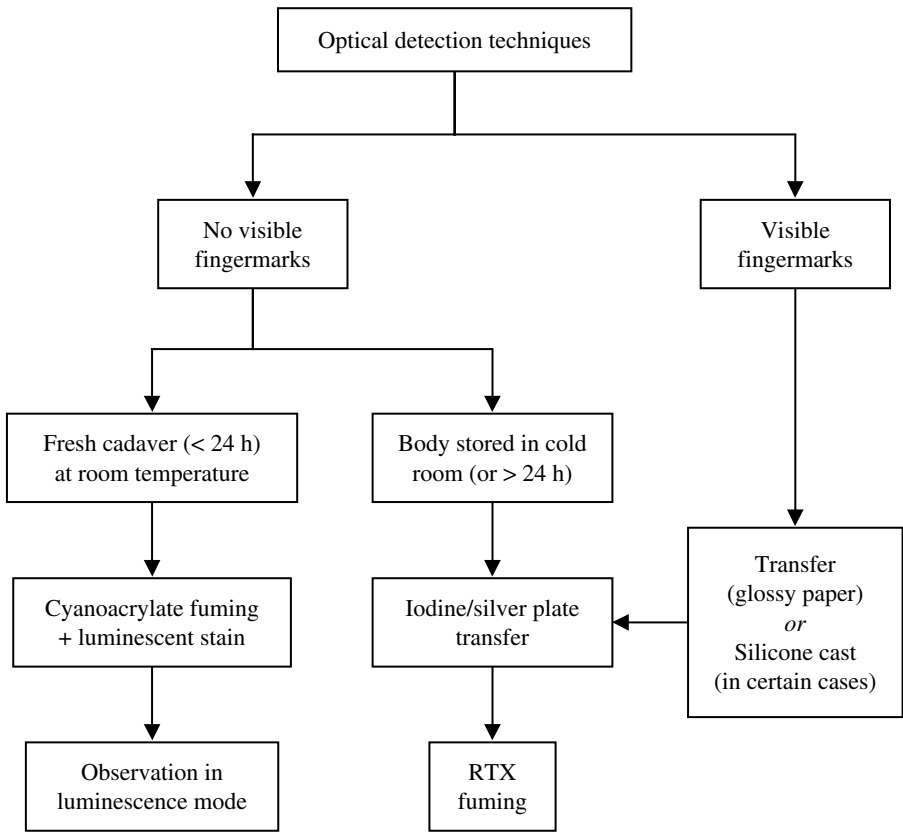

FIGURE A3.6 Recommended sequence of methods for the detection of fingerprints on human skin. (From Hébrard, J. and Donche, A. [1994], Fingerprint detection methods on skin: experimental study on 16 live subjects and 23 cadavers, *J. Forensic Identification*, 44, 623–627. With permission.)

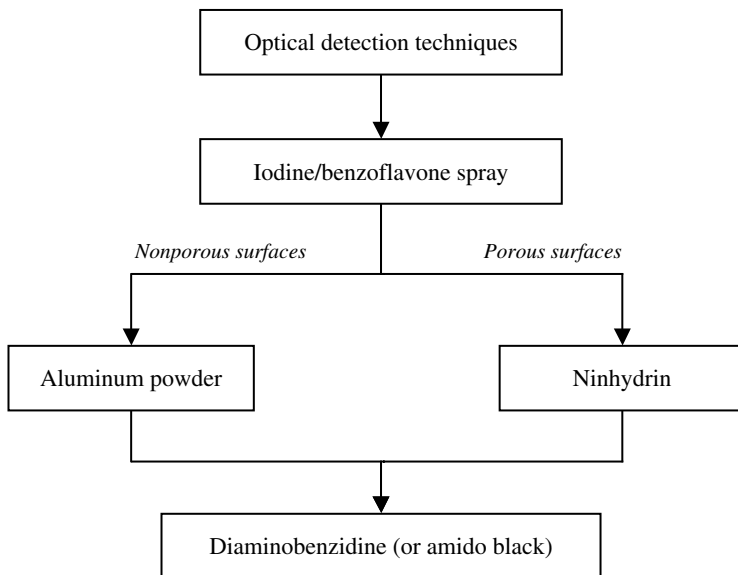

FIGURE A3.7 Recommended sequence of methods for the exploitation of latent and bloody fingermarks at the crime scene. (From Allman, D.S. and Pounds, C.A. [1992b], Sequence of Reagents To Be Used To Develop Fingerprints at a Scene of Crime, Technical CRSE No. 747, Central Research and Support Establishment, Home Office Forensic Science Service, Aldermaston, U.K. With permission.)

Appendix 4

Preparation and Application of Reagents

A4.1 AMIDO BLACK (AB)

A4.1.1 SURFACES

Amido black is a protein stain used specifically for the enhancement of fingermarks in blood on both porous and nonporous surfaces.

A4.1.2 PREPARATION

A4.1.2.1 Methanol-Based Formulation

Methanol-based formulation from Kent (1998):

- Staining solution:* amido black (2 g) is dissolved in methanol (900 ml) and acetic acid (100 ml)
- Washing solutions:* A: methanol, acetic acid (9:1)
B: distilled water, acetic acid (95:5)
C: distilled water

A4.1.2.2 Ethanol/Water-Based Formulation

Ethanol/water-based formulation from Sears and Prizeman (2000):

- Fixing solution:* 5-sulfosalicylic acid (20 g) is dissolved in distilled water (1000 ml)
- Staining solution:* amido black (1 g) is dissolved in ethanol (250 ml), acetic acid (50 ml), and distilled water (700 ml)
- Washing solution:* ethanol (250 ml) is mixed with acetic acid (50 ml) and distilled water (700 ml)

A4.1.3 APPLICATION

A4.1.3.1 Methanol-Based Formulation

Fingermarks in blood should be fixed by treatment with methanol for 5 min before staining. Treatment with amido black is achieved by immersion in the staining solution for 3 to 4 min. The sample is then washed successively in the three washing solutions to clear the background and improve fingerprint contrast. Developed marks are visible as dark blue ridges.

A4.1.3.2 Ethanol/Water-Based Formulation

Articles should be treated with the fixing solution for 5 min and then stained for 5 min. Treated surfaces should then be de-stained using the washing solution. Several changes of solution may be required to remove all excess stain. After a final water wash, the surface should be allowed to dry. The ethanol/water-based solution is nonflammable and nontoxic, making it suitable for use on all surfaces at the crime scene.

A4.2 CYANOACRYLATE — BASIC YELLOW 40 STAIN

A4.2.1 SURFACES

Basic yellow 40 is a luminescent stain for the enhancement of cyanoacrylate-developed marks on nonporous and semiporous surfaces.

A4.2.2 PREPARATION

Working solution: basic yellow 40 (1.5 g) is dissolved in methanol (1000 ml) — (filter if necessary)

A4.2.3 APPLICATION

1. Immerse the cyanoacrylate-treated item in the staining solution for 10 to 20 sec (or apply the staining solution to the surface of the item using a pipette).
2. Wash thoroughly with running water.
3. Dry at room temperature.
4. Examine in the luminescence mode: excitation 440 to 450 nm, observation from around 500 nm (e.g., OG515 long pass barrier filter).

A4.3 CYANOACRYLATE — RHODAMINE 6G STAIN

A4.3.1 SURFACES

Rhodamine 6G is a luminescent stain for the enhancement of cyanoacrylate-developed marks on nonporous and semiporous surfaces.

A4.3.2 PREPARATION

Stock solution: rhodamine 6G (0.4 g) is dissolved in isopropanol (400 ml) and methyl ethyl ketone (600 ml)

Working solution: stock solution (250 ml) is diluted with distilled water (750 ml)

A4.3.3 APPLICATION

1. Immerse the cyanoacrylate-treated item in the staining solution for 10 to 20 sec (or apply the staining solution to the surface of the item using a pipette).
2. Wash thoroughly with running water.
3. Dry at room temperature.
4. Examine in the luminescence mode: excitation 500 to 530 nm, observation from around 550 nm (e.g., KV550 long pass barrier filter).

A4.4 DIAMINOBENZIDINE (DAB)

A4.4.1 SURFACES

Diaminobenzidine (DAB) is a reagent specifically for the enhancement of fingermarks in blood on both porous and nonporous surfaces.

A4.4.2 PREPARATION

Stock solutions:

- A: 2% (w/v) 5-sulfosalicylic acid in distilled water (store at room temperature in a dark glass bottle)
- B: vials of buffer solution prepared by diluting 1M phosphate buffer pH 7.4* (10 ml) with distilled water (80 ml) (stored at room temperature) *(1M phosphate buffer pH 7.4 can be prepared as follows: potassium dihydrogen phosphate [26.8 g] and sodium hydrogen phosphate [142.9 g] dissolved in distilled water [1000 ml])
- C: aliquots of DAB solution prepared by dissolving diaminobenzidine tetrahydrochloride dihydrate (0.1 g) in distilled water (10 ml) (store at -20°C)
- D: 30% hydrogen peroxide solution

Working solution: One aliquot of DAB solution (solution C) is mixed with one vial of buffer solution (solution B), to which is then added 0.5 ml of 30% hydrogen peroxide solution (solution D) (the working solution is not stable and therefore should be made up just before use)

A4.4.3 APPLICATION

Fingermarks in blood are first fixed by immersion in the solution of 5-sulfosalicylic acid (solution A) for 5 min followed by washing with distilled water. Enhancement is then carried out by treatment of the marks with the DAB working solution over approximately 4 min. The developed marks, stained dark brown in color, are then washed with water and allowed to air dry.

For fixed surfaces at the crime scene, or on large objects, a paper towel can be overlaid on the surface to be treated to act as a reagent reservoir. After application of each solution, the paper towel is removed and discarded. A fresh paper towel is used for each treatment.

A4.5 DIAZAFLUORENONE (DFO)

A4.5.1 SURFACES

1,8-Diazafluoren-9-one (DFO) is an amino acid reagent for the detection of latent fingermarks on porous surfaces. Because heat is required for development, heat-sensitive articles cannot be treated with this reagent.

A4.5.2 PREPARATION

A4.5.2.1 HFE7100 Formulation

HFE7100 formulation from Kent (1998):

Working solution: to a solution of
DFO (0.25 g) in
methanol (30 ml) and
acetic acid (20 ml) is added
HFE71DE (275 ml) and
HFE7100 (725 ml)

A4.5.2.2 HFC4310 Formulation

HFC4310 formulation from Stoilovic and Lennard (2000):

Stock solution: to a solution of
DFO (4.0 g) in
dichloromethane (150 ml) is added
methanol (320 ml) and
acetic acid (30 ml)

Working solution: DFO stock solution (90 ml) is diluted with
HFC4310 (to 1000 ml)

A4.5.2.3 Petroleum Ether Formulation

Petroleum ether formulation from Stoilovic and Lennard (2000):

- Stock solution:* to a solution of
DFO (1.8 g) in
dichloromethane (120 ml) is added
methanol (240 ml) and
acetic acid (140 ml)
- Working solution:* DFO stock solution (100 ml) is diluted with
petroleum ether (to 1000 ml)

A4.5.3 APPLICATION

Items to be treated are briefly dipped in the working solution and then allowed to dry. Development is achieved by heating in an oven at 100°C for 20 min or heating in a clothes press (between sheets of absorbent paper) at 180°C for 10 sec. Strong latent marks may be visible under white light as pale pink/purple marks.

Treated marks are luminescent at room temperature using excitation in the 450- to 570-nm range with observation in the 550- to 650-nm region. Various wavelength combinations for the excitation and observation should be evaluated to obtain the best contrast with the surface. Possible filter combinations include excitation at 530 nm with observation at 590 nm, and excitation at 555 nm with observation at 610 nm.

The heating can be repeated if the luminescence has decreased over time due to quenching from the absorption of ambient humidity. In addition, weak marks can sometimes be enhanced by re-treatment with the DFO working solution and reheating.

A4.6 DIMETHYLAMINOCINNAMALDEHYDE (DMAC)

A4.6.1 SURFACES

The dry-transfer DMAC process can be applied to any paper surface, but it is particularly recommended for thermal paper (where reagents such as ninhydrin and DFO cannot be applied).

A4.6.2 PREPARATION

- DMAC solution:* DMAC (0.25 g) is dissolved in
methanol (100 ml)
- Dry-transfer sheets:* Soak clean sheets of copy paper in the DMAC solution
Remove and allow to dry at room temperature
Store the sheets in a snap-seal plastic bag
Store in a refrigerator (may be kept up to 12 months)

A4.6.3 APPLICATION

The dry-transfer method is implemented by placing one transfer sheet on each side of the exhibit. Aluminum foil is then placed on each side, and the “sandwich” placed

in a cold press for 30 to 60 min. While pale red marks may be visible after the treatment, examination and photography should be conducted in the luminescence mode, with excitation in the range 400 to 450 nm and observation in the range 470 to 530 nm. Developed marks should be reexamined after 24 hours, as luminescence intensity will generally increase over this period. (Dry-transfer sheets can be reused several times and then discarded.)

A4.7 GENTIAN VIOLET

A4.7.1 SURFACES

Gentian violet is a stain that can be used to develop latent fingermarks on adhesive surfaces such as the adhesive side of plastic-, paper-, and fabric-backed adhesive tapes.

A4.7.2 PREPARATION

Stock solution: gentian violet (5 g) and phenol* (10 g) are dissolved in ethanol (50 ml)
*(caution: phenol is very toxic)

Working solution: stock solution (1 ml) is diluted with distilled water
(add additional water if a gold film remains after mixing)

A4.7.3 APPLICATION

The solution can be applied with a pipette or by immersion. Tapes with a porous backing (paper or cloth) should be drawn across the surface of the solution, adhesive-side down. Excess reagent is removed by washing under a running tap. Latent fingermarks on the adhesive side of the tape are stained dark purple.

Fingermarks developed with gentian violet on dark surfaces are often difficult to visualize due to poor contrast. Such marks can be transferred onto photographic paper as follows. Prepare a solution of detergent: one drop of concentrated detergent in 1 l of tap water. After development of the marks with gentian violet, the adhesive tape is briefly immersed in the detergent solution. The excess solution is drained from the tape; the adhesive side of the tape is placed in contact with a sheet of fixed and washed white photographic paper (care should be taken that no air bubbles are formed between the adhesive side of the tape and the photographic paper); and the combined tape/paper is placed for 1 h in a press. The tape is peeled off the photographic paper; purple fingermark images should be visible on the paper due to diffusion of the gentian violet into the gelatin. If the transfer is of poor quality (bad contrast, for example), the transfer process can be repeated with a longer period in the press (up to 12 h).

A4.8 GUN BLUE

A4.8.1 SURFACES

Dilute gun-blue solution can be used to develop latent fingerprints on brass cartridge cases. The process can be applied after cyanoacrylate fuming and before the application of a luminescent stain.

A4.8.2 PREPARATION

A working solution is prepared by diluting commercial gun-blue solution with distilled or deionized water. The dilution factor will depend on the brand and strength of the commercial reagent. As a guide, Birchwood-Casey "Super Blue" has been successfully used as a 1-in-20 dilution (e.g., 1 ml of "Super Blue" diluted with 19 ml water). Experiments should be conducted with different dilutions before processing the evidential items.

A4.8.3 APPLICATION

Immerse the cartridge case in the gun-blue working solution and remove when sufficient fingerprint contrast is observed (typically 30 sec to 2 min). After treatment, the cartridge case is rinsed thoroughly with distilled or deionized water and dried. To limit further oxidation of the brass, the treated item should be sealed with varnish or coated with protective oil (e.g., "Ballistol" gun oil spray). Developed marks should be photographed immediately. If the gun-blue treatment is used in sequence after cyanoacrylate fuming and before application of a luminescent stain, then treatment of the cartridge case with varnish or oil is omitted.

A4.9 INDANEDIONE

A4.9.1 SURFACES

1,2-Indanedione is an amino acid reagent for the detection of latent fingerprints on porous surfaces. Developed marks are luminescent at room temperature without further treatment.

A4.9.2 PREPARATION

Working solution:
(Wiesner et al. 2001)

a solution of
indanedione (2 g) in
ethyl acetate (70 ml) is diluted with
HFE7100 (to 1000 ml)

Alternative:
(http://www.bvda.com/EN/prdct-inf/en_ind_1.html)

a solution of
indanedione (1 g) in
ethyl acetate (90 ml) and
acetic acid (10 ml) is diluted with
petroleum ether (to 1000 ml)

Note that, according to our preliminary results, the alternative solution that contains acetic acid gives better results, but the solution is unstable.

A4.9.3 APPLICATION

Items are dipped in the solution and then allowed to dry at room temperature. Recommended development is 100°C for 20 min at 60% relative humidity. Developed marks should be examined and photographed in the luminescence mode: excitation at 530 nm with observation through a 550-nm cutoff filter (Wiesner et al. 2001).

A4.10 IODINE/BENZOFLAVONE

A4.10.1 SURFACES

Iodine/benzoflavone spray can be applied at the crime scene on both porous and nonporous surfaces (e.g., wallpaper, matte and glossy painted surfaces, smooth brickwork/concrete, plasterboard, etc.).

A4.10.2 PREPARATION

Stock solutions (brush): A: 7,8-benzoflavone (12 g) is dissolved in dichloromethane (100 ml)

B: iodine (1 g) is dissolved in carrier solvent (1000 ml) (possible carrier solvents include CFC113 [Arklone], HFE7100, cyclohexane, or methyl cyclohexane [Brennan 2002])

Working solution: solution A (2 ml) is mixed with solution B (100 ml) and the combined reagent allowed to stand for 5 min, then filtered before use (the working solution should be prepared at the crime scene just before use)

A4.10.3 APPLICATION

The reagent is applied as a fine spray (commercial paint spray system or garden spray). Treated latent marks appear as dark blue images after evaporation of the solvent.

Caution: The spray reagent should only be used in a well-ventilated area with appropriate safety equipment (e.g., safety goggles, charcoal filter mask). When using flammable carrier solvents such as cyclohexane or methyl cyclohexane, the reagent must not be used near an ignition source.

A4.11 MULTIMETAL DEPOSITION I (MMDI)

A4.11.1 SURFACES

Multimetal deposition (MMD) can develop latent fingerprints on a wide range of porous, semiporous, and nonporous surfaces. However, the reagents are time-consuming to prepare and apply, which limit their routine application. MMD may be effective on difficult surfaces (e.g., some semiporous substrates such as latex and nitrile gloves) where other techniques are ineffective.

A4.11.2 PREPARATION

A4.11.2.1 Colloidal Gold

All solutions should be prepared using ultrapure, bidistilled water.

Stock solutions:

A: tetrachloroauric acid (gold chloride, 1 g) is dissolved in distilled water (10 ml)

B: sodium citrate (1 g) is dissolved in distilled water (100 ml)

C: citric acid (9.6 g) is dissolved in distilled water (100 ml)

Working solution:

1. Solution A (gold chloride, 1 ml) is added to distilled water (1000 ml)
2. Bring to a boil and add solution B (sodium citrate, 15 ml)
3. Boil gently for 10 min; the solution should be a deep ruby-red color
4. While still hot, stir in Tween 20 or Tween 80 (detergent, 5 ml); let the solution cool
5. Check the pH of the solution (pH meter) and add solution C (citric acid), 1 ml at a time, until a pH of 2.7 is obtained
6. Restore the volume to 1000 ml and check that the pH is still 2.7; store in a clean glass container

A4.11.2.2 Modified Physical Developer (PD)

- Redox solution:* The following chemicals are dissolved in distilled water (1000 ml), with constant stirring, **in the order that they are listed:**
1. ferric nitrate (16 g)
 2. ferrous ammonium sulfate (44 g)
 3. citric acid (11 g)
 4. 1% Tween 20 (0.25 ml)
- Silver nitrate solution:* Silver nitrate (20 g) is dissolved in distilled water (100 ml)
- Working solution:* **This should be made up just before use as it is only stable for about 10 min.**
1 part silver nitrate solution is mixed with 99 parts redox solution (example: 1 ml silver nitrate solution + 99 ml redox solution)

A4.11.3 APPLICATION

Treatment should be performed in a series of clean glass trays under artificial light (not under direct sunlight).

1. In the first dish, the article to be treated is washed with distilled water (about 10 min for nonporous items and 30 min for porous items). For dirty objects, several changes of water may be required.
2. After washing, the article is immersed in the colloidal gold solution (dish 2). The solution is gently agitated to aid development, which may take from 30 to 120 min, depending on the type of surface and the quality of the latent prints. Overdevelopment should be avoided, as this can lead to significant background coloration after the PD treatment. Prints developed at this stage are generally pale pink in color.
3. The sample is rinsed in distilled water (dish 3) — briefly for nonporous surfaces, about 15 min for porous items with, in this latter case, several changes of water.
4. The article is immersed in the freshly prepared modified PD solution (dish 4). Silver deposition will commence immediately and should be allowed to proceed until the best contrast between the prints and the surface is observed (this typically takes from 1 to 2 min).
5. The item should be thoroughly rinsed in distilled water (dishes 5 and 6) to remove excess PD. Tap water can be used for the final rinse.
6. The article is air-dried and the marks photographed. Developed marks will generally be dark gray to black in color.

A4.12 MULTIMETAL DEPOSITION II (MMDII)

A4.12.1 SURFACES

Multimetal deposition (MMD) can develop latent fingerprints on a wide range of porous, semiporous, and nonporous surfaces. However, the reagents are time-consuming to prepare and apply, which limits their routine application. MMD may be effective on difficult surfaces (e.g., some semiporous substrates such as latex and nitrile gloves) where other techniques are ineffective. MMDII is generally considered to be more sensitive than MMDI.

A4.12.2 PREPARATION

A4.12.2.1 Silanized Glassware

Silanization is recommended for all glassware used to prepare and employ the MMDII reagents. This can be achieved as follows:

1. Soak glassware overnight in a bath of 10% Extran (Niaproof Type 8; sodium 2-ethylhexyl sulfate).
2. Rinse well in hot water and then cold water.
3. Dry in an oven at 100°C.
4. Remove from oven and cool to room temperature.
5. Soak for 5 sec in a treatment solution prepared from 4 ml of 3-aminopropyl-triethoxysilane in 200 ml acetone.
6. Rinse twice in acetone.
7. Rinse twice in distilled water.
8. Dry in an oven overnight at 42°C.

Glassware that is silanized in this manner is resistant to numerous washings.

A4.12.2.2 Colloidal Gold

All solutions should be prepared using ultrapure, bidistilled water.

- Stock solutions:*
- A: tetrachloroauric acid (gold chloride, 1 g) is dissolved in distilled water (10 ml)
 - B: sodium citrate (1 g) is dissolved in distilled water (100 ml)
 - C: citric acid (9.6 g) is dissolved in distilled water (100 ml)
 - D: tannic acid (1 g) is dissolved in distilled water (100 ml)

- Working solution:*
1. Solution A (0.5 ml) is added to distilled water (400 ml)
 2. Separately mix distilled water (75 ml), solution B (20 ml), and solution D (0.1 ml)
 3. Heat the two mixtures separately to 60°C
 4. At 60°C, quickly add the second solution (sodium citrate and tannic acid) to the first (tetrachloroauric acid) while mixing vigorously
 5. Bring the mixture to boiling point; the solution should turn orange
 6. Allow to cool to room temperature
 7. Adjust the volume back to 500 ml with distilled water
 8. Allow to cool to room temperature; store in a plastic bottle in the fridge at 4°C
 9. Restore to room temperature immediately before use
 10. Add Tween 20 or Tween 80 (0.5 ml) with stirring
 11. Adjust the pH to 2.7 with solution C

A4.12.2.3 Modified Physical Developer

All solution should be prepared using ultrapure, bidistilled water.

Citrate buffer is prepared by mixing 24 parts citric acid solution (255 g citric acid in 1 l distilled water), 22 parts sodium citrate solution (235 g sodium citrate in 1 l distilled water), and 50 parts distilled water. The buffer should have a pH of 3.8 (add citric acid solution or sodium citrate solution to adjust the pH if necessary).

- Stock solutions:*
- A: silver acetate (0.2 g) is dissolved in distilled water (100 ml)
 - B: hydroquinone (1 g) is dissolved in citrate buffer (200 ml)
- Hydroquinone rinse*
- Solution B (100 ml) is diluted with distilled water (100 ml)
- PD working solution:*
- Solution A (100 ml) is mixed with Solution B (100 ml)
(prepare just before use)

A4.12.3 APPLICATION

The treatment should be performed in a series of silanized glass trays.

1. Wash the item before treatment:
 - Nonporous surfaces — pass quickly through distilled water
 - Porous surfaces — soak for approximately 2 min in distilled water
2. Immerse the exhibit in the colloidal gold solution for 5 to 15 min (gently agitate over this period).
3. Rinse in distilled water.
4. Soak for 2 to 5 min in the hydroquinone rinse.

5. Transfer the item to freshly prepared PD solution and soak for approximately 18 min at room temperature (the solution will become dark gray after 10 to 20 min, but this will not affect results).
6. Rinse in distilled water.
7. Fix with photographic fixer (diluted 1:9 with water) for 2 to 5 min.
8. Rinse with tap water.
9. Air-dry the article and photograph the marks. Developed marks will generally be dark gray in color.

A4.13 NINHYDRIN

A4.13.1 SURFACES

Ninhydrin is an amino acid reagent for the detection of latent fingerprints on porous surfaces.

A4.13.2 PREPARATION

A4.13.2.1 HFE7100 Formulation (Kent 1998)

Stock solution: ninhydrin (25 g) is dissolved in ethanol (225 ml), ethyl acetate (10 ml), and acetic acid (25 ml)

Working solution: ninhydrin stock solution (52 ml) is diluted with HFE7100 (1000 ml)

A4.13.2.2 HFC4310 Formulation (Stoilovic and Lennard 2000)

Stock solution: ninhydrin (40 g) is dissolved in ethanol (350 ml), ethyl acetate (50 ml), and acetic acid (100 ml)

Working solution: ninhydrin stock solution (50 ml) is diluted with HFC4310 (to 1000 ml)

A4.13.2.3 Petroleum Ether Formulation (Margot and Lennard 1994)

Working solution: ninhydrin (4 g) in methanol (20 ml) is added ethyl acetate (70 ml), acetic acid (10 ml), and petroleum ether (to 1000 ml)

A4.13.3 APPLICATION

Items to be treated are briefly immersed in the solution, removed, and air-dried. (For large items, the ninhydrin solution can be applied with a brush or spray.) Development should be allowed to proceed at room temperature, preferably in the dark, with a relative humidity of 50 to 80% over 24 to 48 h.

Ninhydrin-developed marks should be photographed under white light using a yellow bandpass filter (approx. 570 nm) in front of the camera. Ruhemann's purple shows a maximum absorption under these conditions, and thus improved contrast can normally be achieved.

A4.14 NINHYDRIN — METAL SALT TREATMENT

A4.14.1 SURFACES

Metal salt treatment is used for the enhancement of ninhydrin-developed marks on porous surfaces. This treatment can improve contrast in the absorption mode as well as inducing luminescence, particularly at liquid nitrogen temperature (-196°C). While both zinc and cadmium salts can be used, zinc metal salt treatment is preferred due to the toxicity of cadmium. Ninhydrin-developed marks should be photographed before proceeding with metal salt treatment.

A4.14.2 PREPARATION

Stock solution: to a solution of zinc nitrate (8 g) in ethanol (180 ml) is added acetic acid (20 ml)

Working solution: stock solution (6 ml) is diluted with carrier solvent (to 100 ml)^f

Suggested carrier solvents are HFC4310, HFE7100, pentane, or petroleum ether. Note that if the solution goes cloudy, more ethanol should be added with stirring.

A4.14.3 APPLICATION

Treat the ninhydrin-developed marks with the zinc nitrate solution by immersion or by application with a pipette. As the solvent evaporates, a color change (from purple to orange) should be observed, with the maximum absorption shifting to around 490 nm. Enhancement photography of zinc post-treated marks can therefore be achieved in the absorption mode with a 490-nm bandpass barrier filter in front of the camera (or using illumination from a forensic light source operating at this wavelength).

Of more significance than the color change is the luminescence produced by the zinc complex that is formed. The sample is inspected under a forensic light source operating at 490 nm, with observation using a 550- to 570-nm bandpass filter or a 550-nm long pass filter. To favor the luminescence, the sample is cooled to liquid nitrogen temperature (-196°C), which is achieved by placing the sample in an insulated container (such as a polystyrene foam tray) and covering it with a thin layer of liquid nitrogen. The fingerprint luminescence is often weak, and therefore photographic recording generally requires long exposure times (from a few seconds to several minutes).

A4.15 PHYSICAL DEVELOPER (PD)

A4.15.1 SURFACES

Physical developer (PD) can be used for the detection of latent fingerprints on porous surfaces that are or have been wet (a condition that precludes amino acid reagents).

A4.15.2 PREPARATION

All glassware used must be scrupulously clean and free from any contamination. Only good-quality distilled or deionized water should be employed to prepare the solutions. The solutions should only be prepared and manipulated in glass receptacles and away from direct sunlight.

<i>Detergent solution:</i>	N-dodecylamine acetate (4 g) and Synperonic N (4 g) are dissolved in water (1000 ml) (store at least 24 hours before use)
<i>Silver nitrate solution:</i>	silver nitrate (10 g) is dissolved in water (50 ml)
<i>Redox solution:</i>	ferric nitrate (30 g), ferrous ammonium sulfate (80 g), and citric acid (20 g) are added successively (in that order) to water (900 ml) with stirring after dissolution, add detergent solution (40 ml) and stir for 2 min
<i>Maleic acid solution:</i>	maleic acid (25 g) is dissolved in water (1000 ml)
<i>Working solution:</i>	silver nitrate solution (50 ml) is added slowly with stirring to redox solution (940 ml) (stable for up to 1 week if stored in a clean, dark bottle)

A4.15.3 APPLICATION

Treatment should be performed in a series of clean glass trays under artificial light (not under direct sunlight).

1. Wash the sample in distilled (or deionized) water to remove dirt or other surface contamination. This may need to be repeated several times with fresh distilled water if the samples are particularly dirty or if they have been previously treated with ninhydrin or DFO.
2. Soak the sample in the maleic acid solution for 5 min.
3. Rinse the sample in distilled (or deionized) water.

4. Introduce the sample into the PD solution — any latent marks on the surface should develop as dark gray images against a light gray background (the optimum development time ranges from 10 to 30 min). The sample is removed when the best fingerprint contrast is observed.
5. Rinse the sample in distilled (or deionized) water.
6. Repeat the water rinse several times until the rinse water is clear.
7. Allow the sample to dry at room temperature.

Samples can be re-treated with the reagent, but any developed fingerprint must be photographed before proceeding with a second treatment. Avoid overdevelopment with PD, as the treatment cannot be reversed.

Contrast in marks developed with PD on dark surfaces (such as brown paper) can sometimes be improved by immersion of the article in a solution of 50% household bleach and 50% tap water for 2 to 3 min. After treatment, the item is thoroughly rinsed with water and dried.

A4.16 RUTHENIUM TETROXIDE (RTX)

A4.16.1 SURFACES

Ruthenium tetroxide (RTX) vapor reacts with sebaceous material in the latent fingerprint deposit and can be used to develop marks on a range of porous, semiporous, and nonporous surfaces. Developed marks are dark gray in color.

A4.16.2 PREPARATION

- Solution A:* ruthenium(III) chloride hydrate (1 g) is dissolved in distilled water (1000 ml)
- Solution B:* ceric ammonium nitrate (113 g) is dissolved in distilled water (1000 ml)

A4.16.3 APPLICATION

Equal volumes of solutions A and B are mixed together in an enclosed container (plastic wash bottle or glass fuming chamber). Items to be treated are exposed to the RTX fumes that are slowly generated from the mixed solution. Using a plastic wash bottle, the fumes can be directed from the nozzle onto the surface under investigation. Fingermarks generally develop as dark gray images after several minutes (typically 10 to 20 min in the case of a glass fuming chamber).

On some surfaces, fingerprints may develop by direct immersion in the mixed solution. This is especially the case for nonporous surfaces such as plastic. This possibility should be tested on a similar surface before treating the evidential item.

The treatment should be conducted in a laboratory fume hood (or with adequate ventilation), as RTX vapor is irritating to the eyes and respiratory tract. Treatment with RTX may preclude any subsequent fingerprint development by conventional techniques such as cyanoacrylate and DFO.

A4.17 SILVER NITRATE

A4.17.1 SURFACES

Silver nitrate reacts with chlorides in the fingermark deposit and can be used on porous surfaces such as paper and untreated wood.

A4.17.2 PREPARATION

Working solution: silver nitrate (2 g) is dissolved in
methanol (100 ml)
(light sensitive; store in a dark bottle)

A4.17.3 APPLICATION

The solution can be applied with a pipette, by immersion, or by spraying. After treatment, the article is exposed to a source of UV light (such as sunlight, light from a xenon arc lamp, or a UV lamp) until the best contrast between the developed marks and the background is observed. Developed marks, usually dark brown to black in color, must be photographed immediately, and the treated items stored in the dark. (The darkening of the surface with time will be more pronounced with exposure to light.)

A4.18 SMALL-PARTICLE REAGENT (SPR)

A4.18.1 SURFACES

Small-particle reagent (SPR) is a wet powdering technique for the detection of latent fingermarks on wet nonporous surfaces (glass, plastic, paint, metal, etc.).

A4.18.2 PREPARATION

Detergent solution: Tergitol 7 (4 ml) is mixed with
water (500 ml)
Stock solution: molybdenum disulfide powder* (15 g) is mixed with
detergent solution (100 ml)
*(Rocol AS powder, Molibond, or equivalent)
Working solution: stock solution (100 ml) is diluted with
water (900 ml)

A4.18.3 APPLICATION

The best method for application of SPR is by spraying (using a handheld garden spray, for example). The spray bottle must be shaken well before application, since the molybdenum disulfide particles tend to settle on the bottom of the spray bottle

when not in use. After treatment with SPR, the surface is rinsed with water to remove excess. The treatment can be repeated several times, if necessary, to obtain sufficient contrast. Marks developed with this method can be dried and lifted as for marks developed using conventional powder.

A4.19 STICKY-SIDE POWDER

A4.19.1 SURFACES

Sticky-side powder is a thick powder suspension for the development of latent fingerprints on the sticky side of adhesive tape. The method can develop excellent fingerprints and is recommended as an effective replacement for gentian violet on most adhesive surfaces.

A4.19.2 PREPARATION

Detergent solution:

Photoflo™ 200 (10 ml) is mixed with water (10 ml)

Working solution:

black fingerprint powder (e.g., Lightning Black™ Powder) is mixed with sufficient detergent solution to form a suspension that has the consistency of paint

Author:
Trademark?

A4.19.3 APPLICATION

1. Paint the adhesive surface with the powder suspension using a soft brush.
2. Leave for 10 sec to 1 min.
3. Rinse the tape gently under slowly running cold water.
4. Repeat steps 1 to 3 if necessary.
5. Dry the tape at room temperature.
6. Photograph the developed prints in the absorption mode.

References

- Adcock, J.M. (1977), The development of latent fingerprints on human skin: the silver plate method, *J. Forensic Sci.*, 22, 599–605.
- Aguzzi, A. (2002), Le Potentiel des Traces Digitales pour Lier les Cas, technical report, Institut de Police Scientifique et de Criminologie, Université de Lausanne, Switzerland.
- Aitken, C.G.G. (1995), *Statistics and the Evaluation of Evidence for Forensic Scientists*, V. Barnett, Ed., Chichester: John Wiley & Sons.
- Allman, D.S. and Pounds, C.A. (1991a), Diaminobenzidine: A Simple, Safe and Sensitive Method for the Enhancement of Blood Marks at Scene of Crime and in the Laboratory, Technical CRSE No. 773, Central Research and Support Establishment, Home Office Forensic Science Service, Aldermaston, U.K.
- Allman, D.S. and Pounds, C.A. (1991b), Detection of fingerprints on skin, *Forensic Sci. Rev.*, 3, 83–89.
- Allman, D.S., Maggs, S.J., and Pounds, C.A. (1992), The Use of Colloidal Gold / Multi-Metal Deposition for the Detection of Latent Fingerprints — A Preliminary Evaluation, Technical No. 747, Central Research and Support Establishment, Home Office Forensic Science Service, U.K.
- Allman, D.S. and Pounds, C.A. (1992a), The Specificity of Diaminobenzidine for the Detection of Blood, Technical CRSE No. 771, Central Research and Support Establishment, Home Office Forensic Science Service, Aldermaston, U.K.
- Allman, D.S. and Pounds, C.A. (1992b), Sequence of Reagents To Be Used To Develop Fingerprints at a Scene of Crime, Technical CRSE No. 747, Central Research and Support Establishment, Home Office Forensic Science Service, Aldermaston, U.K.
- Almog, J., Hirshfeld, A., and Klug, J.T. (1982), Reagents for the chemical development of latent fingerprints: synthesis and properties of some ninhydrin analogues, *J. Forensic Sci.*, 27, 912–917.
- Almog, J. (1986), personal communication.
- Almog, J., Hirshfeld, A., Sterling, J., and Leonov, D. (1991), Aminoninhydrins: fingerprint reagents with direct fluorogenic activity — preliminary studies, *J. Forensic Sci.*, 36, 101–110.
- Almog, J. (1992), personal communication.
- Almog, J., Hirshfeld, A., Franck, A., Grant, Z., and Ittah, Y. (1992), 5-Methylthio-ninhydrin and related compounds: a novel class of fluorogenic fingerprint reagents, *J. Forensic Sci.*, 37, 688–694.
- Almog, J., Springer, E., Wiesner, S., Frank, A., Khodzhaev, O., Lidor, R., Bahar, E., Varkony, H., Dayan, S., and Rozen, S. (1999), Latent fingerprint visualisation by 1,2-indanedione and related compounds: preliminary results, *J. Forensic Sci.*, 44, 114–118.
- Almog, J., Sears, V.G., Springer, E., Hewlett, D.F., Walker, S., Wiesner, S., Lidor, R., and Bahar, E. (2000), Reagents for the chemical development of latent fingerprints: scope and limitations of benzo[f]ninhydrin in comparison to ninhydrin, *J. Forensic Sci.*, 45, 538–544.

- Almog, J. (2001), Fingerprint development by ninhydrin and its analogues, in *Advances in Fingerprint Technology*, 2nd ed., H.C. Lee and R.E. Gaensslen, Eds., Boca Raton, FL: CRC Press, pp. 177–209.
- Amy, L. (1946), Valeur de la preuve en dactyloscopie, *J. Société Statistique Paris*, 87, 80–87.
- Amy, L. (1947), Valeur de la preuve en dactyloscopie II, *J. Société Statistique Paris*, 88, 189–195.
- Amy, L. (1948), Recherches sur l'identification des traces papillaires, *Annales Médecine Légale*, 28, 96–101.
- Andersen, J. and Bramble, S. (1997), The effects of fingermark enhancement light sources on subsequent PCR-STR DNA analysis of fresh bloodstains, *J. Forensic Sci.*, 42, 303–306.
- Angst, E. (1962), Procédés pour la détermination de l'âge d'empreintes dactyloscopiques sur le papier, *Revue Internationale Criminologie Police Technique*, 16, 134–146.
- Anon. (1911), No two finger prints alike, *Sci. Am.*, 166–167.
- Anon. (1970), Convention action, *Identification News*, 20, 10–11.
- Anon. (1971), Standards committee, *Identification News*, 21, 14–15.
- Anon. (1972), An analysis of standards in fingerprint identification, *FBI Law Enforcement Bull.*, 39, 7–11.
- Anon. (1973), International Association for Identification: standardization committee report, *FBI Law Enforcement Bull.*, 42, 7–8.
- Anon. (1979), Resolution VII, *Identification News*, 29, 12.
- Anon. (1980), Resolution VII amended, *Identification News*, 30, 3.
- Anon. (1992), Editorial comment, *J. Forensic Identification*, 42, 218
- Anon. (2002), European fingerprint standards (a “pointless” exercise), *Fingerprint Whorld*, 28, 19.
- Anthonzioz, A., Aguzzi, A., Girod, A., Egli, N., and Ribaux, O. (2003), Potential use of fingerprint in forensic intelligence: crime scene linking, *Z Zagadnien Nauk Sadowych — Probl. Forensic Sci.*, 51, 166–170.
- Arndt, C.B. (1985), Iodine silver plate transfer method, *RCMP Gaz.*, 47 (5), 19–21.
- Asano, K.G., Bayne, C.K., Horsman, K., and Buchanan, M.V. (2002), Chemical composition of fingerprints for gender determination, *J. Forensic Sci.*, 47, 805–807.
- Ashbaugh, D.R. (1982a), Edgeology / poroscopy / ridgeology — our next evaluative step, *RCMP Gaz.*, 44 (2), 4–6; 45 (2), 12–17; 45 (3), 10–14.
- Ashbaugh, D.R. (1982b), Poroscopy, *Fingerprint Whorld*, 19, 5–12.
- Ashbaugh, D.R. (1991a), Ridgeology, *J. Forensic Identification*, 41, 16–64.
- Ashbaugh, D.R. (1991b), Palmar flexion crease identification, *J. Forensic Identification*, 41, 255–273.
- Ashbaugh, D.R. (1991c), Ridgeology — modern evaluative friction ridge identification, *Fingerprint Whorld*, 17, 14–16.
- Ashbaugh, D.R. (1992), Incipient ridges and the clarity spectrum, *J. Forensic Identification*, 42, 106–114.
- Ashbaugh, D.R. (1999a), A science in transition, in *First International Conference on Forensic Human Identification in the Next Millennium*, London: The Forensic Science Service; www.forensic.gov.uk.
- Ashbaugh, D.R. (1999b), *Qualitative-Quantitative Friction Ridge Analysis — An Introduction to Basic and Advanced Ridgeology*, V.J. Geberth, Ed., Boca Raton, FL: CRC Press.
- Aubert, P. (1877–1878), Des modifications subies par la sécrétion de la sueur dans les maladies de la peau, *Annales Dermatologie Syphiligraphie*, 9, 359–373.
- Auvdel, M.J. (1988), Comparison of laser and high-intensity quartz arc tubes in the detection of body secretions, *J. Forensic Sci.*, 33, 929–945.

- Azoury, M., Zamir, A., Oz, C., and Wiesner, S. (2002), The effect of 1,2-indanedione, a latent fingerprint reagent on subsequent DNA profiling, *J. Forensic Sci.*, 47, 586–588.
- Babler, W.J. (1987), Prenatal development of dermatoglyphic patterns: associations with epidermal ridge volar pad and bone morphology, *Collegium Anthropologicum*, 11, 297–303.
- Babler, W.J. (1991), Embryologic development of epidermal ridges and their configurations, in *Dermatoglyphics — Science in Transition*, Vol. 27 (2), C.C. Plato, R.M. Garruto, B.A. Schaumann, and N.W. Paul, Eds., New York: Wiley-Liss, pp. 95–112.
- Balthazard, V. (1911), De l'identification par les empreintes digitales, *Comptes Rendus des Séances de l'Académie des Sciences*, 152, 1862–1864.
- Baniuk, K. (1990), Determination of age of fingerprints, *Forensic Sci. Int.*, 46, 133–137.
- Baniuk, K. (2000), Importance of laboratory experiment in fingerprint age determination, *Problemy Kryminalistyki*, 228, 69–72.
- Barker, D.A. (1999), Contrast from the past, *J. Forensic Identification*, 49, 589–593.
- Barnum, C.A. and Klasey, D.R. (1997), Factors affecting the recovery of latent prints on firearms, *J. Forensic Identification*, 47, 141–147.
- Batey, G.W., Copeland, J., Donnelly, D.L., Hill, C.L., Laturnus, P.L., McDiarmid, C.H., Miller, K.J., Misner, A.H., Tarjo, A., and Yamashita, A.B. (1988), Metal deposition for latent print development, *J. Forensic Identification*, 48, 165–175.
- Bazen, A.M. (2002), *Fingerprint Identification — Feature Extraction, Matching and Database Search*, Enschede, Netherlands: Twente University Press.
- Beavan, C. (2001), *Fingerprints — The Origins of the Crime Detection and the Murder Case that Launched Forensic Science*, New York: Hyperion.
- Bentsen, R.K., Brown, J.K., Dinsmore, A., Harvey, K.K., and Kee, T.G. (1996), Post firing visualisation of fingerprints on spent cartridge cases, *Sci. Justice*, 36, 3–8.
- Ben-Yosef, N., Almog, J., Frank, A., Springer, E., and Cantu, A.A. (1998), Short UV luminescence for forensic applications: design of a real-time observation system for detection of latent fingerprints and body fluids, *J. Forensic Sci.*, 43, 299–304.
- Benzoni, M. (1994), Evaluation du RTX pour la Révélation des Empreintes Digitales, technical report, Institut de Police Scientifique et de Criminologie, Université de Lausanne, Switzerland.
- Berg, E. (1996), Digital enhancement and transmission of latent prints — who will set the standards? *J. Forensic Identification*, 46, 573–580.
- Berg, E. (2000), Legal ramifications of digital imaging in law enforcement, *Forensic Sci. Commun.*, 2 (4), <http://www.fbi.gov/hq/lab/fsc/backissu/oct2000/berg.htm>.
- Bergeron, J. (2003), Development of bloody prints on dark surfaces with titanium dioxide and methanol, *J. Forensic Identification*, 53, 149–161.
- Berry, J. and Stoney, D.A. (2001), The history and development of fingerprinting, in *Advances in Fingerprint Technology*, 2nd ed., H.C. Lee and R.E. Gaensslen, Eds., Boca Raton, FL: CRC Press, 1–40.
- Bertillon, A. (1885) Instructions signaletiques, Imprimerie administrative, Melun, France.
- Bertillon, A. (1912), Notes et observations médico-légales — les empreintes digitales, *Archives d'Anthropologie Criminelle, de Médecine Légale et de Psychologie Normale et Pathologique*, 27, 36–52.
- Bettencourt, D.S. (1991), A compilation of techniques for processing deceased human skin for latent prints, *J. Forensic Identification*, 41, 111–120.
- Blackledge, R.D. (1998), Re: “Latent print processing by the ruthenium tetroxide method” [letter plus editor's reply], *J. Forensic Identification*, 48, 557–559.

- Blitzer, H.L. and Jacobia, J. (2002), *Forensic Digital Imaging and Photography*, San Diego: Academic Press.
- Bobev, K. (1995), Fingerprints and factors affecting their conditions, *J. Forensic Identification*, 45, 176–183.
- Bohanan, A.M. (1998), Latents from pre-pubescent children versus latents from adults, *J. Forensic Identification*, 48, 570–573.
- Bonnevie, K. (1924), Studies on papillary patterns of human fingers, *J. Genet.*, 15, 1–115.
- Bramble, S.K., Creer, K.E., Qiang, G., and Sheard, B. (1993), Ultraviolet luminescence from latent fingerprints, *Forensic Sci. Int.*, 59, 3–14.
- Bramble, S.K. and Jackson, G.R. (1994), Operational experience of fingermark enhancement by frequency domain filtering, *J. Forensic Sci.*, 39, 920–932.
- Bramble, S.K. (1995), Separation of latent fingermark residue by thin-layer chromatography, *J. Forensic Sci.*, 40, 969–975.
- Bramble, S.K. and Fabrizi, P.M. (1995), Some observations on the effects of image processing functions on fingermark data in the fourier domain, in *Investigative and Trial Image Processing*, San Diego, Cal.: SPIE (International Society for Optical Engineering), pp. 138–144.
- Bramble, S.K., Cantu, A.A., Ramotowski, R.S., and Brennan, J.S. (2000), Deep red to near infrared (NIR) fluorescence on gentian violet-treated latent prints, *J. Forensic Identification*, 50, 33–49.
- Bratton, R.M. and Juhala, J.A. (1995), DFO — dry, *J. Forensic Identification*, 45, 169–172.
- Bratton, R.M. and Gregus, J. (1996), A Black Powder Method to Process Adhesive Tapes, in *Proceedings of the International Symposium on Fingerprint Detection and Identification*, Israel National Police, Ne'urim, Israel, June 26–30, 1995, pp. 143–147.
- Bratton, R.M. and Gregus, J. (1997), Development of a black powder method to process adhesive tapes, *Fingerprint Whorld*, 27, 21–23.
- Brennan, J.S., Bramble, S.K., Crabtree, S., and Wright, G. (1995), Fuming of latent fingerprint using dimethylaminocinnamaldehyde, *J. Forensic Identification*, 45, 373–380.
- Brennan, J.S. (1996), The Development of Fingerprints by Fuming with Dimethylaminocinnamaldehyde (DMAC), in *Proceedings of the International Symposium on Fingerprint Detection and Identification*, Israel National Police, Ne'urim, Israel, June 26–30, 1995, pp. 85–90.
- Brennan, J.S., Davies, L.M., Bramble, S.K., Rollins, V., and Rollins, A. (2001), Isomark Spray: A novel method for the replication of marks, *J. Forensic Identification*, 51, 572–580.
- Brennan, J.S. (2002), personal communication.
- Bridges, B.C. (1963), *Practical Fingerprinting*, New York: Funk and Wagnalls.
- Brown, M. (2000), Is digital better than film, *Digital Photogr. Design*, autumn, 22–27.
- Buchanan, M.V., Asano, K., and Bohanon, A. (1996), Chemical characterization of fingerprints from adults and children, in *Forensic Evidence Analysis and Crime Scene Investigation*, Boston: SPIE (International Society for Optical Engineering), pp. 89–95.
- Bullard, B. and Birge, B. (1996), Applications of a digital darkroom in the forensic laboratory, in *Forensic Evidence Analysis and Crime Scene Investigation*, Boston: SPIE (International Society for Optical Engineering), pp. 75–82.
- Bullock, K.M., Harris, J.S., and Latumus, P.L. (1994), Use of a simple coaxial lighting system to enhance fingerprint and handwriting evidence, *Can. Soc. Forensic Sci. J.*, 27, 69–80.

- Burns, D.S. (1994), Sticky side powder: the Japanese solution, *J. Forensic Identification*, 44, 133–138.
- Burns, T.D., Brown, J.K., Dinsmore, A., and Harvey, K.K. (1998), Base-activated latent fingerprints fumed with a cyanoacrylate monomer: a quantitative study using fourier-transform infra-red spectroscopy, *Analytica Chimica Acta*, 362, 171–176.
- Bush, L. (2002), Golden Hands and Silver Feet, technical report, Australian Federal Police, Canberra.
- Caldwell, J.P., Henderson, W., and Kim, N.D. (2000), ABTS: a safe alternative to DAB for the enhancement of blood fingerprints, *J. Forensic Sci.*, 45, 785–794.
- Campbell, B.M. (1991a), Separation of adhesive tapes, *J. Forensic Identification*, 41, 102–106.
- Campbell, B.M. (1991b), Vacuum chamber cyanoacrylate technique evolution, *RCMP Gaz.*, 53 (12), 12–16.
- Cantu, A.A. (1993), Ninhydrin analogues, in *International Symposium on the Forensic Aspects of Latent Prints*, FBI Academy, Quantico, VA.
- Cantu, A.A., Leben, D.A., Joullié, M.M., Heffner, J., and Hark, R.R. (1993), A comparative examination of several amino acid reagents for visualizing amino acid (glycine) on paper, *J. Forensic Identification*, 43, 44–62.
- Cantu, A.A., Leben, D.A., Ramotowski, R.S., Kopera, J., and Simms, J.R. (1998), Use of acidified hydrogen peroxide to remove excess gun blue from gun blue-treated cartridge cases and to develop latent prints on untreated cartridge cases, *J. Forensic Sciences*, 43, 294–298.
- Cantu, A.A. (2001), Silver physical developers for the visualization of latent prints on paper, *Forensic Sci. Rev.*, 13, 29–64.
- Cantu, A.A. and Johnson, J.L. (2001), Silver physical development of latent prints, in *Advances in Fingerprint Technology*, 2nd ed., H.C. Lee and R.E. Gaensslen, Eds., Boca Raton, FL: CRC Press, pp. 242–247.
- Capel, D., Zisserman, A., Bramble, S., and Compton, D. (1998), An automatic method for the removal of unwanted non-periodic patterns from forensic images, in *Investigation and Forensic Science Technologies*, Boston: SPIE (International Society for Optical Engineering), pp. 274–284.
- Cappelli, R., Lumini, A., Maio, D., and Maltoni, D. (1999), Fingerprint classification by directional image partitioning, *IEEE Trans. Pattern Analysis and Machine Intelligence*, 21, 402–421.
- Cappelli, R., Erol, A., Maio, D., and Maltoni, D. (2000), Synthetic Fingerprint-Image Generation, in *Proceedings of the International Conference on Pattern Recognition (ICPR2000)*, Barcelona, pp. 475–478.
- Chakraborty, R. (1991), The role of heredity and environment on dermatoglyphic traits, in *Dermatoglyphics — Science in Transition*, Vol. 27 (2), C.C. Plato, R.M. Garruto, B.A. Schaumann, and N.W. Paul, Eds., New York: Wiley-Liss, pp. 151–191.
- Champod, C., Lennard, C., and Margot, P.A. (1993), Alphonse Bertillon and dactyloscopy, *J. Forensic Identification*, 43, 604–625.
- Champod, C. (1995), Locard, numerical standards and probable identification, *J. Forensic Identification*, 45, 132–159.
- Champod, C. (1996), Reconnaissance Automatique et Analyse Statistique des Minuties sur les Empreintes Digitales, Ph.D. thesis, Institut de Police Scientifique et de Criminologie, Université de Lausanne, Switzerland.

- Champod, C. and Margot, P.A. (1996), Computer Assisted Analysis of Minutiæ Occurrences on Fingerprints, in *Proceedings of the International Symposium on Fingerprint Detection and Identification*, Israel National Police, Ne'urim, Israel, June 26–30, 1995, pp. 305–318.
- Champod, C. and Margot, P.A. (1997a), Analysis of Minutiæ Occurrences in Fingerprints — the Search for Non-combined Minutiæ, in *Current Topics in Forensic Science — Proceedings of the 14th Meeting of the International Association of Forensic Sciences*, Shunderson Communications, Ottawa, pp. 55–58.
- Champod, C. and Margot, P.A. (1997b), Marks and impressions, in *Proceeding of the 11th Interpol Forensic Science Symposium*, Lyon, France: Forensic Sciences Foundation Press, pp. 161–182.
- Champod, C. and Margot, P.A. (1998), Fingermarks, shosole impressions, ear impressions and toolmarks: a review (September 1995 – August 1998), in *Proceeding of the 12th Interpol Forensic Science Symposium*, Lyon, France: Forensic Sciences Foundation Press, pp. 303–331.
- Champod, C. (1999), The inference of identity of source: theory and practice, in *First International Conference on Forensic Human Identification in the Next Millennium*, London: The Forensic Science Service; <http://www.forensic.gov.uk>.
- Champod, C. (2000a), Fingerprints (dactyloscopy): standard of proof, in *Encyclopaedia of Forensic Science*, J. Siegel, P. Saukko, and G. Knupfer, Eds., London: Academic Press, pp. 884–890.
- Champod, C. (2000b), Identification / individualization: overview and meaning of ID, in *Encyclopaedia of Forensic Science*, J. Siegel, P. Saukko, and G. Knupfer, Eds., London: Academic Press, pp. 1077–1083.
- Champod, C. and Meuwly, D. (2000), The inference of identity in forensic speaker recognition, *Speech Communication*, 31, 193–203.
- Champod, C. and Evett, I.W. (2001), A probabilistic approach to fingerprint evidence, *J. Forensic Identification*, 51, 101–122.
- Champod, C. (2002), Statistics and fingerprint examination, *The Detail*, 22; <http://www.clpex.com/Articles/TheDetail/TheDetail22.htm>.
- Chatterjee, S.K. and Hague, R.V. (1988), *Finger Print or Dactyloscopy and Ridgeoscopy*, Calcutta: M.K. Mukerjee Temple Press.
- Cheeseman, R. and DiMeo, L.A. (1995), Fluorescein as a field-worthy latent bloodstain detection system, *J. Forensic Identification*, 45, 631–646.
- Choudhry, M.Y. and Whritenour, R.D. (1990), A new approach to unraveling tangled adhesive tape for potential detection of latent prints and recovery of trace evidence, *J. Forensic Sci.*, 35, 1373–1383.
- Clark, J.D. (2002), ACE-V: is it scientifically reliable and accurate? *J. Forensic Identification*, 52, 401–408.
- Cole, S. (1998), Witnessing identification: latent fingerprinting evidence and expert knowledge, *Soc. Stud. Sci.*, 28, 687–712.
- Cole, S. (1999), What counts for identity? The historical origins of the methodology of latent fingerprint identification, *Sci. in Context*, 12, 139–172.
- Cole, S. (2000), The myth of fingerprints, *Lingua Franca*, 10, 54–62.
- Cole, S. (2001), *Suspect Identities: A History of Fingerprinting and Criminal Identification*, Cambridge, MA: Harvard University Press.
- Comber, B.A. (2003), Reduction of background features in images of fingerprints using combinations of images acquired under different lighting conditions, *J. Forensic Identification*, 53, 198–208.

- Conn, C., Ramsay, G., Roux, C., and Lennard, C.J. (2001), The effect of metal salt treatment on the photoluminescence of DFO-treated fingerprints, *Forensic Sci. Int.*, 116, 117–123.
- Coutagne, H. and Florence, A. (1889), Les empreintes dans les expertises judiciaires, *Archives d'Anthropologie Criminelle et des Sciences Pénales*, 4, 25–56.
- Cowger, J.F. (1983), *Friction Ridge Skin: Comparison and Identification of Fingerprints*, New York: Elsevier Science Publishing.
- Creer, K.E. (1982), Some applications of an argon ion laser in forensic science, *Forensic Sci. Int.*, 20, 179–190.
- Creer, K.E. (1993), Detection and Photography of Latent Marks Using Specialised Lighting and Imaging Techniques, in *International Symposium on the Forensic Aspects of Latent Prints*, FBI Academy, Quantico, VA.
- Creer, K.E. (1996), Detection and Enhancement of Latent Marks Using Specialised Lighting and Imaging Techniques, in *International Symposium in Fingerprint Detection and Identification*, Israel National Police, Ne'urim, Israel, June 26–30, 1995, pp. 25–35.
- Creighton, J.T. (1997), Visualisation of latent impressions after incidental or direct contact with human blood, *J. Forensic Identification*, 47, 534–541.
- Crispino, F. (2001), Comments on *JFI* 51(3), *J. Forensic Identification*, 51, 449–456.
- Cummings, H., Hollars, M., Peigare, F., and Trozzi, T. (1990), BBD and MBD: multi-purpose reagents for latent print detection, *J. Forensic Identification*, 40, 334–340.
- Cummings, H., Hollars, M., and Trozzi, T. (1993), Getting the most from cyanoacrylate dyes, *J. Forensic Identification*, 43, 37–43.
- Cummins, H.H. (1926), Epidermal ridge configurations in developmental defects, with particular references to the ontogenetic factors which condition ridge direction, *American J. Anat.*, 38, 89–151.
- Cummins, H.H. (1938), Experimental work of fingerprint forgery, *J. Criminal Law, Criminology Police Sci.*, 28, 666–671.
- Cummins, H.H. and Midlo, C. (1943), *Finger Prints, Palms and Soles*, Philadelphia: Blakiston.
- Cummins, H.H. and Midlo, C. (1961), *Finger Prints, Palms and Soles*, 2nd ed., New York: Dover Publications.
- Dalrymple, B.E., Duff, J.M., and Menzel, E.R. (1977), Inherent fingerprint luminescence — detection by laser, *J. Forensic Sci.*, 22, 106–115.
- Dalrymple, B.E. and Menzies, T. (1994), Computer enhancement of evidence through background noise suppression, *J. Forensic Sci.*, 39, 537–546.
- Dankmeijer, J., Waltman, J.M., and De Wilde, A.G. (1980), Biological foundations for forensic identifications based on fingerprints, *Acta Morphol. Neerl.-Scand.*, 18, 67–83.
- Daugman, J. (1999), Recognizing persons by their iris patterns, in *Biometrics — Personal Identification in Networked Society*, A.K. Jain, R. Bolle, and S. Pankanti, Eds., Norwell, MA: Kluwer Academic Publishers, pp. 103–121.
- Daugman, J. and Downing, C. (2001), Epigenetic randomness, complexity, and singularity of human iris patterns, *Proc. R. Soc. — Biological Sci.*, B 268, 1737–1740.
- Daugman, J. (2003), The importance of being random: statistical principles of iris recognition, *Pattern Recognition*, 36, 279–291.
- Davies, P.J., Kobus, H.J., Taylor, M.R., and Wainwright, K.P. (1995), Synthesis and structure of the zinc(ii) and cadmium(ii) complexes produced by photoluminescent enhancement of ninhydrin developed fingerprints using group 12 metal salts, *J. Forensic Sci.*, 40, 565–569.

- Day, K.J. and Bowker, W. (1996), Enhancement of cyanoacrylate developed latent prints using Nile red, *J. Forensic Identification*, 46, 183–187.
- Dell, D.A. and Munger, B.L. (1986), The early embryogenesis of papillary (sweat duct) ridges in primate glabrous skin: the dermatotopic map of cutaneous mechanoreceptors and dermatoglyphics, *J. Comp. Neurology*, 244, 511–532.
- Delmas, B.J. (1988), Postmortem latent print recovery from skin, *J. Forensic Identification*, 38, 49–56.
- De Ryckere, R. (1912), Lettre de Belgique, *Archives d'Anthropologie Criminelle, de Médecine Légale et de Psychologie Normale et Pathologique*, 27, 937–941.
- De Varigny, H. (1891), Les empreintes digitales d'après Galton, *Revue Scientifique*, 17, 557–562.
- Didierjean, C., Debart, M.-H., and Crispino, F. (1998), New formulation of DFO in HFE7100, *Fingerprint Whorld*, 24, 163–167.
- Dikshitulu, Y.S., Prasad, L., Pal, J.N., and Rao, C.V.N. (1986), Aging studies on fingerprint residues using thin layer and high performance liquid chromatography, *Forensic Sci. Int.*, 31, 261–266.
- Dolci, D. (1992), Révélation des Empreintes Digitales sur la Peau, technical report, Institut de Police Scientifique et de Criminologie, Université de Lausanne, Switzerland.
- Donche, A. and Musy, C. (1994), Development of latent fingerprints on cartridge casings, *Fingerprint Whorld*, 20, 13–19.
- Drews, M. (2002), Friction ridge identification process — proposed scientific methodology, *The Detail*, 28 ; <http://www.clpex.com/Articles/Methodology.htm>; <http://www.clpex.com/Articles/TheDetail/TheDetail28.htm>.
- Duff, J.M. and Menzel, E.R. (1978), Laser-assisted thin-layer chromatography and luminescence of fingerprints: an approach to fingerprint age determination, *J. Forensic Sci.*, 23, 129–134.
- Durham, N.M., Fox, K., and Plato, C.C., Eds. (2000), *The State of Dermatoglyphics: the Science of Finger and Palm Prints*, Vol. 2, New York: E. Mellen Press.
- Edzhibov, L.G. (1996), National standards of fingerprint identification, *Fingerprint Whorld*, 22, 153–160.
- Eggleston, R. (1983), *Evidence, Proof and Probability*, 2nd ed., R. Stevens, W. Twining, and C. McCrudden, Eds., London: G. Weidenfeld & Nicolson.
- Epstein, R. (2002), Fingerprints meet Daubert: the myth of fingerprint “science” is revealed, *South. Calif. Law Rev.*, 75, 605–655.
- Evet, I.W. and Williams, R.L. (1995), A review of the sixteen points fingerprint standard in England and Wales, *Fingerprint Whorld*, 21, 125–143.
- Evet, I.W. (1996), Expert evidence and forensic misconceptions of the nature of exact science, *Sci. Justice*, 36, 118–122.
- Faigman, D.L. (2002), Is science different for lawyers? *Science*, 297, 339–340.
- Faulds, H. (1880), On the skin-furrows of the hand, *Nature*, 22, 605.
- Ferguson, N. (1992), Minutiæ discrepancy in the delta area, *Fingerprint Whorld*, 18, 110.
- Findlay, I., Taylor, A., Quirke, P., Frazier, R., and Urquhart, A. (1997), DNA fingerprinting from single cells, *Nature*, 389, 555–556.
- Finkelstein, M.O. and Fairley, W.B. (1970), A Bayesian approach to identification evidence, *Harv. Law Rev.*, 83, 489–517.
- Florence, A. (1885), Les Taches de Sang, Leur Signification en Médecine Judiciaire, Ph.D. thesis No. 256, Faculté de Médecine, Lyon, France.
- Florence, A. (1889), Les taches de sang, leur signification, leur importance en médecine judiciaire, *Annales d'Anthropologie Criminelle et des Sciences Pénales*, 19.

- Flynn, J., Stoilovic, M., and Lennard, C.J. (1999), Detection and enhancement of latent fingerprints on polymer banknotes: a preliminary study, *J. Forensic Identification*, 49, 594–613.
- Foote, R.D. (1977), *Fingerprint Identification: A Survey of Present Technology, Automated Applications and Potential for Future Development*, Criminal Justice Monograph, Vol. 5 (No. 2), Institute of Contemporary Corrections and the Behavioral Sciences, Sam Houston State University, Huntsville, TX.
- Fortunato, S.L. and Walton, G. (1998), Development of latent fingerprints from skin, *J. Forensic Identification*, 48, 704–717.
- Frair, J.A., West, M.H., and Davies, L.E. (1989), A new film for ultraviolet photography, *J. Forensic Sci.*, 34, 234–238.
- Francis, 2002, personal communication.
- Franck, A. and Almog, J. (1993), Modified SPR for latent fingerprint development on wet, dark objects, *J. Forensic Identification*, 43, 240–244.
- Fraval, H., Bennett, A., and Springer, E. (1996), UV Detection of Untreated Latent Fingerprints, in *Proceedings of the International Symposium on Fingerprint Detection and Identification*, Israel National Police, Ne'urim, Israel, June 26–30, 1995, pp. 51–58.
- Frécon, A. (1889), *Des Empreintes en Général*, Ph.D. thesis, Imprimerie Storck, Bibliothèque d'Anthropologie Criminelle et des Sciences Pénales, Lyon, France.
- Frégeau, C.J., Germain, O., and Fourney, R.M. (2000), Fingerprint enhancement revisited and the effects of blood enhancement chemicals on subsequent Profiler Plus™ fluorescent short tandem repeat DNA analysis of fresh and aged bloody fingerprints, *J. Forensic Sci.*, 45, 354–380.
- Froude, J.H. (1996), The Super Glue fuming wand: a preliminary evaluation, *J. Forensic Identification*, 46, 19–31.
- Galton, F. (1892), *Finger Prints*, London: MacMillan and Co.
- Gamboe, M. and O'Daniel, L. (1999), Substitute Ardrex formula, *J. Forensic Identification*, 49, 134–141.
- Geller, B., Springer, E., and Almog, J. (1998), Field devices for cyanoacrylate fuming: a comparative analysis, *J. Forensic Identification*, 48, 442–450.
- Geller, B., Almog, J., Margot, P., and Springer, E. (1999), A chronological review of fingerprint forgery, *J. Forensic Sci.*, 44, 963–968.
- Geller, B., Almog, J., and Margot, P. (2001), Fingerprint forgery — a survey, *J. Forensic Sci.*, 46(3), 731–733.
- German, E.R. (1987), Computer Image Enhancement of Latent Print and Hard Copy Output Devices, in *Proceedings of the International Forensic Symposium on Latent Prints*, FBI Academy, Quantico, VA, pp. 151–152.
- German, E.R. (1991), Analog digital image processing of latent fingerprints, in *Advances in Fingerprint Technology*, H.C. Lee and R.E. Gaensslen, Eds., New York: Elsevier, pp. 193–210.
- Gill, P. (2001), Application of low copy number DNA profiling, *Croatian Medical J.*, 42, 229–232.
- Goode, G.C. and Morris, J.R. (1983), *Latent Fingerprints: A Review of Their Origin, Composition and Methods for Detection*, Technical AWRE Report No. 022/83, Atomic Weapons Research Establishment, Aldermaston, U.K.
- Grady, D.P. (1999), Cyanoacrylate fuming: accelerated by heat within a vacuum, *J. Forensic Identification*, 49, 377–397.
- Graham, D. and Gray, H.C. (1966), The use of x-ray electrography and autoelectrography in forensic investigations, *J. Forensic Sci.*, 11, 124–143.

- Graham, D. (1969), Some technical aspects of the demonstration and visualisation of fingerprints on human skin, *J. Forens. Sci.*, 11, 124–143.
- Grant, H., Springer, E., and Ziv, Z. (1996), Vacuum Metal Deposition Inhibition on Polythene Bags, in *Proceedings of the International Symposium on Fingerprint Detection and Identification*, Israel National Police, Ne'urim, Israel, June 26–30, 1995, pp. 203–215.
- Gray, C. (1978), The detection and persistence of latent fingerprints on human skin: an assessment of the iodine-silver plate method, *J. Forensic Sci. Soc.*, 18, 47–52.
- Gray, M.L. (1996), Sticky-side powder versus gentian violet: the search for the superior method for processing the sticky side of adhesive tape, *J. Forensic Identification*, 46, 268–272.
- Grieve, D.L. (1988), The identification process: attitude and approach, *J. Forensic Identification*, 38, 211–224.
- Grieve, D.L. (1990a), The identification process — the quest for quality, *J. Forensic Identification*, 40, 109–113.
- Grieve, D.L. (1990b), Reflections on quality standards — an American viewpoint, *Fingerprint Whorld*, 15, 108–111.
- Grieve, D.L. (1999a), The identification process: TWGFAST and the search for science, *Fingerprint Whorld*, 25, 315–325.
- Grieve, D.L. (1999b), Built by many hands, *J. Forensic Identification*, 49, 565–579.
- Grigg, R., Malone, J.F., Mongkolaussavaratana, T., and Thianpatanagul, S. (1986), Cycloaddition reactions relevant to the mechanism of the ninhydrin reaction: x-ray crystal structure of protonated Ruhemann's purple, a stable 1,3-dipole, *J. Chem. Soc.: Chem. Commun.*, 421–422.
- Grigg, R., Mongkolaussavaratana, T., Pounds, C.A., and Sivagnanam, S. (1990), 1,8-Diazafluorenone and related compounds — a new reagent for the detection of alpha-amino acids and latent fingerprints, *Tetrahedron Lett.*, 31, 7215–7218.
- Groenendal, H. (1996), Forged Latent Prints, in *Proceedings of the International Symposium on Fingerprint Detection and Identification*, Israel National Police, Ne'urim, Israel, June 26–30, 1995, pp. 373–379.
- Guo, Y.-C. and Xing, L.-P. (1992), Visualisation method for fingerprints on skin by impression of a polyethylene terephthalate (PET) semirigid sheet, *J. Forensic Sci.*, 37, 604–611.
- Gupta, S.R. (1968), Etude statistique des caractéristiques papillaires, *Revue Internationale Police Criminelle*, 5 (218), 130–134.
- Halahmi, E., Levi, O., Kronik, L., and Boxman, R.L. (1997), Development of latent fingerprints using a corona discharge, *J. Forensic Sci.*, 42, 833–841.
- Hale, A. (1952), Morphogenesis of volar skin in the human fetus, *Am. J. Anat.*, 91, 3–43.
- Hamilton, J. and Dibattista, J. (1985), Cyanoacrylate ester — latent print from murdered body, *Fingerprint Whorld*, 11, 18–19.
- Hamilton, P.B. (1965), Amino-acids on hands, *Nature*, 205, 284–285.
- Hamm, E.D. (1988), A latent from human skin or is it? *Fingerprint Whorld*, 14, 56–57.
- Hammer, H.J. (1980), Methods of detecting latent fingerprints on the human skin, *Forensic Sci. Int.*, 16, 35–41.
- Haque, F., Westland, A., and Kerr, F.M. (1983), An improved non-destructive method for the detection of latent fingerprints on documents with iodine-7,8-benzoflavone, *Forensic Sci. Int.*, 21, 79–83.
- Haque, F., Westland, A.D., Milligan, J., and Kerr, F.M. (1989), A small particle (iron oxide) suspension for detection of latent fingerprints on smooth surfaces, *Forensic Sci. Int.*, 41, 73–82.

- Hardwick, S.A. (1981), User Guide to Physical Developer — a Reagent for Detecting Latent Fingerprints, Technical User Guide No. 14/81, Home Office Police Scientific Development Branch, Sandridge, U.K.
- Hardwick, S.A., Kent, T., and Sears, V.G. (1990), *Fingerprint Detection by Fluorescence Examination: A Guide to Operational Implementation*, Sandridge, U.K.: Home Office Police Scientific Development Branch.
- Hardwick, S.A., Kent, T., Sears, V.G., and Winfield, P. (1993), Improvements to the formulation of DFO and the effects of heat on the reaction with latent fingerprints, *FBI Law Enforcement Bull.*, 19, 65–69.
- Hark, R.R., Hauze, D.B., Petrovskaia, O., and Joullié, M.M. (1996), Chemical Detection of Fingerprints — Synthesis of Arylated Ninhydrin Analogues, in *Proceedings of the International Symposium on Fingerprint Detection and Identification*, Israel National Police, Ne'urim, Israel, June 26–30, 1995, pp. 127–135.
- Harvey, K.K., Dinsmore, A., Brown, J.K., and Burn, D.S. (2000), Detection of latent fingerprints by vacuum cyanoacrylate fuming — an improved system, *Fingerprint Whorld*, 26, 29–31.
- Haslett, M. (1983), Fingerprints from skin using the Magnabrush technique, *Fingerprint Whorld*, 8, 118–119.
- Hauze, D.B., Petrovskaia, O., Taylor, B., Joullié, M.M., Ramotowski, R.S., and Cantu, A.A. (1998), 1,2-Indanediones: new reagents for visualizing the amino acid components of latent prints, *J. Forensic Sci.*, 43, 744–747.
- Haylock, S.E. (1989), The light fantastic, *Fingerprint Whorld*, 14, 113–115.
- Hazen, R.J. (2002), Book review: quantitative-qualitative friction ridge analysis, *J. Forensic Identification*, 52, 475–476.
- Hébrard, J. and Donche, A. (1994), Fingerprint detection methods on skin: experimental study on 16 live subjects and 23 cadavers, *J. Forensic Identification*, 44, 623–627.
- Heindl, R. (1927), *System und Praxis der Daktiloskopie*, 3rd ed., Berlin und Leipzig: Walter de Gruyter & Co., Vereinigung Wissenschaftlichen Verleger.
- Henry, E.R. (1900), *Classification and Uses of Finger Prints*, 4th ed., London: Georges Routledge.
- Herod, D.W. and Menzel, E.R. (1982), Laser detection of latent fingerprints: ninhydrin followed by zinc chloride, *J. Forensic Sci.*, 27, 513–518.
- Hess, J. (1971a), The reference shelf, *Finger Print Identification Mag.*, 53 (3), 12–14.
- Hess, J. (1971b), The reference shelf, *Finger Print Identification Mag.*, 53 (5), 11–13.
- Hess, J. (1971c), The reference shelf, *Finger Print Identification Mag.*, 53 (6), 13.
- Hess, J. (1971d), The reference shelf, *Finger Print Identification Mag.*, 53 (4), 17.
- Hewlett, D.F. and Sears, V.G. (1997), Replacements for CFC113 in the ninhydrin process: part 1, *J. Forensic Identification*, 47, 287–289.
- Hewlett, D.F., Sears, V.G., and Suzuki, S. (1997), Replacements for CFC113 in the ninhydrin process: part 2, *J. Forensic Identification*, 47, 300–306.
- Hewlett, D.F. and Sears, V.G. (1999), An operational trial of two non-ozone depleting ninhydrin formulations for latent fingerprint detection, *J. Forensic Identification*, 49, 388–396.
- Holt, S.B. (1968), *The Genetics of Dermal Ridges*, Vol. 492, I. Newton Kugelmass, Ed., Springfield, IL: Charles C. Thomas.
- Holyst, B. (1987), Kriminalistische abschätzung des spurenalters bei fingerpapillarlinien, *Archiv für Kriminologie*, 179, 94–103.
- Hong, L. (1998), Automatic Personal Identification Using Fingerprints, Ph.D. thesis, Michigan State University, Computer Science and Engineering.

- Howard, S. (1993), Basic fuchsin — a guide to a one-step processing for black electrical tape, *J. Forensic Sci.*, 38, 1391–1403.
- Howorka, H. (1989), Questions relating to the determination of the age of objects assuming relevance in criminal investigations, *Fingerprint Whorld*, 15, 23–28.
- Hoysler, R.L. (1992), An alternative G.R.I.T. technique, *J. Forensic Identification*, 42, 219–220.
- Huber, R.A. (1959), Expert witness, *Criminal Law Q.*, 2, 276–295.
- Huber, R.A. (1972), The philosophy of identification, *RCMP Gaz.*, July-August, 9–14.
- Hughes, J.G. (1993), Under the COSHH, *Fingerprint Whorld*, 19, 4.
- Huss, K., Clark, J., and Chisum, W.J. (2000), Which was first — fingerprints or blood? *J. Forensic Identification*, 50, 344–350.
- Hussain, J.I. and Pounds, C.A. (1988), The Enhancement of Marks in Blood, Part 1, 5-Sulphosalicylic Acid: A Convenient and Effective Fixative for Marks Made in Blood, Technical CRSE No. 649, Central Research and Support Establishment, Aldermaston, U.K.
- Imamura, M. and Asahida, M. (1981), Fingerprints lifted from cadaver skin surface, *Identification News*, 31, 13–14.
- Interpol (1995), European Fingerprint Standards, *24th European Regional Conference*, Ljubljana, Slovenia, May 10–12.
- Interpol (2000), Interpol European Expert Group on Fingerprint Identification (IEEGFI), *29th European Regional Conference*, Reykjavik, Iceland, May 17–19.
- Involstad, H. (1976), How long will a fingerprint last? *Fingerprint and Identification Mag.*, 57 (9), 4–5.
- Irrausch, F. (1990), L'Utilisation de l'Oxyde de Fer dans le Réactif de Microparticules, technical report, Institut de Police Scientifique et de Criminologie, Université de Lausanne, Switzerland.
- Isaac, K.L. (1993), A review on detection of latent prints on self-adhesive tapes, *Fingerprint Whorld*, 19, 89–96.
- Jacobson, R.E., Ray, S.F., Attridge, G.G., and Axford, N.R. (2000), *The Manual of Photography: Photography and Digital Imaging*, 9th ed., Oxford, U.K.: Focal Press.
- Jacquat, A. (1999), Evolution des Substances Grasses des Empreintes Digitales au Cours du Temps — Analyse par TLC et GC-MS, technical report, Institut de Police Scientifique et de Criminologie, Université de Lausanne, Switzerland.
- Jain, A.K., Bolle, R., and Pankanti, S., Eds. (1999a), *Biometrics — Personal Identification in Networked Society*, Norwell, MA: Kluwer Academic Publishers.
- Jain, L.C., Halici, U., Hayashi, I., Lee, S.B., and Tsutsui, S., Eds. (1999b), *Intelligent Biometric Techniques in Fingerprint and Face Recognition*, L.C. Jain and I.E. Fel-low, Eds., Boca Raton, FL: CRC Press.
- Jain, A.K. and Pankanti, S. (2001), Automated fingerprint identification and imaging systems, in *Advances in Fingerprint Technology*, 2nd ed., H.C. Lee and R.E. Gaensslen, Eds., Boca Raton, FL: CRC Press, pp. 275–326.
- James, J.D., Pounds, C.A., and Wilshire, B. (1991a), Flake metal powders for revealing latent fingerprint, *J. Forensic Sci.*, 36, 1368–1375.
- James, J.D., Pounds, C.A., and Wilshire, B. (1991b), Obliteration of latent fingerprints, *J. Forensic Sci.*, 36, 1376–1386.
- James, J.D., Pounds, C.A., and Wilshire, B. (1991c), Magnetic flake fingerprint technology, *J. Forensic Identification*, 41, 237–247.
- James, J.D., Pounds, C.A., and Wilshire, B. (1992), New magnetic applicators and magnetic flake powders for revealing latent fingerprints, *J. Forensic Identification*, 42, 531–542.

- James, J.D., Pounds, C.A., and Wilshire, B. (1993), Magnetic flake powders for fingerprint development, *J. Forensic Sci.*, 38, 391–401.
- Jaret, Y., Heriau, M., and Donche, A. (1997), Transfer of bloody fingerprints, *J. Forensic Identification*, 43, 38–41.
- Jian, Z. and Dao-An, G. (1991), A modified cyanoacrylate technique utilizing treated neutral paper for developing latent fingerprints, *Forensic Sci. Int.*, 52, 31–34.
- Johnson, G.A., Creaser, C.S., and Sodeau, J.R. (1991), Fluorescence spectroscopic and HPLC studies of intrinsic fingerprint residues, in *Analytical Applications of Spectroscopy 2*, A.M.C. Davies and C.S. Creaser, Eds., Cambridge, UK: The Royal Society of Chemistry, Thomas Graham House, pp. 207–212.
- Jonakait, R.N. (1994), The meaning of Daubert and what that means for forensic science, *Cardozo Law Rev.*, 15, 2103–2117.
- Jones, N., Davies, L.M., Brennan, J.S., and Bramble, S.K. (2000), Separation of visibly excited fluorescent components in fingerprint residue by thin-layer chromatography, *J. Forensic Sci.*, 45, 1286–1293.
- Jones, N., Mansour, D., Stoilovic, M., Lennard, C.J., and Roux, C. (2001a), The influence of polymer type, print donor and age on the quality of fingerprints developed on plastic substrates using vacuum metal deposition, *Forensic Sci. Int.*, 124, 167–177.
- Jones, N., Stoilovic, M., Lennard, C.J., and Roux, C. (2001b), Vacuum metal deposition: factors affecting normal and reverse development of latent fingerprints on polyethylene substrates, *Forensic Sci. Int.*, 115, 73–88.
- Jones, N. (2002), Metal Deposition Techniques for the Detection and Enhancement of Latent Fingerprints on Semi-Porous Surfaces, Ph.D. thesis, University of Technology, Department of Chemistry, Forensic Science Programme, Sydney, Australia.
- Jones, N. (2002), personal communication.
- Jones, N., Kelly, M., Stoilovic, M., Lennard, C.J., and Roux, C. (2003), The development of latent fingerprints on polymer banknotes, *J. Forensic Identification*, 53, 50–77.
- Jonker, H., Molenaar, A., and Dippel, C.J. (1969), Physical development recording systems: III, physical development, *Photographic Sci. Eng.*, 13, 38–44.
- Jorgensen, D. (1991), Home-made vacuum chamber wins out, *RCMP Gaz.*, 53 (6), 14–16.
- Joullié, M.M., Thompson, T.R., and Nemeroff, N.H. (1991), Ninhydrin and ninhydrin analogs: synthesis and applications, *Tetrahedron*, 47, 8791–8830.
- Jungbluth, W.O. (1992), Replacement for Freon 113, *Fingerprint Whorld*, 18, 26–29.
- Jungbluth, W.O. (1993), Replacement for Freon 113, *J. Forensic Identification*, 43, 226–233.
- Kasper, S.P., Minnillo, D.J., and Rockhold, A.M. (2002), Validating IND (1,2-indanedi-one), *Forensic Sci. Commun.*, 4 (4); <http://www.fbi.gov/hq/lab/fsc/backissu/oct2002/kasper.htm>.
- Kaymaz, E. and Mitra, S. (1992), Analysis and Matching of Degraded and Noisy Fingerprints, in *SPIE Proceedings — Applications of Digital Image Processing XV*, San Diego, CA, pp. 498–509.
- Kaymaz, E. and Mitra, S. (1993), A novel approach to fourier spectral enhancement of laser-luminescent fingerprint images, *J. Forensic Sci.*, 38, 530–541.
- Keith, L.V. and Runion, W. (1998), Short-wave UV imaging casework applications, *J. Forensic Identification*, 48, 563–569.
- Kent, T., Thomas, G.L., Reynoldson, T.E., and East, H.W. (1976), A vacuum coating technique for the development of latent fingerprints on polythene, *J. Forensic Sci. Soc.*, 16, 93–101.
- Kent, T., Ed. (1986), *Manual of Fingerprint Development Techniques*, 1st ed., London: Home Office Scientific Research and Development Branch, Brightman & Stratton Ltd.

- Kent, T. (1996), Two new solvents for ninhydrin, *Fingerprint Whorld*, 22, 108.
- Kent, T. and Winfield, P. (1996), Superglue Fingerprint Development — Atmospheric Pressure and High Humidity, or Vacuum Evaporation? in *Proceedings of the International Symposium on Fingerprint Detection and Identification*, Israel National Police, Ne'urim, Israel, June 26–30, 1995, pp. 59–66.
- Kent, T., Ed. (1998), *Manual of Fingerprint Development Techniques*, 2nd ed., London: Home Office Scientific Research and Development Branch, White Crescent Press Ltd. Luton.
- Kershaw, A. (2001), Standards in evidence: the register of forensic practitioners, *Fingerprint Whorld*, 27, 73–77.
- Kimble, G.W. (1996), Powder suspension processing, *J. Forensic Identification*, 46, 273–280.
- Kimura, S. (1991), Embryologic development of flexion creases, in *Dermatoglyphics — Science in Transition*, Vol. 27 (2), C.C. Plato, R.M. Garruto, B.A. Schaumann, and N.W. Paul, Eds., New York: Wiley-Liss, pp. 113–129.
- Kingston, C.R. (1964), Probabilistic Analysis of Partial Fingerprint Patterns, D. Crim. Dissertation, University of California, Berkeley.
- Kingston, C.R. and Kirk, P.L. (1965), Historical development and evaluation of the twelve point rule in fingerprint identification, *Int. Criminal Police Rev.*, 20 (186), 62–69.
- Kingston, C.R. (1970), The law of probabilities and the credibility of witness and evidence, *J. Forensic Sci.*, 15, 18–27.
- Kirk, P.L. (1963), The ontogeny of criminalistics, *J. Criminal Law, Criminology Police Sci.*, 54, 235–238.
- Klasey, D.R. and Barnum, C.A. (2000), Development and enhancement of latent prints on firearms by vacuum and atmospheric cyanoacrylate fuming, *J. Forensic Identification*, 50, 572–580.
- Knowles, A.M. (1978), Aspects of physicochemical methods for the detection of latent fingerprints, *J. Physics Ser. E: Sci. Instruments*, 11, 713–721.
- Knowles, R. (2000), The new (non-numeric) fingerprint evidence standard — is it pointless? *Sci. Justice*, 40, 120–121.
- Kobus, H.J., Stoilovic, M., and Warrener, R.N. (1983), Simple luminescent post-ninhydrin treatment for the improved visualisation of fingerprints on documents in cases where ninhydrin alone gives poor results, *Forensic Sci. Int.*, 22, 161–170.
- Kobus, H.J., Pigou, P.E., Jahangiri, S., and Taylor, B. (2002), Evaluation of some oxygen, sulfur, and selenium substituted ninhydrin analogues, nitrophenylninhydrin and benzo[f]furoninhydrin, *J. Forensic Sci.*, 47, 254–259.
- Kondo, S. and Asal, R. (1995), A reaction-diffusion wave on the skin of the marine angelfish *Pomacanthus*, *Nature*, 376, 765–768.
- Kosz, D. (2000), New Numerical Methods of Fingerprints Recognition Based on Mathematical Description of Arrangement of Dermatoglyphics and Creation of Minutiae; <http://www.optel.com.pl/software/english/method.htm>.
- Kwan, Q.Y. (1977), Inference of Identity of Source, Ph.D. thesis, University of California, Department of Forensic Science, Berkeley, CA.
- Kyeck, S. (2003), personal communication.
- Lambert, J.L.F. (1990), *International Illustrated Vocabulary of French-English Fingerprint Terminology with a Short Index in Six Languages (Serbian, Japanese, Dutch, Italian, Spanish, German)*, 2nd ed., Ottawa: Ministry of the Solicitor General, Royal Canadian Mounted Police.
- Lambourne, G.T.C. (1984), Fingerprints standards, *Med., Sci. Law*, 24, 227–229.

- Lambourne, G.T.C. (1986), Stop and think about errors (CD tillers) [letter to editor], *Fingerprint Whorld*, 11, 87.
- Lamothe, P.J. and McCormick, P.G. (1972), Influence of acidity on the reaction of ninhydrin with amino acids, *Anal. Chem.*, 44, 821–825.
- Lee, H.C. (1984a), TMB as an enhancement reagent for bloody prints, *Identification News*, 34 (3), 10–11.
- Lee, H.C. (1984b), Benzidine or o-tolidine, *Identification News*, 34 (1), 13–14.
- Lee, H.C. and Gaensslen, R.E. (1984), Cyanoacrylate fuming — theory and procedures, *Identification News*, 34 (6), 8–14.
- Lee, H.C. and Gaensslen, R.E. (1988), The new technology in latent print detection and comparison, *Fingerprint Identification Mag.*, 60 (1), 3–9.
- Lee, H.C., Gaensslen, R.E., Pagliaro, E.M., Guman, M.B., Berka, K.M., Keith, T.P., and Philipps, P. (1989), The effect of presumptive test, latent fingerprint and some other reagents and materials on subsequent serological identification, genetic marker and DNA testing in bloodstains, *J. Forensic Identification*, 39, 339–358.
- Lee, H.C. and Gaensslen, R.E., Eds. (2001a), *Advances in Fingerprint Technology*, 2nd ed., B.A.J. Fisher, Ed., Boca Raton, FL: CRC Press.
- Lee, H.C. and Gaensslen, R.E. (2001b), Methods of latent fingerprint development, in *Advances in Fingerprint Technology*, 2nd ed., H.C. Lee and R.E. Gaensslen, Eds., Boca Raton, FL: CRC Press, pp. 105–175.
- Lempert, R.O. (1977), Modeling relevance, *Mich. Law Rev.*, 75, 1021–1057.
- Lennard, C.J. (1986), New Amino Acid Specific Fingerprint Reagents, Ph.D. thesis, Australian National University, Department of Chemistry, Canberra, Australia.
- Lennard, C.J., Margot, P.A., Stoilovic, M., and Warrener, R.N. (1986), Synthesis of ninhydrin analogues and their application to fingerprint development: preliminary results, *J. Forensic Sci. Soc.*, 26, 323–328.
- Lennard, C.J., Margot, P.A., Sterns, M., and Warrener, R.N. (1987), Photoluminescent enhancement of ninhydrin developed fingerprints by metal complexations: structural studies of complexes formed between Ruhemann's purple and Group IIb metal salts, *J. Forensic Sci.*, 32, 597–605.
- Lennard, C.J. and Margot, P.A. (1988), Sequencing of reagents for the improved visualization of latent fingerprints, *J. Forensic Identification*, 38, 197–210.
- Lennard, C.J., Margot, P.A., Stoilovic, M., and Warrener, R.N. (1988), Synthesis and evaluation of ninhydrin analogues as reagents for the development of latent fingerprints on paper surfaces, *J. Forensic Sci. Soc.*, 28, 3–23.
- Leo, W.F. (1998), Distortion versus dissimilarity in friction skin identification, *J. Forensic Identification*, 48, 125–129.
- LeRoy, H. (1993), Metal Vacuum Deposition and Vacuum Cyanoacrylate Development of Latent Prints, in *International Symposium on the Forensic Aspects of Latent Prints*, FBI Academy, Quantico, VA.
- Lewis, L.A., Smithwick, R.W.I., Devault, G.L., Bolinger, B., and Lewis, S.A.S. (2001), Processes involved in the development of latent fingerprints using the cyanoacrylate fuming method, *J. Forensic Sci.*, 46, 241–246.
- Li, J., *J. Forensic Sci.*, in press.
- Liberti, A., Calabro, G., and Chiarotti, M. (1995), Storage effects on ninhydrin-developed fingerprints enhanced by zinc complexation, *Forensic Sci. Int.*, 72, 161–169.
- Lin, C.H., Liu, J.H., Osterburg, J.W., and Nicol, J.D. (1982a), Fingerprint comparison I: similarity of fingerprints, *J. Forensic Sci.*, 27, 290–304.

- Lin, C.H., Liu, J.H., Osterburg, J.W., and Nicol, J.D. (1982b), Fingerprint comparison II: on the development of a single fingerprint filing and searching system, *J. Forensic Sci.*, 27, 305–317.
- Locard, E. (1903), La dactyloscopie: identification des récidivistes par les empreintes digitales, *Mémoire de l'Académie des Sciences, Belles-lettres et Arts de Lyon*, 147–161.
- Locard, E. (1906), Le sixième congrès d'anthropologie criminelle, *Archives d'Anthropologie Criminelle, de Médecine Légale et de Psychologie Normale et Pathologique*, 21, 865–873.
- Locard, E. (1909), *L'Identification des Récidivistes*, Paris: A. Maloine.
- Locard, E. (1911), Les laboratoires de police, *Archives Internationales de Médecine Légale*, 2, 105–117.
- Locard, E. (1912), L'identification des criminels par l'examen des glandes sudoripares, *Province Médicale*, 1–12.
- Locard, E. (1913), La poroscopie — identification par les orifices sudoripares, *Archives d'Anthropologie Criminelle, de Médecine Légale et de Psychologie Normale et Pathologique*, 28, 528–546.
- Locard, E. (1914), La preuve judiciaire par les empreintes digitales, *Archives d'Anthropologie Criminelle, de Médecine Légale et de Psychologie Normale et Pathologique*, 29, 321–348.
- Locard, E. (1931), *Traité de Criminalistique*, Vol. I à VII, Lyon: Joannès Desvigne et Fils Editeurs.
- Lock, E.R.A., Mazzella, W.D., and Margot, P.A. (1995), A new Europium chelate as a fluorescent dye for cyanoacrylate pretreated fingerprints — EuTTAPhen: Europium thenoyltrifluoro-acetenone ortho-phenanthroline, *J. Forensic Sci.*, 40, 354–358.
- Loesch, D.Z. (1973), Minutiae and clinical genetics, *J. Mental Deficiency Res.*, 17, 97–105.
- Loesch, D.Z. (1983), *Quantitative Dermatoglyphics: Classification, Genetics and Pathology*, Oxford: Oxford University Press.
- Lowe, A.L., Murray, C., Whitaker, J.P., Tully, G., and Gill, P. (2002), The propensity of individuals to deposit DNA and secondary transfer of low level DNA from individuals to inert surfaces, *Forensic Sci. Int.*, 129, 25–34.
- Mairs, G.T. (1933a), Finger prints indexed numerically: a finger print family tree (Part I), *Finger Print Identification Mag.*, 15 (4), 16–18.
- Mairs, G.T. (1933b), Finger prints indexed numerically: a finger print family tree (Part II), *Finger Print Identification Mag.*, 15 (5), 16–18.
- Maltoni, D., Maio, D., Jain, A.K., and Prabhakar, S., Eds. (2003), *Handbook of Fingerprint Identification and Verification*, New York: Springer Verlag.
- Manners, J. (1996), Time for change — the value of the fingerprint system, *Fingerprint Whorl*, 22, 57–68.
- Marcinowski, M. (2000), Evaluation of fingerprint age determination methods, *Problemy Kryminalistyki*, 228, 62–68.
- Mardia, K.V., Li, Q., and Hainsworth, T.J. (1992), On the Penrose hypothesis on fingerprint patterns, *J. Math. Appl. Med. Biol.*, 9, 189–194.
- Margot, P. and Lennard, C.J. (1993), Traces et empreintes: le point sur les nouvelles techniques, *Revue Internationale Police Criminelle*, 48 (441), 10–18.
- Margot, P. and Lennard, C. (1994), *Fingerprint Detection Techniques*, 6th rev. ed., Lausanne, Switzerland: Institut de Police Scientifique et de Criminologie, Université de Lausanne.

- Margot, P. and German, E. (1996), Fingerprint Identification Breakout Meeting, in *Proceedings of the International Symposium on Fingerprint Detection and Identification*, Israel National Police, Ne'urim, Israel, June 26–30, 1995, p. 21.
- Margot, P. (2000), A question of time, *Sci. Justice*, 40, 64–71.
- Mark, Y. (1996), Policemen's Fingerprints at the Scene of Crime, in *Proceedings of the International Symposium on Fingerprint Detection and Identification*, Israel National Police, Ne'urim, Israel, June 26–30, 1995, pp. 411–417.
- Martin, B.L. (1999), Developing latent prints on the adhesive side of black electrical tapes, *J. Forensic Identification*, 49, 127–129.
- Mashiko, K. and Hizaki, M.I. (1977), Latent fingerprint processing: iodine 7,8-benzoflavone method, *Identification News*, 27 (11), 3–5.
- Mashiko, K., German, E.R., Motojima, K., and Colman, C.D. (1991), RTX: a new ruthenium tetroxide fuming procedure, *J. Forensic Identification*, 41, 429–436.
- Mashiko, K. and Miyamoto, T. (1998), Latent fingerprint processing by the ruthenium tetroxide method, *J. Forensic Identification*, 48, 279–290.
- Masters, N.E. (1990), Rhodamine 6G: taming the beast, *J. Forensic Identification*, 40, 265–269.
- Masters, N.E., Morgan, R., and Shipp, E. (1991), DFO, its usage and results, *J. Forensic Identification*, 41, 3–10.
- Masters, N.E. (1992), Rhodamine 6G: disarming the beast, *Fingerprint Whorld*, 18, 62–75.
- Masters, N.E. and DeHaan, J.D. (1996), Vacuum metal deposition and cyanoacrylate detection of older latent prints, *J. Forensic Identification*, 46, 32–45.
- Masters, N.E. (2002), *Safety for the Forensic Identification Specialist*, 2nd ed., Jacksonville: Lightning Powder Co.
- Matsumoto, T. (2002), Importance of Open Discussion on Adversarial Analyses for Mobile Security Technologies — A Case Study for User Identification, in *ITU-T Workshop on Security*, Seoul, Korea.
- Mavalwala, J. (1977), *Dermatoglyphics, an International Bibliography*, Chicago: Mouton Publishers.
- Mazzella, W.D. and Lennard, C.J. (1995), An additional study of cyanoacrylate stains, *J. Forensic Identification*, 45, 5–18.
- McCarthy, M.M. and Grieve, D.L. (1989), Preprocessing with cyanoacrylate ester fuming for fingerprint impressions in blood, *J. Forensic Identification*, 39, 23–32.
- McCarthy, M.M. (1990), Evaluation of ardrex as a luminescent stain for cyanoacrylate processed latent impressions, *J. Forensic Identification*, 40, 75–80.
- McComiskey, P. (1990), DFO: a simple and quick method for the development of latent fingerprints, *Fingerprint Whorld*, 16, 64–65.
- McKasson, S. (2001), I think therefore I probably am, *J. Forensic Identification*, 51, 217–221.
- McRoberts, A.L. and Kuhn, K.E. (1992), A review of the case report — “Determining the evaporation rate of latent impressions on the exterior surfaces of aluminum beverage cans,” *J. Forensic Identification*, 42, 213–218.
- McRoberts, A.L. (1996), Nature never repeats itself, *The Print*, 12, 1–3; <http://www.iinet.com/market/scafo/library/120501.html>.
- McRoberts, A.L. (2002), Scientific working group on friction ridge analysis, study and technology, *J. Forensic Identification*, 52, 263–348.
- Meinhardt, H. (1982), *Models of Biological Pattern Formation*, London: Academic Press.
- Meinhardt, H. (1995), Dynamics of stripe formation, *Nature*, 376, 722–723.
- Mekkaoui Alaoui, I. and Renzel, E.R. (1993), Spectroscopy of rare earth-Ruhemann's purple complexes, *J. Forensic Sci.*, 38, 506–520.

- Mekkaoui Alaoui, I. and Renzel, E.R. (1994), Emission enhancement in terbium-Ruhemann's purple complexes, *Forensic Sci. Int.*, 66, 203–211.
- Menzel, E.R. (1980), *Fingerprint Detection with Lasers*, New York: Marcel Dekker.
- Menzel, E.R. (1985), Comparison of argon-ion, copper-vapor, and frequency-doubled neodymium:yttrium aluminum garnet (nd:yag) lasers for latent fingerprint development, *J. Forensic Sci.*, 30, 383–397.
- Menzel, E.R. (1987), Laser Fingerprint Detection and Development, in *Proceedings of the International Forensic Symposium on Latent Prints*, FBI Academy, Quantico, VA, pp. 25–38.
- Menzel, E.R. (1989), Pretreatment of latent prints for laser development, *Forensic Sci. Rev.*, 1, 43–66.
- Menzel, E.R. and Mitchell, K.E. (1990), Intramolecular energy transfer in the europium-Ruhemann's purple complex: application to latent fingerprint detection, *J. Forensic Sci.*, 35, 35–45.
- Menzel, E.R. (1997), On the identification of fingerprints, *J. Forensic Identification*, 47, 29–33.
- Menzel, E.R. (1999), *Fingerprint Detection with Lasers*, 2nd ed., New York: Marcel Dekker.
- Menzel, E.R. (2001), Fingerprint detection with photoluminescent nanoparticles, in *Advances in Fingerprint Technology*, 2nd ed., H.C. Lee and R.E. Gaensslen, Eds., Boca Raton, FL: CRC Press, pp. 211–240.
- Meuwly, D. and Margot, P.A. (2001), Fingerprint marks, Shoesole and Footprint Impressions, Tire Impressions, Ear Impressions, Toolmarks, Lipmarks and Bitemarks: A Review (September 1998 – August 2001), in *Proceedings of the 13th Interpol Forensic Science Symposium*, Lyon, France, Washington, DC: U.S. Department of Justice, pp. 1–52.
- Meylan, N., Lennard, C.J., and Margot, P.A. (1990), Use of a gaseous electrical discharge to induce luminescence in latent fingerprints, *Forensic Sci. Int.*, 45, 73–83.
- Midkiff, C.R. (1993), Lifetime of a latent: How long? Can you tell? *J. Forensic Identification*, 43, 386–392.
- Midkiff, C.R. (1994), Development of prints on tape, *Fingerprint Whorld*, 20, 5–7.
- Midkiff, C.R. and Codell, D.E. (1995), Development of latent prints on tape, Part II, *Fingerprint Whorld*, 21, 21–26.
- Midkiff, C.R., Codell, D., and Chapman, J. (1997), Development of prints on tape, Part III, *Fingerprint Whorld*, 23, 83–86.
- Migron, Y., Mandler, D., Frank, A., Springer, E., and Almog, J. (1996), Is a Fingerprint Left on a Fired Cartridge? The Development of Latent Fingerprints on Metallic Surfaces by Palladium Deposition, in *Proceedings of the International Symposium on Fingerprint Detection and Identification*, Israel National Police, Ne'urim, Israel, June 26–30, 1995, pp. 217–225.
- Migron, Y. and Mandler, D. (1997), Development of latent fingerprints on unfired cartridges by palladium deposition: a surface study, *J. Forensic Sci.*, 42, 986–992.
- Migron, Y., Hocherman, G., Springer, E., Almog, J., and Mandler, D. (1998), Visualization of sebaceous fingerprints on fired cartridge cases: a laboratory study, *J. Forensic Sci.*, 43, 543–548.
- Mills, B.W. (1993), A cyanoacrylate vacuum chamber — on a budget, *RCMP Gaz.*, 55 (3), 16–17.
- Milne, R. (1996), Magnetic fingerprint powder — a field trial of K9 magnetite flake powder, *Fingerprint Whorld*, 22, 113–116.

- Misner, A., Wilkinson, D., and Watkin, J. (1993), Thenoyl europium chelate: a new fluorescent dye with a narrow emission band to detect cyanoacrylate developed fingerprints on non-porous substrates and cadavers, *J. Forensic Identification*, 43, 154–165.
- Misner, A.H. (1992), Latent fingerprint detection on low density polyethylene comparing vacuum metal deposition to cyanoacrylate fuming and fluorescence, *J. Forensic Identification*, 42, 26–33.
- Mock, J.P. (1985), Cyanoacrylates and heat — a word of caution, *Fingerprint Whorld*, 11, 16–17.
- Moenssens, A.A. (2002), Fingerprint Evidence in the UK, http://www.forensic-evidence.com/site/ID/Buckley_UK.html.
- Moler, E., Ballarin, V., Pessana, F., Torres, S., and Olmo, D. (1998), Fingerprint identification using image enhancement techniques, *J. Forensic Sci.*, 43, 689–692.
- Mong, G., Walter, S., Cantu, A.A., and Ramotowski, R.S. (2001), The chemistry of latent prints from children and adults, *Fingerprint Whorld*, 27, 66–69.
- Montagna, W. and Parakkal, P.F. (1974), *The Structure and Function of Skin*, 3rd ed., London: Academic Press.
- Moorcroft, B. (1996), K9 powder, *Fingerprint Whorld*, 22, 109–112.
- Moore, R.T. (1991), Automatic fingerprint identification systems, in *Advances in Fingerprint Technology*, H.C. Lee and R.E. Gaensslen, Eds., New York: Elsevier Science Publishing, pp. 163–191.
- Morris, A.D. (1992), Superglue as an option to gentian violet on adhesive side of tape, *Fingerprint Whorld*, 18, 101–102.
- Morris, J.R. and Goode, G.C. (1975), NFN — an improved ninhydrin reagent for detection of latent fingerprints, *Police Res. Bull.*, 1974, 45–53.
- Murdock, R.H. and Menzel, E.R. (1993), A computer interfaced time-resolved luminescence imaging system, *J. Forensic Sci.*, 38, 521–529.
- Murphy, M. (1991), A vacuum metal identification, *J. Forensic Identification*, 41, 318–320.
- Murray, J.D. (1993), *Mathematical Biology*, Berlin: Springer-Verlag.
- Neri, R. (1992), Détection des Empreintes Digitales au Cyanoacrylate: Technique “sous Vide” vs. Traditionelle, technical report, Institut de Police Scientifique et de Criminologie, Université de Lausanne, Switzerland.
- Newall, P.J., Richard, M.L., Kafarowski, E., Donnelly, W.J., Meloche, G.E., and Newman, J.C. (1996), Homicide case report: successful amplification and STR typing of bloodstains subjected to fingerprint treatment by cyanoacrylate fuming, *J. Can. Soc. Forensic Sci.*, 29, 1–5.
- Nolan, P.J., Brennan, J.S., Keeley, R.H., and Pounds, C.A. (1984), The imaging of developed fingerprints using the scanning electron microscope, *J. Forensic Sci. Soc.*, 24, 419.
- Norby, J.J. (1992), Can we believe what we see, if we see what we believe? — expert disagreement, *J. Forensic Sci.*, 37, 1115–1124.
- O'Brien, W.J. (1984), My fingerprints? Of course, I lived there! *Australian Police J.*, October–December, 142–147.
- Odén, S. and von Hofsten, B. (1954), Detection of fingerprints by the ninhydrin reaction, *Nature*, 173, 449–450.
- O'Doherty, S. (2001), The myth of fingerprints, *Justice of the Peace*, 165, 896–898.
- Okajima, M. (1966), Anthropologische und erbbiologische Untersuchung der Minutiae bei Deutschen und Japanern — Ihre Häufigkeit in calcanearen Teil der Fussabdrücke, *Zeitschrift für Morphologie und Anthropologie*, 58, 1–37.

- Okajima, M. (1967), Frequency of epidermal-ridge minutiae in the calcar area of Japanese twins, *Am. J. Hum. Gen.*, 19, 660–673.
- Okajima, M. (1970), Frequency of forks in epidermal-ridge minutiae on the finger print, *Am. J. Phys. Anthropology*, 32, 41–48.
- Okajima, M. (1975a), Development of dermal ridges in the fetus, *J. Medical Genet.*, 12, 243–250.
- Okajima, M. (1975b), Technical aspects of dermatoglyphic examination in primates, in *Contemporary Primatology: Proceedings of the Fifth International Congress of Primatology*, S. Kondo, M. Kawai, and A. Ehara, Eds., New York: S. Karger, pp. 49–53.
- Okajima, M. (1977), Epidermal-ridge minutia in the hallucal area, *Mitteilungen der Anthropologischen Gesellschaft in Wien*, 57, 135–139.
- Okajima, M. (1979), Dermal and epidermal structures of the volar skin, in *Dermatoglyphics — Fifty Years Later*, Vol. XV, No. 6, W. Wertelecki, C.C. Plato, and N.W. Paul, Eds., New York: Alan R. Liss, pp. 179–198.
- Okajima, M. (1982), A methodological approach to the development of epidermal ridges on the dermal surface of fetuses, in *Progress in Dermatoglyphic Research*, Vol. 84, C.S. Bartsocas, Ed., New York: Alan R. Liss, pp. 175–188.
- Okajima, M. (1984), Quantitative and genetic features of epidermal ridge minutiae on the palm of twins, *Hum. Heredity*, 34, 285–290.
- Okajima, M. and Newell-Morris, L. (1988), Development of dermal ridges on the volar skin of fetal pigtailed macaques (*Macaca nemestrina*), *Am. J. Anat.*, 183, 323–337.
- Olenik, J.H. (1992), Ardrex: an alternate solvent system, *J. Forensic Identification*, 42, 513–516.
- Olenik, J.H. (1997), A simple three dye blend, *J. Forensic Identification*, 47, 530–533.
- Olsen, R.D. (1978), *Scott's Fingerprint Mechanics*, Springfield, IL: C.C. Thomas.
- Olsen, R.D. (1981), Friction ridge characteristics and points of identity: an unresolved dichotomy of terms, *Identification News*, 31 (11), 12–13.
- Olsen, R.D. and Lee, H.C. (2001), Identification of latent prints, in *Advances in Fingerprint Technology*, 2nd ed., H.C. Lee and R.E. Gaensslen, Eds., Boca Raton, FL: CRC Press, pp. 41–61.
- Osterburg, J.W. and Bloomington, S.A. (1964), An inquiry into the nature of proof: the identity of fingerprints, *J. Forensic Sci.*, 9, 413–427.
- Osterburg, J.W., Parthasarathy, T., Raghavan, T.E.S., and Sclove, S.L. (1977), Development of a mathematical formula for the calculation of fingerprint probabilities based on individual characteristics, *J. Am. Stat. Assoc.*, 72, 772–778.
- Ostrowski, S.H. (2001), Simultaneous impressions: revisiting the controversy, *The Detail*, 13; <http://www.clpex.com/Articles/TheDetail/TheDetail13.htm>.
- Pankanti, S., Prabhakar, S., and Jain, A.K. (2001), On the Individuality of Fingerprints, in *IEEE Computer Vision and Pattern Recognition (CVPR) Conference*, Hawaii, pp. 805–812.
- Parisi, K.M. (1999), Getting the most from fingerprint powders, *J. Forensic Identification*, 49, 494–498.
- Penrose, L.S. (1969), Dermatoglyphics, *Sci. Am.*, December, 72–84.
- Penrose, L.S. and O'Hara, P.T. (1973), The development of epidermal ridges, *J. Medical Genet.*, 10, 201–208.
- Peterson, J.L. (1996), The Status of AFIS Systems Worldwide: Issues of Organizations, Performance and Impact, in *Proceedings of the International Symposium on Fingerprint Detection and Identification*, Israel National Police, Ne'urim, Israel, June 26–30, 1995, pp. 233–254.

- Petruncio, A.V. (2000), A comparative study for the evaluation of two solvents for use in ninhydrin processing of latent print evidence, *J. Forensic Identification*, 50, 462–469.
- Pfister, R. (1985), The optical revelation of latent fingerprints, *Fingerprint Whorld*, 10, 64–70.
- Phillips, C.E., Cole, D.O., and Jones, G.W. (1990), Physical developer: a practical and productive latent print developer, *J. Forensic Identification*, 40, 135–147.
- Pirone, G. (1976), Impronte digitali: legge e tecnica, *La Giustizia Penale*, 155–160.
- Pirone, G. (1991), *La Polizia Scientifica — Criminologia e Indagini Tecniche*, Rimini, Italy: Maggiolini.
- Plato, C.C., Garruto, R.M., Schaumann, B.A., and Paul, N.W., Eds. (1991), *Dermatoglyphics — Science in Transition*, Vol. 27 (2), New York: Wiley-Liss.
- Pounds, C.A. and Hussain, J.J. (1987), Biologic and Chemical Aspects of Latent Fingerprint Detection, in *Proceedings of the International Forensic Symposium on Latent Prints*, FBI Academy, Quantico VA, pp. 9–13.
- Pounds, C.A., Griggs, R., and Mongkolaussavaratana, T. (1990), The use of 1,8-diazafluoren-9-one (DFO) for the fluorescent detection of latent fingerprints on paper: a preliminary evaluation, *J. Forensic Sci.*, 35, 169–175.
- Pounds, C.A. and Allman, D.S. (1991), The Use of 1,8-Diazafluoren-9-one for the Fluorescent Detection of Latent Fingerprints on Paper: Results of Laboratory and Operational Trials, Technical CRSE No. 740, Central Research and Support Establishment, Aldermaston, U.K.
- Pounds, C.A. and Allman, D.S. (1992), A Preliminary Assessment of Thienoninhydrin, 5-Methylthioninhydrin and 5-Aminoninhydrin for Revealing Latent Fingerprints as Fluorescent Images, Technical CRSE No. 750, Central Research and Support Establishment, Aldermaston, U.K.
- Pounds, C.A., Allman, D.S., and Wild, F.M. (1992), The Development of Latent Fingerprints Using an Iodine Spray Technique, Technical CRSE No. 746, Central Research and Support Establishment, Aldermaston, U.K.
- Prabhakar, S. (2001), *Fingerprint Classification and Matching Using a Filterbank*, Ph.D. thesis, Michigan State University, Computer Science and Engineering, Chicago.
- Presley, L.A., Baumstark, A.L., and Dixon, A. (1993), The effects of specific latent fingerprint and questioned document examinations on the amplification and typing of the HLA DQ alpha gene region in forensic casework, *J. Forensic Sci.*, 38, 1028–1036.
- Price, D. and Stow, K. (1998), A method for stopping overdevelopment of silver nitrate treated finger and footwear marks, *Fingerprint Whorld*, 24, 107–110.
- Puri, D.K.S. (1962), Réflexions dactyloscopiques, *Revue Internationale Police Criminelle*, 17 (160), 225–227.
- Puri, D.K.S. (1964), Complément à quelques réflexions dactyloscopiques, *Revue Internationale Police Criminelle*, 19 (178), 130–134.
- Rajtar, P.E. (2000), 3M Novec engineered fluid HFE-7100, *Fingerprint Whorld*, 26, 143–152.
- Ramotowski, R.S. (1996a), Fluorescence Visualization of Latent Fingerprints on Paper Using p-Dimethylaminocinnamaldehyde (PDMAC), in *Proceedings of the International Symposium on Fingerprint Detection and Identification*, Israel National Police, Ne'urim, Israel, June 26–30, 1995, pp. 91–97.
- Ramotowski, R.S. (1996b), Importance of an acid prewash prior to the use of physical developer, *J. Forensic Identification*, 46, 673–677.

- Ramotowski, R.S., Cantu, A.A., Joullié, M.M., and Petrovskaia, O. (1997), 1,2-Indanediones: a preliminary evaluation of a new class of amino acid visualizing compounds, *Fingerprint Whorld*, 23, 131–140; correction in *FW* 24, 136.
- Ramotowski, R.S. (2000), A comparison of different physical developer systems and acid pre-treatments and their effects on developing latent prints, *J. Forensic Identification*, 50, 363–384.
- Ramotowski, R.S. (2001), Composition of latent print residue, in *Advances in Fingerprint Technology*, 2nd ed., H.C. Lee and R.E. Gaensslen, Eds., Boca Raton, FL: CRC Press, pp. 63–104.
- Ramotowski, R.S. and Cantu, A.A. (2001), Recent latent print visualisation research at the US Secret Service, *Fingerprint Whorld*, 27, 59–65.
- Reichardt, G.J., Carr, J.C., and Stone, E.G. (1978), A conventional method for lifting latent fingerprints from human skin surfaces, *J. Forensic Sci.*, 23, 135–141.
- Reiss, R.-A. (1903), *La Photographie Judiciaire*, Paris: Mendel.
- Reiss, R.-A. (1909a), Les méthodes modernes d'identification de criminels, *Wissen und Leben*, 15 Janvier, 338–345.
- Reiss, R.-A. (1909b), Les méthodes modernes d'identification de criminels II: la fiche dactyloscopique, *Wissen und Leben*, 1 Février, 385–389.
- Reiss, R.-A. (1909c), Les méthodes modernes d'identification de criminels III: le portrait parlé, *Wissen und Leben*, 15 Février, 439–452.
- Ribaux, O., Lennard, C., Dugerdil, P., and Margot, P. (1993), Goldfinger: an expert computer system for the determination of fingerprint detection sequences, *J. Forensic Identification*, 43, 468–480.
- Ribaux, O. and Margot, P. (1999), Inference structures for crime analysis and intelligence: the example of burglary using forensic science data, *Forensic Sci. Int.*, 100, 193–210.
- Ritchie, A.T. (2002), An update on some recent Manchester cases, *Fingerprint Whorld*, 28, 11–17.
- Robertson, B. and Vignaux, G.A. (1994), The interpretation of fingerprints, *Expert Evidence*, 3, 3–8.
- Robertson, B. and Vignaux, G.A. (1995), *Interpreting Evidence — Evaluating Forensic Science in the Courtroom*, Chichester: John Wiley & Sons.
- Roddy, A.R. and Stosz, J.D. (1997), Fingerprint features — statistical analysis and system performance estimates, *Proc. IEEE*, 85, 1390–1421.
- Roddy, A.R. and Stosz, J.D. (1999), Fingerprint feature processing techniques and poroscopy, in *Intelligent Biometric Techniques in Fingerprint and Face Recognition*, L.C. Jain, U. Halici, I. Hayashi, S.B. Lee, and S. Tsutsui, Eds., Boca Raton, FL: CRC Press, pp. 35–105.
- Roux, C., Gill, K., Sutton, J., and Lennard, C. (1999), A further study to investigate the effect of fingerprint enhancement techniques on the DNA analysis of bloodstains, *J. Forensic Identification*, 49, 357–376.
- Roux, C., Jones, N., Lennard, C.J., and Stoilovic, M. (2000), Evaluation of 1,2-indanedione and 5,6-dimethoxy-1,2-indanedione for the detection of latent fingerprints on porous surfaces, *J. Forensic Sci.*, 45, 761–769.
- Roux, C. (2003), personal communication.
- Roux, J.A. (1926), *Actes du Premier Congrès de Police Judiciaire Internationale*, Paris: Marchal et Billard, G. Godde succ.
- Roxburgh, T. (1933a), Galton's work on the evidential value of finger prints, *Sankhya: Indian J. Statistics*, 1, 50–62.
- Roxburgh, T. (1933b), On the evidential value of finger prints, *Sankhya: Indian J. Statistics*, 1, 189–214.

- Russ, J.C. (2001), *Forensic Uses of Digital Imaging*, Boca Raton, FL: CRC Press.
- Saferstein, R. and Graf, S.L. (2001), Evaluation of a reflected ultraviolet imaging system for fingerprint detection, *J. Forensic Identification*, 51, 385–393.
- Sahs, P.T. (1992), DAB: an advancement in blood print detection, *J. Forensic Identification*, 42, 412–420.
- Saks, M.J. and Koehler, J.J. (1991), What DNA fingerprinting can teach the law about the rest of forensic science, *Cardozo Law Rev.*, 13, 361–372.
- Saks, M.J. (1994), Implications of the Daubert test for the forensic identification science, *Shepard's Expert Sci. Evidence*, 1, 427–434.
- Saks, M.J. (1998), Merlin and Solomon: lessons from the law's formative encounters with forensic identification science, *Hastings Law J.*, 49, 1069–1141.
- Salaes, V.R., Eves, C.R., and Carey, P.R. (1979), On the detection of fingerprints by laser excited luminescence, *Forensic Sci. Int.*, 14, 229–237.
- Sampson, W.C. (1992), Glass recovery investigative technique: G.R.I.T., *J. Forensic Identification*, 42, 96–100.
- Sampson, W.C. (1993), An inquiry into the methodology of preserving and developing latent prints on expended cartridge casings, *J. Forensic Identification*, 43, 4–12.
- Sampson, W.C. (1995), Glass recovery investigative technique: G.R.I.T., *Fingerprint Whorld*, 21, 55–56.
- Sampson, W.C. (1996), Latent fingerprint evidence on human skin, Part 1, *J. Forensic Identification*, 46, 188–195.
- Sampson, W.C. (1997), Sequential applications in the development and recovery of latent fingerprint evidence from human skin, *Fingerprint Whorld*, 23, 94–97.
- Sampson, W.C., Sampson, K.L., and Shonberger, F. (1998), *Recovery of Latent Fingerprint Evidence from Human Skin: Causation, Isolation and Processing Techniques*, Salem: Lightning Powder Co. and Lynn Peavey Co.
- Sannié, C. and Guérin, D. (1940), *Éléments de Police Scientifique*, Vol. 4, Paris: Hermann & Cie.
- Sannié, C. (1950), Alphonse Bertillon et la dactyloscopie: l'affaire Scheffer, *Revue Internationale Police Criminelle*, 5 (41), 255–262.
- Santamaria Beltran, F. (1953), Une Nouvelle Méthode d'Évaluation des Points Caractéristiques des Crêtes Papillaires, in *Assemblée Générale de la Commission Internationale de Police Criminelle*, Oslo, Norway, June 24–29.
- Sasson, Y. and Almog, J. (1978), Chemical reagents for the development of latent fingerprints, 1: scope and limitations of the reagent 4-dimethylaminocinnamaldehyde, *J. Forensic Sci.*, 23, 852–855.
- Saunders, G.C. (1989), Multimetal Deposition Technique for Latent Fingerprint Development, in *74th IAI Educational Conference Proceedings*, Pensacola, FL, June.
- Saunders, G.C. and Cantu, A.A. (1996), Evaluation of Several Techniques for Developing Latent Prints on Expended Cartridge Casings, in *Proceedings of the International Symposium on Fingerprint Detection and Identification*, Israel National Police, Ne'urim, Israel, June 26–30, 1995, pp. 155–160.
- Saviano, J. (2003), The significance of using Level 1 detail in latent print examinations, *J. Forensic Identification*, 53, 209–218.
- Saviers, K.D. (1987), Friction Skin Characteristics: A Study and Comparison of Proposed Standards, in *Proceedings of the International Forensic Symposium on Latent Prints*, FBI Academy, Quantico, VA, pp. 157–163.
- Saviers, K.D. (1989), Friction skin characteristics: a study and comparison of proposed standards, *J. Forensic Identification*, 39, 157–163.

- Schnetz, B. (1999), La Révélation des Empreintes Digitales par l'Or Colloïdal: l'Amplification par des Techniques Biochimiques, Ph.D. thesis, Institut de Police Scientifique et de Criminologie, Université de Lausanne, Switzerland.
- Schnetz, B. and Margot, P.A. (2001), Technical note: latent fingerprints, colloidal gold and multimetal deposition (MMD): optimisation of the method, *Forensic Sci. Int.*, 118, 21–28.
- Schulz, M.M. and Reichert, W. (2002), Archived or directly swabbed latent fingerprints as a DNA source for STR typing, *Forensic Sci. Int.*, 127, 128–130.
- Schütz, F., Bonfanti, M., and Champod, C. (1999), La révélation des traces papillaires sur les douilles par les techniques de etching et de blueing et comparaison avec la déposition multimétallique, *J. Can. Forensic Sci. Soc.*, 33, 65–81.
- Schwabenland, J.F. (1992), Determining the evaporation rate of latent impressions on the exterior surfaces of aluminum beverage cans, *J. Forensic Identification*, 42, 84–90.
- Schwartz, R.L., Higginbotham, L.C., and Smith, D.R. (2003), The effect of Un-Du® on latent print development, *Fingerprint Whorld*, 29, 66–73.
- Schwarz, L. and Frerichs, I. (2002), Advanced solvent-free application of ninhydrin for detection of latent fingerprints on thermal paper and other surfaces, *J. Forensic Sci.*, 47, 1274–1277.
- Sclove, S.L. (1979), The occurrence of fingerprint characteristics as a two dimensional process, *J. Am. Stat. Assoc.*, 74, 588–595.
- Sclove, S.L. (1980), The occurrence of fingerprint characteristics as a two dimensional Poisson process, *Commun. Statistics — Theor. Methods*, A7, 675–695.
- Sears, V.G. and Prizeman, T.M. (2000), Enhancement of fingerprints in blood, Part 1: the optimization of amido black, *J. Forensic Identification*, 50, 470–480.
- Sears, V.G., Butcher, C.P.G., and Prizeman, T.M. (2001), Enhancement of fingerprints in blood, Part 2: protein dyes, *J. Forensic Identification*, 51, 28–38.
- Sengoopta, C. (2003), *Imprint of the Raj — How Fingerprinting Was Born in Colonial India*, London: Macmillan.
- Sherlock, B.G., Monro, D.M., and Millard, K. (1992), Algorithm for enhancing fingerprint images, *Electron. Lett.*, 28, 1720–1721.
- Sherratt, J. (1979), UFOS (unfounded fingerprint opinions) as evidence in South Africa: when is a point not a point? *South Afr. Law J.*, 96, 287–289.
- Sherstinsky, A. and Picard, R.W. (1994), Restoration and Enhancement of Fingerprint Images Using M-Lattice — A Novel Non-Linear Dynamical System, in *Proceedings of the International Conference on Pattern Recognition*, Jerusalem, pp. 195–200.
- Shin, D.H. and Argue, D.G. (1976), Identification of fingerprints left on human skin, *J. Can. Soc. Forensic Sci.*, 9, 81–84.
- Shipp, E., Roelofs, R., Togneri, E., Wright, R., Atkinson, D., and Henry, B. (1993), Effects of argon laser light, alternate source light, and cyanoacrylate fuming on DNA typing of human bloodstains, *J. Forensic Sci.*, 38, 184–191.
- Shipp, E., Fassett, M., Wright, R., and Togneri, E. (1994), Tetramethylbenzidine to the rescue, *J. Forensic Identification*, 44, 159–164.
- Singh, P. (1963), Pressure distortions in finger printing, *Fingerprint Identification Mag.*, 44 (9), 3–6.
- Smith, C.A.B. (1979), Note on the forms of dermatoglyphic patterns, in *Dermatoglyphics — Fifty Years Later*, Vol. XV, No. 6, W. Wertelecki, C.C. Plato, and N.W. Paul, Eds., New York: Alan R. Liss, pp. 43–52.
- Smith, W.C., Kinney, R.W., and DePartee, D.G. (1993), Latent fingerprints — a forensic approach, *J. Forensic Identification*, 43, 563–570.

- Sneddon, N. (1999), Black powder method to process duct tape, *J. Forensic Identification*, 49, 347–356.
- Sodhi, G.S. and Kaur, J. (2001), Powder method for detecting latent fingerprints: a review, *Forensic Sci. Int.*, 120, 172–176.
- Sorrentino, U. (1948), La preuve dactyloscopique devant les magistrats, *Revue Internationale Criminologie Police Technique*, 2, 14–16.
- Sorrentino, U. (1952), Empreintes digitales, *Revue Internationale Police Criminelle*, 7, 329–337.
- Sorrentino, U. (1956), Identity of digital prints, *Fingerprint Identification Mag.*, 37, 3–5.
- Specter, M. (2002), Do fingerprints lie? The gold standard of forensic evidence is now being challenged, *New Yorker*, 27 May, 96–105.
- Sprangers, W. and Nijboer, H. Eds. (2000), *Harmonisation in Forensic Expertise*, Amsterdam: Thela Thesis.
- Spring, M., Gros, L., and Deinet, W. (1995), Visualisation of Latent Fingerprints with Cyanoacrylates — Summary of the Research Projects of the Private Fresenius Technical College / University of Idstein, commissioned by the Bundeskriminalamt Wiesbaden, Technical KI2, Bundeskriminalamt, Wiesbaden.
- Springer, E., Almog, J., Frank, A., Ziv, Z., Bergman, P., and Gui Qiang, W. (1994), Detection of dry body fluids by inherent short wavelength UV luminescence, *Forensic Sci. Int.*, 66, 164–168.
- Springer, E. and Bergman, P. (1995), A fluorescent small particle reagent (SPR), *J. Forensic Identification*, 45, 164–168.
- Stein, C., Hyeck, S.H., and Henssge, C. (1996), DNA typing of fingerprint reagent treated biological stains, *J. Forensic Sci.*, 41, 1012–1017.
- Steinwender, E. (1958a), L'identification dactyloscopique, *Revue Internationale Criminologie Police Technique*, 12, 128–140.
- Steinwender, E. (1958b), Der daktyloskopische Identitätsnachweis, *Kriminalistik*, 12, 186–194.
- Steinwender, E. (1960), Dactyloscopic identification, *Fingerprint Identification Mag.*, 41, 3–16.
- Stigler, S.M. (1995), Galton and identification by fingerprints, *Genetics*, 140, 857–860.
- Stimac, J.T. (2000), Adhesive tape separation with Un-Du®, *Fingerprint Whorld*, 26, 153–157.
- Stimac, J.T. (2003), Thermal and carbonless papers: a fundamental understanding for latent friction ridge development, *J. Forensic Identification*, 53, 185–197.
- Stoilovic, M., Kobus, H.J., Margot, P.A., and Warren, R.N. (1986), Improved enhancement of ninhydrin developed fingerprints by cadmium complexation using low temperature photoluminescence techniques, *J. Forensic Sci.*, 31, 432–445.
- Stoilovic, M., Margot, P.A., and Lennard, C.J. (1987), Design of a Versatile Light Source for Fingerprint Detection and Enhancement, in *Proceedings of the International Forensic Symposium on Latent Prints*, FBI Academy, Quantico, VA, pp. 153–154.
- Stoilovic, M. (1991), Detection of semen and blood stains using Polilight as a light source, *Forensic Sci. Int.*, 51, 289–296.
- Stoilovic, M. (1993), Improved method for DFO development of latent fingerprints, *Forensic Sci. Int.*, 60, 141–153.
- Stoilovic, M. and Lennard, C.J. (2000), personal communication.
- Stoney, D.A. (1985), Quantitative Assessment of Fingerprint Individuality, Ph.D. thesis, University of California, Berkeley.
- Stoney, D.A. and Thornton, J.I. (1986), A method for the description of minutiae pairs in epidermal ridge patterns, *J. Forensic Sci.*, 31, 1217–1234.

- Stoney, D.A. and Thornton, J.I. (1987), A systematic study of epidermal ridge minutiae, *J. Forensic Sci.*, 32, 1182–1203.
- Stoney, D.A. (1989), Source individuality versus expressed individuality — discussion of “Probability analysis and the evidential value of bolt arrangements” [letter to editor], *J. Forensic Sci.*, 34, 1295–1296.
- Stoney, D.A. (1991), What made us ever think we could individualize using statistics? *J. Forensic Sci. Soc.*, 31, 197–199.
- Stoney, D.A. (1997), Fingerprint identification, §21-2, in *Modern Scientific Evidence: The Law and Science of Expert Testimony*, Vol. 2, D.L. Faigman, D.H. Kaye, M.J. Saks, and J. Sanders, Eds., St. Paul, MN: West Publishing, pp. 55–78.
- Stosz, J.D. and Alyea, L.A. (1994), Automatic system for fingerprint authentication using pores and ridge structures, in *Automatic Systems for the Identification and Inspections of Humans*, San Diego, CA: SPIE (International Society for Optical Engineering), pp. 210–223.
- Stücker, M., Geil, M., Hyeck, S., Hoffman, K., Rochling, A., Memmel, U., and Altmezer, P. (2001), Interpapillary lines — the variable part of the human fingerprint, *J. Forensic Sci.*, 46, 857–861.
- Sutherland, B., Cordiner, S., Bright, J.-A., and Walsh, S.J. (2003), Comments on: “Trace DNA: a review, discussion of theory and application of the transfer of trace quantities of DNA through skin contact” [with author's response], *J. Forensic Sci.*, 48, 467–468.
- Takatsu, M., Kageyama, H., Hirata, H., Akashi, S., Yoko Ta, T., and Shiitana, M. (1991), Development of a new method to detect latent fingerprint on thermal paper with o-alkyl derivatives of ninhydrin, *Rep. Natl. Inst. Police Sci. (Jpn.)*, 44, 1–6.
- Taroni, F. (1990), Cyanoacrylate et Déposition Métallique: Comparaison de Leur Efficacité dans la Révélation des Empreintes Digitales, technical report, Institut de Police Scientifique et de Criminologie, Université de Lausanne, Switzerland.
- Taroni, F., Lennard, C. J., and Margot, P. A. (1990), Latent Fingerprint Detection on Non-Porous Surfaces: Comparison between Metal Deposition and Cyanoacrylate Fuming, in *12th Meeting of the International Association of Forensic Sciences*, Adelaide, Australia.
- Taroni, F. and Margot, P.A. (2000), Fingerprint evidence evaluation: is it really so different to other evidence types? [letter to editor], *Sci. Justice*, 40, 277–278.
- Theys, P., Turgis, Y., Lepareux, A., Chevet, G., and Ceccaldi, P.F. (1968), Nouvelle technique de révélation de traces papillaires latentes (sur le papier) par métallisation sous vide, *Revue Internationale Police Criminelle*, 23 (217), 106–108.
- Thomas, G.L. (1973), The physics of fingerprints, *Criminology*, 8, 21–38.
- Thomas, G.L. (1975), The resistivity of fingerprints, *J. Forensic Sci. Soc.*, 15, 133–135.
- Thomas, G.L. (1978), The physics of fingerprints and their detection, *J. Phys. Ser. E: Sci. Instruments*, 11, 722–731.
- Thornton, J.I. (1977), The one-dissimilarity doctrine in fingerprint identification, *Int. Criminal Police Rev.*, 32 (306), 89–95.
- Thornton, J.I. (1997a), The DNA statistical paradigm vs. everything else, *J. Forensic Sci.*, 42, 758–759.
- Thornton, J.I. (1997b), The general assumptions and rationale of forensic identification, §20, in *Modern Scientific Evidence: The Law and Science of Expert Testimony*, Vol. 2, D.L. Faigman, D.H. Kaye, M.J. Saks, and J. Sanders, Eds., St. Paul, MN: West Publishing, pp. 1–49.
- Tietze, S. and Witthuhn, K. (2001), *Papillarleisten-Struktur der menschlichen Handinnenfläche*, Vol. 9, Neuwied: Luchterhand.

- Tiller, C.D. (1983), Fingerprint identification in United Kingdom — Do they really need 16 points? *Can. Identification Soc. Newsl.*, 6, 5–8.
- Tissier, P., Didierjean, C., Prud'Homme, C., Pichard, J., and Crispino, F. (1999), A “cyanoacrylate case” for developing fingerprints in cars, *Sci. Justice*, 39, 163–166.
- Tribe, L.H. (1971), Trial by mathematics: precision and ritual in the legal process, *Harv. Law Rev.*, 84, 1329–1393.
- Turing, A.M. (1952), The chemical basis of morphogenesis, *Philos. Trans. R. Soc.*, B237, 37–72.
- Tuthill, H. (1994), *Individualization: Principles and Procedures in Criminalistics*, Salem: Lightning Powder Co.
- Tuthill, H.H. (1997), Re: “Sticky-side powder versus gentian violet” [letter to editor with author’s response], *J. Forensic Identification*, 47, 4–10.
- U.S. Department of Justice, Federal Bureau of Investigation (1984), *The Science of Fingerprints*, Washington, DC: U.S. Government Printing Office.
- Valussi, S. (2003), Microfluidic Systems for the Chemical Analysis of Fingerprint Residues, Ph.D. thesis, Imperial College London, Department of Chemistry, London.
- Vanderkolk, J.R. (1993), Class characteristics and could be results, *J. Forensic Identification*, 43, 119–125.
- Vanderkolk, J.R. (1999), Forensic individualization of images using quality and quantity of information, *J. Forensic Identification*, 49, 246–256.
- Vanderkolk, J.R. (2001), Levels of quality and quantity in detail, *J. Forensic Identification*, 51, 461–468.
- van Koppen, P.J. and Crombag, H.F.M. (2000), Oren, lippen en vingers: de waarde van oud en nieuw identificatiebewijs, *Nederlands Juristenblad*, 75, 6–12.
- van Oorshot, R.A.H. and Jones, M.K. (1997), DNA fingerprints from fingerprints, *Nature*, 387, 767.
- Velders, M.J.M. (1997), Blutspuren, *Kriminalistik*, 51, 349–352.
- von Wurmb, N., Meissner, D., and Wegener, R. (2000), Influence of cyanoacrylate on the efficiency of forensic PCRs, *Forensic Sci. Int.*, 124, 11–16.
- Vouk, D.M. (1996), The effects of gold gun blue on individual characteristics on cartridge casings, *AFTE J.*, 28, 256–257.
- Vucetich, J. (1904), *Dactyloscopia Comparada: El Nuevo Sistema Argentino*, La Plata, Argentina: Jacobo Peuser.
- Wade, D.C. (2002), Development of latent prints with titanium dioxide (TiO₂), *J. Forensic Identification*, 52, 551–559.
- Walder, H. (1976), Kriminalistik in der Schweiz, *Kriminalistik*, 30, 178–182.
- Wang, G.Q. (1996), Detecting and Enhancing Latent Fingerprints with Short Wave UV Reflection Photography, in *Proceedings of the International Symposium on Fingerprint Detection and Identification*, Israel National Police, Ne’urim, Israel, June 26–30, 1995, pp. 37–49.
- Warrener, R.N., Kobus, H.J., and Stoilovic, M. (1983), An evaluation of the reagent NBD chloride for the production of luminescent fingerprints on paper: I, support for a xenon arc lamp being a cheaper alternative to an argon ion laser as an excitation source, *Forensic Sci. Int.*, 23, 179–188.
- Warrick, P. (2000), Identification of blood prints on fabrics using amido black and digital enhancement, *J. Forensic Identification*, 50, 20–32.
- Watkin, J.E. (1987), Alternative Lighting Methods for Detecting Latent Prints, in *Proceedings of the International Forensic Symposium on Latent Prints*, FBI Academy, Quantico, VA.

- Watkin, J.E. and Misner, A.H. (1990), Fluorescence and crime scenes in the 90's, *RCMP Gaz.*, 52 (9), 1–5.
- Watkin, J.E., Wilkinson, D., Misner, A.H., and Yamashita, A.B. (1994), Cyanoacrylate fuming of latent prints: vacuum versus heat/humidity, *J. Forensic Identification*, 44, 545–556.
- Watling, W.J. (1993), Using the FFT in forensic digital image enhancement, *J. Forensic Identification*, 43, 573–584.
- Watling, W.J. and Smith, K.O. (1993), Heptane: an alternative to the freon/ninhydrin mixture, *J. Forensic Identification*, 43, 131–134.
- Watling, W.J. (1994), Using color in forensic digital image enhancement, *J. Forensic Identification*, 44, 357–363.
- Wayman, J.L. (2000), When bad science leads to good law: the disturbing irony of the Daubert hearing in the case of U.S. v. Byron C. Mitchell, *Biometrics Hum. Serv.*, 4; <http://www.dss.state.ct.us/digital.htm>.
- Weaver, D.E. and Clary, E.J. (1993), A one-step fluorescent cyanoacrylate fingerprint development technology, *J. Forensic Identification*, 43, 481–492.
- Wendt, G. (1956), Zwillinguntersuchungen über Zwischenlinien und weisse Linien im Abdruck der menschlichen Fingerbeere, *Acta Genet.*, 6, 143–155.
- Wertelecki, W., Plato, C.C., and Paul, N.W., Eds. (1979), *Dermatoglyphics — Fifty Years Later*, Vol. XV, No. 6, New York: Alan R. Liss.
- Wertheim, K. and Maceo, A. (2002), The critical stage of friction ridge and pattern formation, *J. Forensic Identification*, 52, 35–85.
- Wertheim, K. (2003), Fingerprint age determination: is there any hope? *J. Forensic Identification*, 53, 42–49.
- Wertheim, P.A. (1996), The ability equation, *J. Forensic Identification*, 46, 149–159.
- Wertheim, P.A. (1998), Integrity assurance: policies and procedures to prevent fabrication of latent print evidence, *J. Forensic Identification*, 48, 431–441.
- Wertheim, P.A. (2000), Scientific comparison and identification of fingerprint evidence, *Fingerprint Whorld*, 26, 95–106.
- West, M.H., Brasley, R.E., Frair, J., and Hall, F. (1990), Reflective ultraviolet imaging system (RUVIS) and the detection of trace evidence and wounds on human skin, *J. Forensic Identification*, 40, 249–255.
- Wickenheiser, R.A. (2002), Trace DNA: a review, discussion of theory, and application of the transfer of trace quantities of DNA through skin contact, *J. Forensic Sci.*, 47, 442–450.
- Wiesner, S., Springer, E., and Argaman, U. (1996), A Closer Look at the Effects of the Shooting Process on Fingerprint Development on Fired Cartridge Cases, in *Proceedings of the International Symposium on Fingerprint Detection and Identification*, Israel National Police, Ne'urim, Israel, June 26–30, 1995, pp. 161–178.
- Wiesner, S., Springer, E., Sasson, Y., and Almog, J. (2001), Chemical development of latent fingerprints: 1,2-indanedione has come of age, *J. Forensic Sci.*, 46, 1082–1084.
- Wilder, H.H. and Wentworth, B. (1932), *Personal Identification — Methods for the Identification of Individuals Living or Dead*, 2nd ed., T.G. Cooke, Ed., Chicago: The Fingerprint Publishing Association; 1st ed., Boston: Richard G. Badger, 1918.
- Wilkinson, D. and Watkin, J.E. (1993), Europium aryl- β -diketone complexes as fluorescent dyes for the detection of cyanoacrylate developed fingerprints on human skin, *Forensic Sci. Int.*, 60, 67–79.
- Wilkinson, D. and Watkin, J.E. (1994), A comparison of the forensic light sources: Polilight, Luma-Lite, and Spectrum 9000, *J. Forensic Identification*, 44, 632–651.

- Wilkinson, D., Watkin, J.E., and Misner, A.H. (1996a), A comparison of techniques for the visualization of fingerprints on human skin including the application of iodine and α -naphthoflavone, *J. Forensic Identification*, 46, 432–453.
- Wilkinson, D., Watkin, J.E., and Misner, A.H. (1996b), A comparison of techniques for the visualization of fingerprints on human skin including the application of iodine and α -naphthoflavone [correction], *J. Forensic Identification*, 46, 663.
- Wilkinson, D. (2000a), Spectroscopic study of 1,2-indanedione, *Forensic Sci. Int.*, 114, 123–132.
- Wilkinson, D. (2000b), Study of the reaction mechanism of 1,8-diazafluoren-9-one with the amino acid l-alanine, *Forensic Sci. Int.*, 109, 87–103.
- Wilson, B.L. and McCloud, V.D. (1982), Development of latent prints on black plastic tape using crystal violet dye and photographic paper, *Identification News*, 32 (3), 3–4.
- Winstanley, R. (1977), Recovery of latent fingerprints from difficult surfaces by an x-ray method, *J. Forensic Sci. Soc.*, 17, 121–125.
- Xiang-Xin, Z. and Chun-Ge, L. (1988), The historical application of hand prints in Chinese litigation, *J. Forensic Identification*, 38, 277–284.
- Yamashita, A.B. (1994), Use of a benchtop desiccator for vacuum cyanoacrylate treatment of latent prints, *J. Forensic Identification*, 44, 149–158.
- Yamashita, K., Oishi, M., Okiura, T., Shirakami, A., and Ohue, M. (1993), A new method for detection of latent fingerprints on a craft adhesive tape by using SP-Black® powder, *Rep. Natl. Res. Inst. Police Sci. (Jpn.)*, 46, 189–191.
- Yong, A.S.J. (1986), Detection of Latent Fingerprints with Cyanoacrylates: New Techniques Involving Coloured and Photoluminescent Compounds, Ph.D. thesis, National Australian University, Canberra, Australia.
- Yong, A.S.J., Margot, P.A., and Warrener, R.N. (1986), Visual Enhancement of Superglue Developed Fingerprints, in *9th Australian International Forensic Science Symposium*, Melbourne, Australia.
- Young, M. (1984), *Optics and Lasers: Including Fibers and Integrated Optics*, Berlin: Springer Verlag.
- Yvert, A. (1904), L'Identification par les Empreintes Digitales Palmaires (la Dactyloscopie), thèse de doctorat, Université de Lyon, Lyon: A. Storck et Cie Ed.
- Zamir, A., Oz, C., and Geller, B. (2000a), Threat mail and forensic science: DNA profiling from items of evidence after treatment with DFO, *J. Forensic Sci.*, 45, 445–446.
- Zamir, A., Springer, E., and Glattstein, B. (2000b), Fingerprints and DNA: STR typing of DNA extracted from adhesive tape after processing of fingerprints, *J. Forensic Sci.*, 45, 687–688.
- Zamir, A., Oz, C., Leifer, A., and Geller, B. (2002), The effect of small particle reagent employed as a fingerprint enhancement technique on subsequent STR typing from bloodstains, *J. Forensic Identification*, 52, 691–695.
- Zeelenberg, A. (2003), personal communication.
- Ziv, Z. and Springer, E. (1993), More applications of coaxial illumination in fingerprint detecting and photography, *J. Forensic Identification*, 43, 362–367.