

The cover features a dark blue background with a complex, ornate gold floral border. The border consists of stylized, symmetrical branches with small leaves and buds, curving upwards from a central base that resembles the spine of an open book. The overall design is reminiscent of Art Nouveau or Victorian decorative styles.

*First  
American  
Jewish  
Families*

600 Genealogies • 1654-1988



Malcolm H. Stern

Third Edition  
Updated  
and  
Revised

# *First American Jewish Families*

600 Genealogies • 1654–1988

*Third Edition  
Updated and Revised*

*Compiled by*

*Malcolm H. Stern*

*Fellow American Society of Genealogists  
Genealogist, American Jewish Archives*

Ottenheimer Publishers, Inc.  
Baltimore, Maryland



© Copyright 1978, 1960  
AMERICAN JEWISH ARCHIVES  
AMERICAN JEWISH HISTORICAL SOCIETY  
© Copyright 1991  
OTTENHEIMER PUBLISHERS, INC.

**Library of Congress Cataloging in Publication Data**

Stern, Malcolm H.  
First American Jewish families.

Bibliography: p.  
Includes index.

1. Jews in the United States—Genealogy.
  2. United States—Genealogy. I. Title.
- CS59.S76 1978 929'.2'0973 78-17341  
ISBN 0-87068-443-4

Manufactured in the United States of America

## *To Louise*

*Adored and adoring,  
whose loving help  
has brought this  
and so much else  
to joyous reality*



# Acknowledgments

The publication of this book has been made possible by the generosity of many individuals—dear ones and friends. The compiler expresses his gratitude to them, with special thanks to the following.

## *Underwriters*

THE LITTAUER PUBLICATION FUND OF THE AMERICAN JEWISH HISTORICAL SOCIETY a beneficiary of the Lucius N. Littauer Foundation, Harry Starr, President.

THE CENTRAL CONFERENCE OF AMERICAN RABBIS honoring the compiler's completion of ten years as Director of Rabbinic Placement, and establishing the CCAR Genealogical Fund as the repository for gifts toward this publication.

MALCOLM H. STERN & LOUISE B. STERN

## *Patrons*

LEONARD N. SIMONS, Southfield, Michigan  
PAUL UHLMANN, JR, Kansas City, Missouri

## *Subscribers*

LEON L. BERKOWITZ, Philadelphia, Pennsylvania  
CONGREGATION BETH ELOHIM, Charleston, South Carolina  
CONGREGATION EMANU-EL, New York, New York

## *Subscribers (cont.)*

MRS. ROGER A. HORNE, Norfolk, Virginia  
ROBERT C. NUSBAUM, Norfolk, Virginia  
REFORM CONGREGATION KENESETH ISRAEL,  
Elkins Park, Pennsylvania  
EDWARD L. STERN, Plantation, Florida



For the production of this work, the following deserve special gratitude: Wesley Cullen Davidson and Nancy E. R. Opperman for typing and layout of the charts; Gary Mokotoff, leader in genealogy and creative computerizer, and with Rose Ciecierski of Data Universal, Inc., of Teaneck, NJ, for their diligence in the immense task of computerizing the 50,000-name index; Allan T. Hirsh, Jr., Chairman of Ottenheimer Publishers of Baltimore, avid genealogist, for offering republication of this work. My beloved wife, Louise, gave countless hours of her editorial expertise to proofreading the index. Dr. Jacob R. Marcus, mentor, teacher, and friend, who inspired and endowed my original effort, has graciously yielded the copyright owned by the American Jewish Archives to the publisher of this update edition.

# Contents

Acknowledgments	iv	A Compendium of Genealogy	1
Foreword, by Dr. Jacob R. Marcus	vi	Addenda et Corrigenda	309
Preface	vii	Bibliography and Sources	315
How To Use This Book	viii	Update	320
Abbreviations, Signs and Symbols	ix	Index	342



# Foreword

In the historian's tool chest there are few utensils more helpful than genealogical tables. Since 1960, when the American Jewish Archives first published Malcolm Stern's *AMERICANS OF JEWISH DESCENT*, every work dealing with early American Jewish history has utilized it. Scholars have filled footnotes with references to it, popular writers have alluded to it. At least one best seller has been based on it.

The uses of these genealogical charts are manifold: the family researcher seeks American roots. The historian, interested in society, plots the physical and social mobility of people. Changes in family names demonstrate acculturation; intercolonial marriages provide information for the economic historian. Infant mortality, family size and lifespans, and hereditary disease can be traced here. The rise of Jewish communities becomes evident, the interplay of marriage between Jewish natives and Jewish newcomers is documented. Here, most graphically, one can trace the assimilatory effect of intermarriage, and notice, not without irony, the unbroken line that leads from a Polish Jewish immigrant peddler to an American ambassador to one of the Great Powers. There is a sermon and a threnody on every page.

Behind this work lie the heart and soul of a hard-working scholar. Dr. Malcolm H. Stern devoted eleven years to the creation of his original compilation, *AMERICANS OF JEWISH DESCENT*, that established his reputation as the father of American Jewish genealogy. The growth of interest in the field produced his revised and enlarged *FIRST AMERICAN JEWISH FAMILIES*. Through patience and perseverance, he has now brought forth this third "update" edition. All hail to him for setting the record straight and for continuing to produce this important reference tool!

*Jacob R. Marcus*

*American Jewish Archives  
Cincinnati, Ohio*



# Preface

A high school enthusiasm for royal genealogy inoculated me with a virus which became an all-absorbing hobby. After tracing thirteen generations of descendants of Charlemagne, I was well launched on a career of wholesale genealogy. A maturer outgrowth of the hobby arose from a search for a doctoral dissertation in the field of American Jewish History. In June of 1950, I approached the dean of American Jewish historians, my beloved teacher, Professor Jacob Rader Marcus, with a request for a thesis topic. By then Dr. Marcus had created the American Jewish Archives on the Cincinnati campus of Hebrew Union College, and had begun collecting the data on America's Jews. Among his early acquisitions was the large collection of typescript genealogies of Americans of Jewish descent compiled by the late Dr. Walter Max Kraus, and presented to the Archives by his spouse, Marian Nathan Kraus Sandor. Dr. Marcus made this material available to me, and I spent the succeeding eight years revising, correcting, and quadrupling the data in the Kraus-Sandor material. The result was my *AMERICANS OF JEWISH DESCENT*, published by Dr. Marcus at the Hebrew Union College Press in 1960. This pioneer compendium of American Jewish genealogy announced to the reader: "While every effort has been made to secure accurate data, the very nature and magnitude of the compilation make either completeness or total accuracy impossible of achievement. Additions and corrections will be welcomed..." In the intervening years, many have responded to this invitation. New data has appeared in print. And my own researches in archives, court houses, historical societies, congregational records, and cemetery epitaphs, have been on-going.

In 1978, resultant accumulation of data was published jointly by the American Jewish Archives and the American Jewish Historical Society as a contribution to the American Bicentennial under the title: *FIRST AMERICAN JEWISH FAMILIES: 600 GENEALOGIES, 1654-1977*.

The genealogist's task is never complete, for new generations are

born daily. The growth of interest in family history, made accessible to individuals by the newer technologies of photocopying, microforms, and computers, has brought about this updated edition.

My goal over more than forty years has been to try to compile the genealogies of Jewish families established in the United States and Canada prior to 1840, tracing their descendants wherever possible to the present. The year 1840 was chosen because an estimated 10,000 Jews had settled in America by then. Within the succeeding twenty years, more than 200,000 additional Jews were to immigrate, creating an insurmountable task for one genealogist working alone.

Although the vast majority of today's American Jews descend from later immigrants, I am proud that my work has inspired many who have consulted it to pursue their own roots, to create the growing network of Jewish genealogical societies around the world, to sponsor and conduct seminars, and to produce an ever-increasing bibliography of finding aids. Echoing the words of an ancient rabbinic sage, I can honestly say, "From all my disciples have I learned."

This work makes evident the assimilative power of mixed marriage between Jew and non-Jew. Increasingly, I am consulted by non-Jewish descendants of these pioneers, who take delight in discovering Jewish forebears. Until the beginning of this twentieth century, Jews constituted less than one percent of the American population; consequently many Jews were lost to Judaism through intermarriage. However, this volume clearly shows that many of these families contain individuals still loyal to their ancestral faith. A recent Jewish bride in South Carolina could trace ten generations of her ancestors in this book, all of whom were Jews. That is the miracle!

*Malcolm H. Stern*

*New York, N.Y., 1991*



# How To Use This Book

## *To Trace the Ancestry Of An Individual:*

1) Check the *Index* for the individual whom you seek. This is important as the individual may appear in any of four places: a. On his or her own family chart; b. On the spouse's family chart; c. In the section marked *Addenda et Corrigenda*, pages 309 to 314; d. In the section marked *Update*, pages 320 to 341.

2) After locating in the *Index* the individual you are seeking, look first at any references to pages 309 to 341, as these pages correct information that may appear on the genealogical charts. Note the ancestry supplied in those pages as they invariably lead upward to a forebear who is the connecting link to the genealogical charts. This is usually the first person mentioned for that specific family and the *Index* will lead you to his or her page among the genealogical charts.

3) Find this forebear on the genealogical chart. Then trace him upward to parents, grandparents, etc. The male line can usually be followed upward to the first known member of the family. Whenever you reach a person marked "q.v." or "vid.," you must turn to the page so indicated to continue that line upward to earlier ancestors.

## *Reading the Genealogical Charts:*

*Sources.* In the upper left corner of each genealogy will be found the list of Sources. These are the bibliographical or personal sources from which the Compiler derived the information contained on that family tree. For the explanation of abbreviations in the naming of sources see the list of *Bibliography and Sources* to be found on pages 315–320.

*Family Names.* Each page is headed by a family name. Roman numerals (I, II, III, etc.) indicate several *unrelated* families who bear the same name. Arabic numerals in parentheses (1), (2), (3), indicate several pages for *one* family. The family name heading the page is usually that of the progenitor of the family (or of its first American representative) and of his descendants in the male line. If the female line is continued on that page, her spouse will have his name *underlined*. All lines descending from an underlined name bear that surname. When an individual changed his name, the adopted name has a *double underline*, and all descendants bear the new name unless otherwise indicated.

*Cross-References.* Many of the families in this volume intermarried with other families in the book. Two methods are used to show cross-references to another page: 1) q. v. (*quem vide*, meaning "which see"). This shows that the spouse appears on the page bearing his or her surname. For example: On page 1, in the chart labelled AARONS I, HANNAH AARONS married ABRAHAM ALEXANDER, JR. Under his name appears the cross-reference indication "q. v.(1)" This means that full data for ABRAHAM ALEXANDER, JR. is to be found on the first page of the ALEXANDER family chart. The second form of cross-reference is indicated by the term "vid." (abbreviation of "vide" = see). This is used when the spouse so indicated appears on a page headed by a different family name. For example: On page 1, in the chart labelled AARONS II, we find AARON married to HENRIETTA LEVY, and under her name, "vid. LYONS III." This means that HENRIETTA does *not* appear on a LEVY page but will be found on the third of our LYONS genealogies.

# List of Abbreviations

Abr.—Abraham	d.s.p.—died sine prole = without issue	Lond.—London, England	Que.—Quebec, Canada
Adm.—Admiral, Administration	Dan.—Daniel	Lt.—Lieutenant	Rec.—Record(s)
Amst.—Amsterdam, Holland	dau.—daughter	Lt. Col.—Lieutenant Colonel	rem.—remarried
arr.—arrived	dep.—departed	Lt. Com.—Lieutenant Commander	Rev.—Reverend
Atl.—Atlanta, Ga.	Dir.—Director	Lt. Gov.—Lieutenant Governor	(Rev.)—Revolutionary War
b.—born	div.—divorced	m.—married	Ri.—Richmond, Va.
B.C.—British Columbia	e.g.—exempli gratia = for example	M.D.—Doctor of Medicine	Rich./Richm.—Richmond, Va.
Balt./Balto.—Baltimore, Md.	Eliz.—Elizabeth, N.J.	Maj.—Major	3 Riv/Trois Riv.—Trois Rivières, Que.
bap.—baptized	enden.—endenized	merch.—merchant	s.p.—sine prole = without issue
Barb.—Barbados	Eng.—England	mfr.—manufacturer	San Fr.—San Francisco, Cal.
Bart.—Baronet	Episc.—Episcopalian	misc.—miscellaneous	Sav.—Savannah, Ga.
Bav.—Bavaria	f./ff.—following	Mont.—Montreal, Quebec	sis.—sister
bef.—before	Fr.—France	Mord.—Mordecai	Sp.—Spain
bet.—between	Gen.—General, Genealogy	Ms.—manuscript	St. E.—St. Eustatius
Bklyn.—Brooklyn, N.Y.	Geo'tn.—Georgetown, S.C.	Mss.—manuscripts	St. L.—St. Louis, Mo.
Bost.—Boston, Mass.	Ger.—Germany	N.O.—New Orleans, La.	St. T./St. Thos.—Saint Thomas
bur.—buried (in)	Gov.—Governor	NY/N.Y.—New York, N.Y.	Switz.—Switzerland
C.—Century	Gtn.—Georgetown, S.C.	Nashv.—Nashville, Tenn.	Syn.—Synagogue
CSA—Confederate States Army	Hon.—the Honorable	nat.—naturalized	unm.—unmarried
CSN—Confederate States Navy	i.e.—id est = that is	New Orl.—New Orleans, La.	USA—United States Army
ca.—circa = about	inf.—infancy	Newp't.—Newport, Rhode Island	USN—United States Navy
Capt.—Captain	ins.—insane	Nfk/Norf.—Norfolk, Va.	Ven.—Venezuela
Cdr.—Commander	Isl.—Island	No.—number, North	vid.—vide = see
cem.—cemetery	Jac.—Jacob	Ont.—Ontario, Canada	W.I.—West Indies
Ch.—Charleston, S.C.	Jam.—Jamaica	op. cit.—opus citatum = the work cited	W.W.I(II)—World War I or II
Chi.—Chicago, Ill.	Jr.—Junior	p.—page	Wash.—Washington, D.C.
Cinti.—Cincinnati, Ohio	k.—killed	pp.—pages	Wilm.—Wilmington, N.C.
Civ. W.—Civil War	k.i.a.—killed in action	Pbg.—Pittsburgh, Pa.	Württ.—Württemberg, Germany
Cleve.—Cleveland, Ohio	K.C.—Kansas City, Mo.	perh.—perhaps	Xian—Christian
Co.—County	L.—living	Ph./Phila.—Philadelphia, Pa.	
Col.—Colonel	L.A.—Los Angeles, Cal.	Pol.—Poland	
Coll.—Collection(s)	L.I.—Long Island, N.Y.	Port.—Portugal	
Cong.—Congregation	Lanc.—Lancaster, Pa.	pr.—probably	
cont.—continued	Liverp.—Liverpool, Eng.	Pr.—Prussia	
Cur.—Curaçao	loc. cit.—loco citato = in the place cited	Pvt.—Private	
d.—died		q. v.—quem vide = which see	
D.D.S—Doctor of Dental Surgery			

## Signs and Symbols

- \*—indicates footnote
- information applies to entire generation
- ↓ left issue
- = married





*A Compendium  
of Genealogy*





KORN N.O., P. 35  
 TOBIAS GEN.  
 H. A. ALEXANDER-NOTES  
 ELZAS-OJC, P. 93  
 ELZAS MN., P. 8

AARONS I

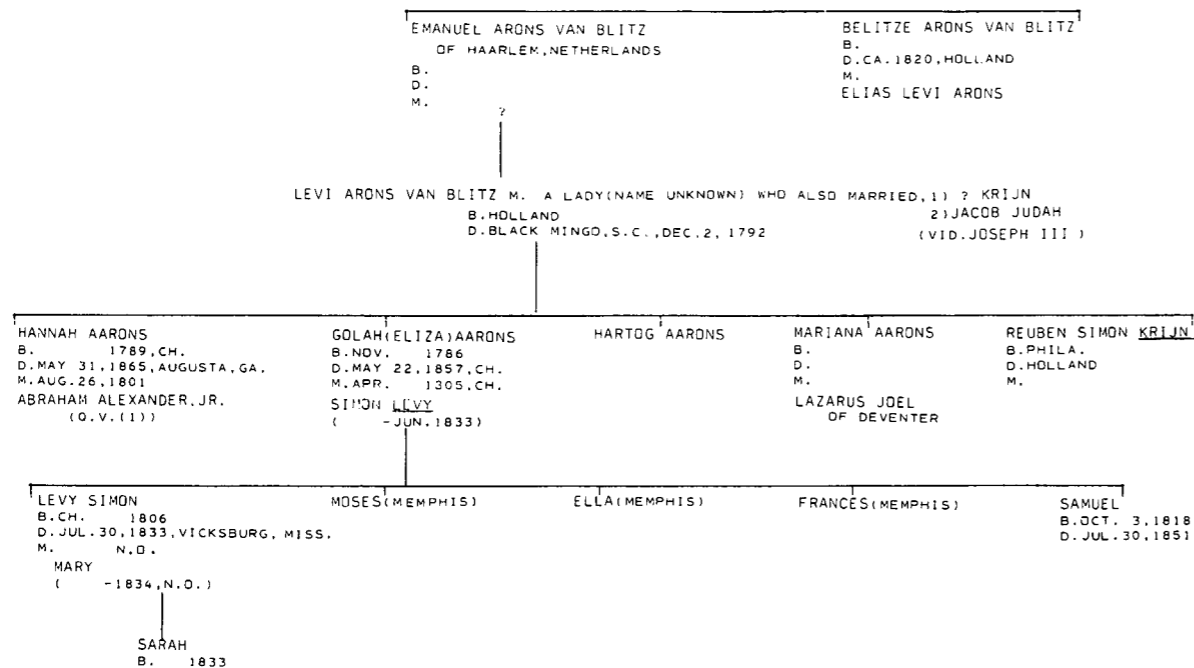

ABENDANONE-COHEN DELMONTE

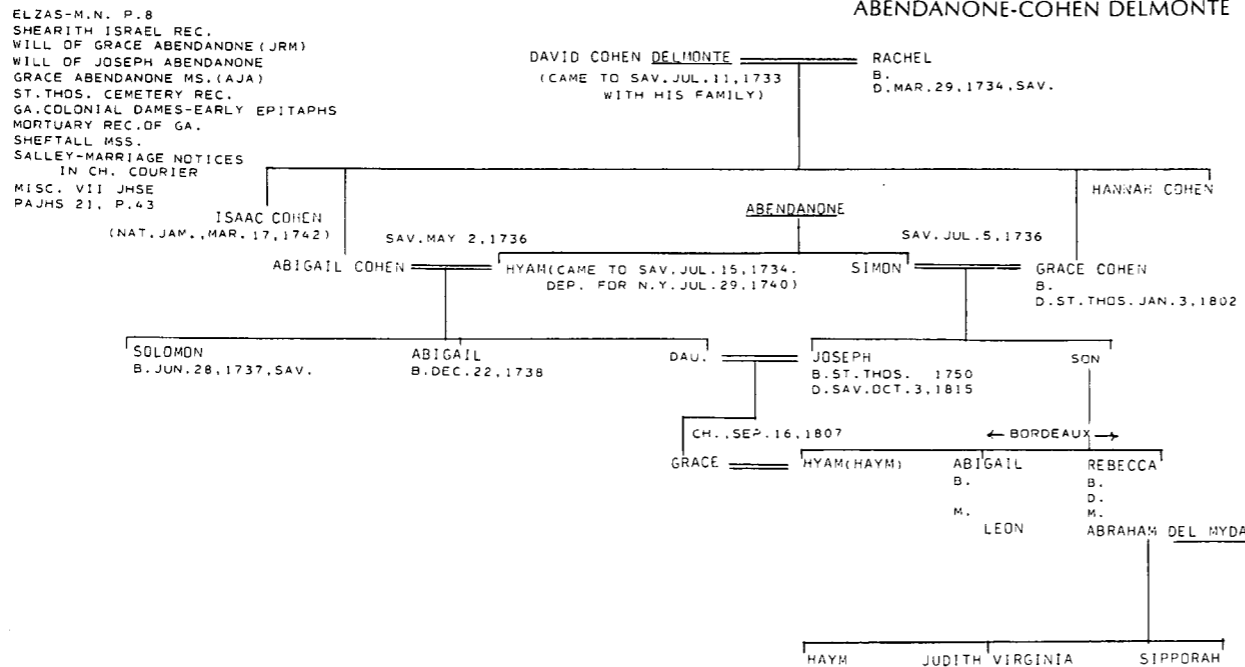

B'NAI JESH. REC.  
 SHEARITH ISRAEL REC.

AARONS II

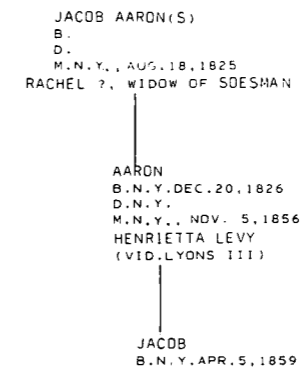

SHEARITH ISRAEL REC.

AARONS III

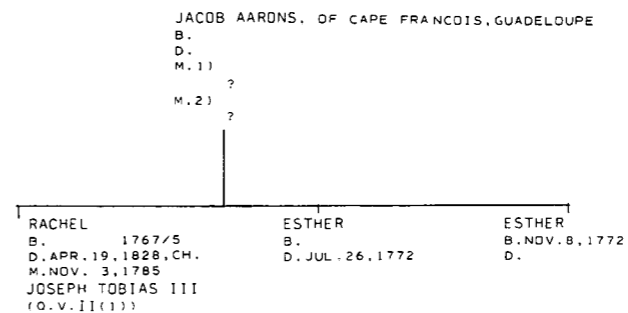

N.Y. CENSUS 1855

AARONS IV

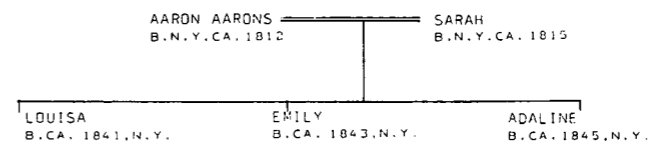

ABRAHAM (1)

ELIZABETH PLAUT

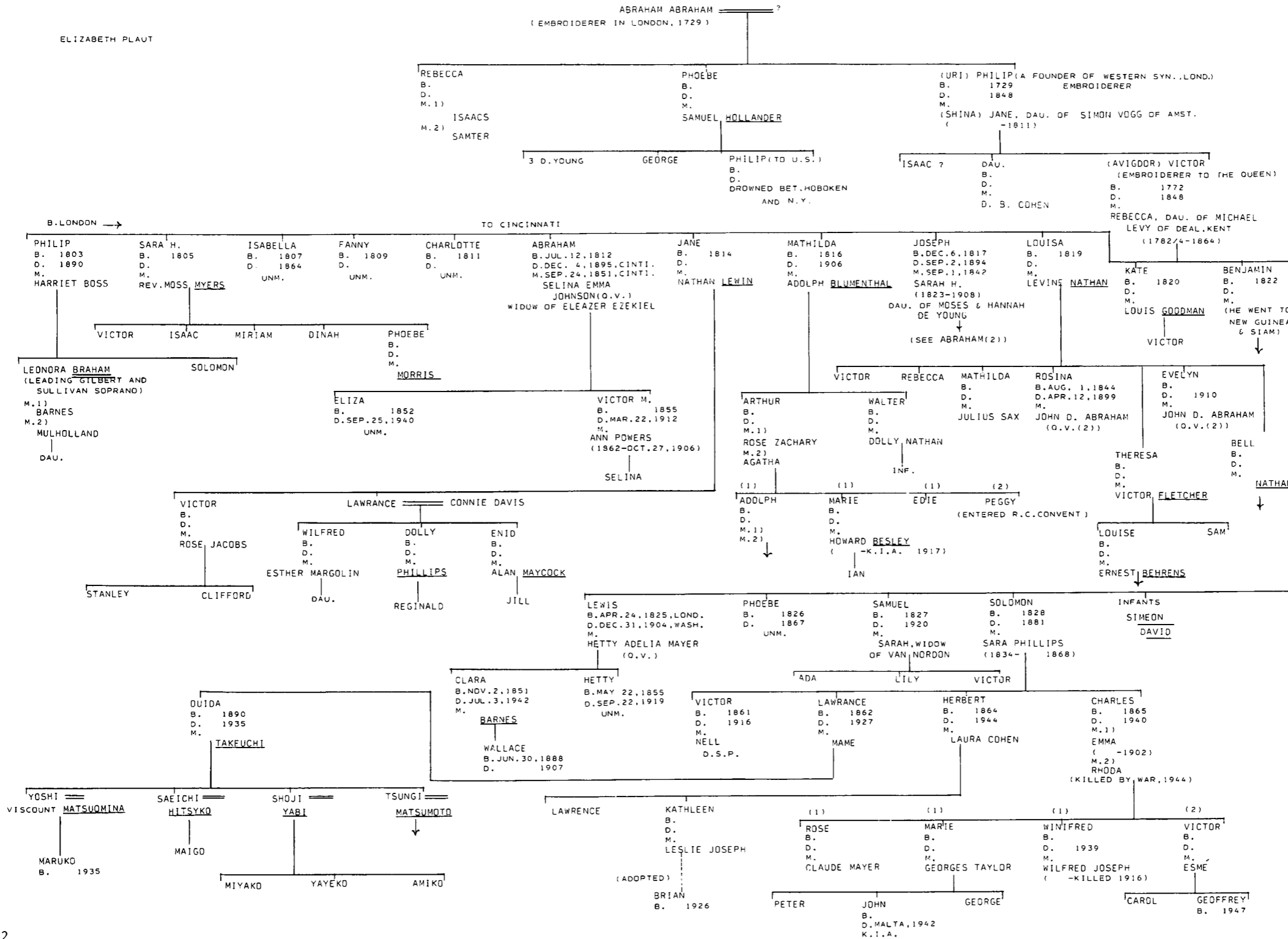

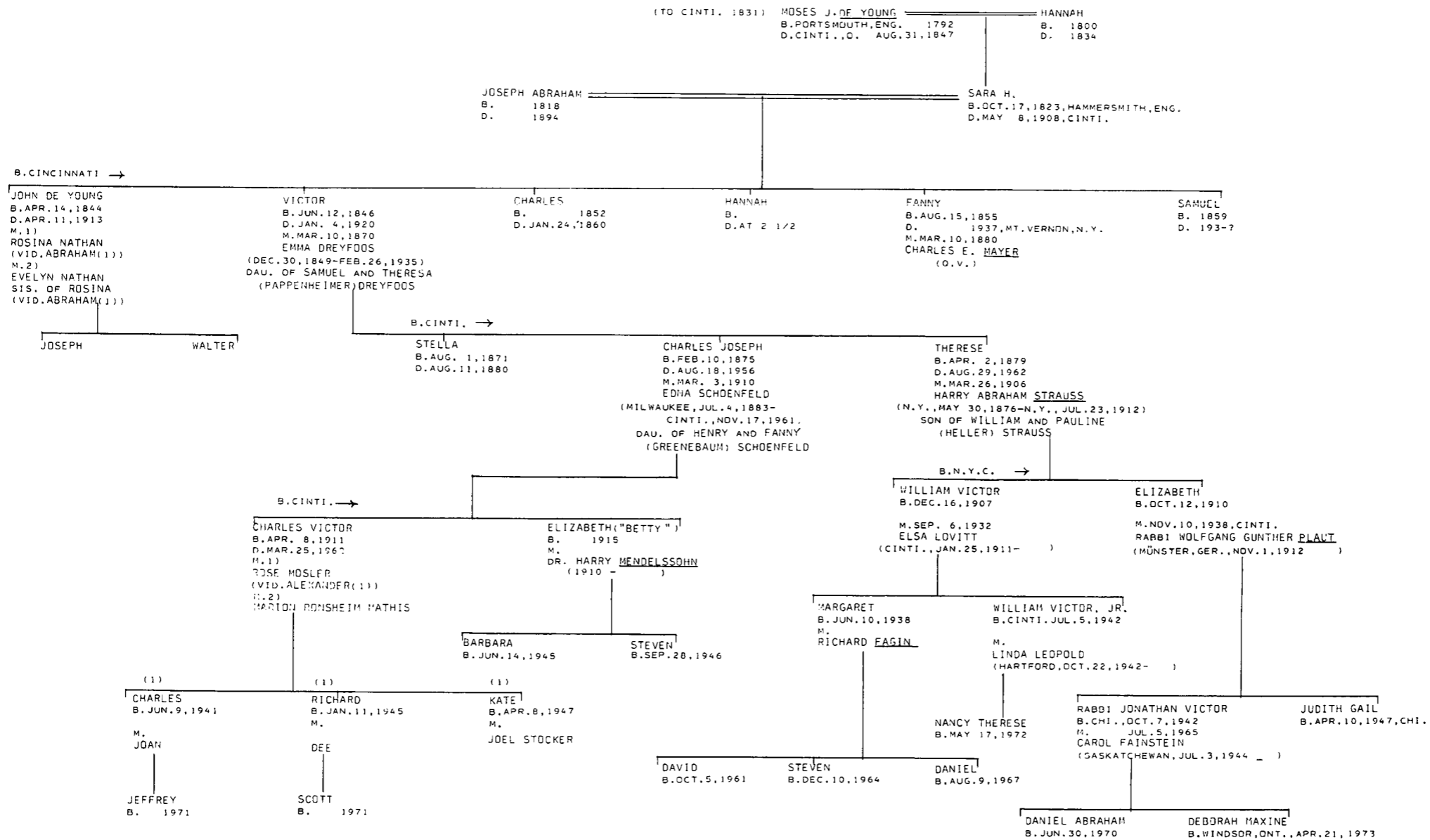

ABRAHAMS I (N.Y.)

ROSENWAIKE  
 AMER. DAILY ADV.  
 KRAUS-SANDOR(AJA)  
 PAJHS, V. 27, P. 150F.  
 GRINSTEIN... JEW. COMMUNITY OF N.Y.  
 POOL-PORTRAITS...  
 ELZAS-OJC, P. 77  
 ELZAS MSS. (NYHS)  
 SHEARITH ISRAEL REC.

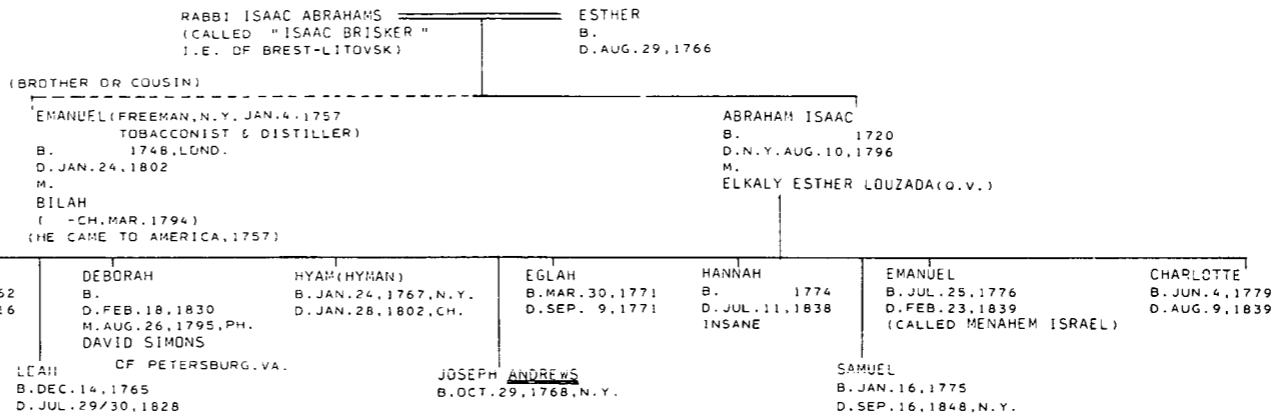

ABRAHAMS III ABRAMS (S.C.)

A. L. MARSH  
 MRS. J. R. MCDAVID  
 EDGAR M. KAHN  
 KRAUS-SANDOR COLL. (AJA)  
 FAM. HIST. OF BENJAMIN MORDECAI (AJA, PH.)  
 DAR LINEAGE BOOKS  
 ELZAS-OJC, P. 40  
 SHEARITH ISRAEL REC.

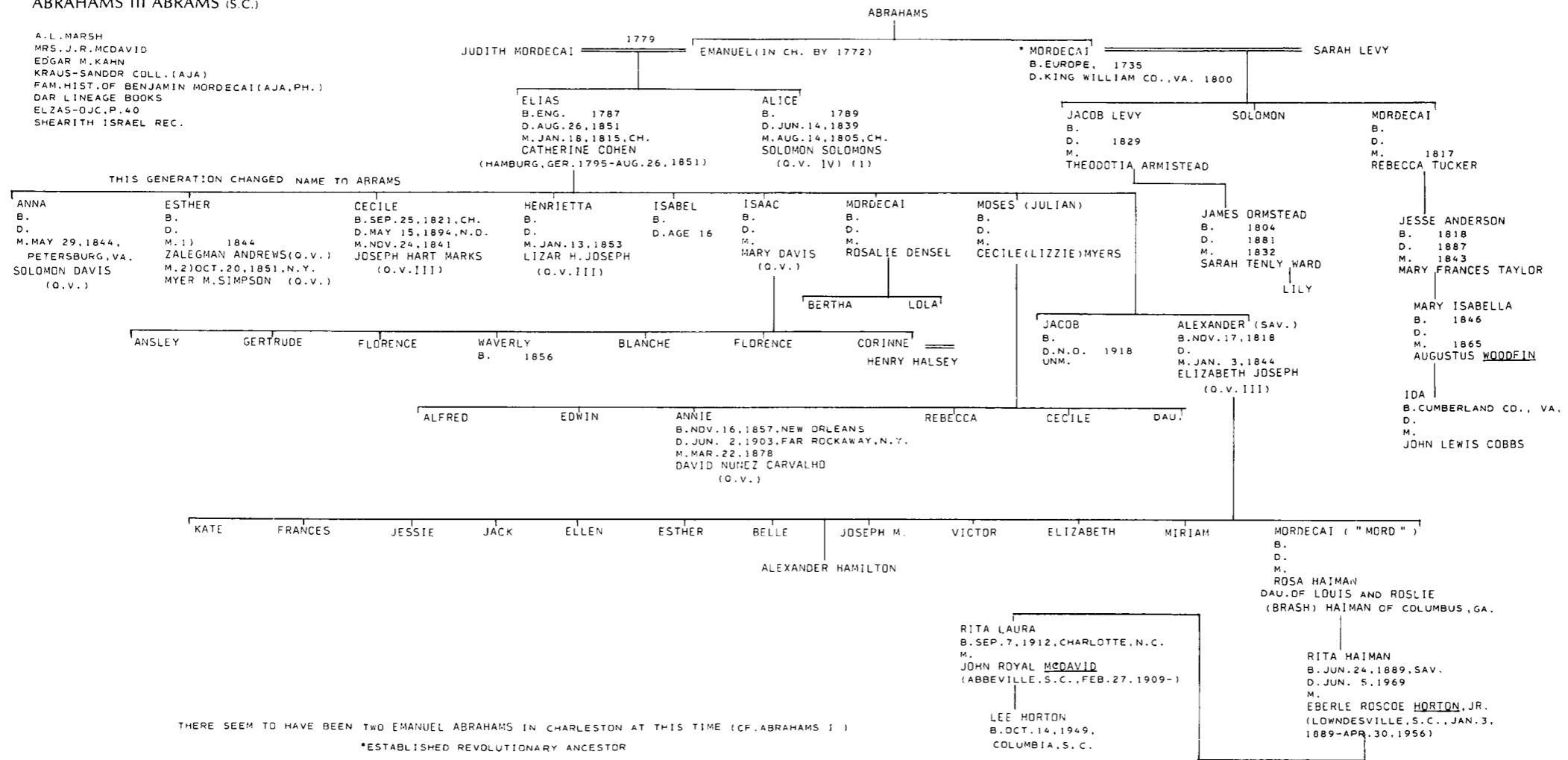

THERE SEEM TO HAVE BEEN TWO EMANUEL ABRAHAMS IN CHARLESTON AT THIS TIME (CF ABRAHAMS I)  
 \*ESTABLISHED REVOLUTIONARY ANCESTOR



ABRAHAMS FAMILY BIBLE  
 (MRS. EDMUND H. ABRAHAMS)  
 LAWRENCE L. FALK GEN.  
 H. A. ALEXANDER-ALEXANDER  
 KRAUS-SANDOR COLL.  
 JACOB ISAACKS MS. (DAP)  
 ELZAS MSS. (NYHS)  
 ELZAS M.N., P. 43  
 FLORENCE ABRAHAMS  
 B. H. LEVY

ABRAHAMS II

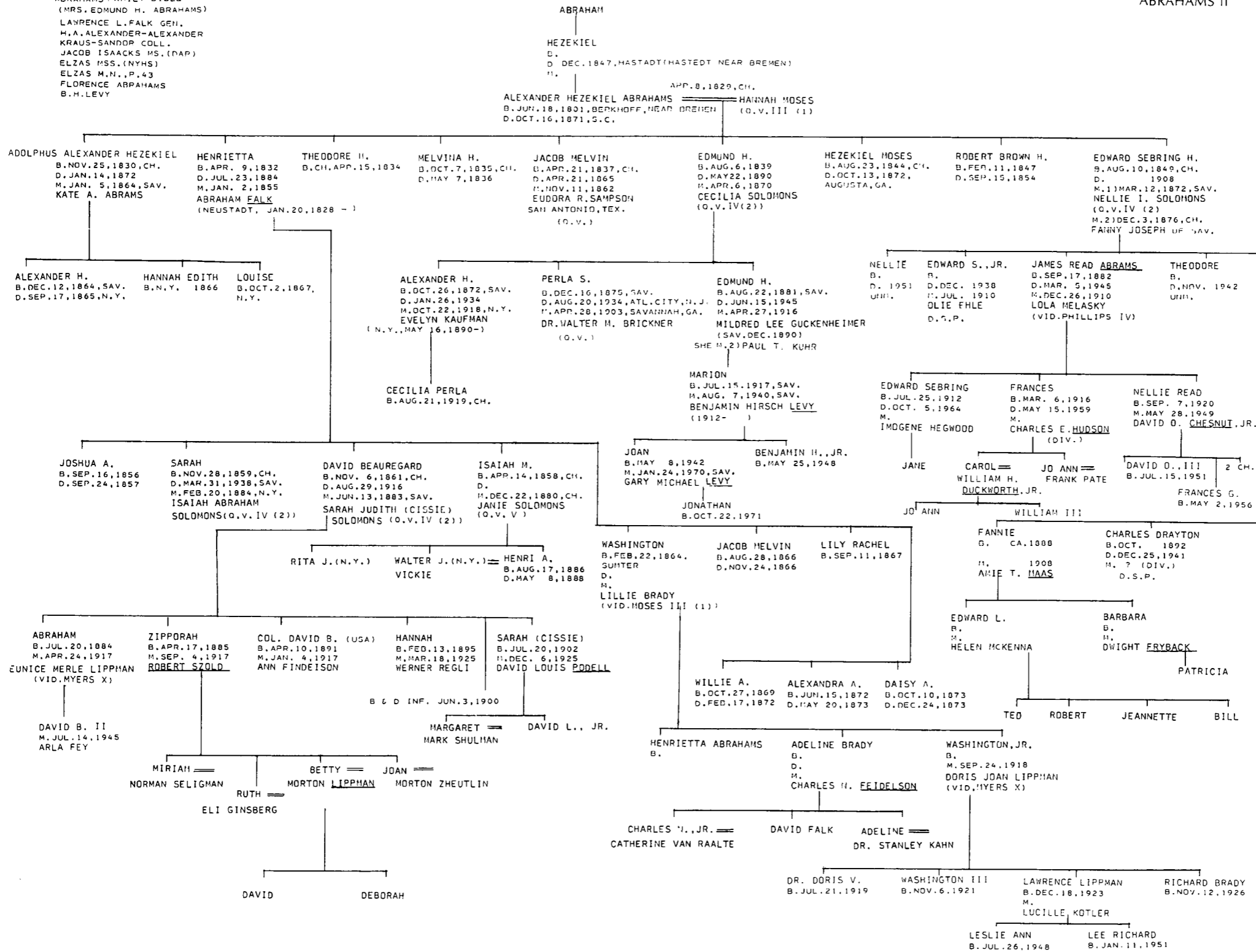

ABRAHAMS IV (NEW YORK)

KRAUS-SANDOR COLL.  
PAJHS, V. 27, P. 74, 110 F.  
ELZAS, M. N. P. 12  
SHEARITH ISRAEL REC.  
STANLEY P. JACOBS  
R'HA'I JESHURIM REC.  
BARBER-N. Y. MARRIAGES  
N. Y. 1850 CENSUS

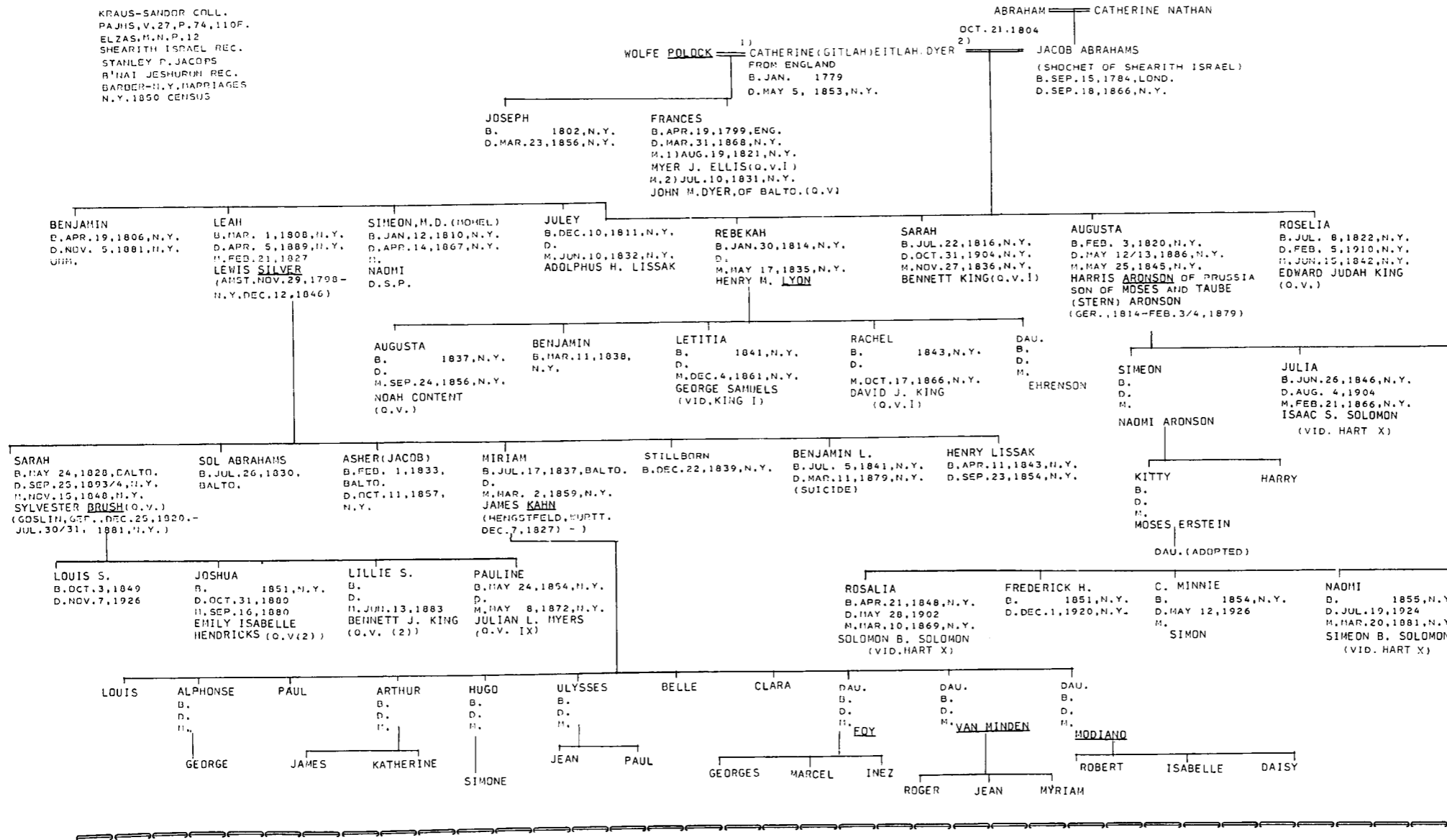

ABRAHAMS V

PAJHS V. 19, P. 118  
POOL-PODTRAITS...

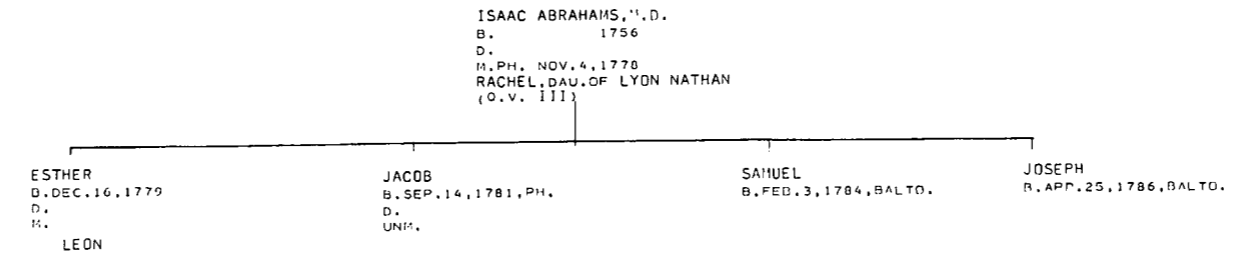

ABRAHAMS VI

D.J.C.  
WILL OF MOSES NUNES  
WILL OF ABRAHAM & ISAAC ABRAHAMS  
SHEFTALL MSS.  
SHEARITH ISRAEL REC.

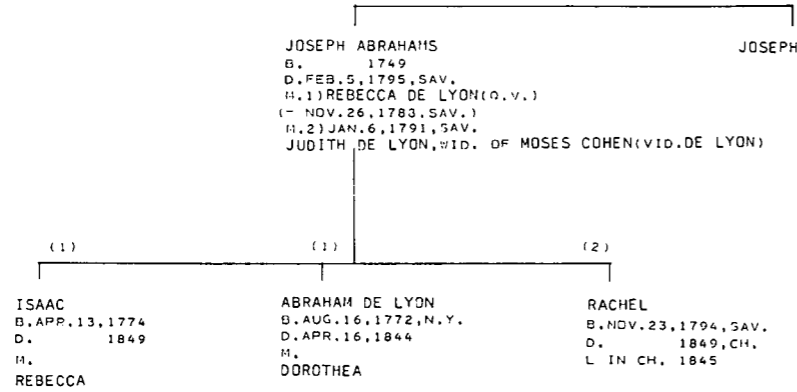

ABRAHAMS VII

E-L

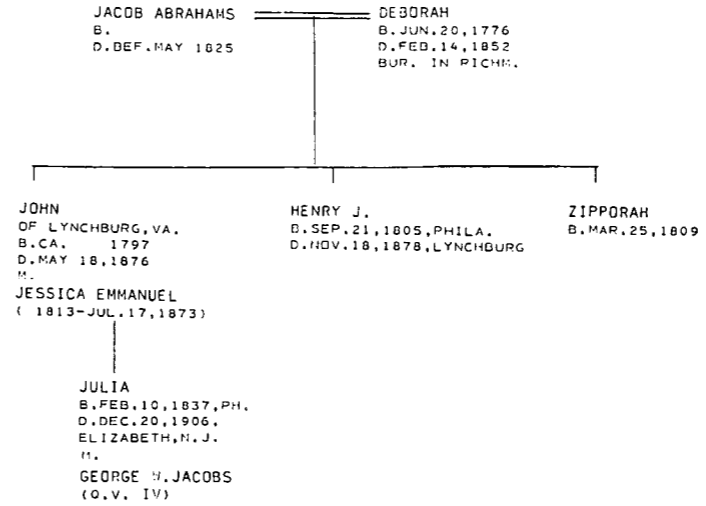

ADOLPHUS

KRAUS-SANDOR COLL.  
PAJHS V. 2, P. 62F.  
PAJHS V. 10, P. 165  
AJHQ LXI, 119F.  
MISC. VII #535  
NYGDR 104, 79  
POOL-PORTRAITS...  
SHEARITH ISRAEL REC.

RAPHAEL ADDLPHUS

BENJAMIN OR EPHRAIM REINE  
B. BONN, GERMANY  
D. BEF. 1759  
M.

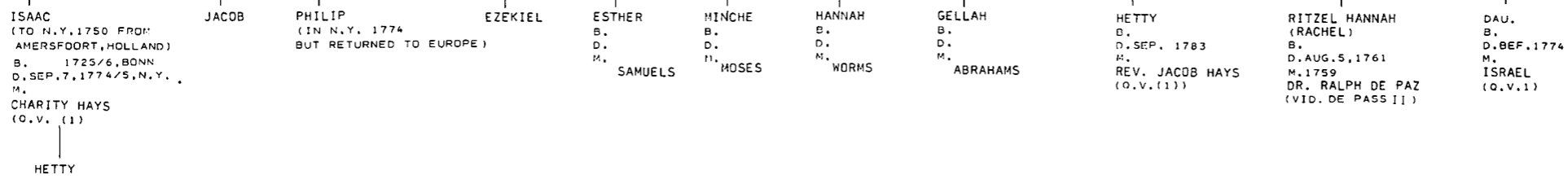

ALEXANDER I (1)

TOBIAS GEN.  
KRAUS-SANDOR COLL.  
JRM COLL.  
PAJHS V. 19, PP. 82, 279  
ELZAS MN  
ELZAS OJC  
SHEARITH ISRAEL REC.  
FLORENCE ABRAHAMS  
ALEXANDER MSS. (AJA)  
H. A. ALEXANDER  
ABBOT L. MOFFAT

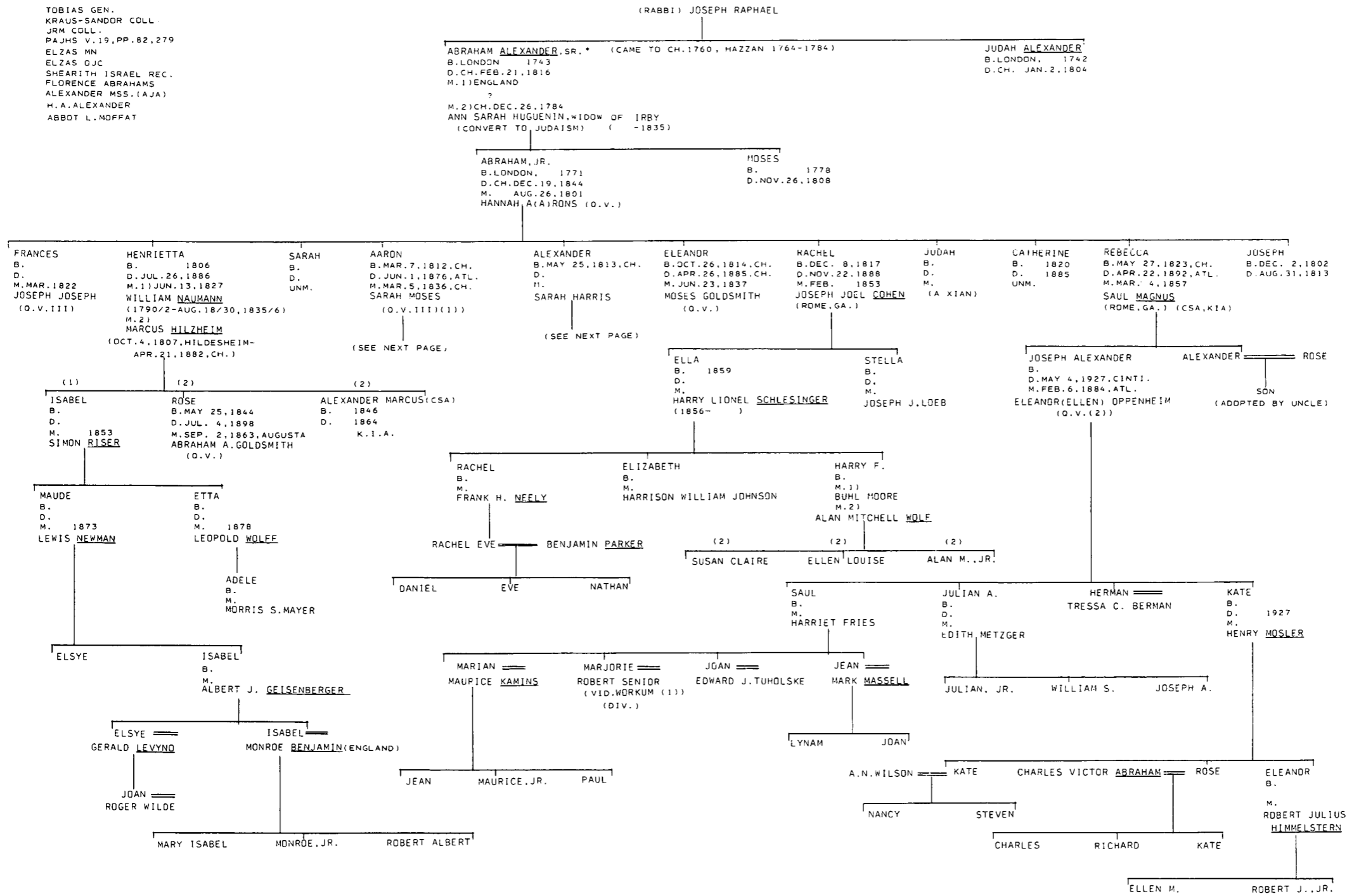

\*ESTABLISHED REVOLUTIONARY ANCESTOR (EAR)

ALEXANDER I (2)

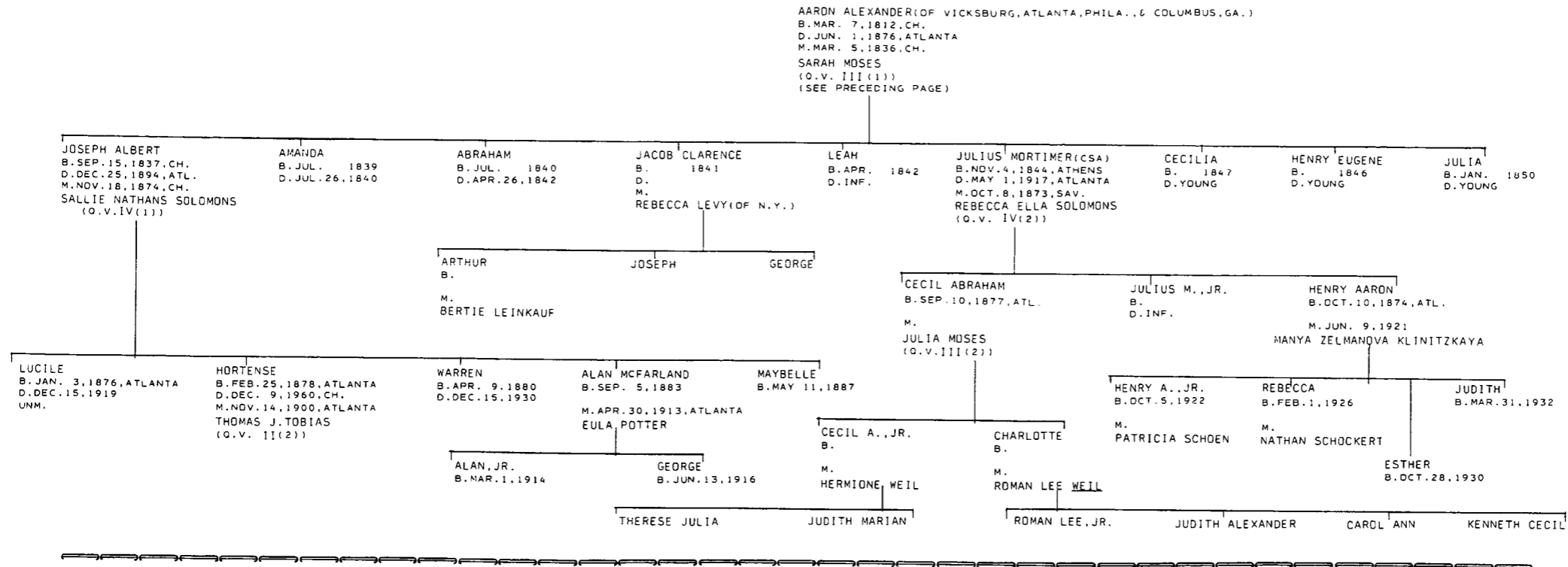

JOHN F. ALEXANDER  
 JON STEDMAN  
 ABBOTT L. MOFFAT

ALEXANDER ALEXANDER OF COLUMBIA, S.C.  
 B. ENG. 1793/1800  
 D. COLUMBIA, JAN. 19, 1857  
 M. SARAH HARRIS SAMPSON  
 (VIO. HARRIS II)

ALEXANDER II

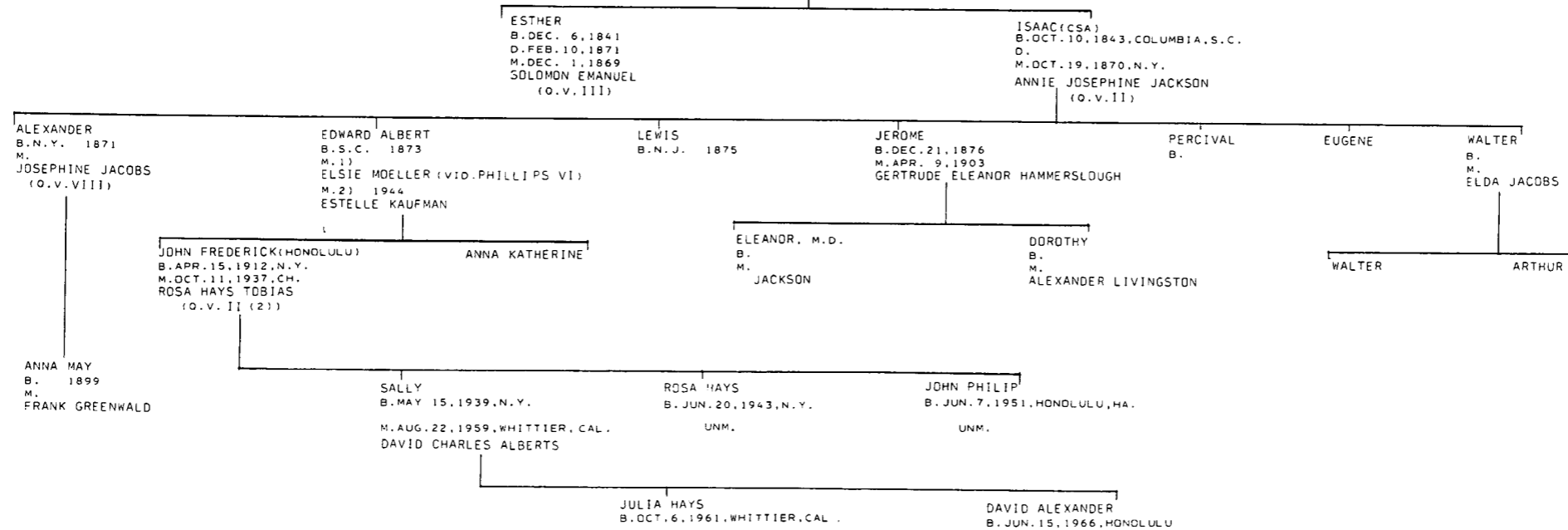

ALLEN

ALLEN GEN.  
JEWISH ENCYCLOPEDIA, V. 8, P. 59  
MORAIS-JEWS OF PHILA.  
KRAUS-SANDOR COLL.  
MICKVE ISRAEL REC.  
SHEARITH ISRAEL REC.  
FLORENCE ABRAHAMS

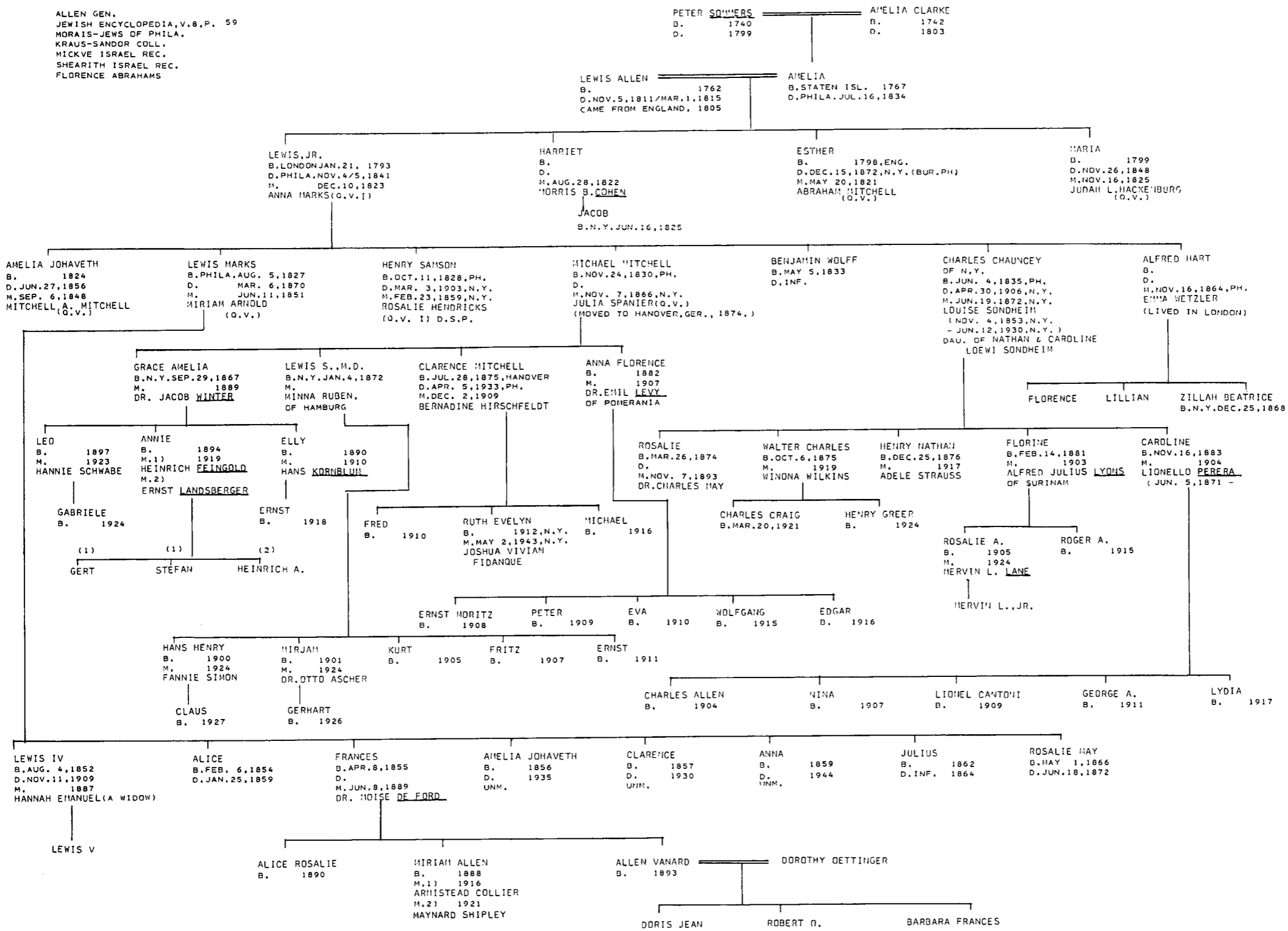

E-L, P. 286  
 R.S. MOH. REC.  
 KRAUS-SANDOR COLL.  
 ST. CHARLES, P. 134 F.  
 ANCKER MS.  
 ELZAS HSS.

ELZAS O. J. C.  
 MICKVE ISRAEL REC.  
 SHEARITH ISRAEL REC.  
 D.A.R.  
 FLO. ABR.  
 HENRY SCHWABACHER

ANCKER (1)

(RICHMOND) ADOLPH ANCKER B. ENG. HETTY PETTIGREW (O.V.)

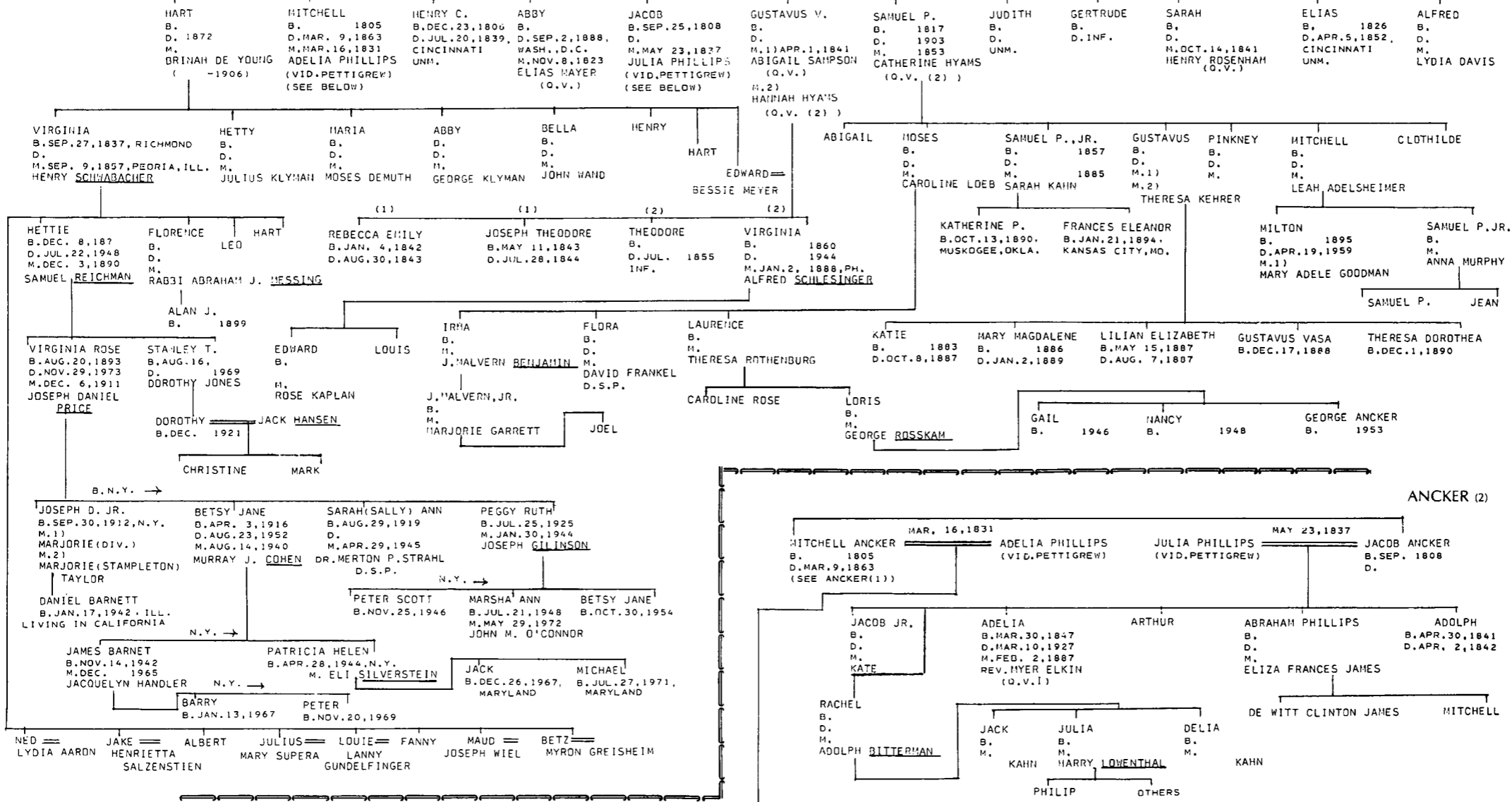

ANCKER (2)

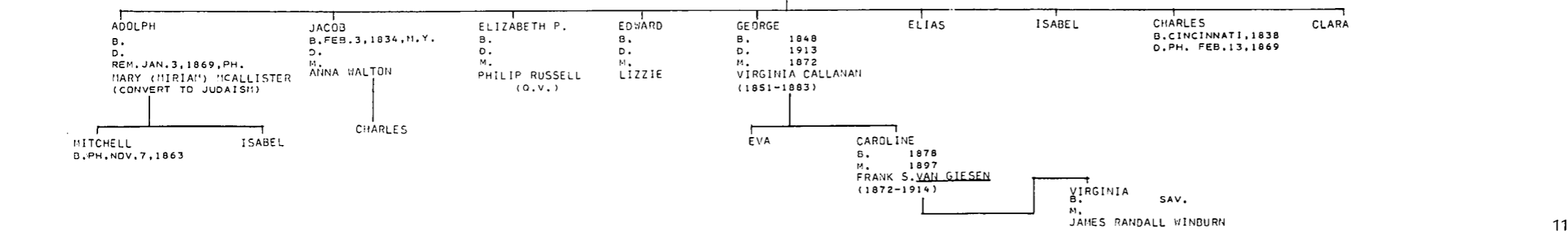



ANDREWS I

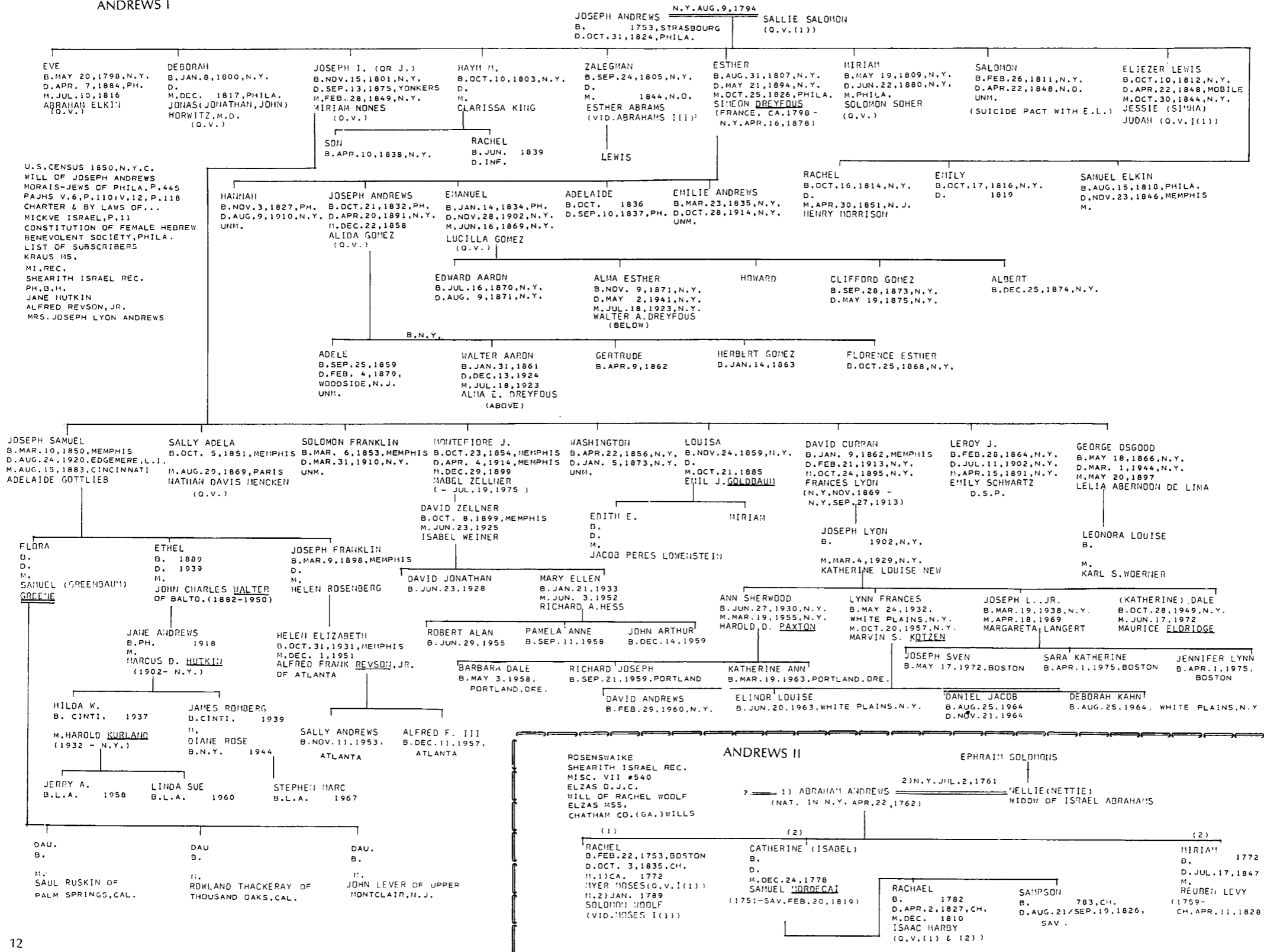

AJYB, 5666, P. 36  
 KRAUS-SANDOR COLL.  
 ARNOLD FAMILY REC. (PHOTOSTAT IN AJA)  
 MICKVE ISRAEL REC.  
 FAMILY HIST. OF BENJ. MORDECAI (PHOTO., AJA)  
 FLORENCE ABRAHAMS

AARON ARNOLD  
 OF IBENHAUSEN, WURTTENBERG

MAYER (CAME TO U.S., 1798)  
 B. DEC. 1, 1785  
 D. NOV. 24, 1868  
 M. MAY 9, 1822  
 FANNY WOLF (O.V.I.)

ARNOLD

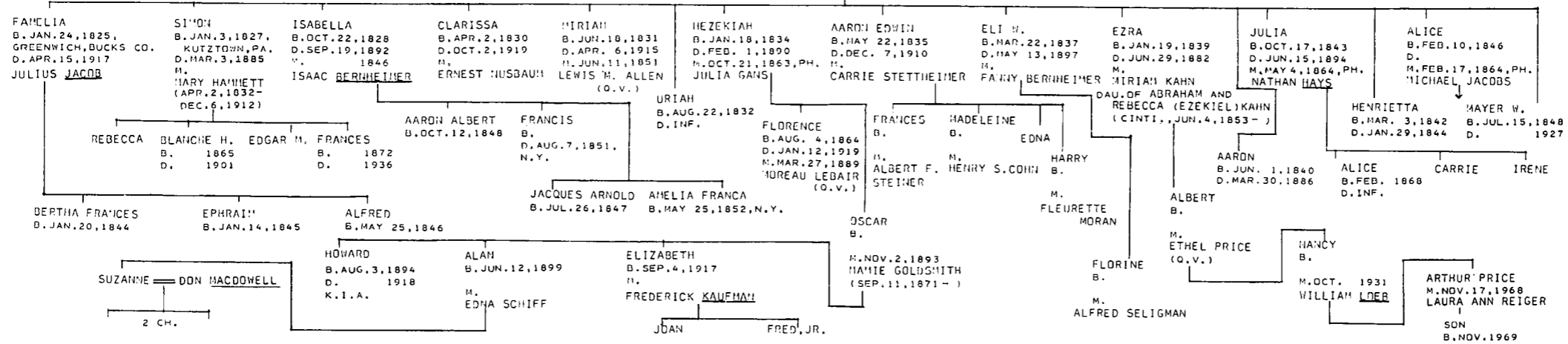

J. R. COHEN  
 W. W. P. 490  
 MORAIS-JEWS OF PHILA.  
 JACKSON GEN. (AJHS)  
 MRS. H. S. CARTER  
 SHEARITH ISRAEL REC.  
 FLORENCE ABRAHAMS  
 FEDERAL ST. CEM.

JOSEPH M. ASCH  
 B. JUL. 12, 1802, POLAND  
 D. JUN. 22, 1866, PH.  
 M. AUG. 4, 1830  
 CLARISSA ULMAN

MOSES M.  
 B. POLAND  
 D. PH. JUN. 16/17, 1829

ASCH

WILL OF ESTHER AZUBY (JR MARCUS COLL.)  
 ELZAS-O. J. C., P. 83

AZUBY

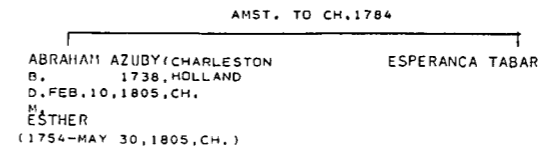
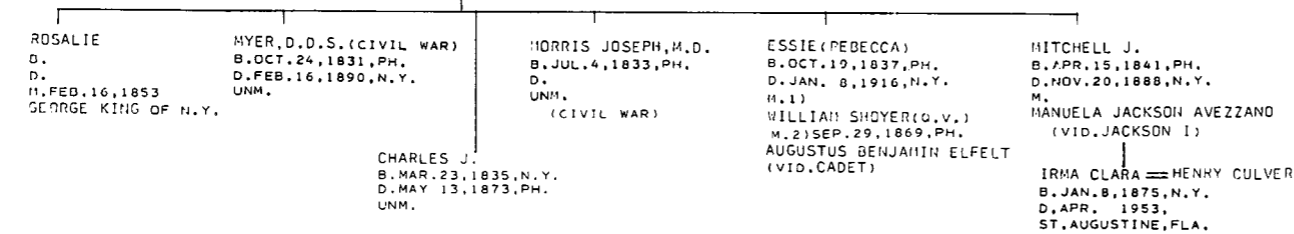

B'NAI JESH, REC.  
 KRAUS-SANDOR COLL.  
 SHEARITH ISRAEL REC.  
 JON STEHMAN (1850 CENSUS)

ISRAEL BACH  
 N.Y. AUG. 12, 1846

BACH

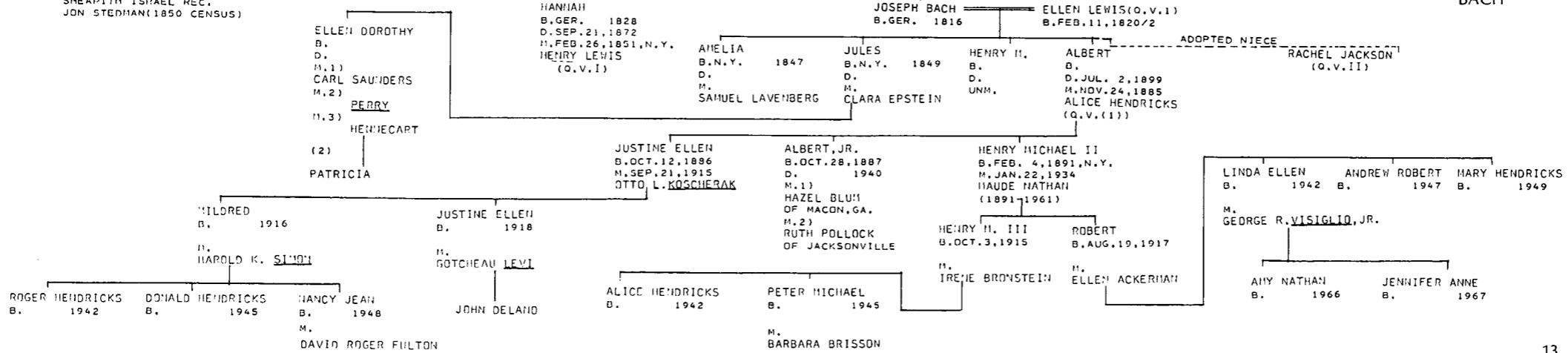

BAMBERGER

PRIOR TO 1881: JACOB BAMBERGER  
FAMILY BIBLE

DAVID BAMBERGER

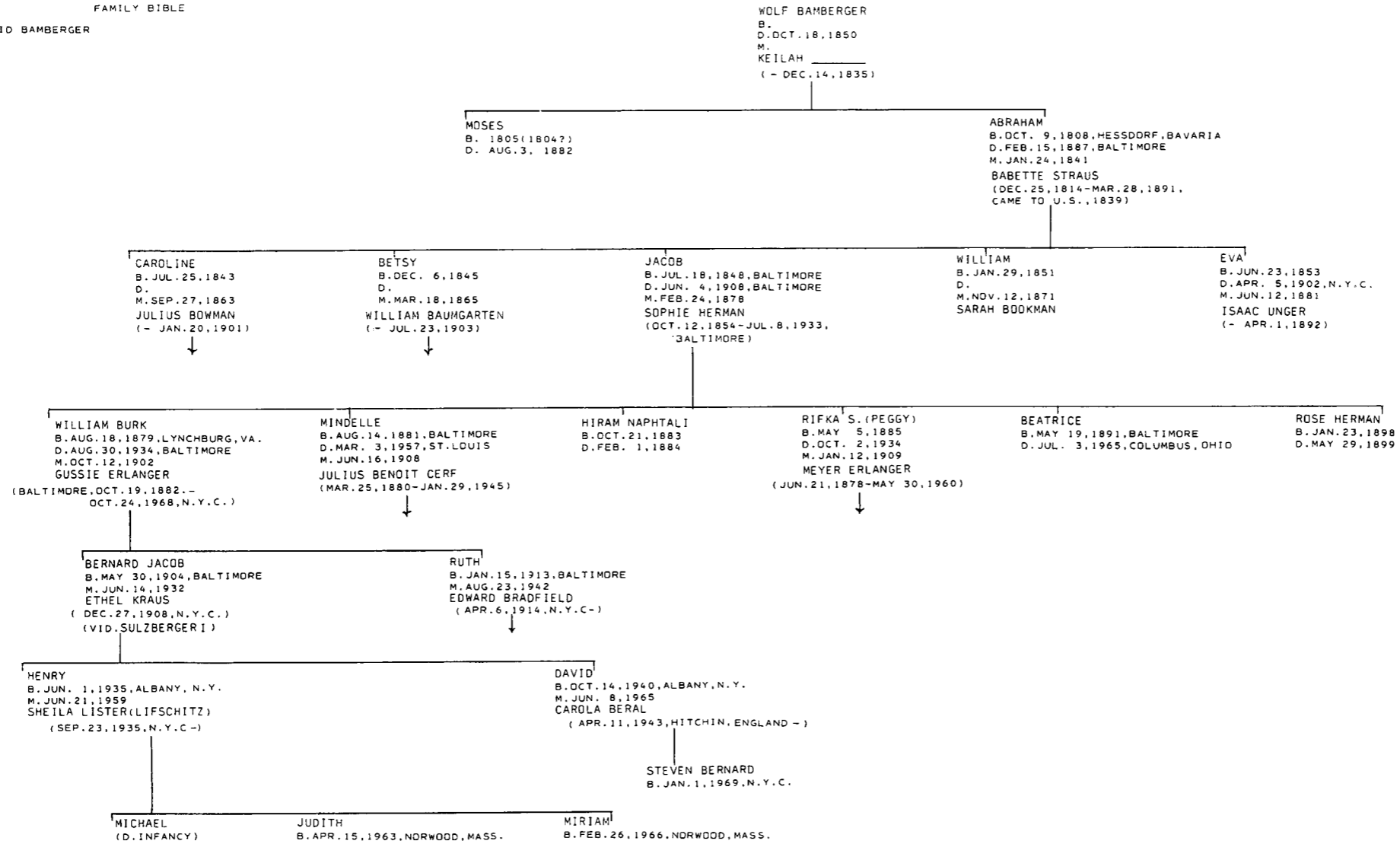

EINHORN MARR, REC.  
AJYB, 5666, P. 39  
KOHN-BARNET FAMILY TREE  
CAROLYN K. BLUMENTHAL  
GATES STERN

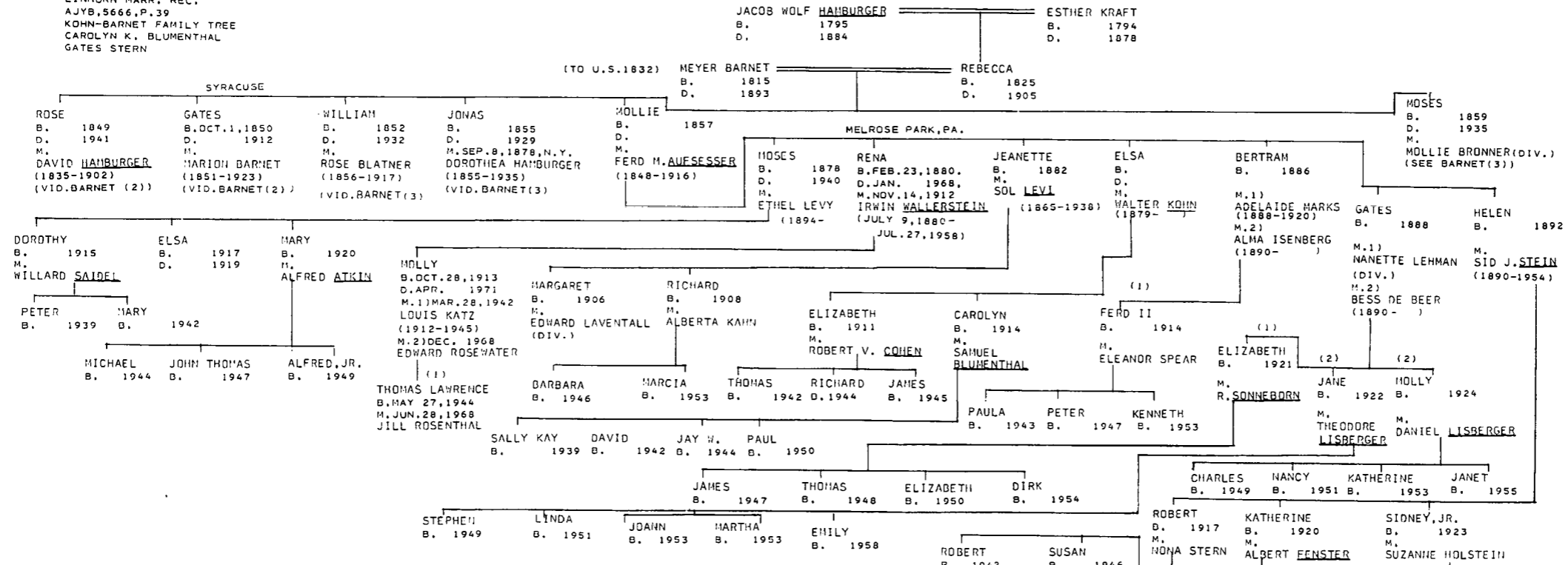

BARNET (2)

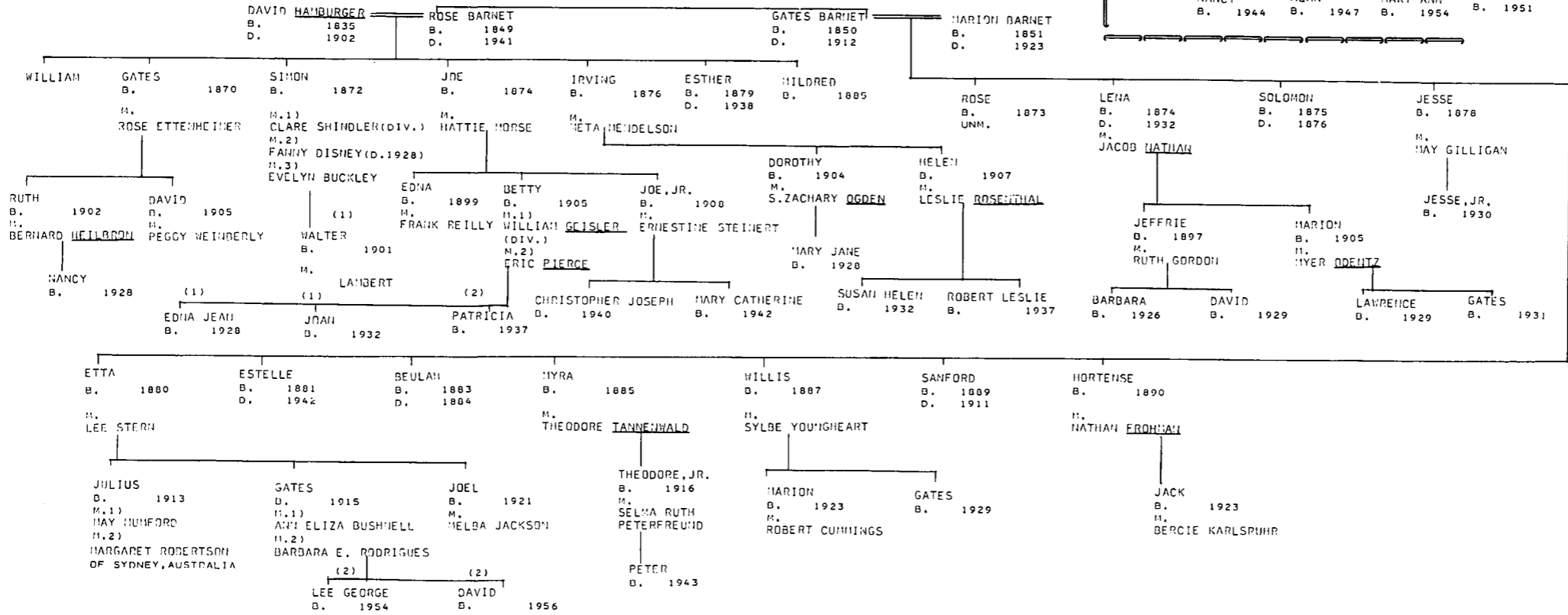

BARNET (3)

(VID. BARNET (1))

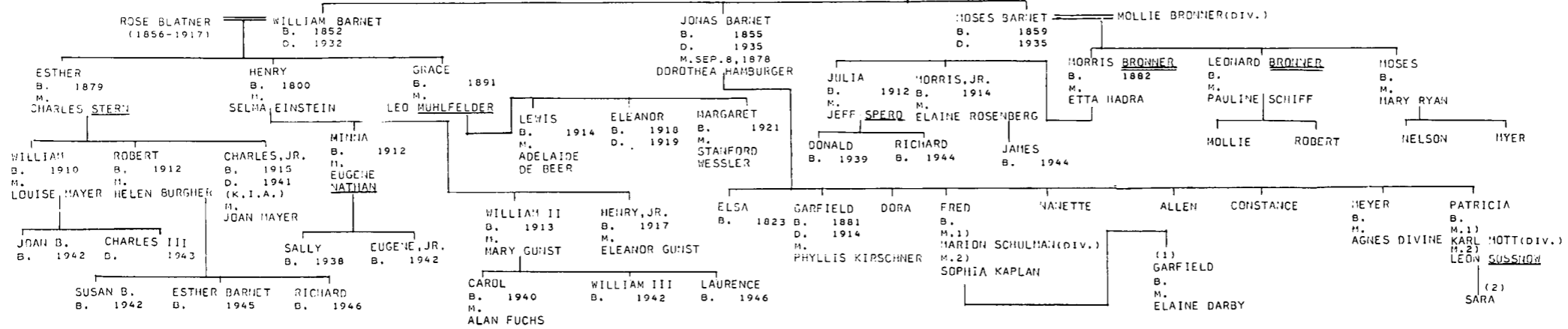

SHEARITH ISRAEL REC.

BARNETT I

B'NAI JESH. REC.

BARNETT II

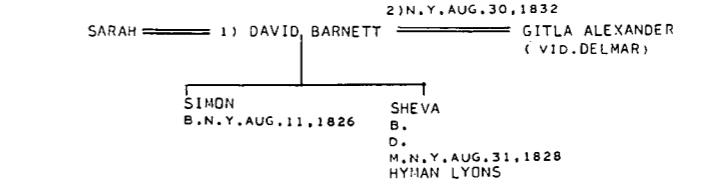
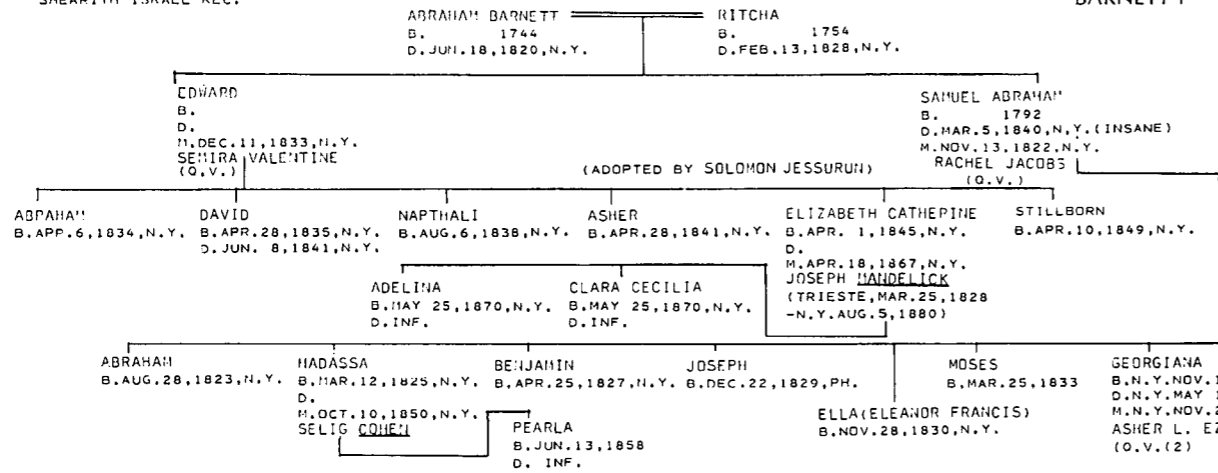

BARNETT IV

BARNETT V

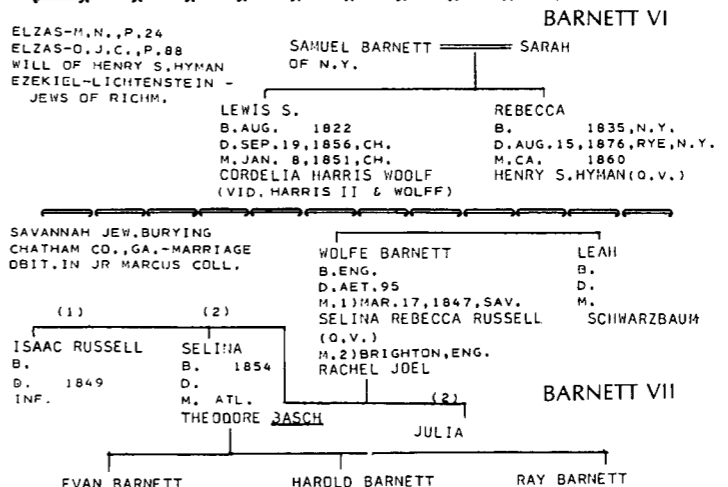
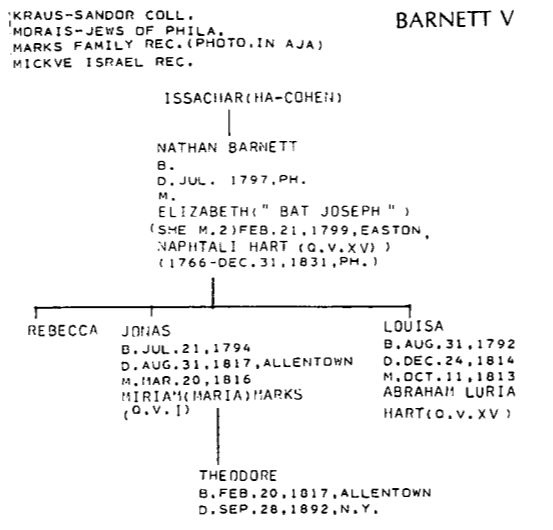
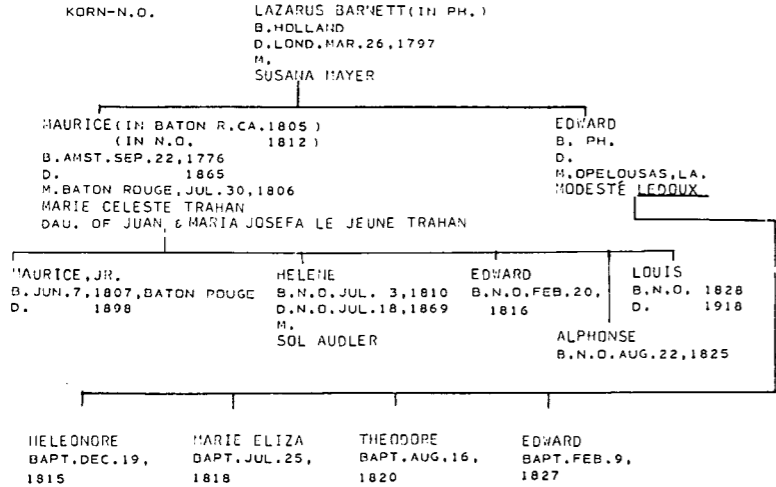
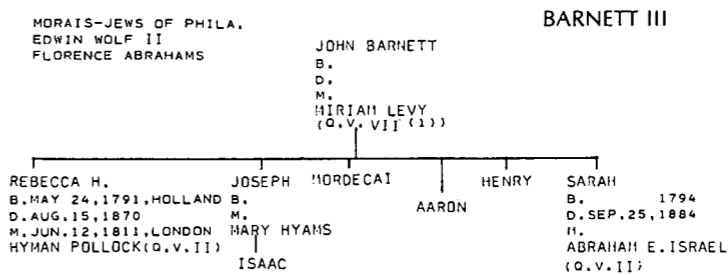

BARRETT

WILL OF JACOB BARRETT  
HAROLD MOISE  
ELZAS MSS.  
O. J. C.  
M. N.

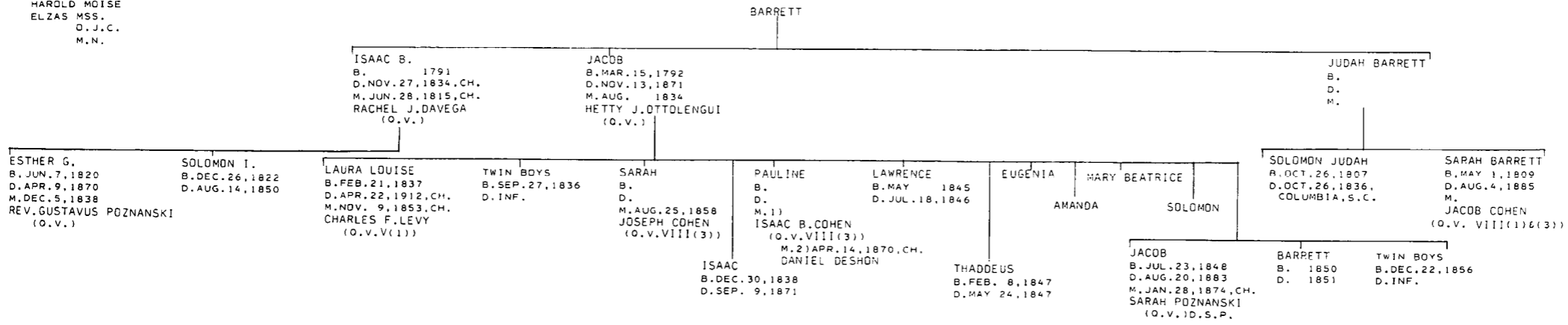

JON STEDMAN  
ELZAS MSS.  
O. J. C.  
M. N.  
SHEARITH ISRAEL REC.  
N. Y. TIMES OBIT.

SIGISMUND BARUC — NANETTE  
BARUC

N. Y. TIMES, 10/6/63  
ELZAS M. N.  
FLORENCE ABRAHAMS  
KRAUS-SANDOR COLL.  
DAR LINEAGE BOOKS  
U. J. E. V. 2

BERNARD OR BENJAMIN BARUCH  
B.  
D.  
M.  
TERESA GREEN

BARUCH I

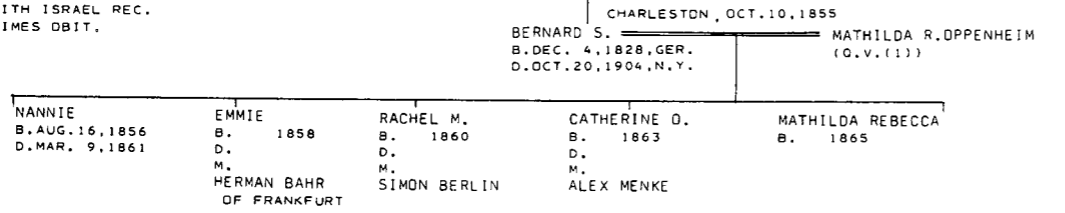

SIMON, M. D. (SURGEON, C. S. A.)  
B. JUL. 29, 1840, SCHWERSENZ, POLAND  
D. 1921, N. Y.  
M.  
(ISABELLE WOLFE  
(O. V. II))

HERMAN, OF CAMDEN  
B.  
D.  
M. MAY 5, 1874 OF G'T'N  
DEBORAH SAMPSON  
(O. V.)

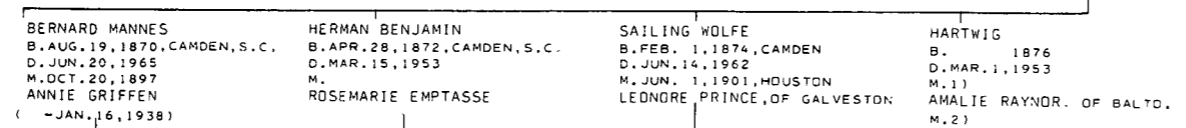

SIMONA B. 1901 M. MEYERS  
AMALIE B. 1902 M. PERRY BELMONT FRANK  
HARTWIG, JR.  
PERRY B., JR.  
B.  
M. JOANNE SCHNECK (DIV.)  
KEVIN DAU.

BERNARD M., JR.  
B. 1901  
M. 1932, GENEVA  
BEATRICE MANN  
OF LONDON

RENEE WILCOX  
B. JUN. 1905  
M.  
H. ROBERT SAMSTAG

ISABELLE WILCOX  
B.  
D. AUG. 25, 1964

ROBERT PARKS  
B. 1908  
M. NOV. 22, 1934  
JEANETTE DE FOREST CANDEE  
BAYSHORE, N. Y. OCT. 5, 1963

MARINA B. 1914/5 INF. M. SYMMERS

SAILING, JR.  
B. JUN. 7, 1904, ELBERON, N. J.

DONALD  
B. JUN. 24, 1910, WEST END, N. J.

ROSEMARY LOUISE — DENNIS SEAN O'MALLEY

ELZAS-JEW. CEM. AT COLUMBIA, S. C.

JOSEPH BARUCH — HANCHEN  
BARUCH II

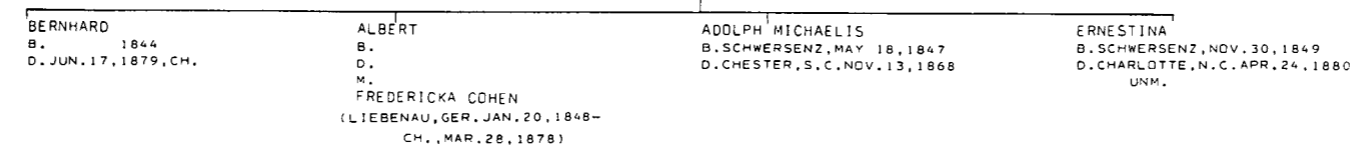

BERNHARD  
B. 1844  
D. JUN. 17, 1879, CH.

ALBERT  
B.  
D.  
M.  
FREDERICKA COHEN  
(LIEBENAU, GER. JAN. 20, 1848-  
CH., MAR. 28, 1878)

ADOLPH MICHAELIS  
B. SCHWERSENZ, MAY 18, 1847  
D. CHESTER, S. C. NOV. 13, 1868

ERNESTINA  
B. SCHWERSENZ, NOV. 30, 1849  
D. CHARLOTTE, N. C. APR. 24, 1880  
UNM.

BENJAMIN I

E.N.A.  
ST. THOS. CEM.  
ST. THOS. MARR.  
EDGAR KAHN  
PAJMS, 12, P. 67  
ELZAS MSS.  
HYAMS FAMILY REC.  
MRS. J. M. FORGOTSON

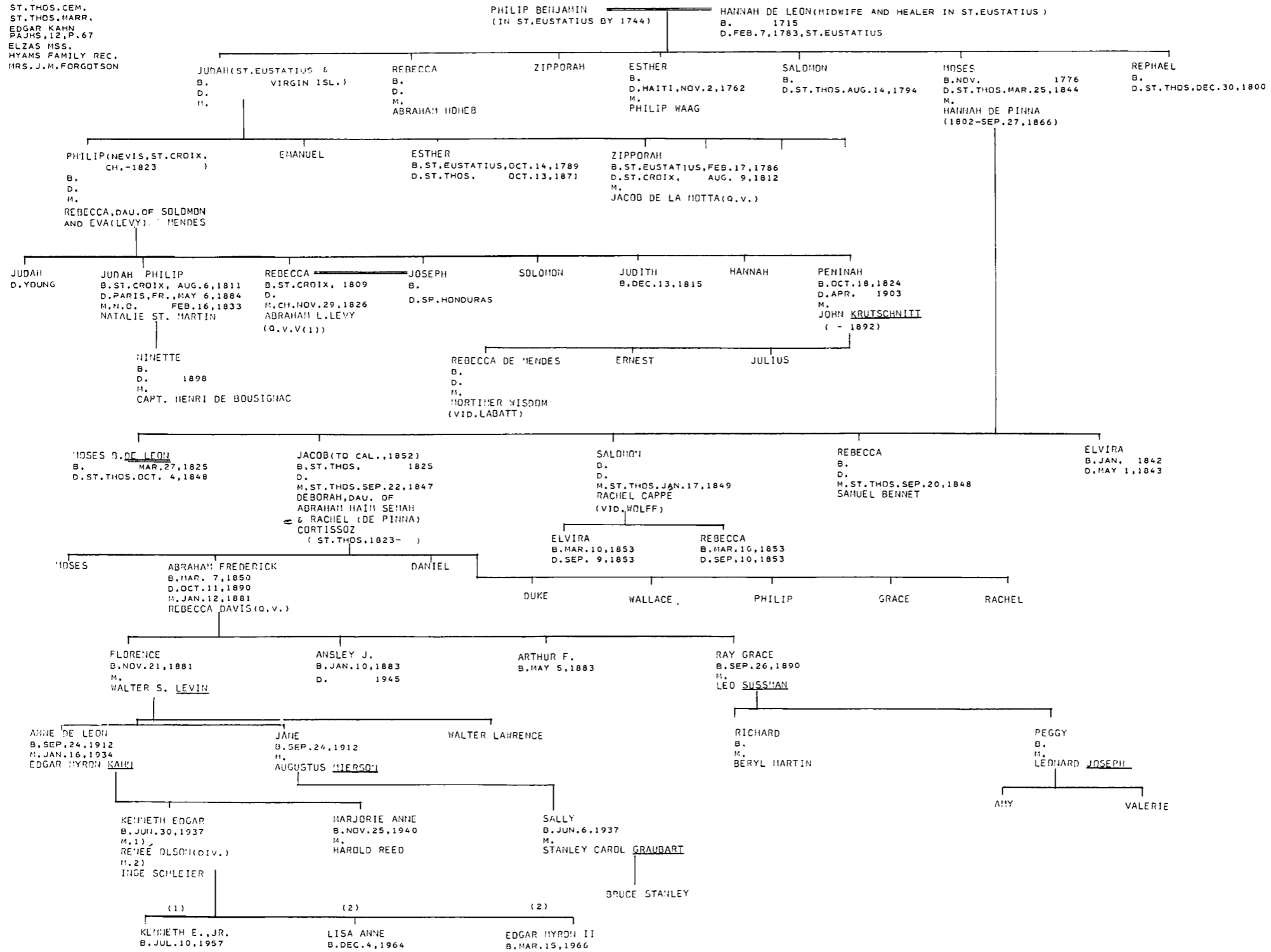



HART PAPERS(AJA)

BENJAMIN II (CANADA)

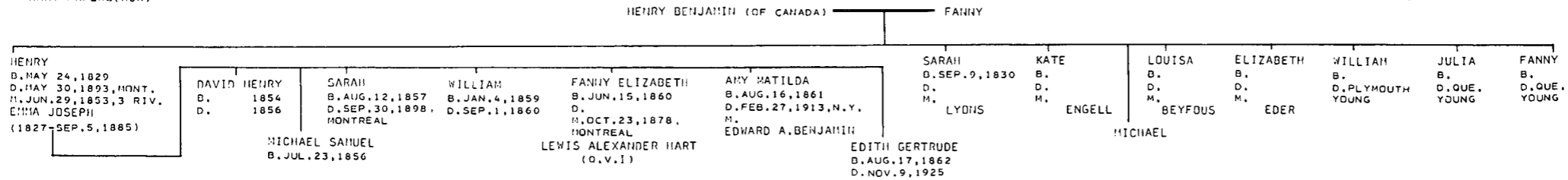

KRAUS-SANDOR COLL. SHEARITH ISRAEL REC. N.Y. CENSUS 1855

BENJAMIN II (N.Y.)

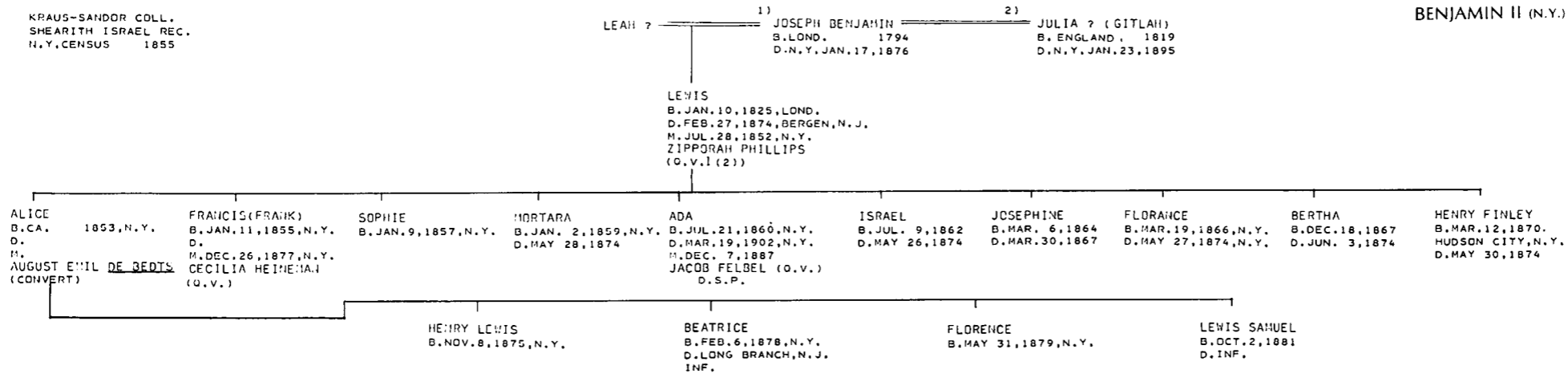

ELZAS H.N., P.9 WILL OF SAMUEL BENSAKEN B.M.KET. ROSENWAIKE KORN-N.O.

BERLANDINA-BENSAKEN

BENZAKEN

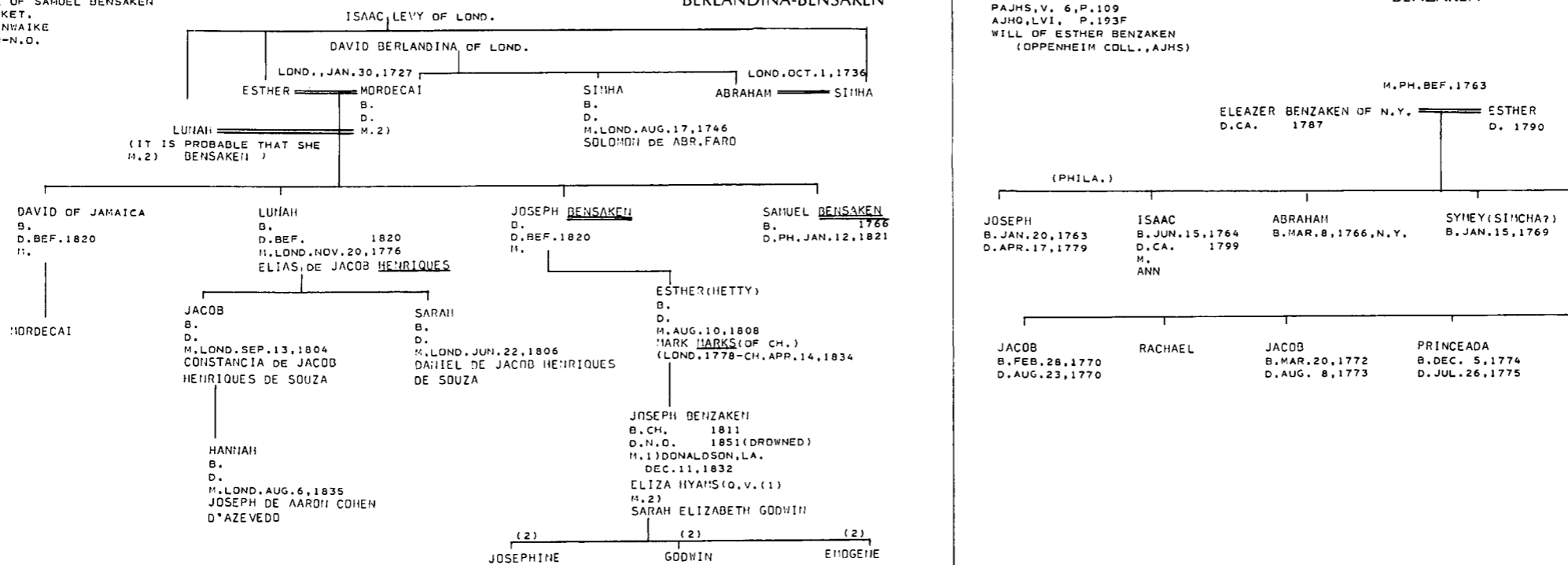

BERNHEIM I (PHILA.)

SANFORD MOSS MSS.  
MICKVE ISRAEL REC.  
R.S.MDH.REC.

SAMSON BERNHEIM — IDA

MORRIS (CAME TO U.S., 1846)  
B. JUN. 26, 1823, HECHINGEN, GER.  
D. JAN. 1, 1878, PHILA.  
M. SEP. 5, 1849, PHILA.  
JULIA MOSS (G.V. (2))

IDA KATHERINE B. JUN. 3, 1850  
D. NOV. 5, 1929  
M. MAR. 19, 1873  
S. BERNARD MAYER  
(GER. - DALLAS, 1926)

LOUIS ISAAC B. FEB. 12, 1852  
D. 1924

WILLIAM B. 1854  
D. 1895  
M. HATTIE

WALTER JACOB B. JUL. 24, 1855  
D. 1925

KATE MOSS B. 1857

ELIZABETH B. 1859  
D. 1867

JOSEPH B. 1861  
D. 1863

LEON B. JAN. 2, 1864, PH.

JULIAN MORRIS B. 1866  
D. 1881

DORA B. 1867  
D. INF.

MORTIMER JULIAN

LEONARD BERNARD B. CINTI., 1874  
M.

MORRIS B.  
M.

JULIA MOSS B. 1876

FELICE B.  
M. RICHARD LYON OF DALLAS

MARGARET CATHERINE

KATE B.  
M. ROLLY JONES

RICHARD B.  
M. BETTY

CATHERINE RICHARD, JR.

BERNHEIM II (CINTI.)

EZEKIEL FAMILY REC. (ESTHER PINCUS)

SAMUEL BERNHEIM  
B.  
D. PROVIDENCE, R. I.  
M. JAN. 6, 1864, RICHMOND  
ROSETTA EZEKIEL (G.V. (1))

B. CINCINNATI →

KATE THERESA B. DEC. 26, 1864, RICH.  
D. DEC. 23, 1889  
M. JAN. 11, 1888  
SIDNEY A. LOTH

WALTER EZEKIEL B. MAY 9, 1866,  
RICH.

LEVI WORKUH B. MAY 21, 1867  
RICH.  
D. AUG. 11, 1868

FREDERICK BRAUER B. APR. 17, 1869, RICH.  
D. INF.

HANNAH EZEKIEL B. AUG. 22, 1871, CINCINNATI  
D. DEC. 17, 1871

LILY BELLE B. MAR. 16, 1873  
D. MAR. 30, 1873

RALPH W. EMERSON B. NOV. 1, 1875

ARTHUR STERN B. AUG. 25, 1877

MOSES EZEKIEL B. JUN. 18, 1879

ELSIE DINSMORE B. AUG. 4, 1880

EDGAR JOHNSON B. MAR. 17, 1882

STANLEY R. JACOBS  
 KRAUS-SANDOR COLL.  
 EDWIN WOLF II  
 MICKVE ISRAEL REC.  
 MYER SOLIS-COHEN  
 FLORENCE ABRAHAMS

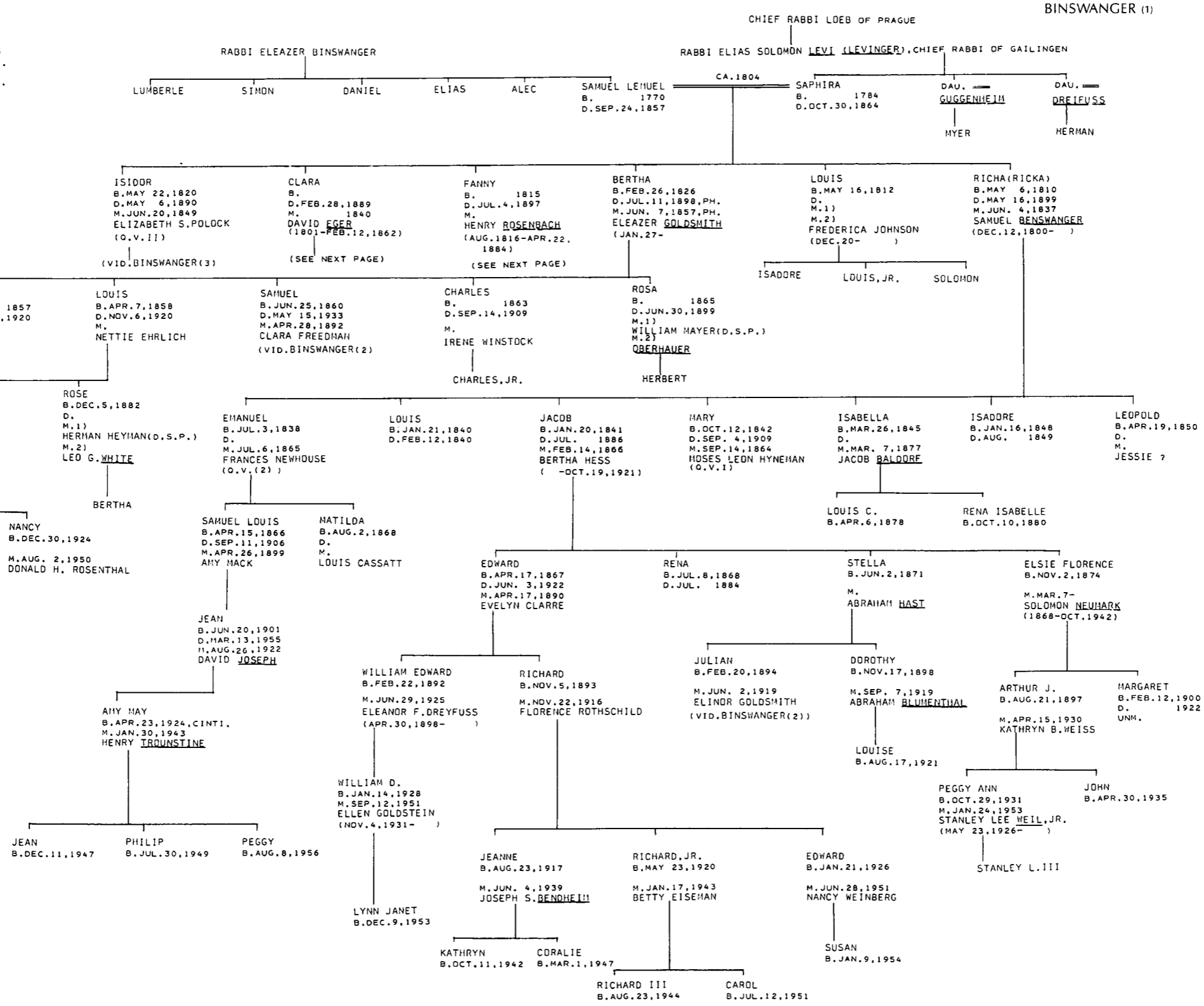

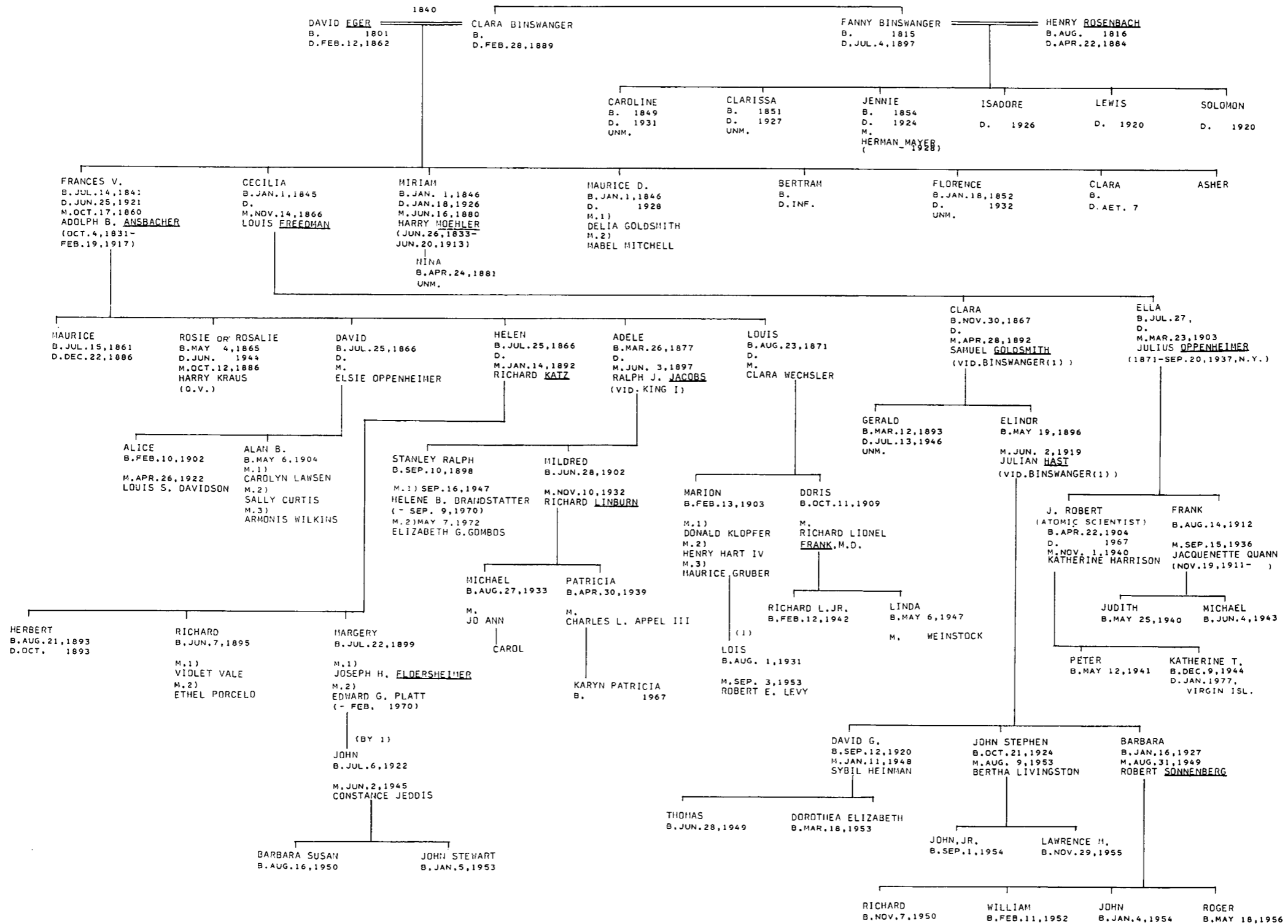

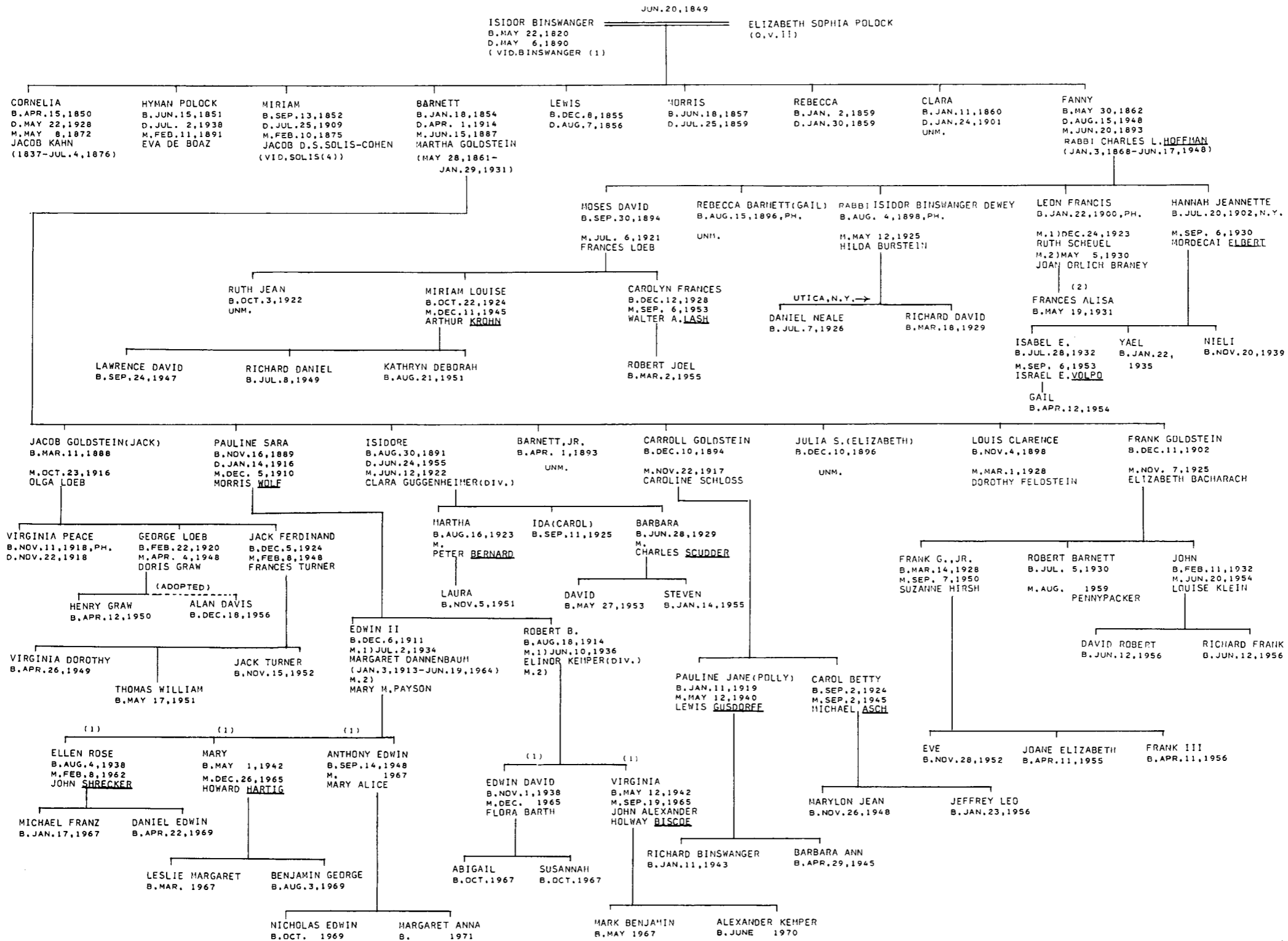

**BLOCH**

ANCKER MS.  
KRAUS MS.  
ST. CHARLES, FIG. 21

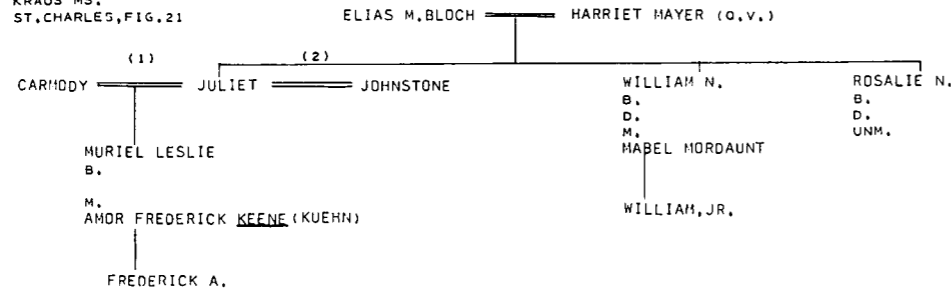

**BLOCK I**

PAJHS, V. 22, P. 195

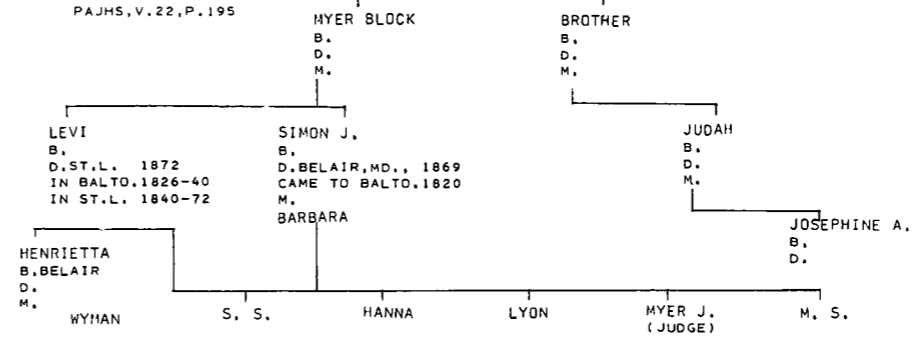

**BLOOMINGDALE**

FLORENCE ABRAHAMS  
MICKVE ISRAEL REC.

EVA EZEKIEL  
B. 1825  
D. SEP. 3, 1858

CHARLES BLOOMINGDALE  
B. AUG. 1, 1814  
D. APR. 5, 1903

CARDLINE ELFELT  
(VID. CADET)

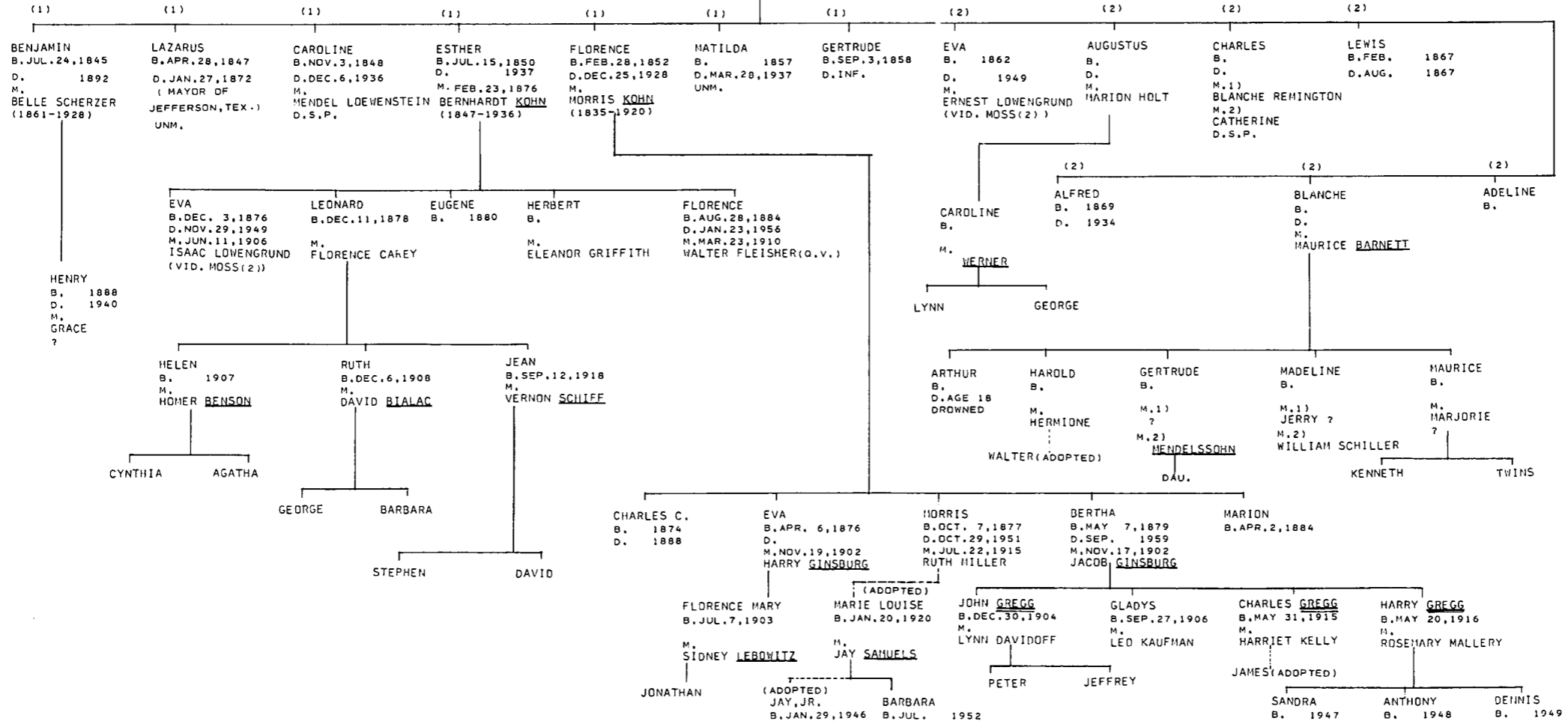

KRAUS-SANDOR COLL.  
E.-L.  
PAJMS, 8, P. 53  
PAJMS 27, P. 70  
WILL OF SIMON BLOCK, JR. (JRM)  
BALTO.-COHEN-ETTING CEM.  
ROSA MAYER GRANT  
PAULINE BOOKER CARTER

(BLOCK)

BLOCK II

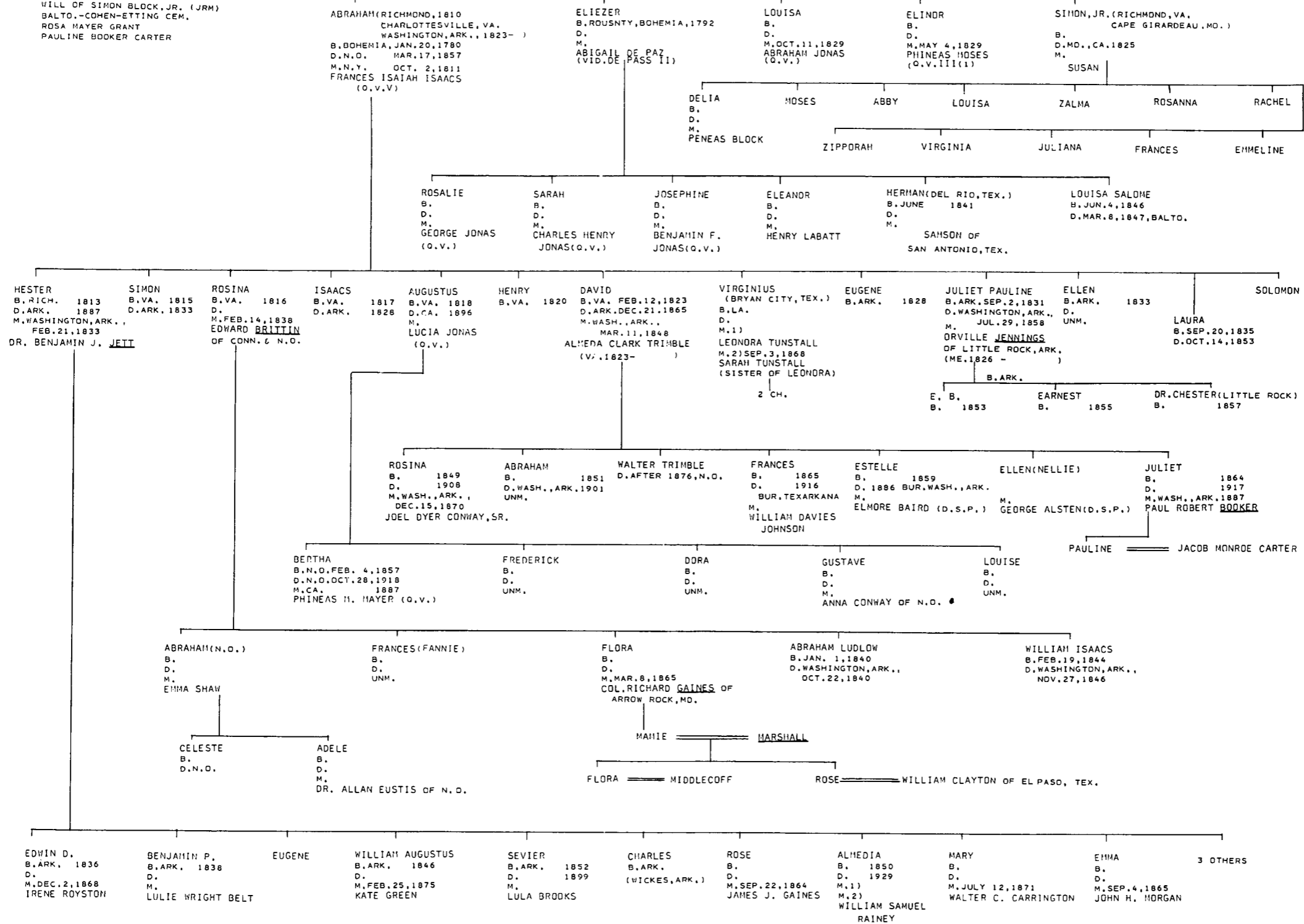



**BOMEISLER**

MICKVE ISRAEL REC.  
R.S.MDH REC.  
W.W.  
MORAIS-JEWS OF PHILA.  
FLORENCE ABRAHAMS

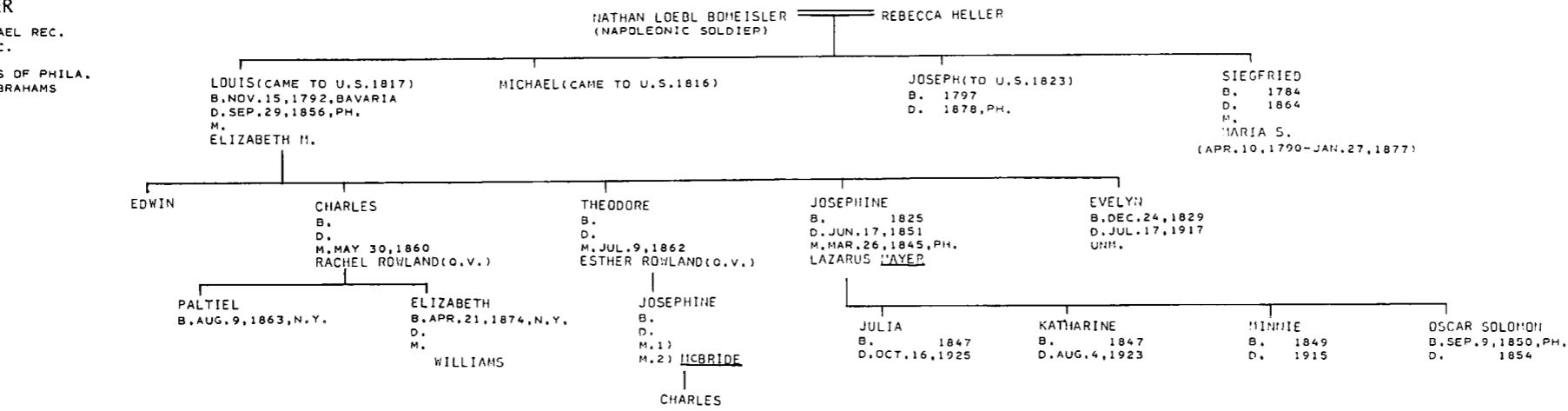

**FONSECA BRANDON**

LEANDER C. LEVY  
BEVIS MARKS REC.  
KRAUS-SANDOR COLL.  
HENDRICKS GEN.  
SHEARITH ISRAEL REC.

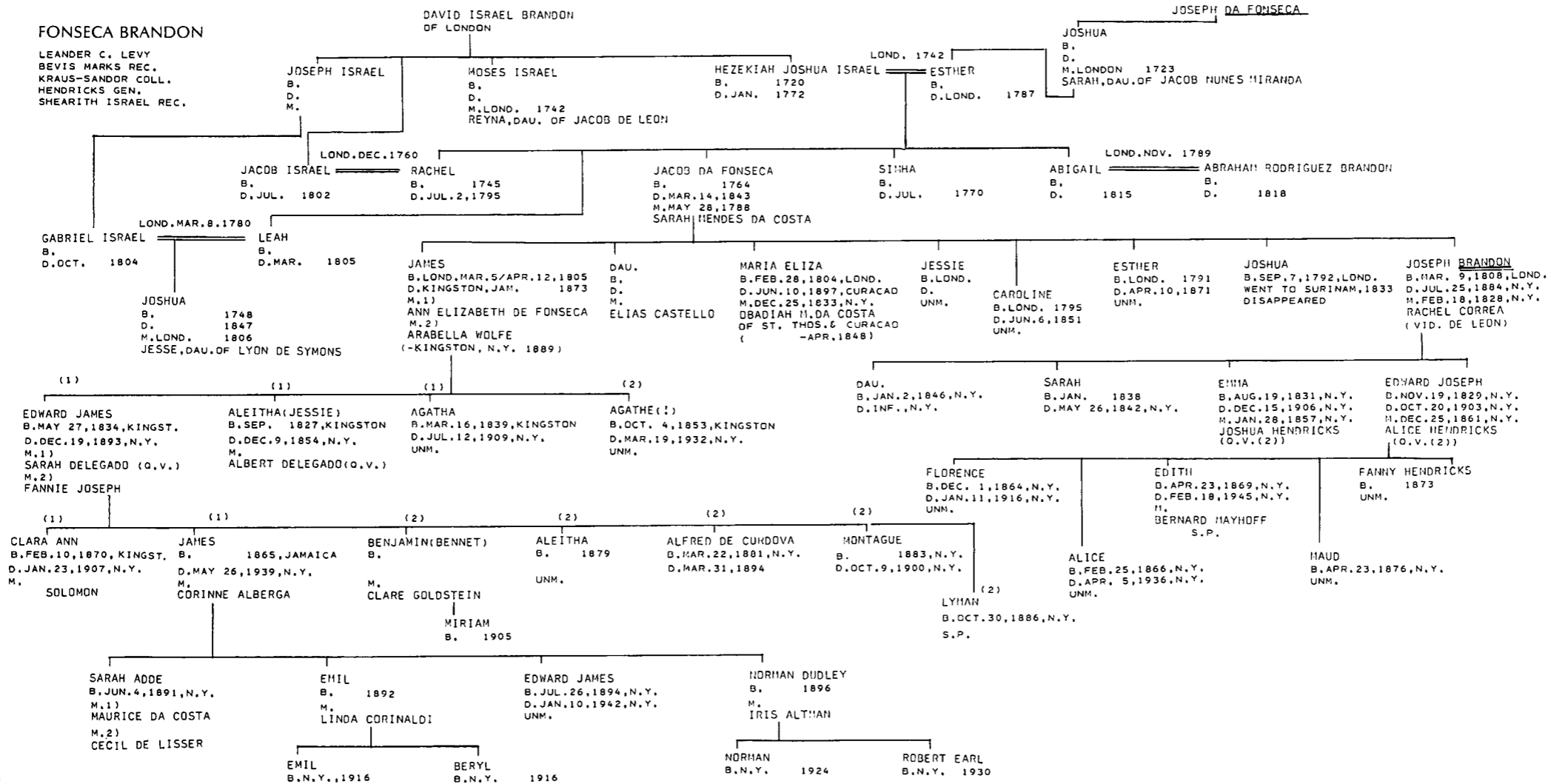

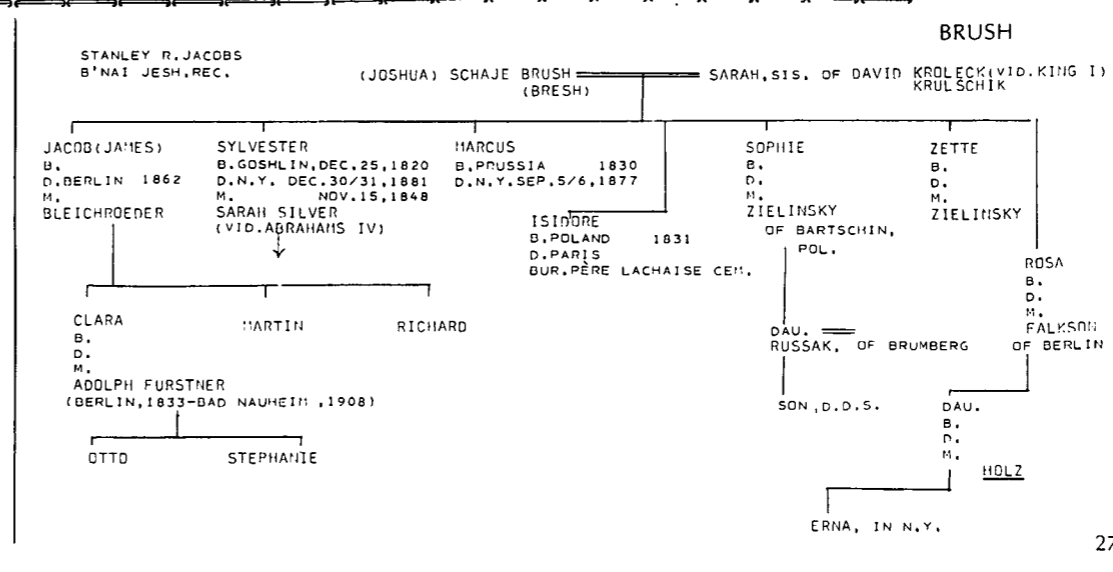
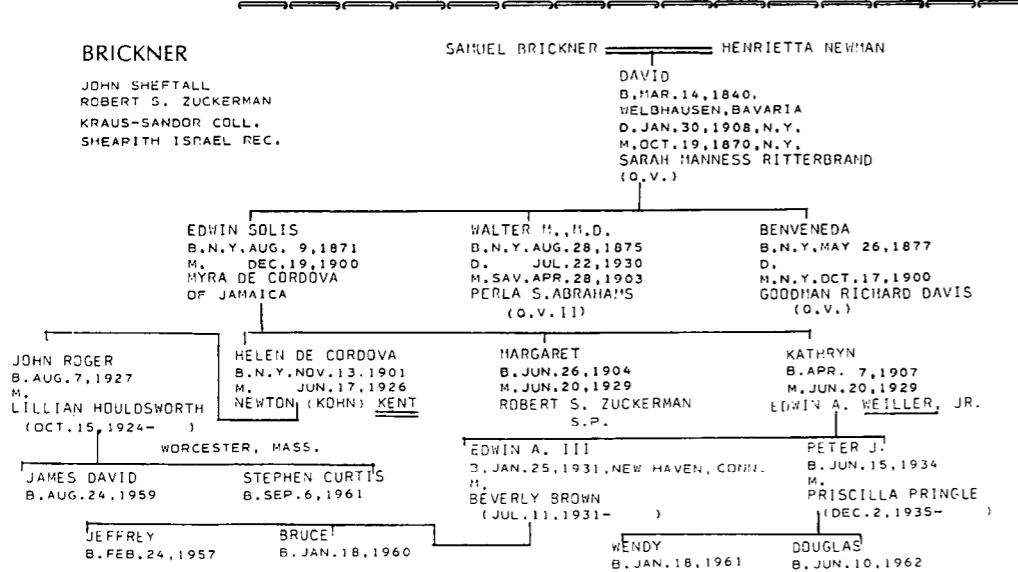
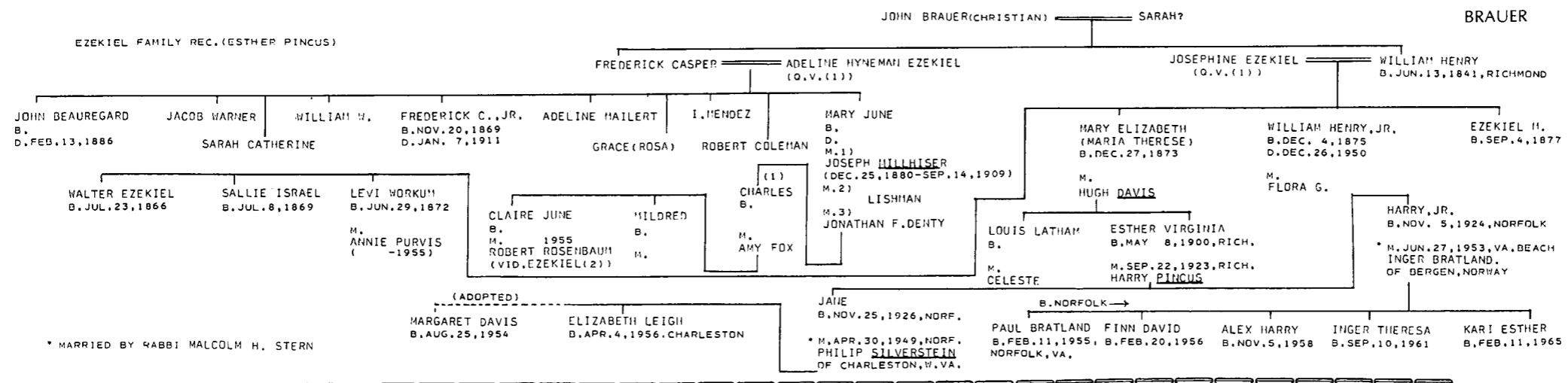
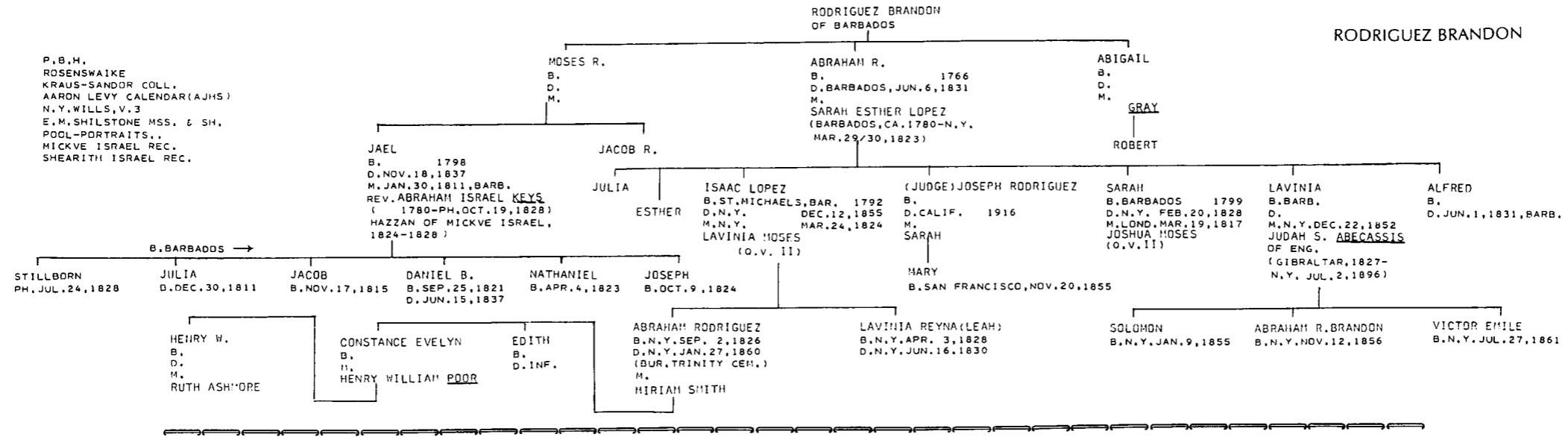

**BUSH**

AJHO LXI, P. 67  
N. C. S. O 54, P. 38  
MISC. VII #502  
COHEN-ETTING MS.  
SHEFTALL MSS.  
BUSH BIBLE (ROSENBAACH COLL.)  
B. JACOBS MOHEL REC.  
KRAUS-SANDOR COLL.

J. E. V. 3, P. 443  
MORAIS-HEWS OF PH., P. 401  
PHILIPSON-LETTERS OF REBECCA  
GRATZ, P. 457  
SAVANNAH JEW. BURYING GROUND  
MICKVE ISRAEL REC.  
SPRUCE ST. CEMETERY REC.  
W. W., P. 425

MATHIAS BUSH  
B. PRAGUE, MAY 10, 1722  
D. PHILA., MAR. 29, 1790  
M. 1)  
TABITHA MEARS (O.V.)  
M. 2) 1764  
REBECCA MYERS-COHN  
(O.V. 1)

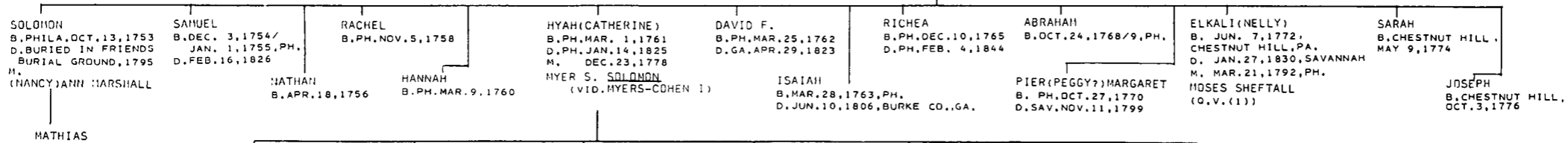

**CADET**

R. S. MOH. REC.  
MICKVE ISRAEL REC.  
MORAIS-JEWS OF PH., P. 71  
PAJHS V. 31, P. 154  
ELZAS MSS.  
ALLEN GEN.  
FLORENCE ABRAHAMS

SIMON DE LYON CADET  
B. LYONS, FR. 1754  
D. PH. MAR. 8, 1845  
M.  
FRANCES (TINA) (1766- JUN. 2, 1866)

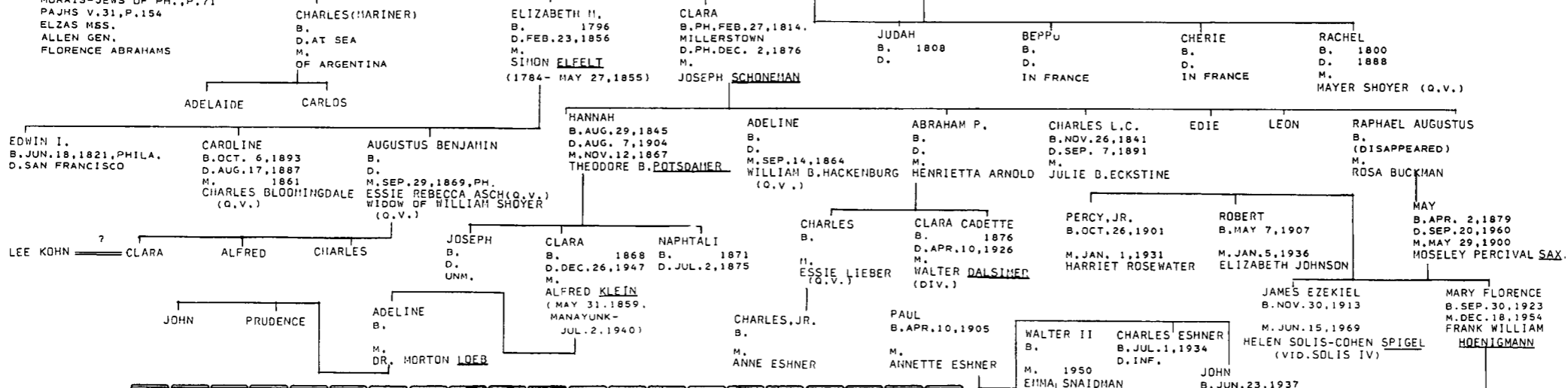

**CANTER**

MOBILE CEM. REC.  
ROSENWAIKE  
E. N. A.  
1790 & 1820 CENSUS  
SAV. BURIAL GROUND (WPA)  
SHEFTALL MS.  
WILL OF JOSHUA CANTER  
WILL OF RACHEL CANTER  
GRACE ABENDANONE  
RACHEL DE LA MOTTA  
MARR. CONVEYANCES  
ELZAS-O. J. C., P. 29  
M. N., P. 7 MSS.  
POOL-PORTRAITS, P. 136 F.  
GEO. H. TUCKER  
JOHN SHEFTALL

JACOB CANTER B. 1741, DENMARK  
D. FEB. 6, 1785, ST. EUSTATIA

REBECCA DE LA MOTTA (O.V.) TO CH.  
B. TO SAV. MAY 28, 1795  
D. DEC. 19, 1835, N. Y. TO CH. JUL. 12, 1796

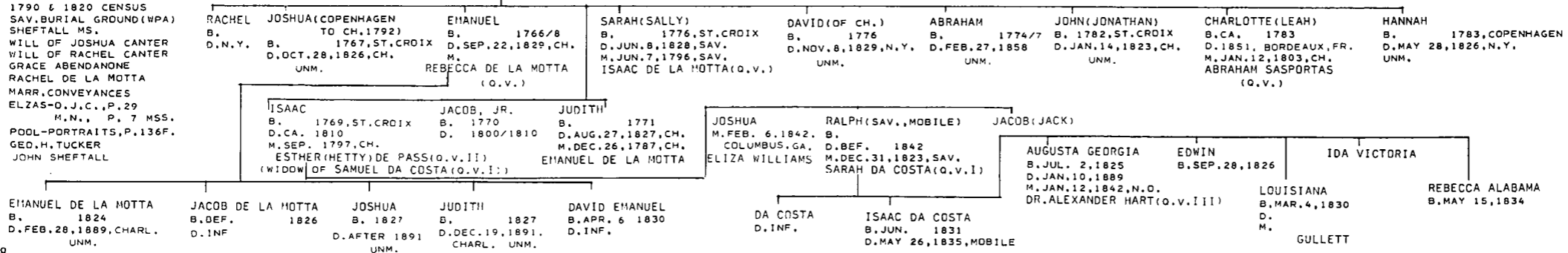

CARDOZO (CARDOZA)

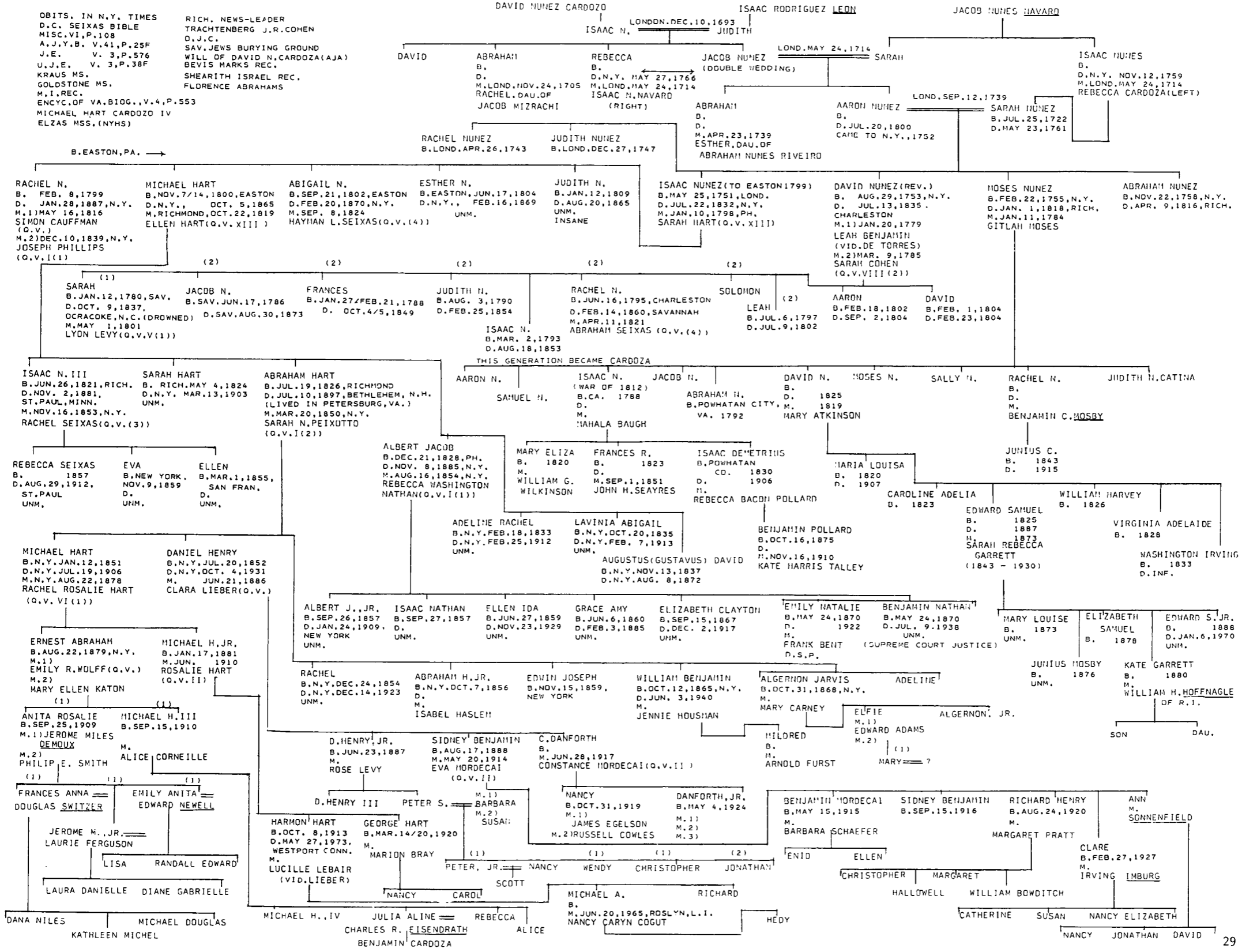

**CARVALHO**

P.B.H.  
B.W.KDRN  
WILL OF EMANUEL  
FLORENCE ABRAHAMS  
U.J.E. V.3,P.54F.  
KRAUS-SANDOR COLL.  
PAJHS V.27,P.463  
MICKVE ISRAEL REC.  
ELZAS-M.N.,P.20  
ELZAS-D.J.C.,P.46  
MRS.HARRY COHN  
BEVIS MARKS REC.  
SHEARITH ISRAEL REC.  
KORN-CARVALHO'S  
'INCIDENTS OF TRAVEL'  
MYER SOLIS-COHN

BENJAMIN RODRIGUES MOREIRA  
OF LONDON

SOLOMON NUNES CARVALHO  
B.  
D.  
M.LOND.APR. 1765  
JUDITH HENRIQUES PIMENTEL

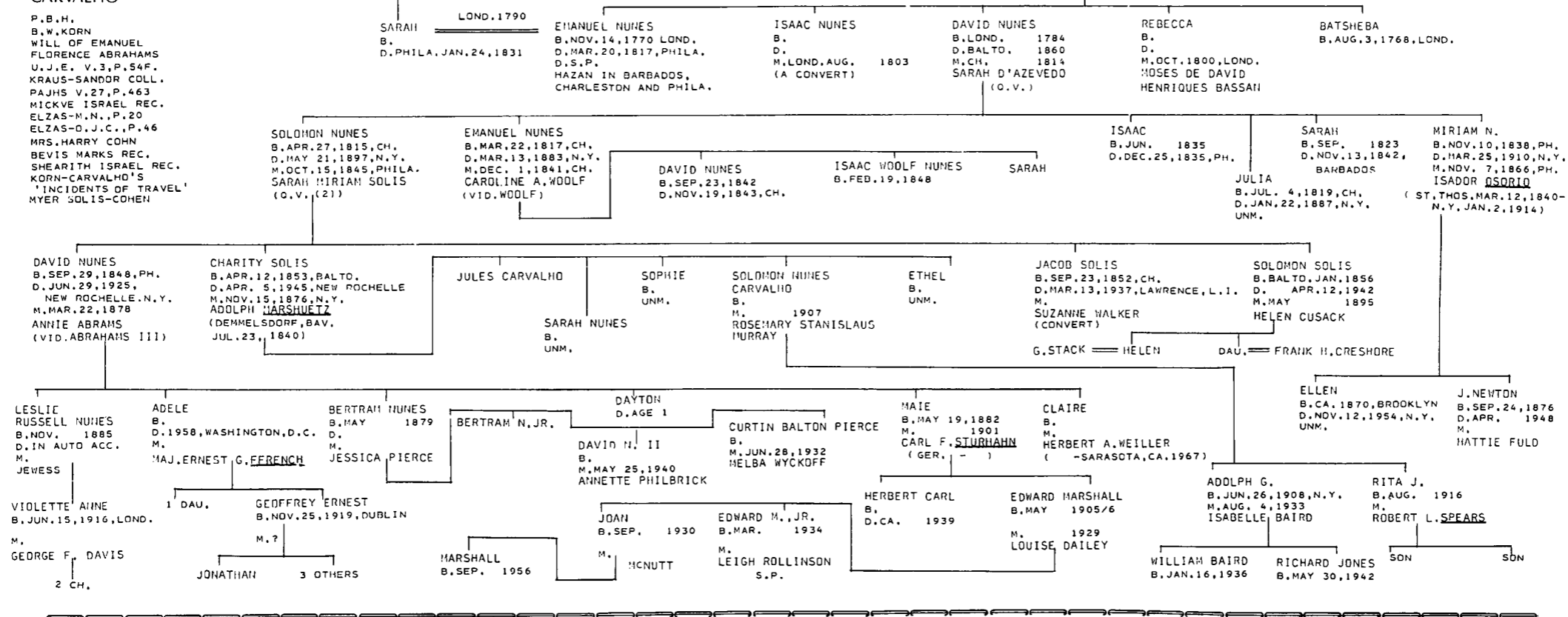

**CAUFFMAN**

LOXLEY MS. (PA. HIST. SOC.)  
U.S. CENSUS, 1800  
H. ROSENBACH-THE JEWS OF PH., P. 17.  
SHEARITH ISRAEL REC.

JOSEPH CAUFFMAN  
B. 1720  
D. PH. FEB. 10, 1807  
M.

SIMON  
B.  
D.  
M. MAY 16, 1816  
RACHEL N. CARDOZA (O.V.)

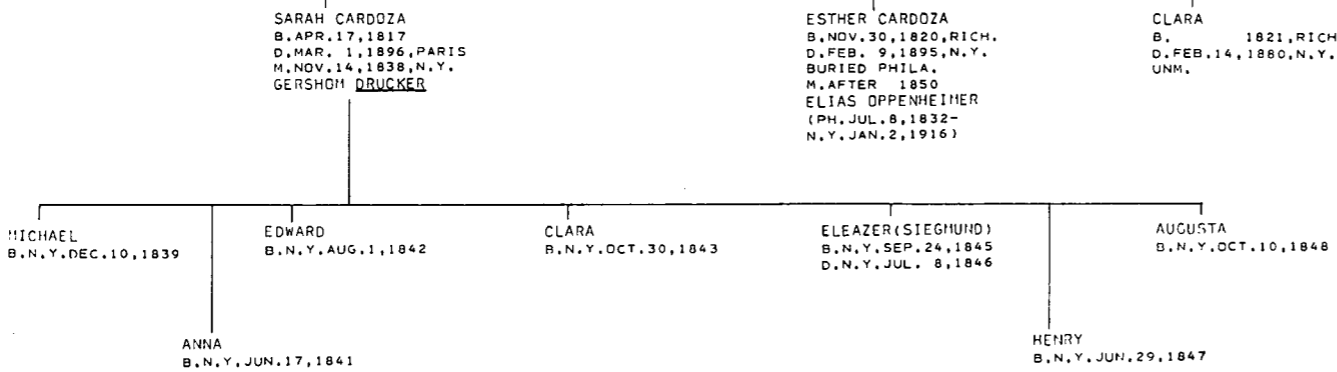

**CLAVA**

AJHO LVII, P. 45  
MISC. VII #543  
W.W.  
MICHAEL GRATZ LETTER BK. (AJHS)  
OPPENHEIM (AJHS)

MOSES CLAVA  
B.  
D.  
M.  
(NATURALIZED LANCASTER, SEPT. 12/24, 1762)  
BENJAMIN MOSES  
B.  
D. MAR. 16, 1785, PHILA.  
M.  
(A XIAN IN CHURCH)  
{ GLOUCESTER, N.J. 1755  
MT. HOLLY, N.J.  
TO PHILA. 1774

N.G.S.O XLIX,P.43  
KRAUS-SANDOR COLL.  
ELZAS,M.N,P.14  
E.COHEN GEN.  
MICKVE ISRAEL REC.  
MARYLAND HIST.MAG.V.18,  
MRS,ALBERT M.COHEN  
FLORENCE ABRAHAMS  
FEDERAL ST.CEM,  
R.S.MOH.REC.

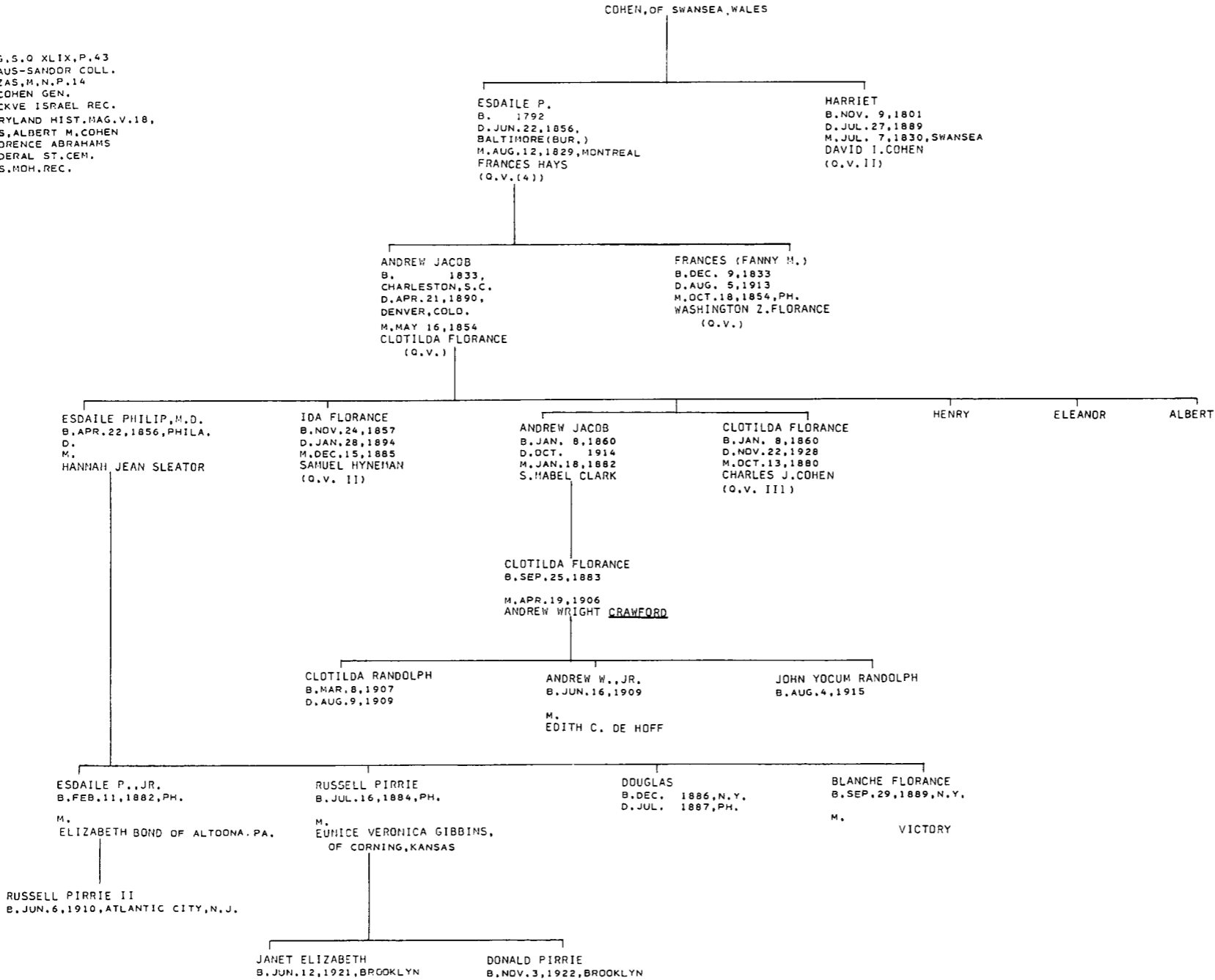

COHEN II (BALTO.)

MORDECAI FAM. BIBLE  
WILL OF JACOB I. COHEN  
WOLF-WHITEMAN-JEWS OF PHILA.  
MD. HIST. MAG. V. 18, PP. 357-376  
V. 19, PP. 54-77  
N.G.S.O. XLIX, P. 43  
M.I. REC.  
U.J.E. V. 3, P. 233F.  
KRAUS MS.  
MYERS MS.  
JEWS OF RICHM. PASSIM.  
SHEARITH ISRAEL REC.  
MYER SOLIS-COHEN  
COHEN-ETTING MSS.  
N.Y. 1855 CENSUS  
B'NAI JESH. REC.

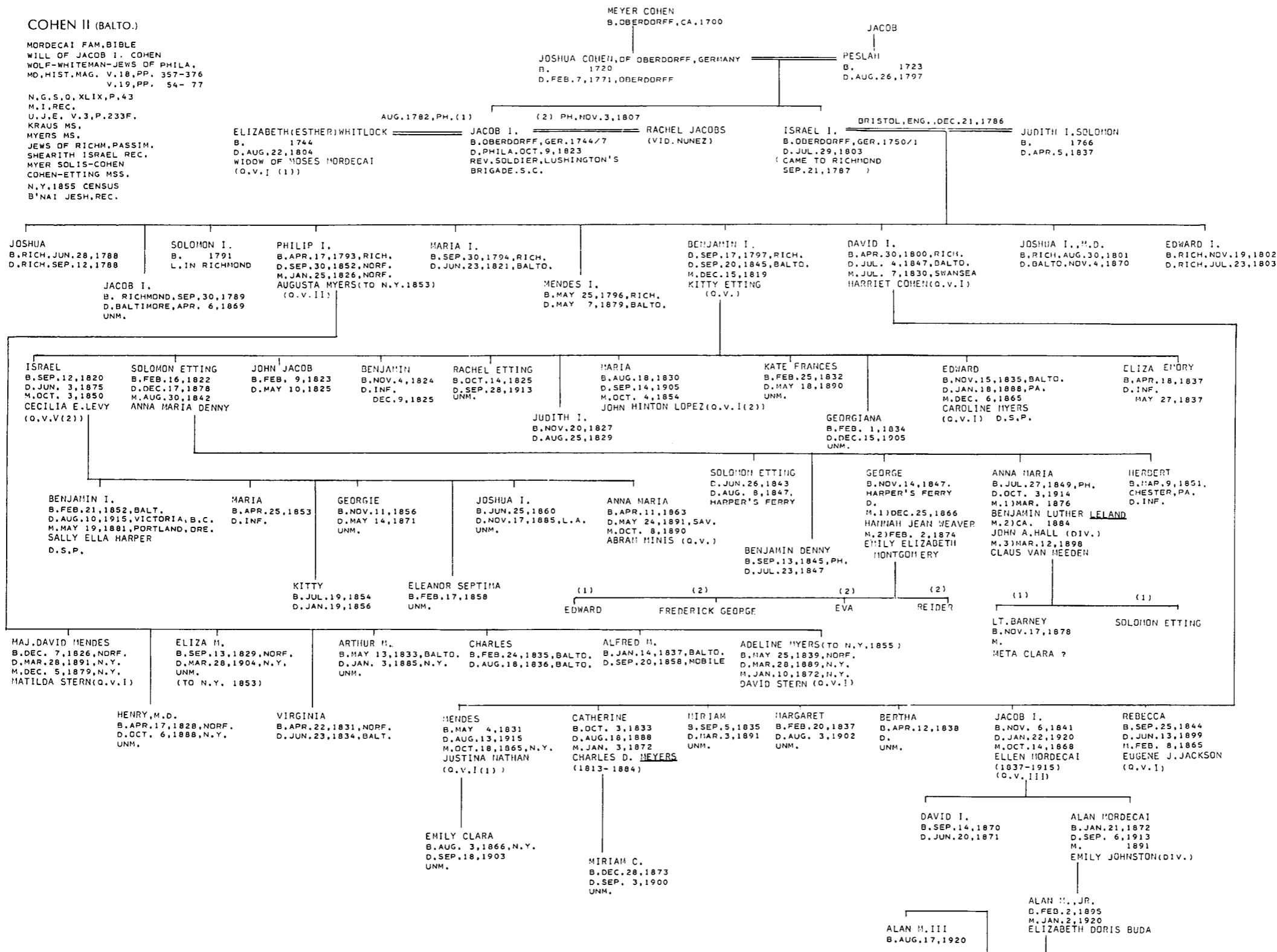

COHEN III (PHILA.)

FEDERAL ST. CEM.  
N.Y. 1855 CENSUS  
W.W., P. 395  
PAJHS V. 9, P. 36  
PAJHS V. 27, P. 486  
PAJHS V. 31, P. 255  
UJE V. 3, P. 249F.  
KRAUS MS.  
COHEN LETTERS (JRM)  
N.Y. WILLS  
CLIPPING FROM AMERICAN STATIONER (JRM)  
SAMUEL-YATES G. (AJA)  
COHEN G. (AJA)  
SHEARITH ISRAEL REC.  
COHEN FAMILY FACTS & FAIRY TALES  
OBIT. IN PHILA. DAILY NEWS 4/3/57

ROSE BARNET (1) JOSEPH COHEN (2) ENG. HANNAH MOSES  
B. ELBERFELD, WESTPHALIA, 1745/46 B. 1800  
D. LONDON, AUG. 1, 1822  
CAME TO U.S. 1768  
RET'D TO ENGLAND

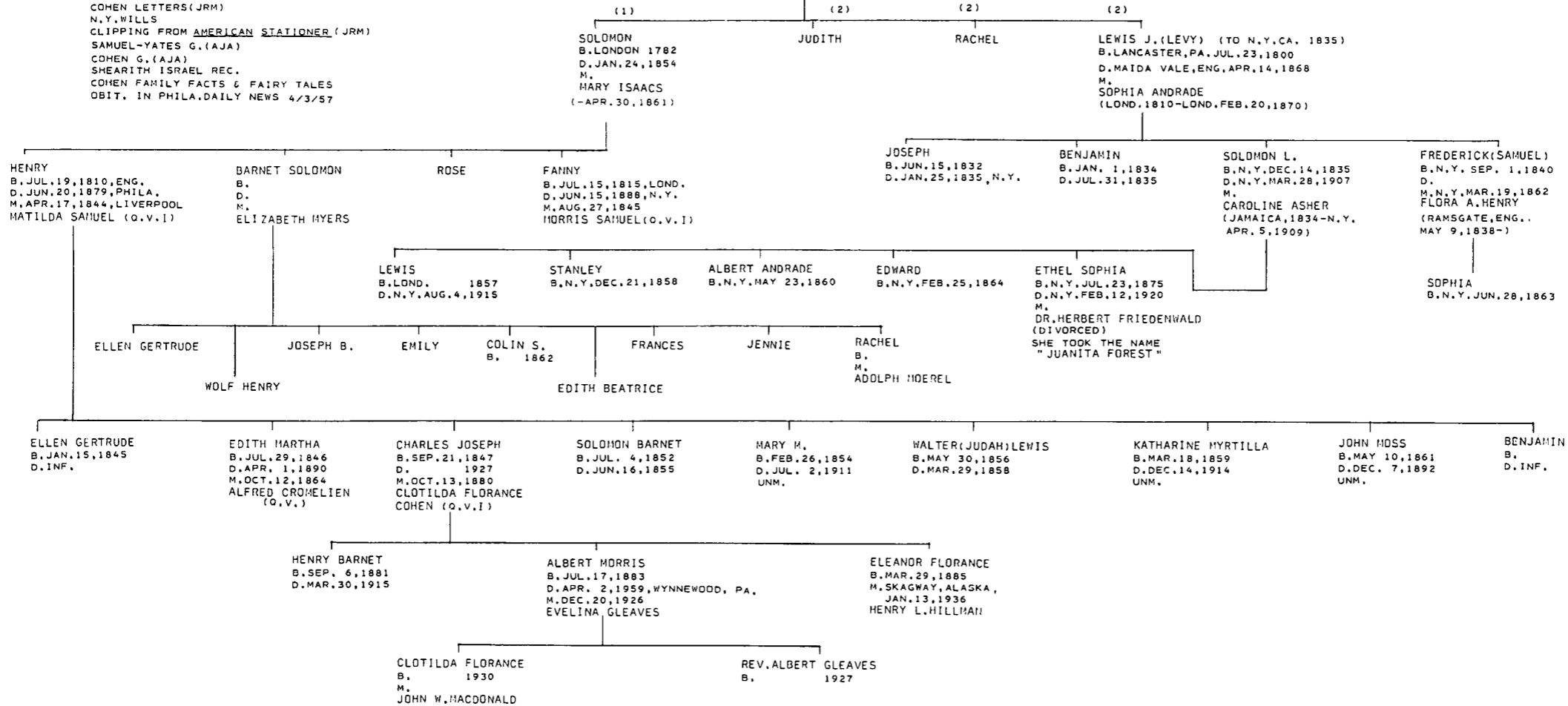

COHEN IV (N.Y.)

VALENTINE'S MANUAL  
PAJHS V. 27, P. 75  
POOL-PORTRAITS...  
SHEARITH ISRAEL REC.  
MICKVE ISRAEL REC.  
MYER SOLIS-COHEN

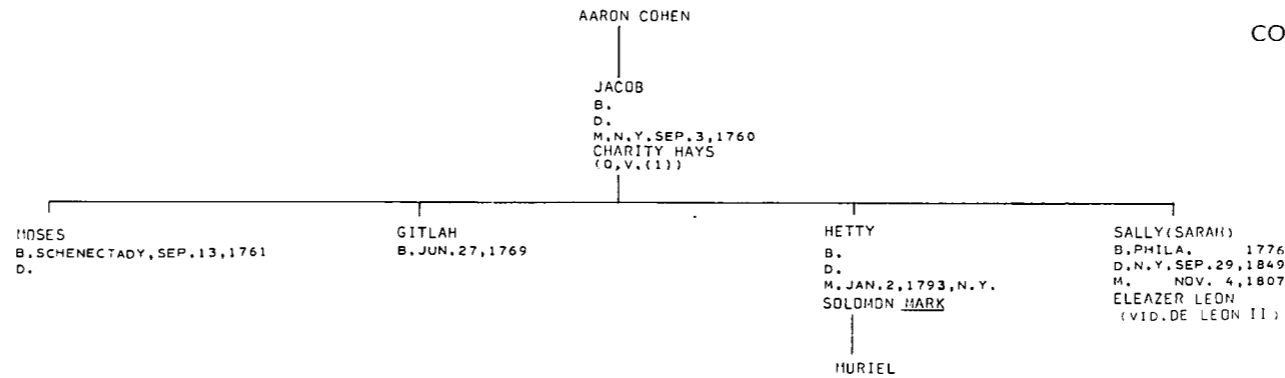



COHEN V (N.Y.)

MRS. DAVID GOODMAN  
B'NAI JESH REC.  
NORFOLK HEB. CEM.  
KRAUS-SANDOR COLL.  
SHEARITH ISRAEL REC.

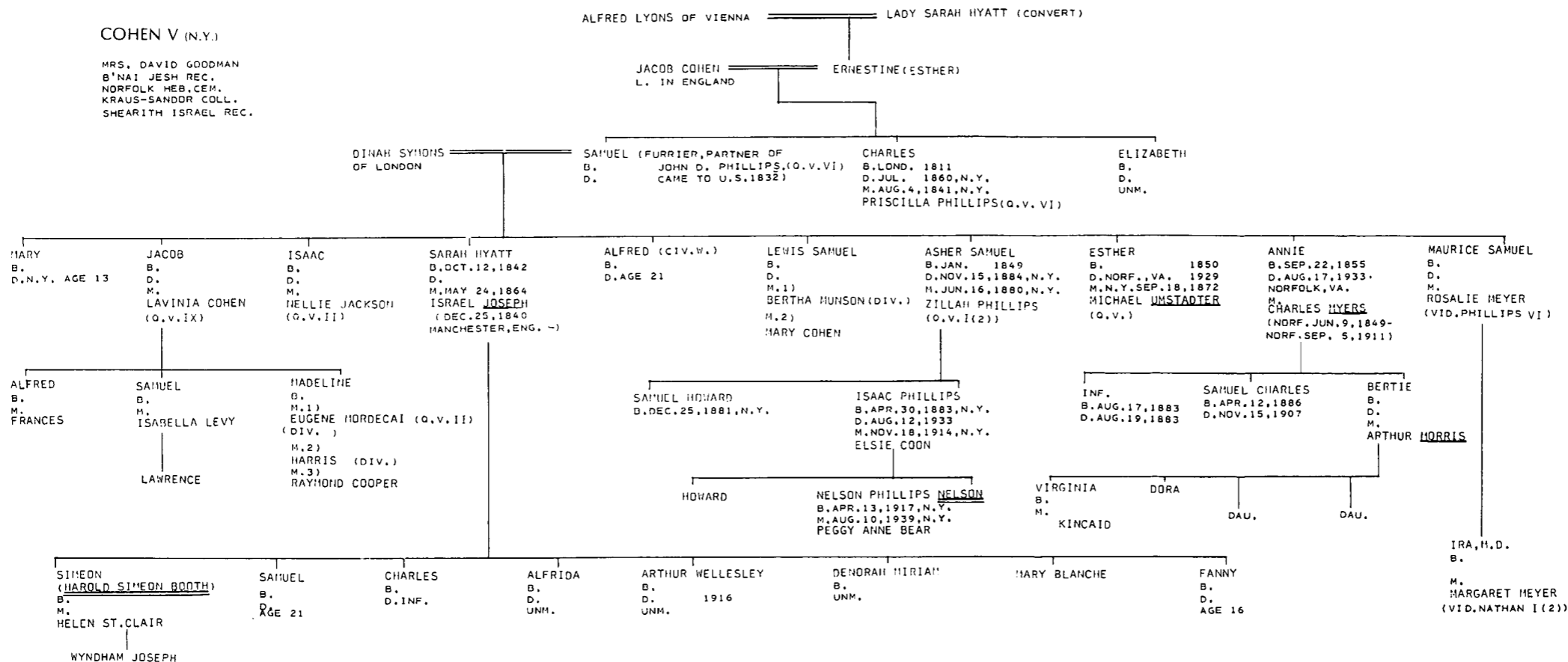

COHEN VI (S.C.)

CHARLES WHITEHEAD (COHEN FAMILY BIBLE)  
KRAUS-SANDOR BOOKS  
MORAIS-JEWS OF PHILA., P. 44  
JEW CEM. AT GEORGETOWN (ELZAS MSS.)  
D.A.R. LINEAGE BOOKS  
AJYB 5666, P. 48  
ELZAS M.N.  
ELZAS D.J.C.

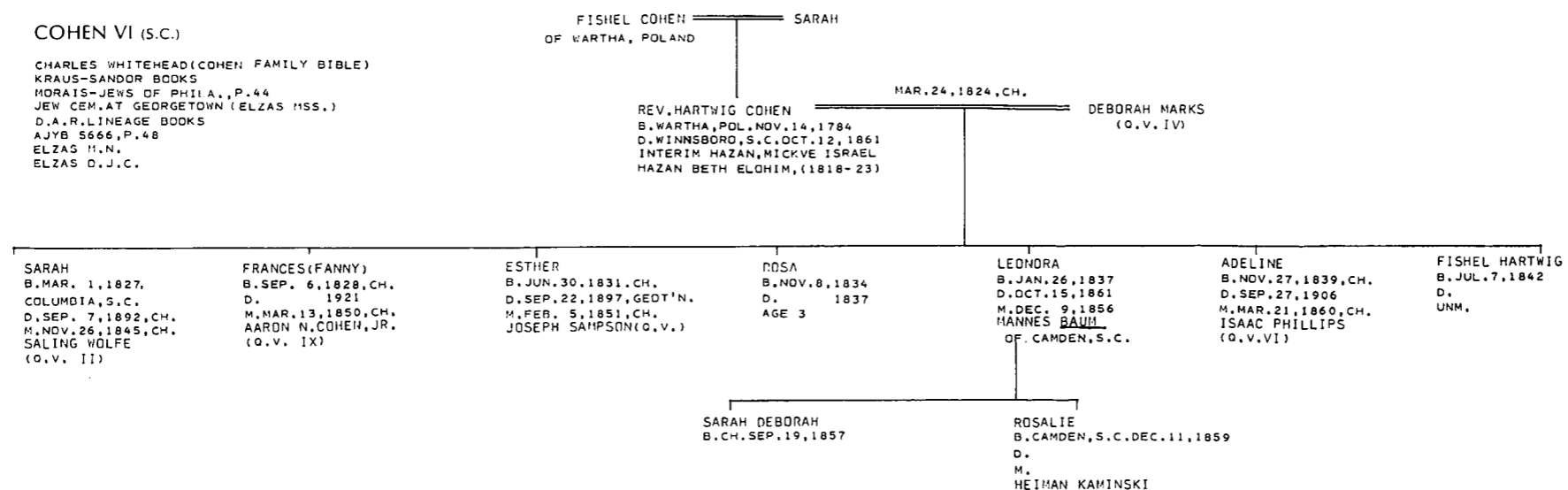

COHEN VII (S.C.)

MOISE-JEW.CEM.AT SUMTER  
HART-RECORDS OF FAMILIES OF HART & COHEN  
LAZARUS GEN.  
MARR. CONVEYANCES  
RAISIN FAMILY  
WILL OF RACHEL HART  
UJE V.3,P.251F.  
ST.CHARLES,P.89  
KRAUS MS.  
MOSES GEN.(AJA)  
ELZAS MS.  
ELZAS M.N.,P.14F.  
ELZAS D.J.C.  
SAMUEL-YATES G.(AJA)  
SHEARITH ISRAEL REC.

IN CH. BY 1788

MORDECAI COHEN DEC.1795 LEAH LAZARUS (Q.V.II)  
B.ZAMOSC,POLAND 1763  
D.CHARLESTON,JUL.8,1848

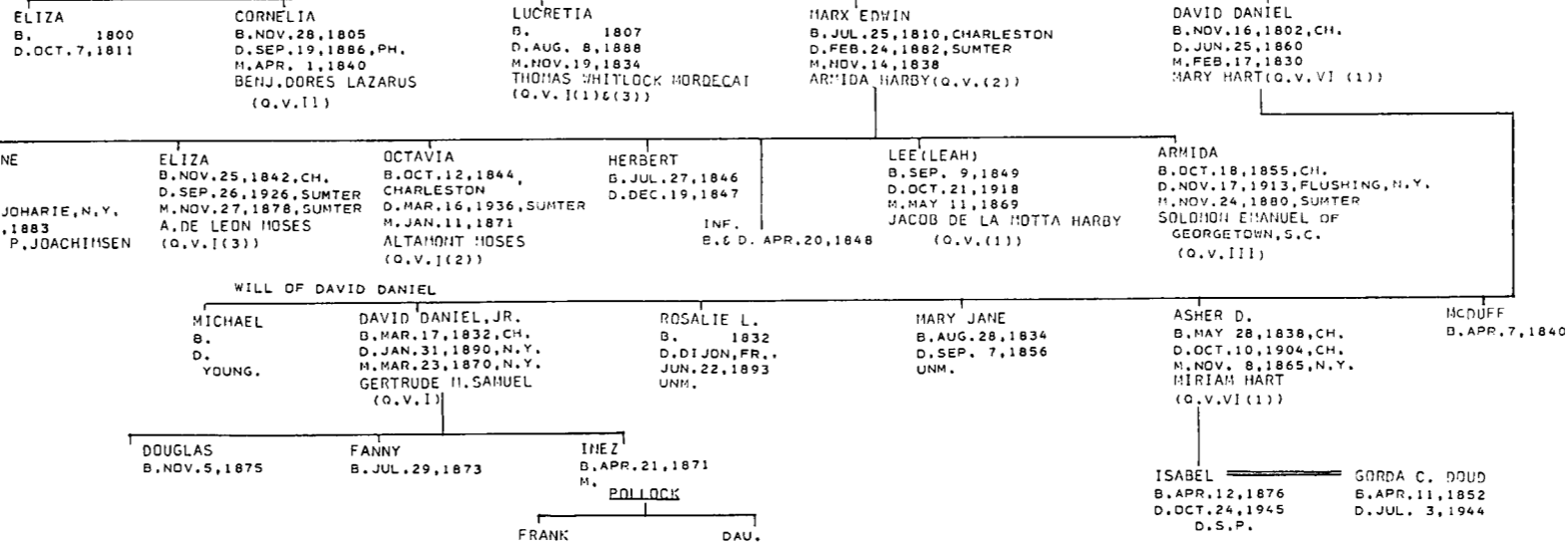

MARRIAGE CONVEYANCES I,210  
WILLS OF SOLOMON,CECILIA AND AARON COHEN(JRM)  
KORN-N.O. JOHN M. SHEFTALL  
ALICE LANDRUM  
HAROLD MOISE  
ROSENWAIKE  
KRAUS-SANDOR COLL.  
PAJHS V.12,P.57  
ELZAS-JEWS OF S.C.,P.45  
ELZAS O.J.C.  
ELZAS M.N.  
ELZAS MSS.  
ELZAS-NEW JEW.CEM.OF B.E.  
CHATHAM CO.,GA.WILLS  
SAV.JEWISH BURYING GROUND  
SHEARITH ISRAEL REC.  
SAMUEL-HIST.&GEN.SAMUEL-YATES  
POULSON'S DAILY ADVERTISER

COHEN VIII (1)

REV. MOSES COHEN (1) DINAH COMGILE (2) APR.1763 JOSEPH DAVID OR CONGUE

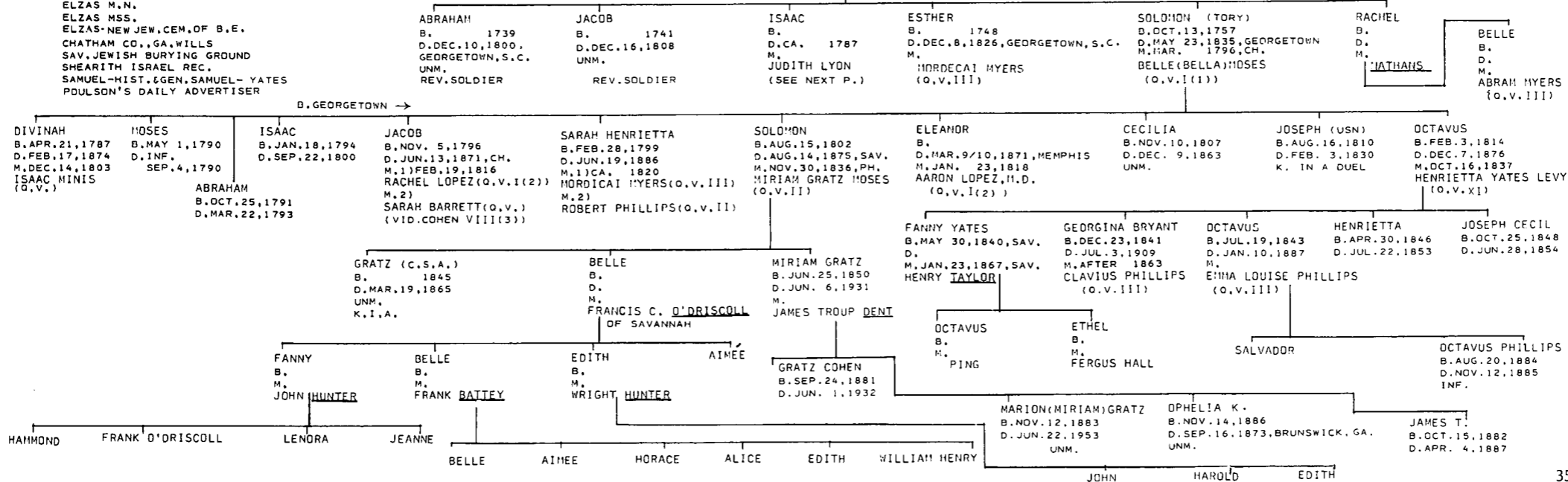

COHEN VIII (2)

JOHN M. SHEFTALL

ISAAC COHEN B. 1748 D.C.A. 1787 (SEE PRECEDING P.)  
 JUDITH LYON B. 1748 D.NOV. 1816, CH.

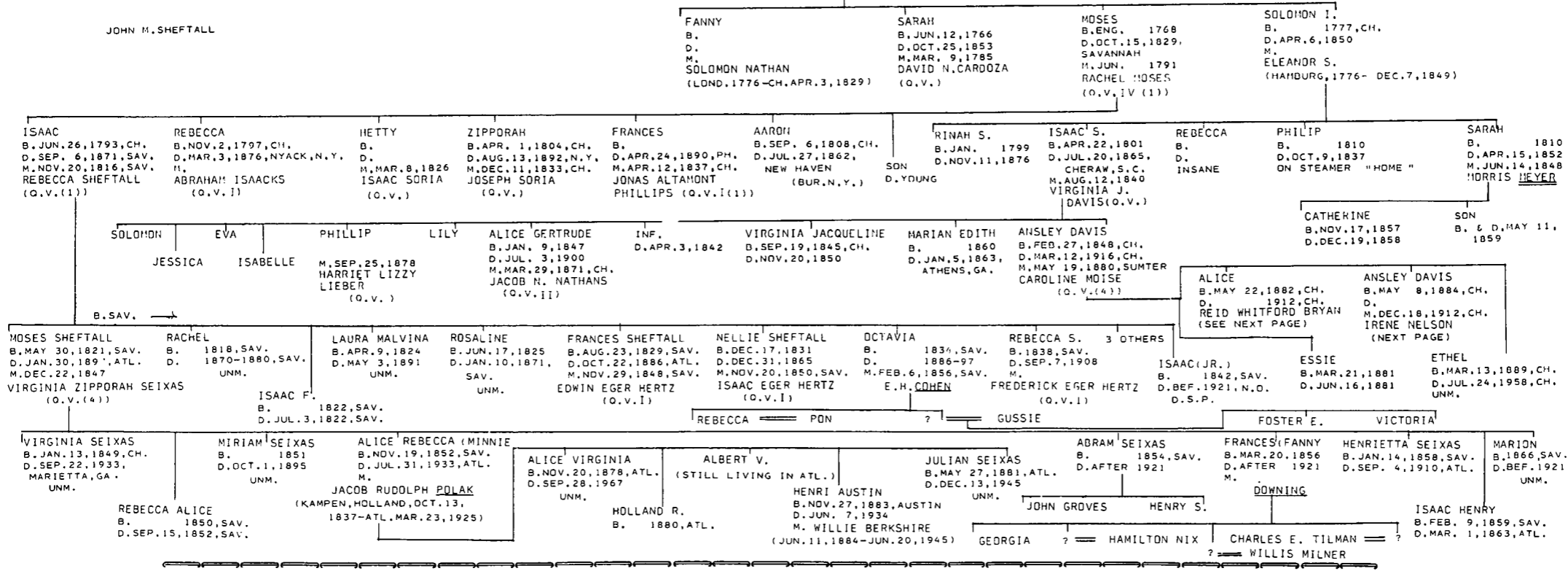

COHEN VIII (3)

RACHEL LOPEZ FEB. 19, 1816 (Q.V. (2))  
 (1) JACOB COHEN B. NOV. 5, 1796, GEORGETOWN, S.C. D. JUN. 13, 1871, CHARLESTON (VID. COHEN VIII (1))  
 (2) SARAH BARRETT (Q.V. (1))

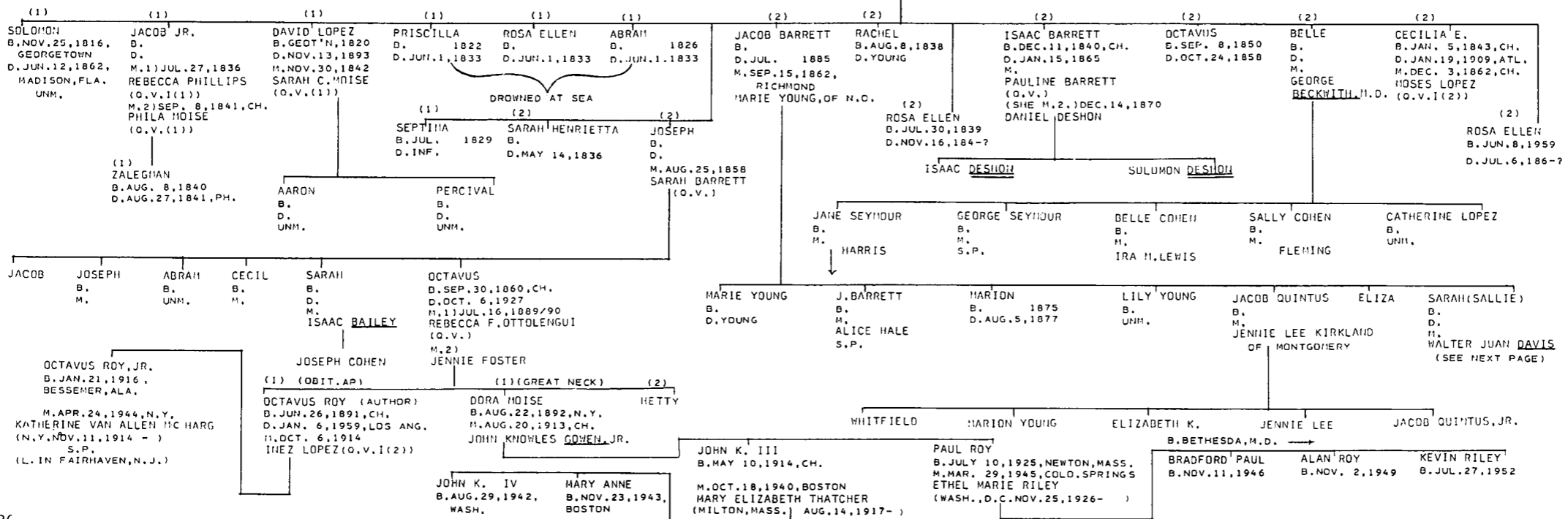

COHEN VIII (4)

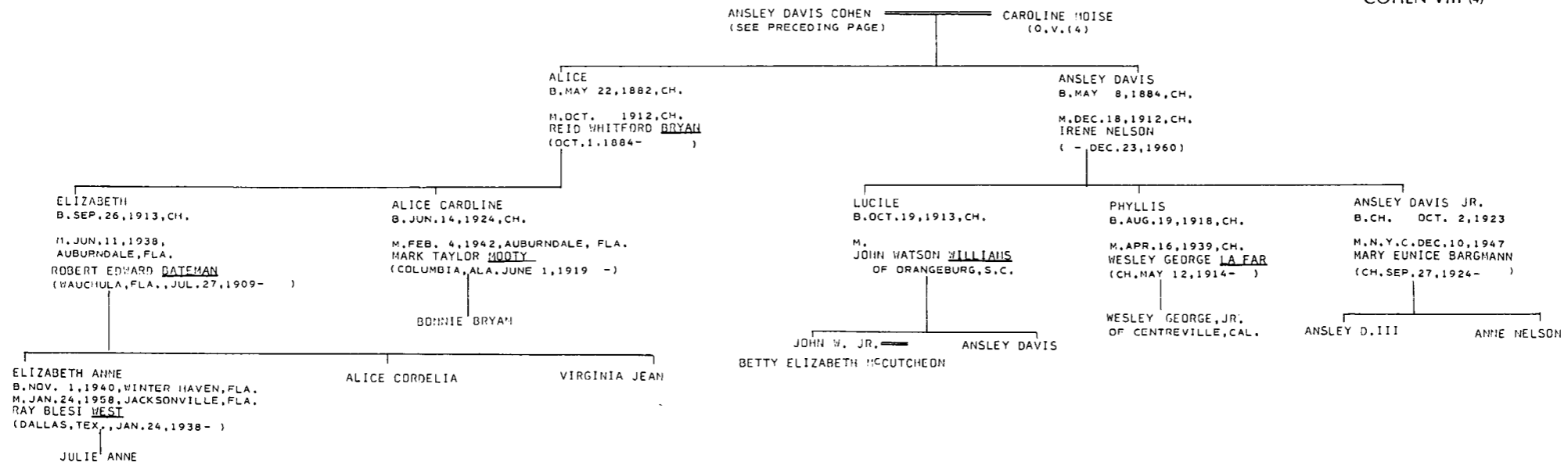

COHEN VIII (5)

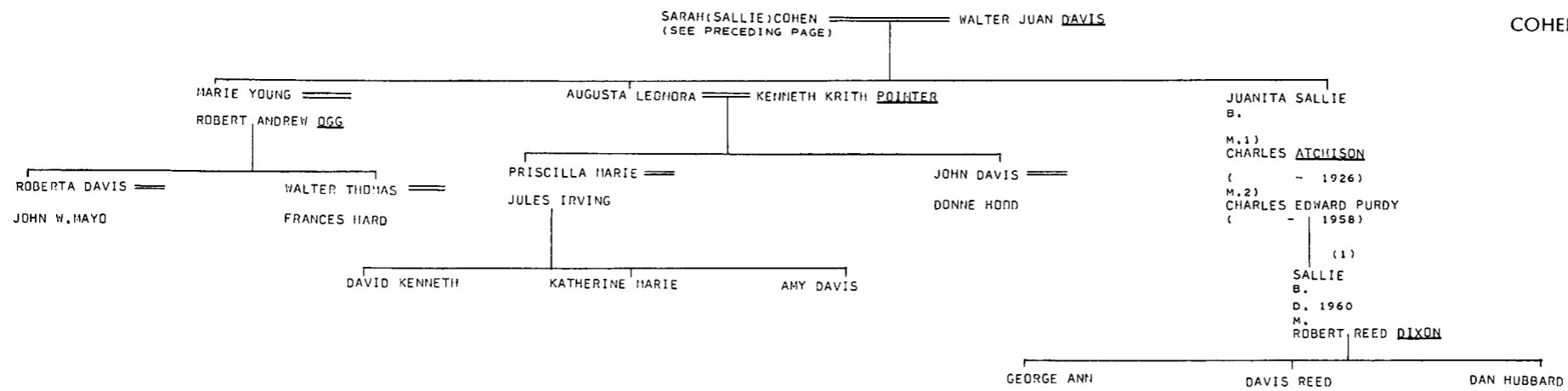

COHEN IX (S.C.)

CHARLES WHITEHEAD  
ELIAS FAMILY BIBLE  
KRAUS-SANDOR COLL.  
ELZAS MSS.  
ELZAS M.N.  
ELZAS O.J.C.  
D.A.R. LINEAGE BOOKS  
SHEARITH ISRAEL REC.  
FLORENCE ABRAHAMS

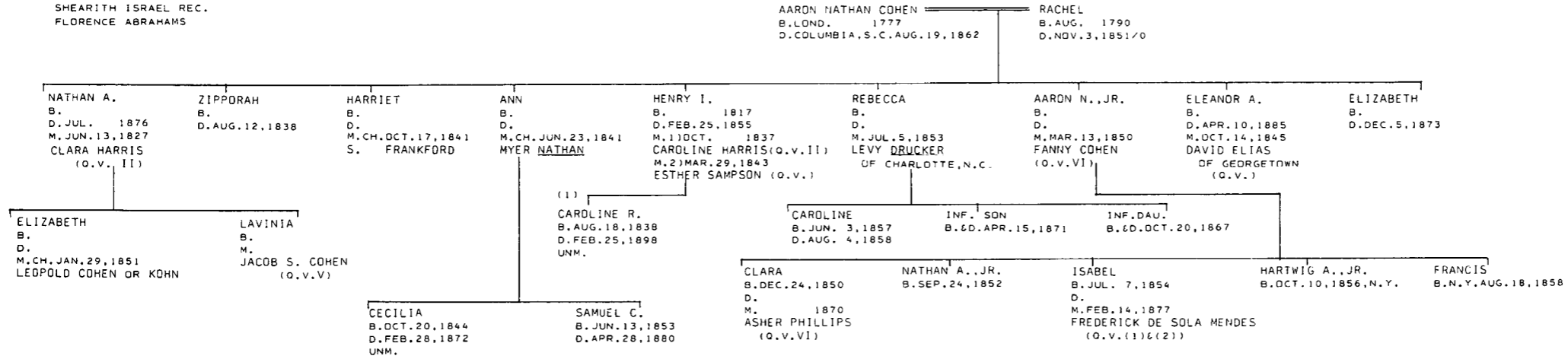

COHEN X (1) (CH. & N.Y.)

AARON LOPEZ MSS. (JRM)  
ABBOT L. MOFFAT  
KORN N.O.  
B'NAI JESH, REC.  
A. J. D., P. 183  
HAROLD MOISE  
PAJHS V. 27, P. 167  
KRAUS MS.  
WILL OF JACOB JACOBS (JRM COLL.)  
ELZAS MSS.  
ELZAS O.J.C.  
ELZAS M.N.  
EMANUEL FAM. REC. (JRM COLL.)  
SHEARITH ISRAEL REC.  
MOORE, ETC. - MEN OF THE SOUTH

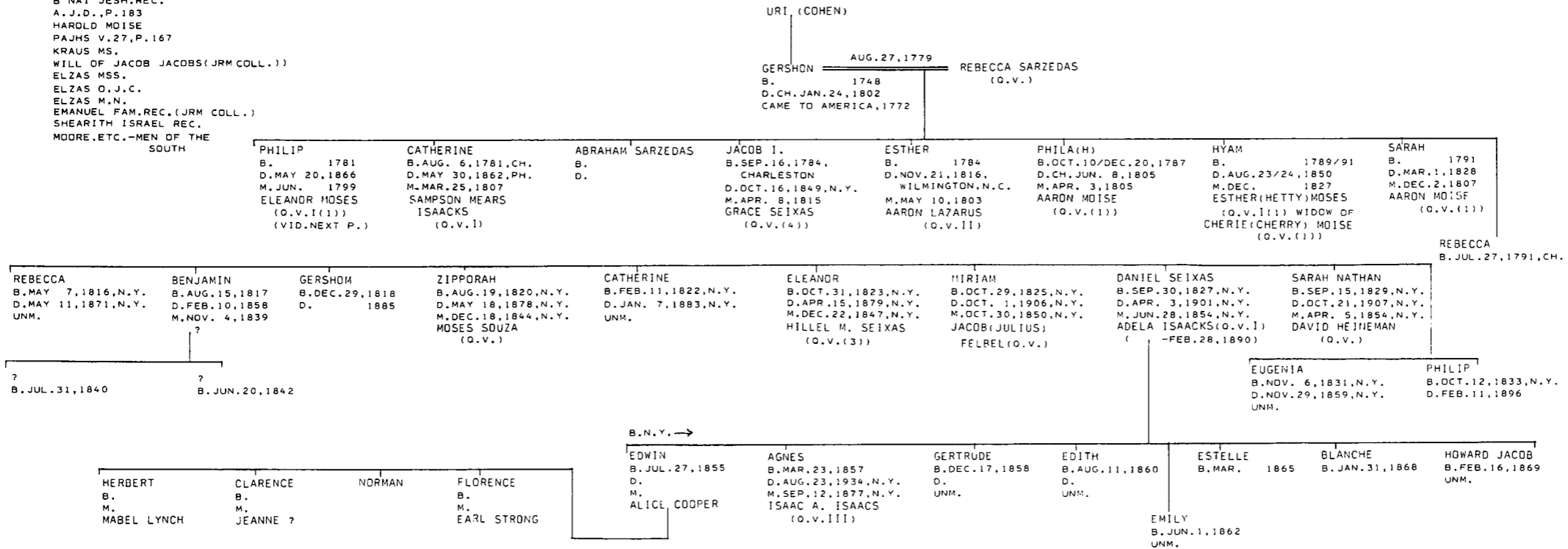

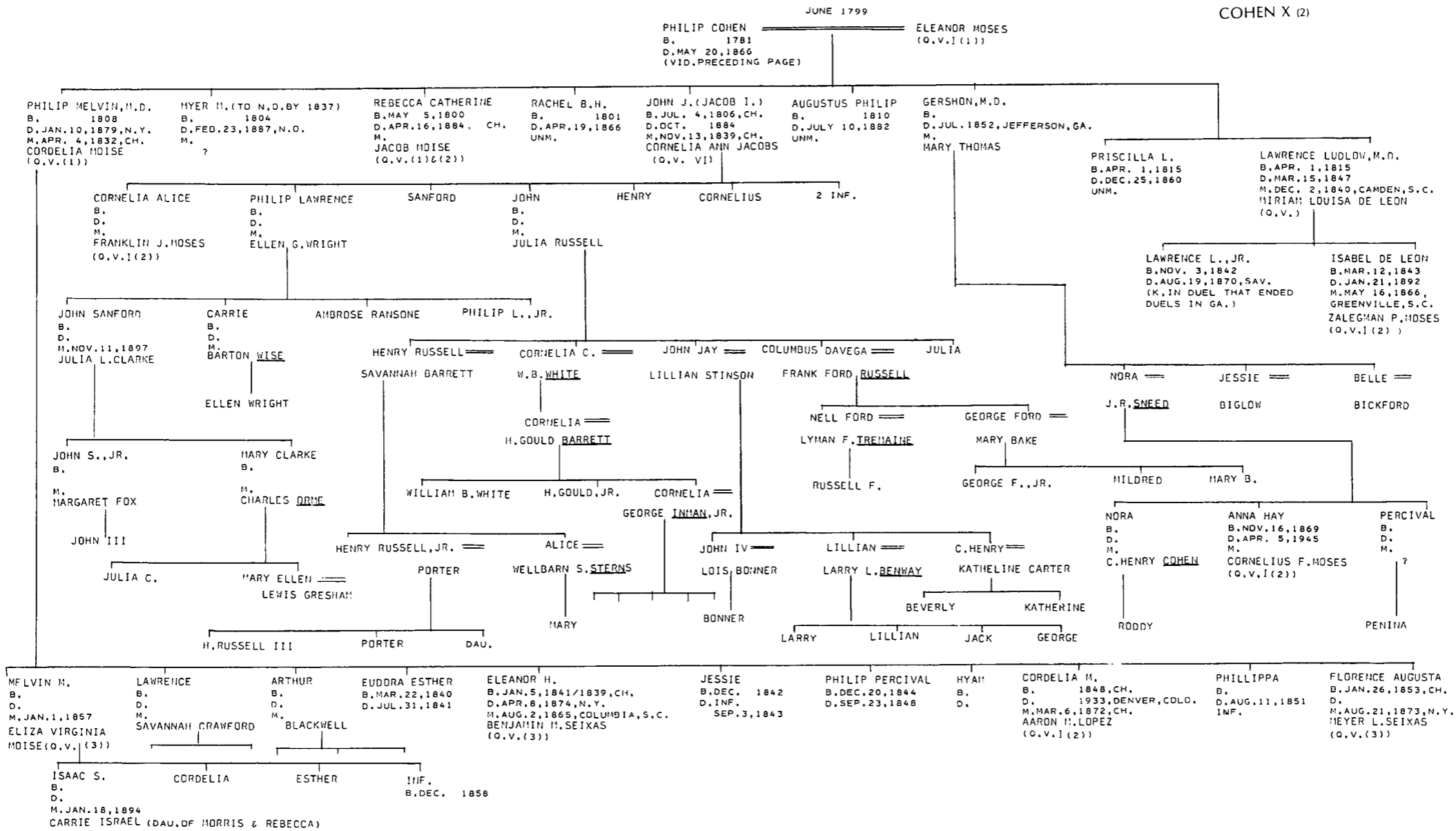

ELZAS O.J.C., P. 5, 6  
KORN-THE JEWS & NEGRO SLAVERY...  
ROTH-RISE OF PROVINCIAL JEWRY  
CHATHAM CO., GA., MARR. REC.

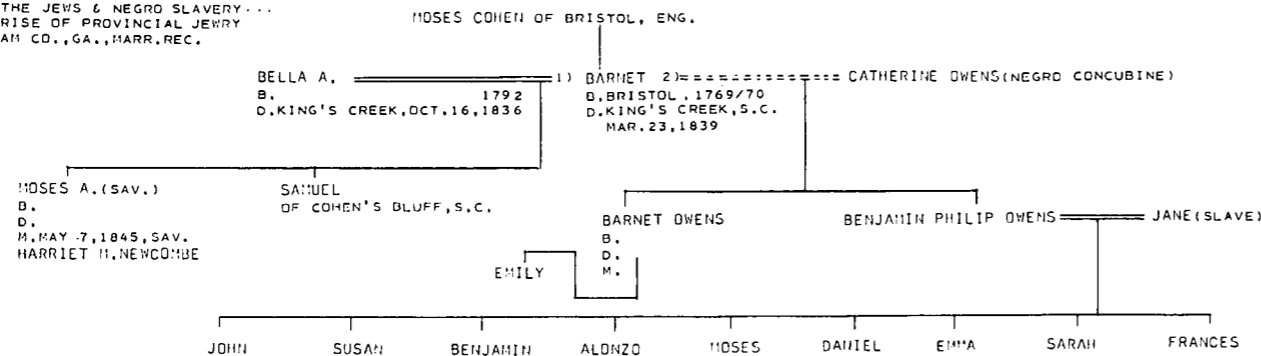

JON STEDMAN (1850 CENSUS)  
B'NAI JESH, REC.  
GRINSTEIN P. 590

COHEN XII

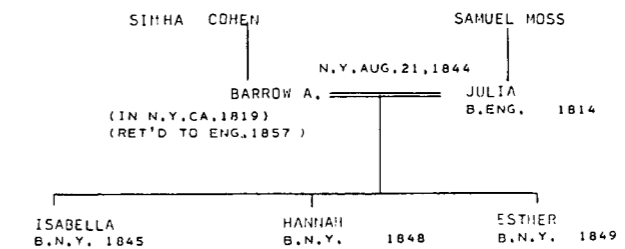

COLEMAN

DAR LINEAGE BOOKS  
FLORENCE ABRAHAMS  
R.S.MDH, REC.

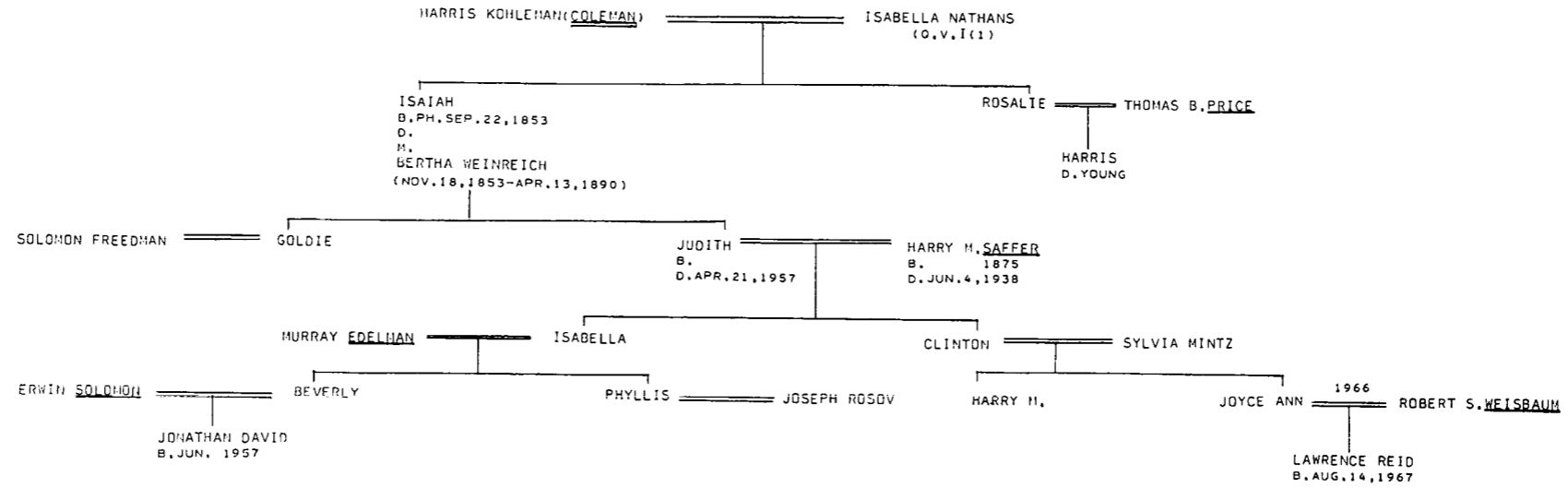

CONTENT

JON STEDMAN (1850 CENSUS)  
B'NAI JESH, REC.  
KRAUS-SANDOR COLL.  
DAVIS-HIST. OF R.S.  
SUPPLE GEN.  
OBIT. IN N.Y. TIMES 2/9/1944

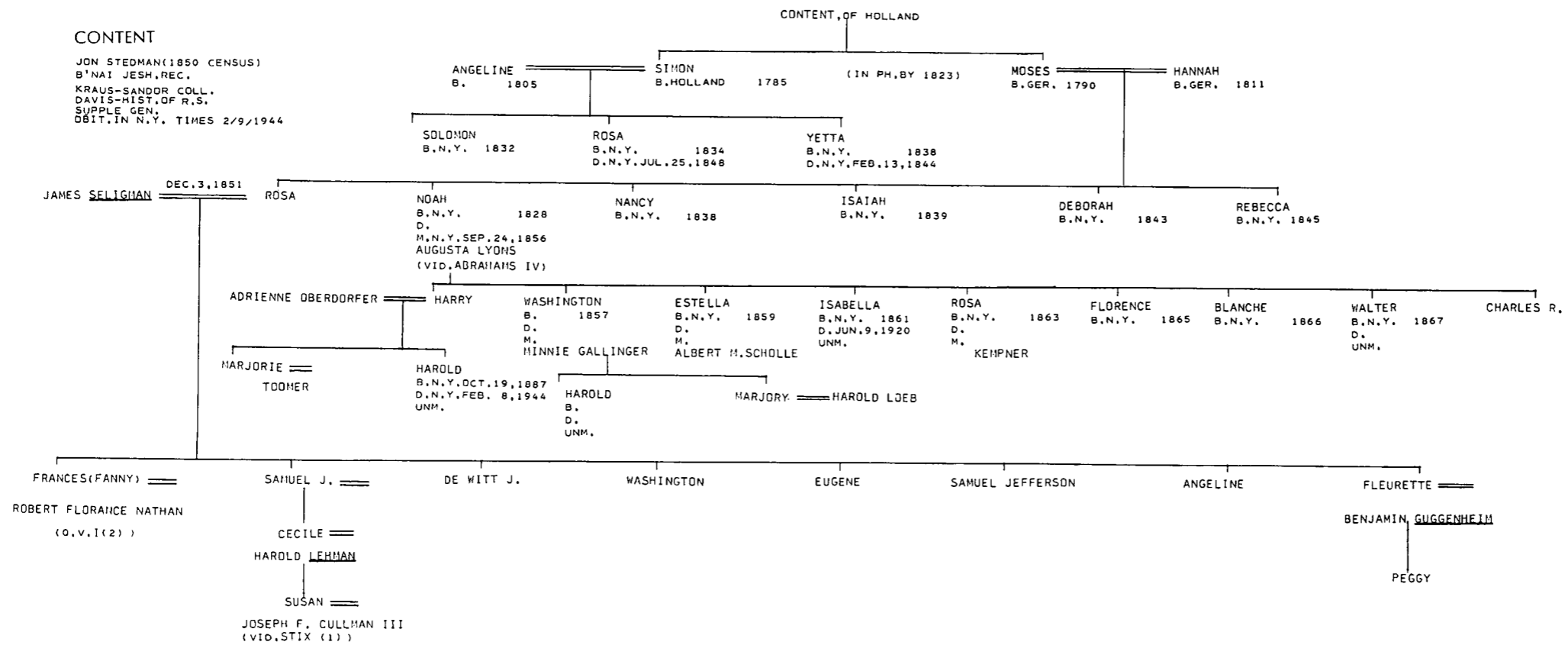

KORN N.O.  
 B'NAI JESH.REC.  
 DAVID J.SLENKER  
 JULIEN D.SAKS  
 KRAUS-SANDOR COLL.  
 MICKVE ISRAEL REC.  
 JRM COLLECTION  
 SHEARITH ISRAEL REC.  
 SPRUCE ST.CEM.  
 SAMUEL-YATES GEN.  
 FLORENCE ABRAHAMS  
 MYER SOLIS-COHEN

CROMELIEN (CROMLINE) (1)

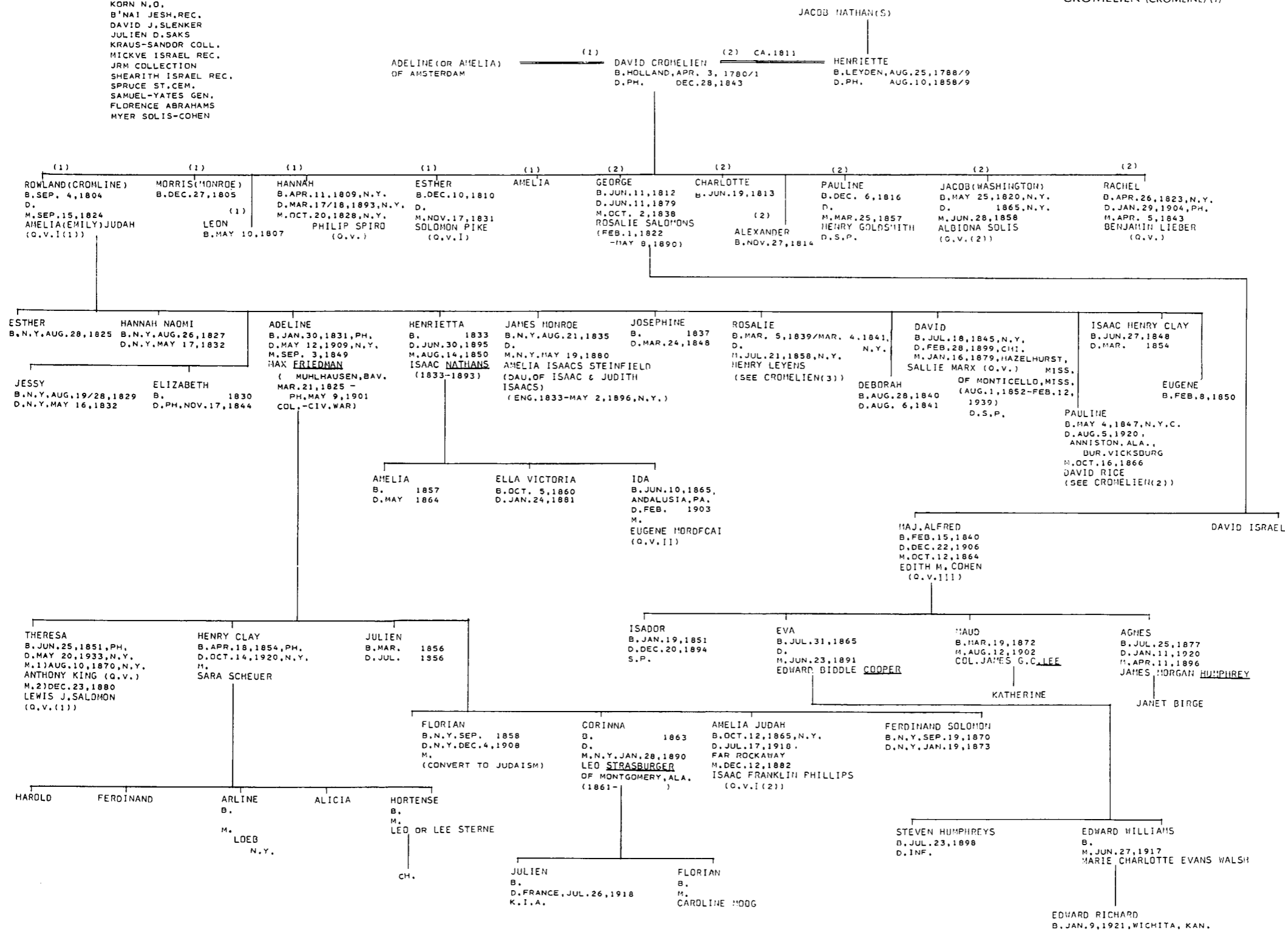



CROMELIEN (2)

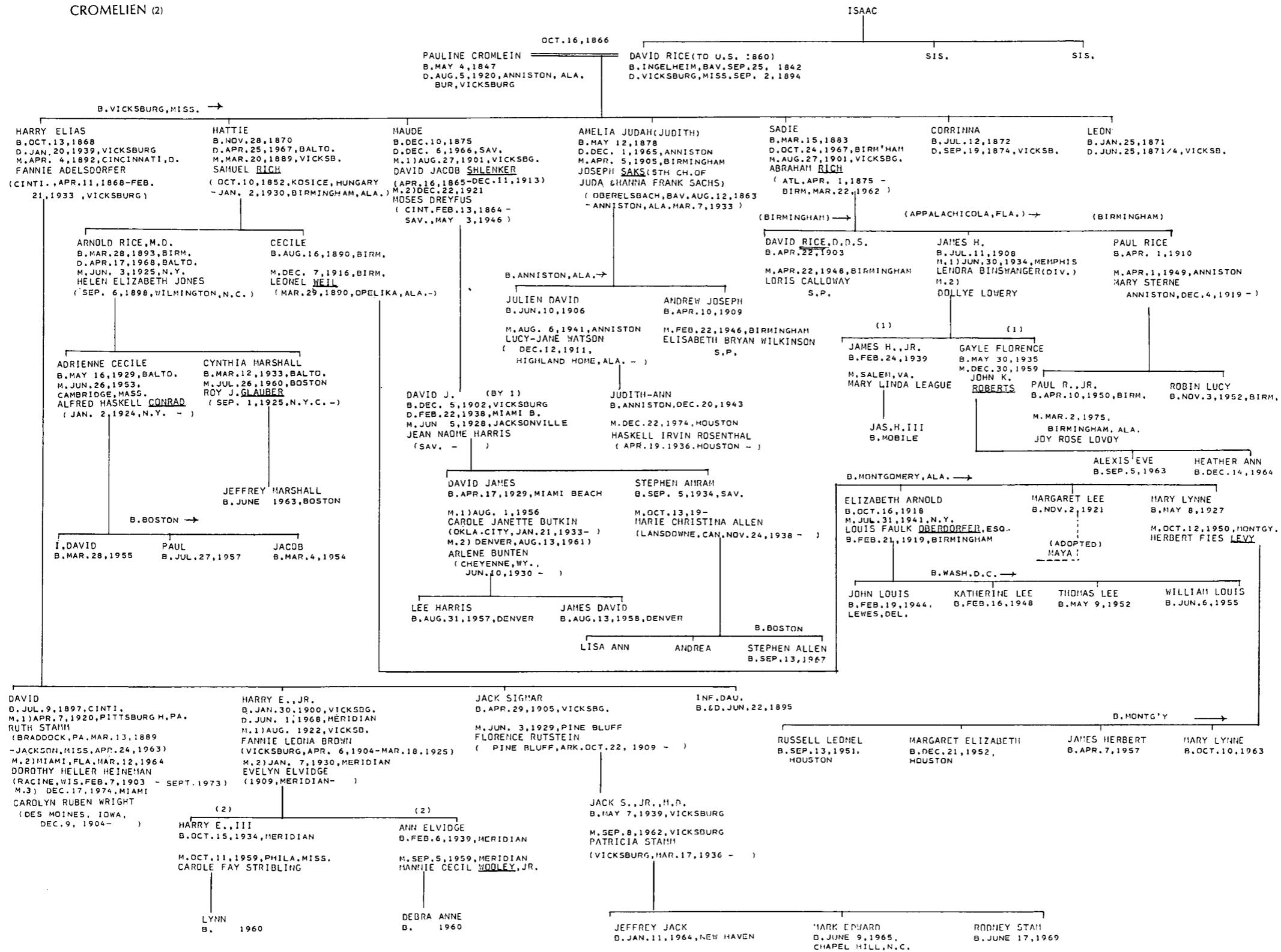

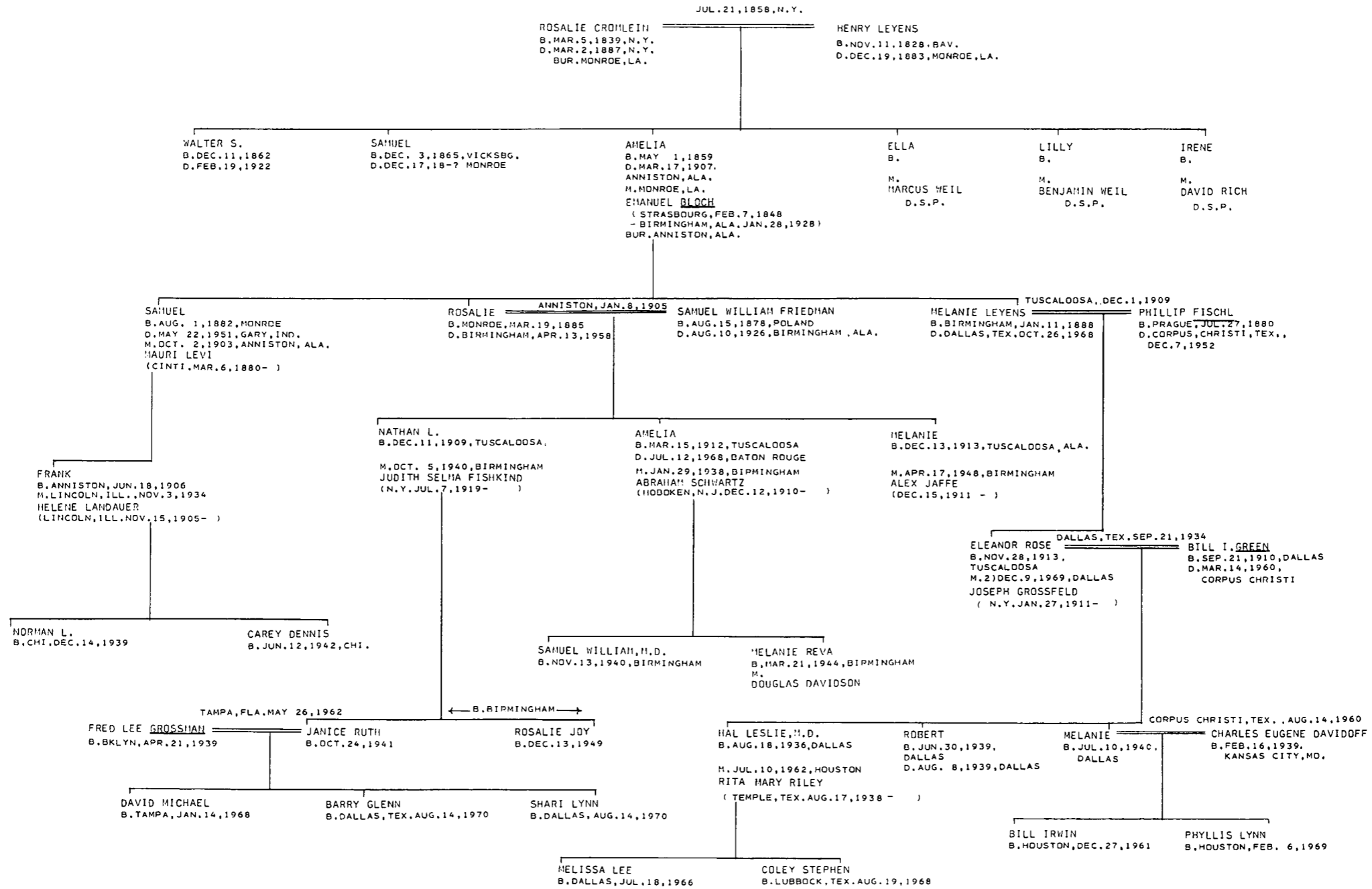

DA COSTA I

BEVIS MARKS REC.  
SHEFTALL MSS.  
PAJHS 19, PP. 51, 76  
38, P. 98F.  
KRAUS-SANDOR COLL.  
ANCKER DAR LINEAGE  
ELZAS-JEWS OF S.C., PT. 2, P. 54  
O.J.C.  
M.N.  
WILLS OF LEAH PIMENTA, SARAH  
DA COSTA, AND MOSES MOLINA  
U.S. 1790 CENSUS  
REZNIKOFF, P. 48  
A.J.D., PP. 51F., 439  
E.S. SALLEY-M.N.  
KORN-JEWS OF MOBILE. N.O.  
MISC. VI

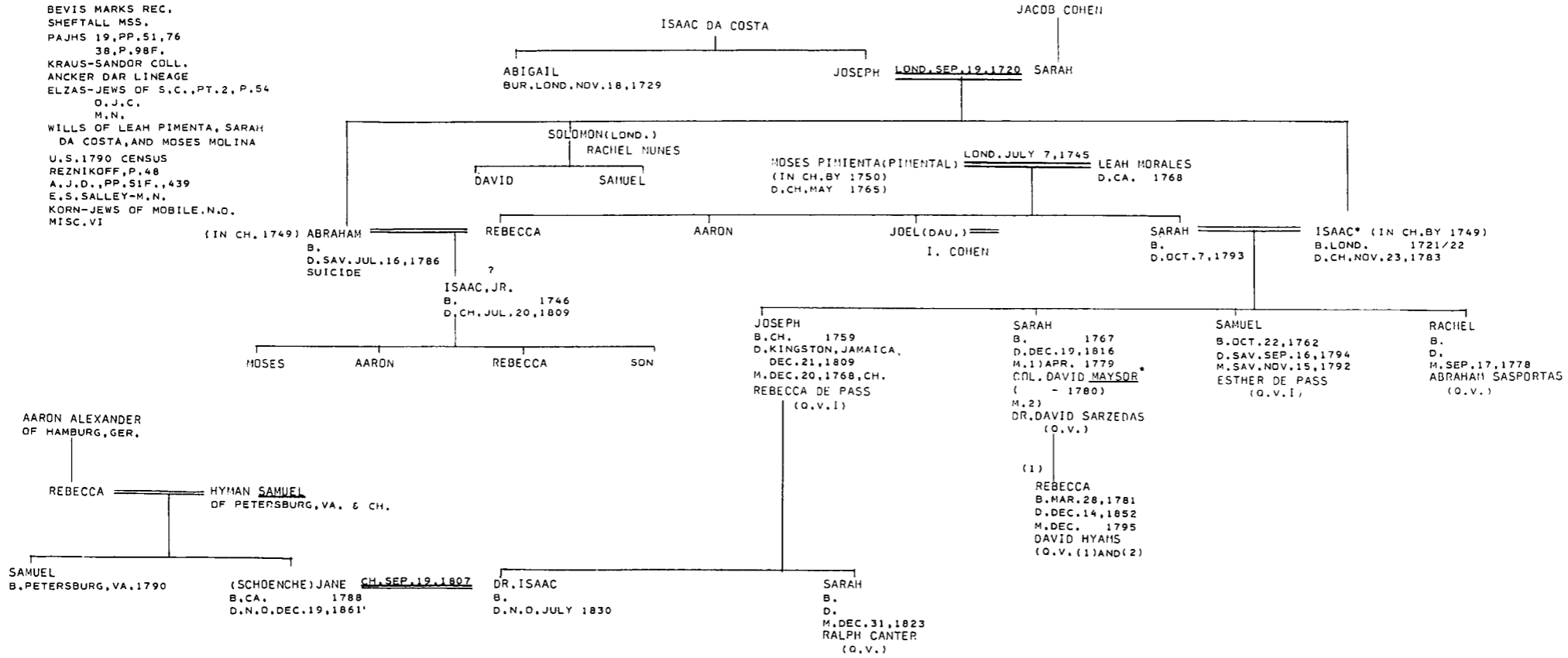

\*ESTABLISHED REVOLUTIONARY ANCESTOR

DA COSTA II

E. N. A.  
MRS. F. I. VANDERCOCK  
PAJHS 42, P. 278  
32, P. 56

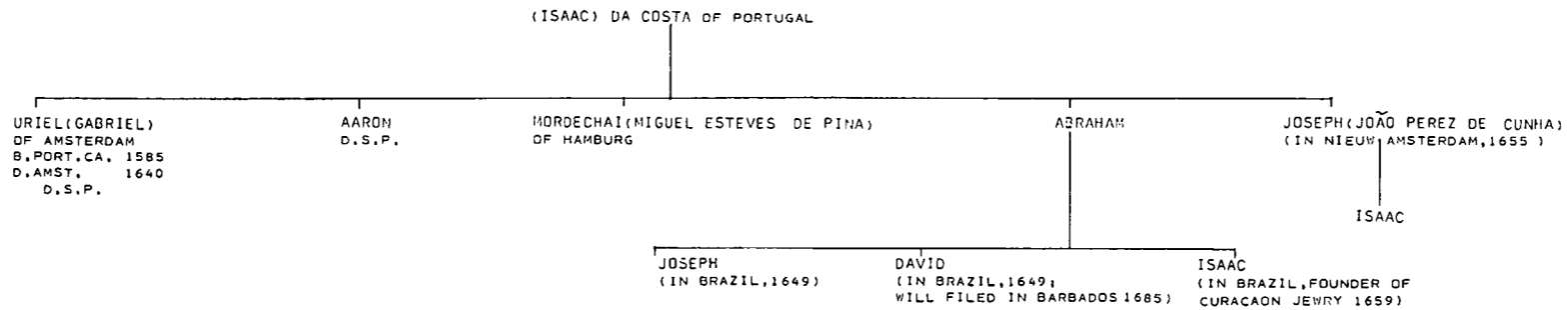

JRM COLL.  
ELZAS MSS.  
O.J.C.  
M.N.  
HAROLD MOISE

DAVEGA

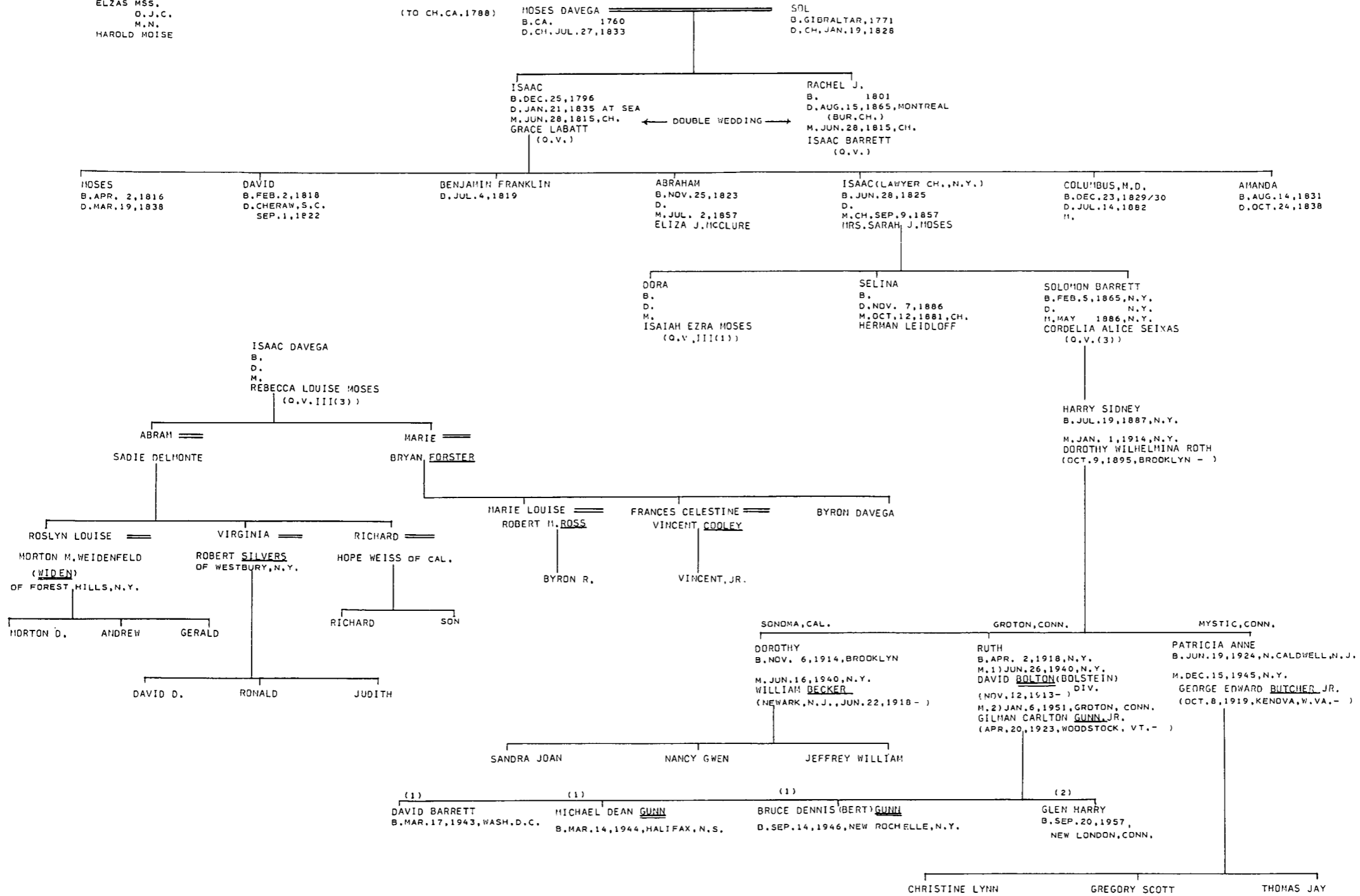

DAVID (1)

FLORENCE ABRAHAMS  
FEDERAL ST. CEM.  
MICH. JEW. HIST., JUN. 1963, P. 156F.  
MRS. E. MILLER  
KRAUS-SANDOR COLL.  
JR MARCUS COLL.  
ELZAS HSS.  
MALCHELOSSE-JUIFS CANADIENNE  
SHEARITH ISRAEL REC.  
HART FAMILY REC. (MS. A. J.)  
ABRAHAM JOSEPH DIARY

EZEKIEL SAMUEL OF R. I.

(IN MONTREAL BY 1763)

LAZARUS DAVID  
(FLEAZER B. DAVID)  
B. SHANSEA, WALES, 1734  
D. MONTREAL, OCT. 22, 1776

R. I. 1761

PHOEBE SAMUEL  
B. ARNHICK, ENG. 1736/7  
D. MONTREAL, OCT. 10, 1786

(WINDSOR, ONT.)



DAVID (2)

CAPT. CHARLES WALKER

COL. ELEAZAR DAVID  
B. JUN. 8, 1811  
D.  
(ABOVE)

ELIZA LOCK WALKER  
B. 1811/2  
D. FEB. 1, 1887, COATICOOK, P. O.

MAJ. HARRIS

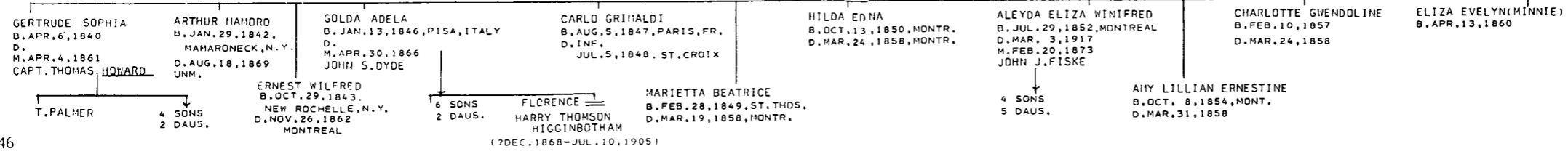

B'NAI JESH, REC.  
JON STEDMAN  
KRAUS-SANDOR COLL.  
SHEARITH ISRAEL REC.  
KORN N.O.

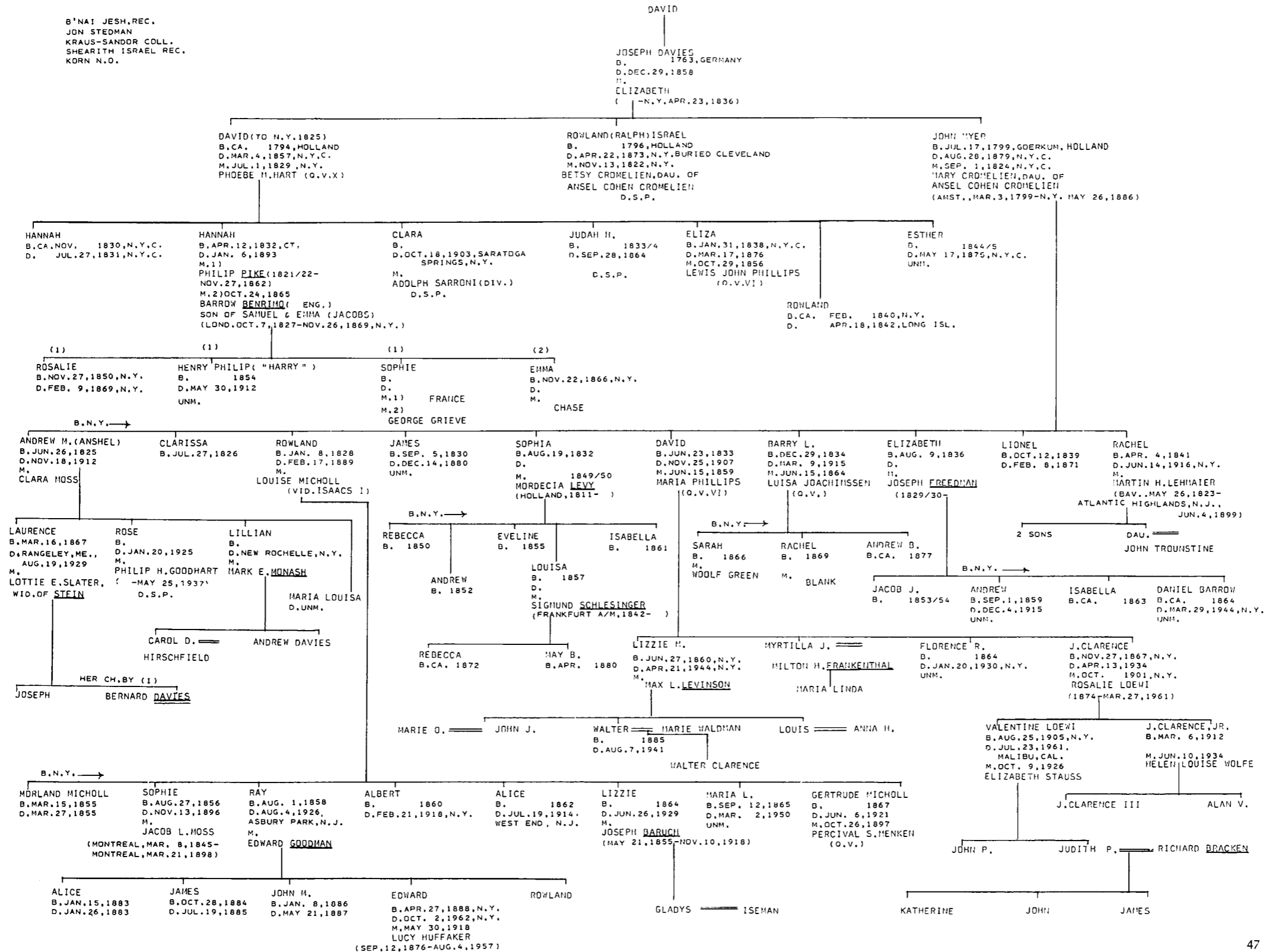

DAVIS I (1) (VA.)

BETH SHALOME KET.  
BETH AHABAH KET.  
EDGAR M. KAHN  
MAXWELL WHITEMAN  
PAJHS 33, P. 6  
KRAUS-SANDOR COLL.  
FLORENCE ABRAHAMS

JON STEDMAN (1850 CENSUS)  
E.-L. P. 290F.  
AMY STEWART MSS. (AJA)  
MARKS FAMILY REC. (AJA)  
B'NAI JESH. REC.

FAMILY HIST. OF BENJAMIN MORDECAI (AJA)  
ELZAS MSS.  
M.N.  
SHEARITH ISRAEL REC.  
HAROLD MOISE  
SUMTER CEM.

DAVID DAVIS  
B. LOND. 1750/65  
D. 1833

ESTHER MORDECAI  
B. 1744  
D. JULY 26, 1844

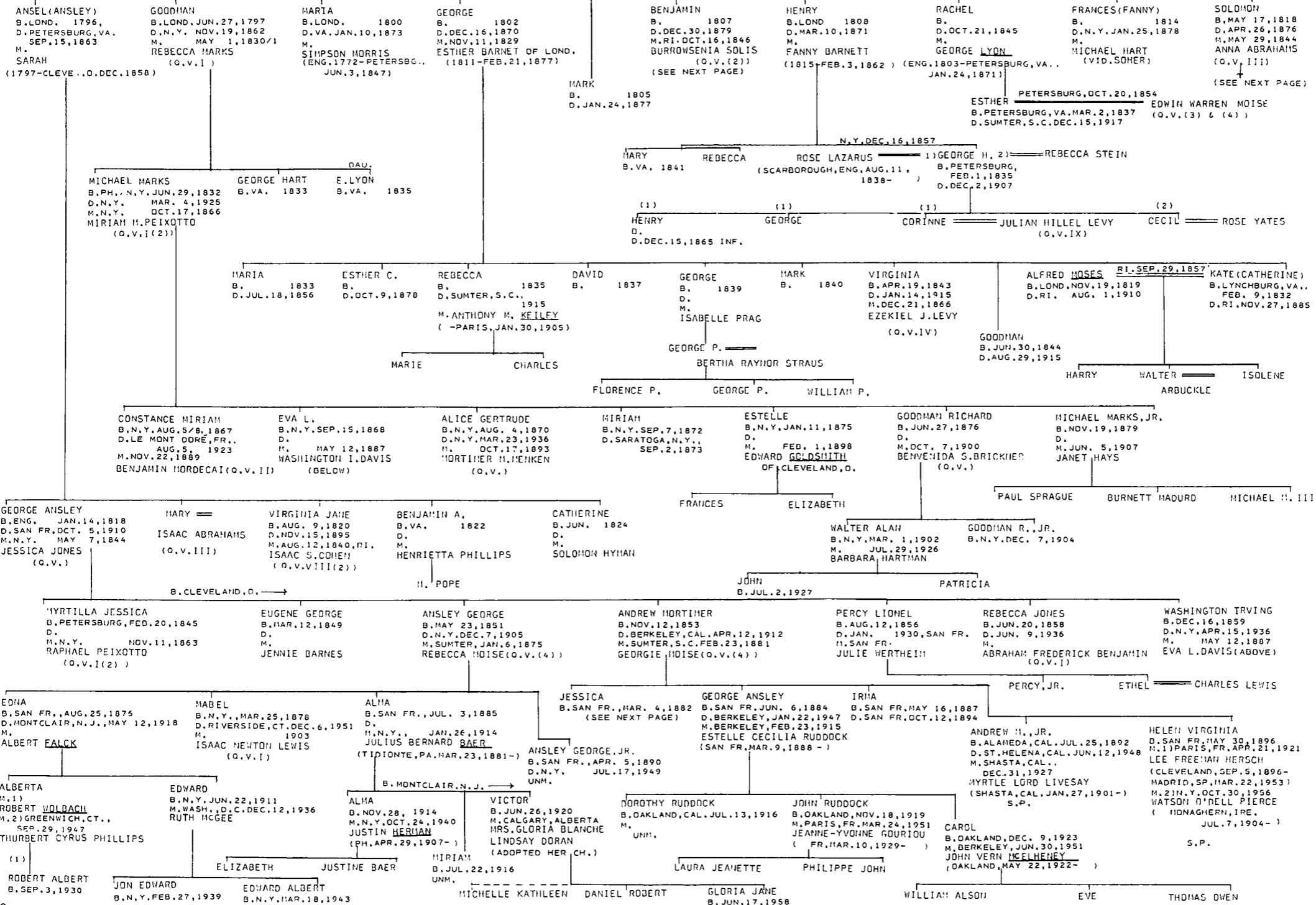

DAVIS I (2)

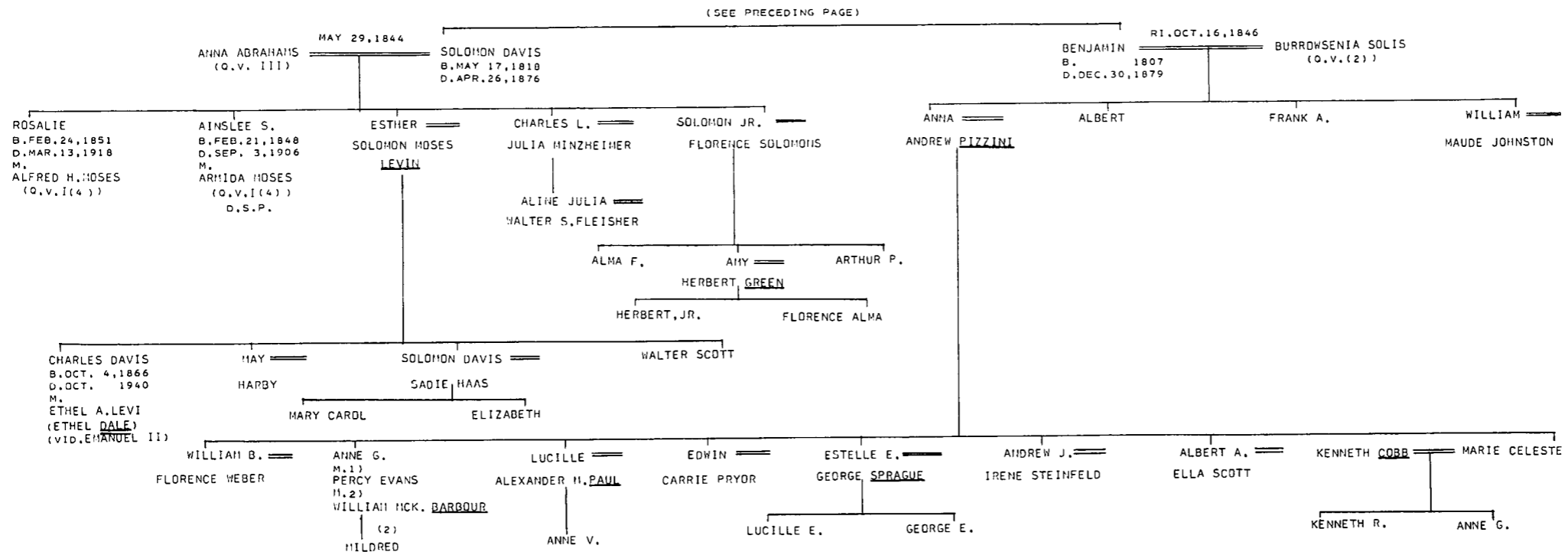

DAVIS I (3)

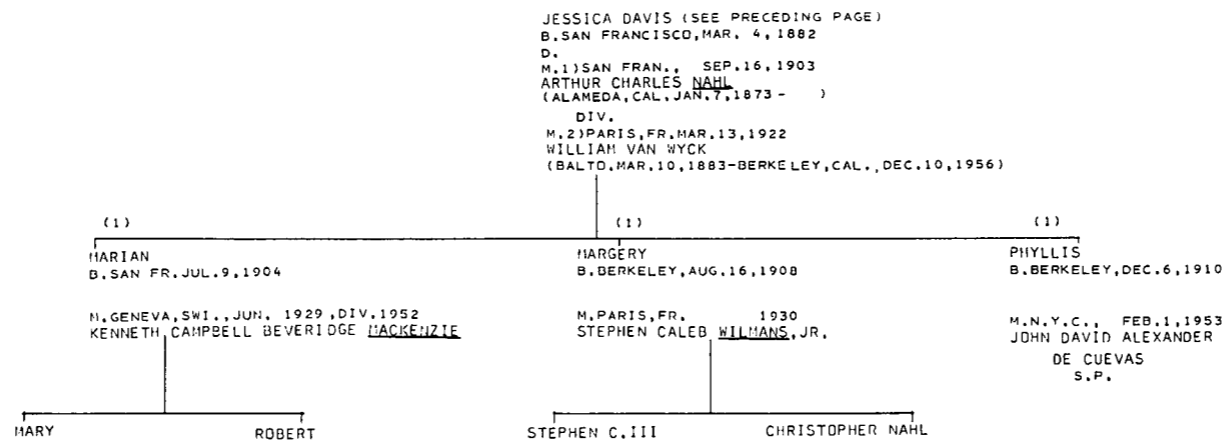



DAVIS II

JON STEDMAN

BENJAMIN DAVIDS (PRAGER)  
(IN N.Y. BY 1816)

SARAH  
B. CA. 1750  
D. APR. 10, 1835, N.Y.

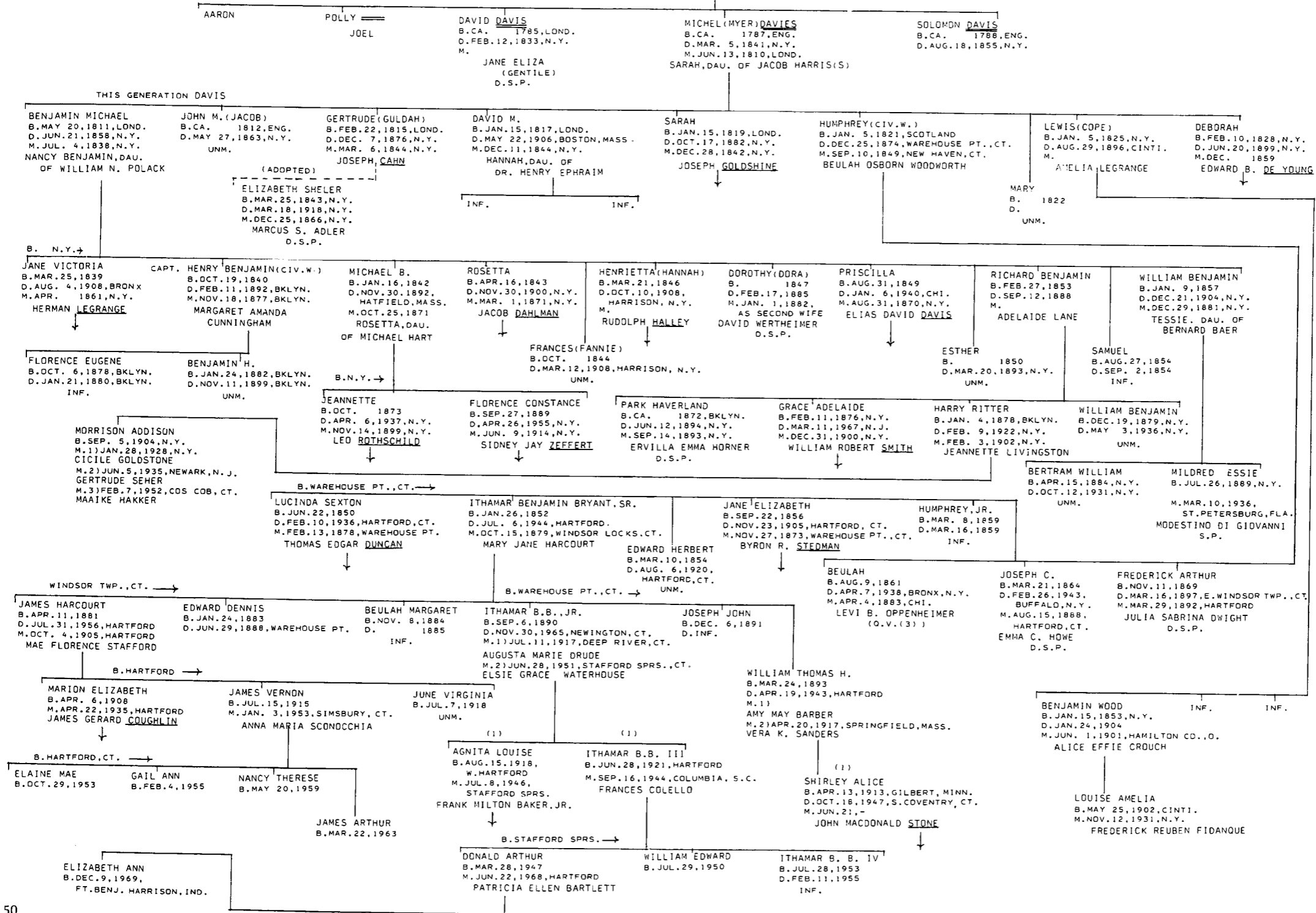

COHEN D'AZEVEDO

BEVIS MARKS KET.  
PICCIOTTO  
ELZAS O.J.C.  
ST.THOS.REC.  
WILL OF RACHEL(SALOM)C.DAZEVEDO  
SHILSTONE  
MRS.HARRY COHN REC.  
FLO. ABR.  
PAJMS V.19,197F.  
S.C.MARR. CONVEYANCES  
FEDERAL ST.CEN.

DANIEL COHEN D'AZEVEDO  
HAHAM MOSES (OF LONDON)  
B.HOLLAND, 1720  
D.LOND.SEP. 1784  
M.1)LOND.NOV.12,1749  
SARA DE HAHAM MOSES GOMES DE MESQUITA  
M.2)LOND.FEB.23,1758  
SARA DE ABRAHAM HENRIQUES FARRO

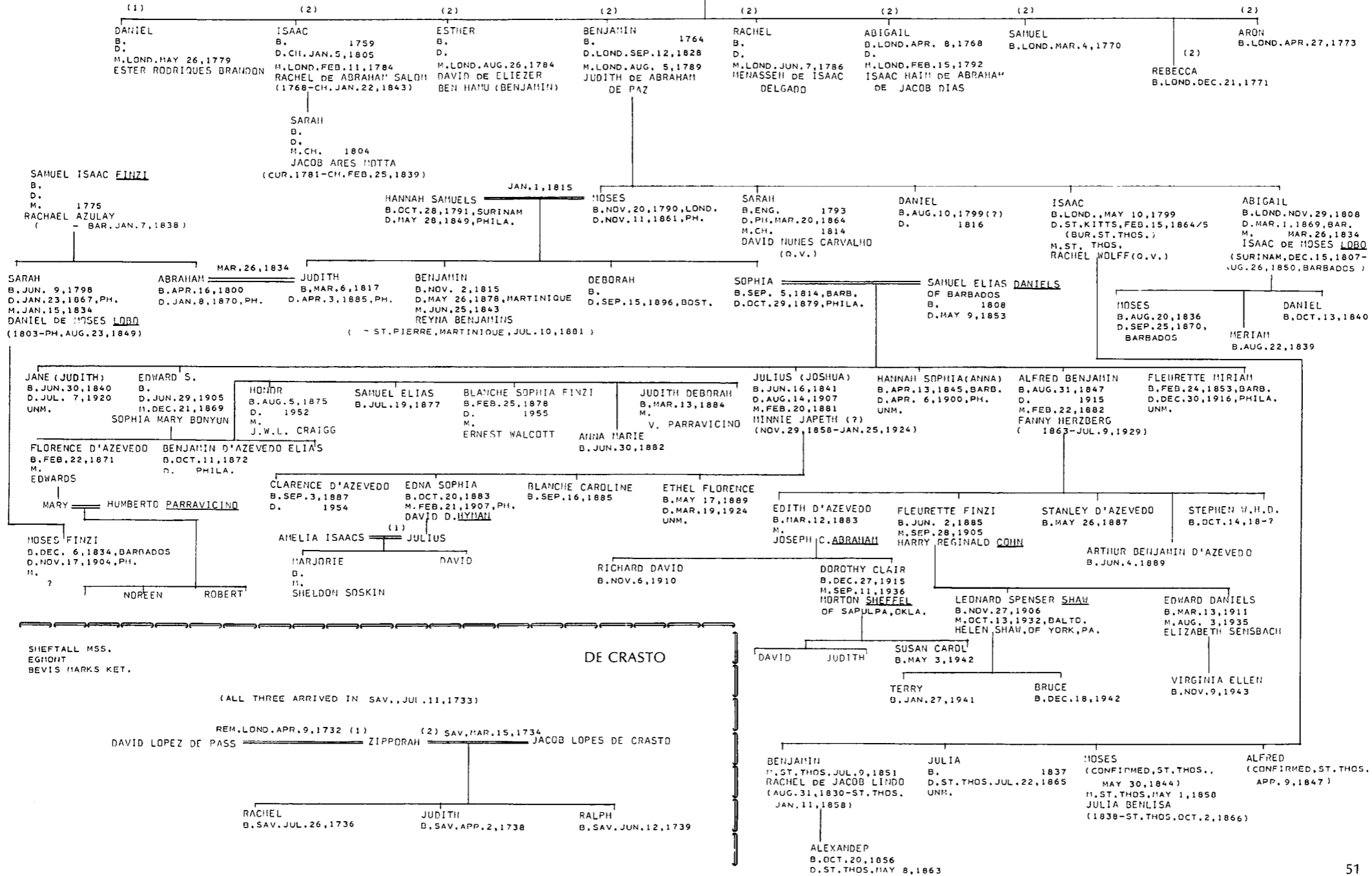

DE CORDOVA (1)

JON STEDMAN  
AJA, XVIII, 141F.  
ENA  
MORAIS-JEWS OF PH.  
DAVIS-RODEPH SHALOM  
FLD. ADR.  
COHEN-100 YEARS OF JEWRY  
IN TEXAS  
W.W.  
BEVIS MARKS KET.  
ANDRADE - JEWS OF JAMAICA

ISAAC DE CORDOVA (OF CONSTANTINOPLE)

MOSES RAPHAEL (CONSTANTINOPLE TO AMST., CA. 1641)  
B.  
D. AMST. 1649

JACOB HAIM (IN BRAZIL)  
D. AMST. 1712/14

LOND., APR. 5, 1702

ABRAHAM SIMHA ISAAC HEZEKIAH RAHEL DE JACOB DIAS ARIAS

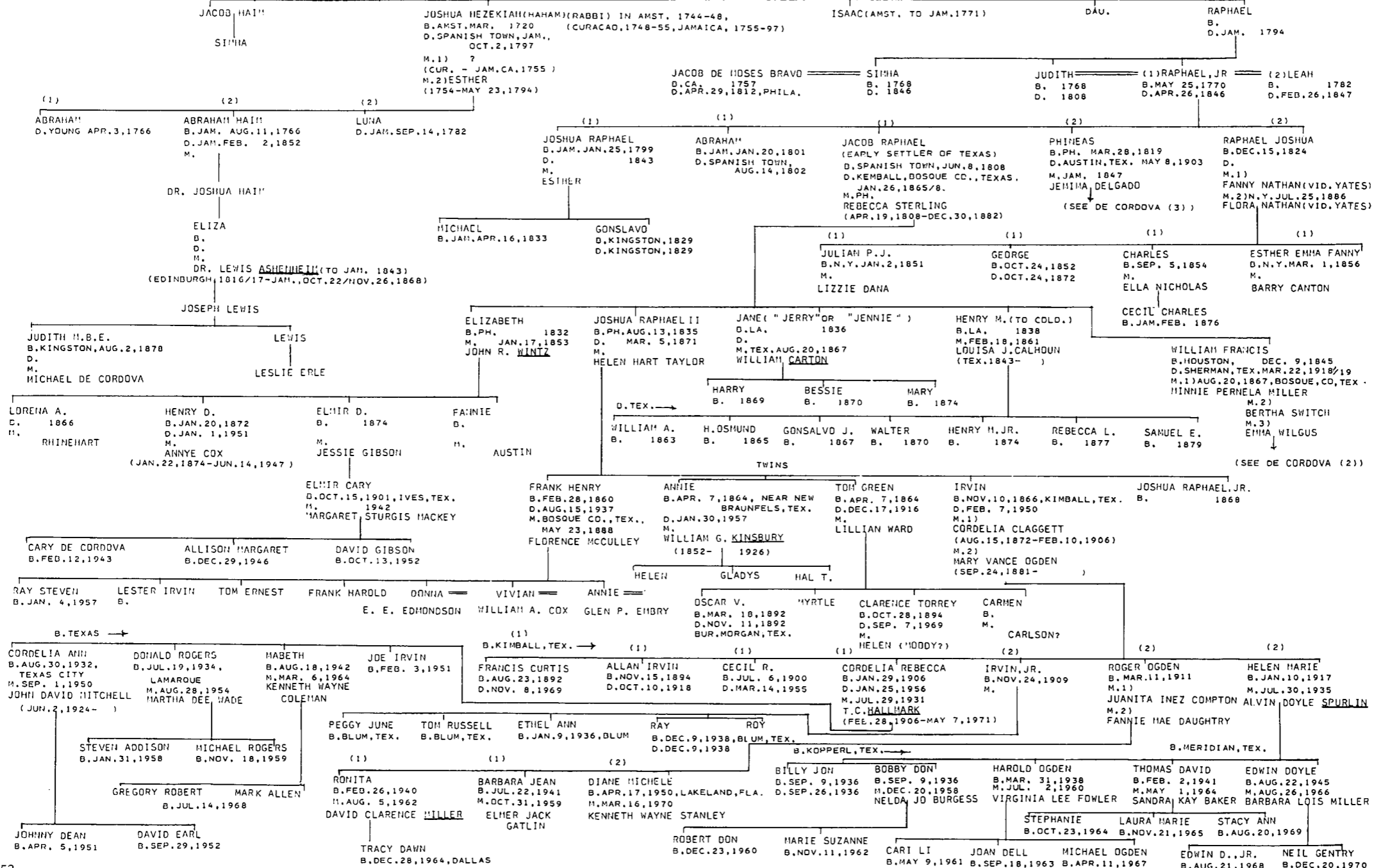

DE CORDOVA (2)

(SEE PRECEDING PAGE)

WILLIAM FRANCIS DE CORDOVA  
 B. HOUSTON, TEX., DEC. 9, 1845  
 D. SHERMAN, TEX., MAR. 22, 1918/9 (BUR. TISHIHINGO, OKLA.)  
 M. 1) BOSQUE CO., TEX., AUG. 20, 1867  
 MINNIE PERNELA MILLER  
 M. 2)  
 BERTHA SWITCH  
 M. 3)  
 EMMA WILGUS

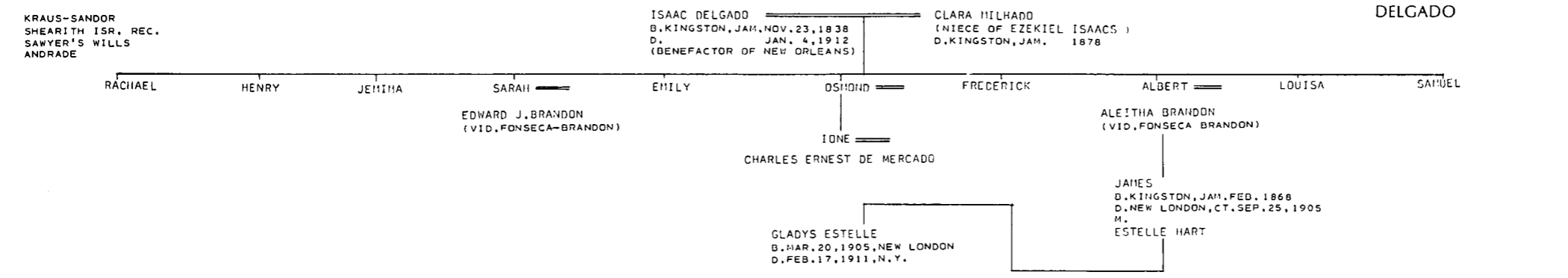
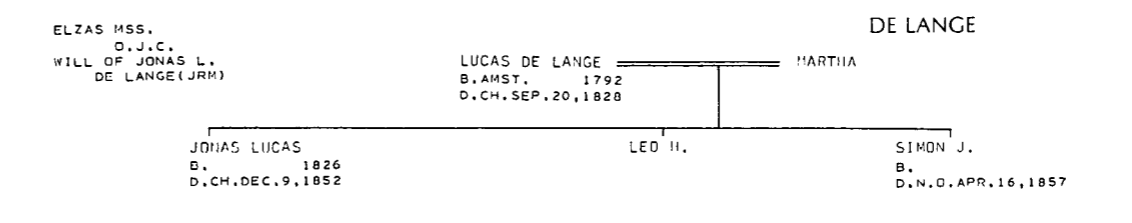
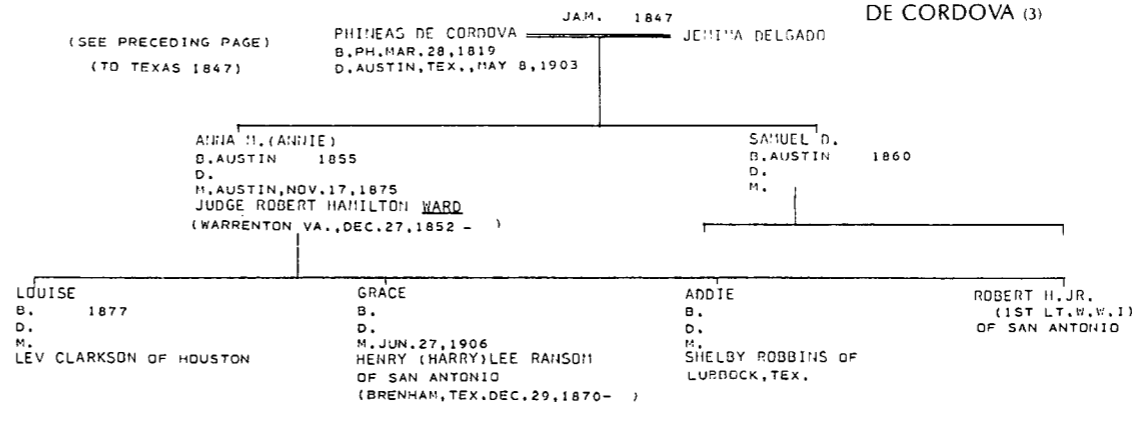
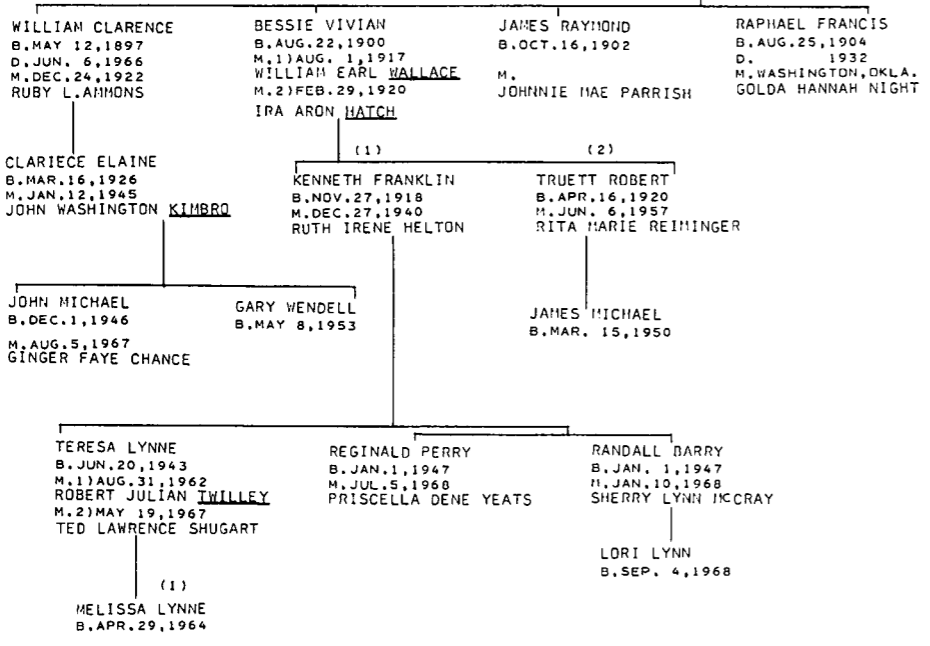
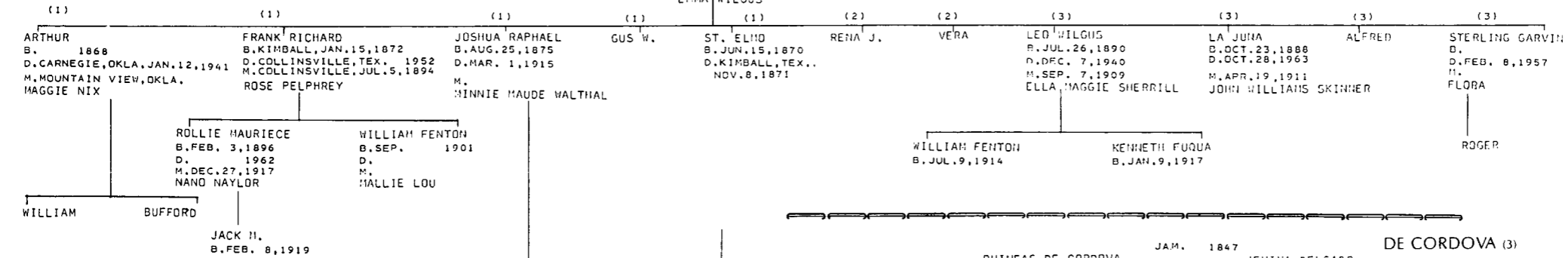

DE LA MOTTA

KRAUS-SANDOR  
PAJHS V.19,PP.80,83  
ELZAS MSS.  
D.J.C.  
M.N.

RAISIN MSS.(PHOTOSTAT AJA)  
SHEARITH ISRAEL REC.  
WILLS OF (ISA)BELLA L. PHILLIPS,  
RACHEL DE LA MOTTA

ENA  
GA. NEWSP.  
ROSENWAIKE  
LAZARUS GEN.(T.J.TOBIAS)  
SHEFTALL  
BARBER-N.Y.MARR.  
JOHN SHEFTALL

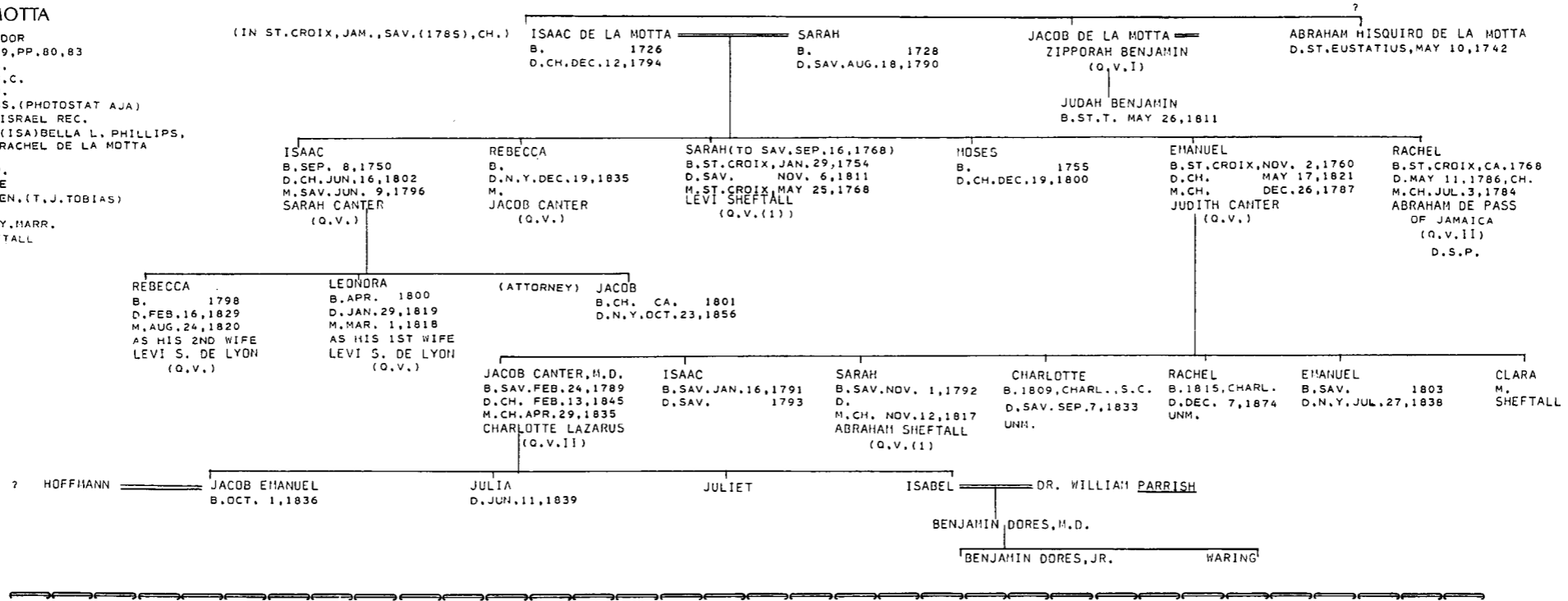

DELMAR

SHEARITH ISRAEL REC.  
U.S.CENSUS, 1850  
B'NAI JESHURUN  
PAJHS V.27,P.111  
ANDRADE-JAMAICA, P.56

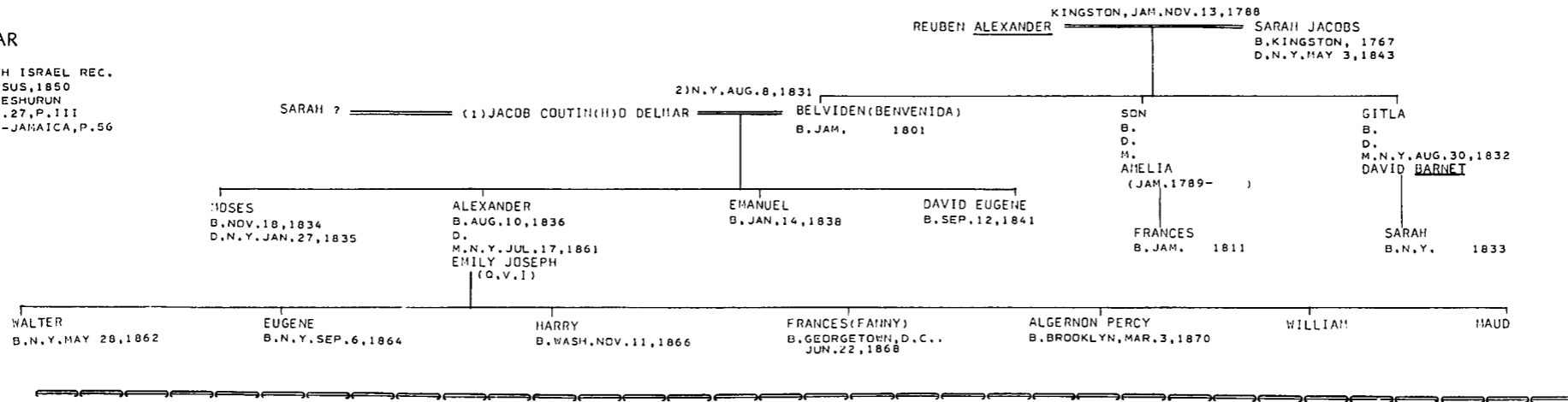

DE LEDESMA

SH.  
EGMONT  
BEVIS MARKS KET.

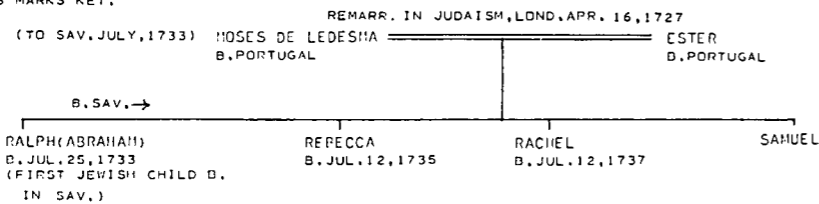

DE MOLINA

SH.  
EGMONT  
BEVIS MARKS KET.

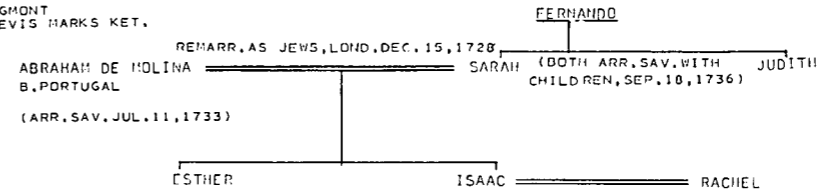

ANDRADE  
 ABBOT LOW MOFFAT  
 MOISE-JEW, CEM. AT SUMTER  
 ALICE LANDRUM  
 PAJHS V.19, P.81  
 PAJHS V.27, P.286  
 UJE V.3, P.498F.  
 KRAUS-SANDOR COLL.  
 ABRAHAM DE JACOB DE LEON BIBLE(AJA)  
 PERRY DE LEON FAMILY REC.(AJA)  
 ST.CHARLES, P.133F.  
 ELZAS MSS.  
 CHATHAM CO., GA. MILLS  
 ELZAS M.H.  
 ELZAS O.J.C.  
 MICKVE ISRAEL REC.  
 HENDRICKS GEN.  
 SHEARITH ISRAEL REC.  
 FED.ST.CEM.  
 S.C.MARR, CONVEYANCES  
 XIV, 296  
 B'NAI JESHURUN  
 MOISE FAMILY

JACOB DE LEON  
PROBABLY OF AMSTERDAM

DE LEON (1)

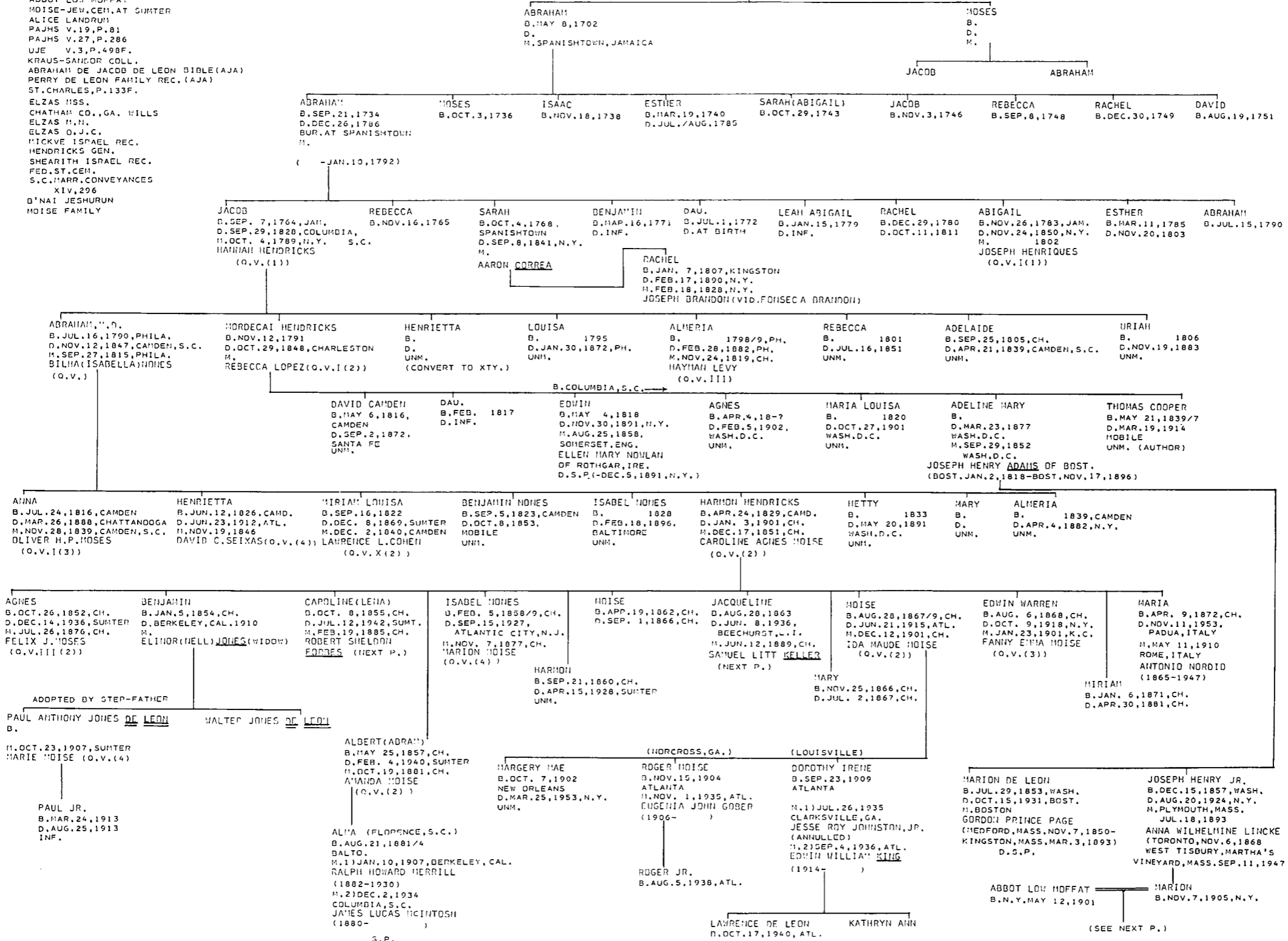

DE LEON I (2)

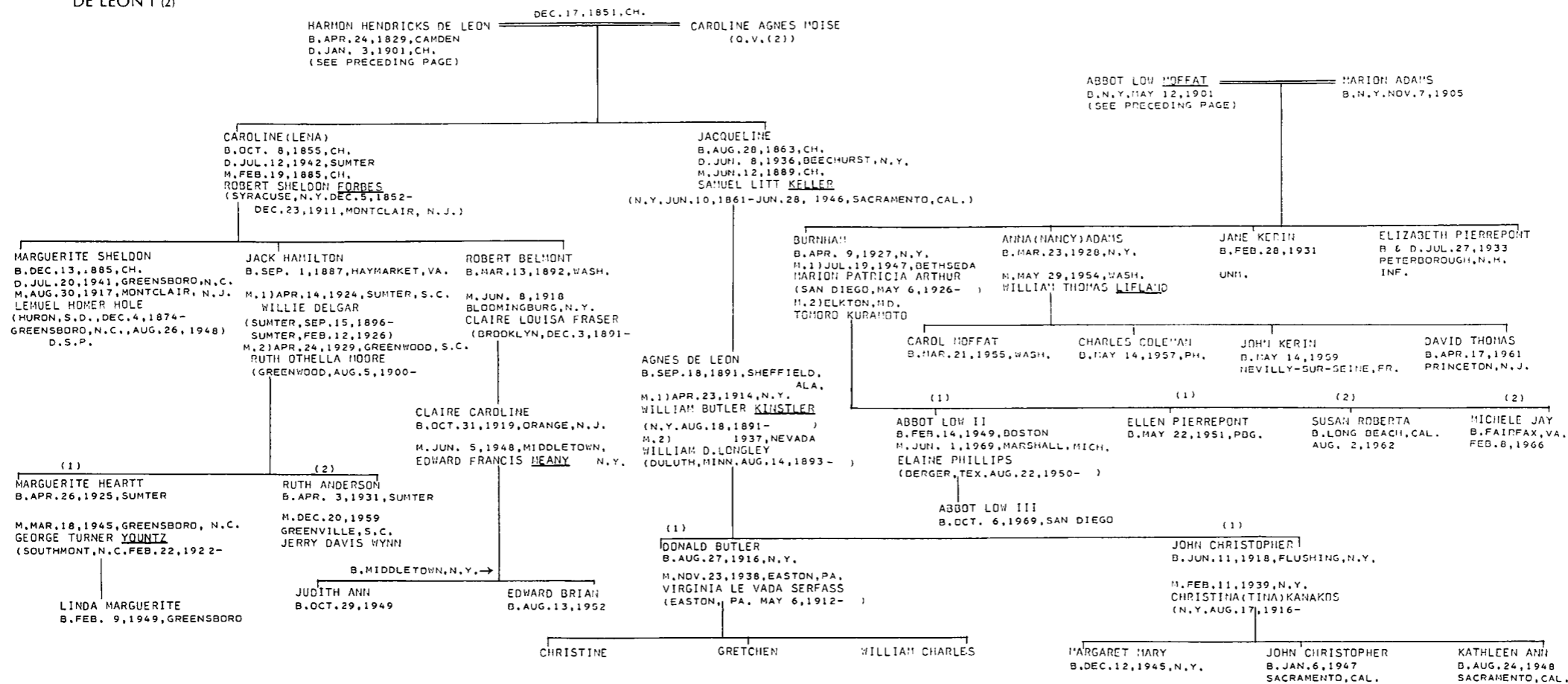

DE LEON II

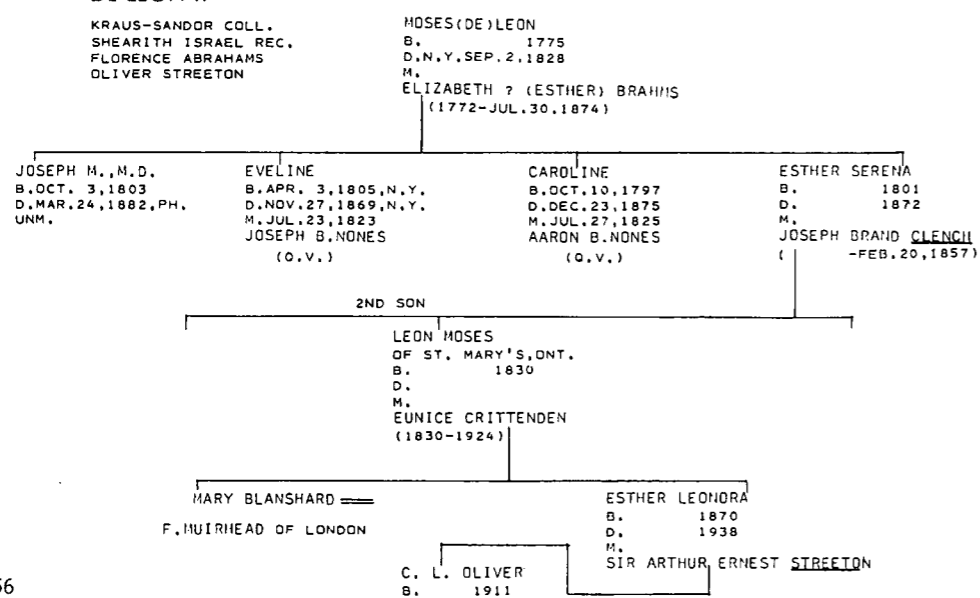

PAJHS V. 6, P. 126  
PAJHS V. 23, P. 150  
ST. CHARLES  
GOLDSTONE GEN.  
HENDRICKS GEN.  
OPPENHEIM COLL. (AJHS)  
POOL-PORTRAITS ..  
AM. JEW. ARCHIVES, V. 1, #2, P. 3  
WILL OF ABR. H. AJHQ LV/345

DE LUCENA

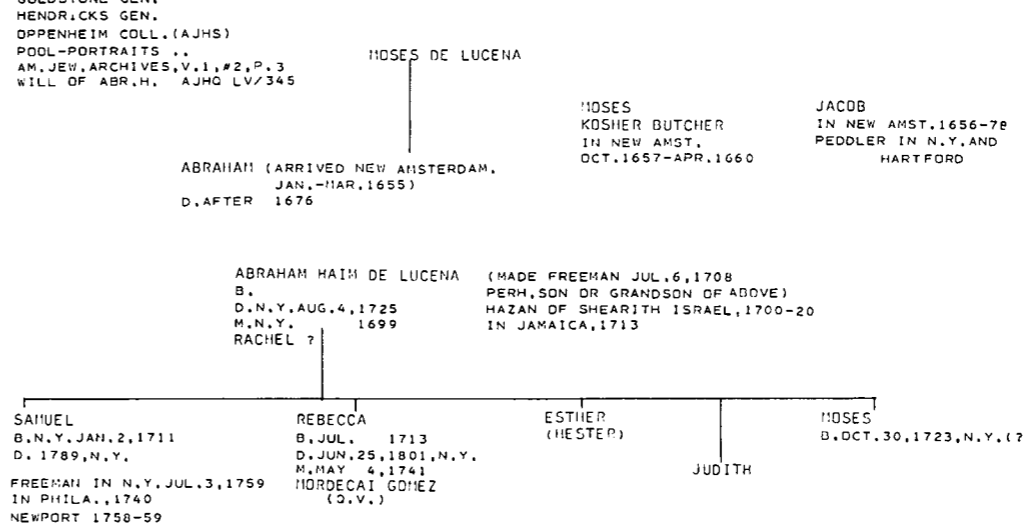

SHEFTALL  
BEVIS MARKS KET. #508  
COHEN-100 YEARS OF JEWRY IN TEXAS  
J.R. COHEN REC.  
MISC. VII 357  
S.C. HARR. CONVEYANCES  
GA. NEWSPAPER VITAL REC.  
JOHN SHEFTALL  
WILL OF SARAH DE LA MOTTA  
ELZAS OJC  
B'NAI JESHURUN

ABRAHAM DE LYON (LEAD) (ARR. SAV. JUL. 11, 1733)  
B. PORTUGAL (NAT. N.Y. OCT. 23, 1741)  
D. BEF. 1761  
M. LOND. JUN. 5, 1732  
ESTHER (MUNEZ (O.V.))

DE LYON

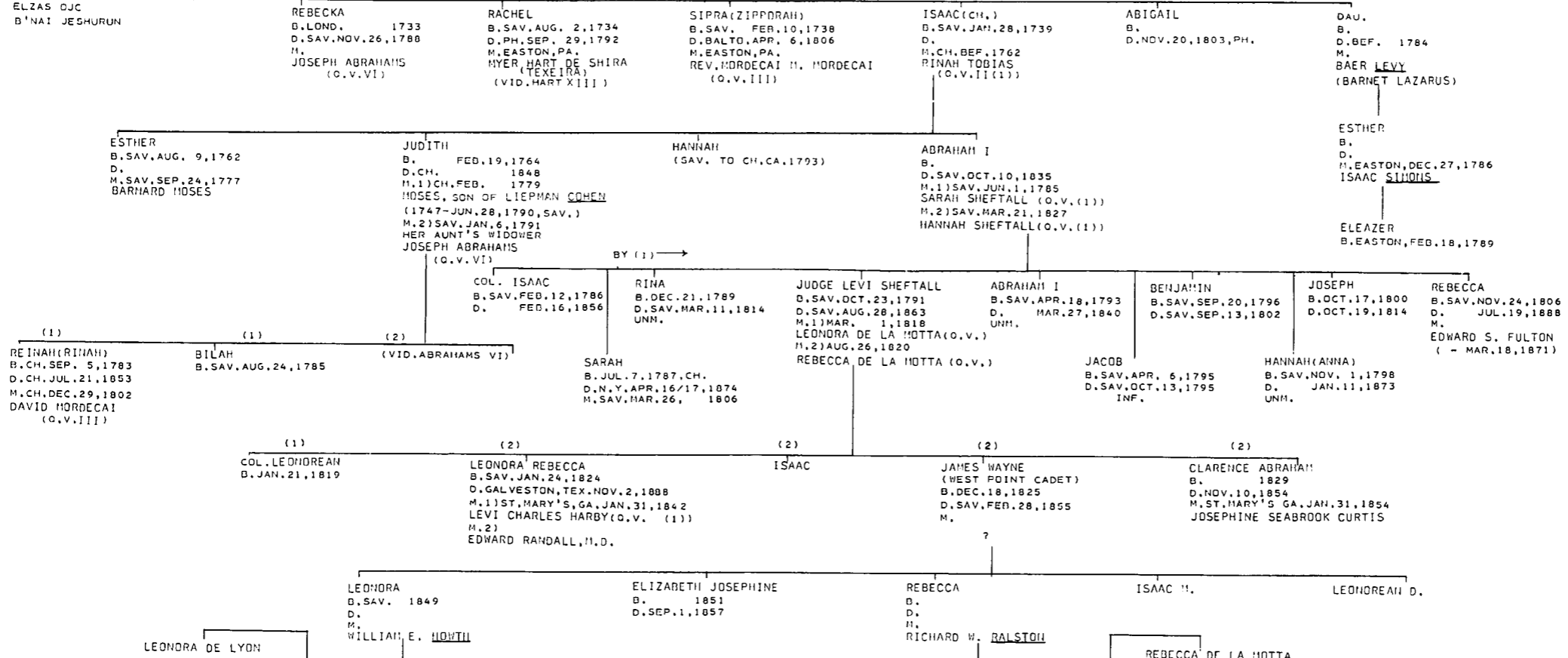

KRAUS-SANDOR COLL.  
PAJHS, V. 23, P. 149  
POOL PORTRAITS, ...  
PAJHS, V. 5, P. 69  
PAJHS, V. 42, P. 277F.  
TRANSACT JHSE, V. 13, P. 14  
WILL OF JOSEPH, AJHO LV/331

BENJAMIN BUENO DE MESQUITA  
B. D. N.Y. 1683  
M. SARAH ?  
(- N.Y. OCT. 24, 1708)

1649-IN BRAZIL  
1660-65-IN JAMAICA  
1665-BANISHED WITH HIS TWO SONS  
1679-IN BARBADOS

BUENO DE MESQUITA

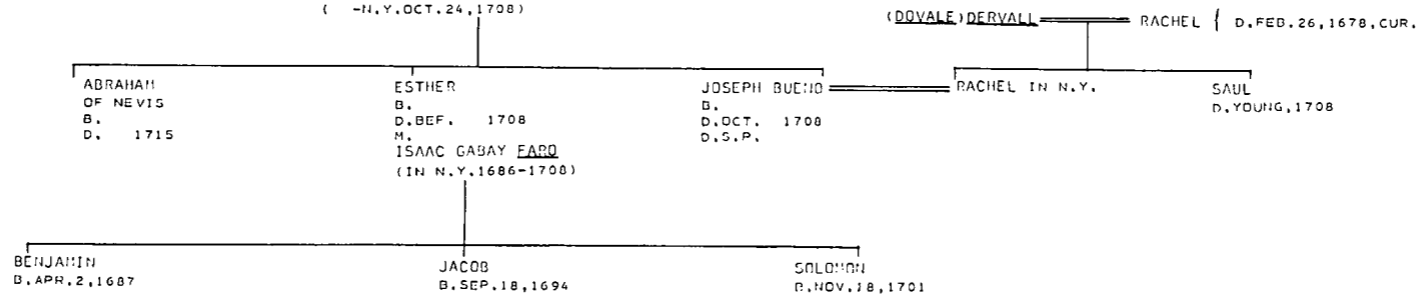



DE PASS I

KRAUS-SANDOR COLL.  
KIRKLAND-KENNEDY-HISTORIC  
CAMDEN(S.C.)  
KENDALL-HIST.OF NEW ORLEANS  
ELZAS-O.J.C.  
M.N.  
MSS.  
H.A.ALEXANDER-ALEXANDER FAMILY

DE PASS(PAZ)OF BORDEAUX

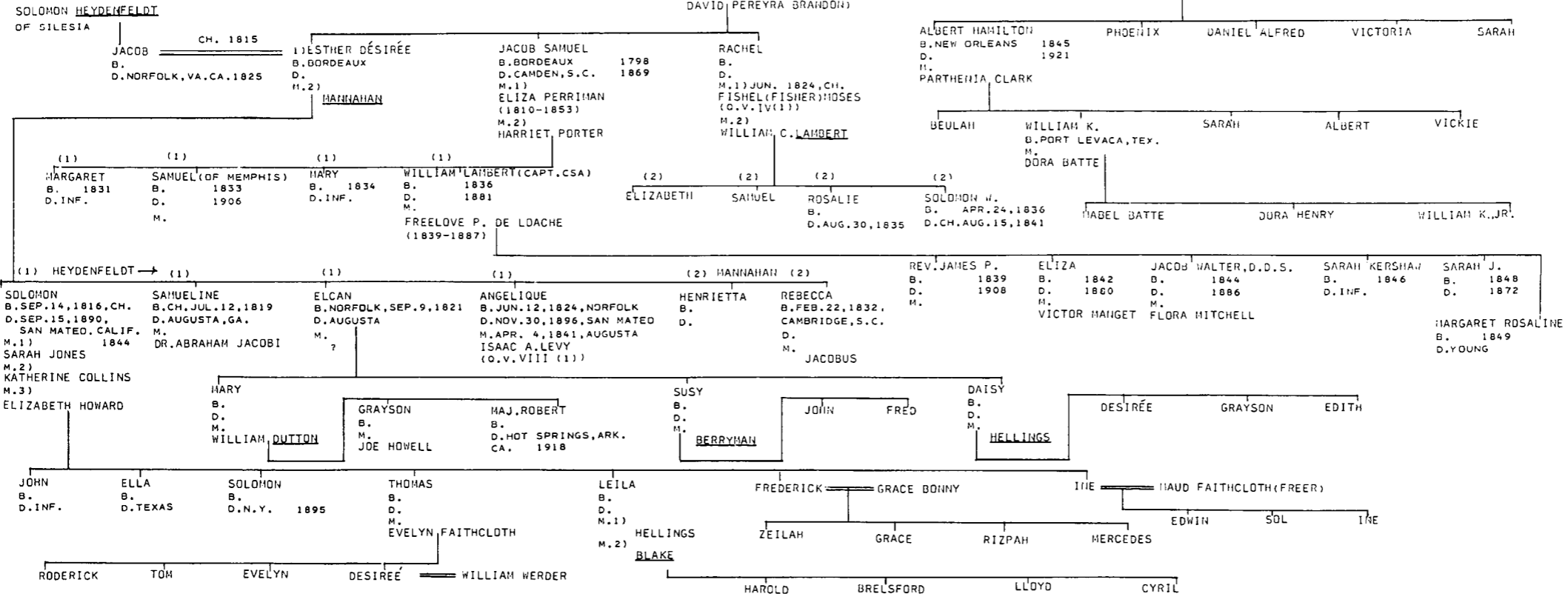

DE PASS II

SHEFTALL  
CLEMENS-N. & S.C. MARR. REC.  
ELZAS MN  
MSS.  
KRAUS-SANDOR COLL.  
ROSENWAIKE  
GA. NEWSPAPER VITAL REC.  
FLD. ABR.  
BEVIS MARKS KET.  
MISC. VI (JHSE)

ABRAHAM ALVAREZ DE PASS

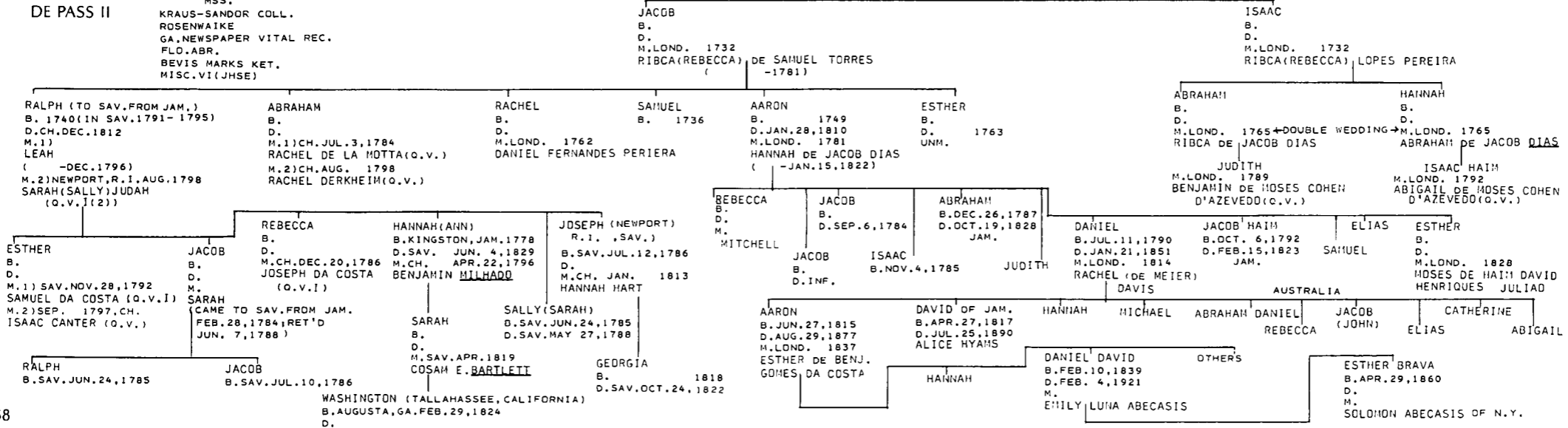

PAJHS, V. 6, P. 109F  
 EZEKIEL-LICHTENSTEIN-JEWS  
 OF RICHMOND, P. 32F.  
 ELZAS-M. N. P. 7  
 MICKVE ISRAEL REC.  
 J. R. COHEN REC.  
 ROSENSWAIKE

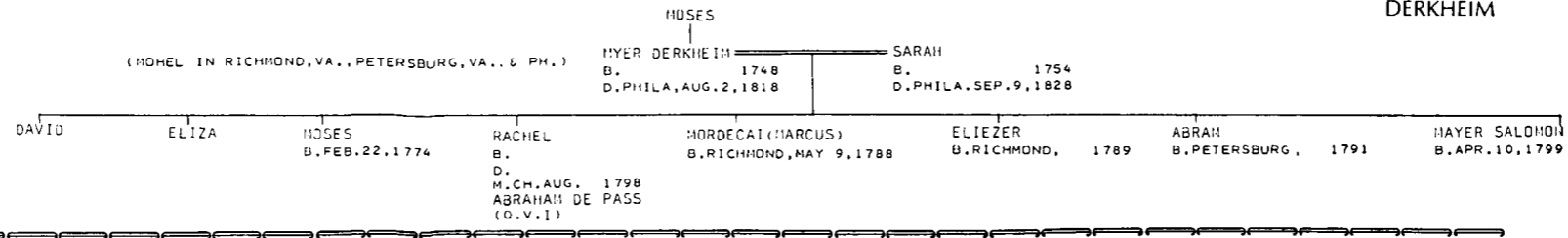

H. PEREIRA MENDES: A BIOG. (N. Y. 1938)  
 KRAUS-SANDOR COLL.  
 UJE V. 3, P. 500  
 JE V. 11, P. 430F.  
 PAJHS V. 23, P. 180F  
 SHEARITH ISRAEL REC.  
 BEVIS MARKS REC.  
 WHO'S WHO IN AMERICA, 1952-53  
 ANITA STEINBERG

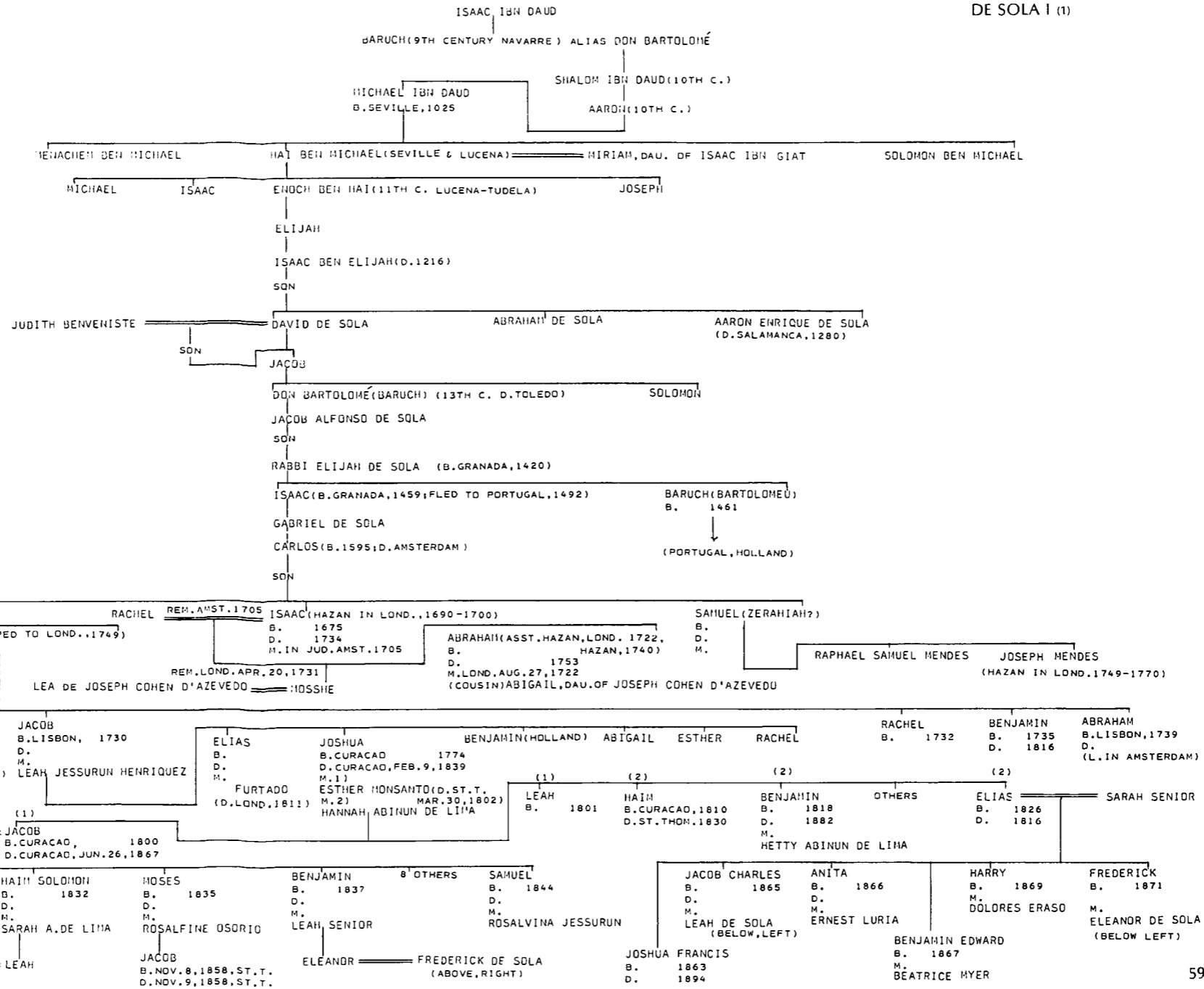

DE SOLA I (2)

FLORENCE ABRAHAMS  
MRS. E. MILLER  
LAWRENCE LANGNER'S  
"MAGIC CURTAIN"

DAVID DE SOLA B. LISBON, 1727  
D. AMSTERDAM, 1797  
(VID. DE SOLA (1))

SARAH JESSURUN D'OLIVEIRA  
OF AMSTERDAM

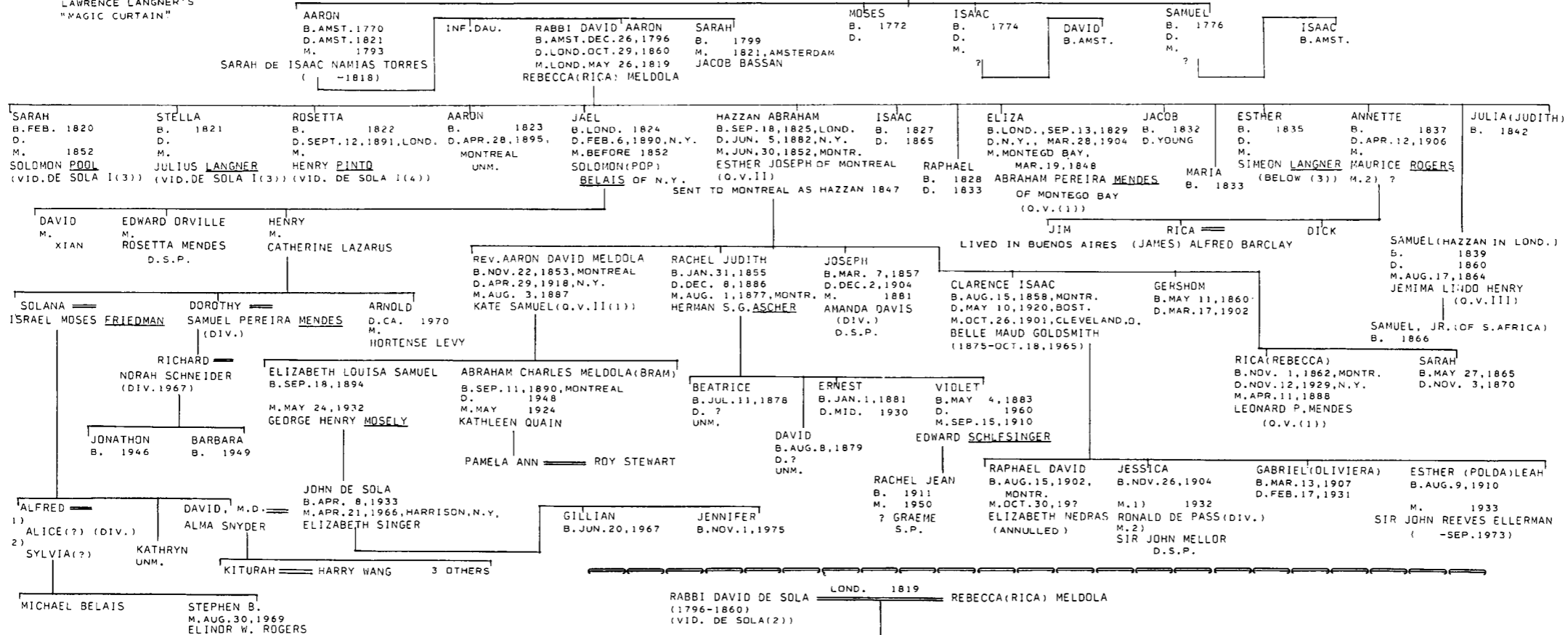

DE SOLA I (3)

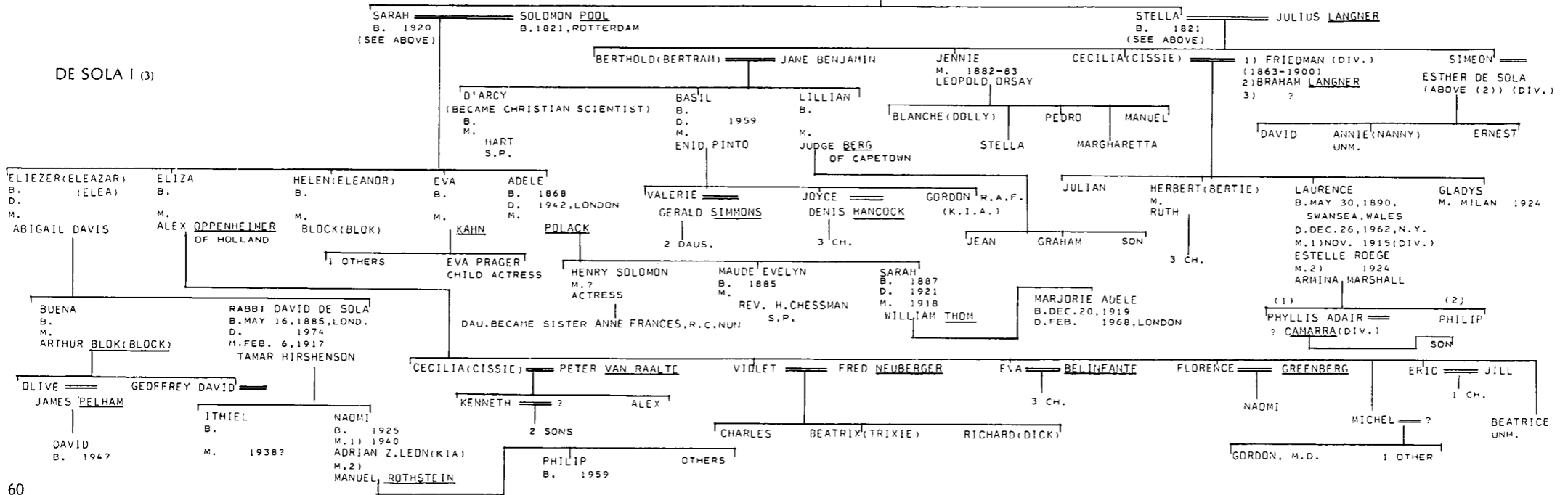

DE SOLA I (4) (PINTO)

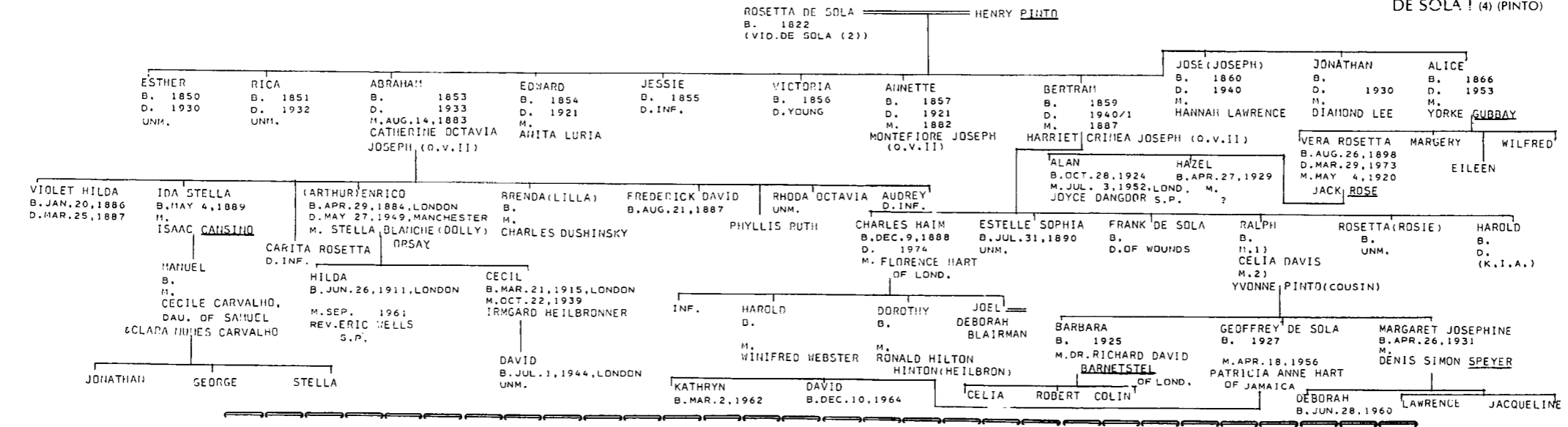

DE SOLA II (1)

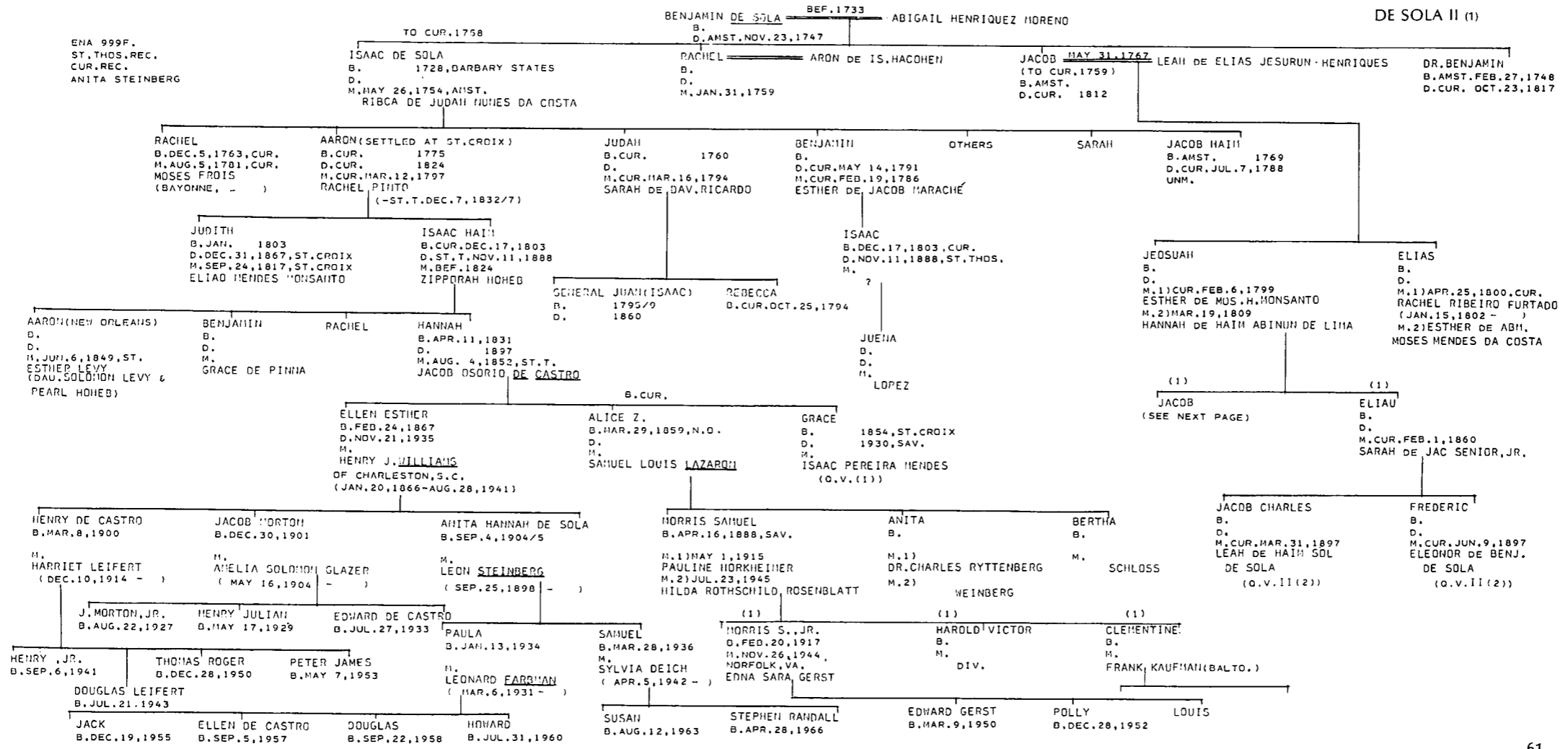

HANNAH ABINUN DE LIMA (2) JESUAH (1) ESTHER MONSANTO  
(SEE PRECEDING PAGE) CUR. JUN. 27, 1826 LEAH DE SELOMOR COHEN HENRIQUES

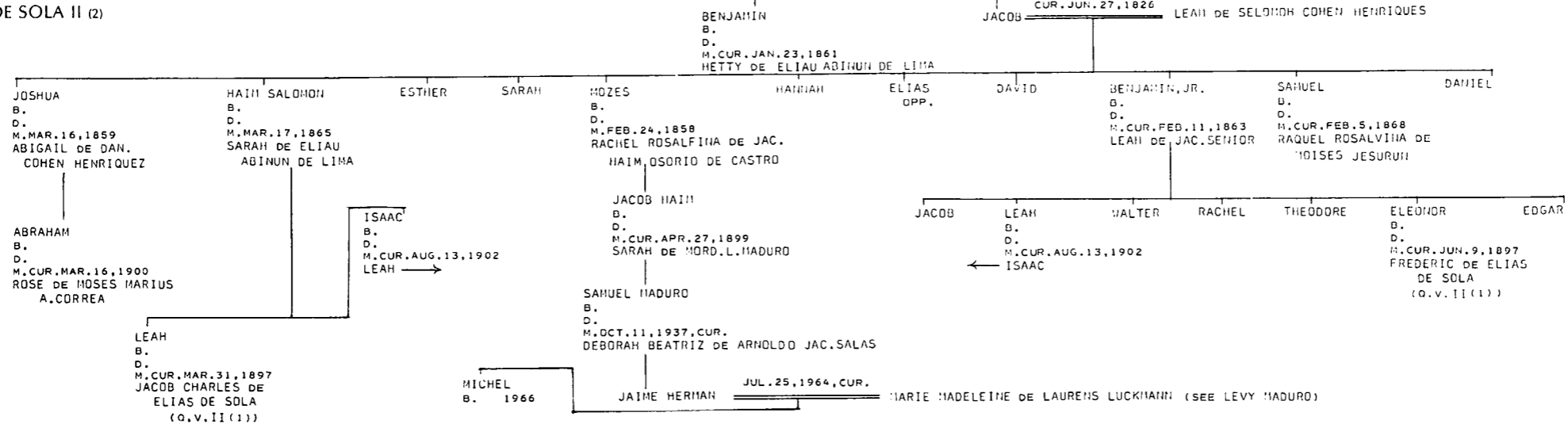

PAJHS, V. 17, P. 198  
PAJHS, V. 27, P. 279F  
PAJHS, V. 23, P. 153  
WILL OF SIMHA DE TORRES  
GOLDSTONE GEN.  
KRAUS-SANDOR COLL.  
POOL-PORTRAITS...

DE TORRES I

MOSES DA SILVA

POOL-PORTRAITS ELZAS MS. SHEARITH ISRAEL REC. ALICE LANDRUM LAZARUS HS. (JRM COLL.) BEVIS MARKS KETUBOT #441 ELZAS O. J. C. P. 33

DE TORRES II

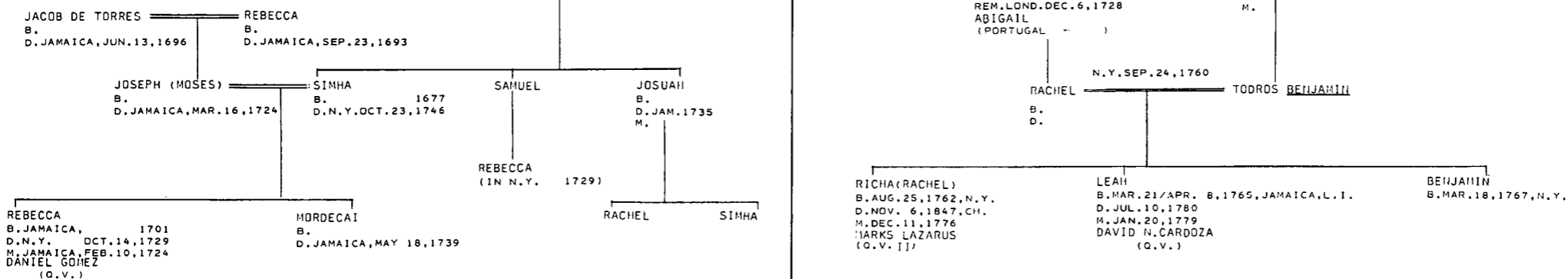

D. LEFKOWITZ-100 YEARS OF JEWRY IN TEXAS  
A. S. DREYFOUS-HEBREW CEM. NO. 1 OF GALVESTON (MIMED)  
A. GUTTMACHER-HIST. OF BALTO. HEB. CONG.  
B'NAI JESHURUN

GERSHOM BAR JEHUQA (DAVID NACHMANIDES)

DYER

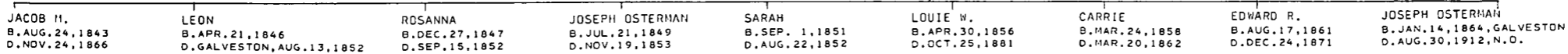
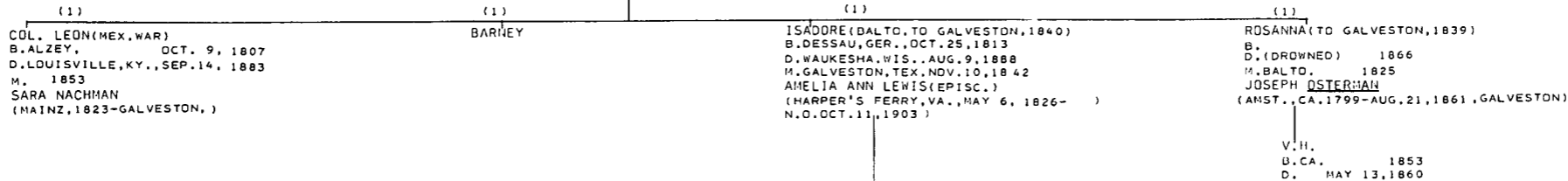
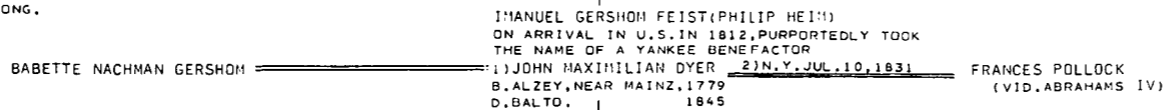

ELIAS FAMILY BIBLE  
ELZAS MSS.  
OJC.  
MN.  
JEW.CEM.AT COLUMBIA  
STERLING PRICE ELIAS

ELIAS

(CAME TO CH., CA. 1830)

LEVY ELIAS  
B. DEESDORF, GER. 1800  
D. CH. DEC. 30, 1877

ROSA L.  
B. BAVARIA 1819  
D. COLUMBIA, S.C. 1868

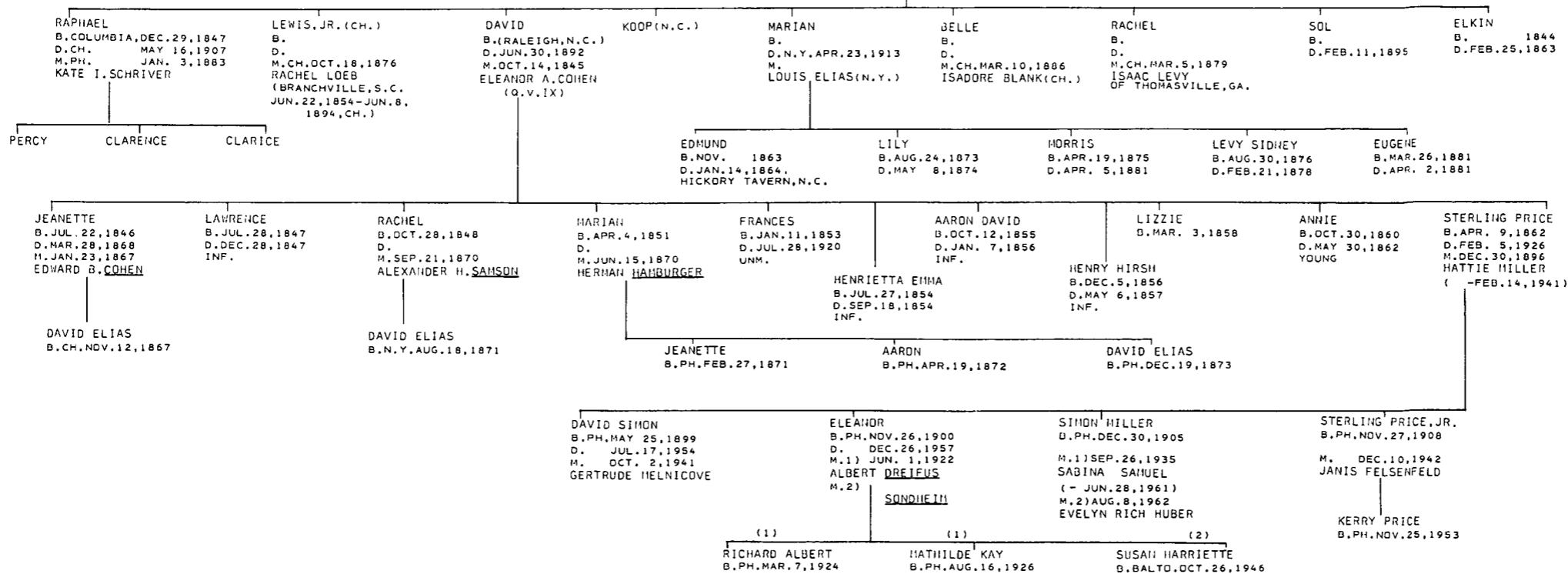

ELIZER

V.L. GUITERMAN MSS.  
ELZAS MSS.  
VITAL REC. OF R.I., V. 4  
SPRAGUE-VITAL REC. OF NEWPORT (HS. NEGHS)  
STILES' MORTALITY REGISTER (TYPESCR. NEGHS)  
MISC. VII #548  
ROSENWAIKE  
AM. D. ADV.

(HAT. N.Y., JUL. 23, 1763)

FEB. 28, 1758, NEWPORT

ISAAC ELIZER  
OF NEWPORT, R. I.  
B. CA. 1718/20  
D. CH. JAN. 2, 1807

RICHE ISAACKS  
(O.V. I)

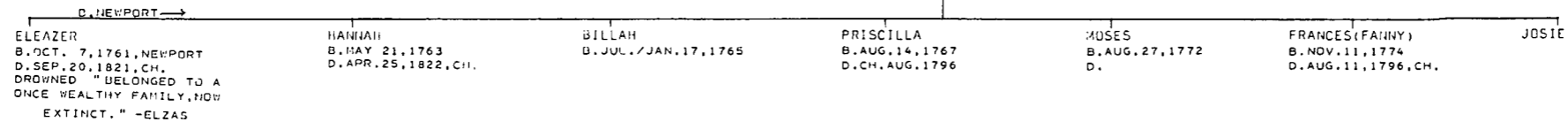

**ELKIN I**

ANCKER MS.  
KRAUS MS.  
ST. CHARLES, P. 134F.  
A. J. Y. B. 5664, P. 51  
5677, P. 106

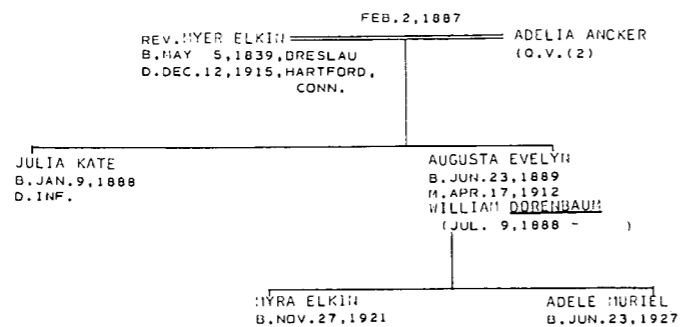

**ELKIN II**

KRAUS-SANDOR COLL.  
SALOMON FAMILY REC. (AJHS)  
PHILIPSON-LETTERS OF REBECCA  
GRATZ, P. 87  
MICKVÉ ISRAEL REC.  
SPRUCE ST. (PH.) CEMETERY REC.

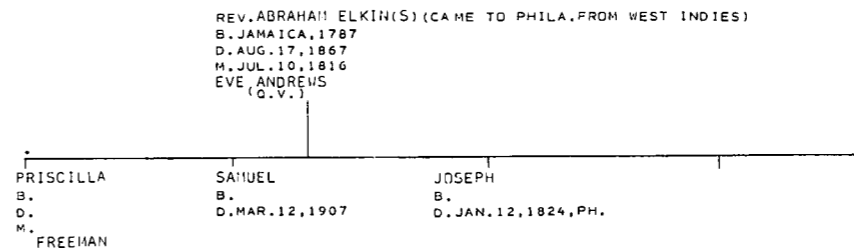

**ELLIS I**

LETTER OF AUGUSTA E. JOHNSON (AJHS)  
ELZAS MSS.  
ELZAS M.N.  
PODL-PORTRAITS...  
SHEARITH ISRAEL REC.  
BARBER, N.Y. MARR.

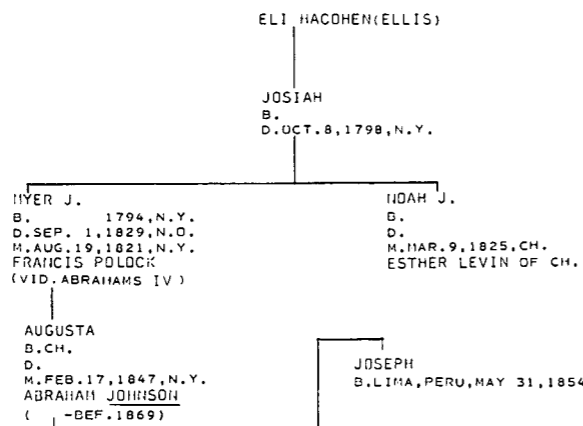

**ELLIS II**

NATHAN GEN.

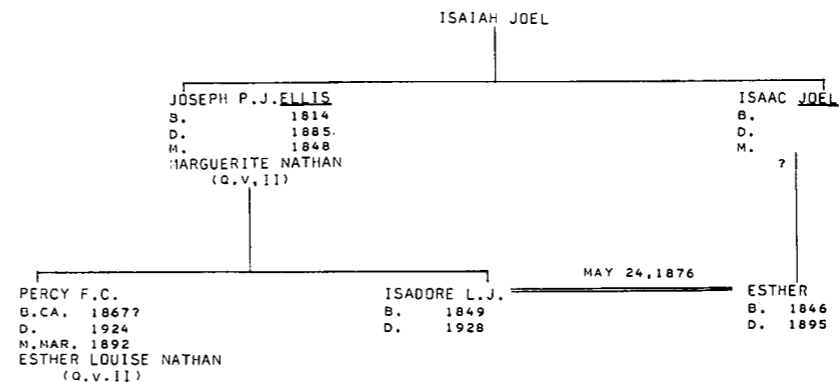

**EMANUEL I**

KRAUS SANDOR-COLL.  
EZEKIEL-LICHTENSTEIN-JEWS OF RICHMOND, P. 291  
WILL OF MARK EMANUEL  
(PETERSBURG, VA. WILLS)  
A. E. MARSH

MARK EMANUEL (CAME TO PETERSBURG, 1832)  
B. 1791, ENG.  
D. AUG. 12, 1851, PETERSBURG, VA.  
M.  
JULIET DAVIS

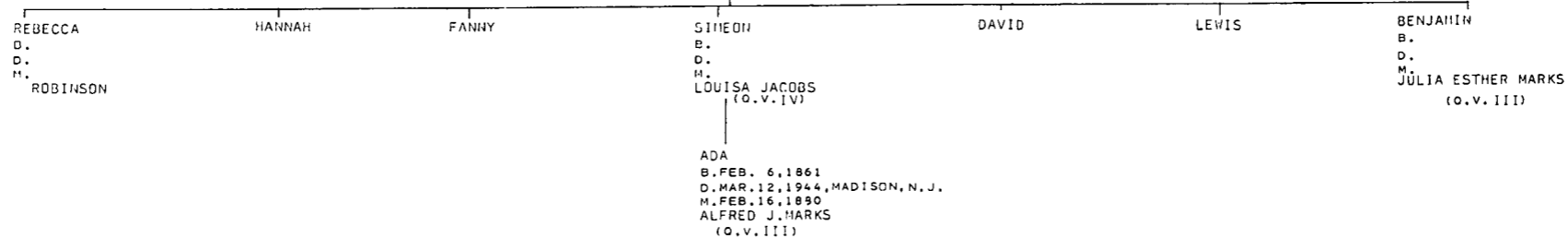

JHSE MISC.VI/192  
J.E.V.9,P.678  
AJYB V.2,P.533  
NORAIJ-JEWS OF PHILA.  
JON STEIN  
FLD ADR.

LEVY EMANUEL  
B. WEISENDORF, GER. 1732 (IN PLYMOUTH BY 1763)  
D.  
M.

SARAH B. FEB. 5, 1800, ENG. D. DEC. 19, 1883  
M.  
LYON J. LEVY (1799-DEC. 14, 1866, PH.) D.S.P.  
MANLY EMANUEL, M.D. B. FEB. 5, 1795, DAVENPORT, ENG. (CAME TO PH. JUL. 31, 1834)  
D. JUL. 2, 1880, PHILA.  
M. DEC. 20, 1826, LOND.  
HANNAH COHEN, DAU. OF PHILIP (ENG. 1806 - AUG. 26, 1885, PH.)  
JONATHAN B. 1797, ENG. D. FEB. 1, 1875 UNM.  
FANNY B. 1809, ENG. D. APR. 26, 1867, PH.

EVELINE B. SEP. 30, 1827  
PHILIP B. DEC. 6, 1829 D. NOV. 7, 1835  
ABRAHAM HYMAN B. SEP. 15, 1832  
ELIZA B. NOV. 1, 1835, PH.  
LYON LEVY (CIV. WAR) B. PH. JUN. 14, 1837 D. PH. OCT. 2, 1877  
CHARLES LEVI B. 1806, ENG.  
ANNI B. 1815/18, ENG.

ABRAHAM B. OCT. 14, 1828 D. JAN. 1829

LOUIS MANLY, M.D. (SURGEON, CIV. W.) B. FEB. 3, 1834, LOND. D. DEC. 27, 1868, PHILA.

DINAH JULIA B. MAY 17, 1839 D. 1925

FEB. 8, 1865  
JOSEPH C. D. CINTI. 1839 D. 1925

HENRY C. LYTTON B. 1846 (VID. WOLFE II)

JACOB (JACK) B. 1845

REBECCA B. 1843 D. M.

RACHEL SARAH B. DEC. 15, 1865 D. MAY 14, 1892 UNM.

ANNIE JOSEPHINE B. MAR. 1, 1868 D. UNM.

ETHEL A. "ETHEL DALE" B. MAR. 14, 1874 D. SEP. 16, 1964 M. CHARLES DAVIS LEVY (O.V. 111)

ISAAC B. 1841

ARTHUR B. 1849

FRIEDLANDER

HIRAH

ESTELLE

KIKI  
LOUIS ("LOU LANDERS")  
HITTLER

JACOB SANGUINETTI D. DEC. 26, 1800, JAM.

ABRAHAM ABRAHAMS

JACOB D. JULY 31, 1870

CAROLINE

ELIAS OF KINGSTON, JAMAICA B. D. JAN. 1875

2) JANE PHILLIPS B. D. OCT. 9, 1893, PH.  
(1) ? DIAS

JONATHAN MANLY B. ENG. MAR. 28, 1831 D. PH. JUN. 24, 1910

JAN. 2, 1878  
EMILY GERTRUDE B. OCT. 24, 1848, KINGSTON D. JAN. 18, 1939, PH.

EDWARD EUSTACE B. JAN. 1849 D. MAY 31, 1909, PH.

PERCY AUGUSTUS (ENGINEER, CENTENNIAL CHICAGO EXPO.) B. JUN. 17, 1844, JAM. D. JAN. 31, 1910, BROOKLYN

PH. DEC. 29, 1875  
SARAH FRANCES B. MAR. 28, 1841, PH. D. FEB. 7, 1907, BROOKLYN

ELIZA B. NOV. 7, 1853, JAM. D. APR. 8, 1937, PH.

LOUISA B. JUL. 14, 1857, JAM. D. JUL. 7, 1919, PH.

ELIAS B. NOV. 11, 1876, PH. D. NOV. 22, 1876

PHILIP C. B. DEC. 1, 1879, PH. D. DEC. 23, 1953 UNM.

GERTRUDE AGNES B. APR. 8, 1881, PH. D. AUG. 31, 1948, E. ORANGE N. J. D. OCT. 24, 1905, NYC.

ESTHER MARION B. AUG. 14, 1883, ATL. CITY, N. J. D. JUN. 8, 1884, ATL. CITY, N. J.

PH. APR. 8, 1903

SOLOMON I. STEIN (JAN. 10, 1879- PH. OCT. 28, 1935)

BLANCHE ESTELLE B. APR. 25, 1881, PH. D. NOV. 24, 1962, PH.

MANLY LYON B. OCT. 19, 1878, BALTO. D. NOV. 4, 1946, JACKSON HTS., L.I. M. 1) CLARISSA C. MACFARLAND B. 1878, PH. D. 1912, PH. M. 2) JUN. 8, 1914, N.Y. VIOLA LEFFERT (LEFKOWITZ) (AUG. 22, 1895, N.Y. - )

EDWARD MANLY B. NOV. 7, 1877, PH. D. MAR. 8, 1880, N. J.

GERTRUDE AGNES B. APR. 8, 1881, PH. D. AUG. 31, 1948, E. ORANGE N. J. D. OCT. 24, 1905, NYC.  
RUDOLPH RAPHAEL ARNSTEIN (STAMPBA, HUNG. MAR. 9, 1872- MAY 17, 1947, N.Y.C.)

ESTHER MARION B. AUG. 14, 1883, ATL. CITY, N. J. D. JUN. 8, 1884, ATL. CITY, N. J.

LEON IGNATIUS B. FEB. 11, 1904, PH. UNM.

DORA EMILY B. JUL. 21, 1906, PH. M. JUN. 1, 1927 LESTER EMANUEL BECKMAN

JONATHAN EMANUEL (WMTI) B. NOV. 10, 1913, PH. M. JUN. 2, 1946, N.Y. HELEN GRACE MICHAELSON (APR. 5, 1920- )

MORITZ B. AUG. 6, 1906, N.Y.C. D. AT BIRTH

MARION CHARLOTTE SANGUINETTI B. JUL. 27, 1910. M. VERNON M. APR. 17, 1943, N.Y. HATHAN RABINOWITZ ROBBINS (N.Y.C. MAY 30, 1905)

PERCY EMANUEL SANGUINETTI B. JAN. 24, 1914, N.Y.C. M. APR. 25, 1952 ISABELLA CHISHOLM TORRANCE (GLASGOW, SCOT. JAN. 1, 1922- )

JOY LORRAINE B. JUN. 11, 1919, N. J. M. MAR. 15, 1959 JOHN PHILIP SOUSA III (OCT. 22, 1913- )

FRANCES THERESA B. MAR. 31, 1908, N.Y.C.

AMY FRANCES TORRANCE B. FEB. 8, 1954, N. J.

BARBARA LOUISE TORRANCE B. JUL. 17, 1956, N. J.

LESTER E., JR. B. FEB. 10, 1933, PH.

DOROTHY STEIN B. FEB. 13, 1930, PH. M. JUL. 10, 1953, PH. MORTON ARTHUR ROTHSCHILD (PH. DEC. 23, 1924- )

MARGARET EMILY B. DEC. 4, 1906, PH. M. OCT. 25, 1936, ARMONK, N.Y. GEORGE JUDSON WEDEN (DEC. 21, 1908, N.Y. - )

MANLY WOODROW B. NOV. 5, 1912, PH. M. JUN. 11, 1939, FLUSHING, L.I. FLORENCE BEATRICE GOODHART (MAR. 16, 1908, N.Y. - )

WILLIAM LEWIS B. MAR. 19, 1944, N. J.

ALAN RUDOLPH B. APR. 23, 1946, N. J.

SUSAN LEE B. JUN. 6, 1954, PH.

JILL ANN B. JUN. 8, 1956, PH.

LAURA "MITTIE" B. OCT. 21, 1939, JACKSON HTS., L.I.

GEORGE J., JR. B. NOV. 29, 1941, JACKSON HTS.

B. FLUSHING, L.I. →

MANLY JEROLD B. MAR. 22, 1942

LINDA SUSAN B. MAR. 14, 1945

RICHARD ALAN B. JAN. 4, 1947

B. PH. →  
JUDITH EMILY B. AUG. 17, 1947

SALLY ELLEN B. JUL. 21, 1950

ROBERT SOL B. JUN. 13, 1953

HANCY SUE B. NOV. 28, 1955



EMANUEL III

E.-L., P. 122  
 PAJHS V. 27, P. 293  
 KRAUS-SANDOR COLL.  
 ELZAS MSS.  
 D.J.C.  
 M.N.  
 JEWIGEM. AT GEO'TN., S.C.  
 JEWISH CEM. AT COLUMBIA, S.C.  
 MOSES FAMILY REC. (JRM COLL.)  
 N.Y. DEATHS (OAR)  
 SHEARITH ISRAEL REC.  
 MOISE-JEW. CEM. AT SUMTER

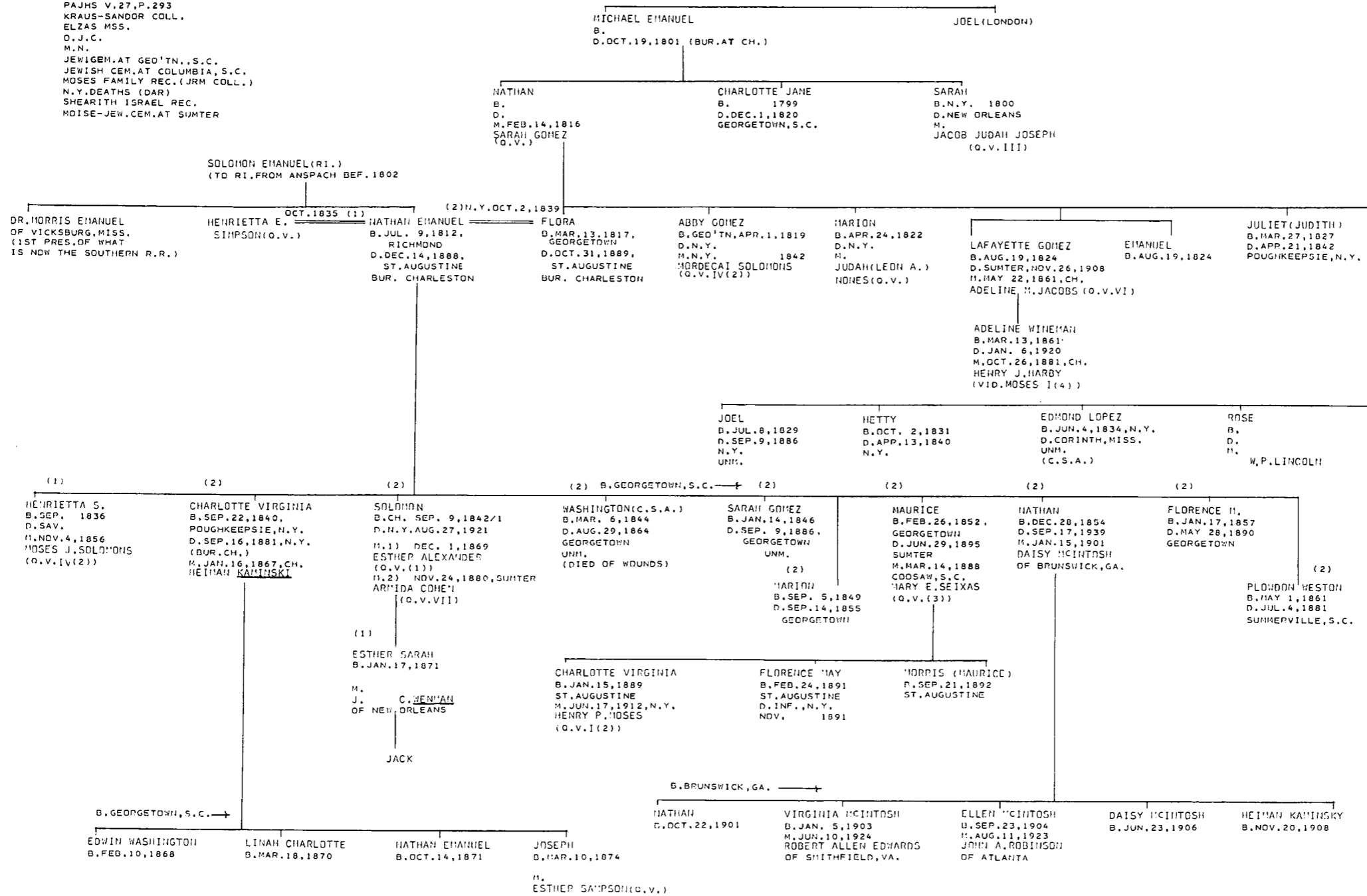

HERSHOWITZ-N.Y.WILLS(I, ADOLPHUS)  
 K.SCOTT-N.Y.POST BOY  
 H.Y.ADMIN.  
 PAJHS V.2,P.63F.V.9,P.30F  
 UJE V.4,P.186F.V.5,P.255  
 MORAIS-JEWS OF PHILA.,P.393F.  
 PHILIPSON-LETTERS OF REBECCA GRATZ  
 KRAUS-SANDOR COLL.  
 HENDRICKS GEN.  
 CHATHAM CO.,GA.,MARRIAGE RECORDS  
 GRATZ REC.(DAR)  
 MARYLAND HIST.MAG. V.15,ND.1,PP.1-20  
 NICKVE ISRAEL REC.  
 ELZAS-JEW.CEMETERY AT GEORGETOWN  
 ELZAS M.N.  
 BARNET JACOBS MOHEL REC. (PHOTO.AJA)  
 SHEARITH ISRAEL REC.  
 MYER SOLIS-COHEN  
 COHEN-ETTING CEM.REC.  
 J.R.COHEN REC.

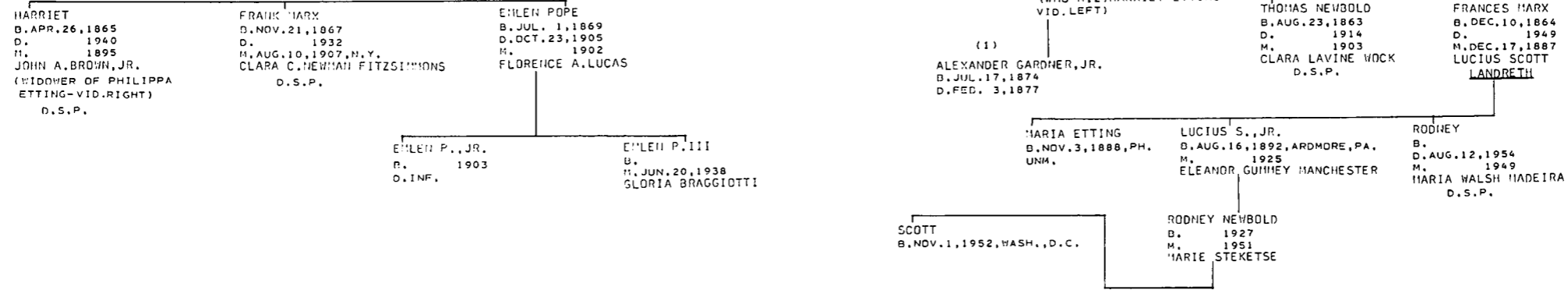
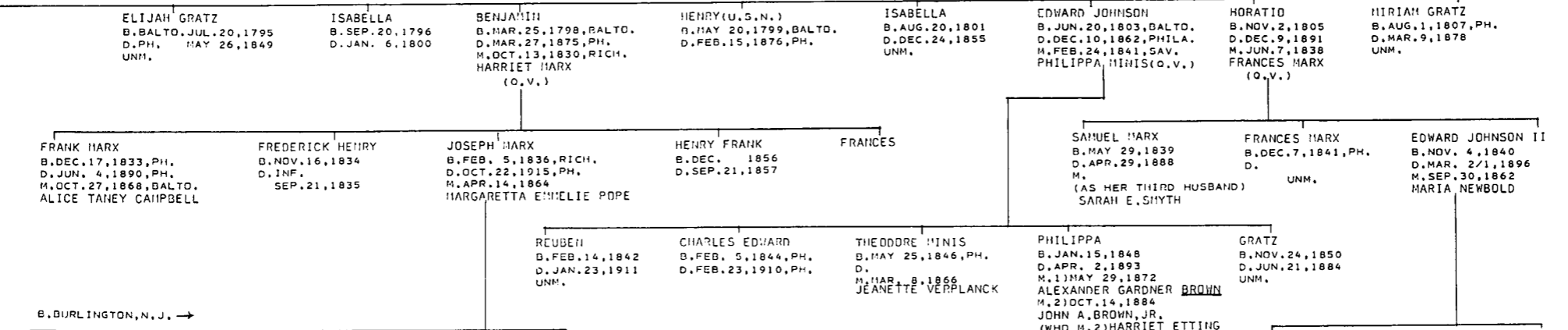
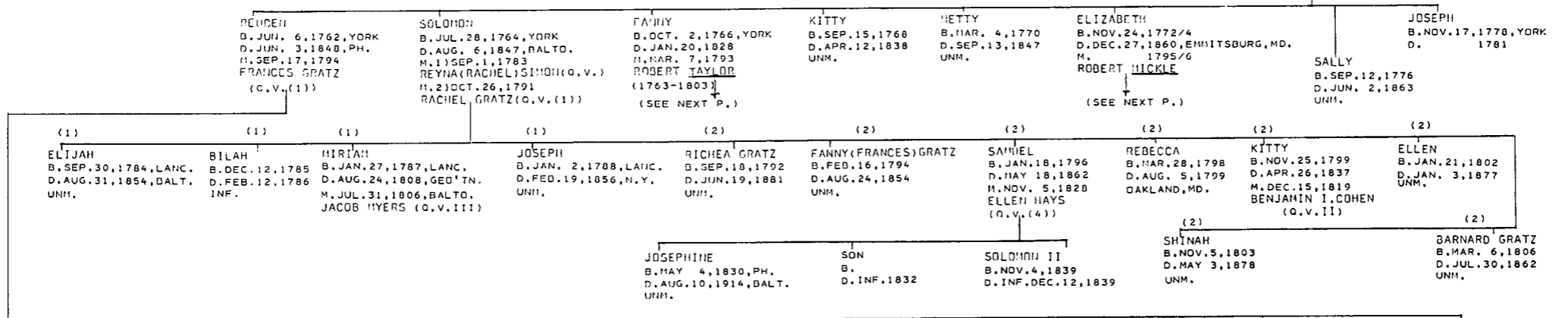
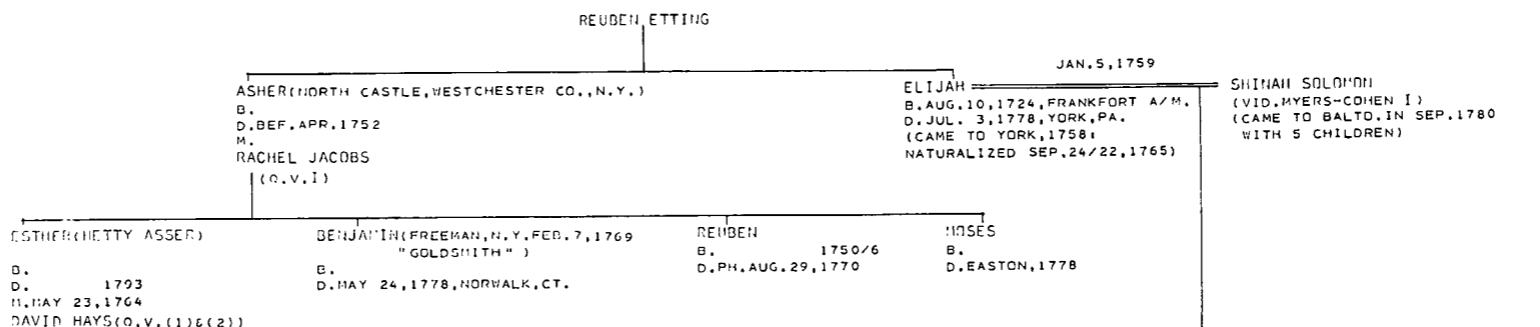

ETTING (2)

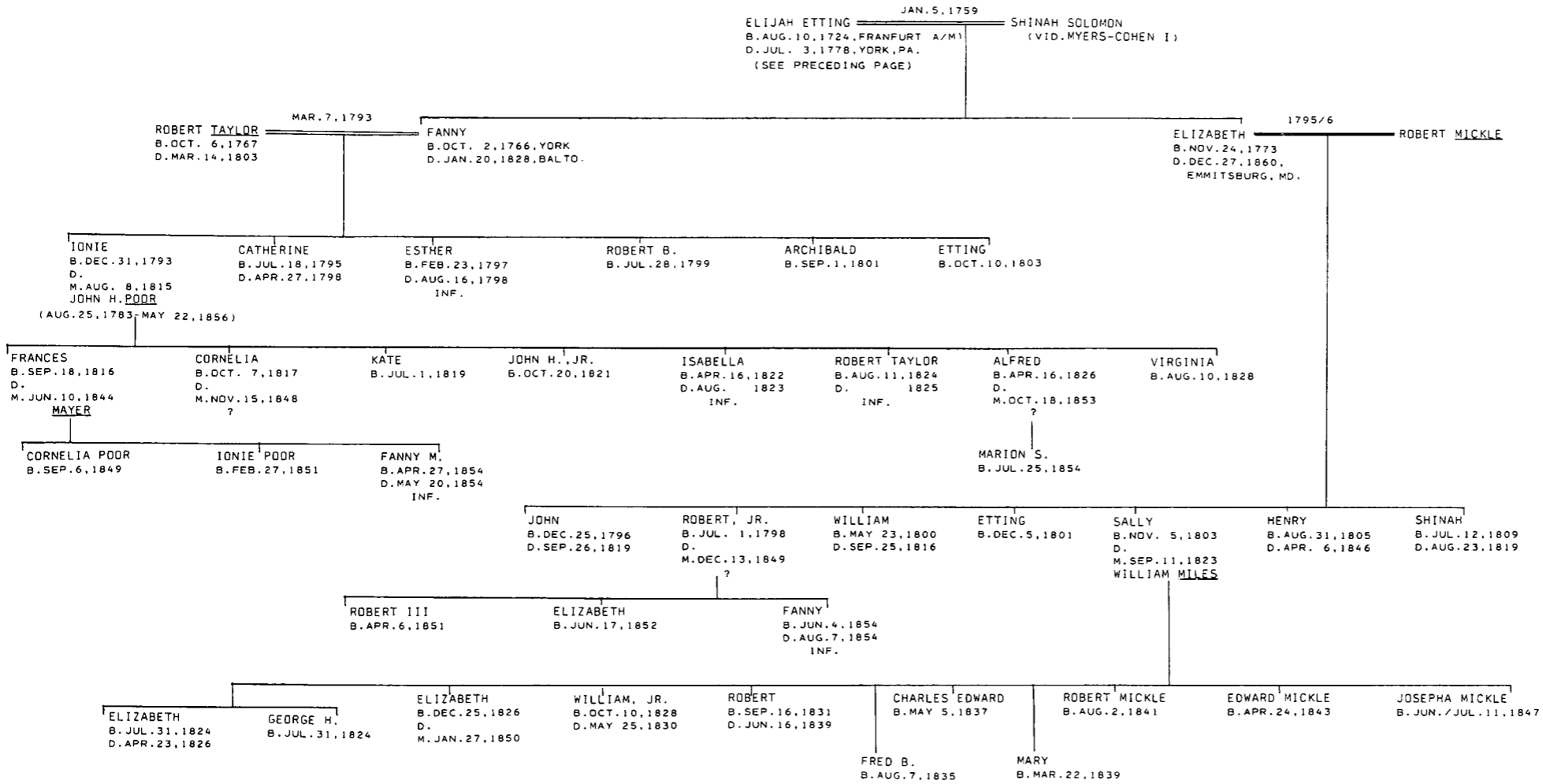

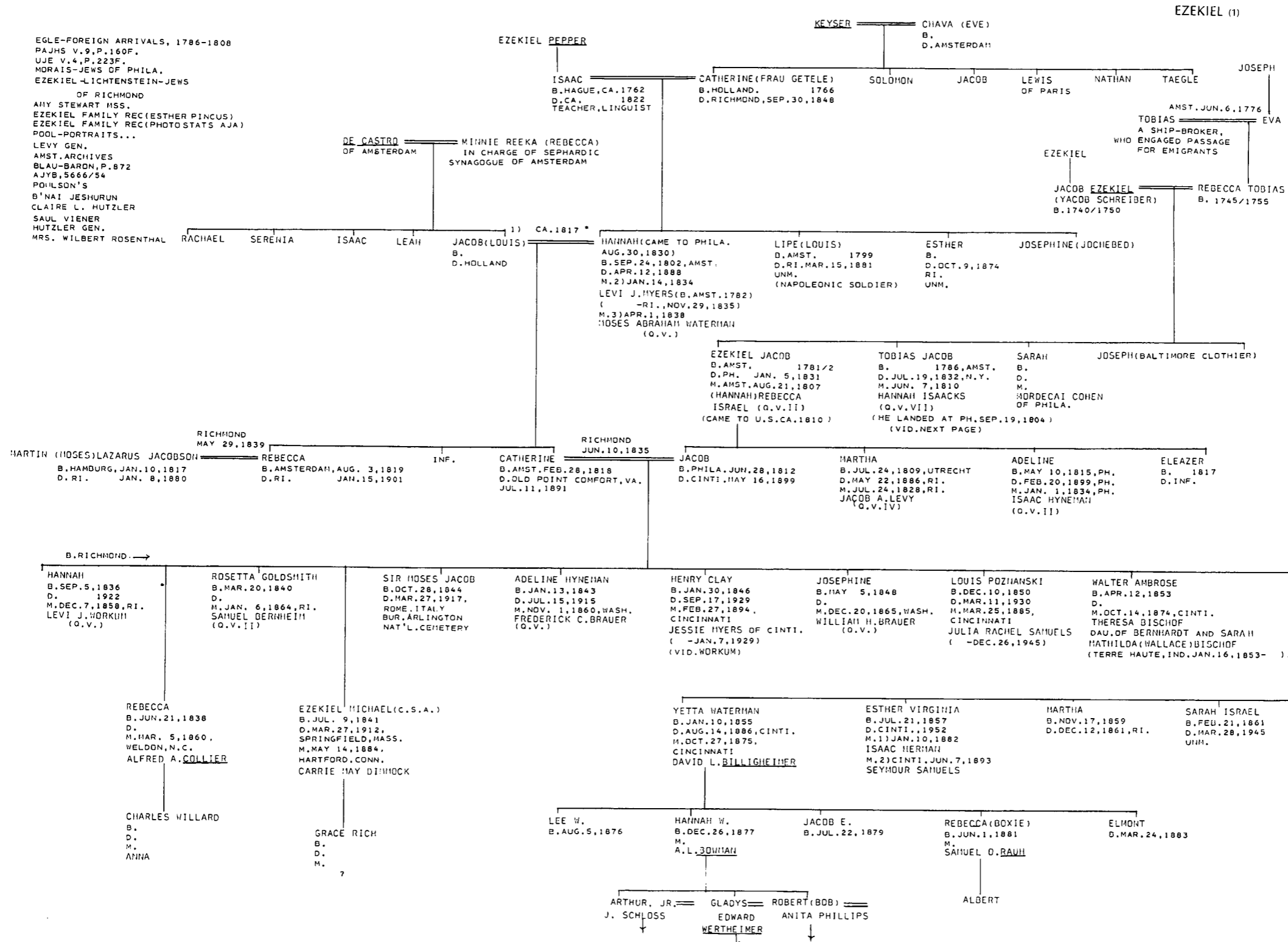

\* NOTE: FAMILY RECORD DATES THE MARRIAGE OF JACOB (LOUIS) DE CASTRO AND HANNAH PEPPER, APR. 13, 1809, BUT THIS DATE IS IMPOSSIBLE, IF HANNAH'S BIRTH DATE IS CORRECT.

EZEKIEL (2)

TOBIAS JACOB EZEKIEL (LANDED IN PHILA., SEP. 19, 1804)  
 B. AMST. 1786 IN RICHMOND BY 1807  
 D. N. Y. JUL. 19, 1832  
 M. JUN. 7, 1810  
 HANNAH ISAACKS (O.V. VII)  
 (SEE PRECEDING PAGE)

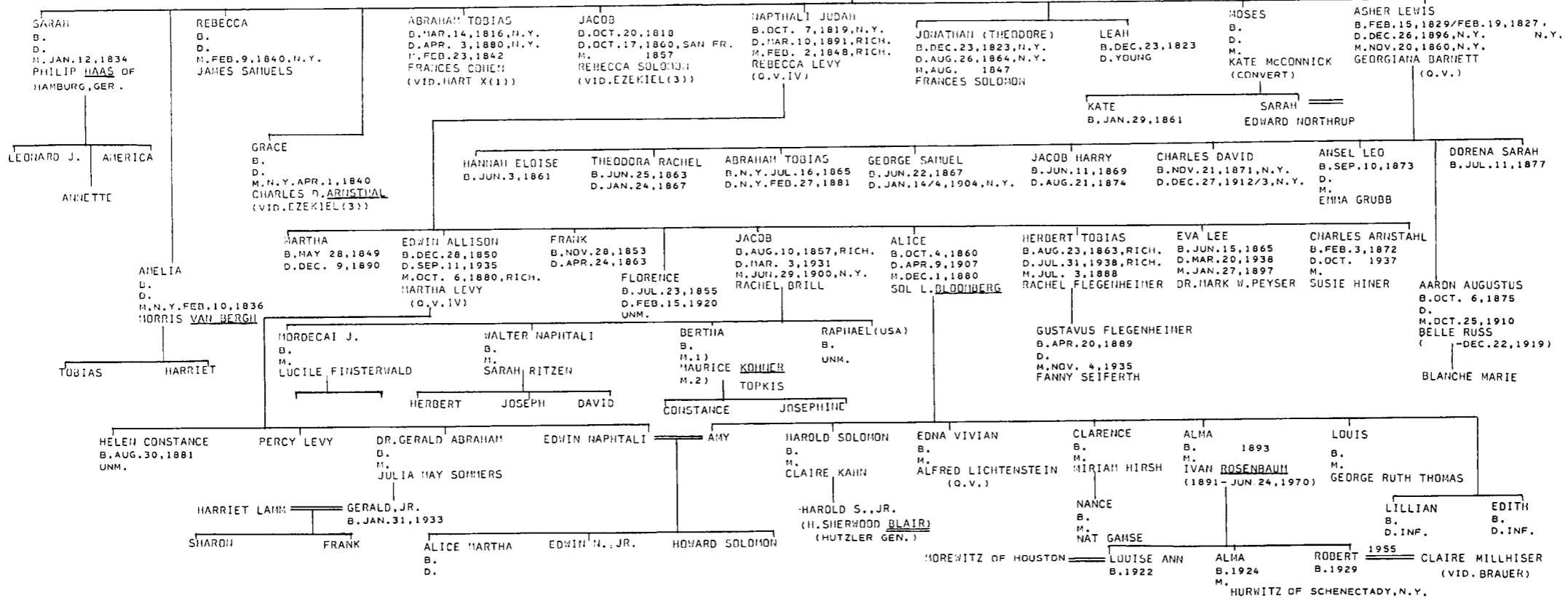

EZEKIEL (3)

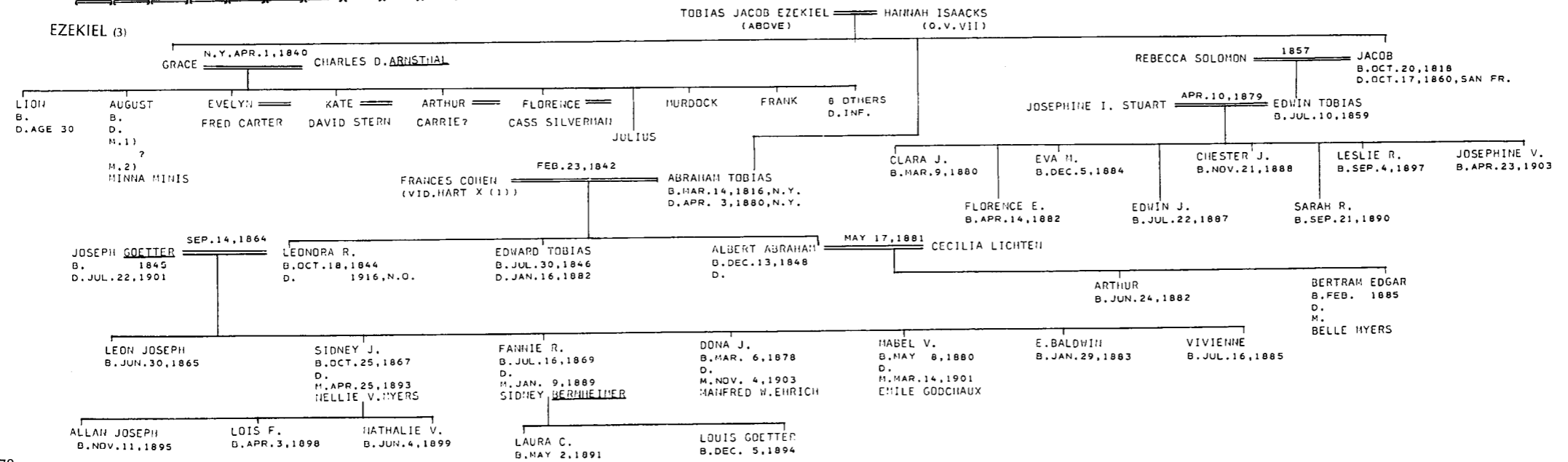

U.J.E.  
MORAIS-JEWS OF PHILA.  
C.J.TELLER-TELLER FAMILY  
IN AMERICA  
FLORENCE ABRAHAMS

BENJAMIN WOLF FLEISHER  
D. 1010  
D. 1845  
M.  
HANNAH TUCHNER  
(1810-1903)

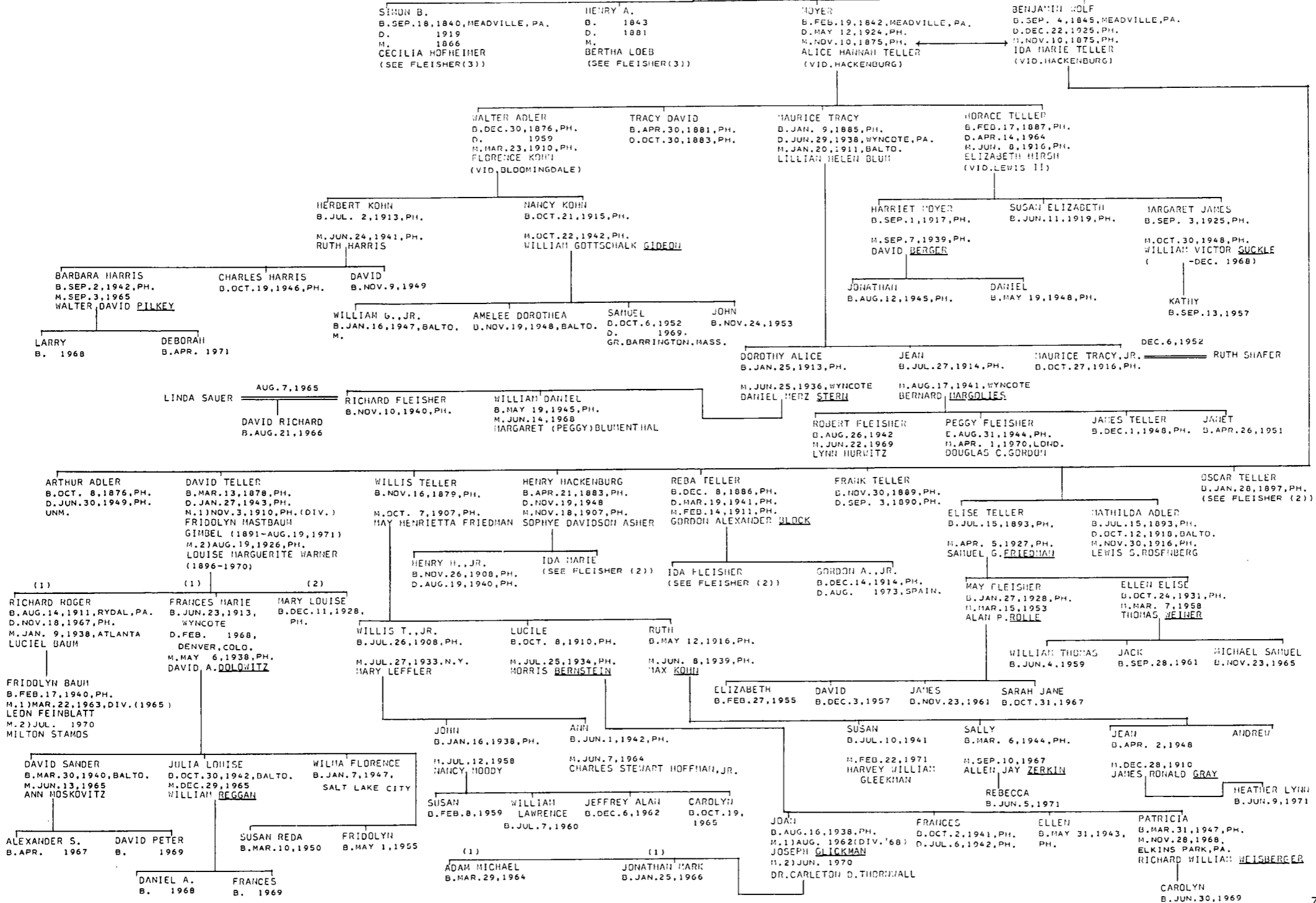

FLEISHER (2)

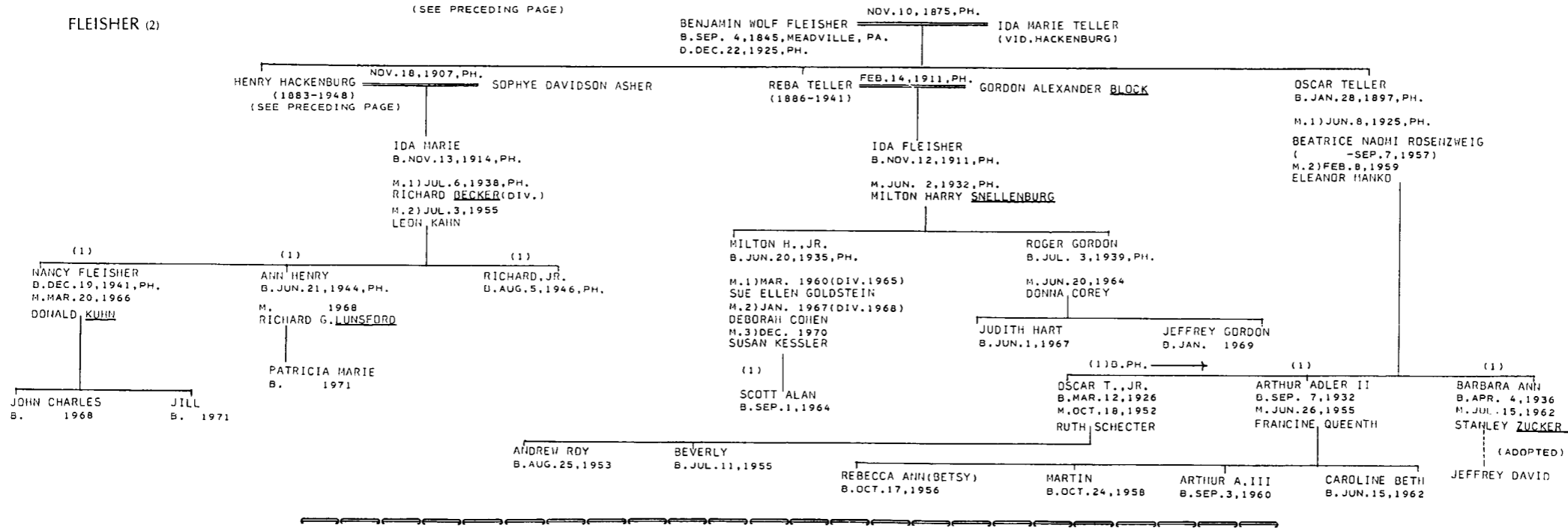

FLEISHER (3)

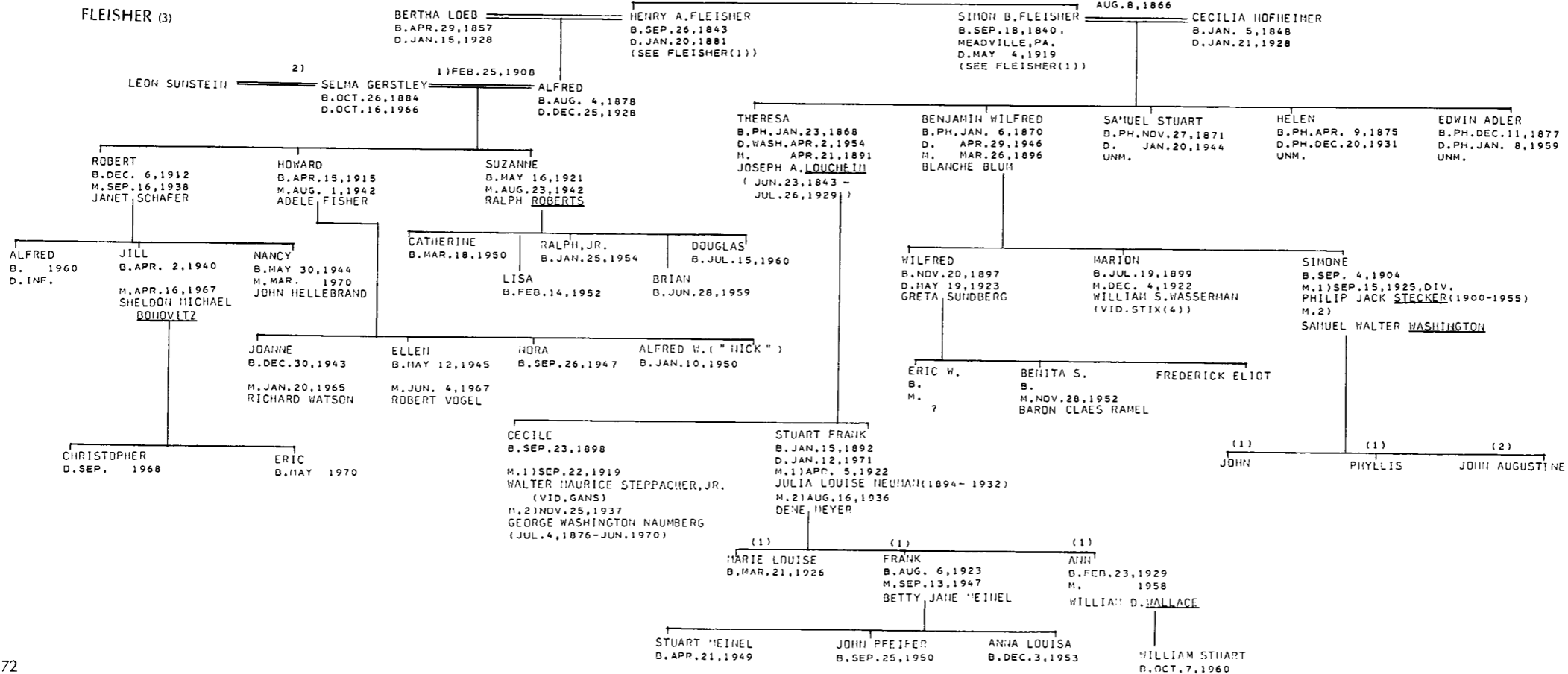

KRAUS-SANDOR COLL.  
SHEARITH ISRAEL REC.

JACOB (JULIUS) FELBEL  
B. OCT. 15, 1823, GER.  
D. NOV. 2, 1904, N.Y.  
M. OCT. 30, 1850  
MIRIAM COHEN  
(O.V. X(1))

FELBEL

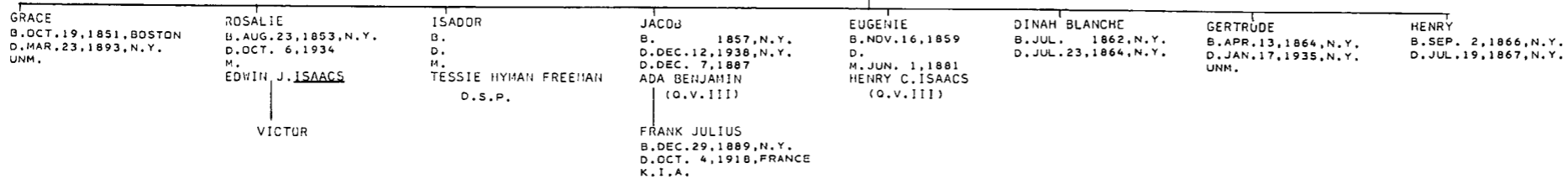

HERSHKOWITZ-N.Y. WILLS (JACOB FONSECA)  
BEVIS MARKS KET. #383, #463  
ANDRADE, P. 140  
BM II #463, #383

ISAAC, GRANTED 1000 ACRES IN JAN. SEP. 26, 1676

FONSECA

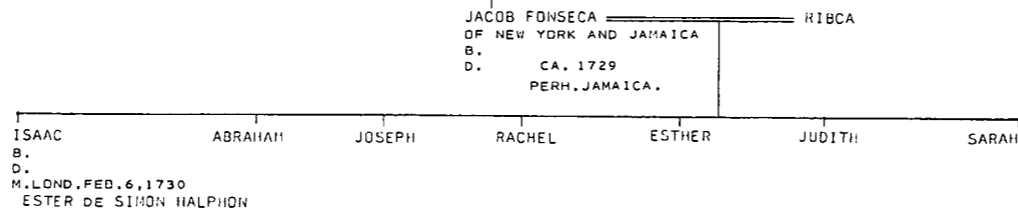



**FLORANCE**

J.E. V.8.P.664  
 KRAUS-SANDOR COLL.  
 ELZAS, M.N. P.13  
 ELEANOR COHEN GEN.(AJA)  
 MICKVE ISRAEL REC.  
 MRS. ALBERT M. COHEN  
 SHEARITH ISRAEL REC.  
 FLORENCE ABRAHAMS  
 FED. ST. CEM.  
 KORN N.O.  
 F. BASIL GUEDALLA  
 RODEPH SHALOM MOH. REC.  
 EVELYN MILLER

(PERH. ZACCARIA LEVY OF BROAD ST. BLDGS.  
 ENDEN, LOND. 19 DEC. 1786)

ZACHARIAH LEVY  
 (CHANGED NAME TO FLORANCE)  
 B.  
 D. NEW ORLEANS, NOV. 15, 1832  
 (DENTIST IN CHARLESTON, 1802;  
 LIVED ALSO IN KY., TENN.)  
 (TO N.O. 1827/28)

SARAH LEVY

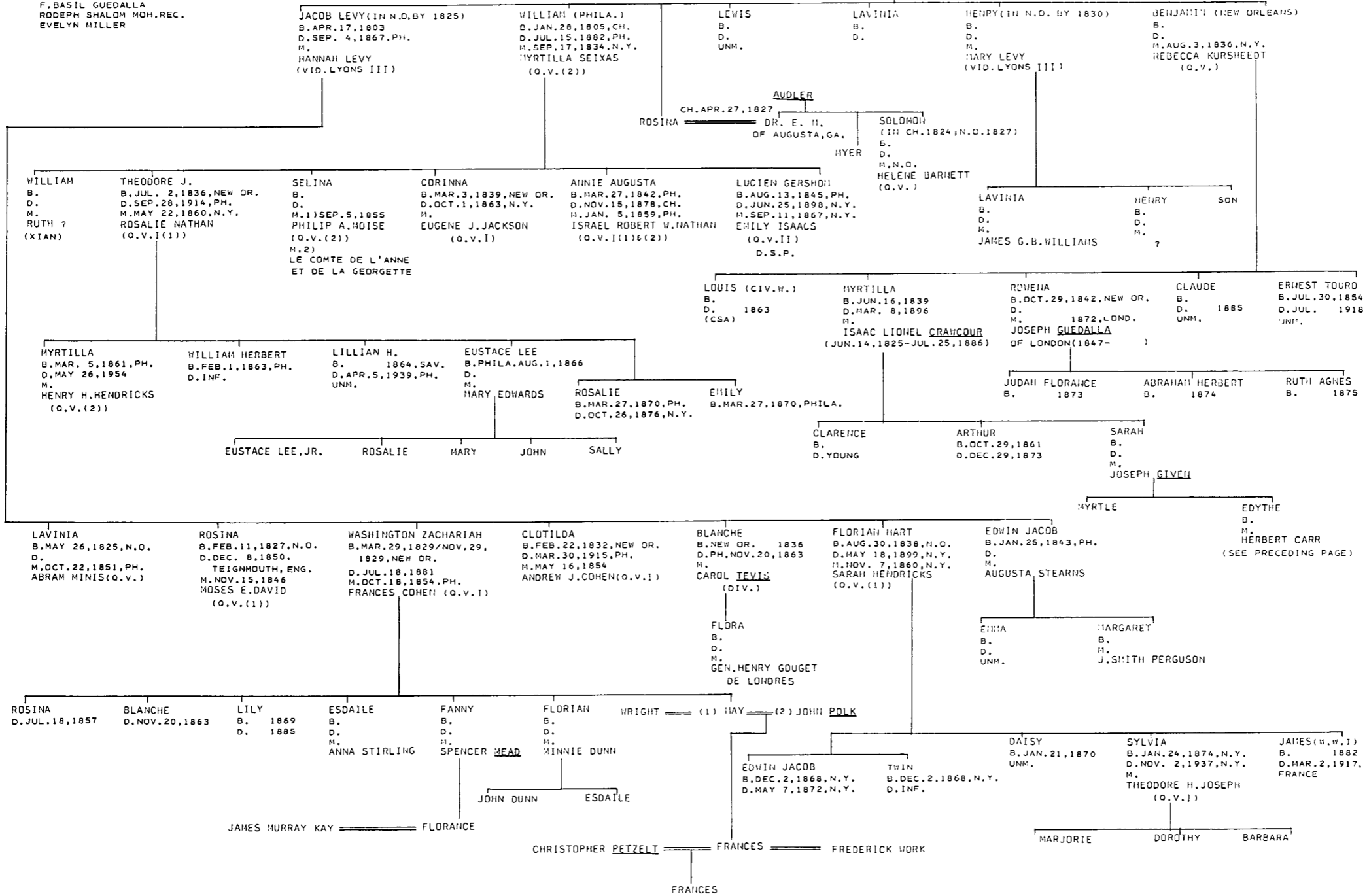

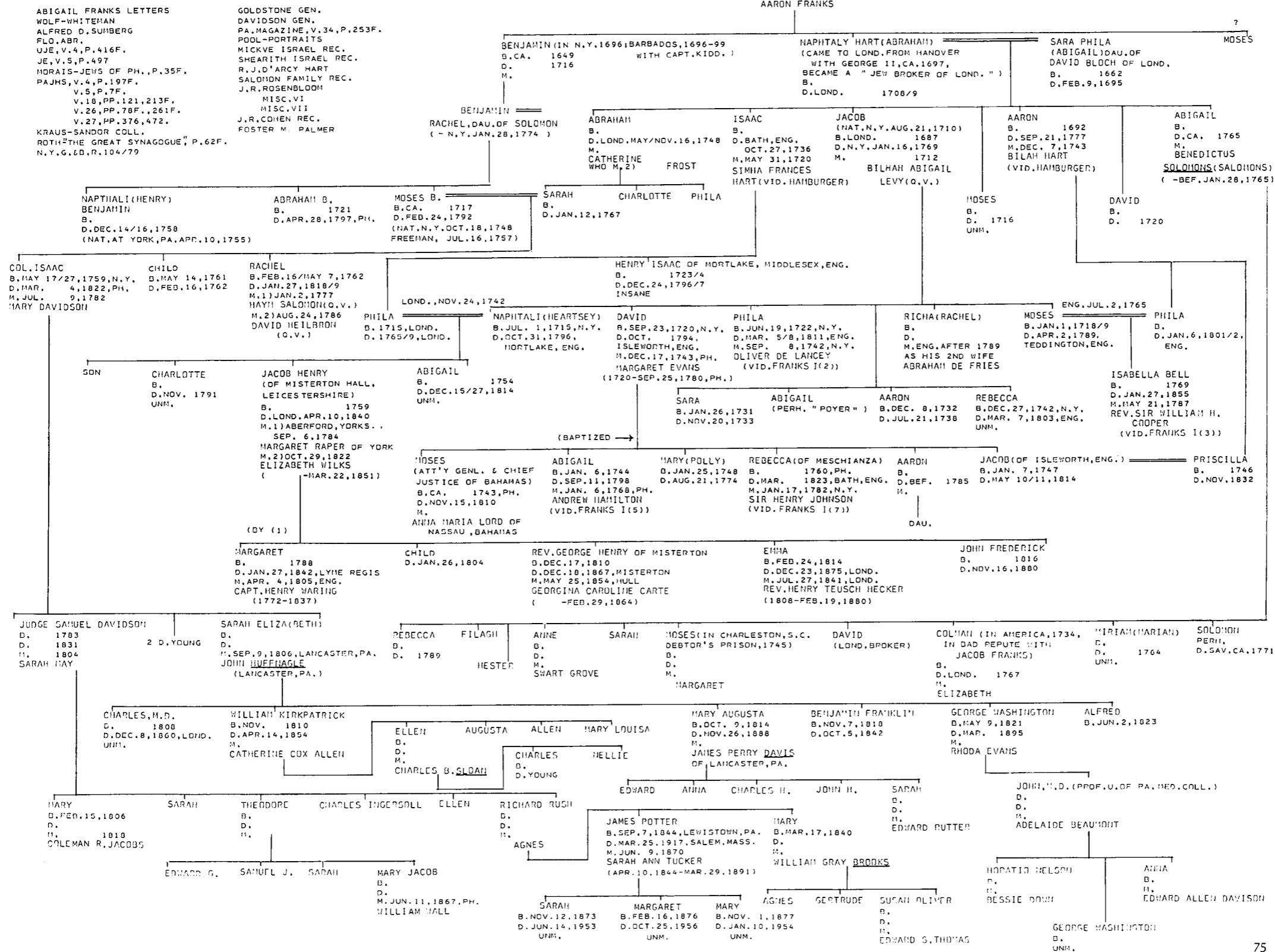

FRANKS I (2) DE LANCEY

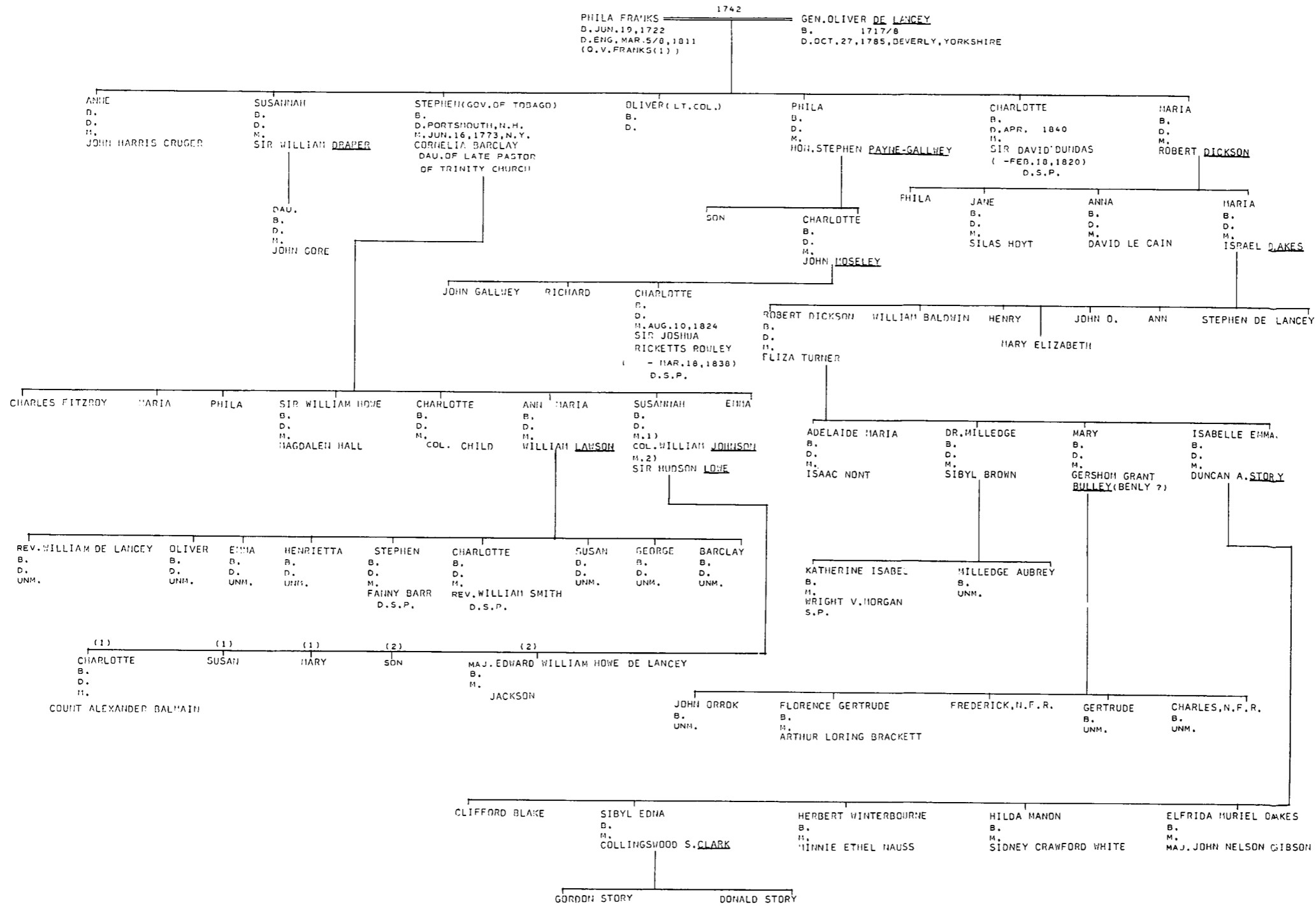

FRANKS I (3) COOPER

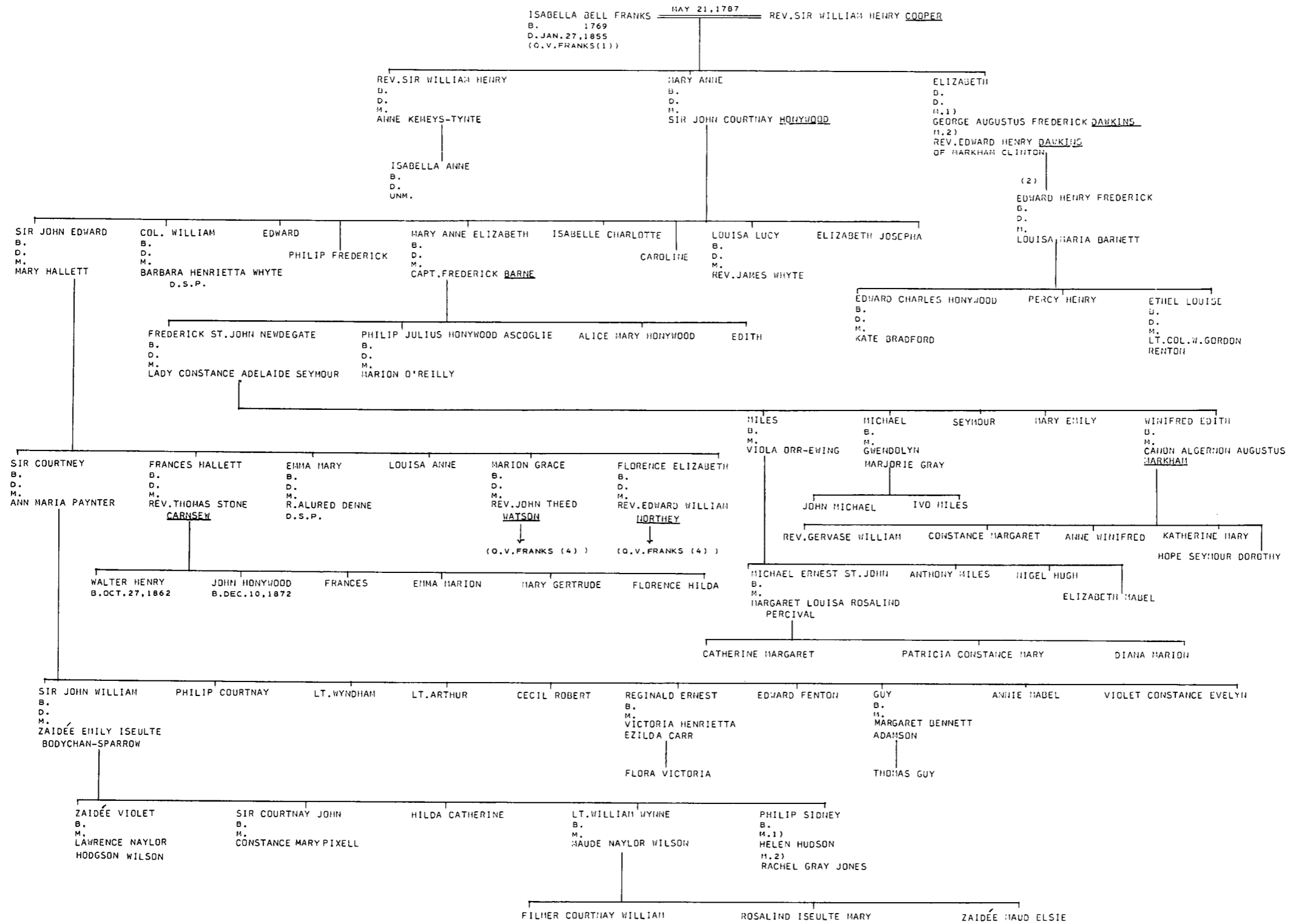

FRANKS I (4) WATSON, NORTHEY

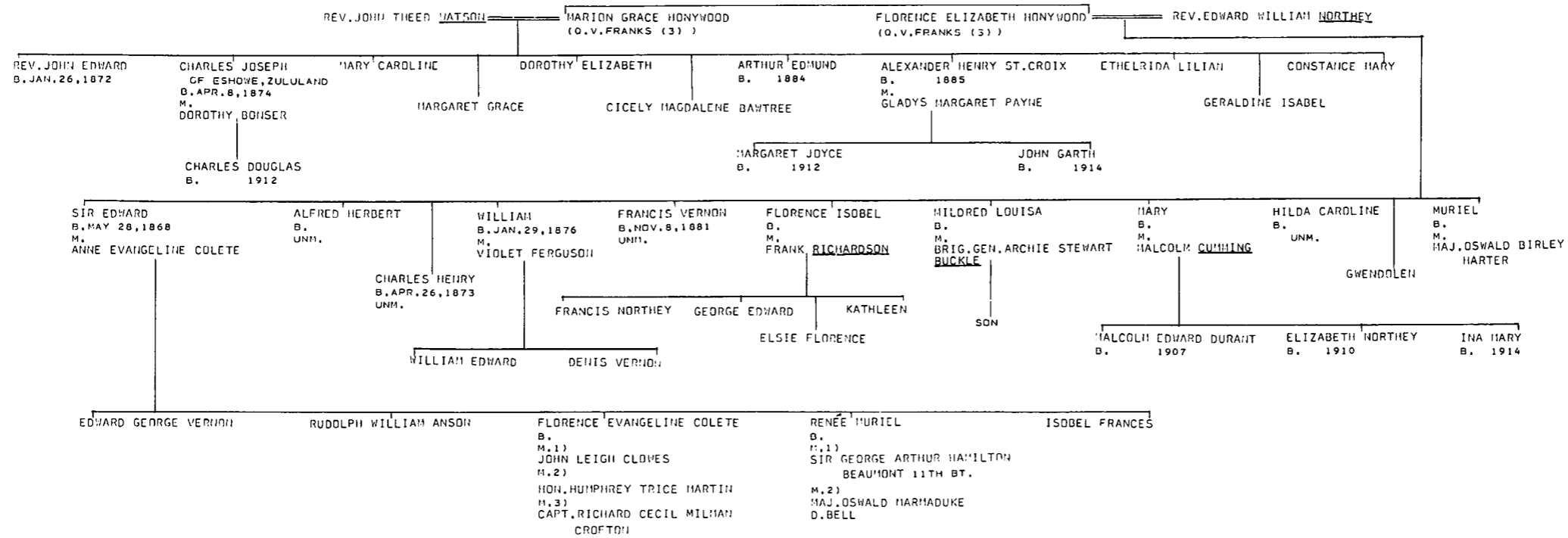

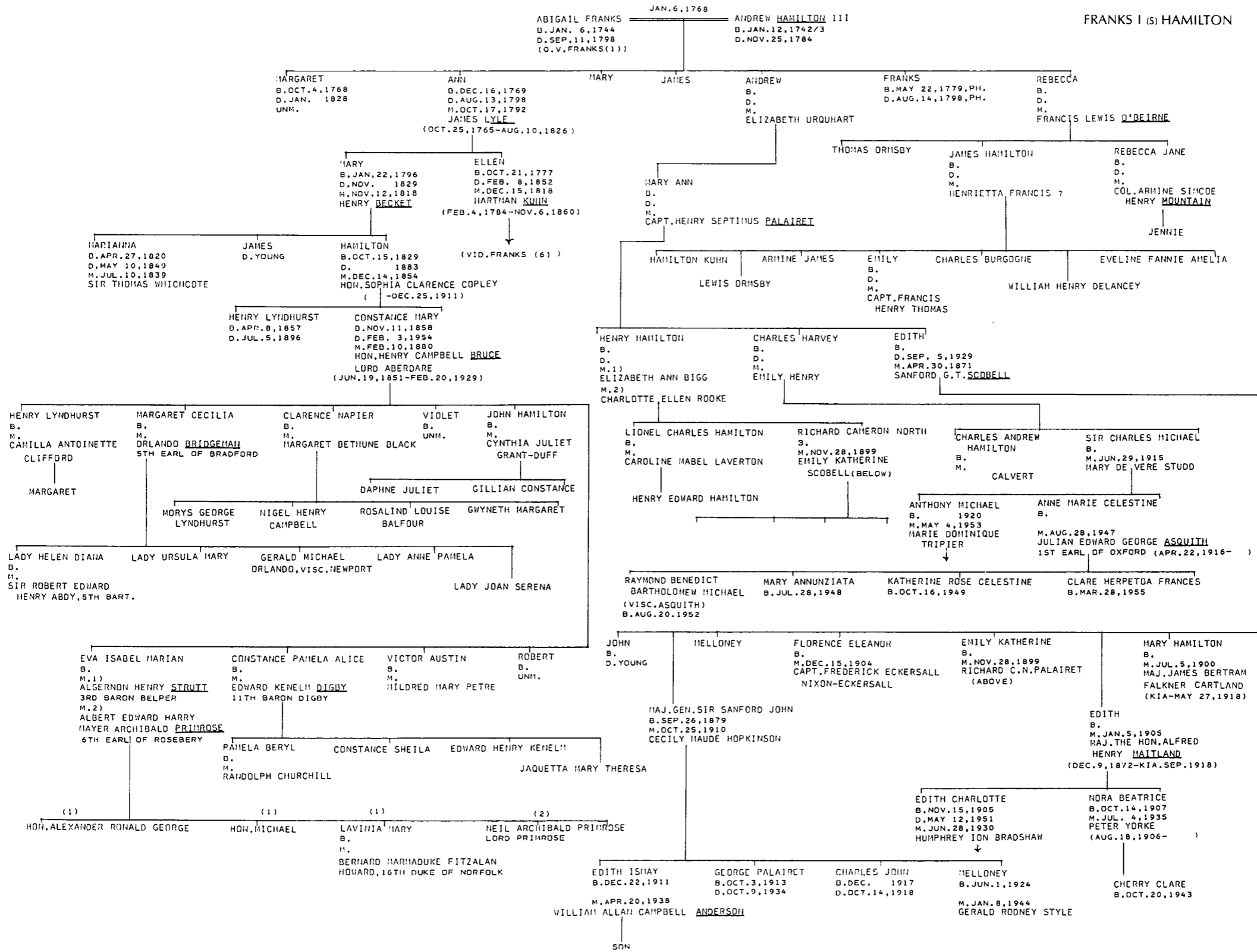

FRANKS I (6) KUHN

FLO. ABR.

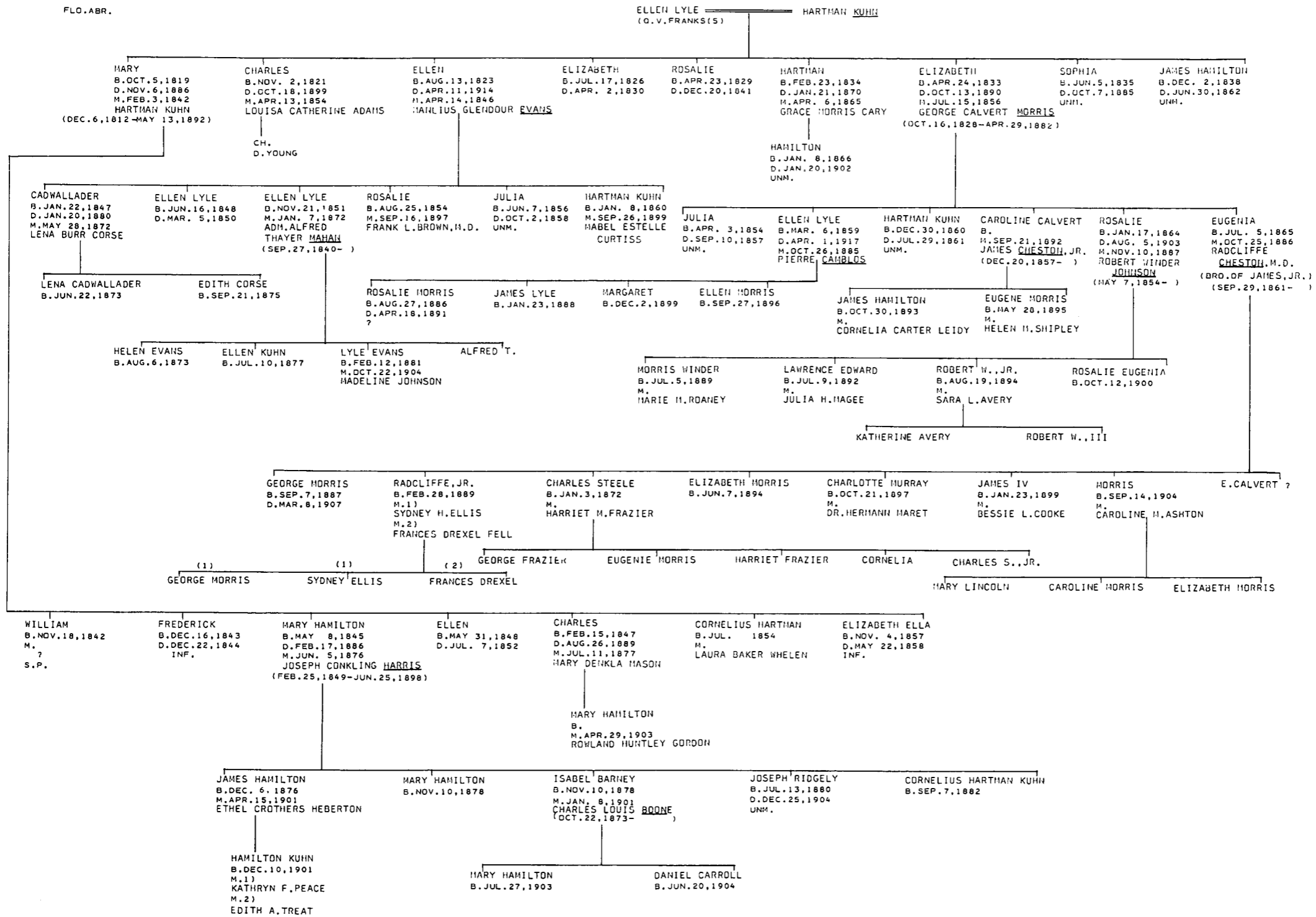

FRANKS I (7) JOHNSON

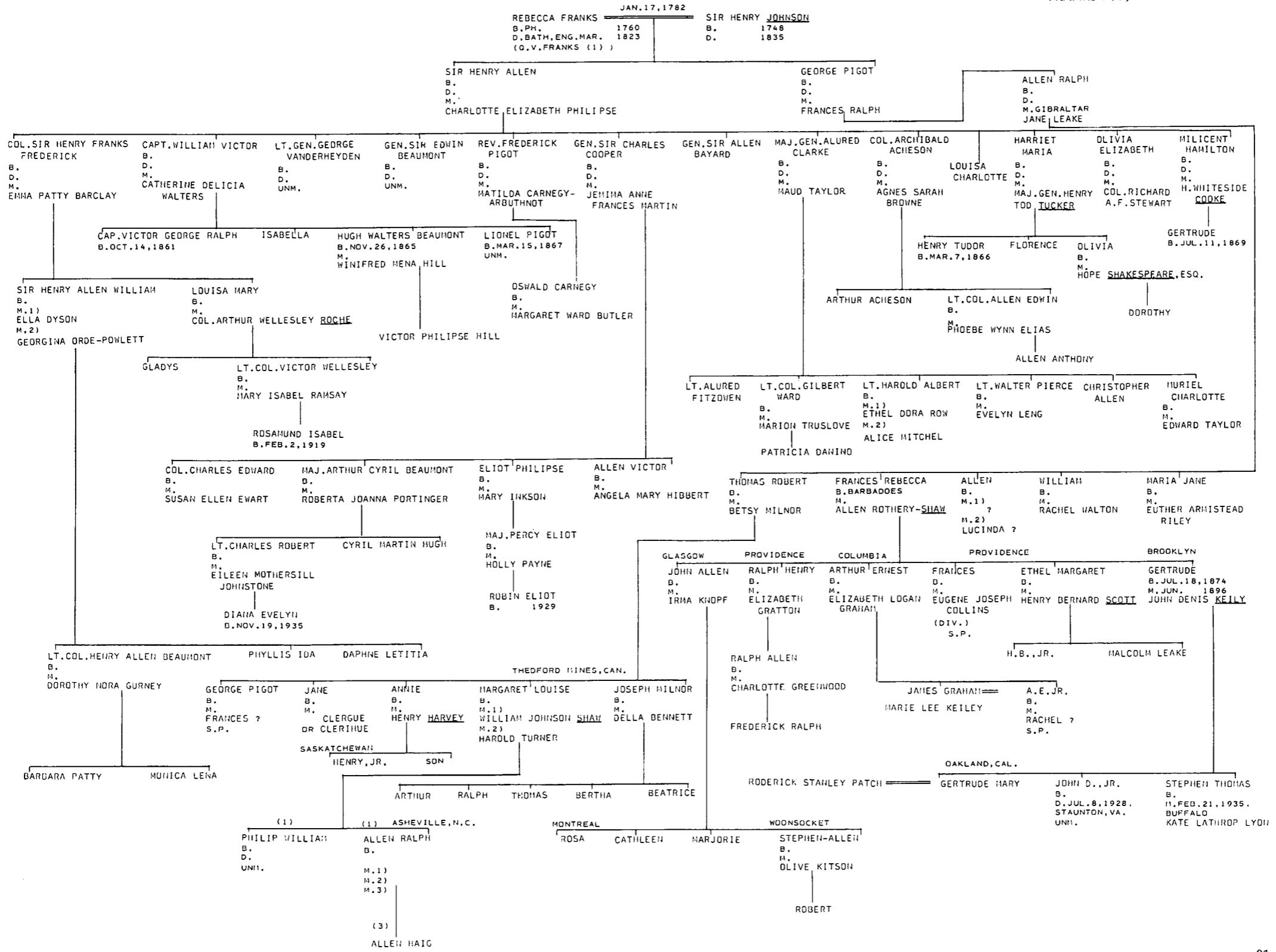



FRANKS II

ADMIN. OF DAVID S. FRANKS  
WOLF-WHITEMAN  
MARCUS-AJD, P. 83F.  
U.S. CENSUS, PHILA. 1790  
FLQ. ABR.  
D.N.B.

JOHN FRANKS, OF PH., QUEBEC, HALIFAX

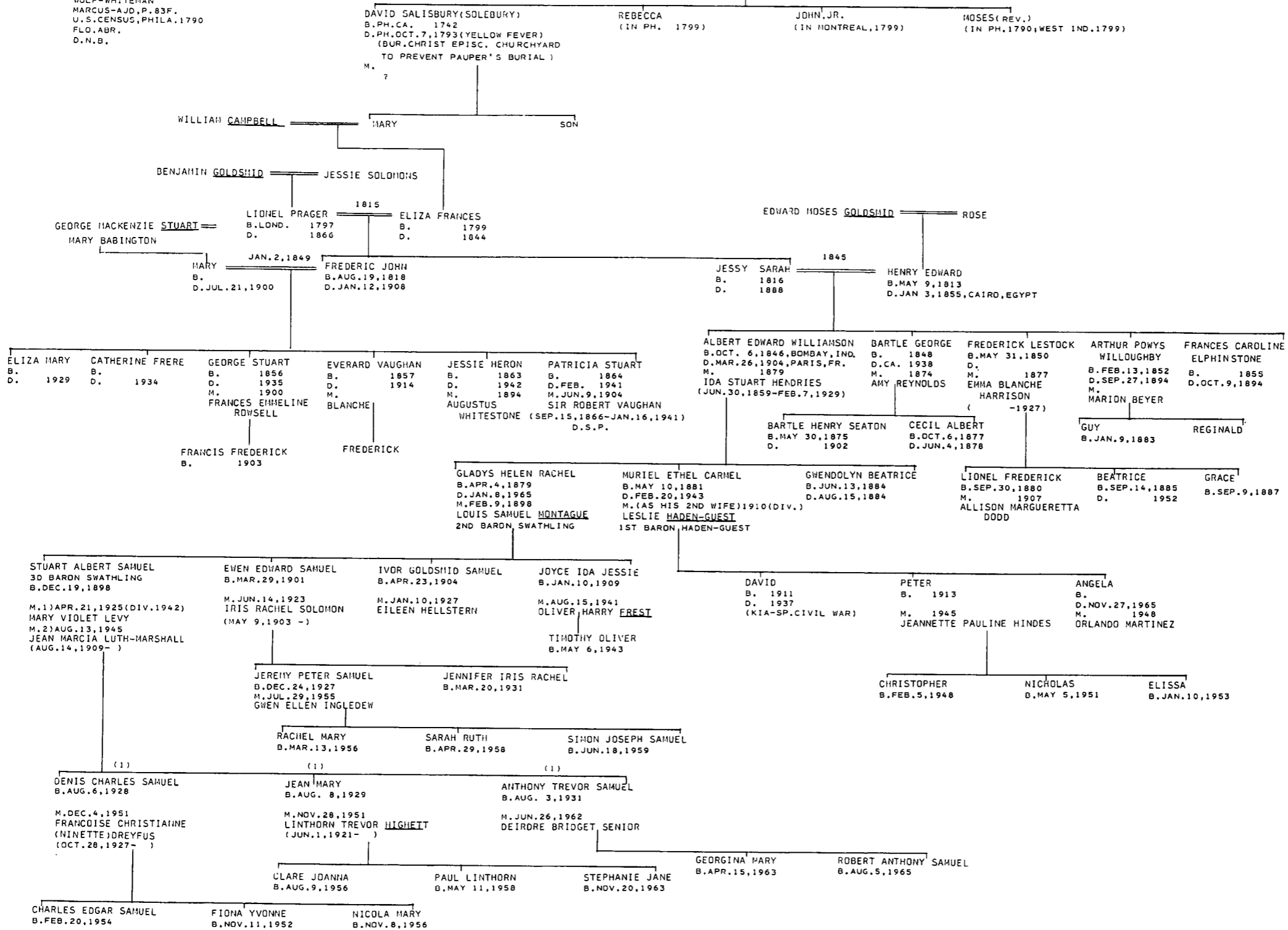

KATZ-BETH EL STORY  
EVELYN MILLER  
MARCUS A.J.D.

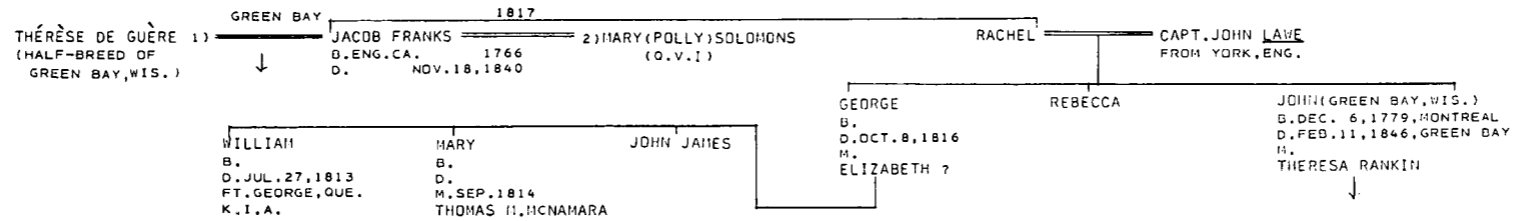

MORAIS-JEWS OF PH., P. 267 F.  
RODEPH SHALOM MOHEL REC.  
EDNA HELLMAN FLO. ABR.  
A.J.Y.B.  
HIST. OF J.E.S.  
FEDERAL ST. CEM.  
U.J.E.

GANS, OF NATZINGEN, WESTPHALIA

GANS

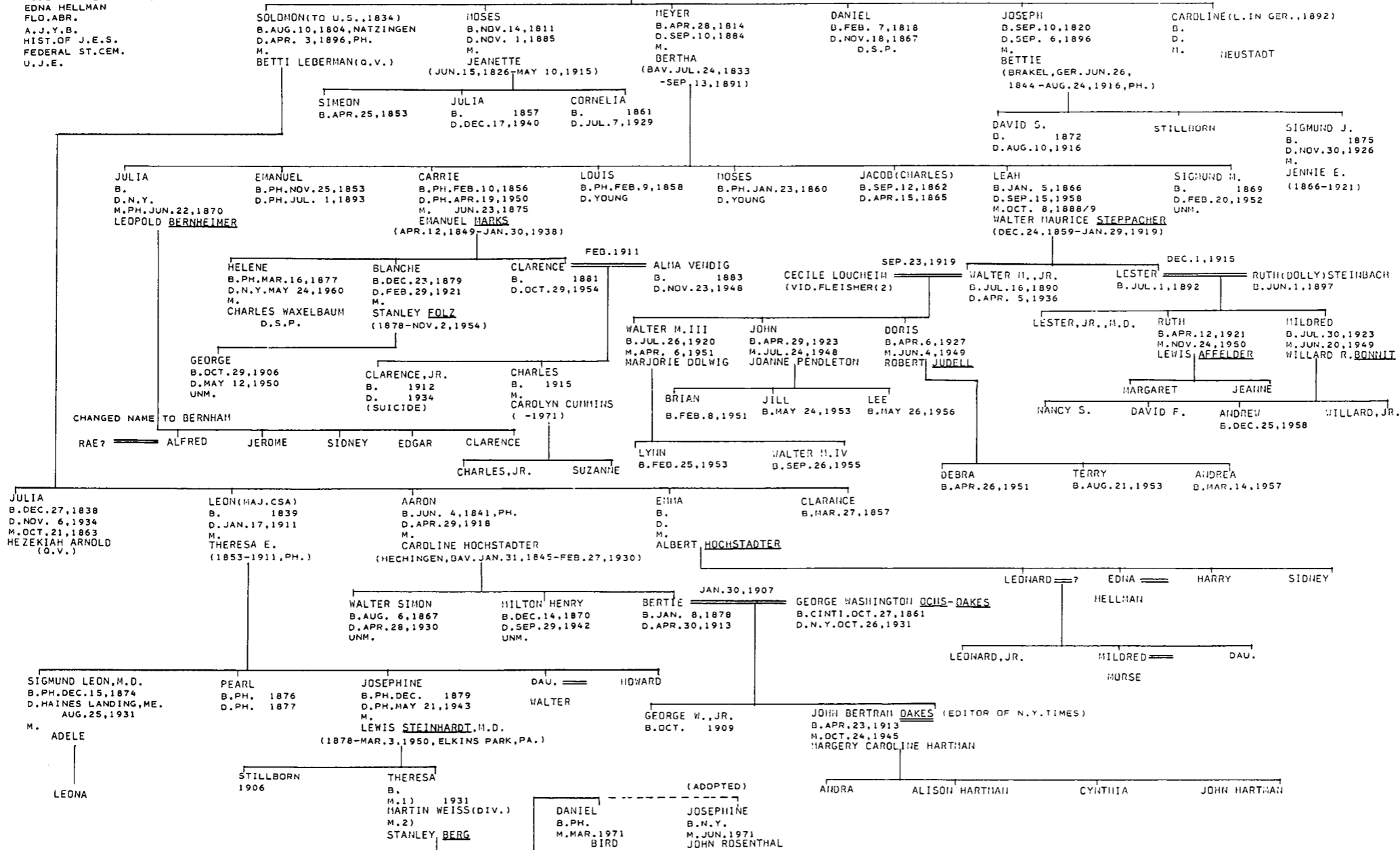

**GOLDSCHMIDT**

KRAUS-SANDOR COLL.  
WILL OF SAMUEL B.H. JUDAH

JOHN MEYER GOLDSCHMIDT  
B. SEP. 24, 1801, HAMBURG, GER.  
D. SEP. 21, 1877  
CAME TO N.Y., 1832

CELESTINE JUDAH  
(Q.V.I(1))  
JUN. 6, 1838

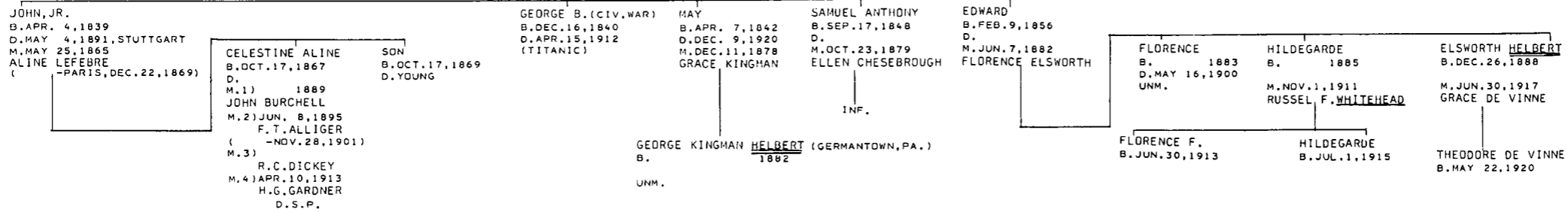

**GOLDSMITH**

ELZAS MSS.  
M.N.  
NEW JEW. CEM. OF BETH ELOHIM  
D.J.C.  
JRM COLL.  
FLORENCE ABRAHAMS  
ROSENSWAIKE

ISAAC M. GOLDSMITH  
B. ROTTERDAM 1774  
D. CH. SEP. 26, 1821

FRANCES (FANNY) PHILLIPS  
(Q.V.IV)

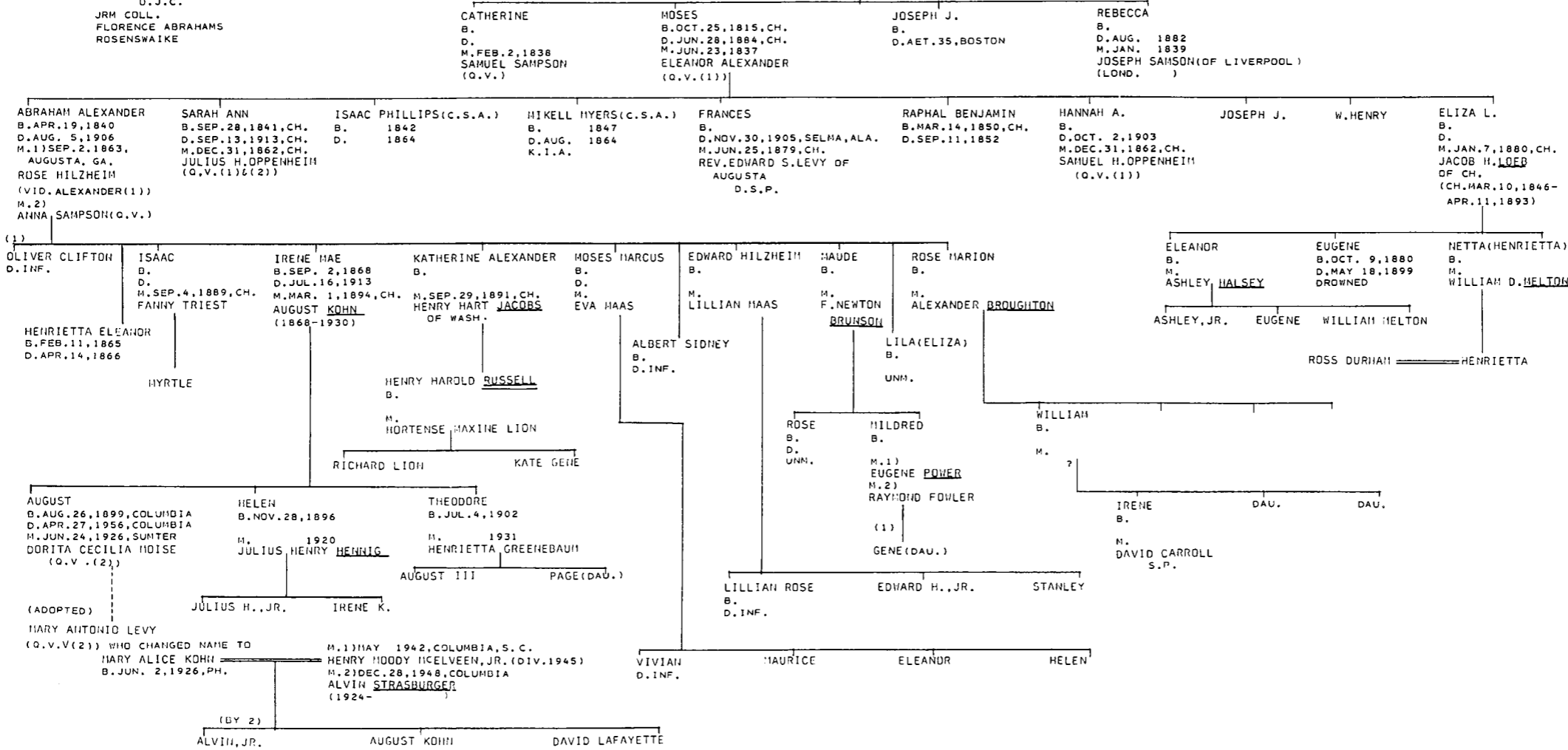

GOMEZ I

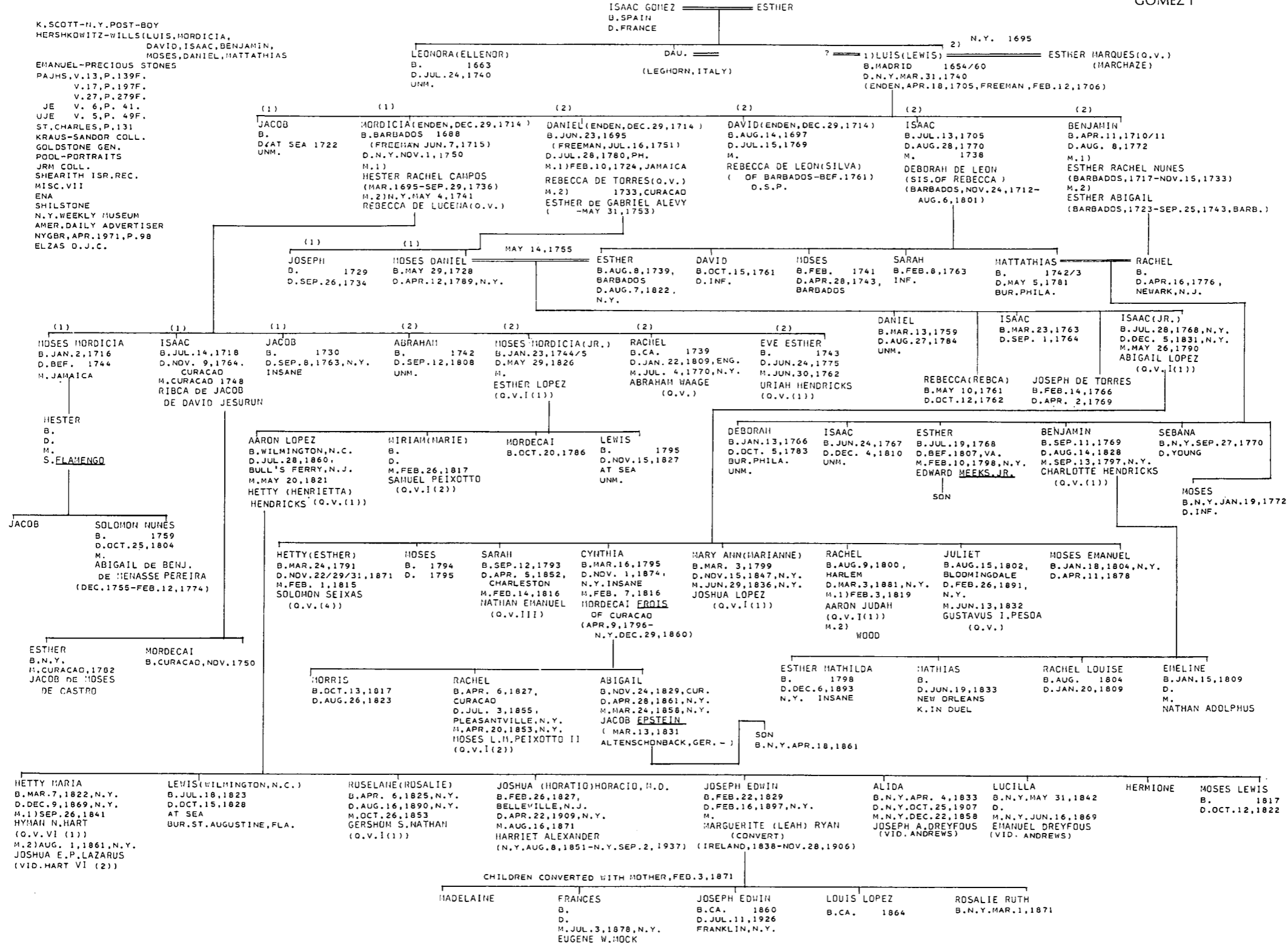

GOMEZ II

GUST MARK  
GLORIA LOUISE FLOWERS  
N.Y. WEEKLY MUSEUM

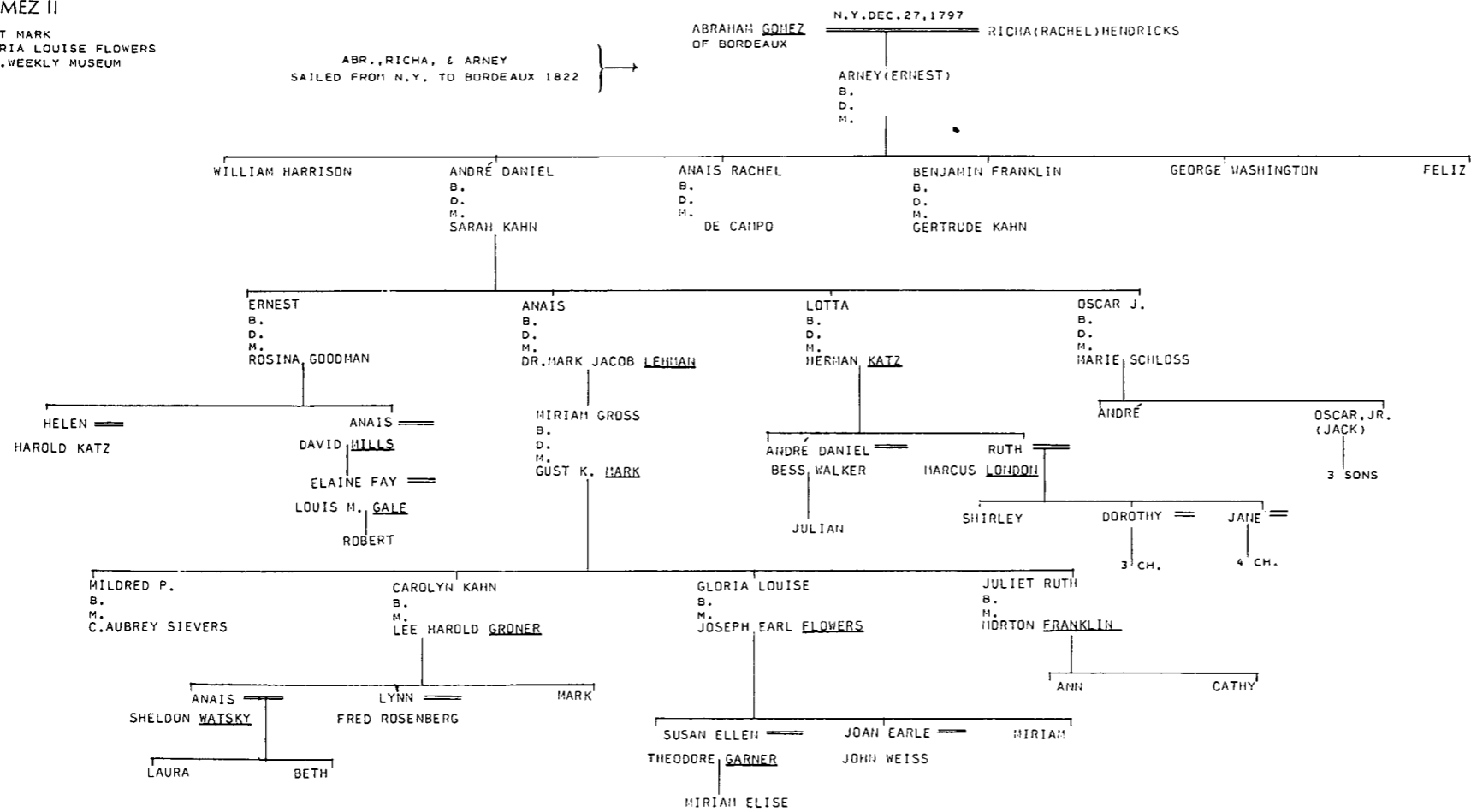

GRATZ (1)

DAR LIBRARY & LINEAGE BOOKS  
 BARNARD JACOBS MOHEL REC. (PHOTO.AJA)  
 FLORENCE ABRAHAMS  
 MISC.VI,#545  
 COHEN-ETTING CEM.  
 W.W.  
 BYERS-B. & M. GRATZ  
 ORGLER, BLOCH, GRATZ GEN.  
 GIST-CARY GEN.  
 N.Y. TIMES, SEPT. 8, 1974

J.E. V.6,P.83  
 U.J.E. V.5,P.317  
 A.J.Y.B. 5687,P.193F  
 PHILIPSON-LETTERS OF REBECCA GRATZ  
 PAJHS V.23,P.1F.  
 MORAIS-JEWS OF PHILA.,P.270  
 KRAUS-SANDOR COLL.  
 WILL OF JACOB HENRY (JRM COLL.)  
 MICKVE ISRAEL REC.  
 ROTH-ANGELO-JEWISH LETTERS  
 GRATZ CLIPPING (DAR)  
 FISH-RELIGIOUS FUNCTIONARIES  
 (MS.AJHS)

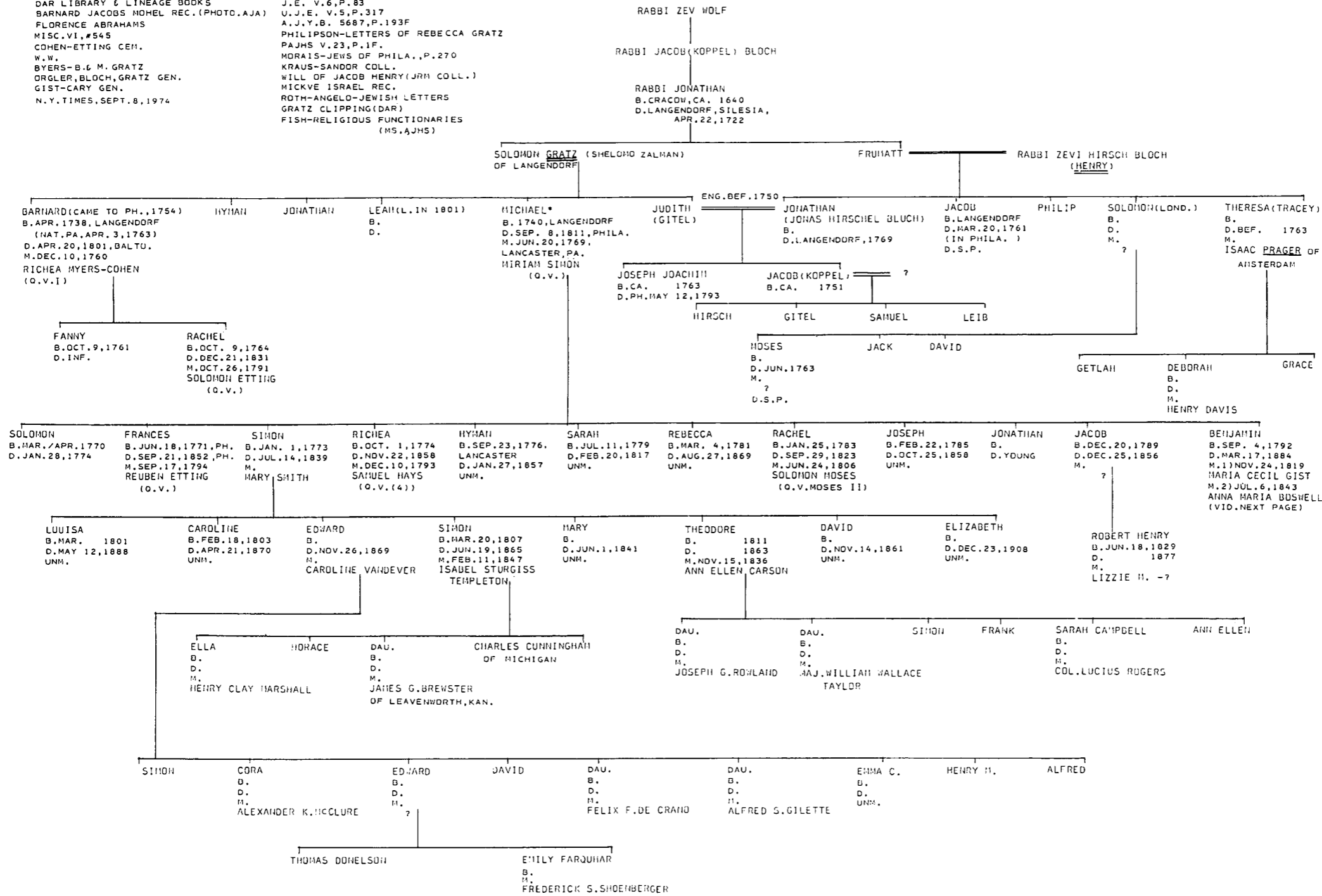

\* ESTABLISHED REVOLUTIONARY ANCESTOR

GRATZ (2)

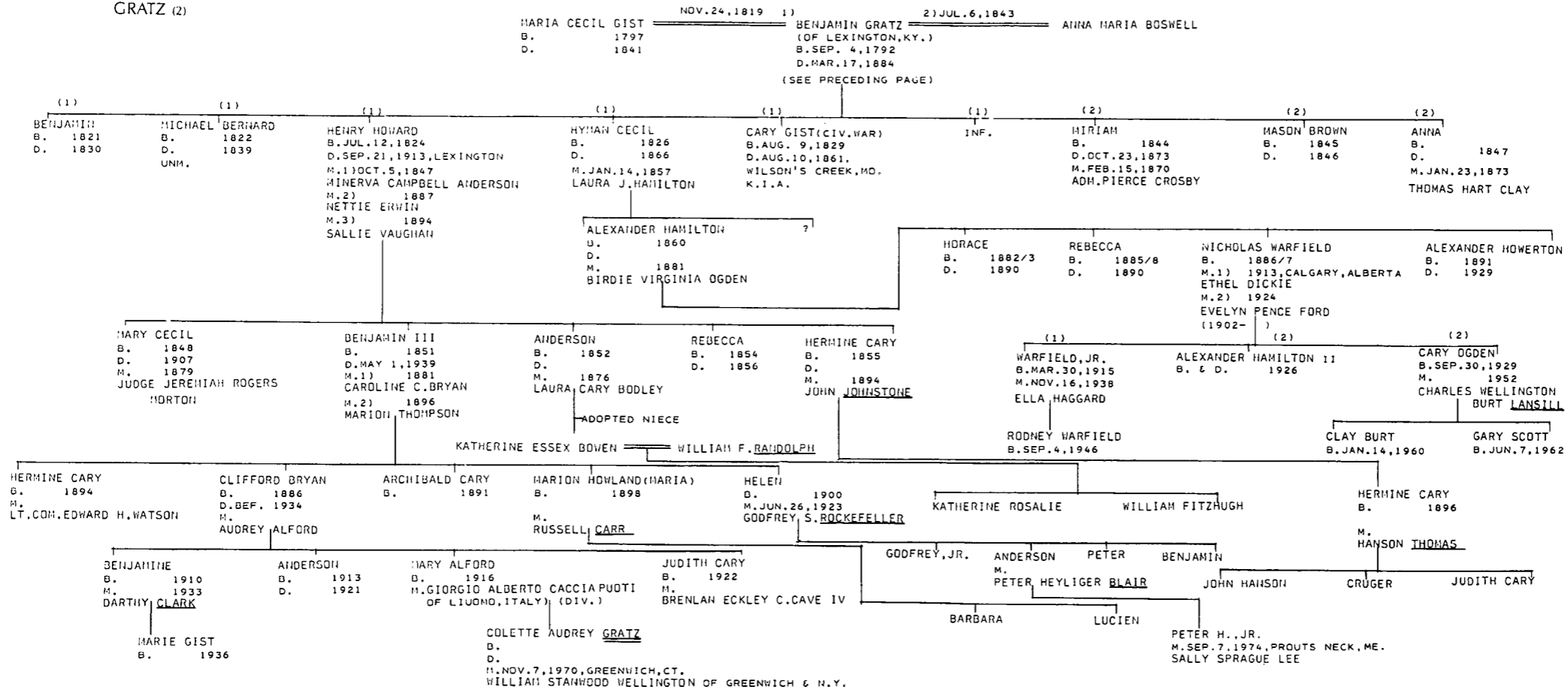

HAAS

KRAUS-SANDOR COLL.  
SHEARITH ISRAEL REC.  
SARAH SADOWSKY

BENJAMIN P. HAAS CHRISTINA

HARTWIG BERNARD (NEW BEDFORD, MASS., 1857)  
B. JUL. 8, 1826, ARNHEIM, HOLLAND  
D. OCT. 8, 1879, N.Y.  
M. AUG. 2, 1857, N.Y.  
SARAH SEIXAS (O.V. (4))

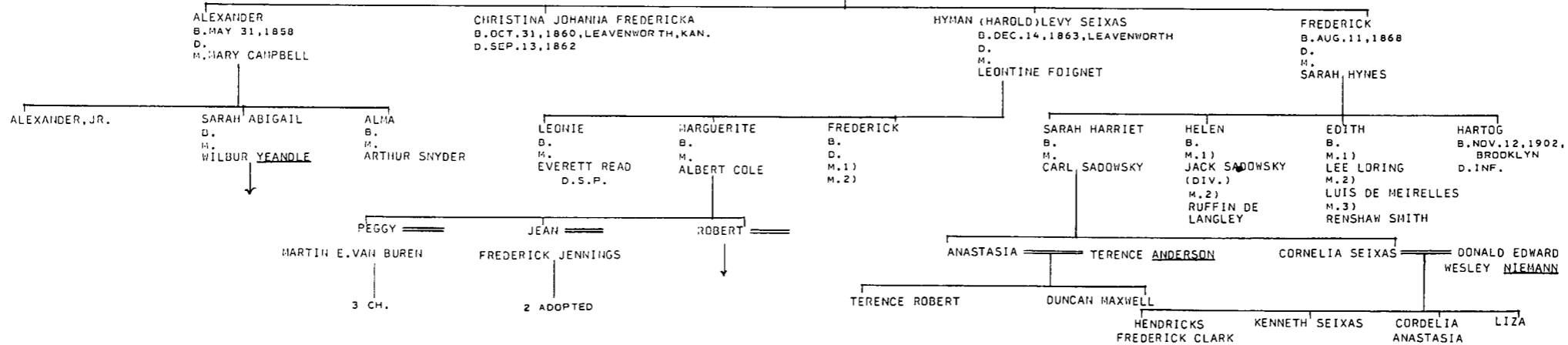

GUGGENHEIMER (1)

UJE  
GUGGENHEIMER FAMILY BIBLE  
SYDNEY CONE-GUGGENHEIMER  
EDNA L. LICHTENFELS-THE GUGGENHEIMER FAMILY TREE  
EZEKIEL-LICHTENSTEIN  
AJYB, 5665  
LYNCHBURG COURT RECS.  
CILLA G. NUSBAUM  
U.S. CENSUS-LYNCHBURG, 1850, 1860  
WHO'S WHO IN WORLD JEWRY,

BROTHERS OR COUSINS

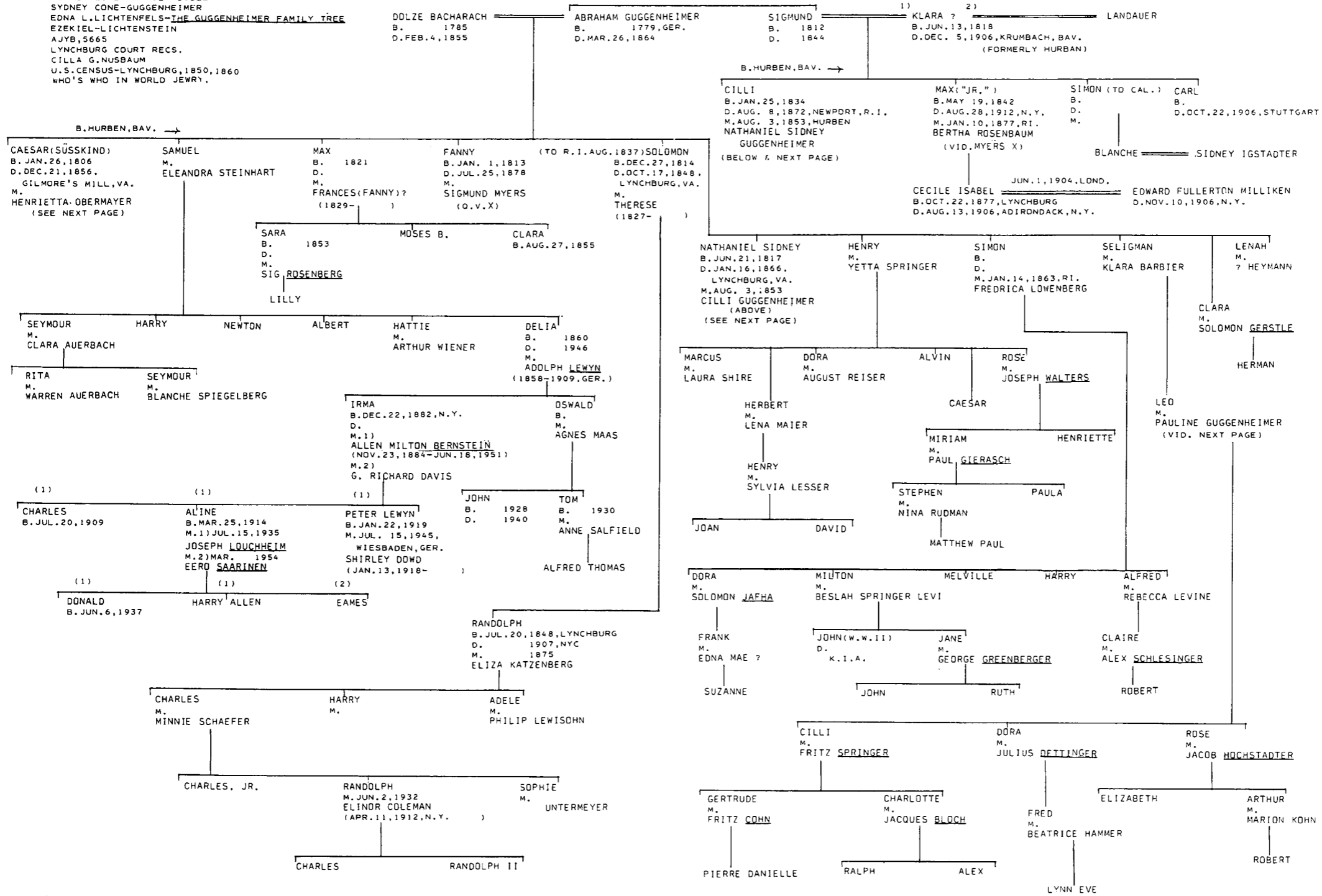



GUGGENHEIMER (2)

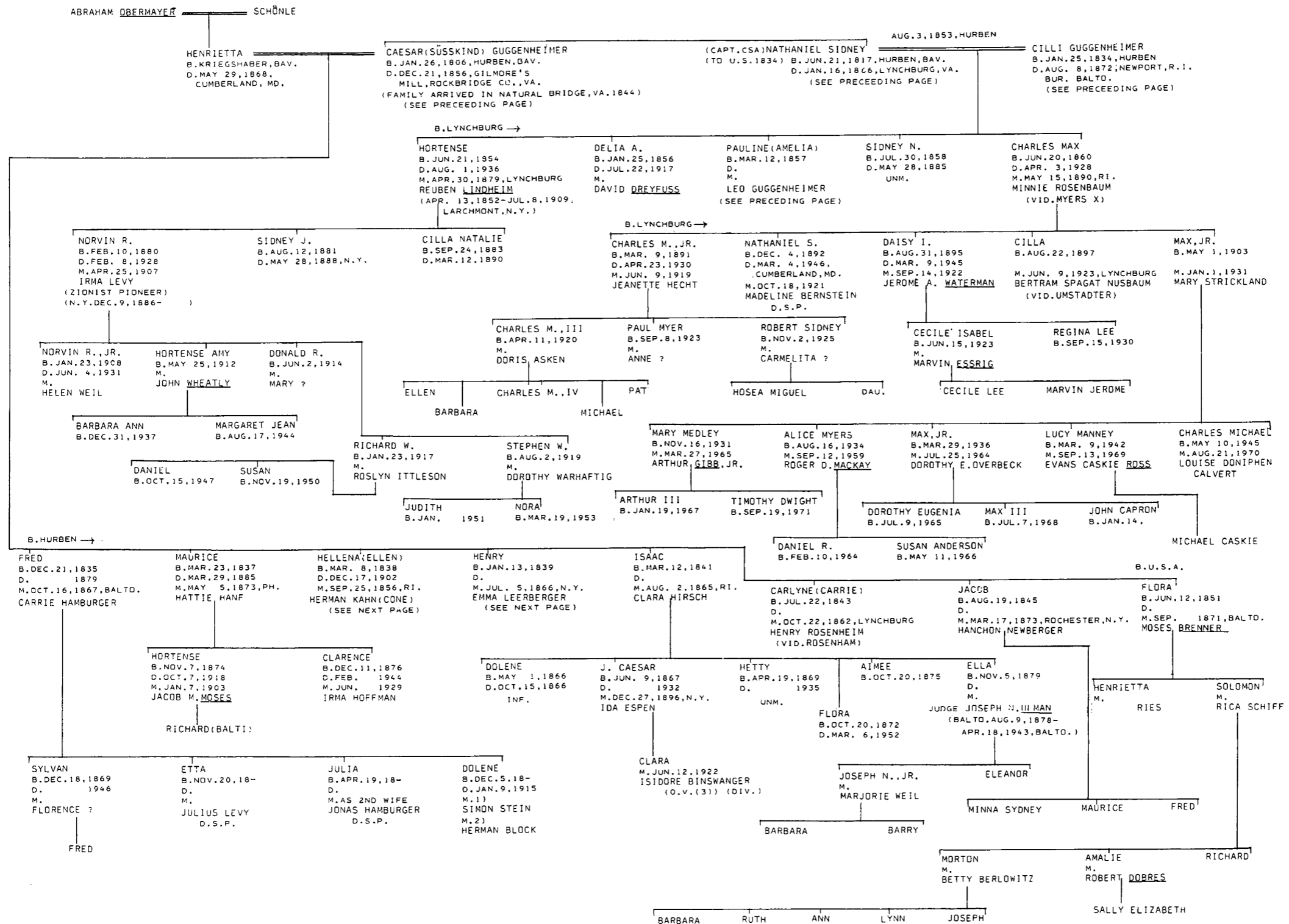

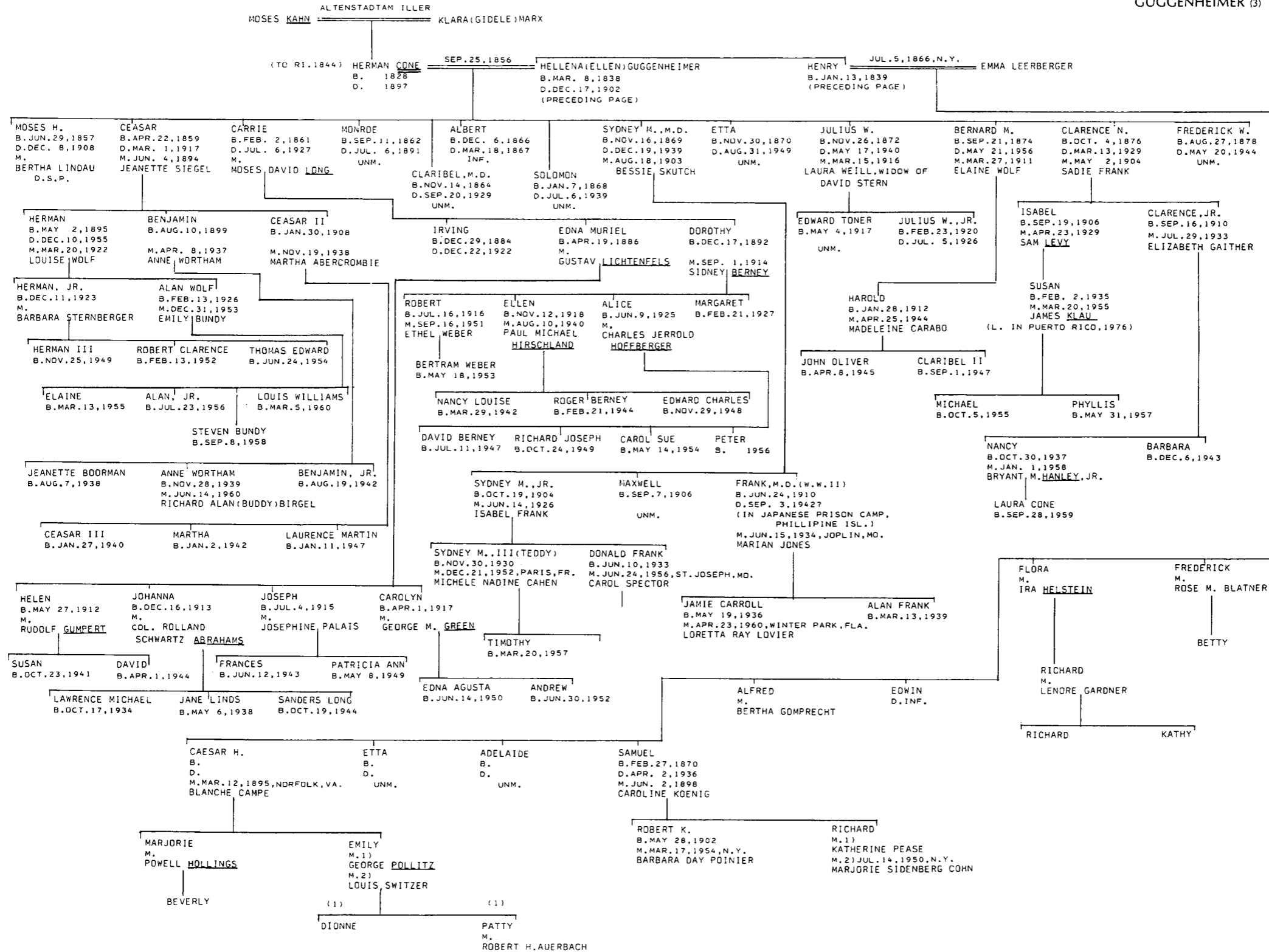

### HACKENBURG

MORAIJ-JEWS OF PHILA.  
ALLEN GEN.  
MICKVE ISRAEL REC.  
C.J.TELLER-TELLER FAMILY IN AMERICA  
W.W. P.490  
PAJHS,V.28,P.282,310

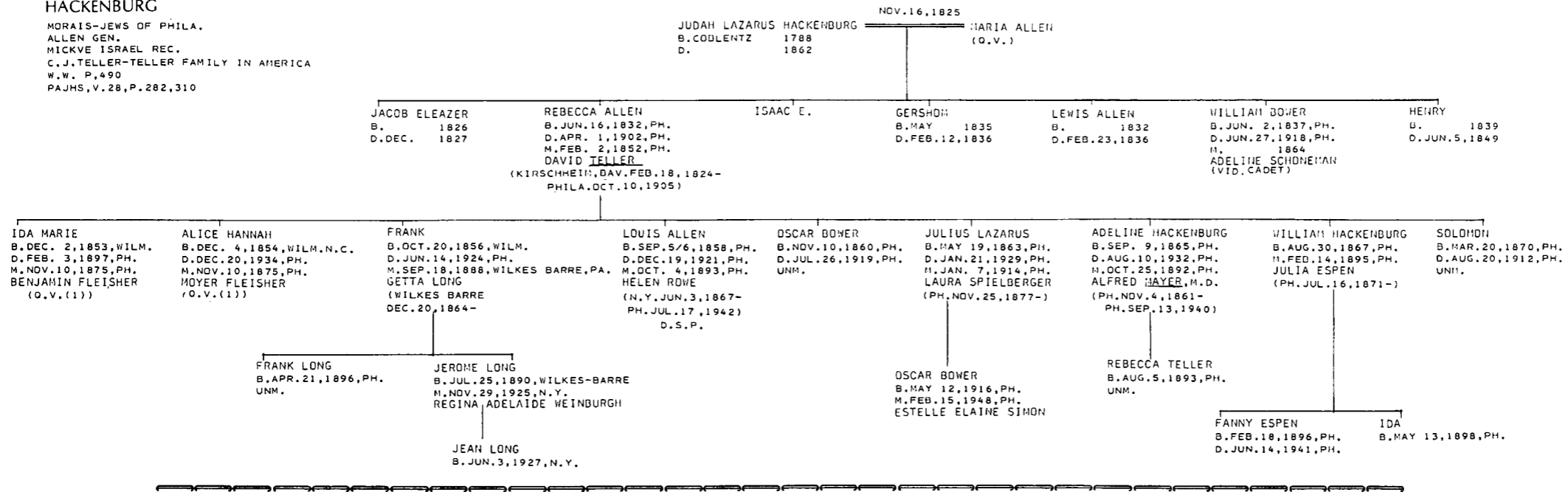

### HAMBURGER-MOSES-LEVY-HART

KRAUS-SANDOR COLL.  
ROTH-THE GREAT SYN., P.65  
BEVIS MARKS REC. I, P.30N.  
MURIEL CHESLER  
ANDRADE  
MISC. III & VII

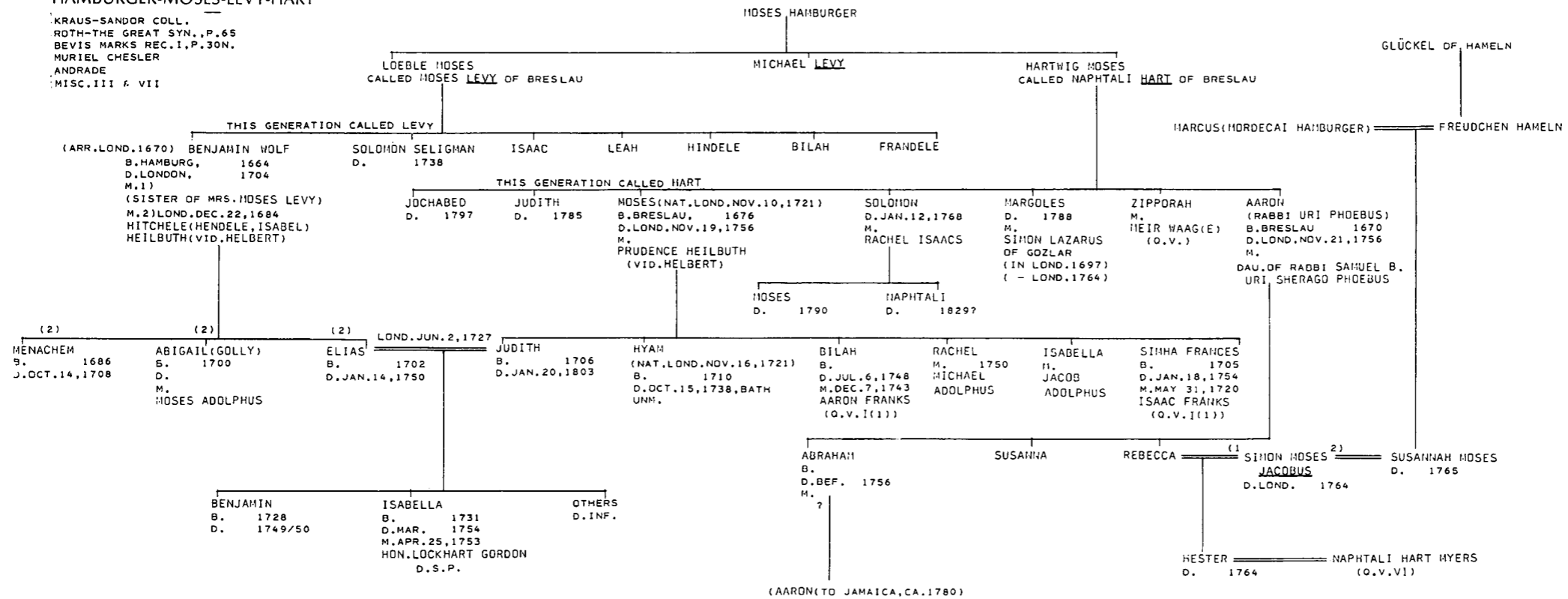

PAJHS V.2,P.147  
 PAJHS V.32,P.46F.  
 UJE V.5,P.213  
 MOSES GEN.  
 HARBY GEN.  
 WILL OF HENRY HARBY(JRM COLL.)  
 HARBY REC.(JRM COLL.)  
 WILL OF ABRAHAM COHEN(JRM COLL.)  
 ELZAS MS.  
 OJC.  
 DAR LINEAGE  
 MOISE-JEW.CEM.AT SUMTER  
 WILL OF GRACE ABENDANONE  
 WILL OF A TOBIAS HARBY  
 JANE L. RAISIN  
 KORN-N.O.,P. 82F.

HARBY

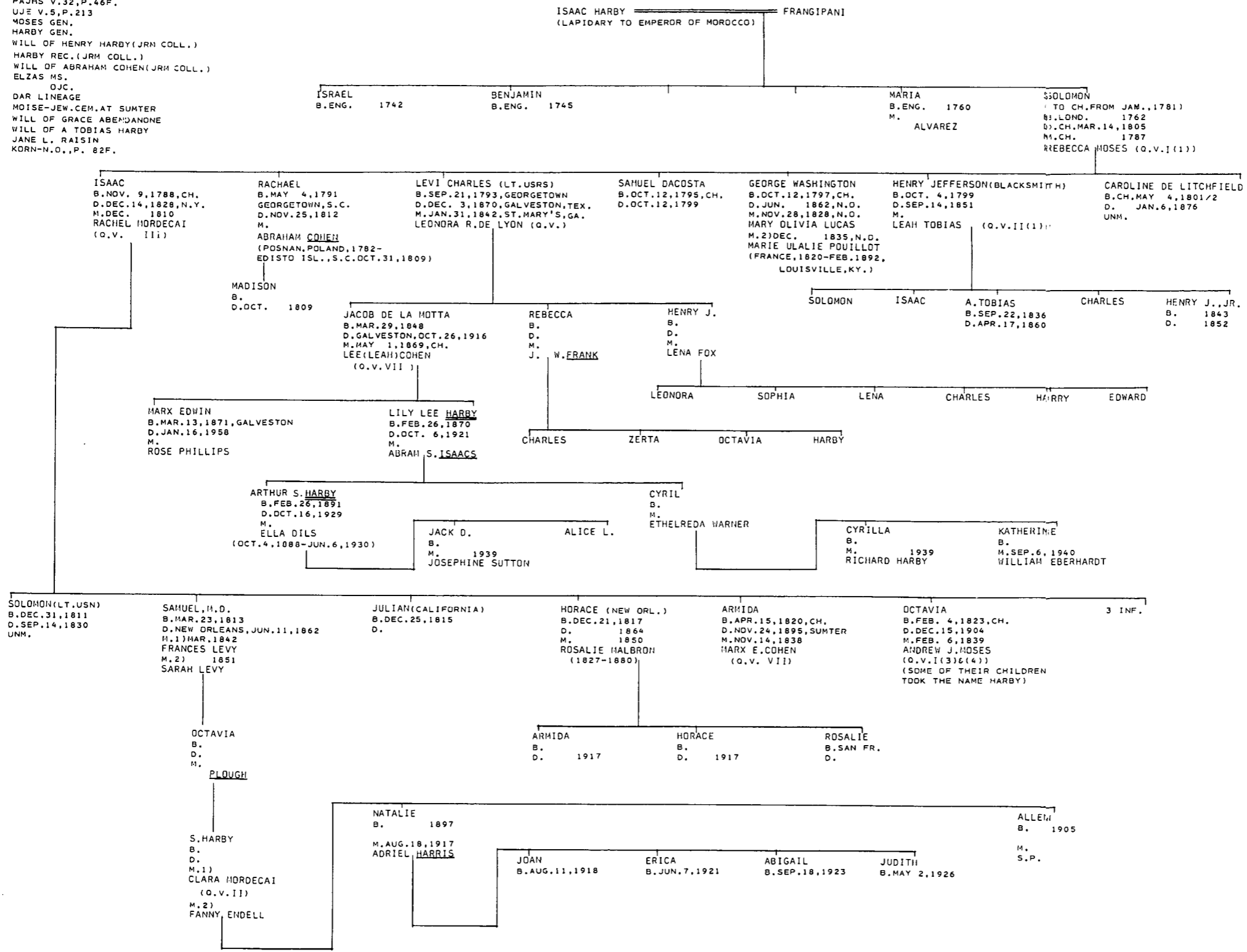

HARRIS I

MOSS-HARRIS GEN.  
NATHAN GEN.  
NATHAN GEN. (AJA)  
ELZAS MSS.  
SAUL VIENER (GOODMAN BIBLE)  
KORN-JEWS OF N.O.  
EGON WOLFF

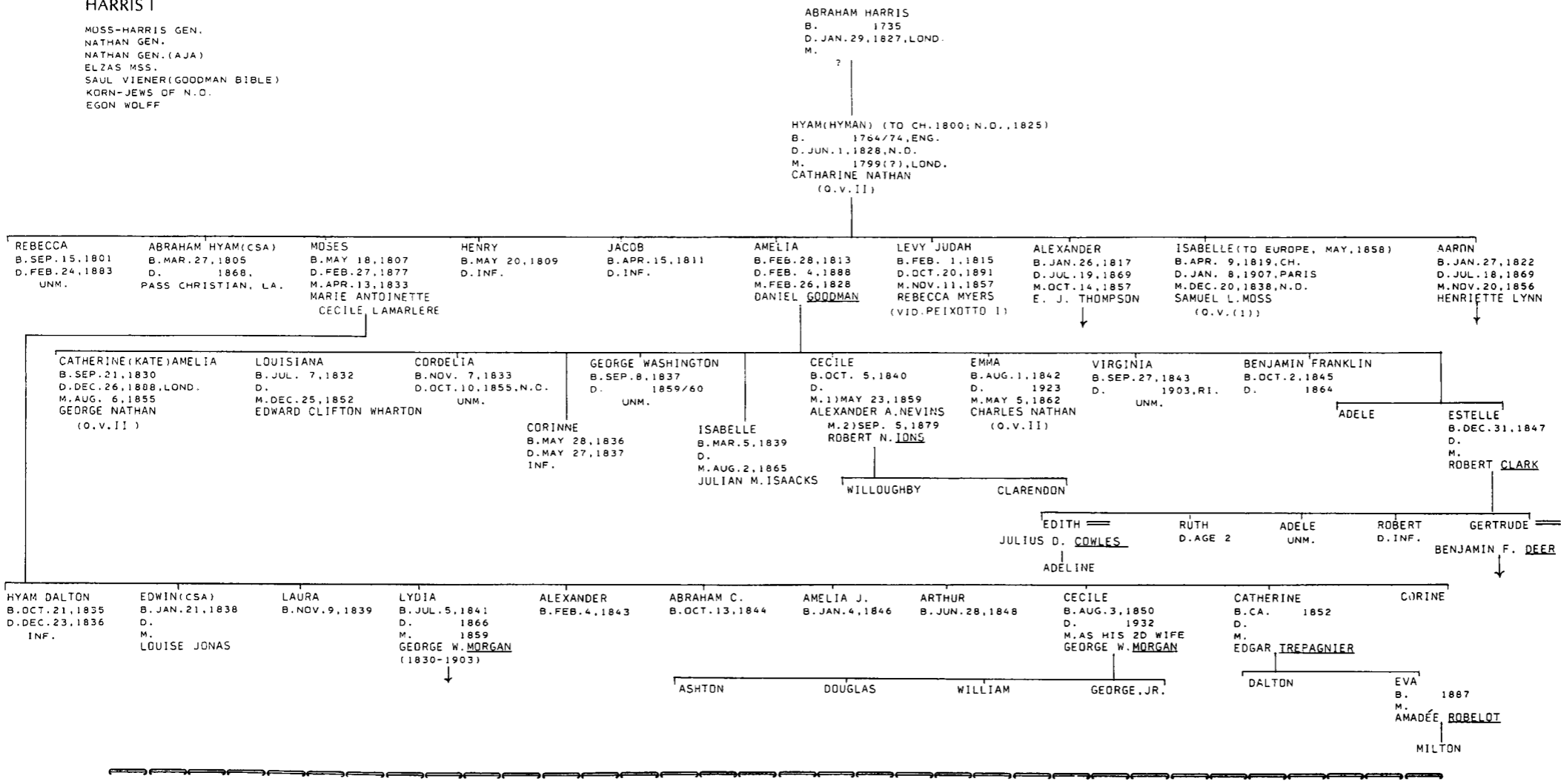

HARRIS II

ELZAS-JEWS OF S.C.  
M.N.  
D.J.C.  
JOHN F. ALEXANDER

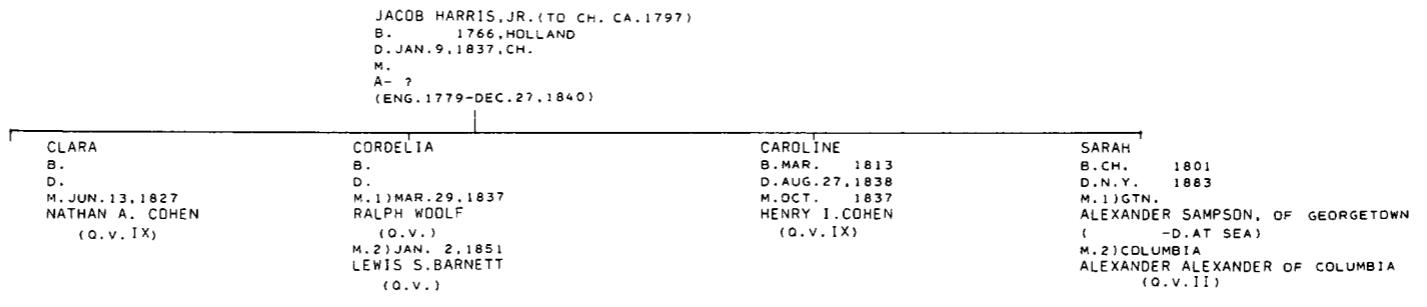

VALENTINE'S MANUAL  
PAJHS, V. 4, P. 215F.  
V. 27, P. 490F.  
UJE, V. 5, P. 223F.  
KRAUS-SANDOR COLL.  
N.Y. MARRIAGES  
MALCHELOSSE-LES JUIFS...  
MICKVE ISRAEL REC.  
SHEARITH ISRAEL REC.  
HART FAMILY REC. (MS. AJA)  
FLO. ABR.  
EVELYN MILLER  
N.Y. WEEKLY MUSEUM

H. J. HART VS. BENJAMIN HART 1849  
DOROTHEA HART CORR. MCCORD MUS.  
FANNY JOSEPH DIARY

(EZEKIEL) HART JUDAH (O.V. III)

HART I (O) CANADA

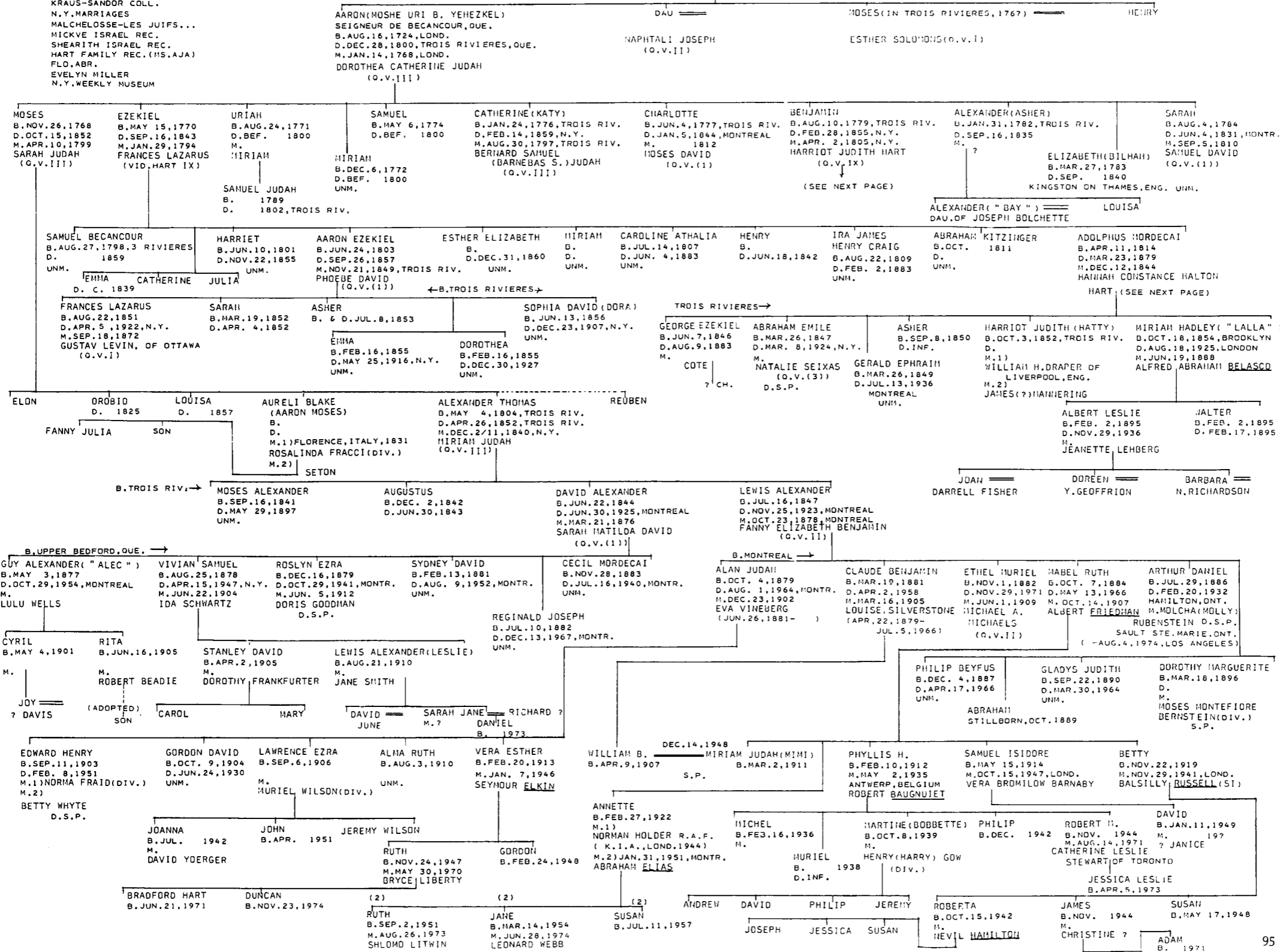

HART I (2) CANADA

BOSTON DIRECTORY OF 1850  
 HARRIOT HART VS. BENJAMIN HART 1849  
 ST. MARTIN'S PARISH RECORDS, ST. MARTINSVILLE, GA.  
 B.G. SACH, HISTORY OF THE JEWS IN CANADA

BENJAMIN HART APR. 2, 1805, N.Y.  
 B. AUG. 10, 1779, TROIS RIV.  
 D. FEB. 28, 1855, N.Y.  
 (SEE PRECEDING PAGE)

HARRIOT JUDITH HART  
 (O.V. IX)

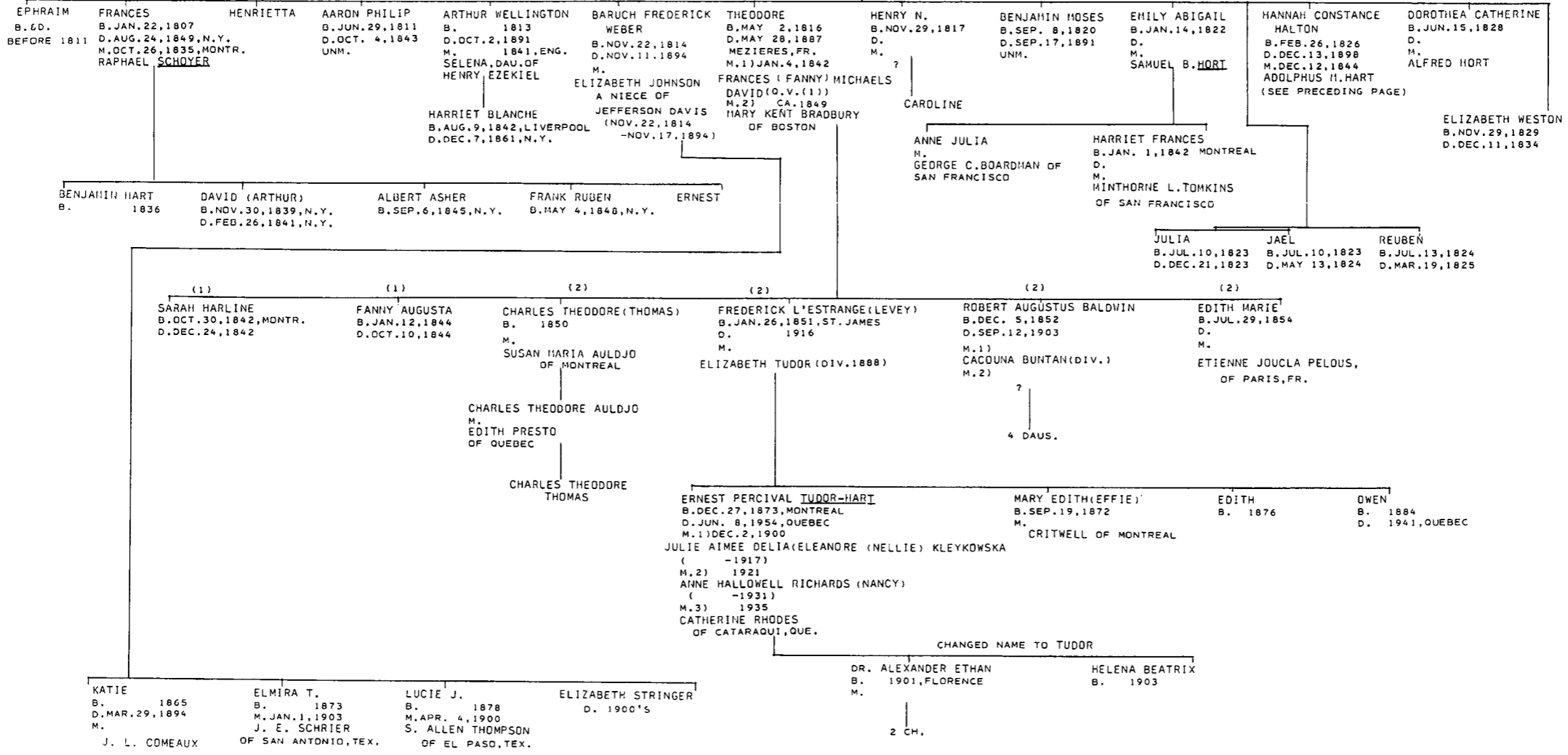

U.S. CENSUS 1860  
PAJHS V. 27, PP. 110, 164  
V. 32, P. 99F.  
UJE V. 5, P. 225  
KRAUS-SANDOR COLL.  
SHEARITH ISRAEL REC.  
THE OLD MERCHANTS, P. 119F.

HART II (N.Y.)

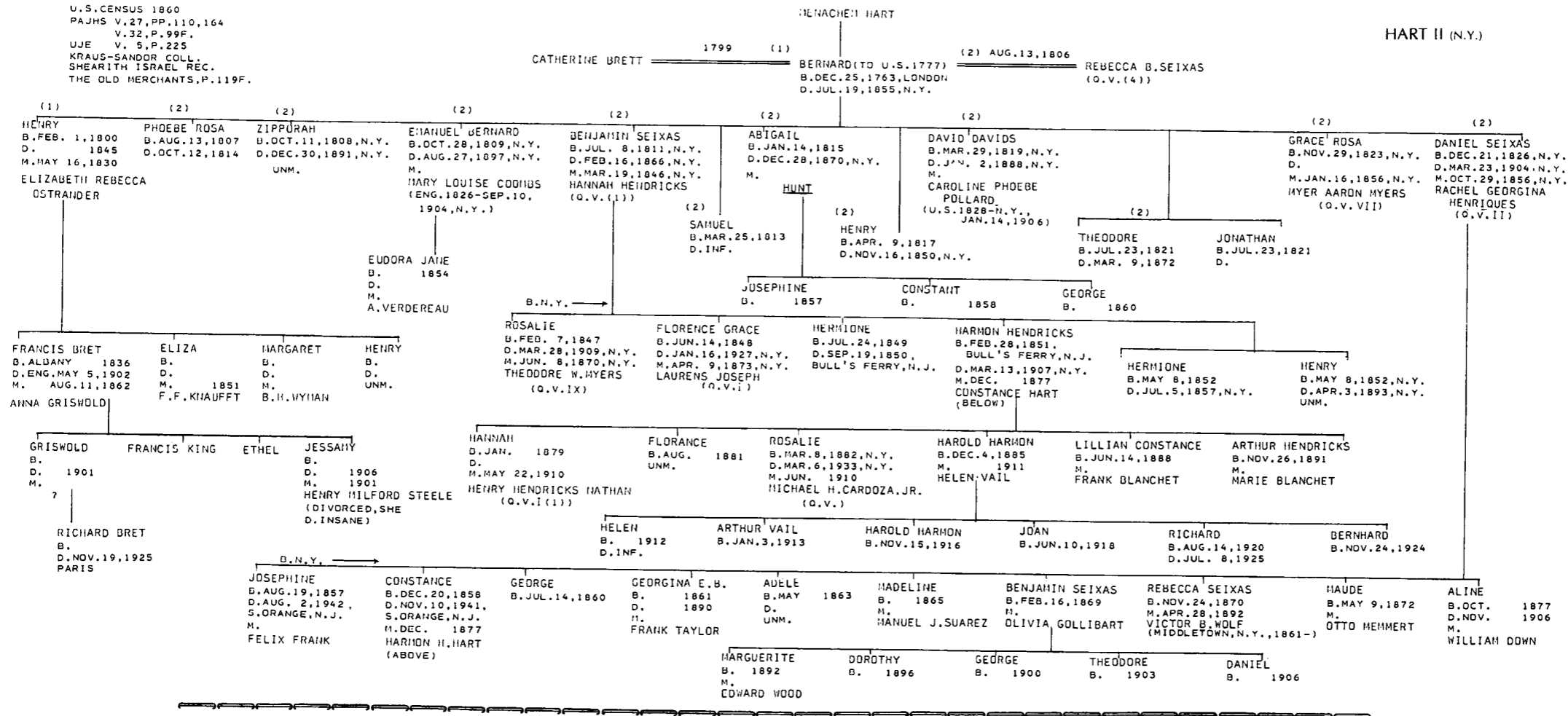

HART III (CHARLESTON, NEW ORLEANS)

WILLS OF PHILIP, ALEXANDER & HART M. HART (JRM COLL.)  
ELZAS MSS. DJC. KORN-N.O.

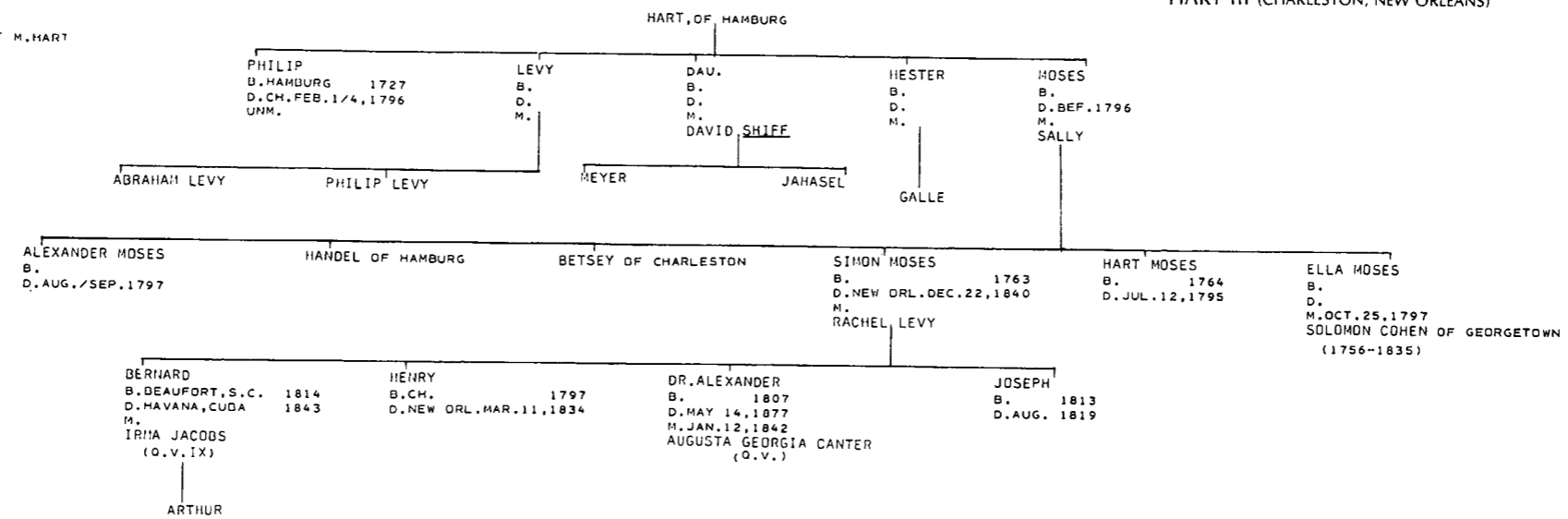



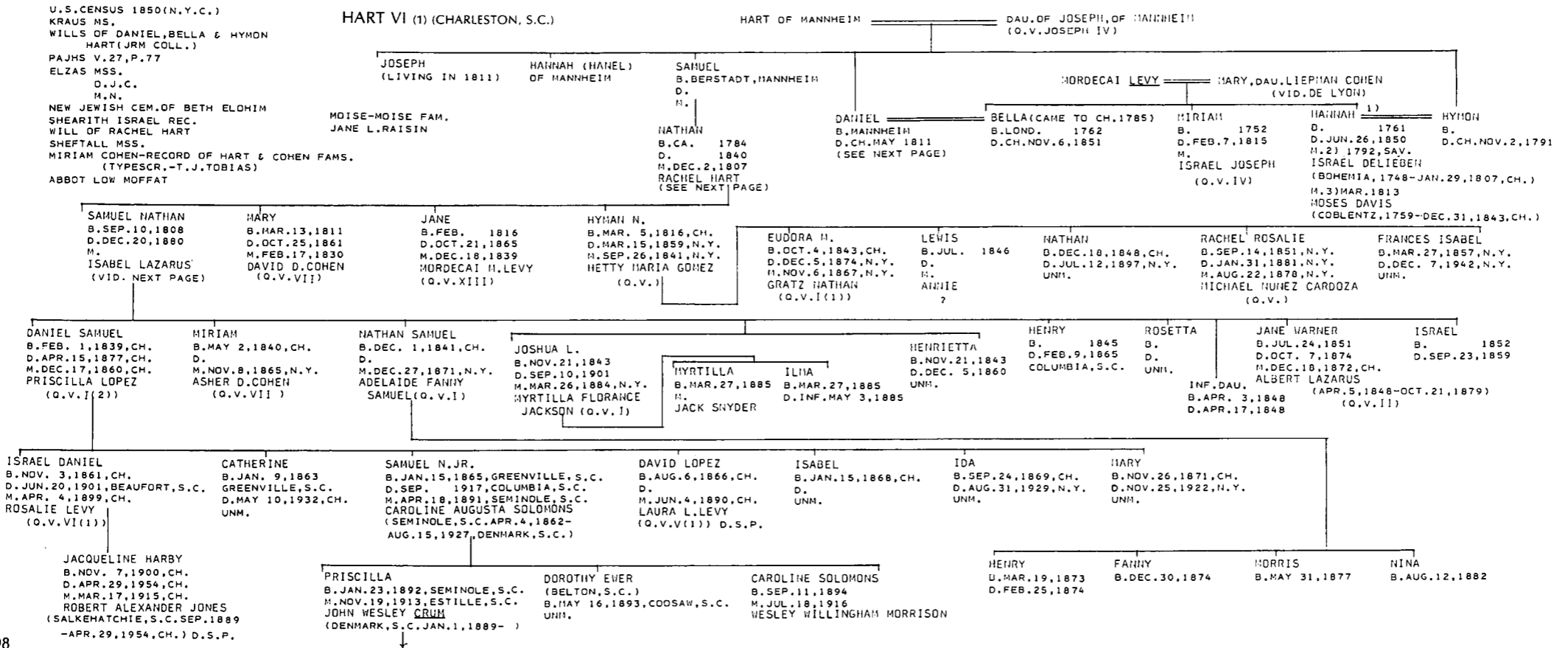
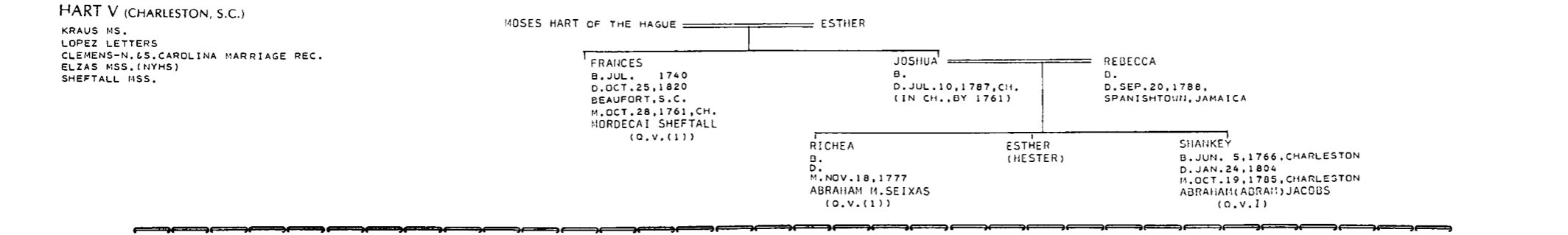
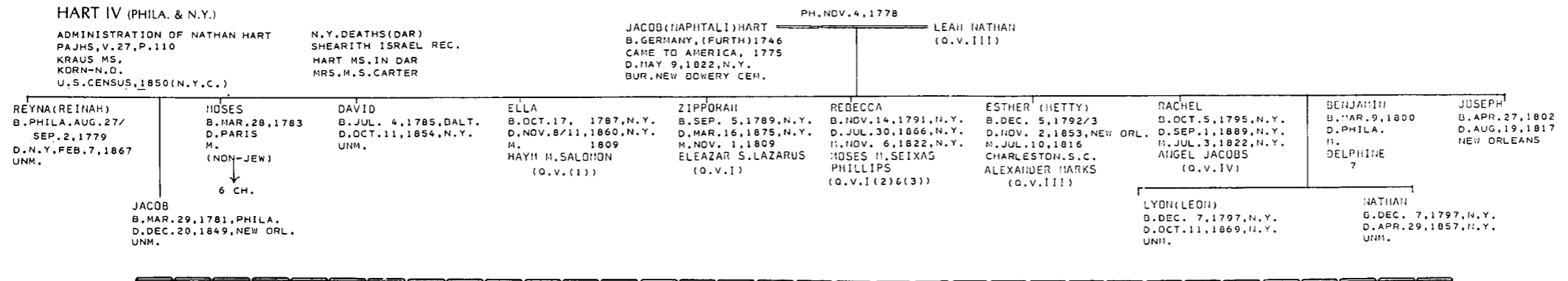

HART VI (2) (CHARLESTON, S.C.)

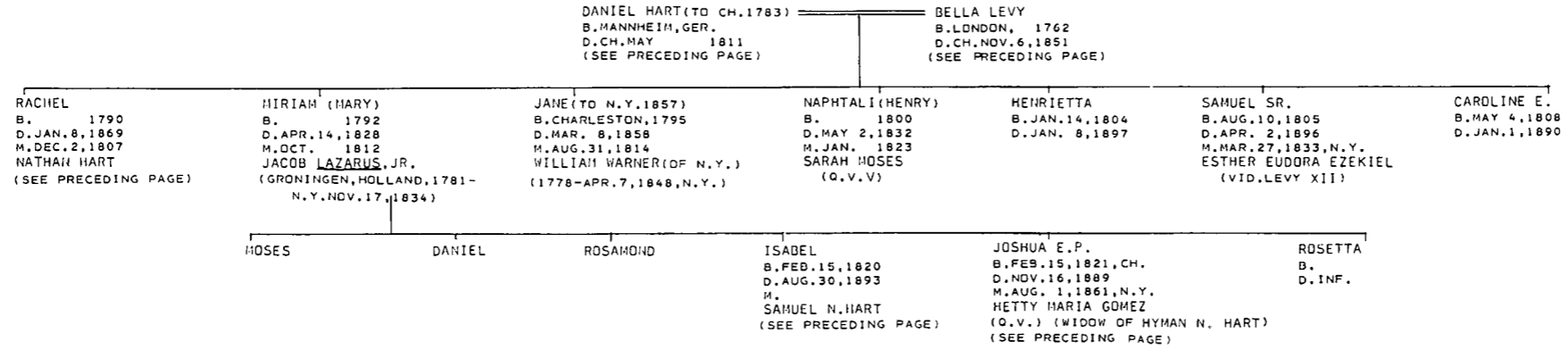

HART VII (LONDON, N. Y., & ST. EUSTATIUS)

KRAUS-SANDOR COLL.  
NEWPORT HISTORICAL MAG. V. 3 & 4  
ADMIN. OF AARON HART (K. SCOTT)  
E. N. A. P. 1050 F.  
HERSHKOWITZ-WILLS (AARON HART)

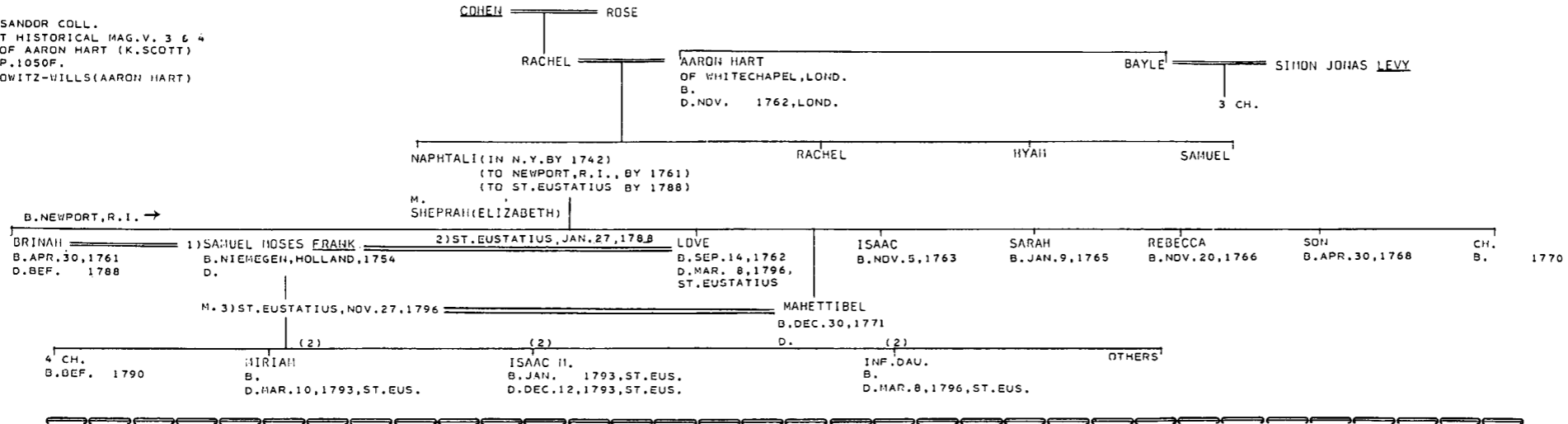

HART VIII (PHILA.)

MORAIJ-JEWS OF PH., P. 53 F., 337  
KRAUS MS.  
MICKVE ISRAEL REC.  
FLO ABR.  
FEDERAL ST. CEM.  
PH. BUR. OF HEALTH REC. (HSP)

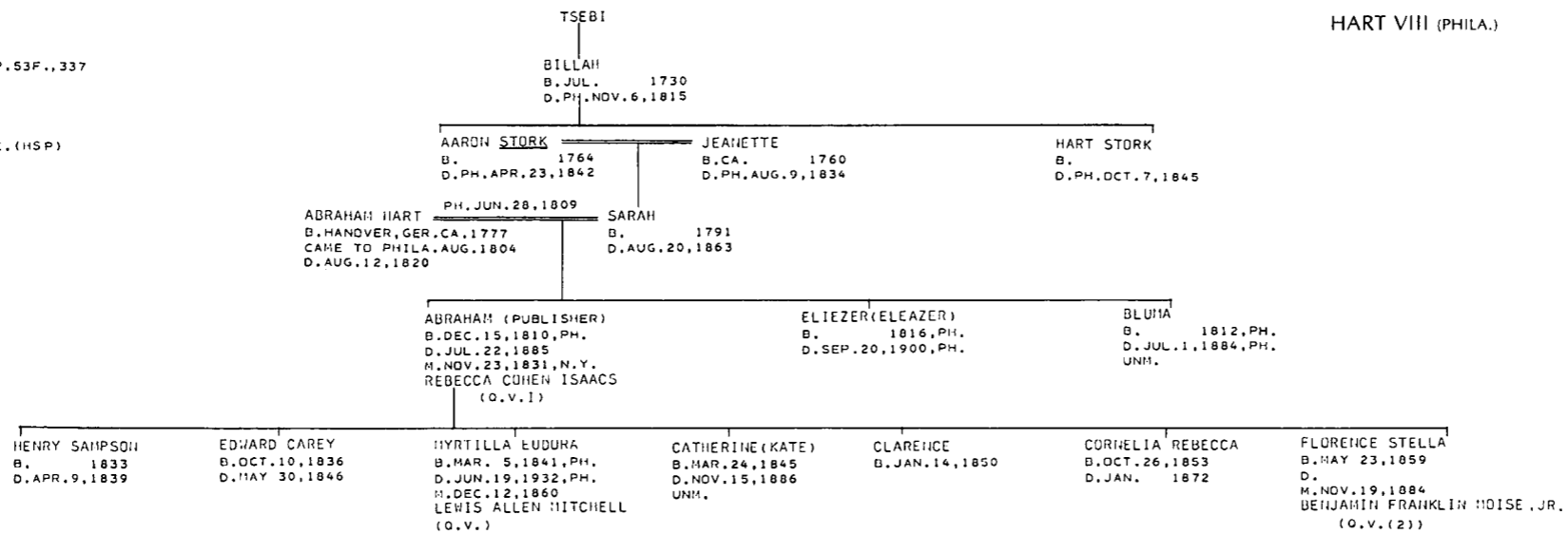

HART IX (N.Y.)

VALENTINE'S MANUAL  
 N.Y. WEEKLY MUSEUM  
 AMERICAN DAILY ADVERTISER  
 PAJHS V.4, P.215F.  
 PAJHS V.27, P.49F.  
 UJE V.5, P.223F.  
 KRAUS-SANDOR COLL.  
 GENEALOGICAL SOC. OF PA. (JRM COLL.)

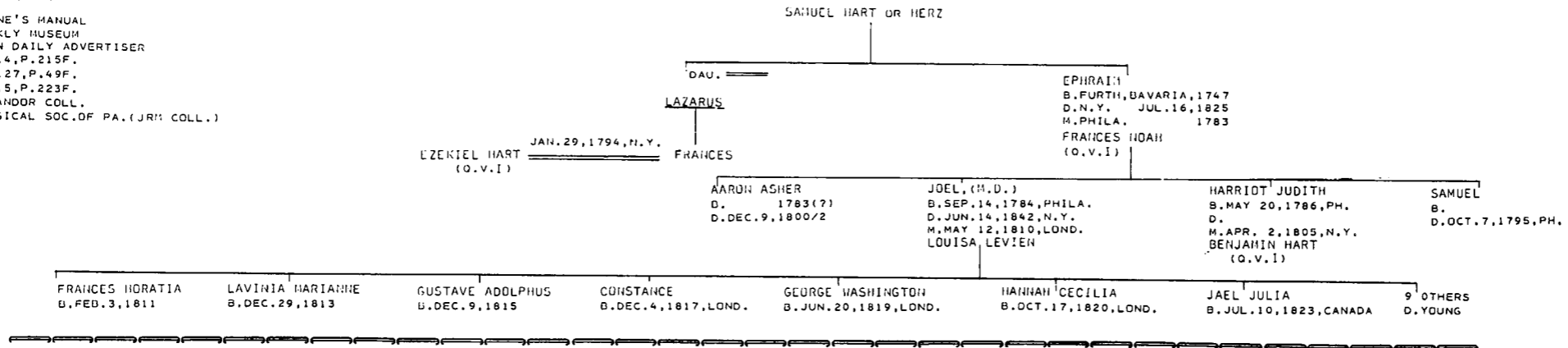

HART XI (PA.)

KRAUS-SANDOR COLL.

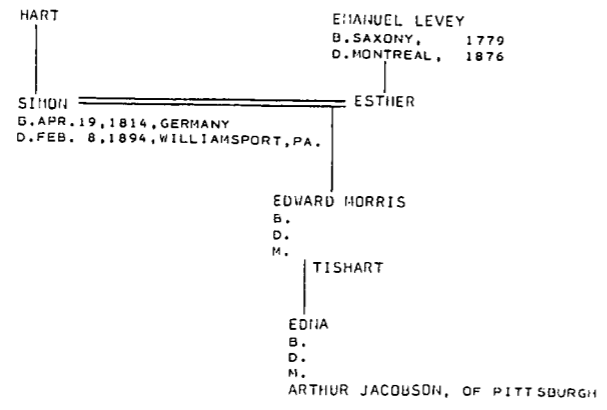

HART XII (CONN. & NEWPORT)

KRAUS-SANDOR COLL.  
 PAJHS V.38, P.87F.  
 NEWPORT HISTORICAL MAG.

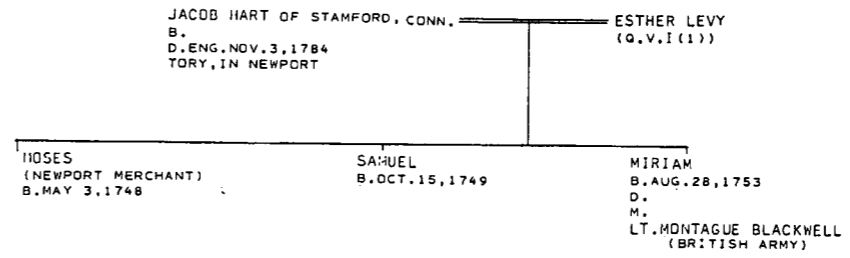

R.J.D'ARCY HART  
 AMY STEWART FAMILY REC.  
 GRINSTEIN-JEW. COMMUNITY OF N.Y.  
 B'NAI JESHURUN REC.  
 KORN-N.O.  
 IRVING KATZ  
 HART-WORKUM REC. (AJA)  
 JON STEDMAN  
 N.Y. CENSUS, 1855  
 KRAUS-SANDOR COLL.  
 U.S.E.V. 5, P. 228  
 FLO. ABR.  
 WILL OF JOHN I. HART  
 AJYB, 5666/67

HART X (1) (N.Y.)

HERTZ JUDAS (NAPHTALI HART) OF NIEDERWEISEL, WETTERAU

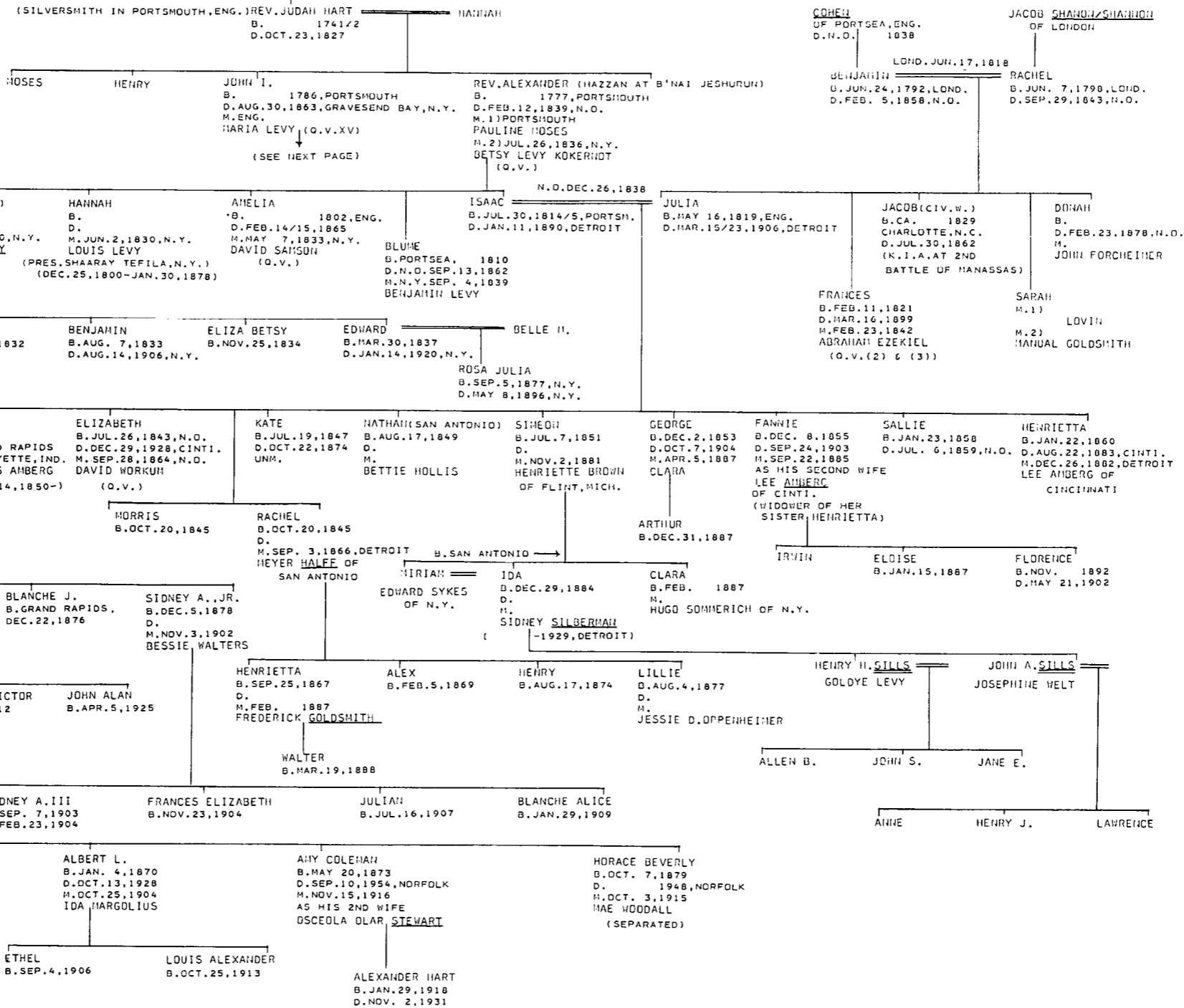

HART X (2) (N.Y.)

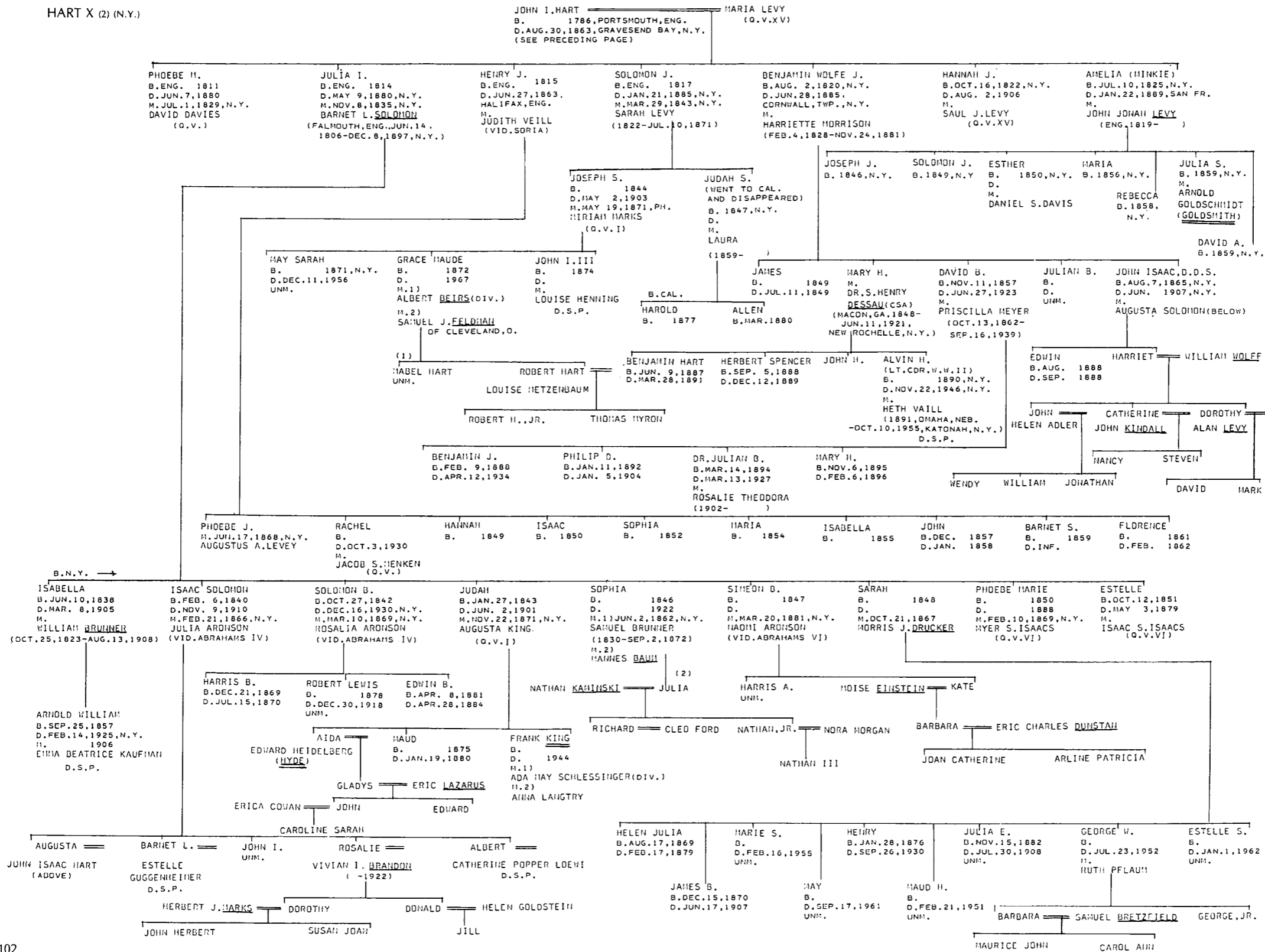

HART XIII (EASTON)

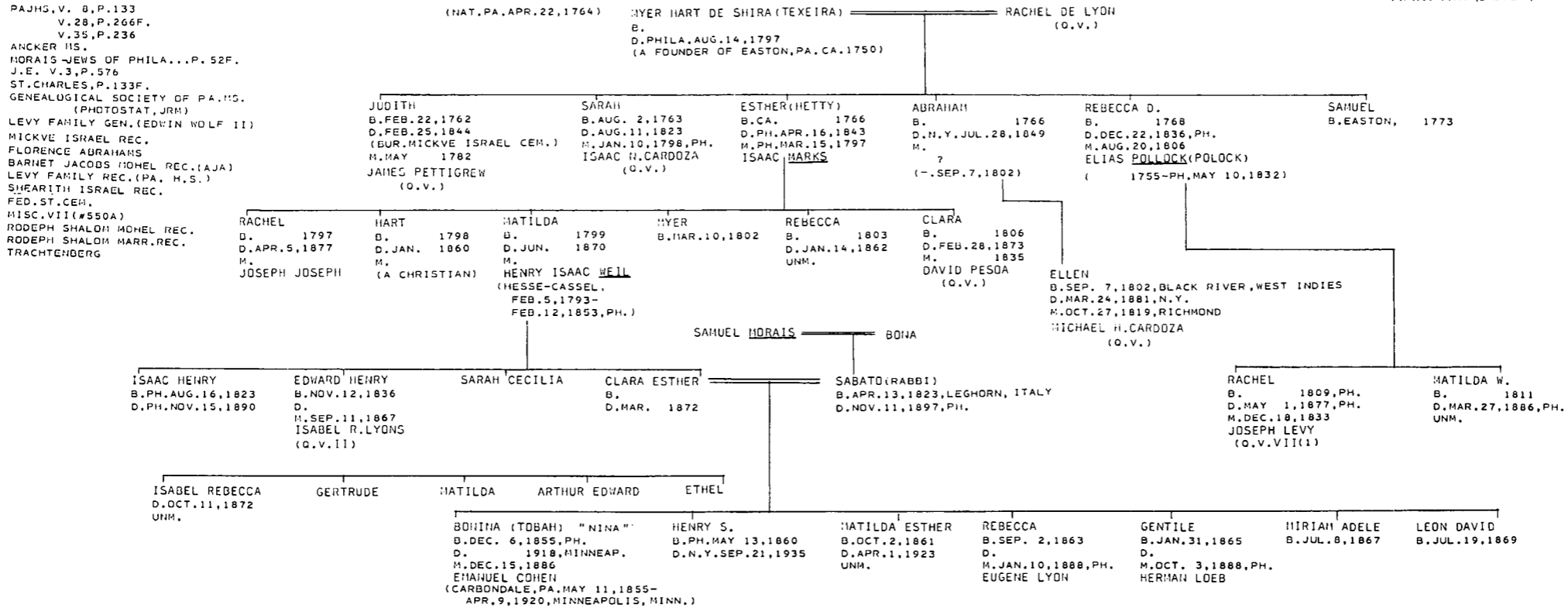

HART XIV (EASTON)

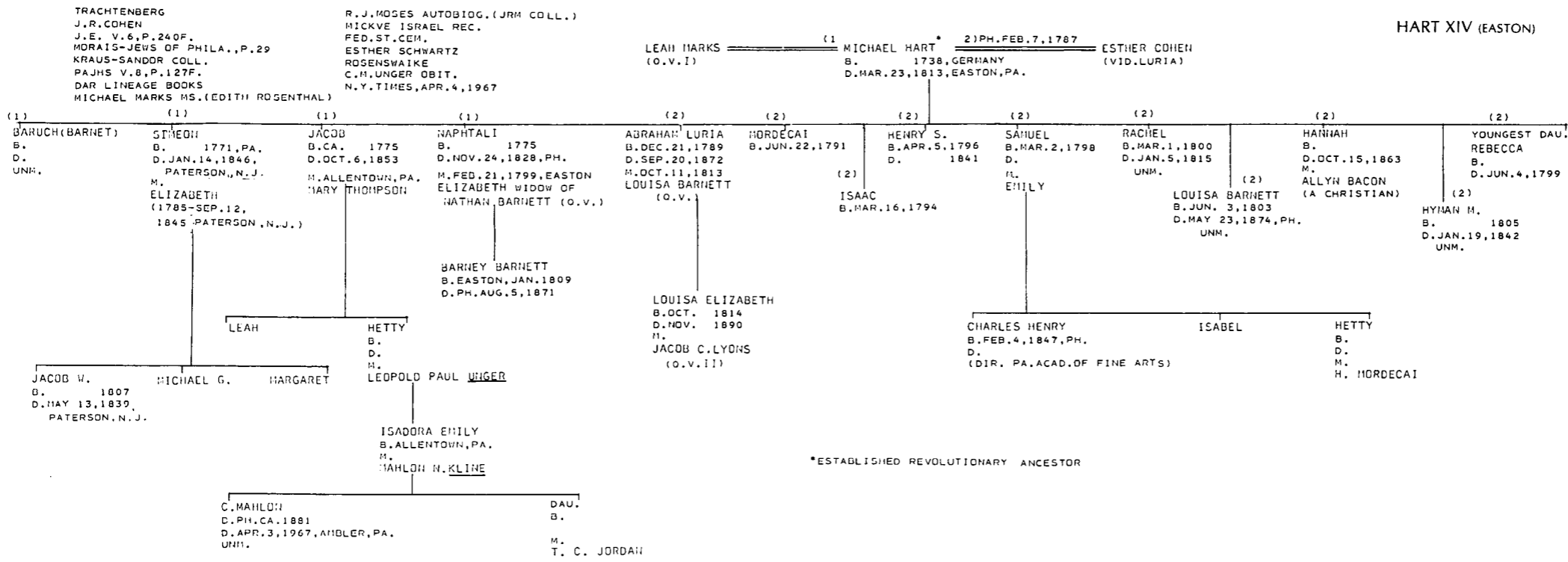

HAYS (1)

HERSKOWITZ WILLS (JUDAH, MICHAEL, YITLAH)  
 AJYB, 5666/67  
 VALLENTINE'S MANUAL  
 SHEFTALL MSS.  
 EHRENFRIED-BOSTON  
 MOSES M. HAYS & JUDAH HAYS REC.  
 N.Y. WEEKLY MUSEUM  
 N.Y. CENSUS 1855  
 OBIT. OF GRACE DOS PASSOS  
 WHO'S WHO IN AMERICA  
 (JOHN R. DOS PASSOS)  
 J.R. COHEN  
 POULSON'S  
 FEDERAL ST. CEMETERY  
 EVELYN MILLER

PAJHS V. 2, P. 63F.  
 V. 12, P. 106F.  
 V. 16, P. 27F.  
 V. 29, PP. 151F, 194, 329 F.  
 V. 33, P. 199F.  
 J.E. V. 6, P. 270  
 U.J.E.V. 5, P. 255  
 MORAIS-JEWS OF PHILA.  
 EZEKIEL-LICHTENSTEIN-JEWS OF RICHM.  
 KRAUS-SANDOR COLL.

PHILIPSON-LETTERS OF REBECCA GRATZ  
 MICKVE ISRAEL REC.  
 SULZBERGER GEN.  
 MYERS-HAYS-MORDECAI MSS. (VA. HIST. SOC.)  
 WILL OF JUDAH HAYS (OPPENHEIM COLL. AJHS)  
 GRATZ CLIPPING (DAR)  
 MALCHELOSSE-LES JUIFS CANADIENNES-...  
 POOL-PORTRAITS...  
 SHEARITH ISRAEL REC.  
 MYER SOLIS-COHEN

SOLOMON HAYS

MICHAEL (JECHIEL)  
 B. HOLLAND  
 D. AUG. 1740

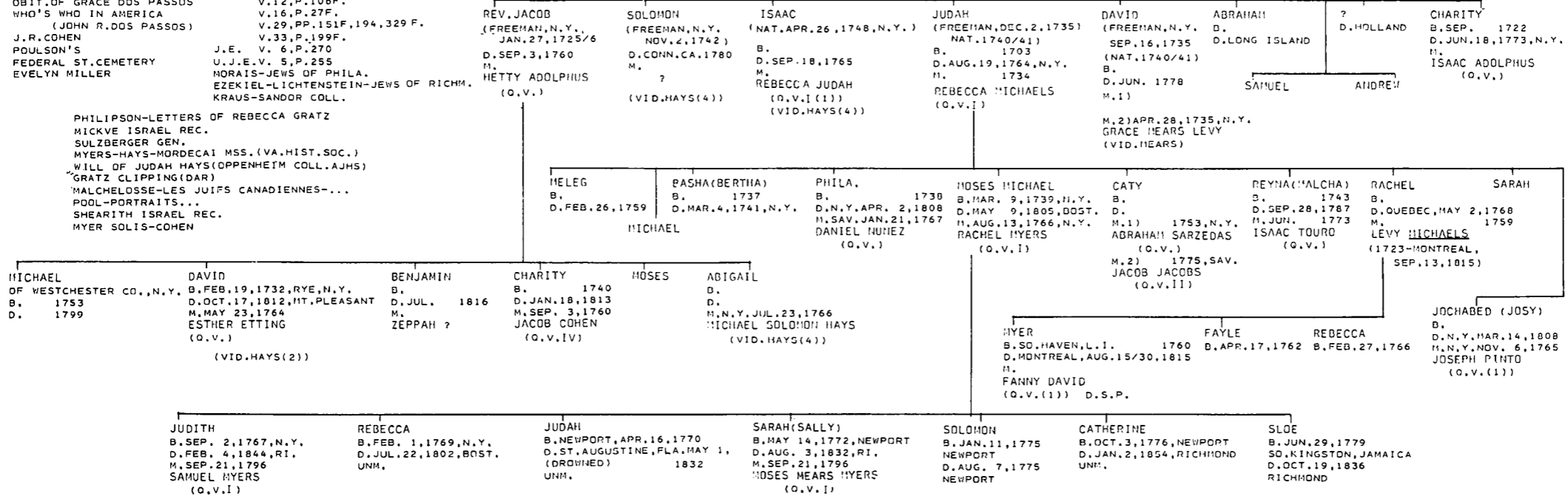

HAYS (2)

DAVID HAYS, JR. (SEE HAYS (1))  
 ESTHER ETTING (O.V.)

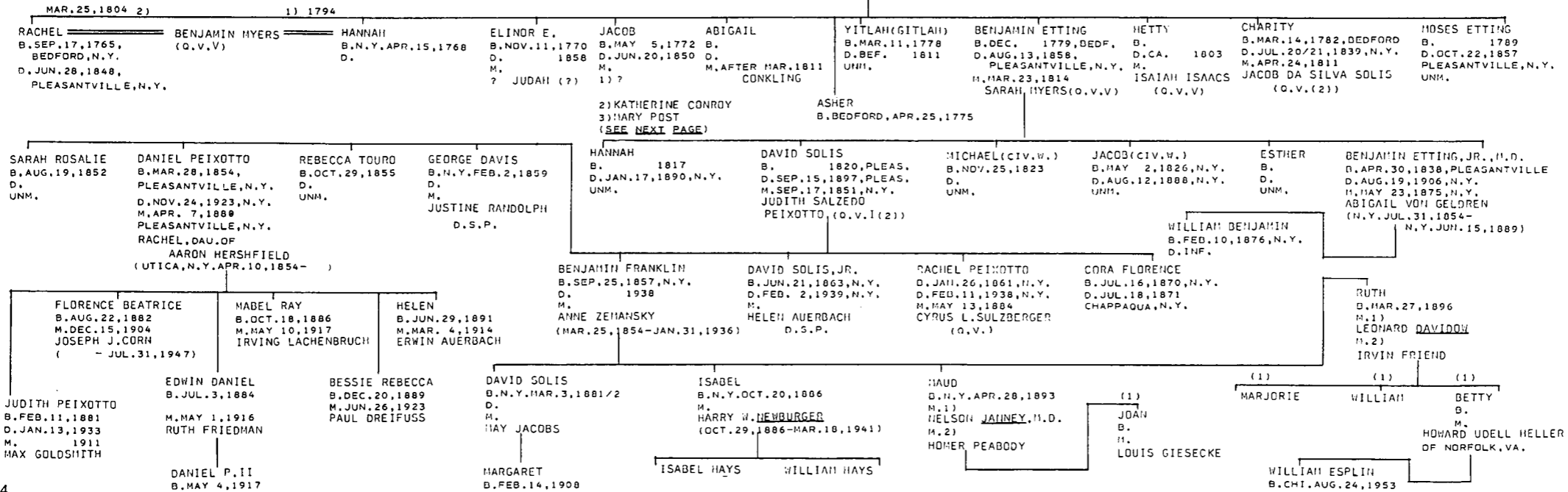

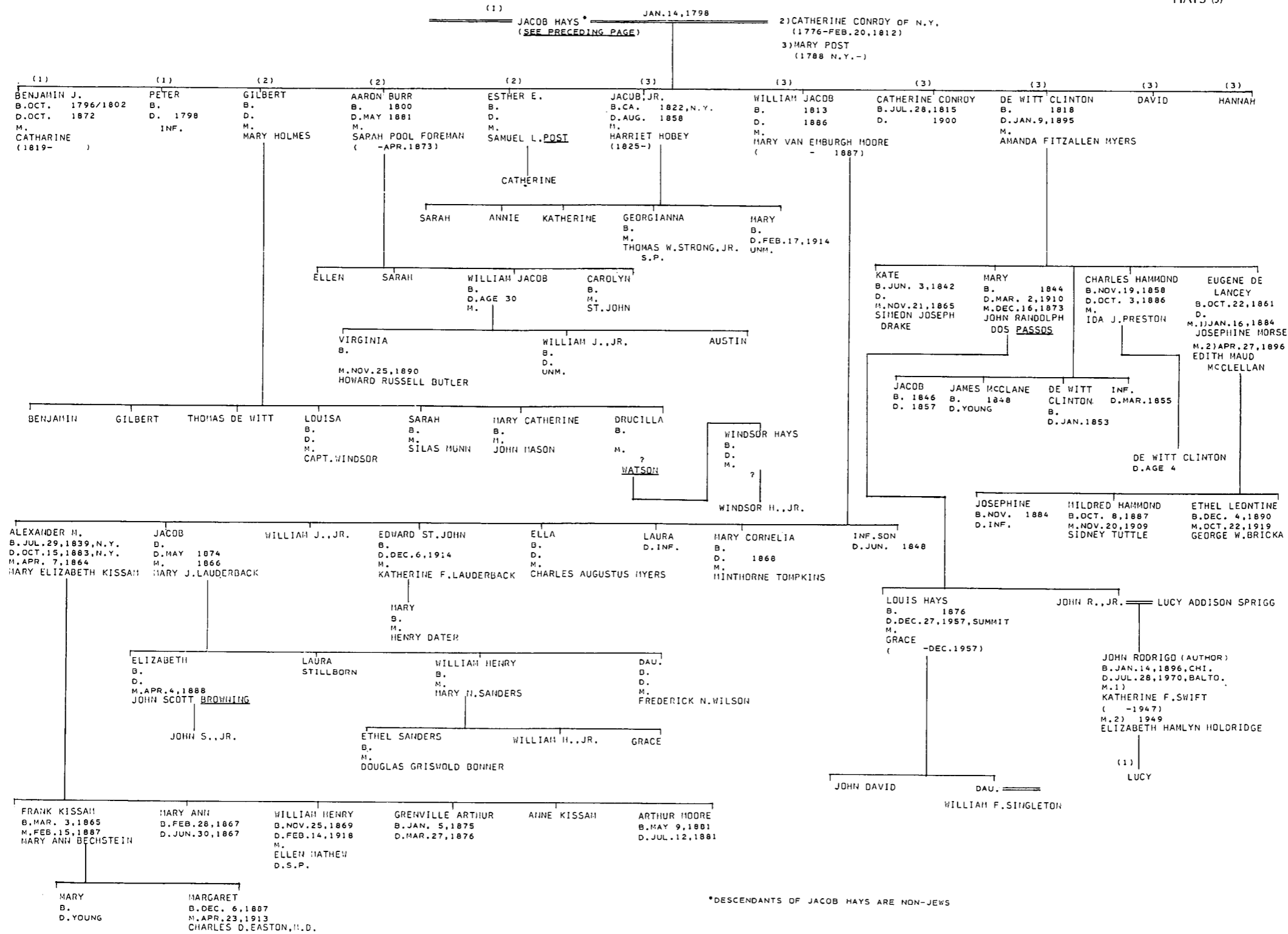

\*DESCENDANTS OF JACOB HAYS ARE NON-JEWS



HAYS (4)

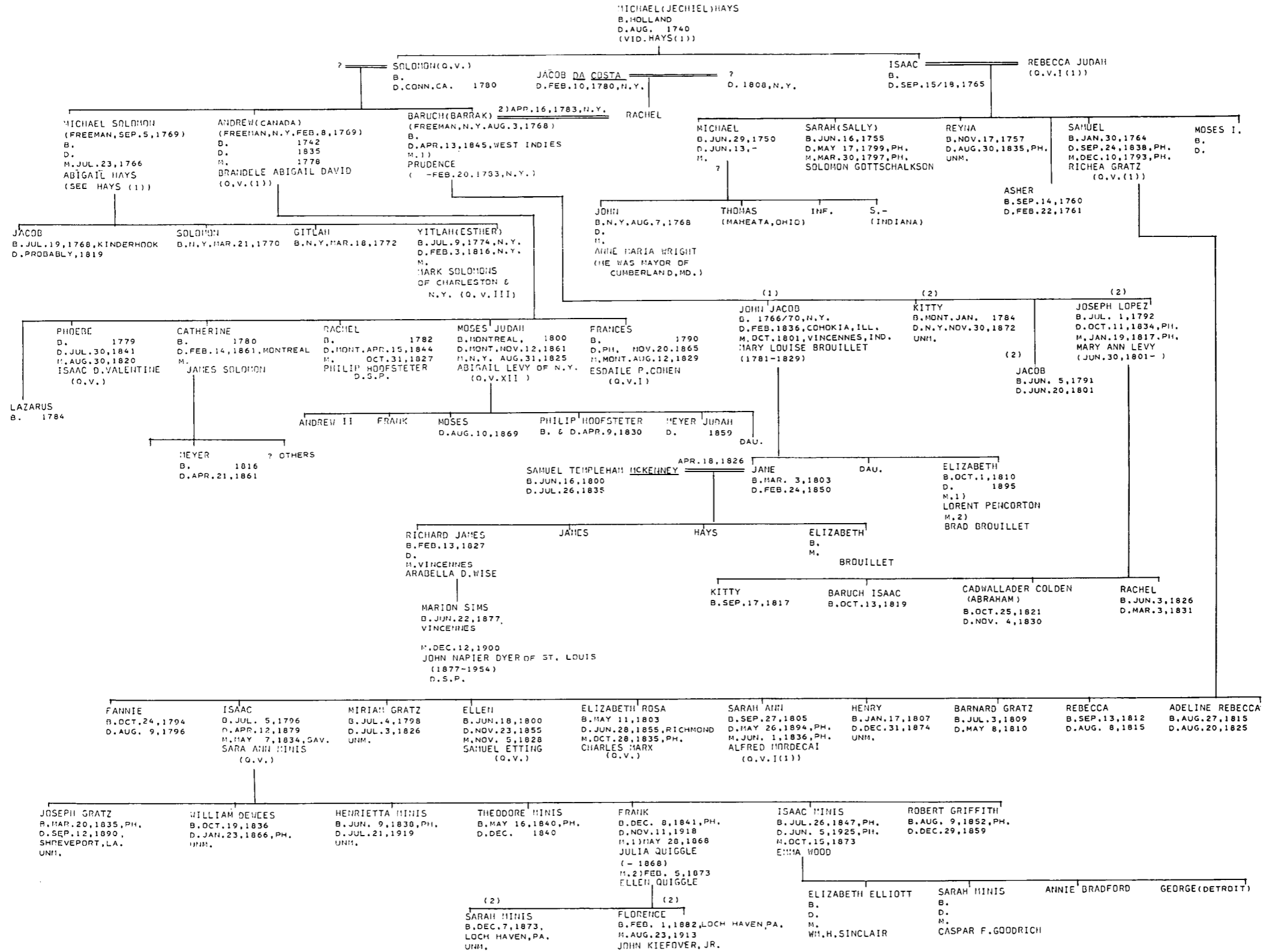

GRINSTEIN-RISE OF JEW. COMMUNITY OF N.Y.  
 NORFOLK, VA. - COURT RECORDS  
 HEBREW CEMETERY  
 FOREST LAWN CEMETERY

MABEL S. HECHT  
 LESTER S. SHERRICK  
 DAVID H. GOODMAN

MINA (1) REV. JONAS HECHT (2)  
 B. 1803, HAMBURG B. AUG. 1, 1826, BADEN  
 D. MAY 27, 1899, NORFOLK, VA. D. MAY 27, 1909, NORFOLK  
 (TO U.S. BEFORE 1838; HAZZAN AT N.Y.)  
 -ANSHE CHESED; NORFOLK-OHEF SHOLOM

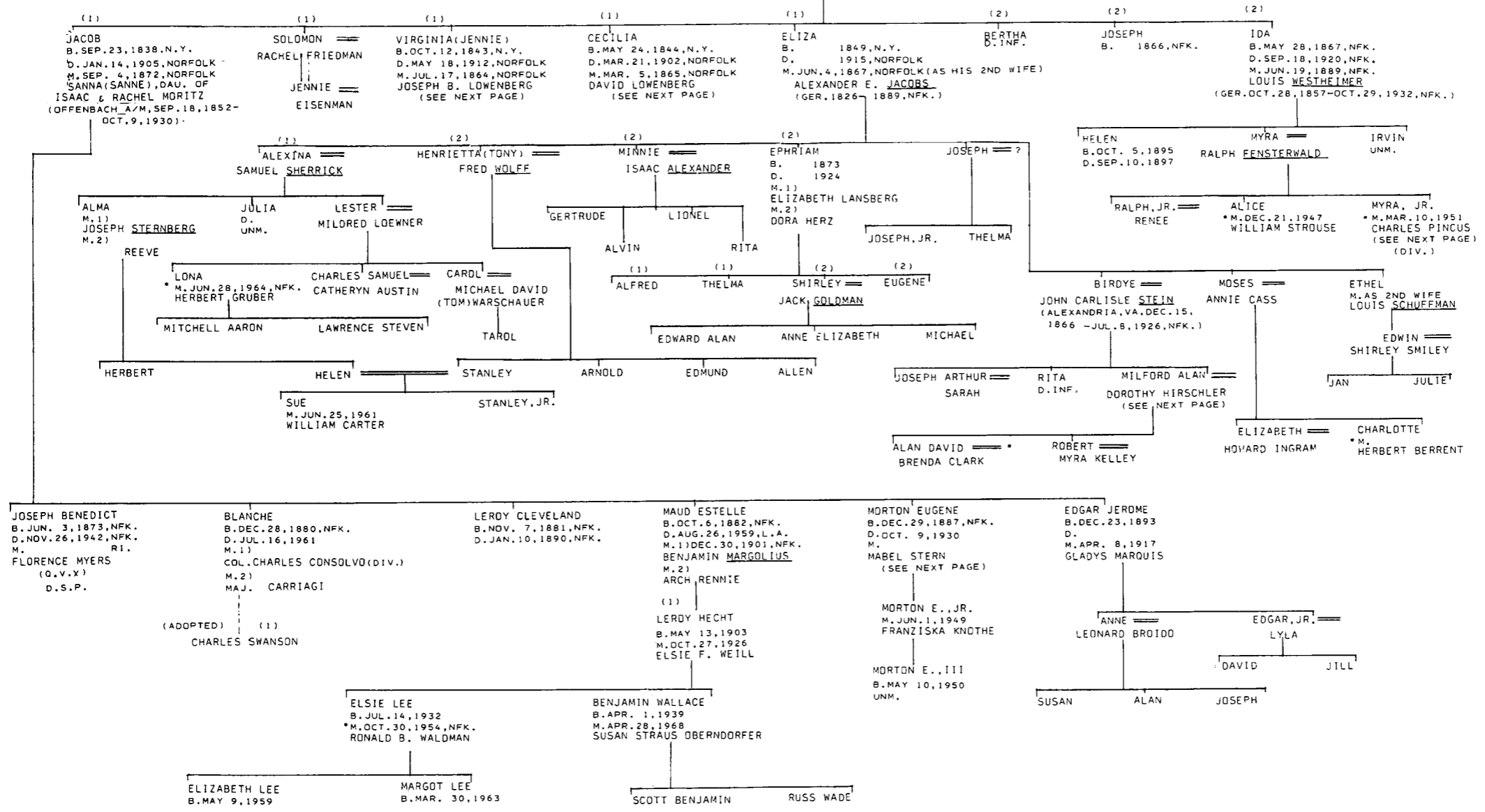

\*MARRIED BY MALCOLM H. STERN

HECHT (2)-LOWENBERG

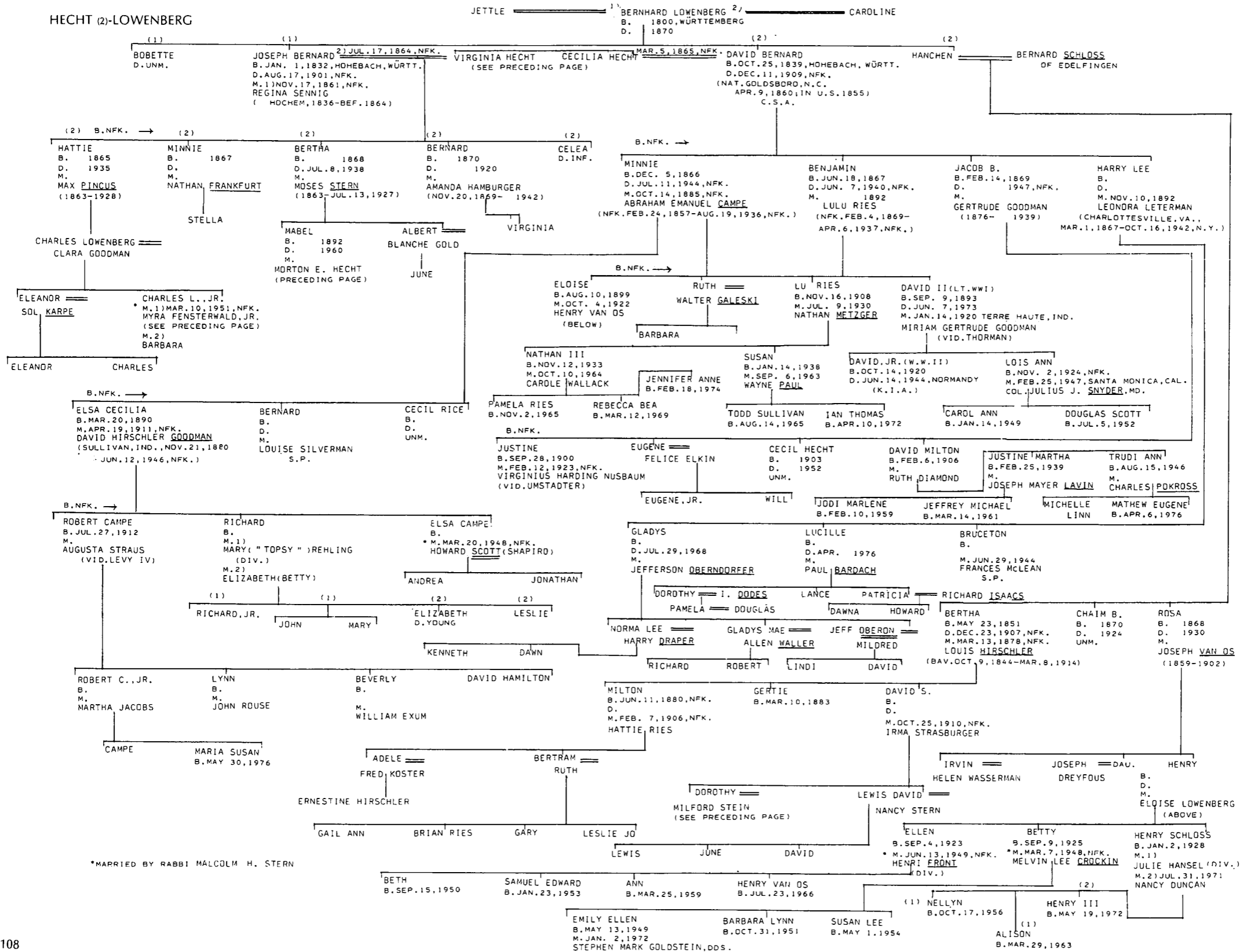

HEILBRON

SALOMON FAMILY REC. (AJHS)  
MICKVE ISRAEL REC.

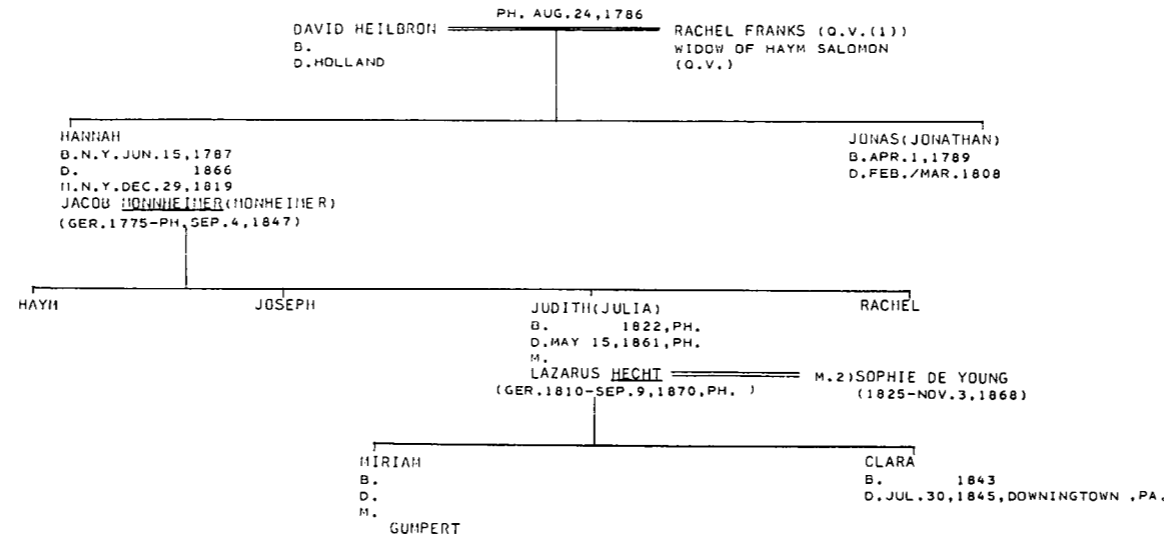

HEINEMAN

KRAUS-SANDOR COLL.  
SHEARITH ISRAEL REC.  
FLO. ABR.  
WHO'S WHO IN AMERICA (JAMES D. OUCHTERLONEY)

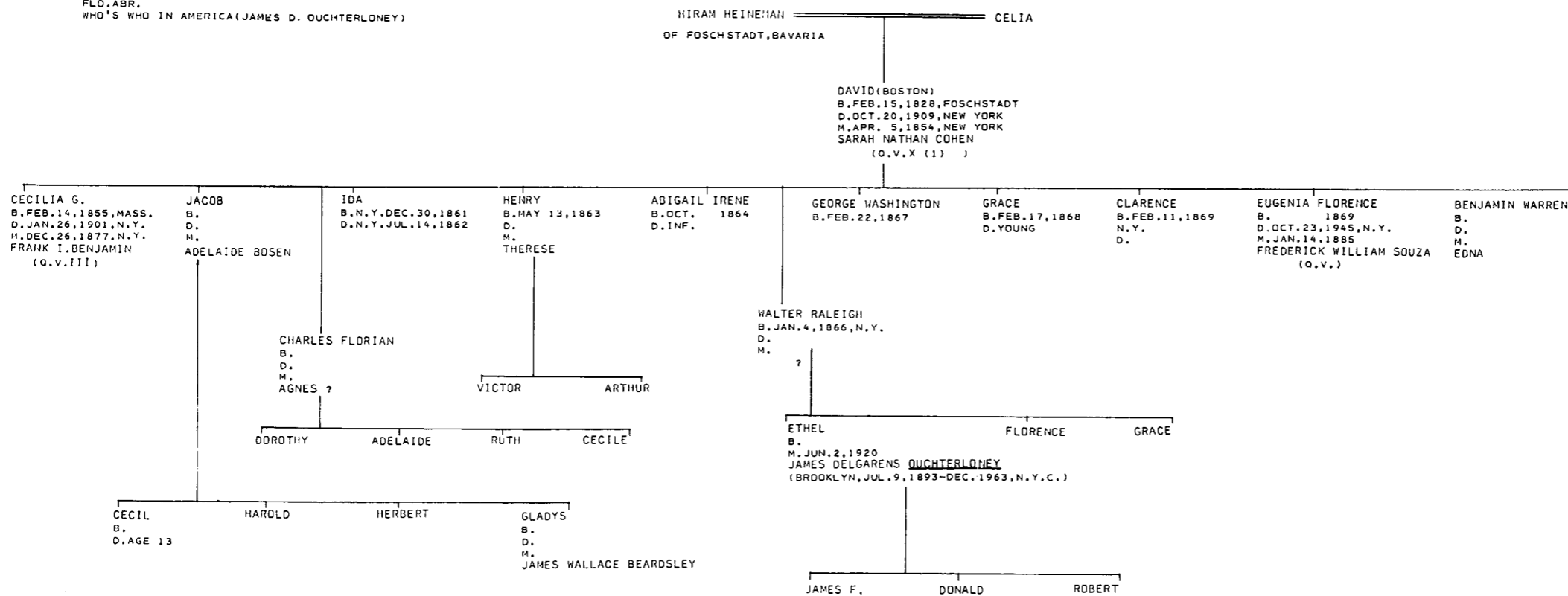

HENDRICKS (1)

PAJHS V.13,P.139  
 V.27,PP.286,387  
 V.31,P.260  
 J.E. V.6,P.346  
 U.J.E. V.5,P.314  
 KRAUS-SANDOR COLL.  
 ST.CHARLES P.131  
 GOLDSTONE MS.(PHOTO,AJA)  
 HENDRICKS GEN.  
 GEN.SOC.OF PA.(JRM)  
 ROTH-ANGLO-JEWISH LETTERS  
 POOL-PORTRAITS...  
 FLD. ABR.  
 SHEARITH ISRAEL REC.  
 WHITEMAN-COPPER FOR AMERICA  
 MISC.VI,P.177F.  
 ROSENSWAIKE  
 N.Y.TIMES-OBIT OF MONTAGUE NAPHTALI  
 ABBOT LOW MOFFAT  
 HELEN ROSE KLAUSNER

CHAIM HENDRICKS OF HOLLAND

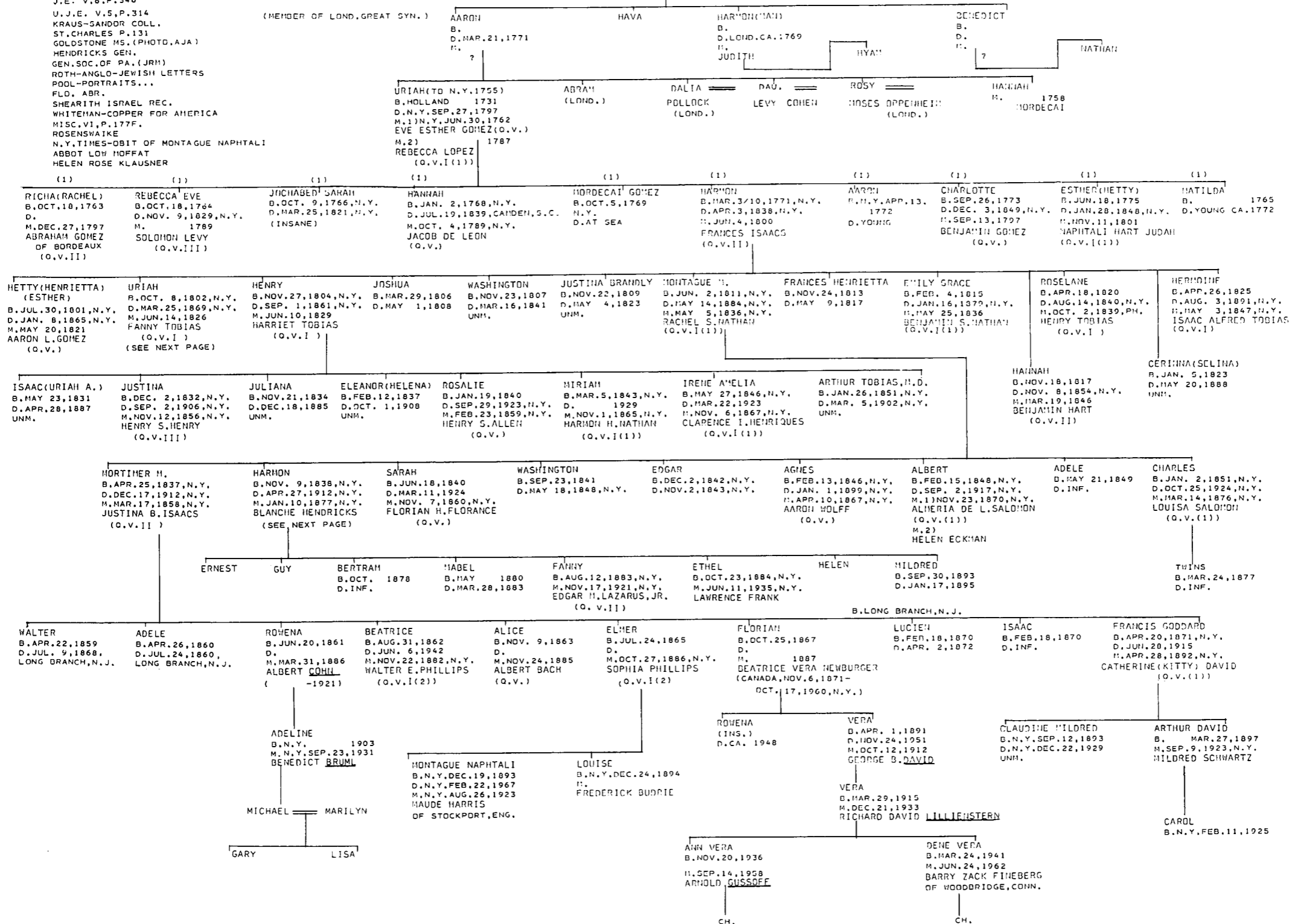

ROSALIE NATHAN HENDRICKS

HENDRICKS (2)

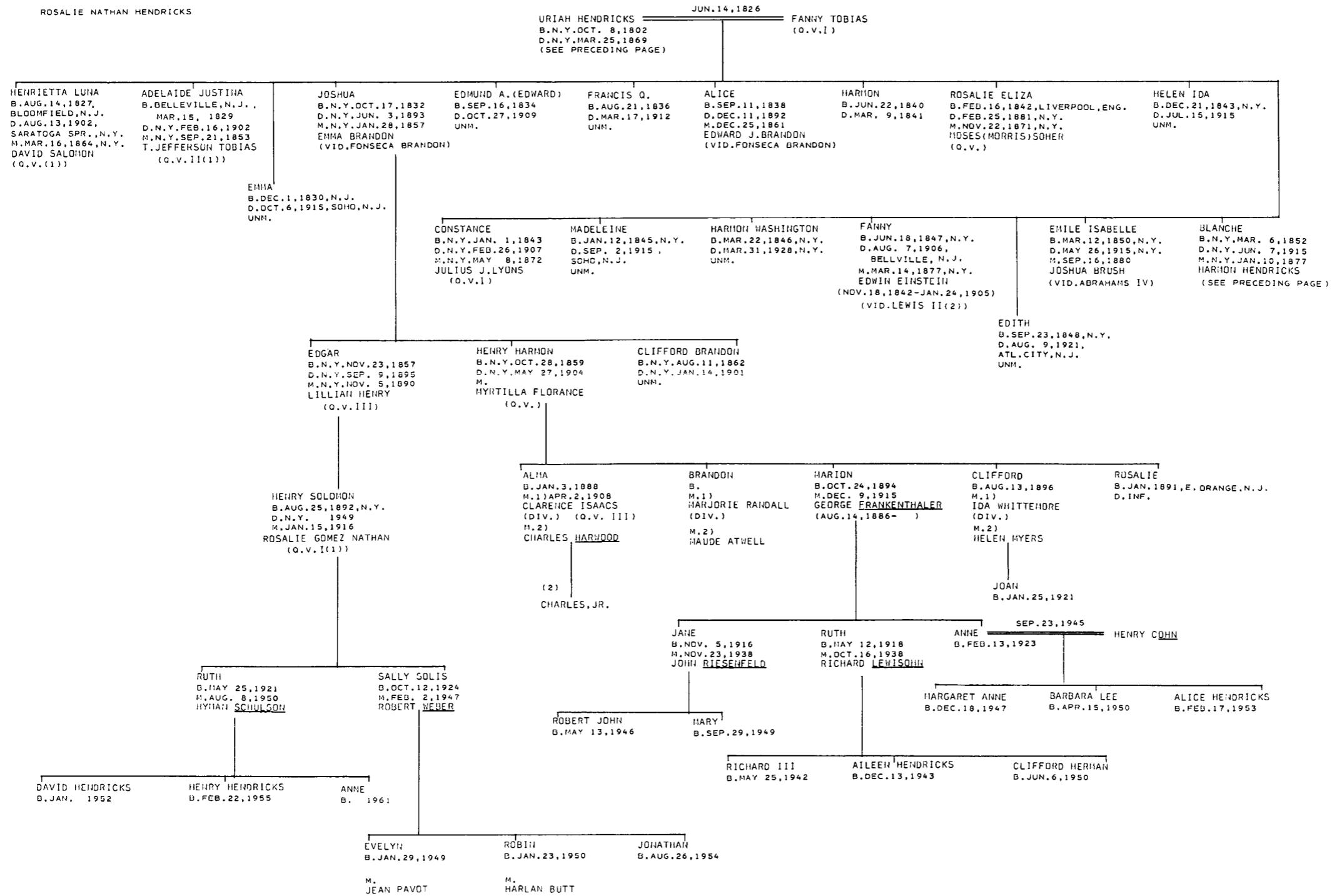

HENRIQUES I (1)

FLO. ABR.  
ELZAS MISS.  
SHEARITH ISRAEL REC.  
MISC. VII (#441)  
U.S. CENSUS, 1880, N.Y.  
N.Y. - IMMIGRATION & NATURALIZATION REC. (AJHS)  
D'NAI JESHURON REC.

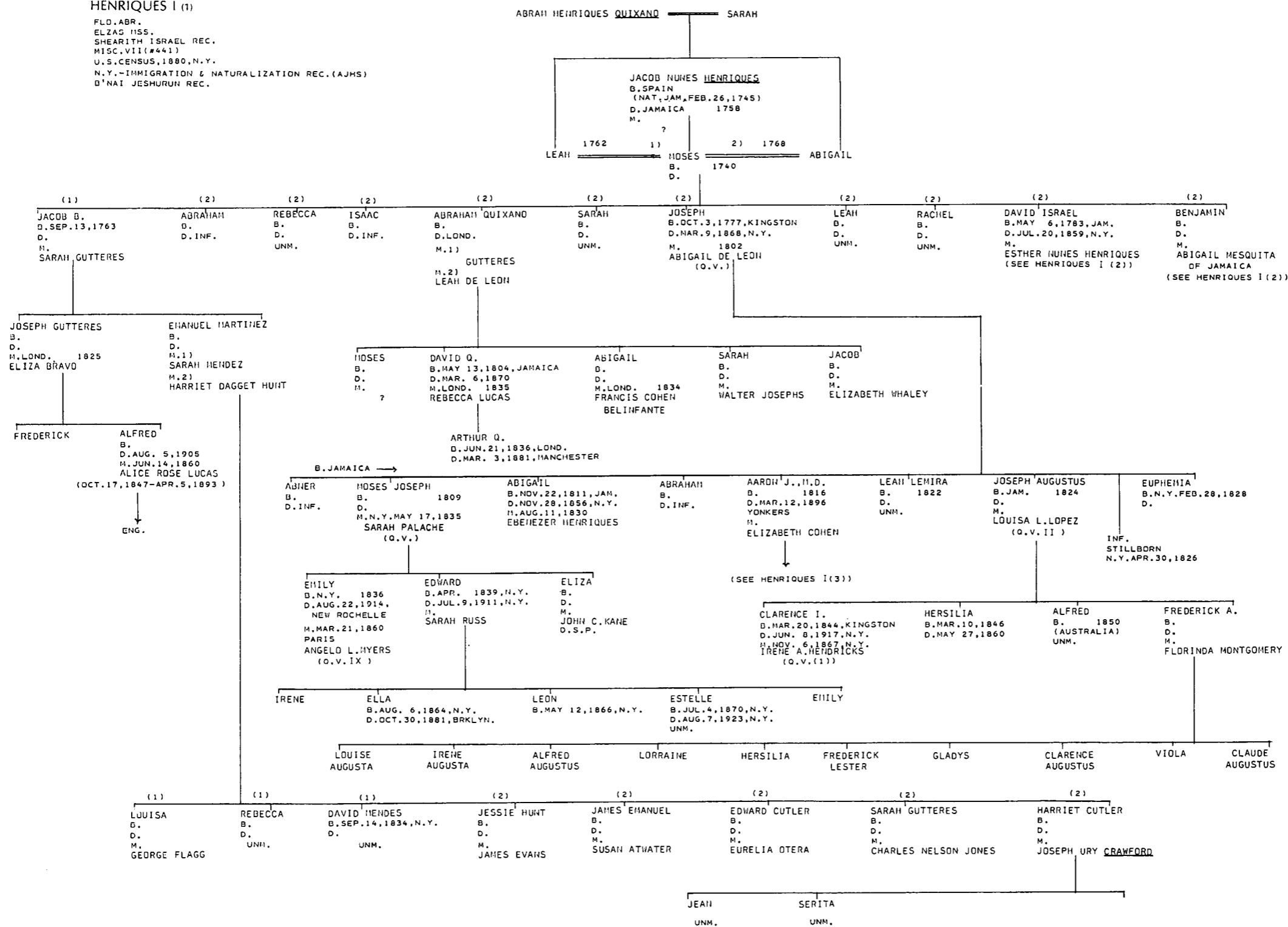

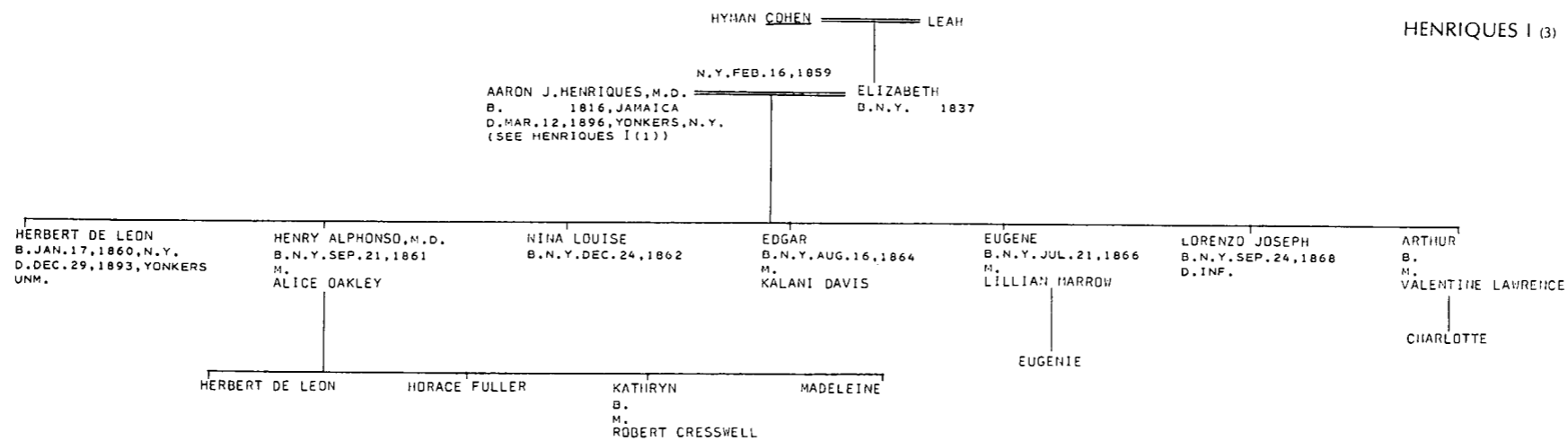
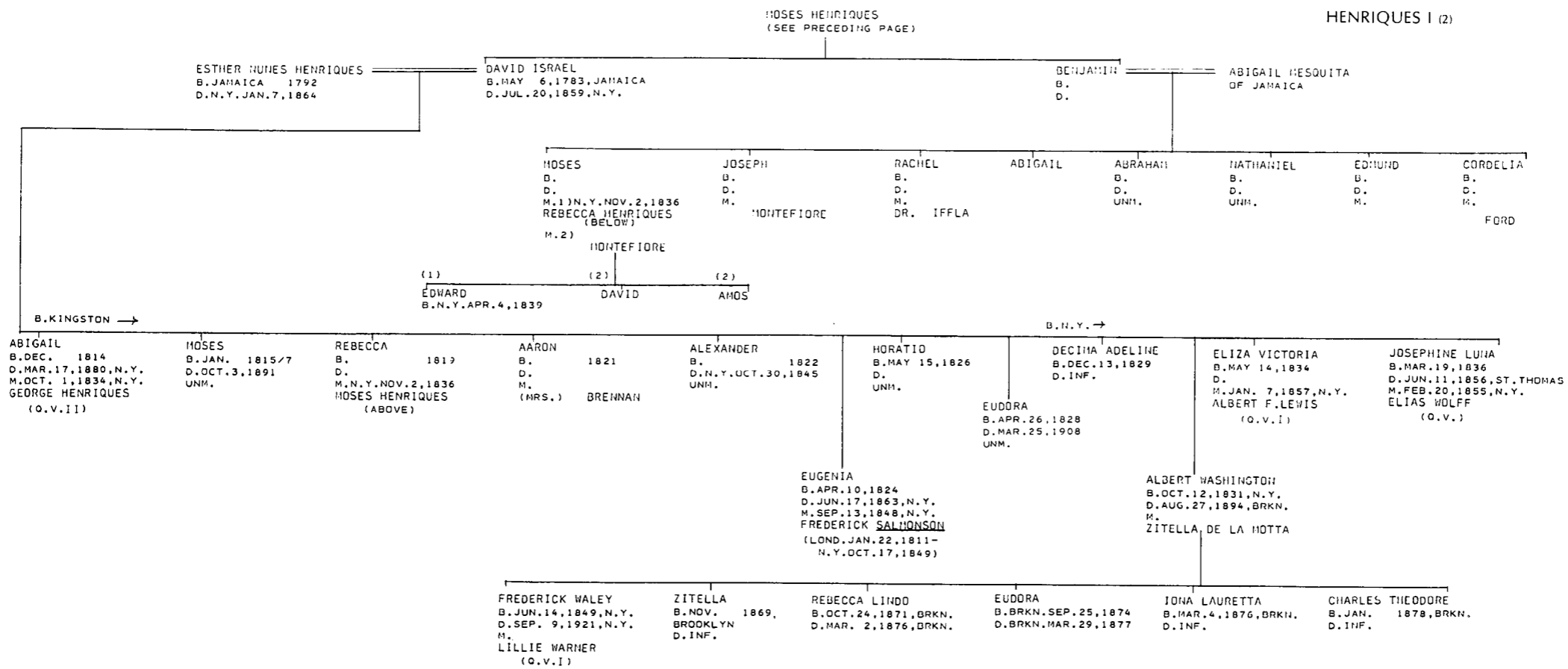



**HENRIQUES II**

U.S.CENSUS,N.Y.1850  
SHEARITH ISRAEL REC.  
N.Y.CENSUS 1855  
N.Y.IMMIGRATION & NATURALIZATION REC.(AJHQ)  
F.J.DALLETT

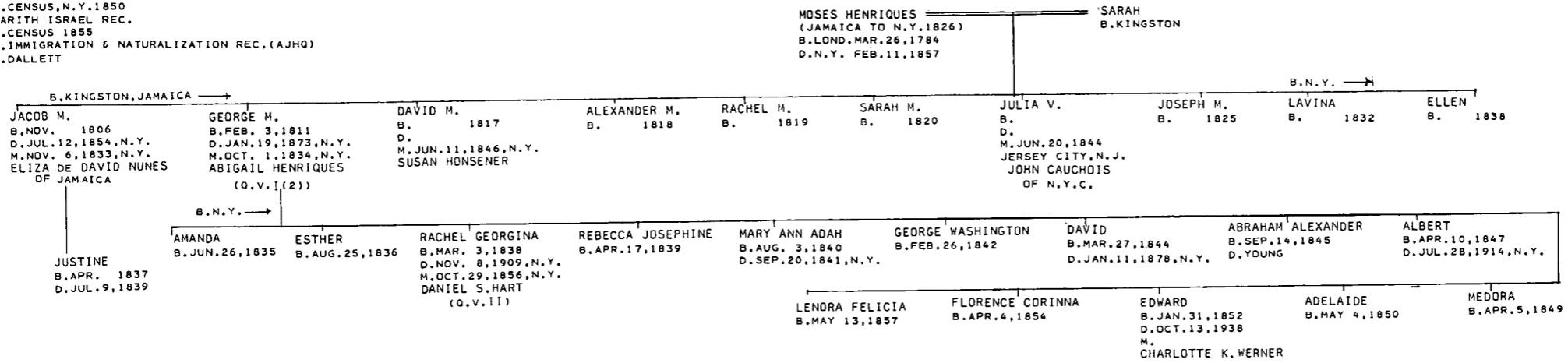

**HENRIQUES III**

SHEFTALL MSS.  
EGMONT  
BEVIS MARKS KET.#390F.

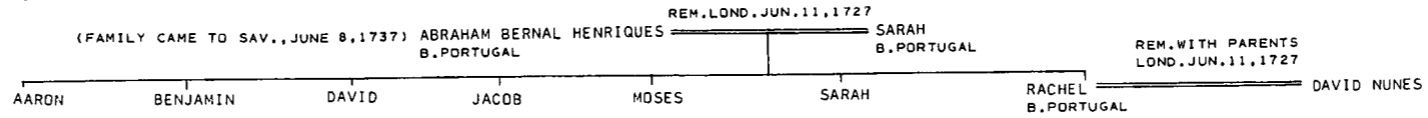

**HELBERT**

MISC.VI  
ROTH-THE GREAT SYNAGOGUE,P.65  
BEVIS MARKS REC.,V.I,P.30N  
KRAUS-SANDOR COLL.

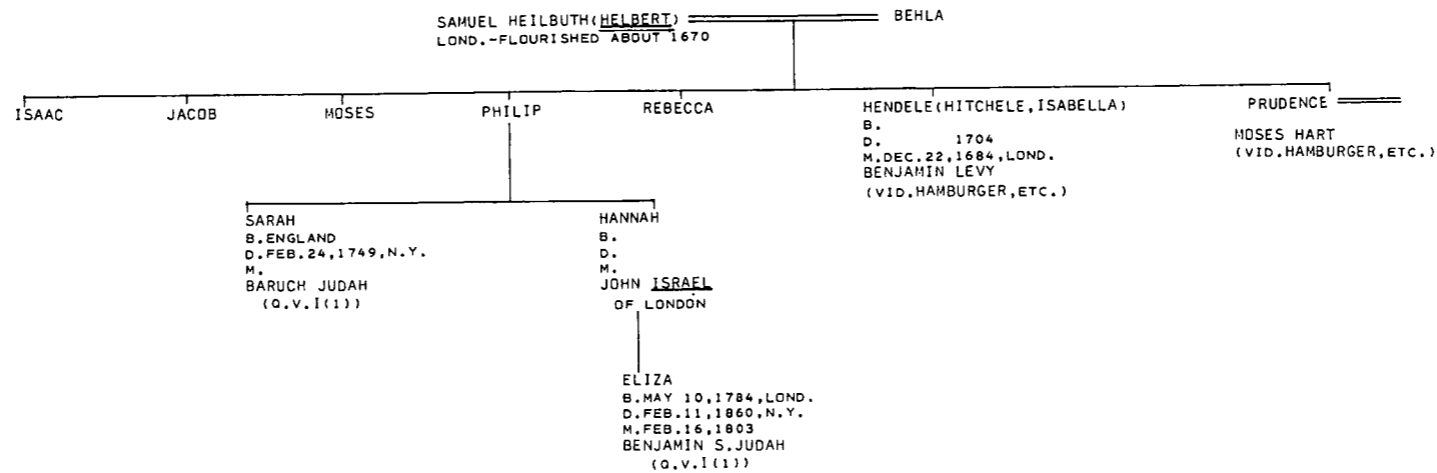

**HENRY I**

PAJHS,V.27,P.349  
ELZAS MSS.  
SHEFTALL MSS.  
WILL OF JACOB P.HENRY  
MRS.GEORGE C.LEWIS

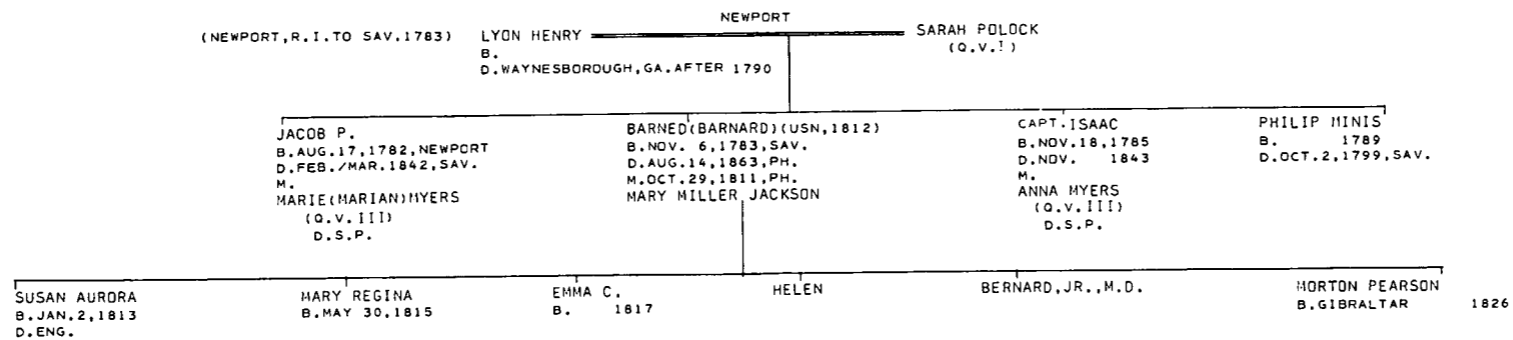

POSTAL-KOPPMAN-JEWISH TOURIST'S GUIDE  
 ELZAS MS.  
 ELZAS D.J.C.  
 WILL OF JUDITH J. HENRY (JRM COLL.)  
 WILL OF AMELIA HENRY  
 ROSENWATKE

HENRY II

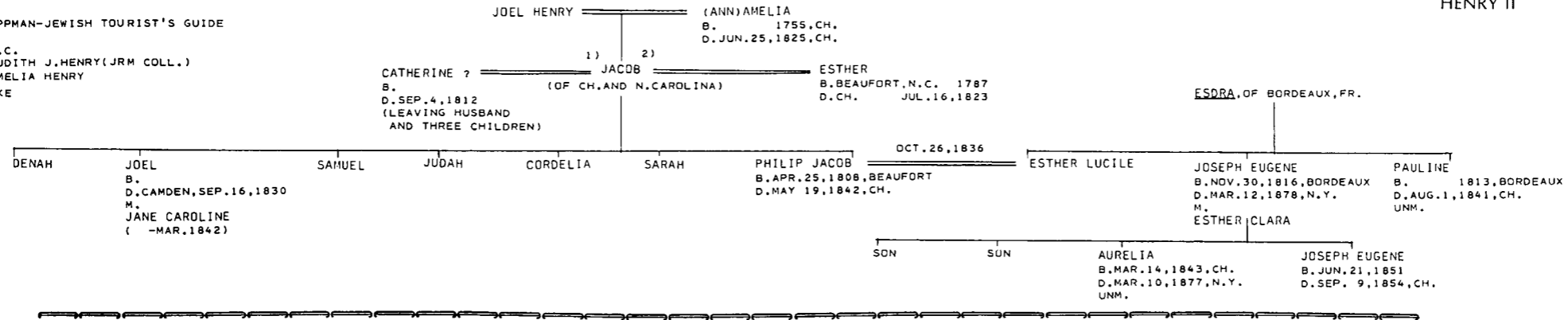

HENDRICKS GEN.  
 KRAUS-SANDOR COLL.  
 SHEARITH ISRAEL REC.  
 FLORENCE ABRAHAMS

HENRY III

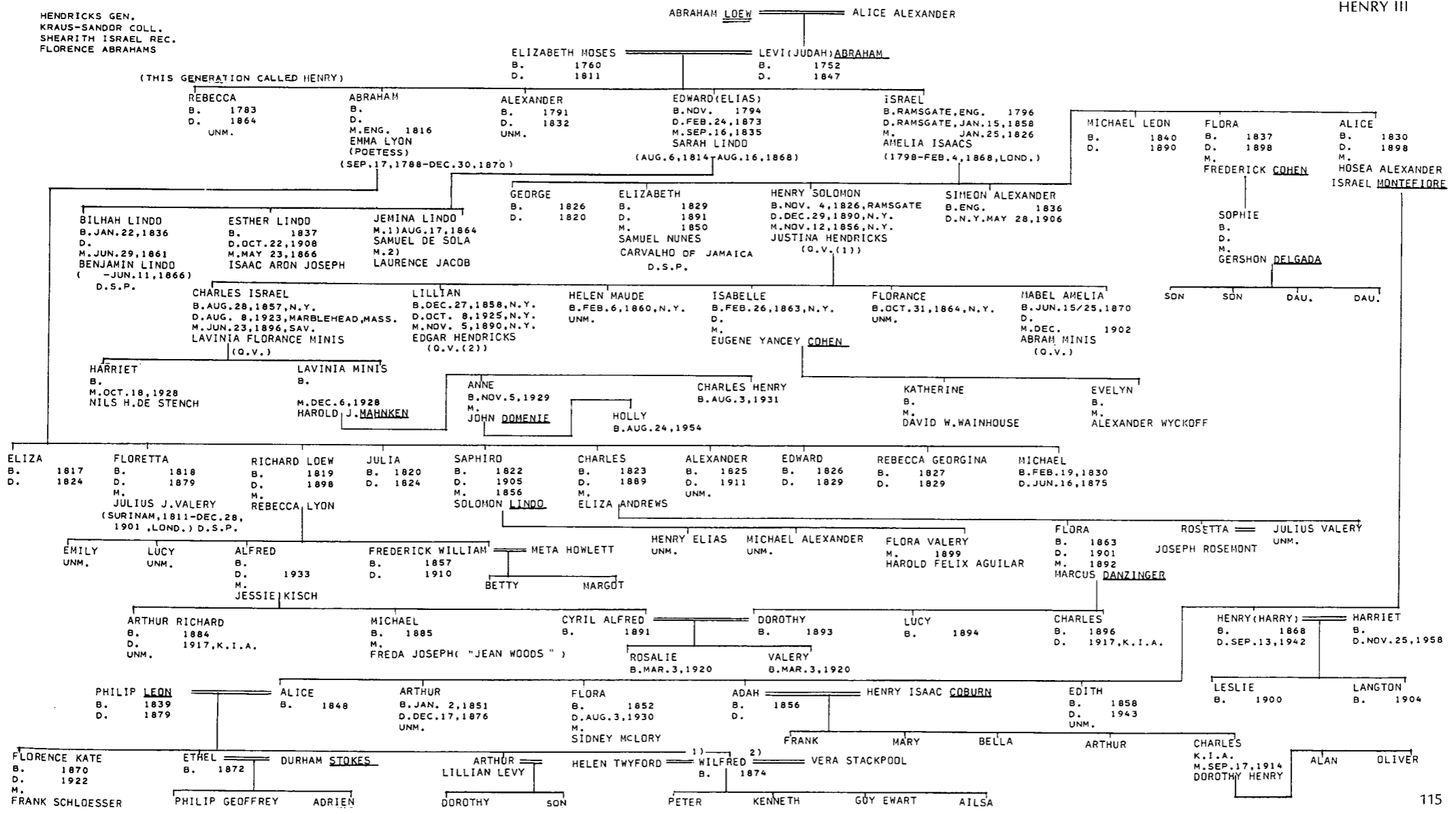

HERMANN  
KORN-N.D.

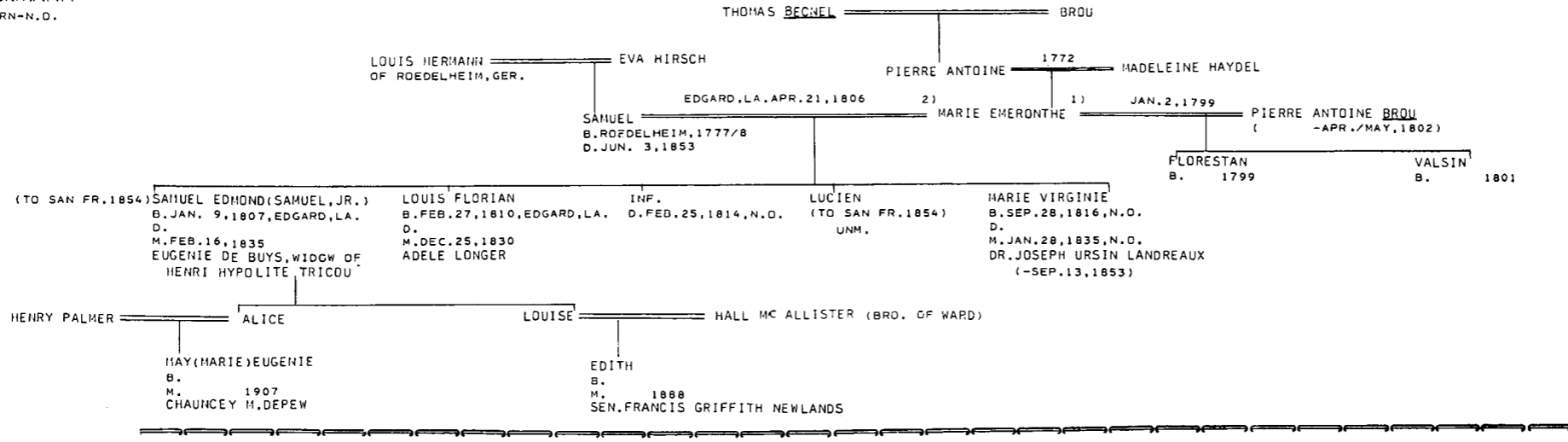

HERZOG  
GOLDSTONE GEN.

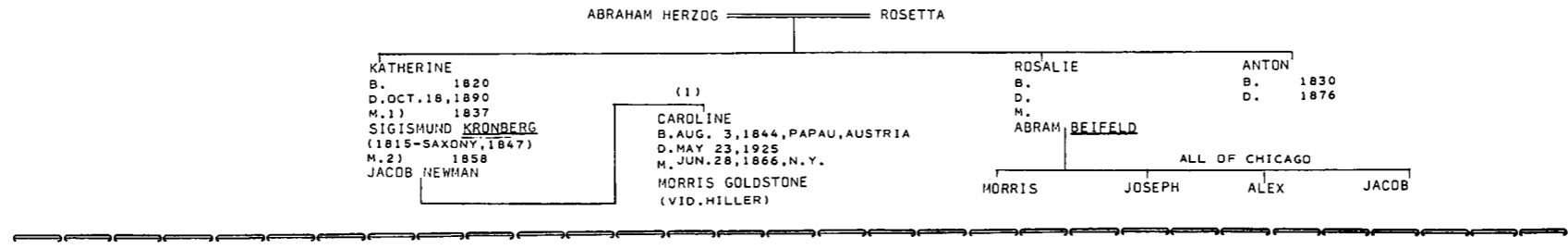

HILLER (GOLDSTONE)  
GOLDSTONE MS. (PHDOSTAT AJA)

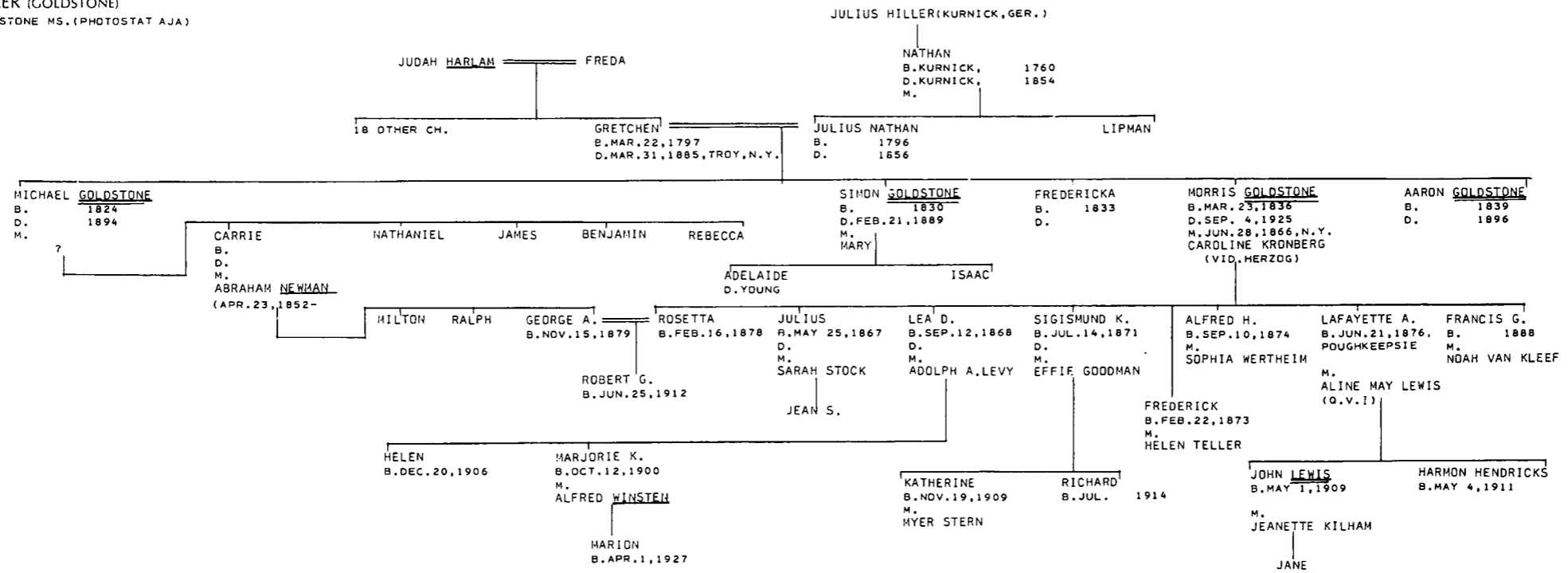

JOHN MCKAY SHEFTALL  
 ELZAS-CEM.OF CONG.BERITH SHALOME  
 MS.  
 NEW JEWISH CEM.OF BETH ELOHIM  
 D.J.C.  
 M.N.  
 SAVANNAH JEWISH BURYING GROUND  
 MRS.W.A.MOORE

HERTZ I

JACOB (EGERHART?) HERTZ CH.SEP.12,1810 REBECCA MORDECAI  
 B.CA. 1776 (O.V.I(1))  
 D.CH.OCT.23,1846

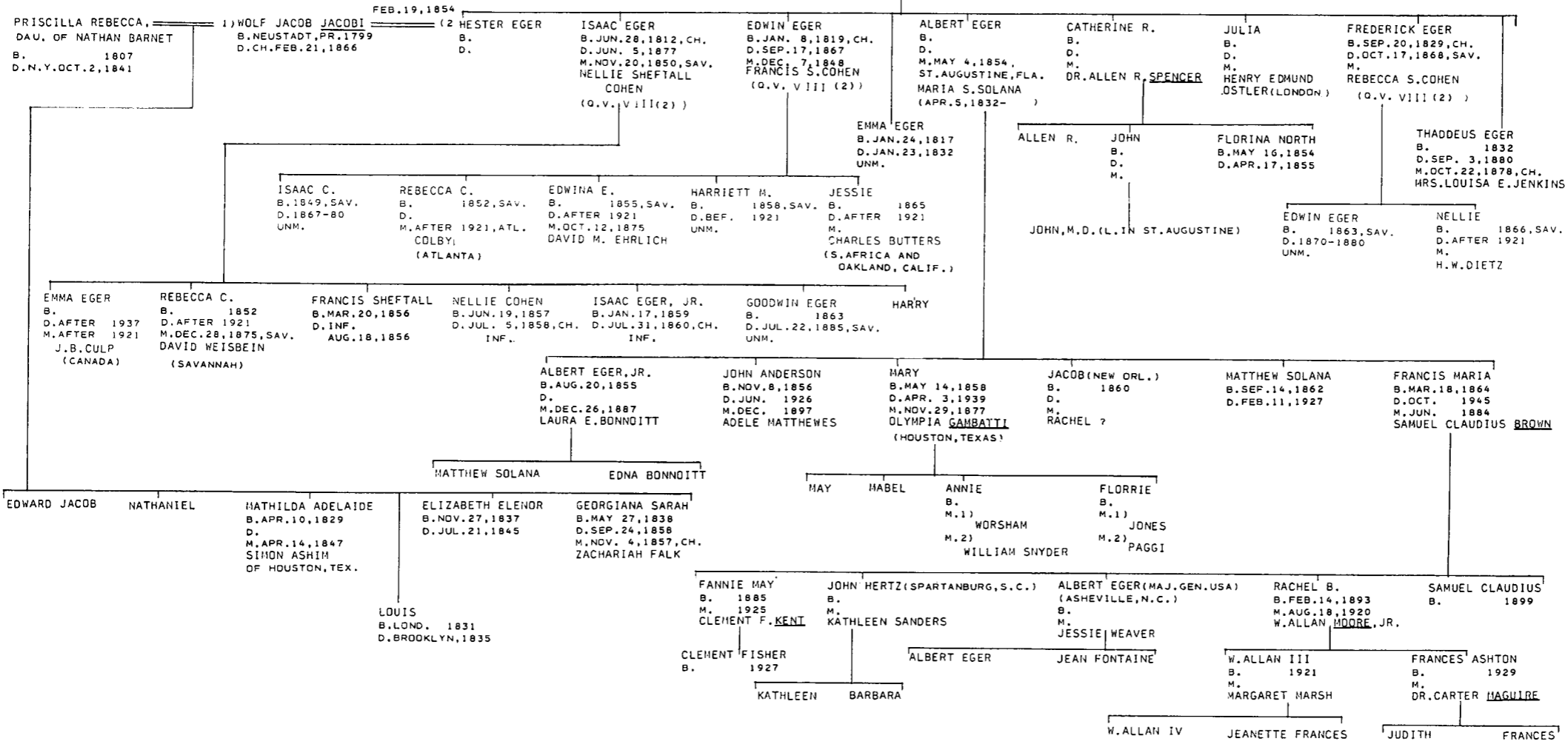

PAJHS, V.2, P.143  
 NGSO, VOL.57, P.219

HERTZ II

JOSEPH HERTZ, M.D. B. D.EUROPE (CAME TO U.S.1832 SETTLED IN NACOGDOCHES, TEX. 1835-IN NATCHEZ, MISS.)

HYMAN D.MAY 19,1833 (IN BOAT ACCIDENT BETWEEN N.O. & NATCHITOCHE)

HERTZ III

SHEARITH ISRAEL REC. ELZAS MS.

DANIEL HERTZ OF HAMBURG, GER.

THEODORE B.DEC.15,1816, HAMBURG D.JAN.18,1894 M.NOV. 2,1853, N.Y. JESSY (SIMHA) JUDAH ANDREWS (V.D. JUDAH I(1))

WILL OF HANDEL M.HERTZ (JRM COLL.) ELZAS-D.J.C. M.N. ROSENWAIKE

ALEXANDER HERTZ B.HILDESHEIM 1774 D.CH.MAR.4,1822

HERTZ IV

HANDEL MOSES HERTZ B.HILDESHEIM 1778 D.CH. SEP.28,1840 M. ISABELLA (CH. 1769-JAN.24,1824)

SARAH N. B.NOV. 2,1804 D.MAY 15,1865 M. NATHAN NATHANS (O.V.II)

**HOHENFELS**

ROSENTHAL MS.  
EDWIN WOLF, 2ND  
MICKVE ISRAEL REC.  
RODEPH SHALOM MOHEL REC.

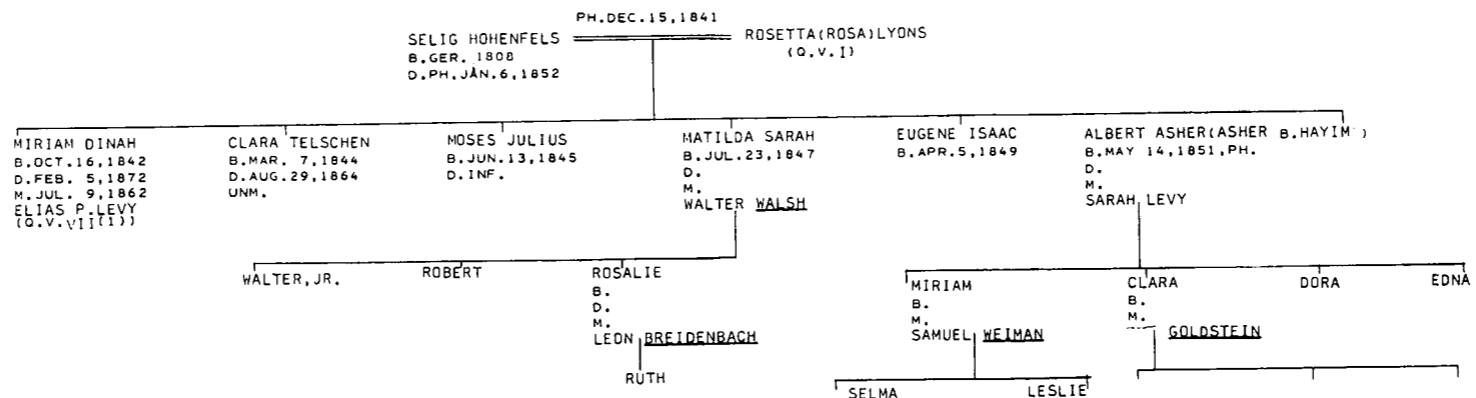

**HORWITZ**

FLO. ABR.  
U. J. E. V. 5, P. 461  
KRAUS MS.  
MRS. M. S. CARTER

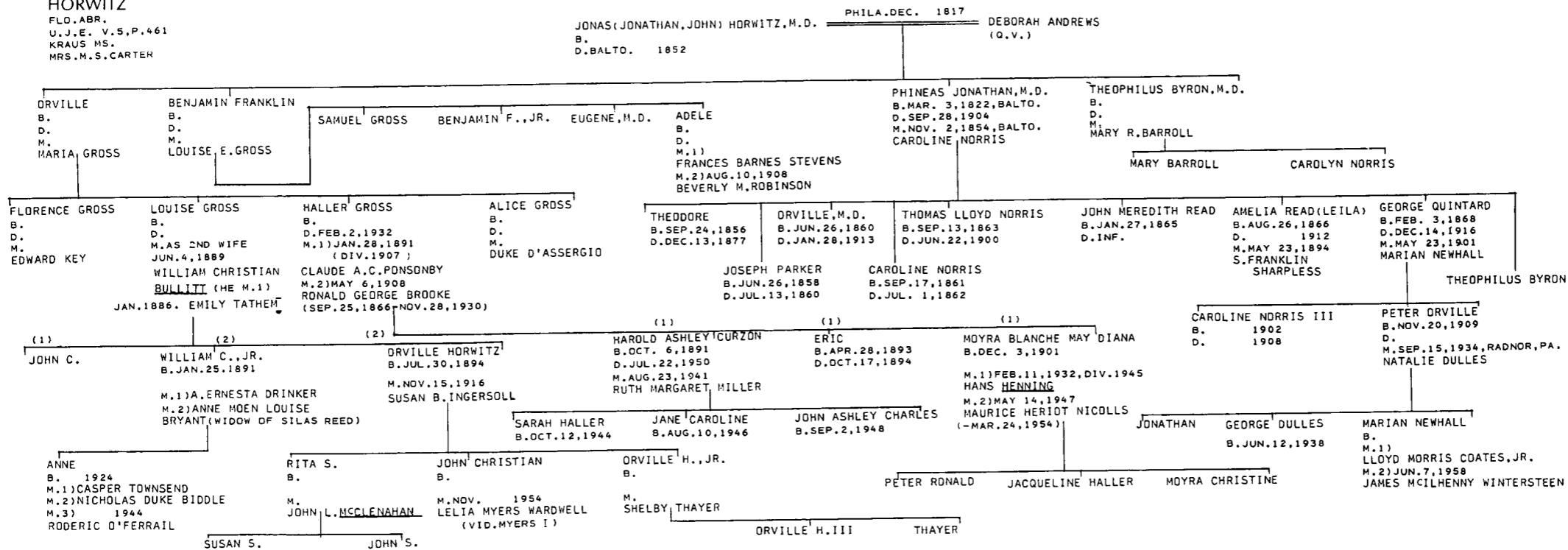

**HUNT**

EZEKIEL-LICHTENSTEIN JEWS OF RICHM.  
SHEARITH ISRAEL REC.  
BETH SHALOME MARR. REC.

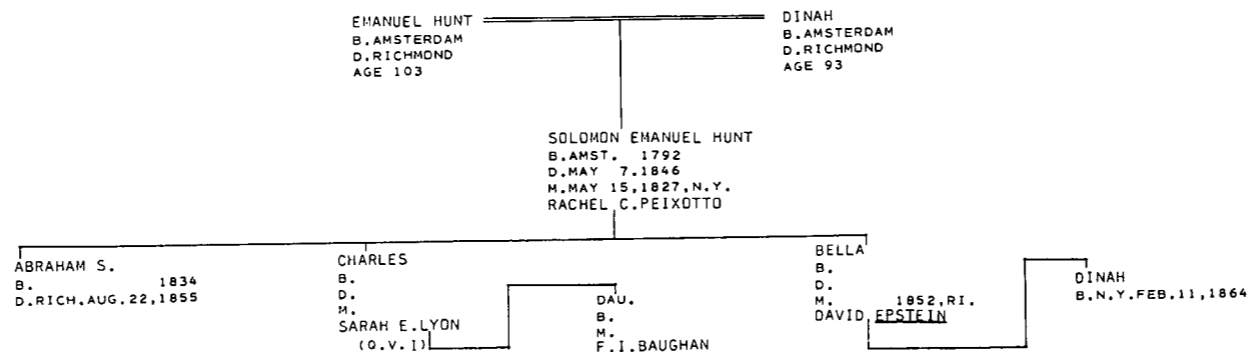

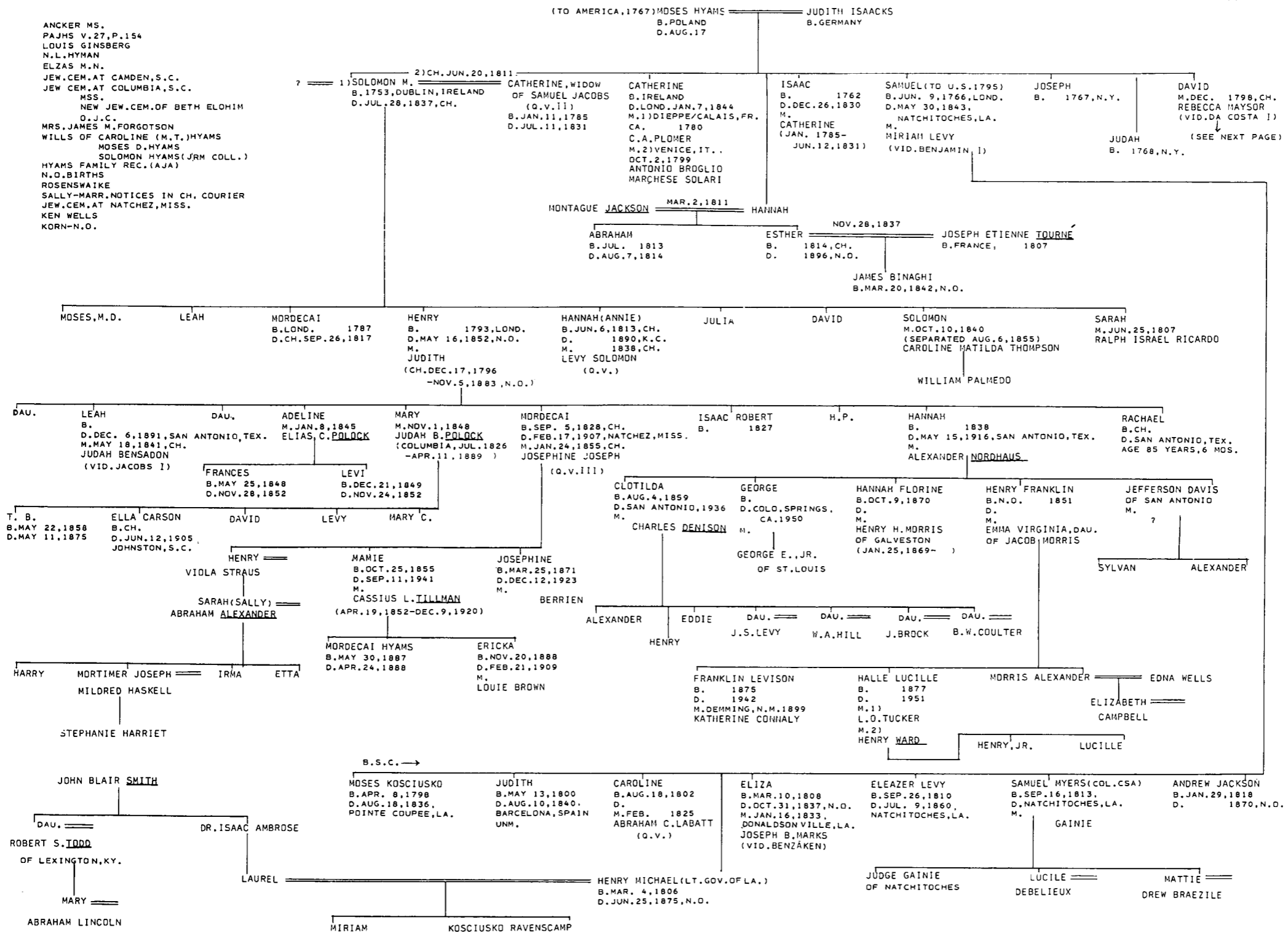

HYAMS (2)

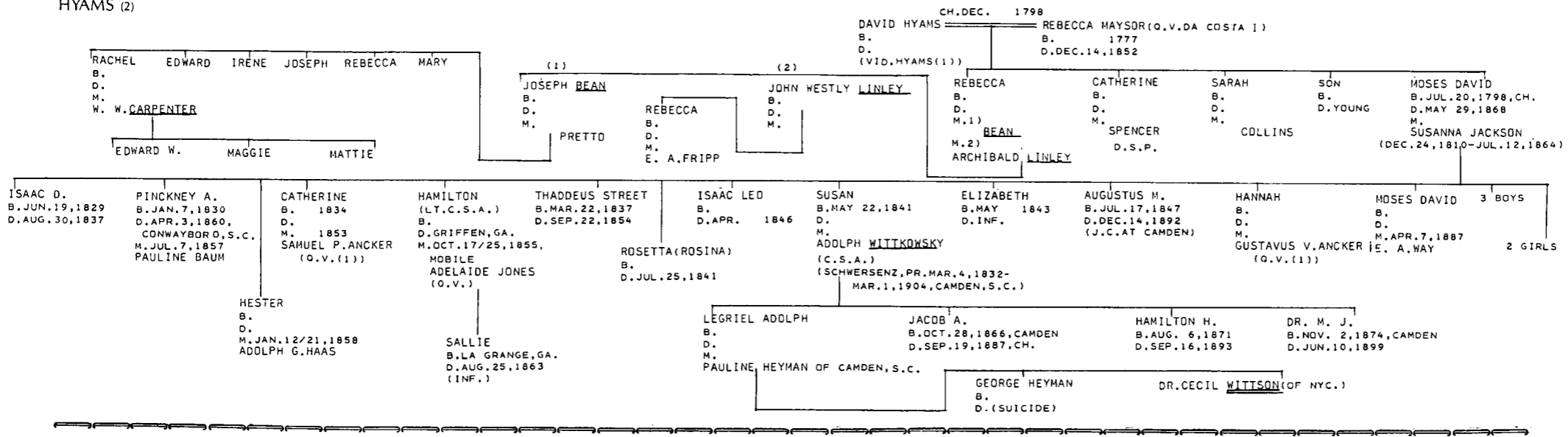

ISAACKS (ISAACS I)

PAJHS V. 27, PP. 349, 372, 416  
 V. 32, P. 125  
 V. 33, P. 202F.  
 UJE V. 5, P. 598F.  
 KRAUS-SANDOR COLL.  
 MORAIS-JEWS OF PH., P. 241F  
 MICKVE ISRAEL REC.  
 POOL-PORTRAITS...  
 JR MARCUS COLL.  
 BARBER-N.Y. DEATHS  
 JACOB ISAACKS MS. (DAR)  
 ELZAS MSS.  
 MICHAEL MARKS MS.  
 SHEARITH ISRAEL REC.  
 WILL OF JACOB (D. 1831)  
 N.Y. WEEKLY MUSEUM  
 MISC. VII (#312)  
 B'NAI JESHURUN REC.  
 KORN-MOBILE  
 ARNOLD-VITAL REC. OF R.I.  
 FEDERAL ST. CEMETERY

(NAT. N.Y. JUN./JUL. 1741)

ABRAHAM ISAACKS  
 B. EMDEN, GERMANY  
 D. SEP. 24, 1743, N.Y.  
 (CAME TO N.Y. 1697/8;  
 MADE FREEMAN, AUG. 6, 1723)

HANNAH MEARS  
 B.  
 D. N.Y. 1745

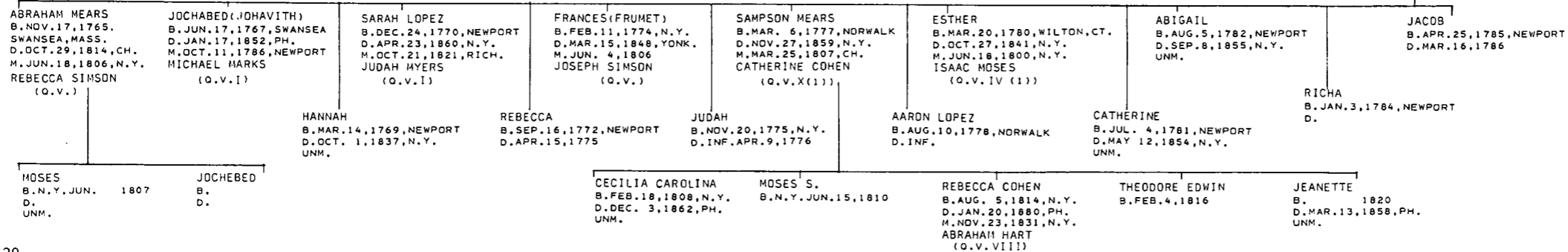
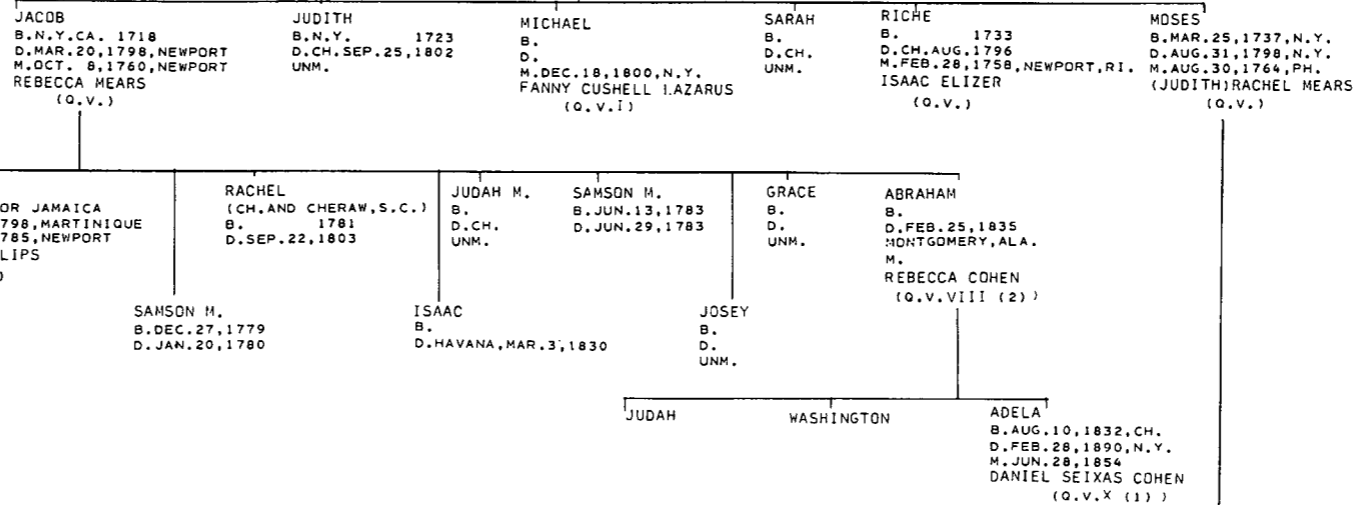

U.S.CENSUS, 1860 (N.Y.), 1880 (N.Y.)  
 MISC. VI, P. 190  
 PAJHS, V. 46, P. 102F.  
 BETH SHALOME MARR, REC.  
 LEVY GEN.  
 KRAUS-SANDOR COLL.  
 FLO. ABR.  
 EZEKIEL-LICHTENSTEIN- JEWS OF RICHM.  
 WILL OF HENRY HYMAN  
 SHEARITH ISRAEL REC.

HYMAN I

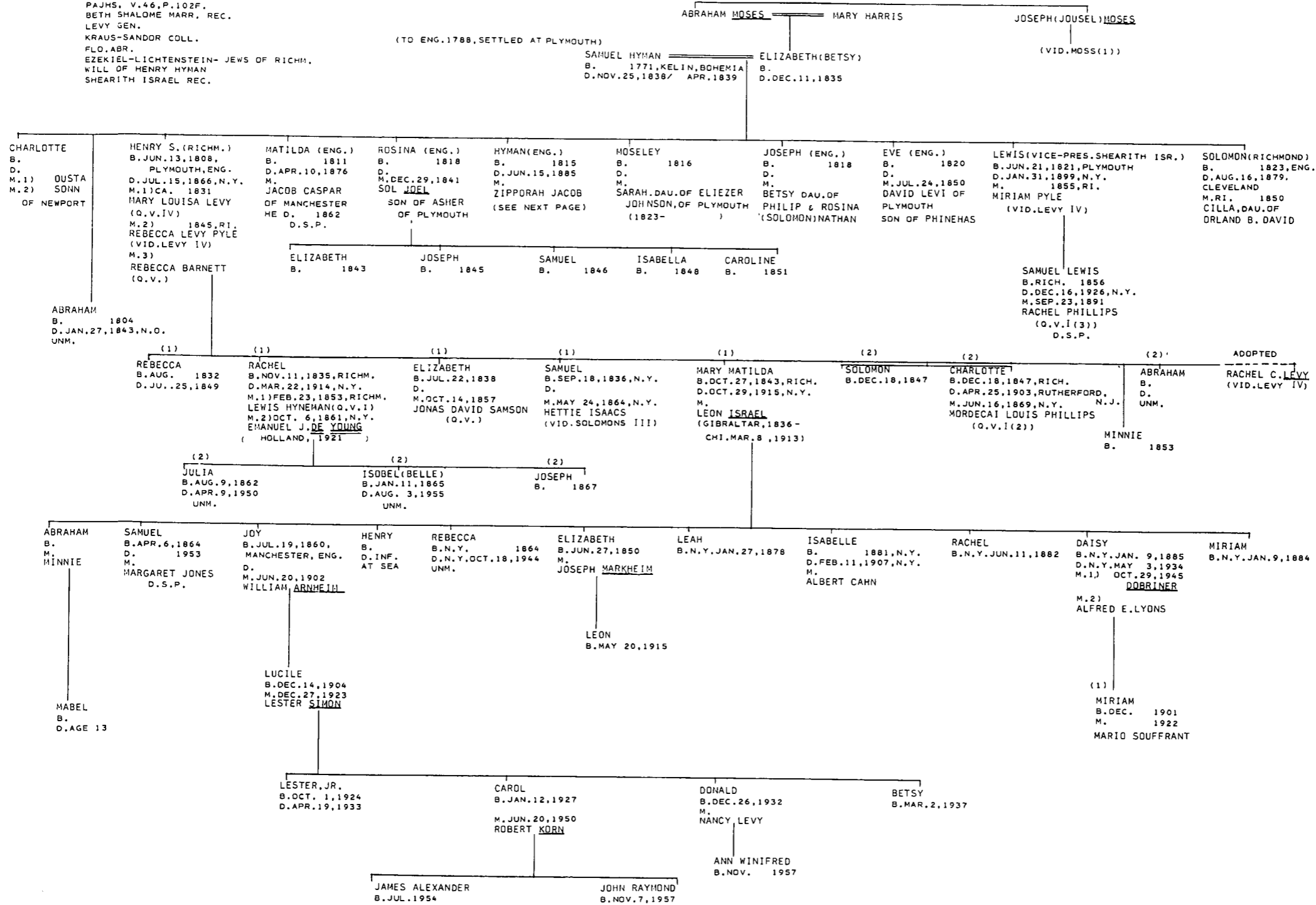



HYMAN II

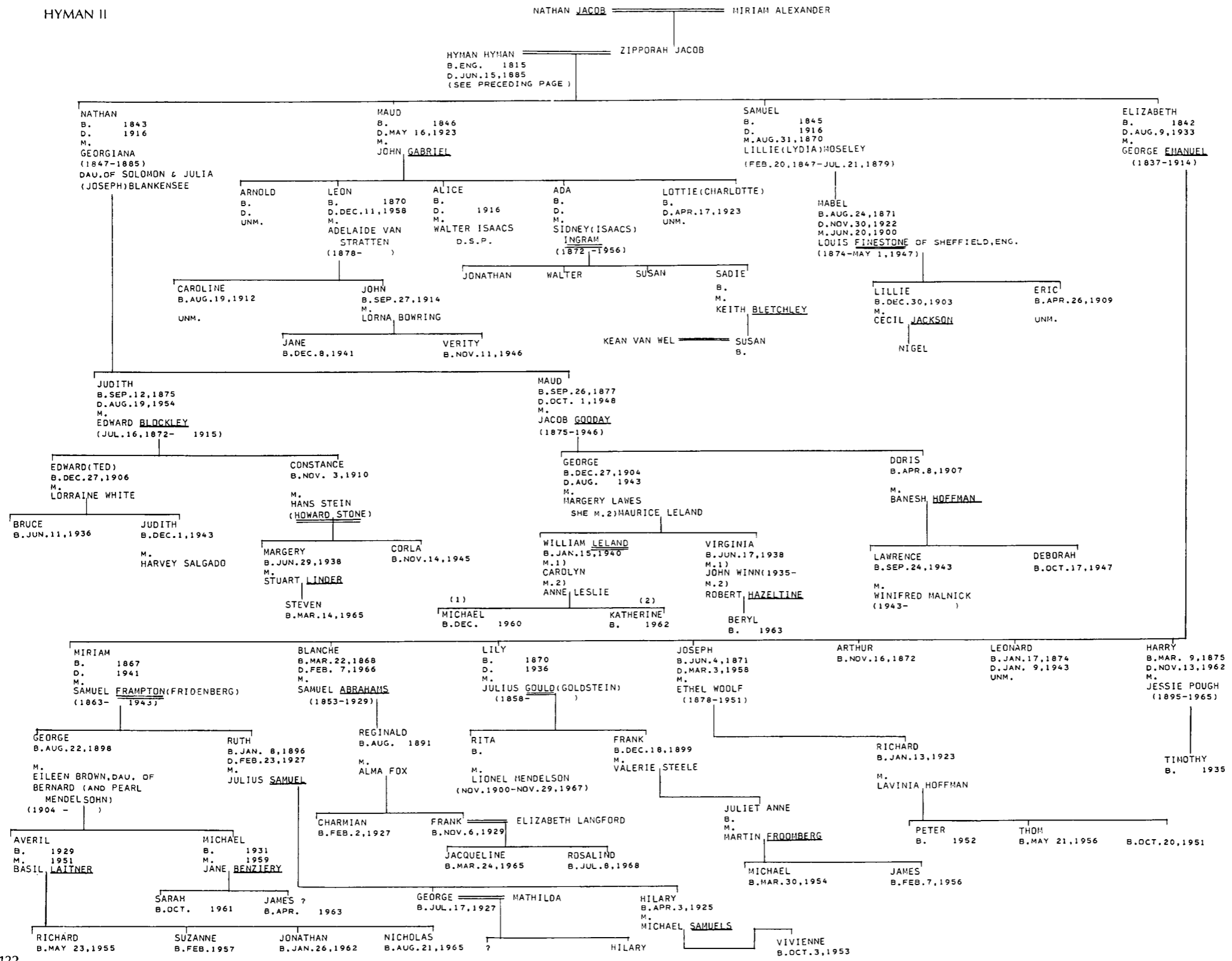



ISAACS II

PAJHS, V. 12, P. 167  
 V. 23, P. 151  
 V. 33, P. 210  
 AJHO, V. LX1, P. 115N  
 KRAUS-SANDOR COLL.  
 ST. CHARLES, P. 126  
 POOL-PORTRAITS...  
 HENDRICKS GEN.  
 GOLDSTONE GEN.  
 ELZAS-JEWS OF S.C., PT. 2, P. 10  
 AMER. JEW. ARCHIVES, V. 3, #1.  
 HERSHKOWITZ-WILLS: SOLOMON ISAACS  
 JOSHUA ISAACS

(SOLOMON) ISAACS REBECCA ? (L. IN N.Y., 1695)

JOSEPH  
 B. 1659 (IN N.Y., 1691; FREEMAN, AUG. 23, 1698)  
 D. N.Y. MAY 25, 1737 (KOSHER BUTCHER; K. WILLIAM'S WAR)

SOLOMON (OF FREEHOLD, N.J., BOSTON & CH.)  
 B. D. CH. 1757  
 ASHER B. D. M. ?  
 JOSHUA B. D. JUL. 1744  
 M. DEC. 1741  
 HANNAH (HINDLAH) LEVY (Q.V. I (1))  
 JUDITH  
 REBECCA B. D. M. 1722, WILTON, CONN.  
 JOSEPH SIMSON (Q.V.)  
 RACHEL

JACOB KING (Q.V. III) MARY (1)  
 SOLOMON B. D. N.Y. 1793 (YELLOW FEVER)  
 JOSHUA B. SEP. 17, 1744, GRENADA, W. I.  
 D. FEB. 16, 1810, N.Y.  
 M. MAR. 28, 1781, LANCASTER, PA.  
 (JUSTINA) BRANDLY LAZARUS (Q.V. III)  
 GRACE B. BEF. 1744  
 D. OCT. 13, 1781, JAMAICA, L. I.  
 NATHAN HART  
 MYER B. JUN. 2, 1779  
 D. AUG. 16, 1779

JOSEPH B. MAR. 21, 1782, LANCASTER, PA.  
 D. JUL. 20, 1783  
 FRANCES B. JUN. 9, 1783, LANCASTER, PA.  
 D. MAY 1, 1854, N.Y.  
 M. JUN. 4, 1800, N.Y.  
 HARMON HENDRICKS (Q.V. (1))  
 SOLOMON J. B. FEB. 26, 1786, N.Y.  
 D. JAN. 13, 1855, N.Y.  
 M. MAY 21, 1829, N.Y.  
 ELKALEH KURSHEEDT (Q.V.)  
 GRACE B. MAY 13, 1788, N.Y.  
 D. INF. AUG. 10, 1791 UNM.  
 SAMPSON B. N.Y. AUG. 29, 1790  
 D. INF. AUG. 10, 1791  
 HANNAH B. JUL. 7, 1792, N.Y.  
 D. NOV. 17, 1867, N.Y.

BRANDLY LAZARUS B. JUN. 12, 1830, BELLEVILLE, N.J.  
 D. FEB. 3, 1833  
 JOSHUA B. N.Y. JUN. 26, 1832  
 D. N.Y. APR. 24, 1883  
 GUSTAVUS JOSEPH B. OCT. 7, 1836, N.Y.  
 D. DEC. 9, 1910, N.Y.  
 M. EUGENIA VAN DUZER D.S.P.  
 JUSTINA BRANDLY (JESSIE) B. FEB. 16, 1839, N.Y.  
 D. JUL. 18, 1885, N.Y.  
 M. MAR. 17, 1858, N.Y.  
 MORTIMER HENDRICKS (Q.V. (1))  
 MOSES MONTEFIORE B. N.Y. FEB. 20, 1841  
 D. N.Y. JUN. 1, 1902  
 FRANCES ZELHIRA B. NOV. 28, 1842, N.Y.  
 D. MAY 19, 1916, N.Y.  
 M. 1) FEB. 21, 1866, N.Y.  
 CHARLES NOÉ BENJAMIN WETZLER M. 2)  
 CHARLES C. EDEY  
 EMIY HANNAH B. JAN. 26, 1845, N.Y.  
 D. OCT. 22, 1918, N.Y.  
 M. SEP. 11, 1867, N.Y.  
 LUCIEN G. FLDRANCE (Q.V.)  
 WASHINGTON SAMPSON B. OCT. 27, 1847, N.Y.  
 D. SEP. 13, 1919, N.Y.  
 UNM.  
 GERTRUDE ADELAIDE B. MAY 10, 1851, N.Y.  
 D. MAY 25, 1912, N.Y.  
 M. OCT. 11, 1871, N.Y.  
 DAVID LIEBER (Q.V.)  
 VIRGINIA GRACE B. NOV. 6, 1834  
 D. NOV. 14, 1881, N.Y.  
 JESSIE LEONORE B. OCT. 1866, N.Y.  
 D. MAR. 3, 1918, N.Y.  
 M. APR. 15, 1891, N.Y.  
 MICHAEL DE MERCADO (KINGSTON, 1867- )  
 EUGENE NOÉ B. JAN. 25, 1868

ISAACS III (1)

SPRUCE ST. (PH.) CEM.  
 SHEARITH ISRAEL REC.  
 ISAACS FAMILY BIBLE  
 JON STEDMAN  
 MICKVE ISRAEL REC.  
 RALPH COLTON  
 B'NAI JESHURUN REC.  
 P. B. H.  
 KRAUS-SANDOR COLL.  
 LEVY GEN.

GATZEL ISAAC PRONT (VAN BRUNT)  
 B. AMST. 1749 (?) (CONTRACT SURGEON ON "BON HOMME RICHARD", 1779)

(TO BOSTON, 1830) ISAAC GERRAT PRONT (GEORGE ISAACS)  
 B. 1772  
 D. PH. DEC. 22, 1842  
 RACHEL SARAH ?  
 B. D. ROCHESTER, N.Y. BEF. 1864

AARON (ISAACS) TO BOSTON, PH. GALVESTON, ATLANTA  
 B. AMST. DEC. 25, 1801  
 D. PH. JAN. 16, 1878  
 M. RI. MAR. 10, 1824  
 ESTHER LEVY (Q.V. IV)  
 (SEE NEXT PAGE)  
 BRINA (TO U.S. 1824 L. IN PH.)  
 B. D. M.  
 TILLIE B. D. M. HANDSCHBERGER  
 TILLIE  
 SOLOMON (ISAAC(S))  
 B. AMST. D. M.  
 HANNAH, DAU. OF LEVY AND LEA MEYERS  
 MATILDA B. D. M. N.Y. JAN. 22, 1834  
 MOSES ABRAHAMS  
 INF. DAU. D. PH. JUL. 1835  
 BRENDILLA B. D. M. AS 2ND WIFE SOLOMON FRIDENBERG (TO U.S. 1827)

JULIUS MITCHELL (OF BUFFALO) DENA B. D. M. HART  
 CERAL

DAU. 1832 ISAAC A. LEWIS B. JAN. 1836 D. SEP. 4, 1837, PH.  
 SOLOMON INF. DAU. D. PH. JUL. 31, 1845  
 BRINDELLA B. PH. AUG. 29, 1847

(1) AARON CLARENCE B. APR. 11, 1849, CLEVELAND  
 D. SEP. 1, 1901, N.Y.  
 M. OCT. 29, 1873, N.Y.  
 MARY CONSTANCE JACKSON (Q.V. I)  
 (1) REBECCA B. OCT. 21, 1850, CLEVELAND  
 D. M. OCT. 29, 1873, N.Y.  
 BARNEY PYLE  
 (1) ALBERT M. B. AUG. 15, 1852, CLEVE.  
 D. JAN. 20, 1923, CHI.  
 M. 1) LENA BISHOFF  
 M. 2) SALLY RAPHAEL  
 BERNARD (CINTI.)  
 HENRY CLAY B. MAY 12, 1855, CLEVE.  
 D. APR. 13, 1916, N.Y.  
 M. JUN. 1, 1881  
 EUGENIE FELBEL (Q.V.)  
 (1) ETHEL MIRIAM B. NOV. 1, 1883  
 D. JUN. 23, 1931  
 M. JAN. 5, 1911  
 ARCHIBALD SOUZA SEIXAS (Q.V. (4))  
 (1) WALTER SCOTT B. MAR. 30, 1857, CLEVELAND  
 D. M. ESSIE ISAACS (SEE NEXT PAGE)  
 (2) CLIFFORD B. SEP. 16, 1879, NYACK, N.Y.  
 D. APR. 1955 UNM.  
 (2) ERNEST R. B. MAY 22, 1883, NYACK, N.Y.  
 D. NOV. 21, 1941  
 M. NOV. 4, 1909  
 HELEN ROTHSCHILD

EUGENE JACKSON B. N.Y. NOV. 18, 1874  
 D. N.Y. FEB. 27, 1929  
 M. LOLA TISHMAN  
 ALBERT B. APR. 12, 1876  
 M. AUG. 1903  
 KITTY  
 EDNA B. MAR. 25, 1882  
 M. DOUD  
 CLARENCE B. OCT. 16, 1885  
 D. OCT. 17, 1938, N.Y.  
 M. APR. 2, 1908  
 ALMA HENDRICKS (DIV.) (Q.V. (2))  
 HENRY B. FEB. 2, 1909  
 DOROTHY B. JUL. 5, 1911  
 M. ALLEN HERBERT  
 BARBARA GAY  
 ROBERT B. NOV. 16, 1910  
 M. OCT. 15, 1940  
 GLADYS STRONGIN  
 EDWIN B. MAR. 19, 1913  
 M. MAR. 11, 1944  
 MARION RYDHOLM  
 ALBERT B. NOV. 13, 1920  
 UNM.  
 CARL B. OCT. 8, 1946, N.Y.  
 LAURIE B. JUL. 16, 1948, N.Y.  
 VINCENT B. APR. 6, 1944  
 PETER B. MAY 10, 1948

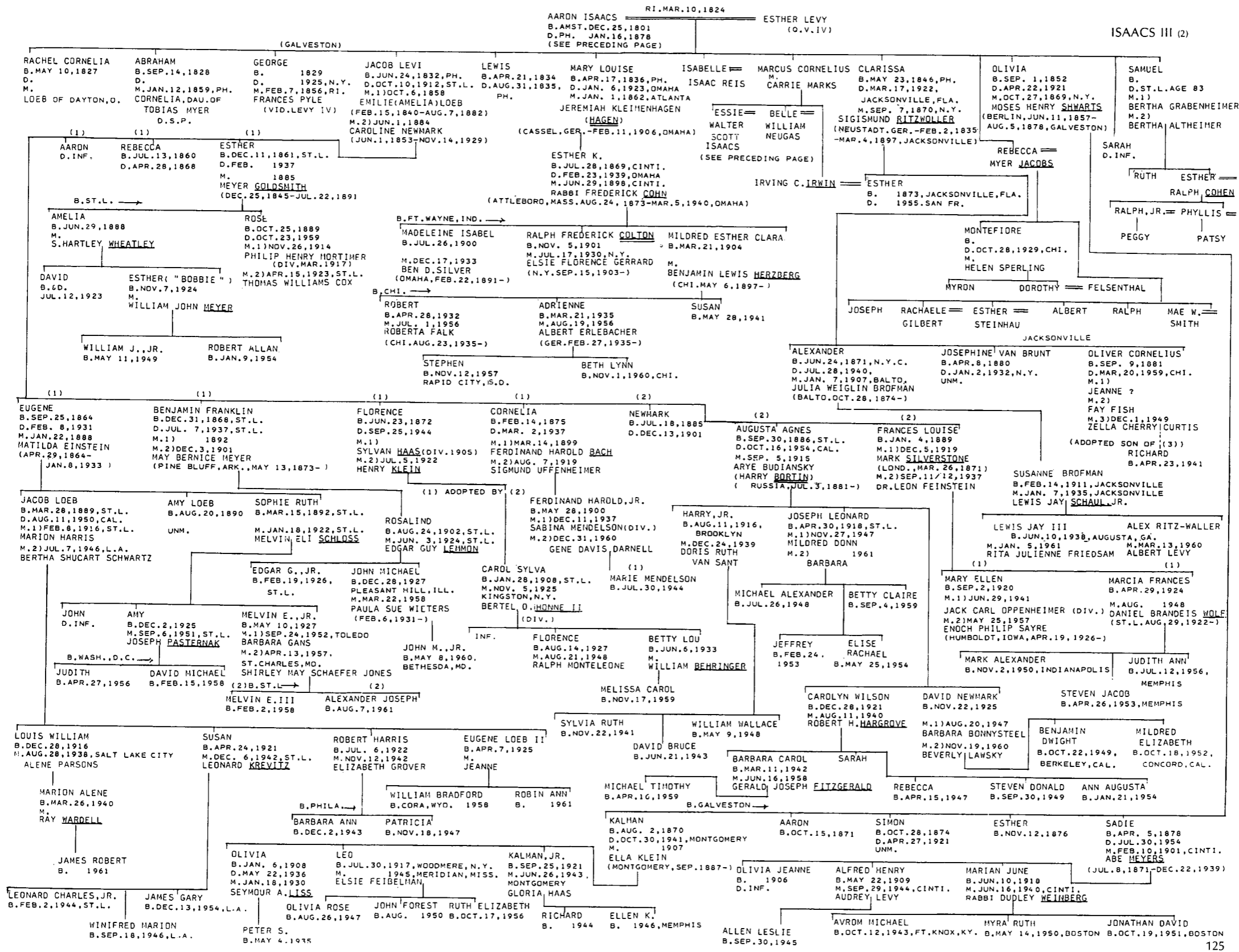

**ISAACS IV**

N.Y. TIMES MAG. 4/8/23  
THE OLD MERCHANTS, P. 317  
VITAL RECORDS FROM GA. NEWSPAPERS  
UJE, V. 5, P. 593  
KRAUS MS.

MARY RUMSEY (A CHRISTIAN)  
B. 1705  
D. JAN. 16, 1770

MAR. 7, 1725

RALPH ISAACS  
B. D. NORWALK, CONN.

AARON ISAACS CA. 1750  
B. AUG. 15, 1724, HAMBURG  
D. SEP. 11, 1798, EASTHAMPTON, L.I.  
(INSCRIBED ON HIS TOMBSTONE:  
"AN ISRAELITE IN WHOM  
THERE IS NO GUILF")

MARY HEDGES (A CHRISTIAN)  
B. SEP. 11, 1720, EASTHAMPTON, L.I.  
D. SEP. 14, 1805, EASTHAMPTON, L.I.

(EXCEPT FOR SOME LEGAL  
AND BUSINESS ASSOCIATIONS  
BETWEEN RALPH AND AARON ISAACS  
THERE IS NOTHING TO SHOW  
THAT RALPH WAS JEWISH)

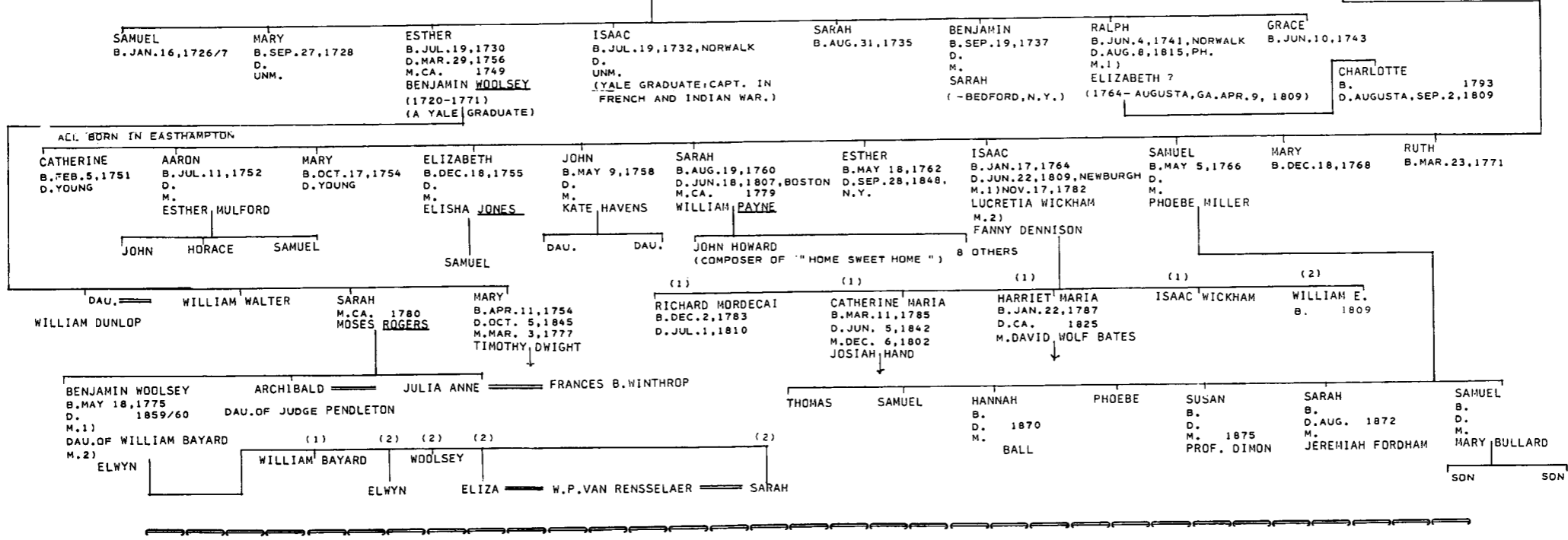

**ISAACS V**

KRAUS-SANDOR COLL.  
WILL OF JACOB COHEN (JRM COLL.)  
WILL OF DAVID ISAACS (ALBEMARLE CO., VA. CH.)  
MARRIAGE RECORDS (ALB. CO., VA. CH.)  
EZEKIEL-LICHTENSTEIN-JEWS OF RICHM.  
RICHMOND, VA. ARGUS  
KORN-JEWS & NEGRO SLAVERY

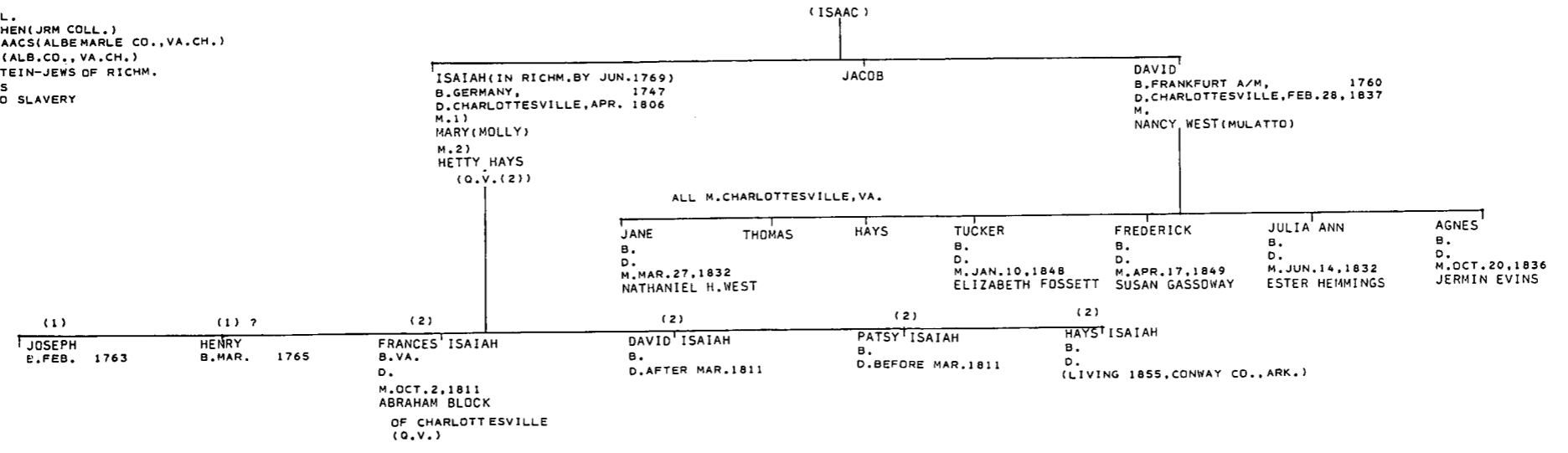

UJE V.5,P.594F.  
KRAUS-SANDOR COLL.  
PHILIP BRODY  
FLO.ABR.  
N.Y.CENSUS,1855  
SOLDMON GEN.  
U.S.CENSUS,1860(N.Y.)  
LEON L.WATTERS  
WHO'S WHO IN AMER.JEWRY 1955  
CAROL SHARLIN LEVY  
JEAN FARLEY MCLAUGHLIN LEVY

MYER SAMUEL ISAACS OF LEEUWARDEN, NETHERLANDS

JACOB SYMONS OF LOND.

ISAACS VI

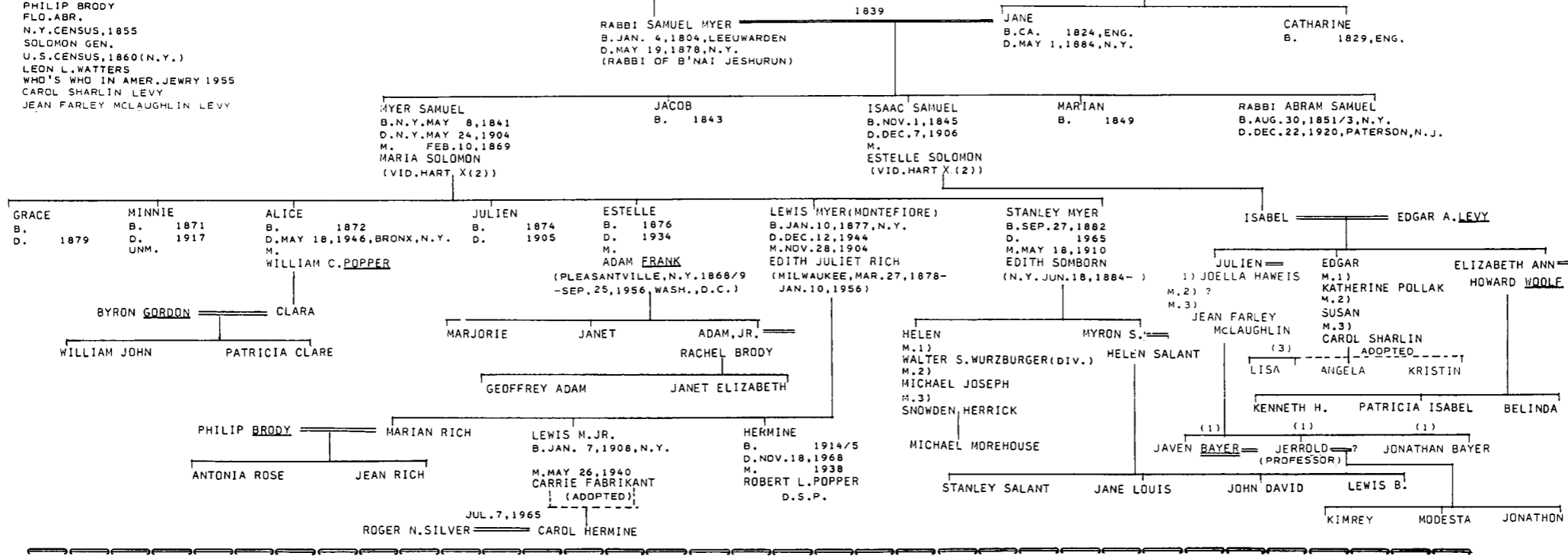

ROSENSWAIKE  
PAJHS, V.50, P.51  
B'NAI JESHURUN REC.

(FREEMAN, N.Y. AUG. 21, 1770)  
(TO N.Y. CA. 1759)

ABRAHAM ISAACKS  
B. AMST. 1737  
D. MAR. 20, 1815

JANETTE

ISAACS VII

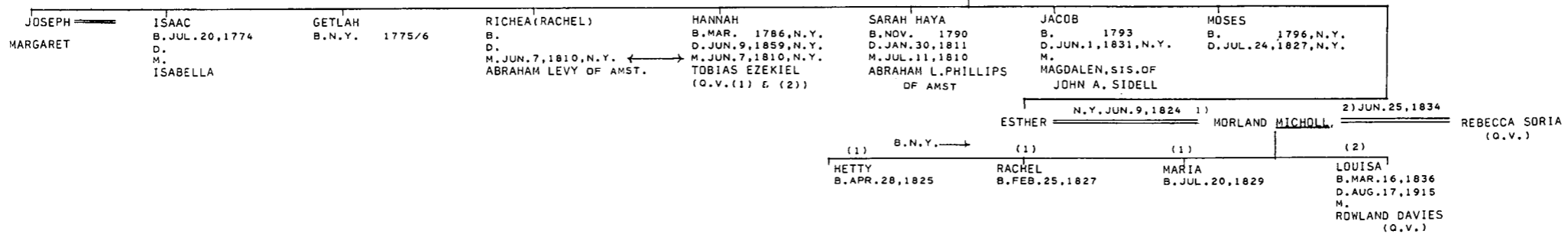

N.Y. CENSUS, 1855  
B'NAI JESHURUN REC.

ISAAC

JACOB KAHN/COHEN

ISAACS VIII

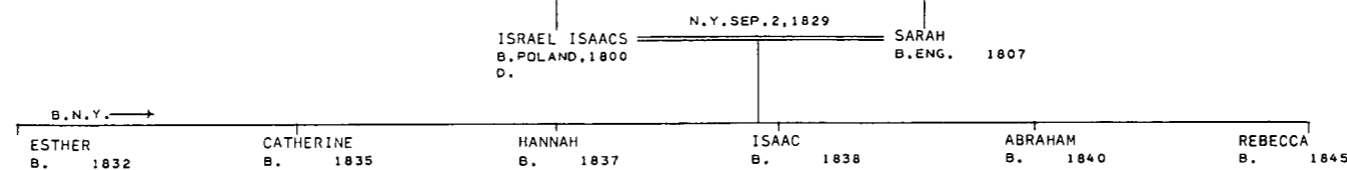

ISRAEL I

UJE V.5,P.619  
MORAIS-JEWS OF PH.  
ELZAS MS.  
DAR LINEAGE BOOKS  
FLORENCE ABRAHAMS  
MISC.VII,#511

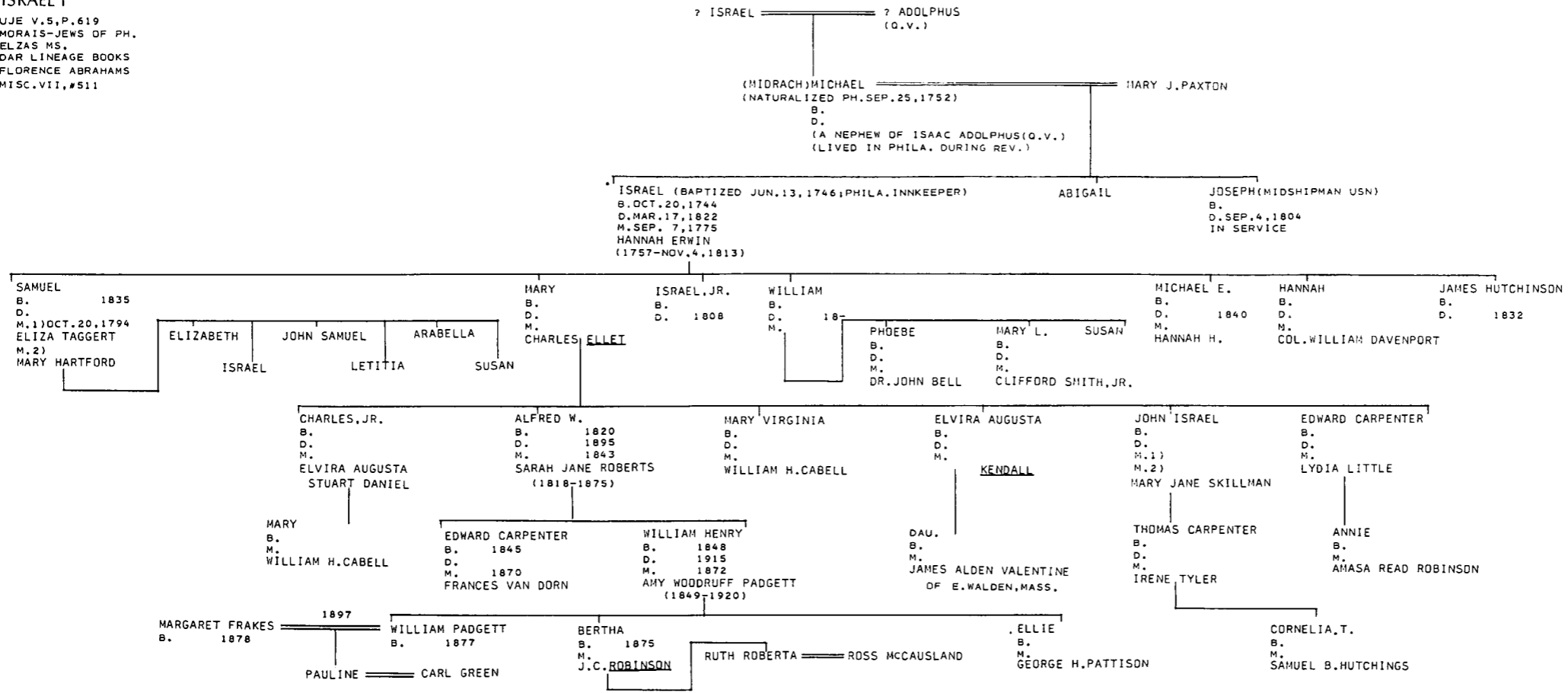

\*ESTABLISHED REVOLUTIONARY ANCESTOR

ISRAEL II

PAJHS V.6,P.109  
DAVIS-HIST. OF CONG. RODEPH SHALON, P. 37  
MORAIS-JEWS OF PHILA.  
MICKVE ISRAEL REC.  
HYNEMAN FAMILY REC. (PHOTO., AJA)  
EDLE-... FOREIGN ARRIVALS  
EZEKIEL-LICHTENSTEIN-JEWS OF RICHM.  
EZEKIEL FAMILY REC.  
POULSON'S  
PBH

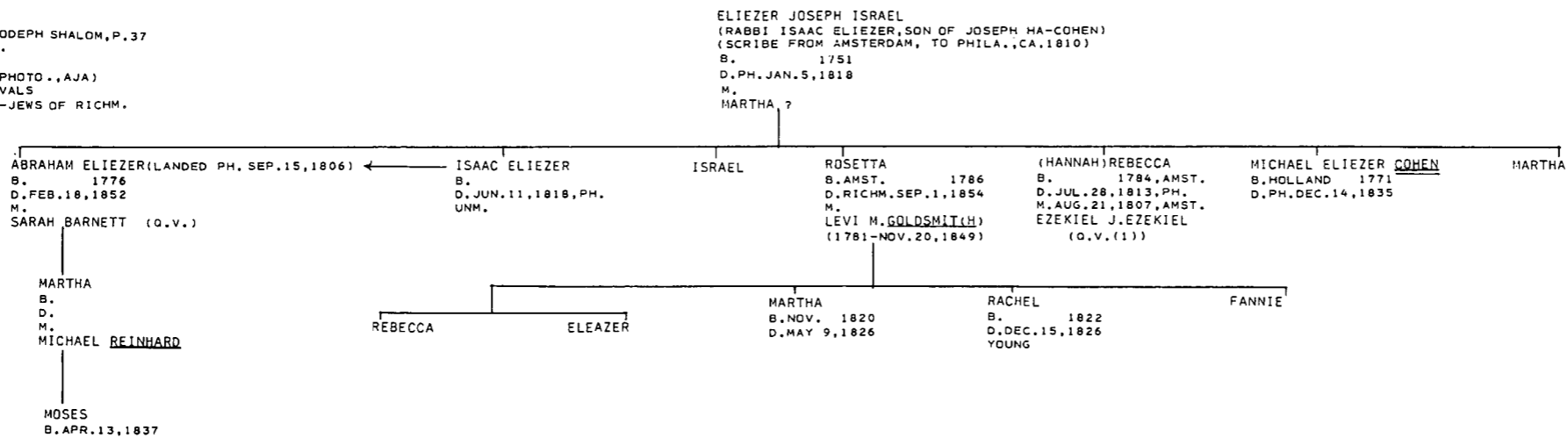

JACKSON I

WILLS OF JOSEPH A., MARY (JON STEDMAN)  
 JACKSON GENEALOGY (AT AJHS)  
 KRAUS COLL.  
 GOLDBERG-MAJOR NOAH', P. 219F.  
 U.J.E., V. 6, P. 4  
 MARYLAND HIST. MAG., V. 19, P. 76  
 SHEARITH ISRAEL REC.  
 FLORENCE ABRAHAMS  
 SAWYER-N.Y. WILLS  
 U.S. CENSUS  
 N.Y. CENSUS, 1855  
 ELZAS-OJC

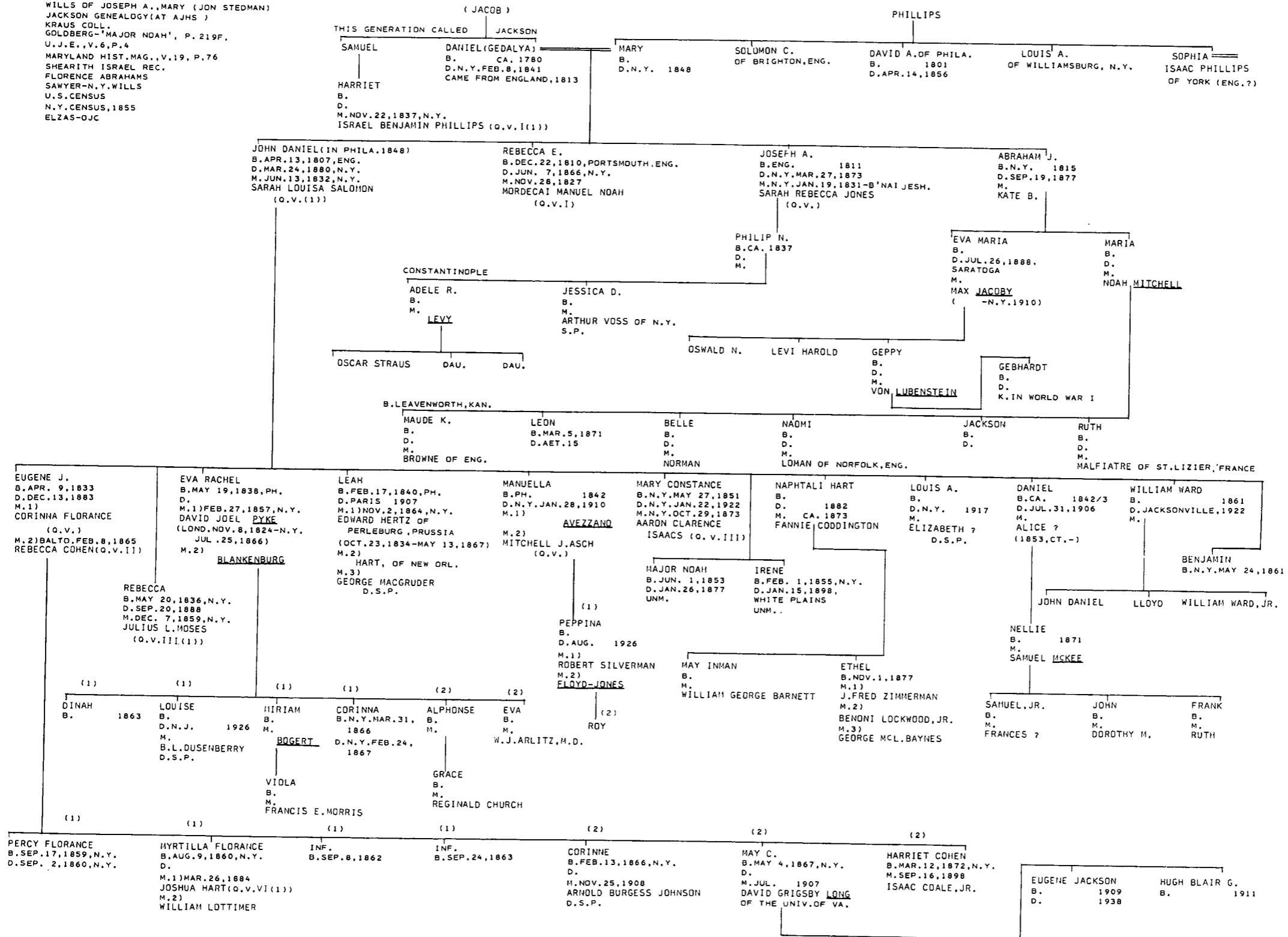



**JACKSON II**

KRAUS-SANDDR COLL.  
SHEARITH ISRAEL REC.  
B'NAI JESHURUN REC.  
FLO.ABR.  
JON STEDMAN

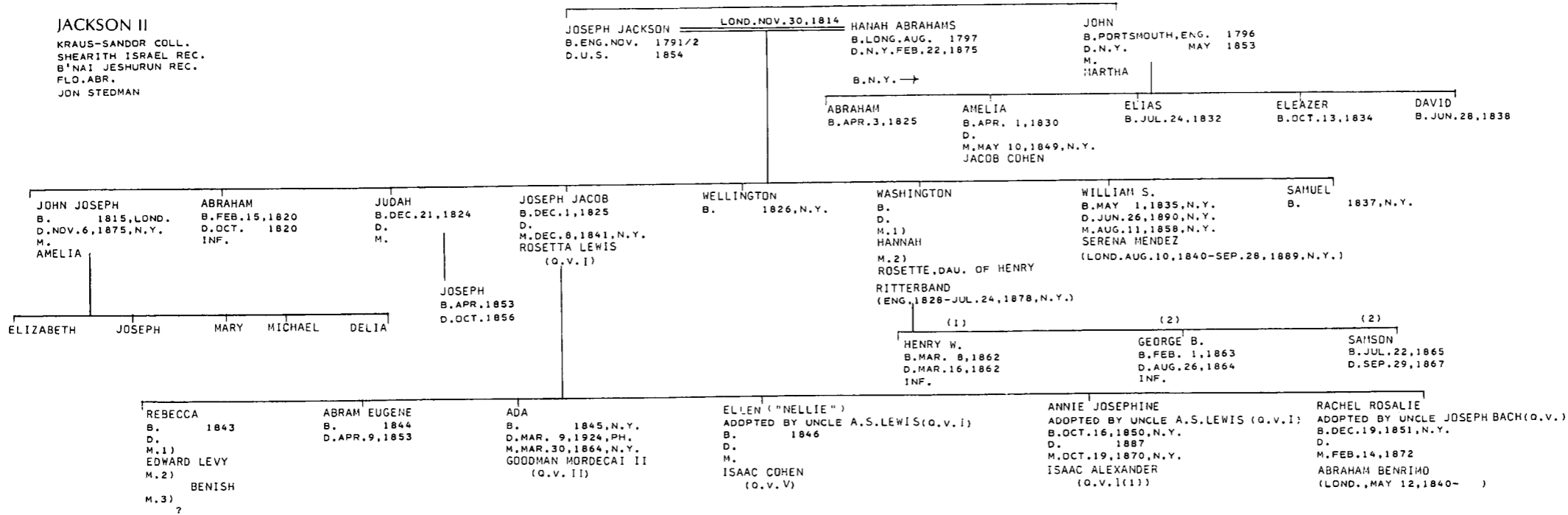

**JACKSON III**

JON STEDMAN

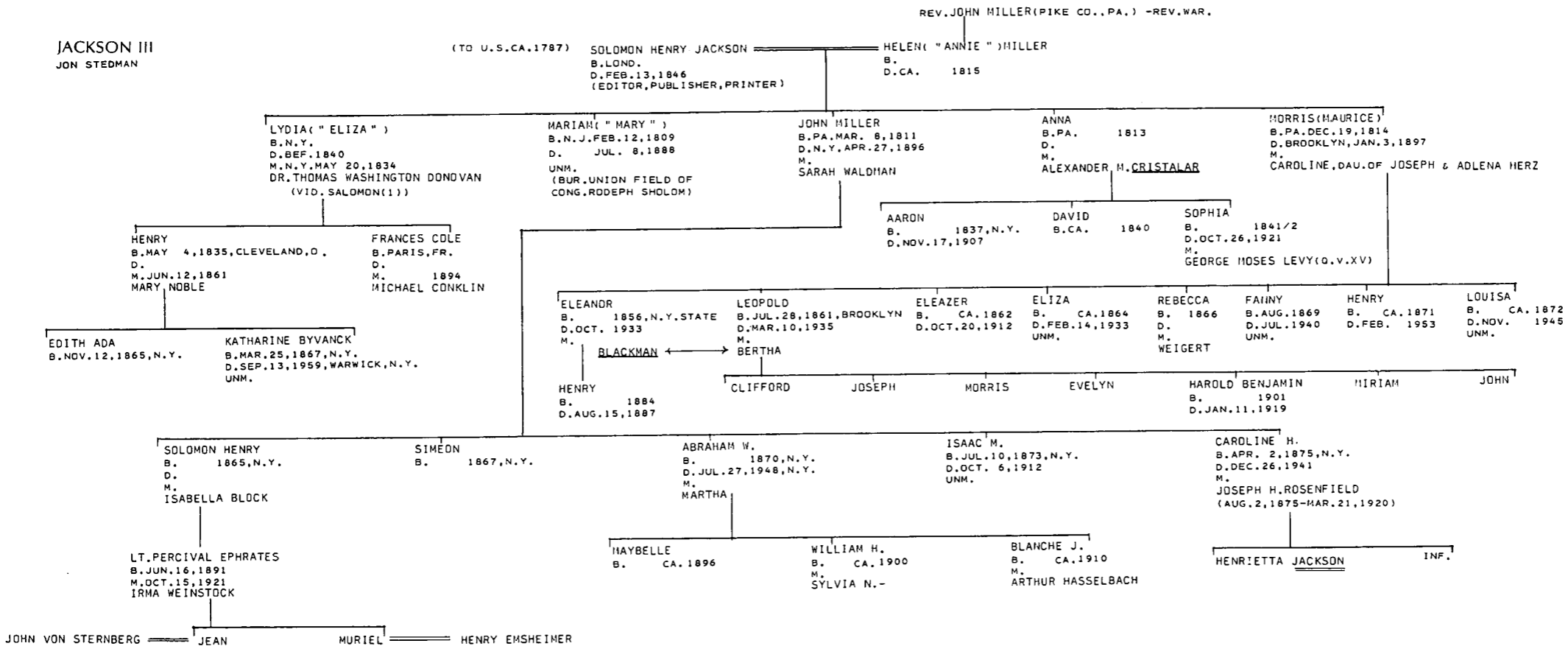

K. SCOTT-N.Y. ADMS.  
KORN-JEWS OF N.O.  
U.S. CENSUS, 1860  
KORN-JEWS OF MOBILE

PAJHS V. 18, P. 101  
PAJHS V. 27, P. 151F.  
KRAUS-SANDOR COLL.  
POOL-PORTRAITS...  
CLEMENS-N. & S. CAR. MARRIAGE RECORDS  
WILL OF SAMPSON SIMSON  
(OPPENHEIM COLL. AJHS)  
NYHS COLL.  
WILLS OF ESTHER SHEFTALL,  
GRACE ABENDANONE (JRM)  
N.Y. DEATHS  
SHEARITH ISRAEL REC.  
ELZAS MS.

JACOBS I

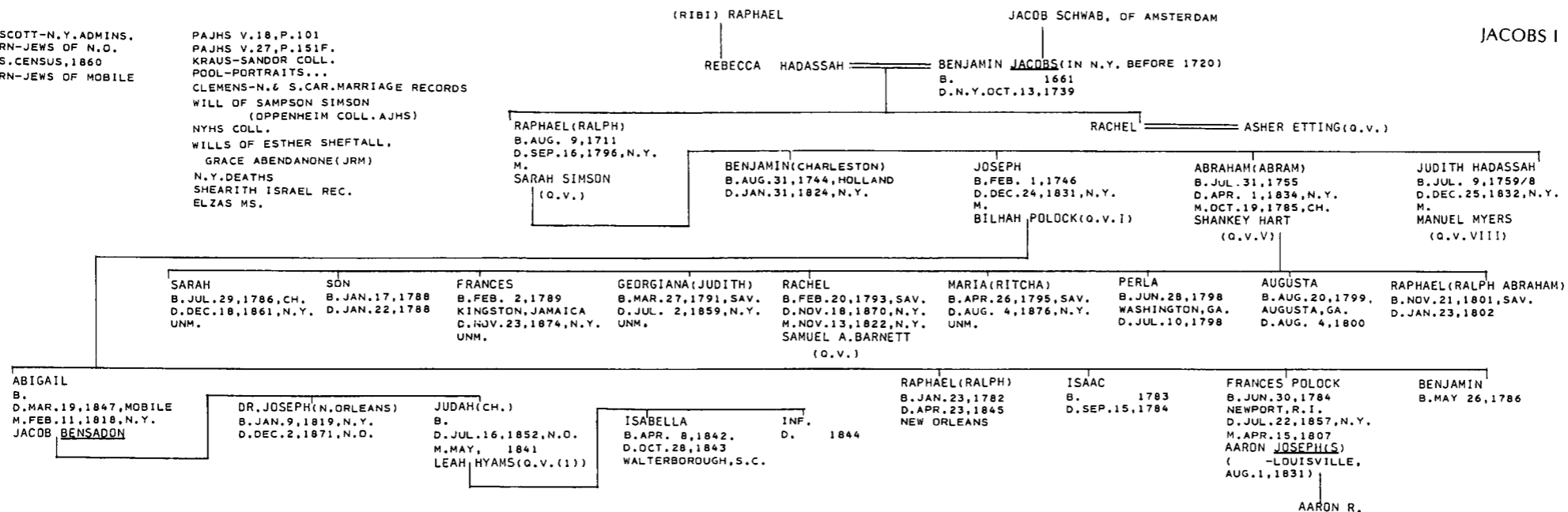

PAJHS V. 27, P. 150F.  
ELZAS-JEWS OF S.C.  
O. J. C.  
M. N.  
WILL OF JACOB JACOBS  
(BLAU & BARON, P. 104F.)  
SHEARITH ISRAEL REC.

(CH., SAV.)

JACOB JACOBS  
B. 1742  
D. NOV. 1, 1797, CH.  
M. NOV. 21, 1775  
CATY HAYS (Q.V. (1))  
WIDOW OF ABRAHAM SARZEDAS (Q.V.)

DAVID JACOBS  
B. D. APR. 24, 1771, ST. EUSTATIA  
M. DEC. 2, 1761, N.Y.  
RICHARD SIMSON (Q.V.)

JACOBS II

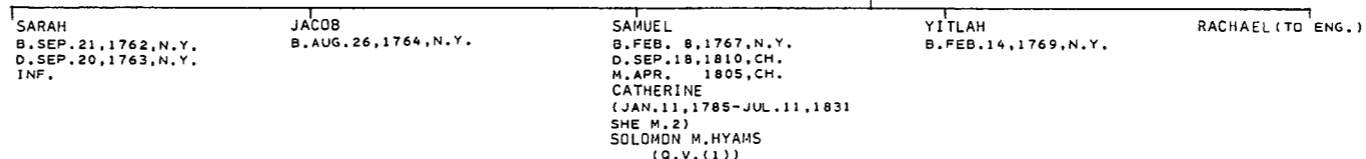

WILL OF BENJAMIN JACOBS (N.Y. ABSTRACTS)  
KRAUS-SANDOR COLL.  
POOL-PORTRAITS...  
SHEARITH ISRAEL REC.  
SAWYER-N.Y. WILLS  
MO. WILLS  
ROSENWAIKE

GOMPERS ISRAEL

(JACOBS)

HANNAH B. SURINAM 1743 D. N.Y. AUG. 20, 1825

BENJAMIN B. SURINAM, 1738 D. N.Y. DEC. 15, 1811

LEVI

SARAH B. SURINAM D. JUL. 12, 1849, N.Y. M. GOMPERS SALOMONS GOMPERS (SURINAM, 1768/72 - FEB. 13, 1831, N.Y.) (NATURALIZED 9 SEP. 1802)

DAU. B. D. M. EZEKIEL BARENT EZEKIEL OF SURINAM

JACOB B. D. M. BENJAMIN, JR.

ISRAEL BENJAMIN B. SURINAM 1781 (NATURALIZED 25 NOV. 1803)

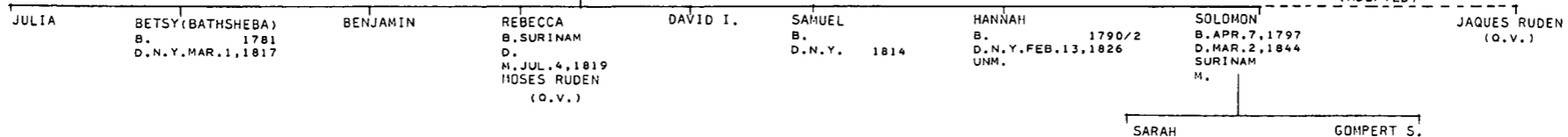

**JACOBS IV**

SHEARITH ISRAEL REC.  
B'NAI JESHURUN REC.  
N.Y.CENSUS, 1855

MYER SOLIS-COHEN  
KRAUS-SANDOR COLL.  
HART MS. (DAR)

ANGEL JACOBS N.Y. JUL. 3, 1822 RACHEL HART  
B. APR. 12, 1795, DARTMOUTH, ENG. (Q.V. IV)  
D. JUN. 13, 1850, N.Y.

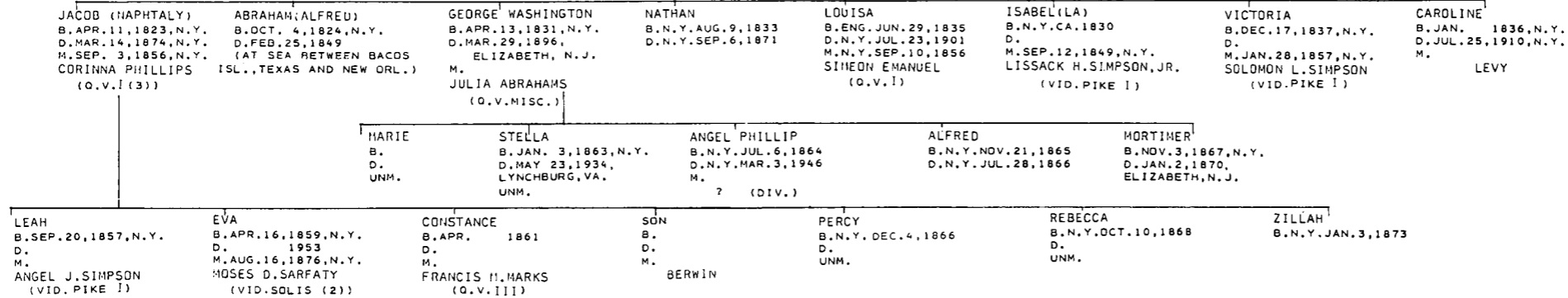

**JACOBS V (1)**

W.W.  
U.S.CENSUS, 1790, 1850  
AJHQ, LVII/24FF.  
MRS. HUGH BRENEHMAN  
CARRINGTON WILLIAMS  
MISCELLANIES VII, #546  
#562  
ROSENWAIKE

KRAUS-SANDOR COLL.  
EZEKIEL-LICHTENSTEIN-JEWS OF RICH.  
WILL OF SOLOMON JACOBS (JRM)  
BARNET JACOBS MOHEL REC.  
PAJHS V. 16, P. 74F.  
VA. MARRIAGE BONDS  
S.A. MOSS-MOSS-HARRIS GENEALOGY  
SPRUCE ST. (PH.) CEMETERY REC.  
HENRY V. HOAGLAND  
MISCELLANIES VII, #546

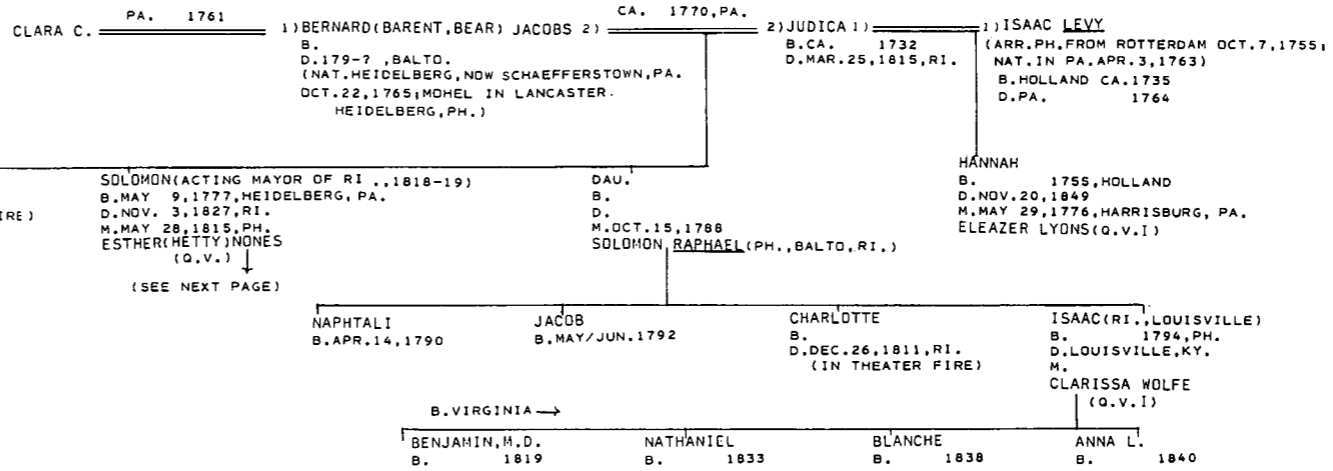

**JACOBS VI**

ELZAS MS.  
M.N.  
NEW JEW. CEM. OF BETH ELOHIM  
O.J.C.  
FLO. ABR.  
LAZARUS GEN. (T. TOBIAS)  
KRAUS-SANDOR COLL.

COL. MYER JACOBS FEB. 17, 1817, CH. REBECCA LAZARUS  
B. JAN. 11, 1791, ENG. (Q.V. II)  
D. NOV. 28, 1861, CH.

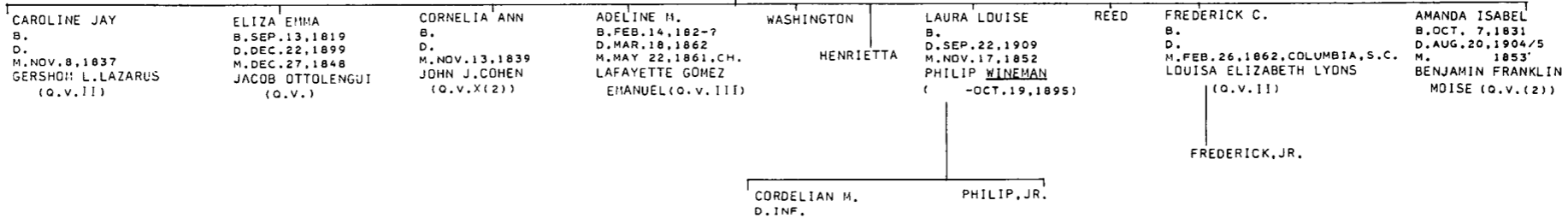

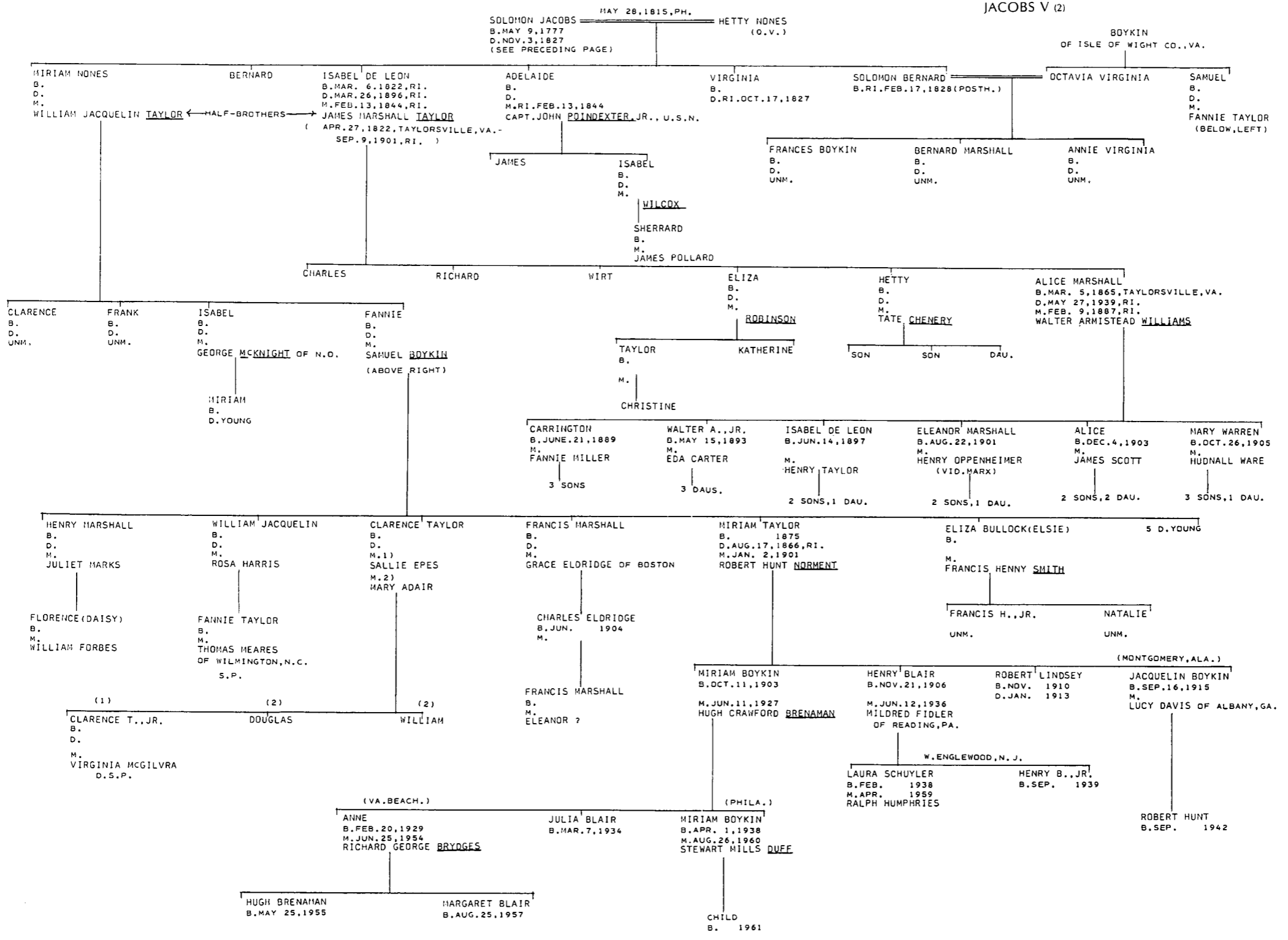

JACOBS VII

LEVY GEN.  
JE VII, P. 45  
AMY STEWART MSS. (AJA)  
BETH SHALOME MARR, REC.  
FLO. ABR.  
ELZAS-NEW JEW. CEM. OF BETH ELOHIM  
B'NAI JESHURUN REC.  
ELIZABETH WEIL JACOBS

EZEKIEL-LICHTENSTEIN-JEWS OF RI.  
ANDRADE-JEWS OF JAMAICA  
RALPH F. COLTON

(JAMAICA) HENRY JACOBS  
B.  
D.  
M.  
RACHEL MESQUITA

JACOB GARSIA (DE PAZ)  
B.  
D.  
M.  
ESTHER BRANDON

MOSFS LYON  
B. MAR. 25, 1794  
D. DEC. 5, 1855  
SPANISH TOWN, JAM.

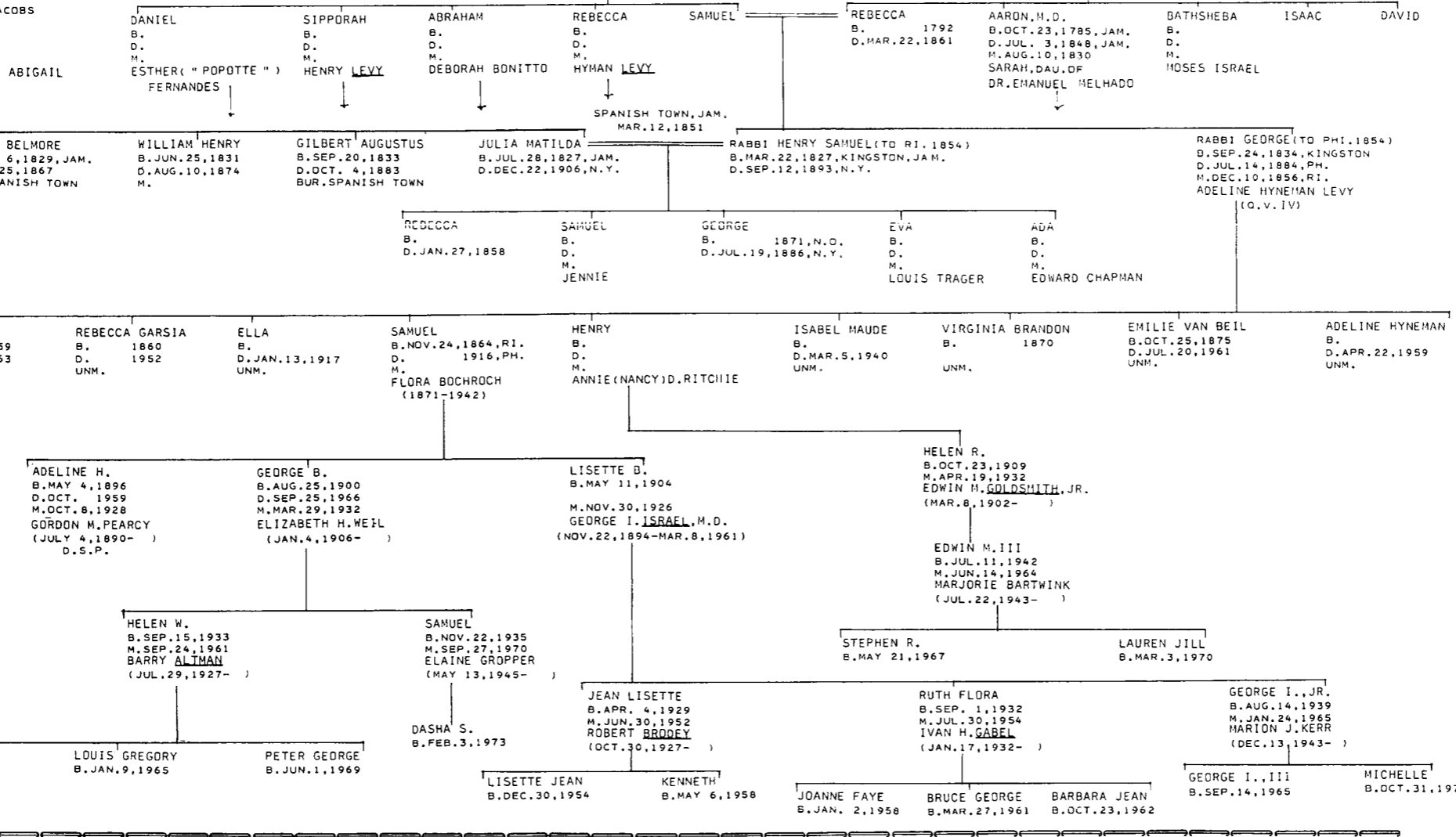

JACOBS VIII

KRAUS-SANDOR COLL.

LEOPOLD JACOBS ELIZABETH LEWIS (Q.V. I) B. 1827

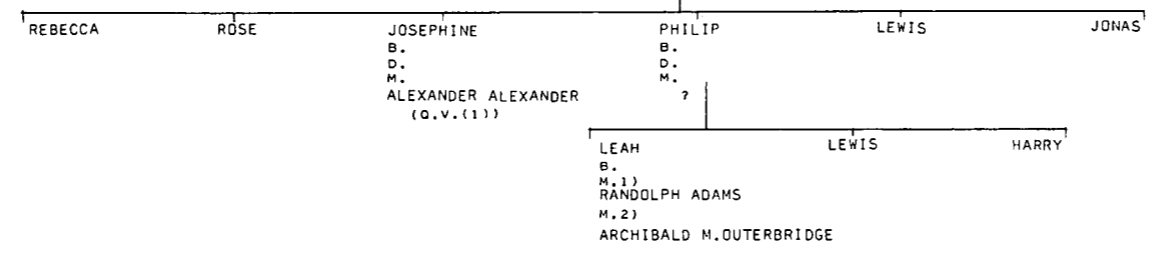

KORN-JEWS OF N.O., P.179F.

JACOBS IX

(MENACHEM) MANIS JACOBS (IN N.O. BEFORE 1812)  
B. AMST. CA. 1782  
D. N.O. SEP. 24, 1839  
M. 1)  
M. 2) N.O. 1826  
ANGELIQUE CHARLOTTE JACINTHE, WIDOW OF DENIS VERNEUILLE  
(PARIS, FR. 1781/82-AUG. 4, 1851, N.O.)

(1) IRMA B. CA. 1815 D. M. BERNARD HART (O.V. !!!)  
(2) THERESE  
(2) FELIX

WILL OF SAMUEL JACOBS (AJA)  
AJD, P. 21

JACOBS X

THOMAS JACOBS OF ST. DENIS, QUE. B. D. M. FEB. 26, 1781, QUEBEC ANGELIQUE MASSE  
SAMUEL OF ST. DENIS B. D. 1786  
MARIE JOSETTE AUDET LAPOINT (2) (2)  
DR. JEAN BAPTISTE PIEUTORD (1) 1758 B. CA. 1731 D. MAR. 1818  
PELAGIE PERRON B. CA. 1739

SAMUEL, JR. B. 1764 D. 1824  
MARIE GENEVIEVE (POLLY) B. D. M. CAPT. STANISLAUS VIGNEAU  
MARIANNE (MARIE ANNE)  
JAMES LEVY  
JEAN BAPTISTE B. AFTER 1775

ROSENWAIKE-JEWS OF BALTO.

MOSES JACOBS B. 1749 D. JAN. 13, 1802, BALTO.  
ESTHER

JACOBS XI

JACOB RACHEL JOHN SARAH MICHAEL B. 1792 D. SEP. 22, 1804, BALTO. BENJAMIN CHARLOTTE JULIET

PAJHS V. 2

V. 8, P. 46F.  
JE, VII, P. 222F.  
UJE, VOL. 6, P. 169F.  
AMER. ISRAELITE, FEB. 21, 1957, P. 6.  
ELIZ. PLAUT  
JOHNSON GEN.

PHINEAS ISRAEL JOHNSON (PORTSMOUTH, ENG. TO CONNELLSVILLE, IND., 1817)  
DAVID ISRAEL (CONNELLSVILLE, IND., 1818 CINCINNATI, O. 1820)  
B. CA. 1795 D. JUN. 15, 1842 M. MAY 16, 1816, ENG. ELIZA DAVIS

JOHNSON

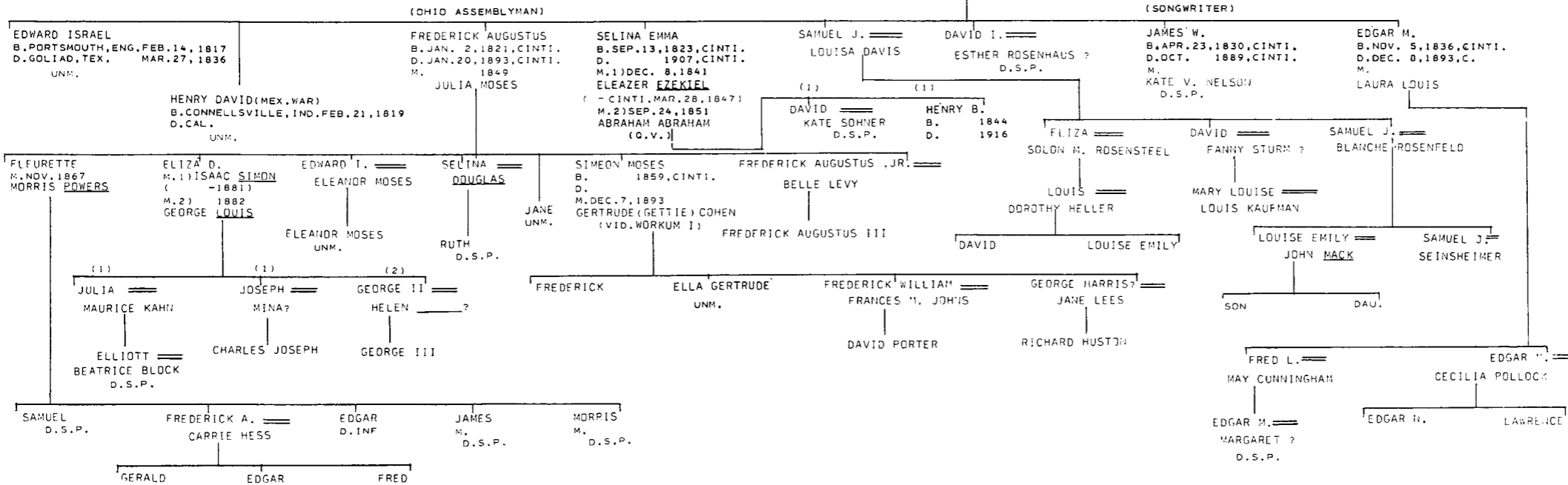

JOACHIMMSEN  
 KRAUS-SANDOR COLL.  
 SHEARITH ISRAEL REC.  
 UJE IV, P. 279  
 U.S. CENSUS 1850  
 B'NAI JESHURON REC.

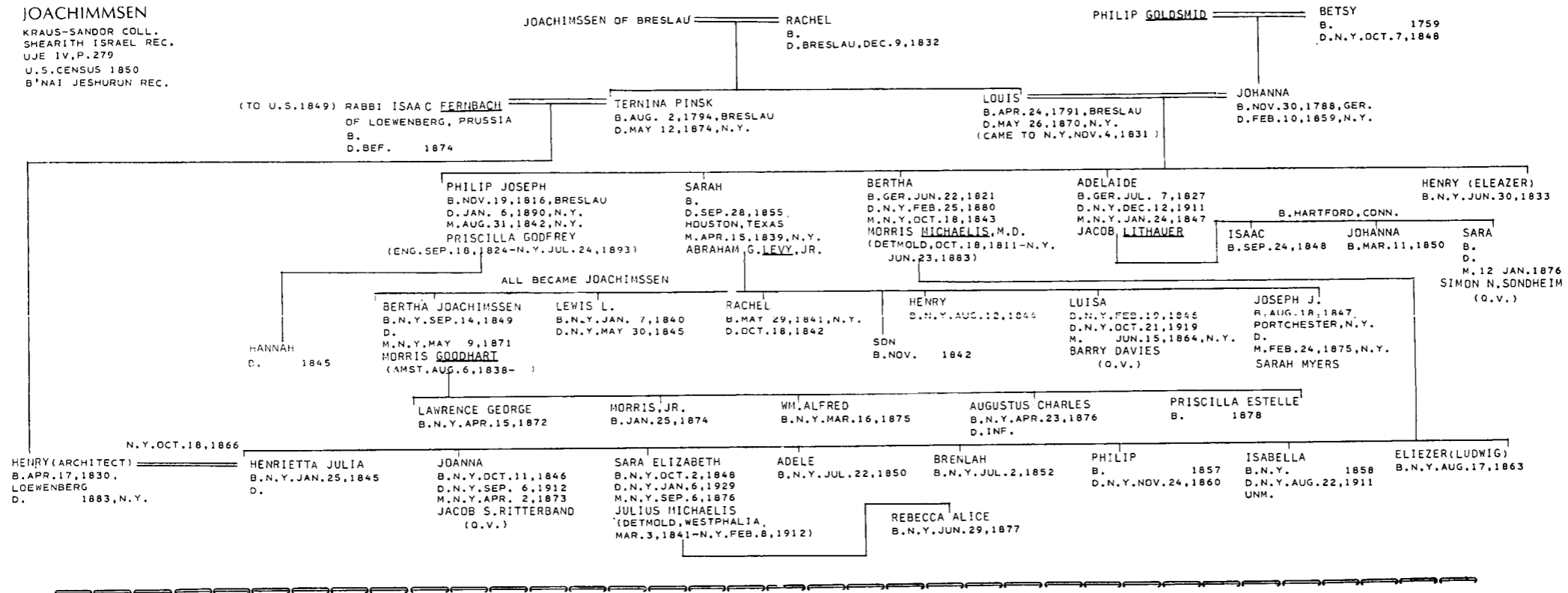

JONAS

CINTI.-UNITED JEW.CEM.REC.  
 JRM COLL.  
 FLO.ABR.  
 ROTH-RISE OF PROVINCIAL JEWRY  
 KORN-JEWS OF N.O.  
 MRS.RICHARD H.GRANT  
 KRAUS-SANDOR COLL.  
 PAJHS V.8,P.44F.  
 V.17,P.123F.

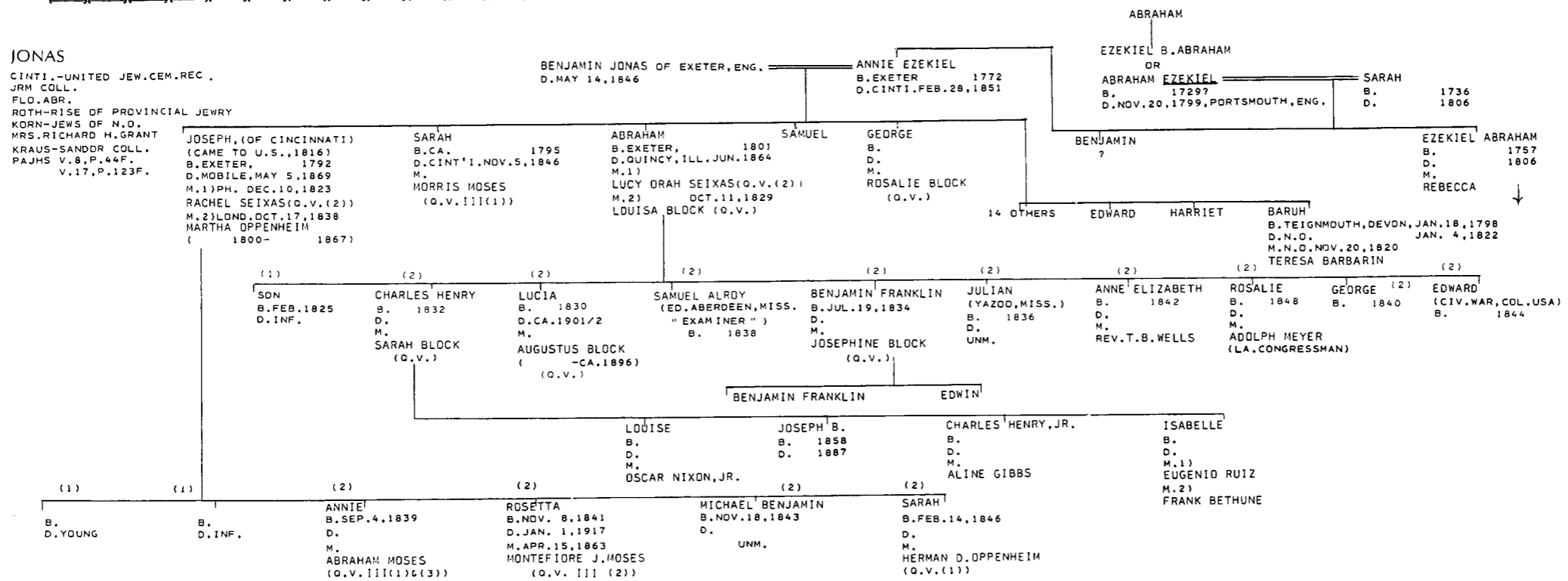

KRAUS-SANDOR COLL.  
MORAIS-JEWS OF PH., P. 331F.  
ROSENTHAL MS.  
MARKS FAMILY REC. (AJA)  
MICKVE ISRAEL REC.

JONES I

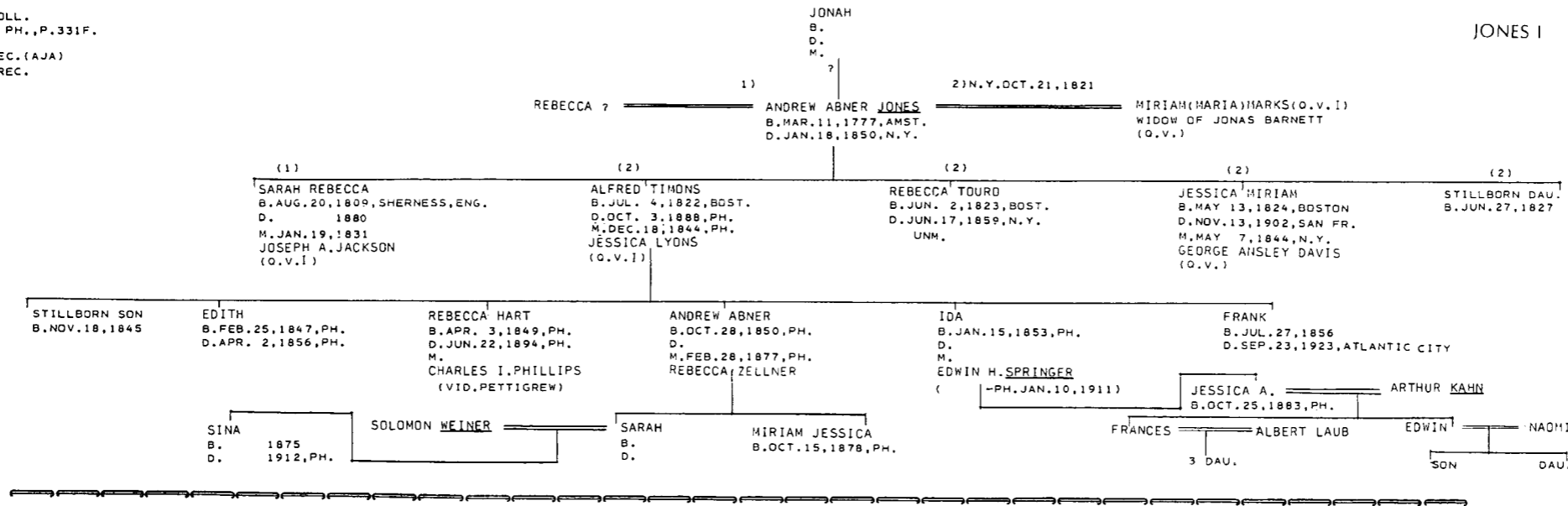

KORN-JEWS OF MOBILE  
WILL OF SAMUEL JONES  
ELZAS-O.J.C.

JONES II

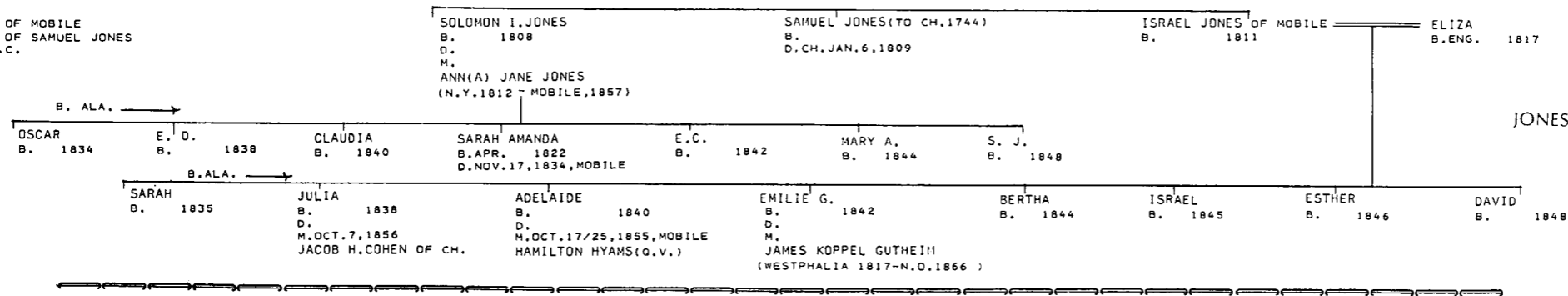

KRAUS-SANDOR COLL.  
EZEKIEL-LICHTENSTEIN-JEWS OF RICHM.  
LETTERS OF RUPERT L. JOSEPH  
R. J. D'ARCY HART  
SHEARITH ISRAEL REC.  
ROSENSWAIKE

JOSEPH I (N.Y.)

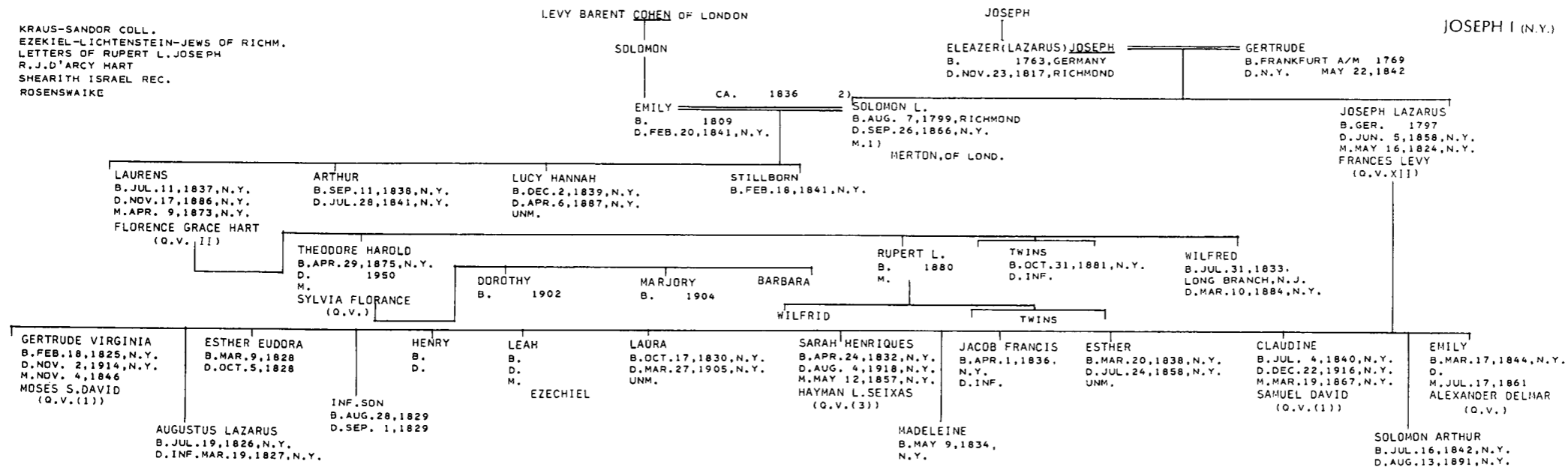



JOSEPH II (CANADA)

J.R.M.  
 MRS. E. MILLER  
 PAJHS V.1, P.117F.  
 UJE V.6, P.194  
 KRAUS-SANDOR COLL.  
 GRATZ CLIPPING(DAR)  
 MALCHELOSSE-LES JUIFS CANADIENNE ...  
 SHEARITH ISRAEL REC.  
 FLORENCE ABRAHAMS

NAPTALI JOSEPH HART  
 B. AMSTERDAM (Q.V.1)

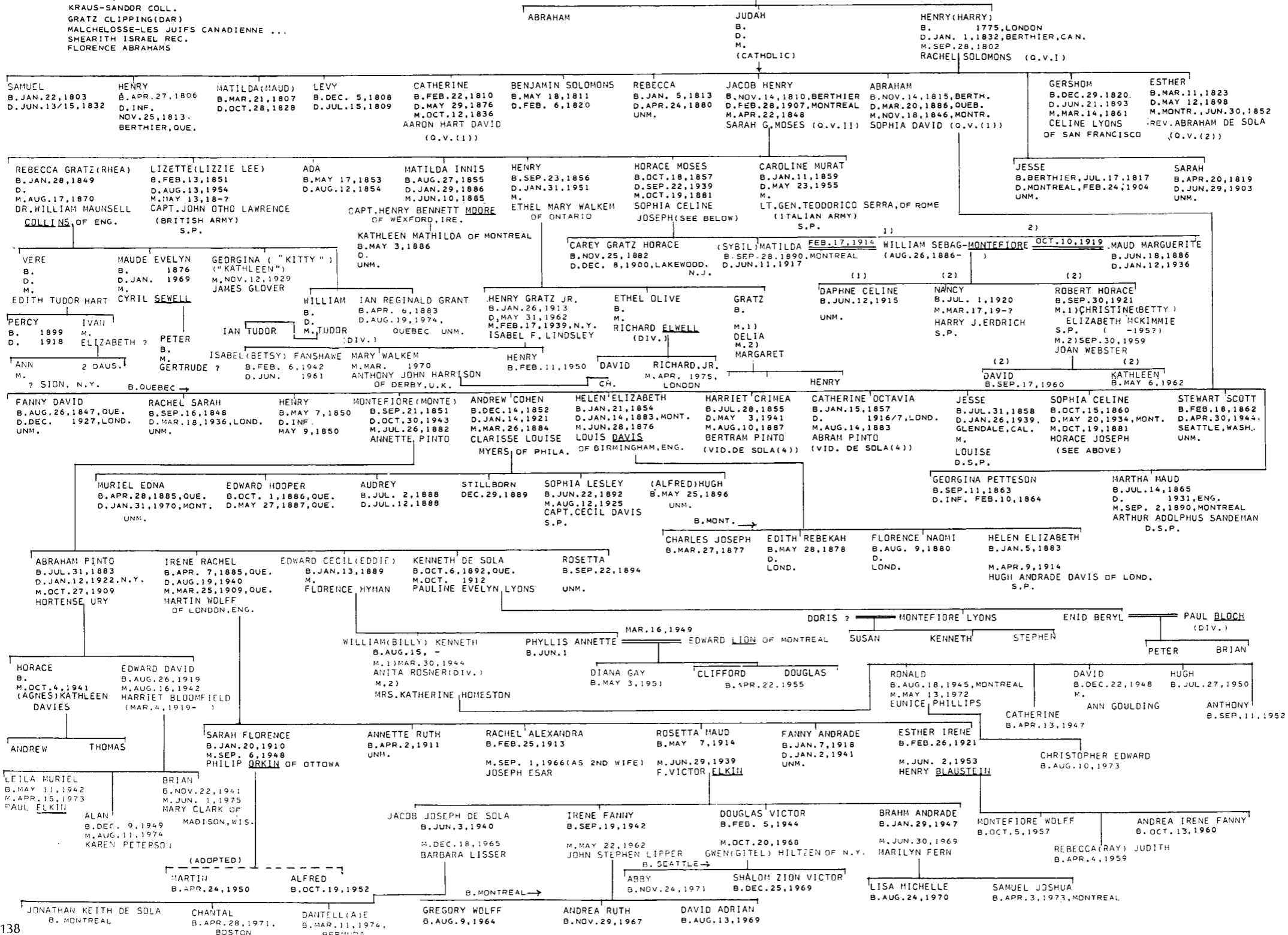

ELZAS MS.  
M.N.  
NEW JEW. CEMETERY  
AT GEORGETOWN, S.C.  
C. J. C.  
H. A. ALEXANDER-ALEXANDER FAMILY  
FLO. ABR.  
NATCHEZ CEMETERY (JULIEN SAKS)

JOSEPH STEGG  
LIZER JOSEPH  
B. MANNHEIM, GER. 1762  
D. GEORGETOWN, S.C. JUN. 25, 1827

SARAH  
B. 1776  
D. GEO'TN. OCT. 8, 1820

JOSEPH III

ELEANOR  
B. NOV. 9, 1794, BLACK MINGO, S.C.  
D. FEB. 6, 1856, SAV.  
M. MAY 5, 1814  
ISRAEL SOLOMONS  
(Q.V. IV (1) & (2))

MOLCIE (MOLSEY)  
B. D. AUG. 16, 1835, CH.  
M. JAN. 11, 1819  
SAMPSON SOLOMONS  
(Q.V. IV (1))

JACOB JUDAH  
B. D. D.  
M. SARAH EMANUEL  
(Q.V. III)

JOSEPH  
B. D. D.  
M. FRANCES ALEXANDER  
(Q.V. I)

SARAH  
B. D. D.  
UNM.

CHARLOTTE  
B. D. D.  
UNM.

ISABELLE  
B. D. D.  
M. LEVY L. JOSEPH

CLARA  
B. D. D.  
UNM.

ELIZABETH  
B. D. D.  
M. JAN. 3, 1844  
ALEXANDER ABRAMS  
(VID. ABRAHAMS III)

LIZAR H.  
B. D. D.  
M. JAN. 13, 1853  
HENRIETTA ABRAMS  
(VID. ABRAHAMS III)

FRANCES  
B. D. D.  
M. JUL. 30, 1851  
MOSES JOSEPH SOLOMONS  
(Q.V. IV (2))

SARAH  
B. 1823  
D. DEC. 2, 1824  
GEO'TN

EMILY  
B. 1839  
D. MAR. 15, 1842

ANNABEL (ISOBEL)  
B. D. D.  
M.

JACOB JUDAH (CSA)  
B. GEO'TN  
D. APR. 7, 1862  
(2D BATTLE OF SHILOH)

MOLCIE  
B. MAY 5, 1841, CH.  
D. NOV. 26, 1910.  
BOSTON, MASS.  
(BUR. NATCHEZ)  
M. JUN. 3, 1873  
ISAAC LOWENBERG  
(HECHINGEN, HOHENZOLLERN,  
MAR. 7, 1837-SEP. 7, 1888)

JOSEPHINE  
B. AUG. 22, 1836, CH.  
D. NOV. 12, 1906.  
NATCHEZ  
M. JAN. 24, 1855  
MORDECAI HYAMS  
(Q.V. (1))

HENRIETTA  
B. D. D.  
M. JAMES NATHANS

NATHANS

SALLIE  
B. MAY 1, 1874  
D. JAN. 13, 1881

HILDA  
B. AUG. 26, 1876  
D. DEC. 30, 1880

ISAAC LOWENBERG  
(HECHINGEN, HOHENZOLLERN,  
MAR. 7, 1837-SEP. 7, 1888)

AVERY J. JEFFERSON

ELZAS MS.  
M.N.  
D. J. C.

JOSEPH, OF MANNHEIM, GERMANY

JOSEPH IV

WILL OF MANUEL JOSEPHSON

JOSEPH

JOSEPHSON

ISRAEL JOSEPH  
B. MANNHEIM 1733  
D. CH. JUN. 9, 1804  
M.

MIRIAM (MARY)  
B. 1791  
D. APR. 15, 1863, SUMTER  
M. FEB. 1809  
LEVY MOSES (Q.V. III (1))

JUDAH (LONDON)  
B. D. D.  
M. ?

MOSES (MANNHEIM)  
B. D. D.  
M. ?

KATEY  
B. D. D.  
M. SOLOMON MOSES GUNDERSHEIM

SERKA  
B. D. D.  
M.

DANIEL  
B. D. D.  
M. HART, OF MANNHEIM (Q.V. VI (1))

MANUEL JOSEPHSON  
B. 1729, GER.  
D. JAN. 30, 1796, PH.  
M. 1759  
RACHEL (RITZEL) JUDAH  
D. S. P. (Q.V. I)

AARON

MORDECAI

4 SISTERS

(IN N.Y., 1700 IN BROOKHAVEN, CONN., 1708  
MADE FREEMAN IN N.Y. JAN. 10, 1715/6)

JUDAH LEIB, OF Breslau

JUDAH I (1)

DAR LINEAGE BK. XCVI, P. 254  
FLORENCE ABRAHAMS  
SHEARITH ISRAEL REC.  
MYER SOLIS-COHEN  
PAJHS V. 11, P. 154  
PAJHS V. 21, P. 5  
PAJHS V. 27, P. 286  
J. E. V. 7, P. 331  
U. J. E. V. 6, P. 231  
KRAUS-SANDOR COLL.  
SOLOMONS MS. (JRM)  
POOL-PORTRAITS...  
WILL OF SAMUEL B. H. JUDAH  
WILL OF BELLA JUDAH  
WILL OF ISAAC JUDAH  
ROSENSWAIKE  
U. S. CENSUS, 1790, 1820  
MORDECAI FAMILY BIBLE

BARUCH JUDAH  
B. Breslau, 1678/9  
D. N. Y. JAN. 12, 1774  
M. 1  
RACHEL JOCHANAN, OF Breslau  
M. 2  
SARAH HELBERT, OF LONDON  
(ENG. - N. Y. FEB. 24, 1749)  
(Q.V.)

JACOB  
B. D. JUN. 20, 1783

REBECCA  
B. 1727/5  
D. PH. MAR. 24, 1817  
M.

SAMUEL  
B. AUG. 19, 1728, N. Y.  
D. OCT. 19, 1781, PH.  
M. DEC. 19, 1759  
JESSIE JONAS  
(LOND. 1736/8-N. Y.  
MAY 8, 1818)

HILLEL (HILLIARD)  
(FREEMAN IN N. Y.  
JAN. 8, 1754)  
B. CA. 1730  
D. CA. 1815  
M. JUN. 1759,  
NEW EBERDAIN  
ABIGAIL SEIXAS  
(Q.V. (1))  
(SEE NEXT PAGE)

RACHEL (RITZEL)  
B. 1732  
D. PH. JAN. 17, 1797  
M. 1759  
MANUEL JOSEPHSON  
D. S. P. (Q.V.)

MOSES  
B. 1735  
D. N. Y. SEP. 25, 1822  
UNM.  
(FREEMAN, N. Y. AUG. 3, 1768)

URIAH JUDAH  
B. D. D.  
M.

DAVID (ENTERED UNIV. OF PA., 1760)

BENJAMIN S.  
B. OCT. 6, 1760  
D. DEC. 24, 1831  
M. FEB. 16, 1803  
ELIZA ISRAEL  
(VID. HELBERT)

AMELIA  
B. SEP. 12, 1761  
D. APR. 22, 1849  
UNM.

SARAH  
B. DEC. 14, 1763, N. Y.  
D. OCT. 12, 1795,  
PATERSON, N. J.  
M. OCT. 22, 1794  
SAMUEL MYERS (Q.V. I)

CARY JEKUTHIEL  
B. SEP. 14, 1766, N. Y.  
D. FEB. 7/16, 1837, N. Y.  
UNM.

JACOB SAMUEL  
B. OCT. 7, 1767, N. Y.  
D. JUN. 20, 1783, PH.  
UNM.

RACHEL  
B. MAY 11, 1772  
D. FEB. 6/8, 1836  
UNM.

NAPTALI HART  
B. JUN. 1/6, 1774  
D. SEP. 16, 1855, N. Y.  
M. NOV. 11, 1801  
ESTHER (HETTY) HENDRICKS  
(Q.V. (1))

AARON  
B. JUN. 20, 1775, N. Y.  
D. JUN. 28, 1834  
M. FEB. 3, 1819  
RACHEL R. GOMEZ  
(Q.V.)

WALTER JONAS (FALK)  
B. APR. 4, 1778, N. Y.  
D. SEP. 15, 1798, N. Y.  
UNM.

SARAH  
B. OCT. 6, 1762  
D. INF.

REBECCA  
B. JUL. 12, 1765  
D. DEC. 19, 1846, N. Y.  
UNM.

RACHEL  
B. SEP. 1768  
D. APR. 29, 1770  
UNM.

BELLA  
B. SEP. 29, 1770  
D. JAN. 16, 1847, N. Y.  
UNM.

FANNY (FRUMET)  
B. MAY 6, 1771  
D. FEB. 14, 1833  
UNM.

DAU.  
B. FEB. 3, 1830  
D. INF.

SAMUEL N.  
B. OCT. 8, 1803  
D. MAR. 2, 1849  
M. JAN. 10, 1844  
MIRIAM NATHAN  
(Q.V. I (1))

HENRIETTA  
B. S. BEND, IND.  
UNM.

AMELIA (EMILY)  
B. JUN. 30, 1806, N. Y.  
D. JUN. 13, 1877, N. Y.  
M. SEP. 15, 1824  
ROWLAND CROMLIN  
(Q.V.)

ADELINE  
B. 1809  
D. FEB. 17, 1851

URIAH HENDRICKS  
B. JUN. 20, 1810  
D. M. 1 JUL. 27, 1836  
GERTRUDE SIMONSON  
(A CONVERT)  
(1812-MAY 9, 1842)

DE WITT CLINTON  
B. D. D.  
M.

RICHEA  
B. D. D.  
M.

RICHEA ANN  
B. 1814  
D. JUN. 1, 1857, N. Y.  
M. NOV. 1, 1843  
THEODORE J. SEIXAS (Q.V. (2))

ANNA  
B. 1839  
D. M. 1868 (AS HIS 2ND WIFE)  
WASHINGTON SHARRETT  
(1831-1911)

SAMUEL B. HELBERT  
B. FEB. 18, 1804, N. Y.  
D. JUL. 21, 1876, N. Y.  
M.

HENRIETTA  
B. MAY 4, 1806  
D. OCT. 1, 1868, N. Y.  
UNM.

AMELIA  
B. APR. 5, 1808  
D. NOV. 11, 1863  
UNM.

MARIA  
B. AUG. 7, 1810  
D. MAY 9, 1899  
M. JAN. 28, 1829  
STEPHEN C. RICHARD

CELESTINE  
B. JUN. 25, 1813  
D. NOV. 19, 1898  
M. JUN. 6, 1838  
JOHN MYER GOLDSCHMIDT  
(Q.V.)

JOHN JACOB  
B. APR. 17, 1816  
D. DEC. 2, 1829  
UNM.

CARY JEKUTHIEL  
B. MAY 17, 1819  
D. JAN. 5, 1850  
UNM.

JESSY (SIMHA)  
B. FEB. 17, 1822  
D. NOV. 17, 1913  
M. 1 OCT. 30, 1844  
ELIEZER L. ANDREWS  
(Q.V.)  
M. 2 NOV. 2, 1853, N. Y.  
THEODORE HERTZ  
(Q.V. III)

WALTER HENRY  
B. MAR. 30, 1825  
D. FEB. 14, 1852, N. Y.  
UNM.

GERTRUDE  
B. D. D.  
M. ANDREW HAGAMAN

EMANUEL  
B. D. AT SEA, 1839

PHILIPPINE EUDORA  
B. 1832  
D. 1899  
M. JUN. 9, 1852  
FREDERICK W. VON STADE  
OF ALTONA, GER.

FREDERICK, JR.  
B. 1855  
D. 1934

GEORGE  
B. APR. 25, 1828, N. Y.  
D. MAY 16, 1856, N. Y.  
UNM.

JUDAH I (2)

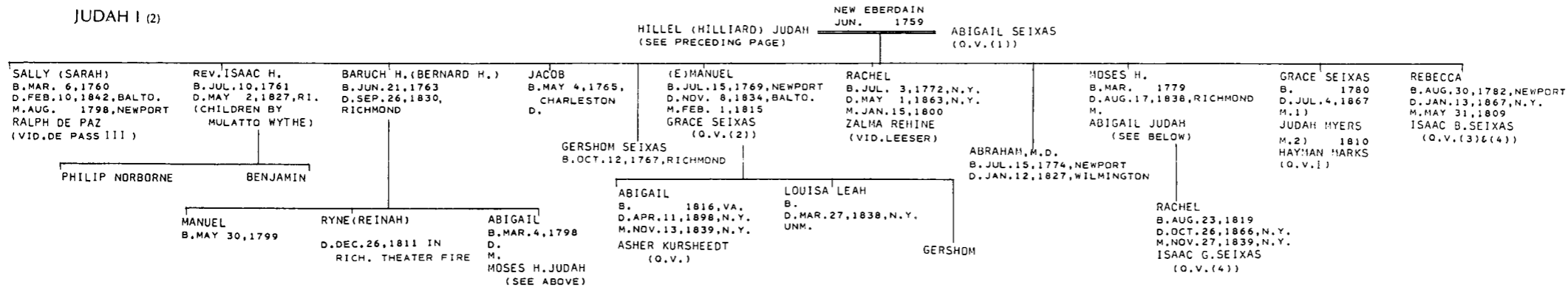

JOHN DICKSON NEEL  
GA. NEWSPAPER  
JUDAH GEN.  
PAJMS V. 27, P. 151  
V. 21, P. 150  
WILL OF MOSES JUDAH  
WILL OF MICHAEL JUDAH  
BARBER-N.Y. MARRIAGES  
KORN-THE JEWS OF MOBILE

JUDAH II (1) (CHRISTIAN)

REV. MICHAEL JUDAH (OF NORWALK, CONN.)  
B. D. N.Y. 1786

MARTHA RAYMOND  
B. JAN. 5, 1734/5

DAVID (OF WESTPORT, CONN.) CHARITY BENNETT  
B. D. 183 M. 1) C. 1780 ESTHER TAYLOR

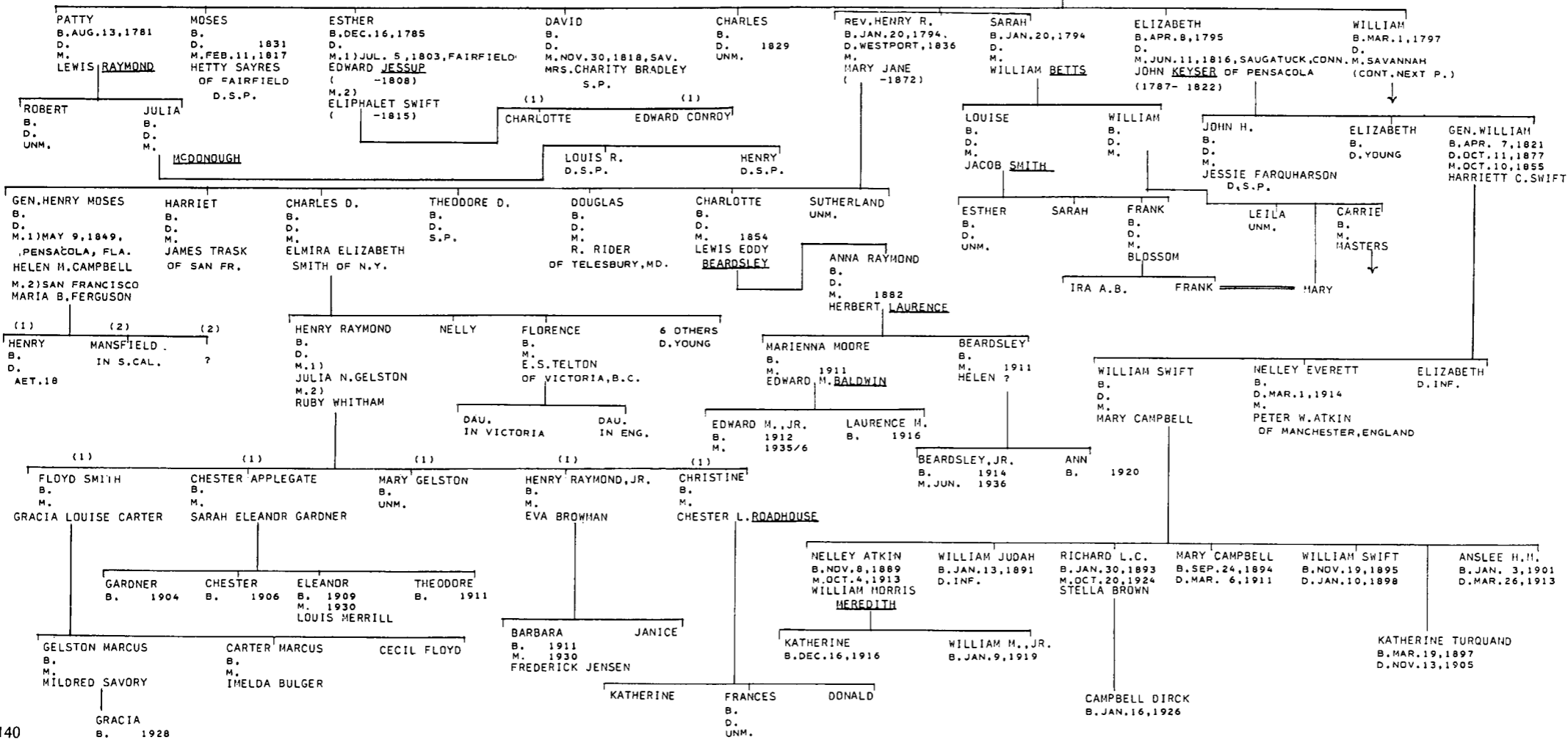

JUDAH II (2) (CHRISTIAN)

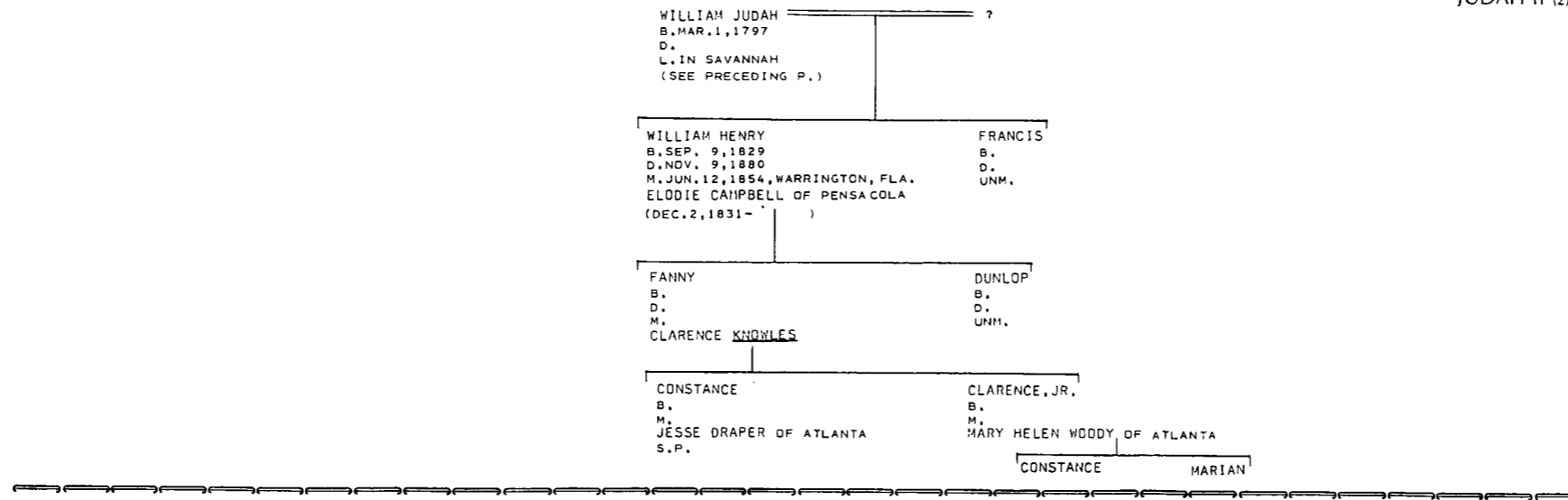

E.L. JUDAH GEN. (AJA)  
EVELYN MILLER  
J.E. V. 7, P. 331  
U.J.E. V. 6, P. 231  
KRAUS-SANDOR COLL.  
SOLOMONS MS.  
SHEARITH ISRAEL REC.  
HART FAMILY REC. (MS. AJA)  
MCCORKLE FAMILY REC. (DAR)  
U.S. CENSUS, 1790  
KATZ-BETH EL STORY  
MISC. VII  
J.R. COHEN REC.

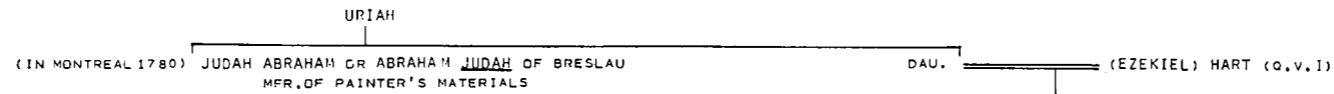

JUDAH III (1)  
(N.Y., MONTREAL, INDIANA)



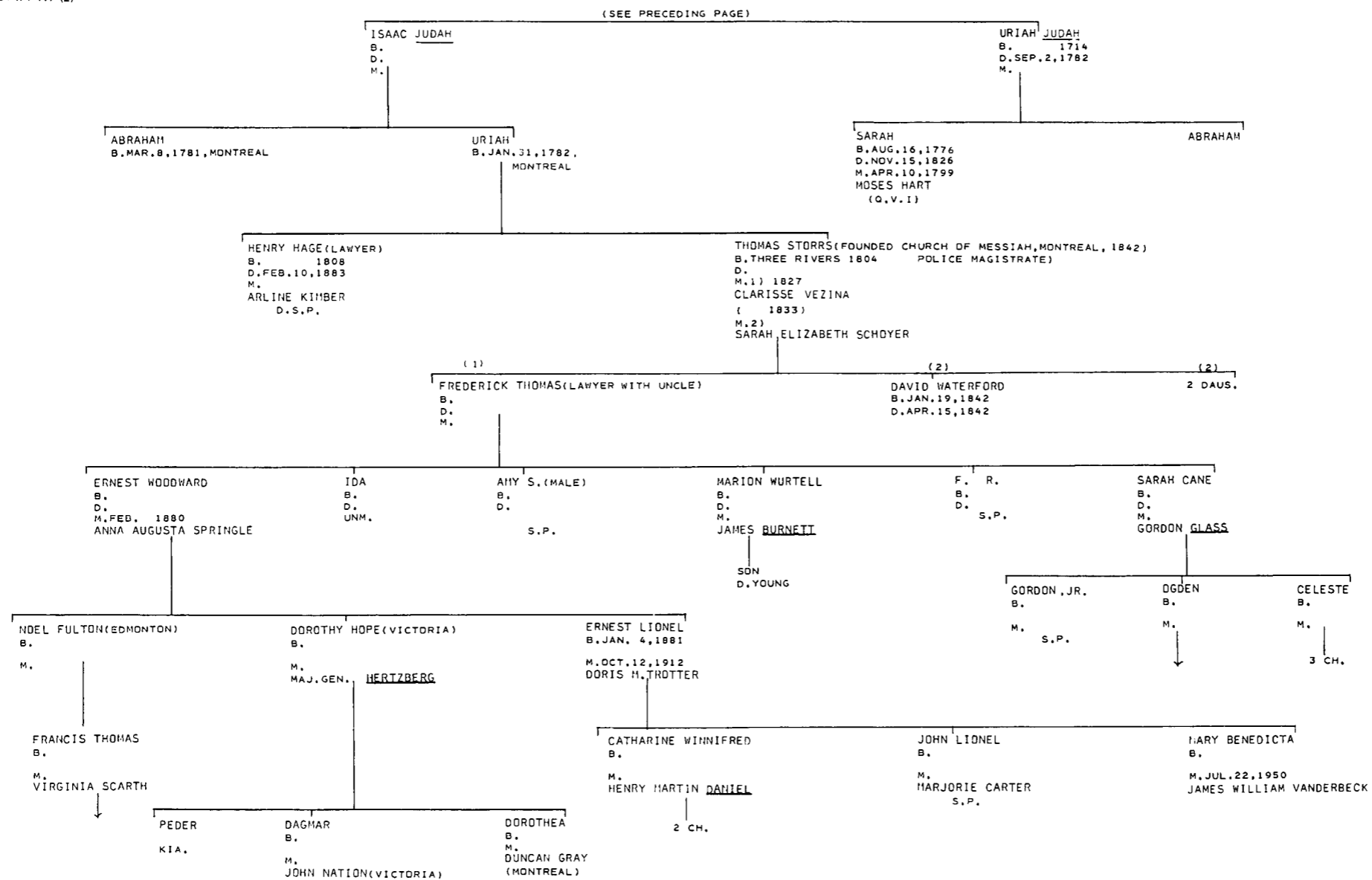

ANKER MS.  
KRAUS MS.  
ST. CHARLES, FIG. 21

KAUFMAN

SAHUEL KAUFMAN  
B. BINGEN, GER.

ROSALIE HAYER  
(O.V.)

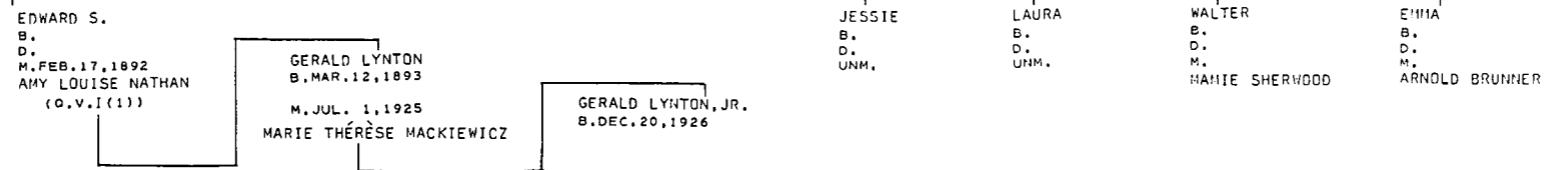

HARMON H. KAYTON  
HISTORY OF THE KAYTON FAMILY  
BERNARD KAYTON  
NORFOLK HEBREW CEMETERY  
NORFOLK COURT RECS.

HERZ KOETHEN OF GELNHAUSEN, HESSE ANHALT-KOETHEN  
(CAME TO U.S. WITH SONS)

KAYTON

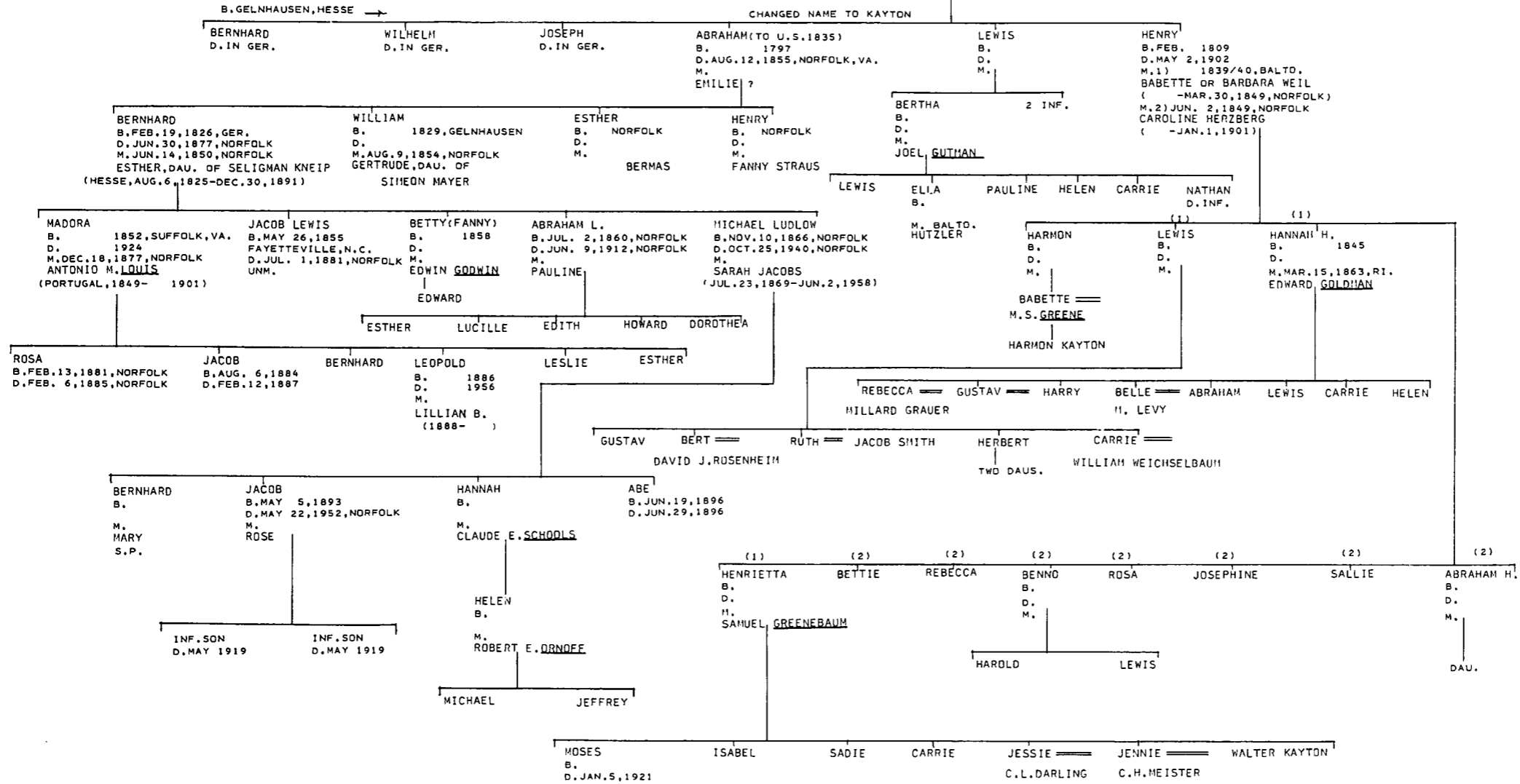

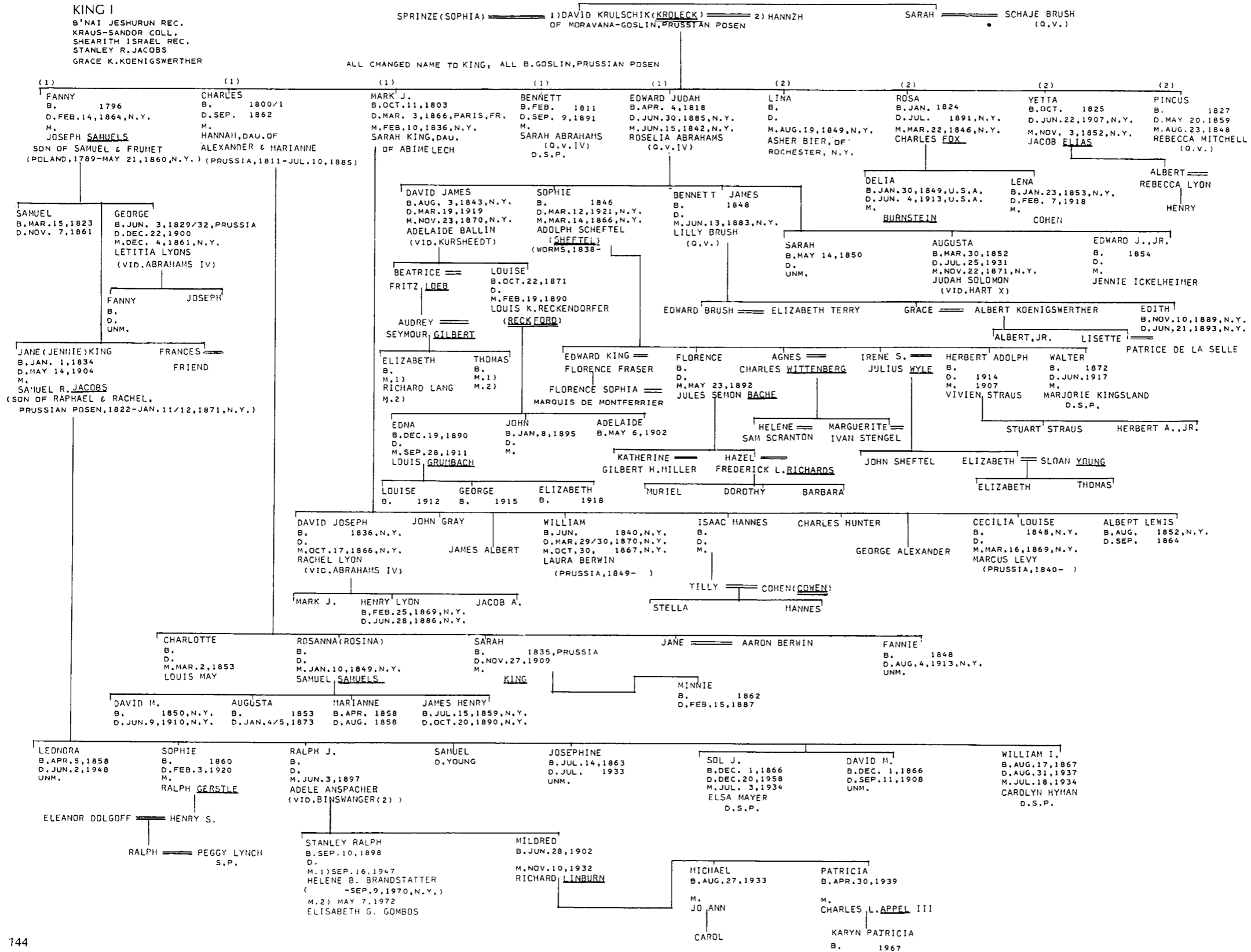

KRAUS-SANDOR COLL.  
EZEKIEL-LICHTENSTEIN  
MICKVE ISRAEL REC.

KING II

JACOB KING 1774 MARY WIDOW OF SOLOMON ISAACS (O.V.I.)  
B. 1774 D.RICH.OCT.22,1824

ISAAC B. 1799 D.PH.NOV.6,1824 ("RICHMOND MERCHANT")  
ELIEZER B.APR. 1804 D.INF.  
JUDAH B.OCT.18,1805 D.INF.

KRAUS-SANDOR COLL.  
SHEARITH ISRAEL REC.  
DARBY G.LIVINGSTON  
NFK. COURT RECORDS  
TUCKER-NFK.MARRIAGE BONDS

KING III

(NFK.,1850;N.Y.1870) HENRY KING B.CA. 1799 HINDA (HANNAH)AARDN

B.NACKEL,PRUSSIA →  
LEOPOLD B. 1823 D.MAR.12,1876,N.Y.  
HENRIETTA B. 1830 D.SEP.14,1905,VA. M.AUG.6,1850,NFK. JOSEPH LEVY  
ANTHONY B.DEC.24,1834/6 D.DEC.28,1876 M.AUG.10,1870,N.Y. THERESA FRIEDMAN (VID.CROMELIEN)  
DAVID LIVINGSTON SARAH COHN MEYER JAN.24,1872,N.Y. FLORA B. NFK. D. N.Y.  
HARRY B. 1872 D. M. RUBINSTEIN

HATTIE JOSEPH ADLER LILLIAN HYMAN SCHLOR LEON MRS. WEINBERGER HENRY SOPHIE FELDBLUM ISADORE IDA SIMON BEATRICE NATHAN FRIEND GOLDIE BEN LECHTMAN EDWIN LOTTIE WINTERS

KORN-JEWS OF N.O.

SIMON BELLA

KOHN

(NATHAN SCHIMM)NATHAN KOHN OCT.27,1778,PETERSBURG, BOHEMIA B. D. BOHEMIA, JAN.18,1831 KIWY/EVA LOBL

B. BOHEMIA →  
LOWY B. D. M. JAN.26,1802 RACHEL FELDSTEIN  
SIMON B. 1781 D. M.  
SAMUEL (TO LA. BY 1806) B. 1783 D. MAY 18,1853,PARIS,FR.  
SELIGMAN B. 1786  
JDACHIM B. 1800 D. 1886,PARIS,FR. M. JUN.22,1834,N.O. MARIE THALIE MARTIN  
HERMANN B. 1806  
JOSEPH B. 1808  
ALPHONSE MILTENBERGER CELESTE DORFEVILLE  
ISAAC HEINE (UNCLE OF HEINRICH) D.OCT.16,1828  
SAMUEL ARTHUR B. NOV.13,1835,N.O. D. 1909/10,PARIS  
JOSEPH GUSTAVE B. MAR.18,1837,N.O. D. SEP. 7,1906  
AMELIE ARMAND MICHEL (IN N.O.1842) MARIE CELESTE AMELIE B. 1832  
MARIE ALICE B. D. M.1) 1875 DUC DE RICHELIEU M.2) ALBERTO PRINCE OF MONACO  
CARL (TO N.O.1830/1) B. D. AUG.27,1895,N.O. M. JUN.27,1850,N.O. CLARA, DAU. OF MAUNSELL WHITE  
EDDUARD B. BOHEMIA, 1825 D. M. VON EMBDEN

KRAUS-SANDOR COLL. (AJA)  
AMERICAN JEWISH YR. BK. V. 47, P. 526

MARCUS MORDECAI KRAUS (KROUSE) B. DEMMELSDORF, BAVARIA, 1792 D. CINCINNATI, DEC. 29, 1845 RACHEL FRANK B. LUTHERISCH, HEILINGSTADT, BAV. 1799 D. CINCINNATI, FEB. 8, 1883

KRAUS

WILLIAM B. OCT. 15, 1823, DEMMELSDORF D. MAY 22, 1899, N.Y. M. OCT. 2, 1850, CIN'TI. MINNIE LAUER (DEMMELOD. NOV. 5, 1831 - WEST END, N.J. AUG. 12, 1913)  
CELIA B. D. M. HERMANN MACK  
MARCUS (MAX) (IN HUNTSVILLE, ALA.) B. JAN. 11, 1829 D. M. LENA STROMBERG

HENRIETTA B. SEP. 5, 1853 D. M. ISAAC ABRAHAM SIMM  
MAX WILLIAM B. NOV. 9, 1855, CIN'TI D. M. OCT. 10, 1888, N.Y. CARRIE MAY ADLER  
HARRY B. D. M. OCT. 12, 1886 ROSIE OR ROSALIE ANSBACHER (VID. BINSWANGER (2))  
BELLE B. AUG. 26, 1861 D. M. HENRY P. SONDSHEIM  
MATHILDA B. D. M. HERMAN ADLER  
STELLA B. M. PERCY W. LANSBURGH  
WALTER MAX, M.D. B. AUG. 25, 1889, N.Y. D. AUG. 22, 1944, N.Y. M. 1) MAY 5, 1917 MARIAN F. NATHAN (O.V.I. (2)) M. 2) DEC. 29, 1929 INES HEFFES ADES OF PARIS  
NAUDE ROSALIE B. JUL. 21, 1887, N.Y. D. DEC. 4, 1953 M. 1) ARISTO W. SLOAN M. 2) AL PACH M. 3) HARRY IRVING D.S.P.  
WILLIAM B. AUG. 26, 1893, N.Y. D. APR. 2, 1920, N.Y. (1) JOHN WALTER B. FEB. 5, 1918 (1) FRANCIS VAN PRAAG B. MAR. 13, 1920  
EDITH JANE



KOKERNOT

JON STEDMAN  
KORN-JEWS OF N.O.

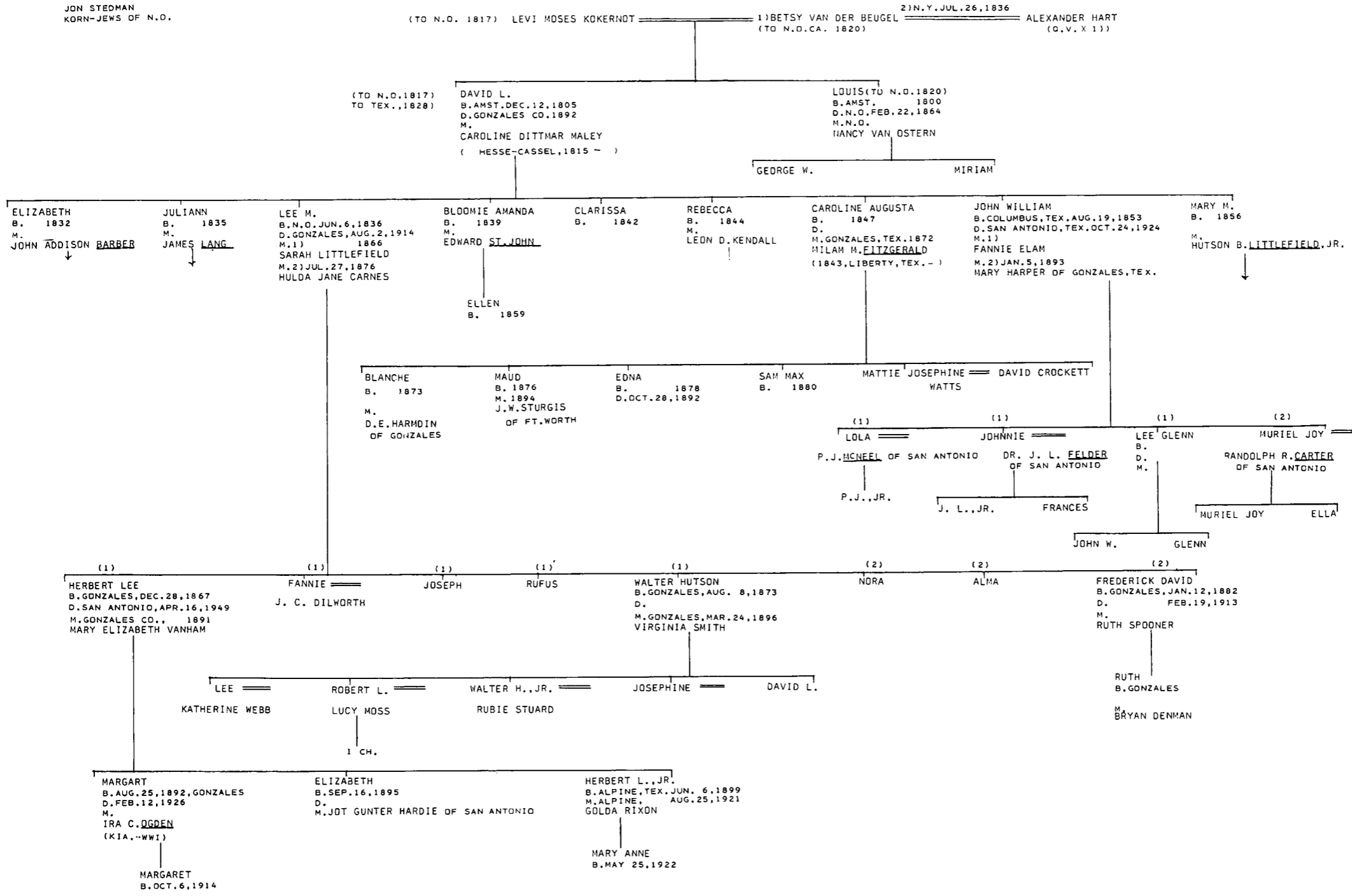

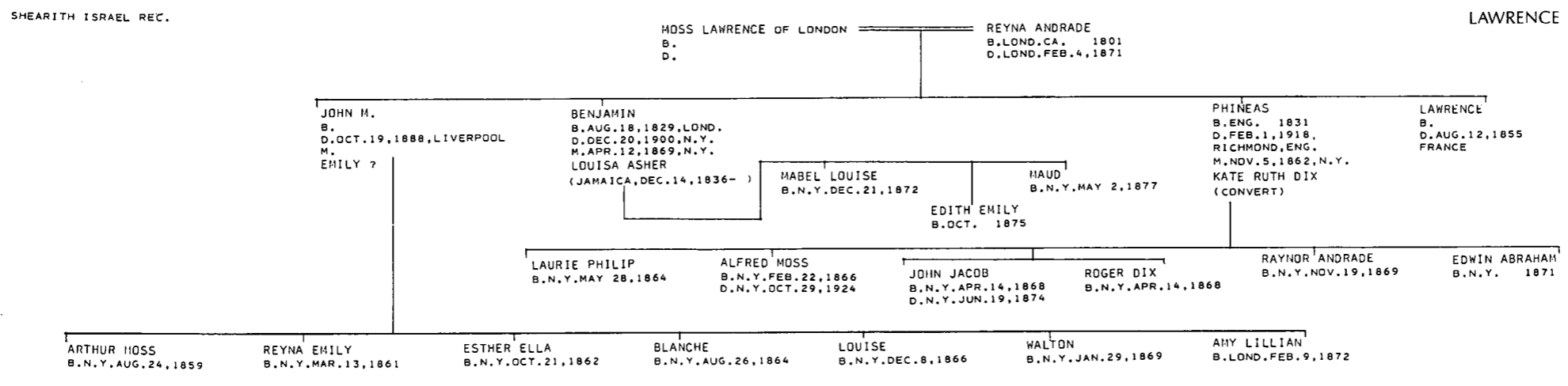
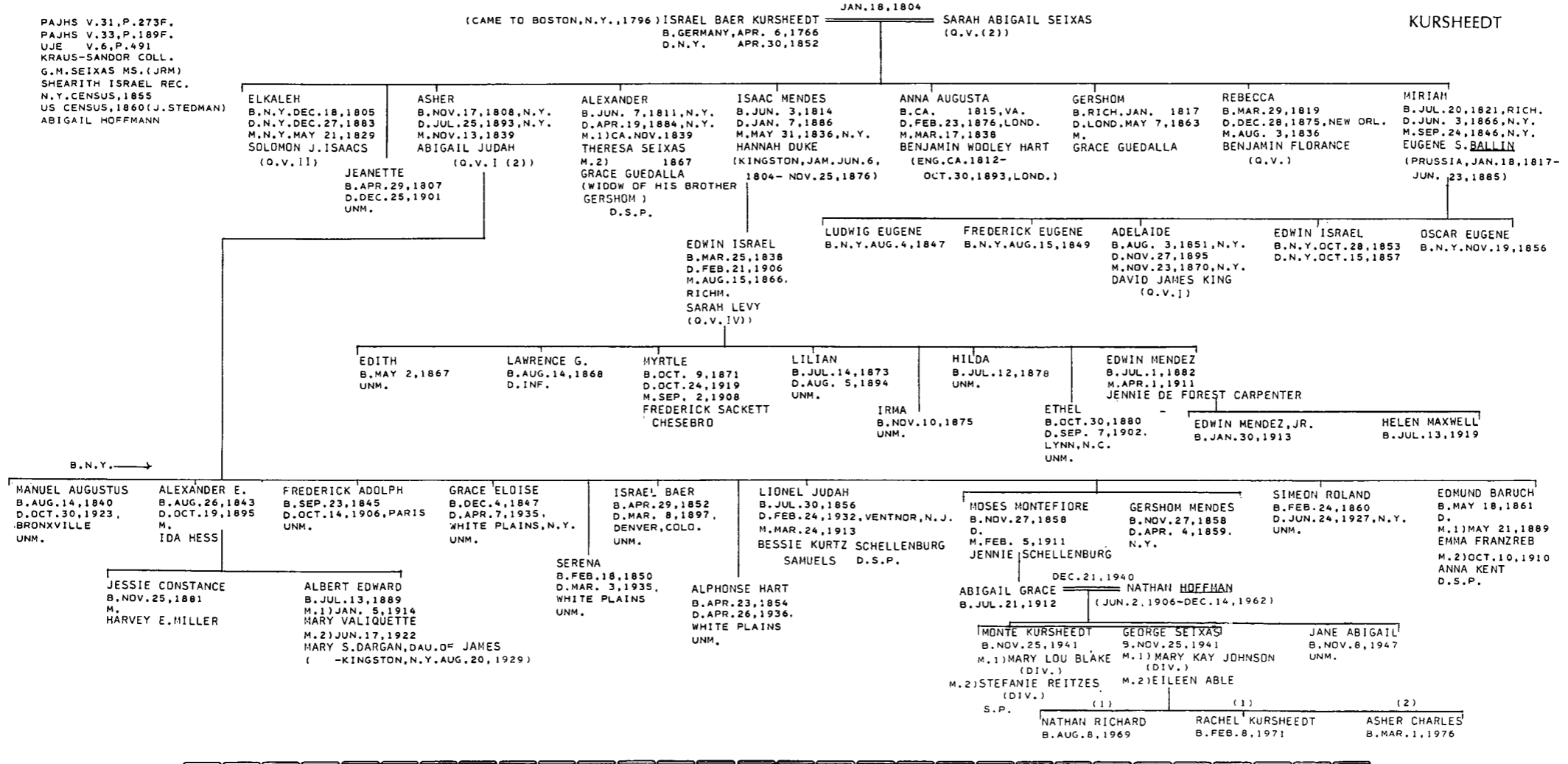

LABATT

NEW ORL. JCC  
 PAJHS, V. 2, P. 139F.  
 HYAMS MS. (JRM)  
 UJE, V. 6, P. 497  
 ELZAS MS.  
 M.N.  
 JEWS OF S.C.  
 DR. H.G. SIMON  
 MRS. JAMES M. FORGOTSON

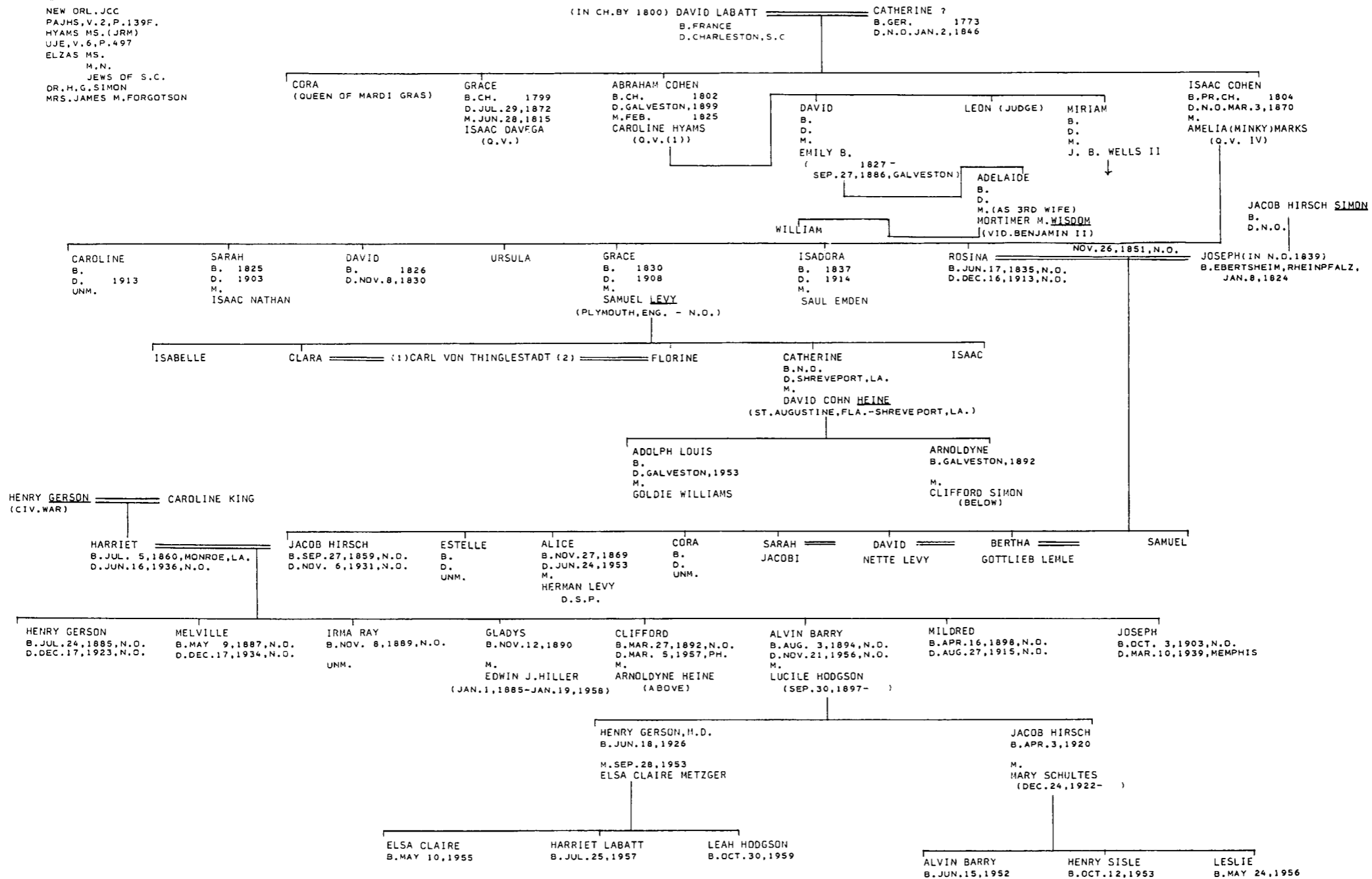

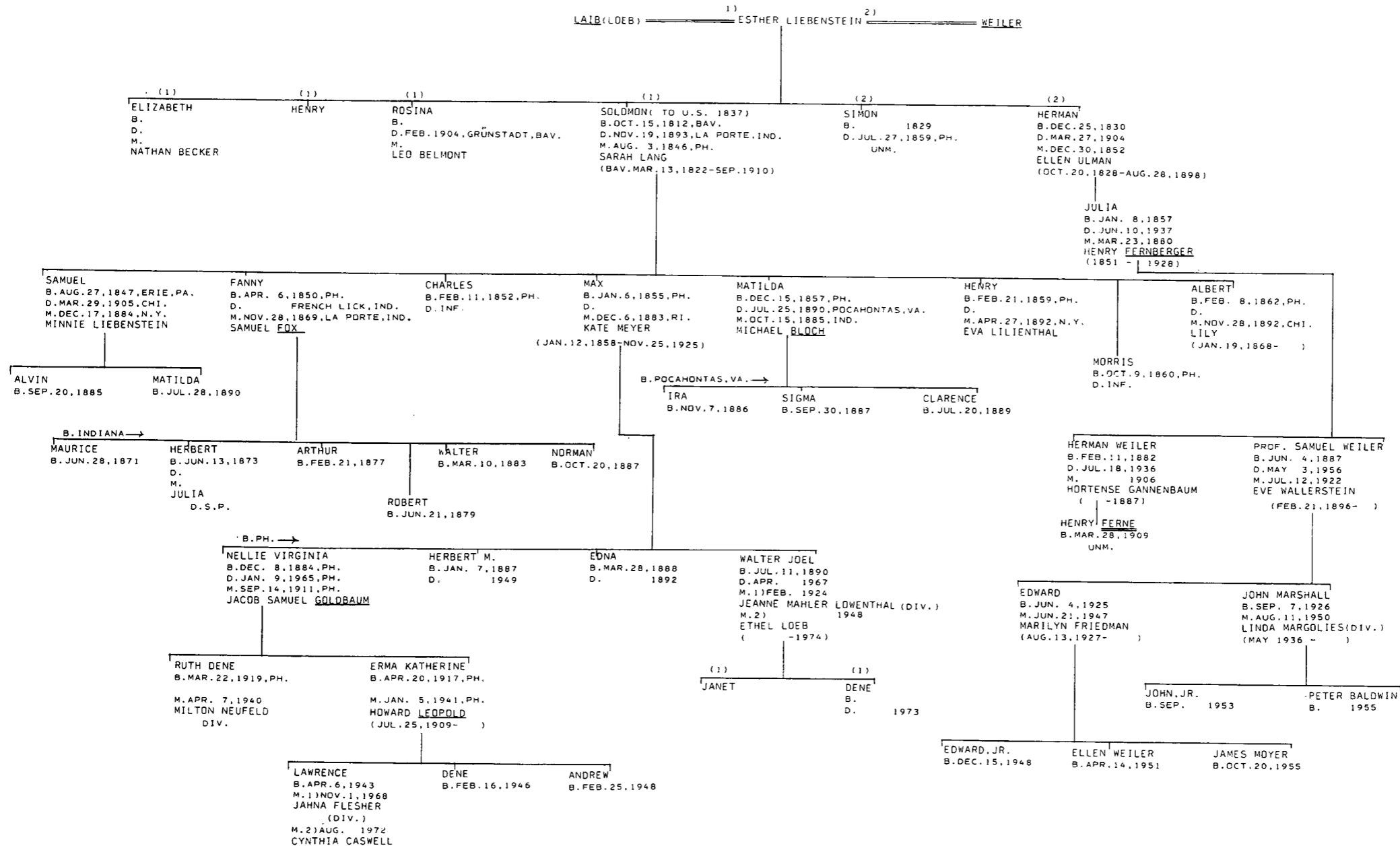

LAZARUS I (N.Y.)

ST. CHARLES, P. 126  
KRAUS-SANDOR COLL.  
AARON LEVY CALENDAR (AJHS)  
WILL OF FANNY ISAACKS  
SHEARITH ISRAEL REC.  
POOL-PORTRAITS...  
N.Y. WEEKLY MUSEUM  
N.Y. CENSUS, 1855

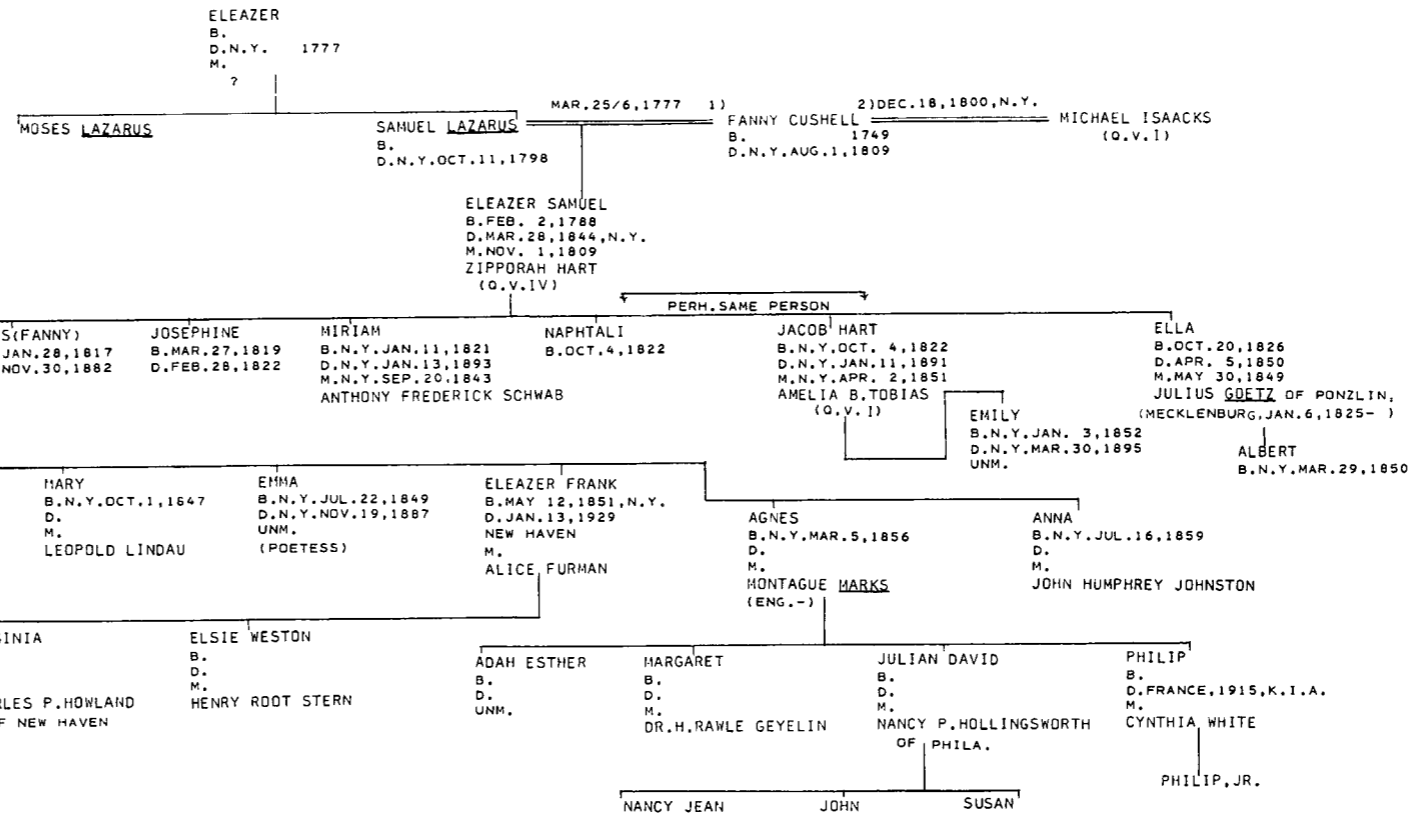

LAZARUS III

ST. CHARLES, P. 126  
KRAUS-SANDOR COLL.  
POOL-PORTRAITS...  
N.Y. WEEKLY MUSEUM  
ROSENWAIKE

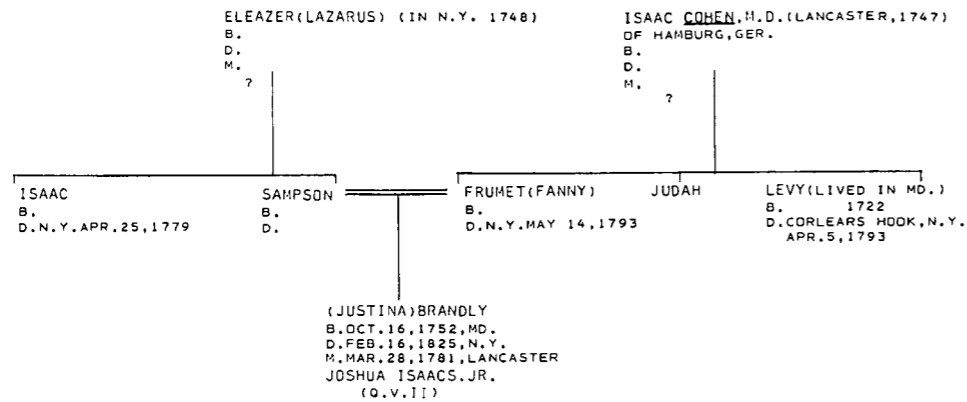

LAZARUS IV

PAJHS V. 12, P. 119  
MOSS GEN.  
ELZAS MS.  
MICKVE ISRAEL REC.

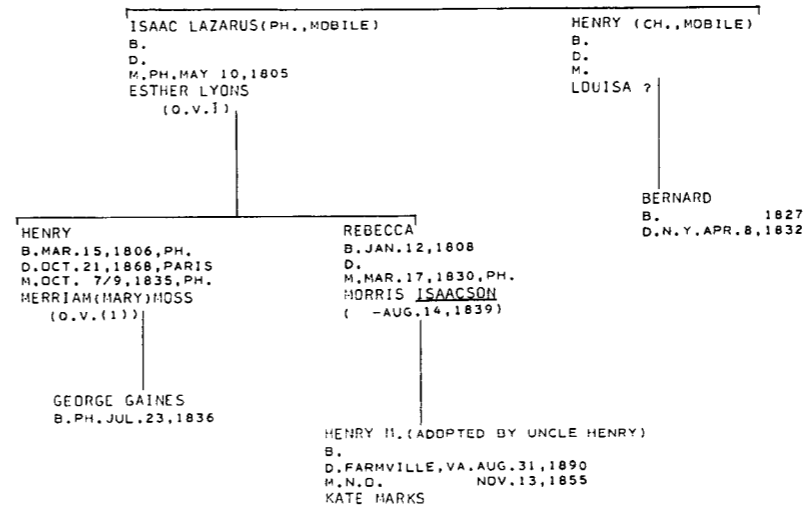

JRM COLL.  
 DAR-HARBY MS.  
 MOSES GEN.  
 KRAUS-SANDOR COLL.  
 ELZAS M.N.  
 MS.  
 O.J.C.  
 WILL OF RACHEL D.LAZARUS  
 ISABELLA \*\*  
 MICHAEL \*\*  
 JOSHUA \*\*  
 ADELINE \*\*

REV. WAR PENSION REC. (NAT'L ARCH.)  
 LAZARUS BIBLE (JANE L. RAISIN)  
 LAZARUS GEN. (T. TOBIAS)  
 DR. AARON S. RAISIN  
 S.C. MARR. CONVEYANCES  
 A.J.Y.B. 5664/88  
 J.B. MORDECAI MS.

(IN CH. BY 1749) MICHAEL LAZARUS

LAZARUS II (S.C.)

MARKS\*  
 B. FEB. 22, 1757, CH.  
 D. NOV. 1, 1835, CH.  
 M. DEC. 11, 1776, CH.  
 RICH (RACHEL) BENJAMIN  
 (VID. DE TORRES)

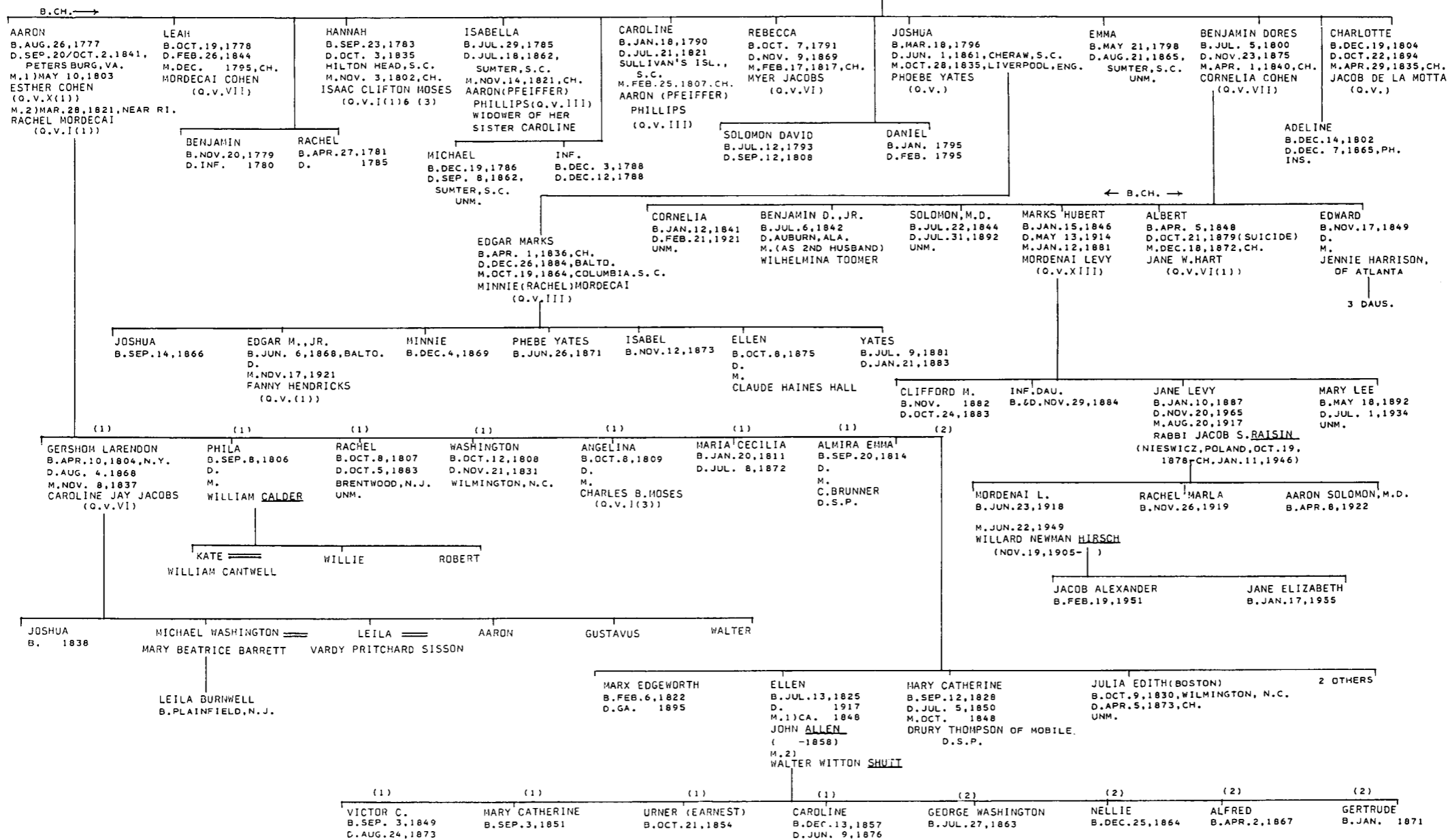

\* ESTABLISHED REVOLUTIONARY ANCESTOR

**LEBERMAN**

F. J. DALLET  
MT. SINAI CEM.  
CHELTEN HILLS CREMATORY  
FLORENCE ABRAHAMS

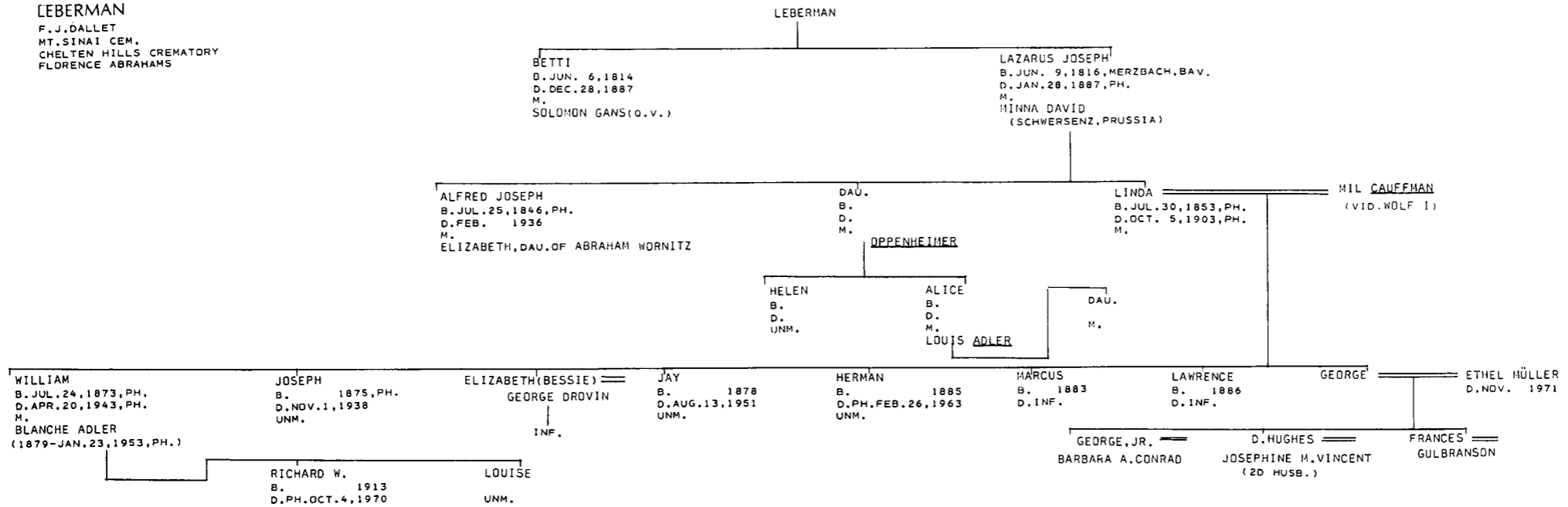

**LEDESMA**

SH.  
EGMONT  
B. M. KET #379

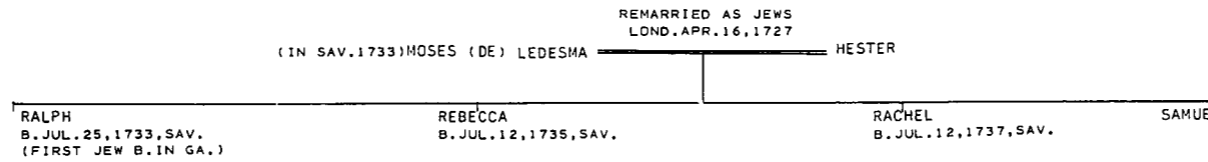

**LEO**

KRAUS-SANDOR COLL.  
PAJHS, V. 10, P. 110  
GRINSTEIN, PASSIM  
SHEARITH ISRAEL REC.  
J. E. V. 7, P. 683  
N. Y. CENSUS 1855  
B'NAI JESHURUN  
RHODA ROYAL

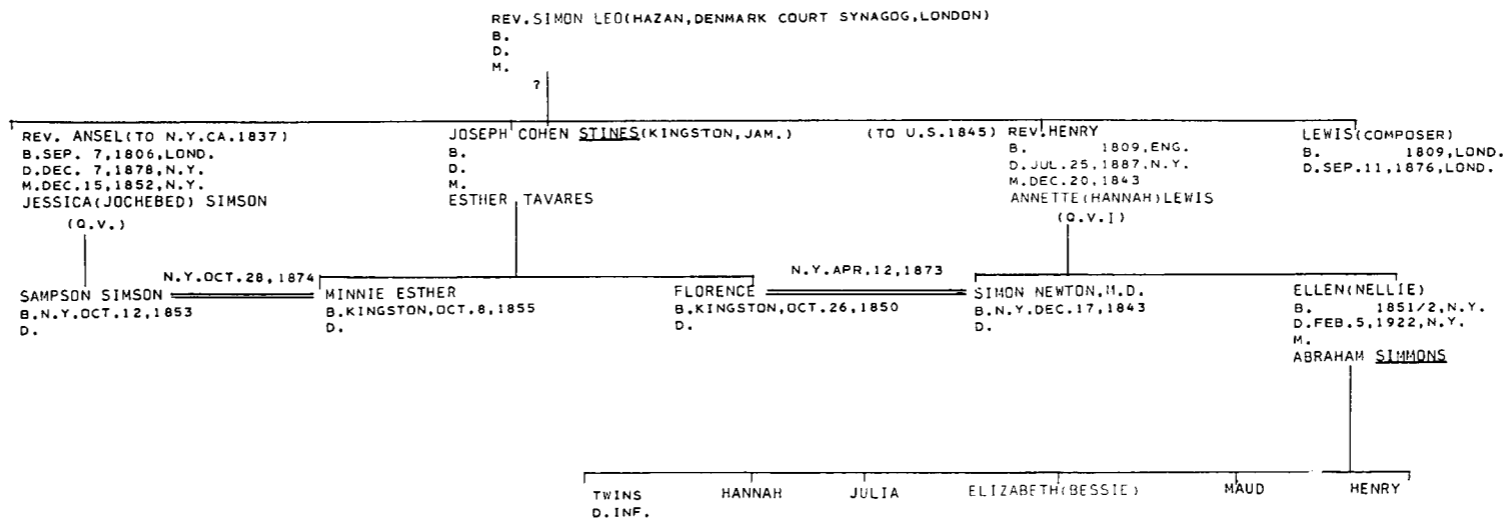

J.E. V.7,P.662F.  
 UJE V.6,P.558  
 JRM COLL.  
 MICKVE ISRAEL REC.

LEESER

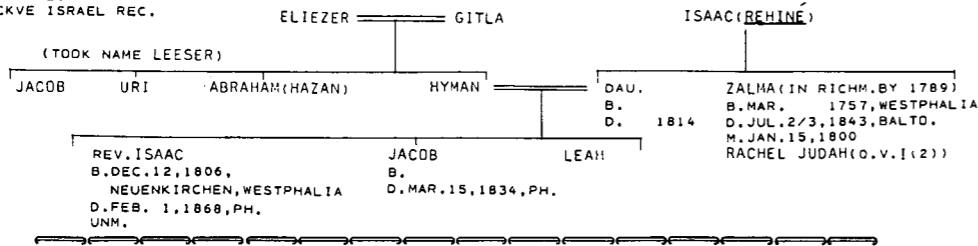

LEVINE  
 FLORENCE ABRAHAMS  
 FED. ST. CEM.

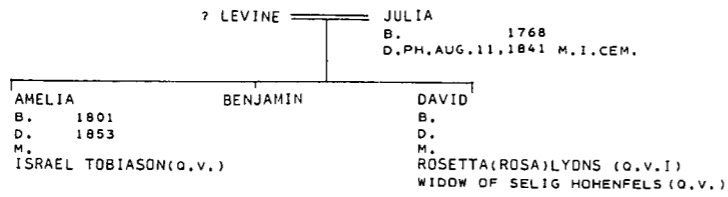

ELZAS MS.  
 ELZAS JEW. CEMETERY AT COLUMBIA  
 ELZAS NEW JEW. CEM. AT CH.  
 ELZAS M.N.  
 ELZAS O.J.C.

LEVIN II

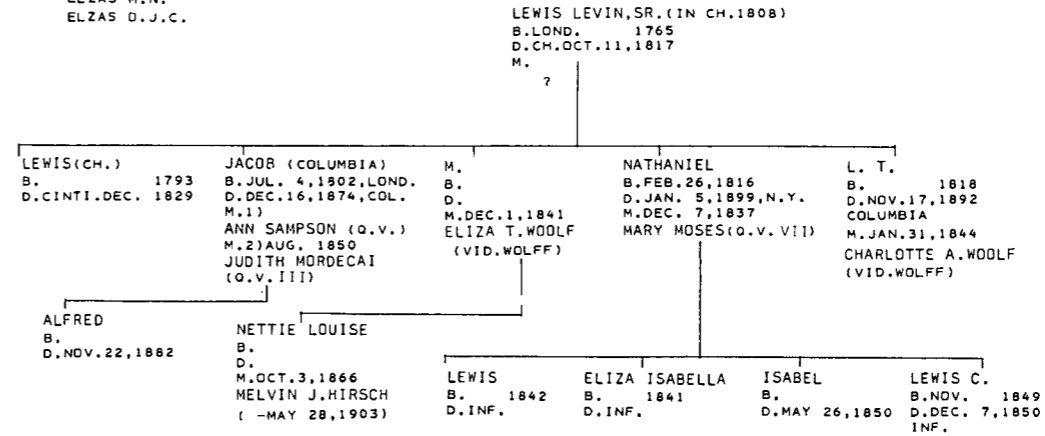

MRS. E. MILLER  
 KRAUS-SANDOR COLL.  
 SHEARITH ISRAEL REC.

JACOB I. LEVIN

LEVIN I

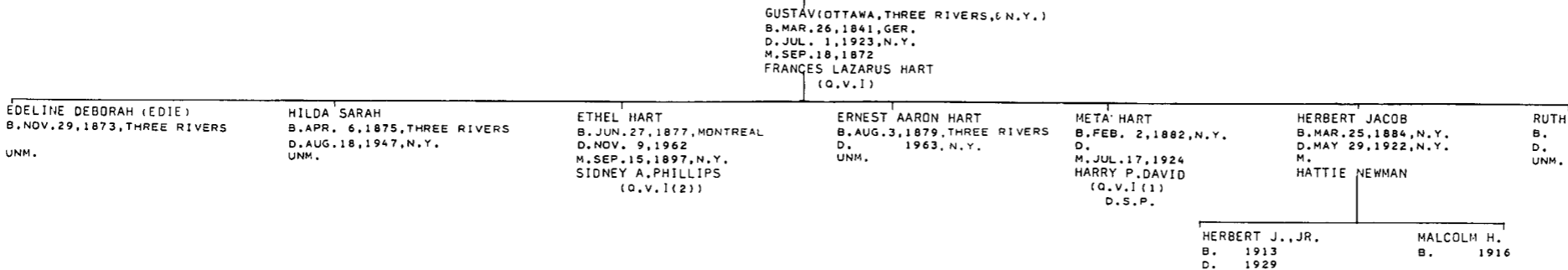

FLO. ABR.

SOLOMON MOSES LEVIN

LEVIN III

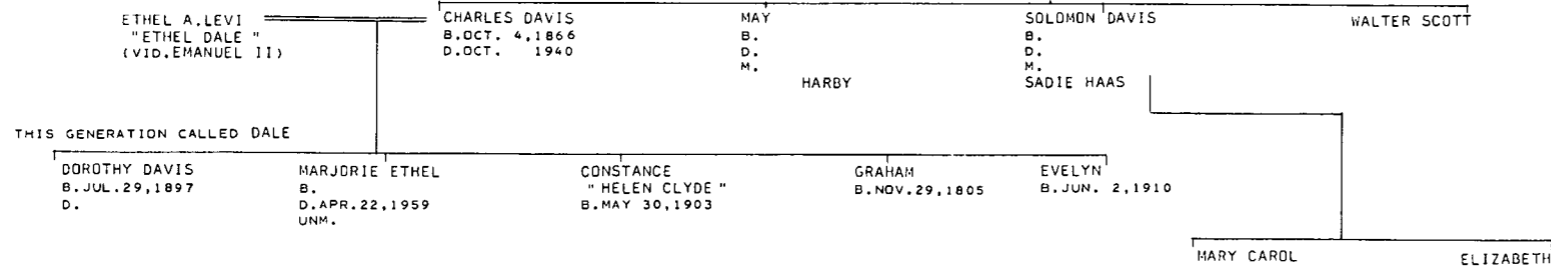



LEVY I (1)

FLQ.ABR.  
 ELZAS-JEWS OF S.C., P.42  
 PAJHS, V.18, P.93F.  
 V.23, P.150, 158  
 V.27, P.161  
 V.33, P.210  
 V.34, P.60F.  
 V.38, P.87F.  
 J.E.V.8, P.59F.  
 KRAUS-SANDOR COLL.  
 TRANSACTIONS VII  
 ROSENWAIKE-BALTO.  
 PHILIP(PAT)WINSOR  
 F.J.DALLETT  
 HERSHKOWITZ-WILLS

N.Y.CALENDAR OF WILLS  
 WILLS OF: ASHER, ISAAC,  
 NATHAN, HETTY  
 MARTHA, RACHEL  
 SAMSON, MOSES  
 GOLDSTONE GEN.  
 HENDRICKS GEN.  
 MICKVE ISRAEL REC.  
 ROTH-THE GREAT SYNAGOGUE  
 FRANKS LETTERS  
 N.Y.MARRIAGE BONDS  
 SOCIAL REGISTER  
 N.Y.TIMES OBITUARIES

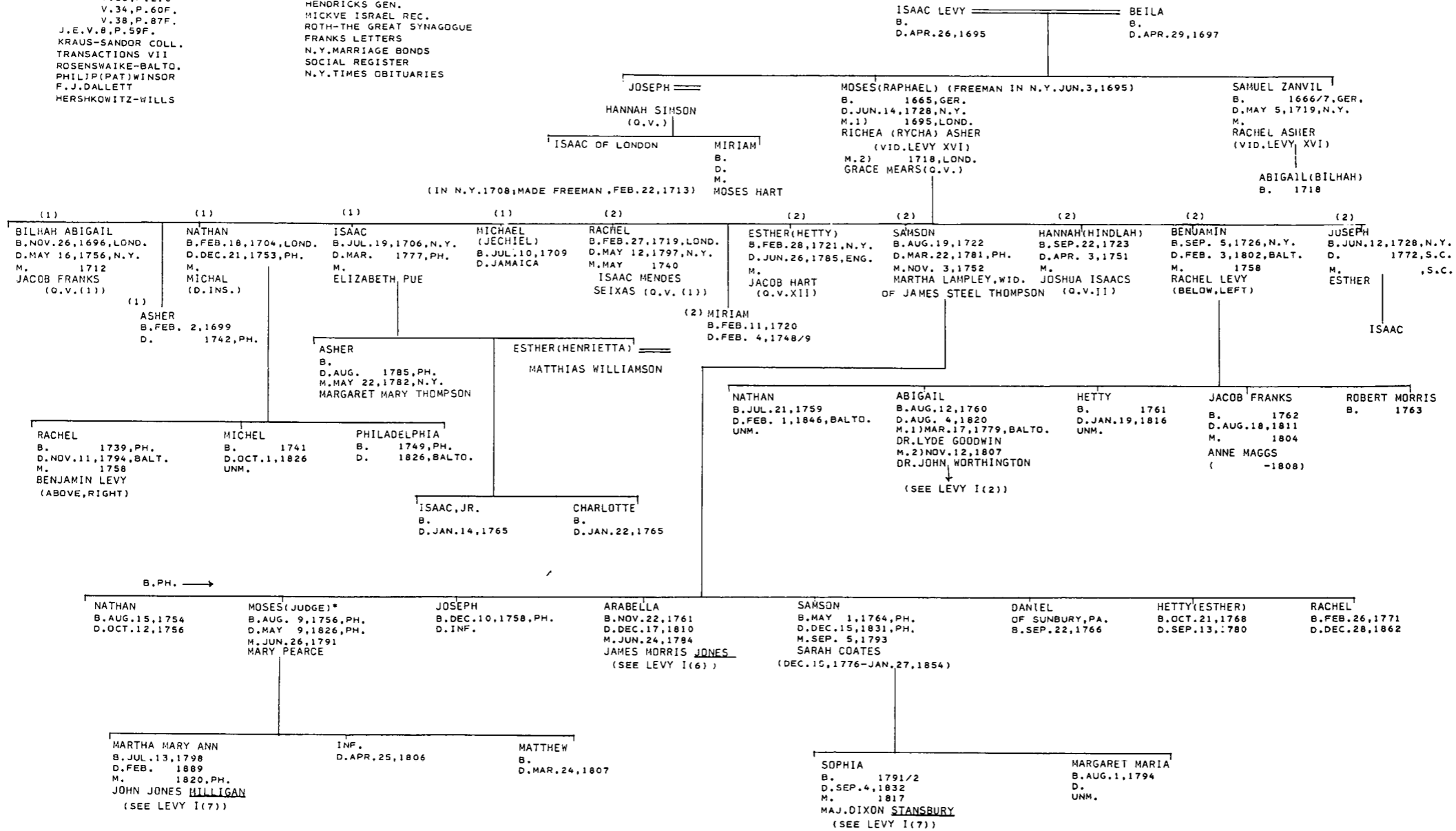

\*ESTABLISHED REVOLUTIONARY ANCESTOR

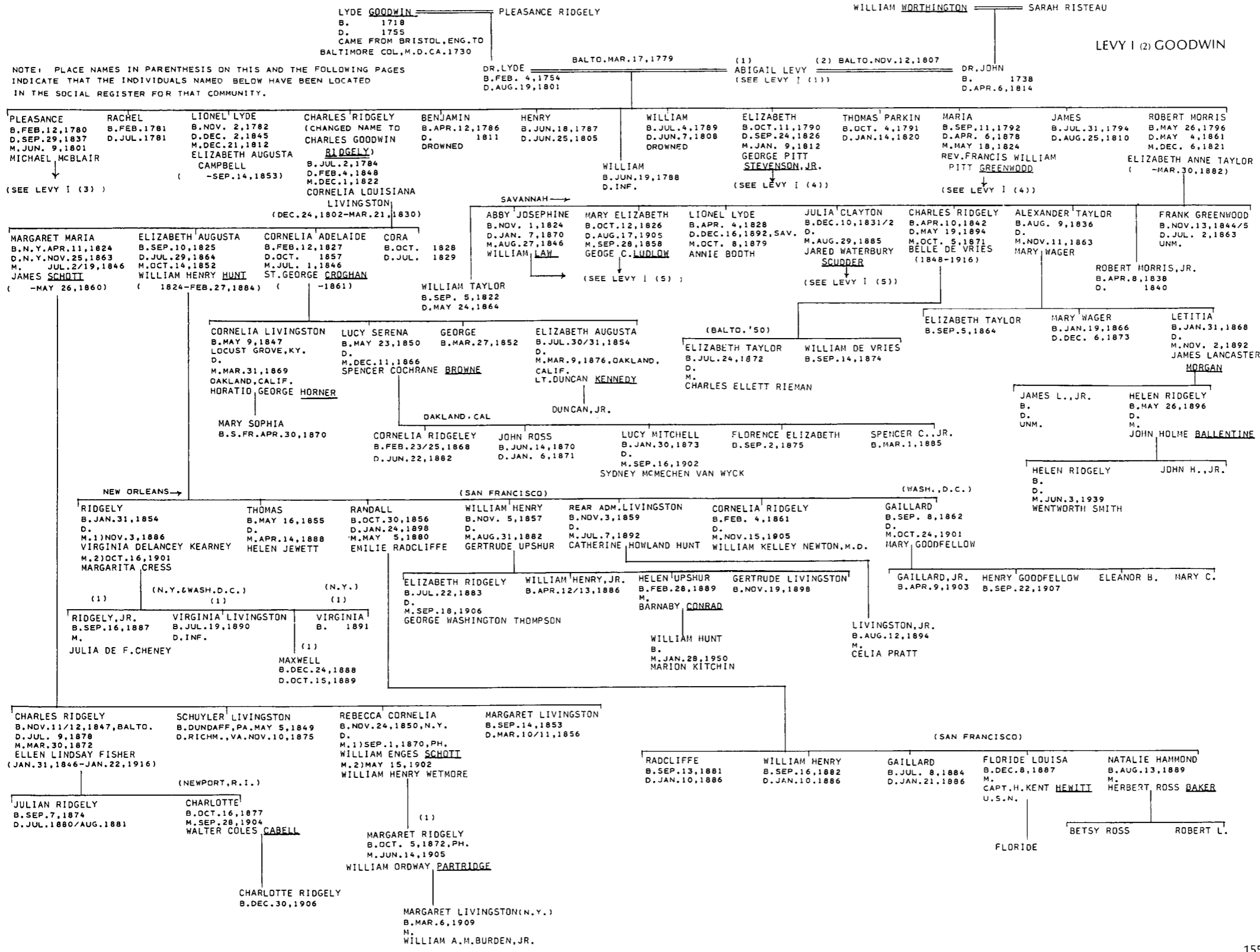

LEVY I (3) McBLAIR

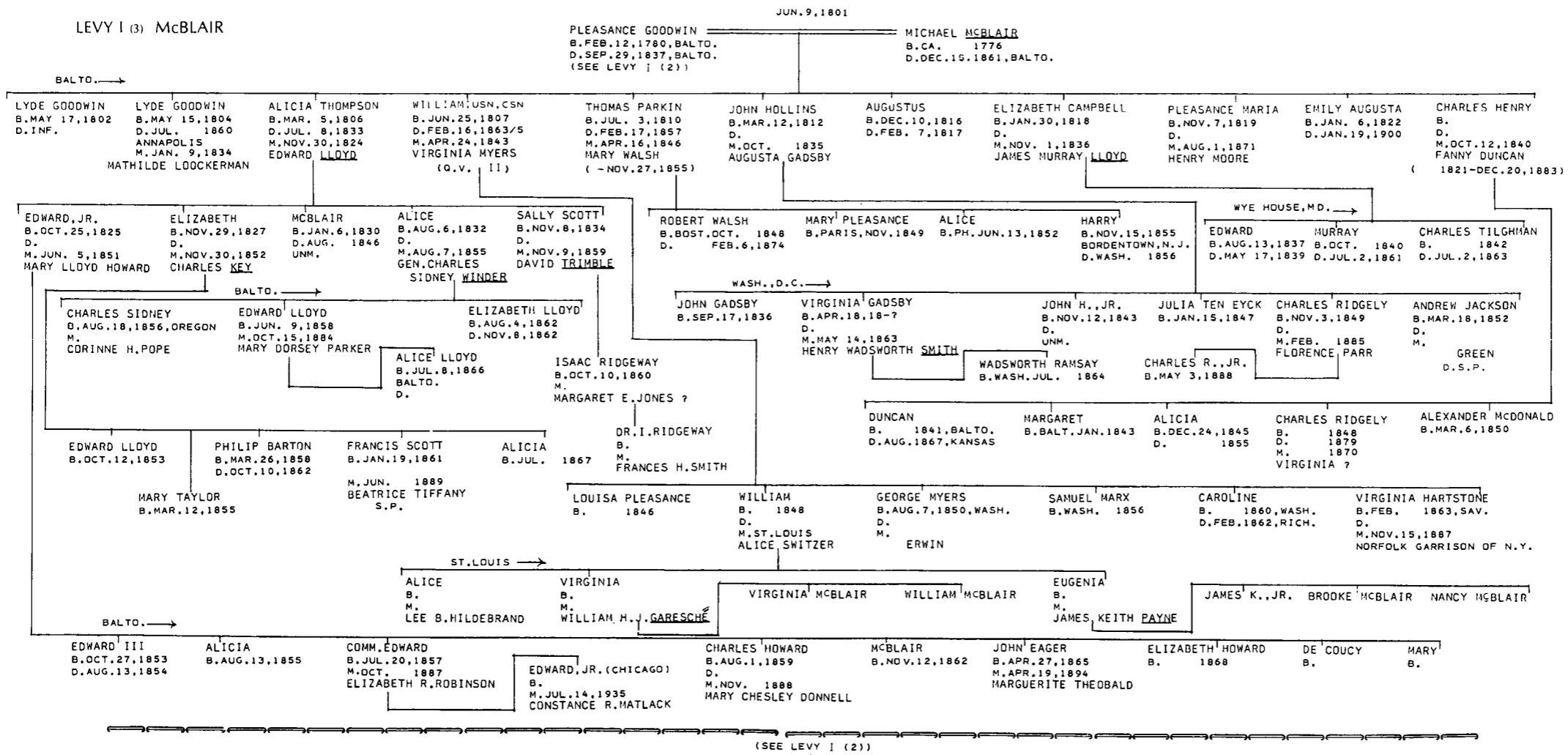

LEVY I (5) LAW, LUDLOW, SCUDDER

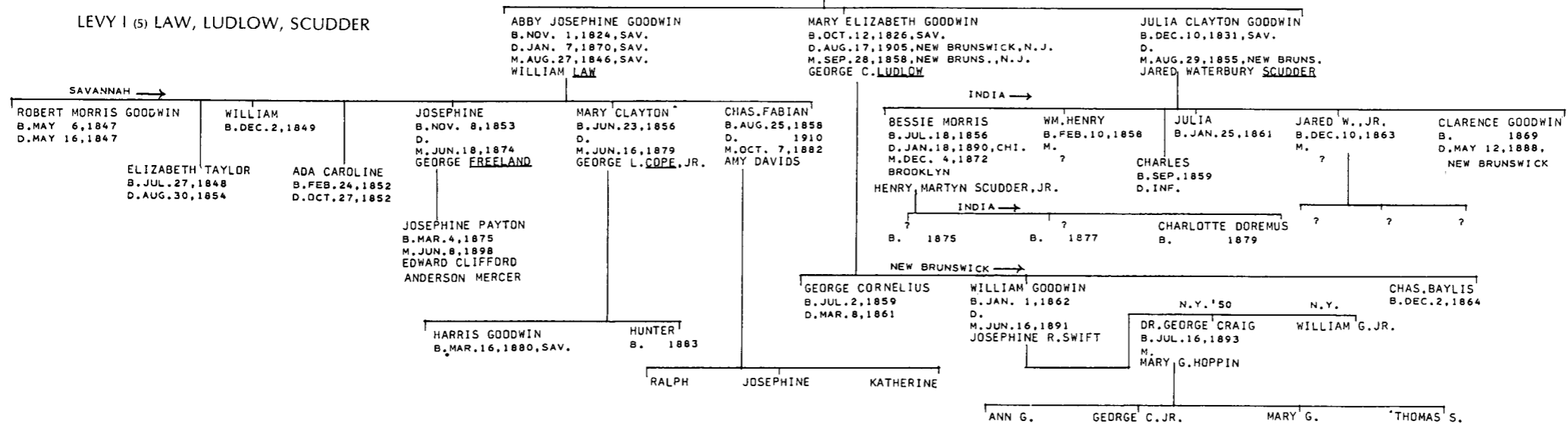

LEVY I (4) STEVENSON, GREENWOOD

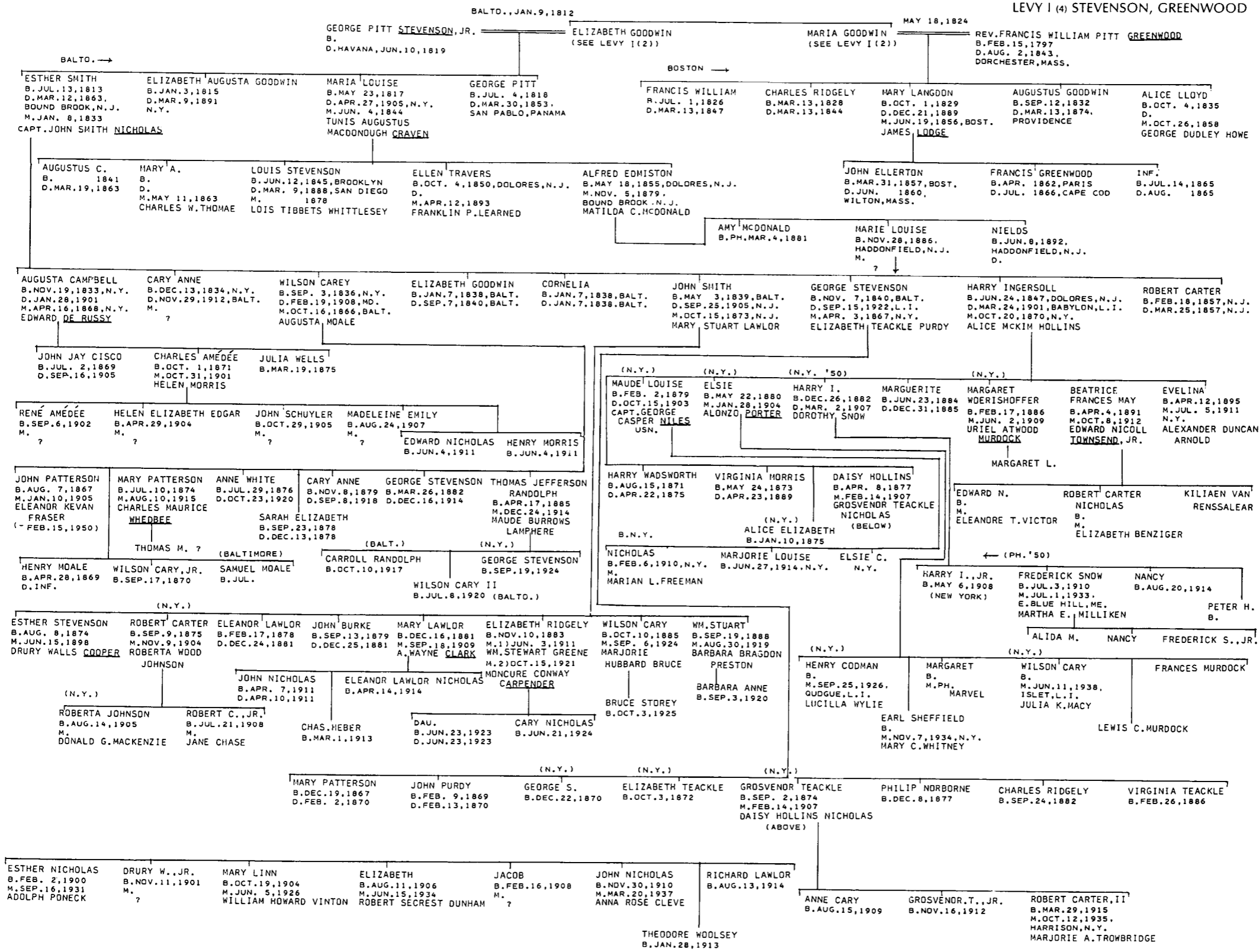

LEVY I (6) JONES

\*GEN. OF THE MORRIS FAM. (PHOTO. IN KR.)

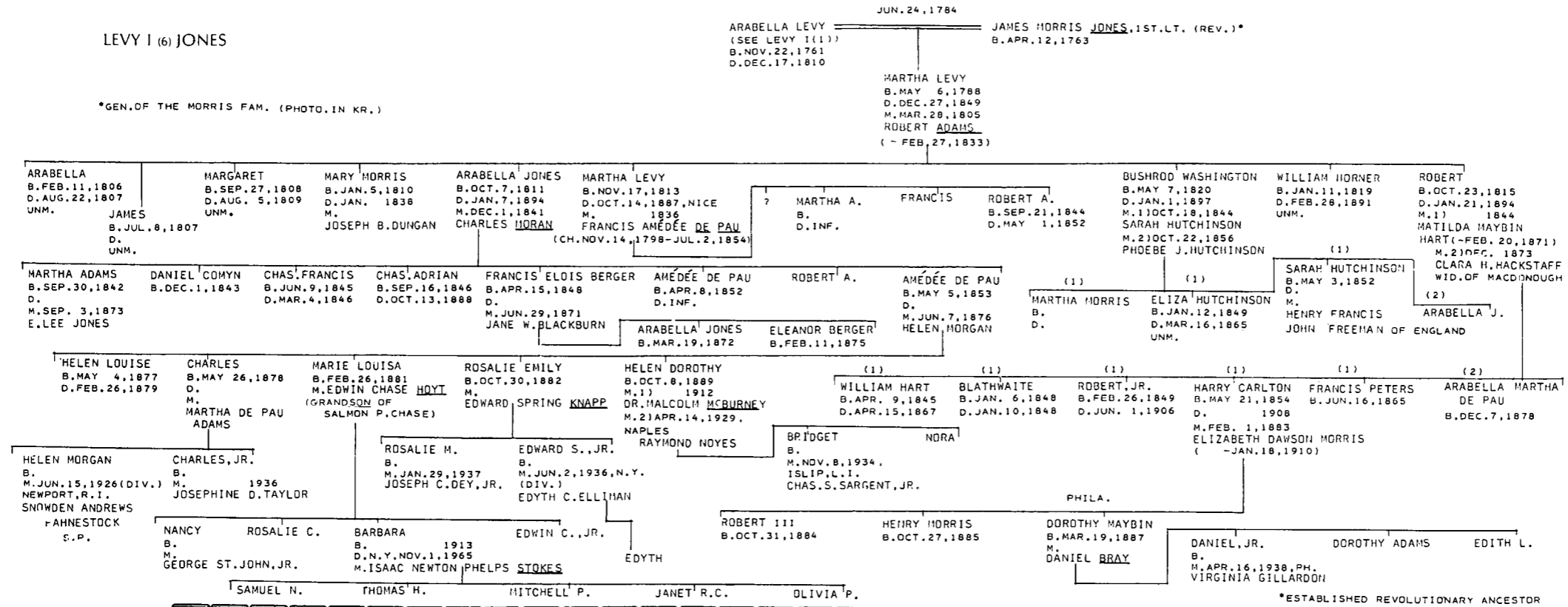

LEVY I (7) MILLIGAN, STANSBURY

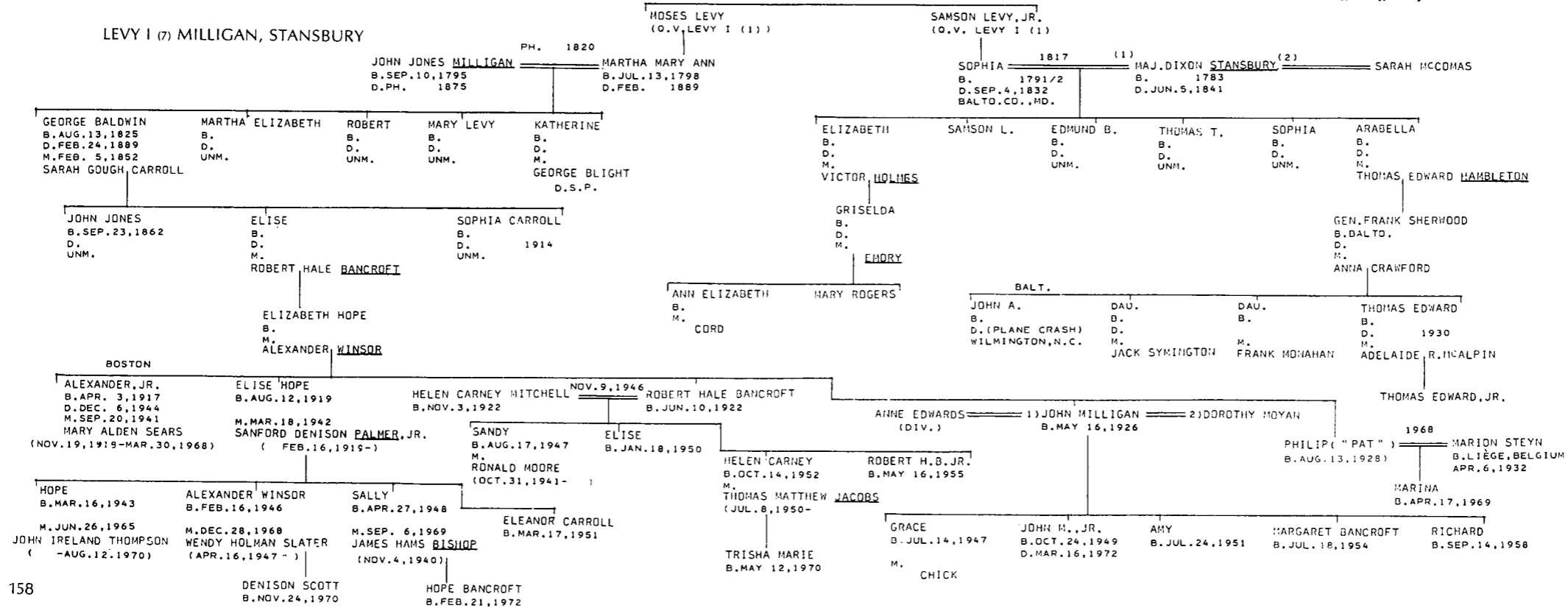

PAJHS, V. 12, P. 91  
 V. 27, P. 111  
 JON STEDMAN  
 B'NAI JESHURUN REC.  
 KRAUS-SANDOR COLL.  
 ELZAS MS.

MICKVE ISRAEL REC.  
 SHEARITH ISRAEL REC.  
 FLO. ABR.  
 WILLS - JOSEPH M. LEVY  
 AMELIA LEVY  
 W.W., P. 198

LEVY II (PA.)

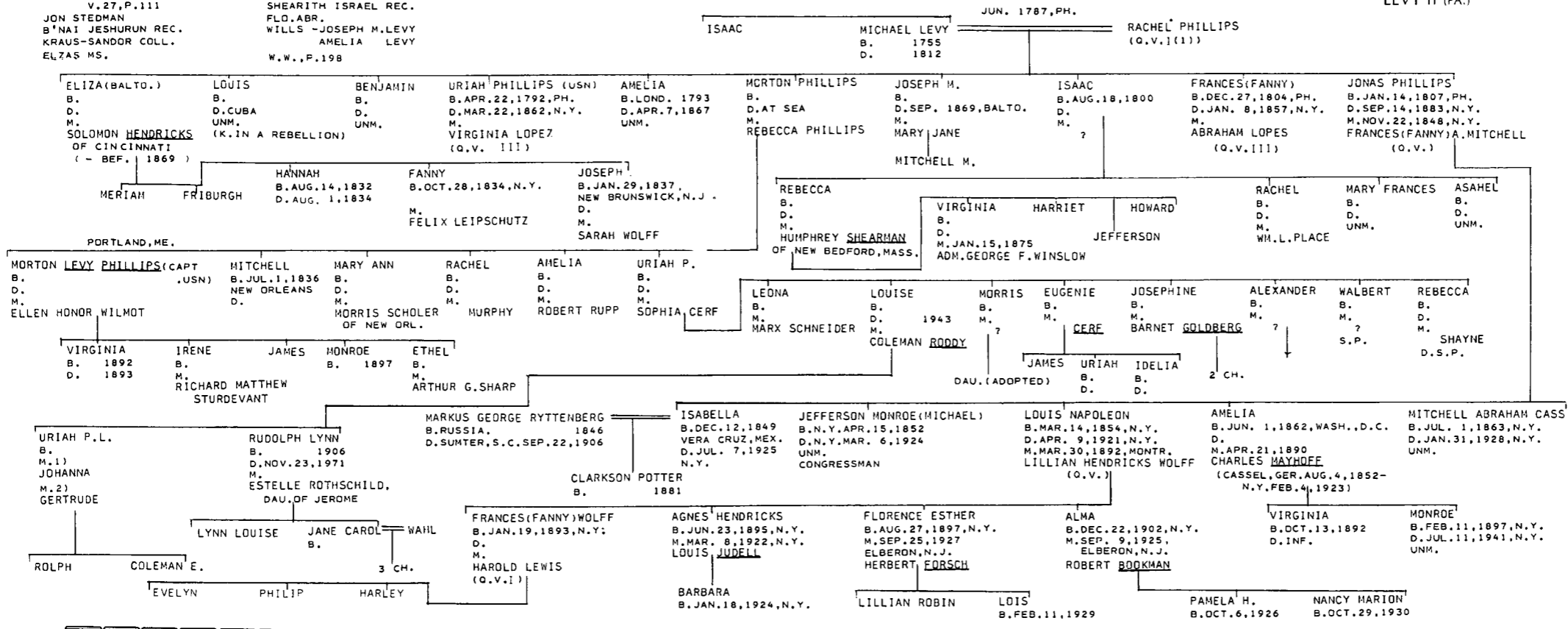

FEDERAL ST. CEM.  
 HERSHKOWITZ-WILLS  
 P. B. M.  
 POULSSON'S  
 JULIA MORDECAI MS.  
 TRANSACTIONS VII  
 MRS. RALPH NEWMAN  
 ELZAS-JEW. CEMETERIES AT  
 COLUMBIA, S.C.  
 MOSS GEN.  
 FLORENCE ABRAHAMS  
 MORAIS-JEWS OF PHILA.

PAJHS V. 4, P. 210  
 V. 27, P. 168F, 286, 336F  
 UJE, V. 8, P. 14  
 KRAUS-SANDOR COLL.  
 HENDRICKS GEN.  
 POOL-PORTRAITS...  
 AARON LEVY CALENDAR  
 N.Y. WILLS  
 SHEARITH ISRAEL REC.  
 ELZAS-M.N.

LEVY III (I) (N.Y.)

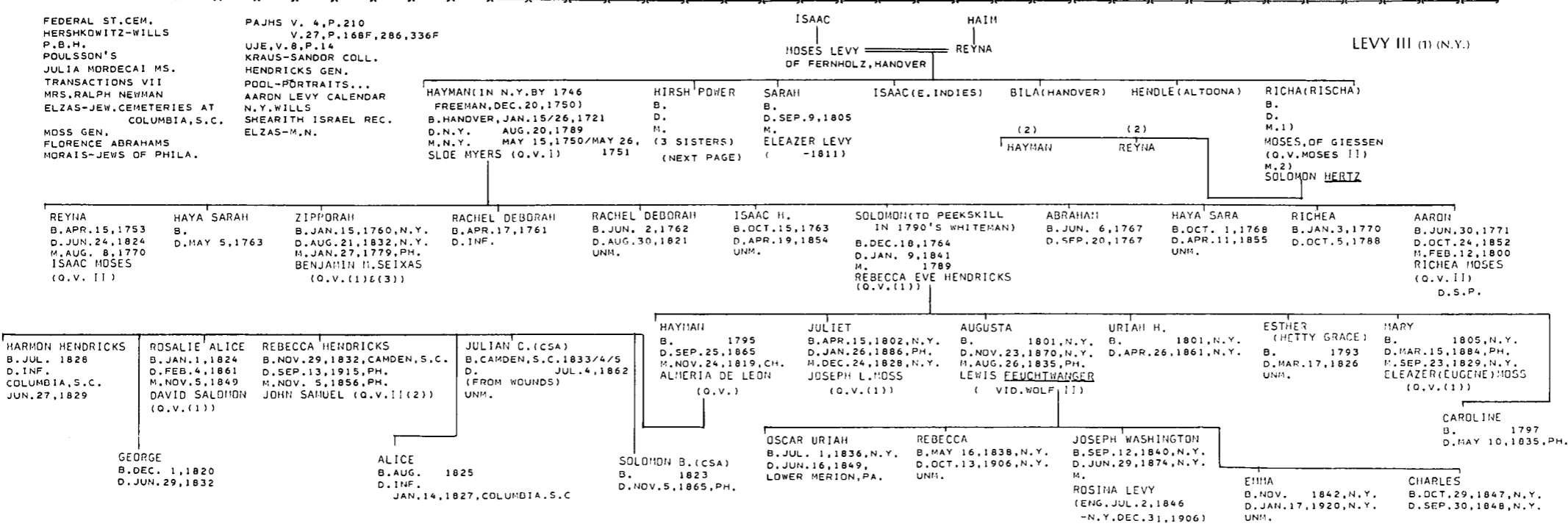

HIRSH POWER (LEVY)  
(SEE PRECEDING PAGE)

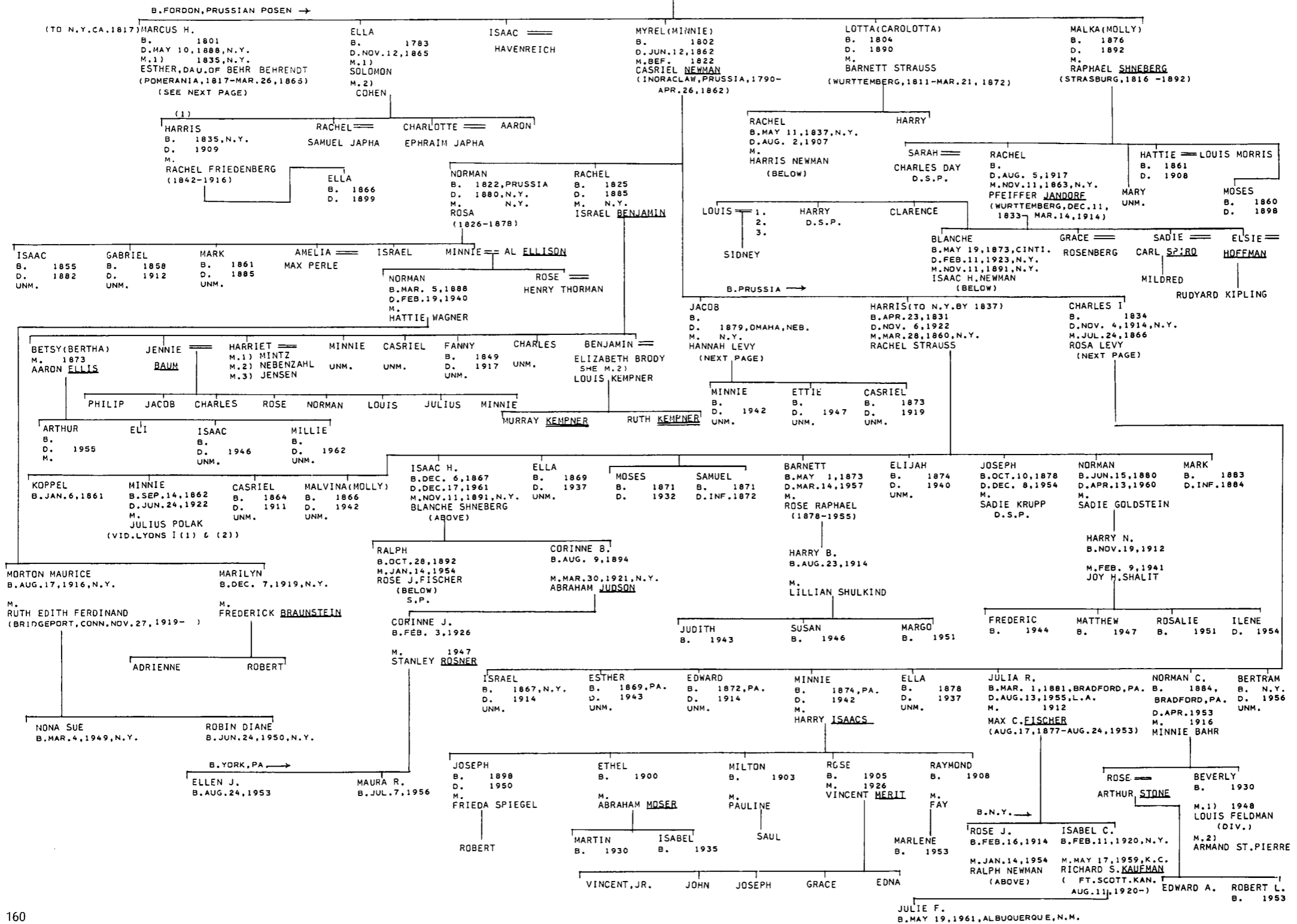

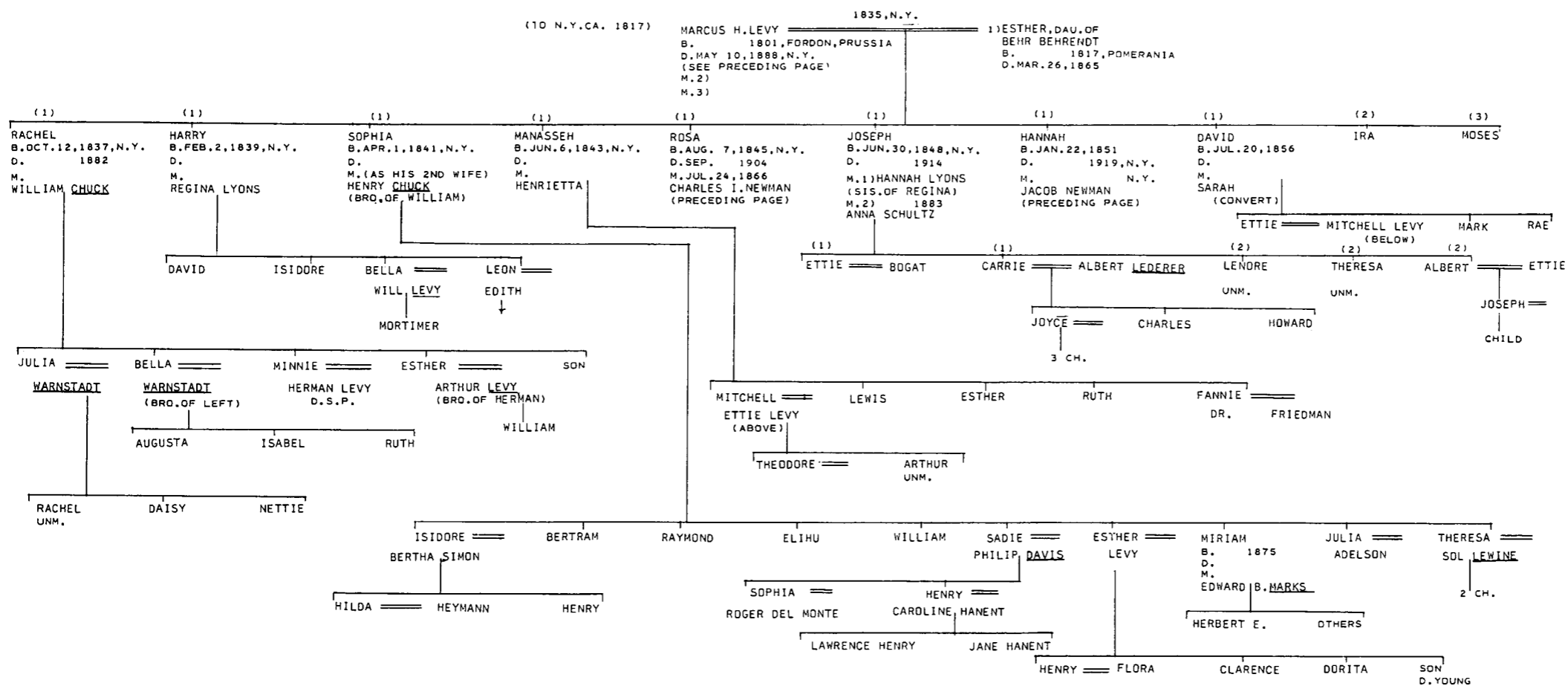



LEVY IV (RICHMOND)

PAJHS,XLVI,P.101F.  
CLARE L.HUTZLER  
RALPH COLTON  
AMY STEWART PAPERS  
FLORENCE ABRAHAMS  
EZEKIEL-LICHTENSTEIN-JEWS OF RICHM.

RI.DAILY DISPATCH,4/24/1878  
ISAACS FAMILY REC.  
FLO.ABR.  
LEVY GEN.  
BETH SHALOME MARR.REC.  
VA.MARR.BONDS  
MYER SOLIS-COHEN

(TO RICHM.1818)ABRAHAM LEVY  
B.AMST. 1769  
D.RICHM.DEC.27,1852

RACHEL CORNELIA BERNARD  
(SARAH RACHEL)  
B.AMST.  
D.RICHM.APR.9/10,1842

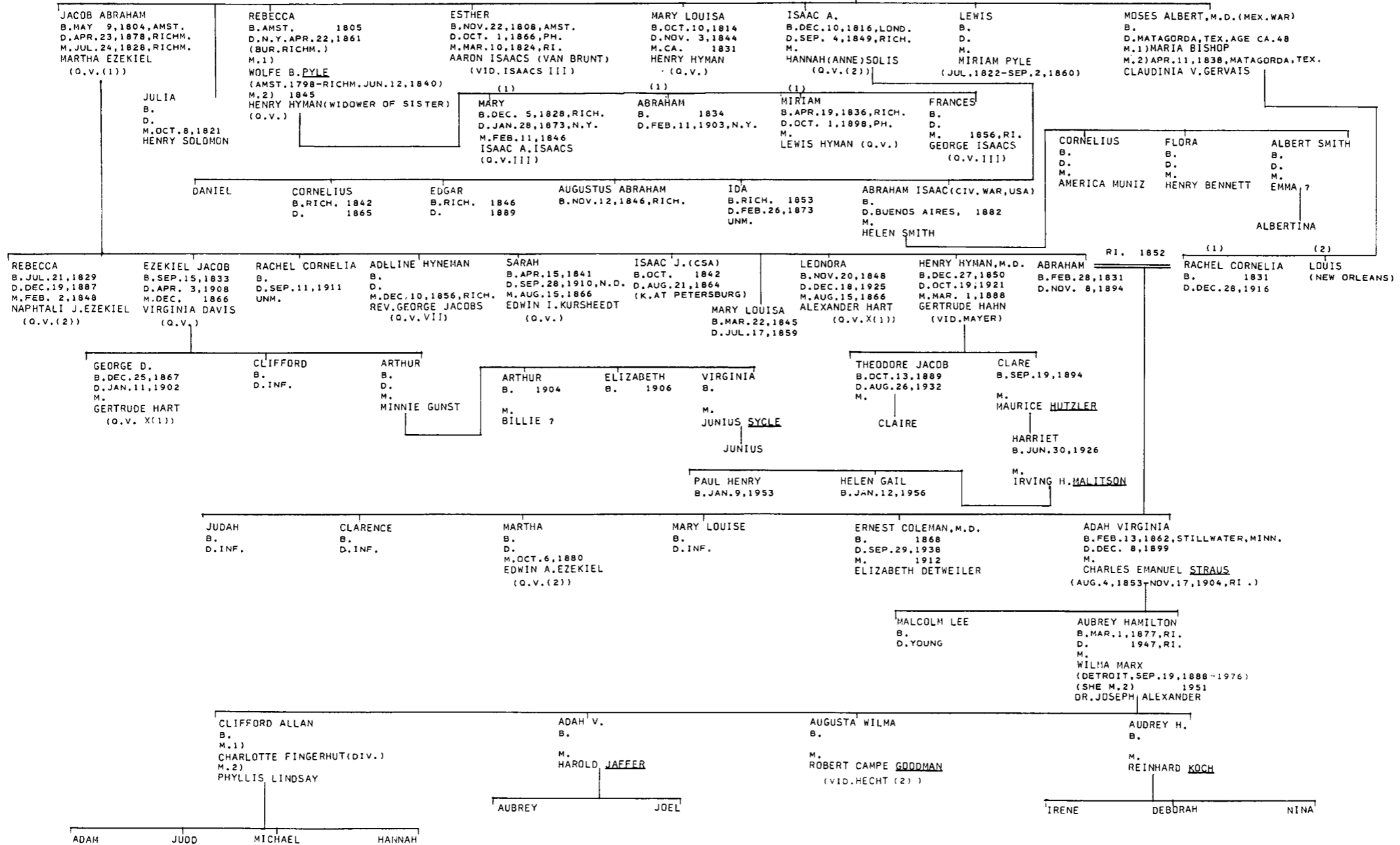

LEVY V (1) (CHARLESTON)

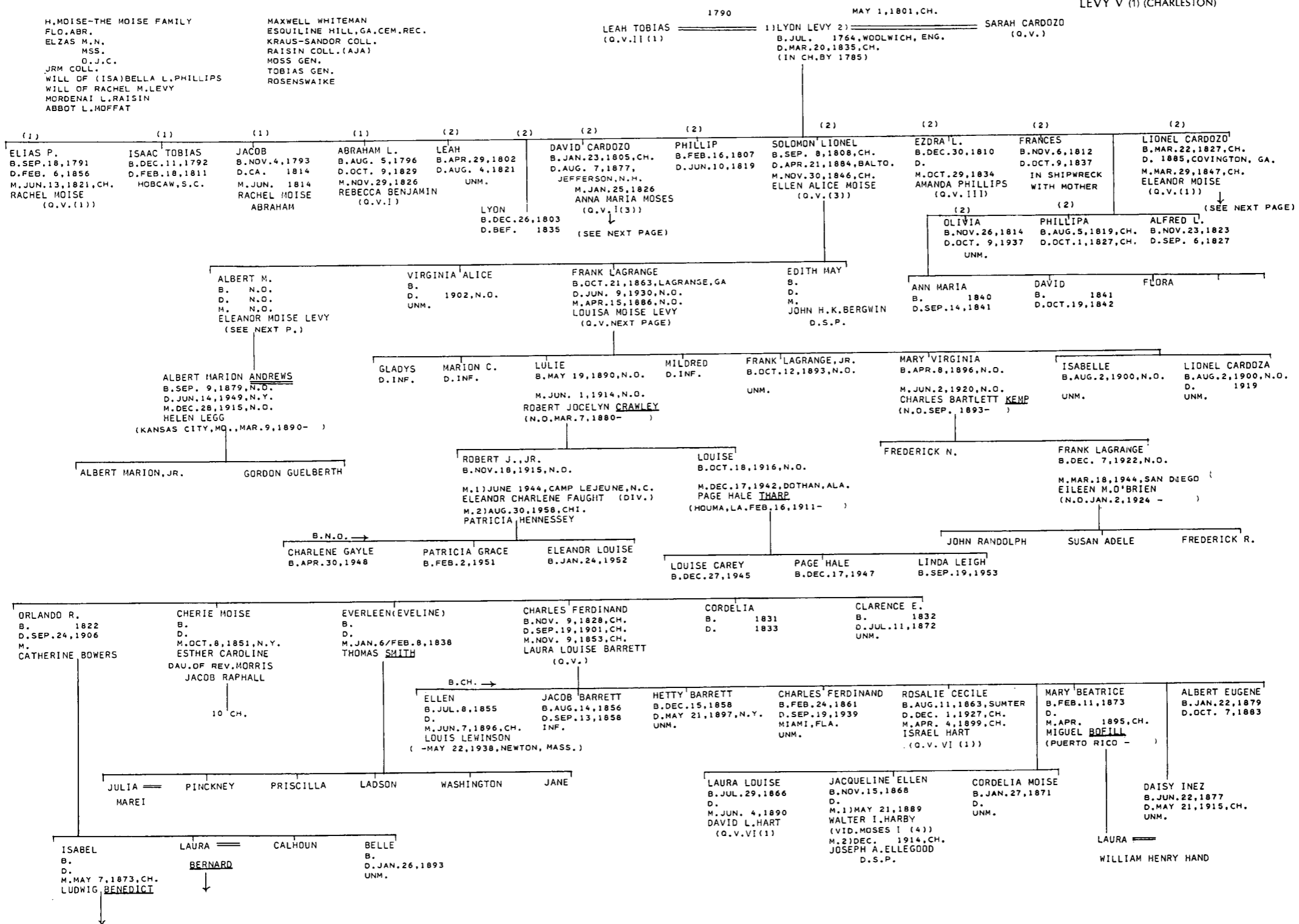

LEVY V (2)

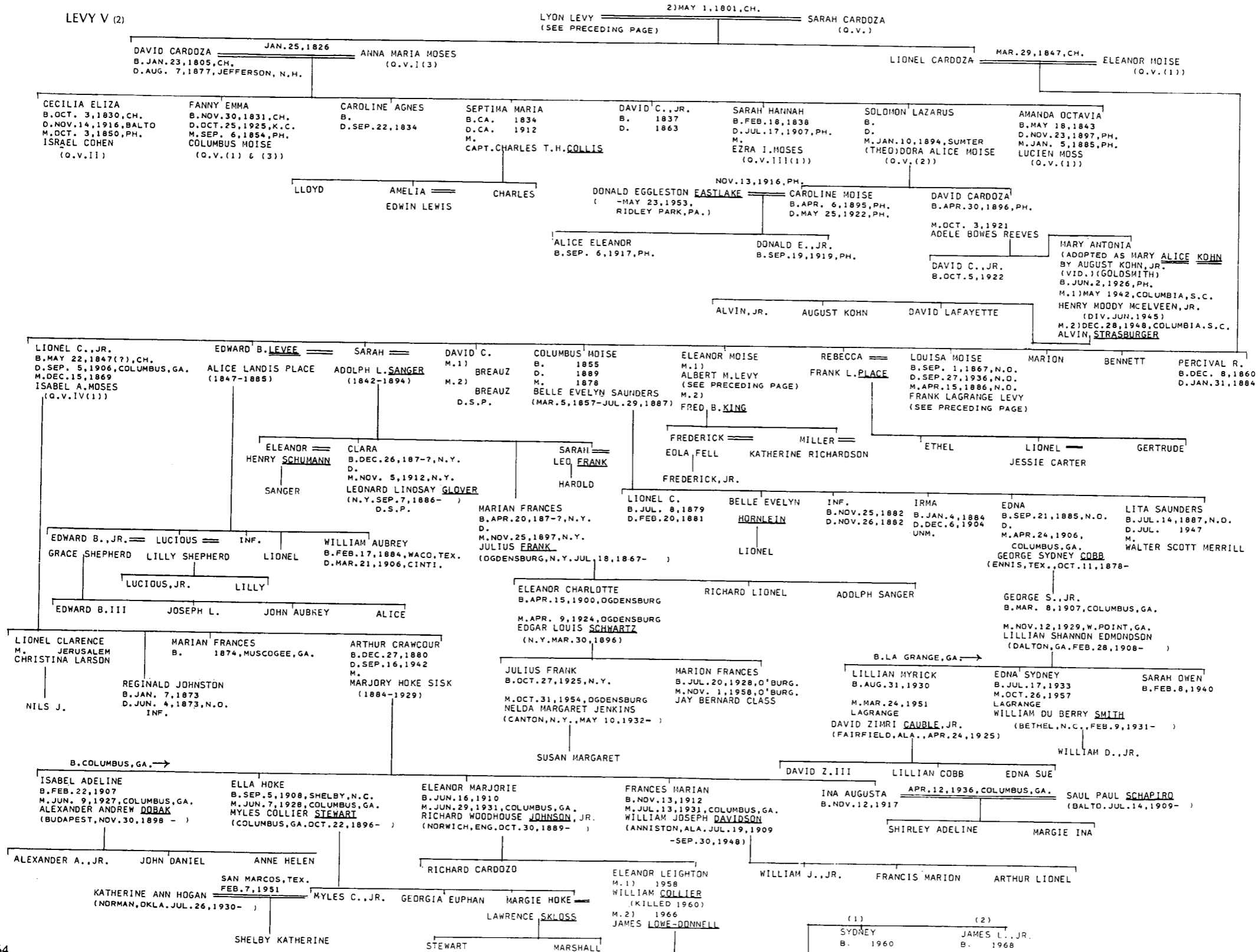

MISC.VII #397  
 HERSHKOWITZ WILLS,P.196F.  
 KORN-BENJAMIN LEVY  
 JEWS OF N.O.  
 PAJHS V. 4,P.189(CORRECTED)  
 PAJHS V.27,P.192F.,348F.  
 PAJHS V.33,P.199F.  
 PHILLIPS GEN.(JRM)  
 V.L.GUITERMAN NOTES(KRAUS-SANDOR COLL.)  
 VITAL RECORDS OF R.I. V.4  
 GUTSTEIN-JEWS OF NEWPORT  
 POOL-PORTRAITS...  
 SHEARITH ISRAEL REC.  
 ELZAS MS.

LEVY VI (NEWPORT & N.Y.)

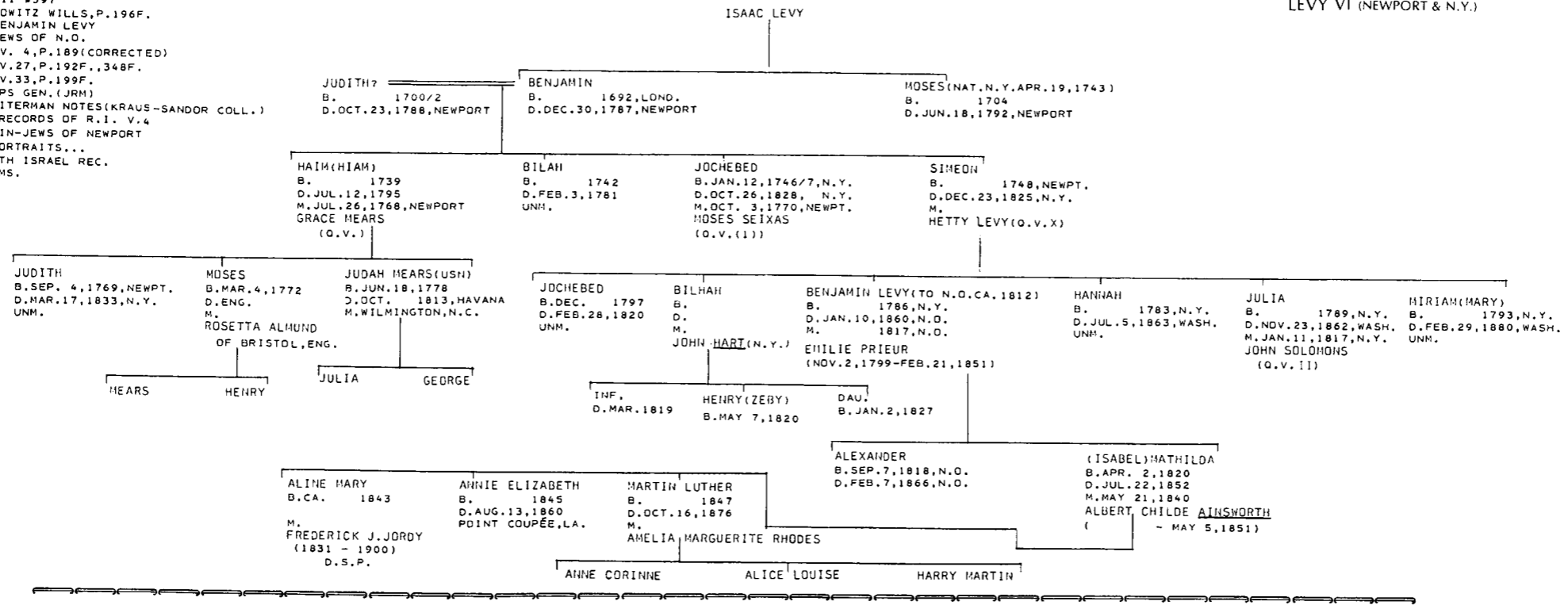

WHO'S WHO IN WORLD JEWRY  
 CCR YEARBOOK  
 FLO. ABR.  
 KORN-JEWS OF N.O.  
 MOISE-JEW CEM. AT SUMTER

KRAUS-SANDOR COLL.  
 ELZAS MS.  
 JRM COLL.

LEVY IX (NEW ORLEANS)

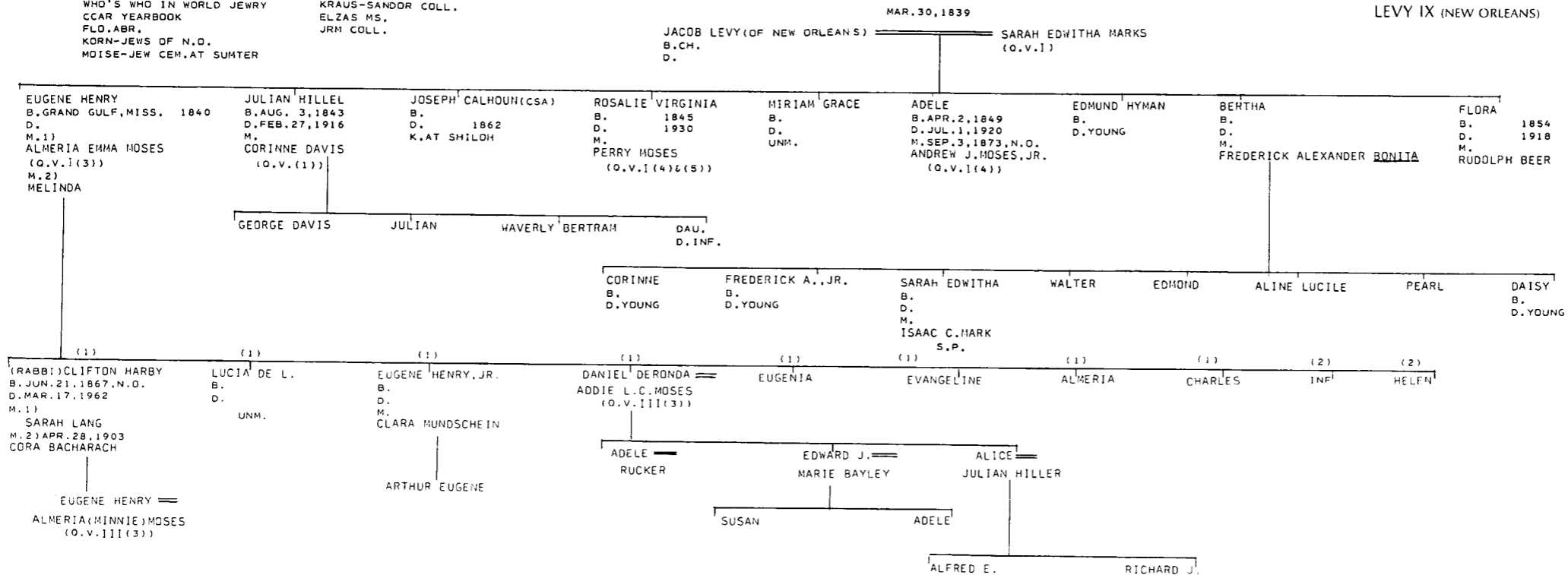

LEVY VII (1) (PA.)

DAVIS-HIST. OF RODEPH SHALOM  
EDWIN WOLF II  
FISH-AARON LEVY  
LEVY MSS. (PA. HS)  
ROSENTHAL MSS.  
MORAIS-JEWS OF PHILA.  
MYER SOLIS-COHEN  
FED. ST. CEM.  
P. B. H.  
FLO. ABR.

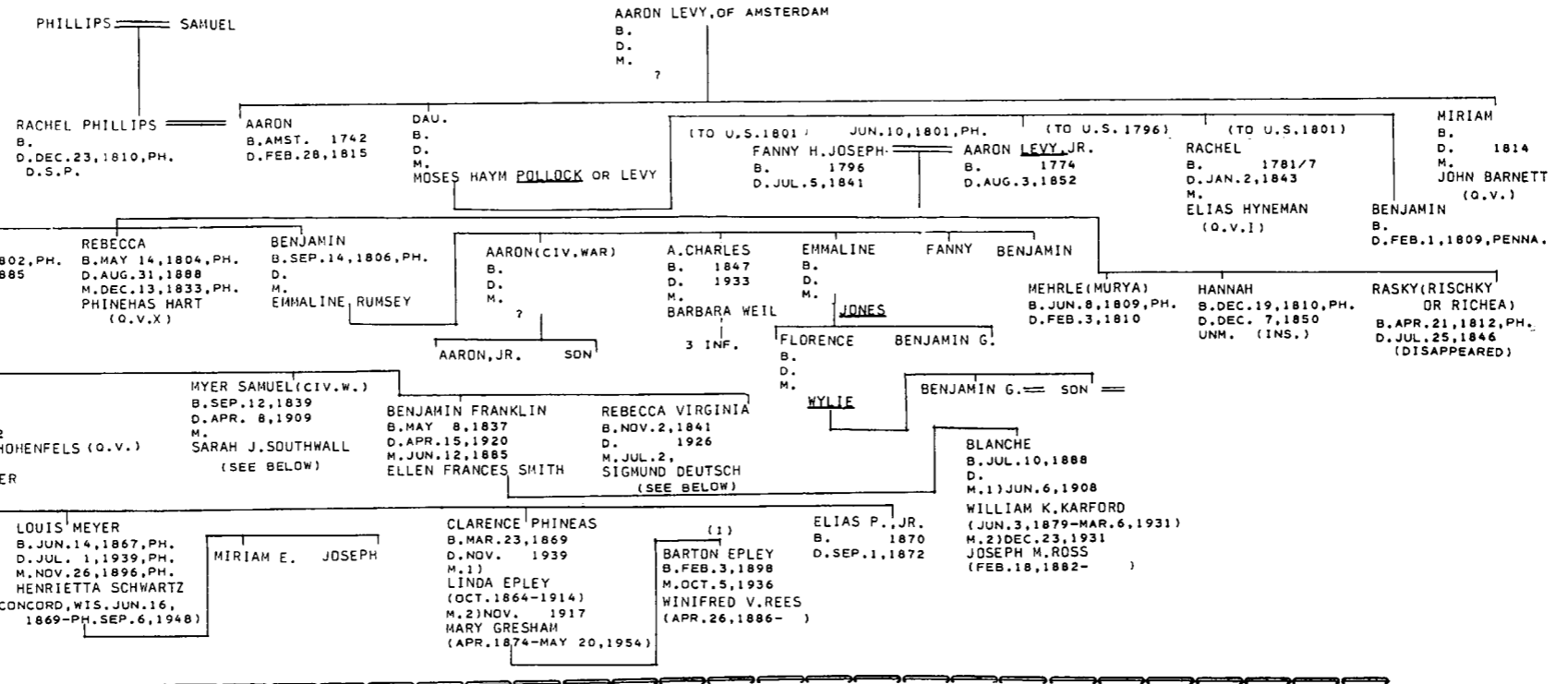

LEVY VII (2)



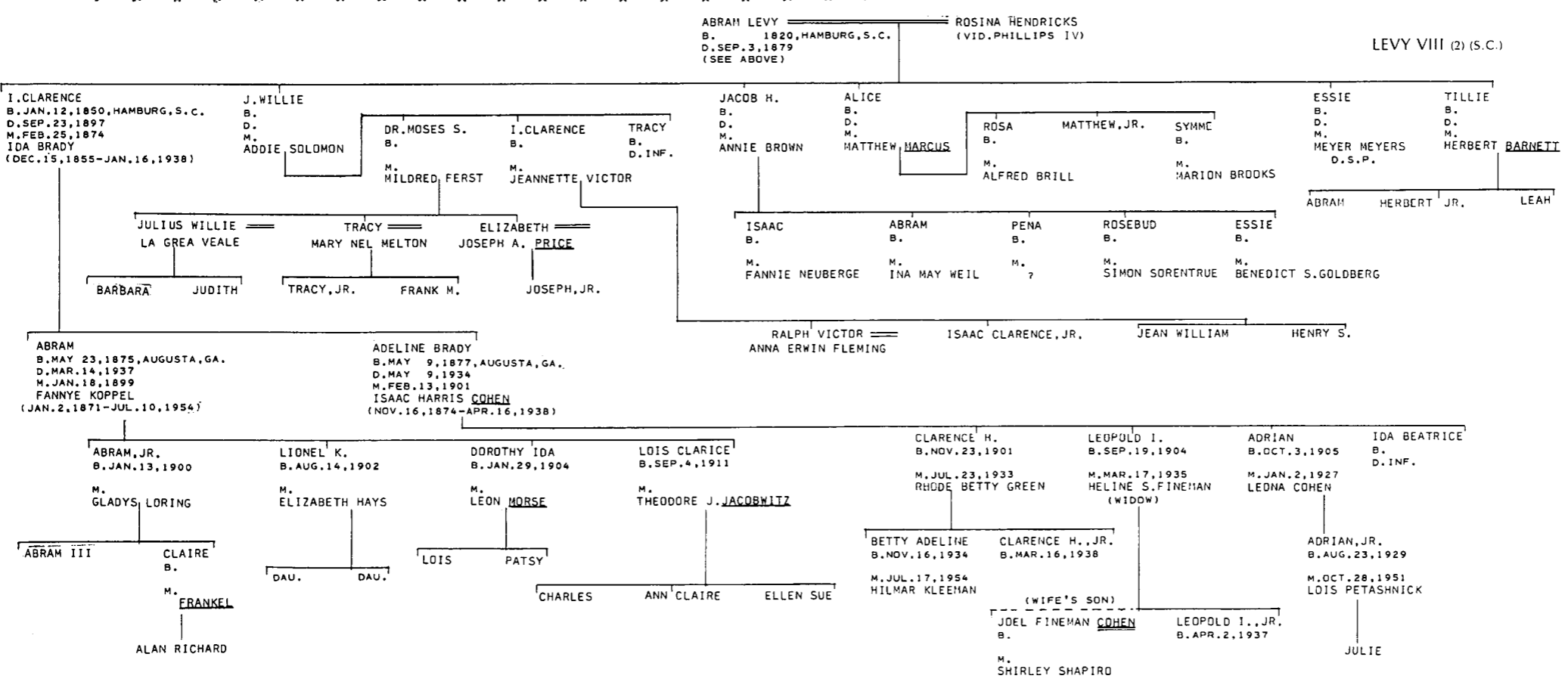
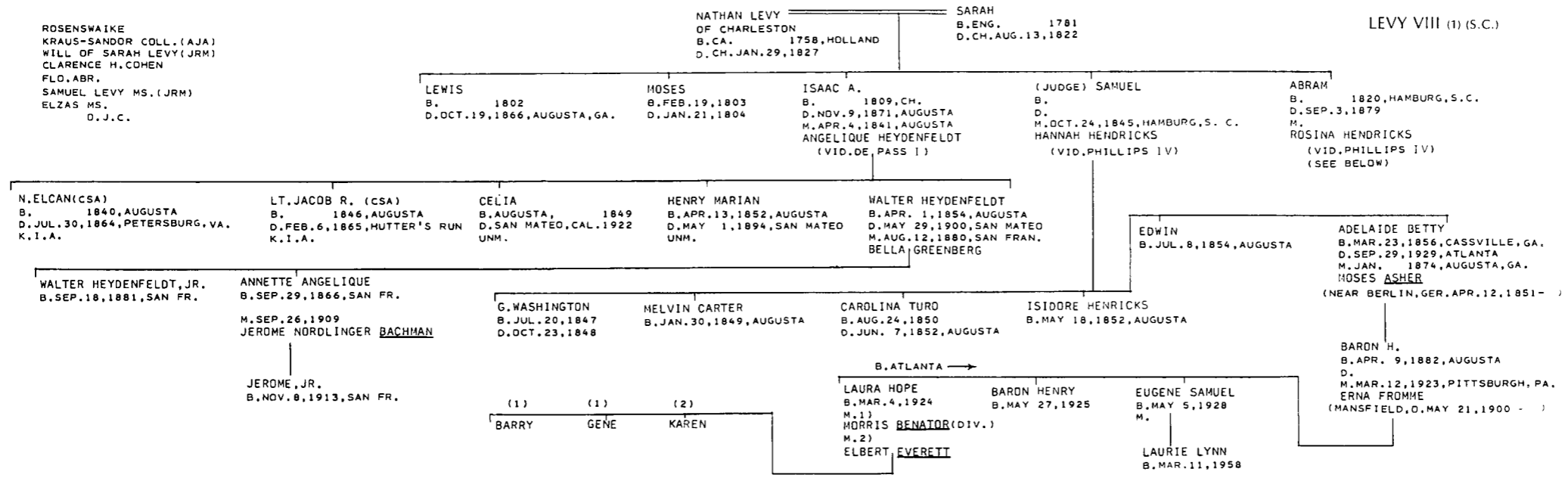

LEVY X (PHILLIPS & MENDES-SEIXAS)

ROSENWAIKE  
MRS. ROBT. R. GRAUCH  
KRAUS-SANDOR COLL.  
ELZAS MS.  
SHEARITH ISRAEL REC.  
POOL- PORTRAITS...  
SALLIE KENT PHILLIPS

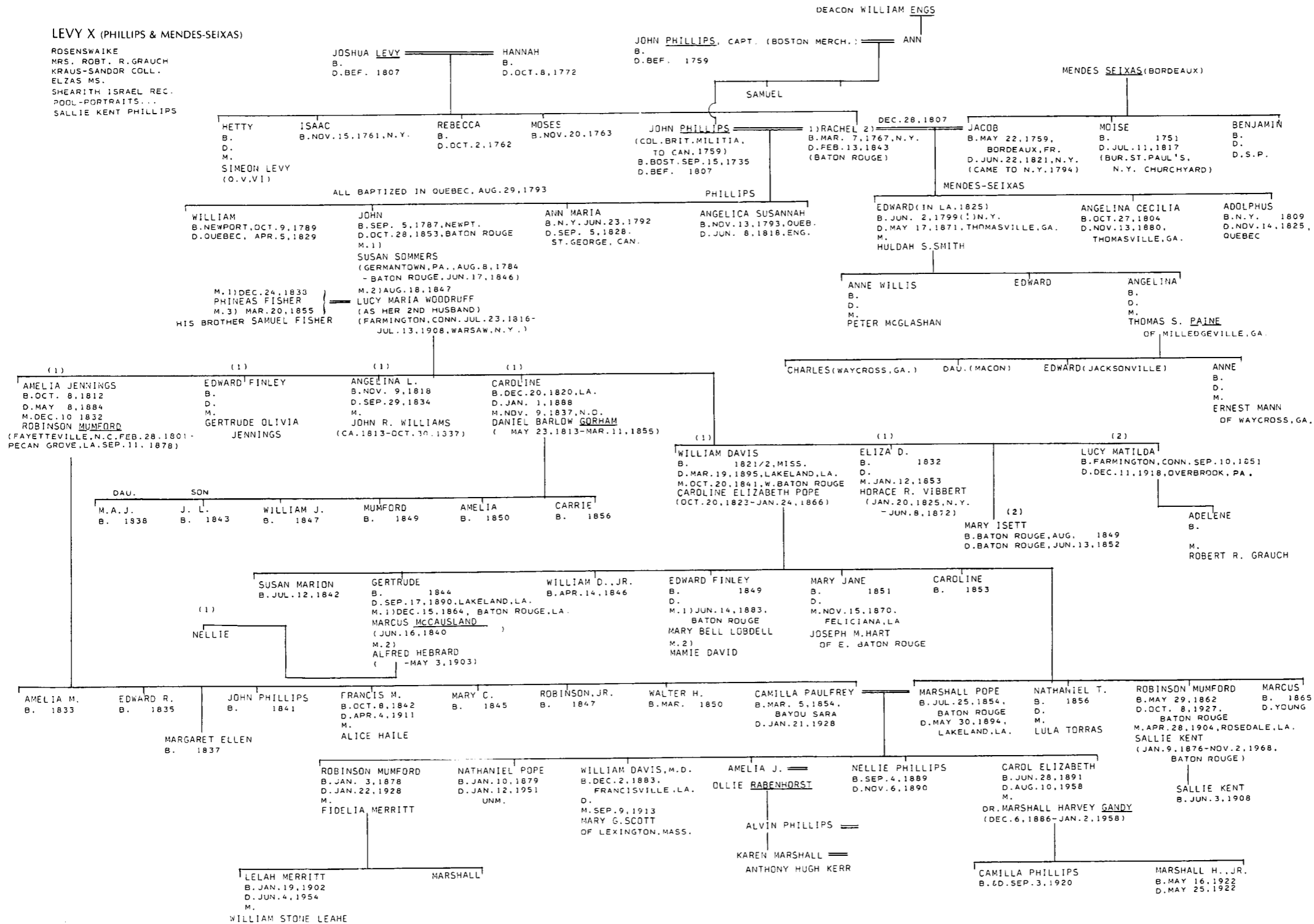

KRAUS-SANDOR COLL.  
PAJHS, V. 19, PP. 85, 296  
ELZAS MS.  
PHILLIPS MS. (L. OF C.)  
WILL OF MOSES C. LEVY, JACOB C. LEVY  
SAMUEL-YATES GEN. (JRM)  
E. COHEN GEN. (JRM)  
HIST. OF SAMUEL-YATES FAMILY  
CHATHAM CO. (GA.) MARRIAGE REC.  
SAUL J. RUBIN

(TO U.S. 1785) MOSES CLAVA LEVY  
B. ZOBNAU, POLAND, 1750  
D. CH. MAR. 30, 1839

SARAH ?  
B. 1767  
D. SAV. JUL. 16, 1858

JACOB CLARISSE (OR CLAVIUS)  
B. DEC. 19, 1788, CH.  
D. JUN. 10, 1875, SAV.  
M. OCT. 21, 1817, LIVERPOOL, ENG.  
FANNY YATES (O.V.)

LEVY XI

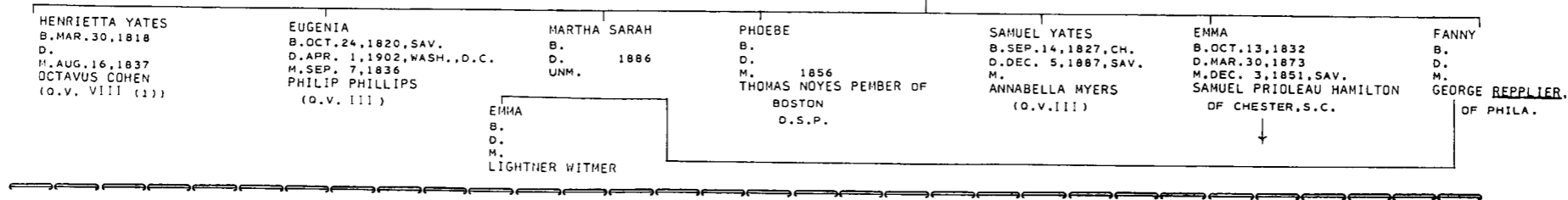

U.S. CIRCUIT CO. (N.Y. DIST. IMMIGR.)  
KRAUS-SANDOR COLL.  
SHEARITH ISRAEL REC.  
N.Y. WEEKLY MUSEUM  
POULSSON'S DAILY ADVERTISER

SIMON LEVY (PH. MONTREAL, IN CANADA, 1760)  
B. D. M. ?

MYER  
B. D. M. ?

LEVY XII

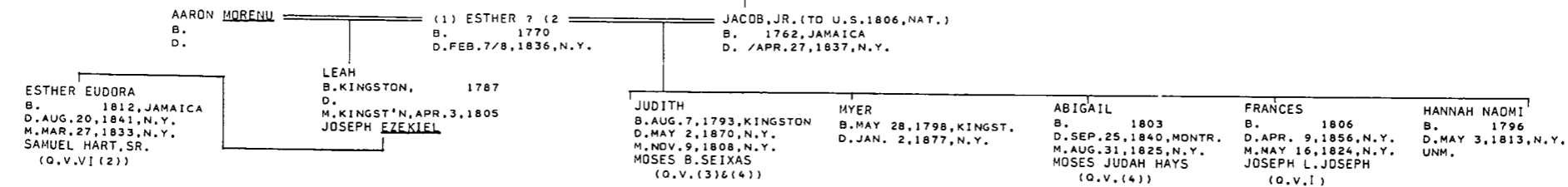

MS.  
O.J.C.  
ELZAS-NEW JEW. CEM. AT CH.  
KIRKLAND-KENNEDY-HISTORIC CAMDEN  
(S.C.) P. 40 6F.  
WILLS RACHEL HART  
SARAH LEVY  
JANE LEVY  
CH. MARR. CONVEYANCES XIV/277  
JANE L. RAISIN

SAMUEL LEVY  
B. 1746  
D. 1842

SARAH MOSES  
B. 1839  
D. 1839

MENACHEM LEVY

LEVY XIII

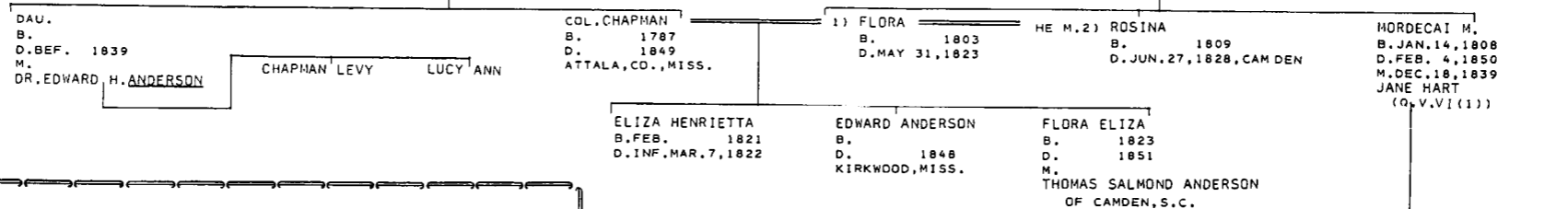

MOSS GEN.  
SHEARITH ISRAEL REC.  
BARBER N.Y. MARR.  
ALSO HS V. 7, P. 74

ASHER SAMUEL LEVY (SURINAM, PH.)  
B. D. M. ?

LEVY XIV

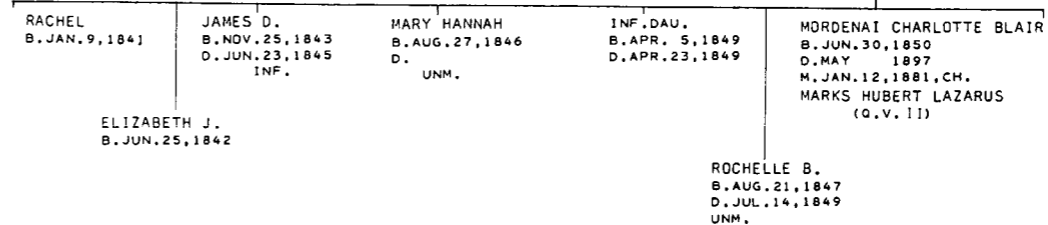
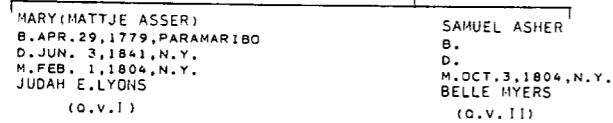



LEVY XV

JON STEDMAN  
B'NAI JESHURUN REC.

ELIAKUM LEVY

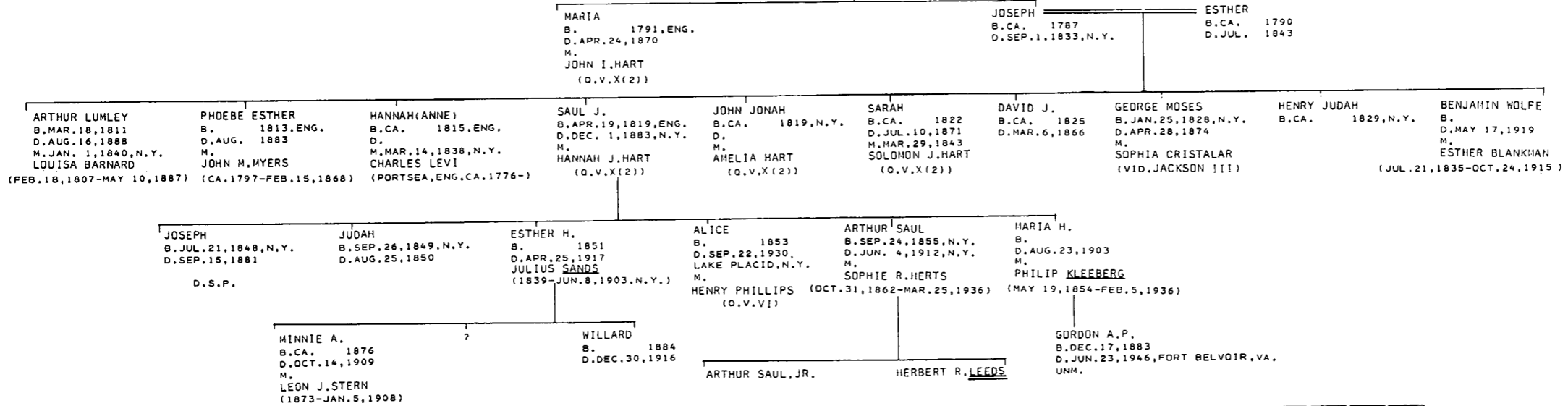

LEVY XVI

A. J. A. III, P. 7  
XXVI, P. 66FF.  
PAJHS XLIV, P. 93  
POOL- PORTRAITS, P. 216F.  
EHRENFRIED-BOSTON, P. 55F.  
HERSHKOWITZ-WILLS, P. 65N

(FIRST JEW TO RESIDE  
PERMANENTLY IN NORTH AMERICA)

(BODEK IN RECIFE, 1654)  
SHOCHET, BODEK & HAZAN  
IN LOND., 1664

BENJAMIN LEVY

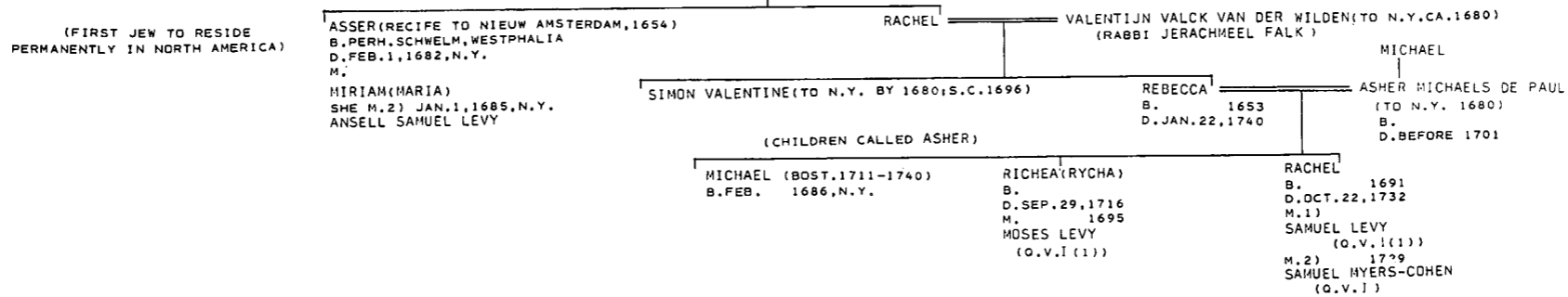

LEVY XVII

AJHQ LVII, P. 49F.  
LXI, P. 69FF.  
MARCUS-EAJ II, P. 48  
CAJ III, P. 1192  
W.W., PP. 49, 64  
ROSENSWAIKE-BALTO.  
AJA, XII, P. 98F  
ROTH-PROVINCIAL JEWRY, P. 89  
DAVID A. BRENER

HAYIM LEVY  
(OXFORD, ENG.)

MARY SIMON (SIS. OF JOSEPH SIMON (O.V.))  
B. CA. 1698

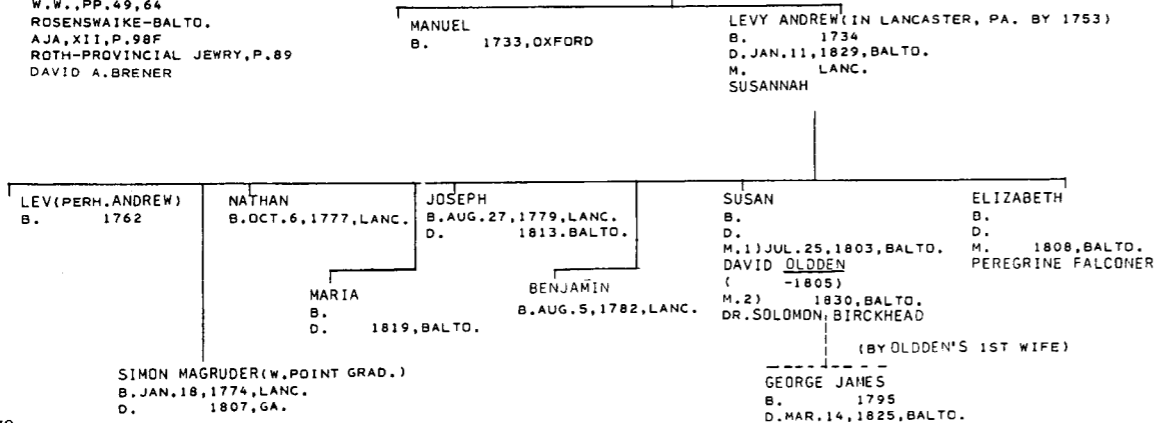

LEVY XVIII

HERSHKOWITZ-WILLS  
P. 161F, 186F.

(JACOB LEVY?)

ROSEY ISRAEL

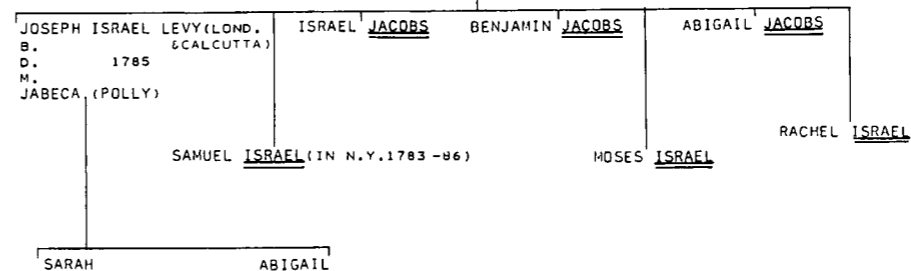

NAT'L CYCLOPAEDIA OF AMER. BIOG. V.9,P.342F.  
 FLA.HIST.QUARTERLY V.19,NO.4,P.319FF.  
 PAJMS.V.25,P.1FF.  
 U.S.DIST.CT.,PH.,REPORTS OF ALIENS,BK.B.,P.163  
 UJE,V.3,P.444 ST.THOS.REC.  
 DAB V.5,P.24

LEVY XIX (YULEE)

SPRUCE ST.CEM.REC.,P.72  
 WICKVE ISRAEL REC.  
 KRAUS-SANDOR COLL.

LEVY XX

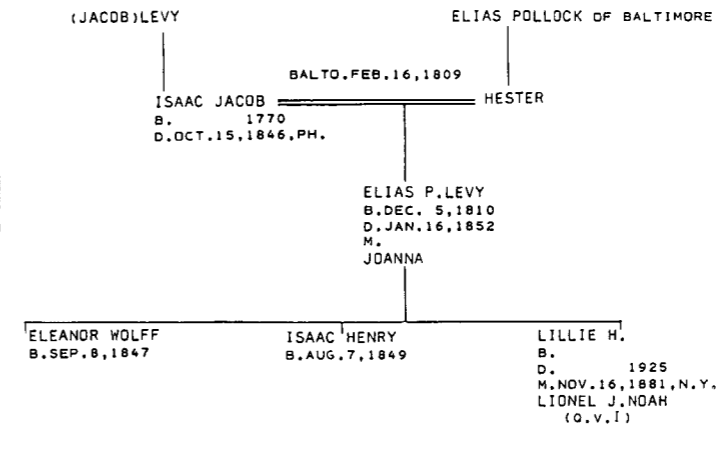
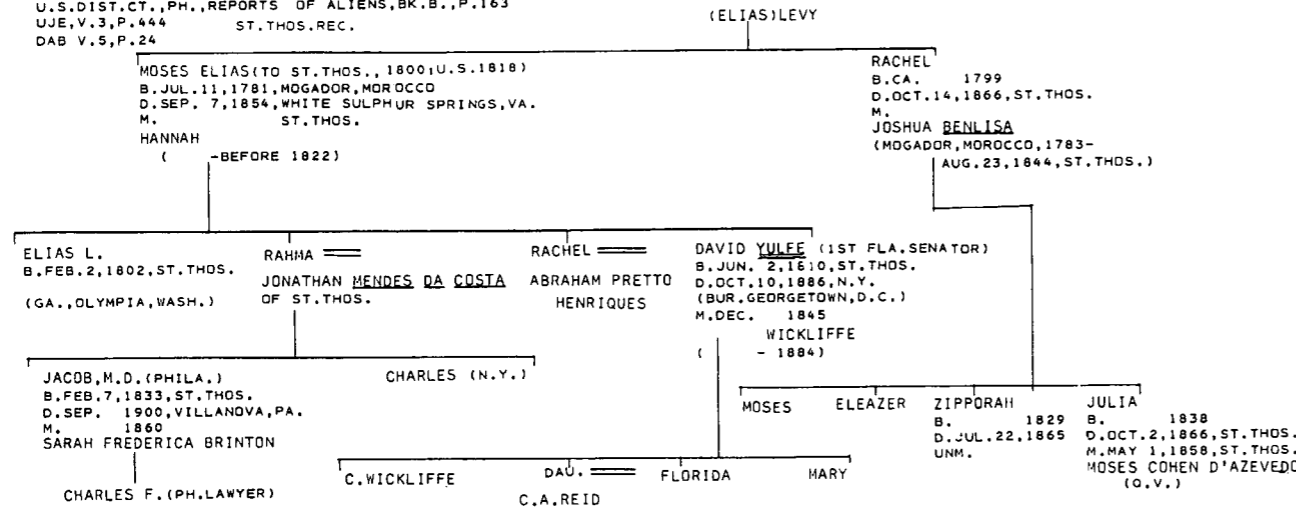

N.Y.CENSUS 1855  
 JON STEDMAN  
 B'NAI JESHURUN REC.  
 KRAUS-SANDOR COLL.  
 GOLDSTONE GEN.

SHEARITH ISRAEL REC.  
 H.MOISE

LONDON

LEWIS I

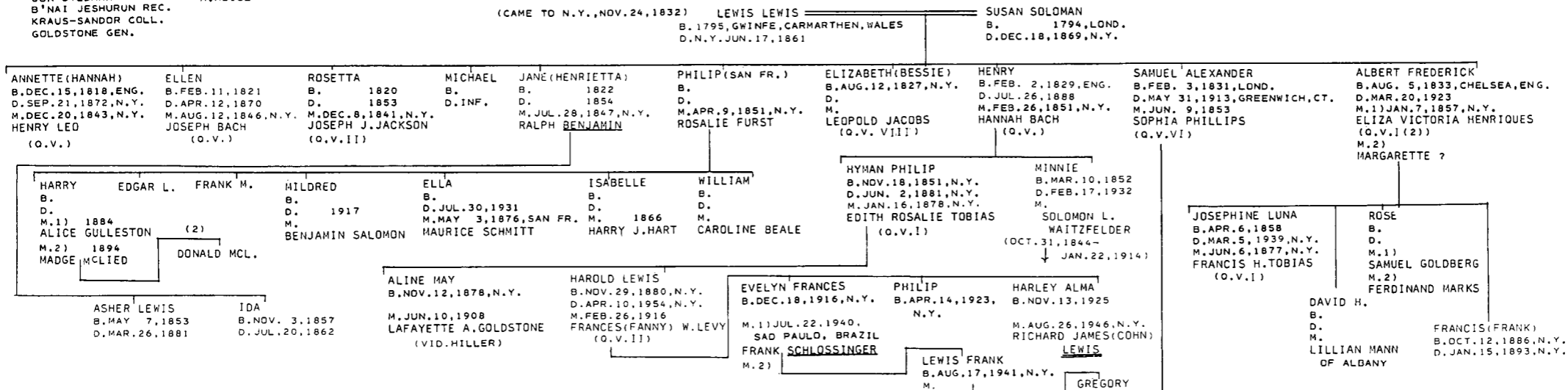

ADOPTED NIECES

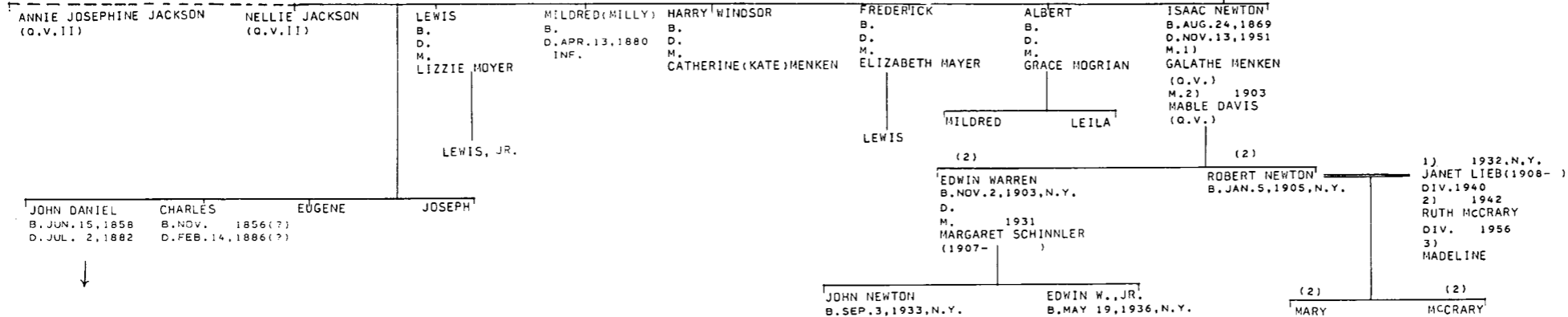

LEWIS II (1)

JANE KAUDERS  
KORN-JEWS OF N.O.  
MRS. STANLEY YARMUTH  
FLO. ABR.  
FEDORA S. FRANK  
U.S. CENSUS 1880  
ELIZABETH FLEISHER  
PAJMS, V. 19, P. 195F.  
SHEARITH ISRAEL REC.  
HENDRICKS GEN.

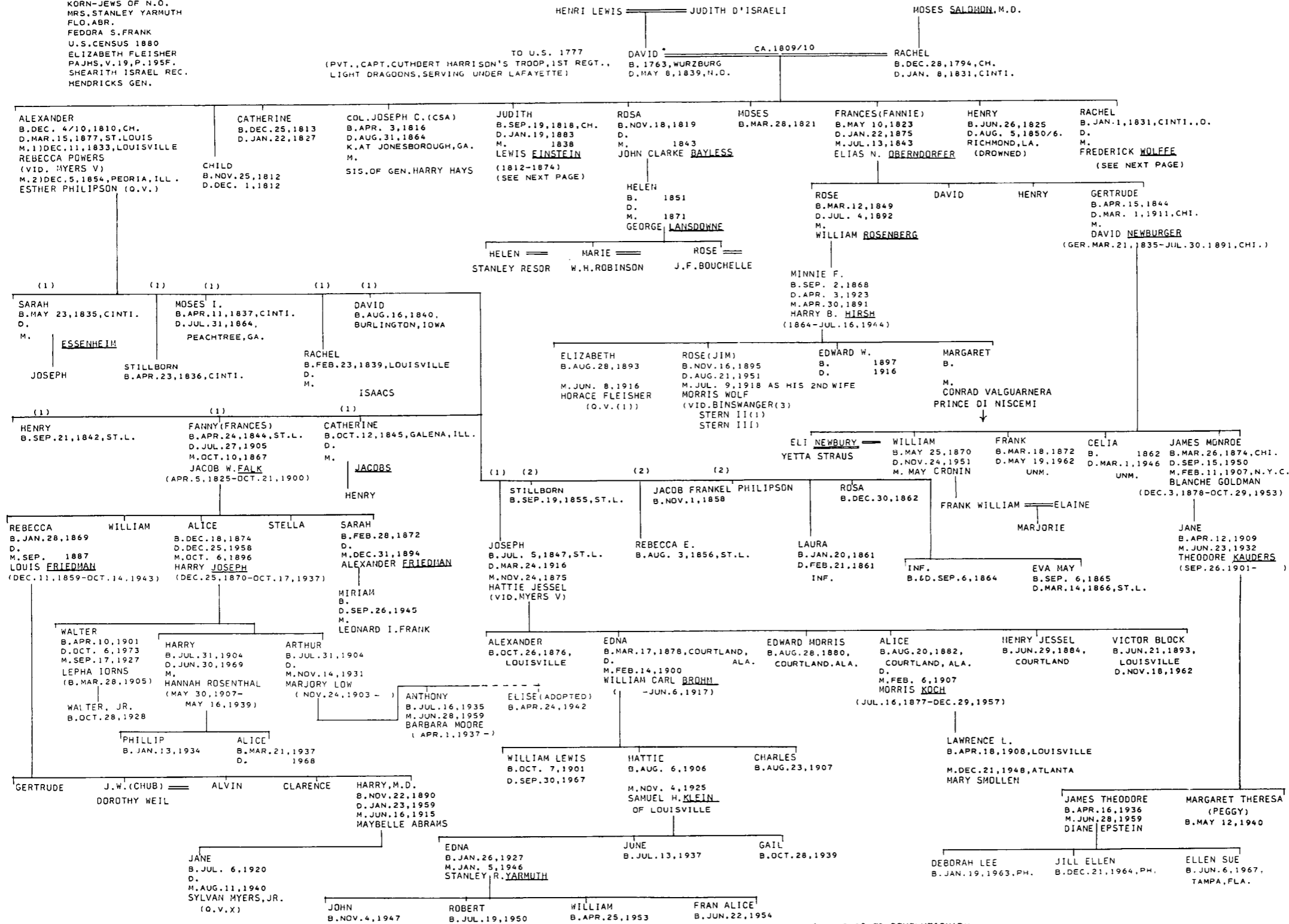

\*ESTABLISHED REVOLUTIONARY ANCESTOR

CA. 1809/10

LEWIS II (2)

DAVID LEWIS  
B. 1763, WURZBURG  
D. MAY 8, 1839, N.O.  
(SEE PRECEDING PAGE)

RACHEL SALOMON  
B. DEC. 28, 1794, CH.  
D. JAN. 8, 1831, CINTI.

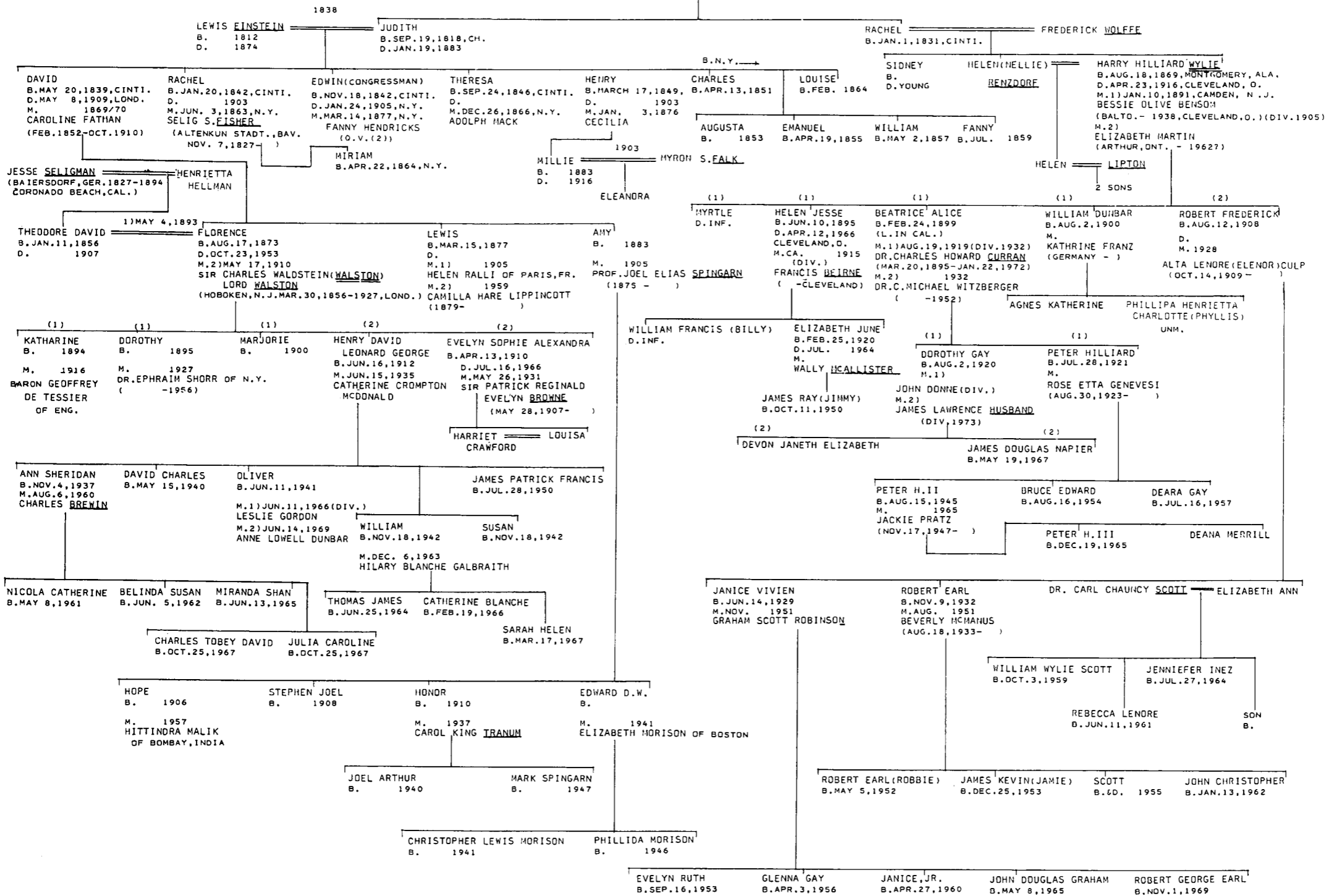

LICHTENSTEIN (VA.)

WHO'S WHO IN AMERICAN JEWRY, 1965  
 LICHTENSTEIN-THE VA. LICHTENSTEINS  
 EZEKIEL-LICHTENSTEIN-THE JEWS OF RICHMOND, P. 301F.

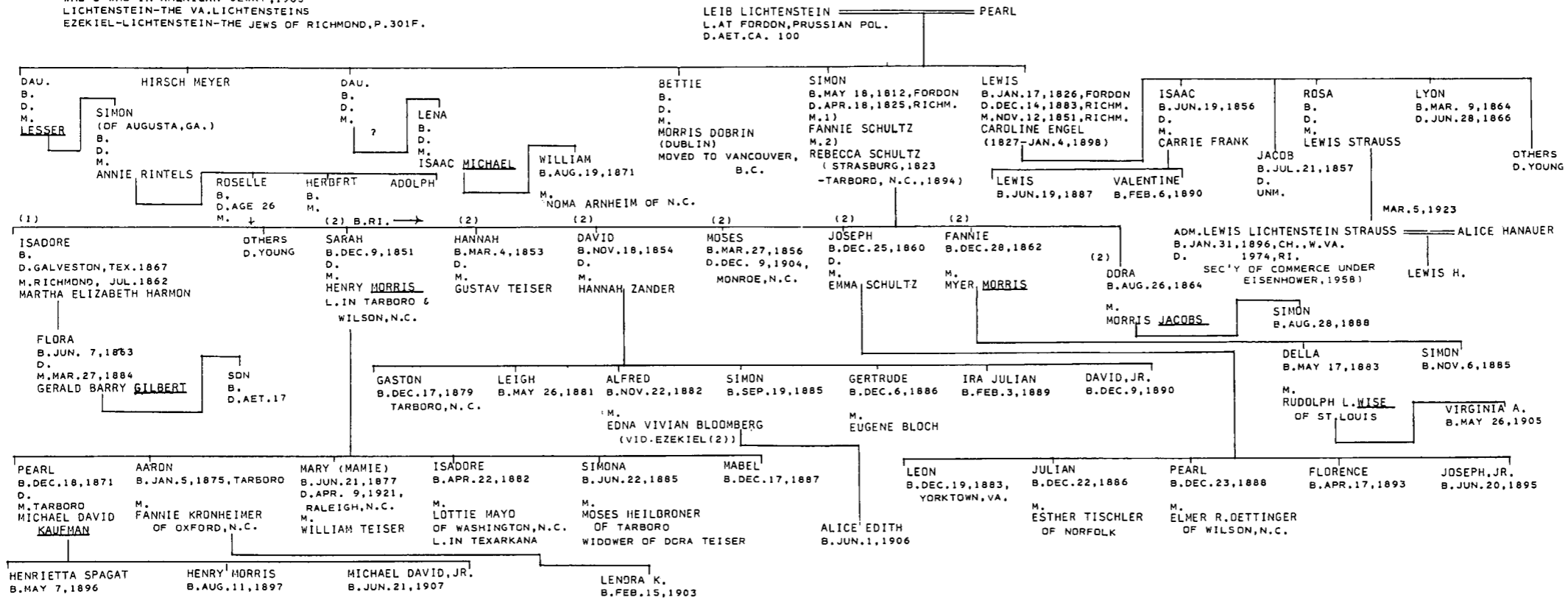

LIEBER (LEBAIR)

LIEBER FAM. BIBLE FLORENCE ABRAHAMS  
 KRAUS-SANDOR COLL. MICKVE ISRAEL REC.

THIS GENERATION CHANGED NAME TO LIEBER (OR LEBAIR)

GEORGE LEVI (B. D. DEC. 16, 1855) and JUDITH (B. D. JUN. 1843) are the parents of CHARLES (N.Y.), JAMES, ROGER, ANNE, ETHEL, JACOB, ISAAC, HENRY, REBECCA, WALTER, ISADORE (ENG.), LOUISA (ENG.), MATILDA, ISAAC (CHI.), JACOB (CIN'TI.), and BENJAMIN.

CHARLES (N.Y.) is married to ANN LEVY. Their children include JAMES, ROGER, ANNE, and ETHEL.

JAMES is married to DIANA EMANUEL. Their children include ROGER, ANNE, and ETHEL.

ROGER is married to ANNE. Their children include ETHEL.

ANNE is married to ETHEL. Their children include JACOB, ISAAC, HENRY, and REBECCA.

JACOB is married to FRIEDLANER. Their children include FLORENCE, HENRY, and DAVID.

ISAAC is married to FRIEDLANER. Their children include FLORENCE, HENRY, and DAVID.

HENRY is married to FRIEDLANER. Their children include FLORENCE, HENRY, and DAVID.

REBECCA is married to FRIEDLANER. Their children include FLORENCE, HENRY, and DAVID.

WALTER is married to BOURNEMOUTH, ENG. M. Their children include ISADORE (ENG.), LOUISA (ENG.), MATILDA, ISAAC (CHI.), JACOB (CIN'TI.), and BENJAMIN.

ISADORE (ENG.) is married to D.S.P. Their children include ISADORE (ENG.), LOUISA (ENG.), MATILDA, ISAAC (CHI.), JACOB (CIN'TI.), and BENJAMIN.

LOUISA (ENG.) is married to D.S.P. Their children include ISADORE (ENG.), LOUISA (ENG.), MATILDA, ISAAC (CHI.), JACOB (CIN'TI.), and BENJAMIN.

MATILDA is married to PRIVY?. Their children include ISADORE (ENG.), LOUISA (ENG.), MATILDA, ISAAC (CHI.), JACOB (CIN'TI.), and BENJAMIN.

ISAAC (CHI.) is married to PRIVY?. Their children include ISADORE (ENG.), LOUISA (ENG.), MATILDA, ISAAC (CHI.), JACOB (CIN'TI.), and BENJAMIN.

JACOB (CIN'TI.) is married to PRIVY?. Their children include ISADORE (ENG.), LOUISA (ENG.), MATILDA, ISAAC (CHI.), JACOB (CIN'TI.), and BENJAMIN.

BENJAMIN is married to FLEURETTE HART. Their children include ISADORE (ENG.), LOUISA (ENG.), MATILDA, ISAAC (CHI.), JACOB (CIN'TI.), and BENJAMIN.

The chart continues to show the marriages and children of these individuals, including names like JULIET, DAVID, FLEURETTE, GEORGE LEVI, JACOB WASHINGTON, BENJAMIN FRANKLIN, WALTER SCOTT, HARRIET LIZZY, CLARA, and MOREAU LESSER, along with their respective birth dates and marriages.

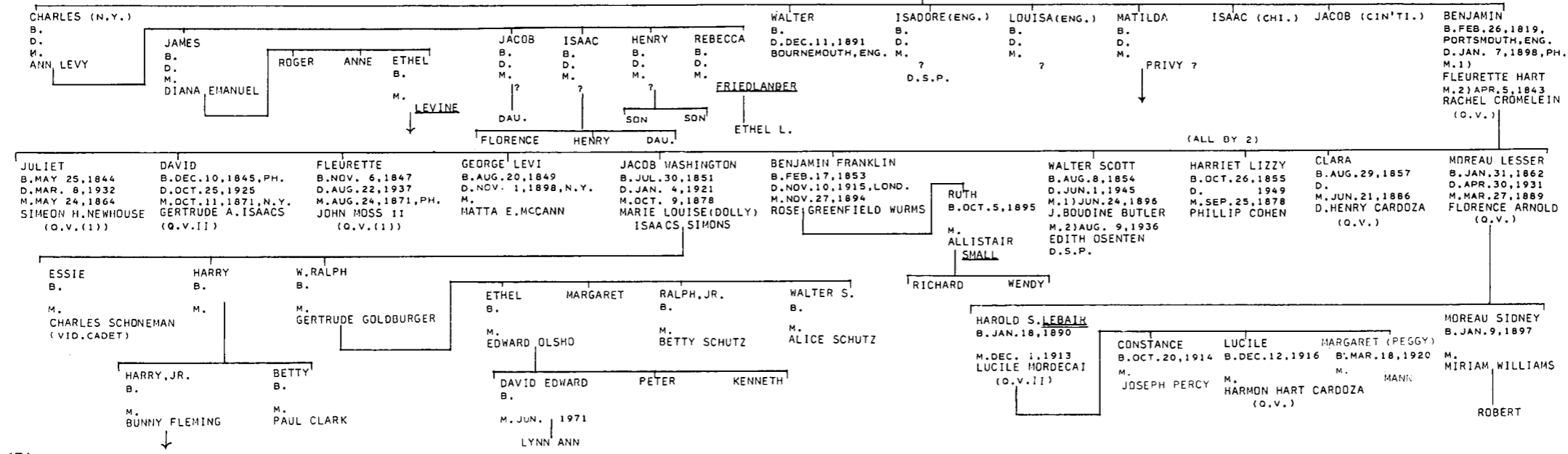

ELZAS-JEW CEM. AT GED' TN, S.C.  
 MSS.  
 O.J.C.  
 MARCUS-AJD, P.4  
 REV. EZRA STILES- BILL OF  
 MORTALITY FOR NEWPORT, R.I., 1760-64  
 (TYPESCR. IN NEHGS.)  
 STILES-LITERARY DIARY  
 TRANSACTIONS JHSE, VII  
 KRAUS-SANDOR COLL.  
 PAJHS V. 2, P. 101  
 V. 10, P. 17  
 V. 23, P. 88F.  
 V. 35, P. 295, 303.  
 V. 27, P. 151F., 200F., 349F.  
 V. 42, P. 303  
 AARON M. LOPEZ REC.  
 MOISE-MOISE FAMILY  
 ABBOT L. MOFFAT  
 B.W. KORN  
 FLORENCE D. NORTHWAY  
 GOLDSTONE GEN.  
 POOL- PORTRAITS...  
 SHEARITH ISRAEL REC.  
 LOPEZ MS. (JRM.)  
 GUTSTEIN-JEWS OF NEWPORT  
 FLORENCE ABRAHAMS

LOPEZ I (1) (RIVERA, NEWPORT, R.I.)

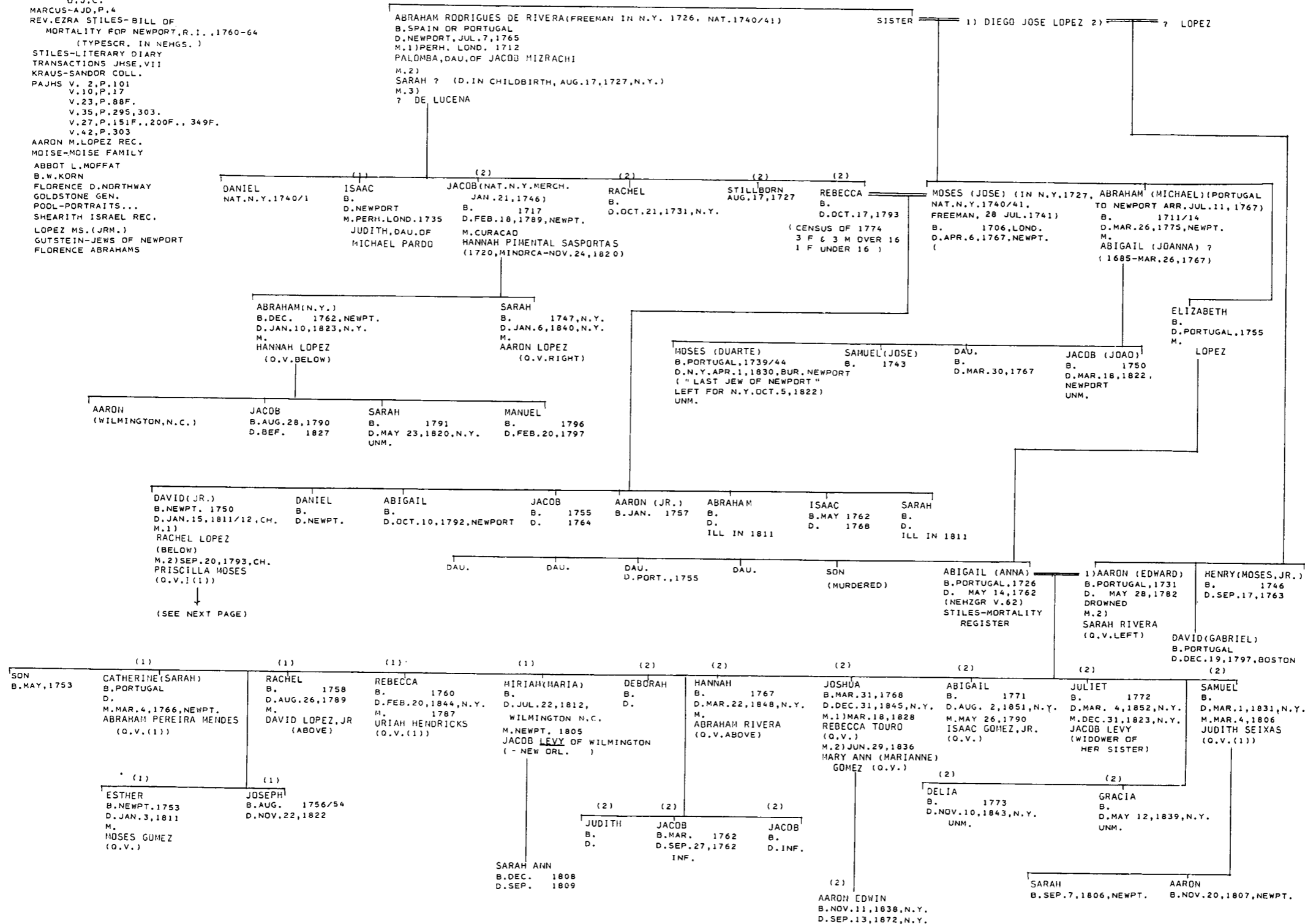

\*NAMES IN PARENTHESES ARE MARRAND NAMES, DROPPED ON ARRIVAL IN AMERICA

LOPEZ I (2) (S.C.)

CH. SEP. 20, 1793

DAVID LOPEZ B. MAR. 1750, NEWPT. D. JAN. 15, 1811/12, CH. (SEE PRECEDING PAGE)  
PRISCILLA MOSES (O.V. I (1))

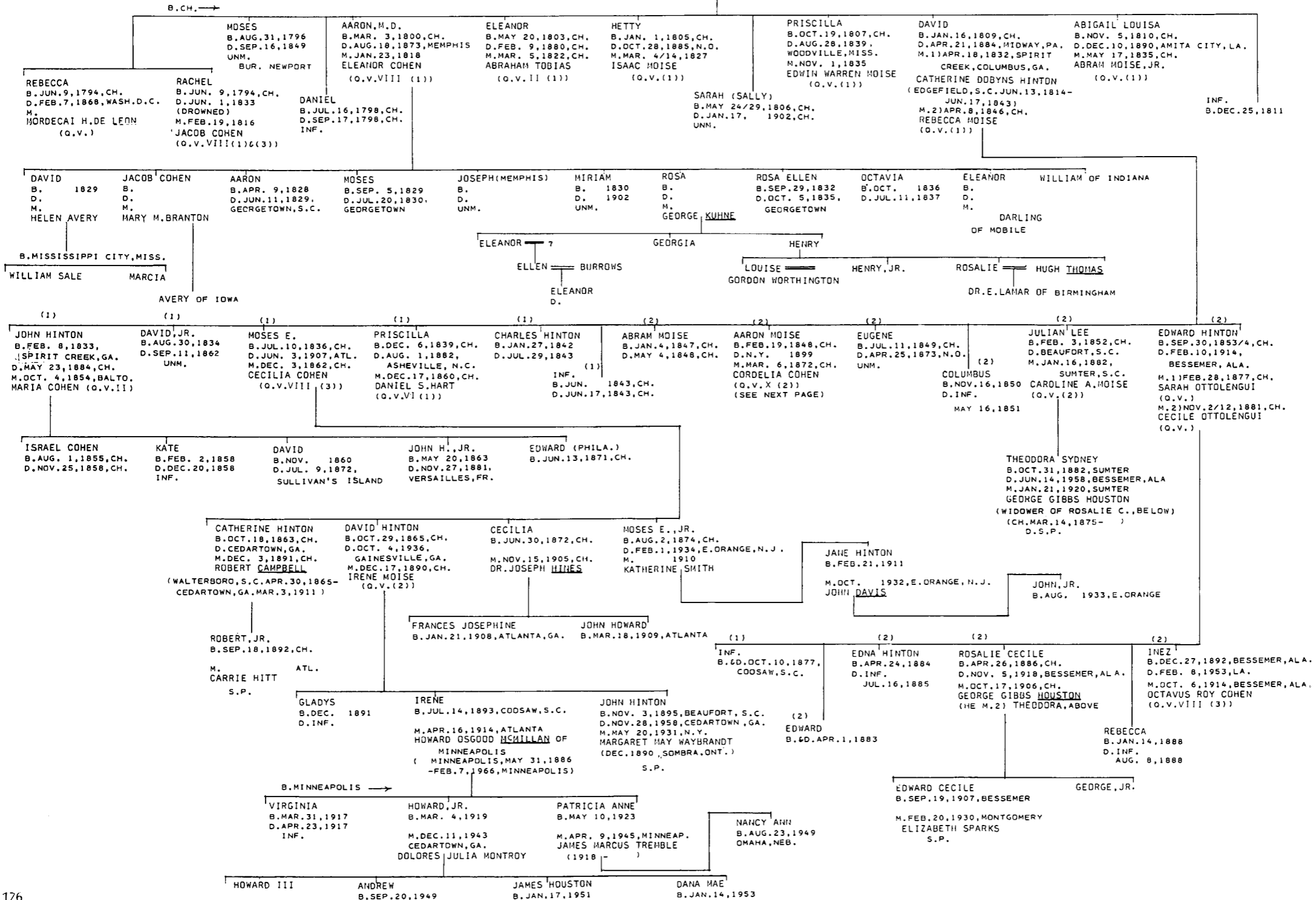

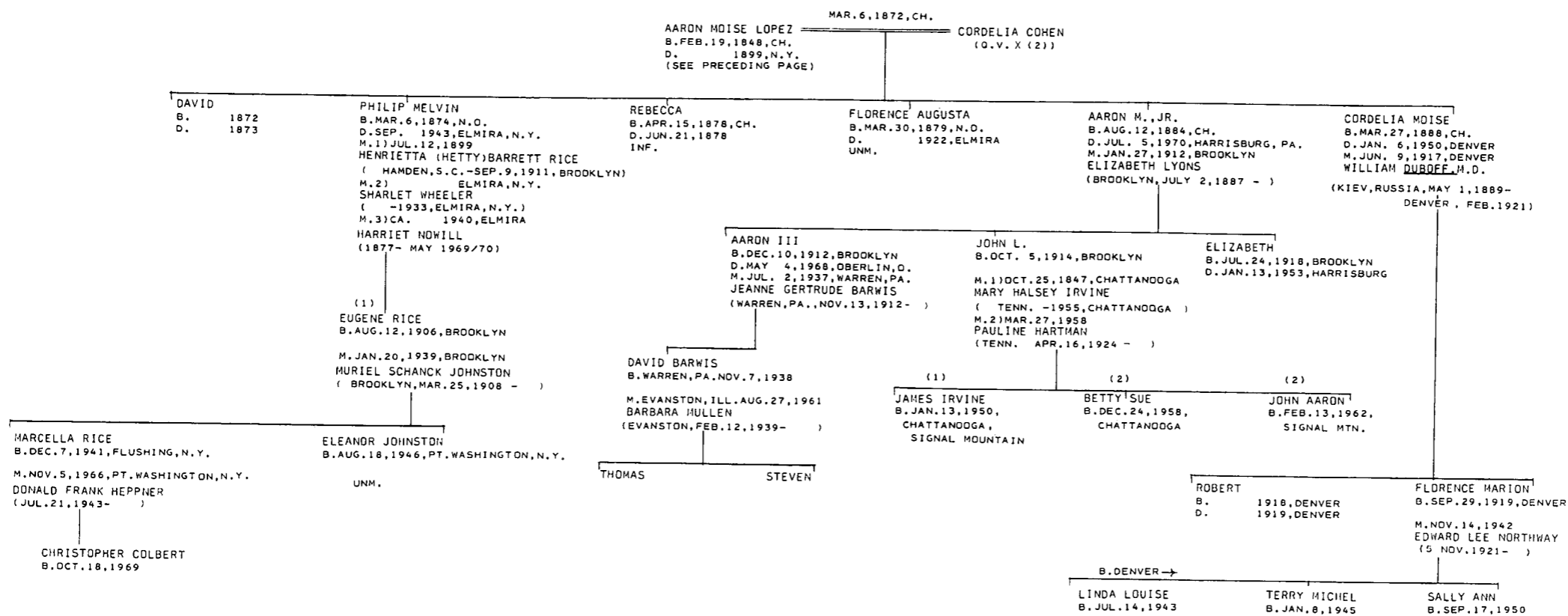



LOPEZ II (DA FONSECA)

CUR.VITAL REC.  
MAY VAZ LOPEZ  
SHEARITH ISRAEL REC.  
ANDRADE-JEWS OF JAMAICA  
EMMANUEL-PRECIOUS STONES, PP.153,206  
NETHERLANDS ANTILLES,P.890F.

DAVID NUNES DA FONSECA

OCT.21,1676,AMST.

HAHAM ELIAU LOPEZ  
B. 1648,MALAGA,SP.  
D.JUL.22,1713,CUR.  
(RABBI IN BARBADOS,1678-1695/6  
IN CUR. 1695/6-1713)

RACHEL  
B. SEVILLE,SP.  
D.MAY 20,1699,CUR.

HAHAM=RABBI  
HAZZAN=READER  
RIBI=TEACHER  
SHOMET=KOSHER BUTCHER  
DE=CHILD OF

ALL B.BARBADOS AND MOVED WITH PARENTS TO CUR.; ALL DESCENDANTS NOT NAMED ELIAU ADDED DA FONSECA TO LOPEZ

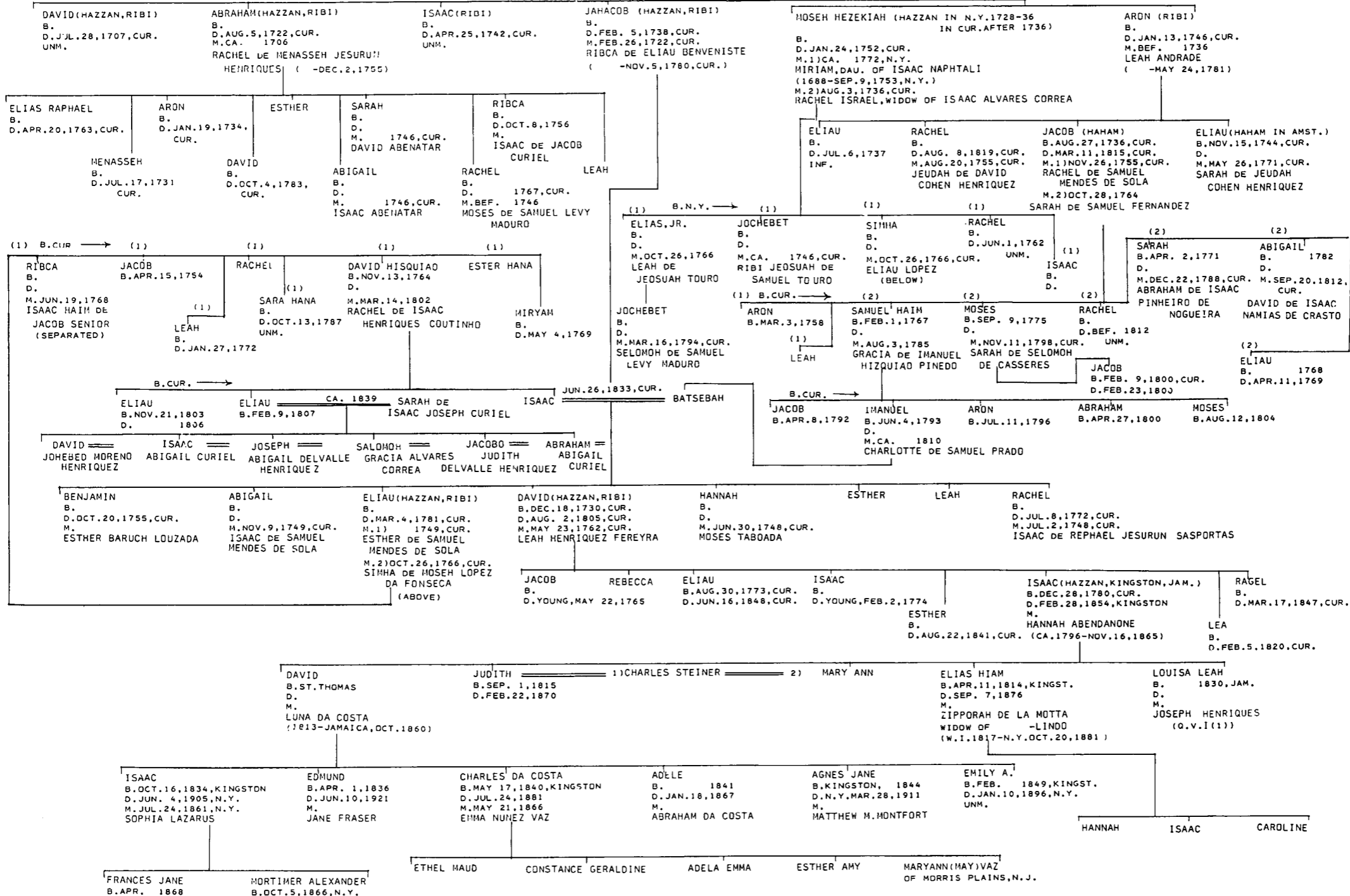

LOPEZ III (WEST INDIES)

ELZAS MS.  
SHEARITH ISRAEL REC.  
WILL OF JOSEPH LEVY  
ANDRADE-JEWS OF JAMAICA

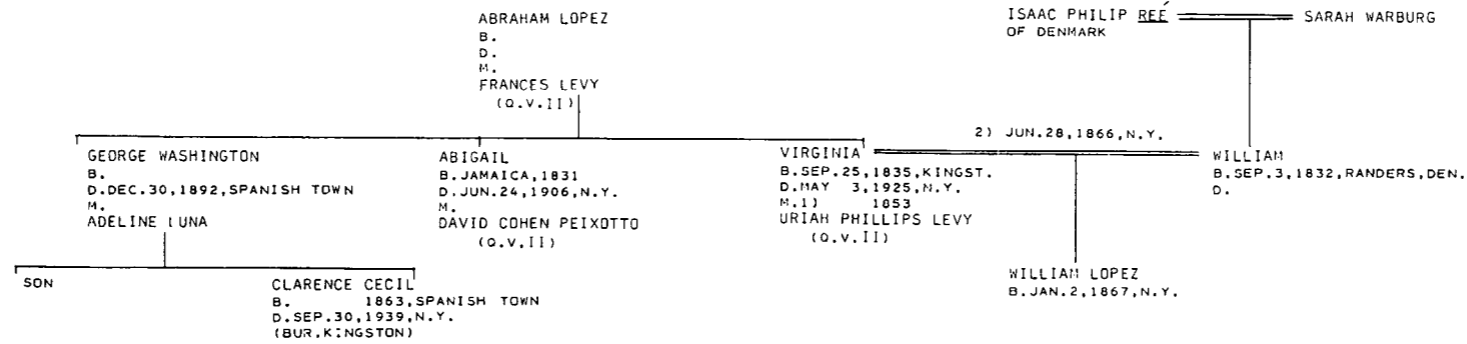

LORYEA

WILL OF ISAAC LORYEA  
ELZAS MSS.  
MN., P. 24  
OJC. P. 85  
MOISE-JEW. CEM. AT SUMTER

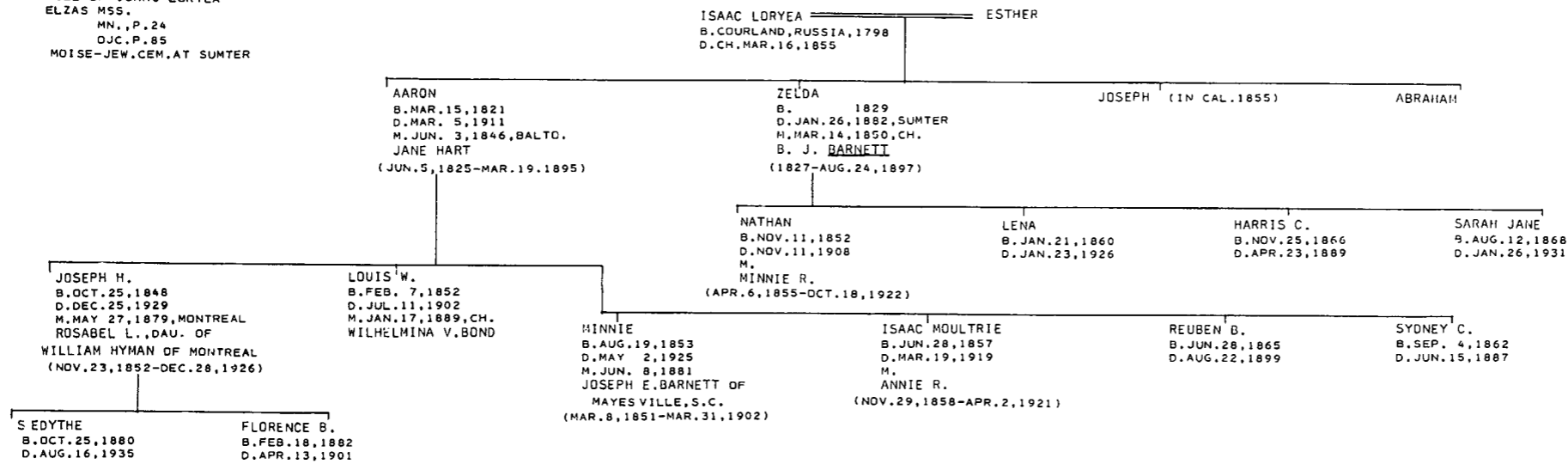

LOUZADA

SHEARITH ISRAEL ESCABOT  
AJHQ LV, P. 347N.  
KRAUS-SANDOR COLL.  
POOL-PORTRAITS ETCHED IN STONE  
DONALD A. SINCLAIR  
SHEARITH ISRAEL REC.

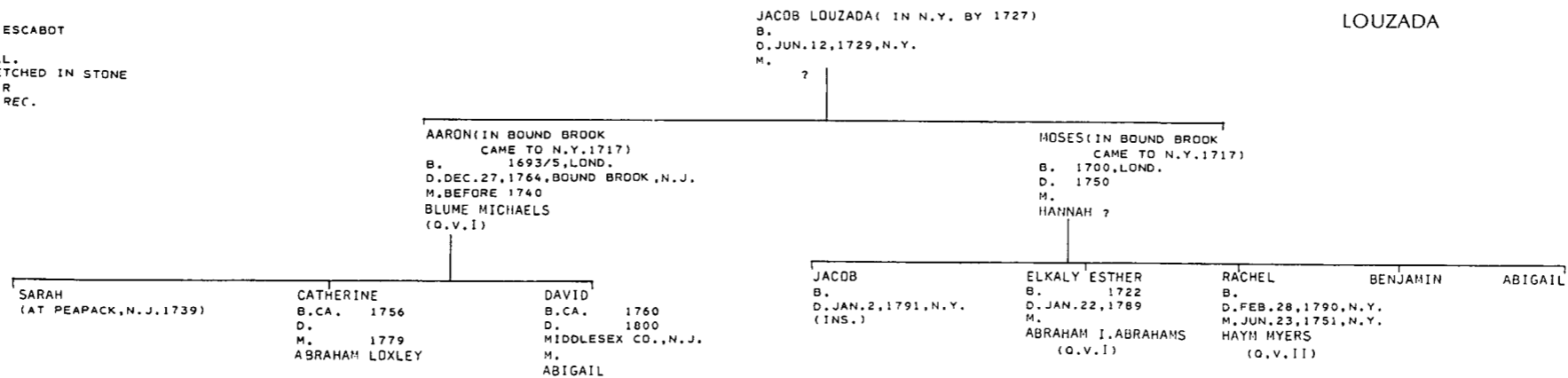

LURIA

J.R. COHEN REC.  
 BEVIS MARKS KETUBOT  
 MISC. JHSE. VI, P. 22  
 PAJMS V. 6, P. 109  
 KRAUS-SANDOR COLL.  
 EZEKIEL-LICHTENSTEIN-JEWS OF RICHM.  
 LYONS MSS. (JRM) P. 219F.  
 MORAIS-JEWS OF PHILA., P. 18  
 ELZAS MS.  
 WILL OF JACOB COHEN (JRM)  
 MICKVE ISRAEL REC.  
 SHEARITH ISRAEL REC.  
 GAINES KINCAID  
 EGON WOLFF

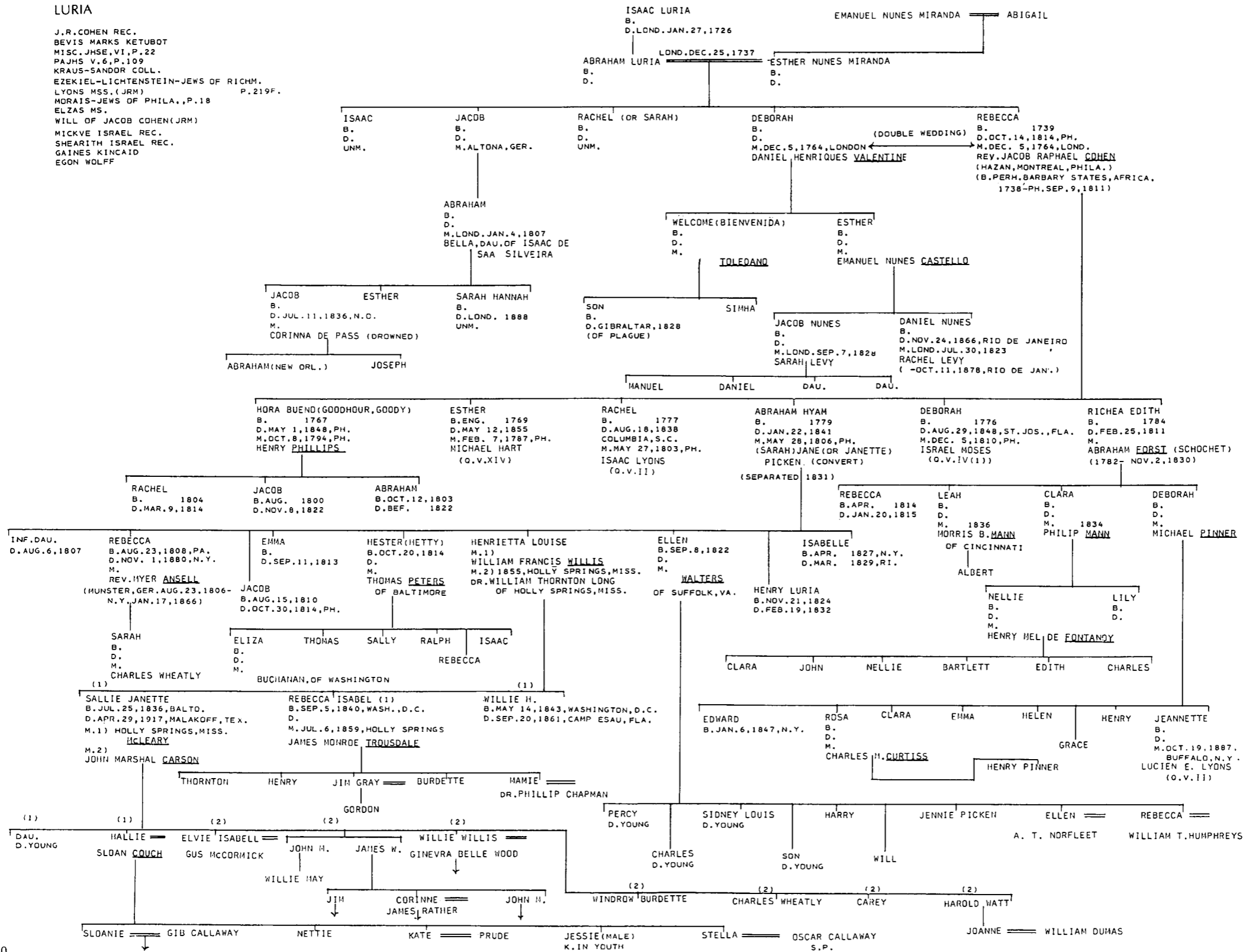

LYON I

EZEKIEL-LICHTENSTEIN-JEWS OF RICHM.  
VA, MARRIAGE ABSTRACTS  
ROSENWAIKE

JACOB (POZNANSKI) LYON  
B. 1777, POZNAK, POSEN, POL.  
D. NOV. 29, 1851  
M. 1)

M. 2)

M. 3)  
ELIZA WHITE  
(NORFOLK, JAN. 15, 1795-RICHMOND, DEC. 20, 1887)

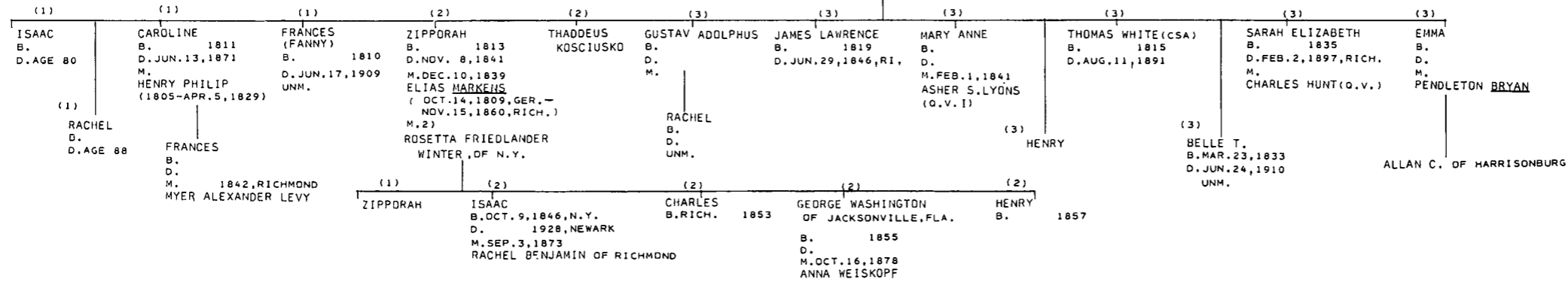

LYON II

KRAUS-SANDOR COLL.  
SHEARITH ISRAEL REC.  
FLORENCE ABRAHAMS  
UJE

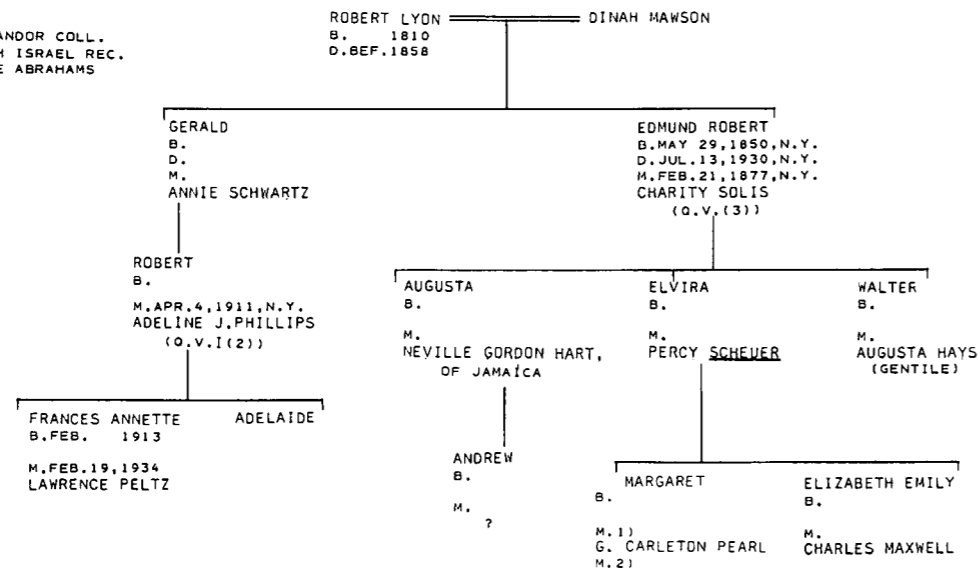

SHEARITH ISRAEL REC.

LYON III

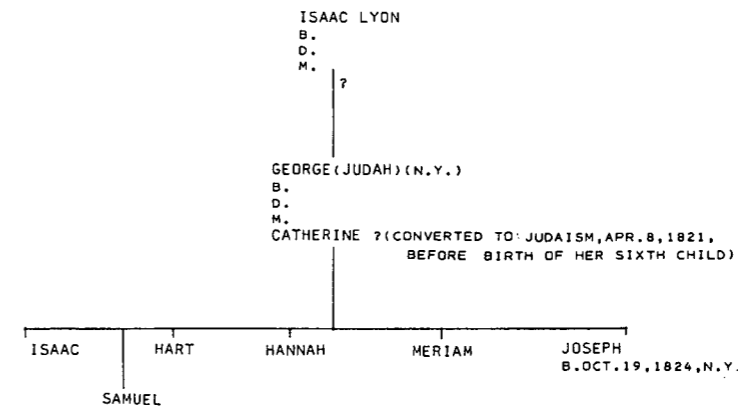

LYONS I (SURINAM, PH. & N.Y.)

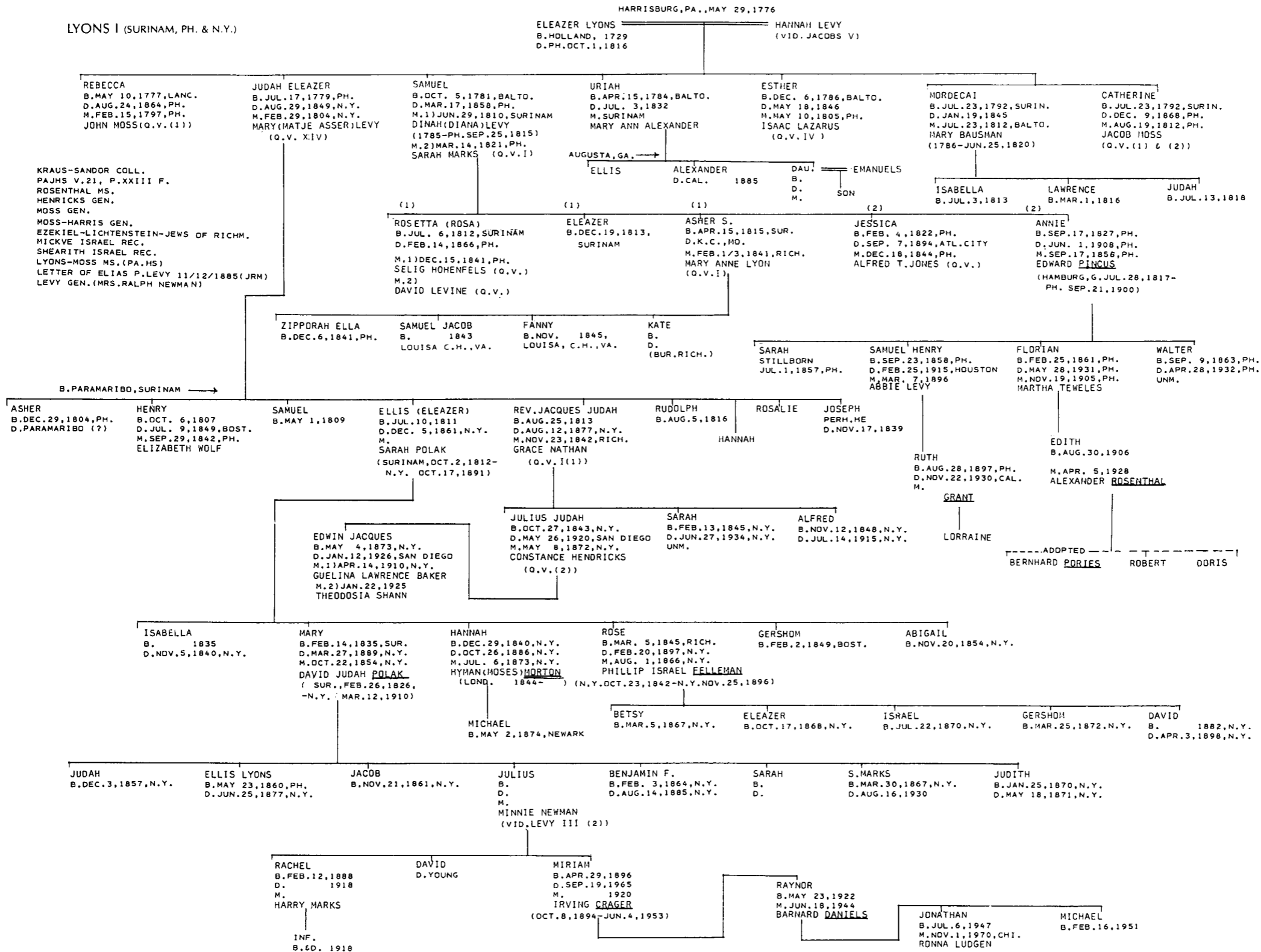

J.R. COHEN REC.  
 LYONS FAM. BIBLE (PHOTOSTAT T.J. TOBIAS)  
 JRM COLL.  
 KRAUS-SANDOR COLL.  
 ELZAS MS.  
 ELZAS O.J.C.  
 ELZAS JEW. CEMETERIES AT COLUMBIA, S.C.  
 LYONS MS. (JRM)  
 MICKVE ISRAEL REC.  
 GORDON GRAY

? LYONS = BILAH

LYONS II (S.C.)

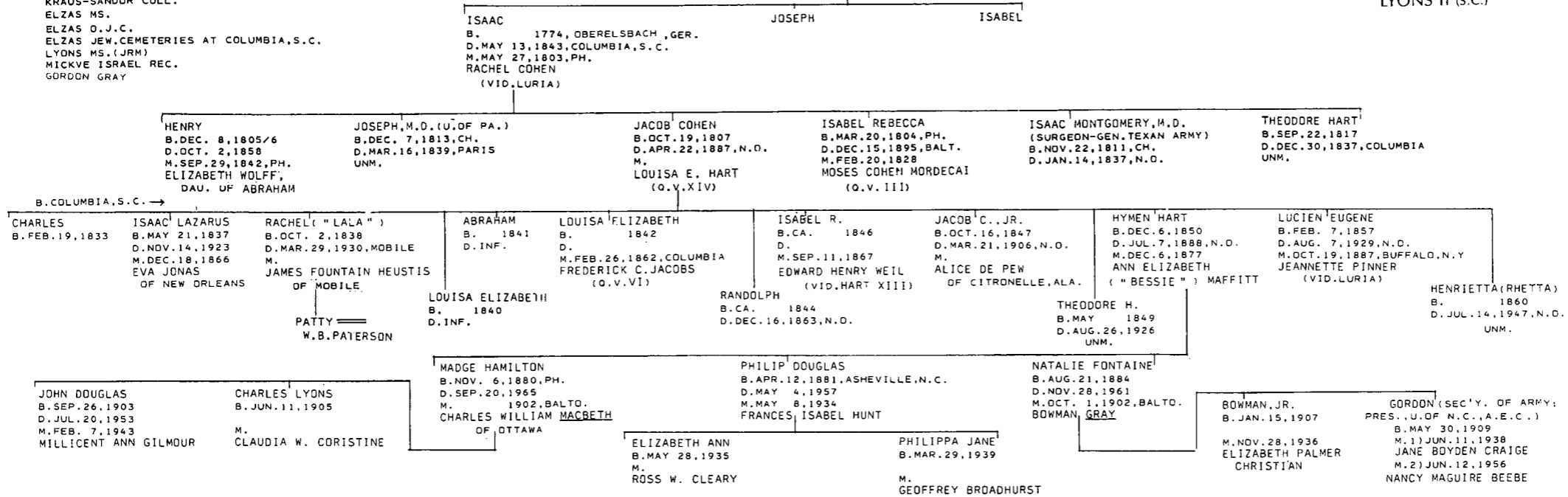

LYONS III (N.Y.)

FEDERAL ST. CEM.  
 KRAUS-SANDOR COLL.  
 MICKVE ISRAEL REC.  
 SHEARITH ISRAEL REC.

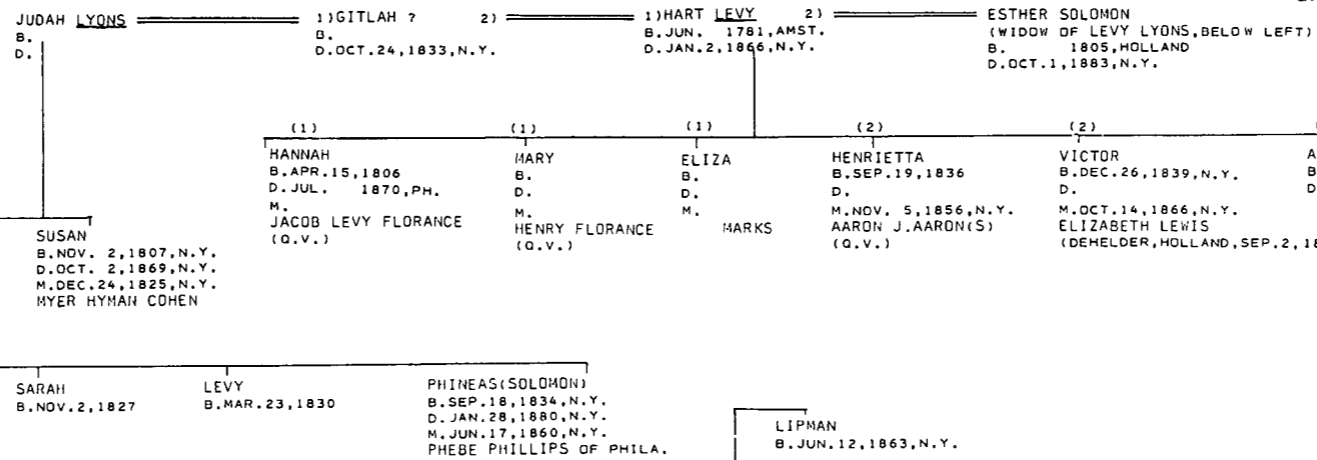

WILL OF SOLOMON LYONS (JRM)  
 J.R. COHEN REC.  
 M. I. CEM. REC.  
 PHILA. GAZETTE, APR. 26, 1824

SOLOMON LYON(S)  
 OF FRANKFORD, PA.  
 B.  
 D. 1812

APR. 11, 1802, PH.

REBECCA (SARAH) (CONVERT)  
 B.  
 D. DEC. 27, 1813, PH.

LYONS IV

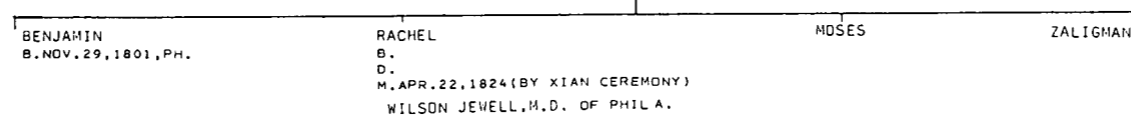

MAILERT

BLAU & BARON, P. 818FF.

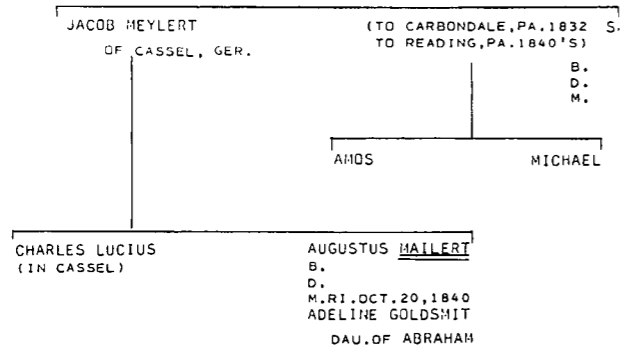

MAIRS

FLO. ADR.  
ELZAS JEWS OF S.C.  
M.N.  
MS.  
O.J.C.

(TO CH. CA. 1801) SIMON MAIRS  
B. BUDINGEN, 1765  
D. CH. DEC. 26, 1835/1831

ELIZABETH  
B. 1769  
D. FEB. 15, 1845

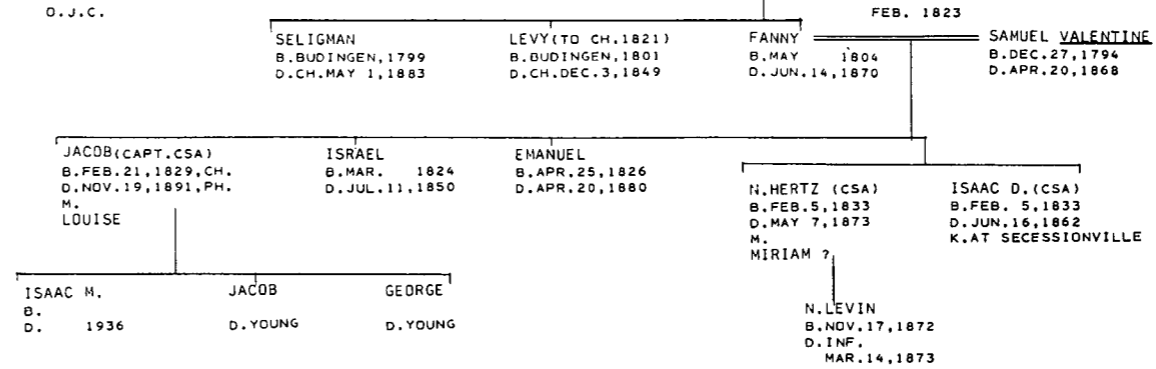

MARACHÉ

EMMANUEL, P. 539  
ENA, PP. 172, 939  
MAXWELL, WHITEMAN  
KRAUS-SANDOR COLL.  
ELZAS MS.  
MICKVE ISRAEL REC.  
SHEARITH ISRAEL REC.  
PAJHS, V. 21, PP. 58, 63  
ROSENBLUM-DICT. OF AMER.  
POULSSON'S JEW. BIOG.  
W.W., P. 175  
LONDON-MINIATURES, P. 13  
NEHGR V. 29, P. 113

JAHACOB MARACHÉ  
D. JUN. 30, 1735, CUR.

BEF. 1708 RAQUEL (D. JAN. 24, 1708, CUR.)  
BEF. 1736 ESTHER MACHORRD (TO N.Y. 1750/1, D. SEP. 28, 1769, CUR.)

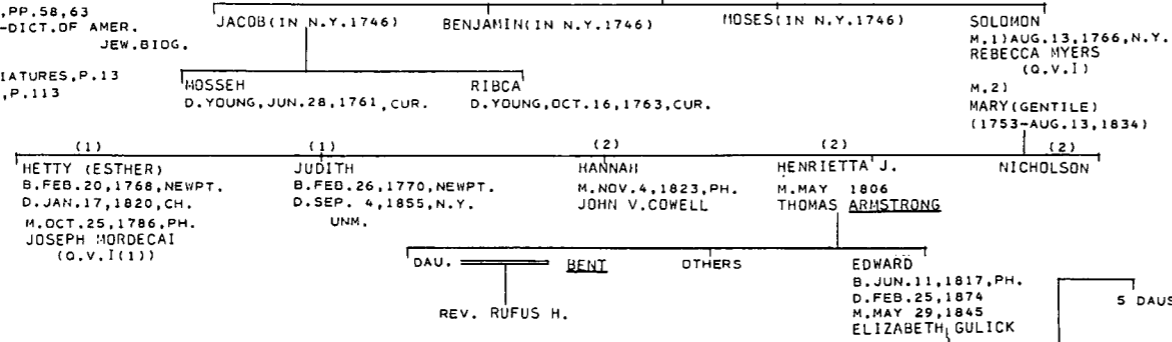

KRAUS-SANDOR COLL.  
SHEARITH ISRAEL REC.

MARCHANT

HENRY MARCHANT  
NANCY WILKERSON

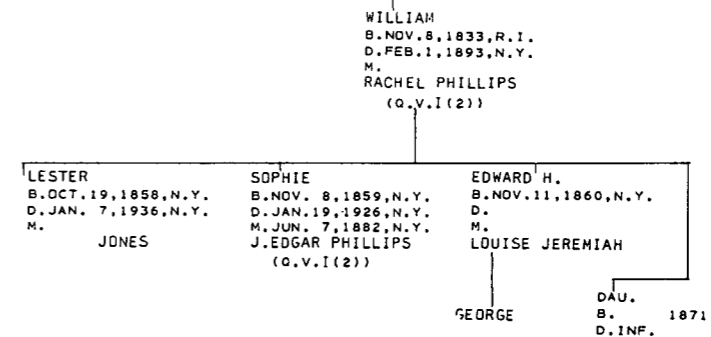

AMER. JEW. ARCHIVES, V. 1, NO. 2  
AJHS COLL.  
CUTLER, WM. RICH. ET AL. -  
GEN. & FAMILY HIST.  
N.Y.G. & BR. 38, P. 11  
CONN. HIST. SOC.

MORDECAI MARKS (TO AMERICA, 1726, BAPT. STRATFORD, CONN.)  
B. LOND. APR. 23, 1706  
D. JAN. 8, 1771  
M. 1) DEC. 1729  
ELIZABETH HAWKINS (DERBY, CONN.)  
M. 2)  
ELIZABETH YORIEU

MARKS II

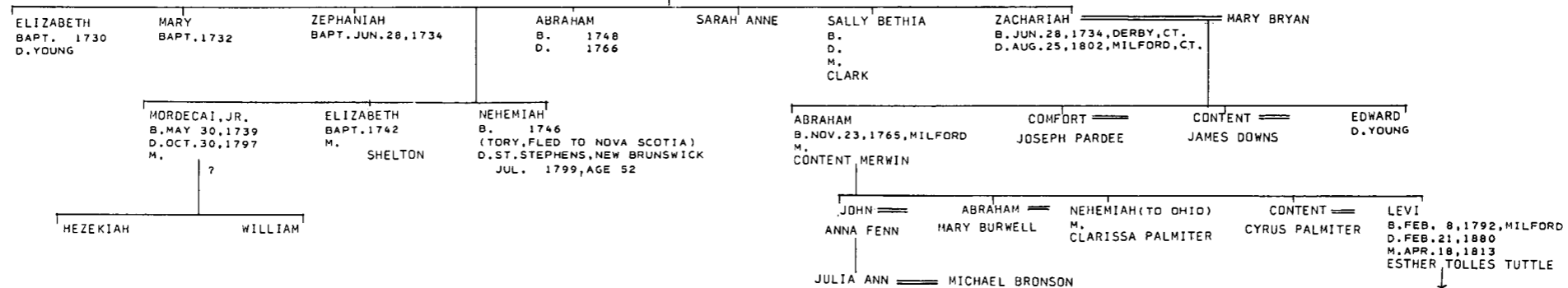

FLO.ABR.  
MISC.JHSE VII  
PHILA.PRESS 10/1/1912  
ESSAYS IN AJH,P.113F.  
TRACHTENBERG-JEWS OF EASTON  
ROSENWAIKE  
KRAUS-SANDOR COLL.  
PAJHS, V.8,P.127F.  
MORAIS-JEWS OF PHILA.,PP.241F.,331F.  
ROSENTHAL MS.  
AJA COLL.  
ALLEN GEN.  
ELZAS MS.  
FLORENCE ABRAHAMS  
BARNET JACOBS MOHEL REC.

FAMILY HISTORY OF BENJ.MORDECAI  
WILL OF HENRY MARKS  
WILL OF I.H.JUDAH  
MICKVE ISRAEL REC.  
SHEARITH ISRAEL REC.

MARKS I (PH. & RICHMOND)

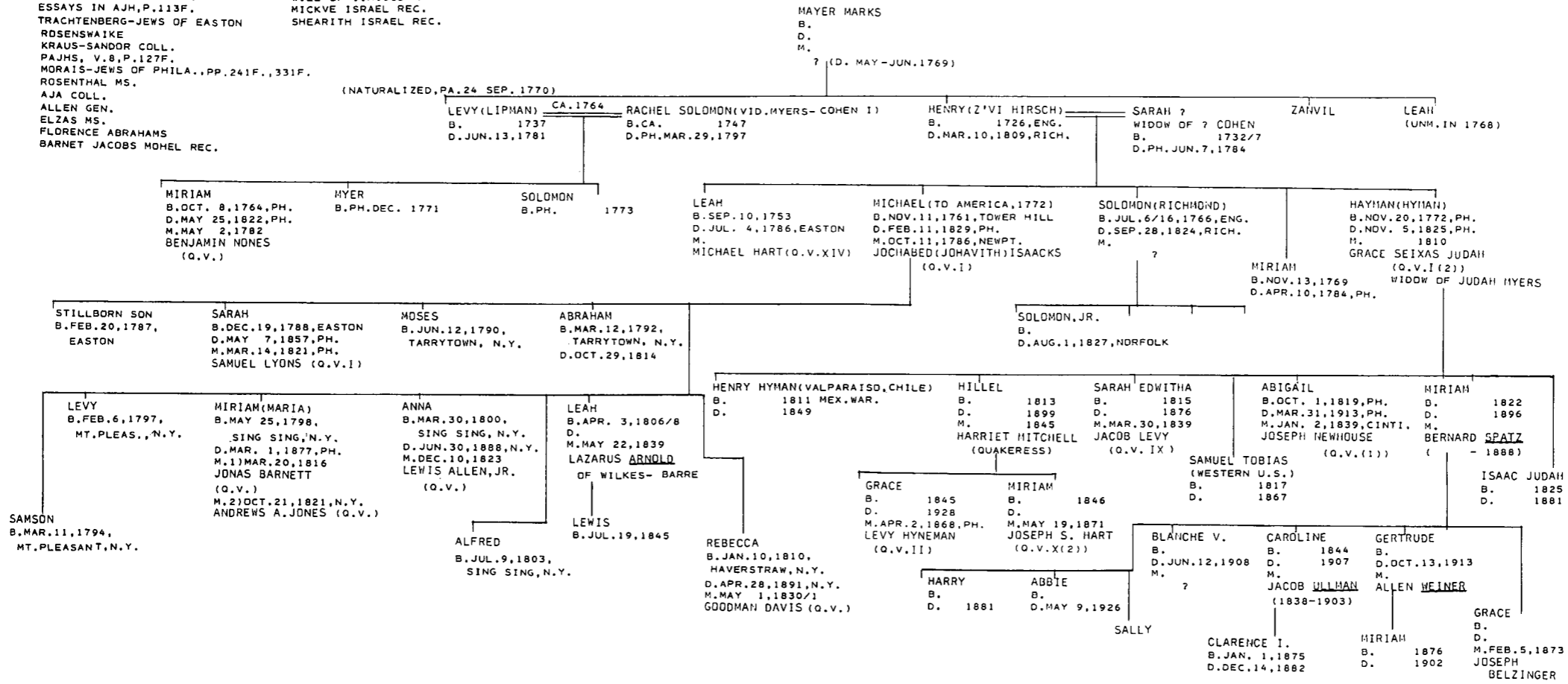

S.A.R. REC.  
ELZAS MS.  
O.A.R. REC.  
WILL OF SAMPSON SIMONS  
P.N.Y.H.S.  
ROSENWAIKE  
FLO.ABR.

MARKS IV

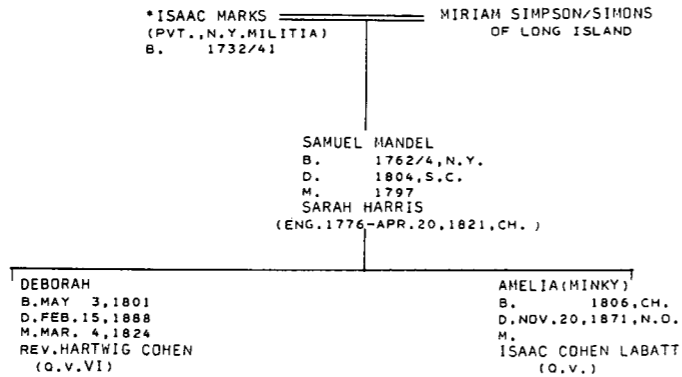

\*ESTABLISHED REVOLUTIONARY ANCESTOR ; INCORRECTLY CALLED SON OF JACOB RODRIGUES (RIGHT)

KORN-BARBADOS WILLS  
KRAUS-SANDOR COLL.  
PAJHS,V.6,P.10  
V.18,P.120  
V.23,P.148  
POOL-PORTRAITS...  
WILL OF JACOB R. MARQUES  
(TJHSE,V.13,P.86)  
SHILSTONE  
JOSHUA M.L.MADURO

MARQUES

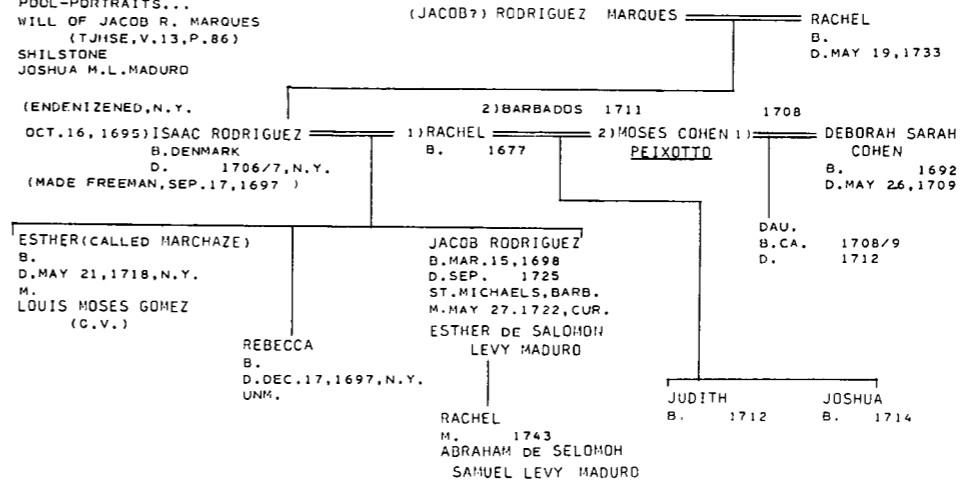



MARKS III (NEW ORLEANS)

KRAUS-SANDOR COLL.  
PAJHS, V.27,P.78,310  
ELZAS MS.  
O.J.C.  
MN.  
JEW.CEMETERIES AT COLUMBIA,S.C.  
MURIEL S. CARTER  
FAM.HISTORY OF BENJAMIN MORDECAI  
WHO'S WHO IN WORLD JEWRY, 1955  
ARTHUR E. MARSH  
J.DREYFOUS GEN.

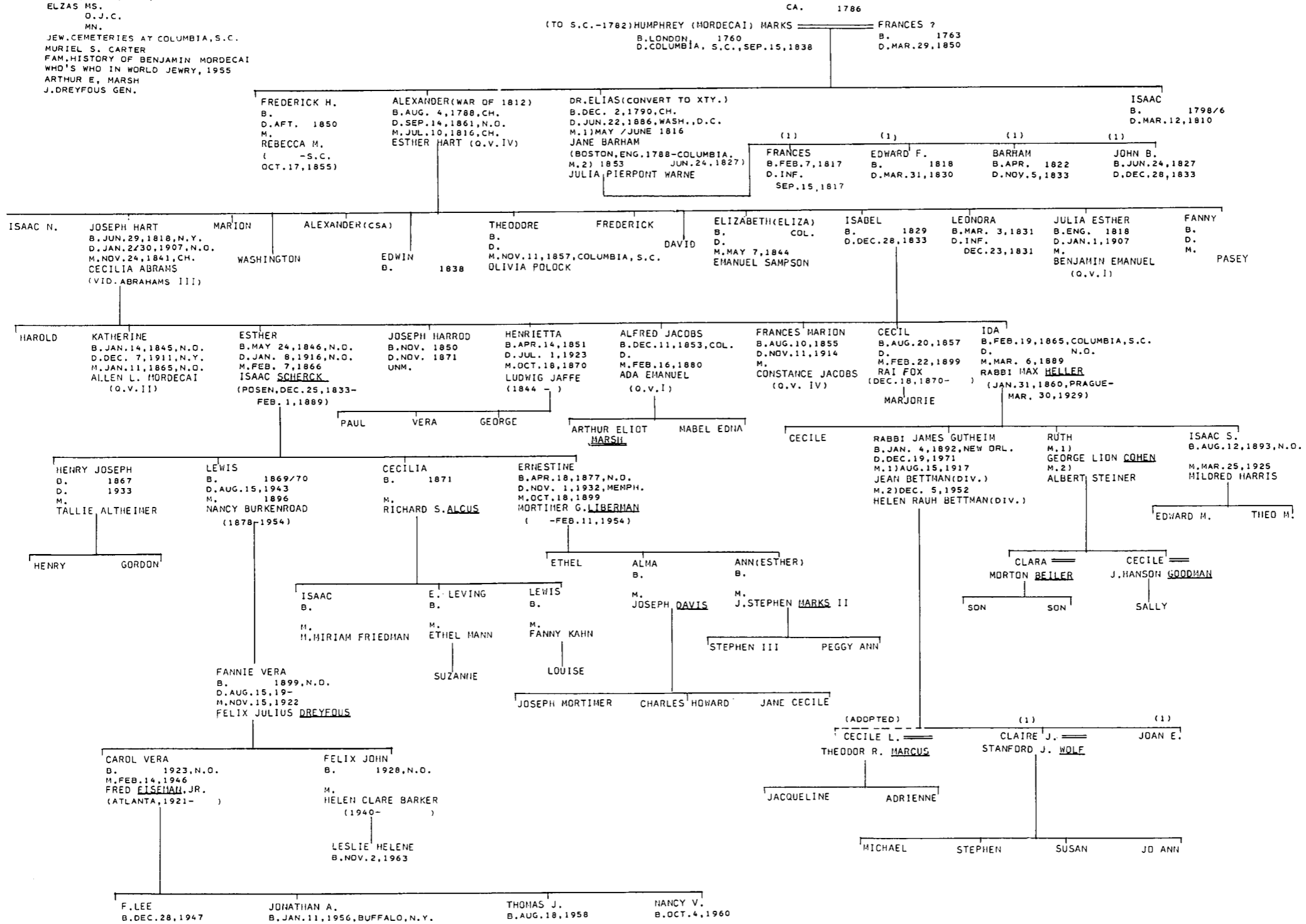

FRIEDMAN-ANCESTRY OF LEE M. FRIEDMAN  
PAJHS XLVII, 211F.

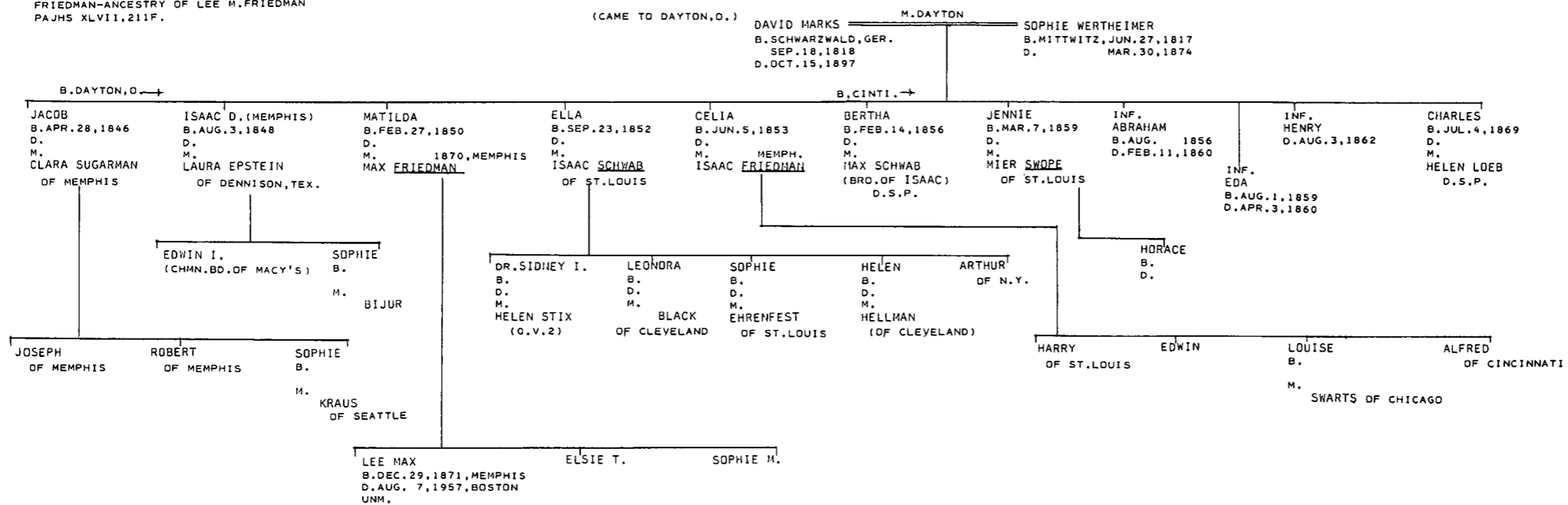

MARX I

AJHQ, L111, P. 291  
 POULSON'S  
 N.Y. WEEKLY MUSEUM  
 BARBER - N.Y. MARR.  
 LONDON-MINIATURES  
 MOSES MYERS MSS.  
 MORAIS-JEWS OF PH., P. 432  
 EZEKIEL-LICHTENSTEIN  
 MISC. TJHSE, IV  
 NORFOLK VA. PILOT 1/6/58  
 WILL OF EMMA MARX  
 JOSEPH MARX  
 SAMUEL MARX  
 WILHELMINA MARX  
 MIKVEH ISRAEL REC.  
 N.Y. DEATHS  
 J.B. MORDECAI

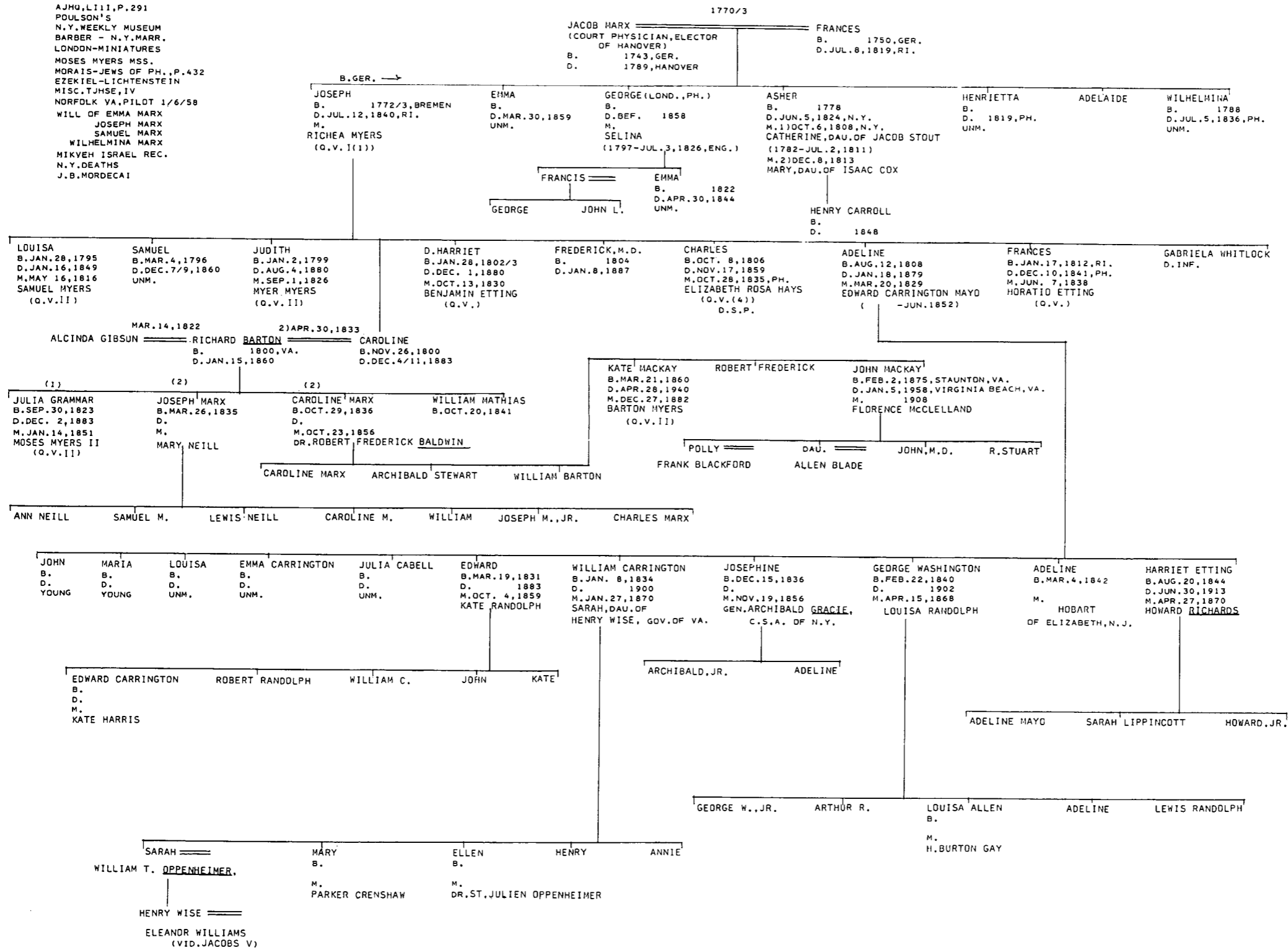

JULIEN SAKS

MARX II-JOEL

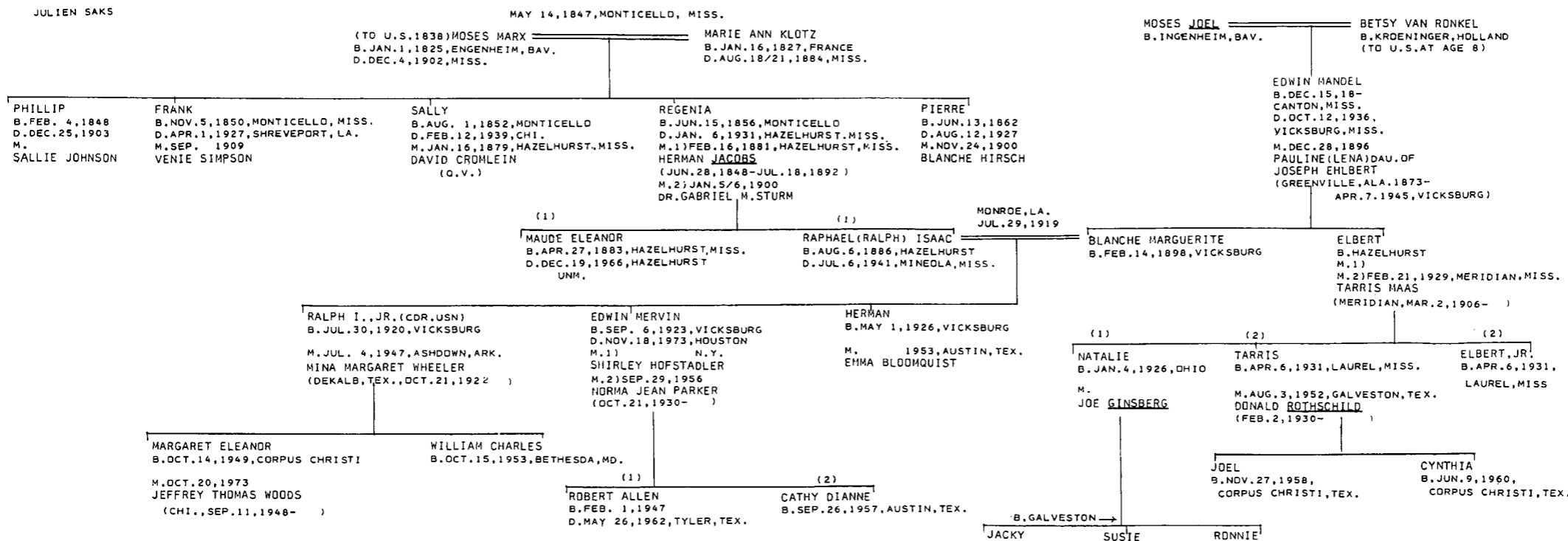

MAYER II-FRANK

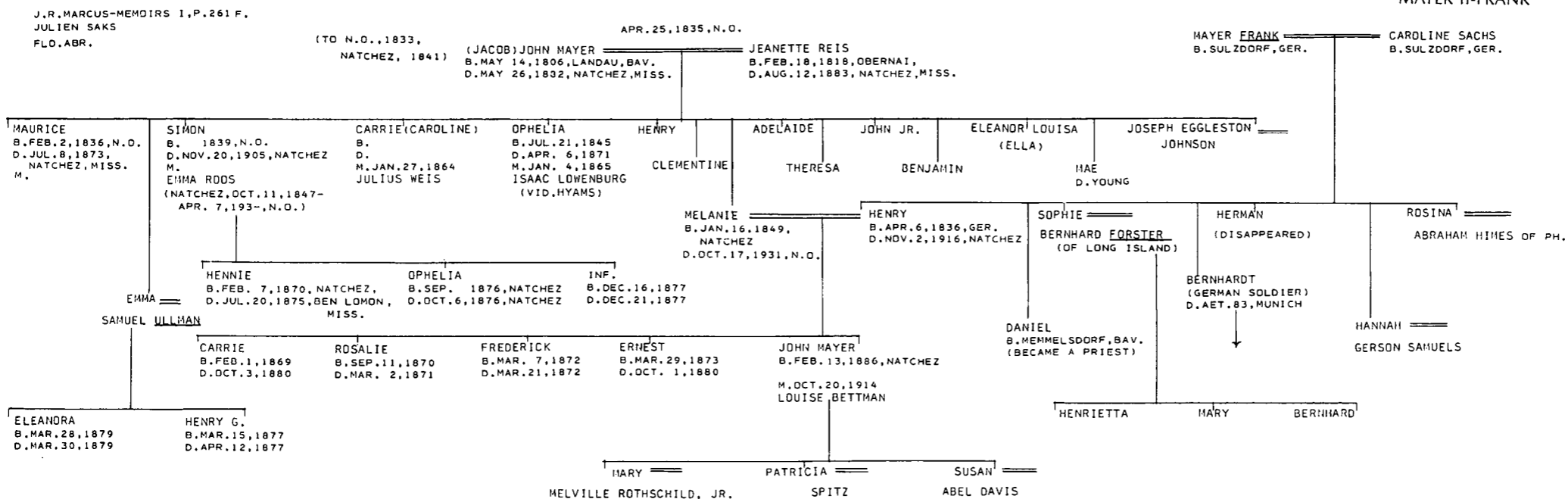

MAYER I

AJHQ, LIX, P.368  
 MAKOVSKY-THE PHILIPSONS  
 ROSA MAYER GRANT  
 ANCKER HS.  
 KRAUS-SANDOR COLL.  
 ST. CHARLES, P.134F.  
 MORAIS-JEWS OF PH., P.536  
 ELIZ. PLAUT

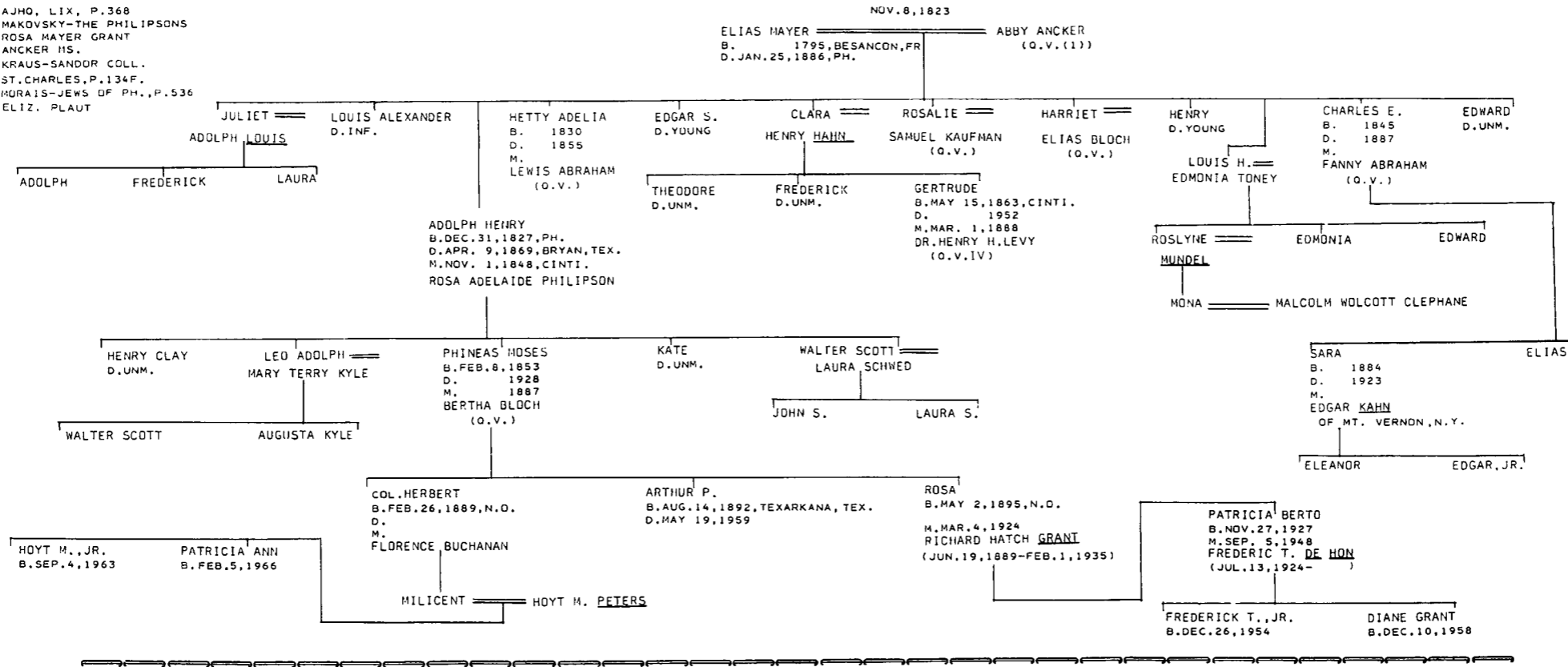

MEARS

PAJHS V.11, P.155  
 V.27, P.372  
 V.33, P.199F.  
 AM. JEW. ARCHIVES, V.1, NO.2, P.15F.  
 MOSES GEN.  
 KRAUS COLL.  
 V.L. GUITERMAN NOTES (KRAUS)  
 ADMINISTRATION ACT BOOK, SOMERSET HOUSE, 1711  
 ROTH- "THE GREAT SYNAGOGUE" P.26F.  
 MYERS-HAYS-MORDECAI MSS. (VA. HIST. SOC.)  
 H.A. ALEXANDER-ALEXANDER FAMILY  
 E.N.A., P.1055  
 MISC. JHSE, VII

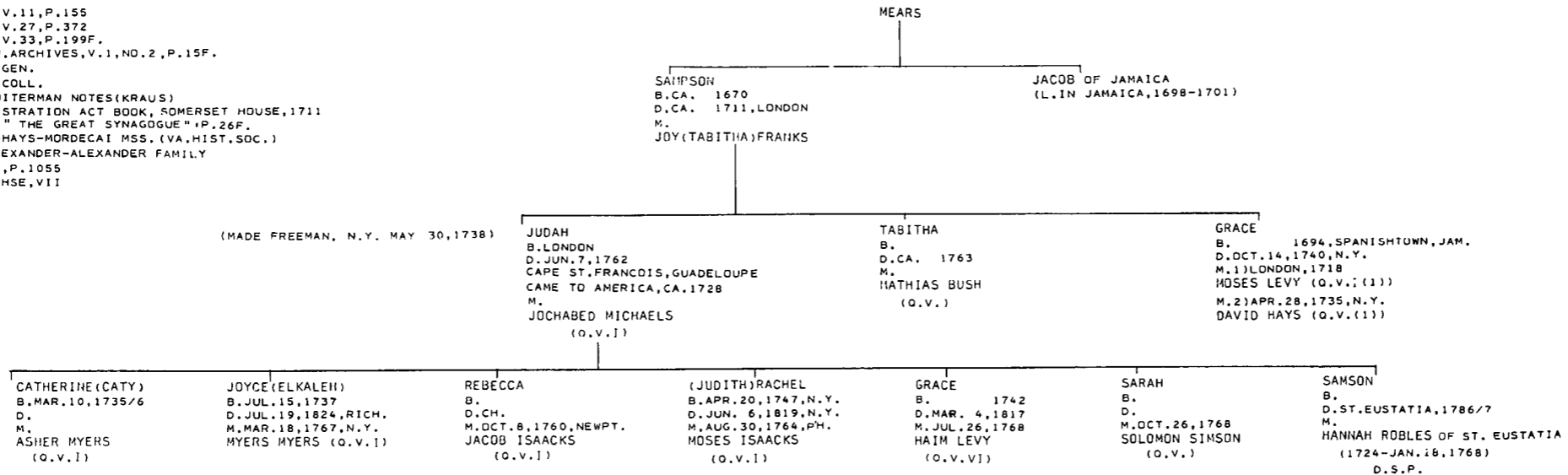

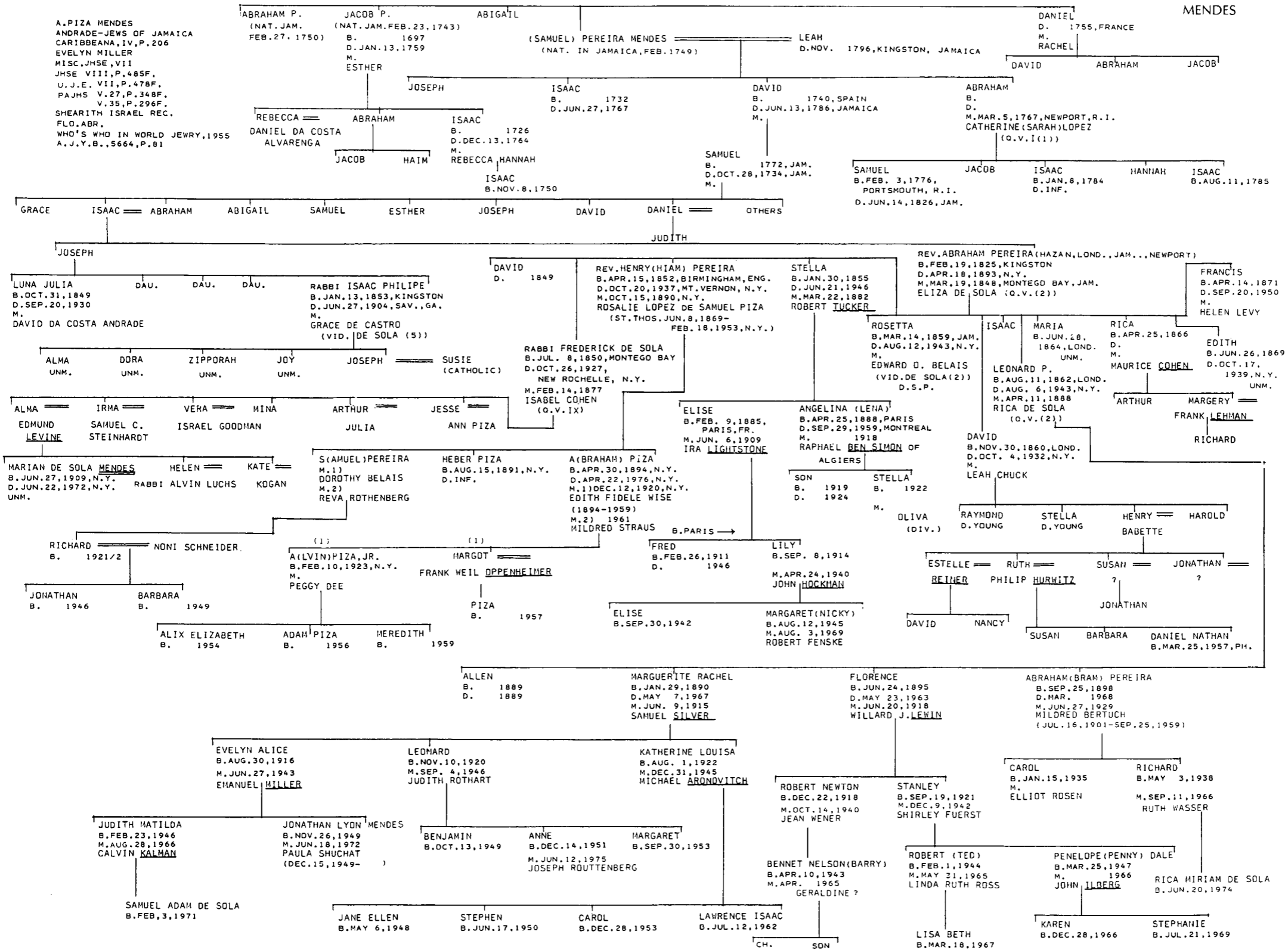

MENKEN-MORANGE

B'NAI JESHURN REC.  
 KRAUS-SANDOR COLL.  
 MICKVE ISRAEL REC.  
 SPRUCE ST. CEM. REC., PH.  
 SHEARITH ISRAEL REC.  
 JON STEDMAN  
 LESSER-WEAVE A WREATH OF LAUREL  
 MRS. JOSEPH LYON ANDREWS

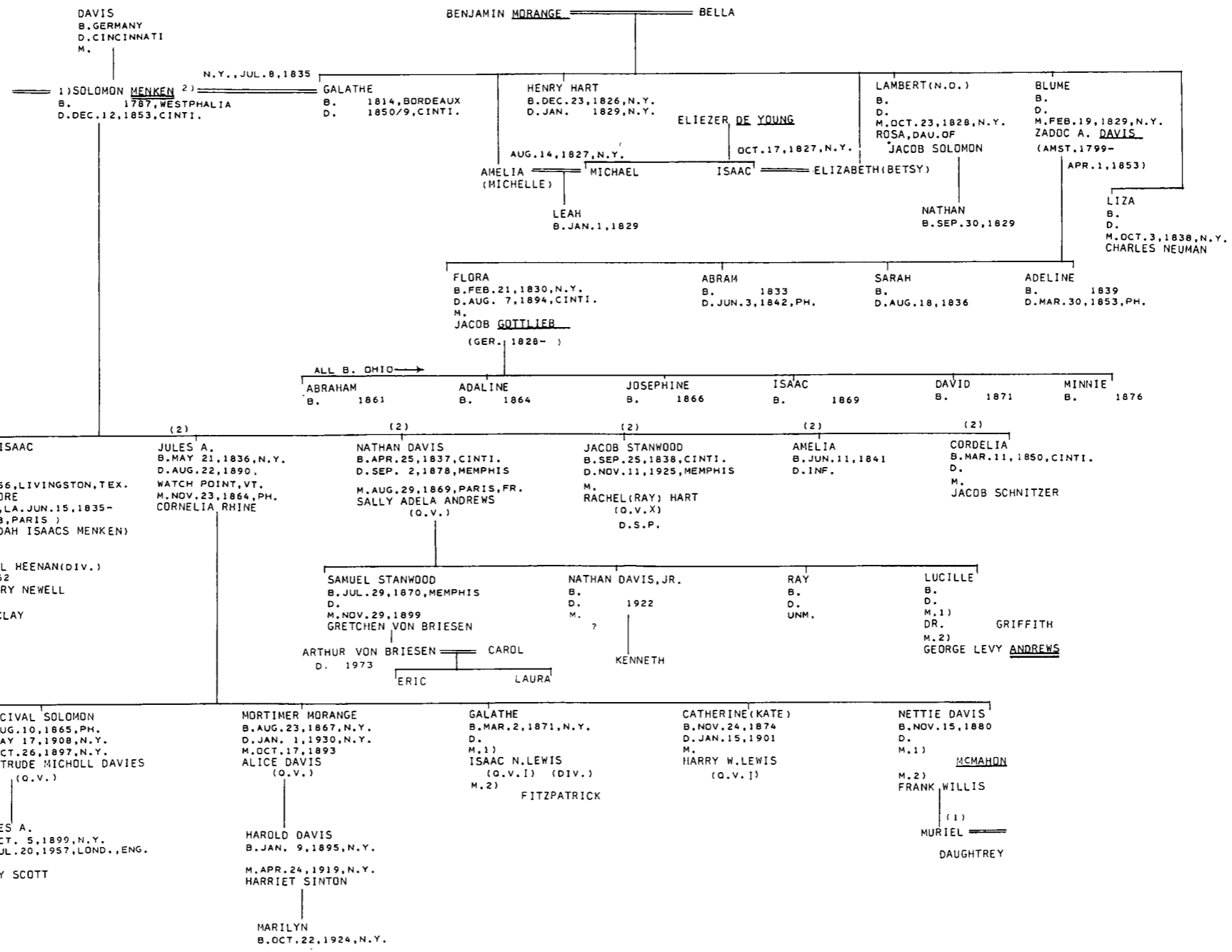

MICHAELS I

PAJHS, V. 23, P. 151  
 V. 33, P. 199F.  
 KRAUS-SANDOR COLL.  
 THE SAINT CHARLES, P. 115F.  
 POOL-PORTRAITS  
 H.A. ALEXANDER-THE ALEXANDER FAMILY  
 EMMANUEL-PRECIOUS STONES, P. 260FF.  
 MERSHKOWITZ-WILLS, P. 59FF., 66

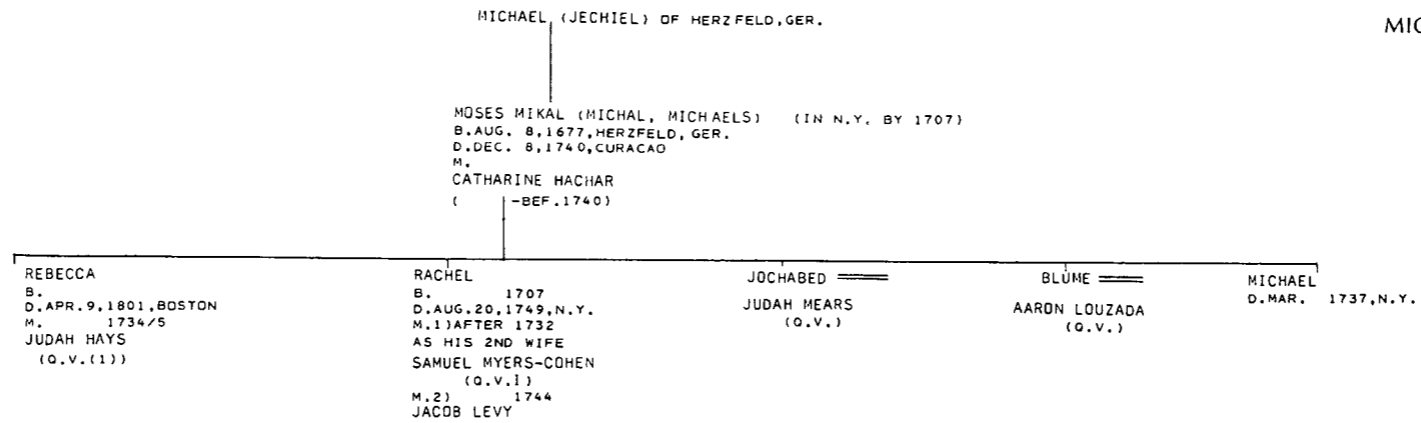

MICHAELS II

HART MS. (AJA)  
 FLORENCE ABRAHAMS  
 MRS. E. MILLER

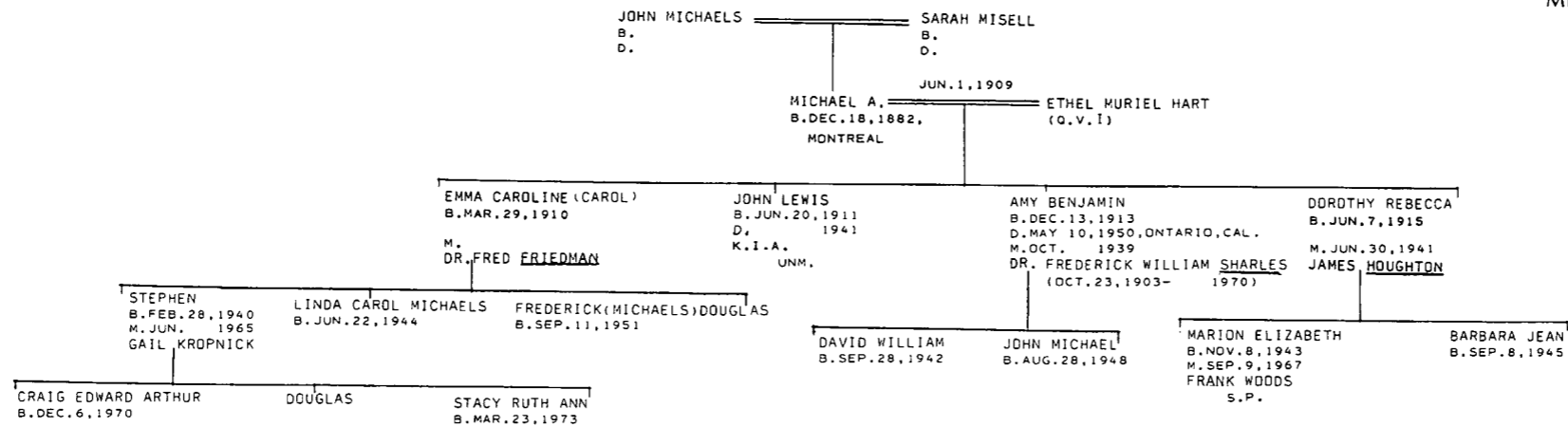

MITCHELL

J.E., V. 8, P. 59  
 MORAIJ-JEWS OF PHILA., PP. 50, 337F.  
 ALLEN GEN.  
 SHEARITH ISRAEL REC.  
 MICKVE ISRAEL REC.  
 FEDERAL ST. CEM.  
 FLO. ABR.  
 B'NAI JESHURUN REC.  
 RODEPH SHALOM REC.

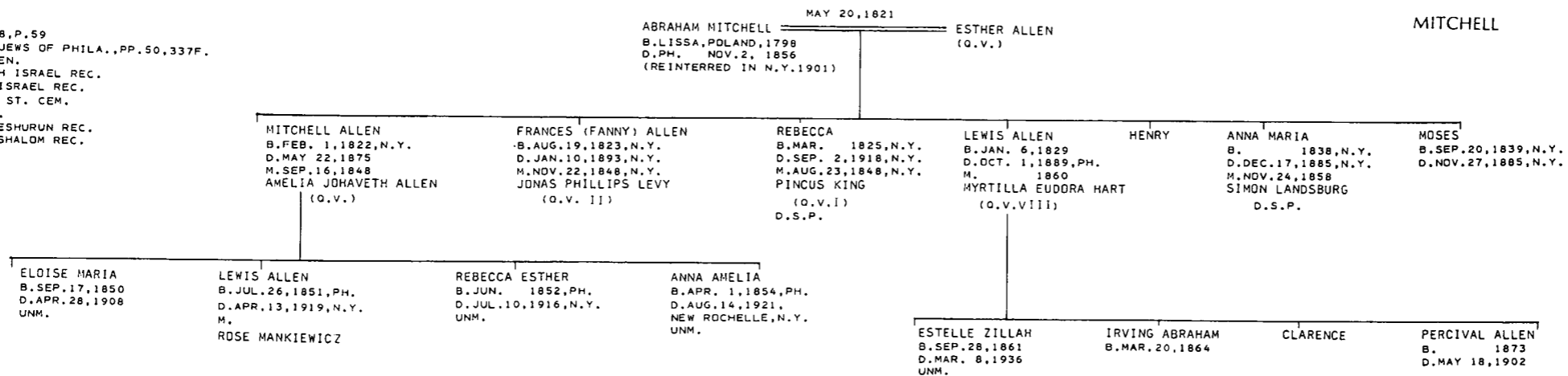



MINIS

ABBOT L. MOFFAT  
GA. NEWSPAPERS  
MINIS MSS. (AJA)  
POULSSON'S  
SH.  
J.E. V. 8, P. 597  
U.J.E. V. 7, P. 568  
PAJHS V. 10, P. 80F.  
KRAUS-SANDOR COLL.  
TOBIAS GEN.

ELZAS MS.  
ELZAS M.N.  
SAVANNAH JEW. BURYING GROUND  
CHATHAM CO. (GA.) MARRIAGE REC.  
CHATHAM CO. (GA.) WILLS  
BIOG. SOUVENIR OF FLA. 6GA., P. 587  
WILL OF ABRAHAM MINIS (JRM) (1754)  
MARCUS-EARLY AMERICAN JEWRY  
FLORENCE ABRAHAMS  
NAT'L GEN. SOC. QUARTERLY

? MINIS

SIMON (TO SAV. JUL. 11, 1733)  
B.  
D.  
UNM.

ABRAHAM  
B. 1691/6, ENG.  
D. JAN. 13, 1757, SAV.

ABIGAIL  
B. 1698/1701  
D. OCT. 11, 1794, SAV.

LEAH  
B. CA. 1726, ENG.  
D. MAY 26, 1802, SAV.  
UNM.

SAMUEL  
B. OCT. 14, 1740  
D. YOUNG

ESTHER  
B. CA. 1731, ENG.  
D. JUL. 4, 1793, SAV.

MINIS  
B. AUG. 17, 1736  
D. NOV. 5, 1771,  
BEAUFORT, S.C.

JOSEPH  
B. SEP. 14, 1738  
D. SEP. 24, 1757

JUDITH  
B. JUN. 24, 1742, SAV.  
D. JAN. 30, 1826, SAV.  
"OLDEST NATIVE OF GA."

HANNAH (ANNA)  
B. JUN. 13, 1744  
D.  
M. APR. 17, 1798, SAV.  
DAVID LEION  
(HAMBURG, GER.)  
(DIV. AUG. 22, 1799)

SARAH (SALLY)  
B. AUG. 7, 1748  
D. OCT. 23, 1810, SAV.

PHILIP (URI) ( "FIRST WHITE  
CHILD CONCEIVED AND BORN IN GA. ")  
B. JUL. 11, 1734, SAV.  
D. MAR. 6, 1789, SAV.  
M. JUL. 20, 1774, NEWPORT  
JUDITH POLOCK (O.V. I)

ABIGAIL  
B. APR. 8, 1775, SAV.  
D. FEB. 25, 1835, GEORGETOWN, S.C.  
UNM.

FRANCES (FANNY)  
B. MAY 17, 1776, SAV.  
D. SEP. 22, 1827, AT SEA  
M. FEB. 12, 1794  
LEVY MYERS (O.V. III)

ABRAHAM  
B. FEB. 23, 1788, SAV.  
D. AUG. 29, 1801, NEWPORT  
UNM.

ISAAC (WAR OF 1812)  
B. JUL. 30, 1780, CH.  
D. NOV. 15, 1856, PH.  
M. DEC. 14, 1803  
GEORGETOWN  
DIVINA COHEN (O.V. VIII (1))

DAU.  
B. JUL. 18, 1782, SAV.  
D. JUL. 30, 1782, SAV.

ESTHER (HETTY)  
B. NOV. 21, 1784/2, SAVANNAH  
D. DEC. 2, 1864  
UNM.

PHILLIPA (POSTHUMOUS)  
B. MAY 30, 1789, SAVANNAH  
D. AUG. 23, 1865  
UNM.

PHILIP, M.D.  
B. JAN. 28, 1805, SAV.  
D. NOV. 28, 1855, BALTO.  
M.  
SARAH A. LIVINGSTON,  
OF N.Y.  
(1807-1892)

HENRIETTA  
B. FEB. 24, 1807, SAV.

SARA ANN  
B. JUL. 5, 1811  
D.  
M. MAY 7, 1834, SAV.  
ISAAC HAYS  
(O.V. (4))

PHILIPPA  
B. FEB. 26, 1818  
D. FEB. 5, 1881  
M. FEB. 24, 1841  
EDWARD J. ETTING  
(O.V.)

ABRAM  
B. NOV. 4, 1820  
D. NOV. 6, 1889, N.Y.  
M. OCT. 22, 1851, PH.  
LAVINIA FLORANCE  
(O.V.)

FRANCES (FANNY)  
B. FEB. 11, 1822  
D.  
UNM.

THEODORE  
B. AUG. 8, 1826, SAV.  
D. FEB. 15, 1850, SAV.  
M. JAN. 12, 1848, CH.  
EMILY TOBIAS  
(O.V. II (1))

MARIA  
B. FEB. 23, 1829  
D. AUG. 17, 1853  
UNM.

REBECCA GRATZ  
B. JUN. 30, 1830  
D.  
UNM.

CECILIA  
B. NOV. 30, 1832  
D.  
UNM.

ELEANOR

ELIZA  
B. MAR. 22, 1809

EMILY  
B. DEC. 27, 1815

THEODORA

SALLIE

ALICE  
B.  
D.  
M.  
NELSON POE

PHILIP HENRY  
B.  
D.  
M.  
ROBERTA CLARK

ISAAC LIVINGSTON  
B.  
D.  
UNM.

ANNIE  
B.  
D.  
M.  
MOLE OF BALTO.

LEILA LIVINGSTON  
B.  
D.  
M.  
SAMUEL EUGENE  
POULTNEY OF BALTO.

CHARLES SPALDING  
B.  
D.

AUGUSTA MEDORA  
B.  
D.

JACOB FLORANCE  
B. NOV. 12, 1852, PH.  
D.  
M. 1)  
LOUISA PORTER GILNER  
M. 2)  
MARY HASKELL

MARIA  
B. DEC. 30, 1853  
D.  
UNM.

ISAAC  
B. JAN. 30, 1857, SAV.  
D. JUN. 19, 1893, N.Y.  
M. MAY 9, 1886  
EUGENIA P. MYERS  
(O.V. III)

ABRAM  
B. MAY 16, 1859  
D. MAR. 30, 1939, SAV.  
M. 1) OCT. 8, 1890  
ANNA MARIA COHEN  
(O.V. II)  
M. 2) DEC. 9, 1902  
HABEL A. HENRY  
(O.V. III)

LAVINIA FLORANCE  
B. JAN. 11, 1864  
D.  
M. JUN. 23, 1896, SAV.  
CHARLES I. HENRY  
(O.V. III)

EUGENE JOHN LIVINGSTON EDGAR CURZON

ISAAC, JR.  
B. FEB. 9, 1887

M. LOUISE COHEN

ROSINA FLORANCE  
B. OCT. 5, 1855, PH.  
D. INF., SAVANNAH

ABRAM, JR.  
B. NOV. 6, 1903

M. FLORENCE POWELL

HENRY PHILLIP  
OF PRINCETON  
B. JUN. 11, 1908

M. DOROTHEA HERTY

PHILIP LIVINGSTON  
B.  
D.  
M.  
GRACE ELLIOT MORRIS

NINA  
B.  
D.  
M.  
WILLIAM V. ELDER

SARAH  
B.  
D.  
UNM.

FLORENCE  
B. JUN. 29, 1922

M. LEONARD MALL

CARDLINE  
B. APR. 9, 1928

M. RAYMOND MAXIM REHM, JR.

FRANCES  
B.

M. GUY EARLE

CARDL EDWARD  
B.

M. MARGARET MAHONEY

EUGENIA  
B.

M. MAX FORMAN

GUY HARMAN  
B. FEB. 23, 1950

RICHARD DAKIN  
B. NOV. 11, 1953

ROBERT POWELL  
B. JAN. 4, 1943

HENRY HOLMES  
B. AUG. 10, 1946

MARGUERITE ANNE  
B. APR. 20, 1945

DOROTHEA  
B. SEP. 4, 1940

SUSAN  
B. APR. 23, 1942

HENRY P., JR.  
B. SEP. 4, 1945

M. ROBIN ADAIR GANS

H. MOISE - THE MOISE FAMILY OF S.C.  
 WILL OF ABRAHAM MOISE  
 ISAAC MOISE  
 RACHEL M. LEVY  
 KRAUS-SANDOR COLL.  
 ELZAS-M.N.  
 D.J.C.  
 MS.  
 LOPEZ GEN.  
 SNOWDEN-HIST. OF S.C., V.4  
 BIOG. & HIST. MEMOIRS OF L.A., V.2  
 FLO. ABR. P. 260  
 MOISE-JEWISH CEM. AT SUMTER, S.C.  
 ROSENSWAIKE

(TO CH. FROM SANTO DOMINGO, 1791) ABRAHAM MOISE  
 B. 1736, ALSACE  
 D. MAY 8, 1809, CH.

ST. EUSTATIA, 1779

SARAH  
 B. 1762  
 D. APR. 15, 1842, CH.

MOISE (1)

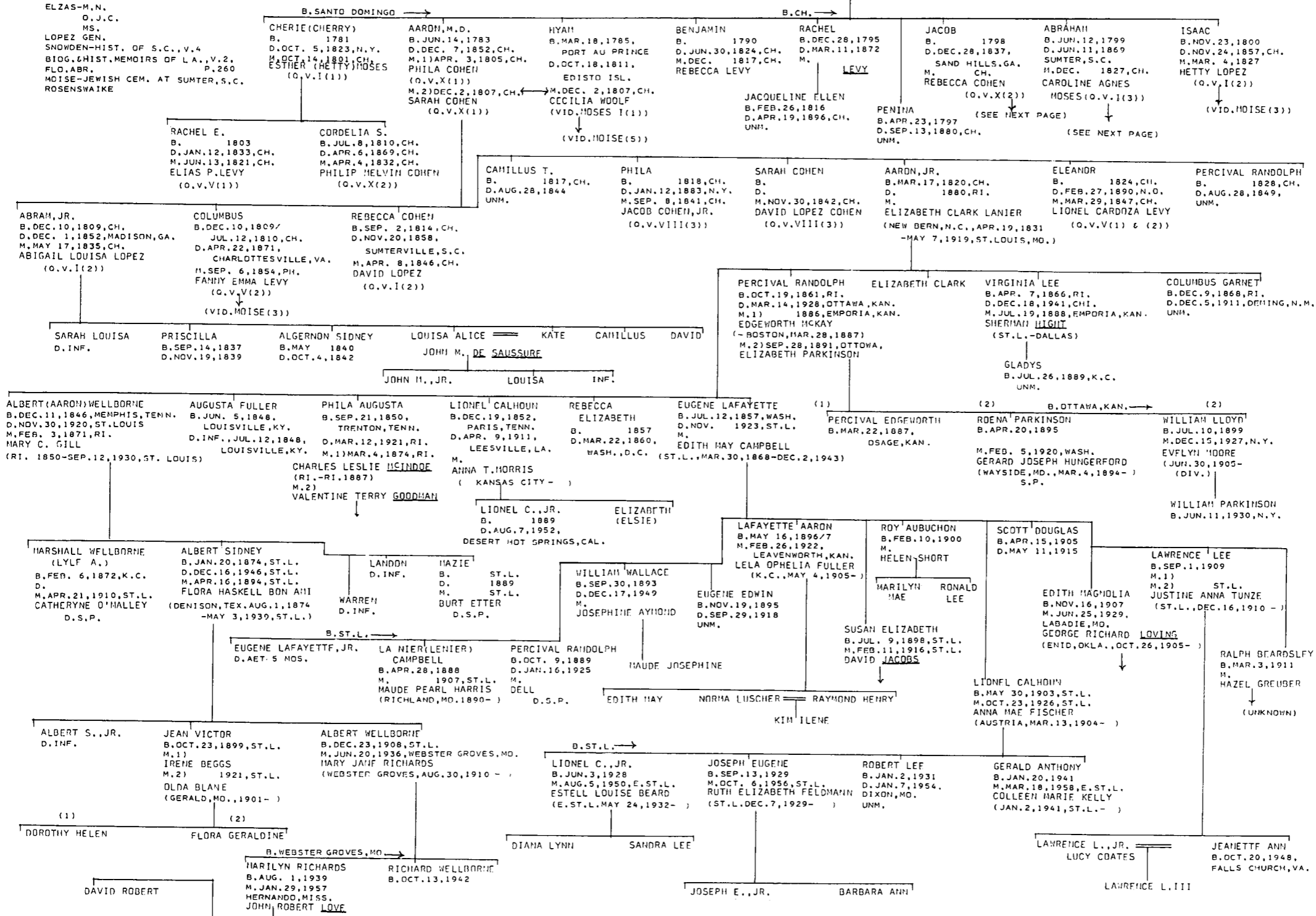

DESCENDANTS WILL BE FOUND IN HAROLD MOISE, THE MOISE FAMILY OF SOUTH CAROLINA, (COLUMBIA, S.C., 1961)

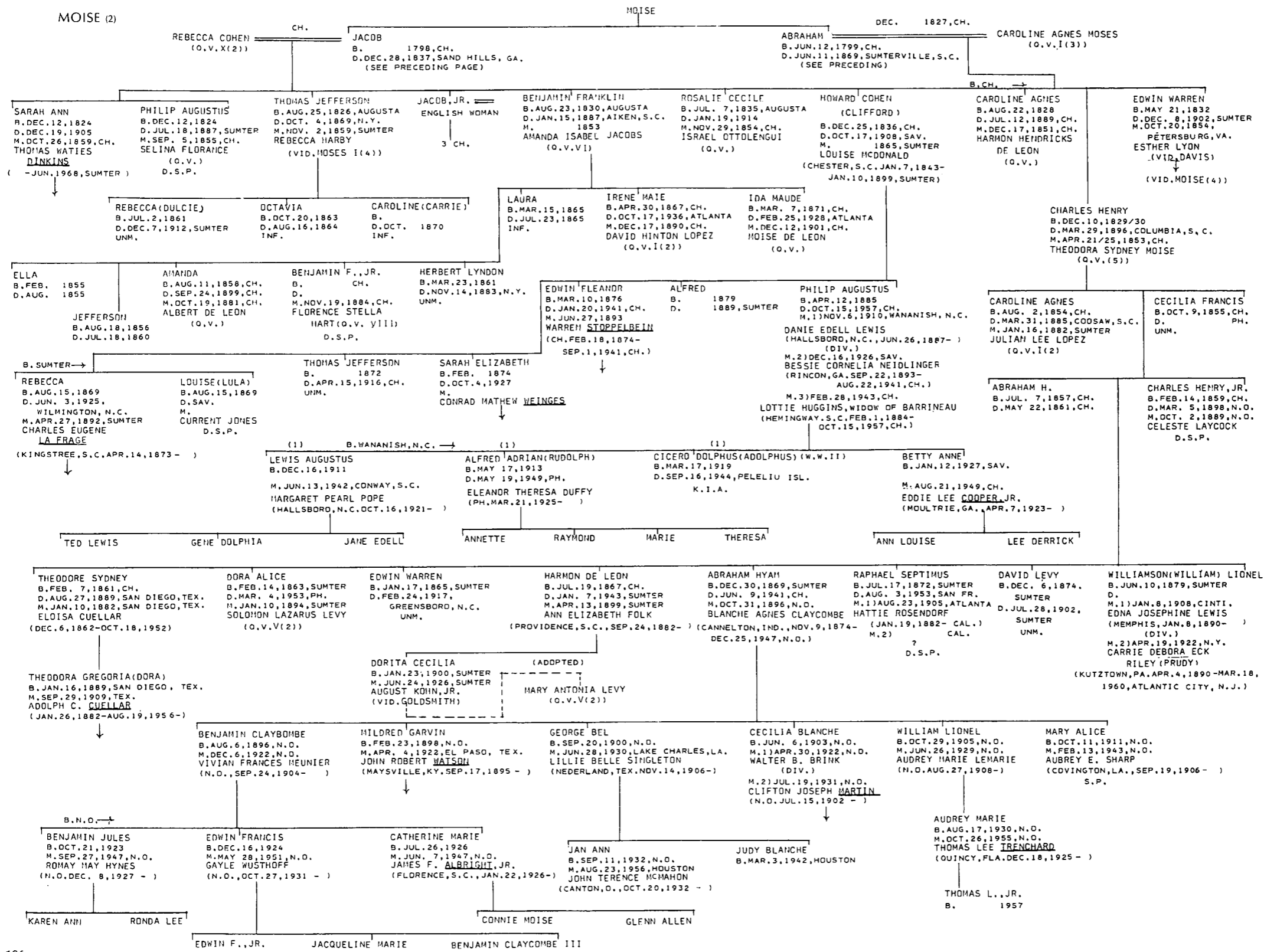

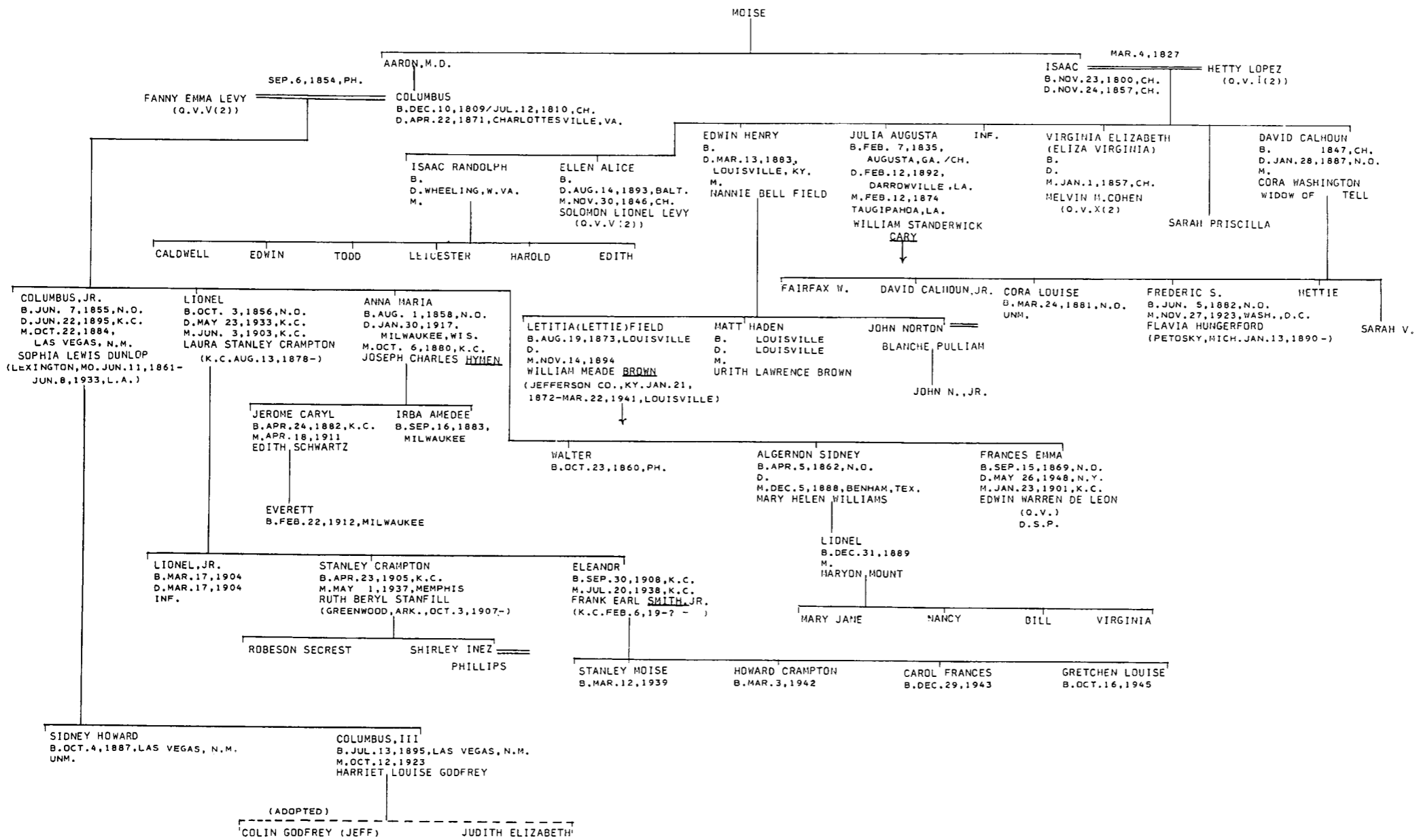

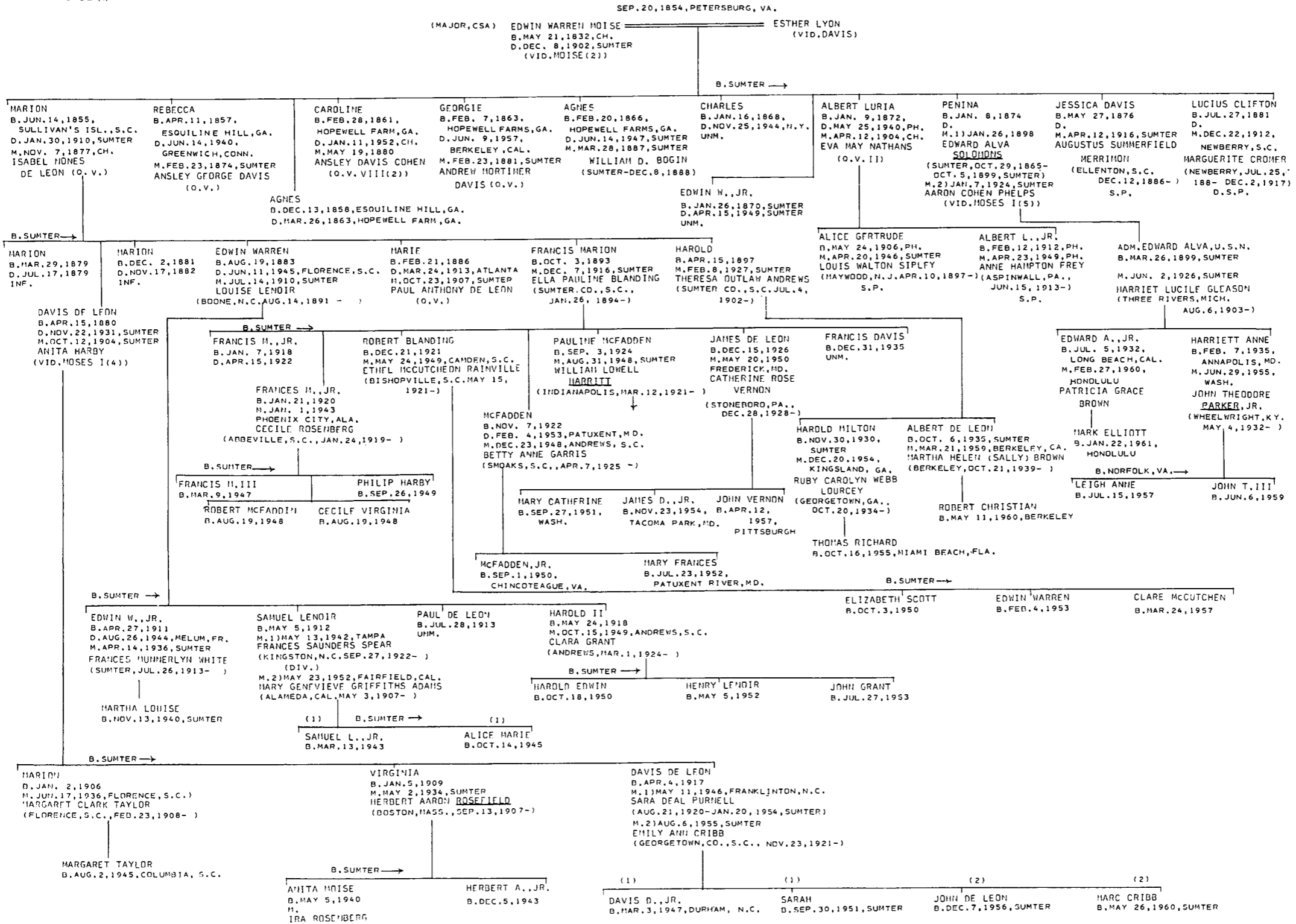

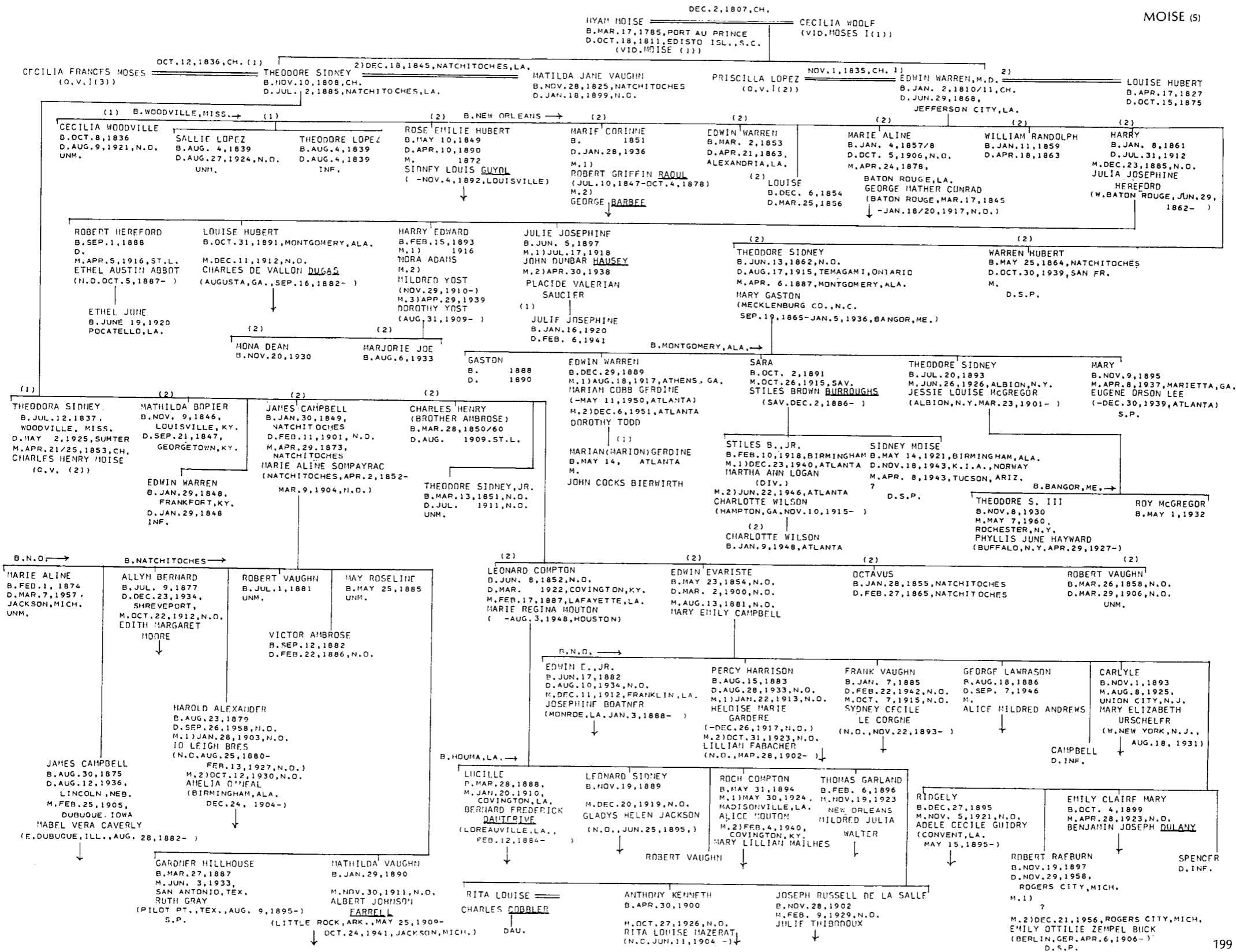

**MORDECAI I (1)**

J.E.V.9,P.10  
 U.J.E. V.7,P.643F.  
 MOSES MYERS FAMILY MSS.  
 MOSES GEN.  
 EZEKIEL-LICHTENSTEIN-  
 "JEWS OF RICHMOND"  
 ELZAS MSS.(NYHS)  
 COHEN- RECORD OF THE  
 MYERS-HAYS-MORDECAI FAMILIES  
 VA.MAG.OF HIST.GBIOG.  
 OCT. 1941,PP.364-373  
 SPRUCE ST.(PHILA.) CEM. REC.  
 MRS. ARTHUR KONZELMAN  
 ELZAS M.N.  
 ELZAS O.J.C.  
 MISC. VII,#552  
 PAJHS V. 6,P.39F.  
 PAJHS V.11,P.197F.

J.B.MORDECAI REC.(VA.H.S.)  
 FEDERAL ST. CEM.  
 POULSSON'S  
 J.G.BULLOCH- "MEMOIR OF  
 THE FAMILIES OF BELLINGER  
 AND DE VEAUX"  
 WILL OF JACOB I.COHEN  
 "JEWS OF RICHMOND"  
 MICKVE ISRAEL RECORDS  
 RAISIN MSS.(AJA)  
 MAGNOLIA CEM.,MORILE  
 RICHMOND TIMES-  
 DISPATCH, AUG.13,1971  
 (OBIT.)

MORDECAI, OF BONN  
 (TO AMERICA,CA.1760  
 NAT.PA.23 SEP.1764)

MOSES MORDECAI  
 B. 1707,BONN,GERP.  
 D.MAY 28,1781,PHILA.

1) ELIZABETH (ESTHER) WHITLOCK  
 B. 1744  
 D.AUG.22,1804,RICH.  
 (CONVERT)

2) PH.AUG.28,1782 JACOB I. COHEN  
 (O.V. II)

JACOB  
 B.APR.11,1762,PHILA.  
 D.SEP. 4,1838,RICH.  
 M.1)JUN.16,1784  
 JUDITH MYERS (O.V.I)  
 M.2)MAR.21,1798  
 REBECCA MYERS(O.V.I)

JOSEPH  
 B.NOV.18,1766,PH.  
 D.JUL.10,1839  
 M.OCT.25,1786,PH.  
 ESTHER MARACHE  
 (O.V.I)

SOLOMON JOSEPH  
 B.MAR.20,1790,VA.  
 D. 1843/50  
 M.APR.20,1817,  
 FRANKLIN,MO.  
 ISABELLA JANE KINCAID  
 (VID.MORDECAI I(3))

ISAAC  
 B.NOV.13,1805  
 D. UNM.

THOMAS WHITLOCK  
 B.DEC.25,1806  
 D.APR.12,1865  
 M.NOV.19,1834  
 LUCRETIA COHEN  
 (O.V.VII)

ESTHER  
 B.AUG.5,1811  
 D. UNM.

ISAAC  
 B.APR.11,1764,PH.  
 D. ALA.  
 M.  
 ZIPPORAH RUSSELL  
 (O.V.)

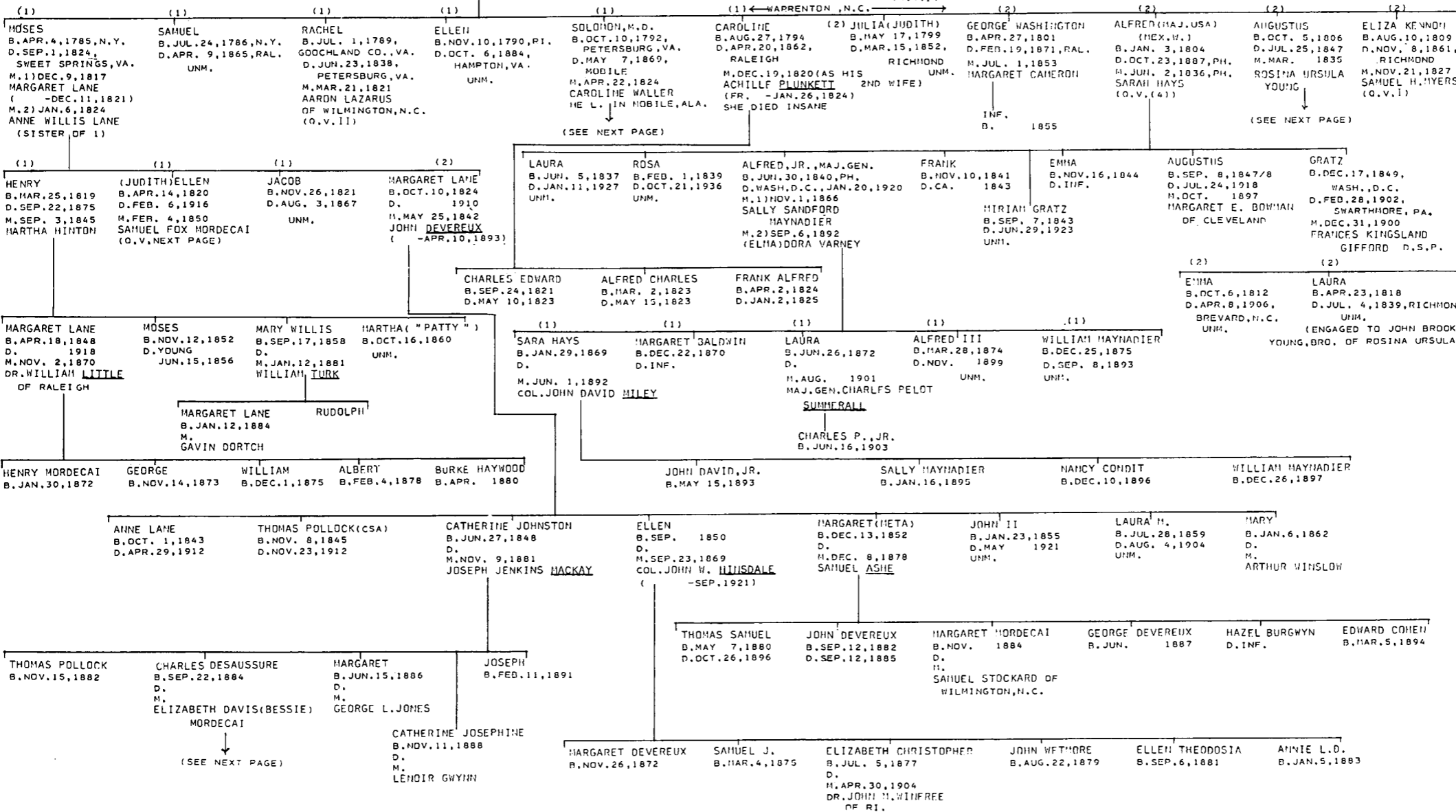

JACOB MORDECAI (SEE PRECEDING PAGE)

MORDECAI I (2)

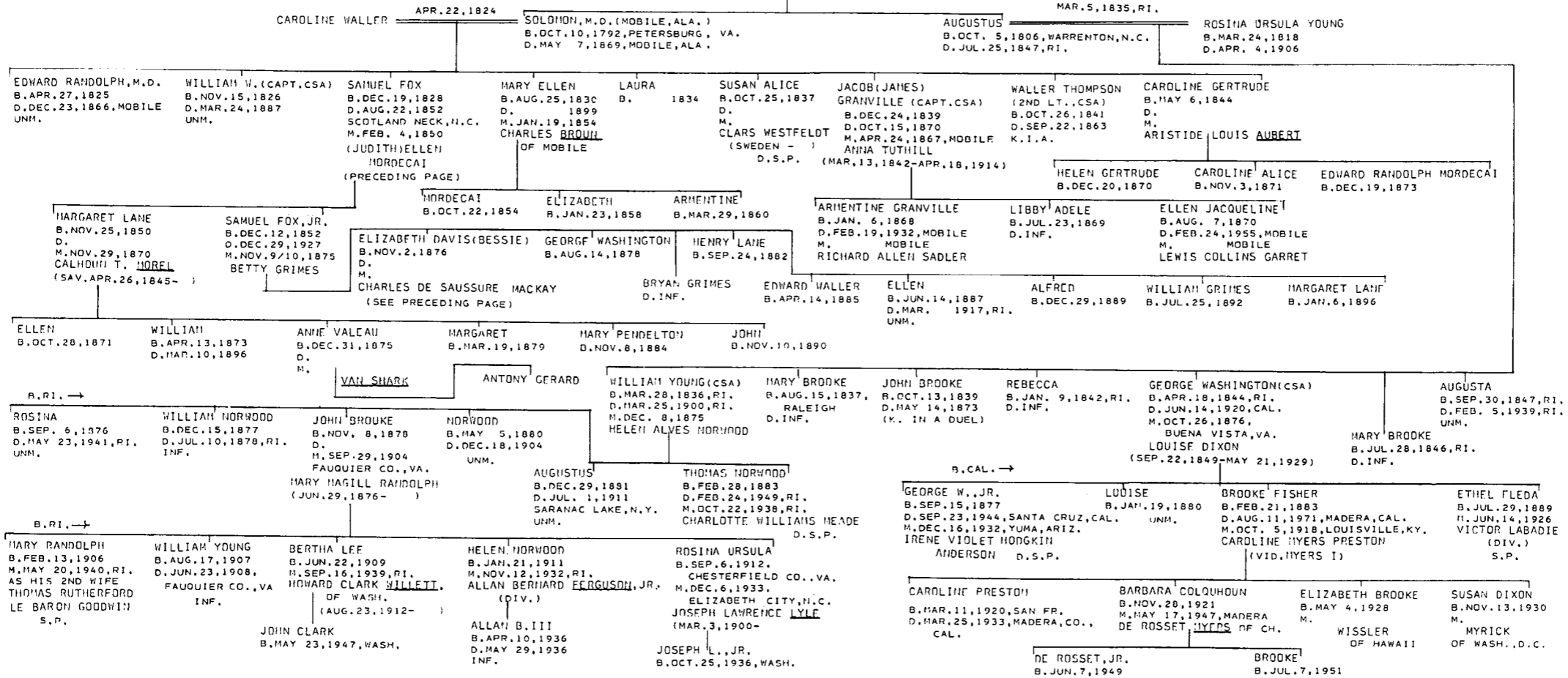

MORDECAI I (3)

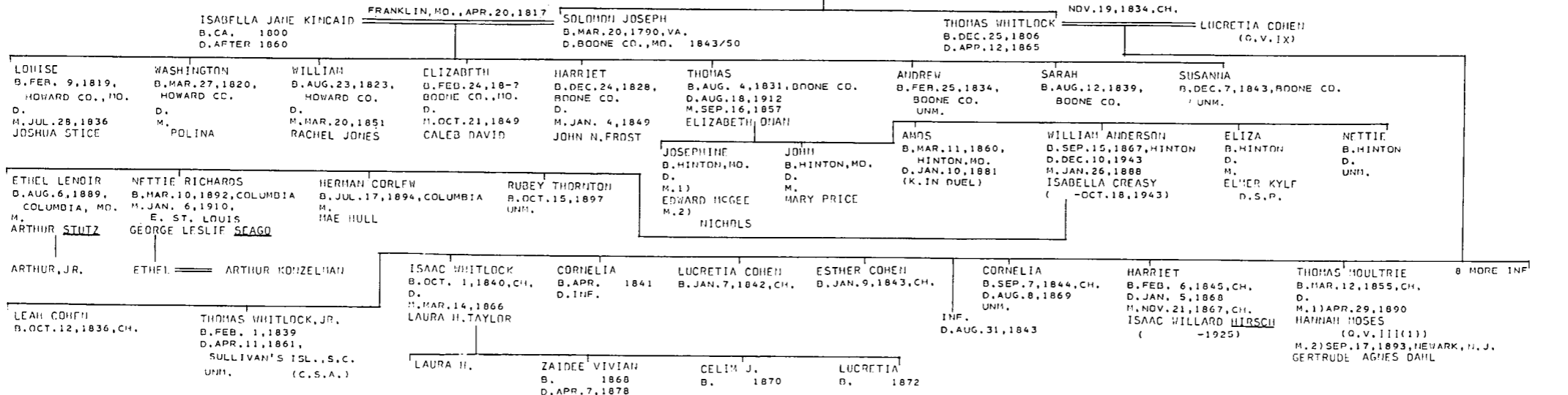



MORDECAI II (S.C.)

ELZAS MSS.  
 ELZAS O.J.C.  
 ELZAS JEW. CEMETERIES AT COLUMBIA, S.C.  
 "FAM. HISTORY OF BENJ. MORDECAI"  
 SHEARITH ISRAEL REC.  
 MD. HIST. SOC. REC.  
 SHEFTALL MSS.  
 B'NAI JESHURUN REC.  
 BARBARA L. SOSKIN  
 S.C. MARRIAGE CONVEYANCE  
 KRAUS-SANDOR COLL.

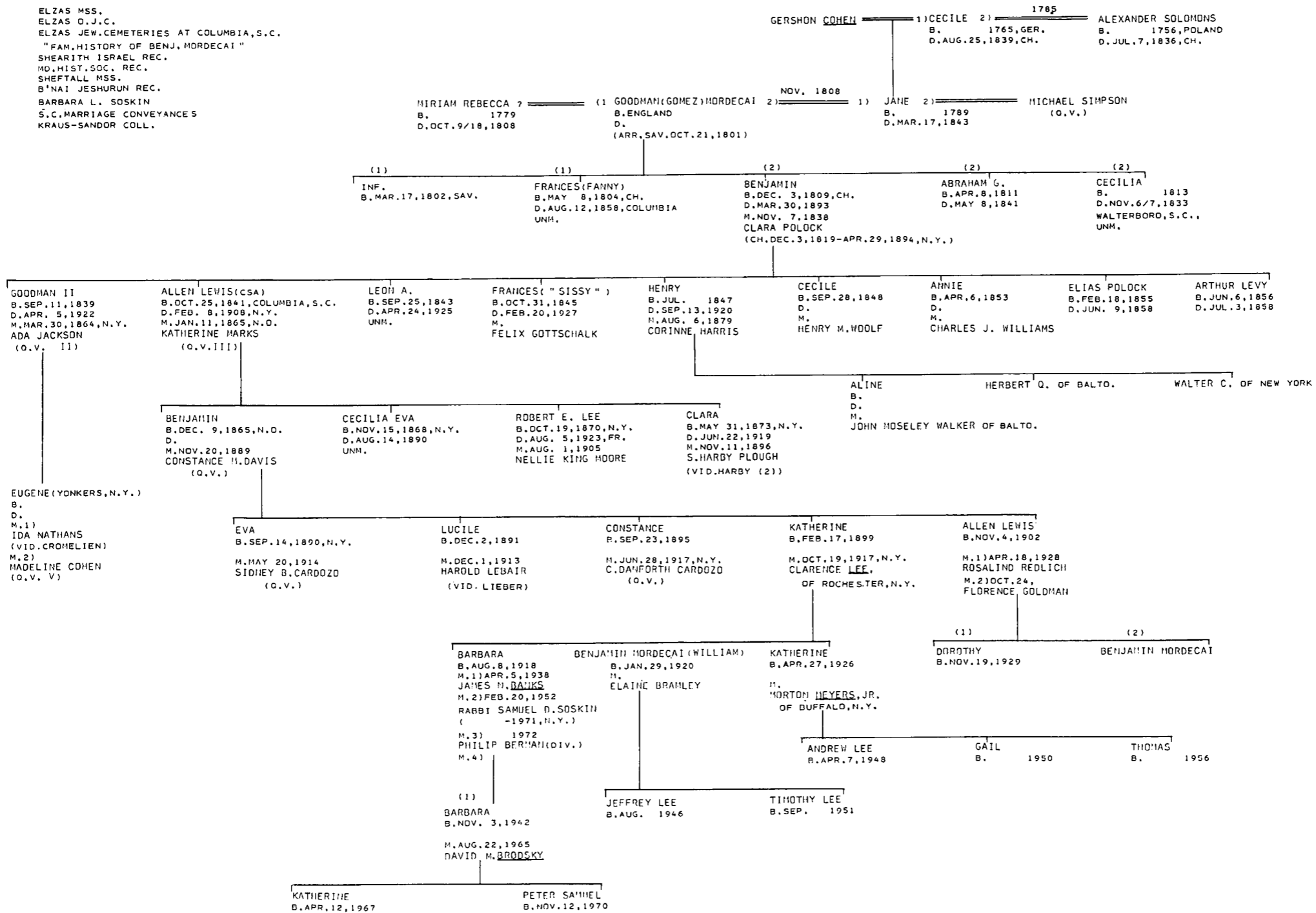

MORDECAI III

SHEFTALL MSS.  
 MRS. HAROLD GRADY  
 MRS. C.A. WILLIAMS  
 ROSENWAIKE-1820 CENSUS  
 BALTO. CITY DIR.  
 KRAUS-SANDOR COLL.  
 MD. MAG. OF HIST.  
 LYONS MS. (JRM)  
 ELZAS MS.  
 M.N.  
 O.J.C.  
 JEW. CEM. AT COLUMBIA (T.J. TOBIAS)  
 D.A.R. REC.  
 MORDECAI FAMILY BIBLE  
 MD. HIST. SOC. REC.  
 MISC. VII #561  
 NORFOLK, VA. VITAL REC.  
 GA. NEWSPAPERS  
 AJHO, V. LVII, NO. 1, P. 24FF.

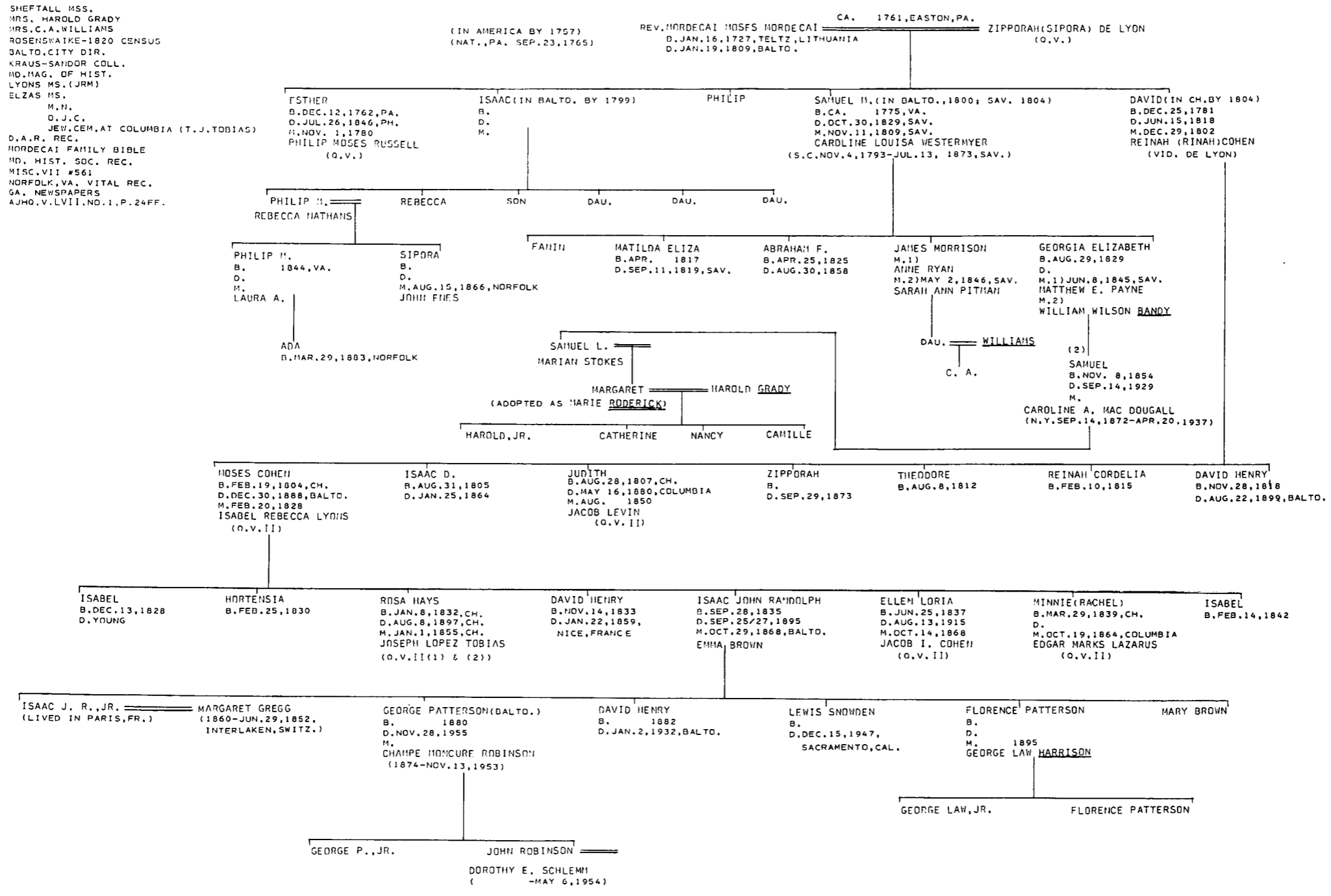

MORRISON

SALEM FIELDS CEM. (J. STEDMAN)  
 KRAUS-SANDOR COLL.  
 PAJHS, V. 27, P. 174  
 SHEARITH ISRAEL REC.  
 1870 CENS. (J. STEDMAN)

MOSES MORRISON  
 B. 1791  
 D. OCT. 19, 1869  
 M. SARAH  
 (1799-MAR. 15, 1872)

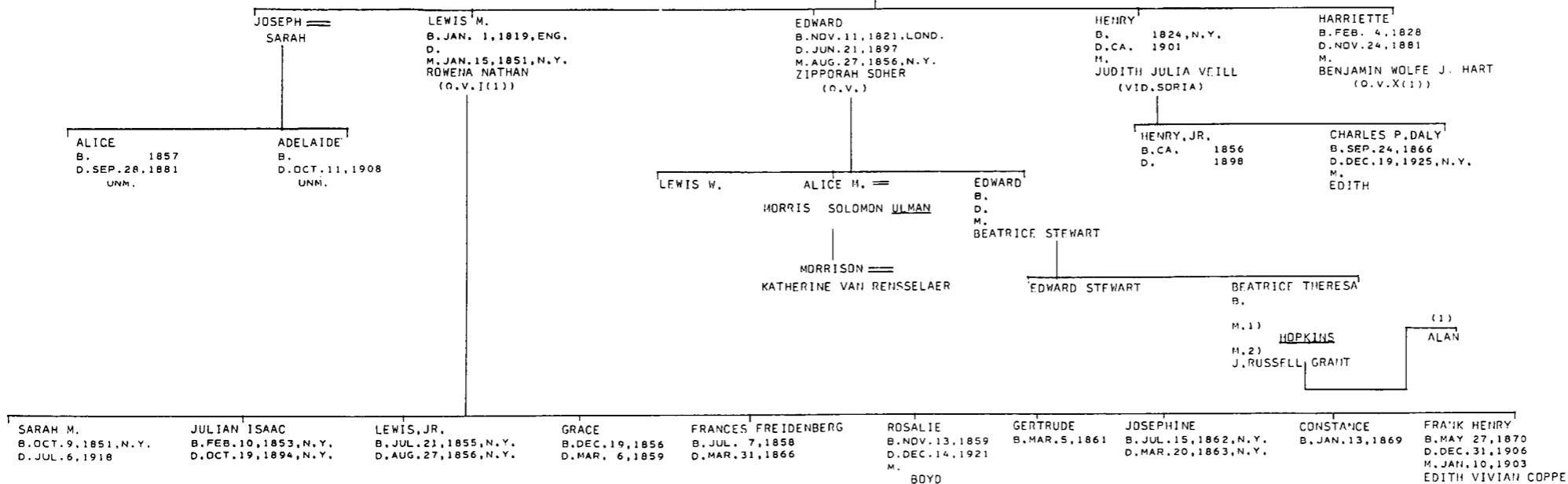

MOSES I (1) (S.C.)

HAROLD MOISE  
SNOWDEN-HIST. OF S.C.  
WILL OF RACHEL A.M. WOOLF (JRM)  
HARBY GEN. (JRM)  
RAISIN MS. (AJA)  
FLO. ADR.  
COL. PERCIVAL S. MOSES  
LAZARUS GEN. (T. J. TOBIAS)  
MRS. ROBERT S. MIDDLEMAS  
LUCY F. BERKMAN

KRAUS-SANDOR COLL.  
ELZAS MS.  
ELZAS O. J. C.  
ELZAS M. N.  
MOSES GEN. (AJA)  
MOSES MS. (DAR)  
ST. CHARLES, P. 84 F.  
SAV. JEW. BURYING GROUND  
POOL- PORTRAITS...  
MOISE-JEW. CEM. AT SUMTER  
S.C. MARRIAGE CONVEYANCES  
NGSO, V. 58, P. 130  
V. 59, P. 50

? FRANGIPINI 1) HYER MOSES 2) CA. 1772 1) RACHEL ANDREWS 2) JAN. 1789  
D. EUROPE, BEF. 1771 B. 1735, ENG. (O.V.) SOLOMON WOOLF

CECILIA  
B. JAN. 2, 1789, CH.  
D. FEB. 6, 1871, CH.  
M. DEC. 2, 1807, CH.  
HYAM MOISE (O.V. (1))

(1) REBECCA B. OCT. 2, 1768 D. DEC. 31, 1854, CH. M. 1787, CH. SOLOMON HARBY (O.V. (1))	(2) BELL (BELLA) B. 1862 D. MAR. 1786, CH. SOLOMON COHEN (O.V. VIII (1))	(2) PRISCILLA B. NOV. 19, 1775, CH. D. SEP. 19, 1866, CH. M. SEP. 20, 1793, CH. DAVID LOPEZ (O.V. I (1) & (2))	(2) ELEANOR B. AUG. 1, 1778 D. MAY 15, 1857 M. JUN. 1799 PHILIP COHEN (O.V. X (1) & (2))	(2) MAJ. HYER B. FEB. 12, 1779, CH. D. MAR. 20, 1833, N.Y. M. NOV. 2, 1803, PH. ESTHER PHILLIPS (O.V. I (1))	(2) ISAAC CLIFTON B. 1781 D. SEP. 3, 1834, NR. NEW HAVEN, CONN. M. NOV. 3, 1802 HANNAH LAZARUS (O.V. I (1))	(2) ESTHER (HETTY) B. 1784 D. APR. 18, 1860, CH. M. 1) OCT. 14, 1801, CH. CHERRY MOISE (O.V. (1)) M. 2) DEC. 1827 HYAM COHEN (O.V. X (1))
---	---	--	--	--	--	--

(2)  
INF.  
K. MAY 1780  
(IN SIEGE OF CHARLESTON)  
(SEE MOSES I (3))

FRANKLIN J.  
B. AUG. 13, 1804, PH.  
D. MAR. 6, 1877, COLUMBIA  
M. 1828  
JANE DORCAS MCCLANAHAN  
OF CHESTERFIELD DIST., S.C.

REBECCA PHILLIPS  
B. OCT. 1, 1806, CH.  
D. DEC. 7, 1889, N.Y.  
UNM.

MONTGOMERY  
B. AUG. 27, 1808, CH.  
D. DEC. 17, 1886, NEWBERRY, S.C.  
M. OCT. 27, 1832  
CATHERINE PHILLIPS  
(O.V. I (1))  
(SEE NEXT PAGE)

RACHEL WOOLF  
B. OCT. 8, 1811, CH.  
D. JUN. 26, 1836, N.Y.  
UNM.

HORTENSIA  
B. JUL. 8, 1815, CH.  
D. APR. 10, 1890, N.Y.  
M. DEC. 31, 1834  
JACOB L. SEIXAS  
(O.V. (3))

ELIZA JANE  
B. 1829  
D. 1852  
M. 1852  
DR. THOMAS BAKER  
D.S.P.

ROSALIE  
B. 1831  
D. 1862  
M. AUG. 27, 1862  
ROBERT SPANN

REBECCA  
B. 1837  
D. 1855  
M. 1855  
THOMAS P. MIKELL

FRANKLIN J., JR.  
(GOV. OF S.C. 1872-74)  
B. SUMTER 1838  
D. WINTHROP, MASS. 1905  
M. EMMA BUFORD RICHARDSON

MARY  
B. 1811  
D. 1811  
M. 1) CHRISTOPHER C. BOWER  
M. 2) WILLIAM NELSON TAFT  
M. 3) DR. HENRY D. GEDDINGS

JANE  
M. DR. SAMUEL CHANDLER BAKER

EMMA  
M. CHARLES BUFORD BRYCE

FRANKLIN (COL. USMC)  
M. MARIE A. RAUM  
D.S.P.

(1) INF. HARRIET (2) WILLIAM (2) EMMA RICHARD ANDERSON

FRANK B. D. YOUNG  
THOMAS B. UNM.

FRANKLIN B. M. LUCY TREZVANT

FRANKLIN HANNIE HAAS  
HENRIETTA NANCY FRANKLIN

JANE B. UNM.  
EMILY B. M. FRANKLIN SPANN  
(SEE BELOW) BAKER

WILLIAM E. B. M. MATTIE MCVEE  
HENRY (HARRY) JUDAH  
HENRIETTA CAMPBELL BRYAN

HENRIETTA M. 1) LYLE BROWN  
M. 2) JOHN JONES

HENRY B. M. BLANCHE RICHBOURG

JANE RUFUS WILSON HENRY BLANCHE

FRANKLIN B. M. EMILY MIKELL (O.V. ABOVE)  
ROBERT B. D. YOUNG JANE REBECCA B. D. YOUNG ROBERT

FLORENCE BAKER UNM.

CLARENCE, JR. JENNIE BAKER WILLIAM CAMPBELL HOSWAIN

EMMA BAKER M. 1) REV. BERKELEY  
M. 2) ALFRED PARKS CHAMBLIS

LUCY STONE JEANNIE BAKER

CLARENCE SAXLEY ALFRED P., JR.

FRANKLIN JAMES

RICHARD BRICE  
CYNTHIA GRINSLEY  
RICHARD B., JR.

HENRY  
LONNIE HAKE  
LONNIE BUFORD

MOSES I (2)

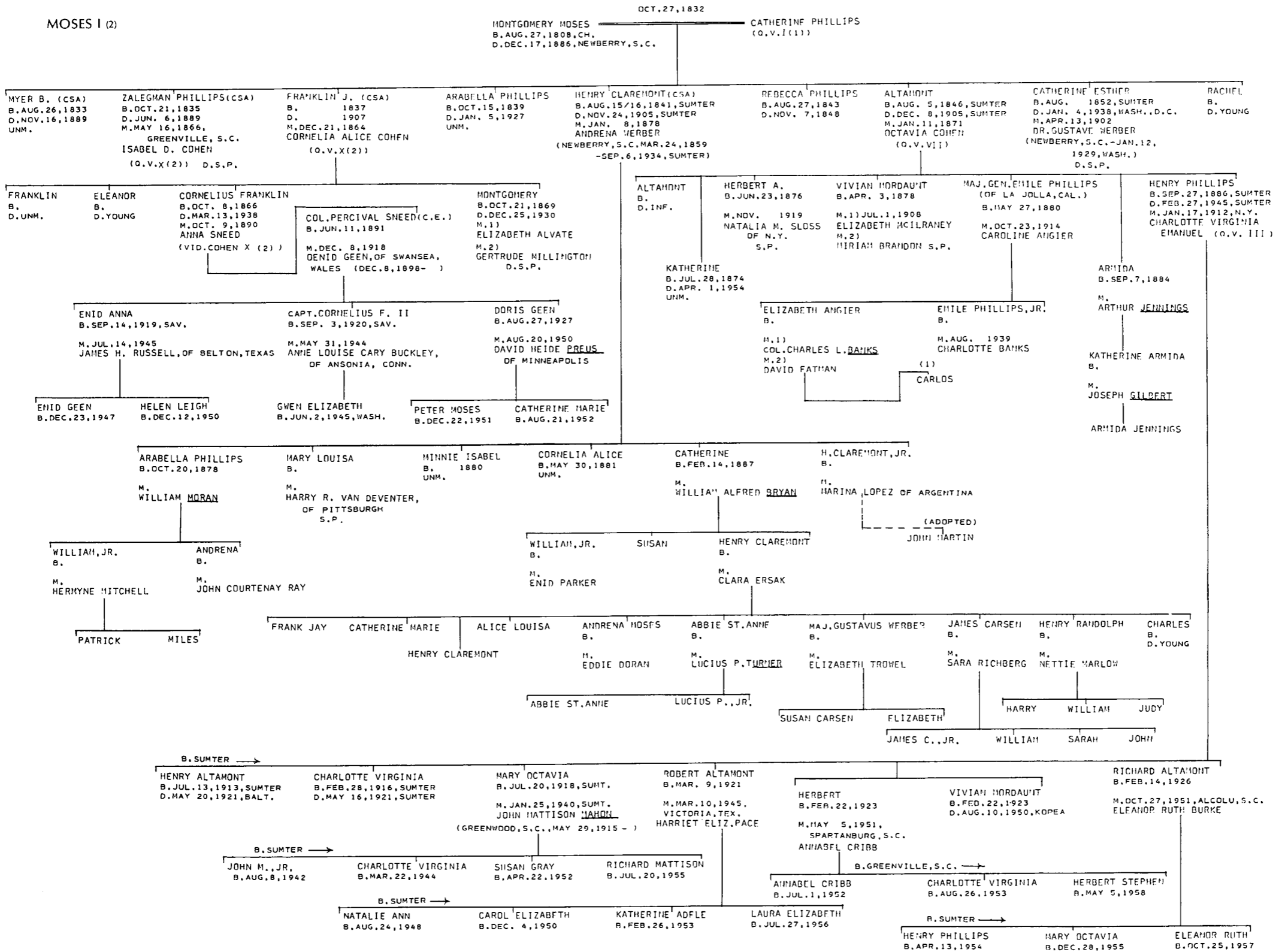

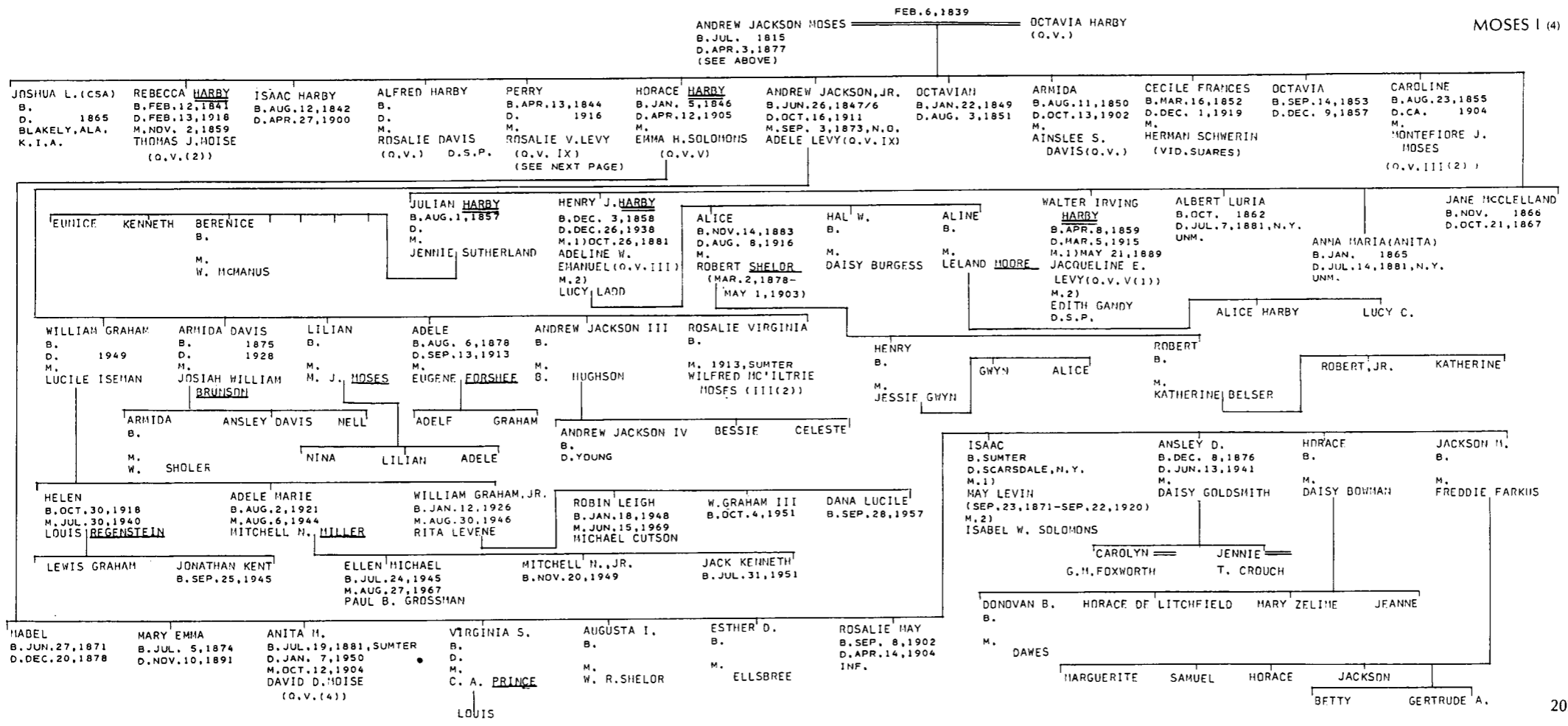
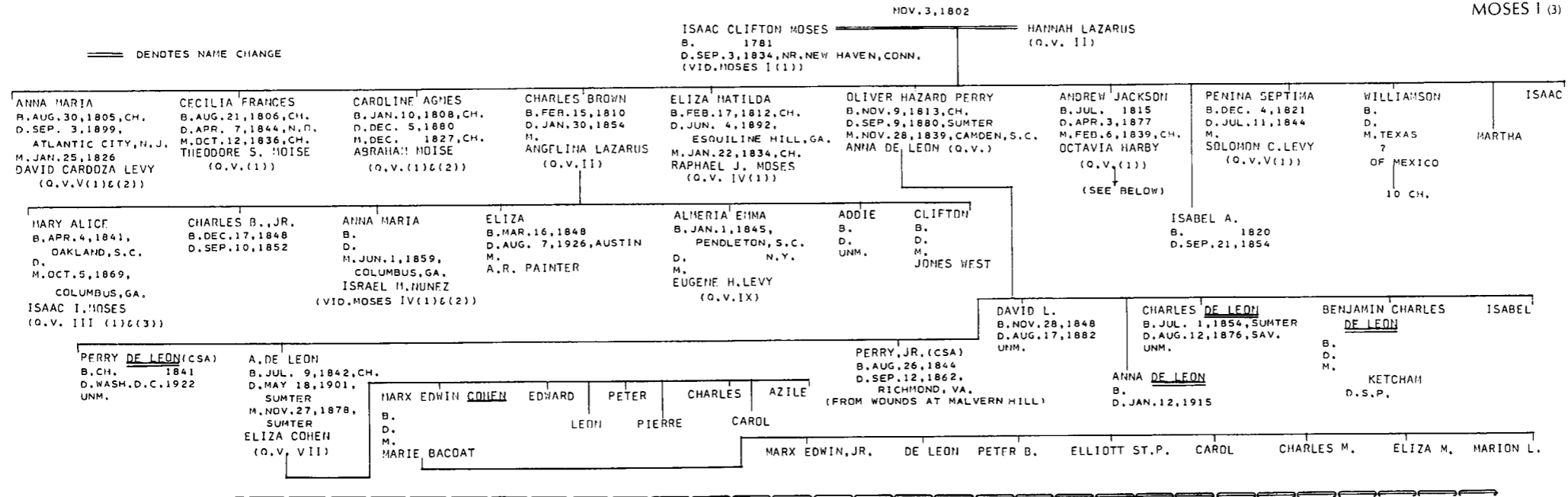

MOSES I (5)

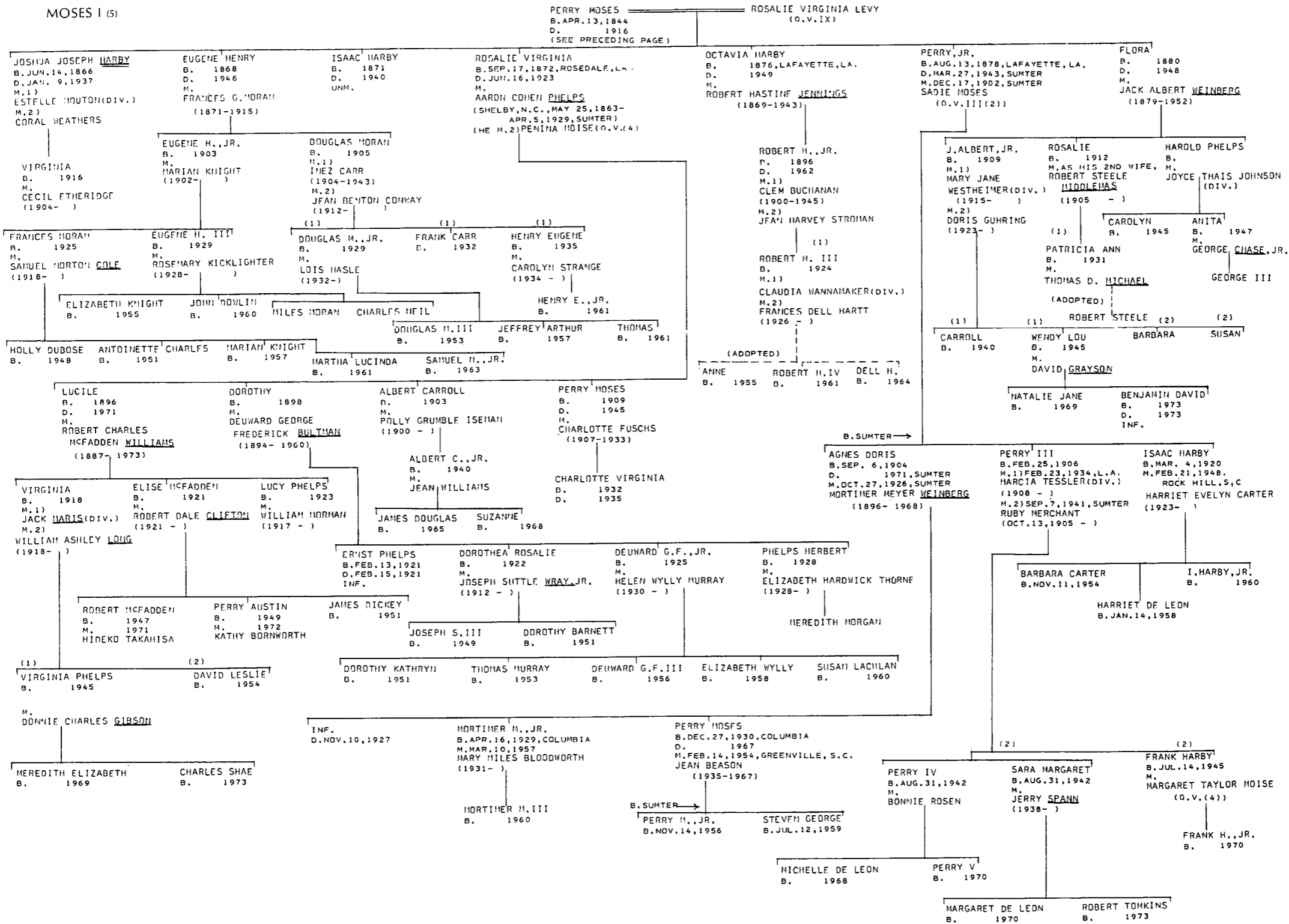

PAJHS V. 4, P. 210  
 PAJHS V. 27, P. 168F., 286, 33 6F.  
 U. J. E. V. 8, P. 14  
 COHEN FAMILY PAPERS  
 HENDRICKS GENEALOGY  
 AARON LEVY CALENDAR  
 MOSS GEN.  
 KRAUS COLLECTION  
 SHEARITH ISRAEL REC.  
 MISC. VII  
 ROSENWAIKE  
 BARBER-N.Y. DEATHS  
 EVELYN MILLER  
 POULSON'S  
 MRS. RALPH NEWMAN

MOSES II (N.Y.)

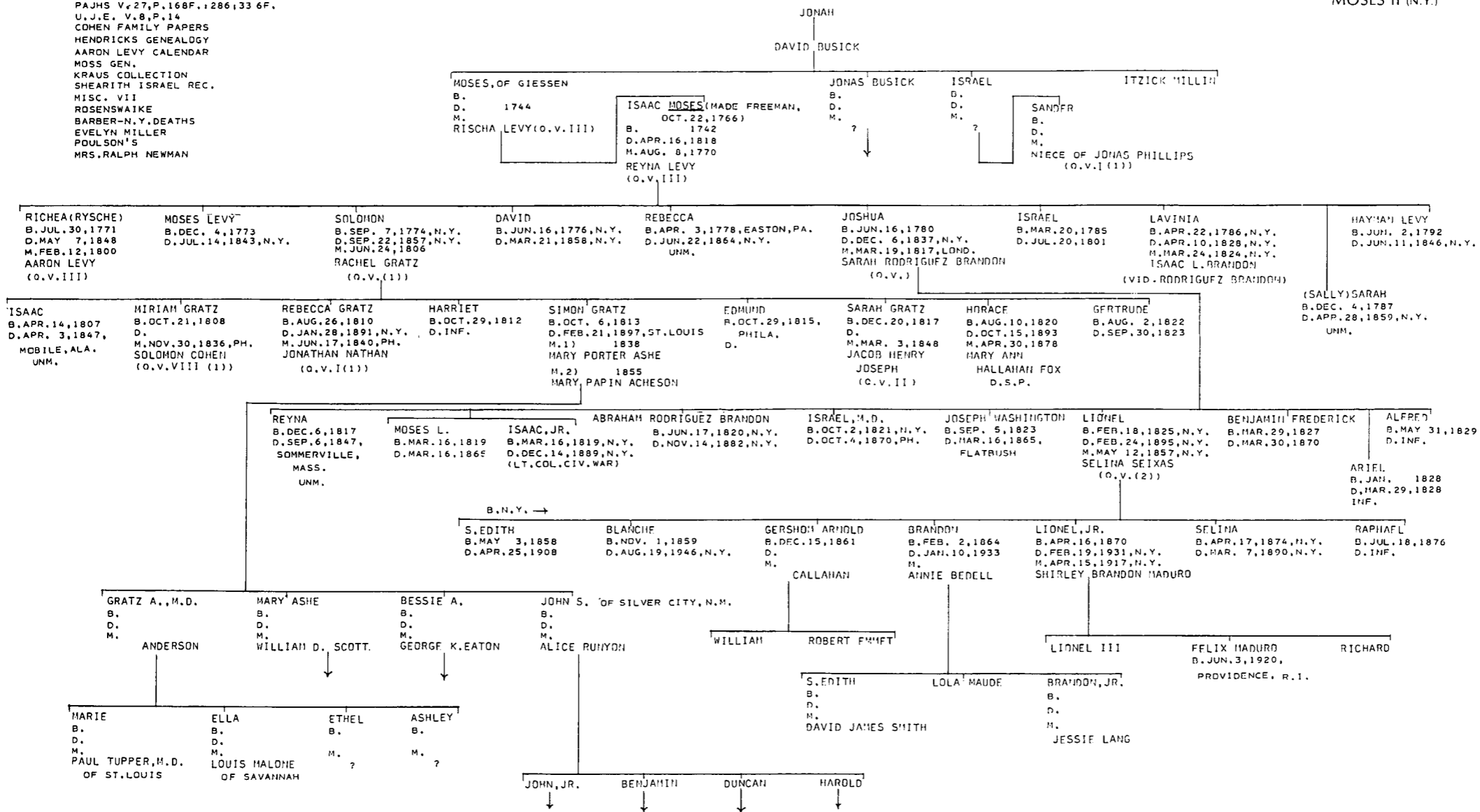



MOSES III (1)

FLO. ABR.  
HAROLD MOISE  
KRAUS-SANDOR COLL.  
PAJHS V. 8, P. 48F.  
SHEARITH ISRAEL REC.  
JACOB ISAACKS MS. (DAR)  
ELZAS MS.  
D. J. C.  
M. N.  
NEW JEW. CEM. OF BETH ELOHIM  
H. A. ALEXANDER-ALEXANDER FAM.  
JACKSON-NOAH GEN. (AJHS)  
FALK GEN.  
ABRAHAMS FAMILY BIBLE  
LUCY F. BERKMAN

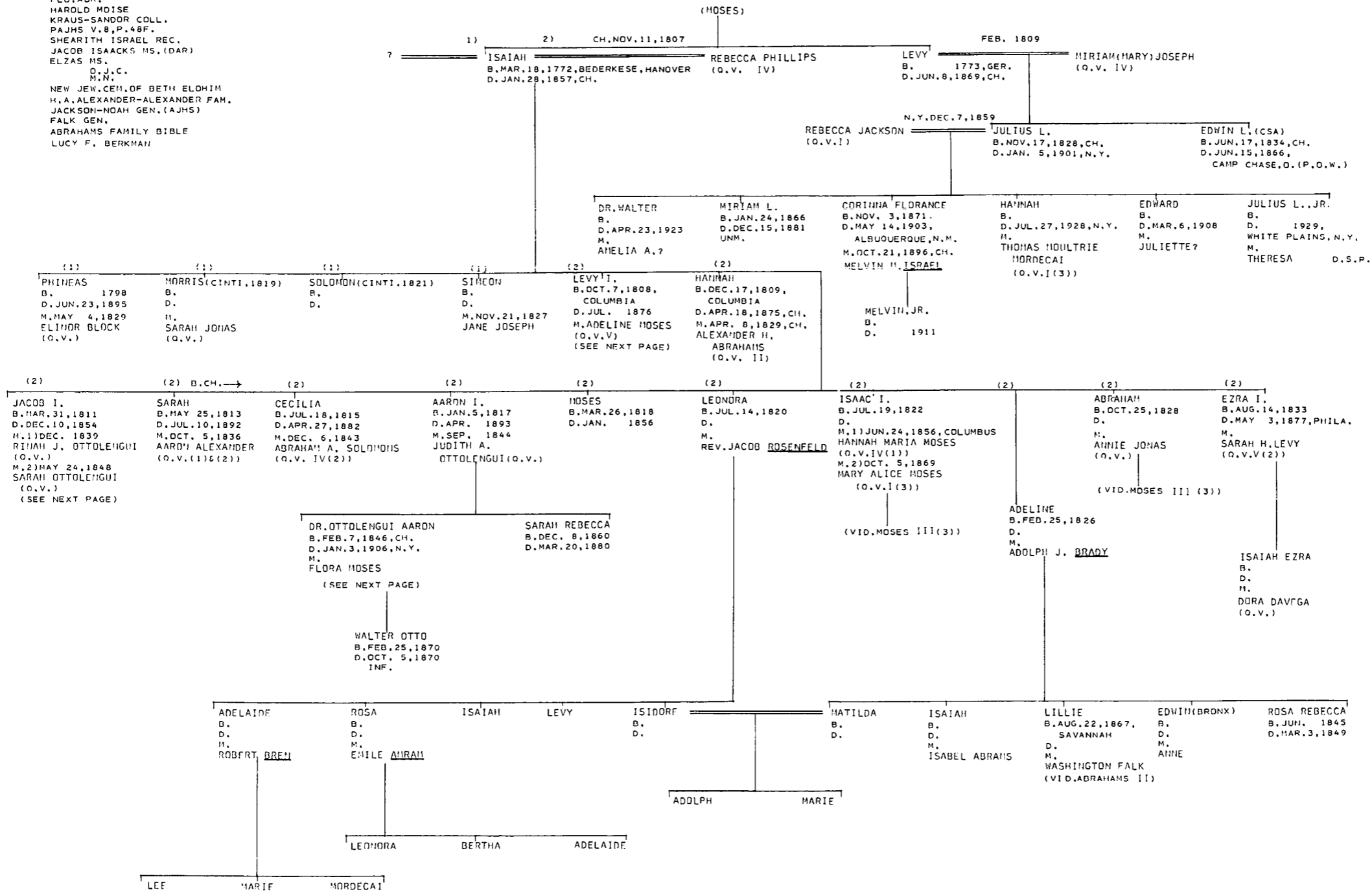

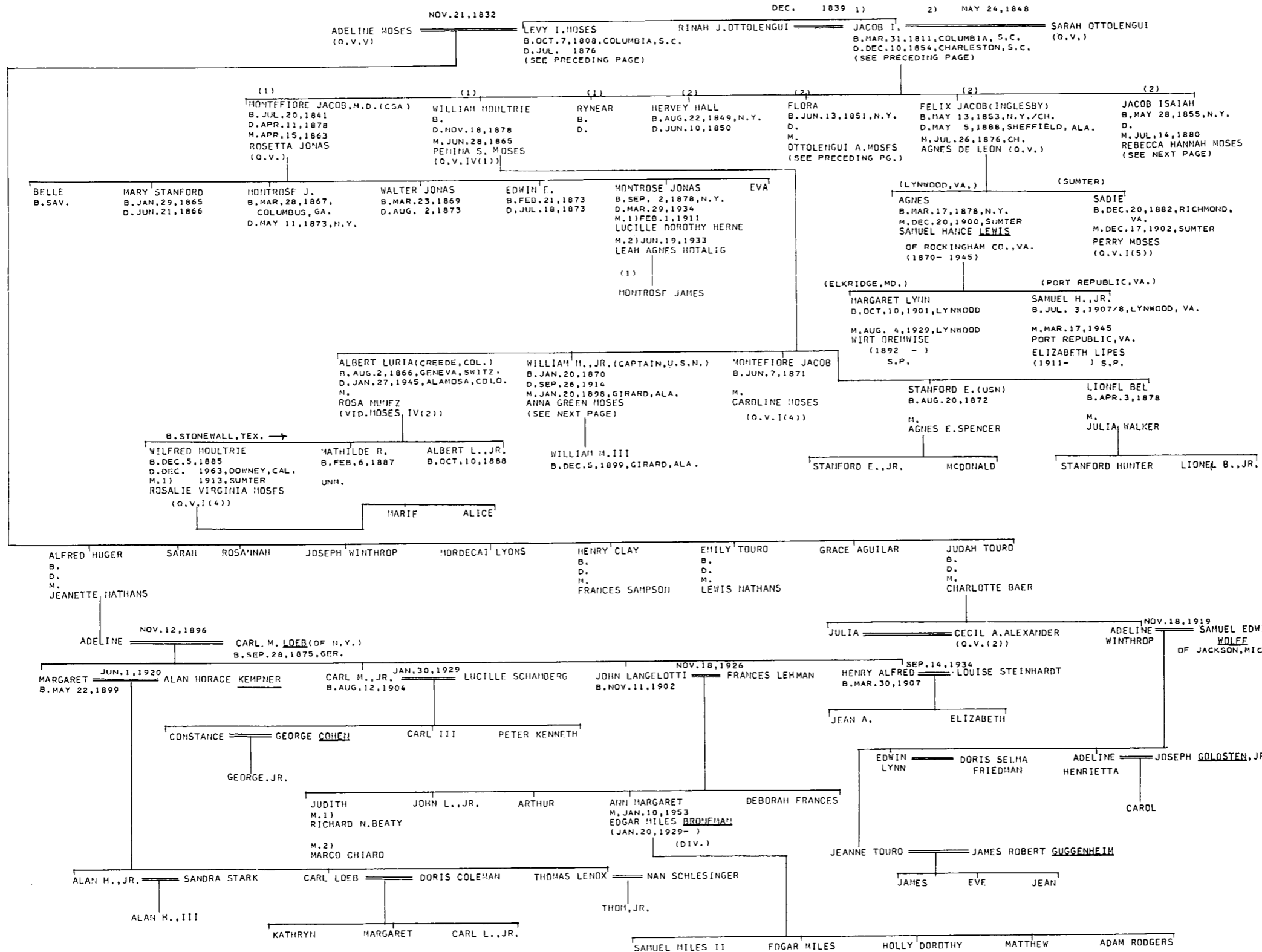

MOSES III (3)

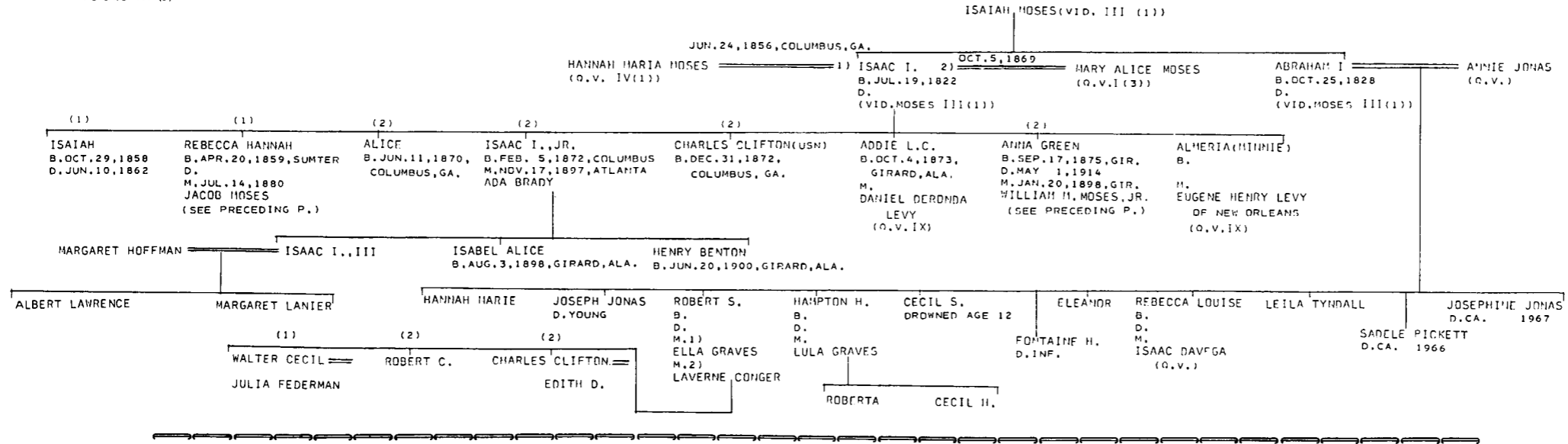

MOSES IV (1) (S.C.)

PAJHS V. 2, P. 49F.  
 V. 50, P. 56  
 UJE V. 8, P. 12F.  
 ST. CHARLES, P. 84F.  
 ELZAS MSS.  
 WILL OF DEBORAH MOSES  
 MOSES MSS. (JRM COLL.)  
 ELZAS-JEWS OF S.C.  
 ESQUILINE HILL, GA., CEM. REC. (JRM)  
 WILL OF ABRAHAM MOSES (JRM)  
 ROSENWATKE  
 J.R. COHEN REC.  
 LUCY F. BERKMAN  
 L. SHEFTALL BIBLE  
 ELZAS M.N.

INDICATES CHANGE OF SURNAME

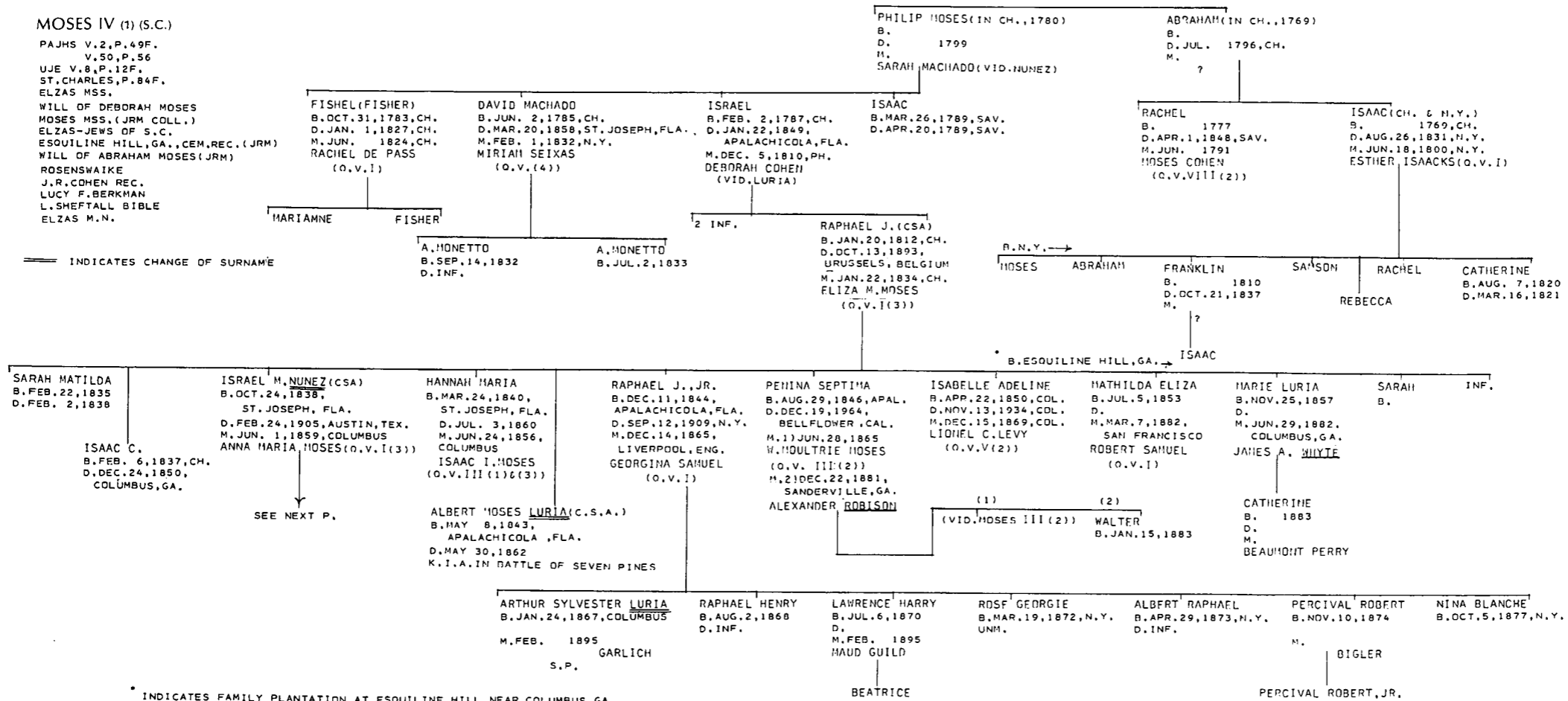

INDICATES FAMILY PLANTATION AT ESQUILINE HILL, NEAR COLUMBUS, GA.

MOSES IV (2)

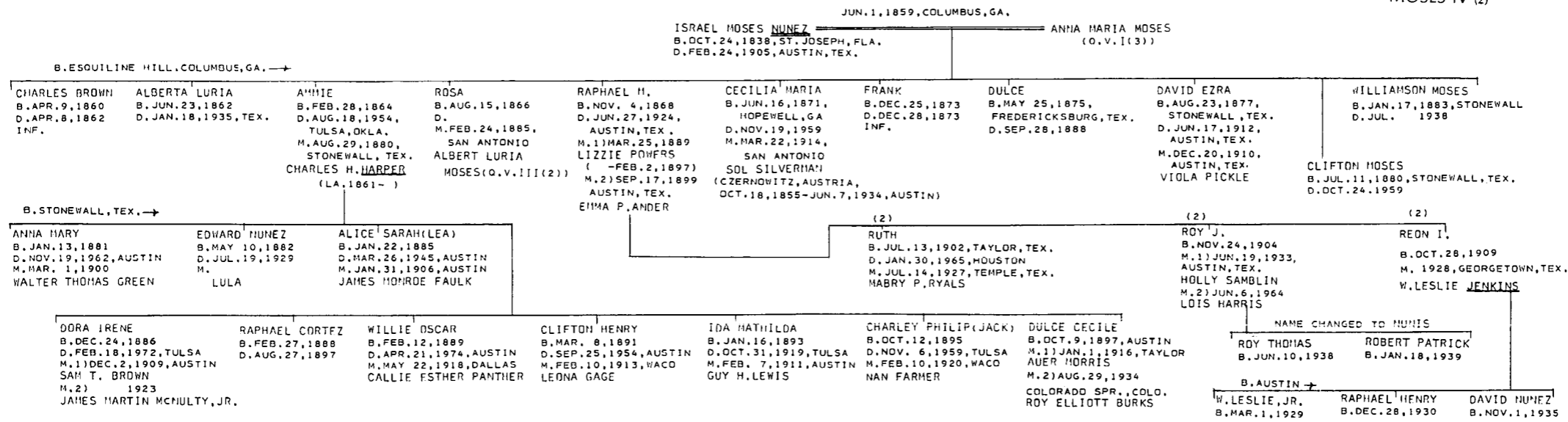

MOSES V

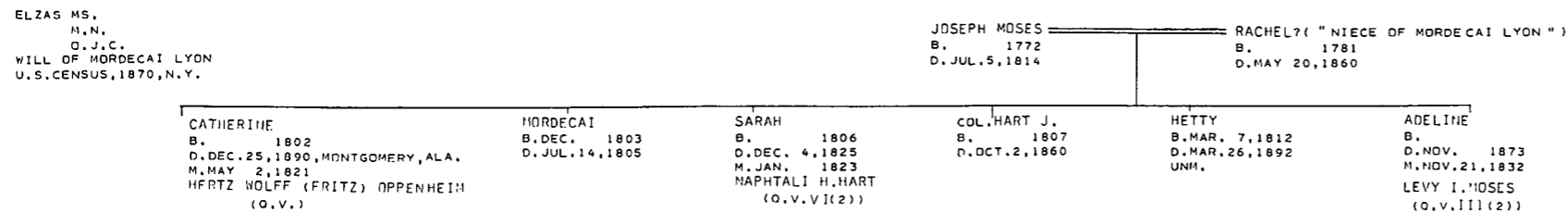

MOSES VI

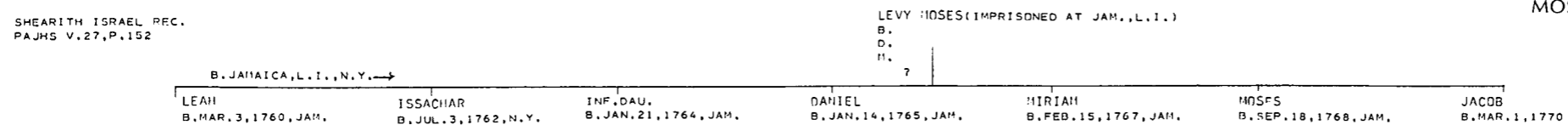

MOSES VIII

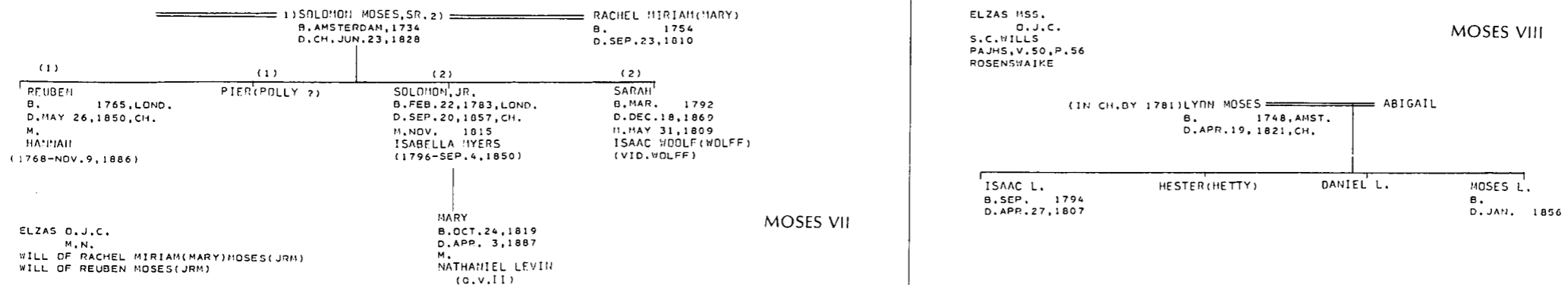

MOSS (1)

ROSENSWAIKE  
R.S. MOHEL REC.  
FLD. ABR.  
POULSON'S  
MORAIS-JEWS OF PHILA.  
MOSS GEN.  
ROSENTHAL MS.  
MICKVE ISRAEL REC.  
SHEARITH ISRAEL REC.  
MOSS-HARRIS-GEN.  
SANFORD A. MOSS NOTES  
HARRIET STRYKER-RODDA

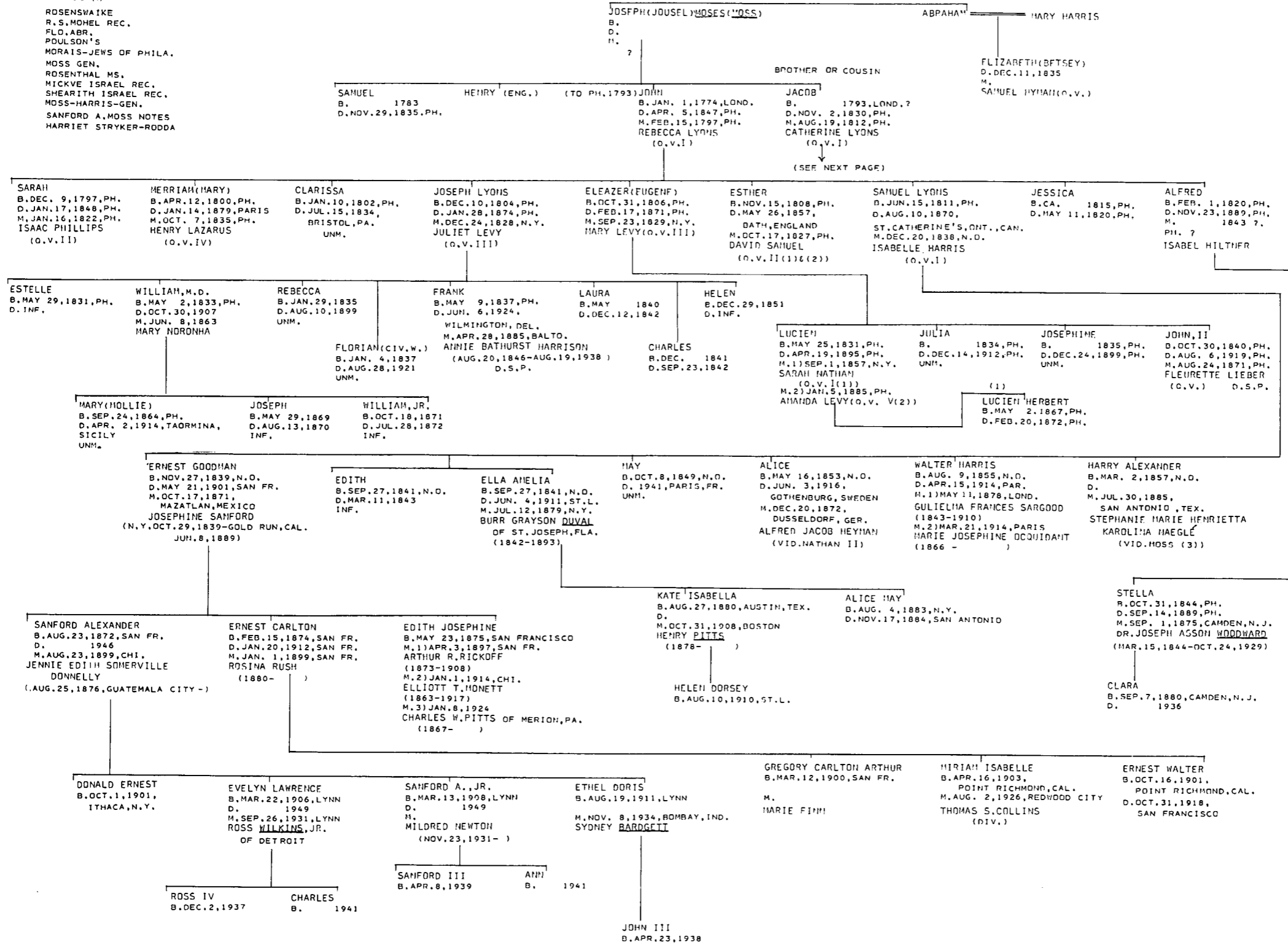

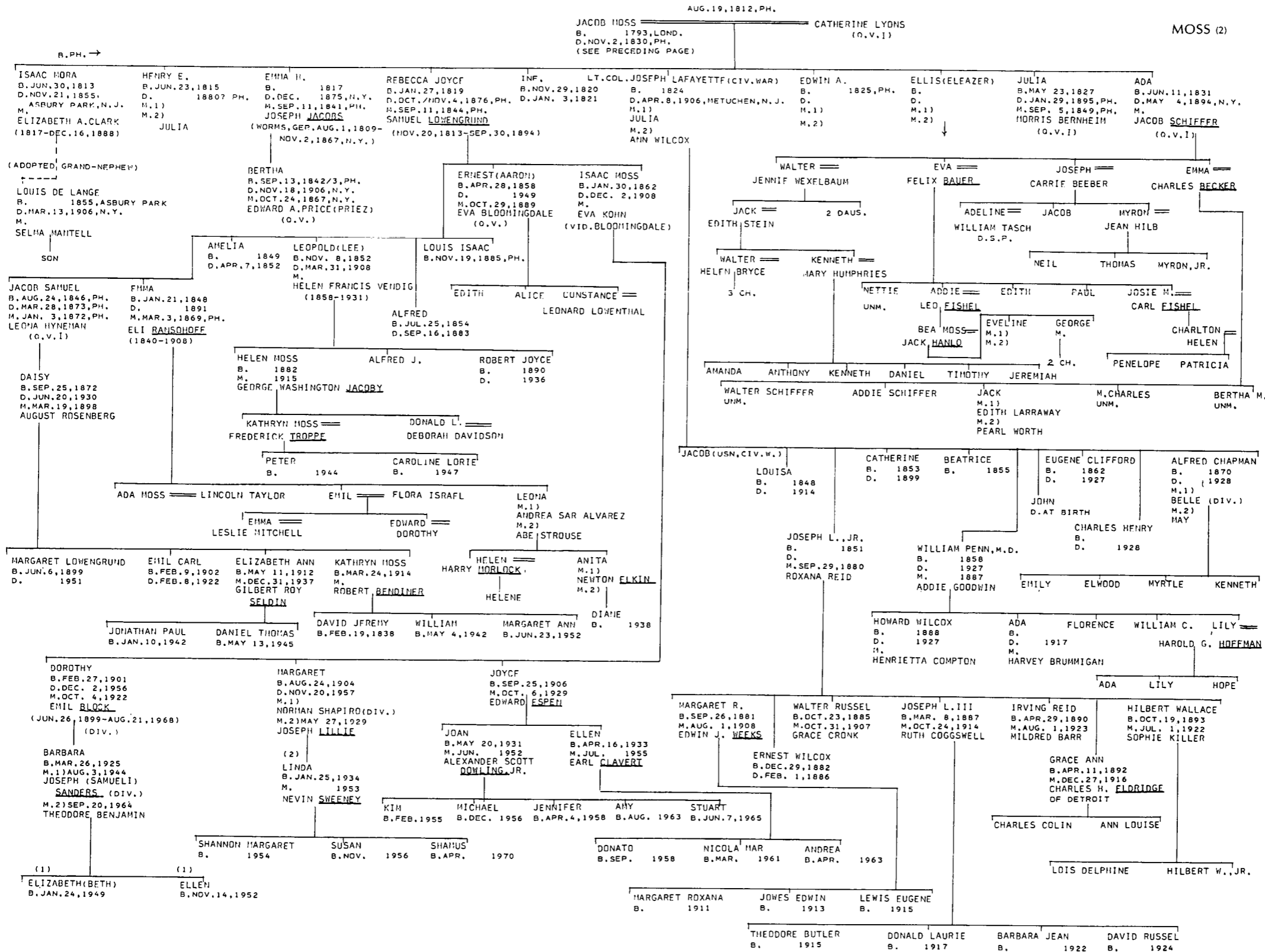

MOSS (3)

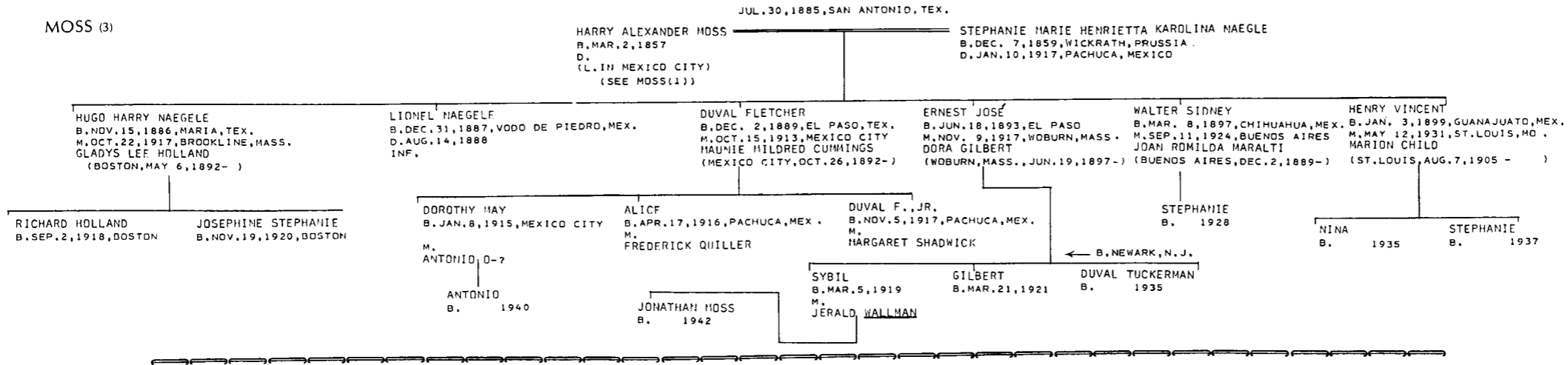

MYERS III (SAVANNAH)

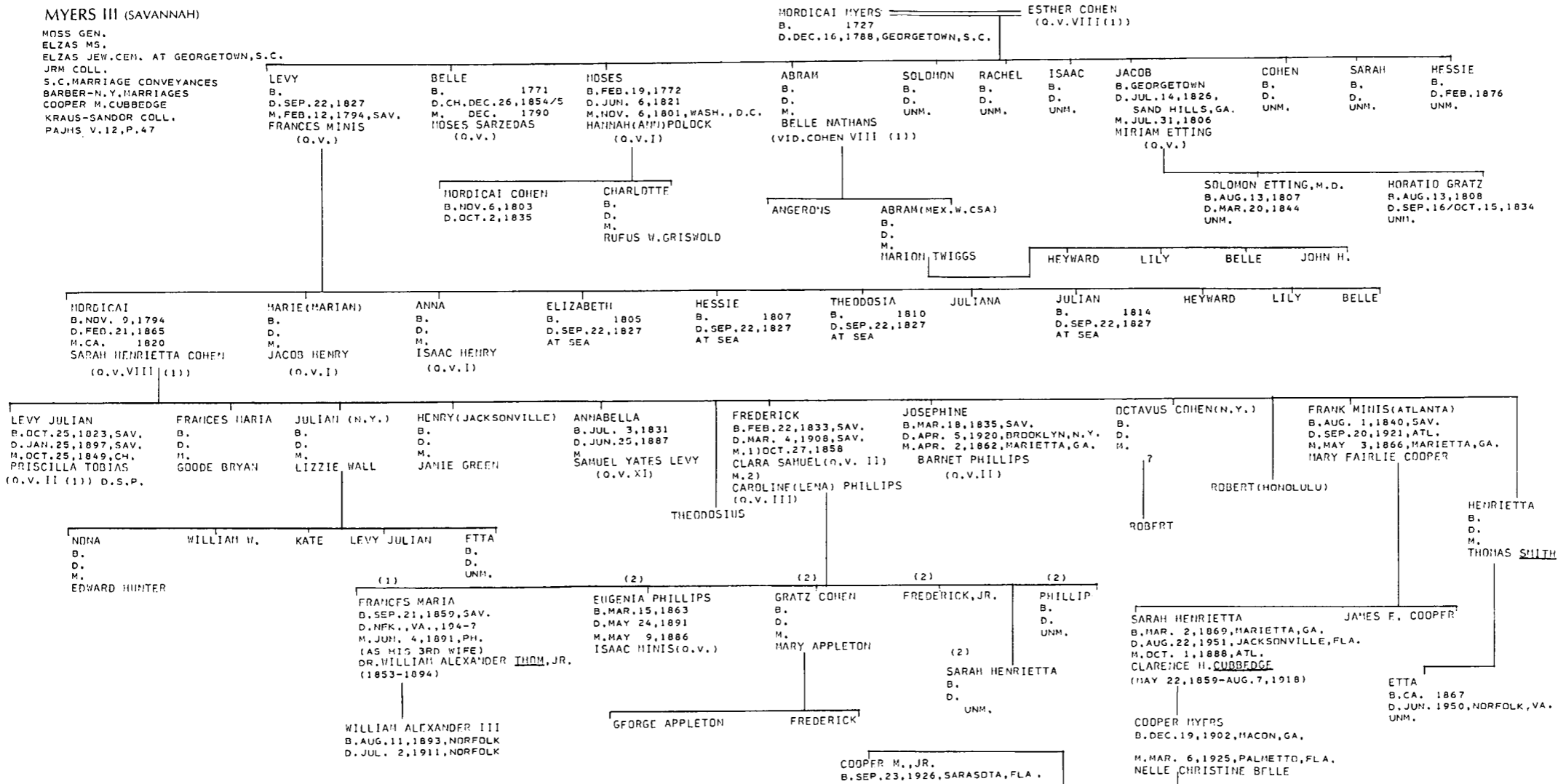

JULIA MORDECAI REC.  
 JOHN BROOKE MORDECAI (MS.V.A.H.S.)  
 MISC.VII  
 VALLENTINE'S MANUAL  
 POOL-PORTRAITS  
 PAJHS V.11,P.155  
 V.27,P.151F.  
 V.33,P.203F.  
 AJHO V.53,P.292  
 V.56,P.116  
 KRAUS-SANDOR COLL.  
 MOSES MYERS MSS.  
 GOLDSTONE MS.  
 EZEKIEL-LICHTENSTEIN  
 AARON LEVY CALENDAR(AJHS)  
 SHEARITH ISRAEL REC.  
 FLO.AAR.  
 J.POSENBAUM-MYER MYERS...  
 SIMSON MS.(JRM)

MYERS I

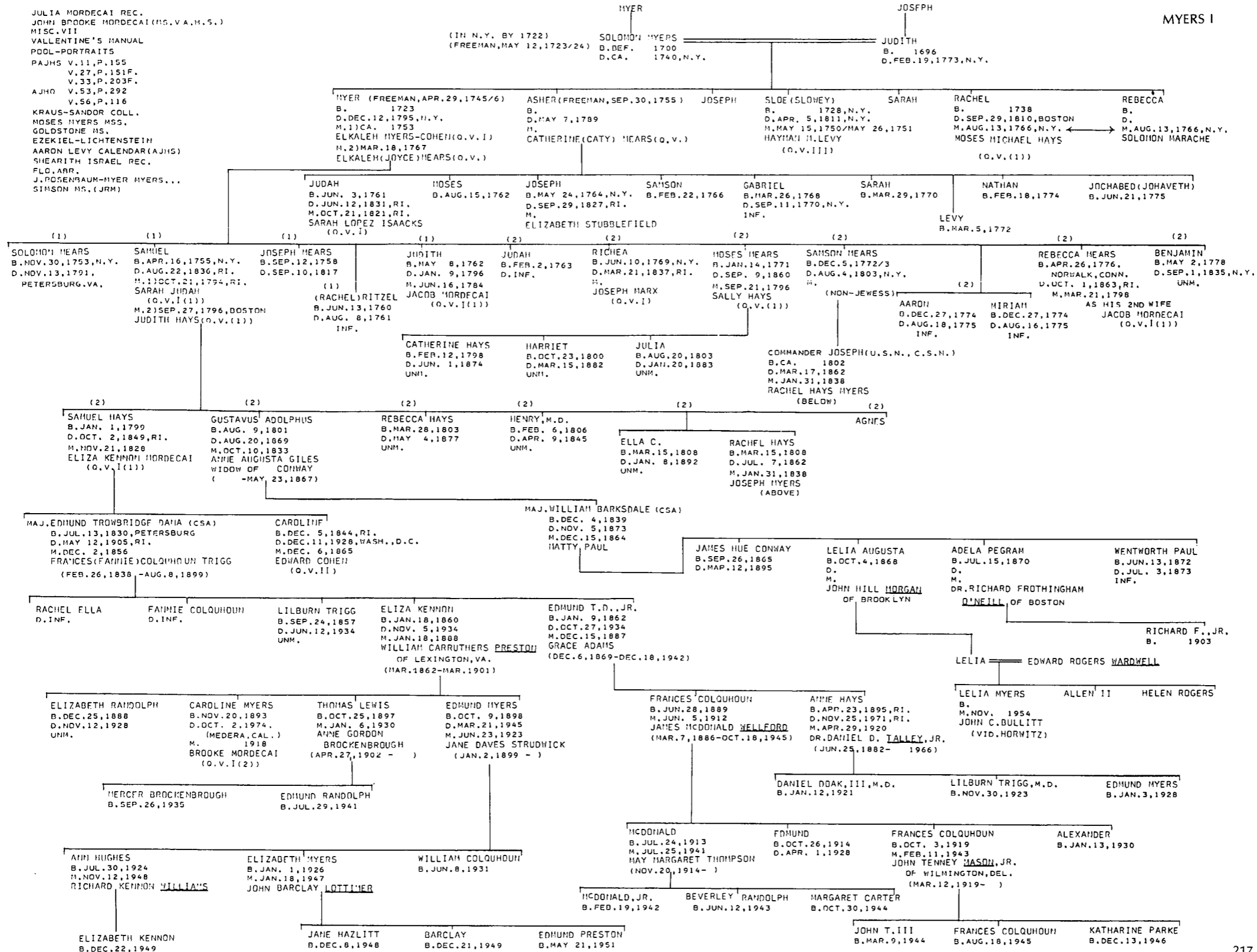



MYERS II

MYERS MSS.  
 KRAUS-SANDOR COLL.  
 PAJHS V.27, PP.74,150,152  
 V.33, P.252FF.  
 JOURNAL OF SJHS, V.I  
 TUCKER-NORFOLK MARRIAGE BONDS  
 NORFOLK NEWSPAPERS  
 SHEARITH ISRAEL REC.  
 POOL-PORTRAITS  
 WILL OF MOSES MYERS

EMINENT & REPRESENTATIVE MEN OF VA. & D.C.  
 EPITAPHS-HEB. CEMETERY, NORFOLK  
 ELMWOOD CEMETERY, NORFOLK  
 EZEKIEL-LICHTENSTEIN  
 QUEBEC GAZETTE, DEC.17,1767  
 RICHMOND NEWSPAPERS  
 ABRIDGED COMPENDIUM OF EARLY AM. FAMILIES  
 MARY GRAHAM MYERS ANDREWS  
 MISC.VII #537  
 BARBER-N.Y.MARRIAGES

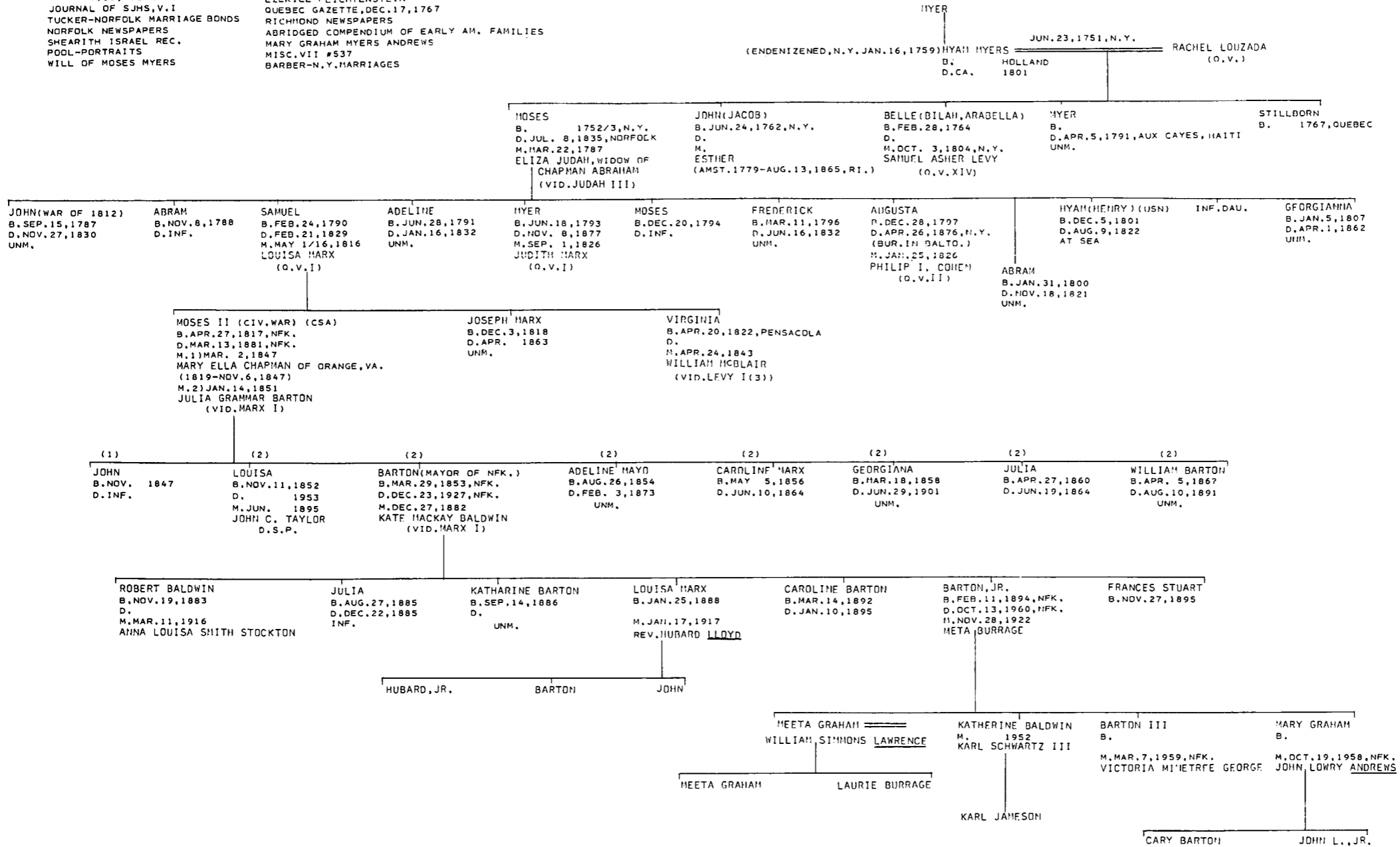

MYERS SOLIS-COHEN  
 BETH SHALOME MARRIAGE REC.(AJA)  
 EZEKIEL-LICHTENSTEIN  
 MILDRED R.BRANDT,M.A.BRANDT II  
 TOMBSTONES-NORFOLK,VA.HEBREW CEMETERY  
 TUCKER-NORFOLK MARRIAGE LICENSES  
 PORTSMOUTH,VA.,MARRIAGE REC.  
 FLO.ABR.

(NAPOLEONIC SOLDIER,  
 TO NORFOLK,CA.1828)

1812/14  
 EMANUEL J. MYERS 1781  
 B.HOLLAND,  
 D.NORFOLK,VA.MAR.22,1871  
 EDEL(ADELINE)WATERMAN  
 (Q.V.)

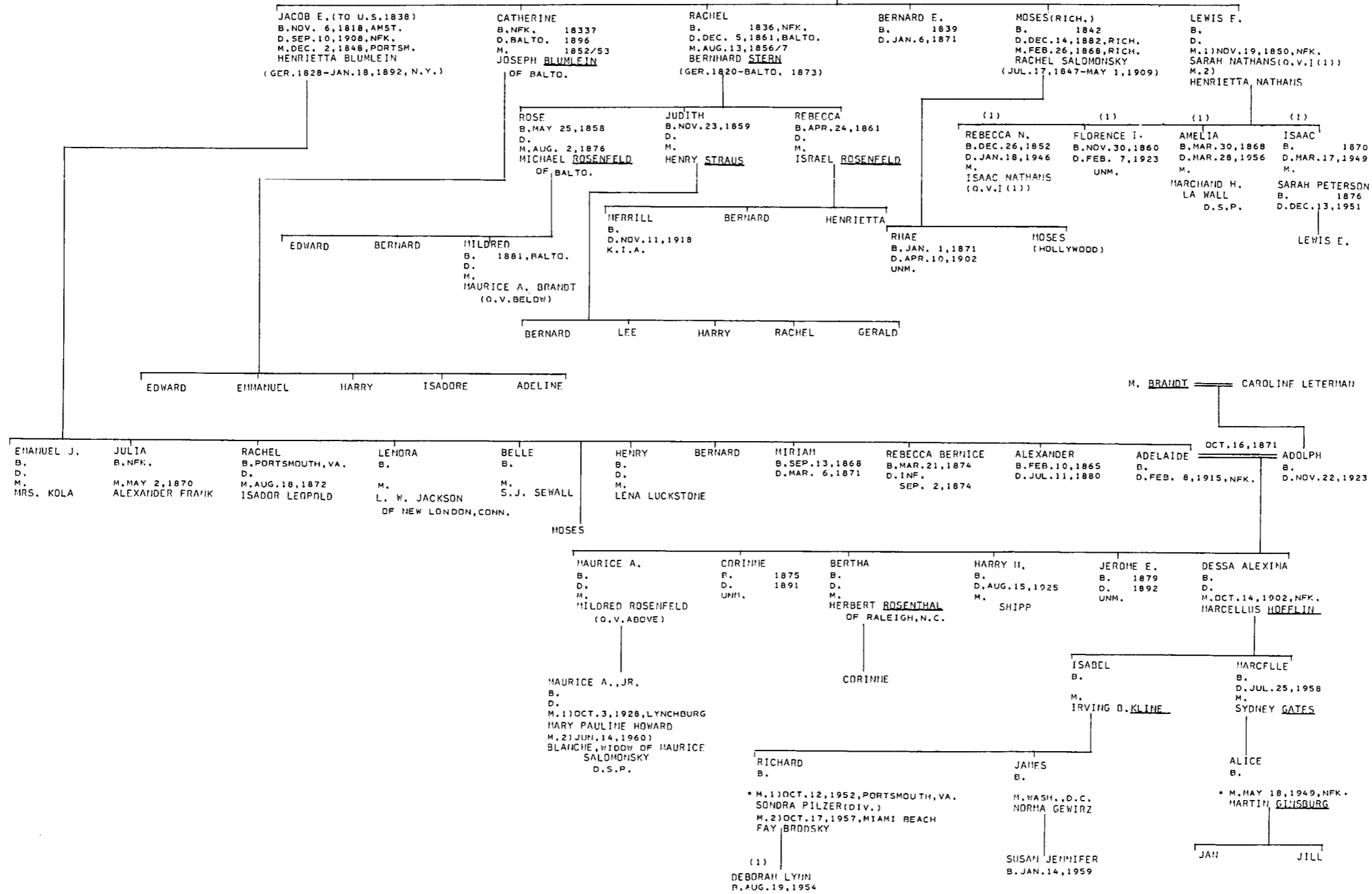

\*MARRIED BY RABBI MALCOLM H. STERN

MYERS V

R.I.J.H.S. NOTES, V.V, P.144;  
 V.VI  
 PAJHS V.26, P.174F,  
 V.27, PP.323,330  
 POOL- PORTRAITS  
 SHEARITH ISRAEL REC.  
 SUMMER SOCIAL REGISTER, 1949  
 D.A.R. REC. ELAINE G. MYERS  
 NEWPORT, R.I. CENSUS, 1774  
 JAMES-BIOG. SKETCHES OF  
 THE BAILEY-MYERS-MASON FAMILY  
 MORDECAI MYERS-REMINISCENCES  
 MYER SOLIS-COHEN  
 FEDORA S. FRANK  
 GEORGE MONTGOMERY  
 B'NAI JESHURUN REC.  
 ROBERT S. ZUCKERMAN

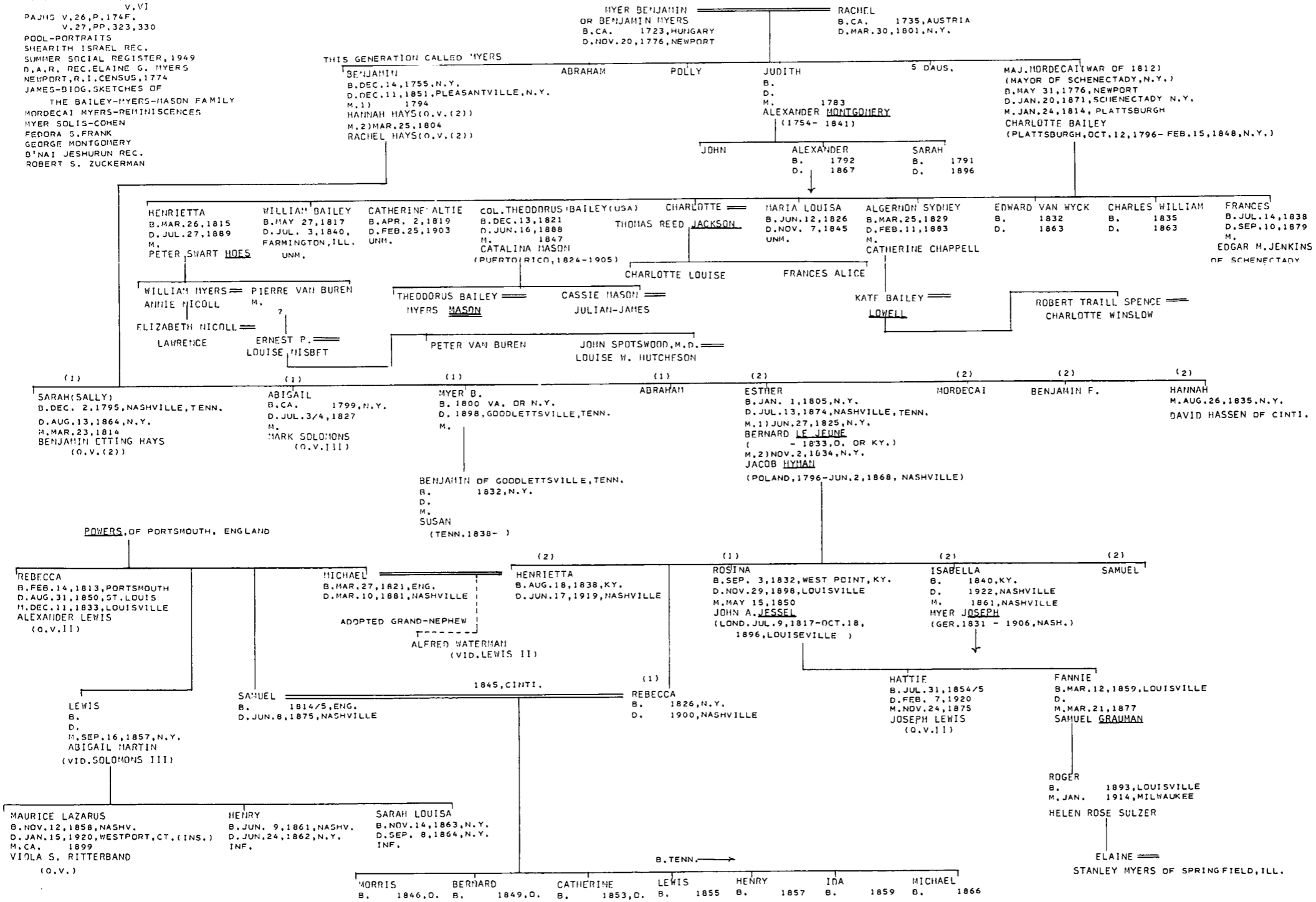

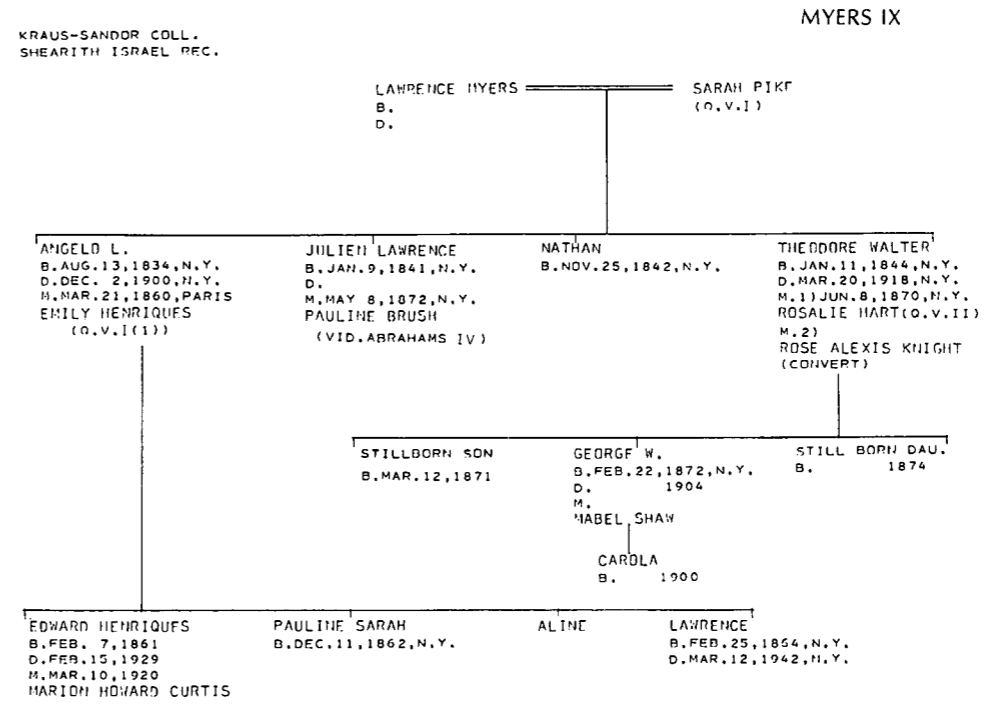
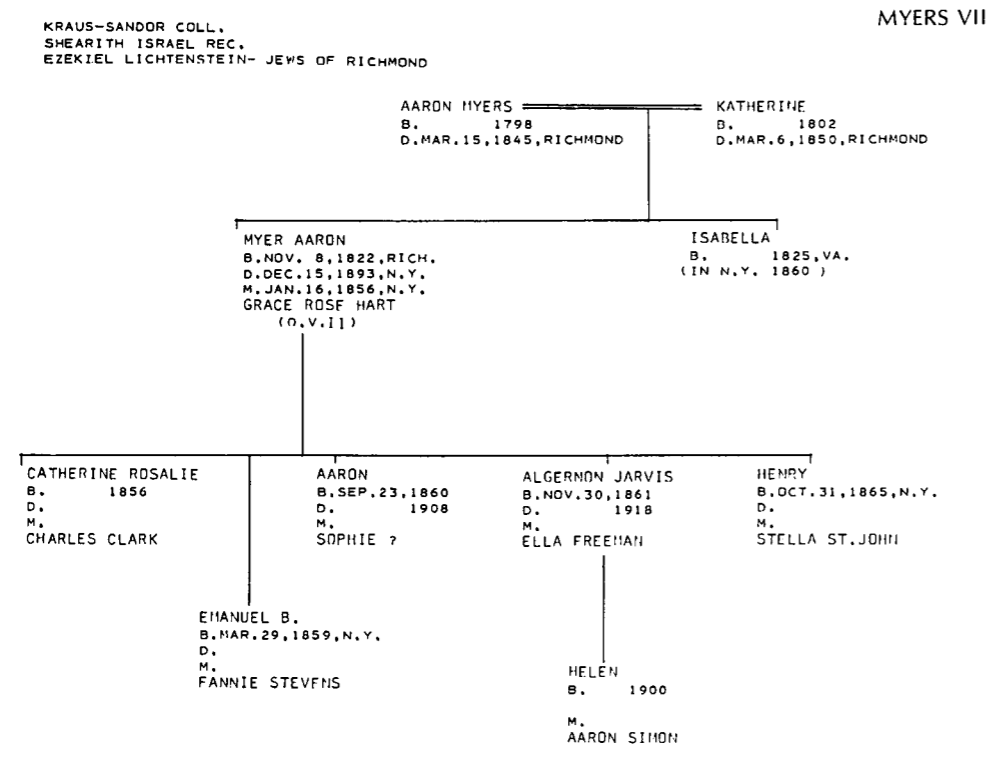
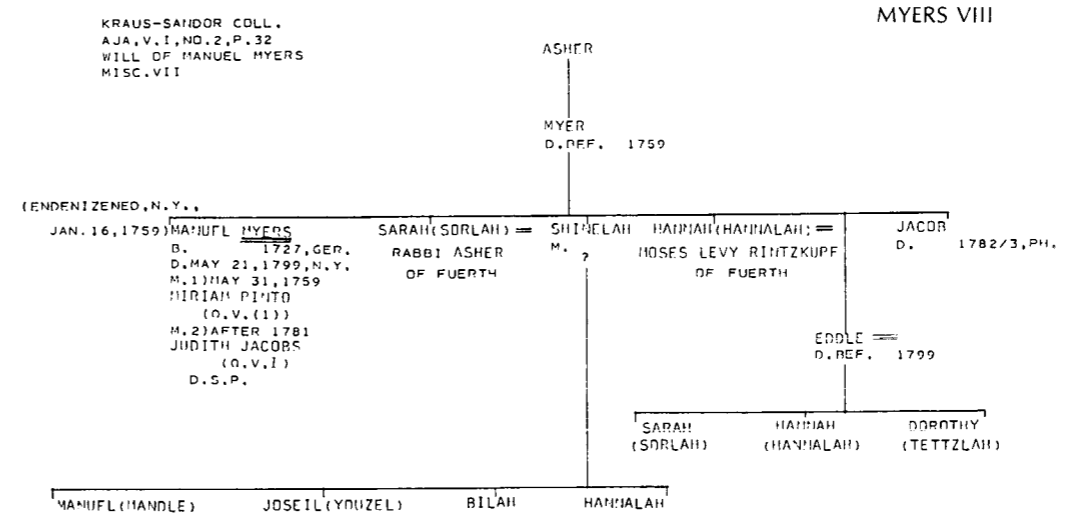
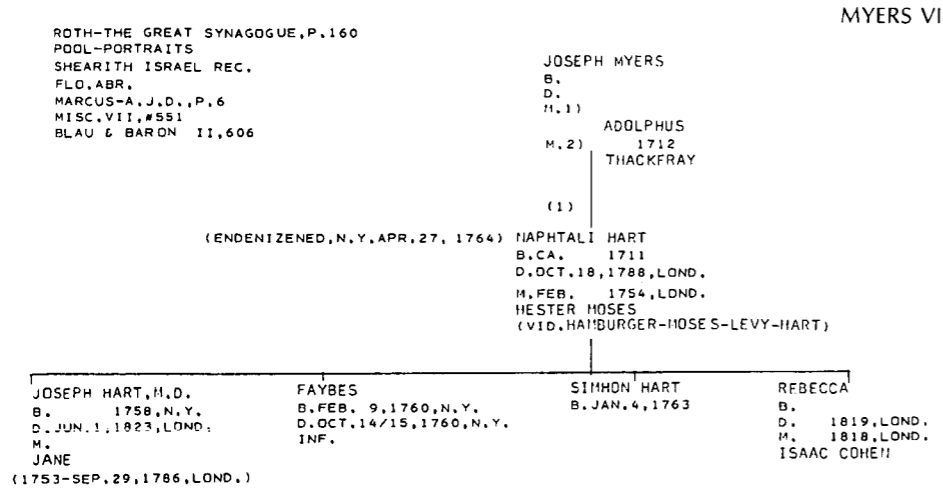

MYERS X

LUCILE S. MYERS  
 EZEKIEL-LICHTENSTEIN  
 CILLA G. NUSSBAUM  
 SYDNEY H. CONE, JR.  
 SAUL VIENER  
 NORFOLK-HEB, CEH.  
 A. J. Y. B. (5665), P. 159  
 ANNE P. MYERS  
 ISAAC ROSENHEIM GEN.

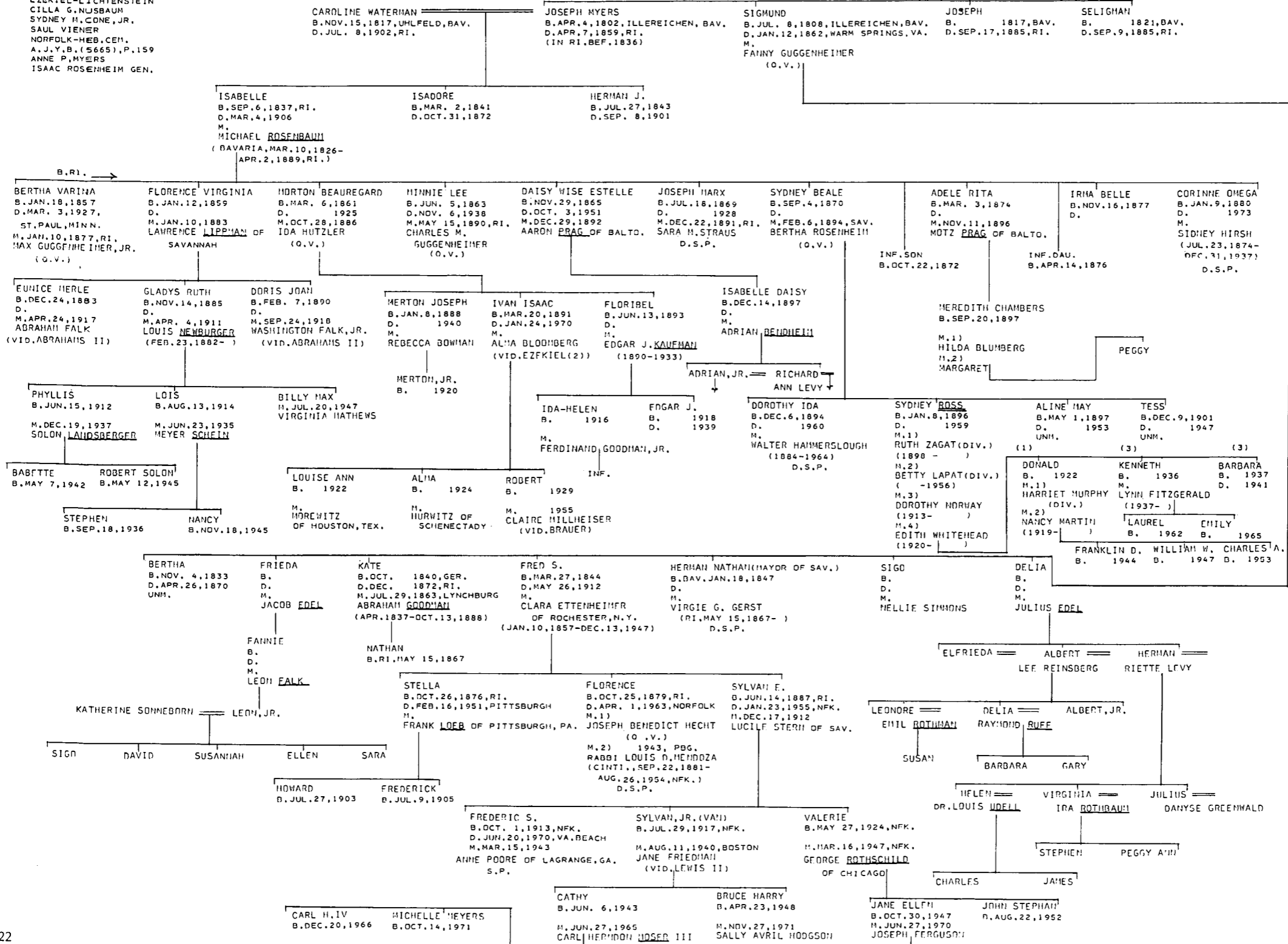

ROSENWAIKE-BALTO.  
 KRAUS-SANDOR COLL.  
 PAJHS V.18,P.99F.  
 V.19,PP.51,61  
 V.20,P.107  
 V.23,P.151F.  
 V.33,P.209F.  
 B.JACOBS MOHEL REC.  
 MDRAIS-JEWS OF PH.,P.410F.  
 ST.CHARLES  
 MOSES GEN.  
 MICKVE ISRAEL REC.  
 SHCARITH ISRAEL REC.  
 PODL-PORTRAITS  
 MISC.VII  
 AJA,V. XII,P.103F.  
 HERSHKOWITZ-WILLS  
 FEDERAL ST.CEM.

MYERS-COHEN I

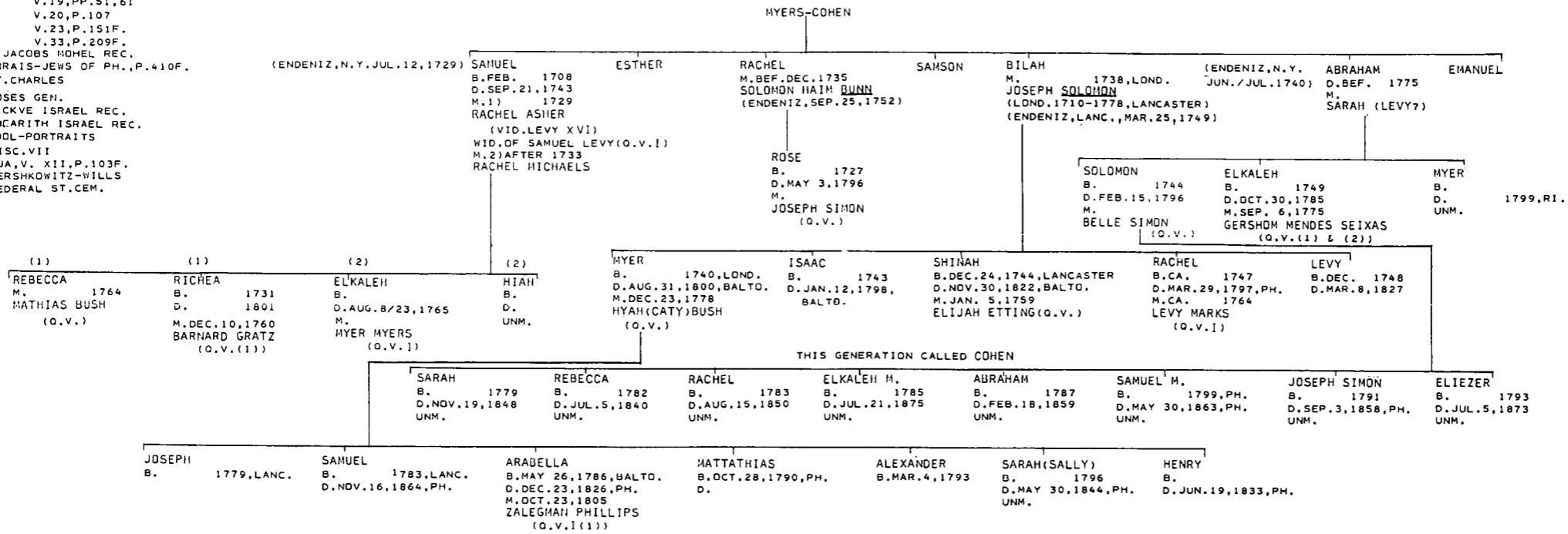

DAR LINEAGE BOOKS: 109,P.304;115,P.261  
 MURIEL S. CARTER  
 SHEARITH ISRAEL REC.  
 B'NAI JESHURUN REC.

MYERS-COHEN II

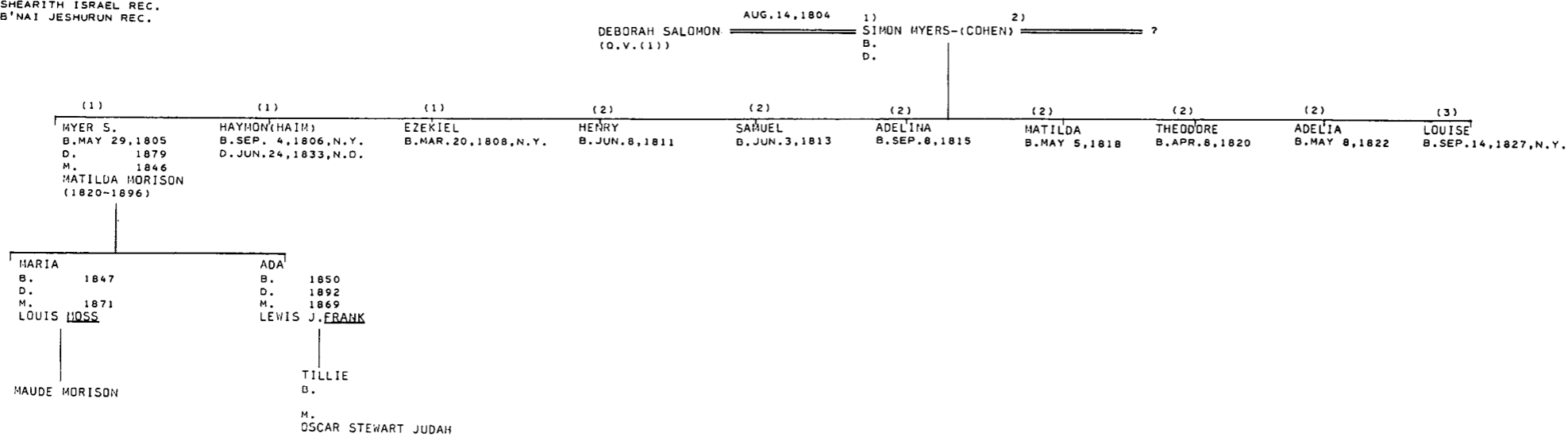

NAAR (1)

PA. ARCH., 2D SER., V. 3  
 EDITH K. NICHOLAS  
 KRAUS-SANDOR COLL.  
 SHEARITH ISRAEL REC.  
 AJHQ, V. 53, P. 373FF.  
 ST. THOS. CEM. REC.  
 E. N. A.  
 J. M. L. MADURO

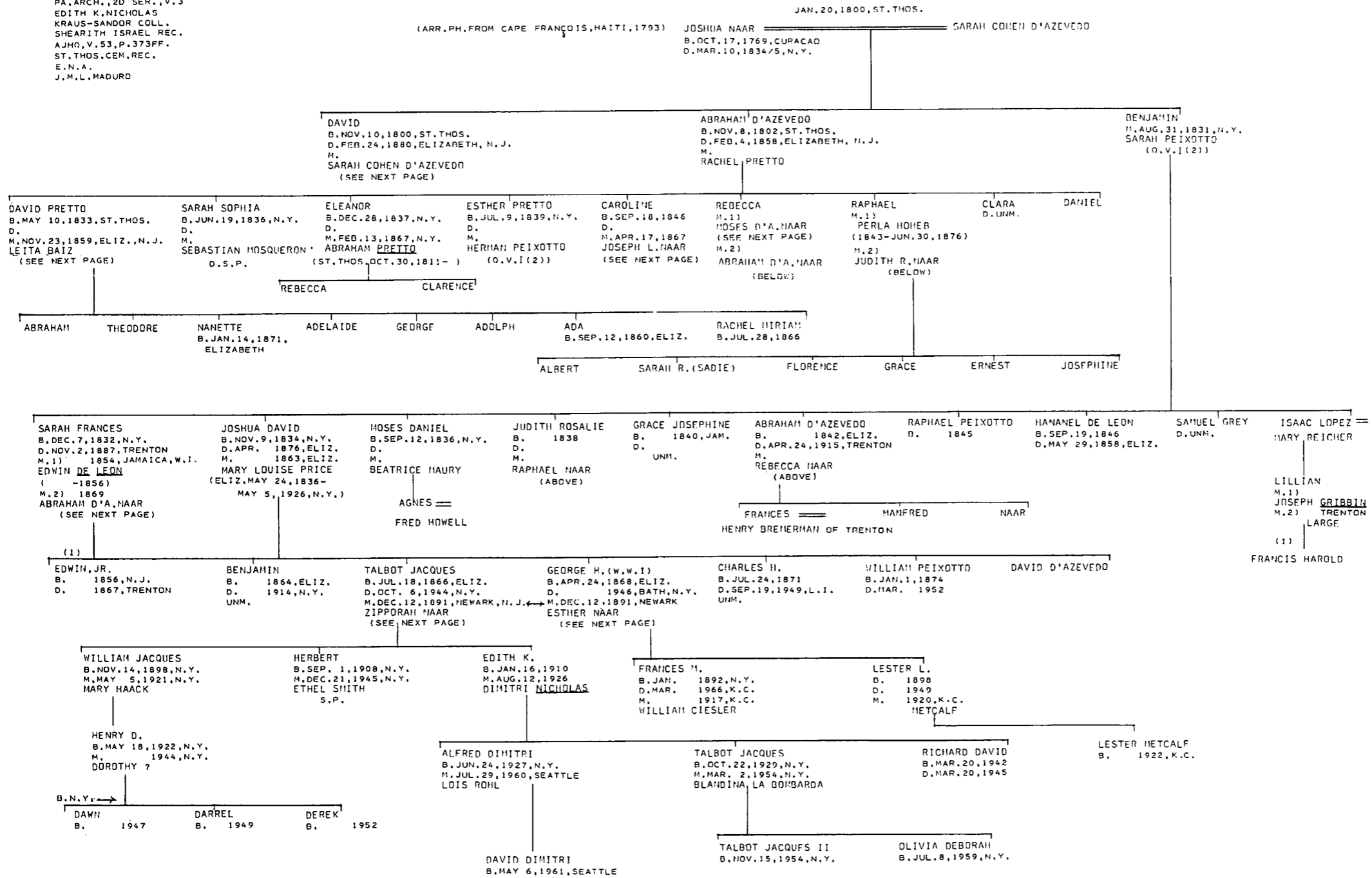

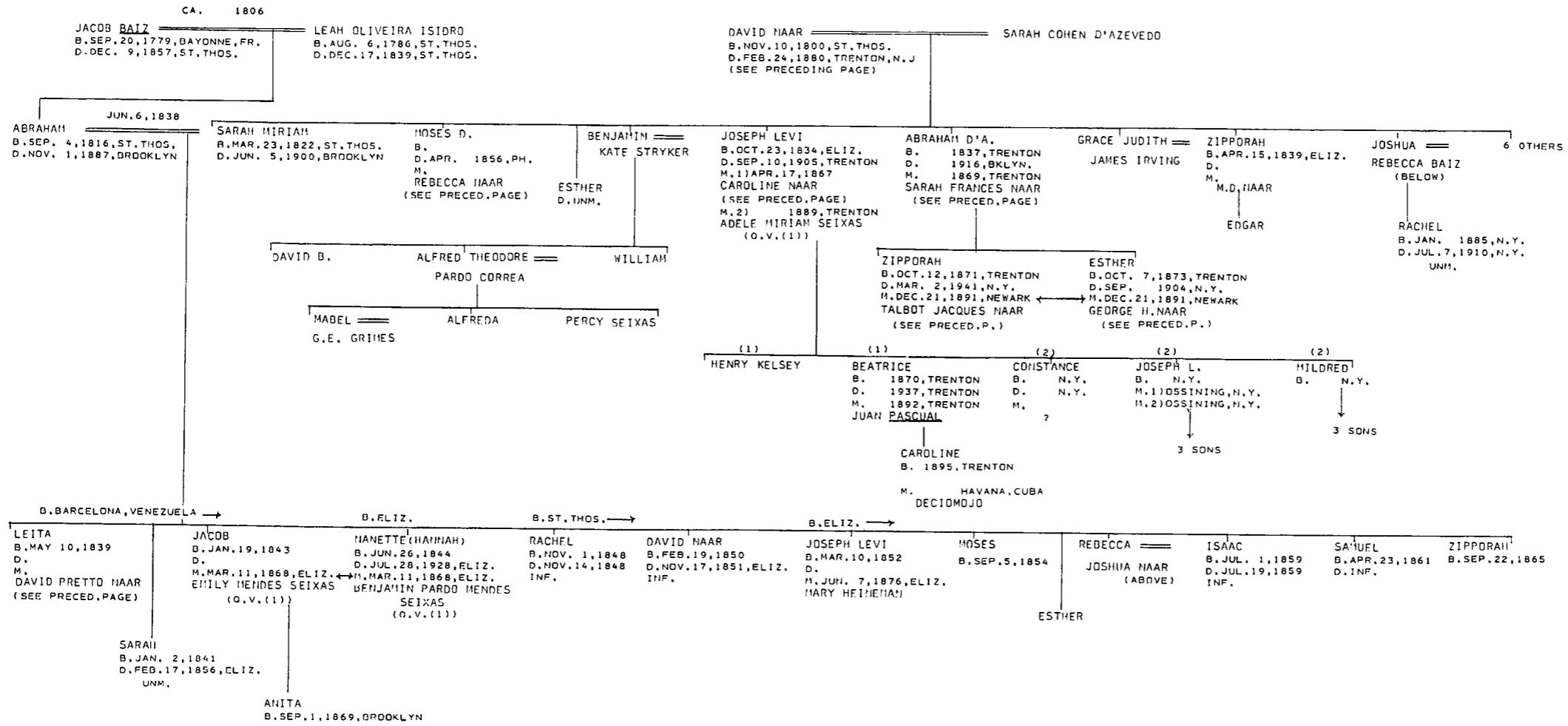



NATHAN I (I) (N.Y.)

KRAUS-SANDOR COLL.  
PAJHS, V. 4, P. 212  
V. 27, P. 166  
V. 31, P. 284F.  
J.E. V. 9, P. 177  
AJYB, 5665, P. 159F.  
GOLDSTONE GEN.  
HENDRICKS GEN.  
U.S. CENSUS 1850  
N.Y. TIMES, MAY 2, 1965 (OBIT.)  
ABE NEBEL  
MOGS GEN.  
SHEARITH ISRAEL REC.  
POOL-PORTRAITS...  
FLORENCE ABRAHAMS  
NATHAN FAMILY BIBLE

JUDAH NATHAN (ENGLAND)  
B.  
D.  
M.

7  
SIMON (WILLIAMSBURG, RICHMOND, 1779; N.Y., 1773)  
B. FROME, SOMERSETSHIRE, ENG. 1746/50  
D. SEP. 8, 1822, N.Y.  
M. AUG. 29, 1780, PH.  
GRACE SEIXAS (O.V. (1))

(ISAAC MENDES) SEIXAS  
B. MAY 24, 1785, N.Y.  
D. MAY 30, 1852, N.Y.  
M. NOV. 30, 1808, N.Y.  
SARAH SEIXAS (O.V. (4))

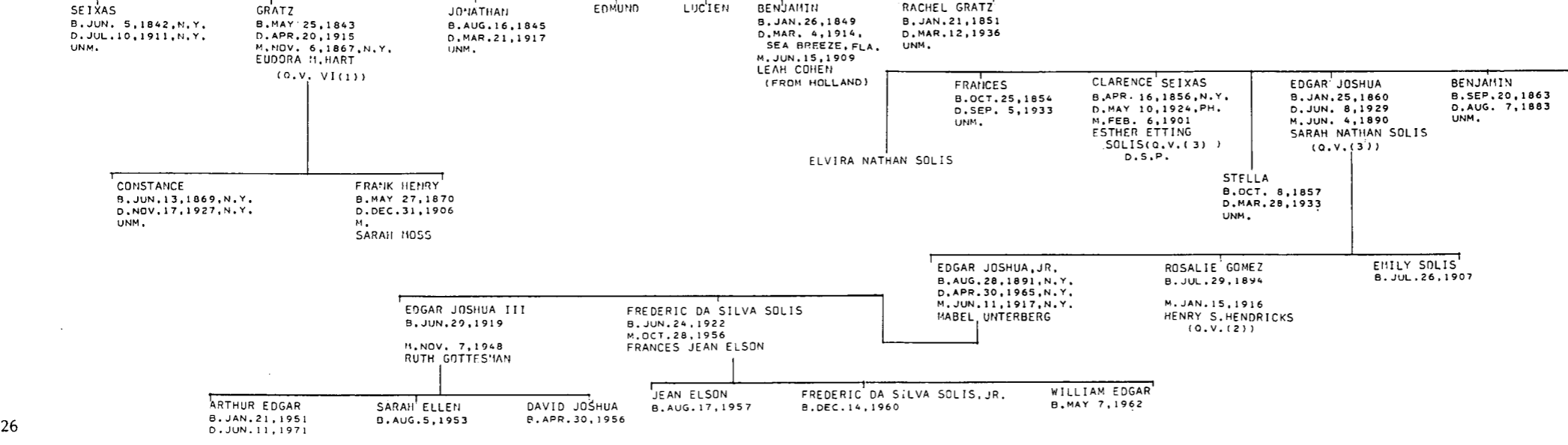
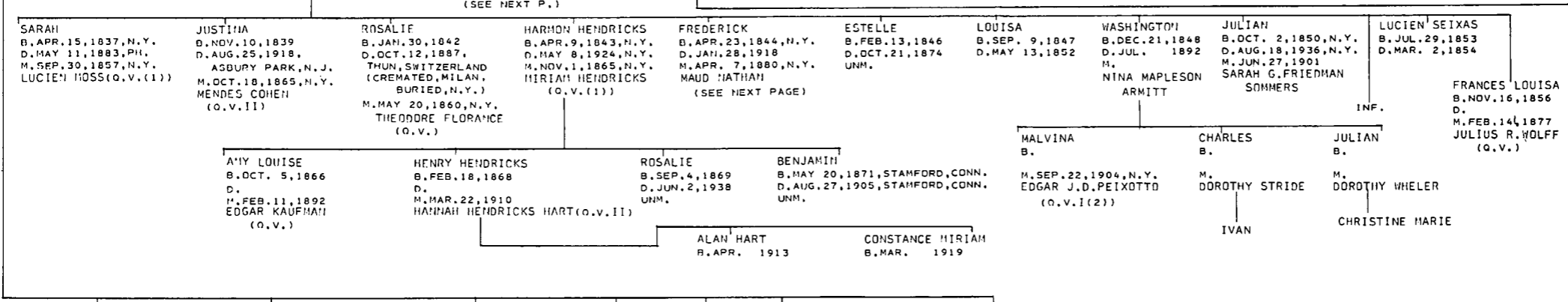
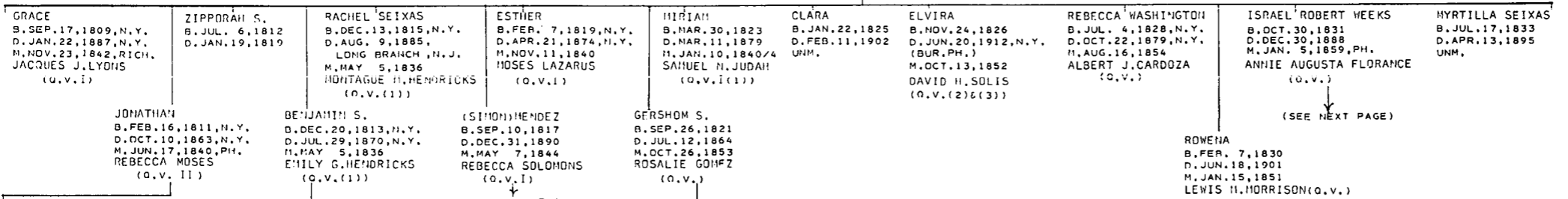

NATHAN I (2)

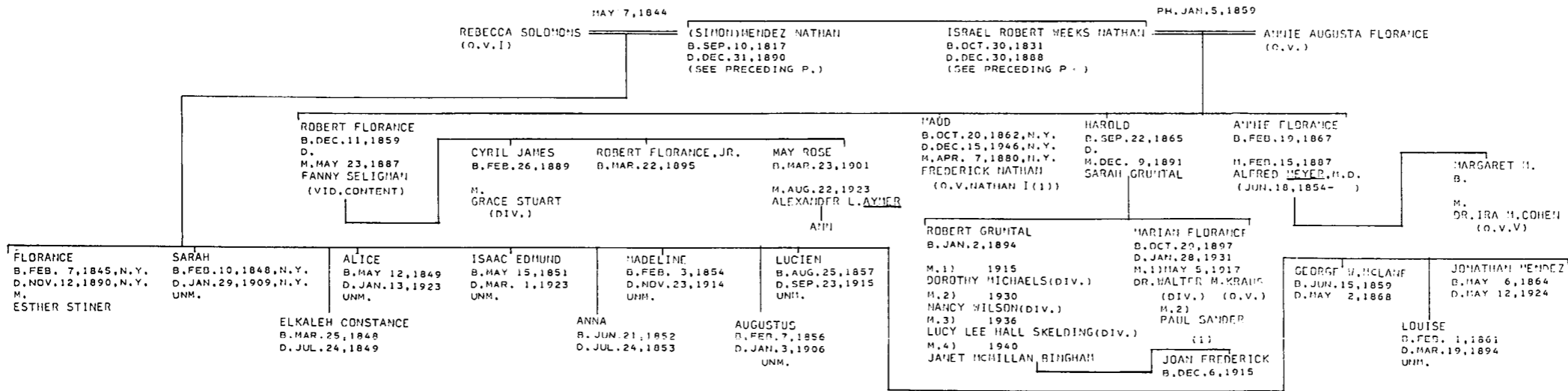

NATHAN III

MISC. VII, #544  
KRAUS-SANDOR COLL.  
PODL-PORTRAITS...

(NAT., READING, PA. APR. 3, 1763) LYDIA NATHAN (SERVED AS SHAMMAS OF HICKVE ISRAEL, PH.)  
B.  
D.  
M. 1750, N.Y.  
CAROLINE WEBB (PROBABLY A CONVERT)

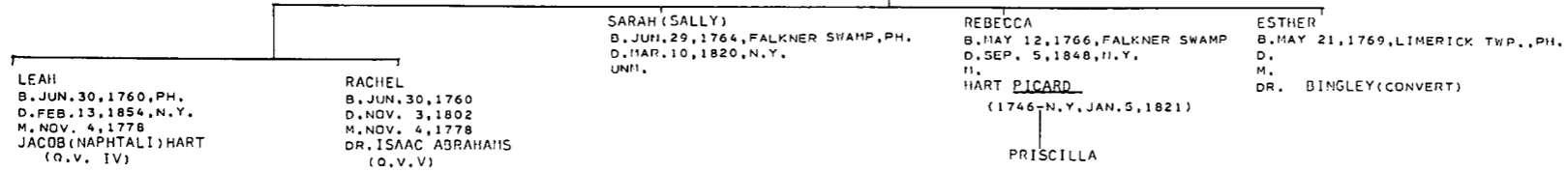

NATHAN IV

JACOB R. COHEN REC.  
WOLF-WHITEMAN

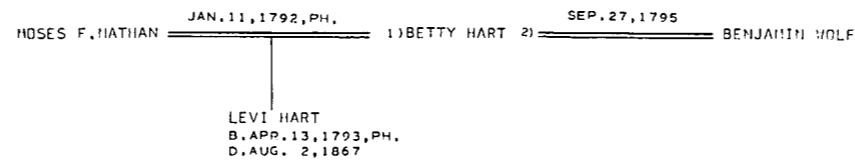

**NATHAN II**

ELZAS MSS. (NYHS)  
O. J. C.  
NATHAN GENEALOGIES (AJA)  
MOSS-HARRIS GEN.  
FLD. ADR.  
EGON WOLFF  
MOISE-JEWISH CEM. AT SUMTER

NATHAN THE SCRIBE OF AMSTERDAM

MOSES NATHAN  
B. PROBABLY AMST.  
D. LOND.  
M. 1)  
MILCO (AMELIA)  
(-AUG. 11, 1808)  
M. 2) SEP. 18, 1808  
EAVE, DAU. OF SAMUEL OF MAYENCE

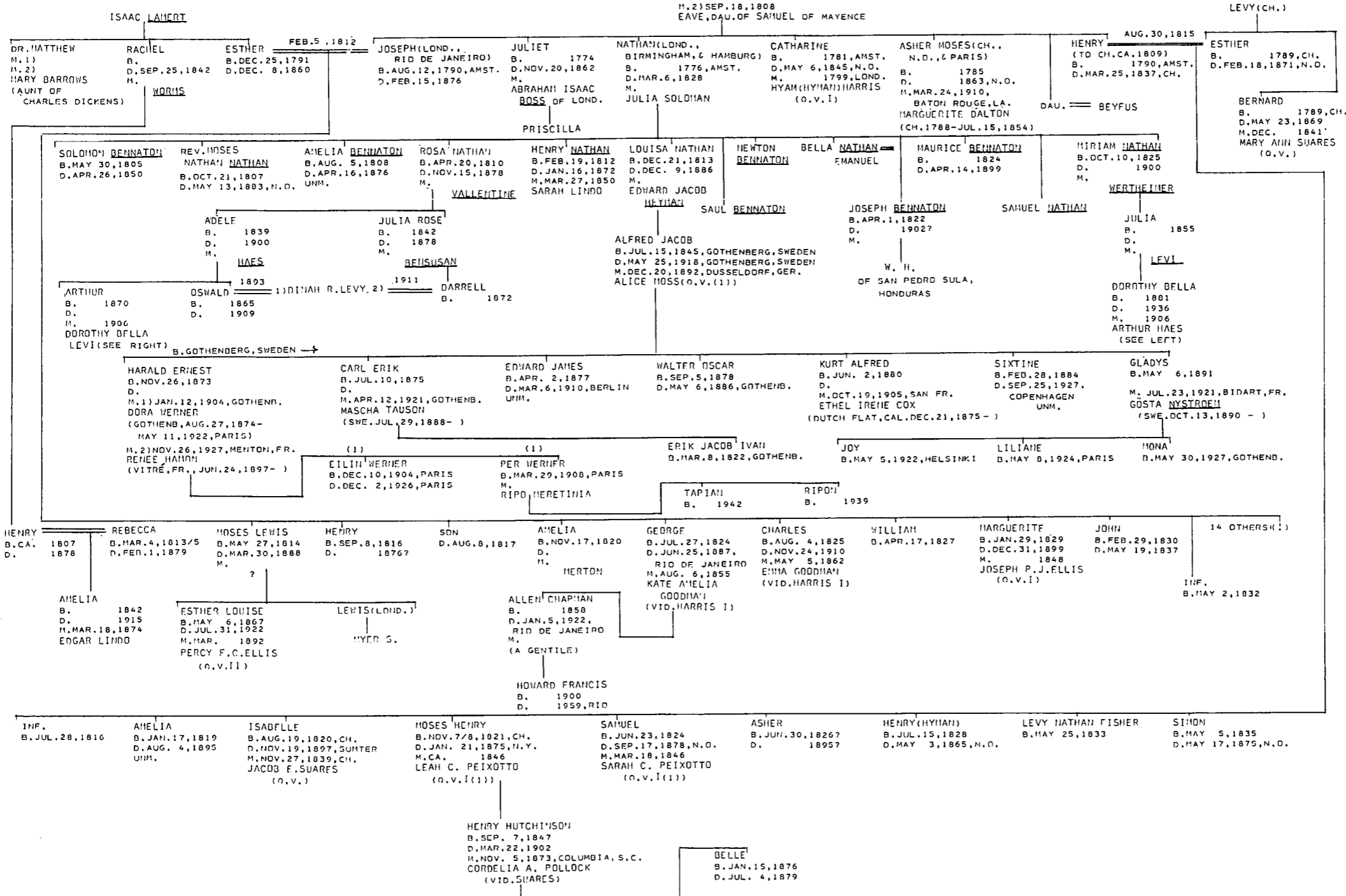

SPRUCE ST. CEM. REC. JACOB R. COHEN REC. KRAUS-SANDOR COLL. PAJHS V. 12, P. 180 HICKVE ISRAEL REC. DAR LINEAGE BOOKS NATHANS MSS (MRS. MELVIN FRANKLIN) MILL OF DAVID NATHANS (D. 1817) PHILIP M. RUSSELL NATHANS MSS. (HSP) FLO. ABR. RODEPH SHALOM REC. MYER SOLIS-COHEN FEDERAL ST. CEM. RUSSELL FAMILY BIBLE U.S. CENSUS 1790, 1800, 1820

BLAU & BARON, VIII, P. 697 MAXWELL WHITEMAN B'NAI JESHURUN REC. JOHN M. SHEFTALL POULSON'S

NATHAN LEVY

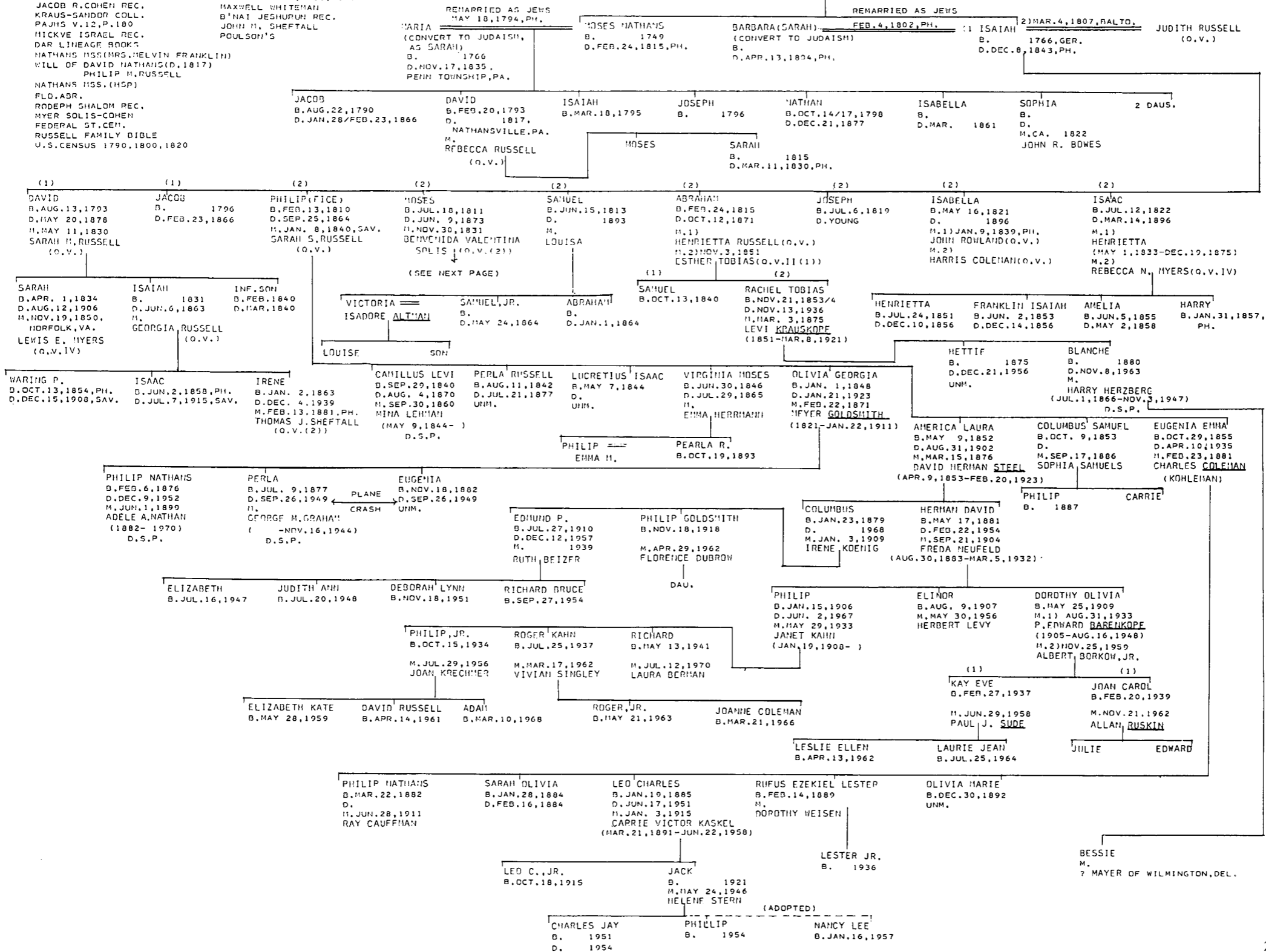

NATHANS I (2)  
MRS. IRWIN L. BERNSTEIN

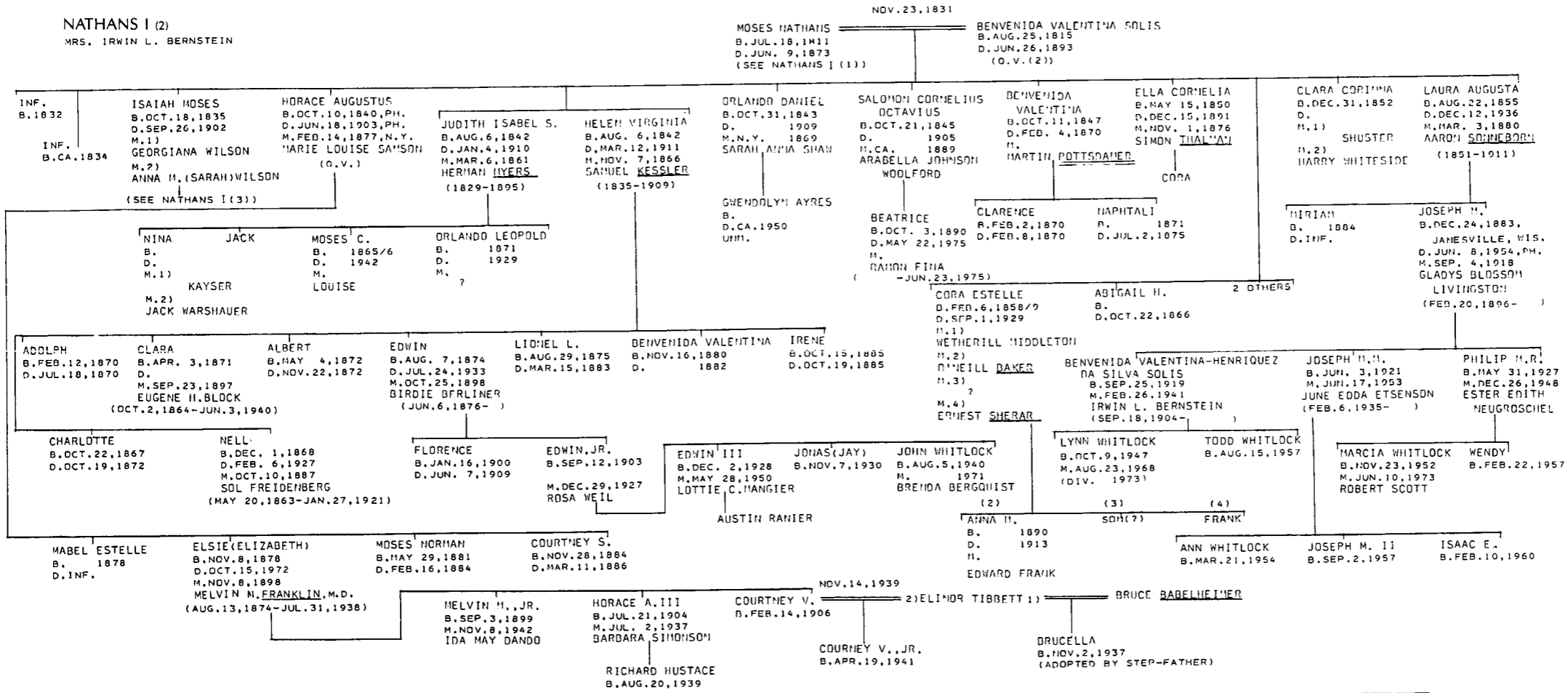

NATHANS I (3)

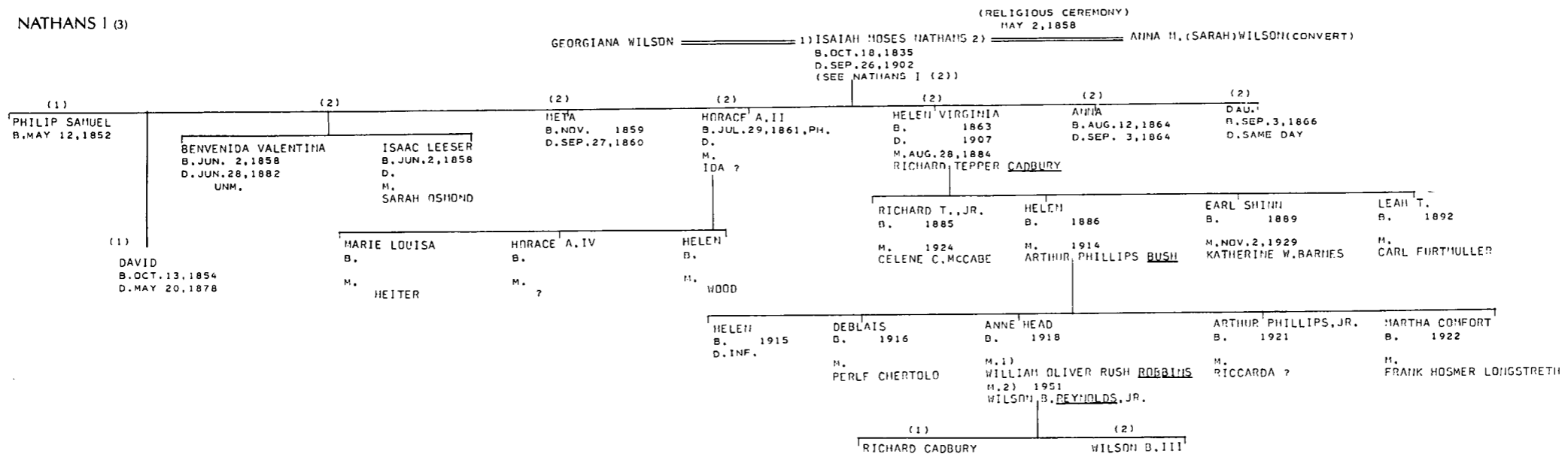

U.S.CENSUS,1880(J.STEDMAN)  
 H.MOISE-THE MOISE FAMILY  
 ELZAS-NEW. JEW.CEM. OF BETH ELOHIM  
 MS.  
 D.J.C.  
 ALEXANDER MS.(AJA)  
 WILL OF NATHAN NATHANS

NATHANS II (CHARLESTON)

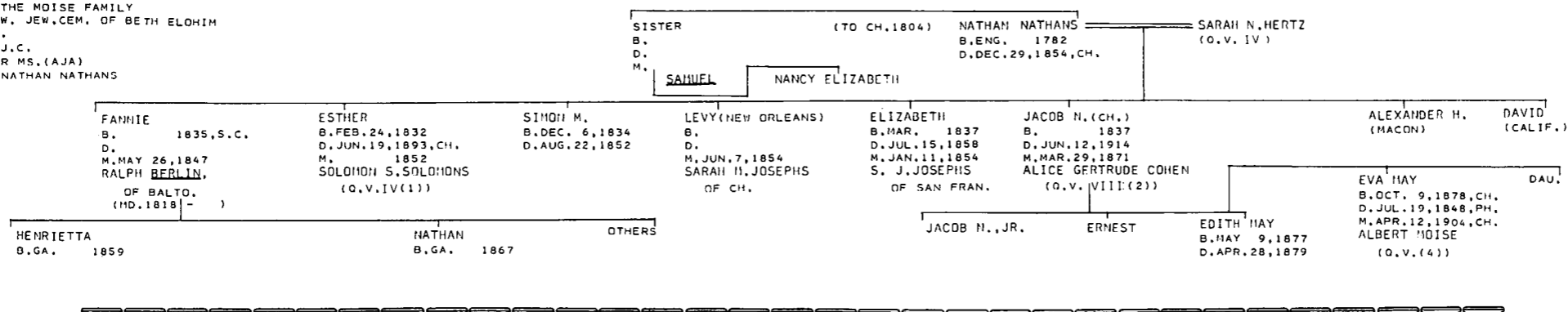

FEDERAL ST.CEM.  
 AJYB 5666,P.78  
 JRM COLL.  
 MICKVE ISRAEL REC.  
 FLORENCE ABRAHAMS  
 ALFRED D.SUMBERG  
 RODEPH SHALOM REC.

SIMEON NEWHOUSE OF ETTLINGEN,BAVARIA FLORENCE OBERDORFER

NEWHOUSE (1)

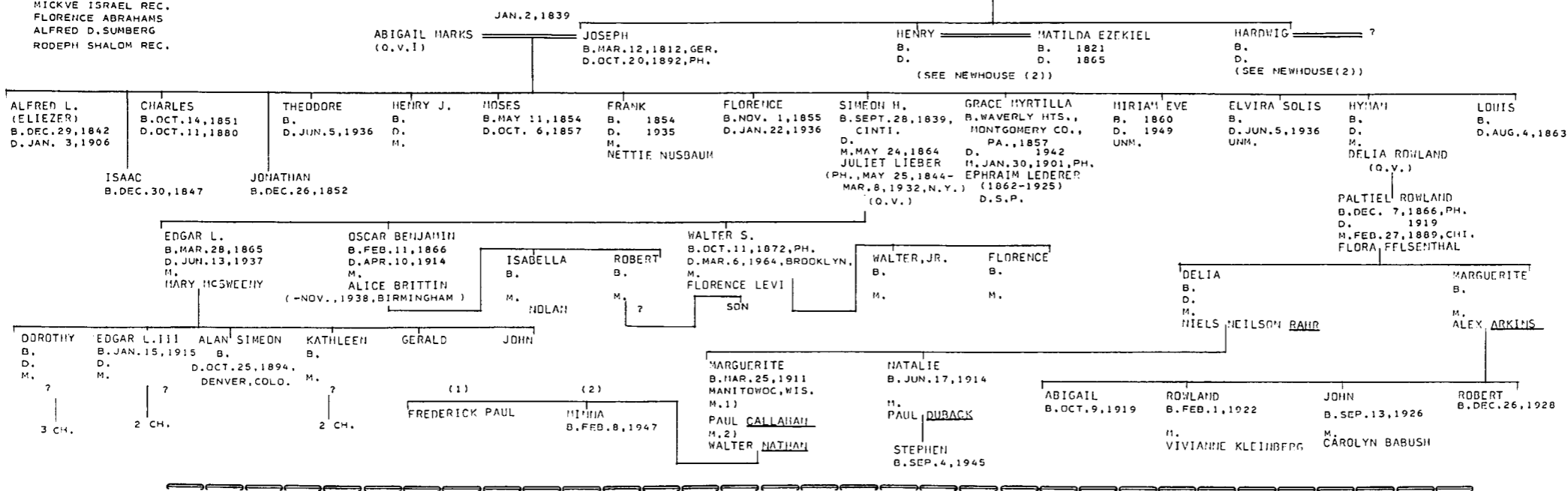

NEWHOUSE (2)

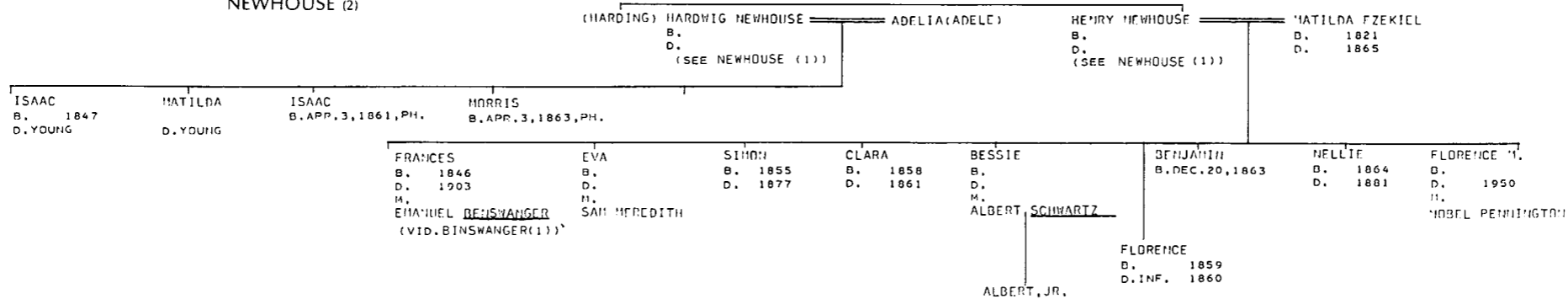

NOAH I

KRAUS-SANDOR COLL.  
JE  
UJE V.8,P.227  
GOLDREBG-MAJOR NOAH  
JACKSON-NOAH GEN.(AJHS)  
MICKVE ISRAEL REC.  
SHEARITH ISRAEL REC.  
W.GUNTHER PLAUT  
POOL-PORTRAITS...  
B'NAI JESHURUN REC.

MANUEL NOAH (REV. WAR)  
B. 1755, MANNHEIM, GER.  
D. JAN. 2/FEB. 22, 1822, N.Y.  
M. AUG. 4, 1784, PH.  
ZIPPORAH PHILLIPS  
(O.V.I (1))

MORDECAI MANUEL B. JUL. 14/19, 1785, PH.  
D. MAR. 22, 1851, N.Y.  
M. NOV. 26, 1827, N.Y.  
REBECCA ESTHER JACKSON  
(O.V.I)

JUDITH B. MAR. 1789, N.Y.  
D. AUG. 24, 1868, N.Y.  
UNM.

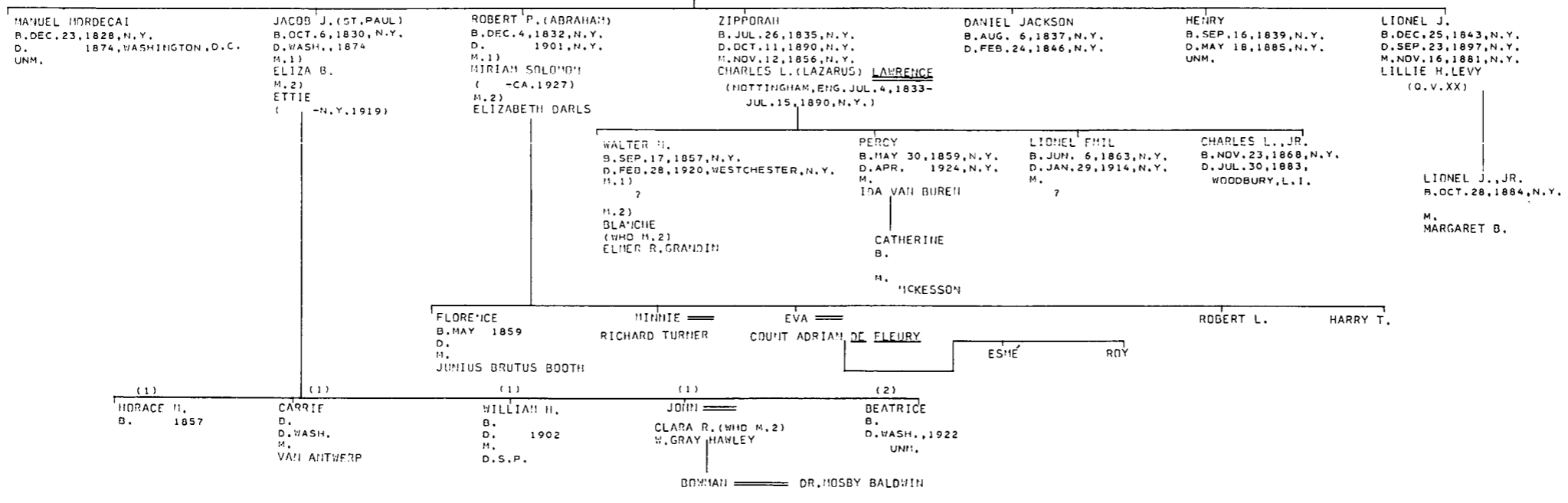

NOAH II

AJHO, V. LVI, P. 207<sup>11</sup>  
SHEARITH ISRAEL REC.  
ROSENWAIKE

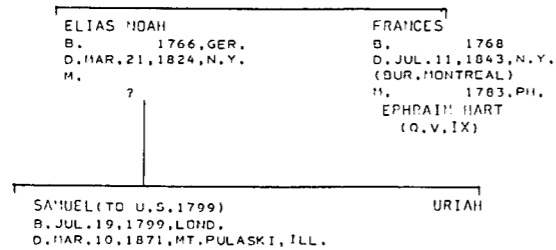

NOAH III

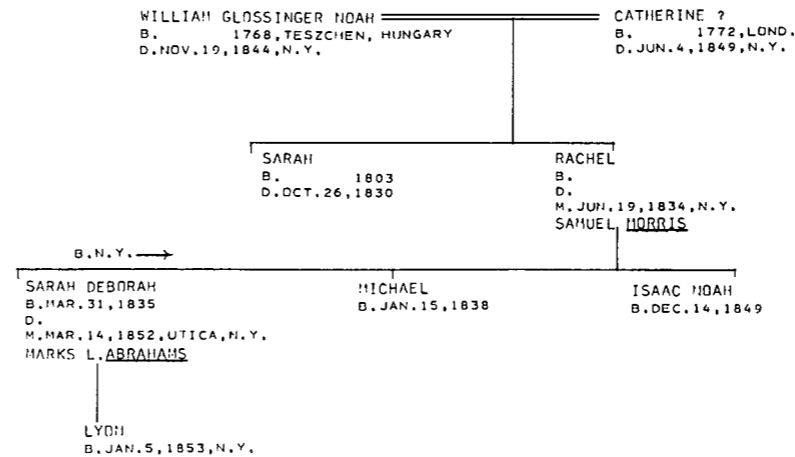

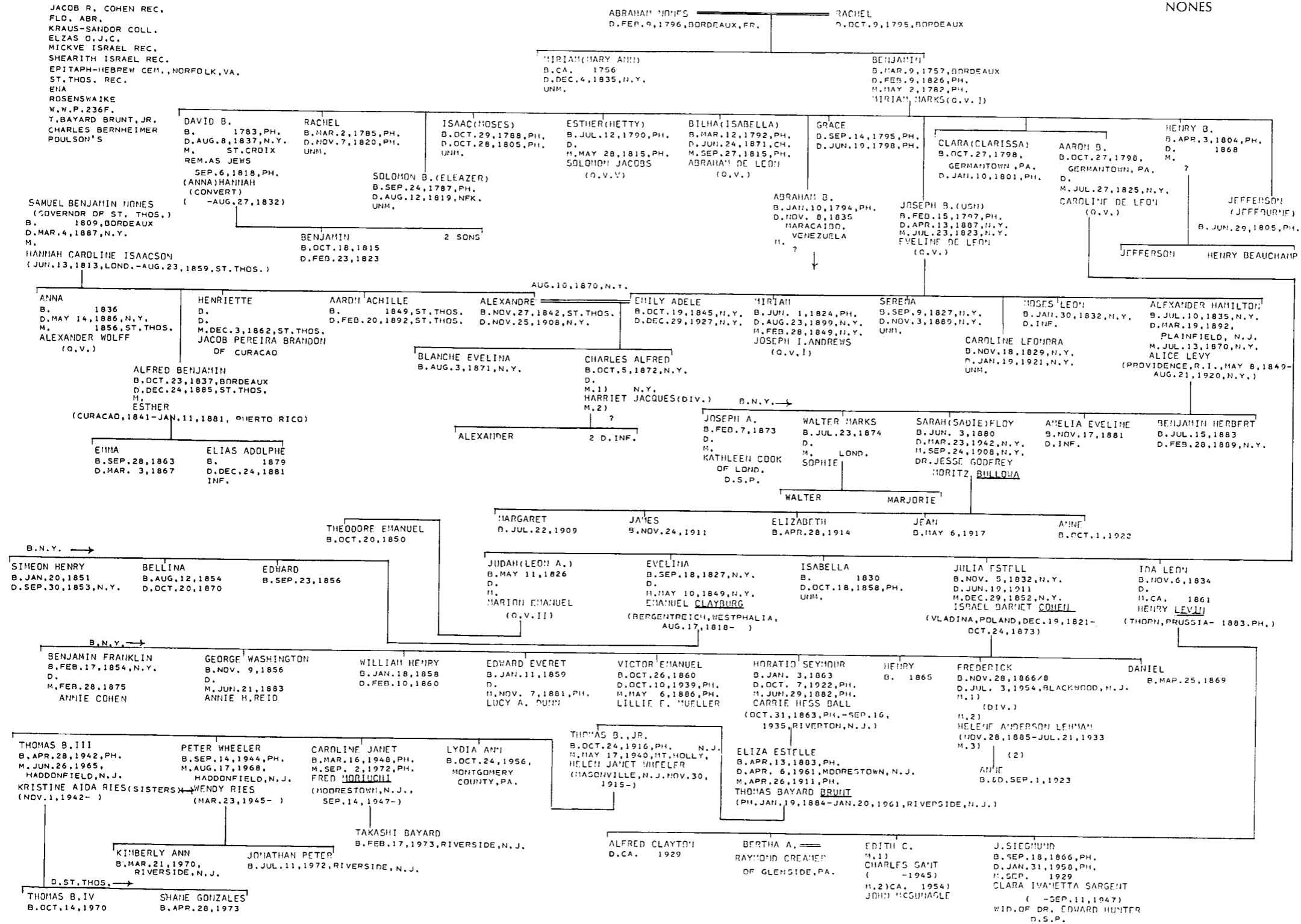



**NUNEZ**

MIGRATION & SETTLEMENT (JHSE), P. 63FF.  
 SHEFTALL MSS.  
 ELZAS MS.  
 CHATHAM CO., GA. WILLS  
 BEVIS MARKS REC.  
 MICKVE ISRAEL REC.  
 FLD. ABR.  
 HGSO, V. 54, P. 43  
 GA. NEWSPAPERS  
 ROSENWAIKE  
 MISC. V. VI  
 KORN-THE JEWS & NEGRO SLAVERY

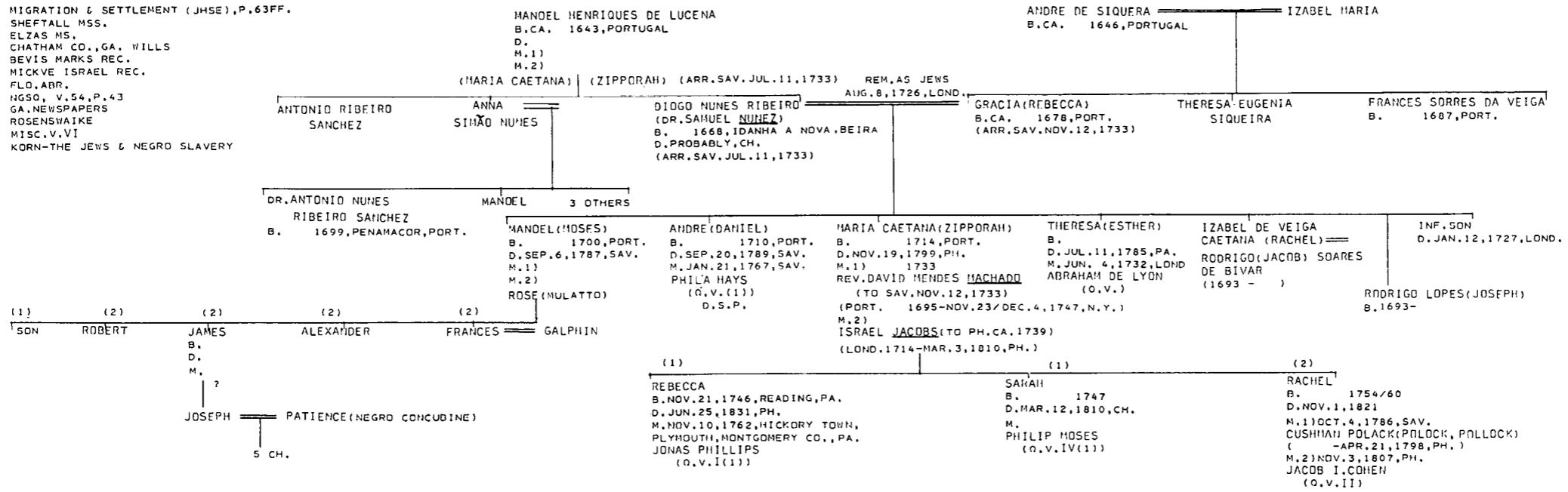

**OTTOLENGUI**

ELZAS M.N.  
 MS.  
 NEW JEWISH CEM. OF BETH ELOHIM  
 D.J.C.  
 WILL OF ABRAHAM OTTOLENGUI (JRM)  
 B.A. RODRIGUES  
 H. MOISE-THE MOISE FAMILY  
 JEWISH CEM. AT SUMTER  
 LAZARUS FAMILY BIBLE  
 ROSENWAIKE  
 SALLEY -M.N.

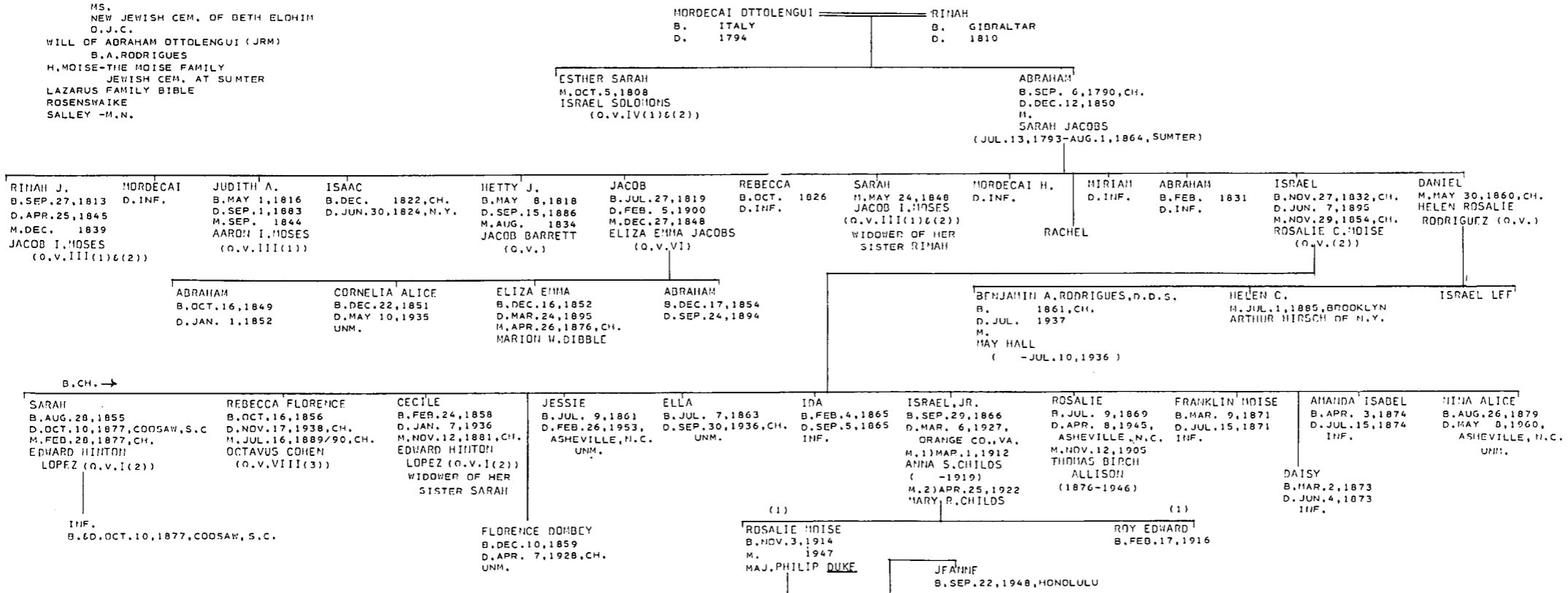

OPPENHEIM (1)

ROSENSTEIN  
E.J., V.12, P.1431F.  
ELZAS O.J.C.  
MS.  
OPPENHEIM MS.(JRM)  
J.E. V.9, P.410; V.12, P.503  
WILL OF HERTZ W. OPPENHEIM  
SHEARITH ISRAEL REC.  
FLO.ABR.  
OPPENHEIM FAMILY REC.(EMILY MEYER)  
ROSENWAIKE  
JON STEDMAN

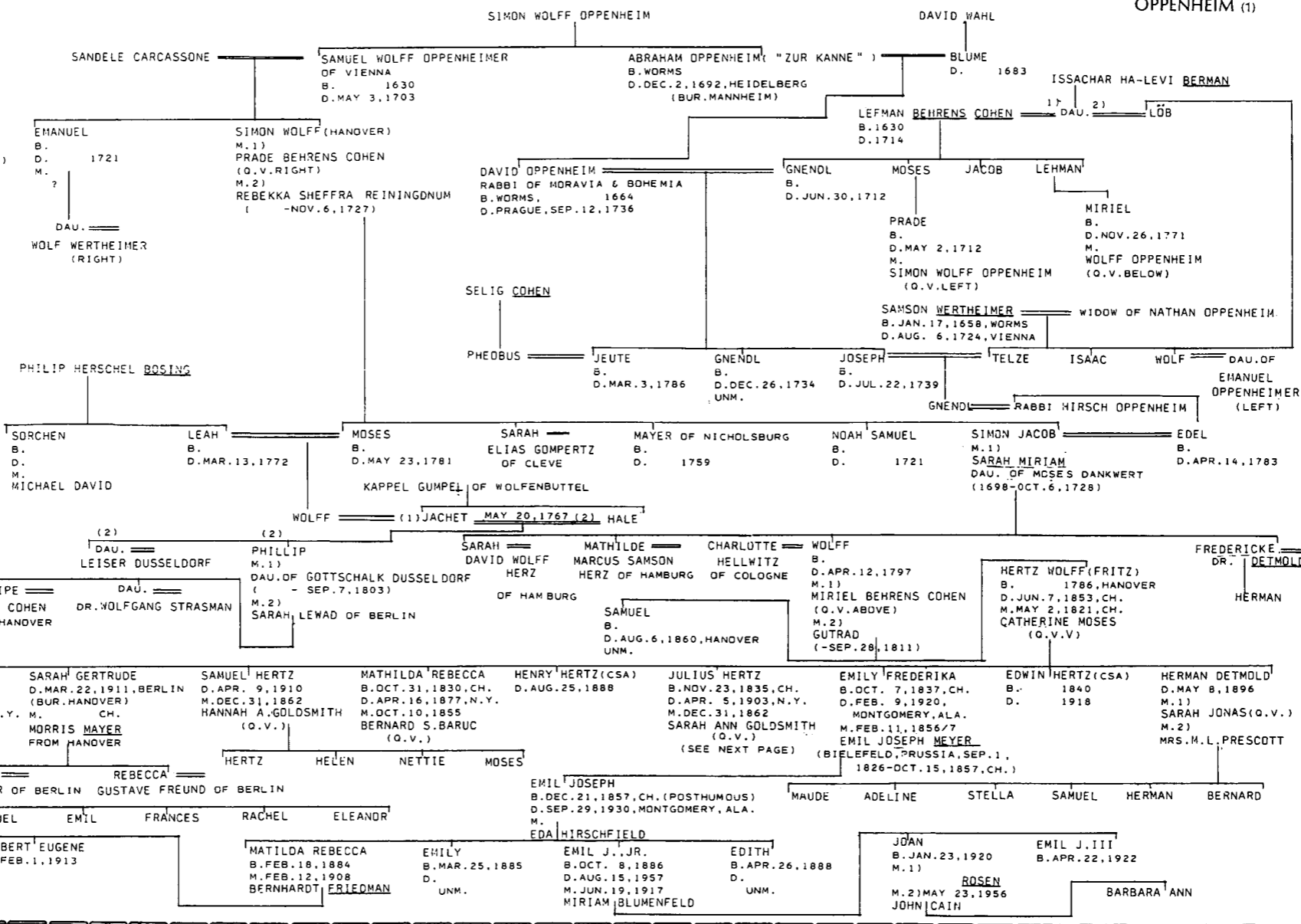

OPPENHEIM (2)

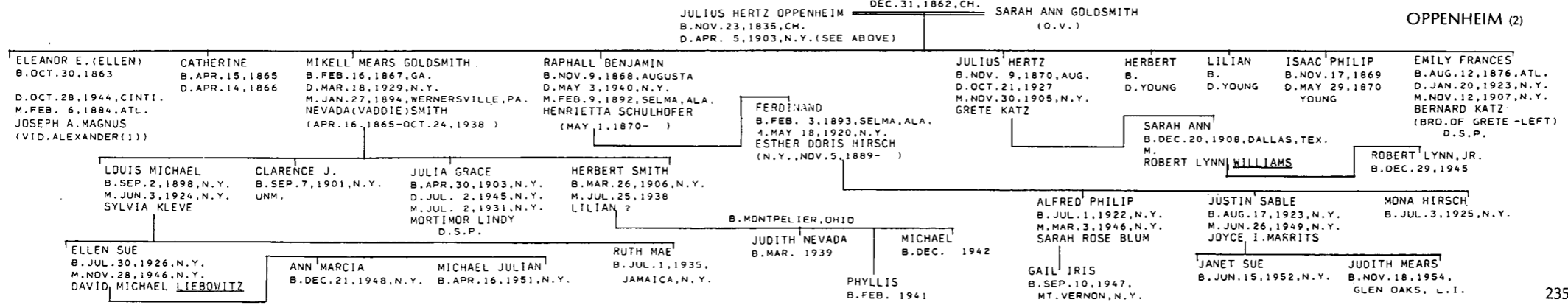

OPPENHEIMER (1)

JON STEDMAN

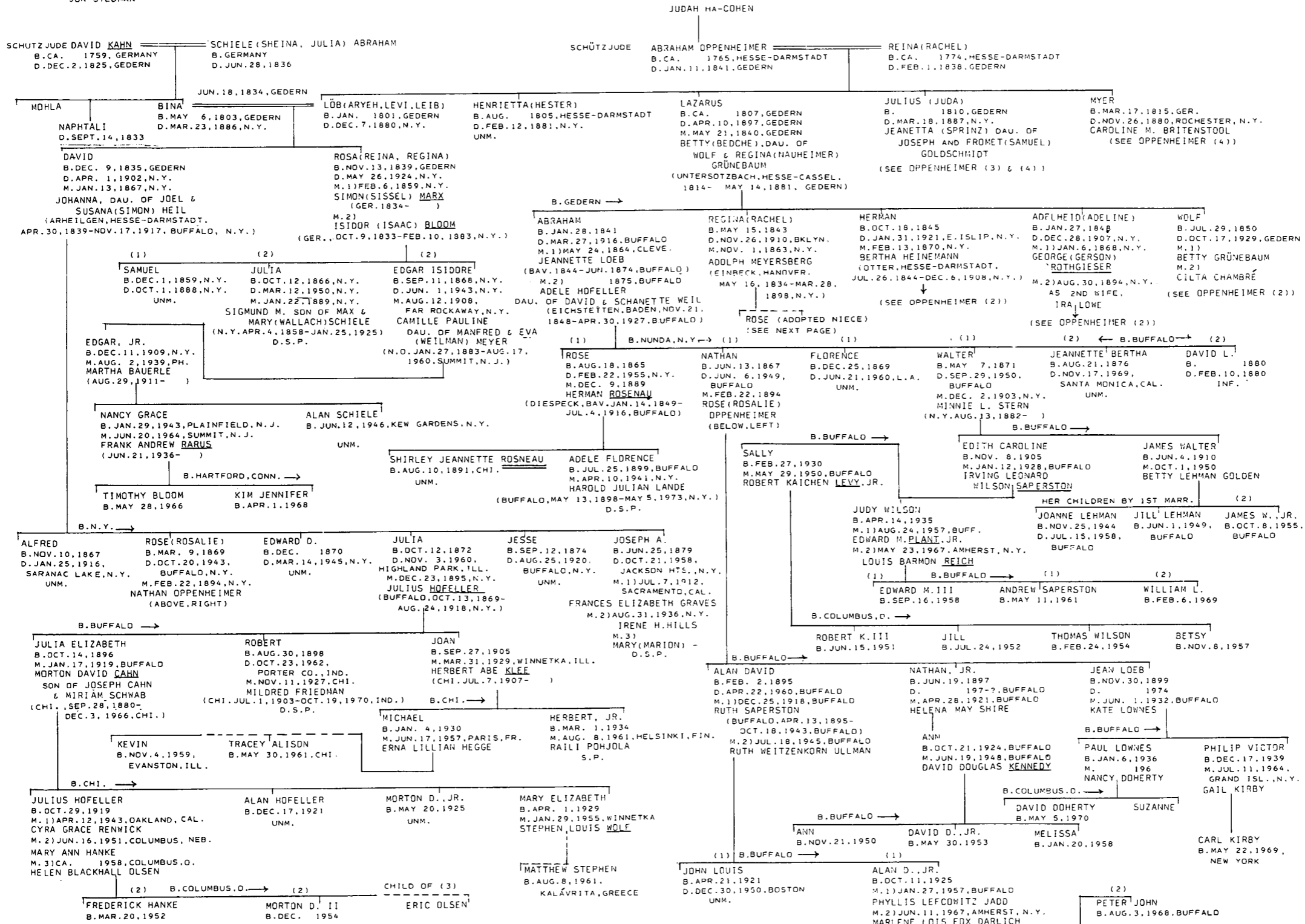

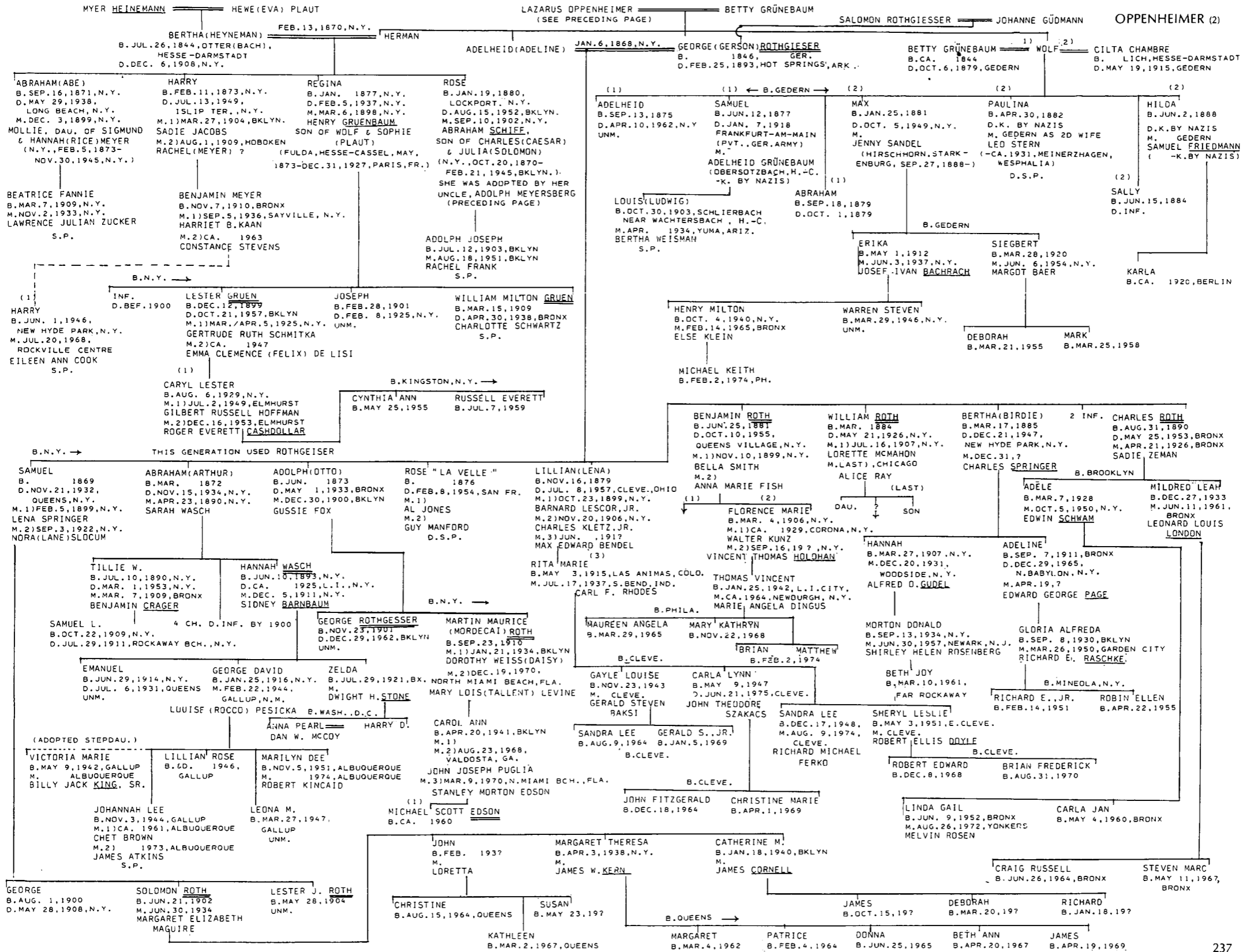

OPPENHEIMER (3)

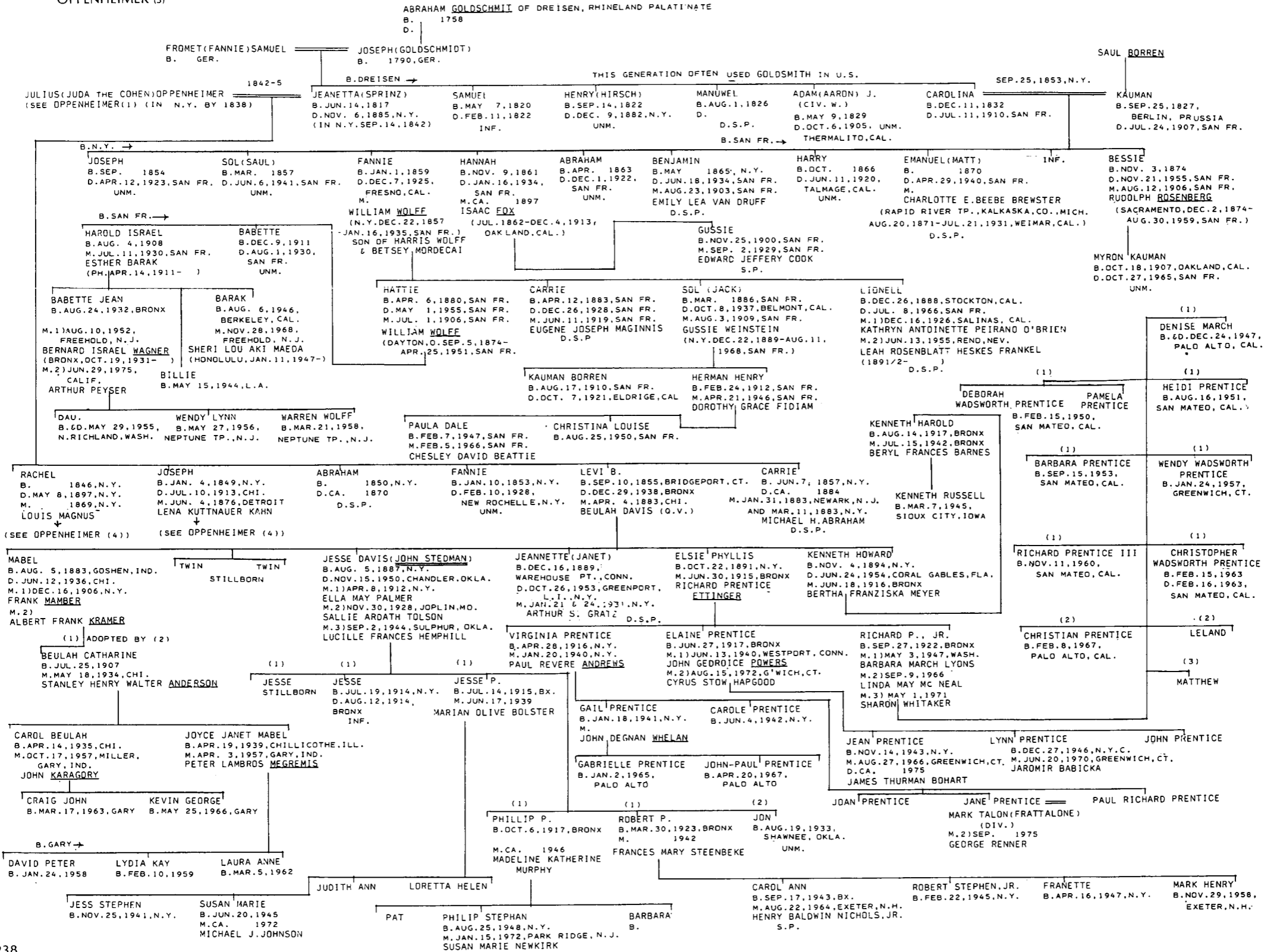

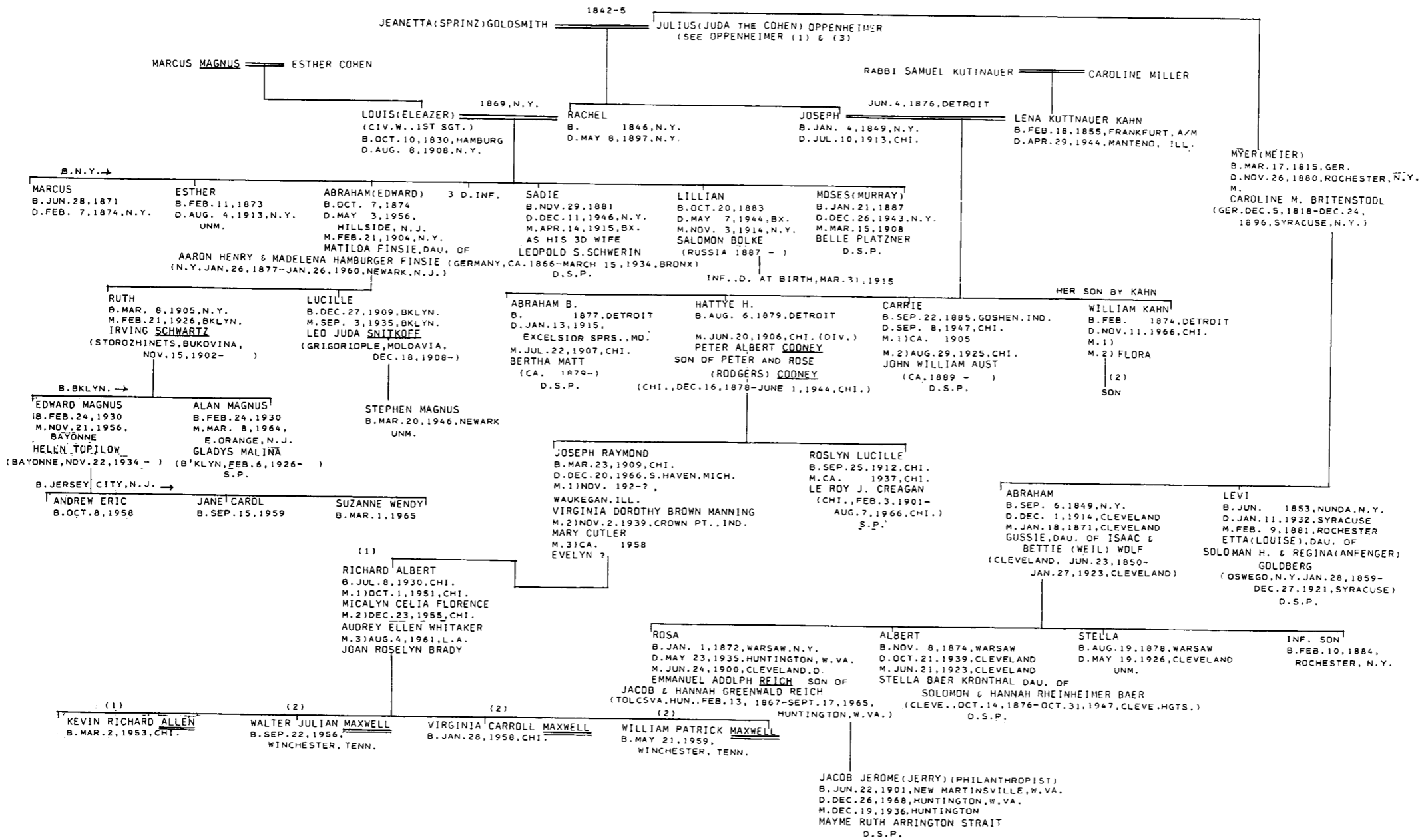

PALACHÉ

SHEARITH ISRAEL REC. PAJHS V.27,P.112

(TO N.Y. 1829)

ALEXANDER PALACHE MORDECAI ELIZA LUNA DE SILVERA

B. KINGSTON, JAMAICA ->

ESTHER B. 1798, ENG. D. JAN. 15, 1863, N.Y. UNM. RACHEL B. JUL. 1809 D. AUG. 17, 1894, N.Y. UNM. SARAH B. CA. 1812 D. JUN. 1, 1878, ENG. M. MAY 17, 1835, N.Y. MOSES J. HENRIQUES (O.V. I (1)) JUDITH B. CA. 1812 D. FEB. 7, 1884, N.Y. UNM.

PEIXOTTO I (1)

KRAUS-SANDOR COLL. CURACAO REC. SHEARITH ISRAEL REC. PAJHS V.27, PP. 167, 264, 342 V.29, P.35 ST. CHARLES, P. 131 GOLDSTONE MS. (AJA) MARKS MS. (AJA) NATHAN GEN. (AJA) ELZAS-JEWS OF S.C. JEWISH CEM. AT COLUMEIA M.N. MSS. (NYHS) AJYB 5665, P. 163 THELMA B. SCHLUSSBERG

HORTENSE PEIXOTTO BLUMBERG REZNIKOFF-JEWS OF CH., P. 290 FAMILY HIST. OF BENJ. MORDECAI POOL-PORTRAITS BEVIS MARKS REC.

SOLOMON C. PEIXOTTO REC. AMST. MUNICIPAL ARCH. EMMANUEL-PRECIOUS STONES E.N.A. ST. THOS. CEM. REC. J.M.L. MADURO ABE NEBEL EDGAR KAHN HELEN E. PEIXOTTO STEVEN W. SIEGEL

PARDO

POOL-PORTRAITS HERSHKOWITZ-WILLS E.N.A.

JOSEPH PARDO (RABBI, VENICE & AMST.) B. SALONIKA, OTTOMAN EMPIRE D. OCT. 11, 1619, AMST. M. ?

ISAAC D. USKUB, SERBIA ABRAHAM D. JERUSALEM DAVID (RABBI, AMST.) B. SALONIKA D. MAR. 15, 1657, AMST. M. RACHEL | SANCHEZ

JOSEPH (RABBI, LOND.) D. AUG. 24, 1677, AMST. M. DAVID (HAZAN, LOND., SURINAM) JOSIAH (RABBI, ROTTERDAM, AMST., CURACAO, JAMAICA) M. DAU. OF RABBI SAUL LEVI MORTEIRA DAVID (RABBI, SURINAM) D. 1716/17 JOSEPH BROWN (ENDENIZENED, N.Y. 1686) D. 1704 SAUL BROWN (HAZAN, NEWPORT, N.Y.) D. 1702/3 M. ESTHER (-1708)

JOSEPH D. APR. 8, 1690, N.Y. SARAH D. MAY 29, 1690, N.Y. JOSIAH B. SEP. 22, 1694, N.Y. D. MAY 22, 1755, CURACAO M. 1731/3, CURACAO ESTHER DE JACOB ISRAEL MONSANTO ABIGAIL D. NOV. 20, 1742, CUR. M. SAMUEL DE BENJAMIN CASSERES SARAH D. JUL. 27, 1723, CUR. UNM. SIMHAH B. D. JAN. 5, 1768, CUR. M. CA. 1717, CUR. SAMUEL IDANHA

ABRAHAM DE LA FAYA SARAH

ESTHER OCT. 8, 1623 DIEGO MENDES PEIXOTTO

ANTONIO MENDES (JOSHUA COHEN) PEIXOTTO

MOZES COHEN RACHEL (ABOAB?) (BRAZIL - ) JOSUAH B. 1663, CAYENNE, FR. GUIANA D. M. OCT. 5, 1688, AMST. ESTHER DE JACOB COHEN PEIXOTTO (BORDEAUX - )

DAVID COHEN (M. 1) RACHEL COHEN PEIXOTTO M. 2) FEB. 27, 1688, AMST. ESTHER DE SAMUEL LOPES HENRIQUES

ISAAC M. 1706, LOND. ESTHER DE MOSES ISRAEL NUNES

ABRAHAM M. 1707, LOND. RACHEL DE MOSES ISRAEL NUNES

DANIEL COHEN (AMST. TO CURACAO) D. PROVIDENCE (?) 1770

GRACIA DE ABRAHAM CAMPOS PEREIRA D. APR. 30, 1788, CUR.

SAMUEL LEVY MADURO AUG. 18, 1765, CUR. (SEE NEXT PAGE)

LEAH COHEN B. 1743 D. AUG. 20, 1827, CUR.

JOSHUA COHEN M. NOV. 21, 1773, CUR. ESTHER DE SOLOMON LEVY MADURO

SARAH COHEN B. CUR. D. M. AUG. 24, 1777 JACOB DE ISAAC JESSURUN SASPORTAS

JOSEPH COHEN B. CUR. D. AT SEA 1799 M. JUL. 20, 1783, CUR. RACHEL LEVY MADURO (SEE NEXT PAGE)

ABRAHAM COHEN D. DEC. 9, 1781, CUR.

B. CUR. -> GRACE COHEN B. AUG. 23, 1775 D. DEC. 26, 1827, ST. THOS. M. AUG. 23, 1795, CUR. MORDECHAY DE DAVID DE MORDECHAI ABINUN DE LIMA

REV. SOLOMON COHEN (HAZAN, ST. THOS., CH.) B. 1785 (ARR. CH., OCT. 5, 1818) D. 1837 M. DEC. 24, 1809, CUR. RACHEL DE DAVID DE ISAAC SUARES (CUR. CA. 1791 - JUN. 25, 1826, CH.)

DANIEL COHEN B. 1789 D. M. MAR. 15, 1804, CUR. RIBCA DE JACOB DE SOLOMON LEVY MADURO

DANIEL D. 1784

DANIEL B. 1789

SEP. 3, 1817, CUR. 1) GRACE ELIAS DE RAPHAEL NAMIAS DE CRASTO 2) DEC. 6, 1837, CUR. LEAH

JOSHUA COHEN (SEMINOLE WAR) B. JUN. 4, 1810, CUR.

ESTHER B. FEB. 3, 1811, CUR. D. SEP. 29, 1853, N.O. M. FEB. 20, 1839, CH. LEWIS HERTZ

RACHEL B. JAN. 31, 1814, CUR. D. JUL. 25, 1843 M. FEB. 1839, CH. ELEAZER MYERS

DAVID E. COHEN B. MAY 16, 1815, CUR. D. APR. 18, 1897, COLUMBIA, S.C. M. OCT. 9, 1839, N.O. CAROLINE SOLOMONS (O.V. IV (1))

GRACE B. OCT. 30, 1817, ST. THOS. UNM.

REBECCA (RIBCA) B. MAR. 4, 1820 D. OCT. 9, 1837 UNM.

LEAH COHEN B. JUN. 29, 1822 D. 1909 M. 1846 MOSES HENRY NATHAN (O.V. II)

DAU. STILLBORN JUL. 7, 1824

SARAH COHEN B. JUN. 23, 1826 D. 1904 M. MAR. 18, 1846 SAMUEL NATHAN (O.V. II)

JOSHUA (ADOPTED BY HIS UNCLE SAMUEL NATHAN)

REBECCA M. NOV. 11, 1857 LEVY JUDAH HARRIS (O.V. I)

R (ACHEL?) M. DEC. 8, 1857 A. J. HOFFMAN OF BEAUFORT, S. C.

SOLOMON C. (CSA) B. 1840, N.O. D. JAN. 1919, ATLANTA M. SEP. 21, 1870, CH. HORTENSE LEVY (-1923)

REV. JULES (CSA)

DANIEL D. YOUNG

B. ATLANTA -> ZELMA B. SEP. 21, 1917 M. MARION LEVY

SOLOMON C. B. MAY 25, 1918 M. SHIRLEY THAYER

HORTENSE B. FEB. 16, 1924 M. JACK BLUMBERG (DIV.)

EDGAR COHEN B. NOV. 21, 1884, CH. D. JUL. 29, 1940, ATL. M. OCT. 24, 1915 HANNAH RACHMIL (PH. NOV. 4, 1899 - )

DAISY C. B. FEB. 27, 1880, COLUMBIA D. JUL. 18, 1954, DAYTONA BEACH, FLA. M. DEC. 27, 1903 MEYER MANUEL BOWMAN

CAROLINE C. SOL SIDNEY WOOD

CAMILLE C. M. 1) HARRY MCCARTHA M. 2) CHARLES BEARDEN

MIRIAM C. PRESTON DOWLING

ADRIENNE C. M. 1) SCOTT KENNETT M. 2) BARSS

HARRY COHEN

WARREN HAYES II

C. B.

ISABEL VESTAL

CORDELIA

JULIET

ROBERT PRESTON, JR.

HATTIE

JOANNE B. APR. 23, 1949

ROBERT B. MAR. 21, 1952

EDWARD C. 9. FEB. 15, 1951

EUGENE MEYER B. NOV. 8, 1929 M. JUN. 5, 1957 PHYLLIS BRIDGES

THELMA LEDLA B. MAR. 31, 1908, CH. M. AUG. 30, 1928, ATL. NATHANIEL SCHLOSSBERG

SOLOMON MANUEL B. JUL. 17, 1909 D. MAY 2, 1948

RICHARD WARREN

HENRY MALCOLM

PEGGY

SAMUEL LEVY MADURO BEF. 1706, AMST. ESTHER VIEYRA

PEIXOTTO I (2)

MOSES LEVY  
B.  
D. NOV. 23, 1766, CUR.  
M. CA. 1740  
RACHEL LOPES  
(-DEC. 17, 1766)

SAMUEL LEVY AUG. 18, 1765, CURACAO LEAH COHEN PEIXOTTO  
B. 1747 (SEE PRECEDING PAGE)  
D. OCT. 24, 1790, CUR.

RACHEL LEVY MADURO B. D. NOV. 23, 1795, CUR. M. JUL. 20, 1783, CURACAO JOSEPH COHEN PEIXOTTO (SEE PRECEDING PAGE)  
RACHEL DE ISAAC SEP. 6/7, 1789, CUR. JESSURUN SASPORTAS B. D. AUG. 14, 1793, CUR.  
1) MOSES LEVY MADURO PEIXOTTO 2) AMST., APR. 19, 1797 B. FEB. 11, 1767, CURACAO D. JUL. 17, 1828, N.Y. (CAME TO N.Y. JUN. 11, 1807)  
JUDITH DE SAMUEL LOPEZ SALZEDO B. SEP. 20, 1766, AMST. D. DEC. 7, 1835, N.Y.  
GRACE B. DEC. 27, 1771, CURACAO D. 1860  
ISAAC LEVY MADURO PEIXOTTO B. CUR., 1773 D. M. JUN. 2, 1805, CUR. SARAH DE DAVID DE JACOB LOPES DIAS  
ESTHER B. 1777, CUR. D. AUG. 20, 1854, CUR. M. FEB. 15, 1807, CUR. DAVID DE DAVID HENRIQUEZ JULIAO

(1) LEAH B. DEC. 27/29, 1790, CUR. D. M. JUL. 27, 1806, CUR. MOSES DE JACOB JESSURUN OF CURACAO  
(1) SAMUEL B. MAY 14, 1793, CUR. D. JUL. 28, 1843, FORT MORGAN M. FEB. 26, 1817, N.Y. MIRIAM (MARIE) GOMEZ (O.V.)  
(2) DANIEL LEVY MADURO B. JUL. 18, 1799, AMST. D. MAY 14, 1843, N.Y. M. MAR. 19, 1823, N.Y. RACHEL SFIXAS (O.V. (4))  
(2) RAPHAEL B. SEP. 12, 1805, CUR. D. MAY 1, 1842, N.Y. M. MAY 11, 1830, N.Y. LUNA DE ARRON N. HENRIQUES (O.V. (4))  
(2) SARAH B. FEB. 10, 1807, CUR. D. M. AUG. 31, 1831, N.Y. BENJAMIN NAAR (O.V. (1))  
(2) GRACE B. MAY 16, 1809, CUR. D. UNM.

MOSES M. AUG. 25, 1857/8, CUR. LUNA (LUNITA) PEIXOTTO (BELOW, RIGHT)  
DANIEL B. FEB. 22, 1831, N.Y.  
HERMAN B. MAY 5, 1832, N.Y. D. M. ESTHER P. NAAR (O.V. (1))  
FRANCIS RAPHAEL B. OCT. 25, 1833, N.Y. D. AUG. 9, 1853, ST. T.  
FREDERICK NAAR B. APR. 3, 1836 D. NOV. 29, 1836 INF.  
LUNA (LUNITA) B. JAN. 24, 1838, N.Y. D. M. AUG. 25, 1857/8, CUR. MOSES DE MOSES JESSURUN (ABOVE, LEFT)

RACHEL LUISA B. JAN. 27, 1820, SAUGATUCK, CONN. D. NOV. 17, 1870, N.Y. UNM. (INS.)  
ESTHER (HETTY) B. AUG. 17, 1821, SAUGATUCK, CONN. D. FEB. 22, 1890, N.Y. M. OCT. 5, 1843, N.Y. JONAS N. PHILLIPS (O.V. I (2))  
REBECCA B. NOV. 22, 1822, N.Y. D. JUN. 10, 1895, N.Y. M. DEC. 5, 1849, N.Y. JOSHUA PHILLIPS (O.V. I (2) & (3))  
MOSES B. MAR. 2, 1825 D. FEB. 20, 1827  
FRANCIS RAPHAEL B. D. M.  
FREDERICK LOUIS NAPLEDN  
HELENE (WASH.)  
FRANCIS D. INF. EDWARD B. 1861 D. CAL. LEONIE B. 1863 D. FRANCE MORTIMER B. D. CAL.

JUDITH SALZEDO B. DEC. 29, 1823, N.Y. D. MAR. 1, 1881, N.Y. M. SEP. 17, 1851, N.Y. DAVID HAYS (O.V. (2))  
ZIPPORAH B. DEC. 15, 1826, N.Y. D. AUG. 17, 1889, N.Y. M. SEP. 6, 1848, N.Y. BENJAMIN H. SEIXAS (O.V. (4))  
SARAH NAAR B. JAN. 26, 1828, N.Y. D. APR. 1, 1900, N.Y. M. MAR. 20, 1850, N.Y. ABRAHAM HART CARDOZO (O.V.)  
MOSES LEVY MADURO II B. FEB. 17, 1830, N.Y. D. SEP. 3, 1890, N.Y. M. APR. 20, 1853, N.Y. RACHEL FROIS (VID. GOMEZ)  
REBECCA B. AUG. 30, 1832 D. 1835  
BENJAMIN FRANKLIN B. NOV. 13, 1834, N.Y. D. SEP. 18, 1890, N.Y. M. JAN. 20, 1858, LOUISVILLE, KY. HANNAH STRAUSS (1841-N.Y. APR. 20, 1901)  
RAPHAEL (SAN FR.) B. SEP. 1, 1837, WILLOUGHBY, OHIO D. MAY 22, 1905, SAN FR. M. NOV. 11, 1863, N.Y. MYRTILLA DAVIS (O.V.)  
MIRIAM MADURO B. FEB. 4, 1842, N.Y. D. APR. 1, 1923, N.Y. M. OCT. 17, 1866, N.Y. MICHAEL MARKS DAVIS (O.V.)

DANIEL LEVY MADURO (SP. AM. WAR) B. MAR. 17, 1854, N.Y. D. OCT. 24, 1898, CUBA M. JAN. 21, 1880, WASH., D.C. IDA JUDITH SOLOMONS (O.V. (1))  
IRMA RACHEL LEVY MADURO B. JAN. 10, 1881, N.Y.  
M. THOMAS CREIGHTON SELLERS  
JEAN REUBEN B. LAWRENCE  
PROF. JESSICA BLANCHE B. OCT. 9, 1864, N.Y. D. 1941, BERKELEY  
SIDNEY SALZEDO B. MAY 9, 1866, N.Y. D. AUG. 1925, CAL. M. 1) MAY 19, 1921 PHYLLIS FRANKEL (DIV.) OF BRISBANE, AUSTRALIA M. 2) SAN FRANCISCO, 1924 JEAN SMALL  
EDGAR J. DAVIS B. DEC. 22, 1867, N.Y. D. JUN. 24, 1925, SAN FR. M. SEP. 22, 1904, N.Y. MALVINA NATHAN (O.V. I (1))  
EUSTACE MADURO B. JUL. 29, 1887, SAN FR. D. 1963 M. 1) 1918 HELEN KELLY, OF TACOMA (DIV.) M. 2) OCT. 31, 1925, SAN FR. CATHARINE DISHMAN

GEORGE DA MADURO B. FEB. 1, 1859, CLEVELAND, O. D. OCT. 12, 1937, WHITE PLAINS UNM.  
MARK PERCY DA MADURO B. OCT. 4, 1862, CLEVE. D. JUL. 5, 1938, PARIS, FR. M. NOV. 22, 1887, N.Y. KATHERINE DE SADOWSKA  
JUDITH EUGENIA SALZEDO B. OCT. 22, 1864, CLEVE. D. SEP. 14, 1944, CHARLESTON, W. VA. M. OCT. 25, 1887, N.Y. JOSEPH (ILLAVA) MORNINGSTAR (FEB. 29, 1860-MAR. 31, 1916, N.Y.)  
FLORIAN (FRANK) B. 1870/9, SAN FR. D. OCT. 28, 1910, PASADENA M.  
VICTORIA MAUD B. LYONS, FR. M. DR. BRONNER  
SIDNEY S. JR. B. CA. 1925, BERKELEY  
ERNEST CLIFFORD B. OCT. 15, 1869, SAN FRANCISCO D. 1941, N.Y. C. M. JAN. 28, 1897 MARY G. HUTCHINSON D. S. P.  
FANNY CORINNE B. SEP. 15, 1860, CLEVE. D. M. DR. ISIDORE BLOOM  
LILLIAN MAUD B. FEB. 16, 1898 M. DRURY K. ADAMS  
MABEL LOUISE B. MAY 8, 1969, CLEVE. D. UNM.  
IRVING B. SAN FR. D. M. PHILLIPINE ISL. 2 CH.NINA MAPLESON B. DEC. 2, 1907, SAN FR. M. 1) SEP. 1930, SAN FR. JOHN HATCH STEWART (-FEB. 14, 1952, PASADENA) M. 2) MAR. 1954, SAN FR. JOHN M. STEFFENS S. P.  
EDGAR RAPHAEL B. OCT. 17, 1905, SAN FR. M. JAN. 16, 1957, PARIS CHRISTINE ADDA OF MONACO S. P.

KARL ILLAVA B. D. MAY 16, 1954, GREENWICH, CT. M. AGATHA BROWN  
JOSEPH, JR. B. M. LAURETTA WOOD  
BENJAMIN (ROBERT) PEIXOTTO B. M. ANN SCOTT S. P.  
FLORA (PEGGY) M. 1) PAUL BURRY OWEN (DIV.) M. 2) JUL. 1934 RAYMOND JOSEPH FUNKHOUSER (1888-)  
PERCY M. EDITH LONG  
MARY C. M. FRANK MAC LENNAN  
JAMES MADURO B. 1920, SAN FR. (1)  
ROLLAND EUSTACE B. 1926, SAN FR. (2)  
ERNEST DISHMAN (2)  
THOMAS WOOD B. SEP. 3, 1926, N.Y. D. JUN. 11, 1964, HARRISON, N.Y. M. JUN. 29, 1949 MARY ELEANOR KLARMAN  
ANNE HUBERTH  
MARGARET R. (1) BARBARA M. (1) JUDITH P. (1)  
THOMAS W. JR. SUSAN MARIE JOSEPH WILLIAM ANNE WOOD EDNA ELIZABETH KARL RICHARD MARY ELEANOR MARTHA



**PEIXOTTO II**  
ELZAS MS.  
SHEARITH ISRAEL REC.

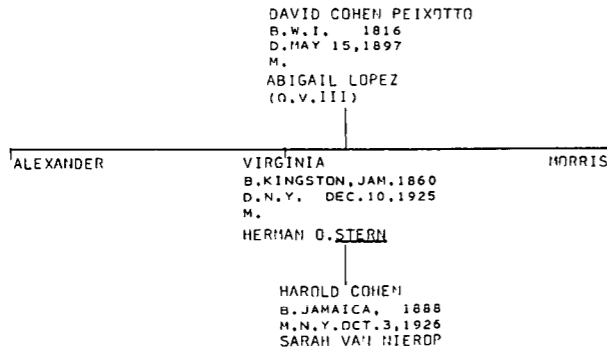

**PEIXOTTO III**  
MORRAIS-JEWS OF PHILA.  
MICKVE ISRAEL REC.  
SHEARITH ISRAEL REC.  
W.V., P. 488

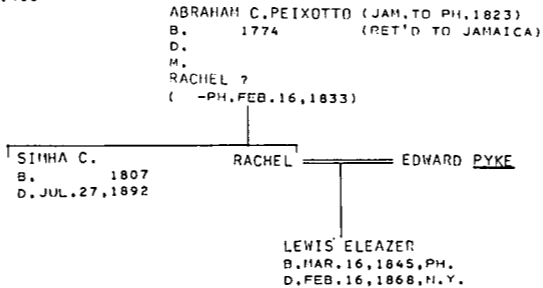

**(RODRIGUES) PEREIRA**  
JOHN F. WYSMULLER  
RIJH NOTES, PASSIM

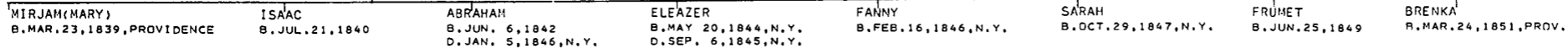
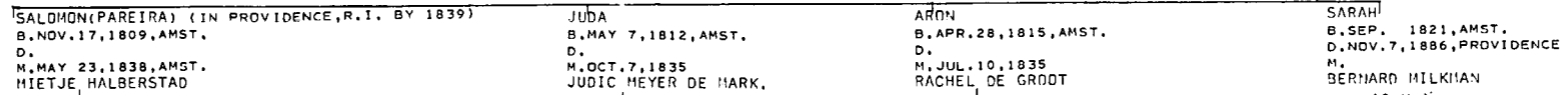
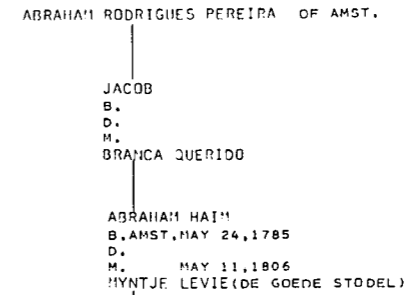

**PESOA**

WILL OF ISAAC PESOA  
JACOB R. COHEN REC.  
ANDRADE-JEWS OF JAMAICA  
FEDERAL ST. CEM.  
KRAUS-SANDOR COLL.  
PAJHS V. 27, P. 292F.  
MORRAIS-JEWS OF PHILA., P. 292F.  
ELZAS MS.  
MICKVE ISRAEL REC.  
SHEARITH ISRAEL REC.  
SPRUCE ST. (PH.) CEMETERY

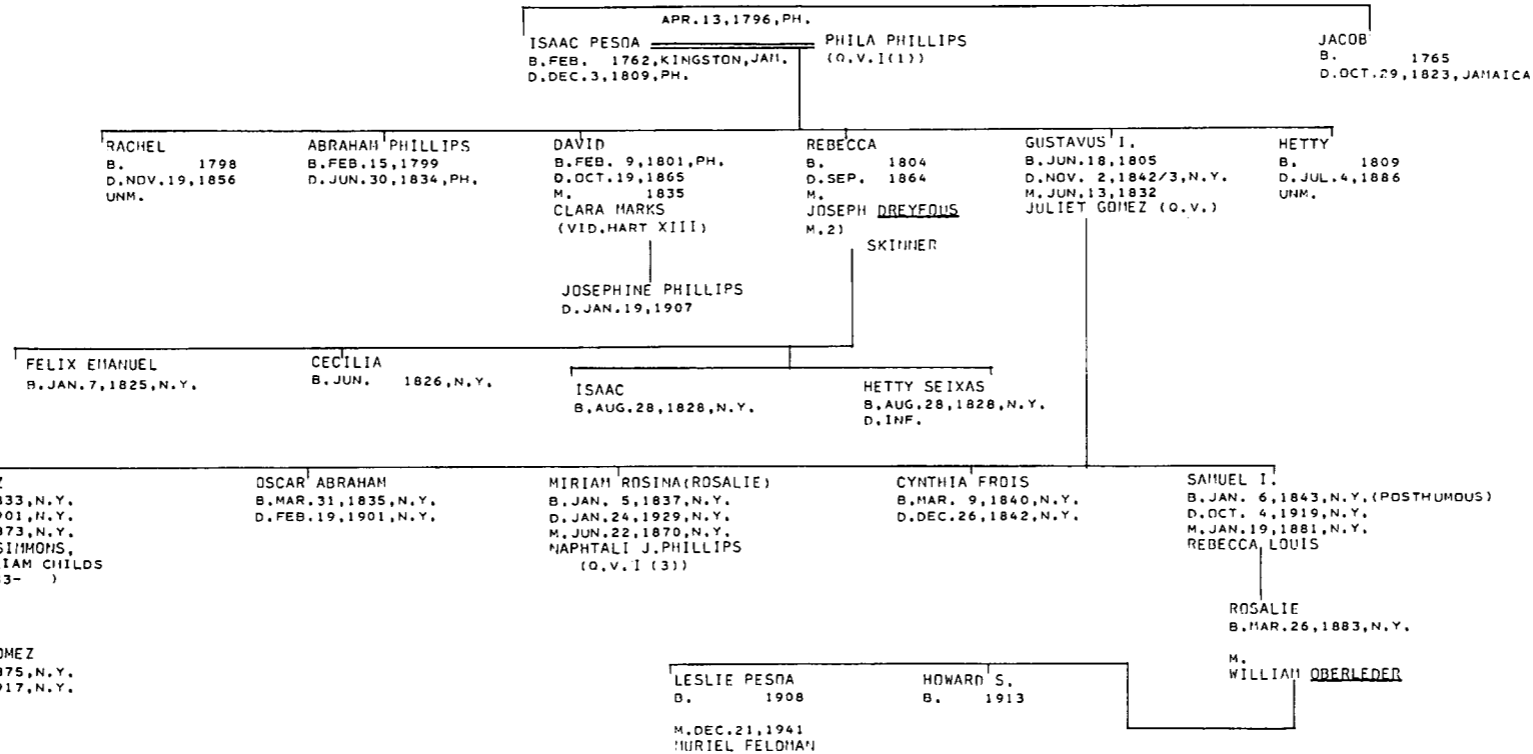

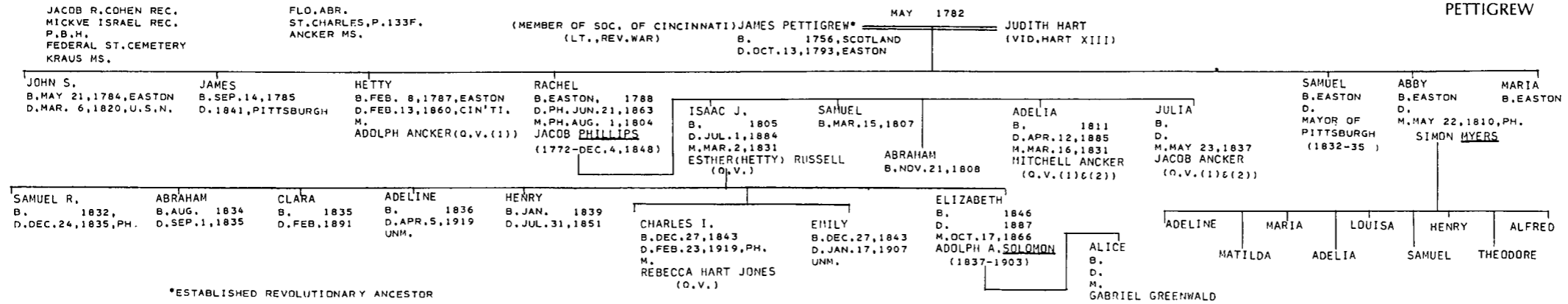

KRAUS-SANDOR COLL. J.E. V. 10, P. 3 PAJHS V. 2, P. 60F. V. 27, PP. 165F; 277 MORAIS-JEWS OF PHILA. ST. CHARLES, P. 86F. PHILLIPS GEN. (JRM) MOSES GEN. (AJA) MICKVE ISRAEL REC. SHEARITH ISRAEL REC. DAR LINEAGE BOOKS POOL-PORTRAITS... SPRUCE ST. (PH.) CEM. REC. FLO. ABR.

WILL OF JONAS PHILLIPS JACOB R. COHEN REC. BARBER - N.Y. MARRIAGES ELZAS O.J.C. U.S. CENSUS, 1850 N.Y. CENSUS, 1855 ROSENWAIKE POULSON'S NGSO, V. 58, P. 134 B'NAI JESHURUN REC.

MOSES, OF FRANKFURT AM MAIN

PHILLIPS I (1) (N.Y.)



\*JONAS PHILLIPS (TO CH., NOV. 1756) FREEMAN, RETAILER N.Y. FEB. 28, 1769 B. 1735, BUSECK, GERMANY D. JAN. 29, 1803, PH. (BUR. N.Y.) M. NOV. 10, 1762, HICKORY TOWN, PLYMOUTH TOWNSHIP, MONTGOMERY CO., PA. REBECCA MACHADO (VID. NUNEZ)

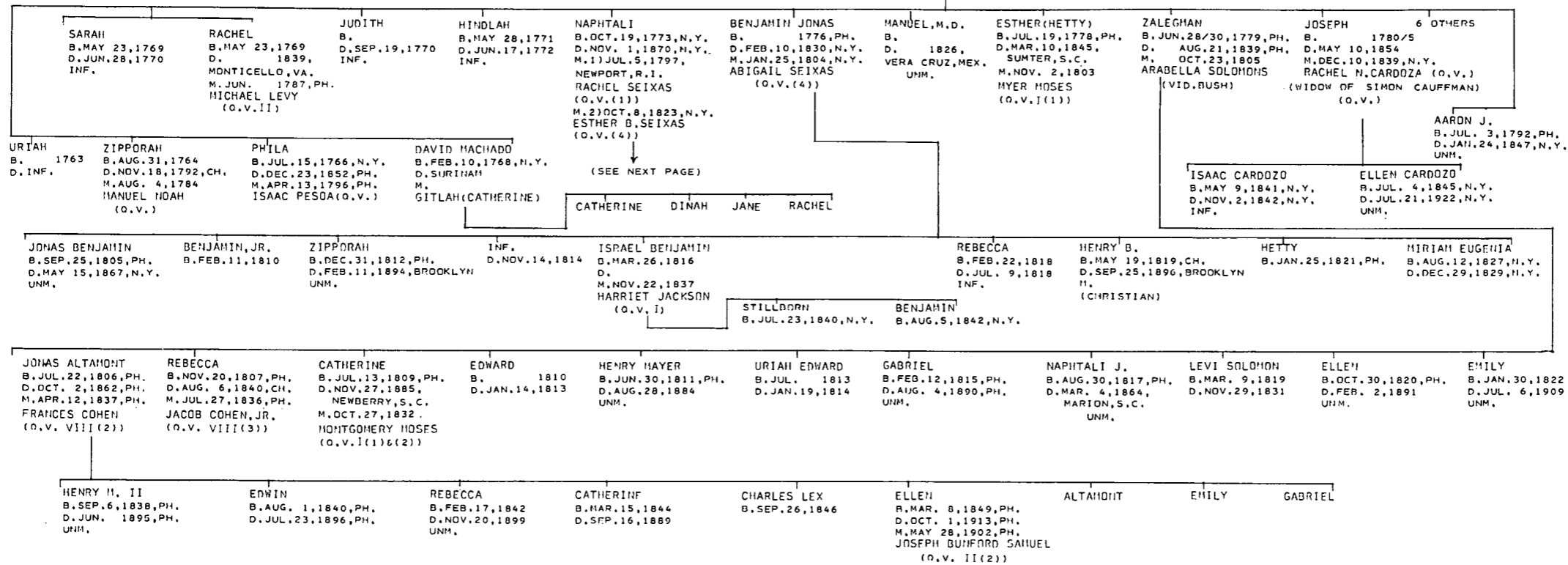

PHILLIPS I (2)

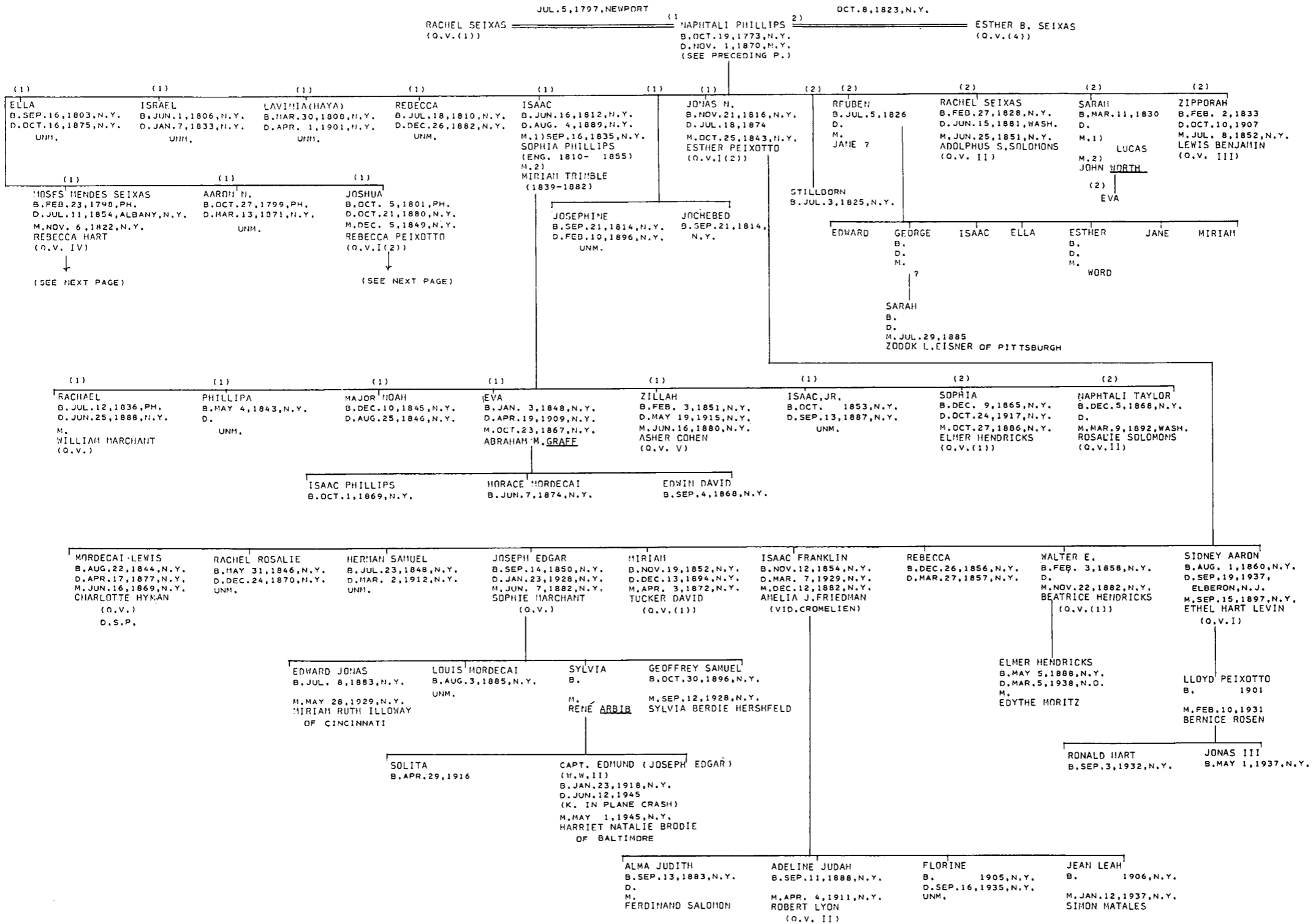

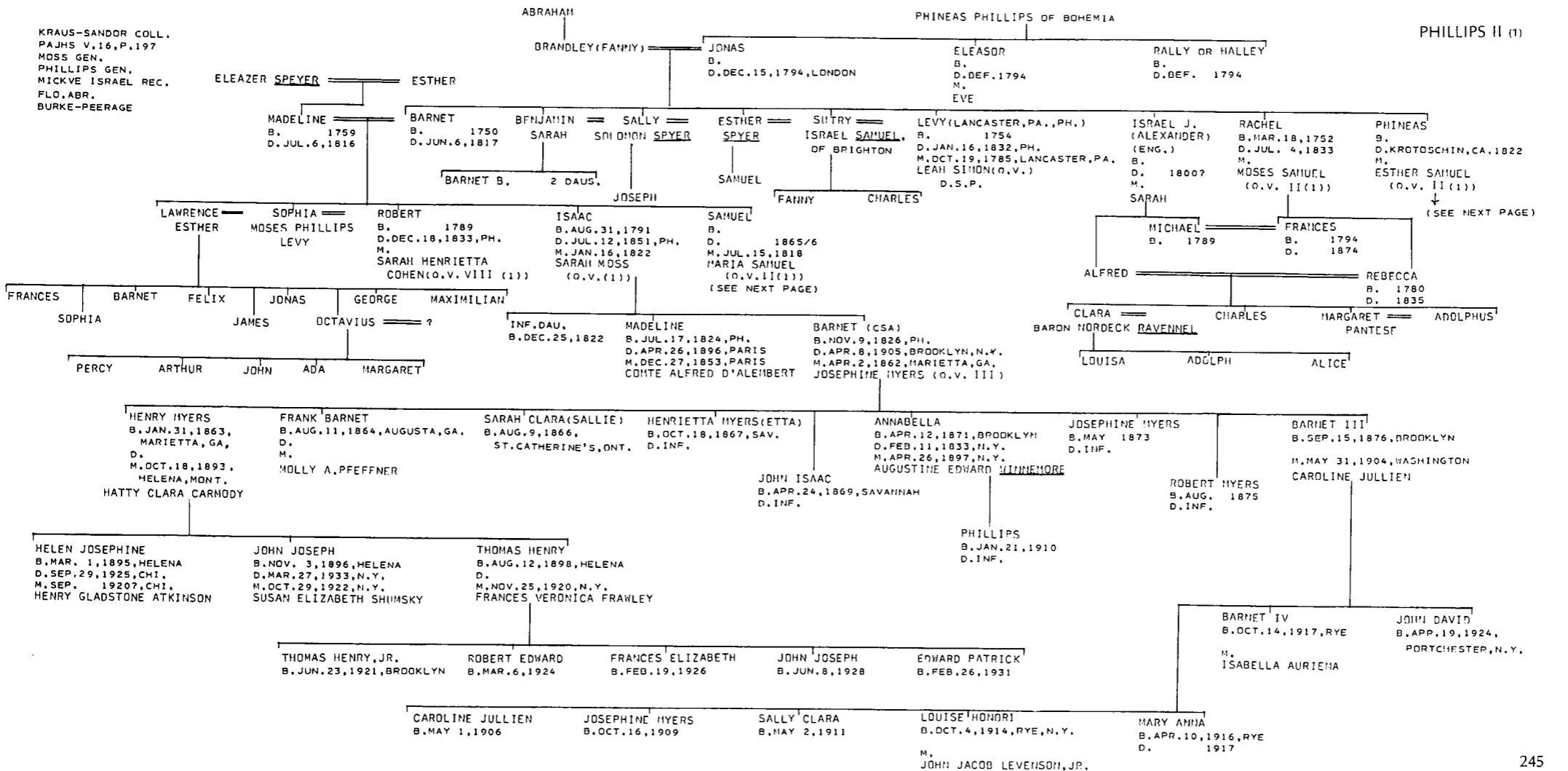
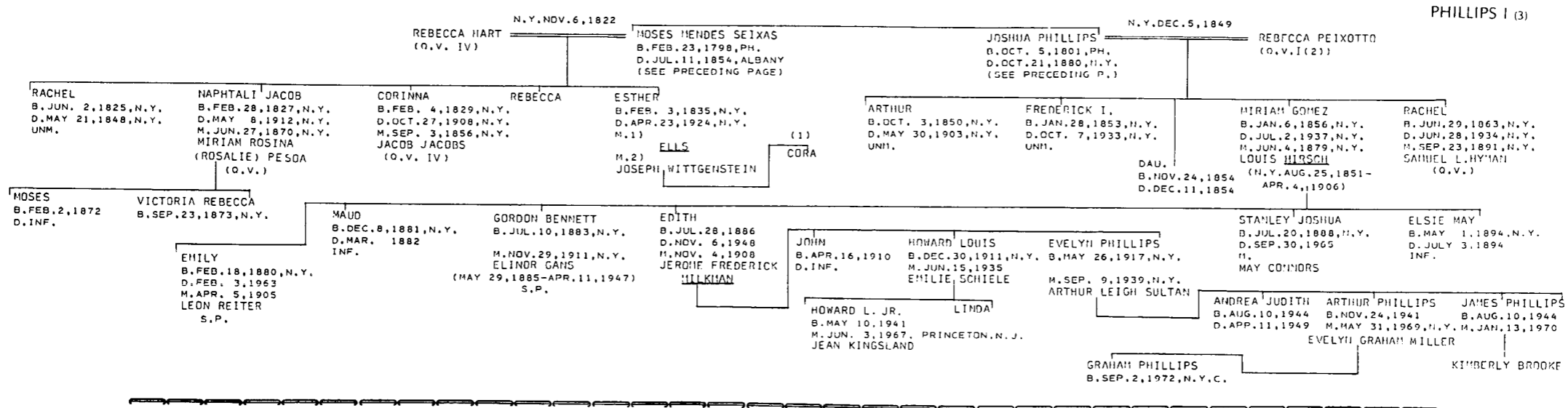

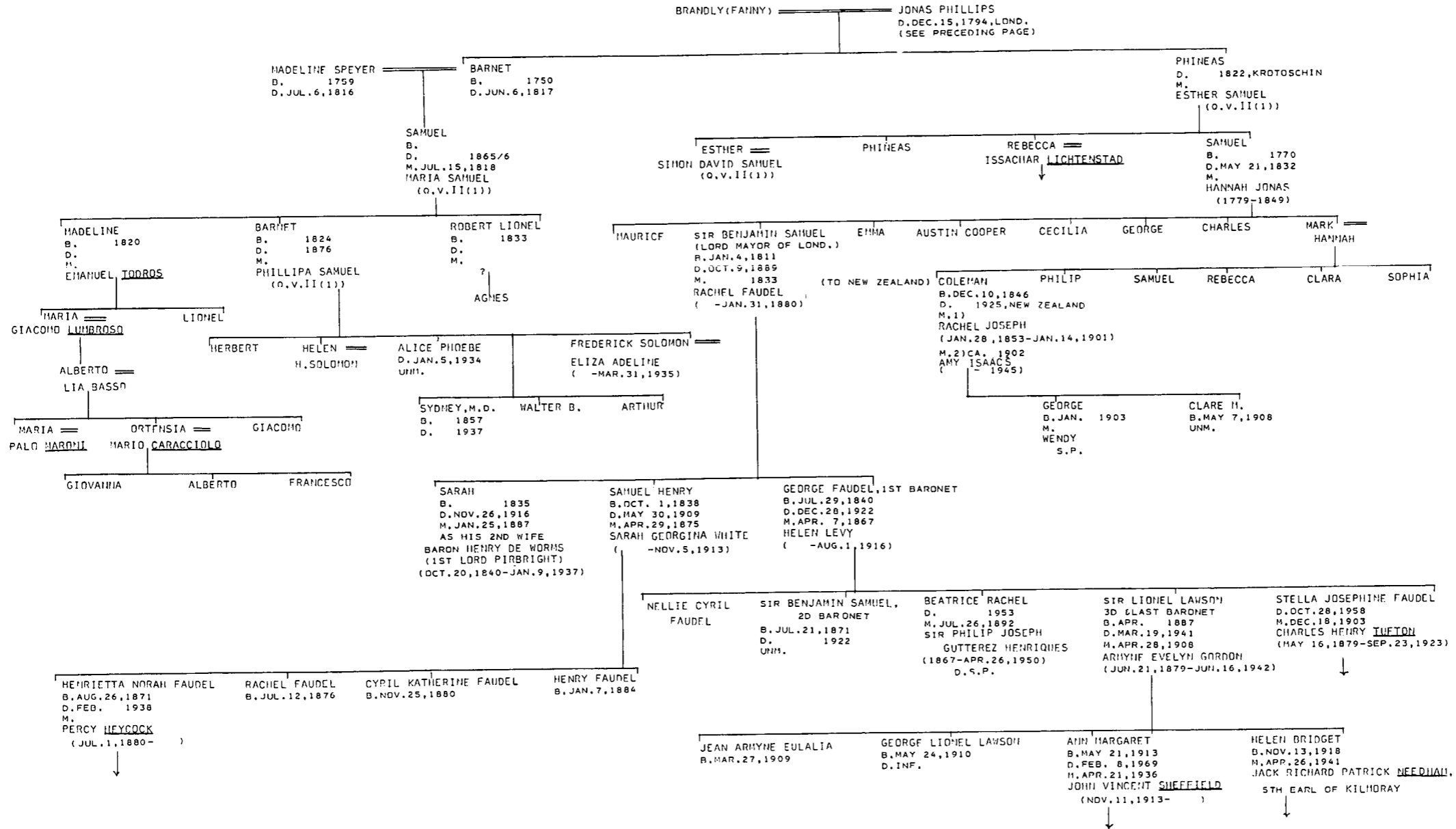

KRAUS-SANDOR COLL.  
PAJHS V.12,P.119  
SAMUEL-YATES GEN.  
ELZAS MS.  
ELZAS O.J.C.  
HARRISON-BING, DICT. OF AMER.  
CONGRESSMAN, P.1678  
PHILLIPS MS(JRM)  
PHILLIPS MS(LC)  
JANE L. RAISIN  
SAUL J. RUBIN

CAROLINE LAZARUS CH. FEB. 25, 1807 (O.V. II)  
AARON (PFFIFFER) PHILLIPS 2) CH. NOV. 14, 1821  
ISABELLA LAZARUS (O.V. II)  
B. JAN. 28, 1780, ANSPACH  
D. FEB. 17, 1834, CH.

PHILLIPS III (ALA.)

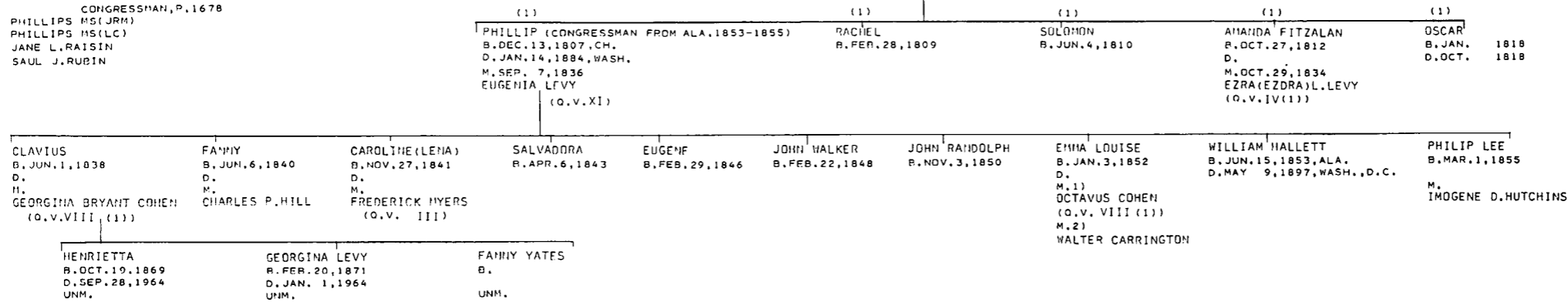

NEWPORT, R.I., AUG. 13, 1785

JACOB ISAACKS MS. (DAR)  
KRAUS-SANDOR COLL.  
PAJHS V. 32, P. 125  
ALEXANDER MS. (JRM)  
H.A. ALEXANDER-ALEXANDER  
FLD. ABR.

JACOB PHILLIPS B. CA. 1750, ENG. D. CA. 1820, CH.  
HANNAH ISAACKS (O.V. I)

PHILLIPS IV

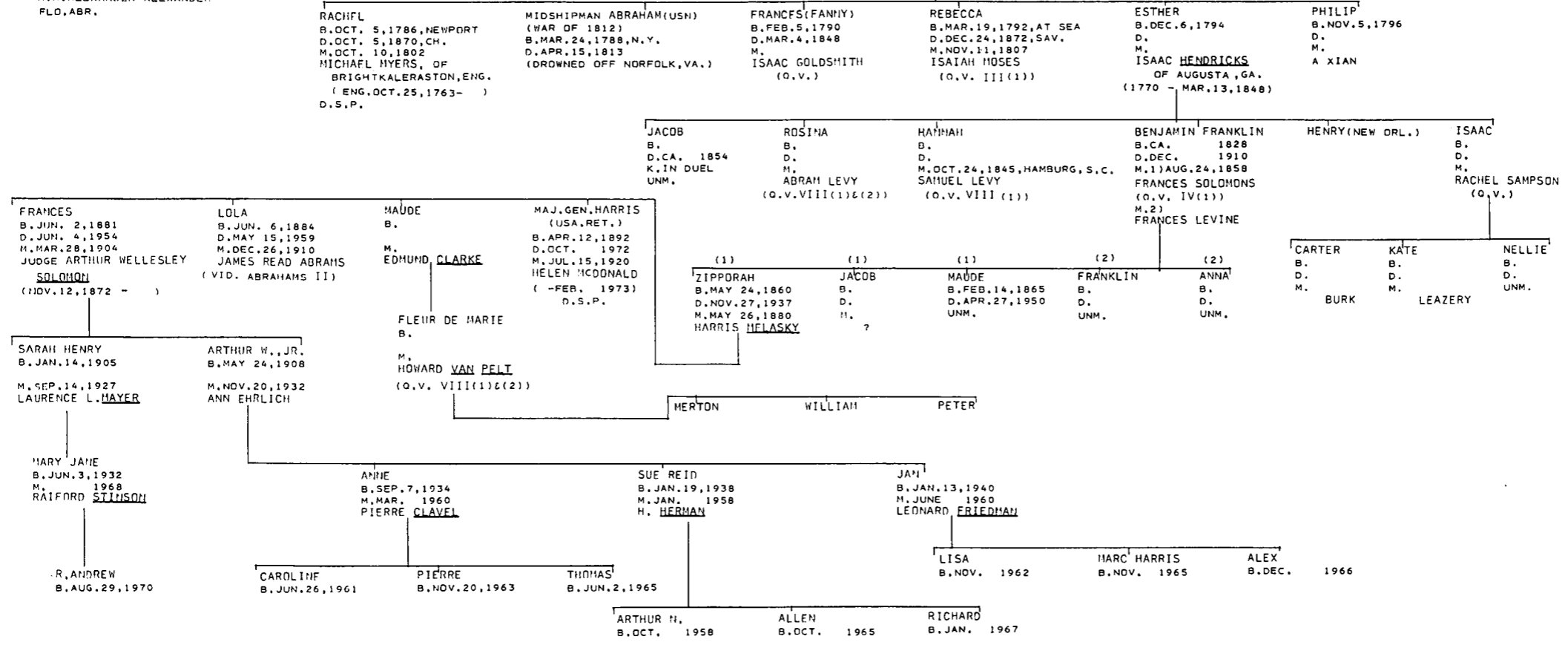

PHILLIPS V (N.Y.)  
PAJHS, V.27,P.111  
SHEARITH ISRAEL REC.

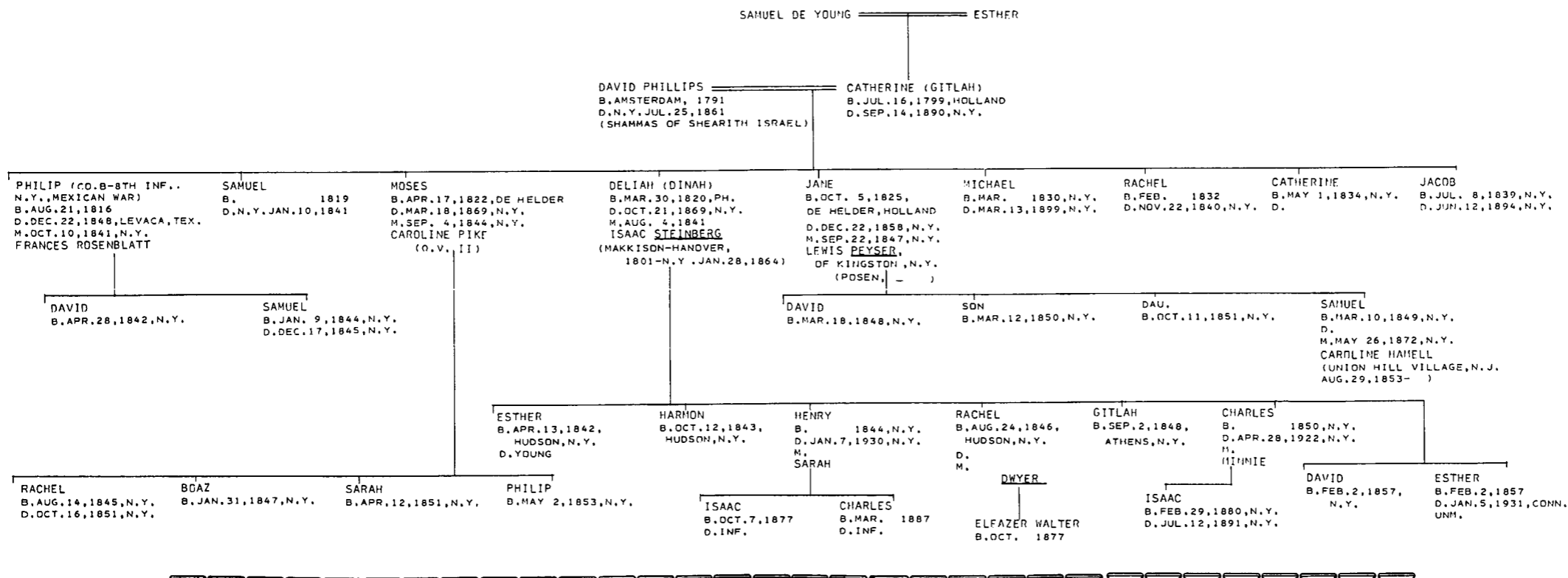

PHILLIPS VII (NEW ORLEANS)  
KORN-JEWS OF N.O.

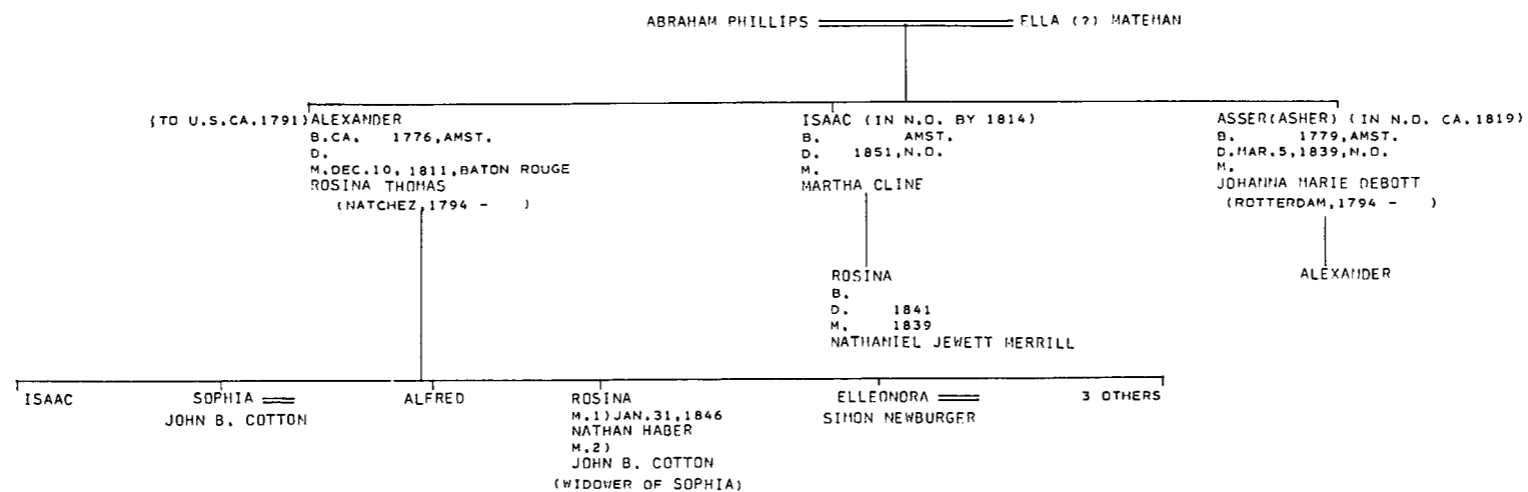

CHARLES WHITEHEAD  
 JON STEDMAN  
 U.S. CENSUS, 1880  
 B'HAI JESHURUN REC.  
 DAR LINEAGE BOOKS  
 JOHN F. ALEXANDER

DANIEL LEVY OF LONDON

PHILLIPS VI

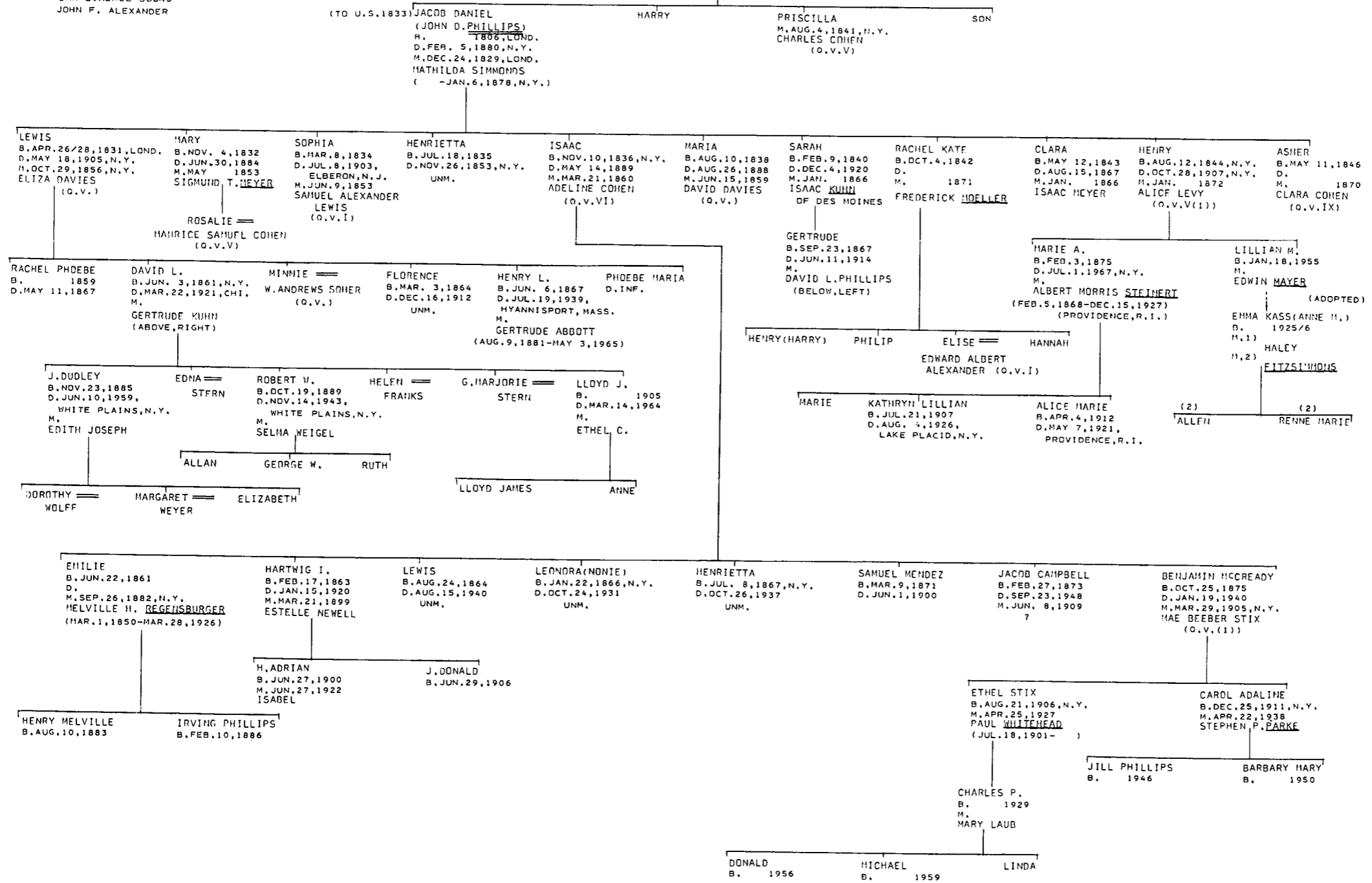



PIKE I

SHEARITH ISRAEL REC.  
B'NAI JESHURUN REC.  
N.Y. CENSUS, 1855

SOLOMON LEVY

MOSES PIKE  
B.  
D.  
M.  
?

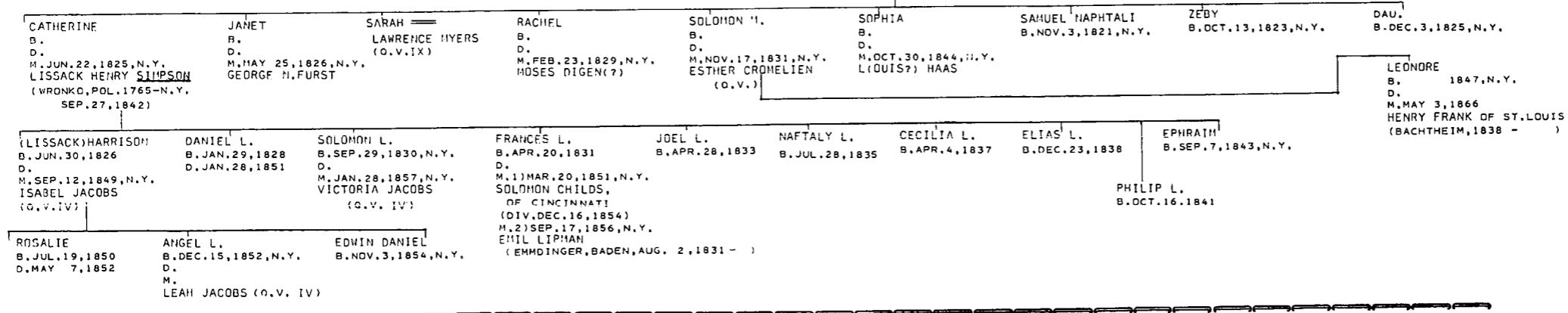

PIKE II

SHEARITH ISRAEL REC.

BOAZ PIKE RACHEL  
B. D. BEF. 1844

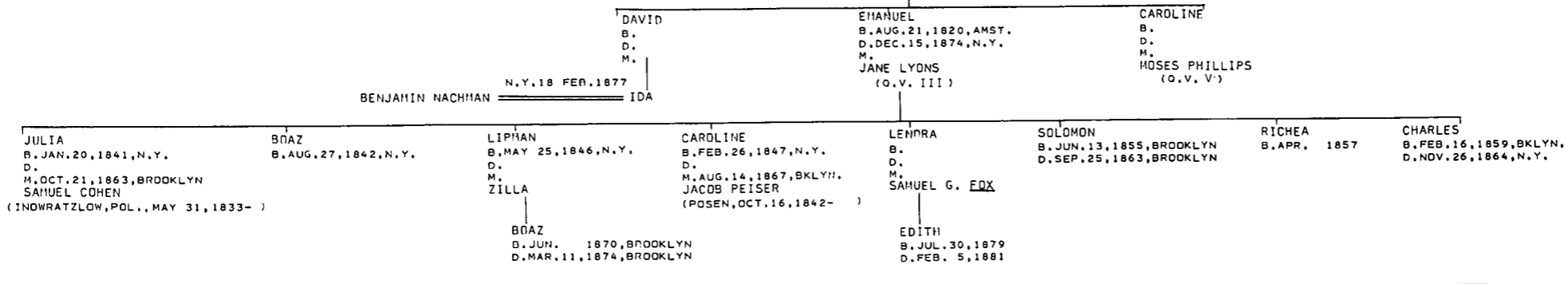

PINHEIRO

KRAUS-SANDOR COLL.  
PAJHS V. 23, P. 157  
POOL-PORTRAITS  
HERSHKOWITZ-WILLS  
E.N.A.  
SHILSTONE

ABRAHAM PINHEIRO OF AMST.

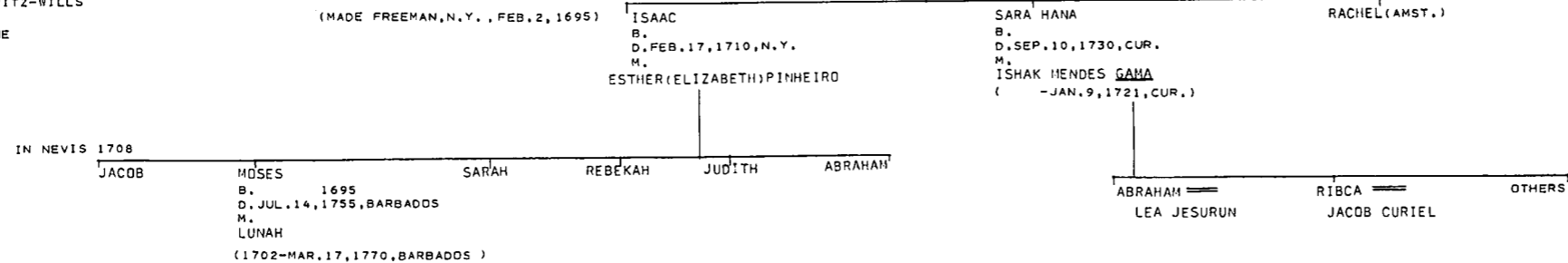

PINTO (1)

JUDAH HAYS REC.  
 N.Y. WEEKLY MUSEUM  
 KRAUS-SANDOR COLL.  
 PAJHS V. 2, P. 49  
 PAJHS V. 13, P. 113F.  
 PAJHS V. 38, P. 92F.  
 N.Y. DEATHS  
 ELZAS MS.  
 POOL-PORTRAITS...  
 EVANS-HIST. OF ROSS CO., OHIO  
 DRICUTT'S-HIST. OF STRATFORD, CONN.  
 STRATFORD VITAL REC.  
 AMER. JEW. ARCHIVES, V. 1, NO. 2, P. 27F.  
 CAR LINEAGE BOOKS  
 BAILEY-EARLY CONN. MARRIAGES  
 PINTO FAMILY PAPERS

(IN STAMFORD, CONN. BY 1725,  
 FREEMAN, N.Y., JUN. 21, 1743)

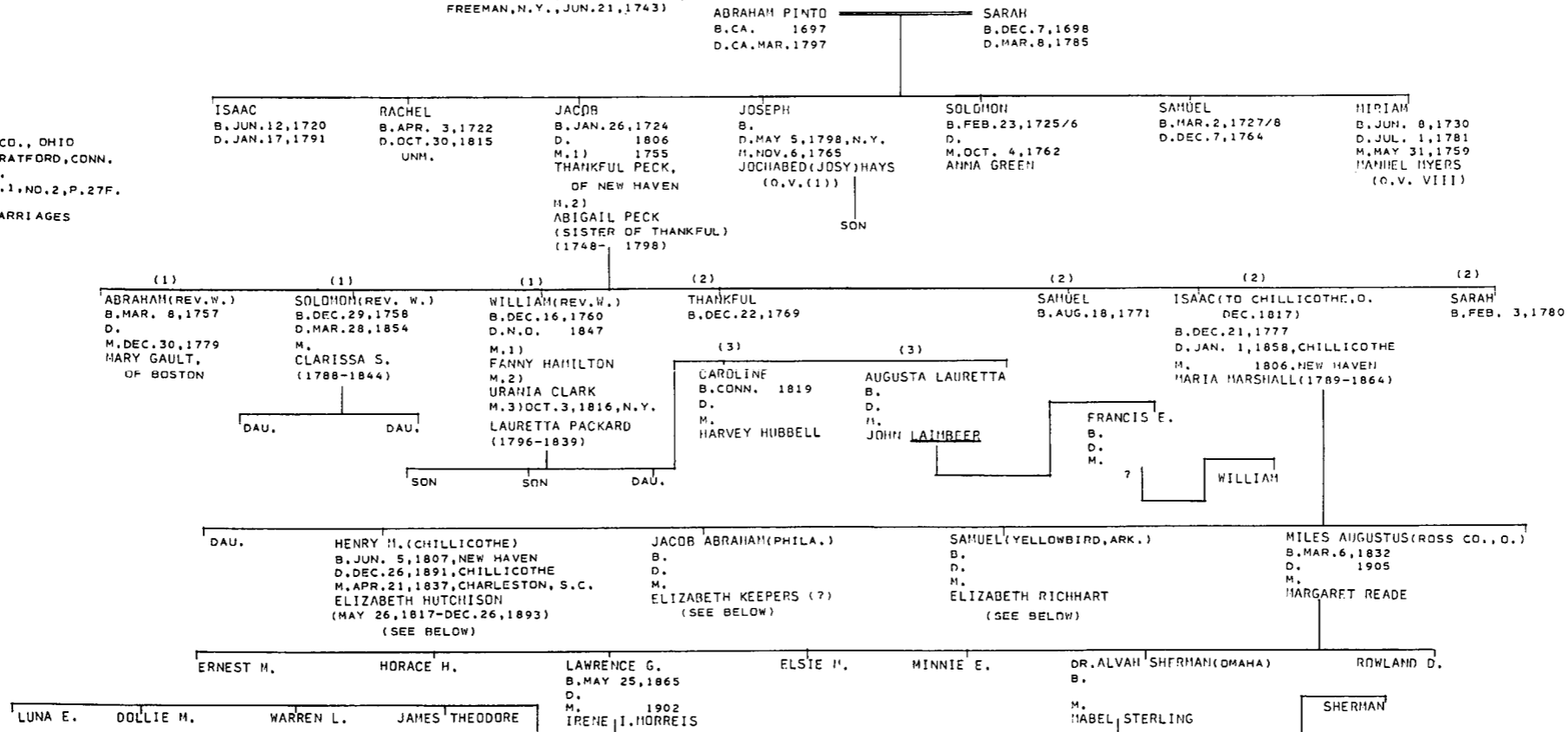

PINTO (2)

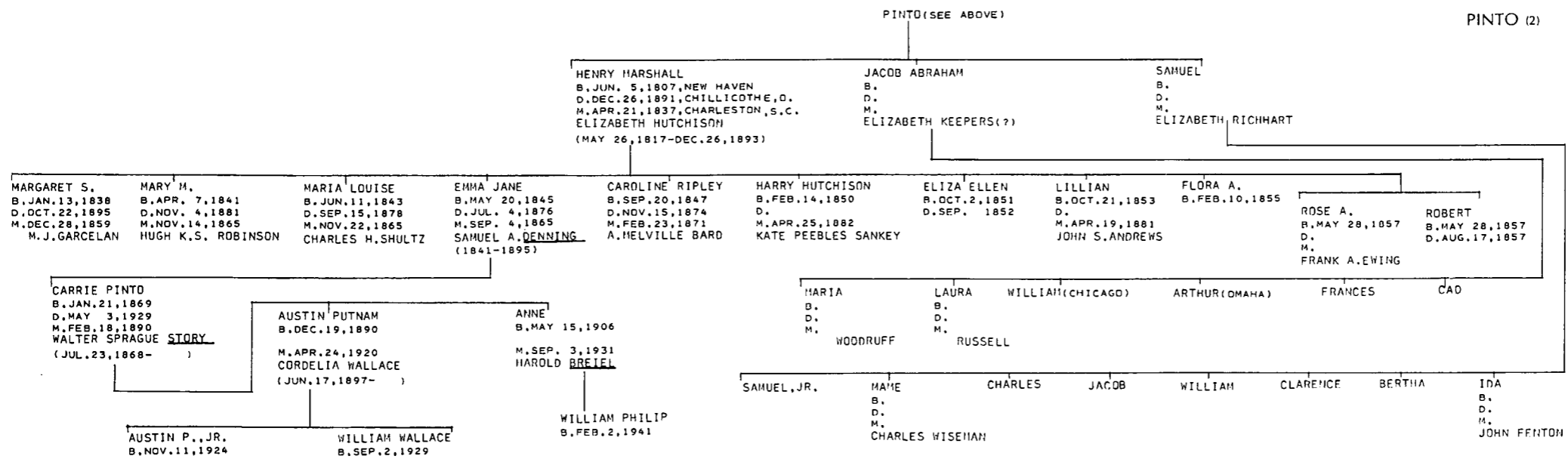

**POLOCK I**

NEHIGR V.62663  
 MARCUS-STUDIES  
 SHEFTALL MS.  
 S.C.MARRIAGE CONVEYANCES  
 GA. NEWSPAPERS  
 ROSENWAIKE  
 SHEARITH ISRAEL REC.  
 KRAUS-SANDOR COLL.  
 PAJHS V.27,P.348F.  
 V.44,P.62

ARNOLD-VITAL REC. OF R.I.  
 GUTSTEIN-JEWS OF NEWPORT  
 ELZAS-JEWISH CEM. AT GEORGETOWN  
 H.A.ALEXANDER-THE ALEXANDER FAMILY

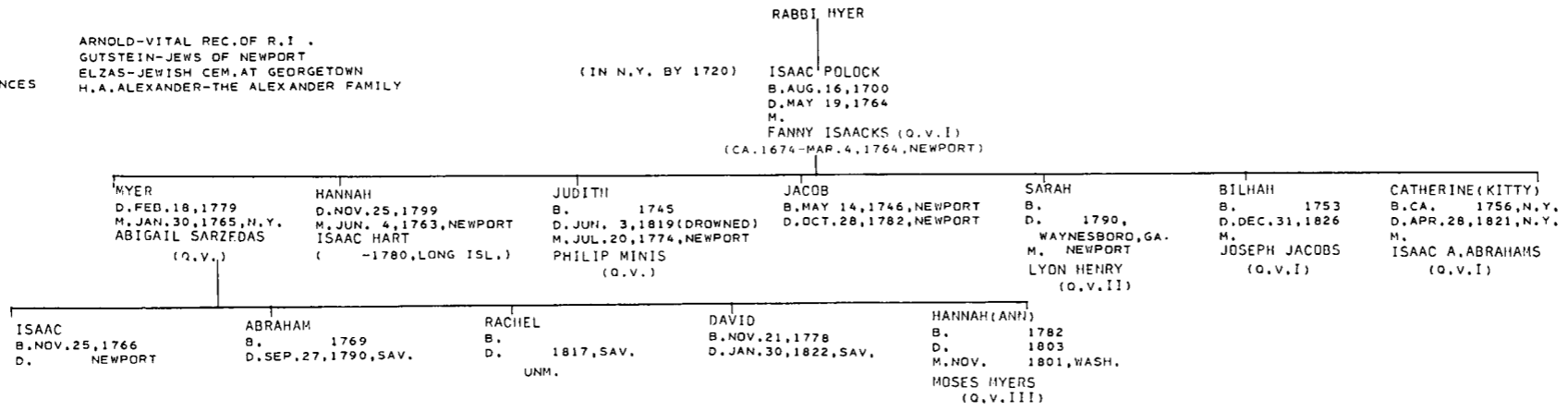

**POLOCK II**

KRAUS-SANDOR COLL.  
 PAJHS V.17,P.217  
 V.31,P.159  
 MORAIS-JEWS OF PHILA.  
 MICKVE ISRAEL REC.  
 EDWIN WOLF II  
 FLD. ABR.  
 ISABELLA SACKEY  
 MYER SOLIS-COHEN  
 JACOB R. COHEN REC.  
 ROSENWAIKE

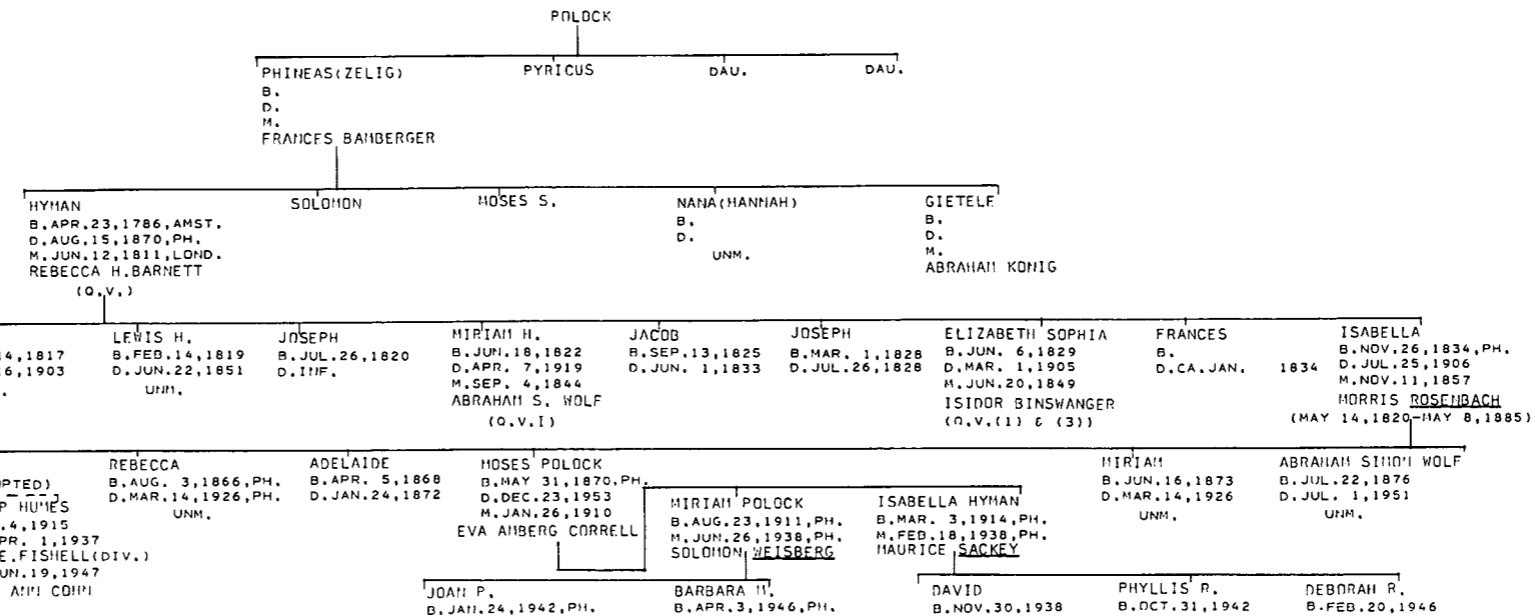

**POZNANSKI**

WILL OF ESTHER POZNANSKI  
 KRAUS-SANDOR COLL.  
 ELZAS MS.  
 UJE V.8,P.612  
 SHEARITH ISRAEL REC.  
 AJHO V.LIV,P.431

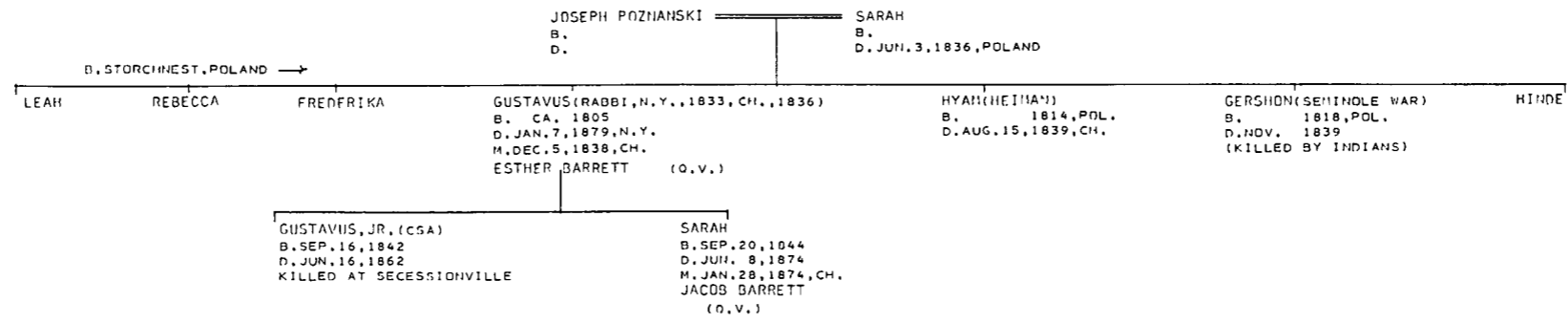

FLO. ARR.  
HARRIET STPYKER-RODDA  
SANFORD A. MOSS

ABRAHAM PREIZ  
OF MAINZ, GER.

EDWARD ALFRED PRICE  
B. FEB. 16, 1840, MAINZ  
D. NOV. 22, 1906, N.Y.  
M. OCT. 24, 1867  
BERTHA JACOBS  
(VID. MOSS (2))

PRICE

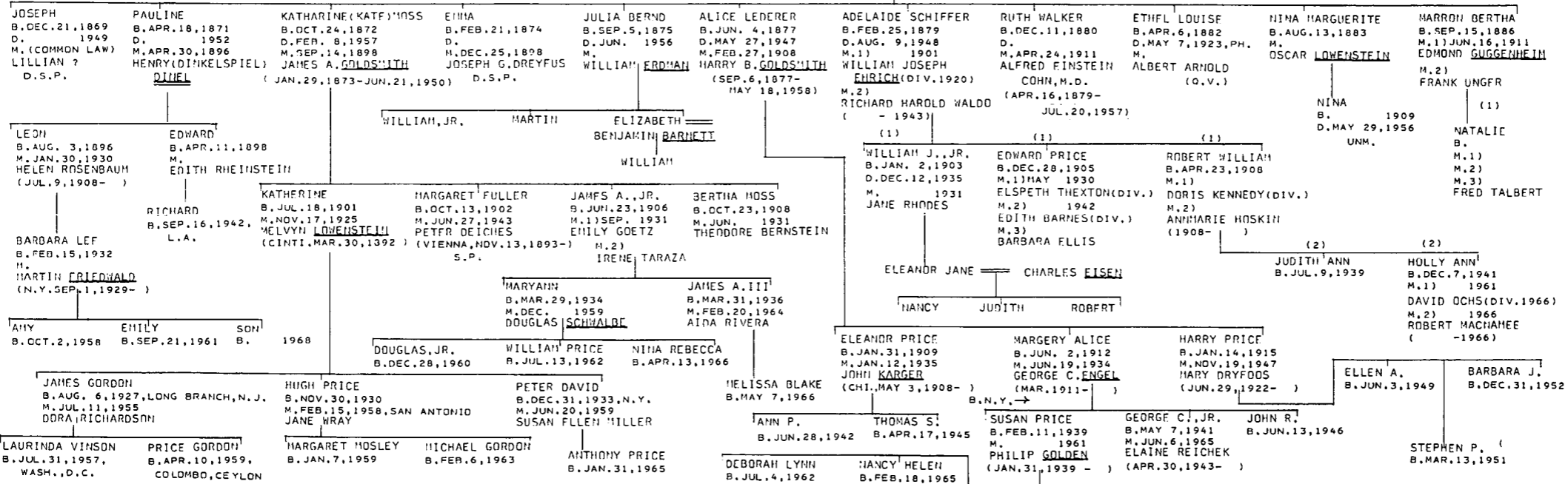

SHEARITH ISRAEL REC.  
B'NAI JESHURUN REC.  
KRAUS-SANDOR COLL.  
MYER SOLIS-COHEN  
ROBERT M. RITTERBAND

MORRIS RITTERBAND HANNAH

LEON MANESS RITTERBAND  
B. 1809, POLAND  
D. SEP. 28, 1860, N.Y.

BENVEDENA SOLIS  
(O.V. (2))

RITTERBAND

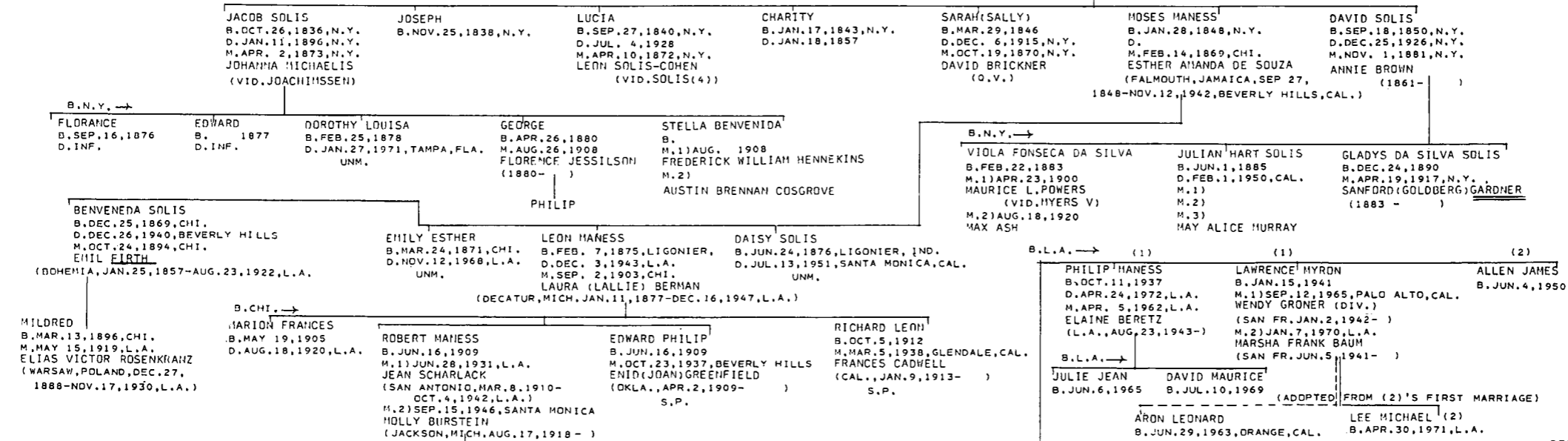

**ROCHELLE**  
KORN-JEWS OF N.O.

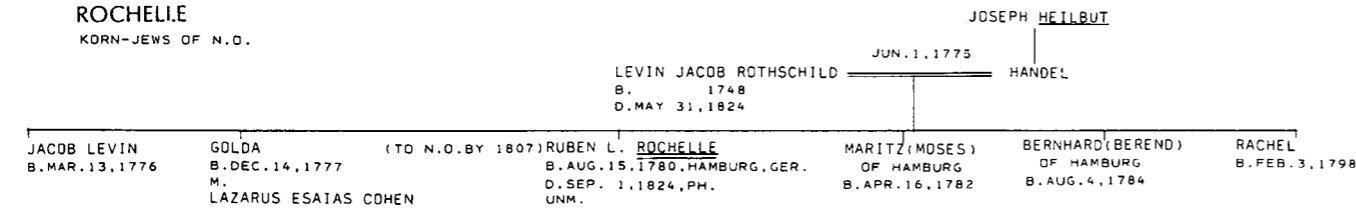

KRAUS-SANDOR COLL.  
MICKVE ISRAEL REC.  
FLO. ABR.  
SOCIAL REGISTER, PH.  
P.B.H.

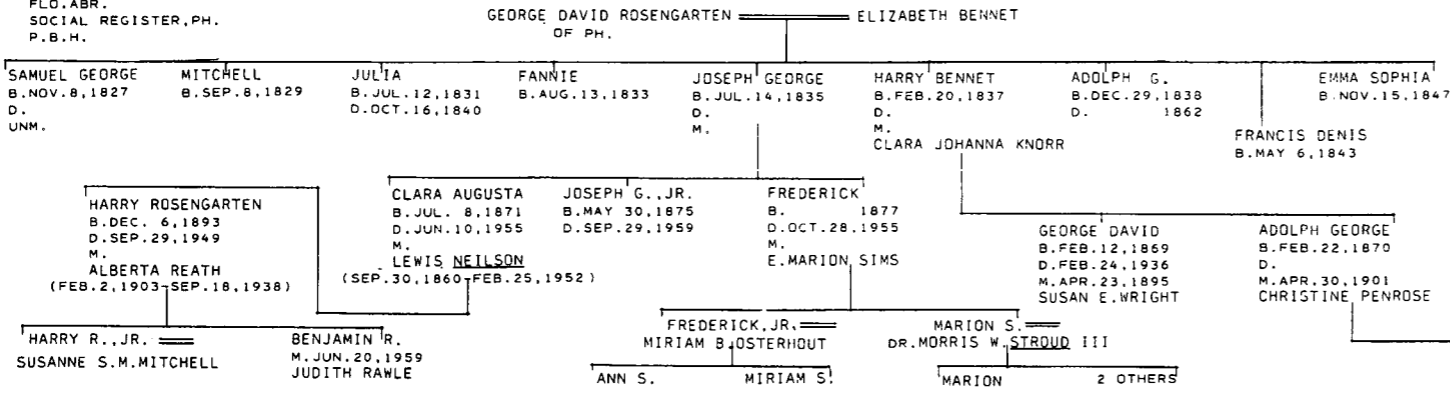

**ROWLAND**

SPRUCE ST. CEMETERY REC.  
FLO. ABR.  
ALFRED D. SUMBERG  
P.B.H.  
B'NAI JESHURUN REC.

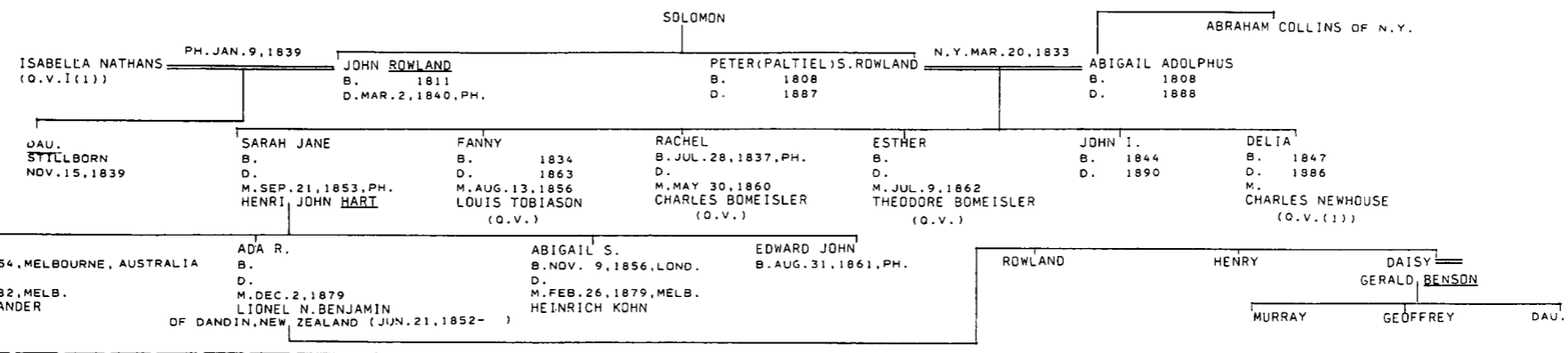

**RUDEN**

POOL-PORTRAITS  
BALTO. WILLS  
SHEARITH ISRAEL REC.  
B'NAI JESHURUN REC.  
JON STEDMAN  
ROSENSWAIKE

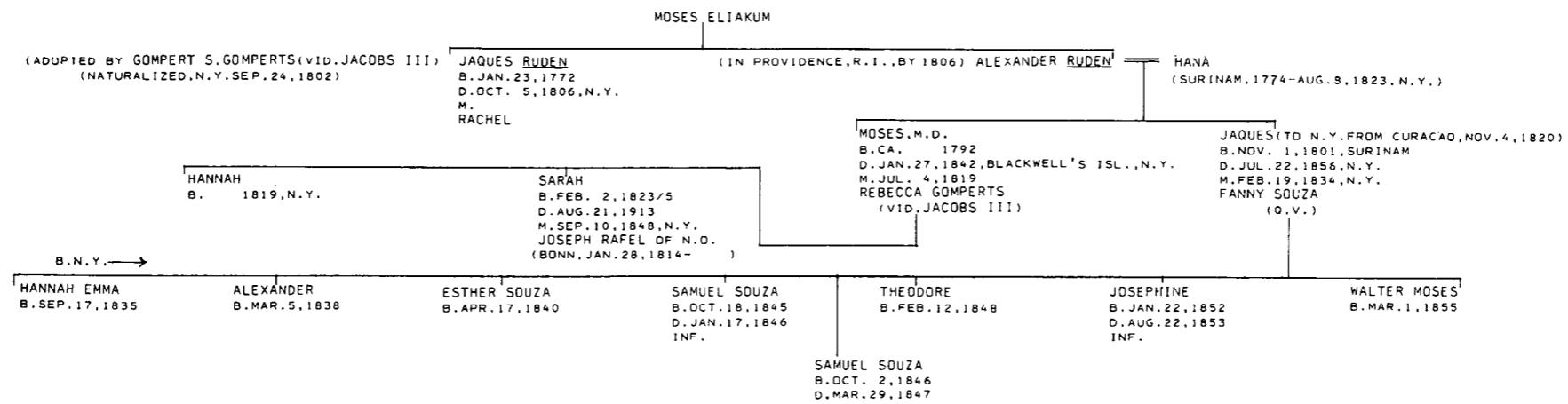

ELZAS MS. M.N. O.J.C. SOLOMONS FAMILY REC. (T.J. TOBIAS) WILL OF BENJAMIN RODRIGUEZ

**RODRIGUEZ**

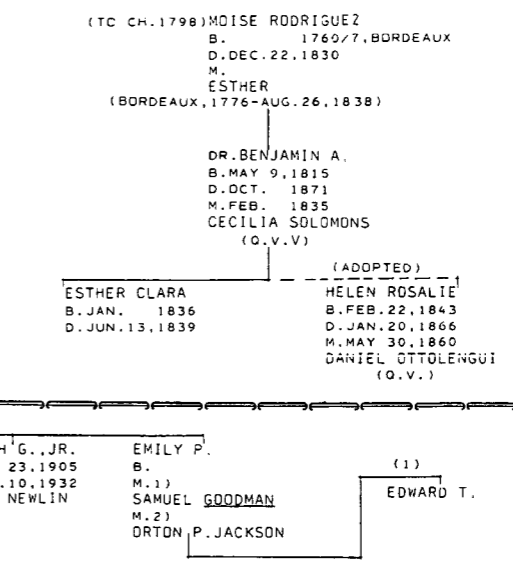

ROSENHEIM

ANCKER MS.  
KRAUS-SANDOR COLL.  
ST. CHARLES, FIG. 21  
RALPH E. BECKER  
EZEKIEL-LICHTENSTEIN  
I. ROSENHEIM GEN.

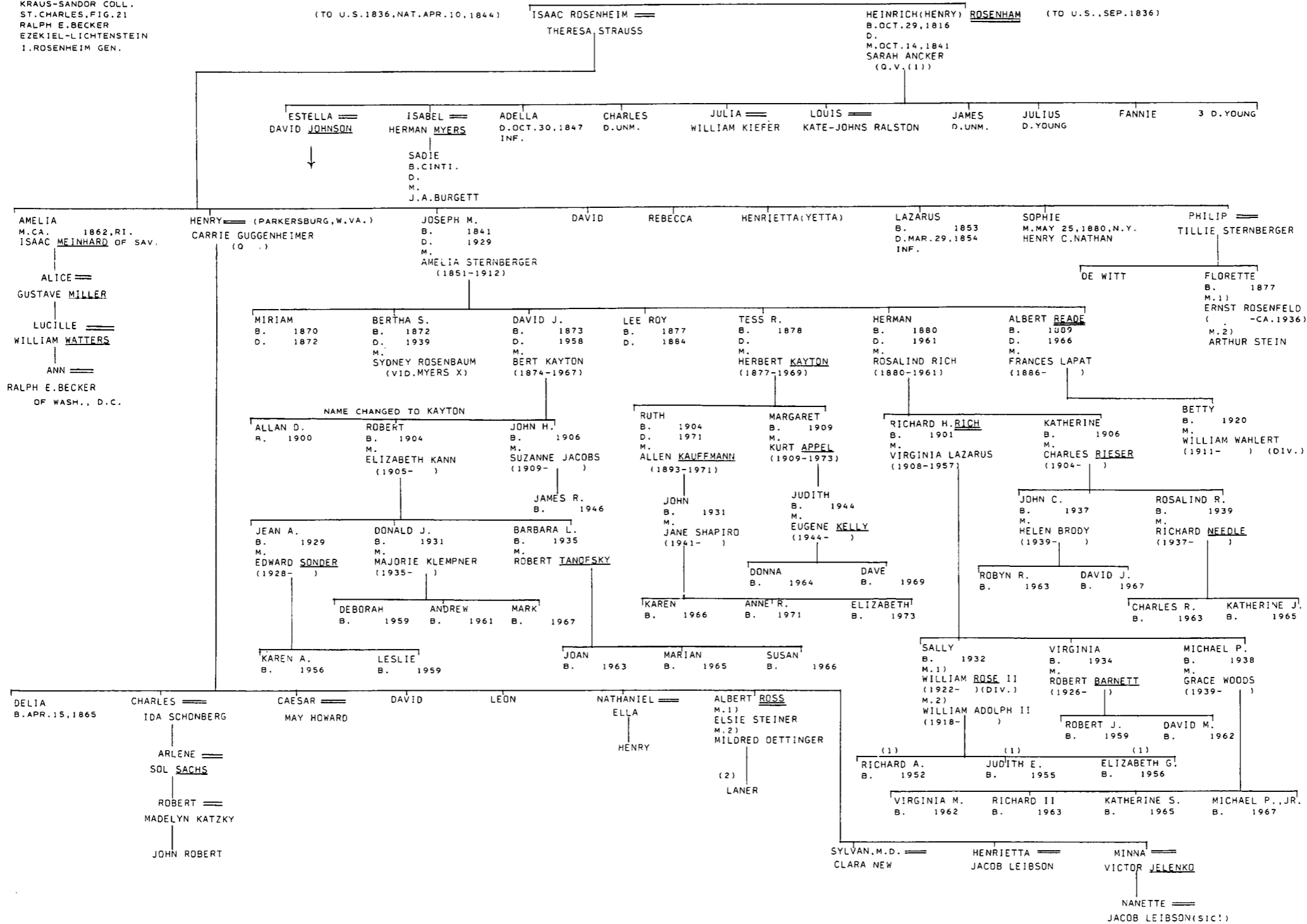

**RUSSELL**

JOHN M. SHEFTALL  
EZEKIEL-LICHTENSTEIN, P. 33  
MORAIS-JEWS OF PH.  
MICKVE ISRAEL REC.  
DAR LINEAGE BOOKS  
WILL OF P. M. RUSSELL (JRM)  
FLD. ABR.  
ELZAS M.N., P. 9  
SHEFTALL MS.  
SPRUCE ST. CEM. REC.

SHEARITH ISRAEL REC.  
CHATHAM CO. MARR. REC.  
ELSIE N. FRANKLIN  
ROSENWAIKE  
CHATHAM CO. MARR. ABSTRACTS  
P. B. H.  
B'NAI JESHURUN REC.  
RUSSELL FAMILY BIBLE

(MOSES) ROESSEL OF OBERFELT, GER.

\* PHILIP MOSES RUSSELL  
B. JUL. 1747, PORTSMOUTH, ENG.  
D. AUG. 11, 1830, GERMANTOWN, PA.  
M. NOV. 1, 1780, PH.  
ESTHER MORDECAI  
(O.V. III)

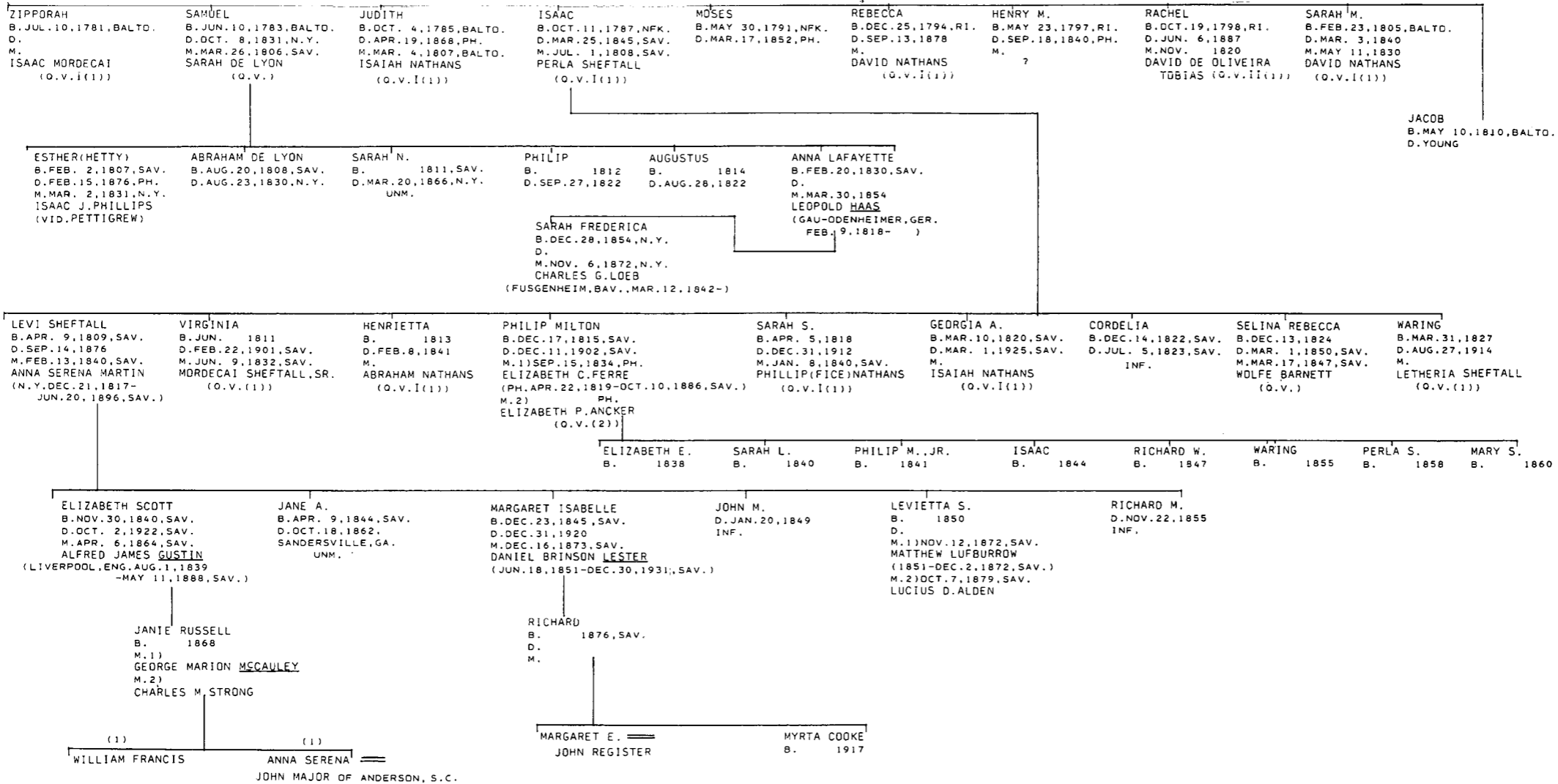

\*ESTABLISHED REVOLUTIONARY ANCESTOR

KRAUS-SANDOR COLL.  
JE V.9,P.671F.  
PAJHS PASSIN  
RUSSELL-HAYM SALOMON...  
SALOMON FAM.REC.(AJHS)  
MURIEL SCHAEFFER CARTER

POOL-PORTRAITS...  
SHEARITH ISRAEL REC.  
FERDINAND L.SOLOMON  
JON STEDMAN

\*HAYM SALOMON JAN.2,1777,N.Y.  
B.LISSA,POLAND,1740  
D.PH. JAN.6,1785

RACHEL FRANKS  
(O.V.(1))

SALOMON (1)

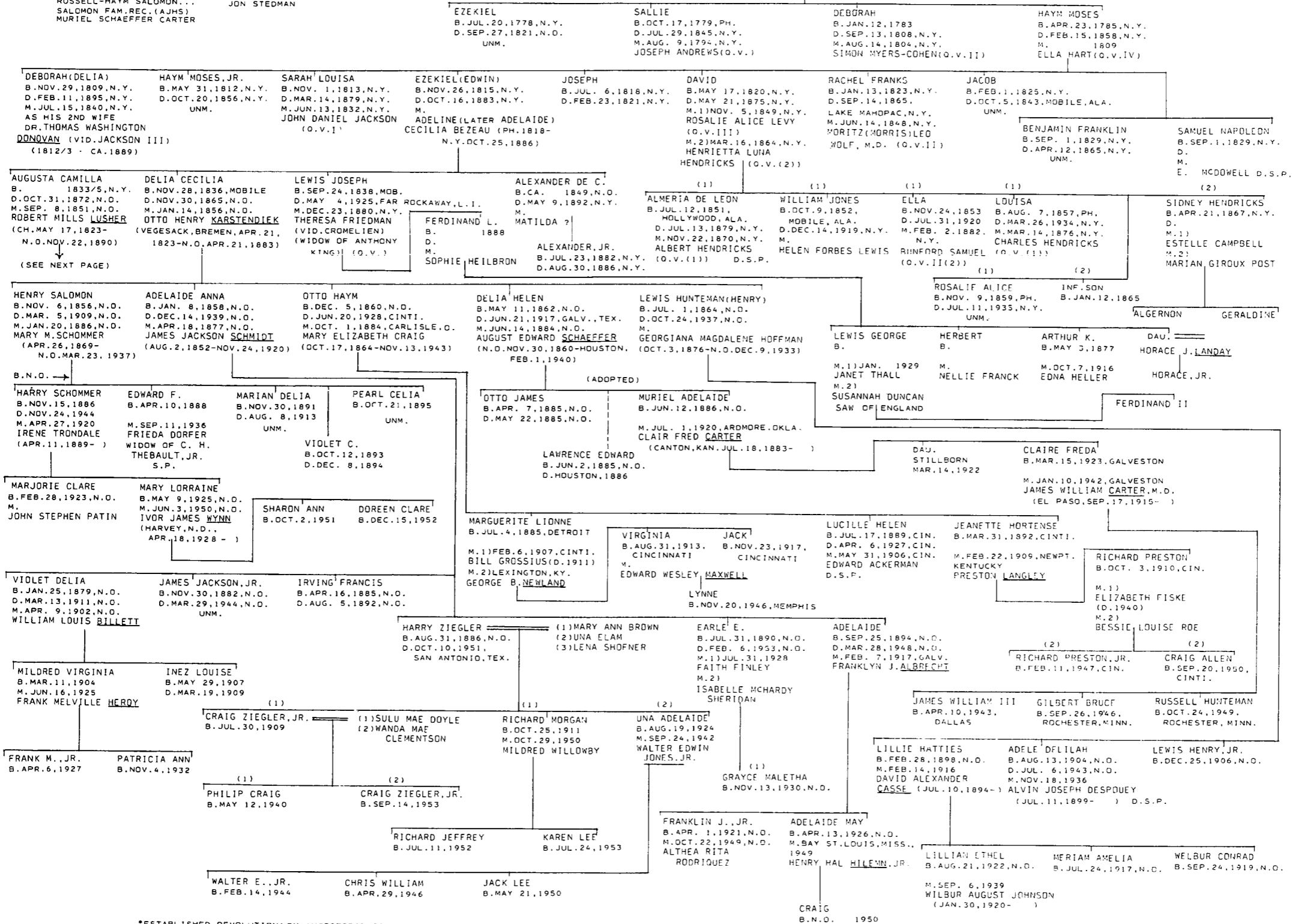

\*ESTABLISHED REVOLUTIONARY ANCESTOR (DAR)



SALOMON (2) (LUSHER)

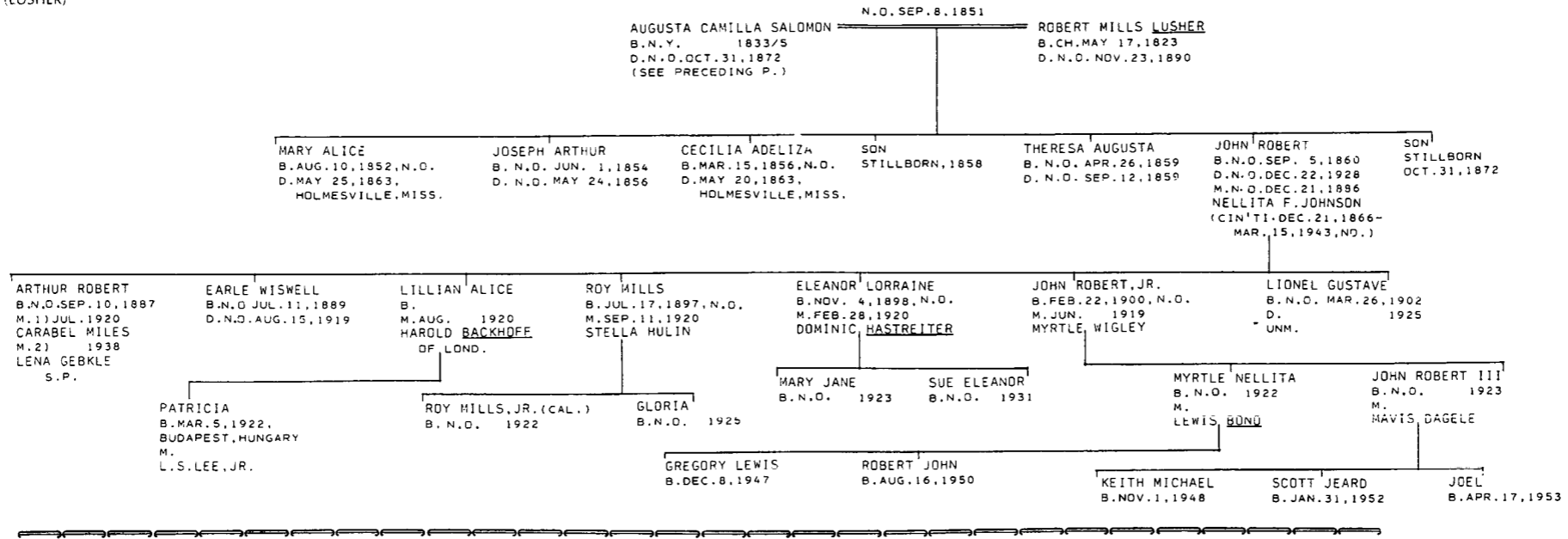

SALVADOR

M.O. SALVADOR  
 MISC. III, VII #231  
 BEVIS MARKS KETUBOT  
 ANGLO-JEWISH NOTABILITIES, PP. 118, 230  
 J.E.V. 4, P. 290  
 U.J.E.V. 9, P. 331  
 PAJHS V. 9, P. 108  
 V. 12, P. 57  
 V. 38, P. 104  
 SALVADOR GEN. (BRITISH MUSEUM)  
 WILLS OF JOSEPH SALVADOR, ABIGAIL  
 FLO. ABR.



SAMPSON

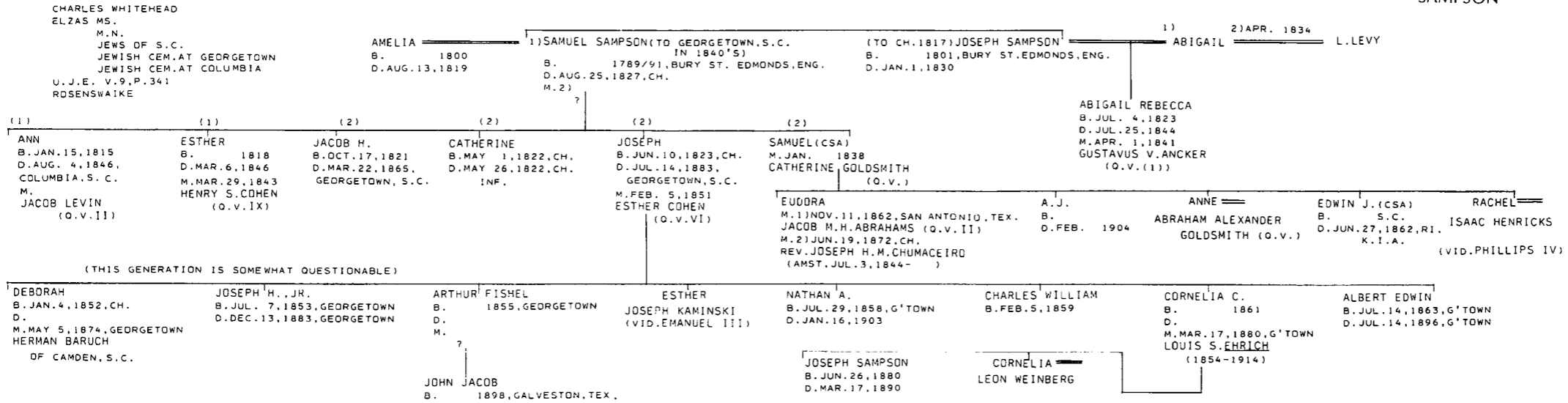

SAMSON

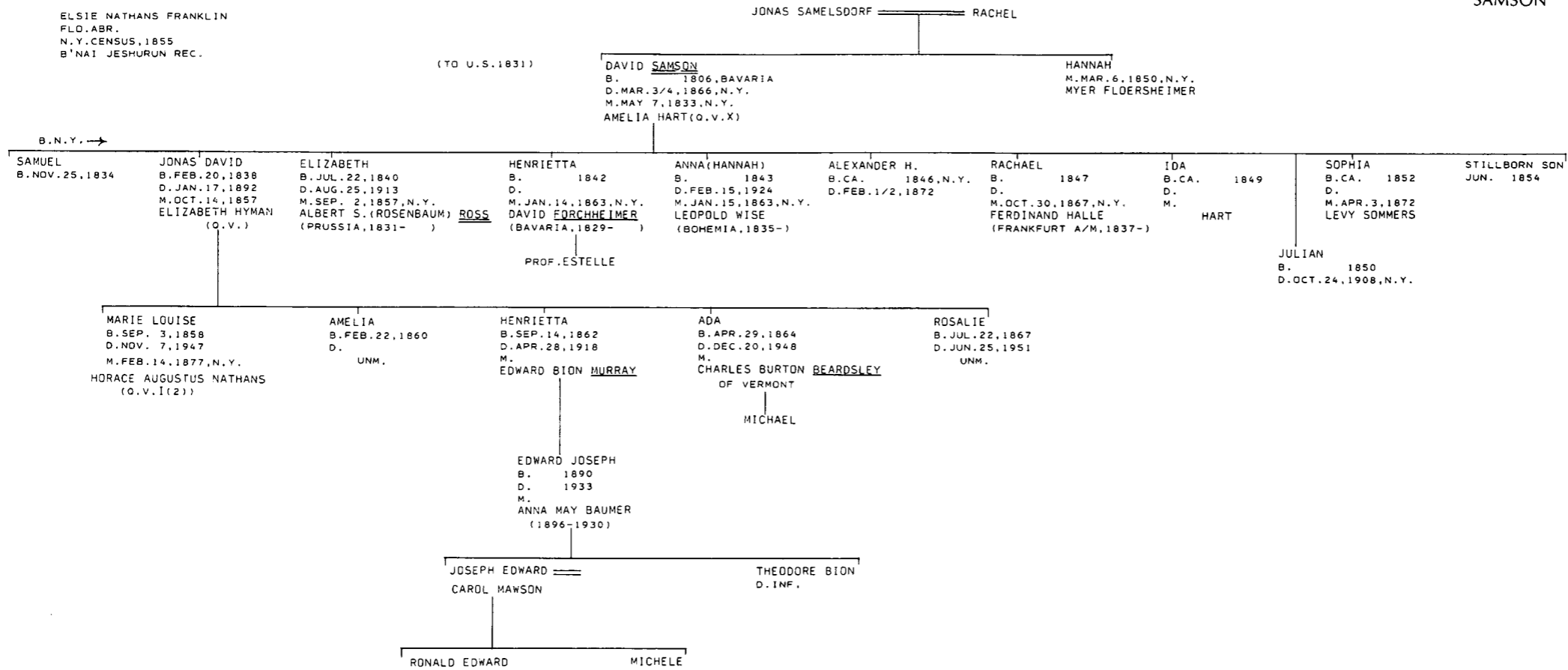

**SAMUEL I**

SAMUEL-YATES GEN. (AJA)  
 SAMUEL-HIST. & GEN. OF SAMUEL AND YATES  
 FLO. ABR.  
 EGON WOLFF  
 U.S. CENSUS, 1880

SAMUEL OF STRELITZ OR KISSINGEN

RALPH SAMUEL JUN. 14, 1769, LOND.  
 B. NOV. 22, 1738, GER.  
 D. JAN. 31, 1809, LIVERPOOL

POLLY LEVY  
 B. DEC. 8, 1745  
 D. DEC. 17, 1803

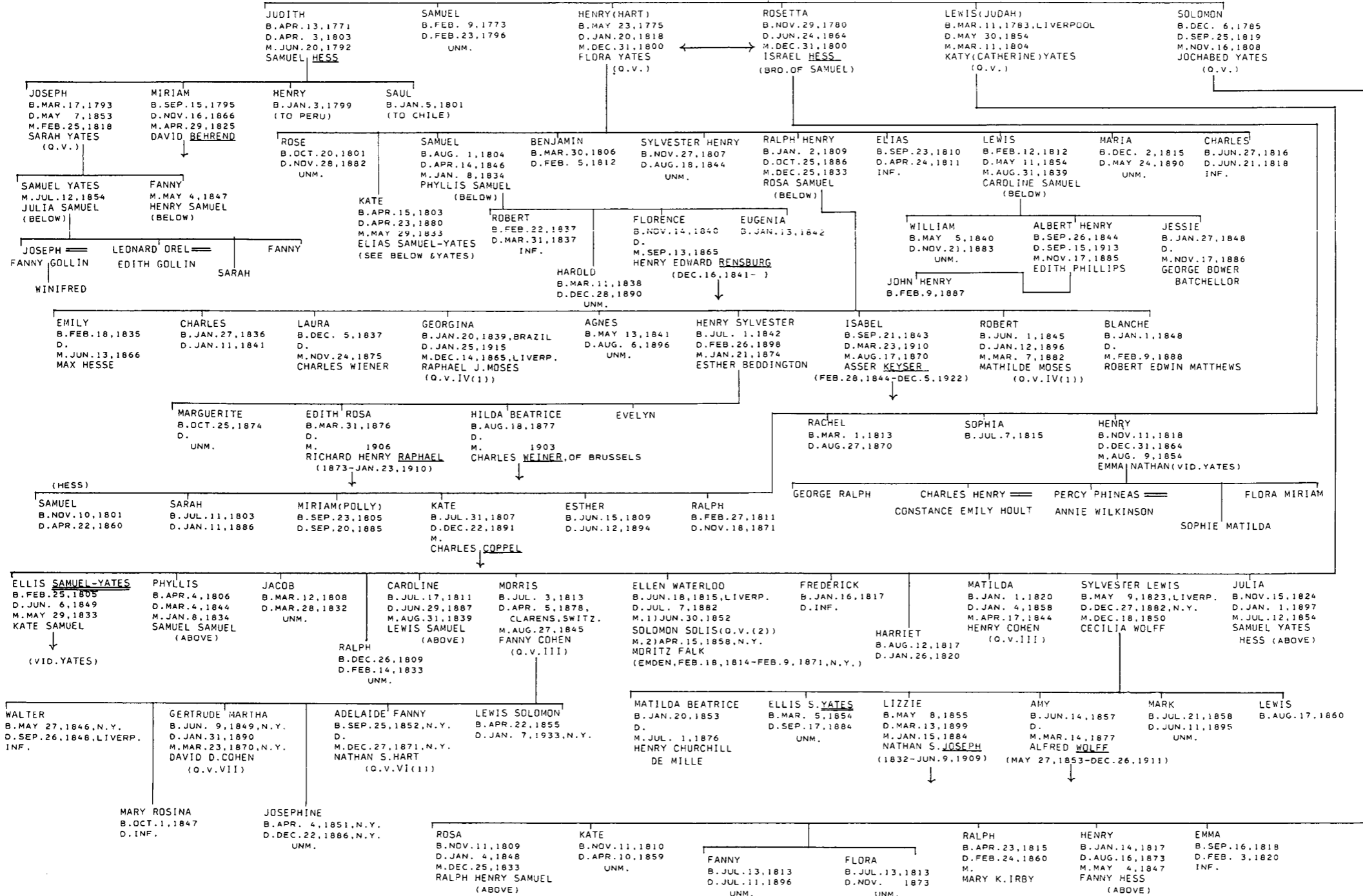

KRAUS-SANDOR COLL.  
 MOSS-SAMUEL GEN.  
 SAMUEL-REC. OF THE SAMUEL FAMILY  
 PHILA. SOCIAL REGISTER  
 J.E.V. 7, P. 454  
 N. ROSENSTEIN  
 FLD. ABR.  
 MORAIS-JEWS OF PHILA.

SAMUEL II (1) (GER., ENG., PHILA.)

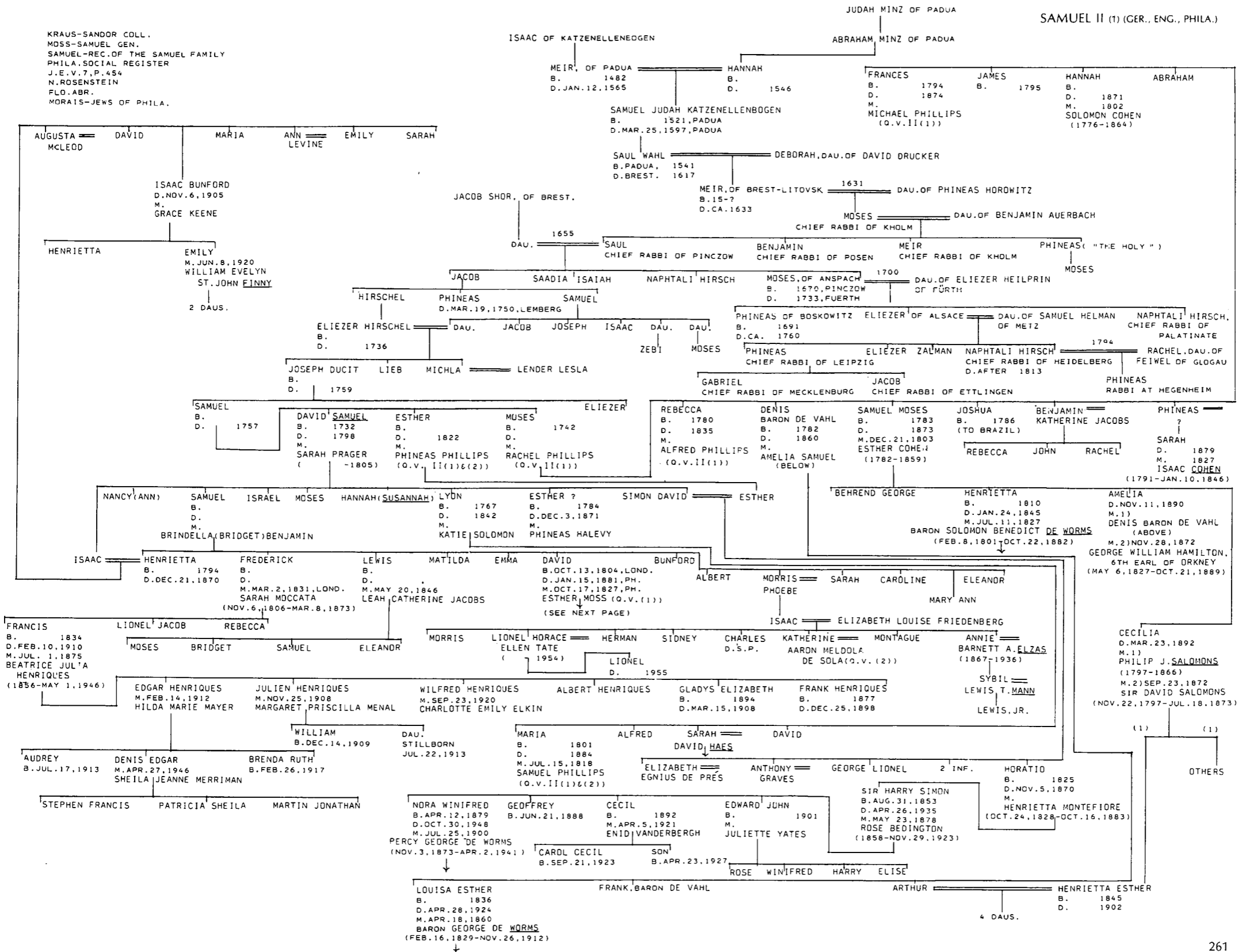

SAMUEL II (2)

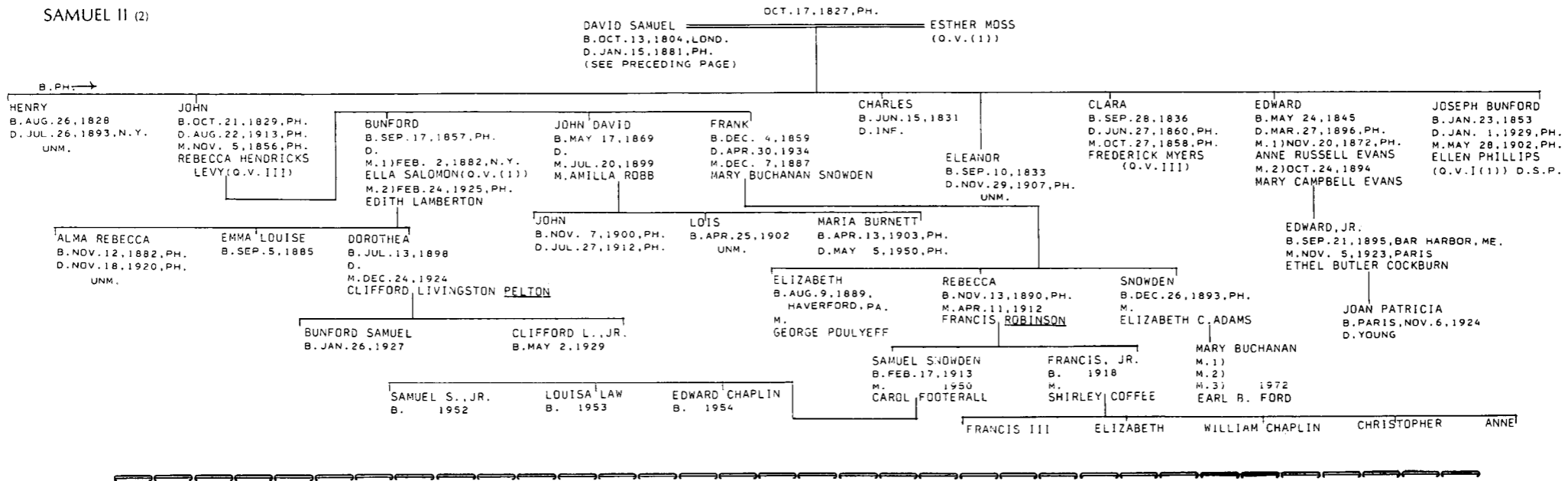

SARZEDAS

KRAUS-SANDOR  
PAJHS V. 12, P. 57  
ELZAS MS.  
SHEARITH ISRAEL REC.  
MYERS-HAYS-MORDECAI MS. (VA. H. S.)  
U.S. CENSUS, 1820  
EVELYN GREENBERG  
GA. NEWSPAPERS  
S.C. MARRIAGE CONVEYANCES  
MISC. VII #473, 474  
SHEFTALL MS.

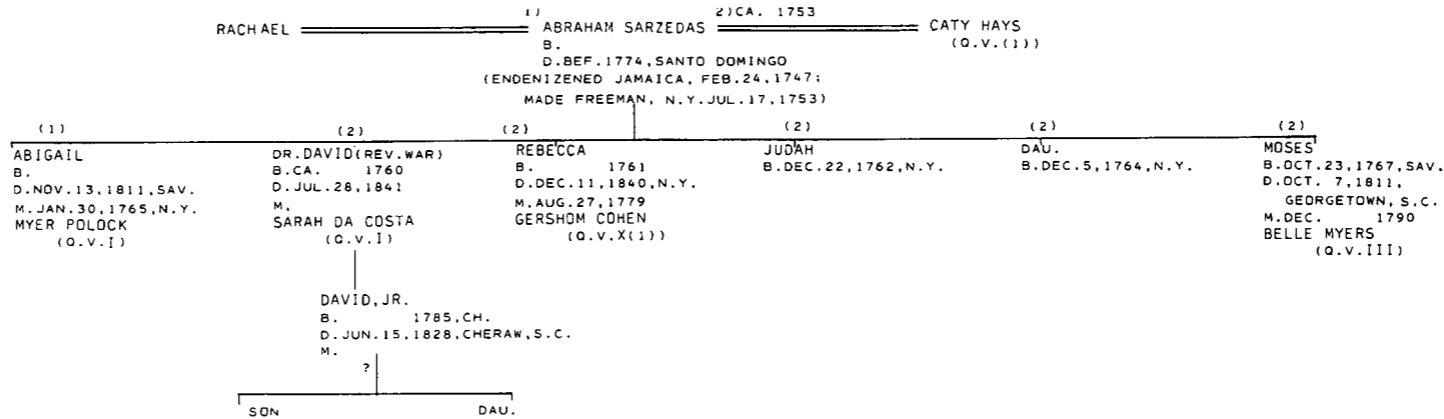

SASPORTAS

KRAUS-SANDOR COLL.  
PAJHS V. 19, P. 81  
V. 27, P. 304  
V. 29, P. 32F.  
ELZAS M.N., P. 7  
MS.  
WILL OF ABRAHAM SASPORTAS  
SHEARITH ISRAEL REC.  
SHEFTALL MS.

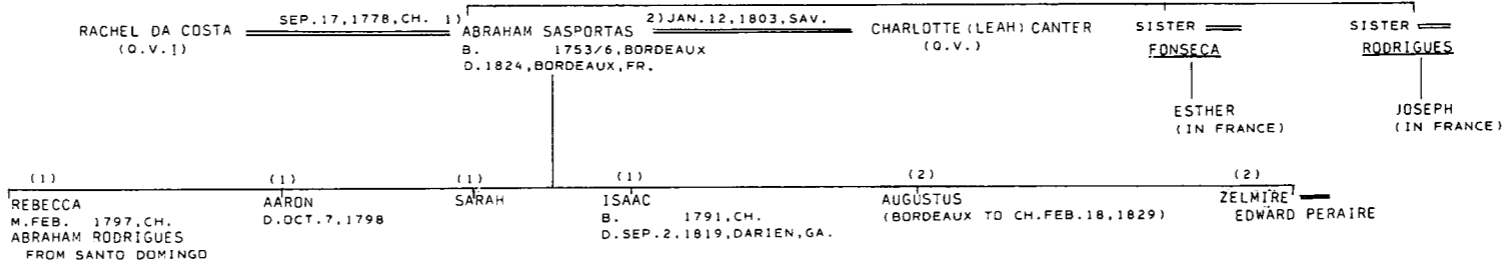

N.Y. WEEKLY MUSEUM  
 WILL OF DAVID C. SEIXAS  
 DAVID CARDOZA SEIXAS BIBLE  
 BEVIS MARKS BIRTH REC.  
 BEVIS MARKS KETUBOT  
 MISC. VII, #214D, 582  
 HERSHKOWITZ-WILLS  
 J.E. V9, P. 159  
 PAJHS V. 4, P. 201F,  
 V. 27, PASSIM  
 THE IMPROVEMENT ERA, FEB. 1936  
 KRAUS-SANDOR COLL.  
 SHEARITH ISRAEL REC.  
 FLD. ABR.  
 EDITH K. NICHOLAS  
 ELZAS O. J. C.  
 N.Y. TIMES OBIT. MAY 22, 1887  
 U.S. CENSUS, 1850  
 ROSENWAIKE  
 VICTORIA FAUTH SUTTON  
 RALPH COLTON  
 LILLIAN DISLANDER  
 JEANNE F. INGRAM  
 ALICE LANDRUM

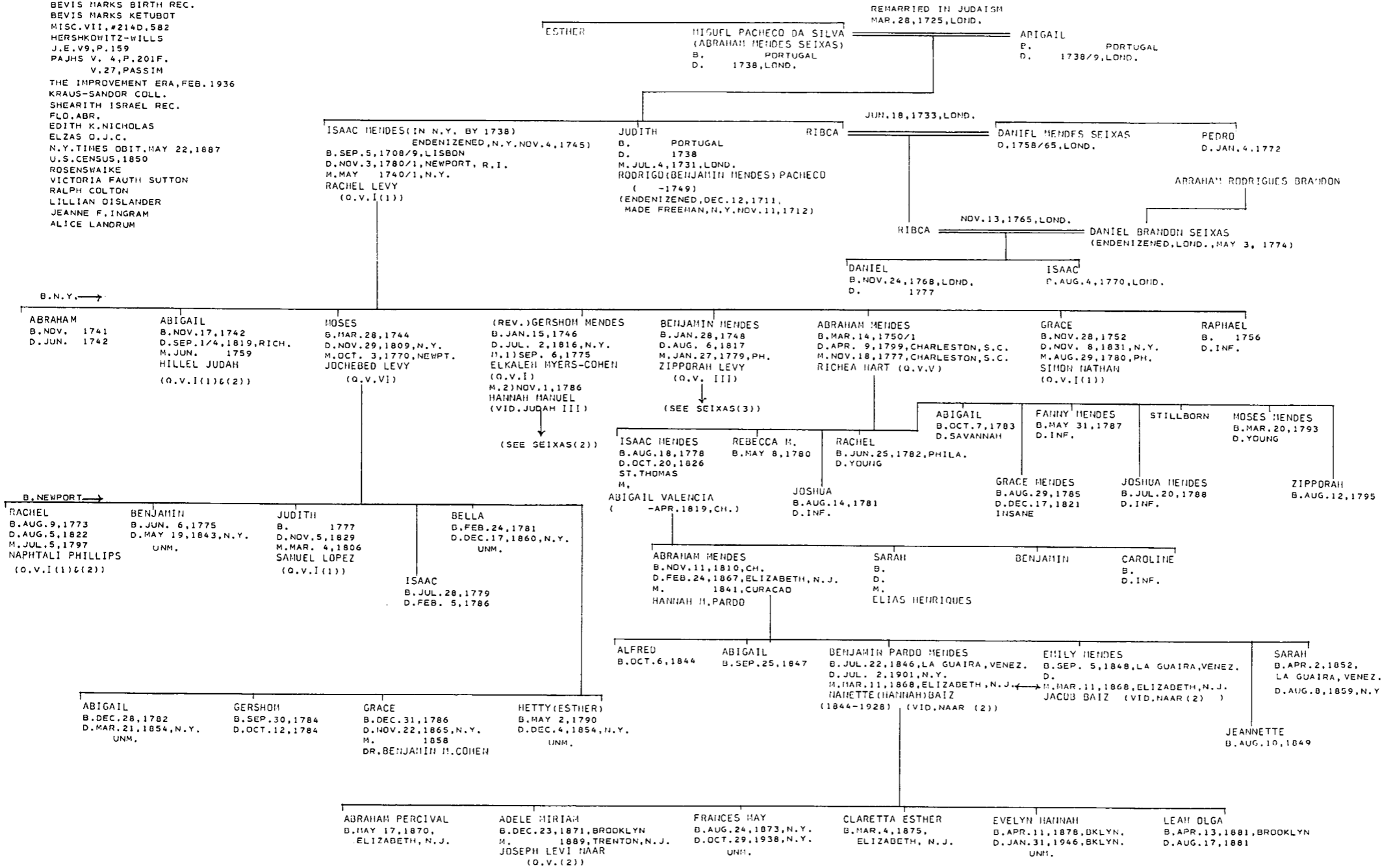

SEIXAS (2)

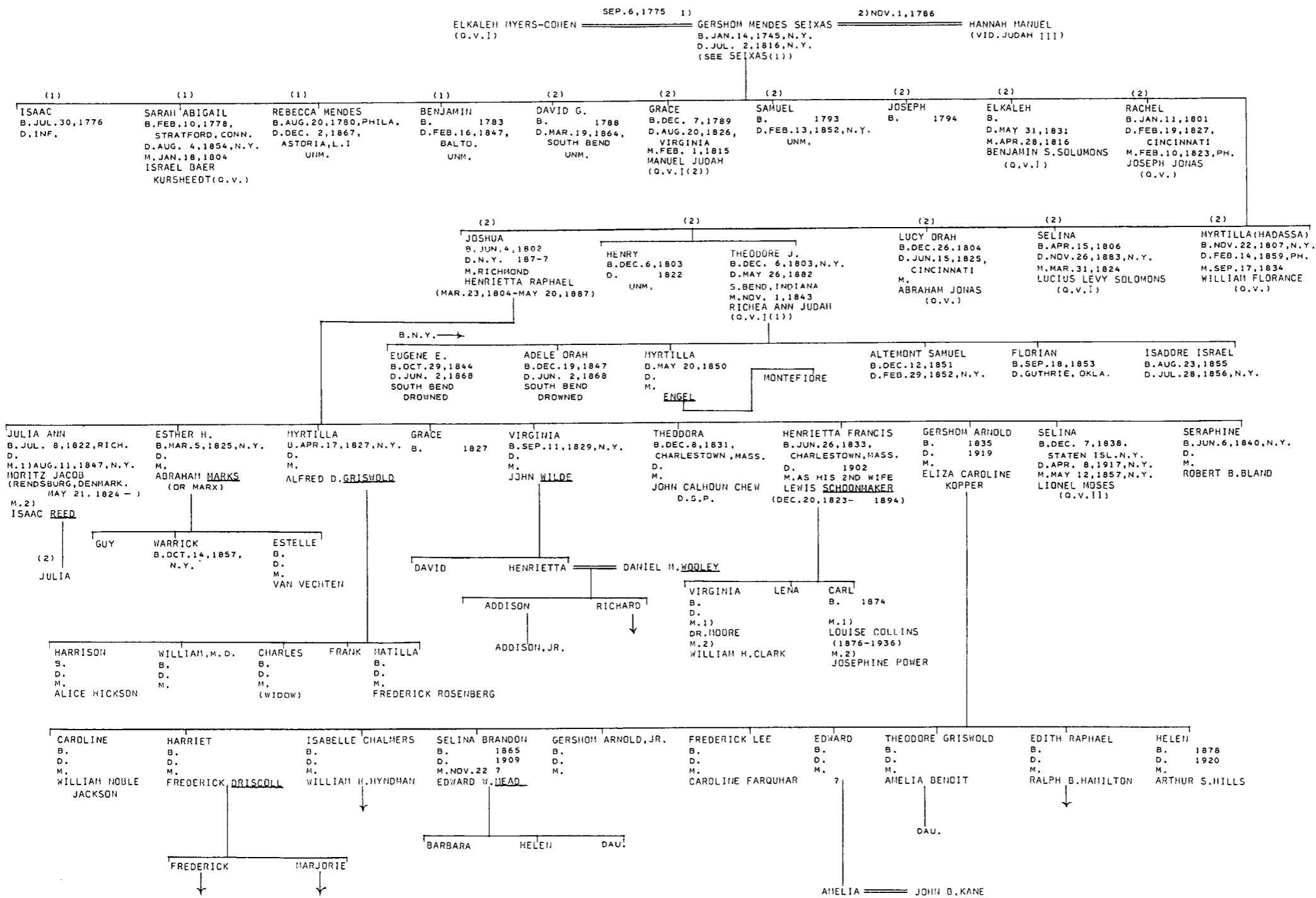

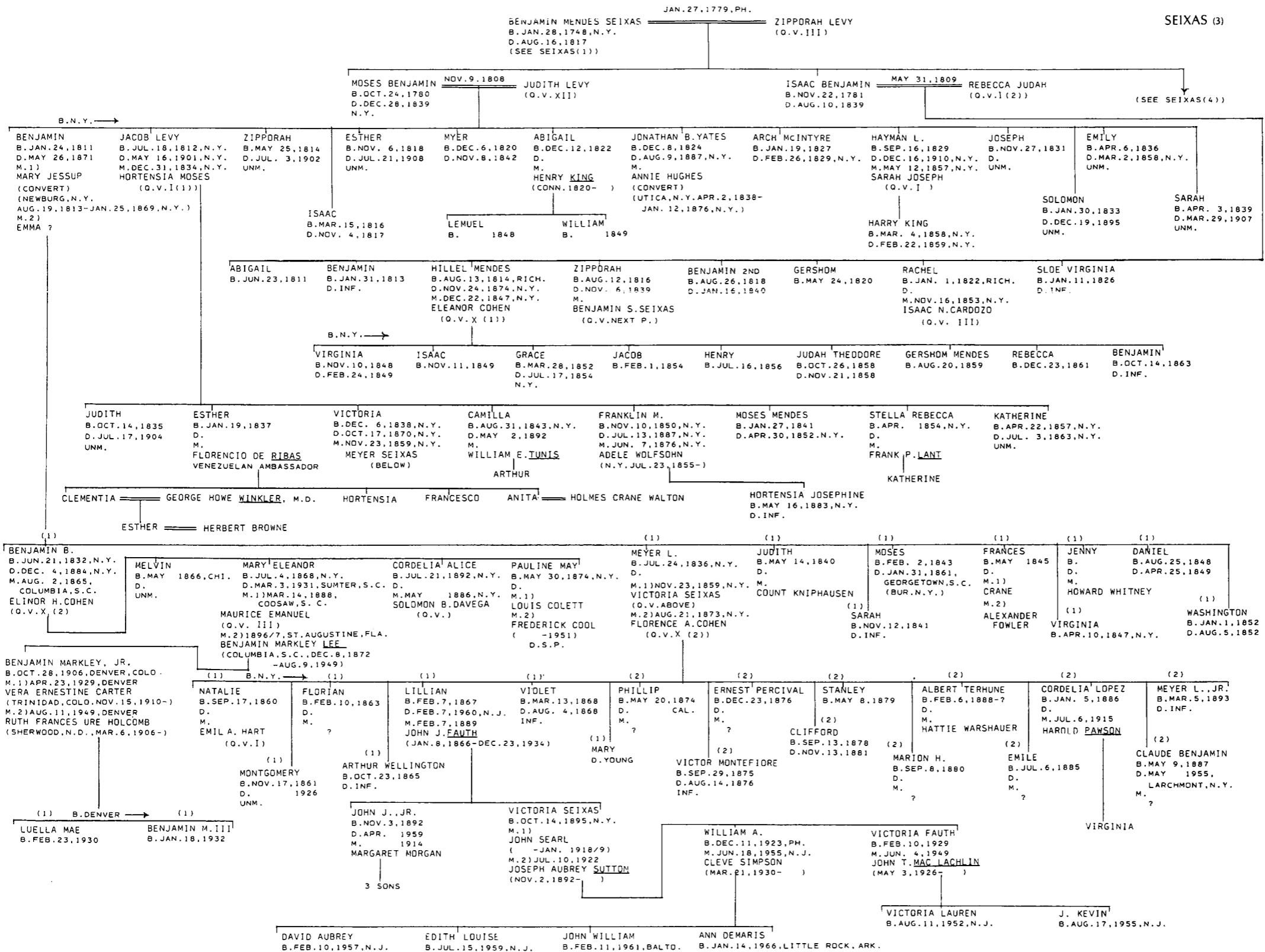



SEIXAS (4)

DR. FRANK A. SEIXAS

JAN. 27, 1779, PH.

BENJAMIN MENDES SEIXAS  
B. JAN. 28, 1748, N.Y.  
D. AUG. 16, 1817, N.Y.  
(SEE SEIXAS (1))

ZIPPORAH LEVY  
(O.V. III)

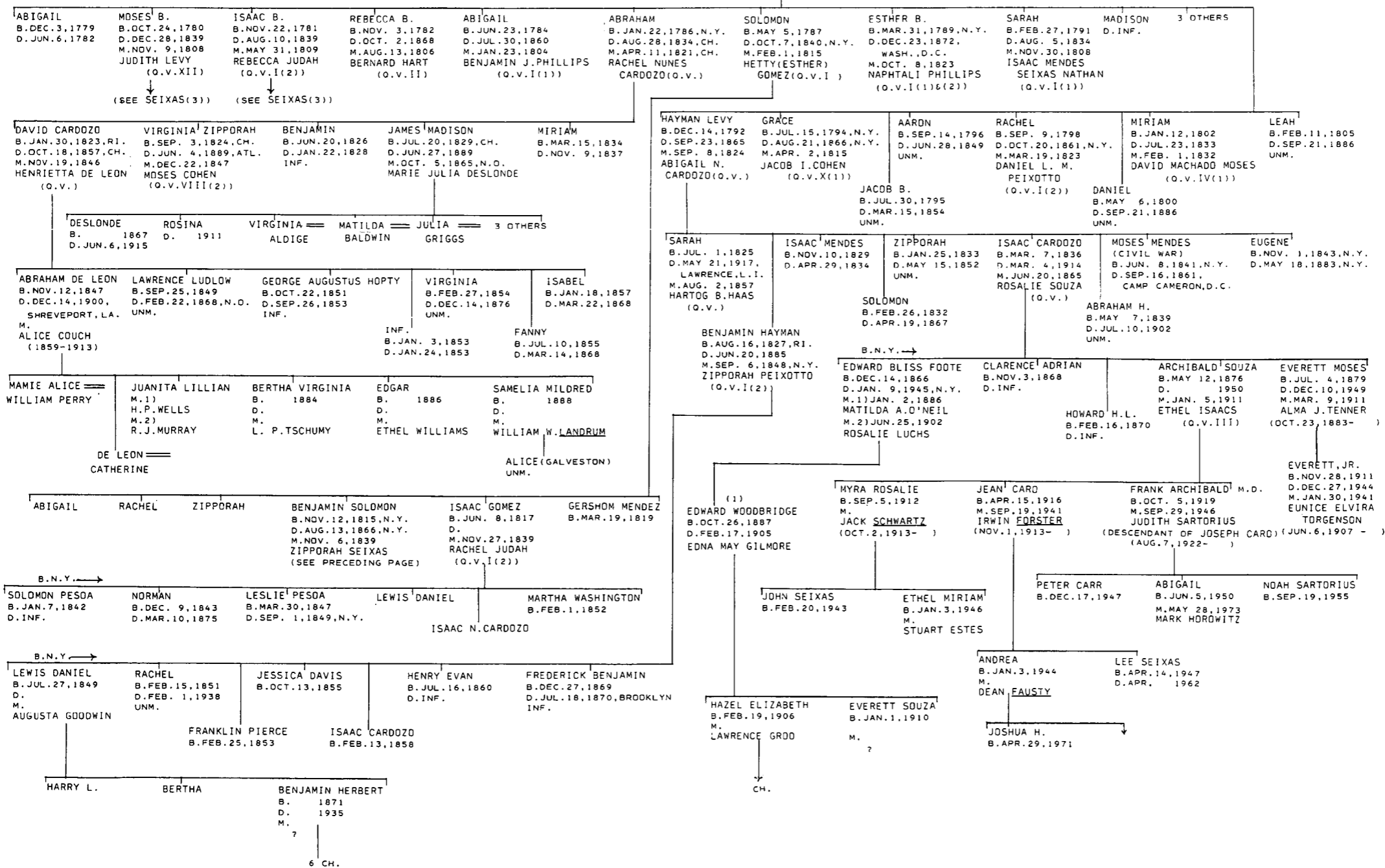

SHEFTALL (1)

SHEFTALL MS.  
JOHN MCK. SHEFTALL  
KRAUS-SANDDR COLL.  
PAJHS V.10, P.80FF.  
V.17, P.167FF.  
ELZAS-JEWS OF S.C., PT.2, P.9  
MSS.  
SAVANNAH JEW. BURYING GROUND  
CHATHAM CO. MARR. REC.  
ABSTRACT OF WILLS, CHATHAM CO.  
ROSENWAIKE  
BIOG. SOUVENIR OF FLA. & GA.,  
P.734.

MIKVEH ISRAEL (PH.) REC.  
MICKVE ISRAEL (SAV.) REC.  
WILLS: LEVI, ESTHER, PERLA SHEFTALL  
DAR REC. OF M.E. HARBY  
FLD. ABR.  
CLARENCE SHEFTALL, JR.  
LAUREL GROVE CEM. REC.  
WILSON-ANNALS OF GA., V.111  
JACK COLEMAN  
WALTER V. ARNOLD, JR.  
LEVI SHEFTALL BIBLE

PERLA B. 1736, SAV. (CAME TO SAV., JUL. 11, 1733)  
BENJAMIN SHEFTALL B. 1692, PRUSSIA D. OCT. 3, 1765  
HANNAH SOLOMONS B. 1699, AMST. D. FEB. 21, 1772, SAV. (CAME TO SAV., OCT. 5, 1738)  
LEVI B. D. DEC. 6, 1775, SAV.

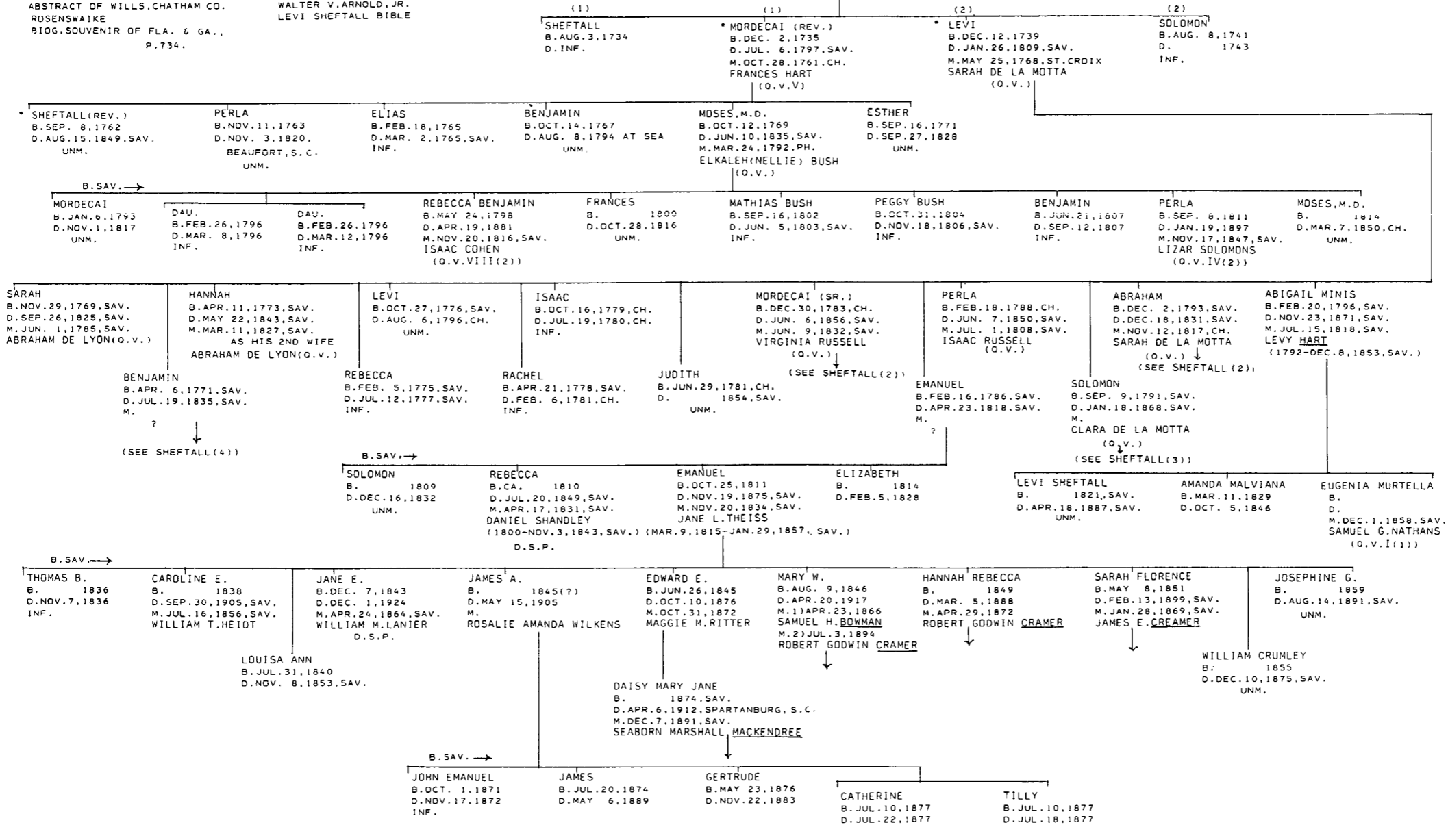

\*ESTABLISHED REVOLUTIONARY ANCESTOR

SHEFTALL (2)

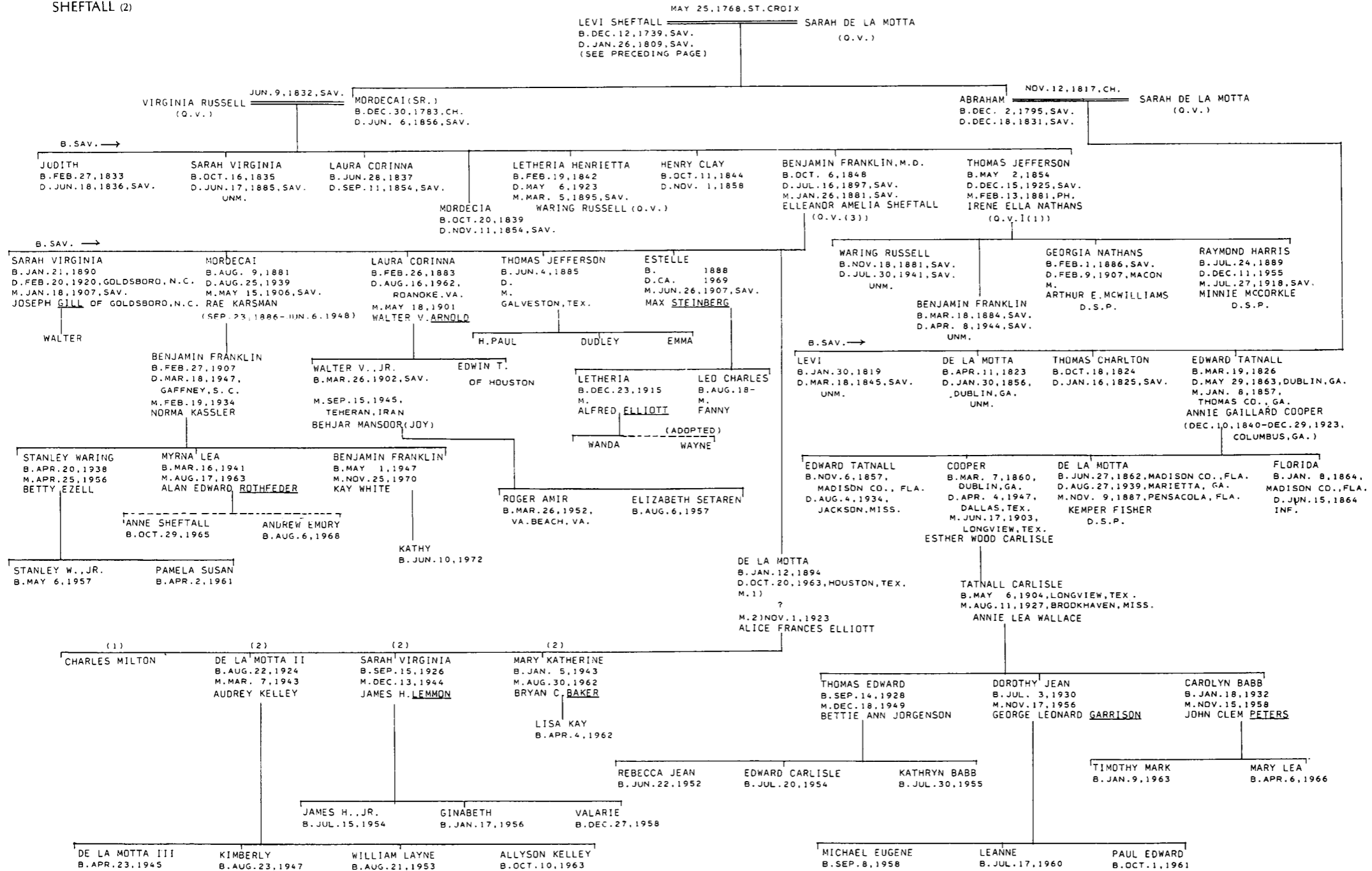

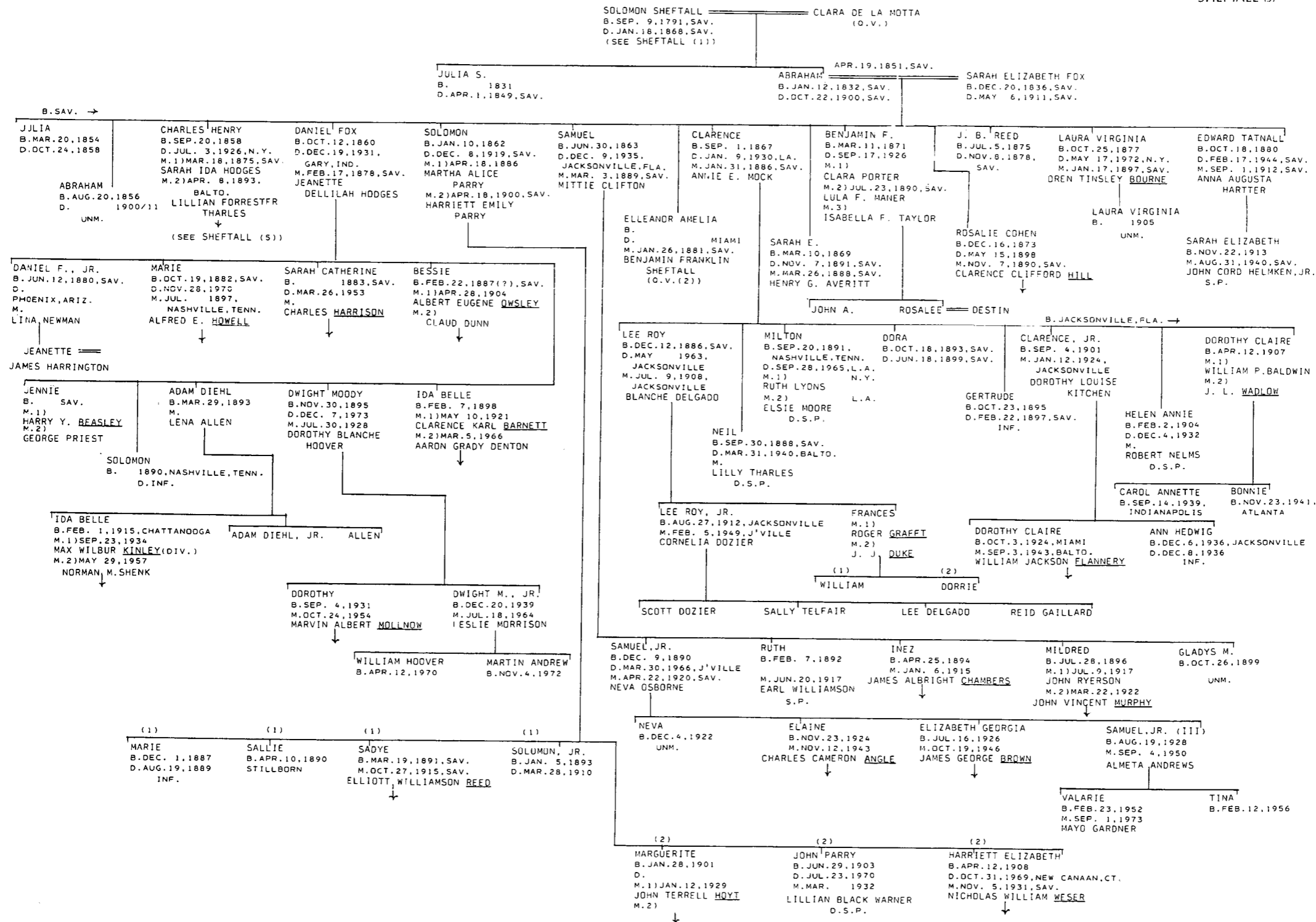

SHEFTALL (4)

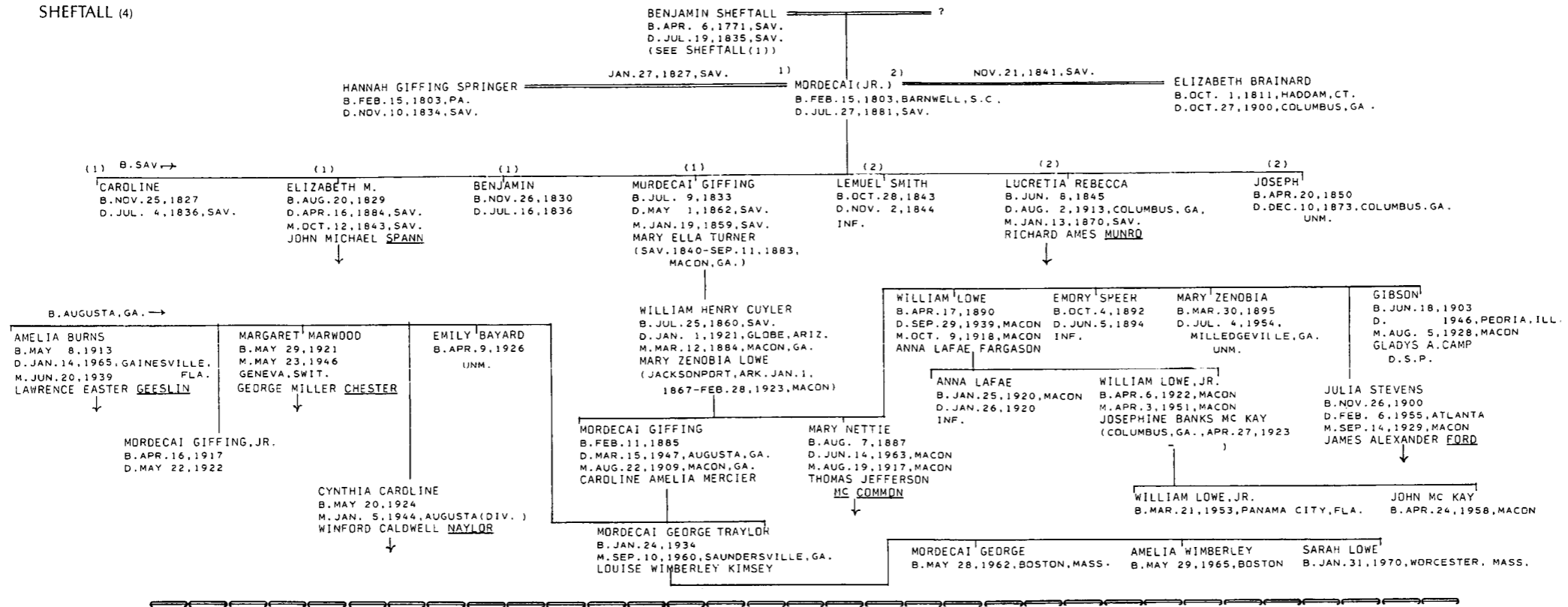

SHEFTALL (5)

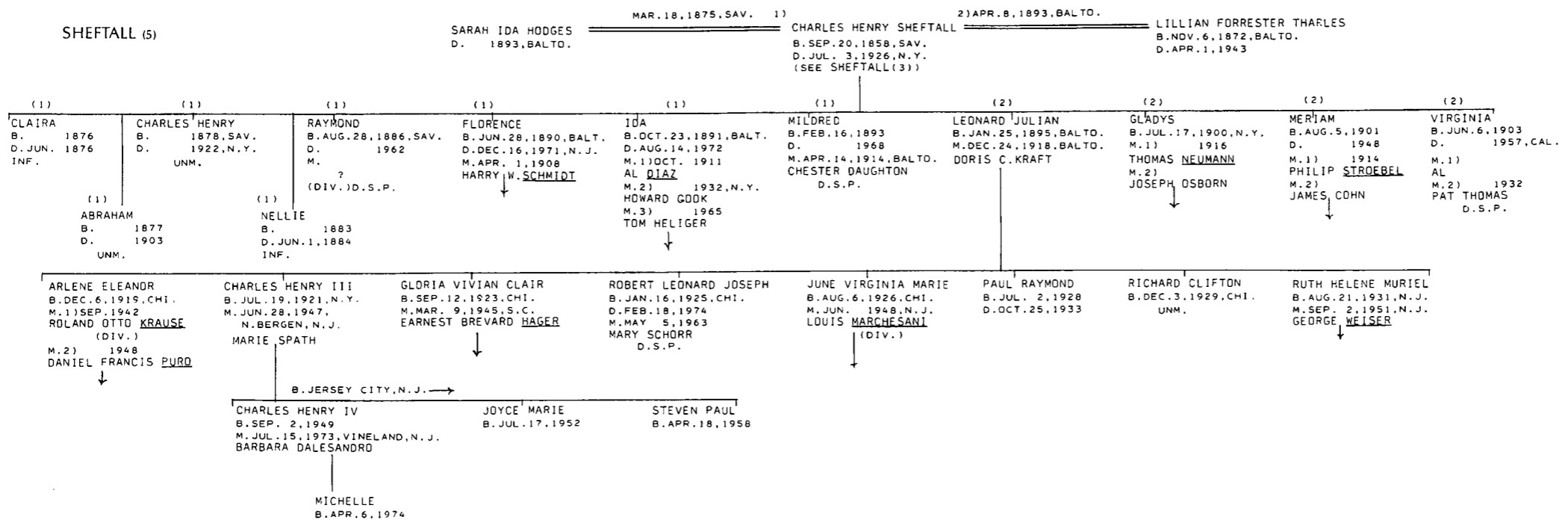

SHOYER

FLO. ABR.  
SHEARITH ISRAEL REC.  
MIKVEH ISRAEL REC.  
RODEPH SHALOM MOHEL REC.  
DAVIS-RODEPH SHALOM

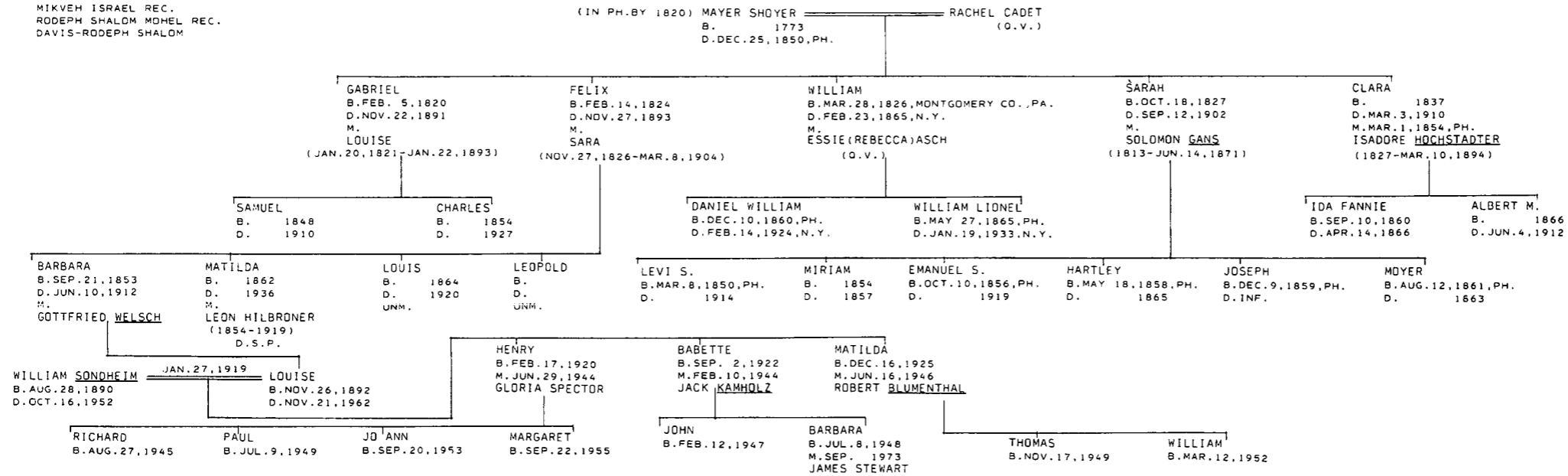

SIMON

SHEARITH ISRAEL REC.  
MIKVEH ISRAEL REC.  
SPRUCE ST. CEM.  
B. JACOBS MOHEL REC.  
AJA, V. XII, P. 107  
W.W., P. 49  
KRAUS-SANDOR COLL.  
PAJHS V. 8, P. 30F.  
V. 21, PP. 154, 156  
V. 27, P. 155  
V. 31, P. 241  
AJHO, LXI, P. 73  
PHILIPSON-REBECCA GRATZ, P. 42  
DAVID A. BRENER

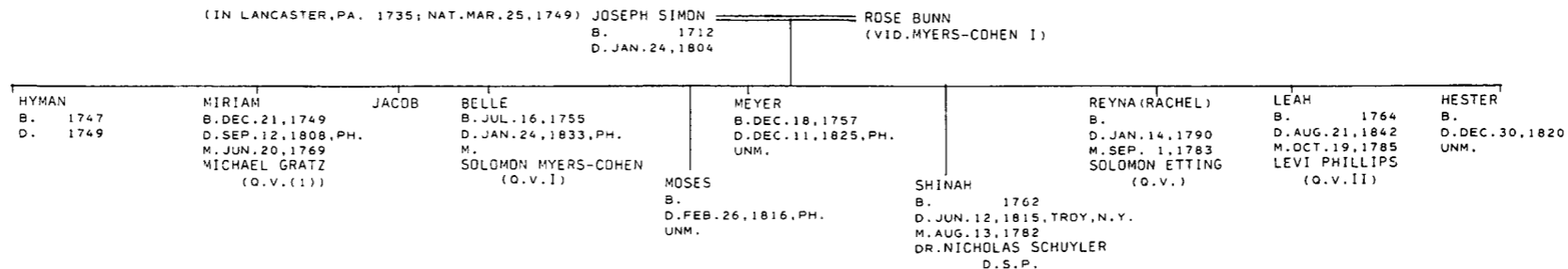

SIMONS

KRAUS-SANDOR COLL.  
ELZAS-JEWS OF S.C.  
MS.  
O.J.C.  
CHATHAM CO. (GA.) WILLS  
WILL OF SAMPSON SIMONS (JRM)  
MONTAGUE SIMONS  
SAV. JEWISH BURYING GROUND

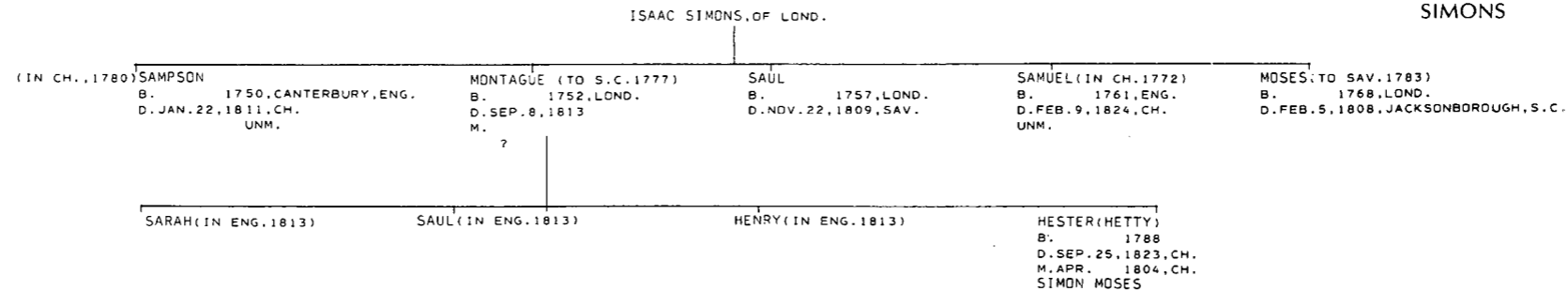

**SIMPSON**

ELZAS MS.  
O. J. C.  
SHEARITH ISRAEL REC.  
A. L. MARSH

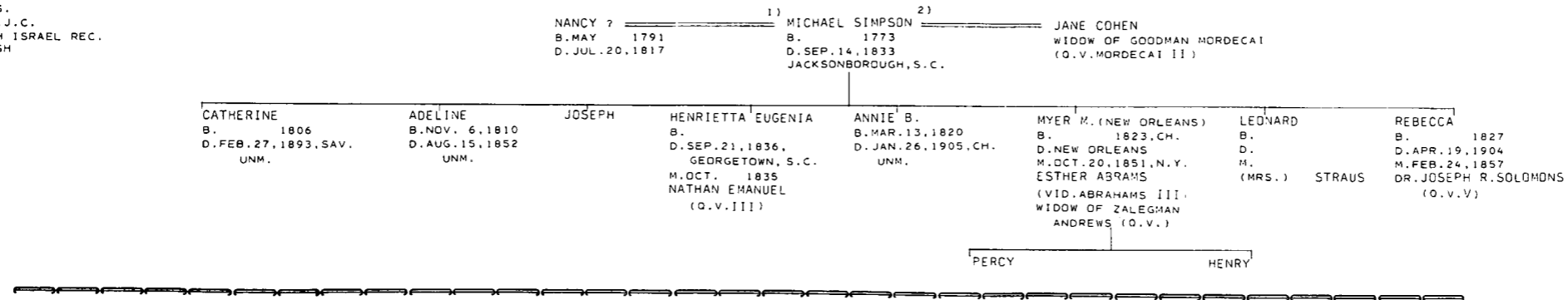

**SIMSON**

SIMSON MS. (AJHS)  
HERSHKOWITZ-WILLS, P.  
N. Y. STATE CENSUS, 1855  
PAJHS V. 10, PP. 109F., 34  
V. 25, P. 88F.  
V. 27, P. 371F.  
V. 33, P. 202  
AMER. JEW. ARCHIVES, V. 1, #2, P. 33F.  
POOL-PORTRAITS...  
SHEARITH ISRAEL REC.  
MISC. VII

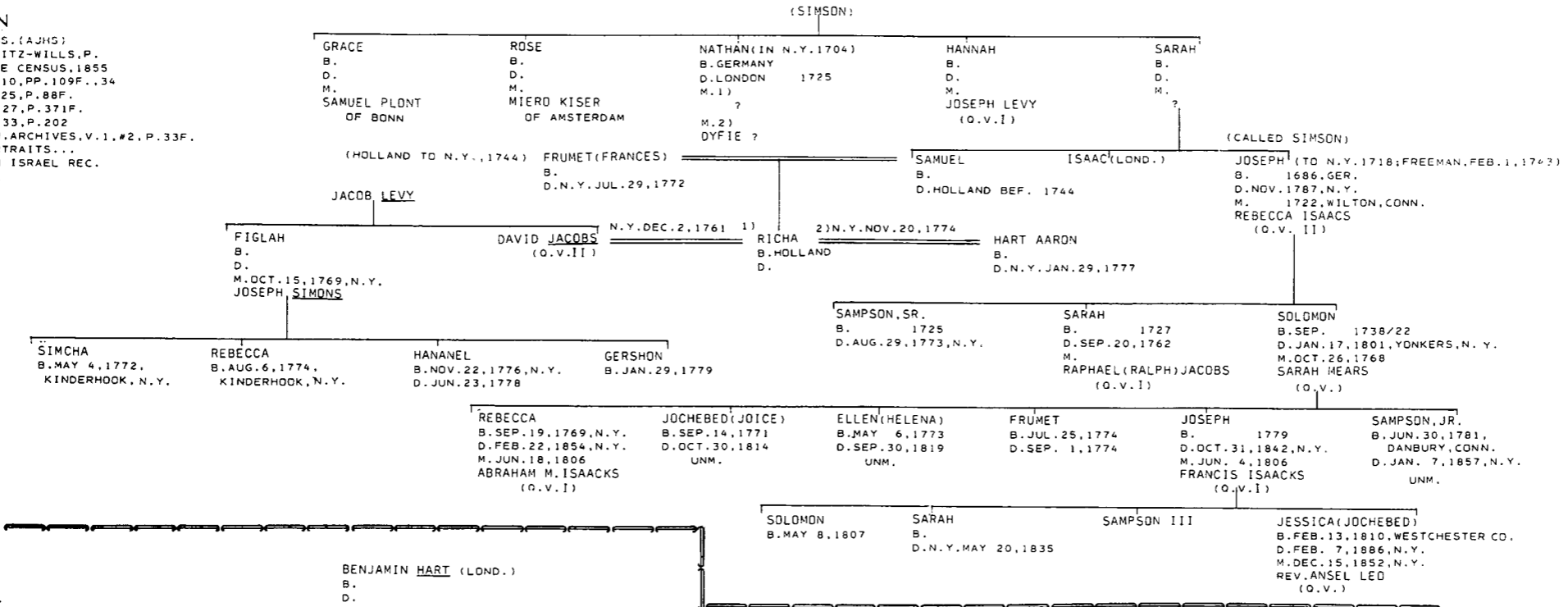

**SOHER**

KURN-N. O.  
EDGAR M. KAHN  
SALEM FIELDS CEM. (J. STEDMAN)  
KRAUS-SANDOR COLL.  
SHEARITH ISRAEL REC.

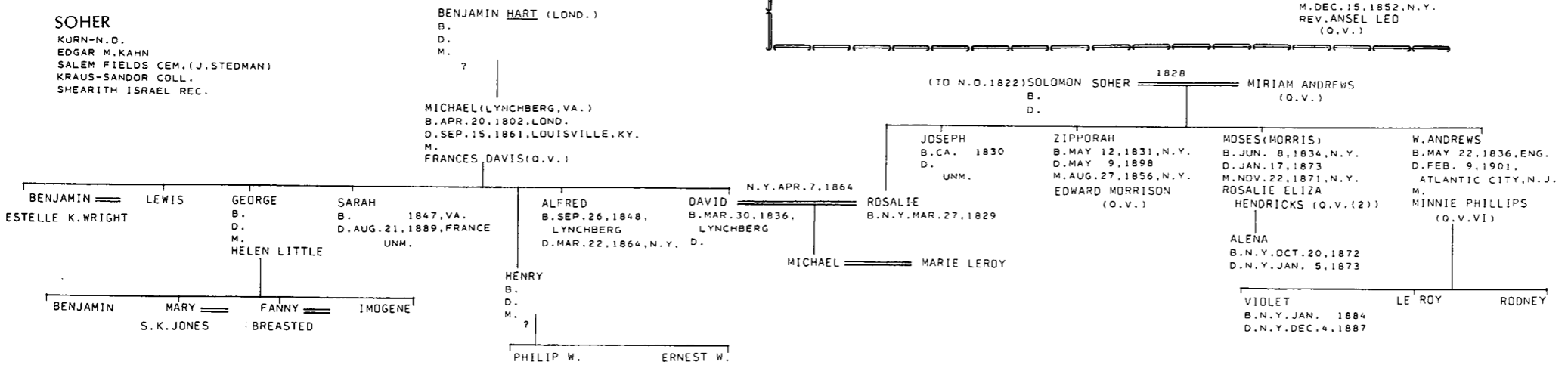

REZNIKOFF-JEWS OF CHARLESTON, PP. 49, 270  
 JAMES M. FORGOTSON  
 LOUIS GINSBERG

SOLOMON

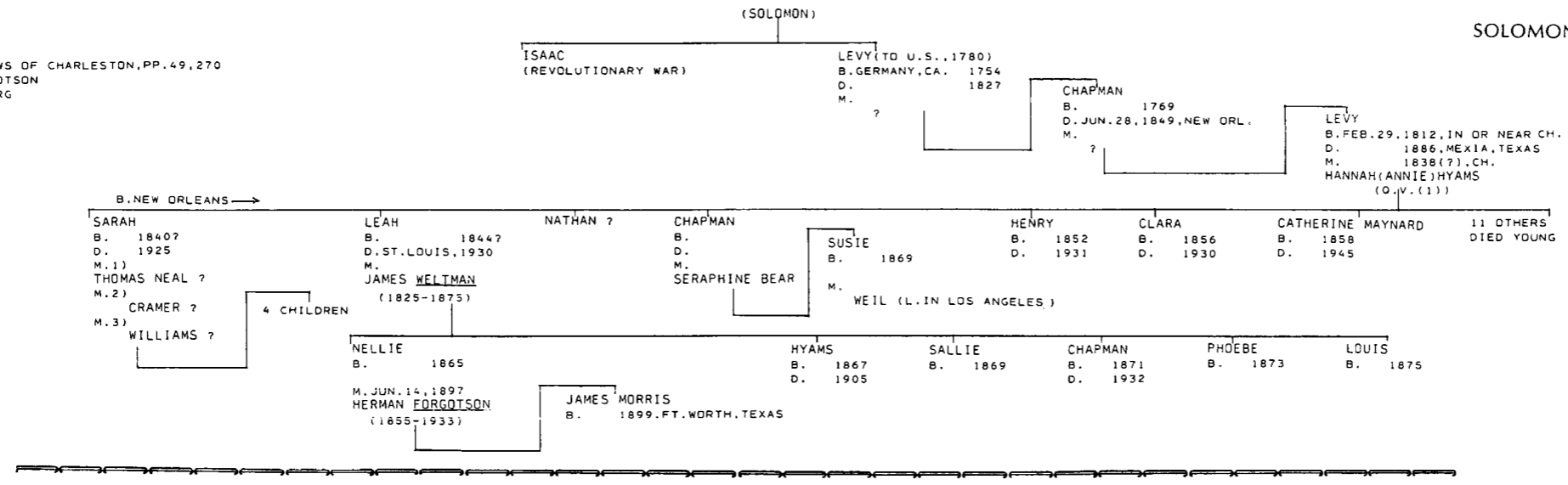

KRAUS-SANDOR COLL.  
 HENDRICKS GEN.  
 EZEKIEL-LICHTENSTEIN-JEWS OF RICHM., P. 290F.  
 FLO. ABR.  
 MICKVE ISRAEL REC.  
 SHEARITH ISRAEL REC.  
 BEVIS MARKS REC.  
 MYER SOLIS-COHEN  
 BETH SHALOME MARRIAGE REC

SOLIS (1)

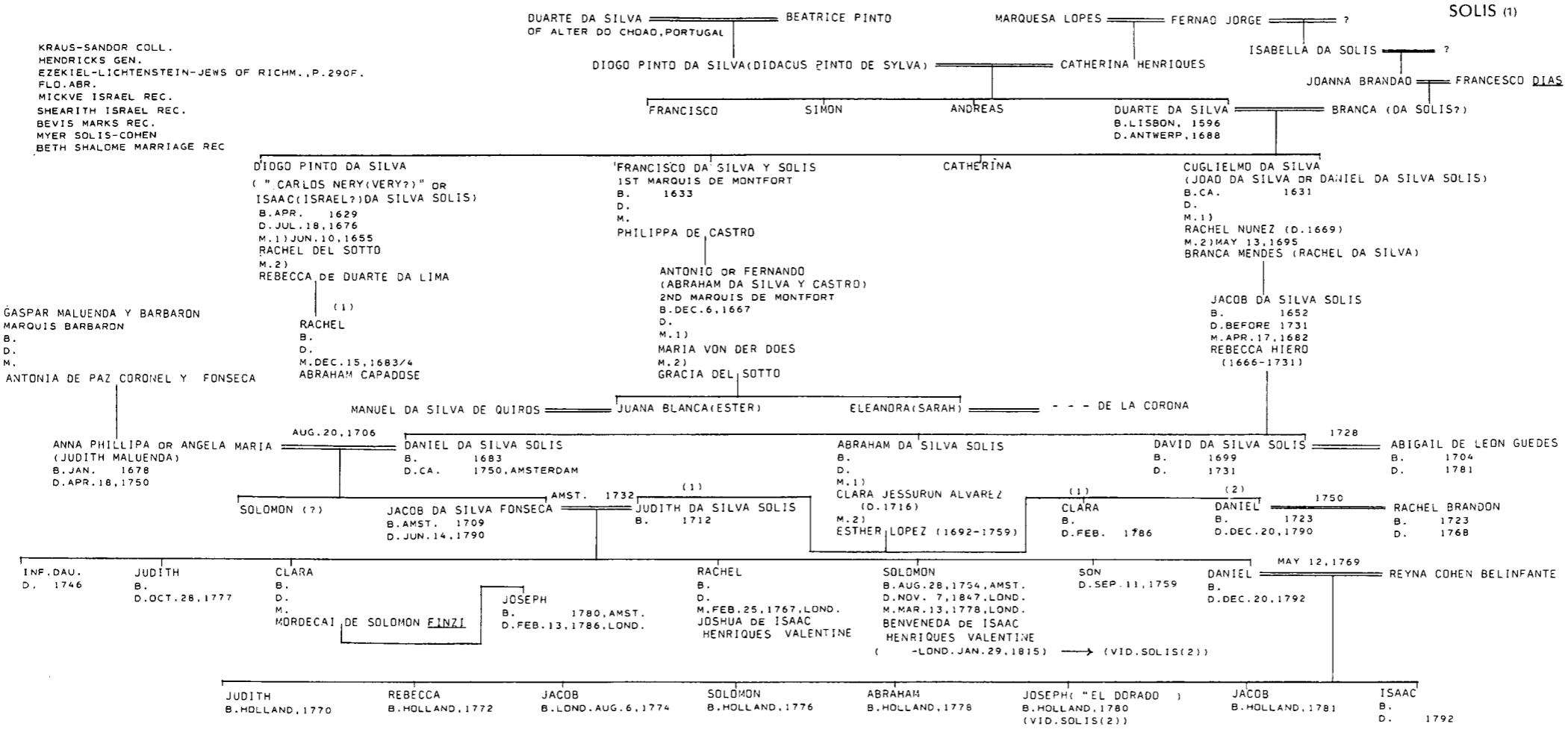



SOLIS (2)

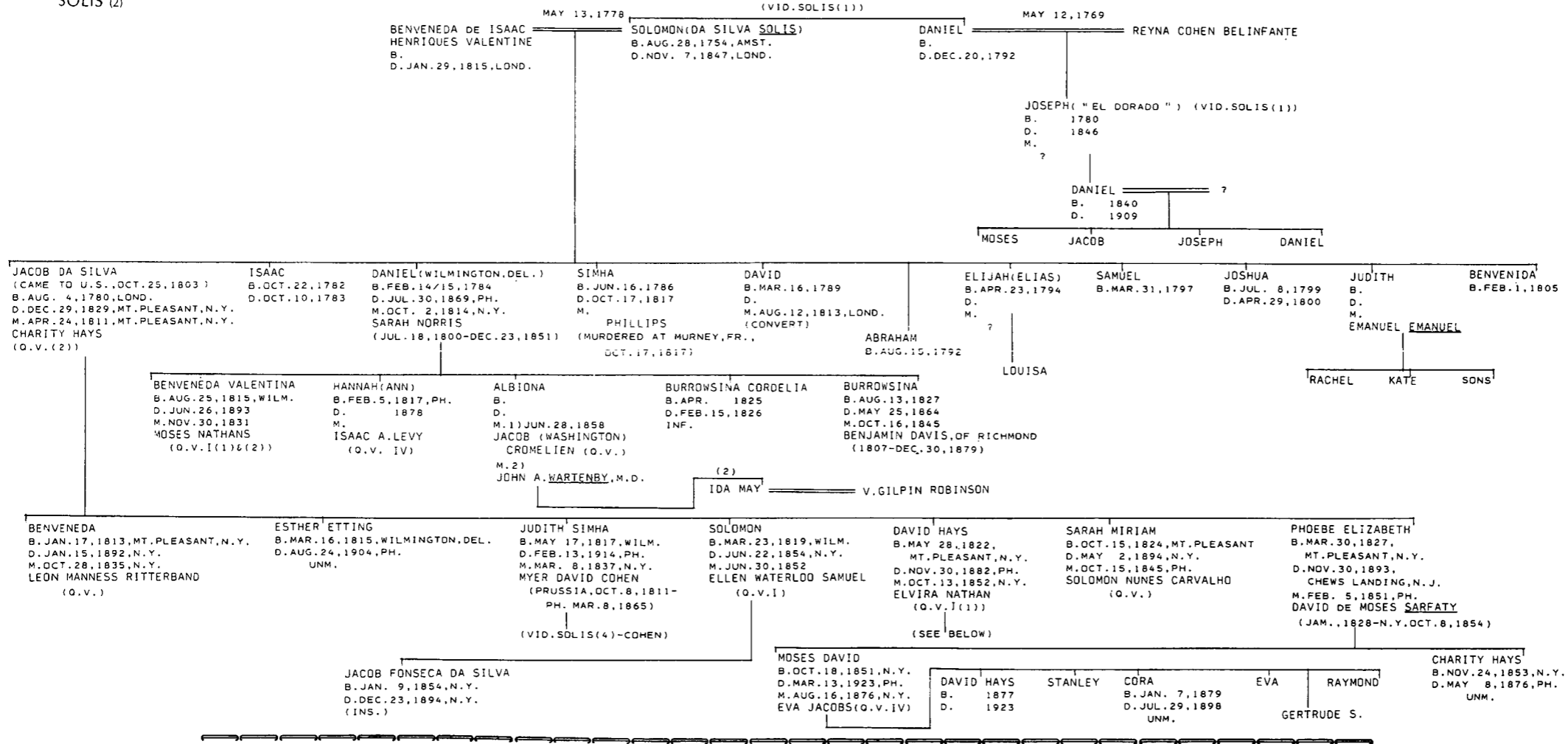

SOLIS (3)

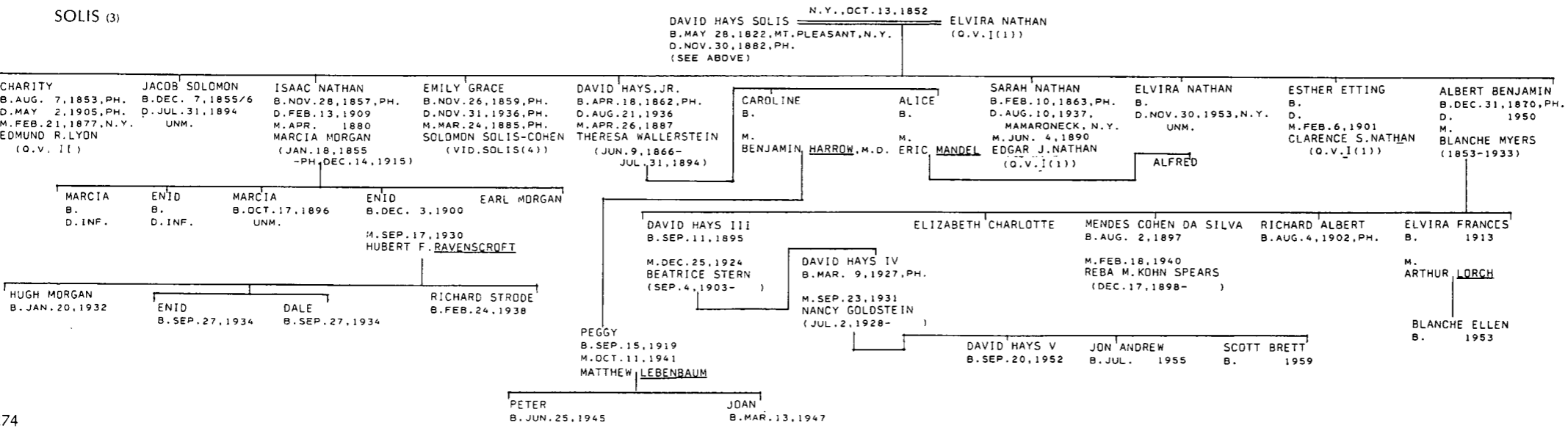

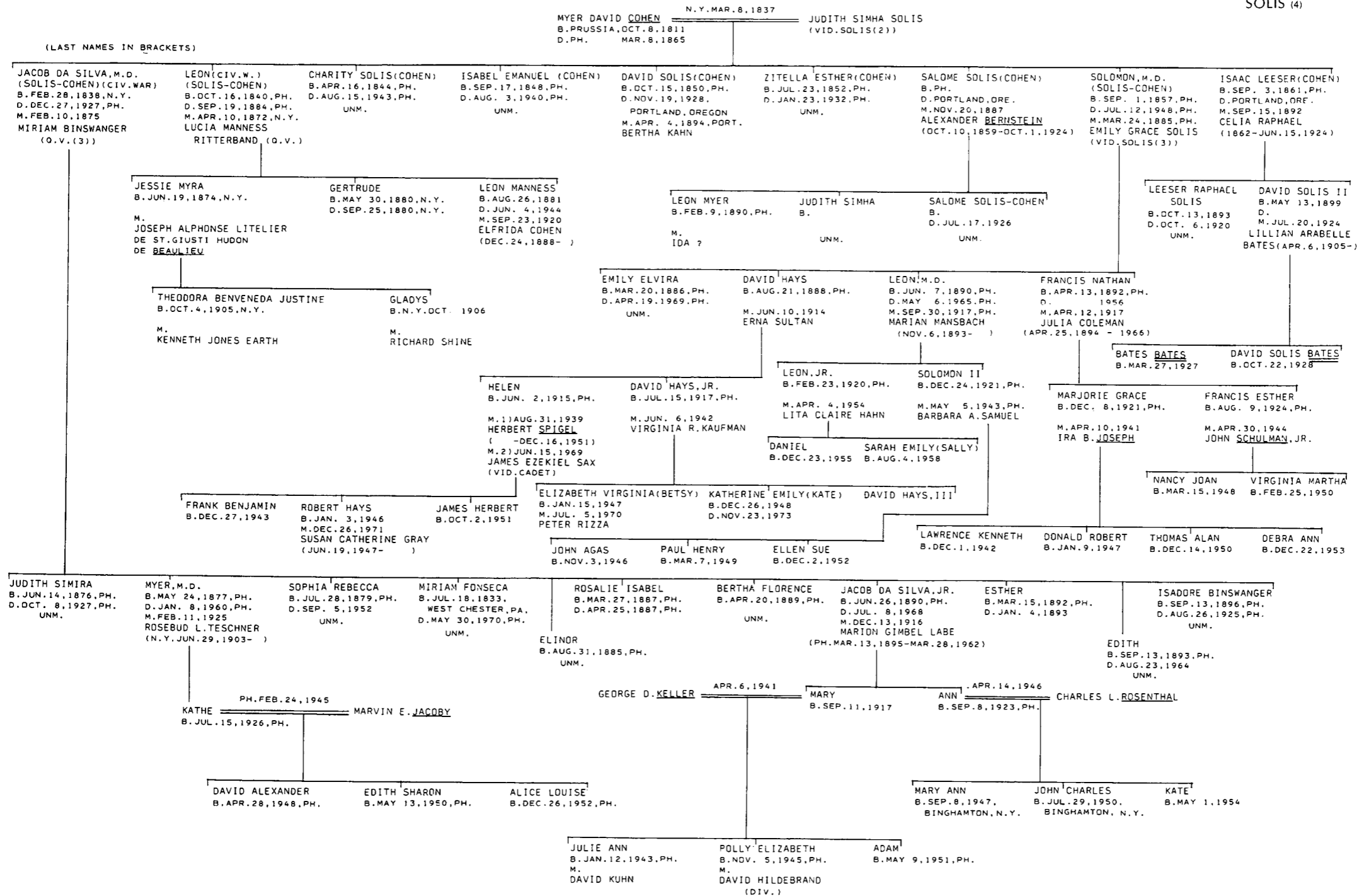

**SOLOMONS I (MONTREAL, ALBANY)**

KRAUS-SANDOR COLL.  
J.E. V.11, P.459F.  
PAJHS, V.27, PP.151, 376  
SOLOMONS MS. (AJA)  
JRM COLL.  
MALCHELOSSE-LES JUIFS...  
POOL-PORTRAITS...  
SHEARITH ISRAEL REC.  
R.J.D'ARCY HART  
KATZ-BETH EL STORY  
FLO.ABR.  
ROSENWAIKE  
BLAU-BARON, P.507F.  
MRS. E. MILLER  
MCCORD MUS.

(SOLOMON)

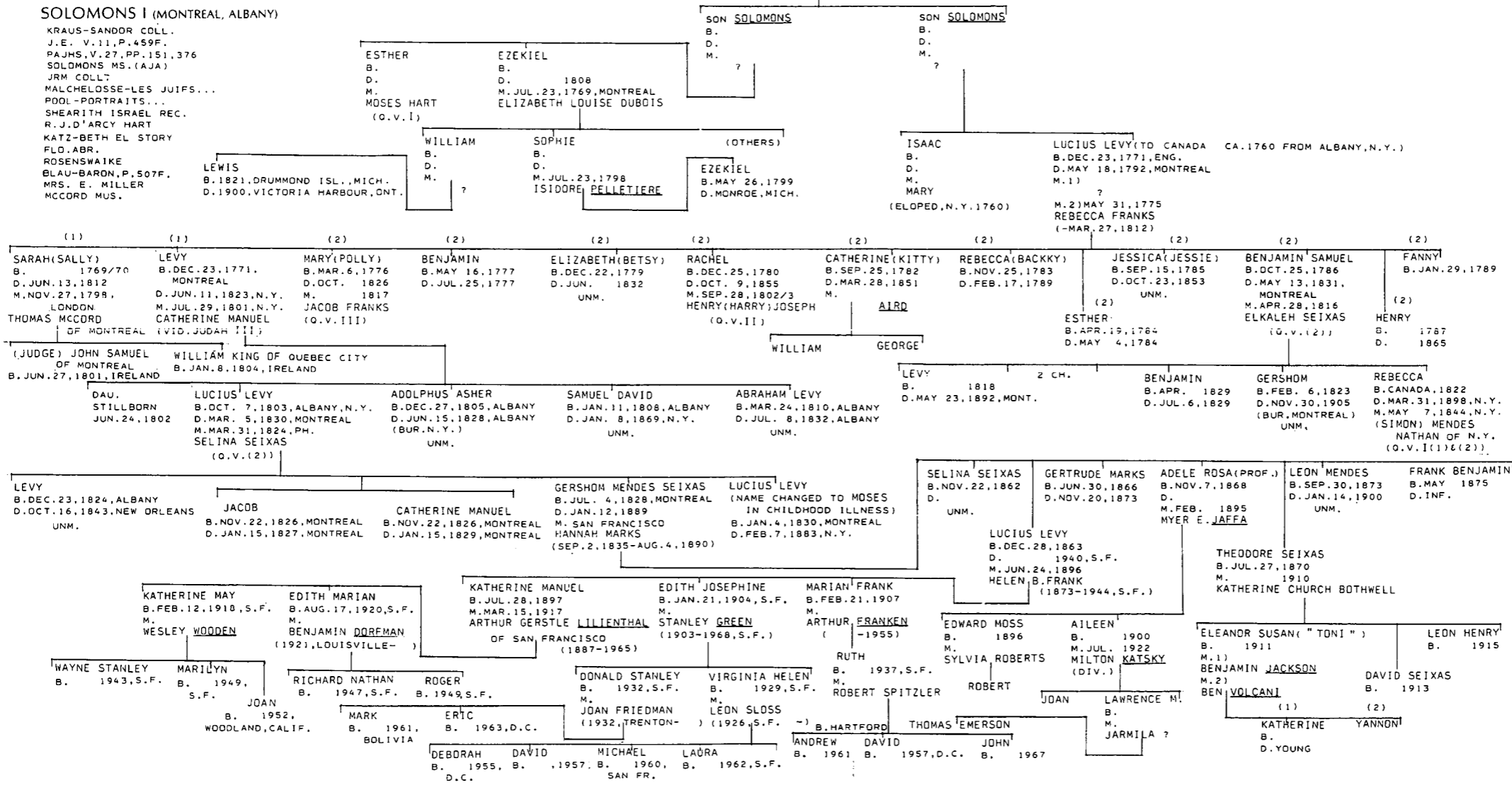

**SOLOMONS II (N.Y. & WASH.)**

KRAUS-SANDOR COLL.  
PHILLIPS GEN. (JRM)  
SHEARITH ISRAEL REC.  
ROSENWAIKE

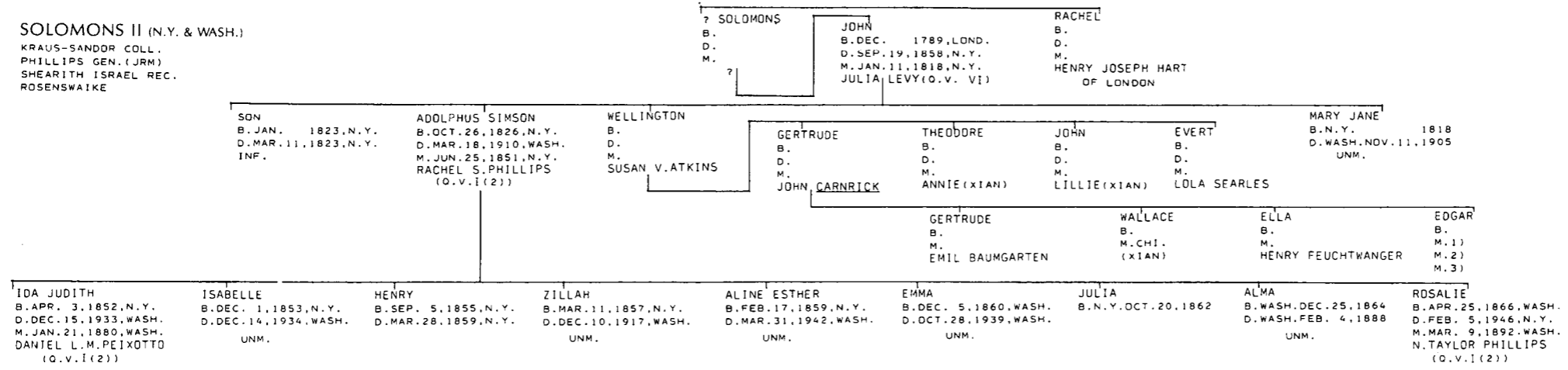

SOLOMONS III (N.Y.)

POOL-PORTRAITS...  
SHEARITH ISRAEL REC.  
FLORENCE ABRAHAMS  
PAJHS V.27,P.78  
B'NAI JESHURUN REC.

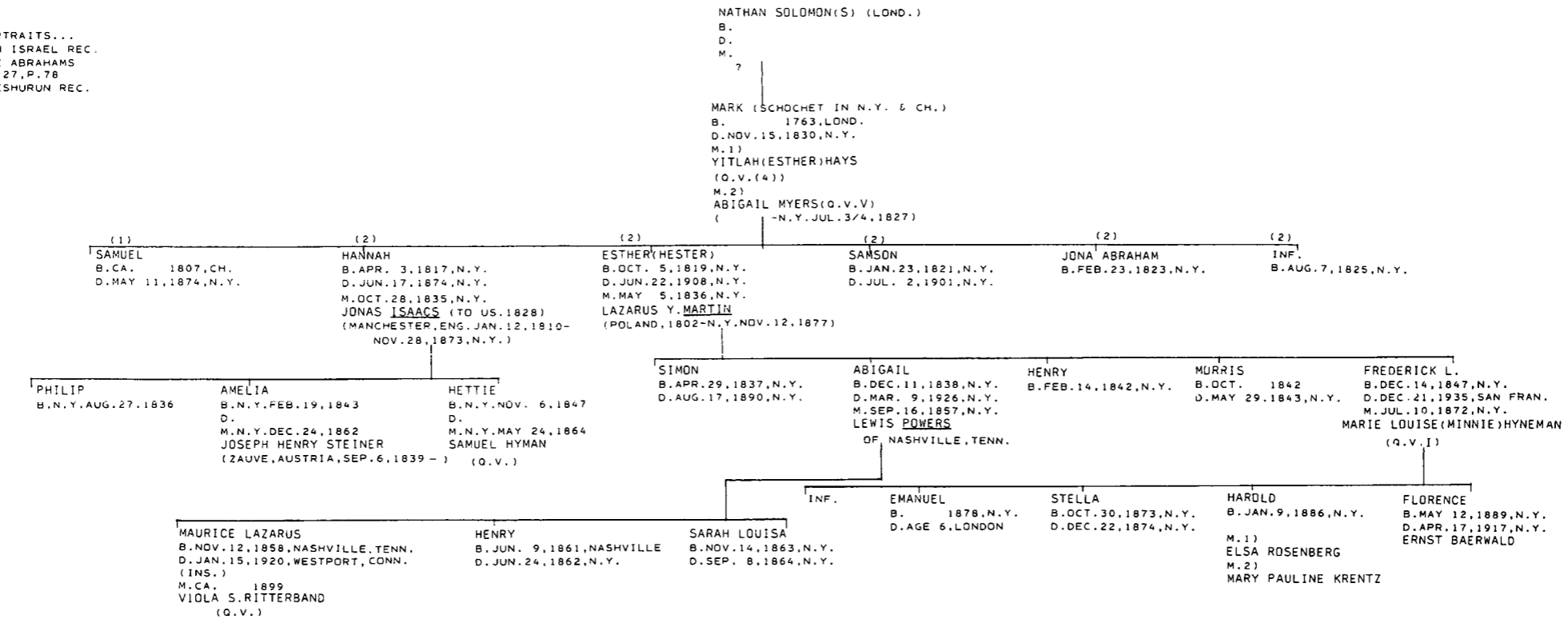

SOLOMONS IV (1)

KRAUS-SANDOR COLL.  
ELZAS MSS.  
O. J. C.  
M. N.  
JEWS OF S. C.  
WILL OF JOSEPH SOLOMONS (JRM)  
ALEXANDER MSS. (AJA)  
JACOB ISAACKS MS. (DAR)  
HORTENSE PEIXOTTO BLUMBERG  
H. A. ALEXANDER-ALEXANDER FAMILY

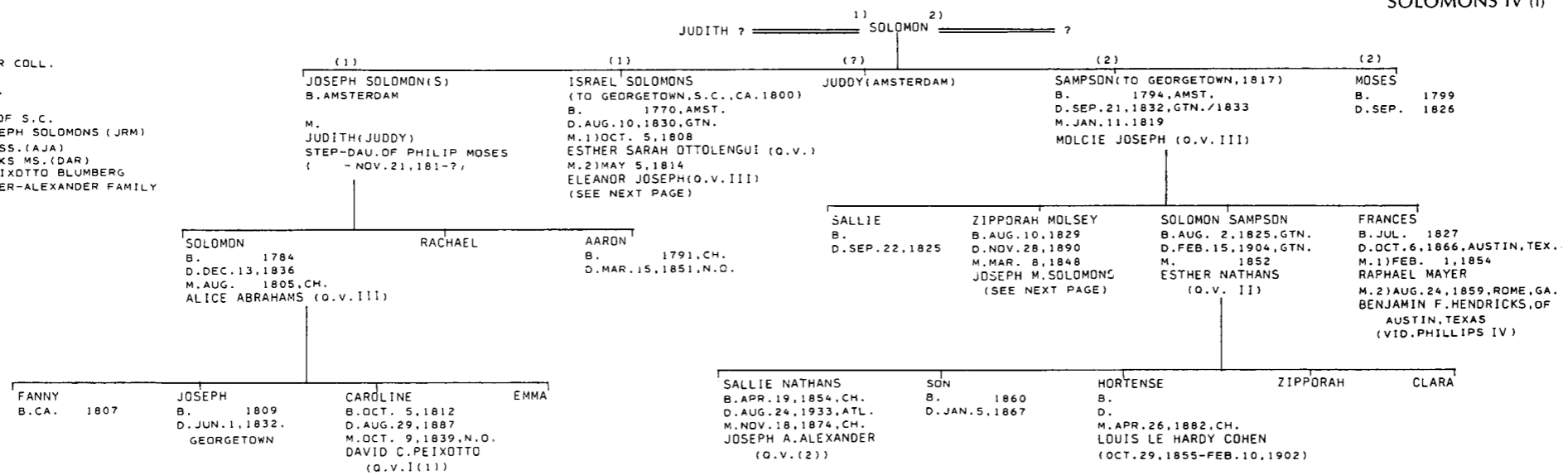

SOLOMONS IV (2)

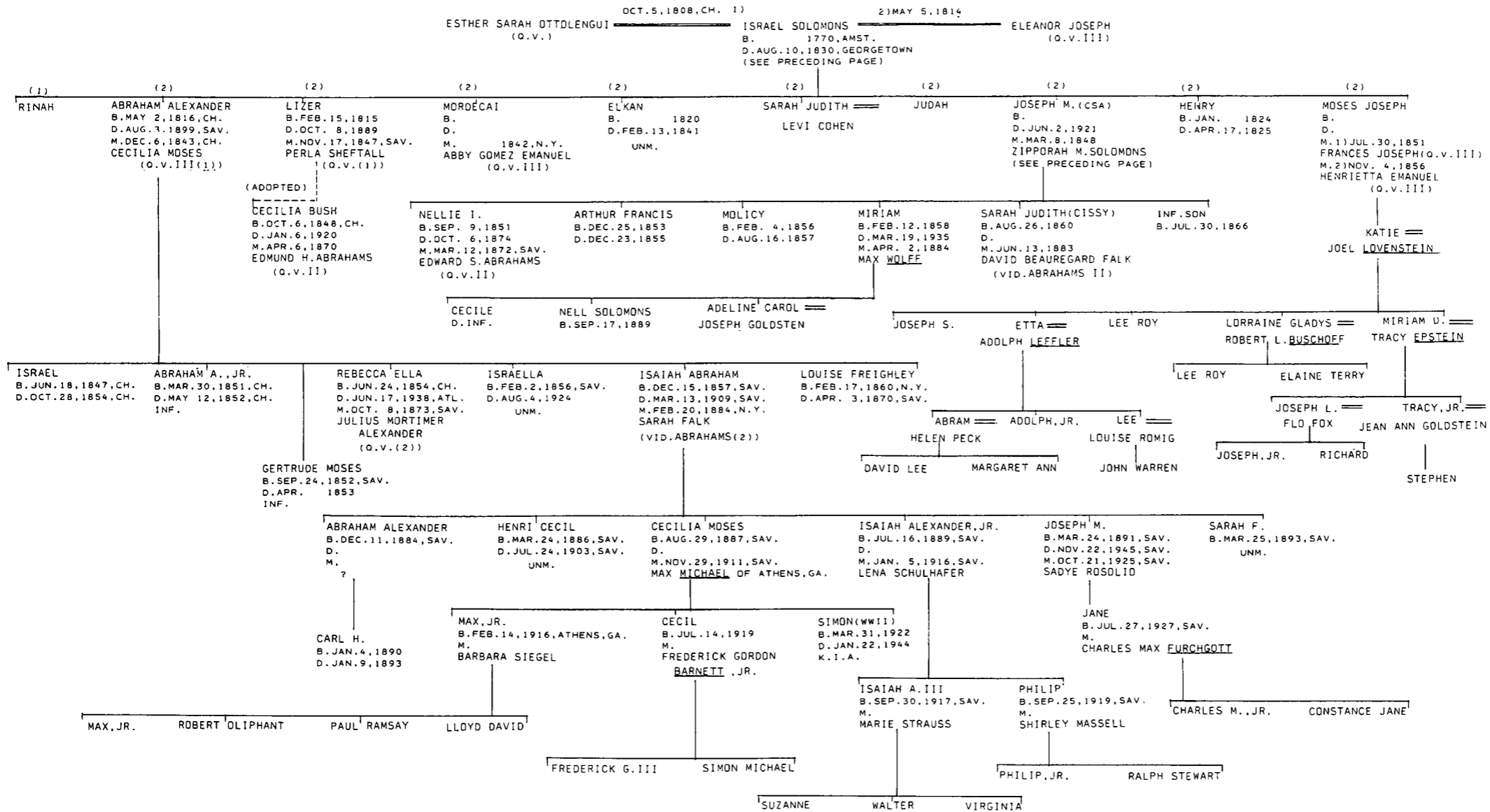

SOLOMONS V

ELZAS MS.  
OJC  
MN  
JEWS OF S.C.  
SAV. JEWISH BURYING GROUND  
SOLOMONS FAMILY REC. (T. J. TOBIAS)  
MOISE-JEWISH CEMETERY AT SUMTER

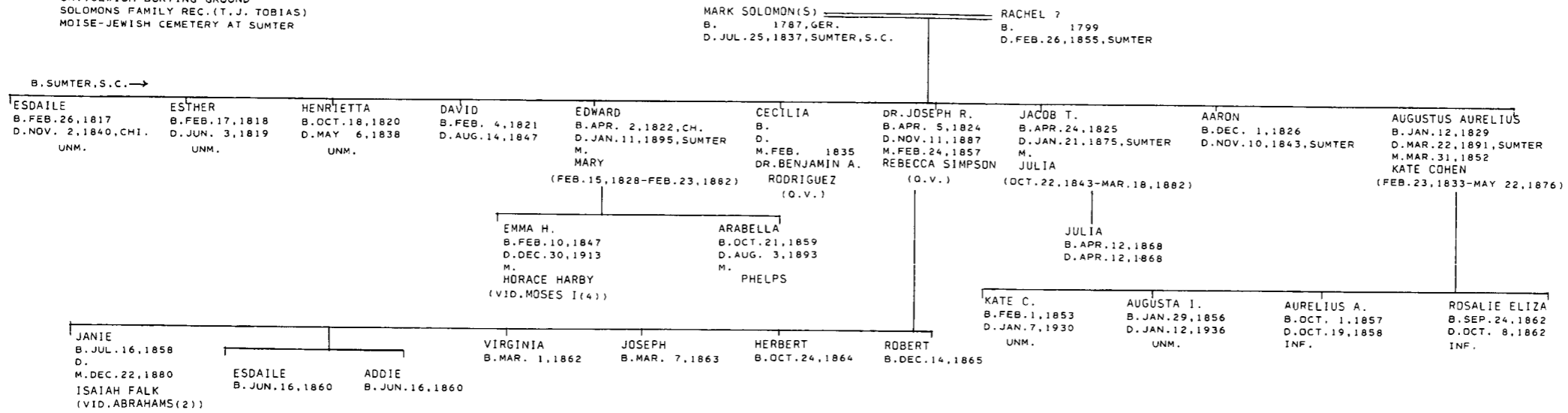

B'NAI JESHURUN REC.  
N.Y. CENSUS, 1855

SONDHEIM

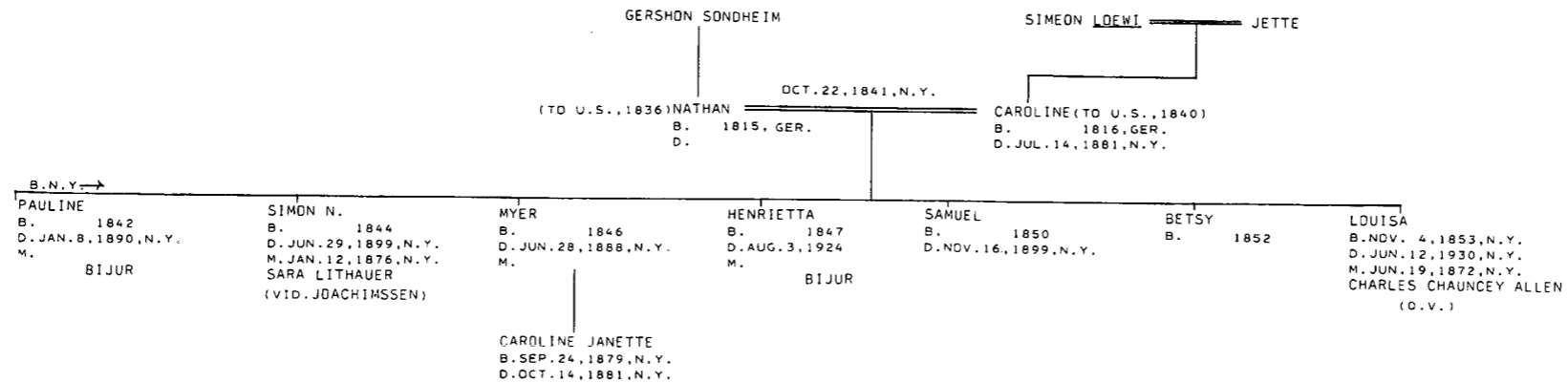

**SORIA**

B'NAI JESHURUN REC.  
WILL OF AARON COHEN  
POOL- PORTRAITS...  
PAJHS V.27,P.475F.  
V.31,P.258F.  
SHEARITH ISRAEL REC.  
JDN STEDMAN

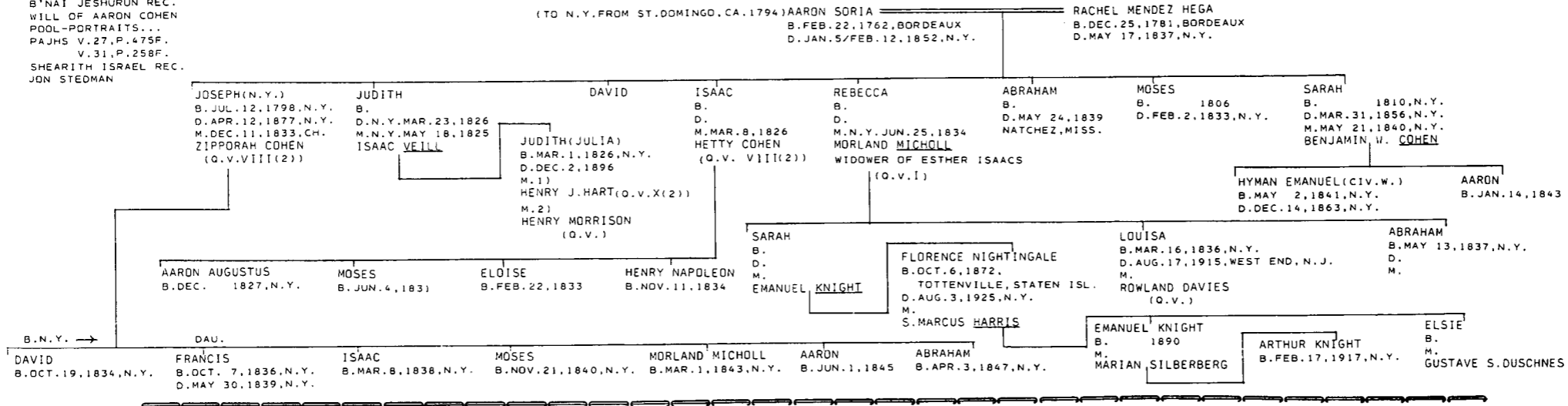

**SOUZA**

KRAUS-SANDOR COLL.  
SHEARITH ISRAEL REC.  
MICKVE ISRAEL REC.  
FLORENCE ABRAHAMS

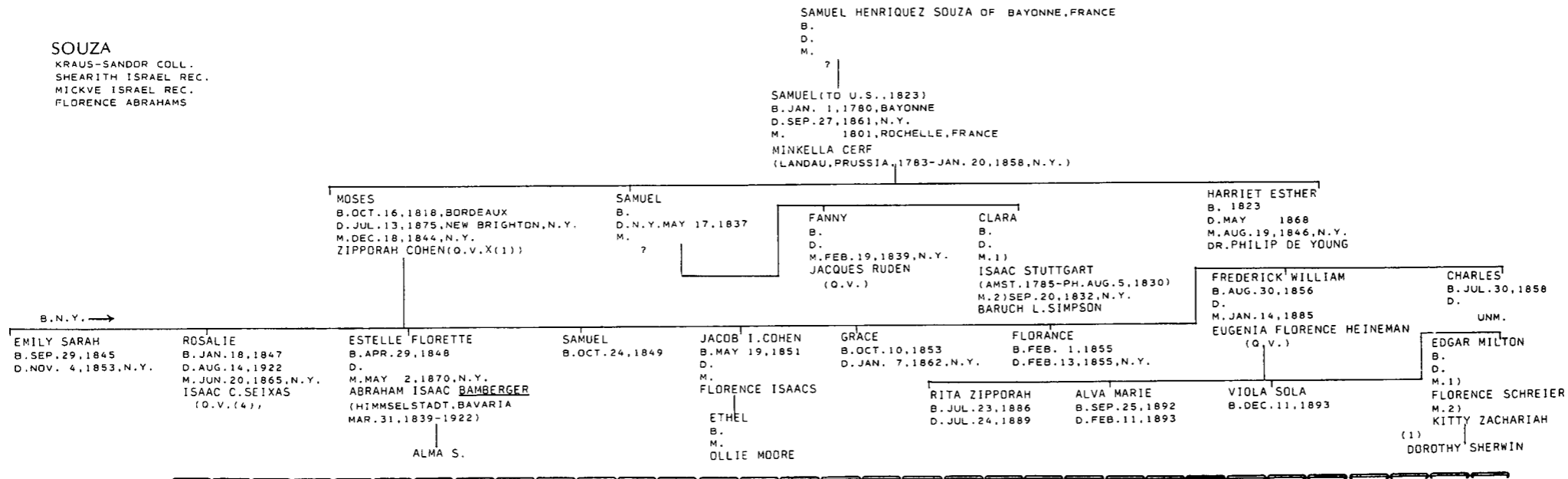

**SPANIER**

KRAUS SANDOR COLL.  
SHEARITH ISRAEL REC.

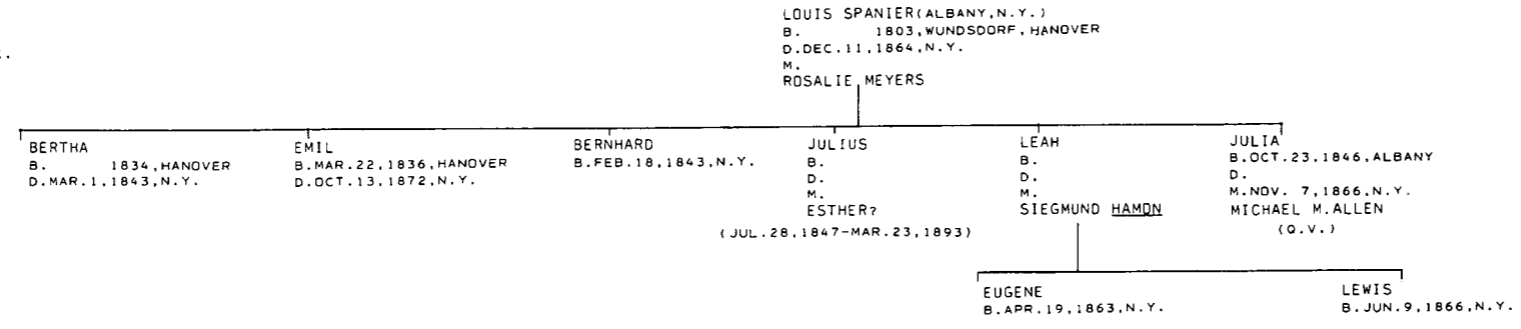

SPIRO

B'NAI JESHURUN REC.  
 FLO. ABR.  
 LEONORE R. ELKUS  
 PEGGY LEHMAN KORN  
 WHO'S WHO IN AMERICA, 1952-3

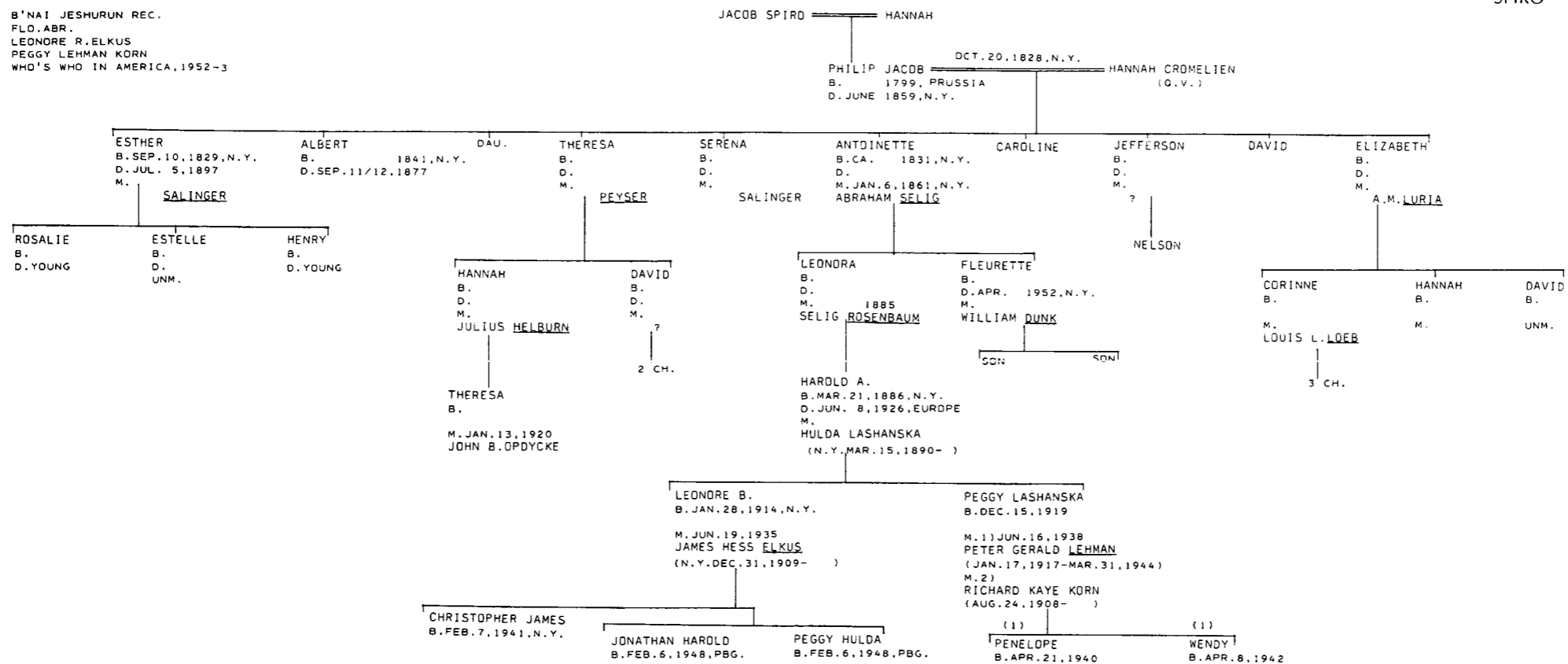

STERN I (N.Y.)

U.S. CENSUS, 1880 (J. STEDMAN)  
 MO. MAG. OF HIST., V. 19, P. 61  
 SHEARITH ISRAEL REC.  
 B'NAI JESHURUN REC.

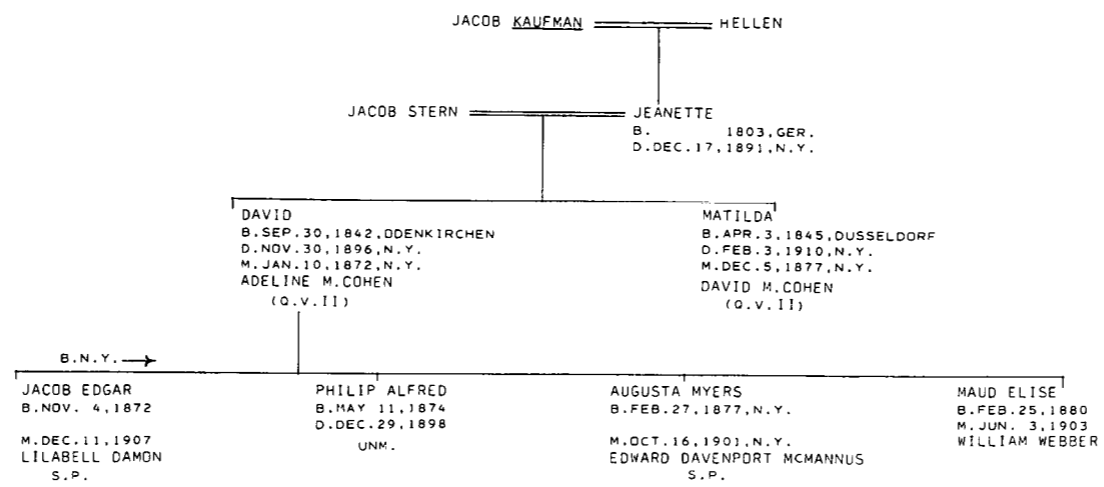



STERN II (1)

STERN FAMILY BIBLE  
 EPITAPHS, ADATH JESHURUN CEMETERY (PH.)  
 RODEPH SHALOM MOHEL REC.

MOSES STERN, OF SCHWETZINGEN, BADEN

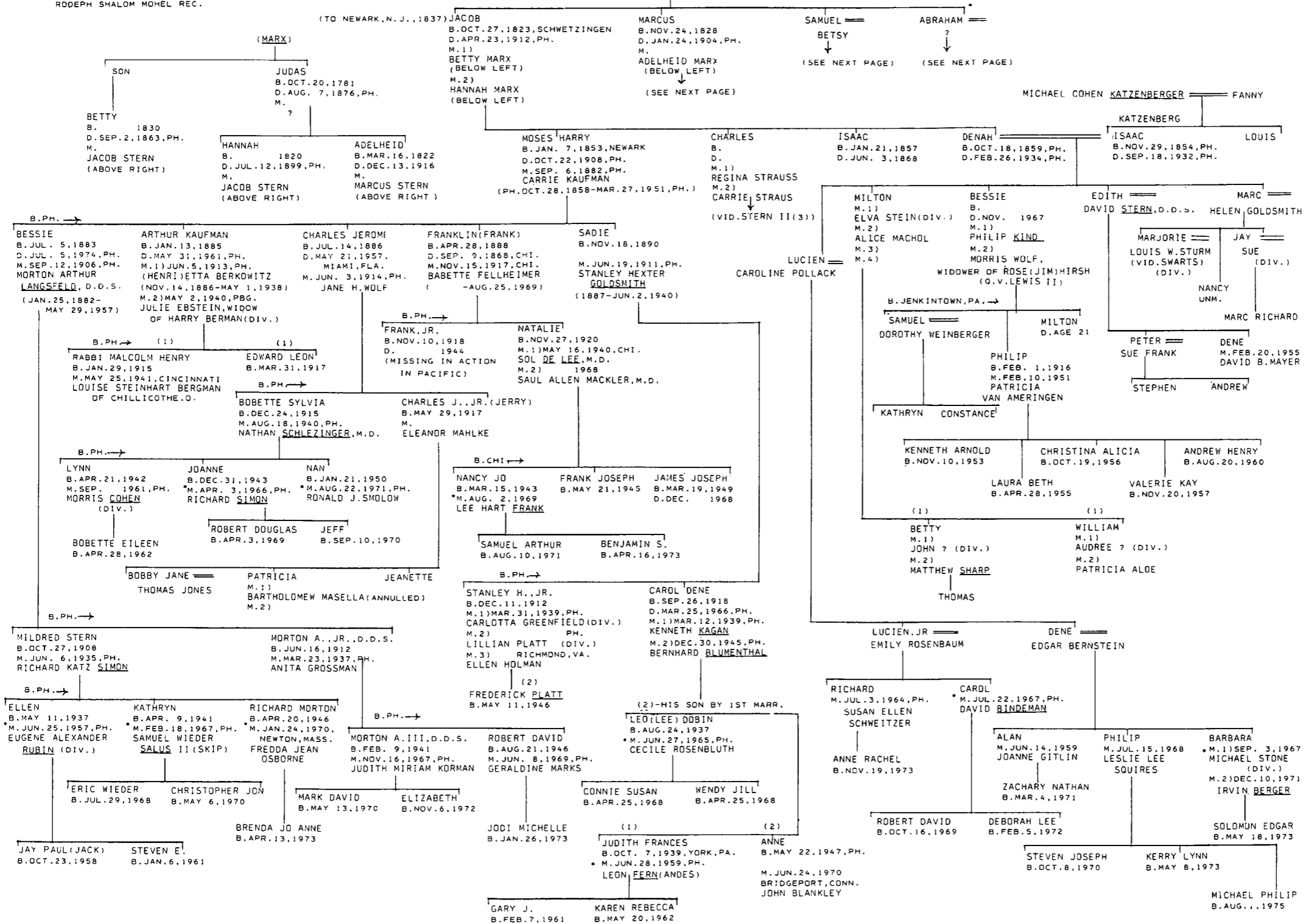

\*MARRIED BY RABBI MALCOLM H. STERN

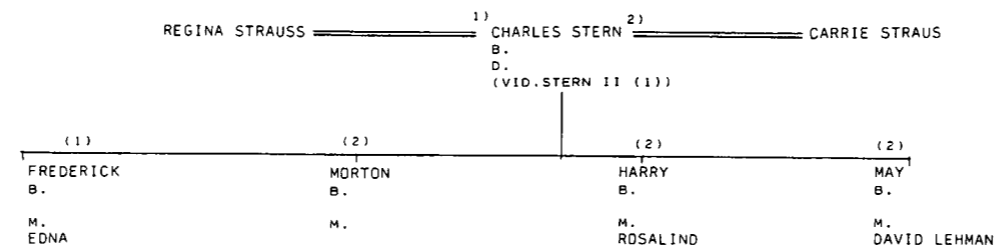
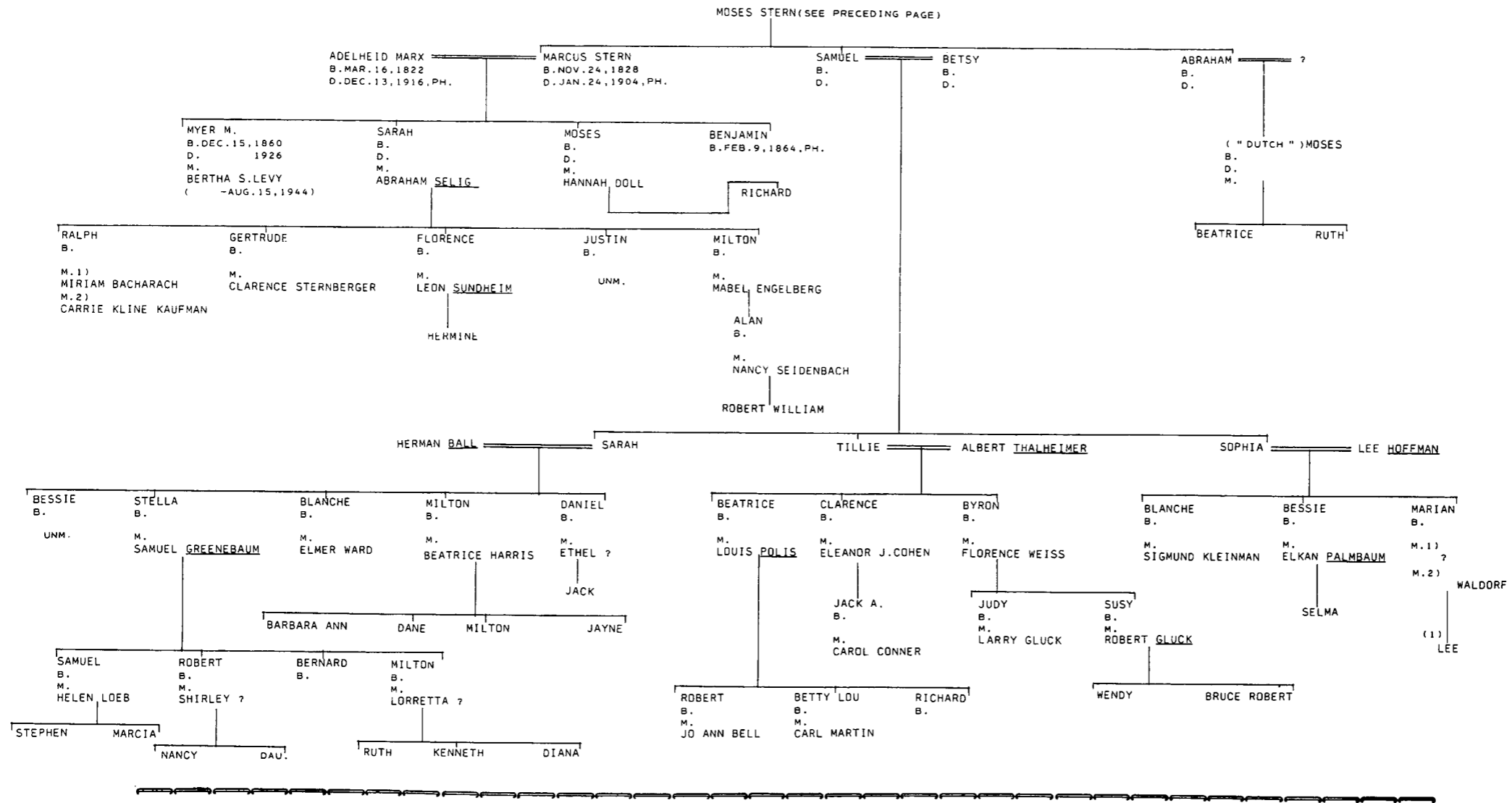

**STERN III**

FLO. ABR.  
FRANCIS JAMES DALLETT  
TRACHTENBERG-CONSIDER THE YEARS  
WHO'S WHO IN WORLD JEWRY 1965  
AJYB 5666, P. 36; 5702, P. 375 F.  
RODEPH SHALOM MOHEL REC.  
BABETTE W. STERN

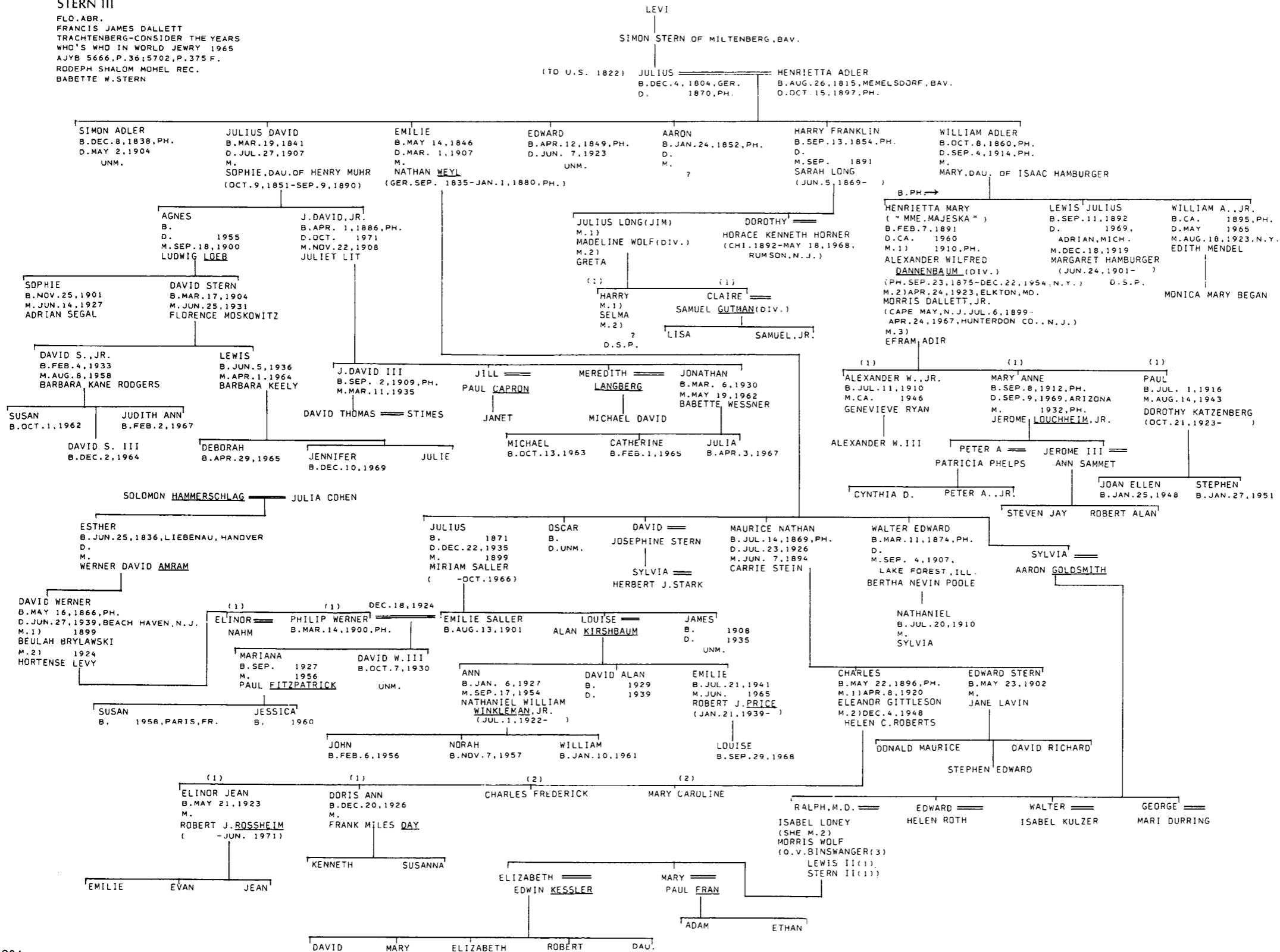

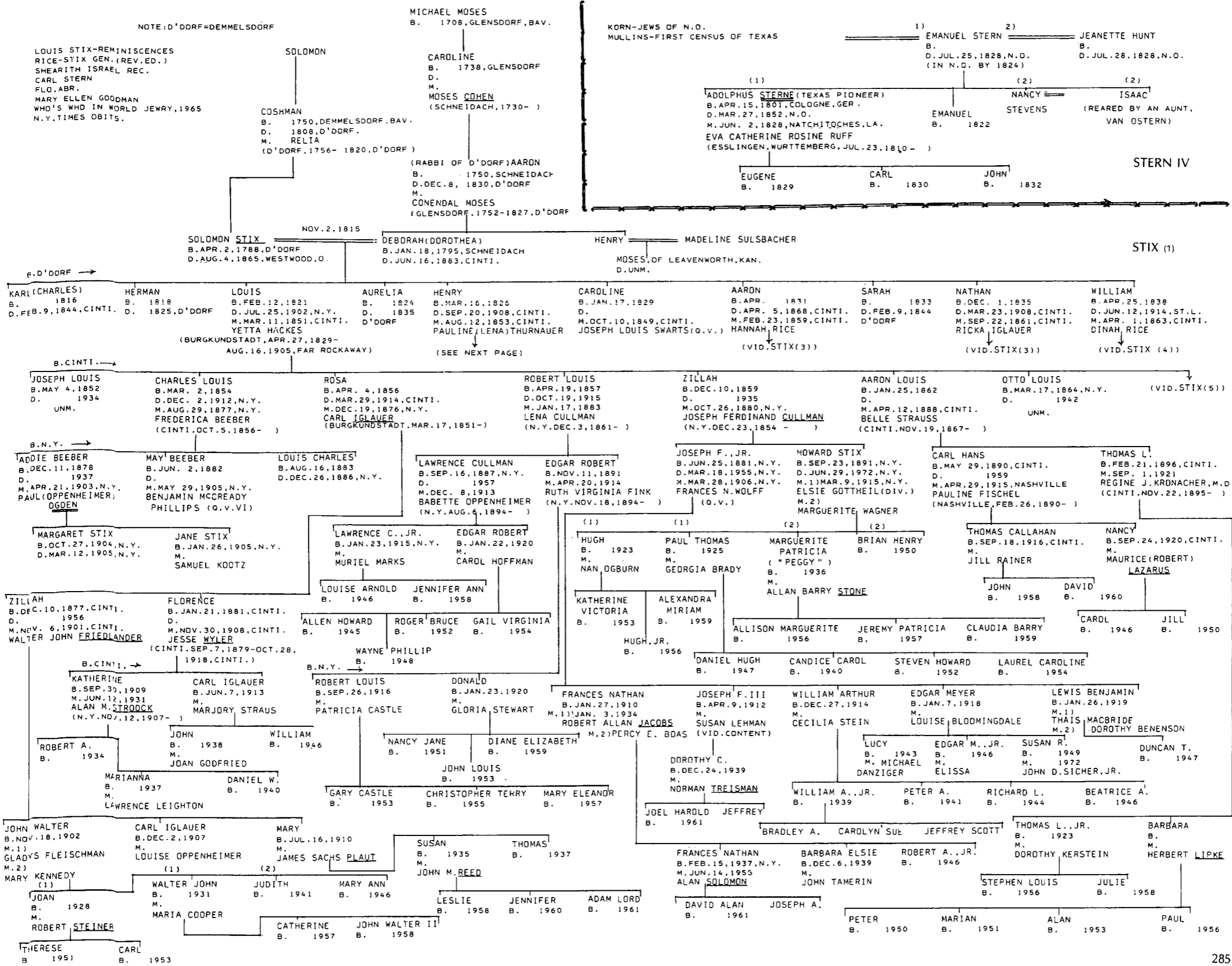

STIX (2)

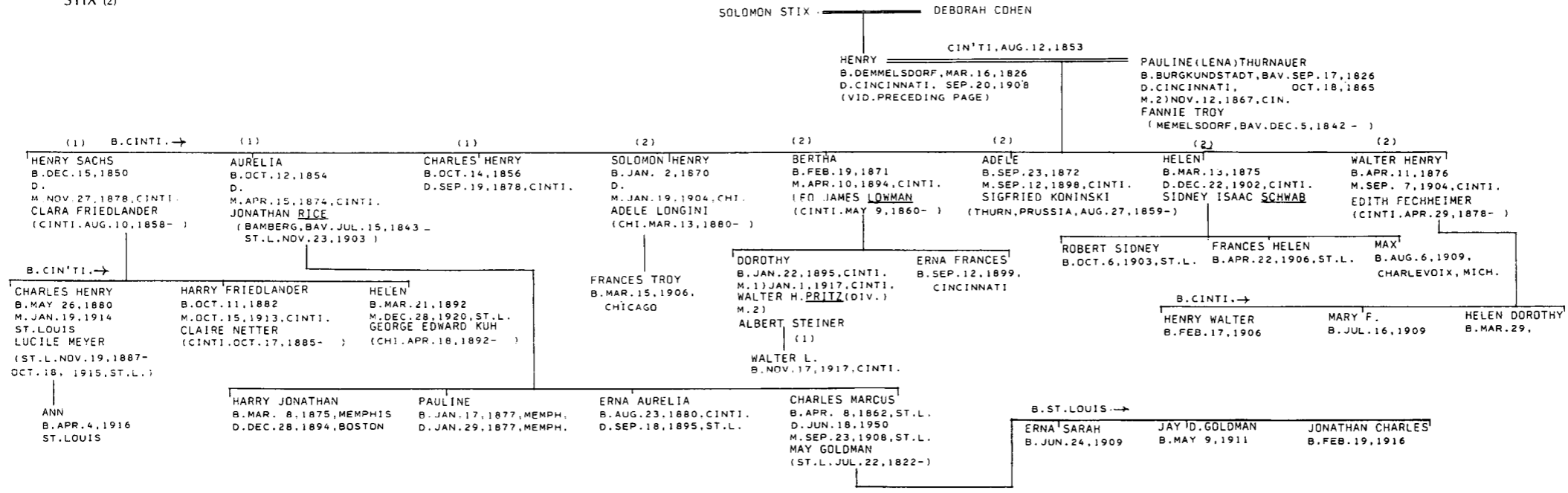

STIX (3)

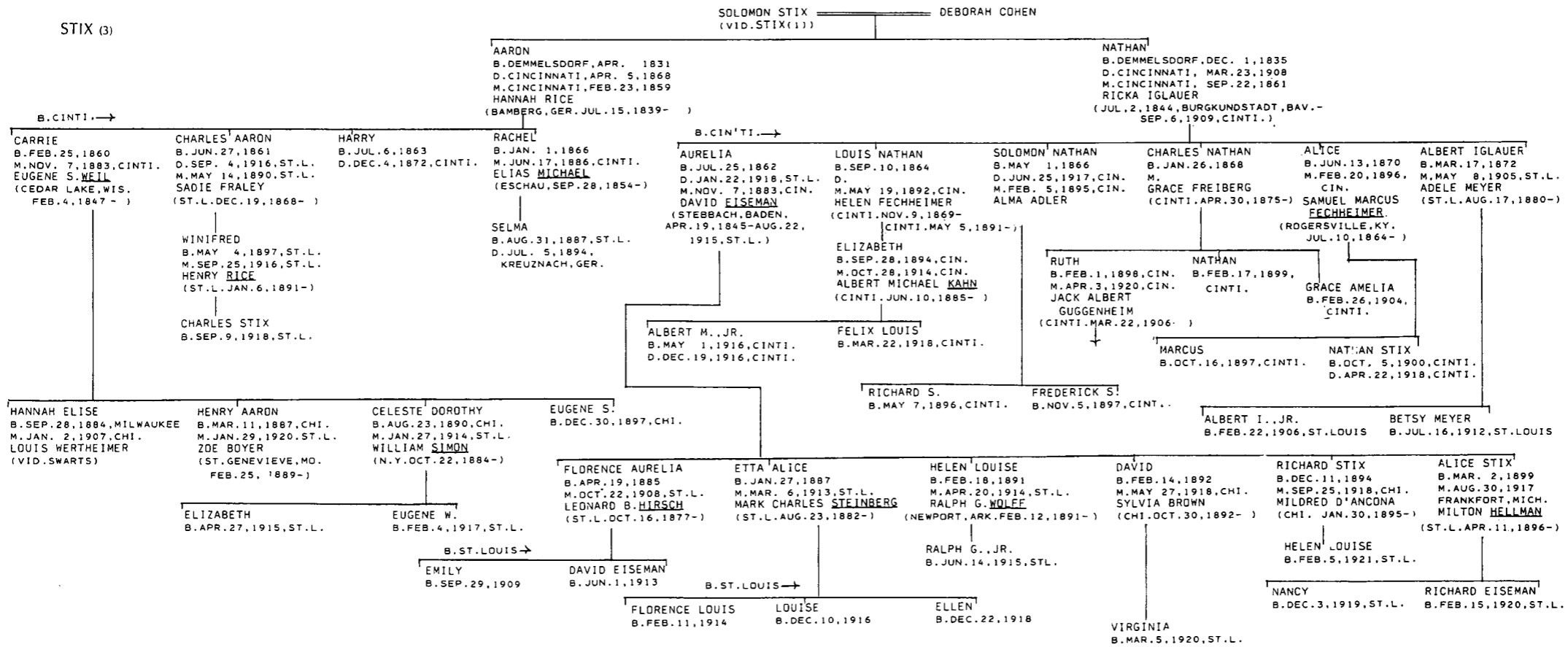

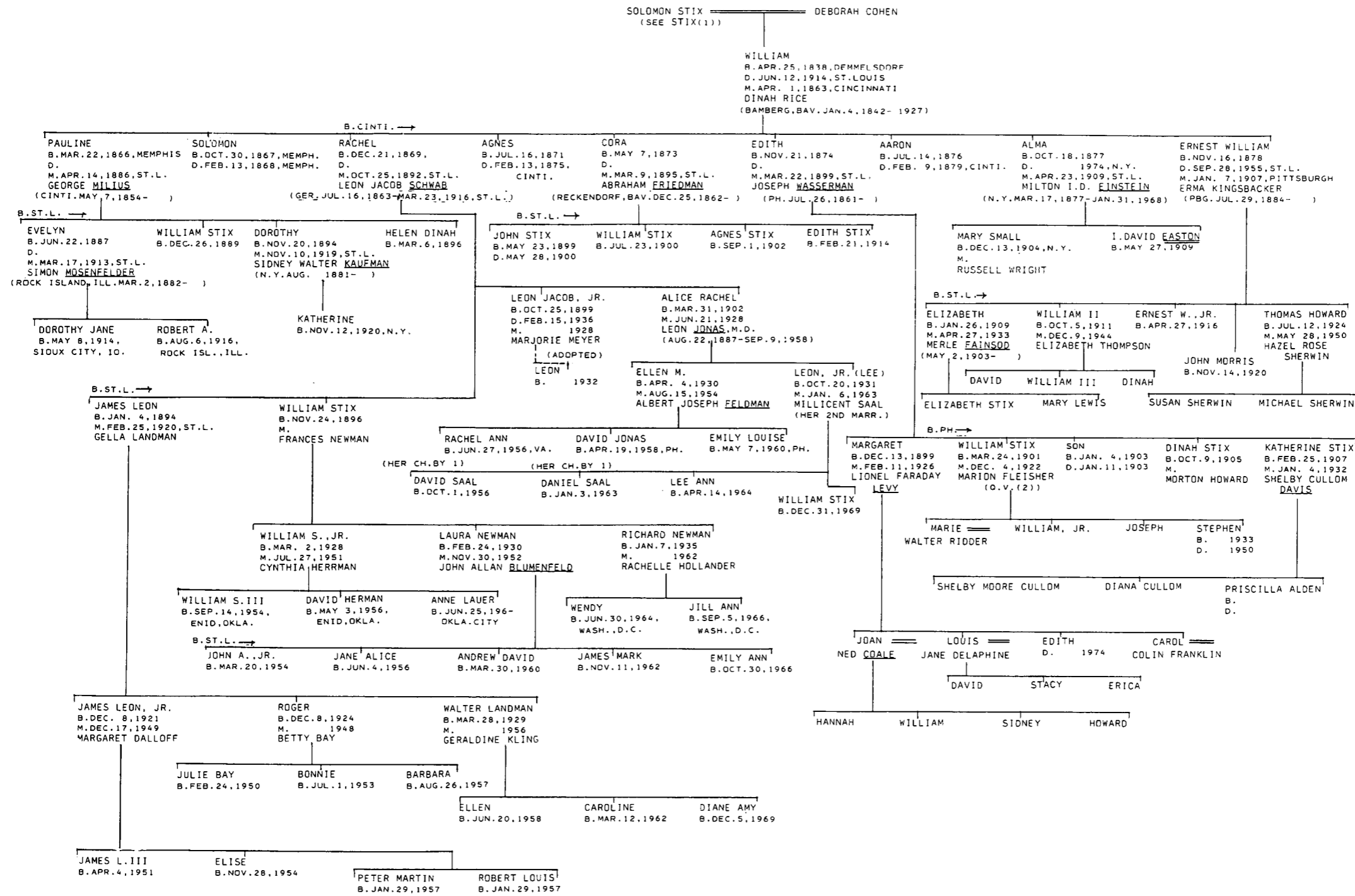

STIX (5)

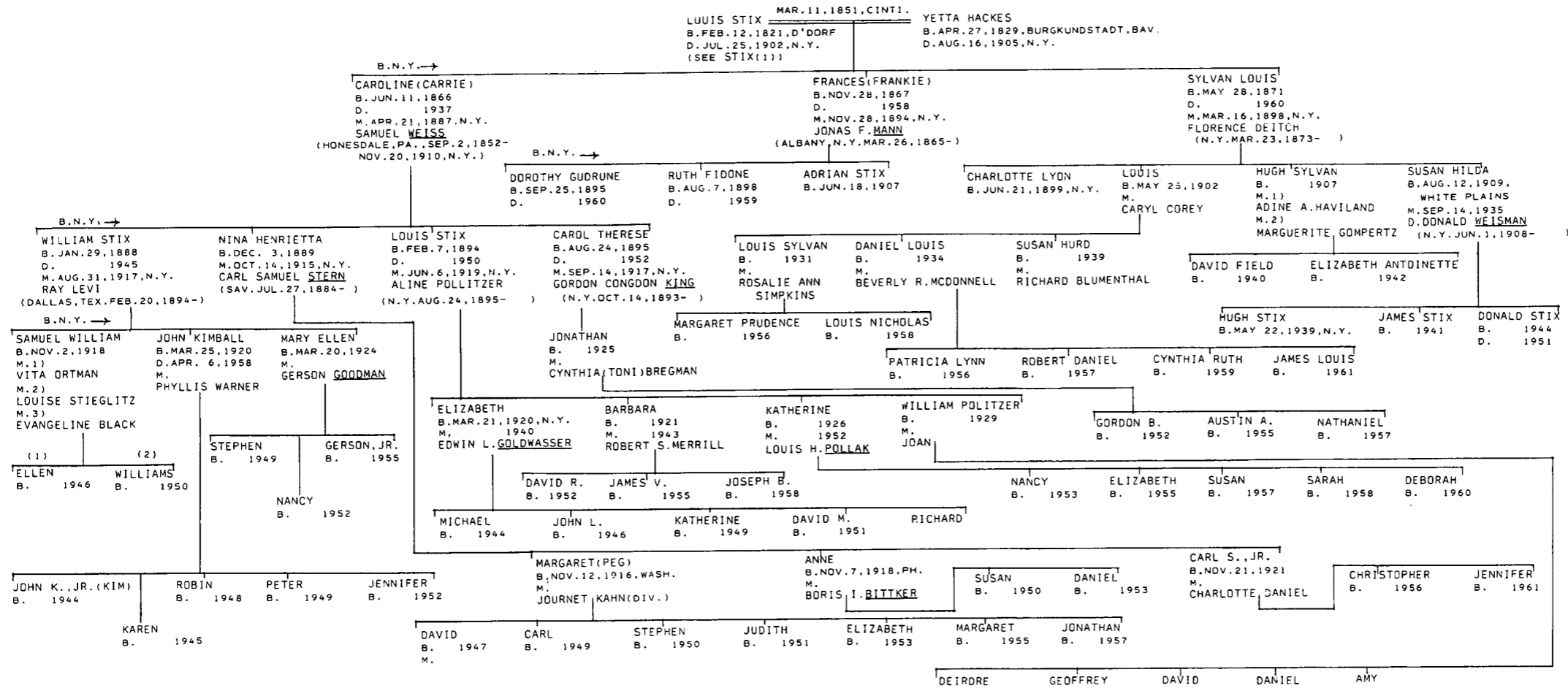

SUARES

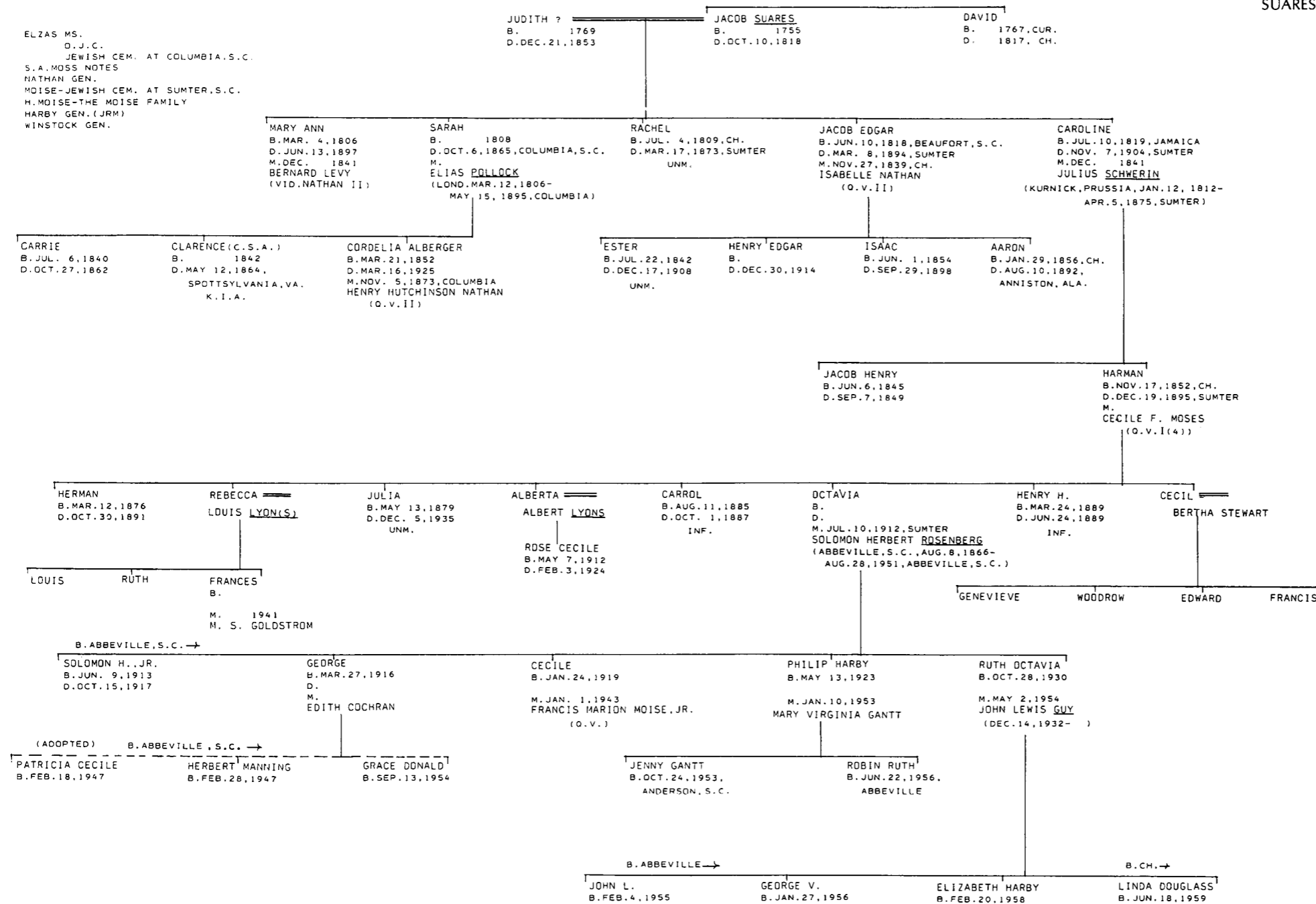



**SULZBERGER (1)**

J.E.V. 11, P. 584F.  
 U.J.E. V. 10, P. 98F.  
 A.J.Y.B. 5663, P. 200  
 5666, P. 107F.  
 5701, P. 24F.  
 PAJHS. V. 20, P. 170F.  
 KRAUS-SANDDR COLL.  
 ROBERT SIMPSON (N.Y. TIMES)  
 WHO'S WHO IN WORLD JEWRY, 1955  
 FED. ST. CEM.  
 FLD. ABR.  
 FRIEDENWALD GEN.  
 IPHIGENE OCHS SULZBERGER  
 WHO'S WHO IN WORLD JEWRY, 1965

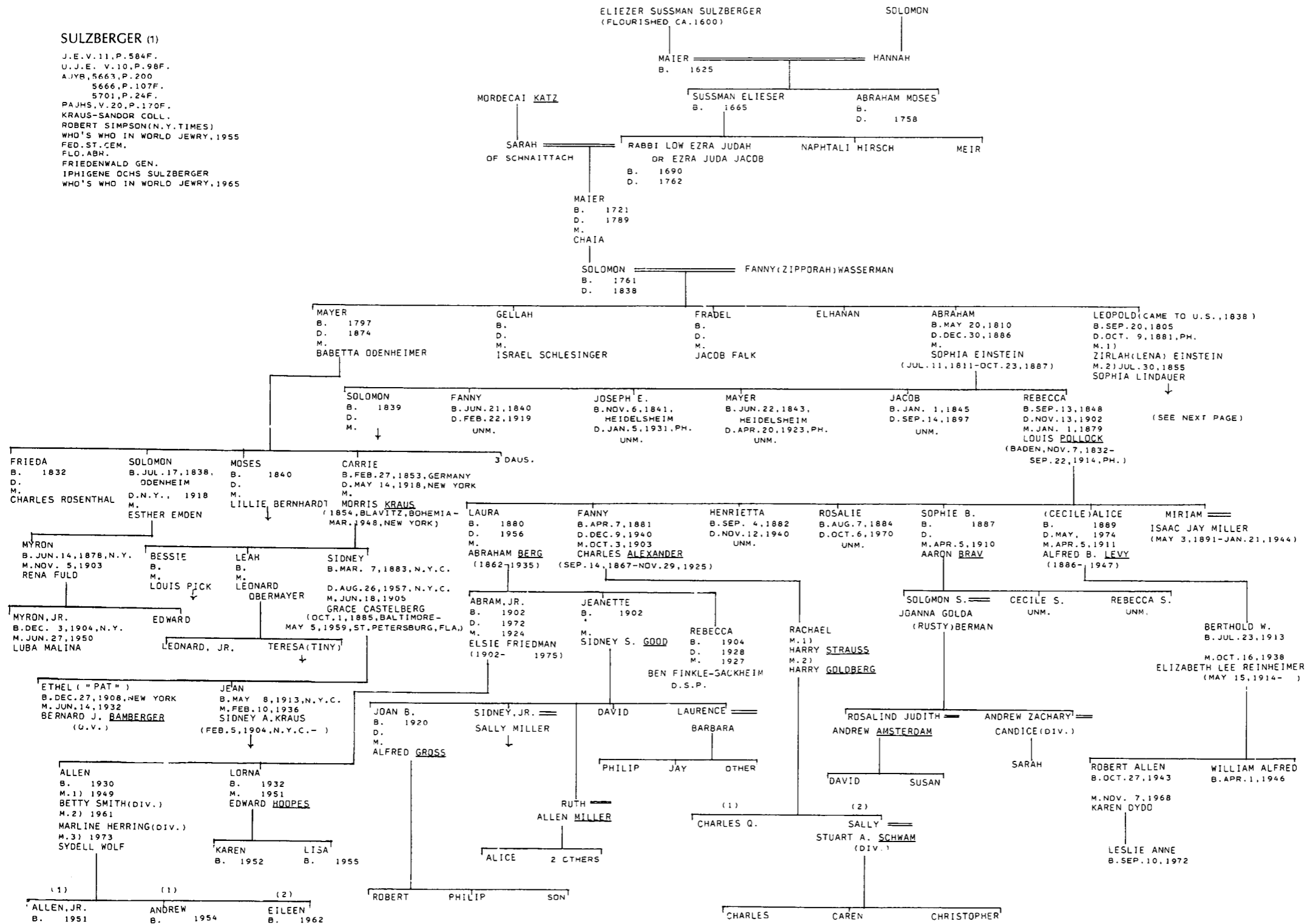

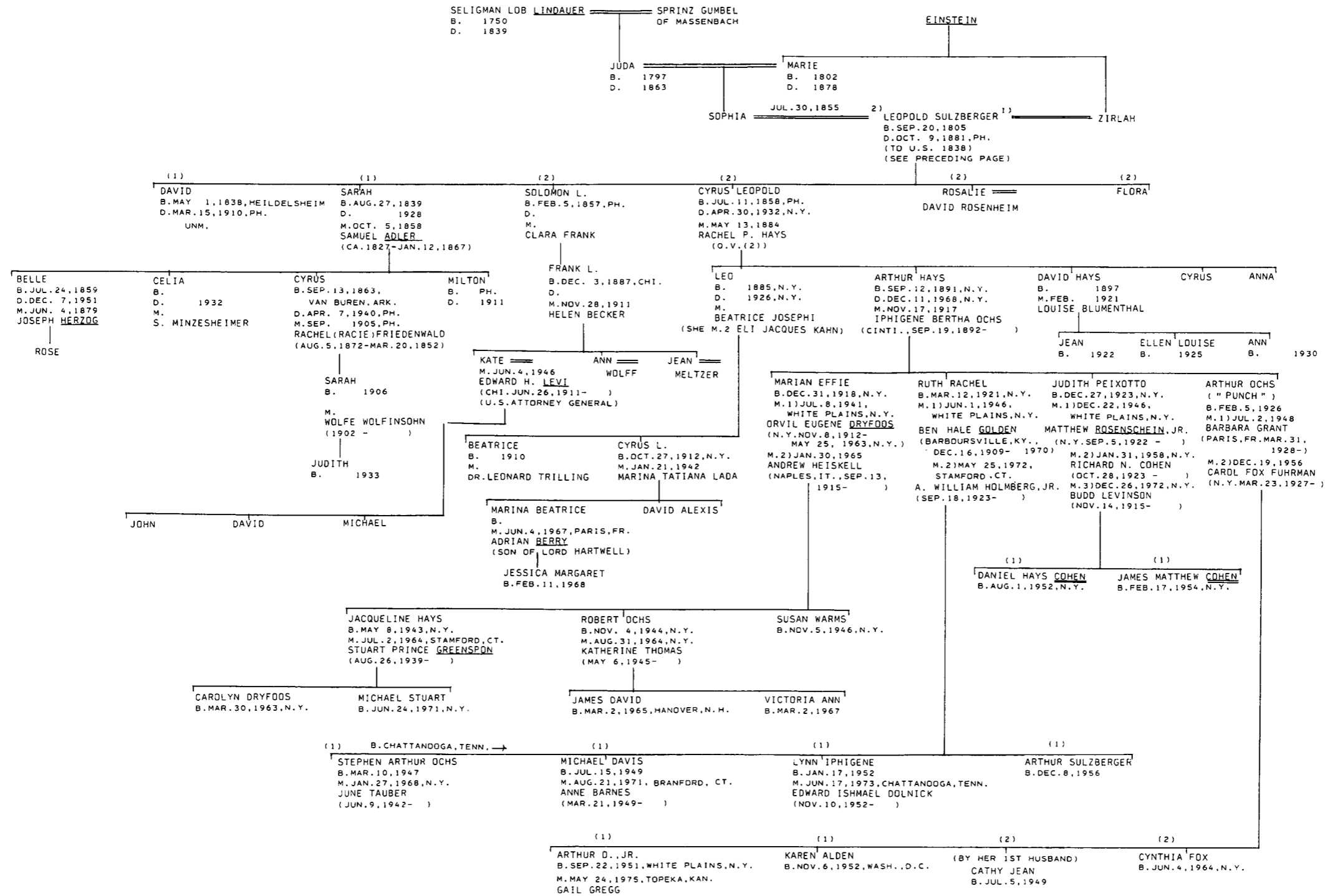

SWARTS

WHO'S WHO IN WORLD JEWRY, 1955  
 AJYB 47, P. 529  
 RICE-GENEALOGY OF THE STIX FAMILY (REVISED)

JOSEPH LOUIS SWARTS  
 B. OCT. 27, 1818, OSTERBURG, BAV.  
 D.  
 M. OCT. 10, 1849, CINCINNATI  
 CAROLINE STIX (Q.V. (1))

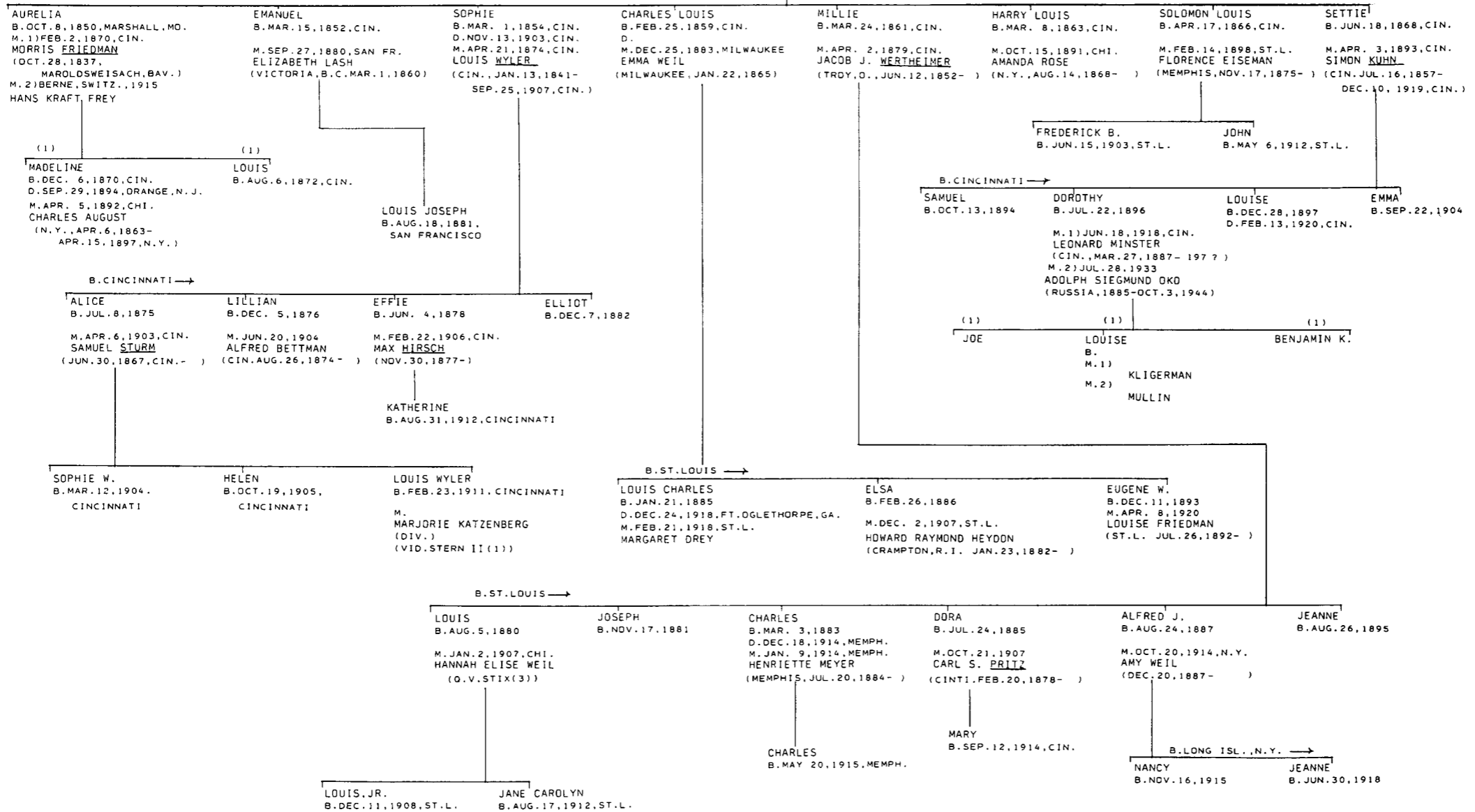

ABE NEBEL  
ROBERT D. GRIES

THORMAN OF UNSLEBEN, BAV.

THORMAN (1)

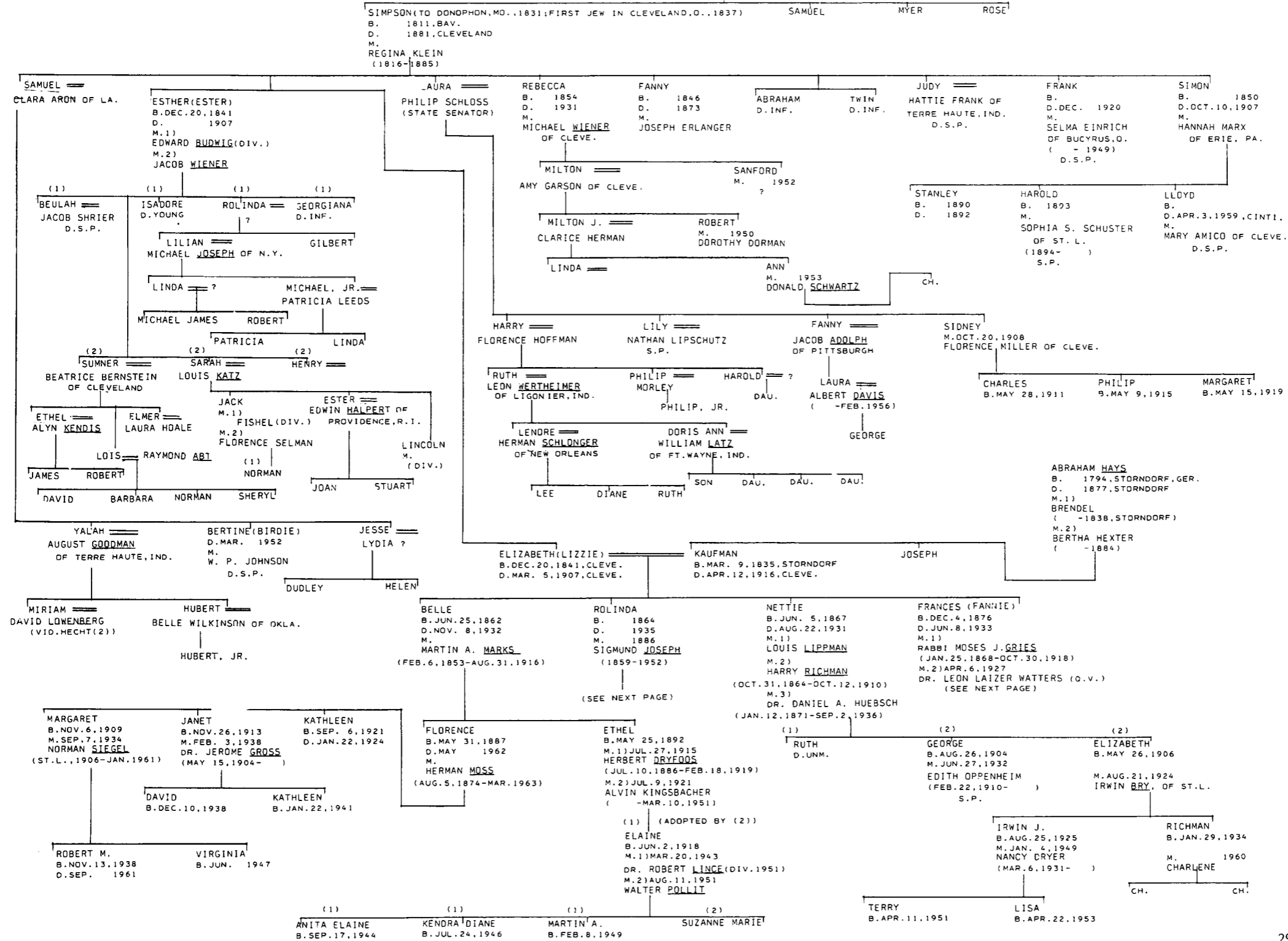

THORMAN (2) HAYS

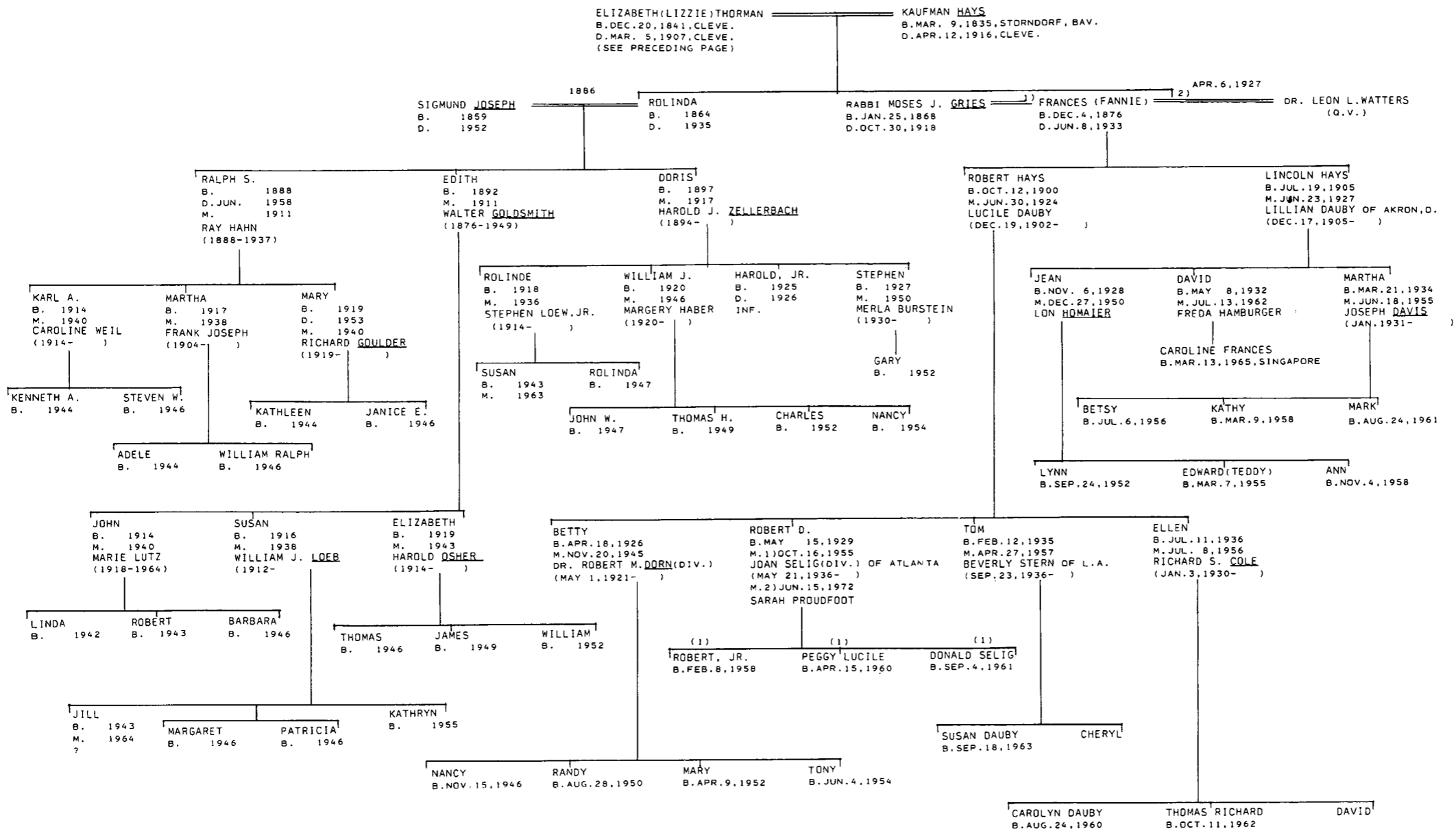

FLO. ABR.  
B'NAI JESHURUN REC.  
STIX GEN.  
PAJHS V. 28, P. 288

(LOUIS TEIM)

TIM (1)

BERNHARDT LOUIS TIM  
B. MAR. 28, 1813, HAMBURG, GER.  
D. FEB. 7, 1872, PH.

FANNIE MARKSTEIN  
B. DEC. 26, 1810, BUCHALBACH, BAV.  
D. SEP. 3, 1887, LONG BEACH, N. J.

MOBILE, ALA.

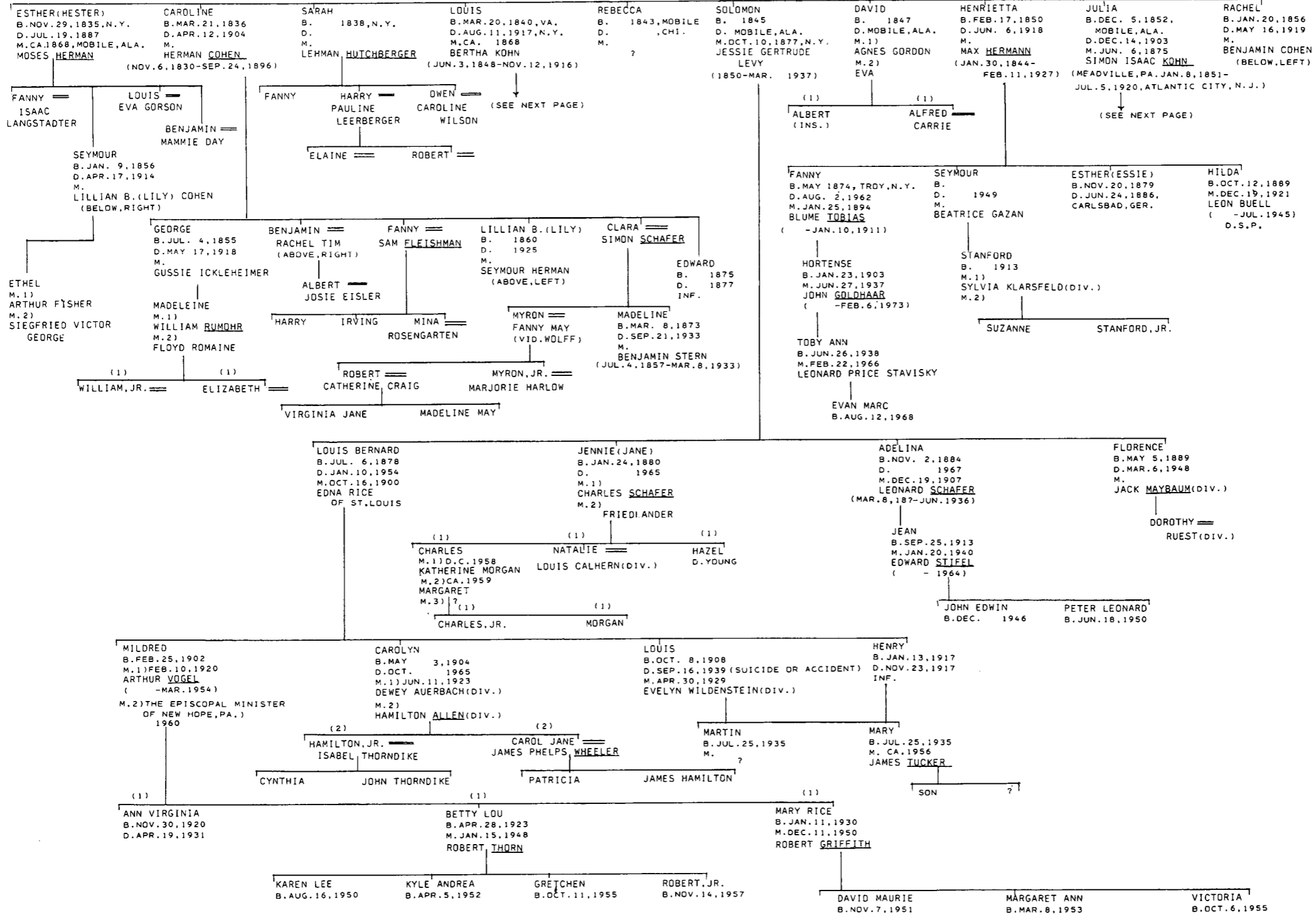

TIM (2)

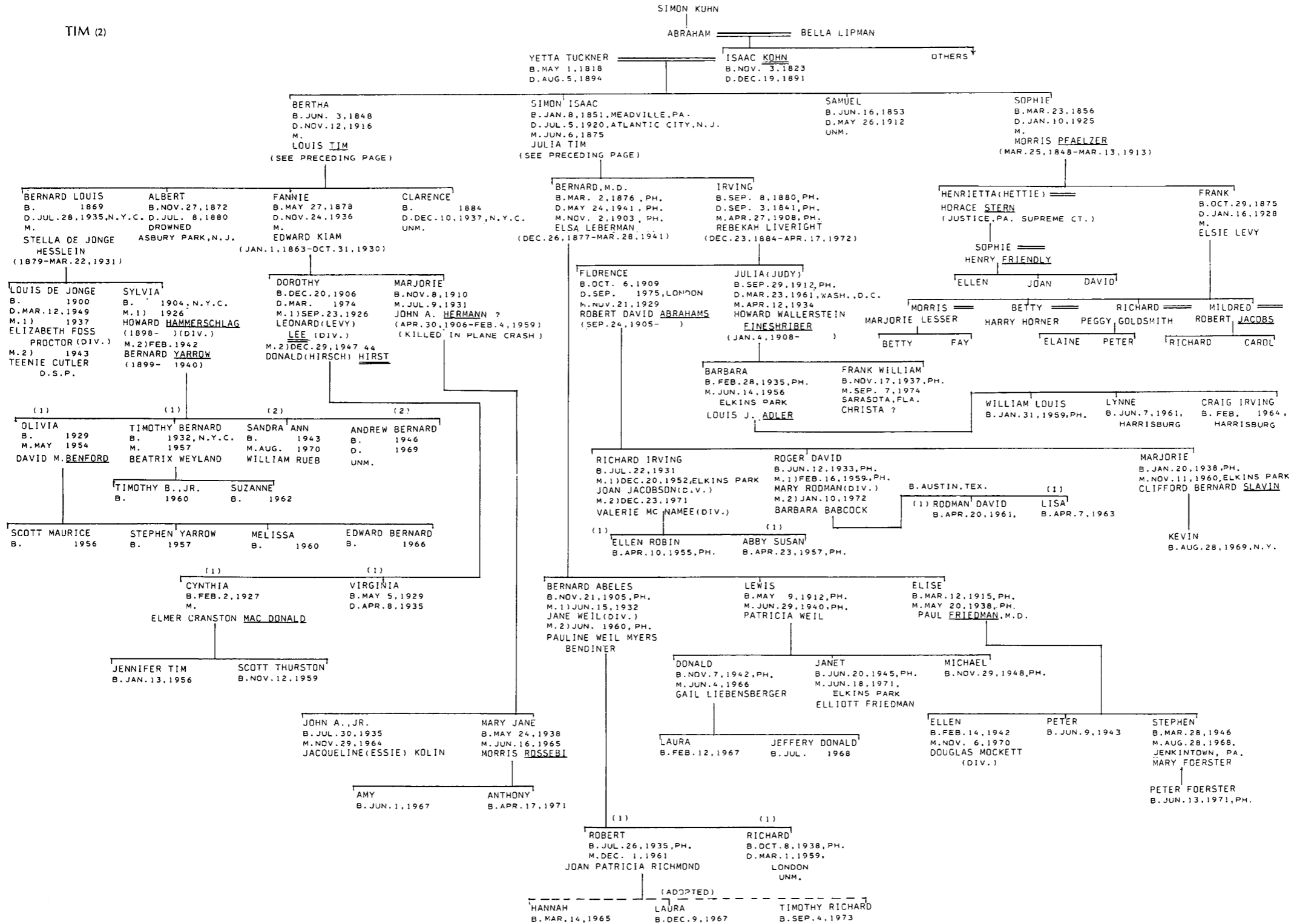

FLO. ABR.  
 JON STEEDMAN  
 MISC. IV  
 BARBER-N.Y. MARRIAGES  
 KRAUS-SANDOR COLL.  
 GOLDSTONE GEN. (AJA)  
 HENDRICKS GEN. (JRM)  
 SHEARITH ISRAEL REC.  
 N.Y. CENSUS, 1855

TOBIAS I (N.Y.)

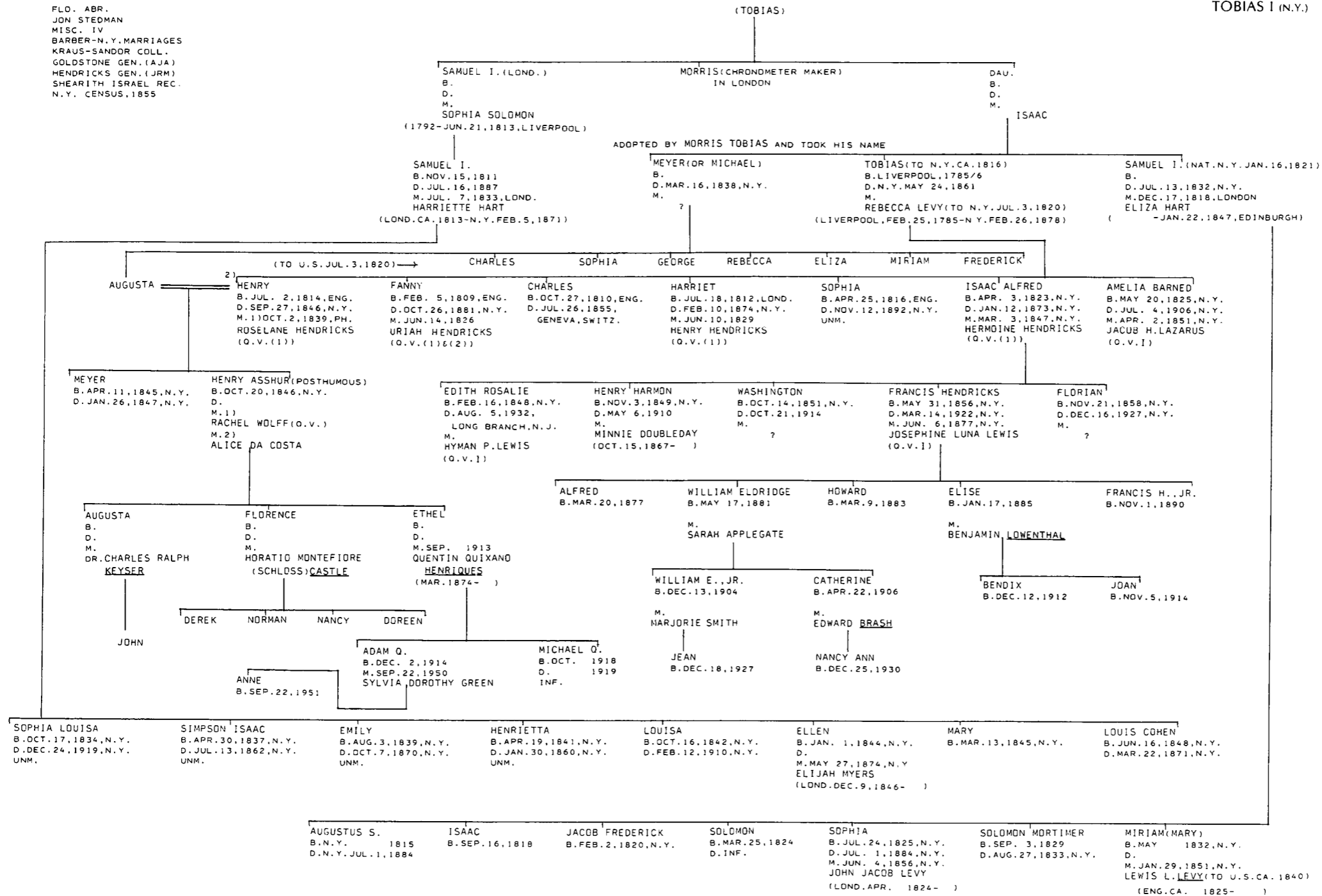



TOBIAS II (1) (CHARLESTON)

TOBIAS GEN. (KRAUS, A.J.)  
 TOBIAS BIBLE (IBID.)  
 KRAUS-SANDOR COLL.  
 PAJHS V. 12, P. 44; V. 10, P. 73  
 ELZAS-JEWS OF S.C.  
 - JEWS OF S.C., PT. 2 P. 8F.  
 M.N.  
 D.J.C.  
 MSS. (NYHS)  
 WILLS OF JUDITH, JACOB, AND ISAAC TOBIAS  
 LOPEZ GEN. (JRM)  
 CLEMENS-N. 6S.C. MARRIAGE REC.  
 SPRUCE ST. (PHILA.) CEMETERY REC.  
 SHEARITH ISRAEL REC.  
 T.J. TOBIAS  
 WILL OF JACOB OLIVEIRA  
 FATHER EDWIN C. TOBIAS  
 MISC. VII, #364  
 SH.  
 EGMONT, P. 91  
 MIKVEH ISRAEL REC.  
 P.B.H.  
 ABBOT LOW MOFFAT  
 AMST. MUNICIPAL ARCHIVE  
 PHILA. PUBLIC LEDGER  
 (OBIT. JUN. 26, 1850)

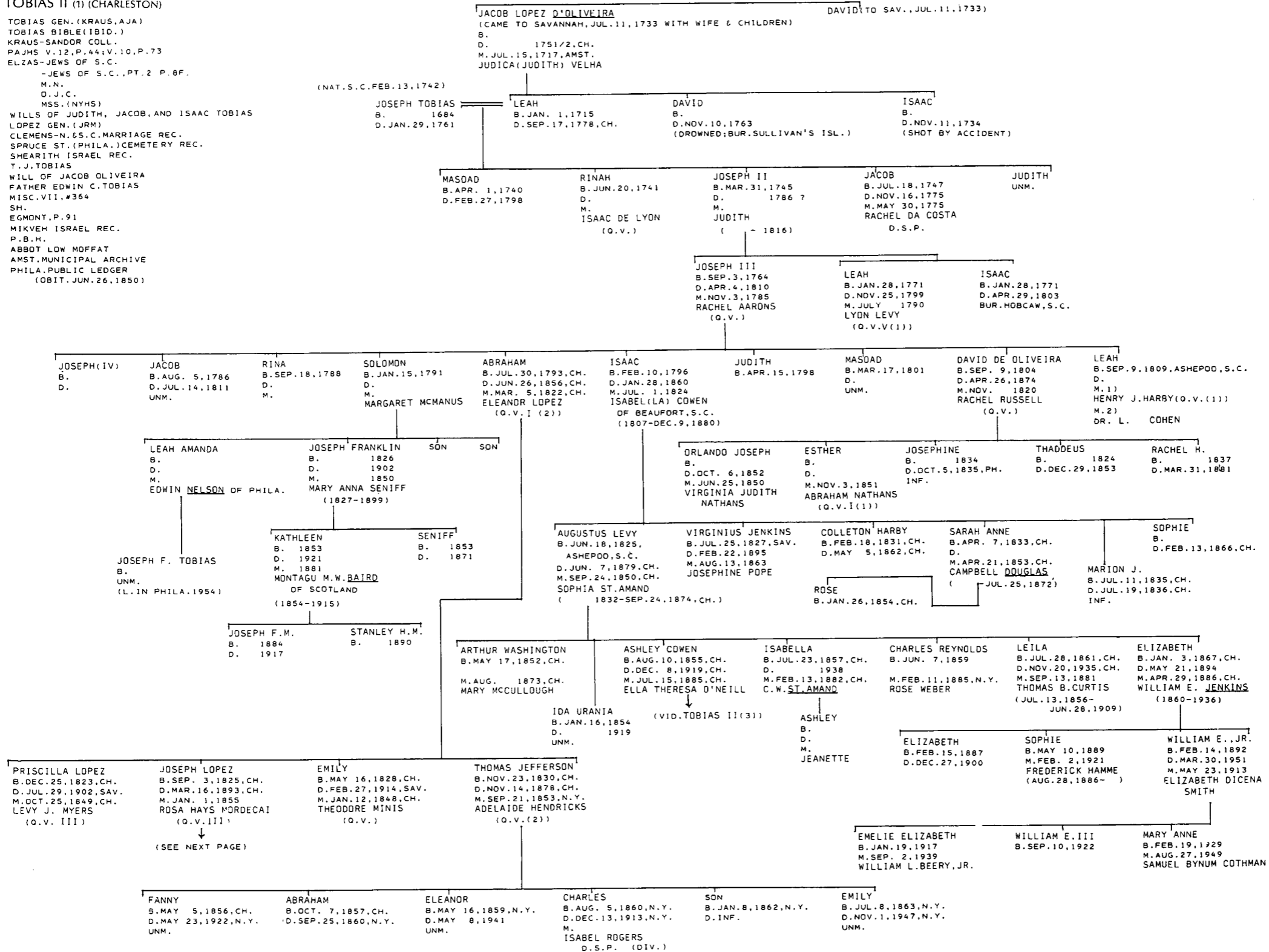

TOBIAS II (2) (CHARLESTON)

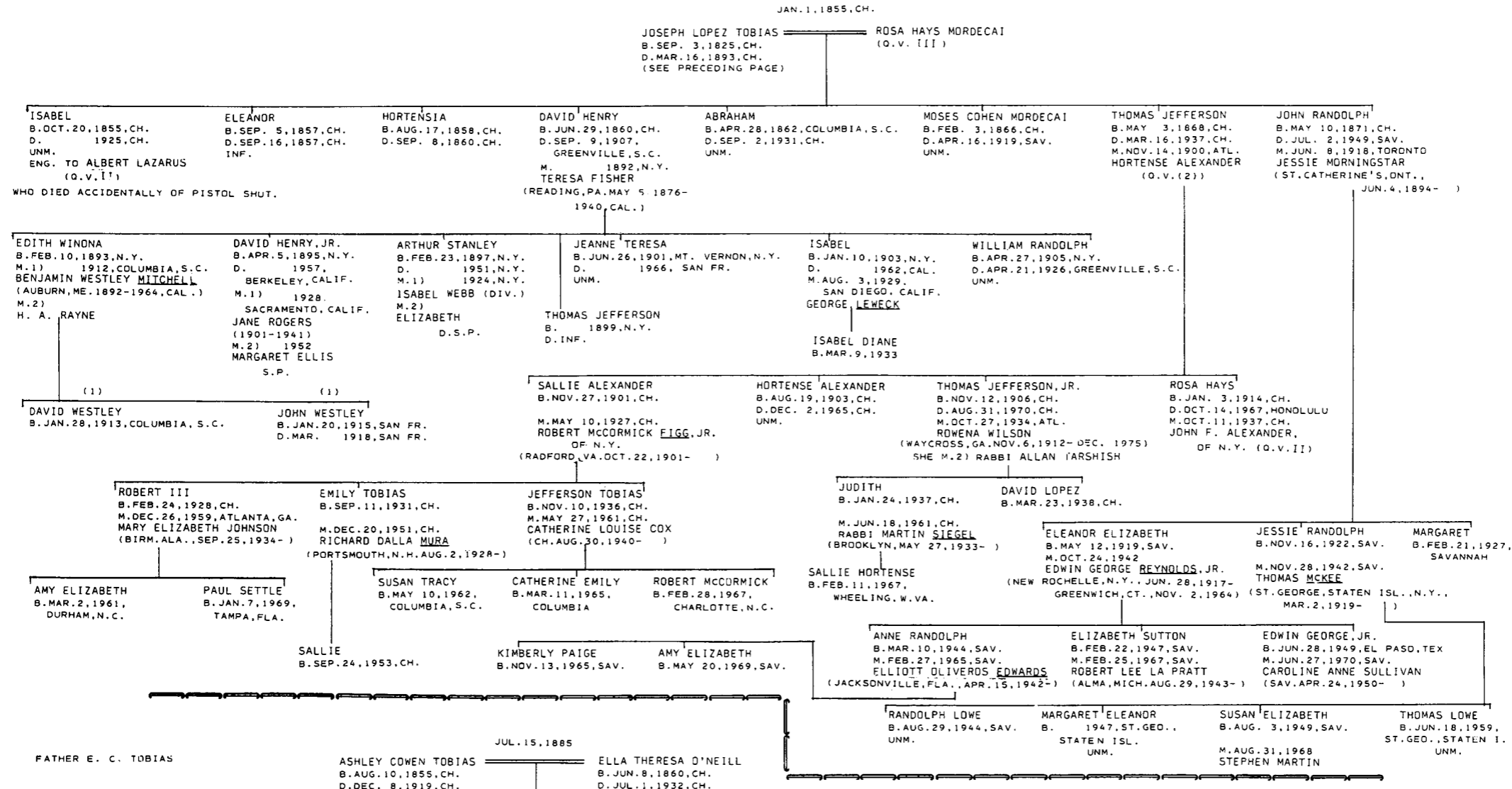

TOBIAS II (3) (CHARLESTON)

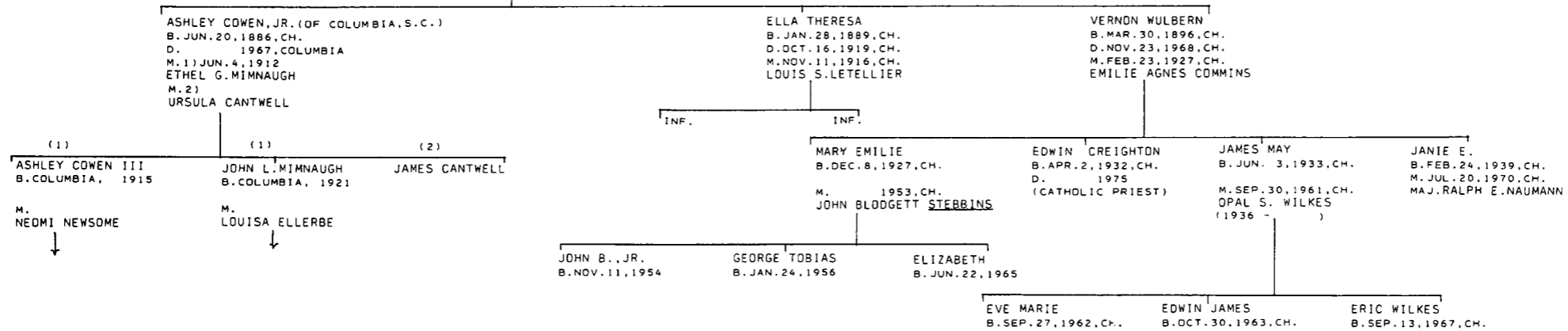

**TOBIASON**

FLO. ABR.  
P.B.H.

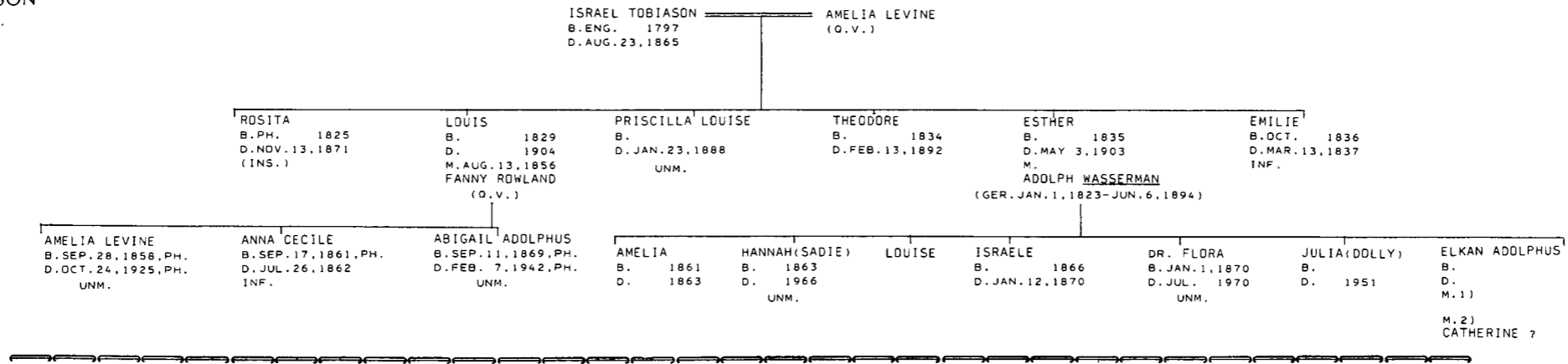

**TOURO**

PAJHS V.13, P.93F.  
V.27, P.417F.  
U.J.E., V.10, P.284F.  
GUTSTEIN- JEWS OF NEWPORT  
AARON LOPEZ & JUDAH TOURO  
SHEARITH ISRAEL REC.

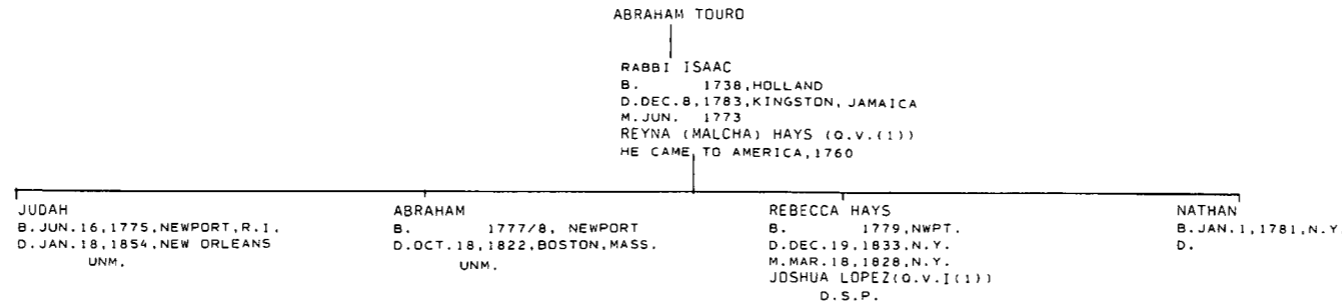

**VALENTINE**

ELZAS MS.  
POOL- PORTRAITS...  
SHEARITH ISRAEL REC.  
ROSENWAIKE

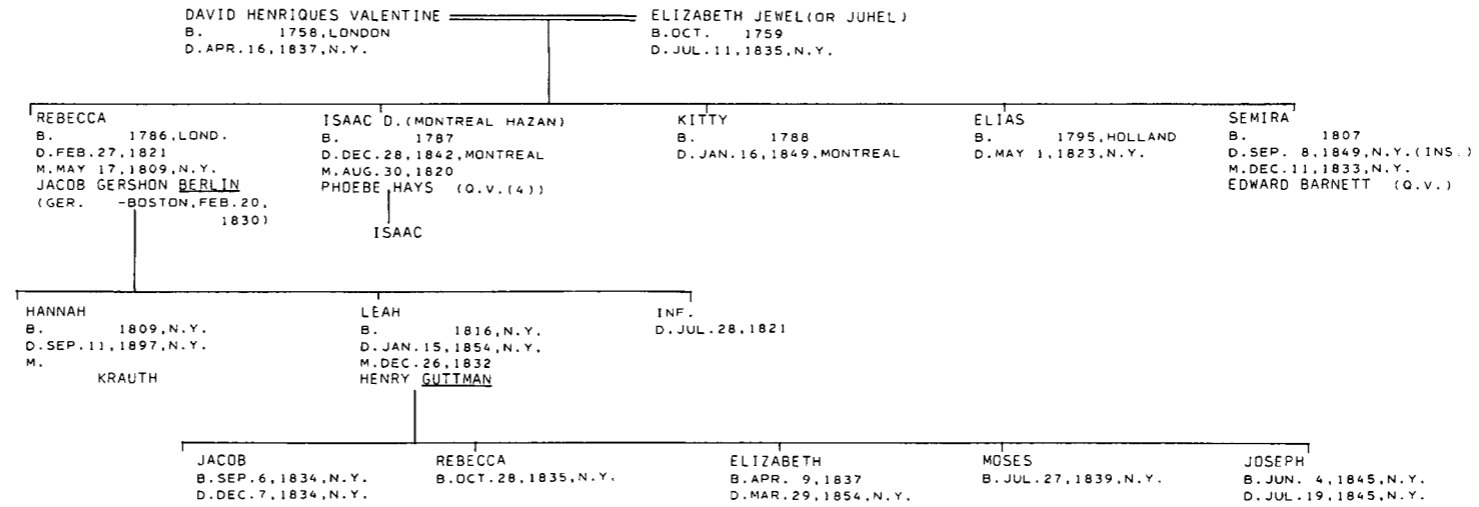

UMSTADTER

NORFOLK HEBREW CEMETERY  
 NORFOLK CITY RECS.  
 U.S. CENSUS, 1870  
 NORFOLK CITY DIRECTORY  
 REFORM ADVOCATE  
 AJYB, 5666, P. 44  
 5674, P. 269  
 HOWARD STERN  
 FLD. ABR.  
 CILLA G. NUSBAUM

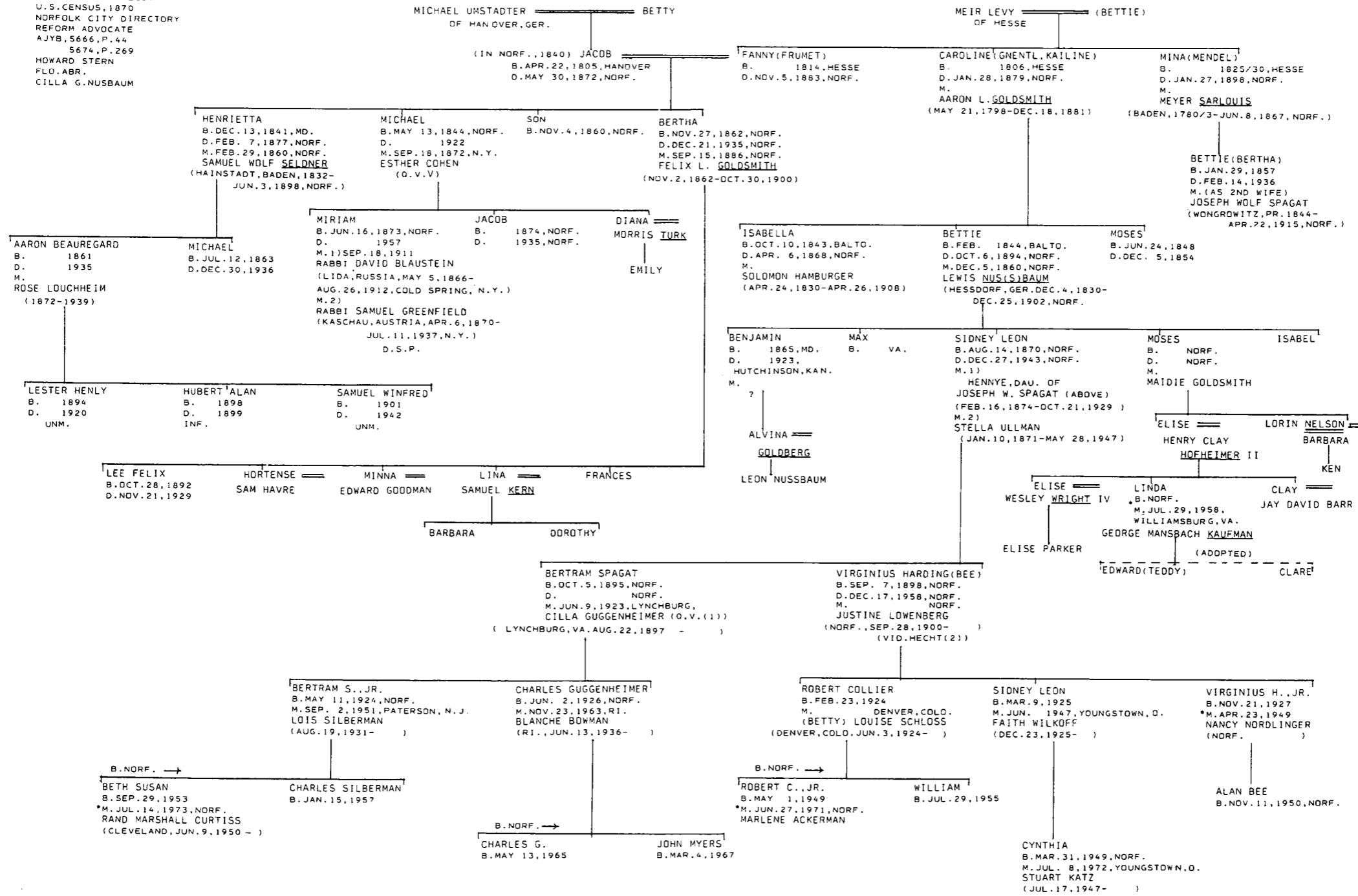

\*MARRIED BY RABBI MALCOLM H. STERN

**VALVERDE**

TJHSE, V. 13, PASSIM  
SHILSTONE  
BARBADOS CENSUS, 1715  
KORN-BARBADOS WILLS  
PAJHS, V. 42, P. 395  
POOL-PORTRAITS, P. 464  
MISC, VII  
B. M. KETUBOT



**WAAG (E)**

KRAUS-SANDOR COLL.  
PAJHS V. 21, P. 156  
PAJHS V. 31, P. 34F.  
SHEARITH ISRAEL REC.  
WILL OF REBECCA GOMEZ (AJHS)

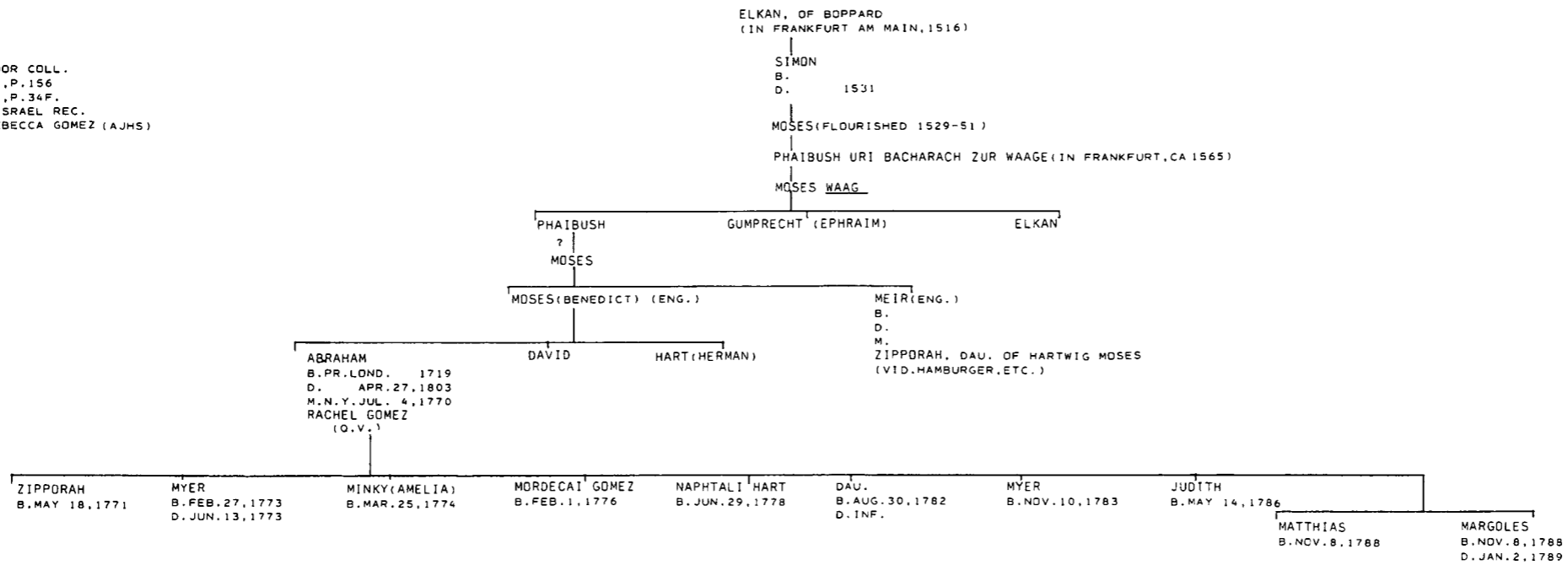

WATERMAN

B'NAI JESHURUN REC.  
EZEKIEL FAMILY REC.  
SHEARITH ISRAEL REC.  
M.A. BRANDT II

LEVI VAN VEEN  
B. CA. 1745, VIENNA  
D. CA. 1820, AMSTERDAM  
M. ?

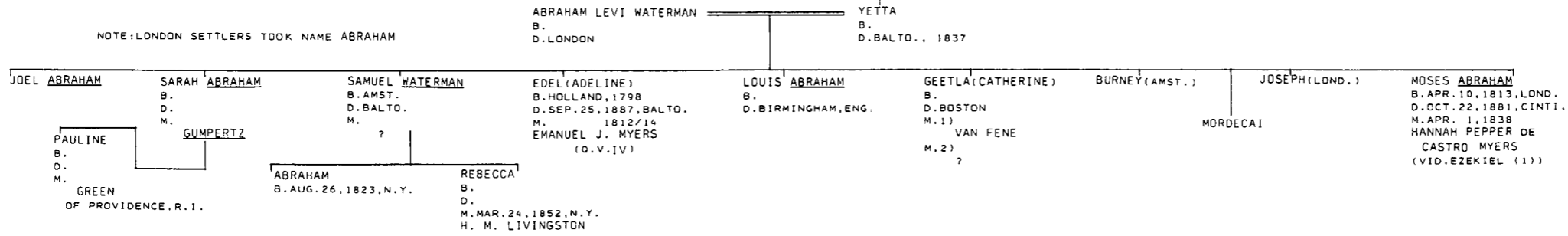

LEON L. WATTERS—PIONEER JEWS OF UTAH  
JON STEDMAN  
WHO'S WHO IN WORLD JEWRY, 1965, P. 1019  
AJYB, 1968, P. 613

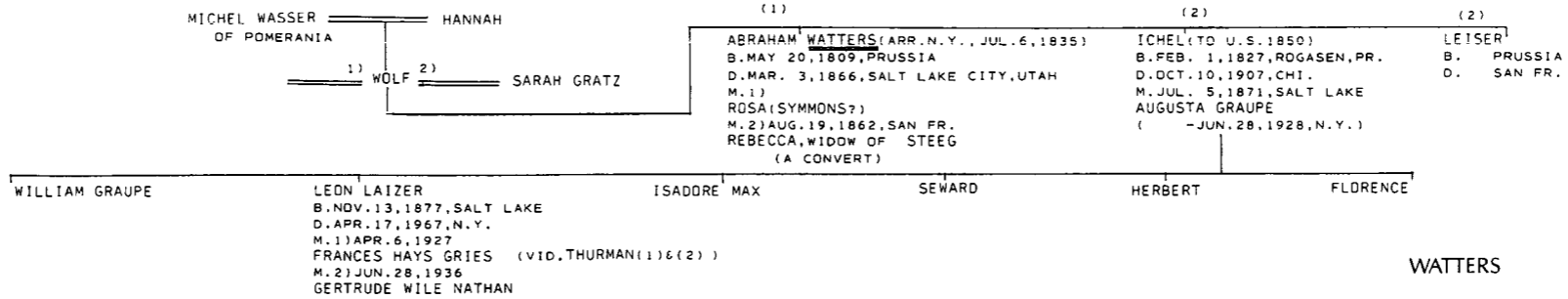

WATTERS

MIKVEH ISRAEL REC.  
MORAIS-JEWS OF PHILA.  
MEYER SOLIS-COHEN  
FEDERAL ST. CEMETERY

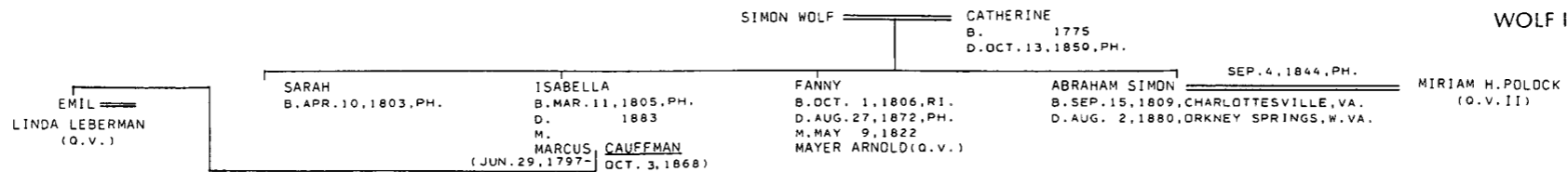

WOLF I

L. BAECK INSTITUTE Y.B., V. X, P. 66FF.  
SHEARITH ISRAEL REC.  
SAWYER-N.Y. WILLS, V. 3  
MORAIS-JEWS OF PHILA.  
N.Y. DEATHS FROM N.Y. EVENING POST  
AJA, V. XIV, P. 26F.  
U.S. CENSUS, 1880

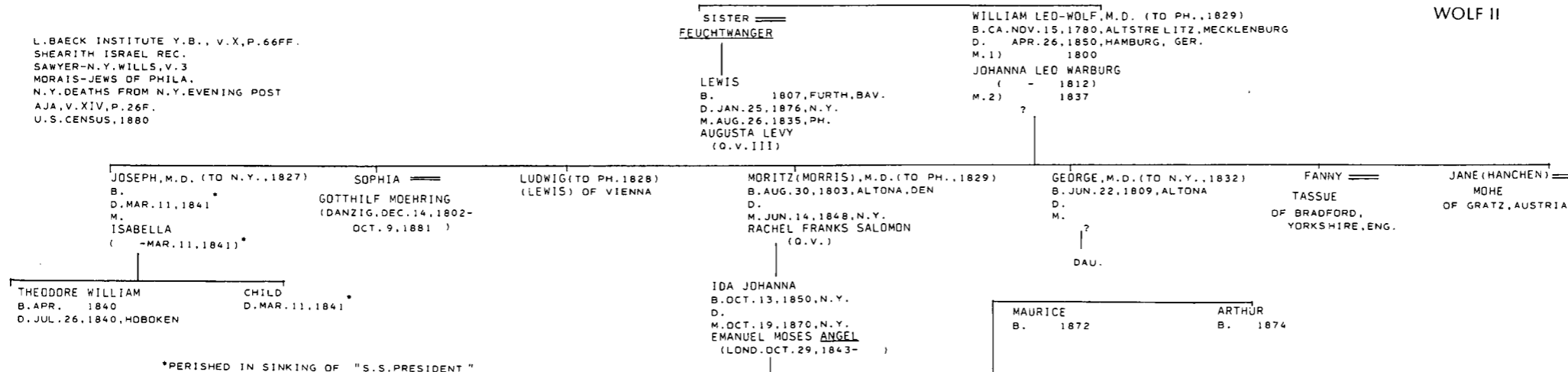

\*PERISHED IN SINKING OF "S.S. PRESIDENT"

**WOLFE I**

THE OLD MERCHANTS, V. 3, PP. 152-159  
 EZÉKIEL-LICHTENSTEIN  
 HENRY V. HOAGLAND  
 RICHMOND PERSONAL PROPERTY RECS.  
 PAJHS, V. 27, P. 112  
 JOHN I. CODDINGTON, F. A. S. G.

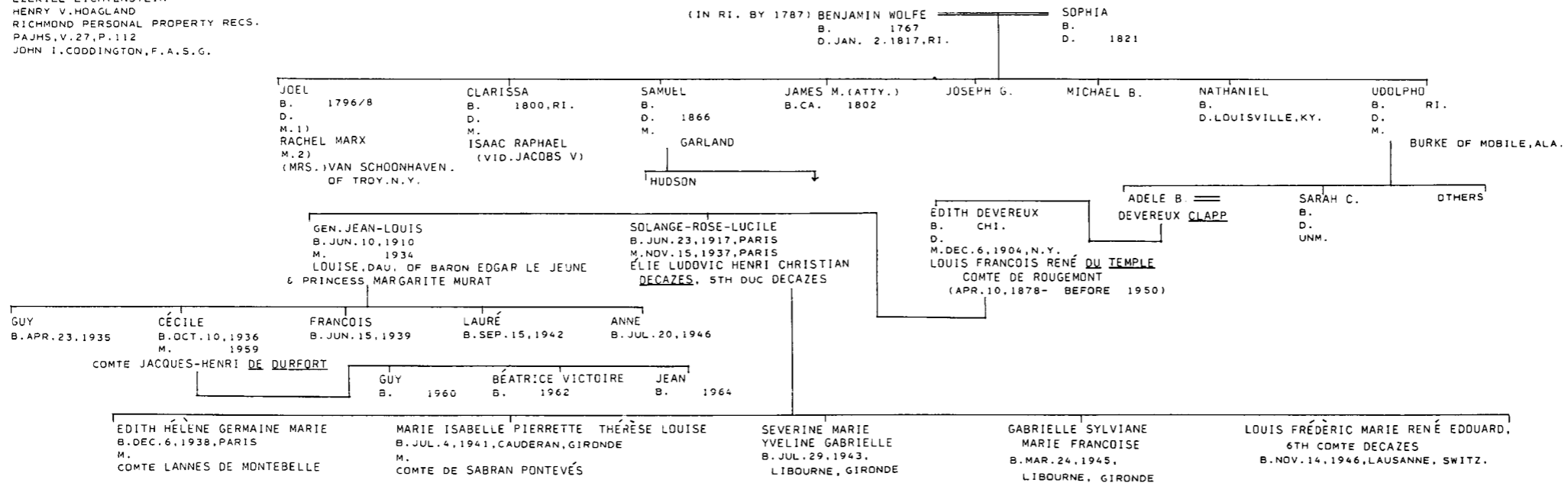

**WOLFE II**

CHARLES WHITEHEAD  
 KRAUS-SANDOR COLL.  
 DAR LINEAGE BOOKS  
 ELZAS-JEW. CEMETERY AT COLUMBIA, S.C.  
 JEW. CEMETERY AT ORANGEBURG, S.C.  
 M. N.  
 M. COIT-MR. BARUCH  
 FLO. ABR.

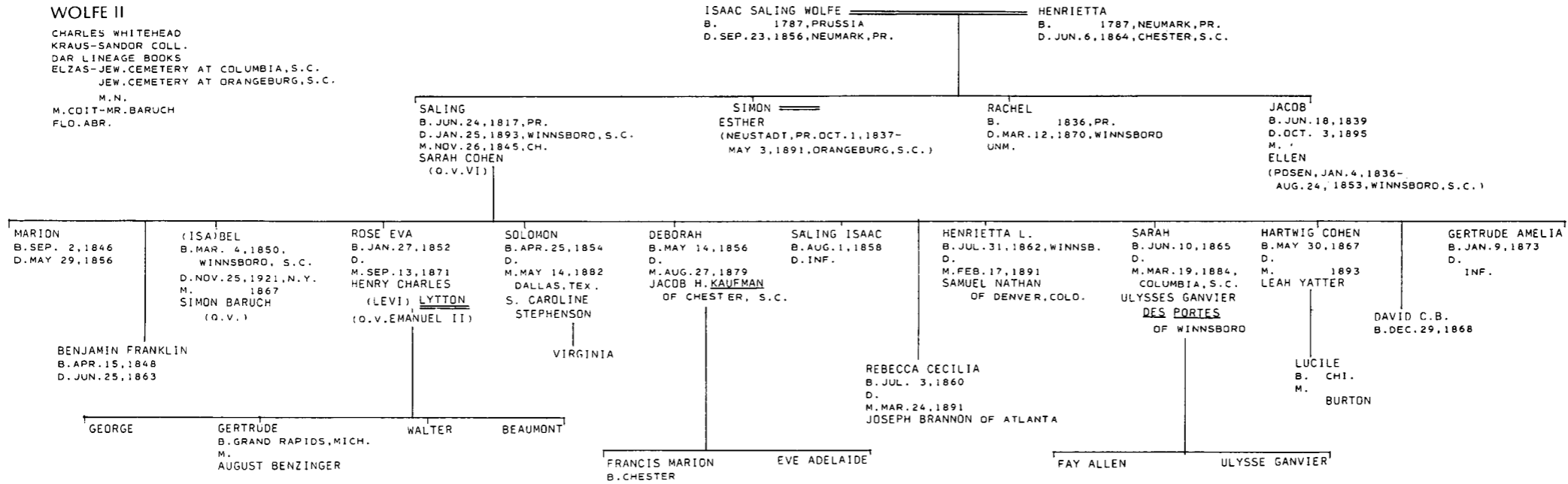

ENA  
ST.THOS.MARRIAGES  
ST.THOS. REC.  
HUC ANNUAL, V.14,P.584  
SHEARITH ISRAEL REC.  
U.S.CENSUS.1880

JACOB HISQUIAO ROBLES (HAZAN IN ST.EUSTATIA)  
B. 1751  
D.DEC.28,1791,ST.E.  
M.  
CATHARINA LEVY

MOSES HUNIG

LEVY <sup>1)</sup> REBECCA TOR(R)IES <sup>2)</sup> DAVID JUDAH HART

BENJAMIN  
B. 1755, KÜTTENBERG(?)BOHEMIA  
D.FEB. 1834,BOHEMIA

REBECCA <sup>1)</sup> MOSES WOLFF <sup>2)</sup>  
B. 1774,ST.E. B. 1756,BERST OF GER.  
D. 1815,ST.THOS.

MIRIAM B. 1767,N.Y.  
SIMON D. 1829  
CHARLOTTE D. JAN. 1, 1798, ST.THOS.  
JUDAH B. APR. 9, 1799, ST.E. D. NOV. 4, 1878, ST.THOS.  
SARAH DE SAMUEL HOHEB (DEC. 1795-APR. 1, 1863, ST.THOS.)

RACHEL HANNAH ELKAH RALPH MIRIAM LEAH AARON  
B. 1815 D. 1850 B. 1804 B. 1850 B. 1808 B. 1866 B. AUG. 6, 1795, ST.KITTS  
D. DEC. 27, 1850, M. 1815 D. DEC. 25, 1881, ST.THOS. D. 1834 M. 1839 D. JUN. 12, 1872, LOND. D. FEB. 1792, ST.THOS.  
JACOB BENJAMIN COL. R. LINDSLAY BENJAMIN MENDES DA COSTA JUDITH PUCTO PETER VAN VLIERDEN ELIAS CHARLES MENDES DA COSTA SAMUEL RACHEL SOLOMON BENJAMIN (O.V.I) REBECCA B. JUN. 1844 D. NOV. 10, 1859, ST.THOS.

JACOB BENJAMIN B. 1815 D. DEC. 27, 1850, ST.THOS. CHARLOTTE B. 1817 D. INF. MOSES B. 1818, ST.E. D. FEB. 5, 1855, M. JUL. 15, 1838, PUERTO CABELLO, VEN. MIRIAM B. 1821 D. M. NOV. 8, 1843, ST.THOS. ELIAS B. DEC. 25, 1822, ST.THOS. D. JUN. 23, 1869, SANTO DOMINGO, M. FEB. 20, 1855, N.Y. JOSEPH B. 1830 D. INF. DANIEL N. B. JAN. 6, 1820, ST.THOS. D. JAN. 13, 1899, N.Y. MIRIAM B. MAY 18, 1823, ST.THOS. D. JUL. 7, 1887, N.Y.

SOLOMON B. 1816 D. APR. 29, 1826, ST.THOS. REBECCA LEVY (ST. CROIX, 1841- AUG. 28, 1889, N.Y.) JACOB MENDES DA COSTA JOSEPHINE LUNA HENRIQUES (O.V.I(2)) RUTH B. 1825 D. INF. ALEXANDER R. B. 1826 D. 1868 M. 1856, ST.THOS. ANNA B. 1827 D. INF. REUBEN JULIUS B. FEB. 2, 1837, ST.THOS. D. SEP. 15, 1911, YONKERS M. OCT. 4, 1854, ST.THOS. RACHEL MIRIAM LEVY (1836- )

MOSES B. NOV. 30, 1849, ST.THOS. D. APR. 6, 1885, N.Y. MILLIE MARTIN NATHAN FANNY B. NOV. 4, 1852, HAMBURG, GER. D. OCT. 3, 1922, N.Y. M. NOV. 5, 1878, N.Y. CHARLES G. WOLFF (BELOW) ALEXANDER B. 1853, ST.THOS. D. NOV. 13, 1919, N.Y. M. LILLIAN GANS HAROLD ALEXANDER B. 1894 D. JUN. 25, 1919, N.Y. M. ROSE CRYSTAL RACHEL B. NOV. 1863 D. NOV. 24, 1864 INF. AARON B. JUN. 23, 1858, N.D. D. AUG. 4, 1859, ST.THOS. INF. DANIEL B. 1866 ST.THOS. ESTHER B. 1865, ST.THOS.

DAVID RACHEL HENRY A. TOBIAS (O.V.I) AARON B. JUN. 18, 1843, ST.THOS. D. JAN. 4, 1920, N.Y. M. APR. 10, 1867, N.Y. AGNES HENDRICKS (O.V.I) AUGUSTA CHARLES GELLER B. MAY 3, 1848, LA GUAIRA, VEN. D. APR. 23, 1898, N.Y. M. NOV. 5, 1873, N.Y. FANNY LEVY (ABOVE) JULIUS RUBEN B. MAY 7, 1849, LA GUAIRA, VEN. D. APR. 25, 1886, N.Y. M. FEB. 14, 1877, N.Y. FRANCES LOUISA NATHAN (O.V.I(1)) EMITA B. JUN. 7, 1851, LA GUAIRA, VEN. BENJAMIN B. 1852 D. FEB. 6, 1855 RACHEL B. 1890, N.Y. M. JUL. 4, 1919, N.Y. GEORGE VICTOR SIMON

LILLIAN HENDRICKS B. JUL. 31, 1866 D. M. MAR. 30, 1892, MONTREAL LOUIS NAPOLEON LEVY (O.V.II) MOSES PERCY B. JAN. 21, 1875, N.Y. D. M. LOTTIE FOX FRANK JOSEPH B. MAR. 5, 1876, N.Y. D. MAR. 24, 1878, N.Y. EDWARD B. M. 1) FOX M. 2) BEE GAY EMITA JOHN B. III JEAN'S. JOHN B. IV RACHEL B. 1890, N.Y. M. JUL. 4, 1919, N.Y. GEORGE VICTOR SIMON FANNY MYRON SCHAFER (VID. TIM) JOSEPHINE MOSES STERN ARTHUR MOSES B. 1881 D. M. 1930 GWENDOLYN MACLEOD FRANCES NATHAN B. NOV. 5, 1883, N.Y. D. M. MAR. 28, 1906, N.Y. JOSEPH FREDERICK CULLMAN, JR. (VID. STIX(1)) EMILY REBECCA B. AUG. 26, 1878, N.Y. D. JAN. 27, 1912, N.Y. M. ERNEST A. CARDOZA (O.V.) JOHN BENJAMIN M. 1) MARY FULLER HOGLISTER M. 2) FLORENCE FULLER JOHN B. JR. RALPH M. 1) LUCY M. 2) MARGARET SCHEUER PEARL MARY RALPH, JR. ROBIN E. WILSON

ELZAS MS.  
M.N.  
NEW CEMETERY AT CH.  
JEWS OF S.C.

(JACOB?) WOOLF SARAH B. 1735 D. JUN. 29, 1831, CH. RACHEL B. 1768 D. JAN. 22, 1843 M. REV. ISAAC COHEN D'AZEVEDO (O.V.) ISAAC B. 1782 D. MAR. 5, 1870, CH. M. MAY 31, 1809, CH. SARAH MOSES (O.V.VII)

LEVI B. MAR. 3, 1810 D. SEP. 25, 1810 INF. MIRIAM R. B. D. APR. 5, 1857, DAYTON, O. M. DEC. 1, 1841, CH. JOHN M. HIRSCH (STOCKHOLM, SWE. DEC. 8, 1801- JUL. 29, 1874, CH.) ELIZA T. B. OCT. 22, 1815 D. OCT. 31, 1867 M. DEC. 1, 1841, CH. MORITZ LEVIN (O.V.II) RALPH B. D. MAR. 29, 1837, CH. CORDELIA HARRIS (O.V.II) CHARLOTTE A. B. NOV. 17, 1817 D. FEB. 1, 1883, CH. M. JAN. 31, 1844, CH. L. T. LEVIN (O.V.II) EMMA C. THEODOSIA B. 1820 D. OCT. 4, 1824, CH. CAROLINE A. B. 1824 D. MAR. 9, 1904, ORANGE CO. M. DEC. 1, 1841, CH. EMANUEL N. CARVALHO (O.V.) THEODOSIA RODDOLPH B. 1833 D. AUG. 13, 1838 SOLOMON JACKSON B. FEB. 1829 D. DEC. 21, 1830 INF. CLARENCE REUBEN B. MAR. 26, 1838 D. JUN. 15, 1867



WORKUM (1)

DAVID L. ACH  
 IRVING I. KATZ  
 B'NAI JESHURUN REC.  
 WORKUM GEN.(AJA)  
 EZEKIEL FAMILY RECS.(E. PINCUS & AJA)  
 SHEARITH ISRAEL  
 U.J.E.  
 PAJHS, V.19,P.202F.  
 AJYB V.29,P.161  
 SENIOR GEN.  
 FECHHEIMER GEN.

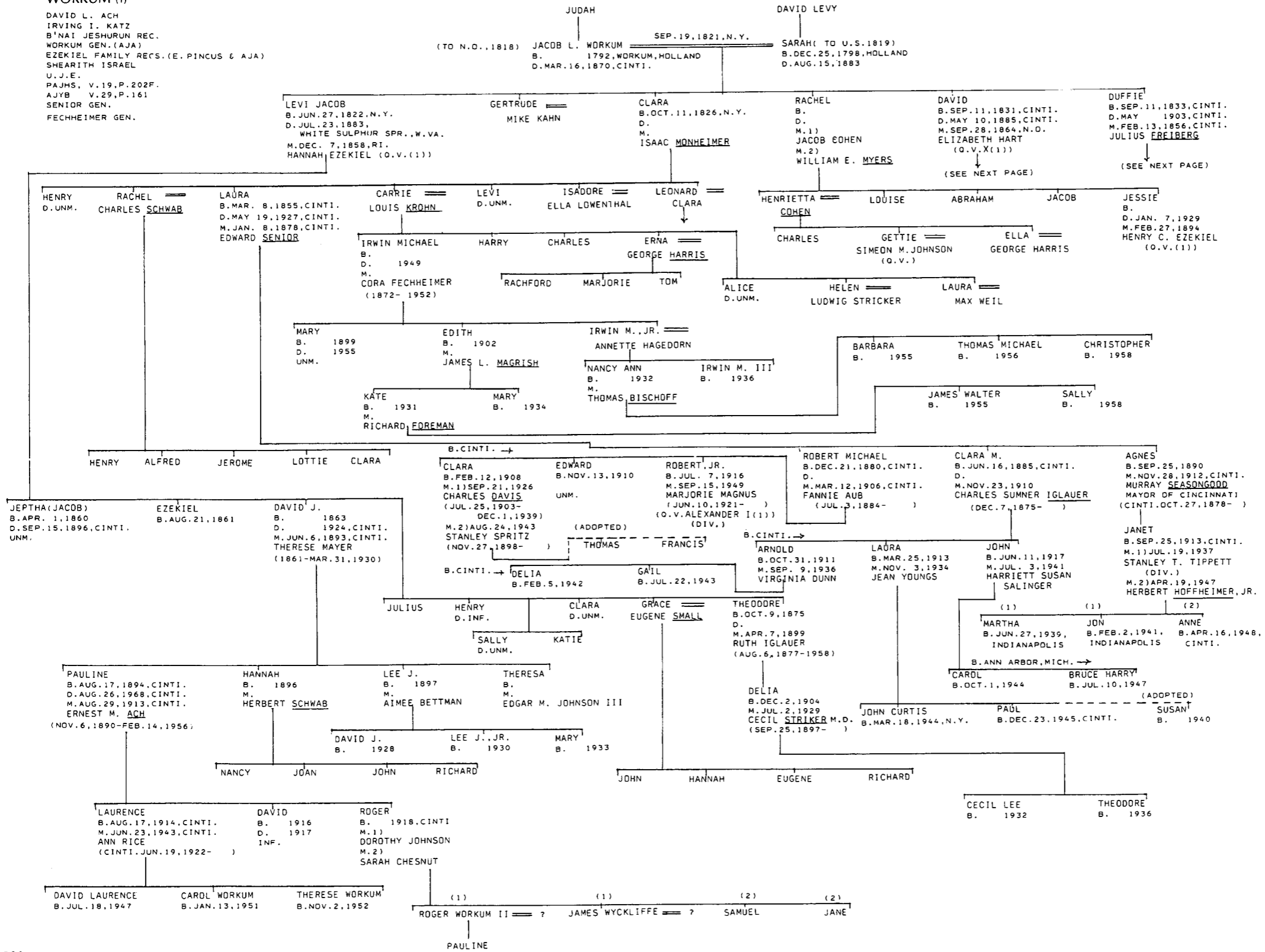

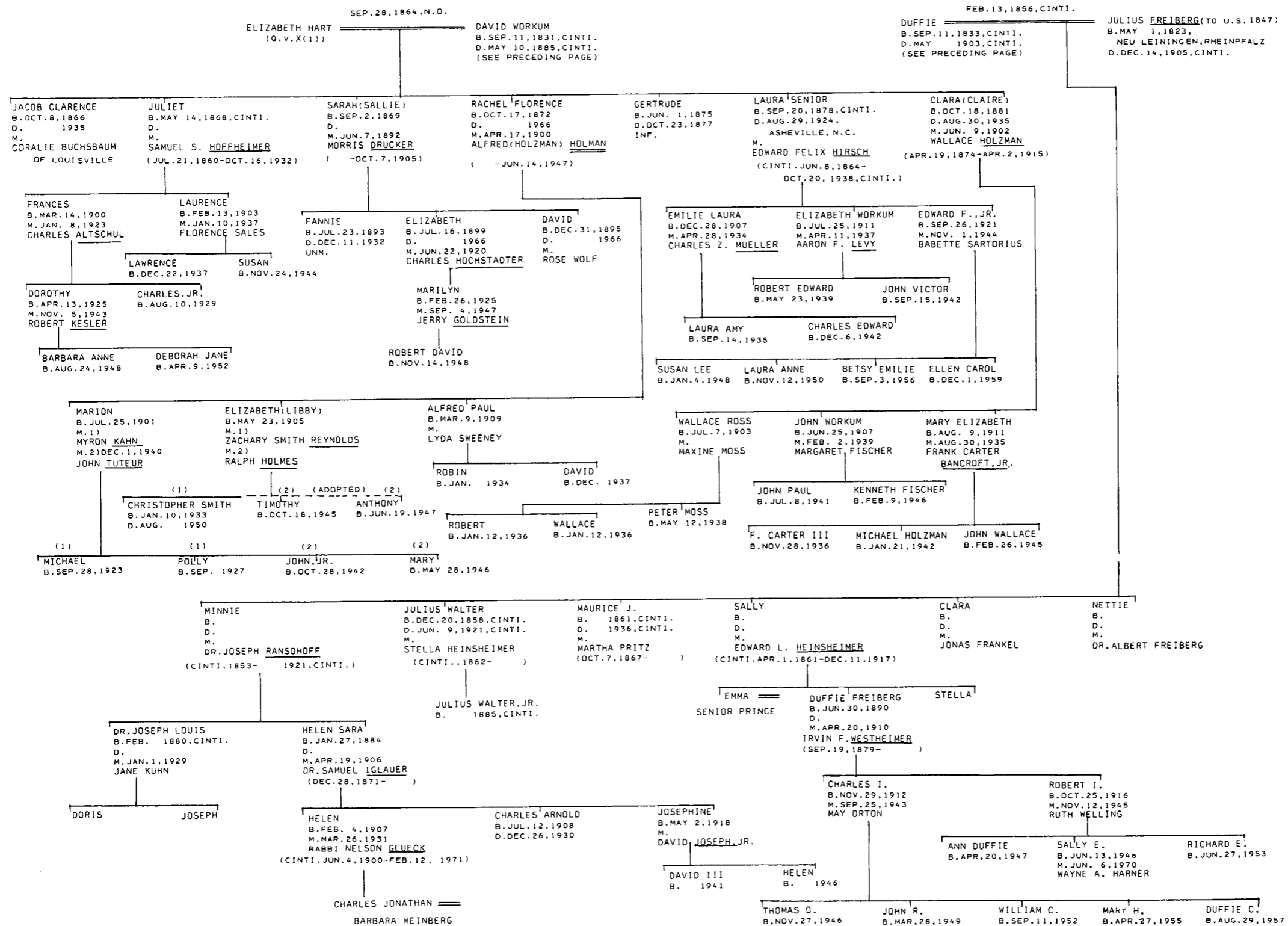

**YATES**

THOMAS J. TOBIAS  
 ELZAS, O. J. C.  
 KRAUS-SANDOR COLL.  
 SAMUEL-HIST. & GEN. OF SAMUEL-YATES  
 SAMUEL-YATES GEN. (AJA)  
 SHEARITH ISRAEL REC.  
 FLD. ABR.

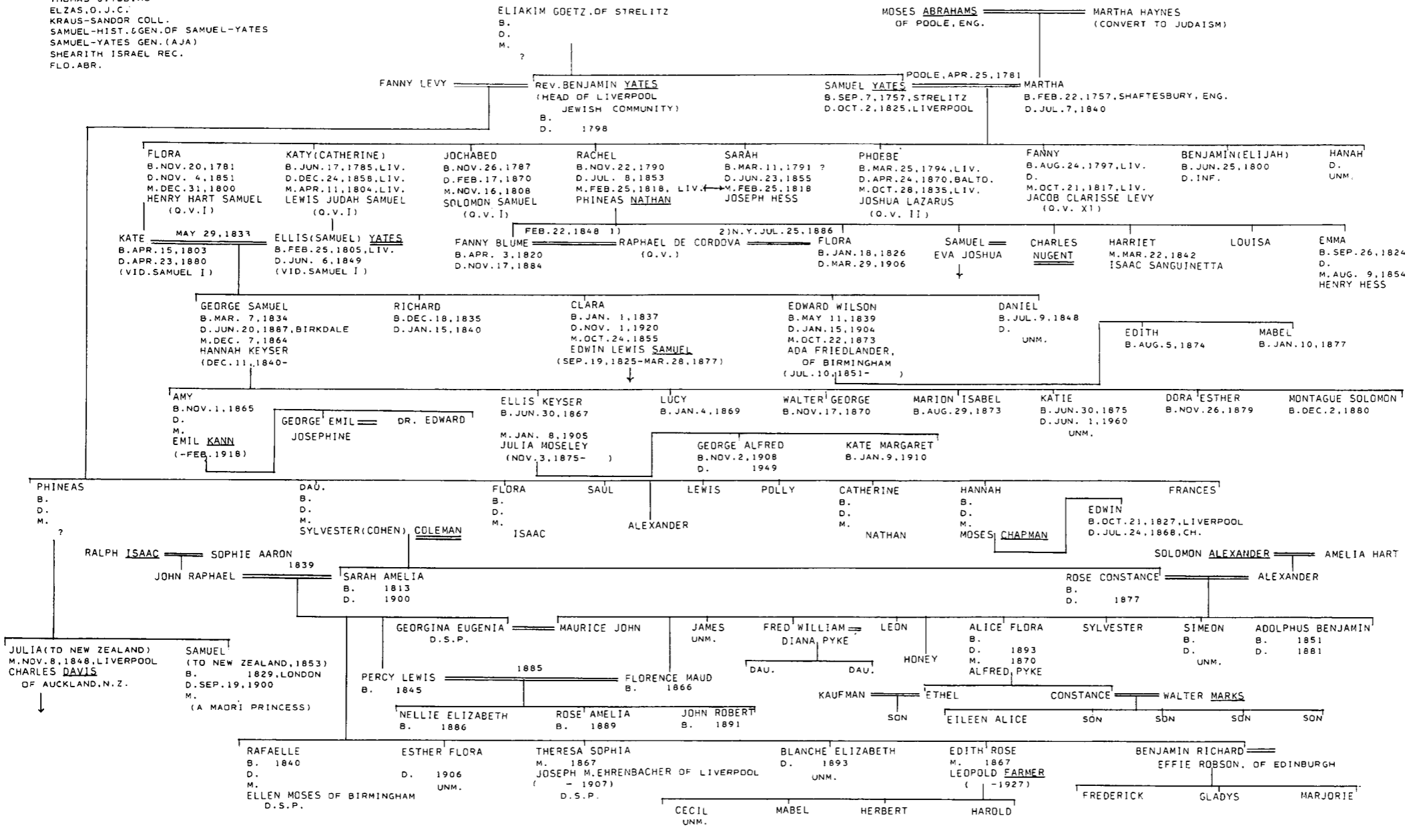

**ZUNTZ**

POOL-PORTRAITS...  
 SHEARITH ISRAEL REC.  
 PAJHS V. 27, PP. 32, 78  
 N.Y. DEATHS (DAR)  
 BARBER-N.Y. MARR.  
 N.Y. WEEKLY MUSEUM

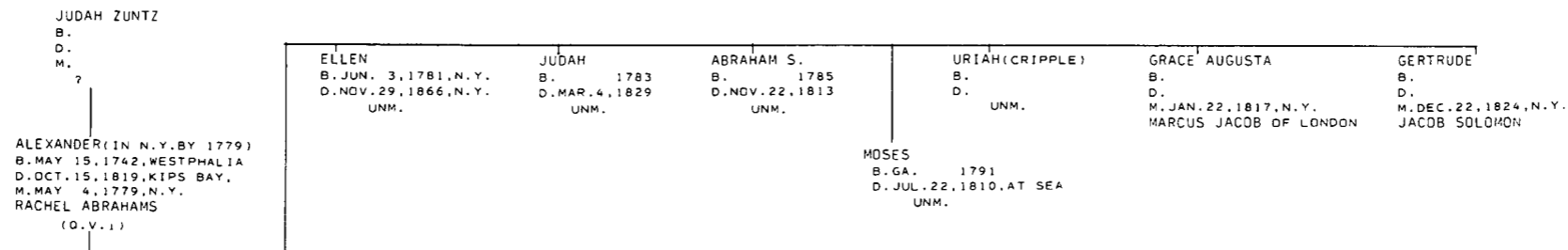

*Addenda et  
Corrigenda*





ADDENDA ET CORRIGENDA

THIS SECTION CONTAINS DATA WHICH ARRIVED TOO LATE FOR INCLUSION ON THE CHARTS, AS WELL AS CORRECTIONS TO THE CHARTS. ALL ADDITIONS AND CORRECTIONS, WHETHER THEY CONSIST OF A SINGLE LETTER OR ARE MORE EXTENSIVE, ARE UNDERLINED. ITEMS NOT UNDERLINED APPEAR UNCHANGED FROM THE CHARTS AND INCORPORATED HERE TO PROVIDE EASY REFERENCE TO THE CHARTS. THE USER IS URGED TO COMPARE THE DATA IN THIS SECTION WITH THE INDICATED CHARTS.

MISCELLANEOUS ADDITIONS OR CORRECTIONS TO AN INDIVIDUAL CHART ARE SEPARATED BY A BROKEN LINE.  
SEVERAL GENERATIONS OF ONE FAMILY ARE INDICATED BY INDENTING FOUR SPACES FOR EACH SUCCEEDING GENERATION. ALL INDIVIDUALS OF THE SAME GENERATION SHARE A COMMON MARGIN OF INDENTATION, AS THE FOLLOWING SCHEME DEMONSTRATES:

PARENTS  
CHILD A  
CHILDREN OF A  
GRANDCHILDREN OF A  
CHILD B  
CHILD 1 OF B  
CHILDREN OF CHILD 1 OF B  
CHILD 2 OF B  
ETC.

SOURCES FROM WHICH THESE DATA ARE DERIVED ARE LISTED IN PARENTHESES AFTER EACH GROUP OF DATA.

PAGE AND FAMILY

5. ABRAHAMS II  
DAVID B. (FALK), DELETE II; M. JUL. 14, 1945, ARLA FEY. (B.H.LEVY)
6. ABRAHAMS IV  
AUGUSTA (LYON) D. JUN. 1910. (JOHN STEDMAN)  
VID. UNDER ISAAC S. SOLOMON, SIMON B. SOLOMON, AND SOLOMON B. SOLOMON SHOULD READ (VID. HART X(2))
6. ABRAHAMS V  
ISAAC ABRAHAMS, DELETE M.D.; B. 1737 (ROSENWAIKE - BALTIMORE)
11. ANCKER (2)  
RACHEL M. ADOLPH BITTERMAN OF EVANSVILLE, IND., AND HAD:  
JULIA M. HARRY LOWENTHAL AND HAD:  
EDWIN  
ARTHUR  
JACK  
PHILIP  
JACK M. HATTIE SCHOLEM, AND HAD:  
LEONORE, D. 1970; M. 1) ROBERT WOLLENBERG OF CHICAGO; M. 2) MALCOLM PFAELZER OF CHICAGO; M. 3) MERRITT DE JONG OF EVANSVILLE  
ALFRED  
FLORENCE, D. 1915; M. 1905; FERD. A. GUMBERTS (1871-1960) AND HAD:  
HELEN FLORENCE, M. APR. 22, 1939, MARON J. SIMON OF NASHVILLE, TENN., & N.Y. S.P.  
RICHARD A.  
WILLIAM A.  
ARTHUR, M. JANICE JAMES AND HAD:  
JANICE, M. EARL LEMOND  
DELIA, M. CLARENCE B. KAHN AND HAD:  
MARGERY  
THEODORE, M. CORINNE KAHN AND HAD:  
JEAN, M. ALVIN LEVY  
ROSEBUD, M. HERMAN COHN OF LITTLE ROCK, ARK. (MRS. MARON J. SIMON)
18. BENJAMIN I  
PHILIP, M. REBECCA, DAU. OF SOLOMON AND EVA (LEVY) DE MENDES AND HAD:  
JACOB LEVY, B. MAR. 20, 1818, FAYETTEVILLE, N.C. (R. DOUTHAT MEADE- JUDAH P.B.)
22. BINSWANGER (2)  
STANLEY RALPH (JACOBS), M. 2) MAY 7, 1972 (STANLEY RALPH JACOBS)  
JULIUS OPPENHEIMER (HANAU, GER. 1871-SEP. 20, 1937, N.Y.) AND HAD:  
J. ROBERT, D. FEB. 18, 1967, PRINCETON, N.J. (JOHN STEDMAN)
23. BINSWANGER (3)  
GEORGE LOEB, M. DORIS JANE GRAM AND HAD:  
HENRY GRAM, M. NOV. 9, 1974, DEBORAH CLAXTON  
ALAN DAVID  
JACK FERDINAND, M. FRANCES TURNER AND HAD:  
VIRGINIA DOROTHY, M. WALTER WINKLER (GEORGE L. BINSWANGER)
27. BRAUER  
HARRY PINCUS (NFK, AUG. 10, 1893-JUL. 1, 1974) (ESTHER D. PINCUS)
29. CARDOZO (CARDOZA)  
ERNEST ABRAHAM, M. 2) MARY E. KAYTON AND HAD:  
MICHAEL H. IV (NOT III), M. ALICE CORNEILLE AND HAD:  
MICHAEL V  
ALICE REBECCA (NOT REBECCA ALICE)  
PETER STERLING M. 1) BARBARA HERRON; M. 2) SUSAN STRONG. BY 1) HE HAD:  
PAMELA (DELETE WENDY)  
DANFORTH, JR., M. 1) SUZANNE SOLOMON; M. 2) PATRICIA FITZSIMMONS; M. 3) PATRICIA LYNCH  
ISAAC N. M. MAHALA BAUGH AND HAD:  
MARY ELIZA, M. WILLIAM G. WILKINSON (1805-1869) AND HAD:  
CLAUDE S.  
EDWARD BERRY  
JAMES HARRIS, B. 1862; D. 1936; M. NELLIE MC CURDY SMITH AND HAD ISSUE

- WILLIAM A. M. LOUISE JANE BURWELL AND HAD:  
LEWIS BURWELL  
RANDOLPH BURWELL, M. CONSTANCE GODDING AND HAD:  
MOSBY GODDING, M. CAROL ALICE WILCOX AND HAD:  
LEWIS BURWELL  
RUSSELL WILCOX  
ALICE CAROL  
RANDOLPH BURWELL, M. MARY WINGFIELD SCOTT AND HAD:  
RANDOLPH B., B. 1956; D. OCT. 25, 1976  
JAMES SCOTT  
CONSTANCE G.  
LEWIS BURWELL  
THOMAS CLOW G. (MICHAEL H. CARDOZO IV)
34. COHEN VI (S.C.)  
FRANCES (FANNY), D. JUN. 22, 1920 (KENNETH H. CHASE)
35. COHEN VIII (1)  
SALVADORA, M. PORTERFIELD (SAUL RUBIN)
38. COHEN IX (S.C.)  
AARON N., JR., M. FANNY COHEN (O.V. VI) AND HAD:  
HENRY I., B. 1844, GA.; D. JAN. 4, 1932, N.Y.; M. EDITH EUGENIA TICE (MAY 5-1867 - NOV. 21, 1941, NEW ROCHELLE, N.Y.) AND HAD:  
LIONEL M., B. 1888; D. JAN. 1, 1934, LEOLA, PA.; M. CATHERINE A. SULLIVAN (-JUNE 28, 1940, BOGOTA, N.J.); D. S.P.  
GLADYS LORRAINE DODGE, B. APR. 4, 1893; M. 1) MAY 26, 1917, N.Y.; JULIAN HUNTINGTON SEAMAN (BRONX, N.Y., DEC. 8, 1889-MAR. 10, 1942, NEW ROCHELLE); M. 2) 1948, ROY MARVIN PRESTON (JUN. 30, 1887-SEP. 9, 1970, GREENWICH, CT.) BY 1 SHE HAD:  
DAU. D. INF.  
BEVERLY HUNTINGTON, B. APR. 7, 1919, N.Y.; M. SEP. 8, 1942, MONTGOMERY, ALA.; HOLLIS H. CHASE (N.Y. MAY 9, 1916-), THEY HAD:  
KENNETH HUNTINGTON, B. JUL. 17, 1944, N.Y.; M. FEB. 14, 1971, JEANNE-NICOLE LEDOUX (JAN. 24, 1946-) (KENNETH H. CHASE)
- 39A. COHEN XIII  
LIEPMAN COHEN, B. GER.; M. AND HAD:  
PHILIP, B. GER.; D. 1786, CH.; UNM. (TO S.C. 1772)  
MOSES, B. GER. 1747; D. JUN. 29, 1790, SAV.; M. FEB. 1779, JUDITH DE LYON (O.V.) AND HAD:  
REINAH (RINAH, RINA), B. SEP. 5, 1783, CH.; D. JUL. 21, 1853; M. DEC. 29, 1802, DAVID MORDECAI (O.V. III)  
BELLA, B. AUG. 24, 1785, SAV.; D. NOV. 1863, CH.; UNM.  
ELIAS, B. GER.; M. AND HAD ISSUE  
JANE  
MARY, D. LOND.; M. LOND. MORDECAI LEVY AND HAD:  
JANE  
FLORA, B. ENG.; D. CH.; M. LOND. MICHAEL EMANUEL (O.V. III)  
MIRIAM, B. 1752; D. FEB. 7, 1815; M. ISRAEL JOSEPH (O.V. IV)  
MANNAH, B. ENG.; 1761; D. JUN. 26, 1850; M. 1) HYMON HART (O.V. VI (1)); M. 2) 1792, SAV.; ISRAEL DELIEBEN (BOHEMIA, 1748-JAN. 29, 1807, CH.); M. 3) MAR. 1813, MOSES DAVIS (GOBLINTZ, 1759-DEC. 31, 1843, CH.)  
EMANUEL, B. ENG.; M. AND HAD:  
ELIZABETH  
MORDECAI M. (VID. LEVY XIII)  
FLORA (VID. LEVY XIII)  
ROSINA (VID. LEVY XIII)  
CATHERINE, D. INF.  
SISTER OF LIEPMAN COHEN M. JACOB AND HAD: (OFFSPRING CALLED JACOBS)  
PHILIP (TO N.Y. 1772), B. GER.; D. N.Y. OCT. 6, 1818; M. ELIZABETH AND HAD:  
DAU. B. JAN. 23, 1819, N.Y.; D. APR. 5, 1821, N.Y.  
SIMON (TO ENG. 1765), B. GER.; D. 1807, LOND.; M. AND HAD:  
JACOB (TO N.Y. 1808); D. CANADA; UNM.  
ABRAHAM (ENG.) (NOEL C. STEVENSON)  
SISTER, B. GER. (SUPREME COURT, JAN. TERM, 1832, P. 102FF; ELZAS OJC; SH.)
49. DAVIS I (2)  
SOLOMON MOSES LEVIN (O.V. III) (FLO. ABR.)
54. DE LA MOTTA  
LEONORA, B. APR. 1800  
RACHEL, B. ST. CROIX, MAY 4, 1768; D. CH. MAY 11, 1796; D. S.P.  
EMANUEL M. JUDITH CANTER AND HAD:  
SARAH, D. SEP. 1, 1844, SAV.  
CHARLOTTE, B. CH. 1809  
RACHEL, B. CH. 1815  
REBECCA, B. OCT. 1793; D. FEB. 8, 1856; M. EMANUEL CANTER (O.V.)  
CLARA, B. CH. 1795; D. SAV. 1864; M. SOLOMON SHEFTALL (O.V. (1) 6 (3)) (JOHN SHEFTALL; LAZARUS GEN.; DE LA MOTTA MS. (AJHS))
56. DE LEON II  
MOSES, D. SEP. 10, 1828  
ELEAZER (CALLED LEON; VID COHEN IV) (OLIVER STREETON)
57. DE LYON  
MOSES SON OF LIEPMAN COHEN (O.V. XIII) (NOEL C. STEVENSON)  
ABRAHAM I., M. SARAH SHEFTALL (O.V. (1)) AND HAD:  
SARAH, B. CH. JUL. 2, 1787  
MORDECAI S., B. 1809; D. FEB. 26, 1856; M. N.Y.; EVELINE (-DEC. 1836, SAV.) AND HAD:  
MARGARET, B. 1831, N.Y.; D. MAR. 1837, SAV. (JOHN SHEFTALL)
62. DYER  
ROSANNA, M. BALTO., FEB. 23, 1825 (IRA ROSENWAIKE)

65. EMANUEL II  
 CHARLES LEVI, B. 1806, ENG.; M. ANN, DAU. OF JOSEPH AND ESTHER LEVY, B. 1815/18, ENG. THEY HAD:  
 JOSEPH, D. N.Y., JAN. 15, 1925; M. DINAH JULIA, D. 1924  
 ISAAC, B. 1841  
 REBECCA, B. 1843  
 JACK (JACOB), B. 1845  
 HENRY C. (HYTON), B. 1846  
 ARTHUR, B. 1848 (JON STEDMAN)

66. EMANUEL III  
 MICHAEL EMANUEL, M. 1824 LEVY (VID. COHEN XIII) AND HAD: (ALL E. ENG.)  
 SIMON  
 JEEL  
 MICHAEL (U.S. SUPREME COURT, JAN. 1832 TERM, P. 102F.)

70. EZEKIEL (2)  
 MORDECAI J. B., B. 1859, P.I., D. 1874, WASH., D.C.; M. LUCILLE FINSTERWALD AND HAD:  
 MARGARET OF CHEVY CHASE, MD.; UNM.  
 DAVID OF CLARKSVILLE, TENN.  
 JONATHAN OF SEATTLE, WASH. (OBIT. WASHINGTON STAR-NEWS)

92. HACKENBURG  
 REBECCA ALLEN, M. 1853 (WILMINGTON, N.C. NEWSPAPERS, D.A.R.M.S.)  
 WILLIAM BOWER, M. SEP. 12, 1864 (RUTH E. LEMBECK)

95. HART I  
 STANLEY DAVID, B. APR. 2, 1905 (EVELYN MILLER)

97. HART II (N.Y.)  
 MADELINE M. MANUEL J. SUAREZ AND HAD:  
 MADDO  
 JOSEPHINE M. A. FRED BECK AND HAD:  
 ALFRED JR.  
 REBECCA SEIXAS M. VICTOR B. WOLF AND HAD:  
 GEORGE  
 MILTON  
 MAUDE M. OTTO MENKERT AND HAD:  
 ALINE M. WILLIAM CLIFF  
 ALINE M. WILLIAM HENRY DOWN; M. 2) STEPHEN TILLEY, BY 1 SHE HAD:  
 WILLIAM  
 NORMA ALINE M. MELVIN E. L. WOLFE AND HAD:  
 ALINE M. EUSTON B. BENJAMIN AND HAD:  
 JANE  
 ANN, M. ROBERT D. CLAFIN (MICHAEL H. CARDOZO IV)

98. HART VI (1)  
 MORDECAI LEVY AND DESCENDANTS APPEAR ABOVE ON COHEN XIII

103. HART XIV (EASTON)  
 LOUISA ELIZABETH, D. NOV. 30, 1890; M. CA. 1834 (GORDON GRAY)

111. HENDRICKS (2)  
 MARY JANE (RIESENFELD), M. VINCENT P. MC CAPTHY  
 RUTH (FRANKENTHALER), M. 1) RICHARD LEWISCHN; M. 2) RICHARD A. FELDON, BY 1 SHE HAD:  
 RICHARD III, M. SANDRA K. SAINE AND HAD:  
 HEATHER HALEY  
 BRANDON KERMIT  
 ALLEN HENDRICKS, M. PETER A. GODSICK AND HAD:  
 VICTORIA  
 ANTHONY L. (MICHAEL H. CARDOZO IV)

114. HENRIQUES II  
 A. ALEXANDER FLORIAN, B. JAN. 31, 1818, KINGSTON, JAM.; D. APR. 20, 1887, N.Y.; M. 1) M. 2) REBECCA  
 JOSEPHINE HENRIQUES (BELOW), BY 2 HE HAD:  
 ALEXANDER FLORIAN JR., B. MAY 15, 1841, N.Y.; D. FEB. 3, 1929; M. 1890, ELIZABETH HARDING BORTH AND HAD:  
 CHARLES RANSOM, B. 1891, N.Y.; D. 1938, LEDMINSTER, MASS.; M. 1918, MARJORIE BERR AND HAD:  
 PRESCOTT, D. 1874, LEDMINSTER, MASS.  
 ELIZABETH M. DONALD PAUL  
 ALEXANDER FLORIAN III, B. FEB. 28, 1895, N.Y.; D. QUOCUE, N.Y.; M. ANITA O'BRIEN  
 DOROTHY REBECCA, B. DEC. 23, 1899; M. 1) JUN. 1922, CARL DYCH, M. 2) MAY 1946, PHILIP VAN  
 DEVENTER, BY 1 SHE HAD:  
 CARL DYCH, JR., B. MAR. 21, 1923, N.Y.; M. 1952, ELIZABETH CUNNINGHAM  
 ELIZABETH, B. MAY 7, 1925; M. EDWARD GRATH, JR.  
 CHARLES, B. 1866, N.Y.; D. FEB. 11, 1911, N.Y.; M. ANNA  
 HARRY PERCY, B. SEP. 21, 1868, N.Y.; D. FEB. 8, 1930, MOUNTAIN LAKES, N.J.; M. OCT. 22, 1902, PLAINFIELD,  
 N.J.; ALICE BARKER AND HAD:  
 HARRY PERCY, JR., B. MAR. 10, 1904, N.Y.; M. JUN. 1918, N.Y.; M. NORMA EDNVILLE AND HAD:  
 HARRY PERCY III, B. MAY 7, 1927, MORRISTOWN, N.J.; M. DEC. 29, 1957, LAFAYETTE, LA.; EMILY  
 WATSON AND HAD:  
 BARBARA, B. MAY 17, 1922, N.Y.; M. 1) PPHAM, N.Y.; EUGENE CARVER; M. 2) SAN JOSE, CALIF.  
 KENNETH RISNER  
 LAURENCE BARKER, B. MAY 1, 1906, N.Y.; M. FEB. 11, 1930, MOUNTAIN LAKES, N.J.; CARLOTTA EMERSON AND  
 HAD:  
 NOEL, B. DEC. 17, 1932, MORRISTOWN, N.J.; M. DEC. 27, 1952, LARCHMONT, N.Y.; BRUCE BRACKENHOFF  
 CARLOTTA, B. OCT. 25, 1938, NEW ROCHELLE, N.Y.; M. JUN. 27, 1956, LARCHMONT, N.Y.; ALAN WEINTE  
 LAURENCE E. JR., B. NOV. 18, 1944, NEW ROCHELLE, N.Y.; M. JUN. 17, 1969, ROANOKE, VA.; DIANA  
 JEFFREY BARKER, B. JUL. 27, 1908, PLAINFIELD, N.J.; M. MAY 21, 1930, CLORIA ROS AND HAD:  
 JEFFREY BARKER, JR., B. JUL. 14, 1934, N.Y.; M. BRONXVILLE, N.Y.; KATHERINE LOEFLER  
 PETER ROS, B. AUG. 6, 1927, N.Y.; M. EAST HARTFORD, CT.; MARLENE UTZ  
 (TWINS) 1) ROSIE, B. MAR. 13, 1940, N.Y.; M. BELHAV, N.Y.; JOHN J. PATTERSON  
 JUDITH, B. MAR. 13, 1940, N.Y.; M. BELHAV, N.Y.; PAUL DUJARDIN (DIV.)

GEORGE M., M. ABIGAIL HENRIQUES (O.V. 1(2)) AND HAD:  
 REBECCA JOSEPHINE, B. APR. 17, 1839, N.Y.; D. AUG. 16, 1891, N.Y.; M. CA. 1860, ALEXANDER FLORIAN  
 HENRIQUES (O.V. ABOVE)  
 GEORGE WASHINGTON, D. JUN. 25, 1890  
 FRANCIS, B. OCT. 18, 1826, N.Y.; D. DEC. 8, 1889, S. ORANGE, N.J.; M. AND HAD:  
 ANNIE, M. OCT. 20, 1875, ST. THOS., GEORGE W. CEAL  
 MARIE LOUISE, M. 1) FEB. 6, 1882, HAROLD COPI AND DE WOLFE; M. 2) OCT. 25, 1890, THEODORE STEARNS  
 WILLIAM, B. OCT. 25, 1871, N.Y.; D. OCT. 9, 1914, N.Y.; M. 1) A (HARRY P. HENRIQUES III)

116. HERZOG  
 KATHERINE, M. 2) 1852, JACOB NEWMAN AND HAD:  
 ABRAHAM, B. APP. 27, 1852; M. CARRIE GOLDSTONE (VID. HILLER (GOLDSTONE))

116. HILLER (GOLDSTONE)  
 -- -- CARRIE, M. ABRAHAM NEWMAN (VID. HERZOG)  
 -- -- JEAN S. D. 1970  
 -- -- SOPHIA WERTHEIM, D. OCT. 10, 1970, L.A.  
 LAFAYETTE A., B. JUN. 22, 1926; M. ALINE MAY LEWIS (O.V. 1) AND HAD:  
 JOHN (TOOK SURNAME LEWIS), M. JEANETTE KILHAM AND HAD:  
 JANE, M. RALPH M. FFAVER AND HAD:  
 GEORGE W. (HARMON H. GOLDSTONE)

118. HUNT  
 ABRAHAM S., B. JUN. 21, 1835, RI. (DR. IRA REZAK)

123. HYNEMAN II  
 LEVY LEON, M. APP. 2, 1868, PH. (FLO. ABR.)

129. JACKSON I  
 JACOB, M. AND HAD:  
 -- -- DANIEL (GEDALYA) (SURNAMED JACKSON); M. MARY (BELOW)  
 -- -- ABRAHAM PHILLIPS, B. 1734; M. AND HAD:  
 MARY, B. 1780, ENG.; D. OCT. 20, 1847, N.Y.; M. DANIEL (GEDALYA) JACKSON (ABOVE)  
 (JON STEDMAN)

137. JOSEPH I  
 THEODORE HAROLD; M. 1) SYLVIA FLORANCE (O.V. 1) (DIV. 1931); M. 2) 1931, RUTH GRAFF DENZER, BY 1 HE HAD:  
 DOROTHY, B. MAR. 17, 1902; UNM.  
 MARJORIE, B. AUG. 30, 1903; M. MAY 27, 1931, THORKIL ASCHEHOUG AND HAD:  
 FREDERIKKE MARJORIE, B. APR. 24, 1934; M. JAN. 2, 1954, JOHN ARVID KLEIN AND HAD:  
 EDWARD THORKIL, B. AUG. 21, 1955  
 (TWINS) WAYNE ERIC, B. NOV. 6, 1957  
 KATHERINE LAURA, B. NOV. 6, 1957  
 (FREDERIKKE MARJORIE) M. 2) NOV. 7, 1966, RICHARD FRANK BAKER AND HAD:  
 RICHARD FRANK BAKER, JR., B. NOV. 1, 1967  
 BARBARA, B. SEP. 26, 1913; M. AND DIV. AND HAD:  
 KALLOOPY  
 LINDA  
 RUPERT LAURENS, B. SEP. 20, 1880; D. UNM. (THORKIL ASCHEHOUG)

143. KAYTON  
 BERT, B. 1874; D. 1967; M. DAVID J. ROSENHEIM (O.V. 1) AND HAD (CHILDREN SURNAMED KAYTON):  
 ALLAN D., B. 1900  
 ROBERT, B. 1904; M. ELIZABETH KANN (1905-) AND HAD:  
 JEAN A., B. 1929; M. EDWARD SONDER (1928-) AND HAD:  
 KAREN A., B. 1956  
 LESLIE, B. 1956  
 DONALD J., B. 1931; M. MARJORIE KLEMPNER (1935-) AND HAD:  
 DESORAH, B. 1959  
 ANDREW, B. 1961  
 MARK, B. 1967  
 BARBARA L., B. 1935; M. ROBERT TANDESKY (1930-) AND HAD:  
 JOAN, B. 1963  
 MARIAN, B. 1965  
 SUSAN, B. 1966  
 JOHN H., B. 1906; M. SUZANNE JACOB (1909-) AND HAD:  
 JAMES B., B. 1946  
 HERBERT, B. 1877; D. 1945; M. TESS R. ROSENHEIM (O.V. 1) AND HAD:  
 RUTH, B. 1904; D. 1971; M. ELLAN KAUFMANN (1893-1971) AND HAD:  
 JOHN, B. 1931; M. JANE SHAPIRO (1941-) AND HAD:  
 KAREN, B. 1966  
 ANNE R., B. 1971  
 ELIZABETH, B. 1973  
 MARGARET, B. 1909; M. KURT APPEL (1909-1973) AND HAD:  
 JUDITH, B. 1944; M. EUGENE KELLY (1944-) AND HAD:  
 DONNA, B. 1964  
 DAVID, B. 1969 (ROSENHEIM GEN.)

147. KURSHEEDT  
 ALBERT EDWARD, D. MAR. 24, 1973; AND HAD:  
 MAE, M. EDWARD JAMES VON WALSBERG AND HAD:  
 WILLIAM, B. 1958  
 JAMES, B. 1967  
 JUSTIN, B. 1959  
 JESSICA, B. 1962  
 -- -- NANCY, B. 1965  
 LIONEL JUDAH, M. BESSIE KURTZ SCHELLENBERG  
 MOSES MONTEFIORE, D. APR. 16, 1942; M. JENNIE SCHELLENBERG  
 ROLAND SIMON (NCL SIMON ROLAND)  
 EDMUND BAER, D. 1952 (ABIGAIL K. HOFFMAN)

148. LABATT  
 SARAH (SIMON), M. EMILE JACOBI AND HAD:

LESTER  
SANFORD  
SON, M. AND HAD:  
ALICE, M. ARNOLD SCHLOSSBERG  
SADIE  
EDYTH (ALICE J. SCHLOSSBERG)

150. LAZARUS I  
MARGARET (MARKS), M. DR. H. RAWLÉ GEYELIN AND HAD:  
HENRY  
PATRICIA  
PETER (MICHAEL H. CARDOZO IV)

151. LAZARUS II  
AARON, D. (DELETE SEP.20) AND HAD:  
GERSHON (ADOPTED SURNAME) LARENDON, B. WILMINGTON, N.C.; D. ATLANTA; M. CH.  
BENJAMIN, B. JUL. 30, 1905, WILM.; D. APR. 19, 1976, WILM., INF.  
PHILA, B. WILM.; D. SEP. 29, 1989; M. FEB. 26, 1939, WILM.  
RACHEL, B. WILM.  
WASHINGTON, B. OCT. 20, 1908, WILM.  
ANGELINA GREEN, B. SMITHVILLE, N.C.; D. SEP. 22, 1987  
ALMIRA EMMA, B. HILLSBOROUGH, N.C.; M. DEC. 10, 1951  
MARX EDGEWORTH, M. OCT. 1853, MARY LAURU  
MARY CATHERINE, D. MOBILE; M. OCT. 2, 1842  
(CHILDREN OF GERSHON LARENDON SHOLD READ:)  
JOSHUA, B. AUG. 21, 1838, CH.; M. AND HAD:  
EDWIN  
GEORGE  
FLORENCE  
(TWINS) MICHAEL WASHINGTON, B. JUL. 13, 1844, CH.; M. OCT. 19, 1972  
GUSTAVUS, B. JUL. 13, 1844, CH.  
AARON, B. FEB. 14, 1840, WILM.  
LEILA, B. AUG. 13, 1848, CH.; M. MAY 15, 1867, ATL. AND HAD:  
CHARLES  
AMOS  
CARRIE  
WALTER, B. FEB. 7, 1853, CH.  
GERSHON, M. JUN. 22, 1882, HOUSTON, TEX.; ANAISE PASDELOUP  
(AARON LAZARUS FAMILY BIBLE, D.A.R. RECORDS, WILM., N.C.)

(153) LEMAN  
EMANUEL LEMAN, B. 1746, AMST.; M. AND HAD:  
LIONELE, B. 1776, AMST.; M. AND HAD:  
MICHAEL L., B. 1807, AMST.; D. 1889, N.Y.; M. FRANCES CASPIR OF CHATHAM, ENG. (TO U.S. 1830) AND HAD:  
MOSES HENRY, B. SEP. 1730, 1874, N.Y.; D. 1913; M. DEC. 4, 1859, N.Y.; MATHILDA HEINSTEIN (REFUGEE-  
FIELD, PRUSSIA NOV. 16, 1841- ), HE SERVED IN CIV. W. THEY HAD:  
FRANCIS FREDERICK, B. OCT. 17, 1860, N.Y.; D. 1933, N.Y.; M. MAR. 3, 1885, HENRIETTE BEGARE  
AND HAD:  
VIOLET FRANCES, B. ST. LOUIS, MO.; M. JUN. 18, 1912, CLARENCE M. HERNE AND HAD:  
MARJORIE HENRIETTE, B. N.Y.; M. JUN. 12, 1936, BERNARD CRYSTAL AND HAD:  
THOMAS HERNE, B. JAN. 21, 1938, N.Y.  
(ABRAM VOSSEN GOODMAN)

154. LEVY I  
MOSES (RAPHAEL), M. 1) 1695, N.Y.; RICHEA (RYCHA) ASHER; M. 2) 1717, N.Y. AND HAD:  
BILHAM ABIGAIL, B. N.Y.; D. N.Y.  
NATHAN, B. N.Y.

159. LEVY II  
JANE CAROL (RODDY), B. 1943; M. SEP. 1965, ANTHONY GEORGE WAHL II (APR. 20, 1943- ) AND HAD:  
HEATHER, B. APR. 20, 1966  
MEGAN, B. JAN. 5, 1968  
ANTHONY G. III, B. APR. 12, 1971  
ABIGAIL, B. FEB. 12, 1973 (FLO. ABR.)

162. LEVY IV (RICHMOND)  
LEWIS/LOUIS (YEHUDA), B. AUG. 16, 1798, AMST.; D. JAN. 29, 1861, HOUSTON, TEX.; M. CA. 1817, MARY A.  
(Maiden Name UNKNOWN) (ENG. JAN. 13, 1800-MAY 6, 1888, BRENHAM, TEX.) AND HAD:  
ABRAM GUSTAVUS, M. D., B. MAY 5, 1818, BOSTON, MASS.; D. MAY 2, 1897, N.Y.; M. 1) ? ; M. 2) ANNA LANDAUER  
(HUBBEN, BAV. JUN. 30, 1835-FEB. 23, 1898, N.Y.), BY 1 HE HAD:  
MOSES A. (CHANGED NAME TO EDWARD A. RUSSELL)  
BY 2 HE HAD:  
CLARA, B. SEP. 14, 1859, N.Y.; D. DEC. 11, 1939, PADUCAH, KY.; M. SEP. 11, 1878, HENRY DRYFUSS (DREYFUSS)  
AND HAD:  
BARNEY JOACHIM, M. D., B. AUG. 8, 1879, PADUCAH; D. OCT. 16, 1950, N.Y.; M. 1) OCT. 3, 1926, CLAIRE  
AGNES BURKE (VINCENNES, IND. OCT. 25, 1878-NOV. 1, 1921, N.Y.); M. 2) SEP. 4, 1922, CELE MC NULTY  
PETERMAN (EMMETSBURG, IOWA - APR. 1923, N.Y.); M. 3) SEP. 2, 1928, ISABEL SINGER (N.Y. NOV. 24,  
1892- ), BY 1 HE HAD:  
JOHN AUGUSTUS, B. SEP. 26, 1907, N.Y.; M. NOV. 25, 1937, FRIEDA MARY TELLER (CLIFTON, N.J.  
SEP. 7, 1910- ) AND HAD:  
JOHN A. JR., B. JUN. 5, 1940, N.Y.; M. JUL. 18, 1967, N.Y.; MARGARET E. FLOOD (HEMPSTEAD,  
N.Y., AUG. 21, 1942- ) AND HAD:  
CHRISTOPHER JOHN, B. APR. 27, 1972, SAN DIEGO, CAL.  
CLAIRE DIANE, B. OCT. 3, 1942, N.Y.; M. AUG. 22, 1964, WILLIAM E. EATON, JR. (JUN. 11,  
1942- ) AND HAD:  
JENNIFER DIANE, B. DEC. 13, 1967, VERO BEACH, FLA.  
BY 3 HE HAD:  
ROSANNE CLAIRE, B. SEP. 12, 1929, N.Y.; M. DEC. 25, 1959, DANIEL NATHAN LEESON (PATRISON, N.J.,  
JUL. 13, 1932- ) AND HAD:  
BARNEY, B. OCT. 26, 1961, N.Y.  
MARTHA STELLA, B. SEP. 23, 1965, N.Y.  
MAYME, B. JAN. 16, 1982, PADUCAH; D. AUG. 26, 1962, PADUCAH; M. JUN. 22, 1909, JAMES JACOB GRUENE-  
BAUM (FRANKFORT, GER. FEB. 23, 1873-FEB. 18, 1963, PADUCAH), D. S. P.  
CARRIE, B. DEC. 4, 1861(?) N.Y.; D. CA. 1911, N.Y.; M. JOE STERN, D. S. P.

REGINA, B. MAR. 11, 1872, N.Y.; D. JAN. 12, 1917, N.Y.; M. APR. 7, 1889, MAX SPRINGER (BADEN-BADEN,  
GER. AUG. 1856-JUN. 23, 1929, N.Y.) AND HAD:  
FLORENCE, B. MAY 21, 1892, MT. VERNON, N.Y.; D. FEB. 19, 1965; M. JUN. 21, 1914, EDGAR NUSSBAUM  
(BUCYRUS, I., JUL. 14, 1836(?) - 1957, N.Y., I. D. S. P.  
ARTHUR, B. 1892, I. 1896  
GLADYS, B. 1898, I. 1898, INF.  
ANNA, B. FEB. 19, 1900, MT. VERNON, N.Y.; M. 1) DEC. 17, 1919, PERCY A. MOSES (GEORGETOWN, S. C.,  
AUG. 27, 1856-FEB. 9, 1966, N.Y.); M. 2) JUN. 29, 1967, MORRIS H. WEPNER (N.Y., FEB. 21, 1900- ) S. P.  
BERNARD A.  
JACOB, B. 1871, I. 4.  
CECILIA C., B. CA. 1938, N. C.; M. 1) A. WERNER; M. 2) CA. 1866, HENRY GILBERT, BY 1 SHE HAD:  
PAULINE, B. 1858  
WILLIAM, B. 1861  
DELIA, B. 1863  
JACOB, B. 1865  
BY 2 SHE HAD:  
BERTHA (PATSY), B. SEP. 27, 1867, HOUSTON, TEX.; D. AUG. 20, 1937, HOUSTON, TEX.; M. LOUIS LECHENGER  
(KITNAKY, KIEV, RUS. 1860- HOUSTON) AND HAD:  
RICHARD, B. M. ROSA KATZER, S. P.  
GILBERT C., B. JUL. 18, 1837; D. NOV. 1951; M. JUN. 30, 1913, SARAH MAE HIRSCH (MAY 3, 1891-DEC. 4,  
1975) AND HAD:  
LOUIS, B. DEC. 10, 1927, HOUSTON; M. 1) JUL. 26, 1945, MARY CAROLINE HANNA (JUL. 19, 1924-SEP.  
26, 1964 (DROWNED)) M. 2) OCT. 20, 1973, BARBARA WEINER (N.Y. OCT. 17, 1925- ) BY 1 HE HAD:  
LAURA, B. MAY 3, 1949, HOUSTON  
PATRICIA, B. JUL. 12, 1951, HOUSTON  
PAULINE, B. MAY 7, 1914; M. OCT. 17, 1937, GERARD JOSEPH MORGENSEN (DEC. 6, 1908-MAY 29,  
1959) AND HAD:  
MARGERY, B. JUL. 28, 1940, HOUSTON; M. ROGER KRUELER (AUG. 17, 1919- ) AND HAD:  
CYNTHIA, B. NOV. 12, 1965  
SHARON, B. NOV. 12, 1969  
CAROL, B. SEP. 9, 1943, HOUSTON; M. BARRY SILVERMAN (APR. 11, 1942- ) AND HAD:  
SCOTT GERARD, B. NOV. 19, 1963  
STACEY, B. AUG. 4, 1972  
JOHN ELLEN, B. DEC. 11, 1945, HOUSTON; UNM.  
PATRY LYNN, B. OCT. 2, 1947, HOUSTON; M. JAN. 1, 1976, GEORGE ROBERT NICHOLS (OCT. 23, 1949)  
LOUIS, B. HOUSTON; D. CA. 1937, N.Y.; M. BECKY ? AND HAD ISSUE  
JULIA ROSALIE, B. AUG. 2, 1927; D. FEB. 25, 1931, BRENHAM, TEX.; M. FEB. 7, 1955, ALEXANDER SIMON  
(KONIN, POL. DEC. 11, 1825-OCT. 9, 1922, BRENHAM, TEX.) AND HAD:  
LOUIS M., B. 1856, TEX.; D. 1917, FEB. 21, 1893, HENRIETTA STIFF (1845-1920) AND HAD:  
EDGAR JULIUS, B. MAR. 6, 1845, HOUSTON; D. APR. 13, 1972, DALLAS; M. DEC. 4, 1912, URA MAE  
AMMERMANN HUELSDON (INTV. 27, 1891-OCT. 10, 1968) D. S. P.  
CARROLL, B. MAR. 30, 1858; D. JUN. 8, 1968, DALLAS; M. DEC. 21, 1911/12, ADRIENNE MITTENTHAL  
(GROESBECK, TEX. JUL. 24, 1892-OCT. 24, 1972, DALLAS) D. S. P.  
MILDRED, B. MAR. 12, 1892; D. MAY, 1967, N. HOLLYWOOD, CAL.; M. ABE HAPT AND HAD:  
HENRY S.  
JAMES HENRY, B. MAR. 9, 1858, D. 1895, AUG. 1, 1925, BRENHAM; UNM.  
MARY (MOLLIE), B. OCT. 4, 1858; M. FRANK MADOLETON  
ROSA, B. NOV. 15, 1861, DALLAS; D. APR. 11, 1953, BRENHAM; M. APR. 8, 1888, SAM RUBENSTEIN (LIVERPOOL,  
ENG. - OCT. 4, 1937, BRENHAM) AND HAD:  
HAROLD SAMUEL, B. MAR. 24, 1893, AUSTIN, TEX.; D. APR. 21, 1968, BRENHAM; M. 1) EDEL MATHEWS  
(-1942, BRENHAM); M. 2) SEP. 1953, ANNE BEATRICE ELLIOTT (CAPESVILLE, TEX., DEC. 27, 1913- )  
BY 1 HE HAD:  
MATHEW S., B. MAY 29, 1915, N. O.; M. ADELLA ROWE (DEC. 24, 1925- ) AND HAD:  
CHERYL JEAN, B. FEB. 13, 1947, N. O.; M. WILLIAM MC KENZIE JENKINS III (APR. 14, 1947- )  
AND HAD:  
WILLIAM MC KENZIE IV, B. JAN. 1, 1971, LAKE CHARLES, LA.  
KELLI DEE ANN, B. JUL. 17, 1975, N. O.  
DAVID, B. DEC. 23, 1950, N. O.  
SAM S., B. 1927, N. O.; M. 1) FRANCES ? ; M. 2) CECILIA KAMER (1926- ), BY 1 HE HAD:  
DAN  
BY 2 HE HAD:  
HAROLD, B. JUN. 7, 1957, N. O.  
CECELIA, B. MAY 23, 1958, N. O.  
SAMUEL, B. NOV. 11, 1960, N. O.  
STEPHEN, B. JUL. 14, 1964, N. O.  
ALICE FRANCES, B. MAR. 7, 1863, BRENHAM; D. JUL. 7, 1873, BRENHAM  
ALEX JACOB, B. NOV. 19, 1864, BRENHAM; D. OCT. 25, 1917, BRENHAM; UNM.  
LEAH C., B. FEB. 15, 1867; M. MARTIN ?  
HANNAH, B. MAR. 11, 1869, BRENHAM; D. MAR. 25, 1965, BRENHAM; M. JAN. 20, 1897, THEODORE EDLZ (CMI,  
NOV. 27, 1861-JAN. 15, 1932, BRENHAM) AND HAD:  
CLARA BEILE ESTHER, B. FEB. 24, 1897, SAN ANTONIO, TEX.; M. SOL LEVY (NASHVILLE, TENN., 1824-  
SEP. 1945, BRENHAM) D. S. P.  
GAIN W., B. DEC. 16, 1870  
JOSEPH CECIL, B. FEB. 19, 1877, BRENHAM; D. APR. 2, 1974, INF.  
ABRAHAM ISAAC, B. MAR. 25, 1875, BRENHAM; D. APR. 13, 1876, INF.  
HARRY EDWARD, B. FEB. 19, 1877, BRENHAM; D. MAR. 28, 1877, INF.  
CLARA JULIA, B. JUL. 21, 1873, BRENHAM; D. APR. 1, 1899, BRENHAM  
ISAAC M., B. 1853, HOUSTON; M. 1) 1862, MARY ? (TEX. 1849- ) AND HAD:  
HENRY, B. 1862, HOUSTON  
13 OTHER CHILDREN (ROSANNE AND DANIEL LEESON)

164. LEVY VI (2)  
ELEANOR MARJORIE, M. RICHARD WOODHOUSE JOHNSON, JR. AND HAD:  
RICHARD CARDOZO (MAJ. USAF); M. NANCY ANN THREKELD (OF CHARITON, IOWA)  
ELEANOR LEIGHTON, M. JAMES JACOB DONNELLY (OF FOLKERTON, TEX.)  
(MAJ. RICHARD CARDOZO JOHNSON)

168. LEVY X (PHILLIPS & MENDES-SEIXAS)  
JOHN (PHILLIPS), M. 1) APR. 6, 1823, SUSAN SOMMERS AND HAD:  
EDWARD FINLEY, B. 1812; M. GERTRUDE OLIVIA JENNINGS (PM, 1813- ) AND HAD:  
AUGUSTUS K., B. 1824, PH.  
JOHN K., B. 1849, PH.  
GERTRUDE S., B. 1849, PH.  
GEORGE J., B. 1852, PH.  
WILLIAM D., B. 1853, PH.



EDWARD FINLEY, B.1849;D. DEC.16.1913.JACKSON,LA.;M.2)MAR.14.1899, MARYE DAVID  
(SALLIE KENT PHILLIPS)

169. LEVY XIII  
EMANUEL LEVY (NOT MENACHEM LEVY) IS PROGENITOR (CF. COHEN XIII, ABOVE)

170. LEVY XV  
SAUL J., B. APR. 9, 1818; M. HANNAH J. HART (O.V.X(2)) AND HAD:  
ESTHER H., M. JULIUS SANDS AND HAD:  
ROSE A., M. ? ROBERTS  
HANNAH (ANNE), M. CHARLES LEVI (VID. EMANUEL II) (JON STEDMAN)

171. LEWIS I  
-- MINNIE, B. MAR. 10, 1852; D. FEB. 17, 1932; M. SOLOMON L. WAITZFELDER (OCT. 31, 1844-JAN. 22, 1914)  
HARLEY ALMA, M. RICHARD JAMES (COHN) (ADOPTED SURNAME LEWIS) AND HAD:  
JAMES HENDRICKS, M. FEB. 1, 1976, JANICE LYNN BERNSTEIN  
SON  
-- SON  
SAMUEL ALEXANDER, M. SOPHIA PHILLIPS (O.V.VI) AND HAD:  
JOHN DANIEL, B. JUN. 15, 1858; D. JUL. 2, 1882  
CHARLES, B. NOV. 1856; D. FEB. 14, 1886  
MILDRED, D. APR. 13, 1880, INF. (HARMON H. GOLDSTONE; N.Y. TIMES 2/2/1976)

(174) LIPMAN  
REV. JACOB LIPMAN (TO US 1819; HAZAN OF RODEPH SHALOM, PH.), B. JUN. 1781, LOND.; M. ESTHER (CA. 1781-  
SEP. 10, 1832, PH.) AND HAD:  
HENRY, B. SEP. 29, 1804, LOND.  
MATILDA, B. AUG. 17, 1805, LOND.  
HELTREY, B. JUL. 14, 1806, LOND.  
RAPHAEL (RALPH), B. OCT. 27, 1808, LOND.; M. ? AND HAD:  
DAU., B. CA. 1836  
HART, B. DEC. 22, 1810, LOND.  
SOLOMON, B. JUL. 15, 1812, LOND.  
MOSES, B. DEC. 4, 1813, LOND.  
SAMUEL, B. DEC. 2, 1814, LOND.  
CATHERINE, B. SEP. 7, 1816, LOND.  
REBECCA, B. NOV. 6, 1818, LOND.  
RACHAEL, B. APR. 17, 1820, PH.  
LEWIS, B. JAN. 14, 1823, PH. (F. JAMES DALLETT; ELZAS MSS.)

175. LOPEZ I(1)-RIVERA  
-- AARON (RIVERA), B. CA. 1793; D. JUN. 15, 1838, WILMINGTON, N.C.  
MIRIAM (MARIA) (LOPEZ), M. STAMFORD, CT., 1805, JACOB LEVY (BRO. OF EVA LEVY MENDES, VID. BENJAMIN I)  
(DAR MS., WILMINGTON, N.C.; PAJMS, V. 27, P. 74)

181. LYON II  
ELVIRA, M. PERCY C. SCHEUER AND HAD:  
MARGARET L., M. I) G. CARLETON PEARL; M. 2) RALPH F. WOLFF (O.V.). BY 1 SHE HAD:  
MARY C., M. CHARLES A. PILLSBURY  
AUGUSTA L., M. WILLIAM PATTERSON NIX  
ELIZABETH EMILY, M. CHARLES B. MAXWELL, AND HAD:  
ELIZABETH LYNN, M. WILLIAM LEE AND HAD:  
MATHEW  
EDMOND  
JOHN (MICHAEL H. CARDOZO IV)

189. MAYER II - FRANK  
ELEANOR LOUISA (ELLA), B. APR. 1860  
JOSEPH EGGLESTON JOHNSON, B. OCT. 22, 1862 (FLO. ABR.)

201. MORDECAI I(3)  
WASHINGTON (CALLED HIMSELF MORDICA), B. MAR. 27, 1820; M. POLINA ? AND HAD:  
JAMES, B. DEC. 30, 1841, BOONE CO., MO.; D. APR. 10, 1869, OPOLIS, CHEROKEE CO., KAN.; M. DEC. 2, 1865,  
GARNETT, ANDERSON CO., KAN.; MARY STONE (JUL. 2, 1850-AUG. 4, 1928, GIRARD, CRAWFORD CO., KAN.)  
AND HAD DESCENDANTS (MRS. JAMES L. MORDICA)

202. MORDECAI II (S.C.)  
EVA, B. SEP. 14, 1890, N.Y.; D. JAN. 1, 1976, HANOVER, N.H. (N.Y. TIMES, 1/4/1976)

207. MOSES I(4)  
ISAAC HARRY, M. 2) ISABEL W. SOLOMONS (1891-JAN. 2, 1975, SCARSDALE, N.Y.) AND HAD:  
WILLIAM, M. AND HAD:  
STEPHEN  
ANN, M. ? CUNNINGHAM AND HAD:  
WILLIAM  
THOMAS  
DOUGLAS  
ESTHER, M. 1) ? ELSPREE, M. 2) ? WILKINS, M. 3) ? COOK, BY 1 SHE HAD:  
DAVID  
JOHN  
BY 2 SHE HAD:  
SUSAN (N.Y. TIMES, 1/4/75)

209. MOSES II  
SIMON GRATZ (OF BORDENTOWN, N.J.), M. 1) FEB. 1838, N.C., MARY PORTER ASHE, DAU. OF COL. SAMUEL ASHE  
(EVELYN MILLER)

222. MYERS X  
DELETE JOSEPH, BAV. 1812  
DELETE SELIGMAN, BAV. 1821  
JOSEPH MYERS, M. CAROLINE WATERMAN AND HAD:

BERTHA  
LE ROY  
MAX  
CLARA  
-- STELLA, M. FRANK LOEB AND HAD:  
HOWARD, M. RUTH ? AND HAD:  
DON  
SUE  
ROBERT, M. KITTY ?  
-- FREDERICK, M. STELLA ?  
FANNIE (EDEL), M. LEON FALK (1870-OCT. 21, 1928) AND HAD:  
MARJORIE, M. ? LEVY  
-- LEON, JR., M. 1) KATHERINE SONNEBORN (DIV.); M. 2) JOSEPHINE SONNEBORN (SIS. OF KATHERINE)  
JANE ELLEN (ROTHSCHILD), M. JOSEPH FERGUSON (DIV.), AND HAD:  
JASON FREDERICK  
JOHN STEPHAN, M. JUN. 12, 1976, ELLEN JEAN WILLIAMS (FLO. ABR.; GEORGE ROTHSCHILD)

227. NATHAN I(2)  
ROBERT GRUNTAL, M. 5) AUG. 10, 1951, CLARA BLUM; M. 6) DEC. 14, 1955, HELEN KNEFLAND; M. 7) ?  
BY 1 HE HAD:  
JOAN FREDERICK, M. MELVIN R. BERGSTROM (FLO. ABR.; WHO'S WHO IN WORLD JEWRY)

NATHAN III  
LYON NATHAN (IN READING, PA. BY 1758)  
BENJAMIN (IN READING, PA. BY 1758) (WOLF-WHITEMAN, P. 396)

228. NATHAN II  
CHARLES (OF RIO DE JANEIRO), M. EMMA GOODMAN (VID. HARRIS I) AND HAD:  
GOODMAN MC DOWELL  
VIRGINIE, UNM.  
ALICE, M. HENRY WATT AND HAD:  
HAROLD  
CHARLES, UNM.  
EDWARD, M. ? AND HAD:  
ALICE  
KENDRICK  
JOSEPH  
MARGARET, D. INF.  
PERCY (SAUL VIENER)

229. NATHAN I(1)  
SAMUEL G., B. OCT. 13, 1840; D. PH.; M. DEC. 1, 1858, SAV.; EUGENIA MURTELLA HART (VID. SHEFTALL I)  
(JOHN SHEFTALL)

233. NONES  
ALFRED BENJAMIN, M. DEC. 24, 1862, ESTHER PEREIRA BRANDON (FLO. ABR.)

241. PEIXOTTO I(2)  
JESSICA BLANCHE, D. OCT. 1941, BERKELEY  
ERNEST CLIFFORD, D. DEC. 6, 1942, N.Y.; M. N.D., MARY GLASCOCK HUTCHINSON (-1956)  
(STEVEN SIEGEL)

247. PHILLIPS III (ALA.)  
FANNY YATES, B. CA. 1885; D. JUN. 27, 1976. (SAUL RUBIN)

254. ROWLAND  
SARAH JANE, M. HENRI JOHN HART AND HAD:  
ISABELLA, M. HUGG FRIEDLANDER AND HAD:  
ARTHUR JONAS, M. OLIVE (WIDOW OF) HOGG AND HAD:  
PATRICIA, M. ARCHIE LLEWELIN  
KENNETH, M. AGNETA ?  
ADA R., M. LIONEL NATHAN BENJAMIN OF DUNEDIN, N.Z. AND HAD:  
MURRAY  
JEFFREY  
NONA  
ABIGAIL SARAH, M. HEINRICH KOHN (-1911) AND HAD:  
SARAH (SADIE) HASCHEK, D. JUL. 12, 1961, M. MONTAGUE A. PHILLIPS AND HAD:  
PETER (FLO. ABR.)

256. RUSSELL  
PHILIP MOSES (NOT MILTON), M. 1) ELIZABETH C. FERRE. BY 1 HE HAD:  
BENJAMIN S., D. INF.  
ELIZABETH ELVIRA, B. NOV. 22, 1837, SAV.; D. FEB. 21, 1902, SAV.; M. FEB. 15, 1855, SAV.; CHARLES JOSEPH  
WHITE (RALTO, JUL. 27, 1825-JAN. 1, 1906) AND HAD ISSUE  
SARAH L., B. APR. 1, 1840, SAV.; D. MAR. 3, 1882, SAV.; M. OCT. 16, 1855, SAV.; ANDREW J. AYLESWORTH  
(PROVIDENCE, R.I., AUG. 11, 1827-JUL. 26, 1899, SAV.) AND HAD:  
DAU.  
PHILIP M., JR., B. JAN. 28, 1842, SAV.; D. MAR. 25, 1890, SAV.; UNM.  
ISAAC ABRAHAM, B. SEP. 28, 1844, SAV.; D. DEC. 23, 1884, SAV.; M. JUL. 3, 1878, SAV.; VIRGINIA EPSTEIN  
(AUG. 4, 1862-JUN. 15, 1922) AND HAD:  
ROBERT TOMBS, B. 1880, SAV.; D. 1939, SAV.; M. NOV. 28, 1905, SAV.; THERESA AGNES ? AND HAD:  
ROBERT T., JR., B. FEB. 4, 1909; D. JUL. 14, 1959; M. SEP. 6, 1929, LOUISE HODGES AND HAD:  
ROBERT EUGENE, B. JUN. 19, 1942; M. OCT. 30, 1964, KITTY CROWDER AND HAD:  
ROBERT T., III, B. JUN. 24, 1965  
VINCENT EUGENE, B. AUG. 24, 1967  
HOLLY, B. MAY 24, 1976  
JOSEPH MATTHEW, B. 1907; D. 1956; UNM.  
RICHARD WAYNE, B. SEP. 15, 1847, SAV.; D. AUG. 25, 1888; M. EMMA AZALEA SPEIR AND HAD:  
ELIZABETH C., B. SEP. 9, 1871, SAV.; D. FEB. 5, 1945, SAV.; M. MAY 1, 1899, SAV.; CHARLES W. MOCK AND  
HAD ISSUE  
PHILIP MOSES, B. NOV. 21, 1876, SAV.; D. AUG. 10, 1955, SAV.; M. 1) OCT. 31, 1899, SAV.; CECILIA M.  
FALLOU, M. 2) JUL. 31, 1917, SAV.; LENA R. HUCHS, BY 1 HE HAD:  
PHILIP M., JR., B. MAY 14, 1902; D. JUN. 2, 1964; M. JUL. 7, 1927, SARAH AVERY AND HAD:

CECILIA MARIE, B. JAN. 30, 1929; M. 1) SEP. 16, 1946, LEONARD JULIAN MEYER (- JUN. 3, 1949);  
M. 2) MAR. 4, 1951, GORDON EDWARD TYO AND HAD ISSUE  
ANGELA ELIZABETH, B. OCT. 4, 1930; M. JAN. 18, 1953, JOSEPH GOLDBERG AND HAD ISSUE  
PHILIP M. III, B. AUG. 21, 1932; M. JAN. 1958, FRANCIS CAROLYN WOODS USHER AND HAD:  
PHYLLIS CAROLYN, B. JUL. 5, 1962  
VIVIAN COLLEEN, B. MAR. 4, 1964  
BY 2 HE HAD:  
VERNON L., B. DEC. 19, 1921; D. FEB. 21, 1950; UNM.  
WARING, B. DEC. 3, 1923; D. JUN. 26, 1933  
MARIE, B. APR. 17, 1918; D. OCT. 20, 1951, THOMAS LAWLESS AND HAD ISSUE  
JUANITA, B. JAN. 6, 1920; M. SEP. 2, 1950, WILLIAM E. BURKE, S.P.  
JULIAN M. TON, B. JAN. 11, 1878, SAV.; D. OCT. 26, 1883, SAV.  
ELLEN S., B. OCT. 11, 1879, SAV.; D. FEB. 12, 1969; M. MAR. 11, 1897, SAV., CLIFFORD W. BARBEE (AUG. 31,  
1873-SEP. 9, 1915) AND HAD ISSUE  
RICHARD WAYNE, B. NOV. 30, 1884; D. DEC. 17, 1953; M. NOV. 14, 1906, SAV., CORRIE ANDERSON AND HAD:  
RICHARD WAYNE, JR., B. APR. 1, 1909; D. MAY 14, 1955; M. DORREEN MORGAN AND HAD:  
JACQUELYN JUANITA, B. NOV. 5, 1926; D. DEC. 27, 1938  
CHARLES R., B. JUL. 5, 1928; D. JUL. 6, 1928, INF.  
CAROLINE, B. AUG. 11, 1911; M. 1925, GEORGE A. REEVES AND HAD ISSUE  
MARY SELINA, B. JAN. 31, 1850, SAV.; D. MAR. 21, 1933, SAV.; M. SEP. 13, 1894, SAV., JOHN HENRY TUBBERSING  
D.S.P.  
MARGARET S., B. OCT. 7, 1952, SAV.; D. JUL. 5, 1953, SAV., INF.  
WARING, B. DEC. 2, 1854, SAV.; D. JAN. 4, 1927, SAV.; M. FEB. 21, 1875, SAV., GEORGIA ANN MENDEL (JUL. 16,  
1857-DEC. 18, 1919, SAV.) AND HAD:  
ISAAC, B. 2, D. SEP. 1875  
THOMAS SHEFTALL, B. MAY 11, 1877, SAV.; D. DEC. 26, 1952; M. DEC. 16, 1903, BERNICE JACOBS (MAY 8,  
1881-MAR. 29, 1936) AND HAD:  
THOMAS S., JR., B. MAR. 29, 1905; UNM.  
GEORGIA, B. APR. 16, 1914; M. MAR. 29, 1939, ABRAM EISENMAN AND HAD ISSUE  
FRANCES M., B. APR. 4, 1879; D. MAY 14, 1923; M. 1) JUL. 23, 1894, SAV., FREDERICK F. RUHL; M. 2) APR. 23,  
1899, SAV., THOMAS J. HARPER, BY 1 SHE HAD ISSUE  
GEORGIA C., B. NOV. 20, 1882; D. SEP. 5, 1913; M. BENJAMIN E. SMITH AND HAD ISSUE  
WARING, B. 1885; D. 1887, INF.  
PERLA SHEFTALL, B. MAY 24, 1857, SAV.; D. MAY 19, 1955; M. 1) ? MENDEL; M. 2) JAN. 28, 1889, JAMES SAWYER;  
M. 3) JUN. 3, 1937, SAV., HANSE ANDREW HANSON; D.S.P.  
THOMAS E. LLOYD, B. MAR. 14, 1861; D. JUL. 12, 1863  
JANIE RUSSELL (GUSTIN), D. JUN. 6, 1937, SAV.; M. 2) CHARLES M. STRONG (- MAR. 31, 1935)  
( JOHN SHEFTALL )

262. SAMUEL II (2)  
SNOWDEN, D. 1939; M. OCT. 15, 1919 (FLO. ABR.)

263. SEIXAS (1)  
(REV.) GERSHOM MENDES, B. JAN. 14, 1746  
BENJAMIN MENDES (ESTABLISHED REVOLUTIONARY ANCESTOR), B. JAN. 17, 1742  
-- GRACE, B. NOV. 24, 1752  
BELLA (SILAH LEVY)  
METTY (ESTHER), B. MAY 2, 1789 (SEIXAS FAMILY BIBLE (AJHS))

(266) SEMON  
EMANUEL SEMON, B. AMST. 1798; D. JUL. 9, 1871, PH.; M. PH., MARY BAILEY (QUAKERESS) AND HAD: (ALL B. VA.)  
RACHEL C., B. CA. 1830, CHARLOTTESVILLE, VA.; D. 1899, PH.; M. 1864, LEHMAN LOVIE (2)  
SARAH TABITHA, B. 1835, CHARLOTTESVILLE; D. MAY 1, 1913, PH.; M. NOV. 16, 1952, JACOB BACHBACH (GER,  
1826-OCT. 1, 1897, PH.) AND HAD:  
MARY, B. JAN. 17, 1854; M. MAY 12, 1875, AUGUST HANFF AND HAD:  
GERTRUDE, B. APR. 2, 1876; M. EVANUEL S. CAMN AND HAD:  
EDITH, M. WALTER HARRIS AND HAD ISSUE  
HELENE, M. RICHARD STRASBURGER AND HAD ISSUE  
MARION, M. BERT NEVINS AND HAD ISSUE  
SADIE, B. MAY 15, 1878; D. JUL. 17, 1878, INF.  
JOSEPH ARTHUR, B. DEC. 25, 1882; M. SOPHIE WOLF AND HAD:  
JOSEPH, JR., M. RUTH GILBERT AND HAD:  
SUSAN  
LINDA  
JANE  
PEGGY JO  
DOROTHY, M. JAMES ZABIN AND HAD:  
ANN  
BARBARA  
MINNIE, B. OCT. 17, 1879; M. RAYMOND AYERS AND HAD:  
MARY  
ROBERT  
SON  
SIMON, B. SEP. 10, 1855  
RACHEL, B. JUL. 30, 1857; M. SEP. 2, 1877, LEO N. LEVI (VICTORIA, TEX. 1856-1904, N.Y.) AND HAD:  
MINNIE, B. JUN. 5, 1879  
FLORENCE, B. APR. 1, 1881  
BERTHA, B. DEC. 22, 1891  
EMANUEL, B. MAR. 21, 1852  
CALLIE (CAROLINE), B. MAR. 19, 1860; D. 1920; M. MAR. 19, 1881, ELIAS HANFF (1853-1939) AND HAD:  
ELIAS, JR., B. JAN. 12, 1891; M. ALMA YERGER  
ARTHUR JOSEPH, B. DEC. 25, 1882; D. FEB. 20, 1949; M. MIRIAM LEVY (- FEB. 22, 1959) AND HAD:  
ARTHUR J. JR., M. ALICE CONNELLY AND HAD:  
CAROL MARJORIE, B. AUG. 27, 1941; D. MAY 29, 1951  
SHARON CONNELLY, B. APR. 20, 1947; M. JAMES ULRICH AND HAD:  
JAMES, JR.  
SCOTT  
TREV  
STILLBORN SON  
EDWARD ALBERT, M. JANE GRAVES AND HAD:  
SALLY, B. 1945  
WENDY, B. 1947  
JEFFREY, B. 1951  
EVA, B. JUL. 9, 1994; D. INF.

CECILE, B. JUL. 10, 1895; M. HENRY SAMUELS (1872-1952) AND HAD:  
CAROLINE, M. BYRON KAYSEN AND HAD:  
ROY  
REBECCA, B. JAN. 22, 1862; M. OCT. 2, 1884, HARRY D. GOHMAN AND HAD:  
RAYMOND  
HARRY, JR.  
SAMUEL, B. JAN. 17, 1864; M. ADDIE NATTINS AND HAD:  
DOROTHY, B. MAR. 1899; M. ? SCHATZKIN AND HAD:  
HARVEY  
DAUL  
ARTHUR  
EMMA, B. APR. 23, 1866; M. ISAAC LEVY AND HAD:  
IRVING LESTER, B. MAY 16, 1896  
REBECCA, M. ? BORMAN, D.S.P.  
EMMA, M. LOUIS LIPPMAN AND HAD:  
LOUIS, JR.  
MIRIAM  
ZERUBABEL, M. ? (XIAN) AND HAD:  
ARRY (ACTION PICTURE ACTOR), M. HAZEL DAWN  
JUDAH, D. YOUNG  
ANNA, M. ISADORE HYMAN, D.S.P.  
ROSA BELLE, D. UNM.  
WILLIAM, D. YOUNG  
JACOB, M. XIAN; D.S.P.  
HENRIETTA, B. 1831; D. MAR. 3, 1887; M. LEVI HEXTER (TREYSA, GER., 1833-OCT. 27, 1909) AND HAD:  
MARY, D. UNM.  
ROSE, D. UNM.  
BENJAMIN, B. 1848; D. NOV. 17, 1865  
JOSEPH, B. NOV. 6, 1836; D. MAY 22, 1880  
3 OTHER CHILDREN (FLO. ABR.; HELENE HANFF, EZEKIEL-LICHTENSTEIN)

267. SHEFTALL (1)  
WOLF, OF FRANKFURT AM ODER; M. AND HAD:  
SCHEFFEL, M. GITTEL AND HAD:  
BENJAMIN SHEFTALL, B. FRANKFURT AM ODER (JOHN SHEFTALL)

271. SIMON  
MARY, M. HAY; M. LEVY OF OXFORD, ENG. (O.V. XVII)  
JOSEPH SIMON, M. ROSE BUNN AND HAD:  
MOSES, B. 1751  
REYNA (RACHEL), B. 1764  
LEAH, B. 1763 (DAVID BRENER)

282. STERN II (1)  
RICHARD MORTON (SIMON), M. FREDDA JEAN OSBORNE AND HAD:  
-- MATHW AARON, B. MAR. 16, 1876, NEWTON, MASS.  
-- NAN (SCHLESZINGER), M. RONALD J. SMOLOW AND HAD:  
-- LAUREN MEREDITH, B. JAN. 19, 1976, PH.  
-- NANCY JC (DE LEE), M. LEE HART FRANK AND HAD:  
-- DANIEL JACOB, B. DEC. 17, 1976, HIGHLAND PARK, ILL.  
-- CAROL DENE GOLDSMITH, M. 1) KENNETH KAGEN, BY 2 SHE HAD:  
ANNE, M. 2) 1976, LONG BEACH, CAL., JAMES PROFITT

283. STERN II (2)  
ALAN (SELIG) M. NANCY SEIDENBACH AND HAD:  
JEANNE  
THOMAS  
CATHY  
ANDREW  
JONATHAN (FLO. ABR.)

284. STERN III  
JULIUS (TO U.S. SEP. 1834), M. 1) ? LORCH (DIV. 1) M. 2) HENRIETTA ADLER  
(BERTRAM W. KORN)

286. STIX (2)  
ERNA SARAH (RICE), M. WILLIAM EISENDRATH AND HAD:  
ELLEN, M. 1) THEODORE STEINERT; M. 2) ? BY 1 SHE HAD:  
WILLIAM C.  
SYLVIA C.  
ERIC  
ANN, M. JOHN B. CHAFFEE AND HAD:  
ELLEN  
JOHN B. JR.  
CAROLYN  
CHARLES R., M. JULIA A. CARDOZO AND HAD:  
BENJAMIN C.  
MARK W.  
JONATHAN CHARLES, M. 1) KATHLEEN REIBELMAN; M. 2) ? GALLWAY, BY 1 HE HAD:  
THOMAS JEFFERSON  
KATHLEEN  
MAY (MICHAEL H. CARDOZO IV)

STIX (3)  
ALICE STIX (EISEMAN) M. MILTON HELLMAN AND HAD:  
MAX B., B. FEB. 8, 1923 (FLO. ABR.)

291. SULZBERGER (2)  
BEATRICE, M. DR. LEONARD TRILLING AND HAD:  
RICHARD J., M. FAY GOLDBERGER AND HAD:  
BETH  
MICHAEL L.  
-- JOHN L.

-- SUSAN WARMS, M. DOUGLAS H. MAZONOWICZ  
 -- CATHY JEAN, M. JOSEPH G. PERPICH  
 ELLEN LOUISE, M. R. PETER STRAUS AND HAD:  
DIANE E. M. CARL TUCKER  
KATHERINE  
JEANNE  
ERIC  
 ANN, M. LEONARD SAND AND HAD:  
DAVID  
ROBERT  
PEGGY (MICHAEL H. CARDUZO IV)

297. TOBIAS I (N.Y.)  
 HENRY ASSHUR, M. I) RACHEL WOLFF (O.V.) AND HAD:  
 AUGUSTA, M. DR. CHARLES RALPH KEYSER AND HAD:  
 JOHN, B. JAN. 29, 1907  
 FLORENCE, B. JAN. 22, 1873, N.Y.; D. MAY 27, 1960, SYDNEY, AUSTRALIA; M. FEB. 17, 1904, LOND., HORATIO  
 MONTEFIORE (SCHLOSS) CASTLE AND HAD: (ALL B. LOND.)  
 NANCY, B. DEC. 29, 1904  
 DEREK, B. JUN. 27, 1906  
 NORMAN, B. APR. 14, 1912  
 DOREEN, B. DEC. 29, 1917  
 ETHEL, D. CA. 1954  
 HENRY, D. INE.

-- FRANCES (FANNY), B. FEB. 5, 1809, ENG.  
 [ISAAC] ALFRED, M. HERMOINE HENDRICKS (O.V. (1)) AND HAD:  
 HENRY HARMON, M. MINNIE DOUBLEDAY (OCT. 15, 1867-JAN. 17, 1953)  
 FRANCIS HENDRICKS, M. JOSEPHINE LUNA LEWIS AND HAD:  
 WILLIAM ELDRIDGE, D. MAY 30, 1942; M. SARAH APPELEGATE AND HAD:  
 CATHERINE A. I., D. FEB. 10, 1967; M. EDWARD BRASCH AND HAD:  
 NANCY ANN, M. RICHARD A. STOUT  
MARGARET ELLEN M. ROBERT H. BALDWIN  
 ELISE, D. MAY 29, 1962; M. BENJAMIN LOWENTHAL AND HAD:  
 JOAN (N.Y.), M. AARON WOLF  
 FLORIAN, D. IINH. (FLO. ABR.)

299. TOBIAS II (2)  
 JUDITH, M. RABBI MARTIN SIEGEL AND HAD:  
TORY SUSAN, B. JAN. 17, 1973, COLUMBIA, MD.

305. WOLFF  
 LILLIAN HENDRICKS, D. JAN. 18, 1953, N.Y. (FLO. ABR.)

*Bibliography  
and Sources*





## B I B L I O G R A P H Y   A N D   S O U R C E S

NOTE: LARGE CAPITALS INDICATE THE FORM IN WHICH REFERENCES ARE LISTED THROUGHOUT THIS WORK. IN MOST INSTANCES, THE ACTUAL SOURCE IS GIVEN; HOWEVER, IN A NUMBER OF CASES, THE SECONDARY SOURCE FROM WHICH OUR INFORMATION WAS DERIVED IS THE ONE LISTED. THE FOLLOWING INITIALS IDENTIFY FREQUENTLY USED COLLECTIONS OF DATA:

AJA - AMERICAN JEWISH ARCHIVES, CINCINNATI, OHIO.  
 AJHS - AMERICAN JEWISH HISTORICAL SOCIETY, WALTHAM, MASS.  
 DAR - LIBRARY OF THE SOCIETY OF DAUGHTERS OF THE AMERICAN REVOLUTION, WASHINGTON, D.C.  
 JRM - THE PERSONAL FILES OF PROFESSOR JACOB RADER MARCUS, CINCINNATI, O.  
 LDS - GENEALOGICAL SOCIETY LIBRARY OF THE CHURCH OF JESUS CHRIST OF LATTER-DAY SAINTS (MORMONS), SALT LAKE CITY, UTAH.  
 NYGBS - LIBRARY OF THE NEW YORK GENEALOGICAL AND BIOGRAPHICAL SOCIETY, NEW YORK, N.Y.  
 NYHS - LIBRARY OF THE NEW YORK HISTORICAL SOCIETY, NEW YORK, N.Y.

### M A N U S C R I P T S   A N D   D O C U M E N T S

- AARON LEVY CALENDAR (AJHS) - DIARY AND GENEALOGICAL NOTES KEPT BY AARON LEVY (1771-1852). PRINTED VERSION IN PAJHS XXVII, 335-345.  
 ABRAHAM DE JACOB DE LEON BIBLE (AJA)  
 ABRAHAMS FAMILY BIBLE (MARION ABRAHAMS LEVY, SAVANNAH, GA.)  
 ADMINISTRATION ACT BOOK, SOMERSET HOUSE, LONDON, ENGLAND. OFFICIAL BRITISH RECORD OF ADMINISTRATIONS.  
 ALBEMARLE CO., VA. MARR. REC. - MARRIAGE RECORDS OF ALBEMARLE COUNTY, VIRGINIA. COUNTY COURT HOUSE, CHARLOTTESVILLE, VA.  
 ALEXANDER MSS. (AJA) (SEE ALSO: DESCENDANTS OF JOSEPH RAPHAEL ALEXANDER; AND ALEXANDER, H.A. - NOTES ON THE ALEXANDER FAMILY.)  
 ALLEN GEN. (AJA) 'THE ALLEN ANCESTRY', AN ILLUSTRATED FAMILY TREE BY VIDA LINDO GUITERMAN.  
 AMST. ARCHIVES - THE MUNICIPAL ARCHIVES OF AMSTERDAM, THE NETHERLANDS.  
 ANCKER MSS./ANCKER DAR LINEAGE. (IRMA ANCKER BENJAMIN, PHILADELPHIA, PA.)  
 ARNOLD FAMILY REC. (AJA)  
 BALTO. - COHEN-ETTING CEM. - SEE: COHEN-ETTING CEM.  
 BAMBERGER, JACOB FAMILY BIBLE (DAVID BAMBERGER, CLEVELAND, O.)  
 BARBADOS CENSUS 1715. CENSUS OF THE ISLAND OF BARBADOS TAKEN A.D. 1715. (TYPESCRIPT. EUSTACE MAXWELL SHILSTONE, BRIDGETOWN, BARBADOS.)  
 BARBER - NY DEATHS - BARBER, G.A. DEATHS TAKEN FROM THE NEW YORK EVENING POST, 1891-1822. 4 V. NEW YORK, 1933. TYPESCRIPT (DAR, NYGBS).  
 BETH AHABAH MARR. REC./KET. (AJA) - MARRIAGE RECORDS (KETUBOT), 1846-1860, OF CONGREGATION BETH AHABAH, RICHMOND, VA.  
 BETH SHALOME MARR. REC./KET. (AJA) - MARRIAGE RECORDS (KETUBOT), 1839-1880, OF CONGREGATION BETH SHALOME, RICHMOND, VA.  
 BEVIS MARKS BIRTH REC. - RECORDS OF BIRTHS IN THE ARCHIVES OF THE SPANISH-PORTUGUESE SYNAGOGUE OF LONDON, ENGLAND.  
 B'NAI JESHURUN REC. (AJA) - VITAL RECORDS OF CONGREGATION B'NAI JESHURUN, NEW YORK, N.Y.  
 BUSH BIBLE (A.S.W. ROSENBAACH COLLECTION, PHILADELPHIA, PA.)  
 CHATHAM CO. MARR. REC. - ABSTRACTS OF MARRIAGE RECORDS, 1805-1852, CHATHAM COUNTY, GA. SAVANNAH, GA., 1934. (W.P.A. TYPESCRIPT, U.S. NATIONAL ARCHIVES, WASHINGTON, D.C.)  
 CHELTEN HILLS CREMATORY - RECORD OF BURIALS, CHELTEN HILLS CREMATORY, PHILADELPHIA, PA.  
 CINTI. - UNITED JEW. CEM. REC. - RECORD OF THE UNITED JEWISH CEMETERY, CINCINNATI, OHIO, 1826-1849. TYPESCRIPT COMPILED 1951. (AJA)  
 COHEN GEN. - GENEALOGY OF THE COHEN FAMILY OF BALTIMORE. COMPILED BY ELEANOR COHEN. (AJA)  
 COHEN LETTERS (JRM) - LETTERS OF THE COHEN FAMILY OF RICHMOND AND BALTIMORE.  
 COHEN-ETTING MSS. (AJA) - VITAL RECORDS OF THE COHEN, ETTING, AND RELATED FAMILIES OF BALTIMORE. (ORIGINALS IN LIBRARY OF JEWISH THEOLOGICAL SEMINARY, NEW YORK, N.Y.)  
 COHEN, J.R. - RECORD BOOK OF REV. JACOB RAPHAEL COHEN, COVERING 1776-1843. (ORIGINAL IN ARCHIVES OF CONGREGATION MIKVEH ISRAEL, PHILADELPHIA, PA.; PUBLISHED WITH ANNOTATIONS IN AJHQ, LIX, SEP. 1969, NO. 1, PP. 23-82).  
 CONE, SYDNEY - GUGGENHEIMER GEN. - GENEALOGY OF THE GUGGENHEIMER, CONE, AND RELATED FAMILIES. GREENSBORO, N.C., 1960.  
 CONN. HIST. SOC. - LIBRARY OF THE CONNECTICUT HISTORICAL SOCIETY, HARTFORD, CONN.  
 CURACAO VITAL RECORDS/ CUR. REC. - VITAL RECORDS FROM THE ORIGINALS OF CONGREGATION MIKVE ISRAEL, WILLEMSTAD, CURACAO, CONSISTING OF:  
 1) REGISTER OF MALE BIRTHS AND DEATHS, 1722-1830  
 2) REGISTER OF FEMALE BIRTHS WITH SPOUSES, 1743-1831  
 3) A FULLER REGISTER OF MALE BIRTHS WITH DEATH DATES, 1700-1817, COMPILED BY REV. SOLOMON COHEN PEIXOTTO. (PHOTOCOPIES, AJA)  
 DAR REC. - MISCELLANEOUS RECORDS IN COLLECTION OF THE SOCIETY OF DAUGHTERS OF THE AMERICAN REVOLUTION, WASHINGTON, D.C., INCLUDING:  
 ELAINE GRAUMAN MYERS, SPRINGFIELD, ILL.  
 M. E. HARBY - MARX EDWIN HARBY, GALVESTON, TEX.  
 DAVIDSON GEN. (DAR) - GENEALOGY OF THE FAMILY OF MARY DAVIDSON (MRS. ISAAC) FRANKS.  
 DE LEON - SEE ALSO: ABRAHAM DE JACOB DE LEON BIBLE  
 DREYFOUS, J. GEN. - GENEALOGY OF FELIX JULIUS DREYFOUS, NEW ORLEANS, LA.  
 DREYFUS, A. S. - HEB. CEM. NO. 1 OF GALVESTON - RECORD OF HEBREW CEMETERY NO. 1 OF GALVESTON, TEX., COMPILED BY RABBI A. STANLEY DREYFUS. (MIMEOGRAPH).  
 EINHORN MARR. REC. (AJA) - RECORD OF MARRIAGES PERFORMED BY REV. DAVID EINHORN IN NEW YORK, FEB. 6, 1878-SEP. 15, 1878.  
 ELIAS FAMILY BIBLE (STERLING PRICE ELIAS, JR., PHILADELPHIA, PA.)  
 ELZAS MSS. (NYHS) PAPERS OF REV. BARNETT A. ELZAS, INCLUDING:  
 DEATH NOTICES, MOSTLY FROM CHARLESTON, S.C. NEWSPAPERS  
 JEW. CEM. AT GEORGETOWN, S.C. - EPITAPHS IN THE JEWISH CEMETERY AT GEORGETOWN, S.C.  
 EMANUEL FAMILY RECORD (JRM) - MISCELLANEOUS GENEALOGICAL NOTES ON THE EMANUEL FAMILY OF SOUTH CAROLINA.  
 EPITAPHS:  
 ADATH JESHURUN CEMETERY, PHILADELPHIA, PA.  
 ELMWOOD CEMETERY, NORFOLK, VA.  
 HEBREW CEMETERY, NORFOLK, VA.  
 ESQUILINE HILL, GA. CEM. RECORD - EPITAPHS IN THE FAMILY CEMETERY OF RAPHAEL MOSES.  
 EZEKIEL FAMILY REC. - GENEALOGICAL RECORD OF THE EZEKIEL FAMILY:  
 1) ANCESTORS AND DESCENDANTS OF JACOB EZEKIEL, COMPILED BY WALTER AMBROSE EZEKIEL, CINCINNATI, O. (AJA, MRS. HARRY PINCUS, SR., NORFOLK, VA.)  
 2) DESCENDANTS OF TOBIAS JACOB EZEKIEL (AJA).  
 FALK, LAURENCE L. GEN. - GENEALOGY OF THE FALK FAMILY OF GEORGIA, COMPILED BY LAURENCE L. FALK, TAMPA, FLA.  
 FECHHEIMER GEN. - GENEALOGY OF THE FECHHEIMER FAMILY, COMPILED BY RICHARD FECHHEIMER, HIGHLAND PARK, ILL.  
 FEDERAL ST. CEM. - LIST OF BURIALS IN THE FEDERAL STREET CEMETERY OF CONGREGATION MIKVEH ISRAEL, PHILADELPHIA, PA., COMPILED BY FLORENCE ABRAHAMS.  
 FRANKS, DAVID S. - ADMIN. - ADMINISTRATION OF THE ESTATE OF DAVID SALISBURY FRANKS, FROM RECORD OF ADMINISTRATIONS, PHILADELPHIA, PA.  
 FRIEDENWALD GEN. - THE FRIEDENWALD FAMILY, 1762-1950. (COMPILER UNKNOWN)  
 FRIEDMAN - ANCESTRY OF LEE M. FRIEDMAN - COMPILED BY LEE M. FRIEDMAN, BOSTON, MASS.  
 GA. COLONIAL DAMES - EPITAPHS - SOME EARLY EPITAPHS IN GEORGIA, COMPILED BY THE GEORGIA SOCIETY OF COLONIAL DAMES OF AMERICA, DURHAM, N.C., 1924.  
 GA. NEWSPAPERS - MARRIAGES & DEATHS 1820 TO 1830, ABSTRACTED FROM EXTANT GEORGIA NEWSPAPERS BY MARY BONOURANT WARREN WITH SARAH FLEMING WHITE, DANIELSVILLE, GA., 1972.  
 GENEALOGICAL SOCIETY OF PENNSYLVANIA - MISCELLANEOUS MANUSCRIPT DATA (JRM).  
 GIST-CARY GEN. - CHART OF THE GIST-CARY FAMILY TREE, 1903, REVISED, 1959, BY N. WARFIELD GRATZ. (AJA)  
 GOLDSTONE GEN. (AJA) - 'GENEALOGY OF SEVERAL OLD NEW YORK FAMILIES, ARRANGED WITH PARTICULAR REFERENCE TO THE ANCESTRY OF JOHN LEWIS, LEWIS GOLDSTONE, AND HARMON HENDRICKS GOLDSTONE, ALSO SHOWING THE TRUE RELATIONSHIP OF SOME OF THEIR COUSINS, AUNTS, UNCLAS, AND OTHER FAMILY CONNECTIONS.' COMPILED BY LAFAYETTE GOLDSTONE; ILLUSTRATED BY VIDA LINDO GUITERMAN.  
 GOLDSTONE MS. (AJA) - GENEALOGICAL DATA PERTAINING TO THE HILLER-GOLDSTONE FAMILY.  
 GRATZ, MICHAEL, LETTER BOOK (AJHS)  
 GRATZ REC. (DAR) - MISCELLANEOUS ITEMS CONCERNING BARNARD GRATZ.  
 GUGGENHEIMER FAMILY BIBLE - FAMILY RECORD OF CAESAR GUGGENHEIMER (PRESENTED BY THE AUTHOR TO SYDNEY CONE, JR., GREENSBORO, N.C.)  
 HARBY GEN. (NYHS) - TRADITIONAL GENEALOGY OF THE HARBY FAMILY, TRACED TO ENGLAND AND MOROCCO.  
 HARBY REC. (JRM) - MISCELLANEOUS RECORDS OF THE HARBY FAMILY.  
 HART PAPERS (AJA) - PAPERS OF THE HART AND JUDAH FAMILIES (ALAN J. HART, MONTREAL, QUE.)  
 HART REC. (AJA) - RECORD - HART & COHEN FAMILIES AFTER THEIR ARRIVAL IN S.C. MIRIAM COHEN, JULY 15, 1966.  
 HART-WORKUM REC. (AJA) FAMILY RECORDS OF ALEXANDER HART, HALFF, WORKUM, AMBERG, AND RELATED FAMILIES.  
 HAYS, MOSES M. & JUDAH REC. (AJA) - RECORDS OF MOSES MICHAEL HAYS AND JUDAH HAYS.  
 HENDRICKS GEN. - GENEALOGIES OF THE HENDRICKS FAMILY, INCLUDING:  
 1) ANCESTORS OF HENRY SOLOMON HENDRICKS AND ROSALIE GRATZ HENDRICKS. TYPESCRIPT (AJA).  
 2) ILLUSTRATED FAMILY TREE BY VIDA LINDO GUITERMAN.  
 HYAMS FAMILY REC. (AJA) - MISCELLANEOUS PAPERS RELATING TO HYAMS FAMILY OF SOUTH CAROLINA.  
 HYNEMAN FAMILY REC. (AJA) - MISCELLANEOUS FAMILY PAPERS OF THE HYNEMAN FAMILY OF PHILADELPHIA, PA.  
 ISAACKS, JACOB MSS. (DAR) - PAPERS RELATED TO THE MILITARY RECORD OF JACOB ISAACKS, AND TO AN UNRELATED TEXAS FAMILY.  
 ISAACS FAMILY BIBLE/ REC. - FAMILY BIBLE AND RECORDS OF AARON ISAACS. COMPILED BY RALPH F. COLTON, CHICAGO, ILL.  
 JACKSON GEN. (AJHS) - DESCENDANTS OF DANIEL (GEDALYA) JACKSON. TYPESCRIPT.  
 JACKSON-NOAH GEN. (AJHS) - GENEALOGIES OF MORDECAI MANUEL NOAH AND HIS WIFE, REBECCA E. JACKSON. TYPESCRIPT.  
 JACOBS, B. MOHEL REC. - RECORD OF THE CIRCUMCISIONS OF BARNARD (BARENT, BEAR) JACOBS. (ORIGINAL, MIKVEH ISRAEL ARCHIVES, PHILADELPHIA, PA.; PHOTOCOPY, AJA. PUBLISHED AS PART OF 'TWO JEWISH FUNCTIONARIES IN COLONIAL PENNSYLVANIA', AJHQ, VOL. LVII, SEP. 1967, NO. 1, PP. 24-51).  
 JOHNSON GEN. - FAMILY OF DAVID ISRAEL JOHNSON OF CINCINNATI (AJA).  
 JOHNSON, AUGUSTA E., LETTER (AJHS).  
 JOSEPH, ABRAHAM DIARY (AJA)  
 JOSEPH, RUPERT L., LETTERS (AJA)  
 JUDAH GEN. (AJA) - DESCENDANTS OF MICHAEL JUDAH OF NORWALK, CONN.  
 KAYTON - HISTORY OF THE FAMILY - HISTORY OF THE KAYTON FAMILY, BY HARMON H. KAYTON. TYPESCRIPT (BERNARD KAYTON, NORFOLK, VA.)  
 KOHN-BARNET FAMILY TREE - ILLUSTRATED FAMILY TREE OF THE KOHN, BARNET, AND OTHER RELATED FAMILIES OF ALBANY, N.Y. COMPILED AND DESIGNED BY WALTER A. KOHN. PHILADELPHIA, PA., 1946. PRINTED. (CAROLYN KOHN BLUMENTHAL).  
 KRAUS MSS. (AJA) - MISCELLANEOUS PAPERS OF DR. WALTER MAX KRAUS.  
 KRAUS-SANDOR COLL. (AJA) - COLLECTION OF GENEALOGICAL DATA COMPILED BY WALTER MAX KRAUS AND MARIAN NATHAN KRAUS SANDOR.  
 LAUREL GROVE CEM. REC. (SAV.) - BURIALS IN LAUREL GROVE CEMETERY, SAVANNAH, GA.  
 LAZARUS FAMILY BIBLE (JANE L. RAISIN) - BIBLE OF THE LAZARUS FAMILY OF CHARLESTON, S.C. IN THE POSSESSION OF THE FAMILY OF JANE L. RAISIN.  
 LAZARUS GEN. - GENEALOGY OF THE LAZARUS FAMILY OF NORTH AND SOUTH CAROLINA. (THOMAS J. TOBIAS)  
 LEVY, ELIAS P. - LETTER (JRM) - LETTER OF ELIAS POLLOCK LEVY RE: FAMILY GENEALOGY.  
 LEVY GEN. (AJA) - DESCENDANTS OF ABRAHAM LEVY AND RACHEL CORNELIA BERNARD OF RICHMOND, VA.  
 LEVY GEN. - GENEALOGY OF THE LEVY AND POLLOCK FAMILIES. COMPILED BY EDWIN WOLF II, PHILADELPHIA.  
 LEVY FAMILY REC. - MISCELLANEOUS PAPERS PERTAINING TO THE FAMILY OF AARON LEVY, JR. OF PHILADELPHIA. (HISTORICAL SOCIETY OF PENNSYLVANIA)  
 LEVY, SAMUEL REC. (JRM) - GENEALOGICAL DATA DERIVED FROM THE FAMILY BIBLE OF SAMUEL LEVY OF HAMBURG, S.C.  
 LICHTENFELS, EDNA - THE GUGGENHEIMER FAMILY TREE - SEE ALSO: CONE, SYDNEY - GUGGENHEIMER GEN.  
 LIEBER FAMILY BIBLE (FA) - FAMILY BIBLE OF THE LIEBER-LEBAIR FAMILY. DATA COPIED BY FLORENCE ABRAHAMS.  
 LOPEZ GEN. (AJA) 'THE DESCENDANTS OF DAVID LOPEZ AND PRISCILLA MOSES' COMPILED BY ABBOT LOW MOFFAT, PRINCETON, N.J., AUGUST 11, 1935; CORRECTED BY HAROLD MOISE IN HIS THE MOISE FAMILY OF SOUTH CAROLINA AND THEIR DESCENDANTS.  
 LOPEZ MSS./LETTERS (JRM) - MISCELLANEOUS DATA AND CORRESPONDENCE OF AARON LOPEZ OF NEWPORT, R.I.  
 LOXLEY MS. - MISCELLANEOUS GENEALOGICAL DATA. (HISTORICAL SOCIETY OF PENNSYLVANIA).  
 LYONS FAMILY BIBLE - FAMILY RECORD OF THE LYONS FAMILY OF SOUTH CAROLINA. (THOMAS J. TOBIAS)  
 LYONS-MOSS MSS. - PAPERS PERTAINING TO THE FAMILIES OF LYONS AND MOSS OF NEW YORK AND PHILADELPHIA. (HISTORICAL SOCIETY OF PENNSYLVANIA).  
 LYONS MSS. (JRM) - GENEALOGICAL DATA ON THE LYONS FAMILY OF COLUMBIA, S.C.  
 MAGNOLIA CEM., MOBILE - BURIALS IN MAGNOLIA CEMETERY, MOBILE, ALA. (BERTRAM W. KORN)

MARKS FAMILY REC. (AJA) - GENEALOGICAL DATA PERTAINING TO MICHAEL MARKS, OF PHILADELPHIA.  
 MARKS, MICHAEL MSS. - PERSONAL PAPERS AND GENEALOGY OF MICHAEL MARKS (EDITH PINCUS ROSENTHAL)  
 MARR. CONVEYANCES - SEE: S.C. MARR. CONVEYANCES  
 MCCORKLE FAMILY REC. (DAR) TYPESCRIPT, DATED JULY 7, 1924, CONTAINING GENEALOGY OF SAMUEL  
 JUDAH.  
 MD. WILLS - WILLS IN MARYLAND HALL OF RECORDS, ANNAPOLIS, MD.  
 M.I. REC. - RECORDS IN THE ARCHIVES OF CONGREGATION MIKVEH ISRAEL, PHILADELPHIA, PA.  
 MICKVE ISRAEL REC. - RECORDS OF CONGREGATION MICKVE ISRAEL, SAVANNAH, GA.  
 MINIS MSS. (AJA) - MISCELLANEOUS RECORDS OF THE MINIS FAMILY OF SAVANNAH, GA.  
 MOBILE CEM. REC. - BURIALS IN CEMETERY, MOBILE, ALA. (BERTRAM W. KORN). SEE ALSO: MAGNOLIA  
 CEM., MOBILE.  
 MORDECAI FAMILY BIBLE - DESCENDANTS OF DAVID MORDECAI OF CHARLESTON, S.C. (THOMAS J. TOBIAS)  
 MORDECAI, JOHN BROOKE, REC. - GENEALOGY OF THE MORDECAI FAMILY OF VIRGINIA AND NORTH CAROLINA.  
 COMPILED BY JOHN BROOKE MORDECAI. (VIRGINIA HISTORICAL SOCIETY).  
 MORDECAI, JULIA, REC. - DESCENDANTS OF MYER MYERS OF NEW YORK, N.Y., COMPILED BY JULIA  
 MORDECAI. MIMEDGRAPHED.  
 MOSES FAMILY REC. (JRM) - DATA PERTAINING TO THE MOSES FAMILY OF SOUTH CAROLINA AND GEORGIA.  
 DERIVED FROM HENRY PHILLIPS MOSES AND OTHER SOURCES.  
 MOSES GEN. (AJA) - GENEALOGY OF THE MOSES FAMILY OF SOUTH CAROLINA AND GEORGIA. COMPILED BY  
 HENRY PHILLIPS MOSES.  
 MOSES MSS. (DAR) - REVOLUTIONARY CLAIMS OF DESCENDANTS OF MYER MOSES.  
 MOSES, R. J., AUTOBIOGRAPHY (JRM) - AUTOBIOGRAPHY OF RAPHAEL J. MOSES.  
 MOSS, SANFORD, MSS. (AJA) - MANUSCRIPT PAPERS OF SANFORD A. MOSS, LYNN, MASS.  
 MOSS-HARRIS GEN. - GENEALOGY OF THE FAMILIES OF MOSS AND HARRIS. COMPILED BY SANFORD A. MOSS.  
 BLUEPRINT (AJA).  
 MT. SINAI CEM. - BURIALS IN MT. SINAI CEMETERY, PHILADELPHIA, PA. (FLORENCE ABRAHAMS)  
 MYERS-HAYS-MORDECAI MSS. - FAMILY PAPERS OF THE MYERS, HAYS, AND MORDECAI FAMILIES OF NEW YORK  
 AND VIRGINIA. (VIRGINIA HISTORICAL SOCIETY)  
 MYERS MSS. - DATA PERTAINING TO THE MYERS FAMILY OF RICHMOND, VA. (VIRGINIA HISTORICAL SOCIETY)  
 MYERS, MOSES, MSS. - FAMILY LETTERS AND DOCUMENTS PERTAINING TO THE FAMILY OF MOSES MYERS  
 OF NORFOLK, VA., INCLUDING:  
 1) BUSINESS LEDGERS (AJA)  
 2) CORRESPONDENCE (CHRYSLER MUSEUM, NORFOLK, VA.)  
 NATCHEZ CEM. - BURIALS IN THE JEWISH CEMETERY, NATCHEZ, MISS. COMPILED BY JULIEN D. SAKS,  
 HOUSTON, TEX.  
 NATHAN FAMILY BIBLE (AJA) - GENEALOGICAL DATA DERIVED FROM THE FAMILY BIBLE OF ISAAC MENDES  
 SEIXAS NATHAN.  
 NATHAN GEN. (AJA) - GENEALOGY OF THE NATHAN FAMILY OF LONDON, ENGLAND, AND CHARLESTON, S.C.  
 COMPILED BY SANFORD A. MOSS. BLUEPRINT.  
 NATHANS LETTERS - CORRESPONDENCE PERTAINING TO THE FAMILY OF HORACE AUGUSTUS NATHANS OF  
 PHILADELPHIA. (HISTORICAL SOCIETY OF PENNSYLVANIA)  
 NATHANS MSS. - FAMILY PAPERS OF THE NATHANS FAMILY OF PHILADELPHIA. (ELSIE NATHANS FRANKLIN)  
 NEW ORLEANS J.C.C. - LABATT FAMILY PAPERS EXHIBITED AT THE NEW ORLEANS JEWISH COMMUNITY  
 CENTER.  
 N.O. BIRTHS (LDS) - RECORDS OF BIRTHS, NEW ORLEANS, LA.  
 NORFOLK COURT REC. - RECORDS IN THE CORPORATION COURT RECORD ROOM, NORFOLK, VA.  
 NORFOLK - FOREST LAWN CEM. - BURIALS IN THE JEWISH SECTION OF FOREST LAWN CEMETERY, NORFOLK, VA.  
 NORFOLK - HEB. CEM. - BURIALS IN HEBREW CEMETERY, NORFOLK, VA. PUBLISHED AS 'NORFOLK'S HEBREW  
 CEMETERY' COMPILED BY LOUISE AND MALCOLM STERN. THE VIRGINIA GENEALOGIST, VOL. 13, NO.1  
 (JAN.-MAR. 1969) TO VOL. 14, NO.3 (JUL.-SEP. 1970).  
 NORFOLK VITAL REC. - MANUSCRIPT VOLUMES LISTING BIRTHS AND MARRIAGES IN THE RECORD ROOM OF  
 THE CORPORATION COURT, NORFOLK, VA.  
 N.Y. DEATHS - SEE: BARBER - N.Y. DEATHS.  
 N.Y. IMMIGRATION & NATURALIZATION REC. - RECORDS OF IMMIGRATION AND NATURALIZATION FOR THE  
 PORT OF NEW YORK, 1825-1833 (AJHS)  
 N.Y. WILLS - WILLS OF NEW YORK CITY, DERIVED FROM COPIES IN THE SURROGATE COURT. SEE:  
 HERSHKOWITZ - WILLS; SAWYER - ABSTRACTS OF N.Y. WILLS.  
 OPPENHEIM FAMILY REC. - GENEALOGY OF THE OPPENHEIM FAMILY OF GERMANY AND CHARLESTON, S.C.  
 (EMILY MEYER, MONTGOMERY, ALA.)  
 OPPENHEIM MSS. - COLLECTIONS OF SAMUEL OPPENHEIM RELATING TO SETTLEMENT OF JEWS IN NORTH  
 AMERICA IN COLONIAL TIMES. (AJHS)  
 ORGLER, BLOCH, GRATZ, GEN. (AJA) GENEALOGY ENTITLED 'FAMILIEN ORGLER, BLOCH, GRATZ AUS LANGEN-  
 DORF KREIS GLEIWITZ' COMPILED BY ALFRED ORGLER, OPPELN, OBERSCHLESSEN.  
 P.B.H./PH. BUR. OF HEALTH REC. - RECORDS OF DEATHS IN THE PHILADELPHIA BUREAU OF HEALTH.  
 (HISTORICAL SOCIETY OF PENNSYLVANIA)  
 PEIXOTTO, SOLOMON C., REC. (AJA) - RECORDS OF REV. SOLOMON COHEN PEIXOTTO OF CURACAO, ST.  
 THOMAS, AND CHARLESTON, S.C.  
 PHILLIPS MSS. - RECORDS OF THE PHILLIPS FAMILY OF CHARLESTON AND ALABAMA, INCLUDING:  
 1) PAPERS OF CONGRESSMAN PHILIP PHILLIPS OF ALABAMA (LIBRARY OF CONGRESS)  
 2) GENEALOGY AND FAMILY RECORDS (JRM)  
 PINTO FAMILY PAPERS - RECORDS OF THE PINTO FAMILY OF NEW HAVEN, CONN. AND CHILLICOTHE, OHIO.  
 (AUSTIN P. STORY, CHILLICOTHE, O.)  
 PORTSMOUTH VA. MARR. REC. - RECORDS OF MARRIAGES, NORFOLK COUNTY COURT HOUSE, PORTSMOUTH, VA.  
 RAISIN FAMILY MSS. - INCLUDING:  
 1) GENEALOGICAL DATA ON THE LAZARUS FAMILY OF NORTH AND SOUTH CAROLINA. COMPILED BY RABBI  
 JACOB S. RAISIN. (AJA)  
 2) LAZARUS FAMILY BIBLE AND OTHER DATA PROVIDED BY JANE L. RAISIN, CHARLESTON, S.C.  
 3) FAMILY DATA PROVIDED BY THE CHILDREN OF RABBI JACOB AND JANE L. RAISIN: DR. AARON S. RAISIN,  
 MORDENAI RAISIN HIRSCH.  
 REV. WAR PENSION RECORDS - ORIGINALS IN THE U.S. NATIONAL ARCHIVES. INDEXED IN PUBLICATION  
 NO. 40 OF NATIONAL GENEALOGICAL SOCIETY PUBLICATIONS, WASHINGTON, D.C.  
 RICHMOND PERSONAL PROPERTY REC. - RECORDS OF PERSONAL PROPERTY TAXES, RICHMOND, VA. (VIRGINIA  
 STATE LIBRARY, RICHMOND, VA.)  
 RODEPH SHALOM MARR. REC. - MARRIAGES RECORDED IN THE ARCHIVES OF CONGREGATION RODEPH SHALOM,  
 PHILADELPHIA, PA.  
 ROSENHEIM, ISAAC, GEN. - GENEALOGY OF DESCENDANTS OF ISAAC ROSENHEIM. (FLORENCE ABRAHAMS)  
 ROSENWAIKE - DATA COMPILED BY IRA ROSEN(S)WAIKE OF PHILADELPHIA FROM CENSUS AND PUBLIC HEALTH  
 RECORDS REGARDING FEDERAL PERIOD JEWS OF NEW YORK, PHILADELPHIA, BALTIMORE, SAVANNAH. PARTIALLY  
 PUBLISHED AS 'JEWISH DEATHS INCLUDED IN THE VITAL RECORDS OF AMERICAN CITIES, 1821-1829'.  
AJHO, VOL. LVIII, MAR. 1969, NO. 3, PP. 360-375.  
 ROSENTHAL MS. - SEE: MARKS, MICHAEL MSS.  
 R. S. MOHEL REC. (AJA) - CIRCUMCISION RECORD KEPT BY THE MOHEL OF CONGREGATION RODEPH SHALOM,  
 PHILADELPHIA, 1835-1864.

RUSSELL FAMILY BIBLE - GENEALOGY OF PHILIP MOSES RUSSELL AND DESCENDANTS. COPIED BY FLORENCE  
 ABRAHAMS. (PHILIP STEEL, PHILADELPHIA, PA.)  
 SALEM FIELDS CEM. - BURIALS IN SALEM FIELDS CEMETERY, BROOKLYN, N.Y. COPIED BY JON STEDMAN.  
 SALOMON FAMILY REC. - GENEALOGY OF HAYM M. SALOMON (AJHS)  
 SALVADOR GEN. (AJA) - GENEALOGY OF THE SALVADOR FAMILY OF LONDON AND SOUTH CAROLINA. (BRITISH  
 MUSEUM)  
 SAMUEL-YATES GEN. - GENEALOGY OF THE FAMILIES OF SAMUEL AND YATES OF LIVERPOOL, ENGLAND, AND  
 NEW YORK. (AJA)  
 SAV. JEWISH BURIAL GROUND - EPITAPHS IN THE 'MORDECAI SHEFTALL' CEMETERY, SAVANNAH, GA., 1797-  
 1801. COMPILED BY W.P.A. TYPESCRIPT. (U.S. NATIONAL ARCHIVES)  
 SAWYER - ABSTRACTS OF N.Y. WILLS - ABSTRACT OF WILLS FOR NEW YORK COUNTY, N.Y., 1801-1892.  
 COMPILED BY R. C. SAWYER. TYPESCRIPT VOLUMES. (DAR, NYGGS)  
 S.C./CH. MARR. CONVEYANCES - MARRIAGE SETTLEMENT RECORDS OF SOUTH CAROLINA, PREDOMINANTLY FROM  
 CHARLESTON, 1785- (SOUTH CAROLINA STATE ARCHIVE, COLUMBIA, S.C.)  
 S.C. WILLS - SOUTH CAROLINA COUNTY WILLS. (SOUTH CAROLINA STATE ARCHIVE, COLUMBIA; ORIGINALS  
 IN SOUTH CAROLINIANA LIBRARY, COLUMBIA, S.C.)  
 SEIXAS, D. C., BIBLE - GENEALOGY OF DESCENDANTS OF DAVID CARDOZA SEIXAS. (ALICE LANDRUM, GALVES-  
 TON, TEXAS).  
 SEIXAS, G.M., MSS. (JRM) GENEALOGICAL NOTES OF THE REV. GERSHOM MENDES SEIXAS. (ABIGAIL  
 KURSHIEDT HOFFMAN, FT. LEE, N.J.)  
 SHANGARAI CHESED MARR. REC. (AJA) - MARRIAGE RECORDS OF CONGREGATION SHANGARAI CHESED (GATES  
 OF MERCY/ TOURO SYNAGOGUE). (TOURO SYNAGOGUE, NEW ORLEANS, LA.)  
 SHEARITH ISRAEL/S.I. REC. (AJA) - VITAL RECORDS OF THE SPANISH AND PORTUGUESE CONGREGATION  
 SHEARITH ISRAEL OF NEW YORK, N.Y.  
 SHEFTALL, L. BIBLE - GENEALOGICAL RECORD OF LEVI SHEFTALL. (JOHN MC KAY SHEFTALL)  
 SHEFTALL MSS. - RECORDS OF THE JEWISH COMMUNITY OF SAVANNAH, GA., 1733-1808. COMPILED BY LEVI  
 SHEFTALL. (KEITH REID COLLECTION, UNIVERSITY OF GEORGIA LIBRARIES, ATHENS, GA.) PARTLY PUB-  
 LISHED AS 'THE SHEFTALL DIARIES: VITAL RECORDS OF SAVANNAH JEWRY (1733-1808)' BY MALCOLM H.  
 STERN. AJHO, VOL. LIV, MAR. 1965, NO.3, PP.243-277.  
 SHILSTONE, E.M., MSS. - NOTES RELATING TO THE JEWS OF BARBADOS. COMPILED BY EUSTACE MAXWELL  
 SHILSTONE, BRIDGETOWN, BARBADOS.  
 SOLOMONS FAMILY REC. - RECORDS OF THE SOLOMONS FAMILY OF SOUTH CAROLINA AND GEORGIA. (THOMAS  
 J. TOBIAS)  
 SOLOMONS MSS. (JRM) - PAPERS PERTAINING TO THE LIFE AND FAMILY OF ADOLPHUS S. SOLOMONS, WASH-  
 INGTON, D.C.  
 SPRAGUE - VITAL RECORDS OF NEWPORT - DATA REGARDING NEWPORT, R.I. (MS. NEW ENGLAND HISTORICAL  
 & GENEALOGICAL SOCIETY, BOSTON, MASS.)  
 SPRUCE ST. CEM. REC. (AJA) - RECORD OF BURIALS IN THE SPRUCE STREET CEMETERY, PHILADELPHIA,  
 PA., ANNOTATED BY LEOPOLD D. GOODMAN. AUGUST 29, 1912.  
 ST. THOS. REC. (AJA) VITAL RECORDS OF THE JEWISH COMMUNITY OF ST. THOMAS, VIRGIN ISLANDS,  
 MOSTLY IN THE POSSESSION OF REV. MOSES D. SASSO, CHARLOTTE AMALIE, ST. THOMAS, INCLUDING:  
 1) DEATHS AND BURIALS IN THE SAVAN CEMETERY, 1792-1802.  
 2) EPITAPHS FROM THE ALTONA CEMETERY, 1837-1916. COMPILED FROM RECORDS IN THE ARCHIVES  
 OF THE JEWISH COMMUNITY IN COPENHAGEN BY JUL. MARGOLINSKY. TYPESCRIPT. COPENHAGEN, 1957.  
 3) CONFIRMATIONS  
 4) MARRIAGES, 1841-1869, COMPILED FROM THE KETUBOT BY MALCOLM H. STERN. TYPESCRIPT.  
 STERN FAMILY RECORDS - INCLUDING:  
 1) FAMILY BIBLE SHOWING GENEALOGY OF FAMILY OF JACOB STERN. (MALCOLM H. STERN)  
 2) MISCELLANEOUS DATA PERTAINING TO THE FAMILY. (IBID. AND LUCIEN KATZENBERG, SR., PHILADEL-  
 PHIA, PA.)  
 STEWART, AMY, MSS. (AJA) - FAMILY RECORDS PRESERVED BY AMY HART STEWART, NORFOLK, VA.,  
 RELATING TO THE HART AND LEVY FAMILIES OF RICHMOND AND THEIR RELATIVES.  
 STILES MORTALITY REGISTER - 'BILL OF MORTALITY FOR NEWPORT, R.I., 1760-1764'. BY REV. EZRA  
 STILES. TYPESCRIPT. (NEW ENGLAND HISTORICAL AND GENEALOGICAL SOCIETY, BOSTON, MASS.)  
 SULZBERGER GEN. - GENEALOGICAL DATA ON THE SULZBERGER FAMILY OF GERMANY, PHILADELPHIA, AND  
 NEW YORK. COMPILED BY ROBERT SIMPSON OF THE NEW YORK TIMES.  
 TOBIAS BIBLE (AJA) FAMILY BIBLE OF THE TOBIAS FAMILY OF CHARLESTON, S.C. (THOMAS J. TOBIAS)  
 TOBIAS GEN. - GENEALOGY OF THE TOBIAS FAMILY OF CHARLESTON, S.C. COMPILED BY THOMAS J. TOBIAS.  
 U.S. CENSUS - DECENNIAL CENSUS OF THE UNITED STATES. (U.S. NATIONAL ARCHIVES)-  
 U.S. CIRCUIT CT. - SEE: N.Y. IMMIGRATION & NATURALIZATION REC.  
 U.S. DISTRICT CT, PH. - REPORTS OF ALIENS, BOOK B, RECORDS OF THE U.S. DISTRICT COURT, PHILA-  
 DELPHIA, PA. TRANSCRIBED BY FRANCIS JAMES DALLETT, VILLANOVA, PA.  
 VA. MARR. BONDS - MARRIAGE BONDS FOR VIRGINIA, MOSTLY RICHMOND. (VIRGINIA STATE LIBRARY,  
 RICHMOND, VA.)  
 WORKUM GEN. (AJA) - GENEALOGICAL DATA CONCERNING THE FAMILY OF JACOB L. WORKUM OF CINCINNATI  
 AND RELATED FAMILIES.

#### WILLS

NAME OF TESTATOR	DATE & LOCATION OF WILL (NUMBERS REFER TO WILL BOOKS & PAGES)	PROBATED	LOCATION OF PRINTED OR PHOTOCOPY
ABENDANONE, GRACE	JAN. 7, 1857, CHATHAM CO., GA.	FILE 102	JRM
ABENDANONE, JOSEPH	SEP. 25, 1815, SAV. E/3	JAN. 4, 1816	AJA
ABRAHAMS, ABRAHAM D.	AUG. 16, 1831, SAV. H/	MAY 10, 1844	
ABRAHAMS, EMANUEL	DEC. 4, 1800, CH. 28/354-5	DEC. 30, 1802	AJA
ABRAHAMS, ISAAC	JUL. 18, 1845, SAV. H/58	NOV. 21, 1849	
ADOLPHUS, ISAAC	SEP. 7, 1774, N.Y. 29/164	SEP. 13, 1774	HERSHKOWITZ, P. 146-150
BARRETT, JACOB	SEP. 21, 1870, CH. JUDGE OF PROBATE	NOV. 24, 1871	
BENSAKEN, SAMUEL	NOV. 29, 1820, PH. 7/247	JAN. 16, 1821	AJA
BENZAKEN, ESTHER	JUN. 8, 1790, N.Y. 40/382	JUL. 1, 1790	HERSHKOWITZ, P. 192-195
BENZAKEN, ISAAC	OCT. 24, 1798, PH. Y/158	APR. 4, 1799	AJA
BLOCK, SIMON, JR.	JUL. 2, 1825, RI. 5/64	AUG. 8, 1825	AJA
CANTER, JOSHUA	OCT. 12, 1826, CH. 45/810-11	FEB. 24, 1851	AJA
CANTER, RACHEL	OCT. 14, 1833, CH. 46/90-93	MAY 28, 1852	AJA
CARDOZA, DAVID N.	AUG. 18, 1824, CH. 40/272-6	JUL. 21, 1835	AJA
CARVALHO, EMANUEL N.	MAR. 16, 1817, PH. 6/435	APR. 28, 1817	
COHEN, ABRAHAM	OCT. 27, 1809, CH. 31/294-5	JAN. 1, 1810	AJA
COHEN, JACOB I.	JAN. 10, 1816, PH. 8/93	OCT. 31, 1823	EZEKIEL-LICHTENSTEIN, P. 330-35
COHEN, JACOB RAPHAEL	DEC. 4, 1810, PH. 3/559	OCT. 23, 1811	AJA
DA COSTA, SARAH	OCT. 2, 1793, CH. 25/89-91	NOV. 18, 1793	AJA
D'AZEVEDO, RACHEL	MAY 5, 1840, CH. 43/556-7	FEB. 23, 1843	AJA
DE LA MOTTA, SARAH	MAY 26, 1829, SAV. 6/	JUN. 26, 1829	

NAME OF TESTATOR	DATE & LOCATION OF WILL	PROBATED	LOCATION OF PRINTED OR PHOTOCOPY
DE LUCENA, ABRAHAM HAIM	FEB.12,1716,N.Y. 10/73	SEP. 2,1725	HERSHKOWITZ, P.33-35
DE MESQUITA, JOSEPH BUENO	OCT.20,1708,N.Y. 7/512	NOV. 1,1708	HERSHKOWITZ, P.15-20
DE TORRES, SIMHA EMANUEL, MARK	FEB.16,1742/3,NY 16/50 1851,PETERSBURG, VA.	NOV.13,1746	HERSHKOWITZ, P.79-83
FONSECA, JACOB	NOV.30,1727,ALBANY,NY F-5	AUG. 9,1729	HERSHKOWITZ, P.44-46
GOMEZ, BENJAMIN	JAN. 3,1770,N.Y. 28/307	SEP.22,1772	HERSHKOWITZ, P.135-138
GOMEZ, DAVID	APR.25,1765,N.Y. 27/87	AUG.14,1769	HERSHKOWITZ, P.125-128
GOMEZ, ISAAC	FEB.16,1769,N.Y. 27/324	OCT. 1,1770	HERSHKOWITZ, P.129-134
GOMEZ, LUIS/LEWIS	DEC.24,1730,N.Y. 13/368	MAY 7, 1740	HERSHKOWITZ, P.62-64
GOMEZ, MORDECAI	MAY 3,1750,N.Y. 17/272	NOV.12,1750	HERSHKOWITZ, P.84-94
GOMEZ, MATTATHIAS	APR.20,1781,N.Y. 36/185	JAN. 2,1784	HERSHKOWITZ, P.151-157
GOMEZ, MOSES DANIEL	AUG.22,1786,N.Y. 40/353	APR. 7,1790	HERSHKOWITZ, P.189-191
GOMEZ, REBECCA	JUL.21,1798,N.Y.	JUL.13,1801	SAWYER-ABSTRACT V.1/7-8
HARBY, A. TOBIAS	MAR.18,1858,CH. 111-18/650	APR.19,1860	AJA
HARBY, HENRY J.	SEP.20,1849,CH. 45/909-10	SEP.18,1851	AJA
HART, ALEXANDER M.	AUG.28,1797,CH. 26/607-8	SEP. 8,1797	AJA
HART, BELLA	AUG.11,1846,CH. 46/21	DEC.30,1851	AJA
HART, DANIEL	APR.23,1811,CH. 31/441-43	MAY 31,1811	AJA
HART, HART MOSES	JUL.12,1795,CH. 25/317-18	JUL.24,1795	AJA
HART, HYMON	OCT.19,1791,CH. 24/946-48	NOV.10,1791	AJA
HART, JOHN I.	FEB.16,1863,N.Y. 152/95	OCT.29,1863	LDS
HART, PHILIP	FEB. 3,1796,CH. 26/397-8	FEB.12,1796	AJA
HART, RACHEL	JAN. 4,1866,CH. 1-4		AJA
HAYS, JUDAH	JUL.22,1763,N.Y. 24/464	AUG.27,1764	HERSHKOWITZ, P.118-124
HENRY, JACOB	APR.14,1760,PH. M/111	MAY 21,1761	AJA
HENRY, JUDITH J.	OCT. 1,1835,CH. 40/364	DEC.14,1835	AJA
HERTZ, HANDEL MOSES	SEP.19,1840,CH. 42/187-8	OCT.13,1840	AJA
HYAMS, CAROLINE	APR. 7,1857,CH.	JAN.12,1858	AJA
(DERIVED FROM COPY IN SOUTH CAROLINIANA LIBRARY, COLUMBIA, S.C., BOX 114,NO.9)			
HYAMS, MOSES D.	MAY 28,1867,CH.	JAN. 5,1869	AJA
(DERIVED FROM COPY IN SOUTH CAROLINIANA LIBRARY, COLUMBIA, S.C., BOX 184,NO.24)			
HYAMS, SOLOMON	DEC.22,1836,CH. 41/635-6	AUG. 4,1837	AJA
ISAACS, FANNY	JUL.27,1809	AUG. 9,1809	SAWYER-ABSTRACT V.1/28
ISAACS, DAVID	MAR.24,1826,ALBEMARLE CO.,VA.12/366	MAR.6,1837	AJA
ISAACS, JOSHUA	JUL.13,1744,N.Y. 15/245	NOV. 6,1744	HERSHKOWITZ, P.69-74
ISAACS, SOLOMON	AUG.26,1751,N.Y. 20/294	JAN.14,1757	HERSHKOWITZ, P.103-106
JACOBS, BENJAMIN	MAY 1,1811,N.Y.	JAN. 7,1812	SAWYER-ABSTRACT V.2/74
JACOBS, JACOB	JUN.24,1796,CH. 26/640-4	NOV.20,1797	BLAU & BARDON, P.104-107
JACOBS, SAMUEL	OCT. 7,1775,OTTAWA		JRM
JACOBS, SOLOMON	NOV. 1,1822,RI. 4/378	DEC. 4,1827	AJA
JUDAH, BELLA	MAR. 3,1837,N.Y.	FEB.12,1847	SAWYER-ABSTRACT V.13/1
JUDAH, MICHAEL	DEC.31,1784		AJA
(DERIVED FROM ORIGINAL IN CONNECTICUT STATE LIBRARY, HARTFORD, CONN.)			
JUDAH, MOSES	APR.27,1831,N.Y. 67/386	JUL.30,1831	AJA
JUDAH, SAMUEL B.H.	NOV. 8,1871,N.Y. 236/392	SEP.16,1876	AJA
LAZARUS, ADELINE	AUG.22,1865,SUMTER,S.C.	DEC. 2,1865	AJA
(DERIVED FROM COPY IN SOUTH CAROLINIANA LIBRARY, COLUMBIA, S.C., BOX 168,NO. 4)			
LAZARUS, JOSHUA	JUL. 4,1859,CH.	JUN. 5,1861	AJA
(DERIVED FROM COPY IN SOUTH CAROLINIANA LIBRARY, COLUMBIA, S.C., BOX 141, NO.3)			
LAZARUS, MICHAEL	AUG.15,1859,CH.	DEC. 1,1862	AJA
(DERIVED FROM COPY IN SOUTH CAROLINIANA LIBRARY, COLUMBIA, S.C., BOX 149, NO.22)			
LAZARUS, RACHEL	MAR.19,1844,CH. 44/261-167	NOV. 9,1847	AJA
LEVY, ASHER	APR.25,1783,PH. 7/183	AUG.12,1785	AJA
LEVY, ISAAC	OCT.22,1776,PH. 1/777	MAY 13,1783	HERSHKOWITZ, P.158-160
LEVY, JANE	OCT.10,1859,CH.	JAN. 3,1866	AJA
(DERIVED FROM COPY IN SOUTH CAROLINIANA LIBRARY, COLUMBIA, S.C., BOX 168, NO.9)			
LEVY, MARTHA L.T.	JAN.16,1806,PH.	APR. 1,1807	AJA
LEVY, MOSES	JUN. 2,1728,N.Y. 859	DEC.18,1728	HERSHKOWITZ, P.36-43
LEVY, MOSES	NOV. 8,1825,PH.	MAY 13,1826	AJA
LEVY, MOSES C.	APR. 1,1837,CH. 41/909-15	APR.2,1839	AJA
LEVY, RACHEL	NOV. 9,1794,BALTO.5/216	DEC.10,1794	AJA
LEVY, RACHEL MOISE	MAR.24,1858,CH.		AJA
(DERIVED FROM COPY IN SOUTH CAROLINIANA LIBRARY, COLUMBIA, S.C.)			
LEVY, SAMSON	MAR. 9,1781,PH. R/416	MAY 16,1781	AJA
LEVY, SARAH	NOV. 8,1839,KERSHAW DIST.,S.C.		AJA
LEVY, SARAH C.	NOV.12,1835,CH. 41/683-6	NOV.13,1837	AJA
LORYEA, ISAAC	MAR.13,1855,CH.	APR. 2,1855	AJA
(DERIVED FROM COPY IN SOUTH CAROLINIANA LIBRARY, COLUMBIA, S.C., BOX 95, NO.13)			
LYON, MORDECAI	APR. 2,1818,CH. 34/16-20	OCT.12,1818	AJA
LYONS, SOLOMON	SEP.15,1806,PH. 4/122	APR.28,1812	JRM
MARKS, HENRY	FEB.13,1809,RI. 1/5	APR.10,1810	AJA
MARQUES, JACOB R.	AUG. 2,1725,BARBADDS 7/555	AUG.21,1725	
(ABSTRACT IN TRANSACTIONS OF THE JEWISH HISTORICAL SOCIETY OF ENGLAND, XIII/86)			
MARX, EMMA	MAR. 6,1858,RI. 19/177	APR.13,1859	AJA
MARX, JOSEPH	SEP.12,1836,RI. 8/251	JUL.15,1840	AJA
MARX, SAMUEL	NOV.23,1859,RI. 13/86	DEC.13,1860	AJA
MARX, WILHELMINA	AUG. 3,1835,RI. 7/220	AUG.26,1836	AJA
MINIS, ABRAHAM	OCT.21,1754,SAV. AA/20-21	MAY 5,1757	AJA
MOISE, ABRAHAM	OCT.16,1854,CH.	JAN.26,1870	AJA
(DERIVED FROM COPY IN SOUTH CAROLINIANA LIBRARY, COLUMBIA, S.C.)			
MOISE, ISAAC	APR.20,1857,CH.	NOV.30,1857	AJA
(DERIVED FROM COPY IN SOUTH CAROLINIANA LIBRARY, COLUMBIA, S.C., BOX 113, NO.16)			
MOLINA, MOSES	DEC.26,1785,CH. 21/774-5	DEC.30,1785	AJA
MOSES, ABRAHAM	MAY 29,1796,CH. 26/476-7	JUL.29,1796	AJA
MOSES, DEBORAH	NOV.14,1837,CH. 45/581-3	OCT. 3,1849	AJA
MOSES, MIRIAM (MARY)	APR.11,1810,CH. 31/391	OCT. 5,1810	AJA
MOSES, REUBEN	MAR.18,1850,CH. 45/682-93	JUN.3,1850	AJA
MYERS, MANUEL	MAY 13,1799,N.Y. 42/605	MAY 28,1799	HERSHKOWITZ, P.208-213
NATHANS, DAVID	JUL.27,1817,PH. M/140	1819	AJA
NATHANS, NATHAN	FEB. 1,1843,CH. 47/543-5	JAN. 8,1855	AJA
NUMES, MOSES	OCT.14,1785,SAV. C/104	MAR.28,1791	AJA
OLIVE(I)RA, JACOB	JUL.27,1751,CH.	MAY 15,1752	AJA
(DERIVED FROM COPY IN SOUTH CAROLINIANA LIBRARY, COLUMBIA, S.C.)			

NAME OF TESTATOR	DATE & LOCATION OF WILL	PROBATED	LOCATION OF PRINTED OR PHOTOCOPY
OPPENHEIM, HERTZ WOLFF	JUN. 1,1848,CH. 46/284-5	JUN.16,1853	AJA
OTTOLENGUI, ABRAHAM	JUL. 1,1850,CH. 45/796-7	DEC.19,1850	AJA
PESOA, ISAAC	JUL.25,1808,PH.	DEC.12,1809	AJA
PHILLIPS, (ISA)BELLA L.	JAN. 6,1862,CH. 49/1000		AJA
PHILLIPS, JONAS	JAN.13,1800,PH. 14/	FEB. 7,1803	AJA
PIMENTA, LEA	NOV.27,1766,CH. 11/301-2	MAR.11,1768	AJA
POZNANSKI, ESTHER B.	MAR.22,1870,CH.		AJA
(DERIVED FROM SOUTH CAROLINIANA LIBRARY, COLUMBIA, S.C.)			
RDRIGUES, BENJAMIN A.	SEP. 6,1781,CH.		AJA
(DERIVED FROM SOUTH CAROLINIANA LIBRARY, COLUMBIA, S.C.)			
RUSSELL, PHILIP M.	JAN.18,1829,PH. N/332	AUG.23,1830	AJA
SALVADOR, JOSEPH	OCT. 7,1782,CH. 22/94-102	JAN.5,1787	AJA
SASPARTAS, ABRAHAM	AUG.21,1820,CH. 30/1067-72	DEC.17,1824	AJA
SEIXAS, DAVID C.	JUN. 8,1856,CH.	OCT.20,1857	AJA
(DERIVED FROM SOUTH CAROLINIANA LIBRARY, COLUMBIA, S.C., BOX 112, NO.22)			
SHEFTALL, ESTHER	JUN. 6,1828,SAV.	OCT. 6,1828	JRM
(DERIVED FROM A LOOSE COPY OF THE WILL IN CHATHAM COUNTY COURT HOUSE, SAVANNAH, GA.)			
SHEFTALL, LEVI	JUL. 4,1808,SAV. E/140	MAR. 7,1809	AJA
SHEFTALL, PERLA	SEP.15,1820,SAV. F	DEC. 5,1820	AJA
(DERIVED FROM WILLS, CHATHAM COUNTY, GEORGIA, 1817-1826. TYPESCRIPT, W.P.A.,1937. COPY IN U.S. NATIONAL ARCHIVES, WASHINGTON, D.C.)			
SIMONS, MONTAGUE	SEP. 6,1813,CH. E/343	SEP. 1813	AJA
(DERIVED FROM SOUTH CAROLINIANA LIBRARY, COLUMBIA, S.C., BOX 15-U, NO.1)			
SIMONS, SAMPSON	JAN.20,1811,CH. 31/455	JUL.26,1811	AJA
SIMSON, SAMPSON	JUL.30,1773,N.Y. 29/44	NOV.18,1773	HERSHKOWITZ, P.139-145
SOLCOMONS, HART	DEC.19,1817,CH. 33/1348-9	DEC.31,1817	AJA
SOLOMONS, JOSEPH	AUG.14,1807,CH. 31/166-8	NOV. 4,1808	AJA
TOBIAS, ISAAC	SEP.26,1859,CH.	FEB. 8,1860	AJA
(DERIVED FROM SOUTH CAROLINIANA LIBRARY, COLUMBIA, S.C., BOX 132, NO.1)			
TOBIAS, JACOD	OCT.28,1775,CH. 18/1-2	APR.17,1776	AJA
TOBIAS, JUDITH	SEP. 4,1815,CH. 33/1055-6	MAR.22,1816	AJA
WDLF, RACHEL A.M.	OCT. 7,1828,CH. 40/317-9	NOV.25,1835	AJA

#### PERIODICALS

AJA - AMERICAN JEWISH ARCHIVES, 1948 TO DATE  
AJHQ - AMERICAN JEWISH HISTORICAL QUARTERLY, SEQUEL TO PAJHS, BEGINNING WITH VOLUME L1, SEPTEMBER, 1961 TO DATE  
AJBY - AMERICAN JEWISH YEAR BOOK, 1899 TO DATE  
AMER. DAILY ADV. - AMERICAN DAILY ADVERTISER, PHILADELPHIA, FOUNDED 1784  
AMERICAN ISRAELITE - CINCINNATI, 1854 TO DATE, FOUNDED BY RABBI ISAAC MAYER WISE  
CARIBBEANA - 6 V., LONDON, 1910-1919  
FLA. HIST. QUARTERLY - FLORIDA HISTORICAL QUARTERLY, 1908 TO DATE  
THE IMPROVEMENT ERA  
L. BAECK INSTITUTE YB - LEO BAECK INSTITUTE YEARBOOK, 1956 TO DATE  
MARYLAND/MD. HIST. MAG. - MARYLAND HISTORICAL MAGAZINE, BALTIMORE, 1905 TO DATE  
MICH. JEW. HIST. - MICHIGAN JEWISH HISTORY, 1960 TO DATE  
MISC. JHSE - MISCELLANIES OF THE JEWISH HISTORICAL SOCIETY OF ENGLAND, LONDON, 1925 TO DATE.  
SINCE 1970, APPENDED TO TJHSE.  
NGSQ/NATL. GEN. SOC. QU. - NATIONAL GENEALOGICAL SOCIETY QUARTERLY, WASHINGTON, D.C., 1912 TO DATE  
NEGR - NEW ENGLAND HISTORICAL AND GENEALOGICAL REGISTER, BOSTON, MASS., 1846 TO DATE  
NORFOLK NEWSPAPERS, NORFOLK, VA.:  
THE AMERICAN BEACON, 1815FF.  
NORFOLK AND PORTSMOUTH DAILY ADVERTISER, 1794FF.  
NORFOLK HERALD, 1819-44  
THE SOUTHERN ARGUS, 1848-60  
NYGBR - THE NEW YORK GENEALOGICAL AND BIOGRAPHICAL RECORD, NEW YORK, N.Y., 1870 TO DATE  
NY TIMES OBIT. - OBITUARIES PUBLISHED IN THE NEW YORK TIMES, NEW YORK, N.Y., 151 TO DATE. INDEX TO OBITUARIES, PUBLISHED SEPARATELY.  
NY WEEKLY MUSEUM - NEW YORK WEEKLY MUSEUM  
PAJHS - PUBLICATIONS OF THE AMERICAN JEWISH HISTORICAL SOCIETY, 50 V., 1893-1960. CONTINUED TO DATE AS AJHQ.  
PA. MAGAZINE - PENNSYLVANIA MAGAZINE OF HISTORY AND BIOGRAPHY, PHILADELPHIA, 1891 TO DATE  
PHILADELPHIA NEWSPAPERS: (SEE ALSO: AMER. DAILY ADV., POULSSON'S)  
PENNSYLVANIA GAZETTE, 1728-1815  
PHILADELPHIA PUBLIC LEDGER, 1836FF.  
POULSSON'S - POULSSON'S DAILY ADVERTISER, CONTINUATION OF AMER. DAILY ADV.  
REFORM ADVOCATE - CHICAGO, 1891-1923. EDITED BY RABBI EMIL G. HIRSCH  
RICHMOND NEWSPAPERS: RICHMOND, VA.  
DAILY DISPATCH  
RICHMOND TIMES-DISPATCH  
RIJHS NOTES - RHODE ISLAND JEWISH HISTORICAL NOTES, PROVIDENCE, R.I., 1954 TO DATE  
ST. CHARLES - THE SAINT CHARLES, NEW YORK, N.Y. EDITED BY DR. WALTER MAX KRAUS. (ONLY V.1,NO.1, JAN. 1935, WAS PUBLISHED)  
SJHS JOURNAL - THE JOURNAL OF THE SOUTHERN JEWISH HISTORICAL SOCIETY, RICHMOND, VA., 1958.  
EDITED BY SAUL VIENER AND OTHERS  
SUMMER SOCIAL REGISTER - NEW YORK, 1949 ED.  
TJHSE - TRANSACTIONS OF THE JEWISH HISTORICAL SOCIETY OF ENGLAND, LONDON, 1893-DATE  
VA. MAG. OF HIST. & BIOG. - VIRGINIA MAGAZINE OF HISTORY AND BIOGRAPHY, RICHMOND, 1893 TO DATE  
WHO'S WHO IN AMERICA - CHICAGO, 1899 TO DATE  
WHO'S WHO IN WORLD JEWRY - NEW YORK, 1955, 1965, 1972



PRINTED BOOKS

- A.J.D. - AMERICAN JEWRY, DOCUMENTS, EIGHTEENTH CENTURY, BY JACOB RADER MARCUS. CINCINNATI: THE HEBREW UNION COLLEGE PRESS, 1959
- ALEXANDER, H.A. - NOTES ON THE ALEXANDER FAMILY OF SOUTH CAROLINA AND GEORGIA AND CONNECTIONS, BY HENRY AARON ALEXANDER. (ATLANTA, GA.): PRIVATELY PRINTED, 1954
- ANDRADE - JEWS OF JAMAICA - A RECORD OF THE JEWS IN JAMAICA FROM THE ENGLISH CONQUEST TO THE PRESENT TIME, BY JACOB A.P.M. ANDRADE, KINGSTON, JAMAICA; THE JAMAICA TIMES, 1941. SEPARATE TYPESCRIPT INDEX, COMPILED BY PAUL. F. WHITE. (COPIES IN AJA; JUDAICA ROOM OF THE NEW YORK PUBLIC LIBRARY)
- ARNOLD - VITAL, REC. OF R.I. - VITAL RECORDS OF RHODE ISLAND, COMPILED BY JAMES N. ARNOLD, 21 V. PROVIDENCE, R.I., 1893. V.4: NEWPORT COUNTY
- BAILEY - EARLY CONN. MARR. - EARLY CONNECTICUT MARRIAGES AS FOUND IN ANCIENT CHURCH RECORDS PRIOR TO 1800, COMPILED BY FREDERIC W. BAILEY, 7 V. NEW HAVEN, 1896-1906
- BALTO. CITY DIR. - CITY DIRECTORIES, BALTIMORE, 1820 FF.
- BIOGRAPHICAL AND HISTORICAL MEMOIRS OF LOUISIANA, 2 V. BOSTON, 1892
- BIOGRAPHICAL SOUVENIR OF THE STATE OF GEORGIA AND FLORIDA, CHICAGO, 1889
- BLAU-BARON - THE JEWS OF THE UNITED STATES, 1790-1840: A DOCUMENTARY HISTORY, EDITED BY JOSEPH L. BLAU AND SALO W. BARON, 3 V. NEW YORK AND LONDON: COLUMBIA UNIVERSITY PRESS, 1963; PHILADELPHIA: THE JEWISH PUBLICATION SOCIETY OF AMERICA, 5724
- B. H. KET./BEVIS MARKS RECORDS - BEVIS MARKS RECORDS, BEING CONTRIBUTIONS TO THE HISTORY OF THE SPANISH AND PORTUGUESE CONGREGATION OF LONDON.
- PART II: ABSTRACTS OF THE KETUBOT OR MARRIAGE CONTRACTS OF THE CONGREGATION FROM EARLIEST TIMES UNTIL 1837, WITH INDEX. OXFORD: UNIVERSITY PRESS, 1949
- PART III: ABSTRACTS OF THE KETUBOT OR MARRIAGE CONTRACTS AND OF THE CIVIL MARRIAGE REGISTERS ... FOR THE PERIOD 1837-1901. LONDON: SPANISH AND PORTUGUESE JEWS CONGREGATION AND THE JEWISH HISTORICAL SOCIETY OF ENGLAND, 1973
- BURKE'S PEERAGE, LONDON, SINCE 1822
- BYARS - B. & M. GRATZ - B. AND M. GRATZ, MERCHANTS IN PHILADELPHIA, 1754-1798, PAPERS OF INTEREST TO THEIR POSTERITY AND THE POSTERITY OF THEIR ASSOCIATES. JEFFERSON CITY, MO., 1916
- CHATHAM CO., GA. WILLS - ABSTRACTS OF WILLS, CHATHAM COUNTY, GEORGIA, 1773-1817, ABSTRACTED AND COMPILED BY MABEL FREEMAN LA FAR, CAROLINE PRICE WILSON. WASHINGTON, D.C.: NATIONAL GENEALOGICAL SOCIETY, 1933 AND 1963. (NGS PUBLICATION NO.6)
- CLEMENS - N. & S.C. MARR REC. - NORTH AND SOUTH CAROLINA MARRIAGE RECORDS, COMPILED BY W.M. CLEMENS. NEW YORK, C1927
- COHEN, MRS. ALBERT M. - FAMILY FACTS AND FAIRY TALES, COMPILED BY EVELINE GLEAVES COHEN. WYNNWOOD, PA.: PRIVATELY PRINTED, 1953
- COHEN - MYERS, HAYS, MORDECAI - RECORDS OF THE MYERS, HAYS, AND MORDECAI FAMILIES FROM 1707-1913, BY CAROLINE COHEN. WASHINGTON, D.C.: PRIVATELY PRINTED, 1913
- COHEN - 100 YEARS OF JEWRY IN TEXAS - ONE HUNDRED YEARS OF JEWRY IN TEXAS, BY DR. HENRY COHEN, DR. DAVID LEFKOWITZ, AND DR. EPHRAIM FISCH. DALLAS: TEXAS CENTENNIAL EXPOSITION, 1936
- COIT - MR. BARUCH - MR. BARUCH, BY MARGARET L. COIT. BOSTON: HOUGHTON MIFFLIN CO., 1957
- D.A.B. - THE DICTIONARY OF AMERICAN BIOGRAPHY, EDITED BY ALLEN JOHNSON AND DUMAS MALONE. 20 V. NEW YORK, 1928-37
- D.N.B. - DICTIONARY OF NATIONAL BIOGRAPHY, EDITED BY SIR LESLIE STEPHEN, SIDNEY LEE. 63 V. LONDON, 1885-1900
- EGLÉ - FOREIGN ARRIVALS - NAMES OF FOREIGNERS WHO TOOK THE OATH OF ALLEGIANCE TO THE PROVINCE AND STATE OF PENNSYLVANIA, 1727-1775, WITH THE FOREIGN ARRIVALS, 1786-1808
- EGMONT - A LIST OF THE EARLY SETTLERS OF GEORGIA (COMPILED FROM THE MANUSCRIPT: A LIST OF PERSONS WHO WENT FROM EUROPE TO GEORGIA ON THEIR OWN ACCOUNT, OR AT THE TRUSTEES' CHARGE, OR WHO JOINED THE COLONY OR WERE BORN IN IT, DISTINGUISHING SUCH AS HAD GRANTS THERE OR WERE ONLY INMATES, FROM THE MANUSCRIPTS OF THE EARL OF EGMONT), EDITED BY E. MERTON COULTER AND ALBERT B. SAYE, ATHENS, GA.: THE UNIVERSITY OF GEORGIA PRESS, C1949
- EHRNFRIED - BOSTON - A CHRONICLE OF BOSTON JEWRY FROM THE COLONIAL SETTLEMENT TO 1901, BY ALBERT EHRNFRIED, BOSTON: PRIVATELY PRINTED, C1963 BY IRVING BERNSTEIN
- ELZAS - JEW. CEM. AT COLUMBIA - THE JEWISH CEMETERIES AT COLUMBIA, S.C., COMPILED BY BARNETT A. ELZAS. CHARLESTON, S.C., 1910
- ELZAS - JEW. CEM. AT CAMDEN - THE JEWISH CEMETERY AT CAMDEN, S.C., COMPILED BY BARNETT A. ELZAS. CHARLESTON, S.C., 1910
- ELZAS - JEW. CEM. AT ORANGEBURG - THE JEWISH CEMETERY AT ORANGEBURG, S.C., COMPILED BY BARNETT A. ELZAS. CHARLESTON, S.C., 1910
- ELZAS - JEWS OF S.C. - THE JEWS OF SOUTH CAROLINA FROM THE EARLIEST TIMES TO THE PRESENT DAY, BY BARNETT A. ELZAS. PHILADELPHIA, PA.: J.B. LIPPINCOTT CO., 1905
- ELZAS - M.N. - JEWISH MARRIAGE NOTICES FROM THE NEWSPAPER PRESS OF CHARLESTON, S.C. (1775-1906), COMPILED BY BARNETT A. ELZAS. NEW YORK, N.Y.: BLOCH PUBLISHING CO., 1917
- ELZAS - NEW JEW. CEM. - THE NEW JEWISH CEMETERY OF K.K. BETH ELOHIM AT CHARLESTON, S.C., COMPILED BY BARNETT A. ELZAS. CHARLESTON, S.C., 1910
- ELZAS - D.J.C. - THE OLD JEWISH CEMETERIES AT CHARLESTON, S.C., A TRANSCRIPT OF THE INSCRIPTIONS ON THEIR TOMBSTONES, 1762-1903, WITH AN INTRODUCTION AND FULL INDEX, BY BARNETT A. ELZAS. CHARLESTON, S.C.: THE DAGGETT PRINTING CO., 1903
- EMINENT AND REPRESENTATIVE MEN OF VA. & D.C. - EMINENT AND REPRESENTATIVE MEN OF VIRGINIA AND THE DISTRICT OF COLUMBIA OF THE NINETEENTH CENTURY. MADISON, WIS., 1893
- EMMANUEL - PRECIOUS STONES - ISAAC S. EMMANUEL, PRECIOUS STONES OF THE JEWS OF CURACAO; CURAÇAO JEWRY, 1656-1957. NEW YORK: BLOCH PUBLISHING CO., 1957
- E.N.A. - ISAAC S. AND SUZANNE EMMANUEL, HISTORY OF THE JEWS OF THE NETHERLANDS ANTILLES, 2 V. CINCINNATI: AMERICAN JEWISH ARCHIVES, 1970
- ENCYC. OF VA. BIOG. - ENCYCLOPEDIA OF VIRGINIA BIOGRAPHY, COMPILED BY L. G. TYLER, 5 V. RICHMOND, VA., 1915
- ESSAYS IN A.J.H. - ESSAYS IN AMERICAN JEWISH HISTORY TO COMMEMORATE THE TENTH ANNIVERSARY OF THE FOUNDING OF THE AMERICAN JEWISH ARCHIVES UNDER THE DIRECTION OF JACOB RADER MARCUS. CINCINNATI: THE AMERICAN JEWISH ARCHIVES, 1958
- EVANS - HIST. OF ROSS COUNTY, O. - EVANS, L. S., A STANDARD HISTORY OF ROSS COUNTY, OHIO, 2 V. CHICAGO, 1917
- EZEKIEL - LICHTENSTEIN/E.-L. - THE HISTORY OF THE JEWS OF RICHMOND FROM 1769 TO 1917, BY HERBERT T. EZEKIEL AND GASTON LICHTENSTEIN. RICHMOND, VA.: HERBERT T. EZEKIEL, 1917
- FISH - AARON LEVY - AARON LEVY, FOUNDER OF AARONSBURG, BY SIDNEY M. FISH. NEW YORK: AMERICAN JEWISH HISTORICAL SOCIETY, 1951 (STUDIES IN AMERICAN JEWISH HISTORY, NO.1)
- FRANKS, ABIGAIL, LETTERS - THE LEE MAX FRIEDMAN COLLECTION OF AMERICAN JEWISH COLONIAL CORRESPONDENCE: LETTERS OF THE FRANKS FAMILY (1733-1748), EDITED BY LEO HERSHKOWITZ AND ISIDORE S. MEYER. WALTHAM, MASS.: AMERICAN JEWISH HISTORICAL SOCIETY, 1968. (STUDIES IN AMERICAN JEWISH HISTORY, NO.5)
- FRIEDMAN - JEW. PIONEERS & PATRIOTS - JEWISH PIONEERS AND PATRIOTS, BY LEE M. FRIEDMAN. PHILADELPHIA: THE JEWISH PUBLICATION SOCIETY OF AMERICA, 1942
- FRIEDMAN - PILGRIMS - PILGRIMS IN A NEW LAND, BY LEE M. FRIEDMAN. PHILADELPHIA: THE JEWISH PUBLICATION SOCIETY OF AMERICA, 1948
- GOLDBERG - MAJOR NOAH - MAJOR NOAH: AMERICAN-JEWISH PIONEER, BY ISAAC GOLDBERG. PHILADELPHIA: THE JEWISH PUBLICATION SOCIETY OF AMERICA, 1936
- GRINSTEIN - THE RISE OF THE JEWISH COMMUNITY OF NEW YORK, 1654-1860, BY HYMAN B. GRINSTEIN. PHILADELPHIA: THE JEWISH PUBLICATION SOCIETY OF AMERICA, 1945
- GUTSTEIN - AARON LOPEZ & JUDAH TOURO - AARON LOPEZ AND JUDAH TOURO: A REFUGEE AND A SON OF A REFUGEE, BY MORRIS A. GUTSTEIN. NEW YORK: BEHRMAN'S JEWISH BOOK HOUSE, 1939
- GUTSTEIN - JEWS OF NEWPORT - THE STORY OF THE JEWS OF NEWPORT, TWO AND A HALF CENTURIES OF JUDAISM, 1658-1908, BY MORRIS A. GUTSTEIN. NEW YORK: BLOCH PUBLISHING CO., 1936. (REWRITTEN AS: TO BIGOTRY NO SANCTION; A JEWISH SHRINE IN AMERICA, 1658-1958. NEW YORK: BLOCH PUBLISHING CO., 1958)
- GUTTMACHER - HIST. OF BALTO. HEB. CONG. - A HISTORY OF BALTIMORE HEBREW CONGREGATION NIDCHE ISRAEL, 1830-1905, BY RABBI ADOLPH GUTTMACHER. BALTIMORE, 1905. (UPDATED AS: THE CHRONICLE OF BALTIMORE HEBREW CONGREGATION, 1830-1975, BY ROSE GREENBERG)
- HERSHKOWITZ - WILLS - WILLS OF EARLY NEW YORK JEWS (1704-1799), BY LEO HERSHKOWITZ. NEW YORK: AMERICAN JEWISH HISTORICAL SOCIETY, 1967. (STUDIES IN AMERICAN JEWISH HISTORY, NO.4)
- HUTZLER GEN. - (GENEALOGY OF THE HUTZLER FAMILY OF RICHMOND, VA., COMPILED BY CHARLES S. HUTZLER.) NO TITLE PAGE, NO DATE.
- JAMES - BIOG. OF THE BAILEY-MYERS-MASON FAMILY - BIOGRAPHICAL SKETCHES OF THE BAILEY-MYERS-MASON FAMILIES, 1776-1908, BY CASSIE MASON MYERS JULIEN-JAMES. NEW YORK: PRIVATELY PRINTED, 1908
- J.E. - THE JEWISH ENCYCLOPEDIA: A DESCRIPTIVE RECORD OF THE HISTORY, RELIGION, LITERATURE, AND CUSTOMS OF THE JEWISH PEOPLE FROM THE EARLIEST TIMES TO THE PRESENT DAY, NEW YORK: FUNK AND WAGNALLS CO., 1901-1906. 12 V
- JEWS OF RICH. - SEE: EZEKIEL-LICHTENSTEIN/E.L.
- KATZ - BETH EL STORY - THE BETH EL STORY, WITH A HISTORY OF THE JEWS IN MICHIGAN BEFORE 1850, BY IRVING I. KATZ, AND THREE HUNDRED YEARS IN AMERICA, BY DR. JACOB R. MARCUS. DETROIT: WAYNE UNIVERSITY PRESS, 1955
- KENDALL - HIST. OF N.O. - JOHN SMITH KENDALL. HISTORY OF NEW ORLEANS, 3 V. NEW YORK, 1922
- KIRKLAND & KENNEDY - HISTORIC CAMDEN (S.C.), BY T. J. KIRKLAND AND R. M. KENNEDY. COLUMBIA, S.C., 1926
- KORN - BARBADOS WILLS - 'BARBADIAN JEWISH WILLS, 1676-1740', BY BERTRAM W. KORN. IN: A BICENTEN-NIAL Festschrift FOR JACOB RADER MARCUS, EDITED BY BERTRAM WALLACE KORN. WALTHAM, MASS.: AMERICAN JEWISH HISTORICAL SOCIETY; NEW YORK: KTAV PUBLISHING HOUSE, INC., 1976. PP.303-322
- KORN - CARVALHO'S 'INCIDENTS OF TRAVEL' - A CENTENARY EDITION OF INCIDENTS OF TRAVEL AND AD-VENTURE IN THE FAR WEST, BY SOLOMON NUNES CARVALHO. EDITED AND WITH AN INTRODUCTION BY BERTRAM WALLACE KORN. PHILADELPHIA: THE JEWISH PUBLICATION SOCIETY OF AMERICA, 1954
- KORN - JEWS & NEGRO SLAVERY - JEWS AND NEGRO SLAVERY IN THE OLD SOUTH, 1789-1865, BY BERTRAM WALLACE KORN. ELKINS PARK, PA.: REFORM CONGREGATION KENESETH ISRAEL, 1961
- KORN - JEWS OF MOBILE - THE JEWS OF MOBILE, ALABAMA, 1763-1841, BY BERTRAM WALLACE KORN. CIN-CINNATI, O.: HEBREW UNION COLLEGE PRESS, 1970
- KORN - N.D. - THE EARLY JEWS OF NEW ORLEANS, BY BERTRAM WALLACE KORN. WALTHAM, MASS.: AMERICAN JEWISH HISTORICAL SOCIETY, 1969
- LESSER - WEAVE A WREATH OF LAUREL - WEAVE A WREATH OF LAUREL, THE LIVES OF FOUR JEWISH CONTRI-BUTORS TO AMERICAN CIVILIZATION, BY ALLEN LESSER. NEW YORK: THE COVEN PRESS, 1938
- LICHTENSTEIN - VA. LICHTENSTEINS - THE VIRGINIA LICHTENSTEINS, BY GASTON LICHTENSTEIN. RICHMOND, 1936
- LONDON - MINIATURES - MINIATURES OF EARLY AMERICAN JEWS, BY HANNAH R. LONDON. SPRINGFIELD, MASS.: THE POND-EKBERG CO., 1953
- LONDON - PORTRAITS - PORTRAITS OF JEWS BY GILBERT STUART AND OTHER EARLY AMERICAN ARTISTS, BY HANNAH R. LONDON. NEW YORK: WILLIAM EDWIN RUDGE, 1927; REPRINTED: RUTLAND, VT.: CHARLES E. TUTTLE, CO., 1969
- LONDON - SHADES - SHADES OF MY FOREFATHERS, BY HANNAH R. LONDON. SPRINGFIELD, MASS.: THE POND-EKBERG CO., 1941
- MAKOVSKY - THE PHILIPSONS - THE PHILIPSONS, THE FIRST JEWISH SETTLERS IN ST. LOUIS, 1807-1858, BY DONALD I. MAKOVSKY. ST. LOUIS: THE JUDAISM SESOUCENTENNIAL COMMITTEE, THANKSGIVING DAY, 1958
- MALCHELDSE - JUIFS CANADIENNE - 'LES JUIFS DANS L'HISTOIRE CANADIENNE' (CAHIER DES DIX, MONT-REAL, 1939). IN: PUBLICATIONS OF THE MINNESOTA HISTORICAL SOCIETY, 1939, PP.167-195
- MARCUS - E.A.J. - EARLY AMERICAN JEWRY; VOLUME I, THE JEWS OF NEW YORK, NEW ENGLAND, AND CANADA, 1649-1794, BY JACOB RADER MARCUS. PHILADELPHIA: THE JEWISH PUBLICATION SOCIETY OF AMERICA, 1951
- - - EARLY AMERICAN JEWRY; VOLUME II, THE JEWS OF PENNSYLVANIA AND THE SOUTH, 1655-1790. PHILADELPHIA: THE JEWISH PUBLICATION SOCIETY OF AMERICA, 1953
- MARCUS - MEMOIRS OF AMERICAN JEWS, 1775-1865, BY JACOB RADER MARCUS, 3 V. PHILADEL- PHIA: THE JEWISH PUBLICATION SOCIETY OF AMERICA, 1955-1956
- MARCUS - STUDIES - STUDIES IN AMERICAN JEWISH HISTORY, STUDIES AND ADDRESSES, BY JACOB RADER MARCUS. CINCINNATI: HEBREW UNION COLLEGE PRESS, 1969
- MENDES, H. PEREIRA, A BIOG. - H. PEREIRA MENDES, A BIOGRAPHY, BY DAVID DE SOLA POOL. NEW YORK: 1938
- MIGRATION & SETTLEMENT - MIGRATION AND SETTLEMENT, PROCEEDINGS OF THE ANGLO-AMERICAN JEWISH HISTORICAL CONFERENCE, HELD IN LONDON JOINTLY BY THE JEWISH HISTORICAL SOCIETY OF ENGLAND AND THE AMERICAN JEWISH HISTORICAL SOCIETY, JULY 1970. RAPPORTEUR: DR. AUBREY NEWMAN. LONDON: THE JEWISH HISTORICAL SOCIETY OF ENGLAND, 1971
- MOISE - JEW. CEM. AT SUMTER - THE JEWISH CEMETERY AT SUMTER, S.C.; A TRANSCRIPTION OF THE NAMES AND DATES ON THE TOMBSTONES, 1874-1942, BY HAROLD MOISE. SUMTER, S.C., 1942
- MOISE - THE MOISE FAMILY - THE MOISE FAMILY OF SOUTH CAROLINA; AN ACCOUNT OF THE LIFE AND DESCENDANTS OF ABRAHAM AND SARAH MOISE WHO SETTLED IN CHARLESTON, SOUTH CAROLINA, IN THE YEAR 1791 A.D., BY HAROLD MOISE. COLUMBIA, S.C.: R. L. BRYAN, CO., 1961
- MOORE, ETC. - MEN OF THE SOUTH - MEN OF THE SOUTH, EDITED BY D.D. MOORE AND OTHERS. NEW ORLEANS, 1922
- MORAS - JEWS OF PH. - THE JEWS OF PHILADELPHIA, THEIR HISTORY FROM THE EARLIEST SETTLEMENTS TO THE PRESENT TIME, BY HENRY SAMUEL MORAS. PHILADELPHIA: THE LEVYTYPE CO., 1894
- MOSS GEN. - GENEALOGY OF JOHN MOSS AND HIS WIFE REBECCA (LYONS) MOSS, BY SANFORD A. MOSS. RUTLAND, VT.: THE TUTTLE PUBLISHING CO., INC., 1937
- MULLINS - FIRST CENSUS OF TEXAS - MARION DAY MULLINS, THE FIRST CENSUS OF TEXAS, 1829-1836, TO WHICH ARE ADDED TEXAS CITIZENSHIP LISTS 1821-1845, AND OTHER EARLY RECORDS OF THE REPUB- LIC OF TEXAS. WASHINGTON: NATIONAL GENEALOGICAL SOCIETY, 1959. (NGS SPECIAL PUBLICATION #22)
- MYERS, MORDECAI - REMINISCENCES - REMINISCENCES 1780 TO 1814 INCLUDING INCIDENTS IN THE WAR OF 1812-14... WRITTEN BY MAJOR MYERS, 13TH INFANTRY, U.S. ARMY TO HIS SON. WASHINGTON, D.C., 1900

NORFOLK CITY DIR. - NORFOLK, VA. CITY DIRECTORIES, 1852 FF  
N.Y. CALENDAR OF WILLS - NEW YORK CALENDAR OF WILLS ON FILE AT ALBANY, 1626-1836, EDITED BY  
B. FERNOW, NEW YORK, 1896  
N.Y. CITY DIRECTORIES - FROM 1786 FF  
ORCUTT'S HIST. OF STRATFORD, CONN. - A HISTORY OF THE OLD TOWN OF STRATFORD AND THE CITY OF  
BRIDGEPORT, CONNECTICUT, BY SAMUEL A. ORCUTT, 2 V. NEW HAVEN, 1886  
OSTERWEIS - REBECCA GRATZ, A STUDY IN CHARM, BY ROLIN G. OSTERWEIS, NEW YORK AND LONDON, 1935  
PA, ARCH. - PENNSYLVANIA ARCHIVES, SERIES 1 - 9, 121 V.  
PHILIPSON - REBECCA GRATZ - LETTERS OF REBECCA GRATZ, EDITED WITH AN INTRODUCTION AND NOTES  
BY RABBI DAVID PHILIPSON, PHILADELPHIA: THE JEWISH PUBLICATION SOCIETY OF AMERICA, 1929  
PICCIOTTO - SKETCHES OF ANGLO-JEWISH HISTORY, BY JAMES PICCIOTTO, REVISED AND EDITED, WITH A  
PROLOGUE, NOTES, AND AN EPILOGUE, BY ISRAEL FINESTEIN, LONDON: THE SONCINO PRESS LTD., 1956  
POOL - AN OLD FAITH - AN OLD FAITH IN THE NEW WORLD; PORTRAIT OF SHEARITH ISRAEL, 1654-1954, BY  
DAVID AND TAMAR DE SOLA POOL, NEW YORK: COLUMBIA UNIVERSITY PRESS, 1955  
POOL - PORTRAITS - DAVID DE SOLA POOL, PORTRAITS ETCHED IN STONE; EARLY JEWISH SETTLERS, 1682-  
1831, NEW YORK: COLUMBIA UNIVERSITY PRESS, 1952  
POSTAL-KOPPMAN - JEWISH TOURIST'S GUIDE - A JEWISH TOURIST'S GUIDE TO THE U.S., BY BERNARD  
POSTAL AND LIONEL KOPPMAN, PHILADELPHIA: THE JEWISH PUBLICATION SOCIETY OF AMERICA, 1954  
REZNIKOFF - JEWS OF CH. - THE JEWS OF CHARLESTON: A HISTORY OF AN AMERICAN JEWISH COMMUNITY, BY  
CHARLES REZNIKOFF WITH THE COLLABORATION OF URIAH Z. ENGELMAN, PHILADELPHIA: THE JEWISH PUB-  
LICATION SOCIETY OF AMERICA, 1950  
RICE-STIX GEN. - THE GENEALOGY OF THE STIX FAMILY, COMPILED BY AURELIA STIX RICE IN 1921.  
ST. LOUIS, MO., 1921  
ROSENBAACH, H. - JEWS OF PH. - THE JEWS OF PHILADELPHIA PRIOR TO 1800, BY HYMAN POLOCK ROSENBAACH.  
PHILADELPHIA: EDWARD STERN AND CO., 1883  
ROSENBLUM - DICT. OF AMER. JEW. BIOG. - A BIOGRAPHICAL DICTIONARY OF EARLY AMERICAN JEWS, COLO-  
NIAL TIMES THROUGH 1800, BY JOSEPH R. ROSENBLUM. (LEXINGTON, KY.:) UNIVERSITY OF KENTUCKY  
PRESS, C1960  
ROSENSTEIN - EILEH TOLEDOT, THESE ARE THE GENERATIONS; GENEALOGICAL DETAILS OF THE ORIGIN OF  
KATZENELLENBOGEN FAMILY AND ITS DESCENDANTS, INCLUDING INTERRELATED FAMILY PEDIGREES, BY N.  
ROSENSTEIN, PRIVATELY PRINTED, 1969. (REVISED AS: THE UNBROKEN CHAIN; BIOGRAPHICAL SKETCHES  
AND THE GENEALOGY OF ILLUSTRIOUS JEWISH FAMILIES FROM THE 15TH-20TH CENTURY, NEW YORK: SHEN-  
GOLD PUBLISHERS, INC., C1976)  
ROSEN(S)WAIKE - 1790 CENSUS - 'AN ESTIMATE AND ANALYSIS OF THE JEWISH POPULATION OF THE UNITED  
STATES IN 1790', BY IRA ROSEN(S)WAIKE, IN: AJJHS, VOL. L, SEPTEMBER, 1960, NO. 1, PP.23-67  
ROSEN(S)WAIKE - 1820 CENSUS - THE JEWISH POPULATION OF THE UNITED STATES AS ESTIMATED FROM  
THE CENSUS OF 1820, BY IRA ROSEN(S)WAIKE, IN: AJJH, VOL. LIII, DECEMBER, 1963, NO. 2, PP.131-178  
ROTH - ANGLO-JEWISH LETTERS - ANGLO-JEWISH LETTERS (1158-1917), EDITED BY CECIL ROTH, LONDON:  
THE SONCINO PRESS, 1938  
ROTH - GREAT SYNAGOGUE - THE GREAT SYNAGOGUE, LONDON, 1690-1940, BY CECIL ROTH, LONDON: EDWARD  
GOLDSTON & SON LTD., 1950  
ROTH - RISE OF PROVINCIAL JEWRY - THE RISE OF PROVINCIAL JEWRY; THE EARLY HISTORY OF THE JEWISH  
COMMUNITIES IN THE ENGLISH COUNTRYSIDE, 1740-1840, BY CECIL ROTH, LONDON: THE JEWISH MONTHLY,  
1950  
RUSSELL - HAYM SALOMON - HAYM SALOMON AND THE REVOLUTION, BY CHARLES EDWARD RUSSELL, NEW YORK:  
COSMOPOLITAN BOOK CORPORATION, 1930  
SAMUEL - REC. OF THE SAMUEL FAMILY - RECORDS OF THE SAMUEL FAMILY COLLECTED FROM ESSAYS, MSS.,  
AND OTHER SOURCES, BY J. BUNFORD SAMUEL, PHILADELPHIA: J. B. LIPPINCOTT CO., 1912  
S.A.R. REC. - A NATIONAL REGISTER OF THE SOCIETY, SONS OF THE AMERICAN REVOLUTION, COMPILED  
BY LOUIS H. CORNISH, NEW YORK, C1902  
SCOTT - N.Y. ADMIN. - KENNETH SCOTT, GENEALOGICAL DATA FROM ADMINISTRATION PAPERS FROM THE  
NEW YORK STATE COURT OF APPEALS, NEW YORK, N.Y., 1972  
SCOTT - POST-BOY - GENEALOGICAL DATA FROM THE NEW YORK POST-BOY, 1743-1773, BY KENNETH SCOTT,  
WASHINGTON, D.C.: NATIONAL GENEALOGICAL SOCIETY, 1970. (NGS SPECIAL PUBLICATION NO.35)  
SH./SHILSTONE - MONUMENTAL INSCRIPTIONS IN THE BURIAL GROUND OF THE JEWISH SYNAGOGUE AT BRIDGE-  
TOWN, BARBADOS, TRANSCRIBED WITH AN INTRODUCTION BY E. M. SHILSTONE, LONDON: THE JEWISH HIS-  
TORICAL SOCIETY OF ENGLAND, N.D.; NEW YORK: AMERICAN JEWISH HISTORICAL SOCIETY, N.D.  
SNOWDEN - HIST. OF S.C. - HISTORY OF SOUTH CAROLINA, BY YATES SNOWDEN, 5 V. NEW YORK, 1920  
STILES - LITERARY DIARY - THE LITERARY DIARY OF EZRA STILES, PRESIDENT OF YALE COLLEGE, EDITED  
UNDER THE AUTHORITY OF THE CORPORATION OF YALE UNIVERSITY, BY FRANKLIN BOWDITCH DEXTER, 3 V.  
NEW YORK, 1901  
STIX, LOUIS - REMINISCENCES - LOUIS STIX, REMINISCENCES, CHRONICLED AS A RECREATION IN HIS  
LATER YEARS (1821-1902), SECOND EDITION, 1963  
STRYKER-RODDA, HARRIET - PRICE-GOLDSMITH-LOWENSTEIN AND RELATED FAMILIES, 1700-1967, FROM THE  
COLLECTED NOTES OF KATHERINE GOLDSMITH-LOWENSTEIN, BY HARRIET STRYKER-RODDA, EDITOR, NEW  
YORK, 1967  
TELLER FAMILY IN AMERICA - TELLER FAMILY IN AMERICA, 1842-1942, BY CHESTER J. TELLER, PHILA-  
DELPHIA, 1944  
THE OLD MERCHANTS - THE OLD MERCHANTS OF NEW YORK CITY, BY WALTER BARRETT, CLERK, NEW YORK:  
CARLETON, 1874  
TRACHTENBERG - CONSIDER THE YEARS; THE STORY OF THE JEWISH COMMUNITY OF EASTON, 1752-1942, BY  
JOSHUA TRACHTENBERG, EASTON, PA.: CENTENNIAL COMMITTEE OF TEMPLE BRITH SHOLOM, 1944  
TUCKER - NFK. MARRIAGE BONDS - ABSTRACTS FROM NORFOLK CITY MARRIAGE BONDS (1797-1850) AND  
OTHER GENEALOGICAL DATA, COMPILED AND ANNOTATED BY GEORGE HOLBERT TUCKER, NORFOLK, VA.:  
WILLIAM H. DELANEY, 1934  
U.J.E. - THE UNIVERSAL JEWISH ENCYCLOPEDIA; AN AUTHORITATIVE AND POPULAR PRESENTATION OF JEWS  
AND JUDAISM SINCE THE EARLIEST TIMES, 10 V. NEW YORK: THE UNIVERSAL JEWISH ENCYCLOPEDIA,  
INC., 1939-1943  
VALENTINE'S MANUAL - VALENTINE'S MANUAL OF THE CORPORATION OF THE CITY OF NEW YORK, EDITED BY  
DAVID T. VALENTINE, 26 V. 1841-1866, NEW YORK.  
WATTERS - PIONEER JEWS OF UTAH - THE PIONEER JEWS OF UTAH, BY LEON L. WATTERS, NEW YORK:  
AMERICAN JEWISH HISTORICAL SOCIETY, 1952. (STUDIES IN AMERICAN JEWISH HISTORY, NO.2)  
WHITEMAN - COPPER FOR AMERICA - COPPER FOR AMERICA, THE HENDRICKS FAMILY AND A NATIONAL INDUS-  
TRY, 1755-1932, BY MAXWELL WHITEMAN, NEW BRUNSWICK, N.J.: RUTGERS UNIVERSITY PRESS, C1971  
WILSON - ANNALS OF GA. - CAROLINE PRICE WILSON, ANNALS OF GEORGIA; IMPORTANT EARLY RECORDS OF  
THE STATE, V.III: MORTUARY RECORDS, ATLANTA, 1933  
WINSTOCK GEN. - THE WINSTOCKS OF SOUTH CAROLINA, BY EVELYN ROSENBERG GROSS, COMPILED IN GREEN-  
WOOD, S.C., 1961-62  
W.W./ WOLF-WHITEMAN - THE HISTORY OF THE JEWS OF PHILADELPHIA FROM COLONIAL TIMES TO THE AGE OF  
JACKSON, BY EDWIN WOLF, 2D, AND MAXWELL WHITEMAN, PHILADELPHIA: THE JEWISH PUBLICATION SO-  
CIETY OF AMERICA, 1957



*Update*

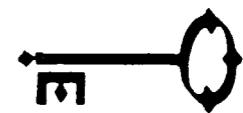



U P D A T E

1. ABENDANONE-COHEN DELMONTE  
GRACE, B.1782;D.DEC.22,1957,NY (OCCIDENT)
4. ABRAHAMS III ABRAMS  
CATHERINE COHEN (VID. MORDECAI II)
- MORDECAI = SARAH LEVY AND HAD:  
MARTHA M. ROBERT ROWE AND HAD:  
JOSEPH (JUDGE, MAYOR OF ST. LOUIS), M. MARGARET ELISA BOICE
- ALEXANDER, M. ELIZABETH JOSEPH, AND HAD:  
CATHERINE (KATE), M.JAN.5,1864, SAV., ADOLPHUS ALEXANDER HEZEKIEL ABRAHAMS (Q.V II)  
FRANCES, M. SALOMON COHEN (JUL.22,1846-JUL.7,1894, SAV.)  
JESSIE, M. DR. WOLF WEICHELBAUM (WAXELBAUM)  
JACOB M. (JACK), B.NOV.26,1847;D.OCT.9,1887, SAV. UNM.  
ELLEN, M. FLEISHMAN OF NY  
ISABEL (BELLE), M.ISAIAH BRADY (VID. MOSES III(1))  
ALEXANDER HAMILTON, D. YOUNG  
JOSEPH M. [BRUNSWICK, GA]  
VICTOR (USA); D.UNM. (MRS. J. R. MC DAVID)
5. ABRAHAMS II  
MARION, M. BENJAMIN HIRSCH LEVY, B.AUG.24,1912 AND HAD:  
JOAN, M. GARY MICHAEL LEVY (MAR. 1942-), AND HAD:  
JONATHAN  
JENNIFER LEIGH, B.DEC.9,1974  
BENJAMIN H. JR.,M.OCT.12,1975, JACKSONVILLE, FL, MARJORIE EDITH EDWARDS (JACK-SONVL. APR.21,1951-), AND HAD:  
BENJAMIN H. III, B.DEC.19,1978, SAV.  
ELIZABETH JEAN, B. JAN.25,1982, SAV. (B. H. LEVY)
11. ANCKER (1)  
ADOLPH ANCKER, B.1774, HAMBURG, GER.;D.JUN.22,1850,CINCINNATI,OH (UNITED HEBREW CEMETERY)
- MÖSES, M.JUN.15,1881, PH CARRIE, DAU. OF MORITZ LOEB (BETH EL EMETH MARRIAGES)
12. ANDREWS I  
ALBERT [DREYFOUS] MAUD HECKMAN AND HAD:  
HOWARD, M. ANNE WACKER AND HAD:  
PAUL GOMEZ, M.1) PATRICIA WANG; M.2) RUTH CAMPBELL AND HAD:  
SANDRA GOMEZ, M. CALAGOROPOULOS  
LEE HENDRICKS  
JEFFREY SCOTT  
CHRISTOPHER PAUL (PAUL G. DREYFOUS)
- EDITH E. (GOLDBAUM) M. JACOB PERES LOWENSTEIN AND HAD:  
LOUISE, B.NOV.12,1913, MEMPHIS;M.JUL.15,1935, EDWARD LEVY (B.JUN.9,1911, PORT ALLEN, LA.) AND HAD:  
EDWARD D., JR., B.AUG.8,1937,N.O.  
EDITH F., B.MAY 23,1940;M.AUG.4,1961, PAUL D. ROSENBLUM (B.JAN.31,1938,N.O.) AND HAD:  
PAUL S. JR.,B.NOV.5,1963,N.O.  
LOUISE NATALIE, B.SEP.14,1965, N.O. (JOSEPH L. ANDREWS, JR.)
13. ARNOLD  
AARON ARNOLD  
MAYER HAD:  
ISABELLA, M. ISAAC BERNHEIMER, B.JEDENHAUSEN, BAV., 1813;D.JUL.25,1893,NY  
CLARISSA M. ERNEST NUSBAUM AND HAD:  
ARTHUR A., B. DEC.13,1851  
MAYER ARNOLD, B. NOV.29,1852  
FANNY, B.JUL.16,1856  
EDGAR, B.JUL.16,1858  
HENRIETTA, B.FEB.6,1860 (RODEPH SHALOM)  
EZRA, M.DEC.26,1877, PH (BETH EL EMETH MARRIAGES)  
ABRAHAM, B.FEB.9,1800, IBENHAUSEN (ARR. US,JUL24,1824), D.FEB.9,1872,BALTO;  
M.MAR.23,1826, PH., MARIA (MARY) ABRAMS (PA, MAY 13,1811-OCT.10,1883, MO;  
DAU. OF LEVI ABRAMS (MAR.25,1769-DEC.30,1833, PA;M.1810, PA, ROSEANNA LINDERMAN

- (AMST., DEC.17,1787-1848,PA). ABRAHAM AND MARIA HAD:  
ISABELLA, B.MAR.27,1829, PA;M.SEP.7,1847, HENRY SIMON, AND HAD:  
ED  
ANNA  
LEVI  
MEYER  
JOSEPH  
FRANKLIN  
AARON [ALL D.UNM.]  
AMANDA, B.MAR.3,1831, PA;D.MAR.9,1853, VA;M.SEP.19,1848, SAM SPRINGER, AND HAD  
SON, ADOPTED BY ISABELLA & HENRY SIMON  
LEVI, B.DEC.21,1833, PA;M.DEC.2,1866, ST.L.;M. AMELIA WOLFF, AND HAD:  
FRED, M. LOUISE SCHMIDT  
EMMA, M. BEN ZUGENT  
SADIE, M.1) JACOB ROHR; M.2) FRANKLIN;M.3) PFIFER  
MIRIAM, B.DEC.8,1835, PA;D. IN FIRE;M.1)JAN.18,1857, COL. MARCUS HESS;M.2) JOSEPH KELLER. D.S.P.  
SIMON J., B.OCT.24,1838;D.JUL.24,1889, ST.L.;M.FEB.19,1871, MIRIAM LEVI, AND HAD:  
ABRAHAM CLARK, B.JUN.9,1872, ST.L.;D.MAR.19,1942, CA;M.JAN.4,1904, TX, MARY E. FROST, AND HAD:  
MARY ELIZABETH  
HESTER  
JANE  
ABRAHAM CLARK, JR.  
LEWIS TRACY, B.FEB.10,1874, ST.L.;D.OCT.2,1960, ST.L.;M.JUN.1,1898, FRIEDA MAYER, AND HAD:  
SANDFORD  
CATHERINE  
EMMA, B.OCT.24,1875, ST.L.;D.AUG.28,1925, ST.L.;M.FEB.28,1899, ST.L., CHARLES S. ERBER, AND HAD:  
SIMON ARNOLD  
CHARLES S., JR.  
LOIS ESTELLE  
SIMON J., JR., B.JUL.13,11881, ST.L.;D.FEB.3,1950, ST.L.;M.OCT.5,1915, MYRTLE SCHERE, AND HAD:  
SIMON J. III  
RICHARD MYRTEN, M. MARY HANEY  
MYRA, B.NOV.16,1885, ST.L.;M.AUG.6,1907. ST.L., SAMUEL KOBER, AND HAD:  
MURIEL JUNE  
LEON (LEVI), B.OCT.30,1887, ST.L.;D.JAN.27,1969, TX;M.SEP.14,1913, LILLIAN GOLDSTEIN. D.S.P.  
AARON, B.DEC.17,1840, PA;D. UNM.  
AMELIA, B.FEB.14,1843, PA;D.1896;M.MAR.21,1866, PA, ABRAHAM VICTOR, AND HAD:  
ISADORE, B. ST.L;D. TX;M. HANNAH BODENHEIMER, AND HAD:  
ISADORE ARNOLD  
MINNIE, M. JACOB WOLFF, ANND HAD:  
ERNA  
WALTER  
CORINNE  
BELLE, M. HARRY STARR, AND HAD:  
EDNA  
SADIE  
ALBERT, D.UNM.  
EDWARD, B.JUN.28,1845, PA;D. UNM.  
LAVINIA, B.NOV.28,1847, BALTO.;M.SEP.2,1868, PA, MOYAS LONGINI, AND HAD:  
EMMA  
LEON  
EMMA, B.FEB.16,1852, PA;D.FEB.19,1873;M.JUN.9,1872, PH, EMMANUEL WEYLE. S.P.  
CLARA, B.APR.6,185-?;M.OCT.18,1876, ABRAHAM E. COHN, AND HAD:  
ALICE  
FANNY, B.AUG.17,185-?;M.AUG.22,1880, MO,, EMMANUEL KAHN, AND HAD:  
CLARA (MRS. RICHARD M. ARNOLD)
15. BARNET (2)  
THEODORE [TANNENWALD], JR., M. SELMA RUTH PETERFREUND AND HAD:  
PETER, M.MAY 1969, CAROL BAUM AND HAD:  
JONATHAN, B.NOV. 1983  
ROBERT, B.MAR.16,1947;M.1979, LESLIE K- AND HAD:  
ALAN, B.JUN.1983  
DAVID, B.SEP.1985 (THEODORE TANNENWALD, JR.)

16. BARNET (3)  
 WILLIAM BARNET, B. SYRACUSE; D. ALBANY; M. ROSE BLATNER, (-ALBANY), AND HAD:  
 ESTHER, M. CHARLES STERN, AND HAD:  
 WILLIAM, M. LOUISE MAYER, AND HAD:  
 JOAN B., M. JOEL GINGUS  
 CHARLES III, M. LINDA MACPIKE, AND HAD:  
 ADAM  
 NOAH  
 ROBERT L. [STERN], D. 1987, M. HELEN BURGHER AND HAD:  
 SUSAN B., M. STEPHEN GEMBERLING AND HAD:  
 JOHN SAMUEL, B. FEB. 1, 1981  
 ESTHER BARNET (BONNIE), M. & DIV.  
 RICHARD, M. THERESA MULQUEENIE AND HAD:  
 SARA HELEN, B. 1980  
 ROBERT JACOB  
 JOSEPH  
 HENRY, M. SELMA EINSTEIN, AND HAD:  
 MINNA, M. EUGENE NATHAN (1911-), AND HAD:  
 SALLY, M. GRAHAM LUCK, AND HAD:  
 JONATHAN  
 MARY  
 GENE [DEL. EUGENE, JR.], B. 1942; D. 1963; M. PETER STONE  
 WILLIAM II, M. MARY GUNST, AND HAD:  
 CAROL, M. DEC. 27, 1964, RABBI ALAN FUCHS, AND HAD:  
 DOUGLAS STEVEN  
 DANIEL ADAM  
 GATES  
 ROSALIE  
 GRACE, M. LEO MUELFELDER, AND HAD:  
 LEWIS, M. ADELAIDE DE BEER (1920-), AND HAD:  
 JAMES LEO, M. BARBARA HAYES, AND HAD:  
 JOSHUA  
 MARGARET, M. STANFORD WESSLER (1917-), AND HAD:  
 JOHN, M. FREDI HURWITZ  
 STEPHEN, M. ELLEN FREED  
 JAMES (MUELFELDER-BARNET GEN.)
16. BARNETT V  
 NATHAN BARNETT M. ELIZABETH ("BAT JOSEPH"), WHO M. 2) NAPHTALI HART,  
 B. 1768  
 ELIZABETH HAD A SISTER, CLARA PIKE  
 NATHAN AND ELIZABETH HAD:  
 JONAS, M. MIRIAM (MARIA) MARKS AND HAD:  
 JONAS THEODORE (DOROTHEE H. CAROUSSO)
18. BENJAMIN I  
 PHILIP BENJAMIN, M. HANNAH DE LEON AND HAD:  
 JUDAH, D. MAR. 22, 1820; M. HANNAH (-MAR. 22, 1820) AND HAD:  
 PHILIP, B. 1779; D. JUN. 11, 1852, CH; M. REBECCA MENDES, (-1847) AND HAD:  
 JUDAH PHILIP, M. NATALIE ST. MARTIN, (-1891)  
 HARRIET (HANNAH) MENDES, B. FEB. 1, 1809  
 JACOB LEVY, B. MAR. 20, 1818, FAYETTEVILLE, NC  
 EMANUEL, M. ESTHER (ST. THOS., 1789-OCT. 3, 1871, ST. THOS.) AND HAD:  
 (ALL B. ST. THOS.)  
 HANNAH, B. DEC. 29, 1808  
 RACHEL, B. JUL. 7, 1810  
 DAVID, B. FEB. 18, 1813; D. JAN. 19, 1890, UNM.  
 SARAH, B. JUN. 11, 1814  
 SOLOMON, B. JUL. 28, 1816  
 ZIPORAH, B. SEP. 30, 1817  
 MOSES, M. HANNAH DE PINNA, B. & D. ST. THOS. AND HAD:  
 SALOMON, M. RACHEL CAPPE, AND HAD:  
 MIRIAM ESTHER, M. BENJAMIN FRIEDENBERG, AND HAD:  
 SYLVIA, M. SYLVAN GROSNER, AND HAD:  
 JOAN, M. THOMAS FROMM, AND HAD:  
 TIMOTHY ALLEN  
 STEPHEN GROSNER  
 DAVID, B. JAN. 14, 1831  
 ABRAHAM, B. AUG. 25, 1829  
 ALEXIS, B. JAN. 20, 1840 (ST. THOS RECS.; ELI EVANS -JUDAH P. BENJAMIN)
19. BENJAMIN II  
 SARAH, M. SAMUEL LYONS AND HAD:

MIRIAM M. EMANUEL BELASCO [HIS BROTHER ALBERT (Q.V. HART I)]. THEY HAD:  
 WALTER  
 ALBERT  
 ENA (INEZ)  
 VIOLA, L. IN FLA., UNM. (VID. HART I) (EVELYN MILLER)

22. BINSWANGER (2)  
 ELLA, D. 1913; M. JULIUS OPPENHEIMER AND HAD:  
 FRANK FRIEDMAN, B. NY; D. FEB. 3, 1985, SAUSALITO, CA; M. 2) MILLIE  
 AND HAD (BY 1)  
 JUDITH, L. IN SAN JCSE, CA  
 MICHAEL, L. IN BOW, WA (OBIT, NY TIMES, 2/4/85)
23. BINSWANGER (3)  
 RABBI CHARLES I. HOFFMAN, D. JUNE 8, 1945
24. BLOOMINGDALE  
 HENRY, M. GRACE HUGHES (ALTSCHULER, "ESTATE OF FLORENCE RHINE")  
 ESTHER, M. FEB. 23, 1876, PH  
 FLORENCE, M. FEB. 26, 1874, PH (BETH EL EMETH MARRIAGES)
25. BLOCK II  
 SIMON, SR., B. BEF. 1742, SCHWIAU, BOHEMIA; D. 1832, CINTI.; M.  
 AND HAD:  
 JACOB (BALTO., RI.), D. 1835; M. AND HAD:  
 ELEAZER, B. MAR. 26, 1797, WILLIAMSBURG, VA; D. FEB. 2, 1886, N.O.; M. 182-?, RI., ABIGAIL  
 DE PAZ (VID. DE PASS II), AND HAD:  
 ROSALIE, B. NOV. 20, 1828; D. 1911; M. GEORGE JONAS (Q.V.)  
 SARAH DE PASS, M. CHARLES HENRY JONAS (Q.V.)  
 JOSEPHINE, M. BENJAMIN F. JONAS (Q.V.)  
 ELEANOR, M. 1852, NY, HENRY J. LABATT (Q.V.)  
 HERMAN MENDELSON (DEL RIO, TX), B. JUN. 1841; M. JENNIE SAMPSON  
 LOUISA SALOME  
 DAVID JUDAH (DECATUR, IL), M. SALLY  
 REHINE DAVID (IN N.O. BY 1853)  
 LOUISA, M. CINTI.  
 ELINOR, M. CINTI.  
 SIMON, JR.  
 [DEL. DELIA, M. PENEAS BLOCK]  
 ELIZABETH, M. ST. LOUIS, JACOB PHILIPSON (Q.V.)  
 LEVI (BALTO.)  
 BRIDESSE, M. HENRY WOODYARD  
 WOLF (WILLIAM), M. MAY 30, 1790, RI., SUSANNA, DAU. OF TURNER HUDSON (SHE D. 1855)  
 AND HAD:  
 NANCY, D. 1854, UNM.  
 DELIA, M. PHINEAS BLOCK  
 ABRAHAM, (RICHMOND, CHARLOTTESVILLE, WASHINGTON, AR)  
 (M. B. DARRISH; IRA ROSENWAIKE IN AJA, NOV. 1979; GORDON GRAY)
28. CADET  
 JOSEPH SCHONEMAN, M2) MAY, 1887, LAURA LEHMAN OF BURLINGTON, IA  
 (JEWISH EXPONENT)
29. CARDOZO [DELETE CARDOZA]  
 ANITA ROSALIE, (MI) JEROME MILES DOUMOUX, AND HAD:  
 JEROME M., JR., M. LAURIE FERGUSON, AND HAD:  
 DIANE GABRELLE  
 MICHAEL H. IV, B. SEP. 15, 1910; M. ALICE CORNEILLE, AND HAD:  
 MICHAEL H. V, M. AND HAD:  
 DEN REBECCA  
 JULIA LOUISA  
 JULIA ALINE, M. CHARLES R. EISENDRATH AND HAD:  
 BENJAMIN CARDOZO  
 MARK WILLIAM  
 [DEL. REBECCA]  
 ALICE REBECCA  
 PETER, JR., M. NANCY KOENIG AND HAD:  
 BARBARA  
 BENJAMIN MORDECAI, M. BARBARA SCHAFER, AND HAD: (MICHAEL H. CARDOZO IV)  
 ELLEN SCHAFER, M. JAN. 15, 1978, NY, ISAAC DAVID SONSINO (B. CAIRO, EGYPT)

(NEW YORK TIMES 1/16/1978)

30. CARVALHO

DAVID NUNES M. SARAH D'AZEVEDO, AND HAD:  
CLARA, M. BALTO., SOLOMON MICHAEL HYAMS, AND HAD:  
SARAH, D. UNM.  
ISABEL  
DAVID NUNES CARVALHO, M. FERNELLA W- , AND HAD:  
DAVID N. C., JR.  
GODFREY M., B. AUG. 22, 1859, BALTO.; D. OCT. 7, 1927, BOSTON, MA; M. MARY IRENE  
ABERCROMBIE (WILL OF GODFREY M. HYAMS, TONY LUCAS)

34. COHEN V

ALFRED LYONS OF VIENNA, M. LADY SARAH HYATT, OF ABERGAVENNY, WALES, DAU. OF  
THE EARL OF CUMBERLAND, AND HAD:  
ERNESTINE ESTHER, M. JACOB, SON OF ASHER COHEN, AND HAD:  
SAMUEL, M. DINAH, DAU. OF ISAAC SIMMONDS AND MARY (DAVIS) AND HAD:  
JACOB S., M. MAY 6, 1861, CH.  
ANNIE, M. CHARLES MYERS, AND HAD:  
BERTIE, M. ARTHUR MORRIS AND HAD:  
VIRGINIA, M. EARLE KINCAID (CAPT. USN), AND HAD:  
VIRGINIA EARLE  
EARLE, JR.  
DORA, M. COLBY WALTON  
ANNETTE, M. HERBERT KNAPP (DIV.)  
BERTHA, M. ELWOOD CHILDERS, AND HAD [ISSUE]  
MAURICE SAMUEL, M. ROSALIE MEYER, AND HAD:  
IRA, M. D., M. 2) DOROTHY DRYFUS  
MARIADINA, M. THEODORE STIVER, AND HAD:  
RICHARD, M. JUDITH AND HAD:  
LAURA  
ANITA, M. 1) RUDOLPH VOGEL; M. 2) RICHARD SKLARSKY, AND HAD (BY 1)  
MARGARET, M. DOUGLAS SHELDON, AND HAD: 3 CH.  
JUDITH (EMILY TURK OBST, RICHARD L. COLLEN)

36. COHEN VIII (2)

REBECCA, B. NOV. 2, 1797, CH.; M. FEB. 16, 1814, CH.  
(KETUBAH IN "AMERICAN JEWISH FOLK ART" EXHIBIT, JEWISH MUSEUM, NY)

PHILIP, M. SEP. 25, 1878, ABINGTON, PA. (BETH EL EMETH MARRIAGES)

OCTAVIA, B. NOV. 5, 1833 SAV.; D. 1896/7; M. FEB. 6, 1856, SAV.; ELEAZER HART COHEN  
(B. JAN. 12, 1819; D. AUG. 27, 1887, MADISON, GA, AND HAD:

SAMUEL BARNETT, B. JUL. 4, 1857; D. FEB. 2, 1909; M. 1) APR. 21, 1886, MADISON, GA, ELIZA  
BELL FOSTER; M. 2) ELLA COX; M. 3) DEC. 31, 1903, AUGUSTA COPELAN (B. OCT. 1, 1877;  
D. AUG. 4, 1979), AND HAD:

(BY 1)  
FOSTER ELEAZER, B. JUN. 8, 1887, MADISON, GA.

(BY 3)  
VICTORIA BILLUPS, B. JUL. 11, 1906; M. JUN. 27, 1927, GEORGE MILLER CLARKE, JR.,  
AND HAD:

GEORGE M. III, B. DEC. 3, 1930, ATHENS, GA.  
JOHN SAMUEL, B. FEB. 17, 1936, DANVILLE, VA.  
REBECCA, B. NOV. 7, 1857; D. ; M. FEB. 1, 1881, MADISON, GA., EDGAR PON, AND HAD:

LEWIS COHEN, B. JAN. 21, 1882  
MAUD LUCILLE, B. MAR. 19, 1883; D. OCT. 11, 1883  
EDNA, B. JUN. 7, 1886

ELEAZER ISAAC, B. AUG. 23, 1862  
INF., B. JAN. 11, 1865; D. JAN. 14, 1865  
INF., B. MAR. 30, 1866 (VICTORIA COHEN CLARKE)

38. COHEN IX (S.C.O)

AARON NATHAN COHEN, B. JAN. 2, 1777, LOND.; M. 1) ZIPPORAH (B. 1778;  
D. JAN. 11, 1810, LOND.); M. 2) RACHEL , AND HAD:

(BY 1)  
ELIZABETH, B. 1802, LOND.  
NATHAN A., B. MAR. 8, 1805, LOND.; M. CH., CLARA HARRIS, AND HAD:  
ELIZABETH, B. AUG. 9, 1833, CH.; M. LEOPOLD COHN  
LAVINIA, B. SEP. 7, 1844, CH.; M. MAY 6, 1861, CH.

(BY 2)  
CLARA NATHAN, B. JAN. 20, 1812  
AARON N., JR., B. MAY 26, 1828

ZIPPORAH, B. APR. 24, 1830  
HARRIET, M. SIMEON FRANKFORD  
[DEL. HENRY - NOT IN THIS FAMILY] (ROBERT L. CULLEN)

39. COHEN X (2)

JOHN J. (JACOB I.) HAD:  
SANDFORD, L IN AUGUSTA, GA  
JOHN J. JR., L IN AUGUSTA, GA  
C. HENRY, B. 1854, CH.; D. JAN. 9, 1924, AUGUSTA, GA, AND HAD:  
RODNEY S., AND HAD  
RODNEY, JR. (JACK J. STEINBERG, "THE JEWS OF AUGUSTA", ANCESTORING XII)

40. CONTENT

JAMES SELIGMAN, B. APR. 14, 1824, BAIERSDORF, BAV.; D. AUG. 20, 1916; M. ROSA [CONTENT],  
B. SEP. 17, 1834; D. DEC. 17, 1907, AND HAD:  
DE WITT J. (DAVID), M. ADDIE BERNHEIMER, AND HAD:  
ALMA, M. 1) FRANK SELIGSBERG; M. 2) WALTER HOCHSTADTER. BY 1 SHE HAD:  
MARJORIE  
SUSAN, M. 1) BENNETT GALEF; M. 2) BENJAMIN MILLER  
JANE, M. 1) DR. LEONARD DRUCKERMAN; M. 2) EDWARD MORRIS  
ETHEL, M. EDGAR DINKELSPIEL (Q.V. BELOW)  
JAMES, D.S.P.  
EUGENE, D. UNM.  
FLEURETTE, M. BENJAMIN GUGGENHEIM, AND HAD:  
BENITA, D. INF.  
PEGGY  
HAZEL (GERALD DINEL)

45. DAVEGA

ISAAC, M. GRACE LABATT, AND HAD:  
BENJAMIN FRANKLIN, B. JUL. 4, 1819; D. AUG. 27, 1891, YOUNTVILLE, CA; M. CECILIA  
ALICE JOSEPH (B. CH.; D. 1893, S.F.) AND HAD: (ALL B. IN S.F.)  
JOSEPH, B. APR. 24, 1861; D. JUL. 13, 1913; M. NADINE HARGREAVES [WIDOW OF HIS  
BROTHER - BELOW], AND HAD:  
NADINE CECILIA, B. FEB. 12, 1909, S.F.; D. APR. 23, 1982, BERKELEY, CA; M. AUG. 5, 1928,  
HERMAN BRUCE THOENI, JR. (B. FEB. 15, 1905; D. AUG. 15, 1959, AND HAD:  
HERMAN B. III, B. SEP. 2, 1932; D. SEP. 15, 1956, SHIRLEY ANN EGERER, AND HAD  
ISSUE  
JANICE MARIE, B. MAR. 22, 1935; M. AUG. 19, 1956, ROBERT EDWARD COX (B. JUN.  
9, 1932), AND HAD:  
KEVIN TIMOTHY, B. APR. 24, 1959, BERKELEY, CA; M. NOV. 7, 1981, REBECCA ANN  
WOLF, AND HAD:  
TIFFANY THEODORA, B. AUG. 11, 1982, CONCORD, CA  
COLEEN ROBIN, B. MAR. 26, 1961, BERKELEY, CA  
LYNDA MARIE, B. FEB. 9, 1970, YOKOSUKA, JAPAN  
KAREN MICHELLE, B. JAN. 13, 1972, BERKELEY, CA  
JEFFERSON EDGAR, B. JUL. 24, 1862; D. AUG. 30, 1931, OAKLAND, CA; M. CA. 1884, ELBONORE  
V. DARCHE  
ISAAC, B. 1863; D. FEB. 2, 1907; M. NADINE HARGREAVES (B. APR. 22, 1885; D. OCT. 30, 1918  
ABRAHAM HENRY, M. D., B. NOV. 25, 1823; D. AUG. 6, 1897, CHESTER, SC; M. ELIZA MC CLURE,  
OF CHESTER, SC, AND HAD:  
SUMTER MC CLURE, B. 1860; D. 1902; M. KATE CANNON, AND HAD ISSUE  
IRENE, B. 1864; D. 1945; M/ D. SLIGH  
LEILA, B. JUL. 9, 1866; D. JUN. 27, 1926; M. DR. W. B. COX, OF CHESTER, SC  
JESSIE, B. 1868; M. J. D. MEANS  
ELIZA JANE, B. 1869  
FLORENCE, B. 1870  
MARY, B. 1871  
GRACE, B. 1873; D. 1940  
ALEXANDRINA, B. 1876; D. 1943; M. ROSS C. STANFORD (JANICE M. THOENI COX)

ISAAC DAVEGA, B. 1860; D. OCT. 12, 1921, NY; M. REBECCA LOUSE MOSES, AND HAD:  
ABRAM DAVID, M. SADIE DELMONTÉ (D. FEB. 16, 1894) AND HAD:  
RICHARD, B. SEP. 18, 1925; M. HOPE WEISS (B. MAY 5, 1926), AND HAD:  
RICHARD, B. APR. 4, 1949, FOREST HILLS, NY; M. TRISH, AND HAD:  
PAMELA, B. SEP. 19, 1970  
JAIME, B. AUG. 17, 1955, JAMAICA, NY  
MARIE, M. BYRON FORSTER (RICHARD DAVEGA; N.Y. TIMES OBIT. 10/13/1921)

46. DAVID (1)

LAZARUS DAVID, M. PHOEBE SAMUEL (D. 1785), AND HAD:  
BRANDELE ABIGAIL, D. 1840  
CAPT. DAVID, D. 1833



SAMUEL, M.SEP.4, 1810  
FRANCES (FANNY), M. LT. MYER (CANADIAN JEW. ARCHIVES, #19-23)

48. DAVIS I (1) (VA)

DAVID DAVIS, M. ESTHER MORDECAI/MORRIS, AND HAD:  
MARIA, M. AS HIS 2ND WIFE  
HENRY, M. AND HAD:  
GEORGE H., M.10, AND HAD:  
CORINNE, M.MAR.8,1882, PETERSBURG, VA, JULIAN HILLEL LEVY  
(BETH EL EMETH MARR.)

52. DE CORDOVA (1)

MOSES RAPHAEL, D.AMST., JUL.2,1649, AND HAD:  
JACOB HAIM, D.AMST, JUN.20,1714, AND HAD:  
MOSES, D.FEB.19,1701, AMST.  
ESTHER, D.FEB.13,1700  
ABRAHAM, D.OCT.30,1740, AND HAD:  
CLARA, D.MAR.28,1740 (AMST. MUNICIPAL ARCHIVES)

58. DE PASS II

RALPH, M.2) SARAH (SALLY) JUDAH, AND HAD:  
ABIGAIL, B.1800;D.NOV.16,1893, N.O.;M. ELIEZER BLOCK (Q.V. ABOVE)  
(IRA ROSENWAIKE, IN AJA, NOV.'790)

61. DE SOLA II (1)

HANNAH, D.APR.15,1897;M. JACOB OSORIO DE CASTRO, AND HAD:  
GRACE, B.DEC.7,1854;M.JUL.25,1877, N.O.  
ZIPPORAH ALICE, M.NOV.4,1886, SAV. SAMUEL LOUIS LAZARON, AND HAD:  
ANITA, B.NOV.26,1889, SAV.  
BERTHA, B.FEB.28,1892, SAV.  
DAVID JEFFERSON, B.NOV.27,1861, N.O.;D.OCT.9,1862, N.O.  
CLARA, B.&D.MAR.9,1863  
ESTHER ELLEN, B.N.O.;M. MAR.8,1899, SAV., HENRY J. WILLIAMS, AND HAD:  
MORTON JACOB, B.DEC.30,1902, CH.  
ANITA HANNAH DE SOLA, B.SEP.4,1905, CH. (I.P.MENDES BIBLE RECORD)

[ADD] DINKELSPIEL/DINEL

LAZARUS DINKELSPIEL, B.1824, BADEN;D.1900, S.F.;M.1861, PAULINE HESS, DAU. OF  
LEVI & THERESE HESS (1843, L.A.-1907, S.F.) AND HAD:  
HENRY DINEL, B.1863;D. ;M.APR.30,1896, PAULINE PRICE, AND HAD ISSUE (VID.  
PRICE)  
CECIL, D.YOUNG, 1864  
LEON, B.1866;D.1878

SAMUEL M. BEATRICE BACHMAN, AND HAD:

LLOYD  
SOPHIE, M. SCHWABACHER  
THERESA, M. EDWARD KALISHER  
FRIEDA, D. 1914;M. SILVERMAN, AND HAD  
ALICE, M. BENIOFF  
JOSEPH, UNM.  
MELVILLE, M. HATTIE  
EDGAR, M. ETHEL F. SELIGMAN (VID. CONTENT, ABOVE), AND HAD:  
EDGAR NED, B. OCT.19,1915;M.APR.26,1958, FLORENCE C. SCHNEIDER  
GERNALD P. DINEL (GERALD DINEL)

62. DYER

FEIST EMANUEL OF MAINZ, M.MOERLE ISAAC OF FRANKFURT A/M, AND HAD:  
EMANUEL GERSHOM FEIST [A.K.A. PHILIPP HEIM], (ARR. BALTO. 1816), TOOK THE  
NAME OF JOHN MAXIMILIAN DYER, B.MAINZ,1779;D.MAR.8,1842,N.Y.;M.I) 1806, BETTGEN  
GERSON [A.K.A.ISABELLA NACHMANN], DAU. OF GERSON (DAVID) NACHMANN.  
SHE WAS B.APR.1785, FINTHEN (NEAR MAINZ);D.1826, BALTO.; HE M.2)JUL.10,  
1831,N.Y., FRANCES POLLOCK ELLIS (VID. ABRAHAMS IV). BY 1 HE HAD:  
FEIST EMANUEL HEIM, WHO TOOK THE NAME OF LEON DYER;M.1853, SARA NACHMANN,  
DAU. OF HIS MOTHER'S TWIN, JOSEPH NACHMANN (A.K.A. JESSEL GERSON)  
JOSEPH  
ISADORE  
RCSANNA (RCSINE), M.BALTO.FEB.23,1825  
HANNAH  
BARNEY  
SOLOMON (JACK KLEIN, IPA S. ROSENWAIKE IN AJHQ, DEC.19770)

63. ELIAS

DARIA ELIAS, M.SCHONTZE KOOPMAN AND HAD:  
ABRAHAM  
DAVID B.RALEIGH,N.C.;D.JUN.30,1892  
LEVY, M. ROSE LILIENTHAL, B.DEC.16,1819, ELMERSHAUSEN, BAV., AND HAD: (ALL B.  
COLUMBIA, S.C.)  
REBECCA, B.1839;D.1896;M. MORRIS ISRAEL, AND HAD ISSUE  
MARIAN (MARY ANN), B.1842  
LOUIS, JR., B.1843;D.1908  
[DEL. SOL]  
ELKAN  
ESTHER, B.1846;D.1893  
RAPHAEL, M. AND HAD:  
[DEL. CLARICE; SUBSTITUTE] GLADYS FRANCES  
KAUFMAN ("KOOOP"), B.1849;D.1910  
MARKUS, B.1852  
JEANETTE, B.1853;D.1893  
CAROLINE, B.1854;D.1855  
RACHEL, B.1857;D.1894  
DAVID, B.1860;D.1917;M. HELEN GRAUSMAN, AND HAD;  
SADIE LEE  
CLARICE  
MIGUEL  
ISABELLE, B.1862 (WILLIAM NADEL)

-- SUSAN HARRIETTE IS THE CHILD OF STERLING PRICE, JR.

65. EMANUEL II

JONATHAN MANLY, USN (CIVIL WAR) HAD:  
BLANCHE ESTELLE, M. SOLOMON I. STEIN (B.JAN.10, 1879, NYC?;D.OCT.28,1935, PH,  
AND HAD:  
LEON IGNATIUS, D.SEP.2,1976, PH.  
DORA EMILY, M. LESTER EMANUEL BECKMAN (NOV.22,1902-MAY26,1955,PH), AND HAD:  
LESTER E., JR., M.MAY 7,1972,PH., PATRICIA A. DURKIN (B.MAR.5,1943,  
YOUNGSTOWN, OH)  
JONATHAN EMANUEL, M. HELEN GRACE MICHAELSON, AND HAD:  
JUDITH EMILY, M.SEP.3,1969, CLEVELAND, OH, PAUL JOHNSON (B.JUL.12,1944),  
AND HAD:  
TIMOTHY BEN, B. APR.1,1971  
BUFFY, B. JUL.4,1974  
ROBERT SOL, M.JUL.4,1978, LONG BEACH ISLAND, NJ, DIANE DUSHOLE LEWIN  
(B.DEC.4,1946)  
NANCY SUE, M.DEC.26,1976, LONG BEACH, CA, DAVE ALAN FOOTDALE (B.NOV.28,  
1955  
MANLY LYON, HAD:  
MANLY WOODROW, M. FLORENCE BEATRICE GOODHART (MAR.16,1918)  
(JONATHAN EMANUEL STEIN)

67. ETTING (1)

ESTHER (HETTY ASSER), B.JUL.1746;D.SEP.8,1790 (PAUL W. PRINDLE)

69. EZEKIEL (1)

JACOB, M. CATHERINE [DE CASTRO], AND HAD:  
CATHERINE, B.1851;D.JUN.23,1853 (UNITED HEBREW CEM., CINTI.)

70. EZEKIEL (2)

TOBIAS JACOB EZEKIEL, HAD:  
AMELIA, D.NY;M.MORRIS VAN BERGH (WHO M.2) DINAH SLOMAN  
REBECCA, B.1810;D.OCT.7,1841, PH  
NAPHTALI JUDAH, HAD:  
MARTHA, D.UNM.  
EDWIN ALLISON, HAD  
HELEN CONSTANCE, D.1957  
PERCY LEVY, B.DEC.24,1882;D.1943  
DR. GERALD ABRAHAM, B.MAY 1886;D.1952;M. JULIA MAE SCMMERS (1905-1962),  
AND HAD:  
GERALD ABRAHAM, M. HARRIET LAMM (1930, AND HAD:  
SHARON PATRICIA, B.1957  
FRANK GERALD, B.1961  
ALAN WAYNE, B. 1967  
EDWIN NAPHTALI, B.MAY 9,1887; D.1959;M. AMY [BLOOMBERG] ,B.1887;D.1968  
AND HAD:  
ALICE MARTHA, B.FEB.16,1913;D.JUN.29,1923  
EDWIN NAPHTALI, JR., B. SEP.10,1914

HOWARD SOLOMON. B.SEP.23,1917;KdM. MARGARET, AND HAD:  
 LYNN  
 JACOB LEVY, HAD:  
 BERTHA, B.1903,RI;D.OCT.1978,WASH.;M.1)OCT.1,1925, MAURICE KOHNER (D.  
 1954);M.2) BERNARD TOPKIS (D.1977). BY 1 SHE HAD:  
 JOSEPHINE, M.ZUKAV  
 RAPHAEL (OF CLEVELAND HTS,OH), M.PEGGY  
 MOSES, B.JAN.15,1826, NY;D.FEB.25,1876, NY;M.1858  
 ASHER LEWIS, B.FEB.19,1829  
 (E.S. LAZARUS MOHEL REC.,SI; CLAIRE LEVY HUTZLER; OBIT. OF BERTHA TOPKIS;  
 DANIEL LEESON)

EZEKIEL (3)  
 ABRAHAM TOBIAS, B. PH;D. MONTGOMERY,AL, AND HAD:  
 LEONORA R., M.MONTGOMERY, JOSEPH GOETTER (HE D.MONTGOMERY), AND HAD: (ALL B.  
 IN MONTGOMERY)  
 SIDNEY J., M.1898, SELMA,AL, AND HAD:(ALL B. IN MONTGOMERY)  
 FANNIE R., M. MONTGOMERY, AND HAD:  
 LEONA (NOT LAURA) C., B.MONTGOMERY  
 LOUIS GOETTER, B. NY  
 EDWARD TOBIAS, B. N.O.  
 ALBERT ABRAHAM, B.N.O., M.CECILIA LICHTEN (D.NOV.14,1913, GREENVILLE,AL) AND  
 HAD:  
 ARTHUR, B.GREENVILLE,AL (CLAIRE LEVY HUTZLER)

74. FLORANCE  
 LEWIS (LEVI), D.1831 (BUREAU OF HEALTH, PH)

75. FRANKS I(1)  
 JACOB, M. BILHAH ABIGAIL LEVY, AND HAD:  
 ABRAHAM, B. 1713, NY; D. CAN.; M. LADY ELIZABETH CECIL, B. 1716,NC, AND HAD:  
 JACOB, B. 1728  
 NEHEMIAH, B. 1730  
 MICHAEL, B. 1733  
 [ADD FROM P.82]  
 DAVID SALISBURY, B. 1747, PH;D.OCT.7,1793; M. SARAH (SAIRY) FRANKS,  
 B.1755, NC; D.1809, NC, AND HAD:  
 MARY, M. WILLIAM CAMPBELL  
 JACOB, B. 1780, NC;D. 1868, TN; M.ELIZABETH WILKERSON, B.1785,  
 NC;D.1886, TN, AND HAD:  
 JOHN FRANKS, B.1810, NC;D.1872, TN;M. MARGARET STRICKLAND, B. 1815,  
 TN; D.1898 TN, AND HAD:  
 JOHN FRANKS (JR.), B. 1842, TN;D. 1883, TN;M. VIANNAH PERRY, B.  
 1866;D.1902, AND HAD:  
 JOHN ALEX, B. 1877,TN; D.1955, TN; M. MARY FANNY PAULK, B.1876,  
 TX; D.1943, TN, AND HAD:  
 HERBERT H. FRANKS, B. 1919, TN.; M. BEVERLY BEACH, B.  
 1921;D.1951 (HERBERT H. FRANKS, TILLAMOOK, OR)

82. FRANKS II  
 DELETE DAVID S. FRANKS (SEE ABOVE)

83. GANS  
 LOUIS, D.APR.20,1859 (BUREAU OF HEALTH, PH)  
 LEAH (LILLIE), M.OCT.3,1889, WALTER MEYER STEPPACHER, AND HAD:  
 WALTER MAURICE  
 LESTER GANS (U. OF PA. APPLICATION OF WALTER MAURICE STEPPACHER, COURTESY  
 OF F. J. DALLETT)  
 LEON (MAJ.CSA), M.JAN.28,1874, PH, THERESA E. HAMBURGER  
 (BETH EL EMETH MARR. REC)

85. GOMEZ I  
 ISAAC, M.CURACAO, AUG.25,1748, AND HAD:  
 ESTHER, M.CURACAO, MAR.3,1782 (CUR. MARR. REC.)

86. GOMEZ II  
 RICHA (RACHEL) HENDRICKS (Q.V.(1))  
 OSCAR J. M. MARIE S. SCHLOSS, AND HAD:  
 ANDRE DANIEL; M. ALMA DORIA, AND HAD:  
 ANDRE D. JR., M. LESLIE, AND HAD:  
 ANDRE D. III  
 OSCAR J.,JR., M.SANTA H. MARCUSE, AND HAD:  
 BARRY JACK, M. SIMONE CHASSIN, AND HAD:

LANA LANE  
 RICHARD JACK, M. KAREN CHARLEBOIS, AND HAD:  
 BRIDGET MARIE  
 MONICA MARIE  
 ALEXANDER RICH  
 BRUCE JACK, M. WENDI EPSTEIN, AND HAD:  
 STACY MICHELLE  
 BRIAN JAY (OSCAR J. GOMEZ, JR.)

87. GRATZ (1)  
 NOAH MOSES JECHIEL HAD  
 RABBI CALEB ABRAHAM, D. VIENNA, APR.1599, AND HAD:  
 RABBI SIMON ZEV WOLF, D.SEP.24,1646,CRACOW;M. MALKA (D.1646, CRACOW), DAU.  
 OF RABBI ISAAH MENACHEM MENDEL BEN YITZCHAK (CA.1520-1599, CRACOW), AND  
 HAD:  
 RABBI JACOB (KOPPEL) BLOCH, D.1680, CRACOW, AND HAD:  
 RABBI JONATHAN BLOCH, B.CA.1640, CRACOW;D.APR.22,1722, LANGENDORF,  
 SILESIA;M. BERACHA, AND HAD:  
 SOLOMON [TOOK NAME GRAETZ FROM POLISH TOWN] (SHELOMO ZALMAN)  
 RABBI ZEVI HIRSCH BLOCH [HIS SONS TOOK THE SURNAME HENRY]  
 FREIDEL/FRUMMET, D.1744,LANGENDORF;M. JECHIEL MICHAEL ORGLER  
 (B.LANGENDORF;D.AUG.15,1733, LANGENDORF), AND HAD:  
 FEIGELE, M. SALOMON BEN MEYER GRAETZ (B.GRAETZ, NEAR TROPPAU,  
 SILESIA; D.BEF.1748, LANGENDORF), AND HAD:  
 BARNARD, ETC. (JOHN HENRY RICHTER)

ROBERT HENRY, M.JAN.15,1857, LIZZIE A. STILES  
 (PH MARR. & OBITS., 1857-60, PH. SAT. BULLETIN, TYPESCR. NYG&B)

93. HARBY  
 LILA LEE HARBY, M. ABRAM S. ISAACS (Q.V.VI) (ISAACS-SALANT GEN.)

94. HARRIS II  
 CAROLINE, D. AUG.28, 1838; M.OCT.25,1837, HENRY S. COHEN  
 (RICHARD COLLEN)

101.HART X(1)  
 FRANCES [COHEN], B.FEB.11,1821, YORKVILLE, SC; D.MAR.16,1899, MONTGOMERY,  
 AL  
 JACOB, D. AUG.30,1862 (CLARE LEVY HUTZLER)

102.HART X(2)  
 BENJAMIN WOLFE J., M.APR.12,1847  
 (HENRY WHITTEMORE, PROGRESSIVE, PATRIOTIC, AND PHILANTHROPIC HEBREWS OF  
 THE NEW WORLD)

103.HART XIII  
 MEYER HART [MARKS], B.1798;D.JAN.29,1860  
 (PHILA. MARRIAGES & OBITUARIES, 1857-60, TYPESCR. NYG&B)

HART XIV  
 MICHAEL HART, M.1)CA.1773, LEAH MARKS. BY 1, HE HAD: (ALL B. EASTON, PA)  
 NAPHTALI, B.1775  
 JACOB, B.APR.3,1777;D.OCT.19,1853;M. ALLENTOWN, PA., MARY THOMPSON  
 (JAN.20,1785-JUN.11,1866, ALLENTOWN) AND HAD:  
 MARY  
 LEAH, B.AUG.1809;D.FEB.23,1885, UNM.  
 CAROLINE, B.JAN.3,1811;D.JAN.3,1877, UNM.  
 HETTIE, B.NOV.30,1812;D.SEP.9,1870;M.SEP.24,1840,ALLENTOWN, LEOPOLD PAUL  
 UNGER (KOENIGSBERG, PRUSSIA,JAN.2,1812-JUL.25,1859,ALLENTOWN) [THEY AND  
 THEIR CHILDREN BECAME EPISCOPALIAN] AND HAD:  
 EDMUND, B.1841;D.N.O.  
 ANNE CAROLINE, B.1843;D.1905;M. WILLIAM H. ARNEY  
 LEWIS RAPHAEL, B.1845;D.1917;M. ANNA MARIA KESSLER  
 ISADORE EMILIE, B.APR.1,1851,ALLENTOWN;D.JUN.13,1939,PH.;M.MAR.19,1874,  
 MAHLON N. KLINE (BERKS CO.,PA, FEB.6,1846-NOV.27,1909, PH), AND HAD:  
 CLARENCE MAHLON, B.MAY 29,1880,PH.  
 ISADORE C., M.HARRY STEWART VALENTINE  
 LEAH ELIZABETH, M. F. CARRICK JORDAN  
 CLARA AGUSTA, B.1854;D.1936;M. H. WILLARD ALLISON  
 (MRS. D. J. PONTARELLI)

SIMEON, B.1782  
 MICHAEL HART, M.2) ESTHER COHEN, AND HAD: [ALL B. EASTON]

HANNAH, B.1788  
 ABRAHAM LURIA, HAD  
 LOUISA ELIZABETH, D.NOV.30,1890, BALTO.;M.CA.1834  
 MORDECAI  
 ISAAC, D.YOUNG  
 HENRY S., D.BEFORE 1817  
 SAMUEL, HAD:  
 HETTY, M. DAVID HENRY MORDECAI (Q.V. III)  
 REBECCA, D.YOUNG, JUN.4,1799  
 RACHEL  
 BARUCH (BARNET), B.CA.1802;D.1875/6,N.O.  
 LOUISA BARNETT  
 HYMAN M. (DOROTHEE HUGHES CAROUSSO)

104. HAYS (1)  
 REV. JACOB HAD:  
 BENJAMIN, B.CA.1733;D.JUL.1,1816;M. ZIPORAH (1734-DEC.5,1818)  
 ABRAHAM [GREENWICH,CT], D.1796;M. ? AND HAD:  
 ESTHER, M. NEHEMIAH MEAD, AND HAD:  
 HULDA  
 RACHEL, M. PETER AVERY  
 HANNAH M. WALTER BUTLER  
 ELIZABETH, M. JOHN ADDINGTON  
 CHARITY, M. ? AND HAD:  
 AMY  
 HENRY (PAUL W. PRINDLE, IRWIN MILLER)

HAYS (2)  
 DAVID SOLIS, B.SEP.15,1820 (E. S. LAZARUS MOHEL REC.)

105. HAYS (4)  
 CATHERINE, B.1780; M.1), JAMES SOLOMON; M.2) PHILLIP HOFSTETTER [WIDOWER OF HER  
 SISTER]  
 RACHEL, M. PHILLIP HOFSTETTER  
 MOSES JUDAH, B.1789, HAD:  
 ANDREW II, B.1826  
 FRANK J. (N.O.)  
 A. B. (DAVID ROME - "ON THE EARLY HARTS - THEIR CONTEMPORARIES")  
 ANNIE BRADFORD, M. WILLIAM NORRIS, M.D.;D.S.P. (F. J. DALLETT)

107. HECHT (1)  
 ELIZABETH LEE [WALDMAN], B.MAY 9,1959;M.DEC.27,1981,N.Y., JOSEPH BERL HASPIEL,  
 AND HAD:  
 SARAH JUDITH, B.DEC.3,1987, ST. LOUIS (MALCOLM H. STERN)

SOLOMON, B.1847;D.1944;M. RACHEL FRIEDMAN (1855-1922), AND HAD:  
 LEIGH, B.MAR.15,1882;D.JUL.17,1914;M.1) ? (DIV.);M.2)AUG.27,1906,IDA FELI-  
 CIA WOOTEN (NORFOLK MARRIAGE RECS.;HEBREW CEMETERY)  
 JOSEPH, B.APR.30,1865;D.NOV.19,1919;M.OCT.21,1896, HATTIE LETERMAN (CHARLOTTE-  
 VILLE, NOV.6,1874-DEC.2,1936), AND HAD:  
 JOSEPH, JR., B.SEP.8,1907;D.SEP.18,1907, INF.  
 HELEN CECILIA, B.NOV. 1897;D.APR.12,1901  
 JEROME LETERMAN, B.FEB.22,1900;D.JUN.15,1941;M. ADA BUTLER (B.JUL.7,1911- )  
 HELEN CECILIA, B.JAN.3,1930;M.SEP.18,1948, LEONARD SUTTON, AND HAD:  
 GAIL JOAN, B.DEC.17,1952  
 MARLA CAROL, B.OCT.11,1955  
 DIANE FAYE, B.NOV.1,1957;M.MAY 25,1980, MARK HARRIS WAITSMAN  
 JACQUELINE LEE, B.FEB.28,1935;M.FEB.18,1961, IRVING ALPERN, AND HAD:  
 BENAY ESTA, B.JAN.5,1965  
 [TWIN]  
 DARIN MITCHELL, B.NOV.24,1967  
 ADRIAN SCOTT, B.NOV.24,1967 (HELEN C. H. SUTTON)

108. HECHT (2)-LOWENBERG  
 ELSA CECILIA [CAMPE GOODMAN], D.JUL.28,1986, VA. BEACH,VA; M.DAVID HIRSCHLER  
 GOODMAN, AND HAD:  
 ROBERT CAMPE M. AUGUSTA WILMA STRAUS (VID. LEVY IV), AND HAD:  
 ROBERT CAMPE, JR., B.1942;M. MARTHA JACOBS (1948-), AND HAD:  
 ROBERT CAMPE III, B.1973  
 LYNN AUGUSTA, B.1944;M.1) JOHN ROUSE (DIV.);M.2) DAVID ZOLL 91947-), AND  
 HAD: (BY 2)  
 ALLISON, B.1985

DAVID HAMILTON, B.1950;M. MARIAN AHEARN (1954-)  
 BEVERLY ALICE, B.1951;M. WILLIAM EXUM (DIV.)  
 ELSA CAMPE, D.1987, RI  
 (MALCOLM H. STERN, DANIEL LEESON)

111. HENDRICKS (2)  
 ALMA, M.1) CLARENCE ISAACS, AND HAD:  
 HENRY  
 DOROTHY  
 SHE M.2) CHARLES HARWOOD (HOROWITZ) AND HAD:  
 CHARLES, JR., B.MAY 21,1919,NY;D.JAN.21,1987, SCARSDALE,NY, UNM.  
 (OBIT. OF CHARLES HARWOOD, JR., NY TIMES)

-----  
 HENRY SOLOMON, HAD:  
 RUTH, M. HYMAN SCHULSON, AND HAD:  
 DAVID HENDRICKS, B. JAN.31,1952;M.JUL.3,1984, SHERREE STARR, AND HAD:  
 LOREE  
 JAIMEE  
 HENRY M.MAY 8,1988, RACHEL ELLENBERG  
 ANNE RACHEL, B.JAN.8,1961;M.JUN.16,1985, STEPHEN BRUCE YOUNG  
 SALLY SOLIS, M. ROBERT WEBER, AND HAD:  
 EVELYN, M. JEAN PAVOT [DIV.]  
 ROBIN, M. HARLAN FAULKNER BUTT, AND ADOPTED:  
 JACLYN KIM, B.OCT.20,1985  
 JONATHAN, M. CECILIA (RUTH H. SCHULSON)

113. HENRIQUES I(2)  
 EUDORA, D.MAR.21,1908  
 DECIMA ADELINE, D.MAY 21,1831 (SHEARITH ISRAEL REC.)

114. HENRY I  
 BERNARD, JR. M.D. (USN);D. 1860;M. PAULINE E., DAU. OF JOHN JACOB VAN DER KAMP.  
 D.S.P.  
 MORTON PEARSON, B.FEB.11,1826;D.DEC.24,1901;M. ANNIE MCKEE, AND HAD:  
 WILLIAM BARKLIE, B.DEC.5,1867, PH;D.DEC.24,1930, PALM BEACH,FL;M.1) WASH-  
 INGTON, DC,, ALICE BELKNAP (DIV.);M.2) MARY FARIS PANCOAST CONAWAY  
 (-JUL.20,1930, LYMINGTON, HANTS, ENG.) BY 1 HE HAD:  
 BARKLIE MCKEE, B.1902;M.1) BARBARA, DAU. OF HARRY PAYNE WHITNEY (DIV.);M.2)  
 MARGARET C. TROWBRIDGE GRIGGS. BY 1 HE HAD:  
 GERTRUDE VANDERBILT WHITNEY  
 WILLIAM BARKLIE II  
 BY 2 HE HAD:  
 HAROLD S.  
 RICHARD M.  
 ALICE ELLEN, B.1906; M. VON BRIESEN OF NY (DIV.)  
 MORTON J. (CAPT. USA), B.AUG.22,1869, MONTGOMERY CO.,PA;M. APR.2,1902, REBECCA  
 A. MORISON OF BALTO. (F. J. DALLETT)

118. HORWITZ  
 ORVILLE HORWITZ [BULLITT], D.JUL.31,1979, FT. WASHINGTON, PA. AND HAD:  
 LOUISA, M. WARD (OBIT. PHILA. INQUIRER, AUG.2,1979)

118. HUNT  
 SOLOMON EMANUEL HUNT, HAD:  
 DINAH/DIANA, M.1846, MYER STERN (BAV.1824-1899,NY) [A FOUNDER OF TEMPLE EMANU-  
 EL,NY), AND HAD:  
 SIMON, B.OCT.13,1847, RICHMOND,VA;M.SEP.22,1874/5, SARA, DAU. OF DAVID &  
 NANCY STERN, AND HAD:  
 WALTER D.  
 HENRY ROOT, M. ELSIE WESTON LAZARUS (Q.V.I), AND HAD:  
 HENRY, R. JR.  
 8 OTHERS  
 (THOMAS W. EVANS; UJE V.10,P.59)

119. HYAMS (1)  
 MOSES, D. AUG.1796 (N. L. HYMAN -THE JEWS OF IRELAND)

123. HYNEMAN I  
 REBECCA FRANCES, M. SOLOMON C. VAN BEIL  
 (R. DALE IRVINEO)

## 127. ISAACS VI

MYER SAMUEL ISAACS HAD:

RABBI SAMUEL MYER, M. JANE SYMONS, AND HAD:

REBECCA, B.1887RACHEL, B.1858;D.1904;M. V. E. ABECCASSISMYER SAMUEL, M. PHOEBE MARIA SOLOMON, AND HAD:GRACE, B.1869MINNIE, B.1918JULIAN

ESTELLE, M. ADAM FRANK, AND HAD:

MARJORIE, B.1907;D.1975JANET, B.1909;D.1915

ADAM, JR., B.1912;M. RACHEL BRODY, AND HAD:

JEFFREY, B.1942;M. DIANE CRONE, AND HAD:THOMAS, B.1973JANET ELIZABETH, B.1945

LEWIS MYER (MCNTEFIORE), M. EDITH JULIET RICH, AND HAD:

MARIAN RICH, M. PHILIP BRODY, AND HAD:

JEANNE RICH

LEWIS, JR., HAD:

CAROL HERMINE, B.1941HERMINE, B.1915

STANLEY MYER, M. EDITH SOMBORN, AND HAD:

HELEN (CASEY), M.1) PETER WURZBURGER; M.3) SNOWDEN GERRICK. BY 3 SHE HAD:MICHAEL MOREHOUSE, B.1947;M. LOEK VAN DYK, AND HAD:SUSAN REBECCA, B. 1978

MYRON S., M. HELEN SALANT, AND HAD:

STANLEY SALANT, B.1939;M. JULIE GILDENJANE LOUIS, B.1943;M.1) TIM AARON DOYLE; M.2) GERARD TOUSSAINT (1941)JOHN DAVID, B.1945;M. AMY HAMBURGER[REPLACE LEWIS B. WITH]LENI, B. 1950;M. JON BOORSTIN

ISAAC SAMUEL, M.1878 ESTELLE SOLOMON, AND HAD:

ISABELLE, B.1879;D.1924;M. EDGAR A. LEVY, AND HAD:

JULIEN, B.1906EDGAR, JR., B.1908;D.1975ELIZABETH ANN, B.1913

RABBI ABRAM SAMUEL, M. LILA LEE HARBY (Q.V.)

[SONS TOOK THE NAME HARBY (Q.V.)] (ISAACS-SALANT GEN.)

## 130. JACKSON III

ANNA, M. ALEXANDER M. CRISTALAR, AND HAD:

JEHIEL, B.FEB.4,1835AARON, B.SEP.14,1836DAVID, B.OCT.28,1838

(E. L. LAZARUS MOHEL RECORD)

## 132. JACOBS V

DAU. M. SOLOMON RAPHAEL AND HAD:

HENRIETTA, B.MAR.23,1804;D.MAY 20,1887;M.RI., JOSHUA SEIXAS (Q.V.(2))

## 132. JACOBS VI

CAROLINE JAY, D.JUL.1,1894;M.1) GERSHOM L. LAZARUS;M.2) FAY

(LAZARUS FAMILY RECORD)

## 135. JOHNSON

PHINEAS ISRAEL JOHNSON, B.MAR.9,1792, ENG.;D.OCT.7, 1854, TX;M.JUN.25,1818, IN,

CLARISSA HARLOW CLARK (E) (PA, SEP.13,1796-NOV.19,1882, TX), AND HAD:

EDWARD C., B.APR.9,1819, KY;M.JAN.5,1846, JANE WEBB RAFFERTY, AND HAD:CHARLES W., B.AUG.7,1846MATILDA MARION, B.APR.25,1822, MO;D.AUG.30,1889, MO;M.JAN.16,1840, KY, SOLOMONJULIUS LEVI (PORTSEA, ENG., AUG.20,1815-FEB.19,1877, MO) [TO US 1835], ANDHAD:CLARA, B.OCT.11,1849;D.OCT.4,1900;M.1862, CHARLES BLOCK. D.S.P.ELIZABETH, B.FEB.28,1842;D.1908;M. THOMAS G. BLOCK, AND HAD:SOLOMON J.MATILDAALEXANDER ELEAZER

TREPHEA, B.JUN.1,1843;D.SEP.1,1917;M.JUL.26,1866, MORRIS JACKS, AND HAD:

HANNAHPHINEASBENJOHN W.MAE

CAROLINNE

JOHN S.;D.APR.7,1844;D. INF.

PHINEAS, B.AUG.30,1847;D. INF.ESTHER PHOEBE, B.OCT.24,1848;D.1903;M. SIMON ZUKOR, AND HAD:DAVID

DAVID, B.FEB.17,1950;D.1867

MIRIAM LOUISE, B.FEB.19,1852;D.DEC.25, 1930;M.FEB.19,1871, SIMON J. ARNOLD

(Q.V.)

SOPHIA MISSOURI, B.JUN.2,1854;D.JUN.7,1927;M., ROBERT PUNCH, AND HAD:

ROSEDIONHARRYMORRISCLARICE

ZANETTA APOLINA, B.APR.2,1861;D.JUL.25,1940;M. ROBERT LEVY, AND HAD:

SOLOMONHARRYCHARLESMATILDA

LEWIS S., B.MAY 24,1824, IN;D.OCT.6,1867, TX

GEORGE WASHINGTON, B.MAR.13,1827, LA;D.MAY 8,1886, TX;M.AUG.26,1856, ST.L.,

MARY ANNE KELLEY, AND HAD:

HOWELL HARDIN, B.JUL.13,1863, TX;M.1897, VIOLET EUDALY, AND HAD:HARTRALPHGORDONCHARLES DWIGHT

CLARA, B.1864

GEORGE W., B.1866

MATTIE L., B.1875, TX;M.1893, TX, JOHN ODOM, AND HAD:

ENIDMATTIE SUEHELENJOHNNIEGARLANDCLIFFORD

PHINEAS I. JR., M.D., B.NOV.11,1829, KY;D.SEP.9,1876, TX;M. LAURA

BENJAMIN F., B.MAR.31,1832, KY;D.APR.20,1839, KY

CLARA H., B.APR.16,1836, KY;D.MAR.25,1839, KY

SAMUEL F., B.SEP.24,1838, KY;D.187-?, TX

THERESA, B.1867, AR

NED, B.1869, TX

DAVID ISRAEL JOHNSON, D.JAN.15,1842, OH, AND HAD:

HENRY DAVIS;D.1850

FREDERICK AUGUSTUS HAD:

SIMEON MOSES, B.MAR.18,1859;D.APR.8,1957, CINTI.

SAMUEL J., D.1893, OH

DAVID I., D.1893, OH

JAMES. W., B.APR.28,1831;D.OCT.1887

(MRS. RICHARD, M. ARNOLD;UNITED HEB. CEM.,CINTI.)

## 136. JONAS

JOSEPH, M.2) MARTHA OPPENHEIM (1800-FEB.29,1867)

(UNITED HEB. CEM.)

MICHAEL BENJAMIN, D.DEC. 1917, ST. LOUIS

(SUSAN MOSES)

## 137. JONES I

ALFRED TIMONS HAD:

REBECCA HART, M.JUL.3,1878, PH, CHARLES I. PHILLIPS

IDA, M.1878 EDWIN H. SPRINGER (BETH EL EMETH MARR.)

## 137. JONES II

ISRAEL ISAAC, B.FEB.6,1810;D.DEC.26,1876, AND HAD:

JULIA, M.OCT.7,1856, MOBILE, JACOB H. COHEN (Q.V.IX)

ESTHER, M.APR.28,1869, I.CLIPTON MOSES (Q.V.I(3)) (ZEITZ-MOBILE MARR.;

RICHARD L. COLLEN)

## 138. JOSEPH II

NAPHTALI JOSEPH HAD:

JUDAH, M.CATHERINE, DAU. OF SIMON LAZARUS AND HIS CATHOLIC WIFE, AND HAD:

HENRY A., B.APR.20,1795 (JAMES HANSEN, WIS. HIST. SOC. MS.)

HENRY (HARRY), D.JUN.21,1832; M.1803, RACHEL SOLOMONS

HANNAH, B.1777;D.JUN.6,1837, BERTHIER (ROME "ON THE EARLY HARTS")

139. JUDAH I(1)  
 ANNA, B. JUN. 11, 1839, NYC; D. JUL. 20, 1914, STATEN ISL.; M. WASHINGTON SHARRETT (STATEN ISL. 1831-JUL. 10, 1911, STATEN ISL.) (MARY LOUISE TODD)

140. JUDAH I(2)  
 SALLY (SARAH) M. RALPH DE PAZ (VID. DE PASS II)  
 DAVID (ROME "ON THE EARLY HARTS")

141-142. JUDAH III(1) & (2)  
 (NOTE: THE FOLLOWING SOURCES GIVE SO MANY VARIANTS FROM OUR TEXT AND FROM EACH OTHER, THAT THE COMPILER IS UNABLE TO ESTABLISH AN ACCURATE GENEALOGY. COMPARE: EVELYN MILLER, "SAMUEL JUDAH: THE FIRST JEWISH GRADUATE OF QUEEN'S COLLEGE (RUTGERS)", IN RUTH MARCUS PATT, THE JEWISH SCENE IN NEW JERSEY'S RARITAN VALLEY: SUPPLEMENT 1980, (NEW BRUNSWICK, NJ, 1980) PP. 10-17. DAVID ROME, COMPILER, "ON THE EARLY HARTS - THEIR CONTEMPORARIES", IN CANADIAN JEWISH ARCHIVES, NOS. 19-23 (MONTREAL, 1981- )

143. KAYTON  
 HENRY, B. FEB. 5, 1809, AND HAD: [BY 1]  
 HARMON, B. 1841; D. 1930; M. REBECCA RIGLANDER (1847-1929), AND HAD:  
 BABETTE, B. 1874; D. 1941; M. MOSES GREENEBAUM [SEE BELOW]  
 HANNA, B. 1845; D. 1908; M. EDWARD GOLDMAN (1838-1901), AND HAD:  
 REBECCA, B. 1863; M. MILLARD F. GRAUER, AND HAD:  
 ALBERT, B. 1886; M. HATTIE A. SCHACK (1887-), AND HAD:  
 WILLIAM S., B. 1913; M. MIRIAM JACOBY (1917-), AND HAD:  
 ANTHONY MILLARD, B. 1942  
 MILTON, B. 1887; M. ROSE (1902-), DAU OF LOUIS AND HELEN (LOWENSTEIN) LEIPHEIMER, AND HAD:  
 MILLARD J., B. 1927; M. JOAN WOLF, AND HAD:  
 WENDY  
 LOIS H., B. 1930; M. HUGH MELVORN, AND HAD:  
 RICHARD  
 JEFFREY  
 EDWIN, B. 1889; M. DOROTHY L. GOODMAN (1894-), AND HAD:  
 EDWIN B., B. 1916; M. ELAIN MCKENZIE, AND HAD (ADOPTED):  
 WILLIAM  
 GUS (DEL. TAV), B. 1865; D. 1972; M. LILLIAN LYON (1889-), AND HAD:  
 HAZEL, B. 1913; M. HOWARD A. KUMIN, AND HAD:  
 GERSHON  
 SYLVIA L., B. 1915; M. NORMAN STULMAN, AND HAD:  
 ANITA  
 ELYSE, B. 1921  
 HELEN, B. 1927  
 HARRY, B. 1867; D. 1906; M. ROSE ERLANGER (1871-), AND HAD:  
 MARTIN E., B. 1894; M. CLARE BROUGHTON, AND HAD:  
 ROSE L., B. 1917; M. ADRIAN DE WINDT  
 ARTHUR, B. 1896; M. BETSY BRETZFELDER, AND HAD:  
 ROBERT H.  
 LEWIS, B. 1869; D. 1940; M. MELANIE PRINCE, AND HAD:  
 EDWARD P., B. 1902; M. E.C. LOEB  
 BELLA H., B. 1871; M. MOSES LEVI, AND HAD:  
 SELMA, B. 1899; M. JOE BRENNAN, AND HAD:  
 EDWARD, B. 1917; M. GRACE MASSY (1918-), AND HAD:  
 BETTY ANN, B. 1939  
 WILLIAM, B. 1940  
 JOSEPH, B. 1941  
 EDNA G., B. 1902; M. LUDWIG LEVY, AND HAD:  
 LEOPOLD, B. 1920  
 HAROLD G., B. 1910; M. BESS FELDMAN, AND HAD:  
 MALCOLM, B. 1935  
 ABRAHAM, B. 1872; D. 1919  
 CARRIE K., B. 1875; D. 1932; M. (AS 2ND WIFE) LOUIS LEIPHEIMER (ABOVE), AND HAD:  
 HAZEL C., B. 1912; M. CARL RUDOLPH, S.P.  
 HELEN, B. 1884; D. 1888  
 LEWIS, B. 1843; D. 1921; M. JENNIE BERNARD (1853-1927), AND HAD:  
 GUSTAV, B. 1872; D. 1939, UNM.  
 BERT, B. 1874; D. 1967; M. DAVID ROSENHEIM (Q.V.) (CHILDREN TOOK THE NAME KAYTON)  
 RUTH, B. 1875; D. 1936; M. JACOB G. SMITH, AND HAD:  
 KAYTON, B. 1907; M. JOSEPHINE WACHTEL (1907-), AND HAD:  
 BARBARA LEE, B. 1935; M. MERRILL A. LEVY (1929-), AND HAD:  
 ALAN M., B. 1957  
 ROBERT KAYTON, B. 1958  
 JOHN B., B. 1965

KAYTON, JR., B. 1937; M. 1) RUTH WEINER (1942) (DIVORCED); M. 2) LUCILLE HARRIS (1949-). BY 1 HE HAD:  
 KAYTON III, B. 1962  
 DEBORAH, B. 1963  
 NANCY, B. 1966  
 HERBERT, B. 1877; D. 1969; M. TESS ROSENHEIM (Q.V. FOR ISSUE)  
 CARRIE, B. 1878; D. 1943; M. WILLIAM WEICHELBAUM (1878-1965), AND HAD:  
 ALICE, B. 1905; M. IRVING OSTERWEIL (1901-1974), AND HAD:  
 JOHN, B. 1942; M. LESLIE ANN FALK (VID. ABRAHAMS II)  
 WILLIAM, JR., B. 1908; M. MILDRED WOLF (1914-)  
 HENRIETTA, B. 1847; D. 1918; M. SAMUEL GREENEBAUM (1841-1922), AND HAD:  
 MOSES S. [CHANGED HIS NAME TO GREENE], B. 1867; M. BABETTE KAYTON (ABOVE), AND HAD:  
 HARMON, B. 1912; M. MARI KORETZ (1913-)  
 ISABEL, B. 1870  
 SADIE, B. 1873  
 CARRIE, B. 1876  
 WALTER KAYTON, B. 1878; M. ANNE AXLER, AND HAD:  
 RUTH, B. 1916; M. ROBERT GRUMBINE (1915-)  
 EVELYN, B. 1921  
 JESSIE, B. 1882; M. CLARENCE L. DARLING, AND HAD:  
 WALTER L., B. 1911; M. DOROTHY DOBBINS  
 JENNIE A., B. 1883; M. CLARENCE H. MEISTER (-1935), AND HAD:  
 LORRAIN, B. 1913; M. ALFRED P. LOWY (1911-), AND HAD:  
 ALAN, B. 1939  
 HENRY, M. 2) CAROLINE HERZBERG, B. 1823, AND HAD:  
 BERTHA (BETTIE), B. 1850; D. 1940; M. SEMMY COHEN (1841-1918), AND HAD:  
 LOUIS, B. 1870; D. 1939  
 HELEN, B. 1872  
 ISIDORE, B. 1873  
 STELLA, B. 1875  
 FLORENCE, B. 1877; M. EMILE DREYFOUS (1879-)  
 BERT [CHANGED NAME TO CAYTON], B. 1879; M. MARTHA ZANGER (1885-)  
 HERBERT [CHANGED NAME TO CAYTON], B. 1882; M. IRMA SPITZER (1886-), AND HAD:  
 MARGARET JOY, B. 1910; M. NORMAN TYRE, AND HAD:  
 SUSAN, B. 1940  
 ROBERT JIM, B. 1915  
 REBECCA, B. 1852; D. 1923; M. JAN. 19, 1881, PH., SIGMUND MEYERS, AND HAD:  
 MILTON, B. 1882; M. ETHEL ALSCHULER  
 ROSE, B. 1884; M. LEOPOLD STEIFEL, AND HAD:  
 BABETTE, B. 1921; D.  
 HERBERT, M. LINDA HENLY, AND HAD:  
 FREDRICK, B. 1917; M. ELIZABETH JONES  
 ERNEST, B. 1919  
 RICHARD, B. 1923  
 BENNO, B. 1854; D. 1929; M. LOUISE STRAHL (1865-), AND HAD:  
 HAROLD, B. 1891; M. GEORGETTE BEACH  
 LEWIS, B. 1901; M. MARIE HARTUNG, AND HAD:  
 LEWIS, JR., B. 1931; D. 1948  
 CARYL, B. 1935; M.  
 ROSA, B. 1856; D. 1933; M. MORVILLE CLARKE (1864-1925), S.P.  
 JOSEPHINE, B. 1858; D. 1937; M. HERMAN WEIL (1851-1899), AND HAD:  
 HELENE, B. 1878; M. MORTIMER MOSES (CHANGED NAME TO MOSER)  
 SALLIE, B. 1860; D. 1940; M. JOSEPH WORMSER (1857-1915), AND HAD:  
 SIDNEY, B. 1893; D. 1943; M. HELOISE JELINEK, AND HAD:  
 RUTH, B. 1917  
 HERBERT, B. 1896; M. ROSE BLOCK (1893-)  
 ABRAHAM H., B. 1867; D. 1940; M. LUCILE SOLOMON (-1939), AND HAD:  
 CARRIE, B. 1891; M. VADEN CLARKE  
 (KAYTON GEN.; BETH EL EMETH MARR., FLO. ABR.)

145. KING III  
 HENRY HAD:  
 LEOPOLD, M. SARAH, AND HAD:  
 BERTHA, B. CA. 1859, NY; D. AUG. 11, 1924, NY, UNM.  
 HATTIE, D. AUG. 30, 1924, NY, UNM.  
 HENRIETTA, B. AUG. 6, 1830; M. JOSEPH LEVY (JAN. 10, 1825-SEP. 28, 1914), SON OF LIEB & FLORA LEVY AND HAD:  
 FLORA, B. MAY 17, 1851; M. MEYER LIVINGSTON, SON OF LIEB LEVINSON AND ESTHER, AND HAD:  
 HATTIE, B. NOV. 8, 1872, NEW BRUNSWICK, NJ; D. JUN. 10, 1957; M. MAY 15, 1892, JOSEPH ADLER (-AUG. 3, 1935), AND HAD:  
 GLADYS, B. MAR. 21, 1893; D. DEC. 10, 1960; M. MAY 20, 1923, ADOLPH LESSER, AND

HAD:  
MAX MEYER, B.MAY 26,1924;M.APR.1965, LORRAINE HULSMAN, AND HAD:  
ADRIENNE HELENE, B.SEP.1965  
FRANK, B.FEB.17,1928;M.APR.16,1951, HANNAH HOFFMAN, AND HAD:  
DAVID, B.MAY 21, 1953  
SUSAN, B.DEC.8,1956  
JOANNE, B.AUG.23,1959  
RICHARD, B.NOV.20,1963  
IRVING, B.SEP.23,1899;M.1932, STELLA FOX  
EDNA, B.DEC.25,1901;M.JAN.14,1925, MARTY DUBMAN, AND HAD:  
CHARLES, B.OCT.3,1928;M.MAY 30,1951, JOAN GOLDSTEIN, AND HAD:  
ANDREW JAMES, B.MAY 25,1954  
NINA JO, B.OCT.25,1955  
JANIE LESLIE, B.OCT.20,1963  
MORTON, B.MAR.26,1932;M.JUN.15,1958, LITA LIPSCHUTZ, AND HAD:  
JONATHAN MORRIS, B.FEB.26,1968  
LILLIE, B.DEC.20,1874;M.JUL.1,1894, HYMAN SCHLOSS, AND HAD:  
MERWIN, B.DEC.12,1895  
LAWRENCE, B.DEC.31,1901;M. JANICE MONROE AND HAD:  
NORMA  
GOLDIE, B.JAN.24,1877;D.APR.7,1952;M.JAN.21,1900, BENJAMIN LECHTMAN, AND  
HAD:  
ALBERT, B.FEB.10,1902;D.JUL.7,1962;M.OCT.21,1934, SOPHIE SCHNEIDER  
HENRIETTA, B.NOV.9,1905;M.MAR.3,1935, AL MILK, AND HAD:  
BENJAMIN L., B.OCT.8,1938;M.MAR.24,1968, LESLIE BERG  
RICHARD H., B.JUL.6,1942;M.JUN.30,1966, HATTIE FULD  
IRA, B.DEC.24,1908;M.JAN.20,1935, LILLIAN SINGER, AND HAD:  
JUDITH LEE, B.DEC.18,1937;M.DEC.21,1958, IRVING MAYERSFIELD, AND HAD:  
GAIL, B.OCT.4,1959  
MARK, B. SEP.3,-  
BENJAMIN S., B.NOV.25,1940  
LEON, OCT.6,1879;D.JUL20,1932, UNM.  
HENRY H., B.OCT.26,1881;M.NOV.4,1906, SOPHIE FELDBLUM, AND HAD:  
PHILIP, B.OCT.10,1907  
BEATRICE, B.JUL.11,1884;M.JAN.31,1912, NATHAN FRIEND, AND HAD:  
SYLVIA, B.JUN.14,1914;D.NOV. 1947;M. IRVING GOLDEN, AND HAD:  
ROBERT LEE, B.SEP.14,1938  
BRUCE EDWARD, B.SEP.1,1942  
DIANE JOAN, B.OCT 31, 1946  
MYRON, B.FEB.4,1917;M. FLORENCE SHAPIRO, AND HAD:  
ALAN DAVID, B.JUL.22,1944  
JUDITH FAY, B.JUL.31,1947  
ISIDORE M., B.NOV.11,1887;D.JUL.1968;M.MAR.24,1918, ADA SIMON, AND HAD:  
MYRA, B.MAR.1,1920;M.JUN.29,1941, SIDNEY DRUCKER, AND HAD:  
LEON MARK, B.DEC.2,1943  
FLORA ANN, B.FEB.17,1945;D.APR.7,1968  
LARRY MARK, B.JUL.19,1954  
EDWIN, B.FEB.9,1892;D.MAY 6,1932;M. LOTTIE WINTER, AND HAD:  
MARJORIE, B.APR.14,1920;M.FEB.14,1941, HOWARD TRUSSEL, AND HAD:  
STEPHEN EDWARD, B.SEP.13,1942  
JAMES ALAN, B.OCT.18,1945  
JOAN PATRICIA, B.MAY 3,1948 (LIVINGSTON GEN., EDNA A. DUBMAN)

146. KOKERNOT  
 DAVID LEVI, HAD:  
 LEE M. (LEVI MOSES), HAD:  
 FANNIE, M. JAMES COLWELL DILLWORTH, AND HAD:  
 MATALIE  
 JAMES COLWELL, JR.  
 JOSEPHINE, M. PECK, AND HAD:  
 JOSEPHINE  
 BEN  
 RUFUS, D. INF.  
 WALTER HUTSON, HAD:  
 DAVID L., M.APR. 1932, JOHNNIE SUE HIX, AND HAD:  
 DAVID L., JR.  
 SUSAN K., M. JERRY RICE [CINCINNATI]  
 LENORE (NORA), M. COKE EMORY DILLWORTH, AND HAD:  
 C. EMORY, JR.  
 ALMA, M. EVERETT LAWLEY AND HAD:  
 EVERETT L., JR.  
 LENORE, M. ELMER HENKEL, AND HAD  
 MARTHA JANE

ALMA, M. LEE BROTHERS, AND HAD:  
 ROBERT LEE  
 AL (NATALIE ORNISH)

147. KURSHEEDT  
 GERSHOM, M. JUN 12, 1861, GRACE GUEDALLA (1818- ) (BEVIS MARKS RECS.III)

--- ABIGAIL GRACE, M. NATHAN HOFFMAN, AND HAD:  
 MONTE KURSHEEDT, M.3] FRANCESCA MARIA DE CARLO (B.MAR.29,1946) [DIV.][AND  
 ADOPTED HER CHILD]  
 ALICIA ROSALIE DE CARLO, B.NOV.24,1972  
 (THEY ALSO HAVE:)  
 MARA CECELIA ABIGAIL DE CARLO, B.MAR.30,1977  
 GEORGE SEIXAS, M.2) EILEEN ABLE, AND HAD:  
 HALEY ABLE, B.SEP. 1979  
 JANE ABIGAIL, M.JUNE 1977, PHILIP STEVEN PARESS (B.FEB.22,1945), AND HAD:  
 DANIEL NATHAN, B.NOV.7,1980  
 JENNIFER ESTHER. B.APR.8,1986 (ABIGAIL G. K. HOFFMAN)

148. LABATT  
 ABRAHAM COHEN, M.FEB.16, 1825, CH AND HAD:  
 DAVID COHEN (CAPT.CSA), HAD:  
 ADELAIDE, M. MORTIMER WISDOM (VID. BENJAMIN I)  
 HENRY, M.1854,NY, ELEANOR BLOCK (Q.V.II)  
 JACOB (CSA)  
 JACKSON (CSA)  
 10 OTHERS  
 (S.C. MAGAZINE OF ANCESTRAL RESEARCH, SPRING 1973;A.S. WOLF, THE AMERICAN JEW  
 AS PATRIOT...;MATT DARRISH)

150. LAZARUS I  
 ELEAZER SAMUEL, HAD:  
 MOSES, HAD:  
 SARAH, B. NY,OCT.11, 1842  
 AGNES, M. MONTAGUE MARKS, AND HAD:  
 MARGARET GLADYS, M.SEP.9,1916, SAUNDERSTOWN, RI, DR. HENRY ROSS GEYELIN,  
 M.D. (1884-SEP.7,1942), AND HAD:  
 PETER, D.PH  
 PATRICIA, M. VICTOR L. DREXEL  
 ANNIE HUMPHREY, D.JAN.16,1937, VENICE, ITALY;M. JOHN HENRY JOHNSTONE  
 (D.1941,NY)  
 THEODORE SAMUEL, B.JUL.16,1815  
 MIRIAM, M. ANTHONY FREDERICK SCHWAB, (DEC.22,1815-), AND HAD:  
 FRANCES JEANETTA, B.FEB.2,1849  
 JACOB HART (NAPHTALI) (ABRAHAM J. KARP; E.S. LAZARUS MOHEL REC.; F. J.  
 DALLETT; WILLS OF ANNIE & JOHN JOHNSTONE)

150. LAZARUS IV  
 REBECCA, D.FEB.10,1871,N.O.;M. MORRIS ISAACSON (LOND.,1781-AUG.14,1839, CO-  
 VINGTON, LA), AND HAD:  
 ALFRED HENRY (MAJ.CSA), B.MAR.5,1833,PH;D.N.O.;M.ST.LANDRY PARISH,LA., L.,DAU  
 OF JUDGE JOHN DANIEL  
 HENRY M. (HARRY) (CAPT.CSA), B.MAY 10,1835,PH;D.NOV.1,1904,N.O.;M.1) KATE  
 MARKS (-1892);M.2) 1901, BELLE MC VEA OF POINTE COUPE PARISH, LA, AND HAD:  
 HARRY, JR. [TEXAS]  
 DAU., M. E. M. COOPER OF MEMPHIS  
 VICTORIA, M. BENJAMIN WASHINGTON SEAWELL  
 AMIE B., M. IGNATIUS CAULFIELD (COL. H. HARDING ISAACSON)

151. LAZARUS II  
 AARON HAD:  
 GERSHOM LARENDON, D. ATL., AND HAD:  
 JOSHUA, B.AUG.21,1838,CH.;M.JUN.22,1862, HOUSTON,TX, ANAISE PASDELOUP, AND  
 HAD:  
 EDWIN  
 GEORGE  
 FLORENCE  
 AARON, B.FEB.14,1840, WILMINGTON, NC  
 GUSTAVUS, B.NOV.1,1842,CH  
 MICHAEL WASHINGTON, B.JUL.13,1844,CH;M.OCT.19,1870  
 LEILA, B.AUG.13,1848; M. VARDY PRITCHARD SISSON, AND HAD:  
 CHARLES  
 AMOS

CARRIE  
 WALTER, B.FEB.7,1853,CH  
 PHILA COHEN, D.OCT.9,1888;M.FEB.24,1839, WILMINGTON,NC, AS HIS 2ND WIFE, WILLIAM CALDER (JAN.28,1792-DEC.20,1844) OF CHARLESTOWN, MA, AND HAD:  
CATHERINE THEODOSIA [DEL.KATE]; B.FEB.19,1840;D.JUL.1,1863  
ROBERT EDWARD, (CSA) B.FEB.7,1842;D.FEB.12,1888;M.NOV.16,1869, ATHALIAH KEITH (1842-1876), AND HAD:  
 PHILA LAZARUS, B.FEB.22,1871;D.MAY 1959;M.APR.26,1893, JOSEPH KEITH NYE (DIV.)  
 EDWIN KEITH, B.AUG.20,1874;D.AUG.29,1901  
WASHINGTON LAZARUS (CSA) [DELETE WILLIE; NAME CHANGED TO WILLIAM, JR. AFTER EARLY DEATH OF HIS FATHER], B.MAY 5,1844;M.NOV.27,1872, ALICE LONDON BOATRIGT, AND HAD: [HER CHILD BY FIRST MARRIAGE]  
WILLIAM III, B.DEC.7,1853;D.JUN.20,1874  
 [THEY ALSO HAD:]  
MARY FULLERTON, B.JUL.20,1875;D.JUN.9,1851;M.APR.28,1910, WILLIAM MAYO ATKINSON (K. IN WWI), AND HAD:  
WILLIAM MAYO, JR., B.MAY 21, 1911;M. MARY JOHNSON (JACKIE) STOCKARD (VID. MORDECAI I(1), AND HAD:  
 MARY CALDER  
 MARGARET (MARGO), M. GEORGE SEGAL OF BASEL, SWITZ.  
 CALDER (USAAF, WWII), B.FEB.14,1915;D.MAY 10,1944, BRAZIL THEODORE, B.MAR.7,1878;D.1886  
 MILTON, B.JUL.12,1881;D.MAY 1,1948  
ROBERT EDWARD II, B.JUN.19,1884;D.SEP.22,1947;M.NOV.7,1916, SUE BRENT PRINCE, AND HAD:  
SUE BRENT, B.JAN.24,1918;M.MAY 11,1948, JOHN ALBERT CROWN, AND HAD:  
 SUE BRENT, B.MAR.19,1949  
JOHN ALBERT, JR., B.NOV.24,1950  
TREADWELL RICE, B.OCT.2,1952  
CATHERINE CALDER, B.JUL.15,1954  
ALICE, B.AUG.9,1920;M.JUN.15,1941, WARD CLARKSON MILES, AND HAD:  
DAVID RHYS, B.JAN.14,1950  
JOEL EDWARD, B.APR.17,1952  
PRUDENCE ANN, B.MAY 12,1954  
STUART CALDER, B.JAN.17,1956  
ROBERT EDWARD III, B.SEP.6,1922  
HUGH COURINEY, B.OCT.12,1891;M.JAN.26,1917, BARBARA DOZIER, AND HAD:  
WILLIAM BEACH, B.OCT.8,1921  
 WASHINGTON, B.SEP.20,1808  
 ANGELINA GREEN, D.SEP.22,1887  
 MARIA CECILIA, D.JUN.8,1872  
 ALMERIA EMMA, D.MAR.25,1888;M.DEC.10,1851  
 MARX EDGEWORTH, D.MAY 20,1896, SAND MTN.,AL;M.OCT.1852, MARY LAUNCE (DIV.)  
 ELLEN HAD:  
 URNER [MISSISSIPPI]  
 CAROLINE [DROWNED]  
 GEORGE WASHINGTON [NEW ROCHELLE, NY]  
 NELLIE, D.UNM.  
 ALFRED, M. LUCILE  
 MARY CATHERINE, M.OCT.9,1849  
 (PHILA L. C. NYE, "RECORDS AND RECOLLECTIONS OF THE CALDERS OF WILMINGTON" [MS.]

153. LEESER

ISAAC ELEASER OF DUELMEN, WESTPHALIA, B.1695;D.1768;M. MAGDALENE JACOB, AND HAD:  
ELIEZER ISAAC OF DUELMEN, B.APR.4,1737;D.1816/21;M. GITLA LEFFMANN, AND HAD:  
 [NOTE: ON SEP.22,1813, THE FAMILY REGISTERED THE SURNAME AS LEESER]  
ISAAC, B.NOV.24,1769;D.JAN.13,1854 [MANY DESCENDANTS]  
ABRAHAM [CHAZAN], B.JUL.9,1785;D.UNM. [CHANGED NAME IN 1846 TO STERNFELD]  
URI (LEFFMANN), B.NOV.8,1772;M. SARA RHEINE, (1771-NOV.27,1814), DAU. OF ISAAC SALOMON AND LENA COHEN OF RHEINE, AND SISTER OF SALOMON ISAAC COHEN [KNOWN IN U.S. AS ZALMA REHINE]. LEFFMANN AND SARA HAD: [ALL B. NEUENKIRCHEN, WESTPHALIA]:  
LEA, B.JAN.13,1805;D.AUG.7,1876;M.CA.1834, HARTOG ELKUS, AND HAD:  
 LEFFMANN  
 SOPHIE, B.1836 [TO PH.1865]  
 BETJE, B.1839 [TO PH.1865]  
 2 OTHERS  
 (REV.) ISAAC, B.DEC.12,1805/6  
 JACOB, B.SEP.11,1809;D.MAR.15,1834, PH. UNM.  
 JACOB, M. BILLA, DAU. OF ISAAC GOTTSCHALK, AND HAD:  
 LEFFMANN, M. ROSALIE SPIEGEL, AND HAD:  
JACOB M. PAULINE SALOMON, AND HAD:

HERMANN, M.RHEA ZONDERVAN, AND HAD:

DAU.  
HELGA, M. LEO BECKER  
HYMAN, B.1778  
EVA, B.1780;D.FEB.4,1853 (HELGA BECKER-LEESER)

157. LEVY I (4) STEVENSON, GREENWOOD  
 ALONZO POTTER (HENRY B. HOFF)

159. LEVY II

ELIZA, D. BALTO;M. SOLOMON HENRICKS OF NEW BRUNSWICK, NJ, AND HAD:  
 BENJAMIN  
MERIAM, M. FRIBOURG, AND HAD:  
 LOUISA  
 LEON  
 ERNEST  
FANNY, M.CALEB ARCHER, AND HAD:  
 MORTON  
 LIDA FRANCES (RALPH MICHAEL GEHRING)

--- PAMELA HENDRICKS, M. WALLACE LITWIN (NOV.22,1914,NY-) (DIV.)  
 (DR. RICHARD D. PLOTZ)

162. LEVY IV (RICHMOND)

ABRAHAM LEVY, HAD:  
LEWIS A. [SEE "ADDENDA ET CORRIGENDA"]  
MOSES ALBERT, M.D., B.CA.1803, AMST.;D.CA.MAY 23,1848 [SUICIDE], MATAGORDA, TX;  
 M.1) CA. 1830, MARIA BISHOP (D.BEF. OCT.1835);M.2)APR.4, 1838, MATAGORDA, TX,  
CLAUDINIA OLIVIA GERVAIS. BY 1 HE HAD:  
MARTHA, M. RI (PHILA. BETH EL EMETH MARR.)  
ADAH VIRGINIA, M. CHARLES EMANUEL STRAUS, AND HAD:  
AUBREY HAMILTON, HAD:  
CLIFFORD ALLAN, B.1912;D.MAR.12, 1987, MIAMI, FL.;M.2) PHYLLIS LINC-SAY, AND HAD:  
 ADAM, B.1956  
 MATTHEW [NOT MICHAEL], B.1958  
 JUDD, B.1959  
 HANNAH, B.1963  
ADAH VIRGINIA, M. HAROLD JAFFER, AND HAD:  
AUBREY GORDON, B.1955 M. ROBERTA MILLS (1953-) AND HAD:  
MARTIN SAMUEL, B.1984  
JOEL STRAUS, B.1956  
AUDREY HELEN, B.1923; M. REINHARD WILLIAM KOCH (1920-), AND HAD:  
 IRENE LOUISE, B.1951  
 DEBORAH SUE, B.1954;M. STUART DURST  
 NINA LORRAINE, B.1956

BY 2 HE HAD:

KATHERINE O., M.1) WILLIAM BARRETT; M.2) JOHN LINK. BY 1 SHE HAD:  
 HENRY  
 CLAUDINIA  
 ISABELLA S.  
 WILLIAM J.

BY 2 SHE HAD:

RICHARD  
 LEWIS  
 JOHN  
ALBERT GERVAIS, B.1840;D.1853  
LAURA VIRGINIA, B.1843;D.1903;M. EDWARD H. LOMBARD, AND HAD:  
 MINERVA  
KATHERINE LEWIS, B.1868;D.1957;M. EDWIN THOMAS MERRICK (1859-), AND HAD:  
LAURA, B.1890;D.1969;M. THEODORE PRATT, AND HAD:  
GWENDOLYN, B. & D.1917  
THEODORE, B.1920;M. BETTIE CURLAND, AND HAD:  
 THEODORE, B.1949  
 KATHERINE, B.1951  
 STEPHEN LOVELAND, B.1954  
 LAURIAN DYKMAN, B.1983  
MERRICK, B.1922;M. MARIETTA BOYLE (-1969), AND HAD:  
 MERRICK, M. SHARON, AND HAD:  
 MELISSA, B.1971  
 MERRICK, B.1974  
 MEREDITH, B.1976

LAWRENCE, B.1949  
 SUSAN, B.1950, M. DAVID JON VAN NESS, AND HAD: [TWINS]  
 ERIK PRATT, B.1976  
 JAMES HAPGOOD, B.1976  
 CHRISTOPHER, B.1954  
 EDWIN THOMAS, B.1892;D.1907  
 SUSAN BREWER, B.1893;M. JACKSON A. DYKMAN  
 KATHERINE LOMBARD, B.1897;D.1904  
 GERVAIS F., B.1870;D.1948;M. HARRIET LOUISE FUQUA (1875-1958), AND HAD:  
 GERVAIS F., B.1896;D.1958;M. MARY KATHERINE MURDOCK, AND HAD:  
 GERVAIS, B. & D.1927  
 LEE, B.1933;M. MARY LEE FLOTTE (1940-), AND HAD:  
 DEBRA ANN, B.1965  
 LUCILLE MARIE, B.1897;D.1958;M. ?  
 JULIAN HOBSON, B.1898;D.1978;M. ?, AND HAD:  
 JULIAN HOBSON, M. ALICIA MARTIN, AND HAD:  
 JULIAN HOBSON, B.1947;M. ROBERTA JEAN OWENS (1945-), AND HAD:  
 ROBERT JULIAN, B. 1975  
 DAVID H., M. IRMA KRAFT  
 JOHN EDWARD, B.1882;D.1948;M. ANNA BROWNSON (1891-1968), AND HAD:  
 JOHN EDWARD, B.1913;M. AUDREY TALLEY (1920-), AND HAD:  
 AUDREY VIRGINIA, B.1941; M. LARRY BORDEAU  
 NANCY JUDITH, B.1945;M.1) RAYMOND JOSEPH ELIAS (1939-);M.2) STEVENS.  
 BY 1 SHE HAD:  
 ROBERT DERIN, B.1965  
 BY 2 SHE HAD:  
 MICHAEL MARION, B.1980  
 JOHN EDWARD, B.1950  
 JANE EILEEN, B.1953;M. WARREN DALE WINTERS, AND HAD:  
 APRIL JOY, B.1972  
 KIMBERLY JANE, B.1974  
 JEFFREY TALLEY, B.1958  
 LAURA, B.1916;M. JONATHAN DANIEL ADDISON  
 DOROTHY, B.1917; JOSEPH BENTLEY ALEXANDER, AND HAD:  
 DOROTHY ANN, B.1941;M. CHARLES HOUK, AND HAD:  
 MARY BENTLEY, B. 1970  
 ANNA, B.1973  
 JOHN BENTLEY, B.1945  
 MARY ELIZABETH, B.1947; M. MURRAY ANDREW DECOTEAU, AND HAD:  
 VAN ANDREW, B.1973  
 PATRICIA ALEXANDER, B.1948  
 CHARLES GILLETTE, B.1845;D.1858  
 LEWIS FISHER, B.1847;D.1930;M. LYNDA CATHERINE HARRIS (1858-1930), AND HAD:  
 ADAM GIFFEN, B.1883;D.1955;M. PEARL GREEN (1914-)  
 CLAUDINIA GERVAIS, B.1885;D.1954  
 LYNDA CATHERINE, B.1887;D.1958; M. CHARLES A. BURRIS  
 LEWIS HARRIS, B.1888;D.1957;M. JESSIE GERTRUDE BURNS (1895-1955), AND HAD:  
 LEWIS HARRIS, B.1917;M. PHYLLIS MARIE LOUISIE WILLIAMS (1917-), AND HAD:  
 LILLIAN ELISE, B.1946;M. OSBORNE JEFFERSON DYKES (1944-)  
 LEWIS JOHNESS, B.1951;M. DEBORAH ETHEL TANNER (1942-), AND HAD:  
 SARAH ELIZABETH, B.1977  
 RACHEL ANNE, B.1981  
 JESSIE BURNS, B.1923;M. ARTHUR WADE FOSS (1925-), AND HAD:  
 LINDA CATHERINE, B.1953;M. PHILIP ROBERT GRANT (1953-), AND HAD:  
 SAMUEL [FOSS-GRANT], B.1985  
 ANDREW PHILLIP [FOSS-GRANT], B.1987  
 NANCY ELIZABETH, B.1954  
 SALLY LEVY, B.1966;M. JAIMES ANDRES COLOCHO-BOSQUE (1960-), AND HAD:  
 ANDRES WADE, B.1987  
 MILDRED HEBER, B.1927;M.1) JOSEPH RAYMOND CALEYO (1927-);M.2) SCOTNEY  
 CHARLES GEORGE (1926-). BY 1 SHE HAD:  
 ANITA MARIE, B.1957;M. STEPHEN ALLEN CORCORAN (1952-)  
 JOSEPH LEWIS, B.1959; M. DARLEEN SUSAN HAY (1961-)  
 CHARLES ALBERT, B.1890;D.1921;M. LUCY WREN PILCHER (1894-), AND HAD:  
 CHARLES ALBERT, B.1917;M. MADRIA STRAWN (1919-)  
 (DANIEL LEESON)

165. LEVY VI  
 HENRY (ZEBY), B.APR.26,1820 (E. S. LAZARUS MOHEL REC., SI)

165. LEVY IX  
 JACOB LEVY, B.OCT.30,1814,CH;D.JUN.14,1873;M.N.O., AND HAD:  
 EUGENE HENRY, B.JAN.23,1840;D.JUN.1,1921, NY;M.1) 1865, AND HAD:

EUGENE HENRY, JR., B.FEB.1872,N.O.;D.FEB.1963,N.Y.;M.APR.2,1902, CLARA  
 MONDSCHHEIN, AND HAD:  
 ELMER MAXIMILIAN, B.NOV.25,1904,N.O.;D.DEC.31,1985,BRKLYN;M.APR.8,1948,  
 AUGUSTA SINGER (PATERSON, NJ, SEP.14,1913-), AND HAD:  
 SUSAN ANITA, B.JAN.21,1953 (SUSAN ANITA LEVY)  
 JULIAN HILLEL, M.MAR.8,1882, PETERSBURG, VA (BETH EL EMETH MARR., PH)

166. LEVY VII(1)  
 ELIAS PHINEAS, M.2)APR.25,1880, MANAYUNK, PH, (BETH EL EMETH MARR., PH)
167. LEVY VIII(1)  
 (JUDGE) SAMUEL [NOT A SON OF NATHAN LEVY; TO U.S., DEC.15,1841], B.SEP.11,1821,  
 OLDENBERG, GER.;D.SEP.14,1889, AUGUSTA, GA, AND HAD:  
 EDWIN EZEKIEL  
 AGNES ESTER  
 SAMUELLA, M. 1880, AS HIS 2ND WIFE, LOUIS COHEN, AND HAD:  
 6 CH.  
 JACOB P.  
 ROSABELL, B.MAY 13,1864, CASSVILLE, GA  
 GRACE AGUILAR (JACK J. STEINBERG, "THE JEWS OF AUGUSTA", ANCESTORING XII)
167. LEVY VIII(2)  
 J. WILLIE, B.1859  
 ALICE, B.MAR.1860, AUGUSTA, GA;D.AUG.31,1927;M.CA.1875, MADISON [NOT MATTHEW]  
 JOSEPH MARCUS (PA. 1854-AUG.31,1897, AUGUSTA, GA.), AND HAD: [ALL B. AUGUSTA]  
 ABRAM SOLOMON, B.CA. 1876  
 ASHER JOSEPH, B.FEB.15,1878;D.AUG.26,1941;M.JUL.11,1920, SAN FR., JENNIE Y.  
 STEIN LEVIN, AND HAD: [ALL B. SAN FRANCISCO]  
 MADISON JOSEPH, B.JUL.19,1921, UNM.  
 DONALD CLARENCE, B.MAR.19,1923;M.AUG.15,1948, TREVA JO HATCHETT, AND HAD:  
 GERRIE, B.FEB.1,1954, HEIDELBERG, GER.  
 DONALD JAMES, B.JUL.17,1956, SAN FR.;M.NOV.8,1979, GWEN ELIZABETH FOY  
 MARILYN ALICE, B.MAY 3,1930;M.1)JUN.28,1953, ROBERT CHARLES ROSEN (DIV.);  
 M.2) 1968, CALVIN BAXTER (DIV.) BY 1 SHE HAD: [ALL B. SAN FR.]  
 MARK CHARLES, B.FEB.29,1956  
 LINDA JENNY, B.OCT.31,1958  
 JENNIFER, B.MAR.14,1969  
 ROSINA, B.JUN. 1881  
 SIMMIE, B.AUG.1882  
 MADISON, B.APR.1888  
 CLARENCE, B. JUN.1889  
 (JACK STEINBERG, "THE JEWS OF AUGUSTA", ANCESTORING XII)
169. LEVY XI  
 EMMA, B.1878, NY;D.MAR.31,1972, PH;M.JUN.11,1904, PROF. LIGHTNER WITMER (PH  
 JUN.28,1867-JUL.19,1956, BRYN MAWR, PA) (F. J. DALLETT)
169. LEVY XII  
 JACOB, JR., B.1753;D.MAY 1,1837, NY (SHEARITH ISRAEL)
169. LEVY XIII  
 [NOT MENACHEM] EMANUEL LEVY (MORDENAI L. RAISIN)
170. LEVY XV  
 JOSEPH, M. ESTHER, D.JUL.27,1843,BATH, STATEN ISL., NY, AND HAD:  
 JOHN JONAH, B.AUG.7,1820,ENG;D.OCT.19,1908, SAN FR.;M.SEP.2,1846, BATH, S.I.,  
 AMELIA HART, AND HAD:  
 JOSEPH J., B.SEP.27,1847;D.OCT.19,1900  
 SOLOMON J., B.JUL.14,1849;D.OCT.20,1908;M.OCT.20,1884, SAN FR., BERTHA  
 STRAUSS (CA, JUL.1864-JAN.9,1940), AND HAD:  
 MABEL AMELIA, B.JUL.11,1878;M.DEC.12,1909, LEO W. GOLDSTONE (MAR.19,1773-  
 DEC.29,1957)  
 BARBARA L. GOLDSTONE, B.JUN.2,1911;M. 1932, ARTHUR LOESCH (DIV.), AND  
 HAD :  
 DONALD, M.1) JEANNETTE;M.2) BARBARA. BY 1 HE HAD:  
 GARY  
 BRUCE  
 BY 2 HE HAD:  
 LISA  
 RICHARD STANLEY [CHANGED HIS NAME TO GOULD], M. ELIZABETH FINNERTY, AND  
 HAD:  
 TOM, M. DIANE DODDS  
 JOHN



BARBARA, M. W. L. FERDON, AND HAD:

WILL  
BEN

CHRIS, M. BRENDA BYUS, AND HAD:

REBECCA MARY  
BOB  
TIM  
CATHY

ESTHER, B. JUN. 12, 1851; D. JAN. 28, 1920; M. JAN. 15, 1873, NY, DANIEL S. DAVIS  
(LOND., JUN. 12, 1835-JUL. 5, 1917, SAN FR.), AND HAD:

SAM D., B. JUN. 9, 1974, NY; D. FEB. 20, 1946; M. JUL. 2, 1899, SEATTLE, MABEL MAC  
KENZIE

AMELIA, B. APR. 14, 1875, NY; M. MAR. 3, 1901, SAN FR., LOUIS BLOCH, AND HAD:

CLAIRE  
RUTH

JOHN J., B. JUL. 26, 1878, SAN FR.; M. FEB. 12, 11908, SAN FR., JOHN J. ILOYD  
MARIA, B. SEP. 11, 1853; D. MAY 29, 1926

REBECCA, B. MAY 29, 1855; D. 1936

JULIA S., B. SEP. 4, 1858; D. DEC. 14, 1945; M. MAR. 3, 1898, PORTLAND, OR, ARNOLD  
GOLDSCHMIDT [CHANGED TO GOLDSMITH] (HAMBURG, GER., FEB. 25, 1854-), AND  
HAD:

LEONORA AMELIA B. MAR. 12, 1885; M. APR. 4, 1928, L.A., WILLIAM JOHN LAWSON

DAVID J., B. SEP. 21, 1891, PORTLAND, OR; M. JAN. 11, 1922, SAN FR., DELPHINE BENEHIM

JOHN ARNOLD [CHANGED NAME TO GALEN]

DAVID A., B. MAY 16, 1860; D. 1939, SAN FR.; M. AUG. 3, 1892, SAN FR., THERESA  
ZEKIND, AND HAD:

AMELIA K., B. SEP. 23, 1893; M. JAN. 12, 1922, IRVING GOTTHEIM, ANND HAD:

JULIET THERESA, M. MORTON MILLS (TIM GOULD)

170. LEVY XVII

SAMUEL LEVY HAD:

HAYIM, M. MARY SIMON, B. 1688; D. 1791, AND HAD:

LEVY ANDREW, B. 1746; M. CA. 1761, SUSANNAH ? (1745-JUL. 1807), AND HAD:

MARIA, B. 1778; D. UNM.

JOSEPH, D. OCT. 3, 1813

BENJAMIN, D. 1793

SUSAN, B. 1785

ELIZABETH, B. 1793; D. 1867; M. PEREGRINE FALCONER, AND HAD:

WILLIAM ANDREW, M. AND HAD:

HENRY ERVIN

WILLIAM CHARLES

GEORGE COMEGYS

JOHN PEREGRINE

SEPTIMUS

MARGARET BURNEY

COMEGYS, D. UNM.

GEORGE, D. UNM. (DAVID BRENNER, THE JEWS OF LANCASTER, PA.)

173. LEWIS II(2)

RACHEL, M. FREDERICK WOLFF [NOT WOLFFE] (SWITZ. 1830-), AND HAD:

WILLIAM, B. 1860; D. 1864, MOBILE, AL

STILLBORN, 1862

EDWIN, B. 1864

NELLIE, B. 1866; M. REINSKOPF [NOT RENZDORF]

WILLIAM, B. 1868

HENRY [CHANGED HIS NAME TO HARRY HILLIARD WYLIE], B. 1870

SIDNEY, B. 1872; D. YOUNG (GAY CURRAN DESMOND)

174. LIEBER (LEBAIR)

CHARLES LEVI [SAME PERSON AS ON EMANUEL II], B. 1806 AND HAD:

[DEL. JAMES] JOSEPH F. M. DINAH EMANUEL

BENJAMIN LIEBER [BECAME LEBAIR], AND HAD:

HARRIET LIZZY, M. ABINGTON, PA, PHILIP I. COHEN (OV VIII(2)

(JONATHAN E. STEIN, BETH EL EMETH MARR., PH)

175. LOPEZ (RIVERA, NEWPORT, RI)

ISAAC RODRIGUES DE RIVERA, D. APR. 2, 1715, LONDON, AND HAD:

ABRAHAM, M. 1) JUL. 6, 1712, LONDON, AND HAD:

ISAAC, [DEL. M. LOND. 1735, JUDITH, DAU. OF MICHAEL PARDO

JACOB, M. 1741 CURACAO, HANNAH, DAU. OF SAMUEL RODRIGUEZ PIMENTEL, AND WID.

OF ABRAHAM SASPORTAS (MINORCA, FEB. 1720-NOV. 4, 1820, NY) AND HAD:

ABRAHAM, AND HAD:

AARON, B. AUG. 19, 1795, NY; D. JUN. 15, 1838, WILMINGTON, NC; M. JUN. 3, 1830,

WILMINGTON, MARY ADAMS BLANKS PIERCE (1801-OCT. 20, 1870), AND HAD:

SARAH LOPEZ, B. DEC. 26, 1833, WILM.; D. DEC. 22, 1923, WILM.; M. JUN. 15, 1853,  
WILM., WILLIAM LUMSDEN SMITH TOWNSHEND, AND HAD DESCENDANTS

REBECCA, M. MOSES (JCSE) LOPEZ, AND HAD:

ISAAC, B. FEB. 19, 1762; D. SEP. 21, 1822, NEWPORT

(MISCELLANIES OF THE JEW. HIST. SOC. OF ENG., VI, P. 15, #466; BEVIS MARKS KETUBOT  
NOS. 181, 562; LUCY L. MILLER; TOURO CEM.)

177 LOPEZ I(3)

AARON MOISE LOPEZ, HAD:

PHILIP MELVIN, HAD:

EUGENE RICE, HAD:

MARCELLA RICE, M. DONALD FRANK HEPPNER, AND HAD:

CATHERINE JOHNSTON, B. MAR. 2, 1973

ELEANOR LOPEZ, B. MAY 4, 1976

BRIAN RICE, SEP. 12, 1978

ELEANOR JOHNSTON, M. MAY 7, 1980, HARVARD, MA, ROBERT J. ANDERSON, AND HAD:

MOLLIE WILKES LOPEZ, B. APR. 10, 1981

AARON MOISE, JR. HAD:

JOHN L., HAD:

JAMES IRVINE, M. LYNN SADLER (MEMPHIS, MAR. 3, 1953-) AND HAD:

CHRISTOPHER, B. JAN. 21, 1981, CHATTANOOGA, TN

SARAH ELIZABETH, B. MAY 25, 1984, MEMPHIS, TN

BETTY SUE, M. MAY 19, 1984, WALTER H. STAMPER III

CORDELIA MOISE, M. WILLIAM DUBOFF, AND HAD:

FLORENCE MARIAN, M. EDWARD NORTHWAY, AND HAD:

LINDA LOUISE, M. JUN. 7, 1974, VINCENT ROSSIGNOL [DIV. 1985]

TERRY MICHAEL, M. JAN. 29, 1978, SANTA FE, NM, SHELLA PATA (CA, NOV. 28,

1954-). [HE ADOPTED HER SON]:

MICHAEL JOHN, B. AUG. 8, 1971, CERILLOS, NM

THEY HAD: [B. SANTA FE]

RACHEL ELIZABETH, B. NOV. 13, 1978

REBEKAH MARIE, B. APR. 12, 1981 (FLORENCE DUBOFF NORTHWAY)

180. LURIA

[DEL. EMANUEL NUNES MIRANDA, M. ABIGAIL]

ABRAHAM, D. FEB. 3, 1768, LONDON; M. 1) RACHEL ESTHER ? , D. AUG. 21, 1737, LOND.; M. 2)

ESTHER (RIBCA ESTHER) NUNES MIRANDA, D. DEC. 5, 1756, LOND., AND HAD:

REBECCA

DEBORAH, M. DANIEL HENRIQUES VALENTINE, AND HAD:

WELCOME, M. TOLEDANO [OF GIBRALTAR], AND HAD:

SIMHA (SARAH), B. 1795/6, LOND.; D. DEC. 1874, LOND., UNM.

DAU.

SON, D. YOUNG

ESTHER, B. 1771/2, LOND.; D. MAR. 17, 1847, LOND.; M. EMANUEL NUNES CASTELLO

(AMST. 1741/2-MAY 31, 1818, LOND.), AND HAD:

JACOB NUNES, B. JUL. 8, 1797, LOND.; D. APR. 30, 1881, LOND.; M. SEP. 7, 1818,

SARAH BEHERO ALEVY, AND HAD: [ALL B. LOND.]

MANUEL, B. 1827; D. JUN. 22, 1905, LOND.; M. OCT. 31, 1855, LOND., ELIZA-

BETH BILHA, DAU. OF SIMON MAGNUS (-JUL. 21, 1894, LOND.), AND HAD:

JACOB, B. SEP. 3, 1856, LOND.; D. MAR. 17, 1905, NICE, FR.; M. NOV. 6, 1877,

LOND., ALICE, DAU. OF LEON BENHAM (1855-APR. 17, 1890, GENEVA, SWITZ.),

AND HAD: [ALL B. LOND.]

DAU., JUL. 31, 1878

MANUEL, B. DEC. 27, 1879; M. APR. 19, 1928, DOROTHY HELENA, DAU. OF

LEOPOLD SUTRO (1896-OCT. 29, 1936, LOND.)

LEON BENHAM, B. SEP. 9, 1881; D. APR. 30, 1948; M. JAN. 22, 1908, LOND., LAURA

ETHEL, DAU. OF RICHARD SONNENTHOL, AND HAD:

NINA, B. FEB. 9, 1909, LOND.

RACHEL, B. JUN. 24, 1884; M. JAN. 15, 1908, LOND., HAROLD NUNES CARVALHO

SIMON MAGNUS, M. APR. 9, 1919, LOND., RENEE, DAU. OF JACQUES DREYFUS

ESTHER, B. APR. 4, 1828; D. FEB. 1, 1890, LOND., UNM.

BARUCH, B. AUG. 15, 1829; D. AUG. 15, 1868, LOND.; M. MAR. 25, 1863, LOND.,

SOPHIA, DAU. OF BENJAMIN WOLFF, AND HAD: [ALL B. LOND.]

JACOB, B. JAN. 4, 1864; D. JAN. 17, 1864

AMY SARAH, B. JUN. 25, 1865; D. SEP. 8, 1865

BENJAMIN WOLFF, B. JAN. 21, 1867; D. JAN. 2, 1937; M. JUL. 1, 1925, LOND.,

WINFRED CLAIRE, DAU. OF HERBERT P. MARSDEN

DANIEL, B. DEC. 11, 1831; D. AUG. 6, 1883, LOND.; M. JUL. 2, 1862, LOND., SARAH,

DAU. OF JUDAH ALOOF, AND HAD: [ALL B. LOND.]

JAMES, B. MAY 29, 1863; D. JUL. 18, 1928, LOND.; M. 1) NOV. 4, 1896, LOND.,

EDITH SARAH, (JUN. 13, 1866-JUN. 24, 1907), DAU. OF ELLIS A. FRANKLIN;

M. 2) AUG. 19, 1909, SARAH, DAU. OF ABRAHAM G. FRANKLIN. BY 2 HE HAD:

STILLBORN SON, B.JUN.25,1810, LOND.  
 PERCY, B.1865;D.MAY 20,1918, LOND.;M.JUN.19,1888, LOND., EDITH MIRIAM  
 (1865-OCT.9,1945, LOND.), DAU. OF JOSEPH DE CASTRO, AND HAD:  
 FLORENCE, M.FEB.2,1909, LOND., HON. GERALD MONTAGU, SON OF LORD  
 SWAYTHLING  
 HANNAH, B.MAR.6,1835;D.FEB.25,1906, LOND., UNM.  
 SOLOMON, B.AUG.3,1837  
 DANIEL NUNES, B.JUN.7,1798, LOND. AND HAD: (B. LOND.)  
 EMANUEL NUNES, B.MAY 20,1824  
 ESTHER NUNES, B.1825  
 RABBI ISAAC, B.MAY 4,1745;D.DEC.29,1822, LOND.  
 JACOB, B.MAY 24, 1747, LOND.;D.JUL.21,1805, LOND.;M. SARAH DE IMANUEL SALO  
 ISRAEL (-APR.16,1780), AND HAD:  
 ABRAHAM, B.APR.3,1780, HAMBURG, GER.;D.APR.13,1814, BARBADOS; M. BILHA  
 (BELLA) DE SAA SILVEIRA (1791-JUN.1871, LOND), AND HAD: [ALL B. BARBADOS]  
 JACOB, B.1808;D.(DROWNED)M. CORINNA, DAU. OF JOSEPH DE PASS [DEL. DROWNED]  
 AND HAD:  
 ABRAHAM, D.UNM.  
 JOSEPH, D.INF.  
 SARAH HANNAH, B.APR.15,1810;D.JAN.8,1878  
 ESTHER DE SAA, B.1811;D.SEP.18,1871, LOND., UNM.  
 RACHEL, D.JUN.3,1773, LOND., UNM.  
 SARAH, D.FEB.12,1776, UNM.  
 (JO WHITE LINN,ED., THE ANCESTRY OF NATHALIE FONTAINE LYONS, JUDITH B. ENDELMAN)

181 LYON II  
 AUGUSTA, M. NEVILLE GORDON HART, AND HAD:  
 ANDREW, M. LONI ?, AND HAD:  
 GEOFFREY  
 LYNN  
 ELVIRA, B.1878;D.1977;M. PERCY CHARLES SCHEUER (D.1923), AND HAD:  
 MARGARET LYON, B.1915;M.1) GEORGE CARLETON PEARL;M.2) RALPH FULLER WOLFF  
 (Q.V.II). BY 1 SHE HAD:  
 CARLETON DAY, B.1943;M. JUDITH ANN WEATHERSTON  
 AUGUSTA LYON, B.1947;M. WILLIAM PATTERSON NIX, AND HAD:  
 ELLIOT PATTERSON, B.1977  
 ADAM BRADSTREET, B.1979  
 MARY CORLISS, B.1950;M. CHARLES ALFRED PILLSBURY  
 ELIZABETH EMILY, B.1913;M. CHARLES MAXWELL, AND HAD:  
 ELIZABETH, B. 1943;M. WILLIAM LEE, AND HAD:  
 MATTHEW  
 EDMUND  
 CAROLINE, B.1977  
 JOHN WORTHEN, B.1946 (RALPH F. WOLFF)

181 LYON III  
 ISAAC LYON, M.ELIZABETH ?, AND HAD:  
 GEORGE (JUDAH), B.SEP.25,1833,NY (E. S. LAZARUS MOHEL REC.)

182 LYONS I  
 ISABELLA, B.1835;D.192-?, UNM. [NOT NOV.5,1840],  
 MARY, M. DAVID JUDAH POLAK, AND HAD:  
 JULIUS, M. ? LEVY [NOT MINNIE NEWMAN; DEL. DESCENDANTS], AND HAD:  
 ARCHIBALD, M. RUTH, AND HAD:  
 BARBARA  
 ANN  
 SARAH, B.1865/6;D.CA.1929, UNM.  
 MARK STRAUSE; M.CA. 1895, HARRIET SARAH (SADIE) HIRSCH (1895?-), AND HAD:  
 DAVID, B.1878;D.1973;M. ROSALIE DANZIGER, AND HAD:  
 SYLVIA, B.1927, NY;M. EDWARD SACHS, AND HAD:  
 NANCY, B.1952  
 EDWARD MARK, B.1953  
 MARCIA, B.1913, NY;M. LAURENCE LEONARD, AND HAD:  
 DAVID (ADOPTED)  
 MARK  
 CECILIA ISABELLE, B.1899;D.1968;M. EUGENE ALEXANDER. D.S.P.  
 ADOLPH H., B.1902;M. MARION BLAUBAUM, AND HAD:  
 MARJORIE JOAN, B.1922;M.1929, MARVIN LYLE PARIS, AND HAD:  
 MARK LYLE, B.1954  
 ROBERT OWEN, B.1957  
 HANNAH, M. HYMAN (MOSES) MORTON, AND HAD:  
 SARAH, D.1976, UNM.  
 ROSE, M. PHILLIP ISRAEL FELLEMAN, AND HAD:

ISRAEL, D.CA.1940;M. HARRIET (WHO M.2) AL REISS), AND HAD:  
 PHILLIP (MARJORIE J. PARIS)

183. LYONS II  
 HENRY, M. ELIZABETH WOLFF (PH. 1818- )  
 JOSEPH [DEL. M.D. U.OF PA.], ATTORNEY  
 JACOB COHEN, M.CA.1834, PH, AND HAD:  
 [DEL. CHARLES, B.FEB.19,1833]  
 ISAAC LAZARUS (CAPT. CSA) \*  
 ISABELLA R., D.JAN.25,1943, PH  
 JACOB C., JR. (JACK)  
 THEODORE HART  
 HYMEN HART, B.DEC.6,1852;D.ASHEVILLE, NC [NOT N.O.];M.PH, AND HAD:  
 NATHALIE FONTAINE \*  
 CHARLES M., B.1853;D.NOV.7,1876, N.O.  
 ESTHER HART, B.1856/7;D.MAR.28,1883, UNM. \*= DESCENDANTS ARE DETAILED IN  
 THE SOURCE FOR THE ABOVE: (JO WHITE LINN, ED., THE ANCESTRY OF NATHALIE FONTAINE LYONS)

184. MARACHE  
 SOLOMON, M.2)MAY 12,1787, PH, MARY HOLTON, AND HAD:  
 HENRIETTA J., M. THOMAS ARMSTRONG, AND HAD:  
 THOMAS, JR., B.1812, PH  
 EMMELINE J., M. DAVID J. BENT, AND HAD:  
 REV. RUFUS HOWARD, B.SEP.23,1850;D.JUL.9,1932;M. DR. SARAH POINDEXTER,  
 AND HAD:  
 FRANCES, M. HAYWARD  
 DAU., M. D. N. MAC KUBBIN  
 HARRY HOWARD (F. J. DALLETT)

184. MARKS II  
 MORDECAI, JR., D. HUNTINGTON, CT, AND HAD:  
 HEZEKIAH, OF HUNTINGTON, CT (IRWIN MILLER)

185. MARKS I  
 LEVY (LIPMAN) HAD:  
 SOLOMON, JR., B.1773, PH;D.AUG.1,1827, NORFOLK [NOT SON OF SOLOMON (RICHMOND)]  
 (MALCOLM H. STERN)  
 - - - - -  
 SARAH EDWITHA, B,SEP.5,1815, PH;D.JUL.15,1876, VERMILION, LA;M. N.O.  
 (SARAH ANITA LEVY)

186. MARKS III (NEW ORLEANS)  
 DR. FREDERICK H., M. ANN L. [NOT REBECCA H.], AND HAD:  
 FRANCES  
 REBECCA, M.RICHMOND HAWLEY  
 FREDERICK HUMPHREY  
 OSCAR  
 ELIZABETH  
 THOMAS HUMPHREY  
 EDWARD  
 ALEXANDER HAD: [IN CHRONOLOGICAL ORDER]  
 ELIZABETH (ELIZA)  
 JULIA ESTHER  
 ISAAC N.  
 JOSEPH HART, HAD:  
 ESTHER, M. ISAAC SCHERCK, AND HAD:  
 LEWIS, D. ? [NOT AUG.15,1943], AND HAD:  
 FANNIE VERA, D. AUG.15,1943  
 FREDERICK  
 JACOB WASHINGTON  
 DAVID  
 ISABEL  
 LEONORA  
 THEODORE  
 EDWIN  
 MARION  
 ALEXANDER  
 FANNY (WILL OF FRANCES MARKS (1850); CAROL D. EISEMAN)

191. MENDES  
 ISAAC PHILIP, HAD: [ALL B. SAV.]  
 ALMA, B.OCT.20,1878  
 DCRA, B.DEC.6,1880

- JOSEPH HAIM, B.AUG.1,1883  
ZIPORAH, B.OCT.17,1885  
JOY, B.NOV.10,1890
- RABBI FREDERICK DE SOLA, HAD:  
DAVID MARTIN, B.SEP.26,1888
- A(LVIN) PIZA, JR., D.1988, NY
- DAVID DE SOLA, B.1860;D.1932;M. LEAH CHUCK (NY 1864-JUL.8,1938, NY), AND HAD:  
HENRY DE SOLA, B.MAR.20,1893, NY;D.JUL.20,1982, NY;M.JUN.24,1917, BABBETTE,  
DAU. OF SUSSMAN & GUTTA (OTTENSOSER) REINHARDT (NY, APR.27,1896- ), AND HAD:  
ESTELLE, B.MAY 21, 1919;M.JUNE 18,1944, WALTER REINER (-MAR.16,1983), AND  
HAD:  
NANCY, B.NOV.23,1946;M.AUG.18,1968, MARTIN ZIMMERMAN, AND HAD:  
JONATHAN, B.APR.28,1076  
DANIEL, B.APR.20,1979  
DAVID, B.MAY 18,1950;M.NOV.28,1974, ANN DEBLINGER  
JONATHAN DE SOLA, B.NOV.3,1920;M.DEC.5,1955, MARY ELLEN ROSENBLUTH (AUG.  
17,1931-MAR.24,1988), AND HAD:  
ELIZA, B.SEP.12,1959  
JOSHUA, B.SEP.17,1962  
SUZANNE, B.DEC.26,1923;D.FEB.26,1975;M.JUN.18,1944, ARTHUR C. KRAGAN, AND  
HAD:  
ROBERT, B.NOV.4,1945  
JOHN, B.DEC.13,1948;M.1) MARJORIE GANG;M.2) PETRA WATSON. BY 2 HE HAD:  
CALICO, B.SEP.16,1973  
PATRICIA, B.JUN.17,1955  
WILLIAM, B.SEP.16,1956;M.MAY 25, 1985, MARGARET LELAND  
RUTH, B.APR.2,1926;M.JUN.20,1948, PHILIP HURWITZ, AND HAD:  
SUSAN, B.APR.29,1950;M.JUL.8,1984, ARNOLD GLICKSTEIN  
BARBARA, B.MAY 1, 1953;M.AUG.10,1980, ANDREW KATZ  
DANIEL NATHAN, B.MAR.25, 1957, PH;M.APR.5, 1986, JOAN LEWENGRUB  
(I. P. MENDES BIBLE REC.; SHEARITH ISR.; JONATHAN DE S. MENDES)
192. MENKEN-MORANGE  
GALATHE, D.OCT.3,1859 (UNITED HEB. CEM., CINTI.)
193. MITCHELL  
MOSES, B.1837 (E. S. LAZARUS MOHEL REC.)
196. MOISE(2)  
JACOB, D.AUGUSTA, GA, AND HAD;  
ELEANOR JANE, B.1829;D.1833, AUGUSTA
196. MOISE(3)  
ISAAC, HAD:  
JULIAN SIDNEY, B.1834;D.1835, AUGUSTA  
(JACK J. STEINBERG, "THE JEWS OF AUGUSTA," ANCESTORING XII)
198. MOISE(4)  
ANITA MOISE [ROSEFIELD], M. IRA ROSENBERG, AND HAD:  
DAVID  
VIRGINIA  
MINDELLE (VIRGINIA M. ROSEFIELD)
200. MORDECAI I(1)  
MARGARET MORDECAI [ASHE], M. SAMUEL ALBERT STOCKARD, AND HAD:  
MARY JOHNSON (JACKIE), M. WILLIAM MAYO ATKINSON, JR. (VID. LAZARUS II,  
ABOVE)  
META (RALEIGH, NC) (PHILA L. C. NYE, ...THE CALDERS OF WILMINGTON)
- ISAAC, B.1764, PH;D.AFTER 1830, AL, AND HAD: [B.NC, MOVED TO LAMAR CO.,AL]  
JOHN, B.CA.1813, AND HAD 10 CHILDREN  
SAMUEL, B.CA.1816  
ISAAC R., B.MAR.9,1818;M. MARY A. SMITH, AND HAD:  
TENESSEE ANN (LORA A. PETERS)
202. MORDECAI II (SC)  
GERSHON COHEN, HAD:  
CATHERINE, M. ELIAS ABRAMS (VID. ABRAHAMS III ABRAMS (SC)  
(RITA L. H. MC DAVID)

203. MORDECAI III  
SAMUEL M., B. VA. [IN PITTSBURGH AREA, THEN PART OF VA.]  
DAVID HAD:  
DAVID HENRY, M.HETTY HART (Q.V. XIV) (LORA A. PETERS)
205. MOSES I(1) (SC)  
REBECCA R., M.NOV.22,1855, SUMTERVILLE, SC, THOMAS P. MIKELL, OF EDISTO ISL.,  
SC, AND HAD:  
JANE MC CLELLAND  
WILLIAM EPHRAIM (DEAN, U OF PA LAW SCHL), B.FEB.29,1868, SUMTER, SC;D.JAN.  
20,1944, CH;M.APR.12,1894, MARTHA [NOT MATTIE] TURNER MC BEE (-JAN.24,1952,  
CHESTNUT HILL, PA), AND HAD:  
WILLIAM E., JR., D.JUN.29,1944  
MARY MC BEE, M.JUL.20,1921, RT. REV.OLIVER JAMES HART (EPISC. BP OF PA)  
(YORK,SC, JUL.18,1892-MAY 4,1978, ORANGE,NJ)  
RT. REV. HENRY (HARRY) JUDAH (EPISC. BP OF ATLANTA), B.AUG.4,1873, SUMTER;  
D.FEB.20,1942;M.NOV.8,1905, HENRIETTA CAMPBELL BRYAN, AND HAD:  
HENRIETTA CAMPBELL BRYAN (F. J. DALLETT)
206. MOSES I(2)  
FRANKLIN J. (CSA), B.OCT.15,1837 (E. S. LAZARUS MOHEL REC)
207. MOSES I(3)  
ALMERIA EMMA, D.1893;M.1865  
ADDIE, B.1846;D.OCT.30,1916, MOBILE, AL  
CLIFTON, M.APR.28,1869, MOBILE, ESTHER JONES (Q.V.II)  
(SUSAN ANITA LEVY; PHILA L. C. NYE,...THE CALDERS OF WILMINGTON, R. J. ZEITZ,  
MOBILE MARRIAGES)
207. MOSES I(4)  
ANDREW JACKSON, JR., HAD:  
WILLIAM GRAHAM, B.MAY 31, 1874, SUMTER;M.JUL.15,1914, MANNING,SC, LUCILE ISE-  
MAN, AND HAD: [B.SUMTER]  
ELLEN ISEMAN, B.JUL.1,1916;D. YOUNG  
HELEN LUCILE;M.JUL.30,1939, LOUIS REGENSTEIN, AND HAD:  
LEWIS GRAHAM, B.FEB.21,1943, WASH.,DC;M.SEP.11,1976, WICHITA, KS,  
JANICE KAY MENDENHALL, AND HAD:  
ANNA LUCILE, B.AUG.14,1979, WASH.  
JONATHAN KENT, B.SEP.23,1945,ATLANTA, GA;M.DEC.26,1971, ATLANTA,  
LYNN DIANE ALTOUNIAN, AND HAD: [B.ATLANTA]  
PAIGE DIANA, B.MAY 11,1974  
JONATHAN K., JR., B.FEB.5,1979  
ADELE MARIE, B.AUG.24,1921, M.MITCHELL MILLER, AND HAD:  
ELLEN MICHAEL, [DIV.]  
JACK KENNETH, M.JUL.26,1975, SHELLEY RUSSIN, AND HAD:  
JAMIE LISA, B. MAR.22,1980  
WILLIAM GRAHAM, JR., M.AUG.31,1947, RITA LEVENE, AND HAD:  
ROBIN LEIGH, B.JAN.18,1949;M.MAY 30,1976, PH, MARK POLLACK, AND HAD:  
ANDREW JACKSON, B.APR.15,1979  
DANA LUCILE, M.JUN.1,1980, N.O., LOUIS SHEPARD  
ARMIDA, B.AUG.15,1875, SUMTER;M.JAN.1,1902, JOSIAH WILLIAM BRUNSON, AND HAD:  
ANSLEY DAVIS, B.DEC.23,1902, ST. LOUIS, MO  
ARMIDA DAVIS, B.AUG.9,1905, SUMTER  
NELLIE, B.MAR.9,1908, JACKSONVILLE, FL  
LILLIAN, B.FEB.17,1877, SUMTER;M.FEB.10,1907, SUMTER MONTEFIORE JACOB MOSES  
(Q.V.III(2) FOR HIM AND THEIR CHILDREN  
ADELE, M.DEC.12,1906, SUMTER, EUGENE FORSHEE, AND HAD:  
ADELE, B.OCT.21,1907, SUMTER  
GRAHAM, B.MAR.5,1911, SUMTER  
ANDREW JACKSON III, B.SEP.6,1880, BELL BUCKLE, TN;M. SUMTER, BESSIE HUGHSON,  
AND HAD:  
EDNA ELIZABETH, B.JUN.19,1920, SUMTER  
CELESTE ROSALIE, B.JAN.25,1924  
ROSALIE VIRGINIA, B.JUL.24,1882;M.FEB.24,1909, WILFRED MOULTRIE MOSES(Q.V.III  
(2)  
CAROLINE [DEL.: M. MONTEFIORE J. MOSES (Q.V.III(2))  
(LOUIS REGENSTEIN, SUSAN MOSES)
209. MOSES II (NY)  
SOLOMON, M. PH, AND HAD:  
SIMON GRATZ, M.D., M.1)FEB.9,1838, WILMINGTON,NC [ALL CHILDREN BY 1]  
(KETUBAH OF SOLOMON MOSES; WILMINGTON, NC MARR., DAR TYPESCR.; DR. SAMUEL A. SOULE)

210. MOSES III(1)  
 LEVY I., D.JUL.21,1876, MONTGOMERY, AL (JUDITH ENDELMAN)  
 -----  
 ISAIAH, M. ISABELLE ABRAMS (VID. ABRAHAMS III ABRAMS (SC)  
 (RITA L. H. MC DAVID)
211. MOSES III(2)  
 LEVI I., D.JUL.21,1876, MONTGOMERY, AL, AND HAD: [IN CHRONOLOGICAL ORDER]  
 SARAH A., B.NOV.25,1833, CH;D.AUG.1,1861,CH, UNM.  
 JOSEPH WINTHROP, B. CH;D.1876, MONTG., UNM.  
 ROSANNA CECILIA, B.SEP.20,1838,CH;D.FEB.8,1922, MONTG., UNM.  
 ALFRED HUGER, B.SEP.16,1840,CH;D.MAY 24,1918, ST. LOUIS, MO;M.NOV.8,1871,  
 LOUISVILLE, KY, JEANNETTE, DAU. OF MORRIS & HANNAH (DINKELSPIEL) NATHAN  
 (KY,NOV.22,1849-NOV.15,1919, ST. LOUIS), AND HAD:  
 SARAH A., B.SEP.3,1872,MONTG.;D.DEC.5,1928, ST. LOUIS;M. HAWLEY  
 ALFRED H., JR., B.1875, MONTG.  
 ADELINE, B.1877, MONTG.;D.NOV.28,1953,NY;M.NOV.12,1896, ST. LOUIS, CARL  
 LOEB (FRANKFURT A/M, SEP.28,1875-JAN.3,1955, NY, AND HAD:  
 JOHN LANGELOTH, AND HAD:  
 JOHN L., JR. (US AMBASSADOR TO DENMARK), B.MAY 2,1930,NY;M.1) APR.1960,  
 NINA SUNBY (DIV.), AND HAD:  
 ALEXANDRA  
 NICHOLAS  
 LEE JOHNSTON, B.1878/9, MONTG.  
 JOSEPH WINTHROP, B.JAN.18,1880, MONTG.;D.JAN.17,1927, ST. LOUIS(?)  
 MORDECAI LYON, B.AUG.30,1842, CH;D.JUN.6,1918, ST. LOUIS, UNM.  
 JUDAH TOURO, D.1920, MONTG.  
 GRACE AGUILAR, D.OCT.1931, MONTG., UNM.  
 EMILY  
 HENRY CLAY  
 JACOB I., HAD:  
 MONTEFIORE JACOB, B.CH;D.NY, AND HAD:  
 BELLE, B.MAR.2,1864,SAV.;D.1944, WINSTED, CT, UNM.  
 MONTROSE JONAS, M.2)JUN.19,1923, LEAH AGNES HOUGHTALING, AND HAD:  
 LAWRENCE SUTHERLAND, B.MAY24,1933  
 EVA MAY, B.APR.17,1871, NY;D.1943, UNM.  
 WILLIAM MOULTRIE, B.JUN.28,1843, AND HAD:  
 ALBERT LURIA, HAD  
 WILFRED MOULTRIE, M.FEB.24,1909, SUMTER, ROSALIE VIRGINIA MOSES (Q.V.I  
 (4), AND HAD: [B.CREDE,CO]  
 MARIE, B.FEB.26,1911  
 ALICE MARJORIE, B.DEC.1913  
 MONTEFIORE JACOB, M.FEB.10,1907, SUMTER, LILIAN [NOT CAROLINE] MOSES  
 (Q.V.I(4), AND HAD:  
 NINA, B.FEB.24,1909, CREDE CO  
 LILIAN, B.MAR.20,1910, GREELEY, CO  
 ADELE, B.FEB. 1916, GREELEY, CO  
 RYNEAR, M.D., B.1845, SC;D. NY;M. ? , HAD 4 SONS  
 FLORA, D.MAR.1,1900, NY  
 (JUDITH ENDELMAN; LOUIS REGENSTEIN; WHO'S WHO IN WORLD JEWRY, 1972; JOHN L. LOEB, JR.;SUSAN MC:
213. MOSES V  
 ADELINE, B.OCT.23,1809, CH;D.NOV.19,1873, MONTGOMERY, AL;M. CH  
 (JUDITH ENDELMAN)
215. MOSS(2)  
 LEOPOLD (LEE) [LOWENGRUND], M.DEC.8,1880, PH (BETH EL EMETH MARR., PH)
219. MYERS IV  
 EMANUEL J., M. BERTHA SHALEK, WIDOW OF HERMAN KOEHLER  
 HENRY, M. LENA LUCKSTONE, AND HAD:  
 CLIFFORD, M. AIMEE, AND HAD: A SON (MARON SIMON)
221. MYERS IX  
 LAWRENCE MYERS, M.MAY 22,1833,NY, SARAH PIKE (Q.V.I)  
 (EAKLE & CERNY, EDS., THE SOURCE, P.608)
222. MYERS X  
 FRED S., D.RI, AND HAD:  
 STELLA, M. FRANK LOEB, AND HAD:  
 HOWARD, M. RUTH , AND HAD:  
 DONALD  
 SUSAN
- ROBERT, M. KITTY  
 FREDERICK, M. STELLA  
 SYLVAN E., HAD:  
 VALERIE, M.MAR.16,1946 GEORGE ROTHSCHILD, AND HAD:  
 JANE ELLEN, M.1) JOSEPH FERGUSON (DIV.);M.2)DEC.24,1986, ROBERT JACOBSEN.  
 BY 1 SHE HAD:  
 JASON FREDERIC, B.MAR.1,1974  
 JOHN STEPHAN, M.JUN.12,1976, ELLEN JEAN WILLIAMS, AND HAD: [B. EVANSTON, IL]  
 JENNIFER ERIN, B.MAY 19,1983  
 ANDREW JOHN, B.MAR.3,1988 (VALERIE M. ROTHSCHILD)
226. NATHAN I(1) (NY)  
 EDGAR JCOSHUA, JR., HAD:  
 EDGAR JOSHUA III, M. RUTH GOTTESMAN (FEB.23,1927- ) HAD:  
 SARA [DEL. H], M.FEB.15,1981, JOEL D. KAZIS (JAN.27,1953- ), AND HAD:  
 JOSHUA AARON NATHAN, B.JUL.17,1985  
 DAVID JOSHUA, M.JAN.18,1987, REBECCA LEIGH CHAPLAN (APR.1,1958- ), AND HAD:  
 AARON EDGAR, B.NOV.24,1987  
 ROSALIE GOMEZ, D.FEB.21,1986, NY (EDGAR J. NATHAN, III; RUTH H. SCHULSON)
227. NATHAN I(2)  
 MARION FLORANCE, M.2) PAUL SANDOR (MALCOLM H. STERN)
228. NATHAN II  
 REV. MOSES NATHAN NATHAN [HAZAN IN ST. THOS., KINGSTON, AND N.O.]
229. NATHANS I(1)  
 PHILIP (FICE), B.PH;D.PH, AND HAD:  
 OLIVIA GEORGIA, M. MEYER GOLDSMITH, AND HAD:  
 PHILIP NATHANS, M. ADELE ANATHAN  
 AMERICA LAURA, M. DAVID HERMAN STEEL, AND HAD:  
 COLUMBUS, D.JUN.23,1966;M. IRENE KOENIG (-APR.2,1977), AND HAD:  
 EDMUND P., HAD:  
 ELIZABETH, M. DR. JOHN WALTON, AND HAD:  
 KALEN  
 JUDITH ANN, M.BRUCE ZEIDEL, AND HAD:  
 ADAM  
 DAU.  
 PHILIP GOLDSMITH, HAD:  
 ROBBIE DAWN, B.AUG.25,1965  
 HERMAN DAVID, M. FRIDA NEUFELD (-MAR.5,1952), AND HAD:  
 PHILIP NATHANS , D.JUN.4,1964;M. JANET KAHN (-DEC.14,1979), AND HAD:  
 PHILIP N., JR., M. JOAN KRECHMER (FEB.15,1937- ), AND HAD:  
 ADAM PHILIP, B.MAR.25, 1968  
 ROGER KAHN, M. VIVIAN SINGLEY (FEB.14,1934- )  
 RICHARD DAVID, M. LAURA BERMAN (MAR.14,1944- )  
 ELINOR, D.JUN.19,1978;M. HERBERT LEVY (APR.2,1905- )  
 DOROTHY OLIVIA, M., P. EDWARD BARENKOPF, AND HAD:  
 KAY EVE, M. PAUL J. SUDE (OCT.29,1933- ), AND HAD:  
 LESLIE ELIN  
 JOAN CAROL, M. ALLAN REISKIN (APR.24,1936- ), AND HAD:  
 JULIE ANNE, B.NOV.24,1964  
 EDWARD DAVID, B.OCT.27,1966  
 EUGENIA EMMA, B.PH;D.SAV.;M.PH. CHARLES COLEMAN (KOHLEMAN) (GNESEN  
 PRUSSIAN-POSEN, FEB.24,1843-OCT.22,1922,SAV.), AND HAD:  
 PHILIP NATHANS, B.SAV.;D.NOV.30,1972, JACKSONVILLE, FL;M. RAY KAUFFMAN  
 (SYRACUSE, NY, SEP.3,1888- ) S.P.  
 LEO CHARLES, B.JAN.9,1885;M. CARRIE KASKEL VICTOR (MAR.25,1891-), AND HAD:  
 [B. SAV.]  
 JACK, B.JUN.4,1921;M.MAY 25,1946, HELENE STERN (NY,APR.22,1925- ), AND  
 HAD:  
 CHARLES JAY, B.AUG.8,1951, PH;D.APR.27,1954,PH  
 PHILIP, B.APR.9,1954, CAMDEN, NJ  
 NANCY LEE, B.PH;M.DEC.18,1976, JACKSONVILLE, FL., EDWARD IRA SILVERMAN  
 (BOSTON, JUL.26,1954- ), AND HAD: [B. JACKSONVILLE]  
 CHERYL ANN, B.JAN.17,1980  
 MICHAL CHARLES, B.AUG.10,1982  
 RUFUS EZEKIEL LESTER, D.JUN.8,1954;M. DOROTHY WIESEN (APR.1,1900-AUG. 22,  
 1974), AND HAD:  
 LESTER, JR., B.FEB.3,1936  
 OLIVIA MARIE, B.DEC.30, 1891, SAV.
- BLANCHE MIRIAM [KRAUSKOPF], B.SEP.26,1880;M. HARRY HERZBERG, AND HAD:

BESSIE GWENDOLYN, B.OCT.5,1905;M. HERBERT J. MAYER (MAY 21,1901- ), AND HAD:

HARRY ALBERT, B.FEB.25,1927;M.DEC.16,1951, SANDRA GOLDBERG, AND HAD:  
CATHY ANN, B.DEC.27,1955  
LINDA GWEN, B.MAR.7,1959

HARRY, B.JAN.31,1857;M.JAN.14,1878, PH, MIRIAM LOUISA E. KARTSHER  
(JACK COLEMAN, PHILIP N. STEEL, JR., BETH EL EMETH MARR.)

230. NATHANS I(2)  
BENVENIDA VALENTINA-HENRIQUEZ DA SILVA SOLIS [SONNEBORN], M. IRWIN L. BERNSTEIN, AND HAD:

LYNN WHITLOCK, M.2) JUL.5,1985, PH, DENIS MICHAEL CURLEY, AND HAD:  
BENVENIDA VALENTINA HENRIQUEZ DA SILVA SOLIS SONNEBORN, B.NOV.27,1986

PHILIP M. R. [SONNEBORN] HAD:  
MARCIA WHITLOCK, M.2)JUL.2,1979, NY, JOHN FABIANI, AND HAD:  
JOSEPH SONNEBORN, B.JUL.29,1982  
MICHAEL SONNEBORN, DEC.25,1985  
WENDY GOLDA, M.AUG.27,1978, NY, JOHN TURETSKY, AND HAD:  
LAUREL BLOSSOM SONNEBORN, B.JUN.21,1986 (BENVENIDA V.H.S. BERNSTEIN)

231. NATHANS II (CHARLESTON)  
ALEX [NOT ALEXANDER], B.1834, CH;D.1900, MACON, GA  
(MARIAN & GUS KAUFMAN, THE BURIALS OF CONG. BETH ISRAEL, MACON, GA)

231. NEWHOUSE (1)  
FRANK, M.DEC.6,1882, PH., NETTIE, DAU. OF SOLOMON NUSBAUM  
(BETH EL EMETH MARR.)

231. NEWHOUSE (2)  
EVA, M. SAM MEREDITH, D.S.P.  
SIMON, D.S.P.  
FLORENCE M., M. NOBEL PENNINGTON, D.S.P.  
(ESTATE OF FLORENCE RHINE, DAVID A. LONG)

232. NOAH I  
MANUEL MORDECAI, D.FEB. 1873  
JACOB, D.OCT.13,1797 (JONATHAN SARNA, JACKSONIAN JEW)

233. NONES  
RAPHAEL NONES, B.CA.1688;D.JUL.9,1748, BORDEAUX;M. JUDICA LOPES (CA.1690-FEB. 24,1763, BORDEAUX), AND HAD: [B. BORDEAUX]

DAVID NONES, B.JUL.22,1708;D.JUL.17,1780, BORDEAUX;M. SARA ?, AND HAD:

DAVID  
SARA  
JUDITH  
MIRANDE  
MARDOCHEE, B.MAR.11,1739  
ISAAC

AARON, B.JAN.22,1714;M. SARA PEREYRE, AND HAD:

AARON, B.FEB.17,1745

2 DAUS.

BENJAMIN, B.JUL.10,1752

JACOB, B.20 AUG.1720, M. ROSE FERNANDEZ, AND HAD:

MIRIAM, B.JUN.25,1754

SELOMO, B.JAN.22,1765

DANIEL, B.SEP.25, 1723; M. ESTER ALVARES, AND HAD:

RACHEL, B.SEP.21,1753

RAPHAEL, B.JAN.30,1755

SARA, B.MAR.24,1756

MARDOCHEE, B.MAR.5,175

JUDIQUÉ, B.SEP.6,1761

ISAAC, B.NOV.28,1763

REBECCA, B.JUN.15,1764

ABRAHAM, B. 1766

REBECCA, B.MAY 3,1769

LEAH, B.APR.8,1772

DAVID, B.AUG.15,1774

SIPORA, B.APR.3,1777

ABRAHAM BENJAMIN, B.CA. 1724;D.FEB.11,1796, BORDEAUX;M.JUL.10,1752,

RACHEL, DAU. OF ABRAHAM AND MIRIANDE (MIRYAM) (LOPES) NONES (CA.1725/36-SEP. 12,1796, AND HAD: [B. BORDEAUX]

ESTER, B.FEB.4,1753;D.FEB.19,1753

ANNE MARIE/ MARIE ANNE/ MIRIAM  
ABRAHAM BENJAMIN/ BENJAMIN ABRAHAM, HAD:

DAVID B., HAD:

JOSEPH D., B.1813, SPAIN;D. BALTO;M. HANNAH (NJ,1816- ), AND HAD [B. BALTO.]

HENRY S. B.OCT.1839;D.1912, BALTO.;M.1) ;M.2) M. LARUE ASTOR;M.3) AN-  
NIE E. (1850-1913), AND HAD: [B.BALTO.]

CONSTANT J., B.1863;M.EMMA (IL, JUL.1873- ), AND HAD:

HARRY D., B.JUL. 1894, DENVER

JAMES H.

MARY D., D. YOUNG

ADELAIDE I., B.OCT.1849;D.1938, BALTO., UNM.

ISABELLA D., B.OCT.,1850;D.1924, BALTO.;M. GEORGE THOMAS HEWING  
(BALTO., OCT.1852-1922, BALTO.), AND HAD: [B.BALTO.]

ALVIN NONES, B.JAN.1880;D.1949, BALTO.;M. ADA CHAMBERLAIN (1892-  
1972, BALTO.), AND HAD: [B.BALTO.]

ALVIN N.,JR., B.MAY 19,1909;M.1) CATHERINE PEREGOY (1908-1964);  
M.2) DOROTHY GUNTRUND, AND HAD: [B.BALTO.]

VIRGINIA, B.1939;D.1945

ALVIN N., III, B.1942;M. SHARRON DEEM, AND HAD:

CYNTHIA CAROL, B.MAR.1974

SUSAN CAROL, B.1944;M. CHARLES NEWMAN, AND HAD:

ANDREW WARREN, B.1971

CATHERINE JANETTE, B.MAR.1974

ADA, B.1914;D.1968;M. JOHN ANDERSON, AND HAD:

ADA LOUISE, B.1944;M. MARK FREEMAN

WILLIAM BANKS, B.1915;M. ANN, AND HAD: [TWINS]

WILLIAM B., JR., B.1947, M. ROSEANN CHART, AND HAD:

SHANI

NANCY, B.1947, M. SMITH

DORIS, B.1920;M. EARL BRINK

GEORGE T., JR., B.1881;M. BESSIE, D.S.P.

ADELAIDE I., B.1883;D.1898, BALTO., UNM.

MARY G., B.NOV.1889;D.1956, BALTO.;M. JOHN J. PIVEC (1894-1964),  
D.S.P.

ISAAC D., B.1817, SPAIN;D.JAN.6,1888, PH;M.1) HANNAH MC CALLAN;M.2)

ANGELINA ? (-1853);M.3) CATHERINE ? (-1864);M.4) MARY SHERMAN (1835-)

HE HAD: (B. PH)

BENJAMIN I., B.1841;D.SEP.3,1847, PH.

MARY, B.1842;D.JUN.13,1885, PH, UNM.

JOHN I., B.AUG.1847;MAR.25,1853, PH.

LAURA, B.JAN.1856;D.JUL.30,1856

VIRGINIA, B.1860

WILLIAM I., B. JUL.1,1865;D.OCT.15,1943, PH;M.1) IDA VIRGINIA (MAY  
1865-MAY 1914), DIV.;M.2) JESSIE LUDY (FEB.1877-MAR.1955), AND HAD:

[B. PH]

WILLIAM I.,JR., B.JUN.1883;D.FEB.4,1964, DEL. CO.;PA;M.1) BERTHA ;  
M.2) EDITH MARKS. HE HAD:

BERTHA, OF DETROIT

MARY JOSEPHINE, B.JAN.1885;D.AUG.12,1903, PH, UNM.

SADIE, B.OCT.1886;D.SEP.11,1910, PH, UNM.

FANNIE, B.DEC.1889;D.DEC.8,1967, ATLANTIC CITY, NJ;M. WILLIAM BOEHM  
[ISSUE]

FRANK WALTER, B.OCT.1890;D.FEB.8,1966, PH;M.MARY TAYLOR (PH 1893-  
1958, PH), AND HAD:

VIRGINIA, B.FEB.5,1913, PH;M. ALBERT CODY (FEB.15,1903-  
DEC.18,1977, PORT LUCIE, FL) [ISSUE]

THOMAS, B.JAN.1893;D.JUL.17,1893

ROBERTS ASHTON, B.JUN.11,1914;M.1) INA C. HANSHAW (DIV.);M.2) MAE  
MAULE. HE HAD:

ROBERTS A., JR., B.SEP.1,1936, PH;M. ESTHER BLEVINS, AND HAD:

[B. BERLIN, NJ]

CHERYL LYNN, B.SEP.20,1961

ROBERTS A. III, B.DEC.,24,1962

DOROTHY, B.AUG.10,1916;M. WALTER PARKER MILLER (DIV.)

SOLOMON D., B.1820/21;D.AUG.22,1869, PH;M.MARY ANN HOGLAN (PA, 1821-  
SEP.8,1863, PH), AND HAD: [B. PH]

ANNA, B.1845;D.OCT.11,1933, PH, UNM.

EDWIN, B.MAR.1847;D.JAN.10,1905, PH;M.1) HENRIETTA A. M. (-  
FEB.5,1887);M.2) I., WID. OF STRICKLAND (JAN.1848- ). HE HAD: [B.PH]

EDWARD L., B.JUN.1873;D.JAN.10,1874, PH

EMMA, B.NOV.1886;D.AUG.9,1887, PH

CHARLES D., B.MAR.1825;D.JUN.29,1903, PH;M.MARY JANE CHURCH

ABRAHAM B.; M. MARIA DE LOS ANGELES MARTINEZ, AND HAD: [B. MARACAIBO]  
 RAFAEL, B.1830;D.1912, MARACAIBO;M.ANA ANGULO (-1879), AND HAD:  
 [B. MARACAIBO]  
 RAFAEL, B.CA.1858;D.1893, CARACAS;M. DOMITILIA RAMIREZ, AND HAD:  
 [B. CARACAS]  
 RAFAEL  
 ANA T.  
 DELIA, M. ADOLFO D'ONZANO  
 FEDERICO, B.CA.1860;D.1895;M. ANA T. TROCONIS, AND HAD: [B.CARACAS]  
 RAMON  
 FEDERICO, B.1890;D.1946, CARACAS;M. FLOR M. NEGRON, AND HAD:  
 [B.CARACAS]  
 ALFRED  
 RAMON  
 ISABEL  
 ISOLINA  
 ABRAHAM, B.1862;D.1903, CARACAS;M. ANTONIO FONSECA CELIA, AND HAD:  
 [B. CARACAS]  
 JOSE RAFAEL, M. MARIA GARCIA  
 BENJAMIN  
 ALBERTO  
 ABRAHAM, M. JOSEFINA SUCRE, AND HAD: [B. CARACAS]  
 CARLOS ENRIQUES  
 GRACIELA  
 ANGELA, M. RAUL VILLASMIL. [ISSUE]  
 JOSEFINA  
 ANA, M. ROMULO PARRIA. [ISSUE]  
 PEDRO, B.MAY 1868;D. MOMSON, MA;M. ANNA A. THAYER  
 JOSEPH B. (USN), HAD:  
 ALEXANDER HAMILTON, HAD:  
 WALTER MARKS, D.MAR.10,1942, NY;M. SOPHIE F. PAYNE (OXFORD, ENG.,  
 MAR.4,1883-MAY 2,1978, PITTSBURGH, PA), AND HAD: [B. NY]  
 WALTER ALEXANDER PAYNE, B.OCT.1,1908;D.NOV.7,1963, WASH.,DC, UNM.  
 MARJORIE FLETCHER, B.APR.15,1912;M. KENDALL P. JONES, OF  
 PITTSBURGH [ISSUE]  
 SARAH (SADIE) FLOY, M. JESSE GODFREY MORITZ BULLOWA, AND HAD: [B.NY]  
 MARGARET, UNM.  
 JAMES, D.NOV.24,1970;M. LILLIAN WUCHER, AND HAD:  
 SUSAN, B.1949  
 JANE, B.1951  
 RALPH, B.FEB.22,1953, DOBBS FERRY, NY  
 AARON B., B.OCT.27,1798;D.JUN.20,1855, CINCINNATI, AND HAD:  
 JUDAH (LEON AARON), D.1897, JAMAICA, NY, AND HAD: [B.NY]  
 THEODORE EMANUEL  
 LYLE B., B.1860;D.1881, UNM.  
 EVELINE, D.MAY 31,1912, NY;M. EMANUEL CLAYBURGH, AND HAD:  
 ALBERT, B.NOV.24,1863, NY;D.MAY 15, 1946, MT. KISCO, NY;M. ALMA  
 LACKENBRUCH (PH, 1882-AUG.4,1958, NYO, AND HAD:  
 ALBERT H., B.MAR.7,1909, NY;M.1) BARBARA CORLIES;M.2) JULIE DORR, AND  
 HAD: [B. NY]  
 CORDLIES, B.OCT.25,1934;M.10 LUDELLA FAYDEEN;M.2) MARIE, AND  
 HAD:  
 LEE  
 LUDELLA  
 JILL [ACTRESS], B.APR.30,1944;M. DAVID RABB  
 JAMES DORR, B.MAY 23,1949  
 ALMA EVELINE, B.OCT.22,1915;M. JAMES HOOPER GREW (BOSTON, DEC.16,  
 1906), AND HAD: [B. BOSTON, MA]  
 ALMA, B.JUL.29,1941  
 EDWARD STURGIS, B.MAY 29,1944;M. PRISCILLA PERKINS  
 JAMES HOOPER, JR., B.MAY 5,1948  
 JULIA ESTELLE, M. ISRAEL BARNET COHEN, AND HAD:  
 BENJAMIN FRANKLIN, M. ANNIE COHEN (ENG., DEC.1852-), AND HAD: [B.  
 NY]  
 ISRAEL, B.OCT. 1877  
 HOWARD, B. JUN. 1881  
 GEORGE WASHINGTON, D.OCT.1,1931, PITTSBURGH, PA;M.2) BESSIE M.  
 EDWARD EVERETT, M. LUCY A. DUNN (DEC.1861- ), AND HAD: [B. PH]  
 EDWARD R., B.OCT.1882  
 ARTHUR S., B.DEC.1891  
 VICTOR EMANUEL, M. LILLIE E. MUELLER (APR.1867- ), AND HAD: [B.PH]  
 MABEL L., B.JUN.1887  
 CLAUDIA C., B.FEB.1890

HORATIO SEYMOUR, HAD:  
 ELIZA ESTELLE, M. THOMAS BAYARD BRUNT, AND HAD:  
 THOMAS B., JR., HAD:  
 PETER WHEELER HAD: [B. WILLINGBORO, NJ]  
 KATHRYN WENDY, B.NOV.15,1976  
 TIMOTHY WHEELER, B.NOV.25,1978  
 CAROLINE JANET, M. FRED MORIUCHI, AND HAD: [B.WILLINGBORO]  
 CHRISTOPHER NAOJI, B.OCT.17,1975  
 SEIJI HAROLD, B.JUN.17,1979  
 HENRY, D.1870, NY  
 DANIEL, M. LOUISE  
 HENRY B., D.AUG.25,1868, WILMINGTON, DE;M., ANNA M. RINO (PH, JUN.6,1804-  
 APR.15,1887, WILMINGTON, AND HAD:  
 JEFFERSON HENRY, B.NOV.14,1824, PH;M.1) ELLEN S. JOHNSTON (1822-1852);  
 M.2) FANNIE E. JARVIS (DIV.)  
 WASHINGTON, B.OCT.10,1827, PH;D.SEP.9,1853, PENSACOLA, FL, UNM.  
 HENRY BEAUCHAMP, B.MAY 15, 1830, PH;D.APR.9,1905, WILMINGTON;M. SUSAN  
 G. RICHARDSON (1849-1929, WILMINGTON). D.S.P.  
 ANNA VIRGINIA, B.MAY 1, 1833, EAST RIVER, VA; D.MAY 15,1833  
 JOHN MC INNIS, B.MAR.22,1834, NY;D.SEP.1,1859, WILMINGTON, UNM.  
 SAMUEL SMITH, B.APR.22,1837, TOMKINSVILLE, NY;D.JAN.10,1915, NARBERTH,  
 PA; M.1) HARRIET A. HODGSON (1837-1882);M.2) LIZZIE L. COOPER (1861-  
 1907), AND HAD:  
 ROBERT HODGSON, B.JAN.28, 1864, WILMINGTON;D.DEC.28,1936, PH; M.  
 SUZIE C. WILKINS (1864-1943, PH), AND HAD: [B. PH]  
 GEORGE WILKINS, B.JAN.30,1885;D.SEP.27,1889  
 ROBERT H., JR., B.JUN.2,1887;D.JULY 2, 1970, PH;M. MABEL WEIDNER  
 (PA, 1899-), D.S.  
 IDA, B.AUG.12,1889, PH;D.JULY 9,1929, NARBERTH, PA;M. JOSEPH M. WILEY,  
 JR. (1868-1908) [ISSUE]  
 HENRY BENJAMIN, B.DEC.6,1870, PH;D.MAY 1, 1918, PH;M. ELIZABETH  
 SLATER (1873-1939), D.S.P.  
 EARL RINO, B.SEP.2,1886, PH;D.JUL.19,1887  
 ALBERT COOPER, B.JUN.21, 1883, PH;M. GERTRUDE A. BECK (1888- )  
 ALBERT SMITH, B.APR.28,1840, EASTPORT, ME;D.APR.24,1887, WILMINGTON,  
 DE;M.1) EMMA L. NEGUS;M.2) IDA WELLS, AND HAD:  
 LILLIE, B.1878, PH  
 MARY KIRBY, B.JUN.18,1842, EASTPORT, ME;D.APR.17,1897, WILMINGTON, DE;  
 M. ROBERT SMITH RALSTON (PH, 1824-1884) [ISSUE]  
 SUE ROBINSON, B.MAY 9, 1845, WILMINGTON;D.JUL. 1845, WILMINGTON  
 JEFFERSON D.JULY 20,1869, PH;M.1) GEORGIANA DIBLIN (PH, 1813-JUL.  
 14,1833, NY);M.2) MARY LOUISE MARSHALL (AVON, CT, MAR.16,1816-DEC. 21,1897,  
 FT WAYNE, IN), AND HAD:  
 [BY 1]  
 SARAH ANN, B.JUL.14,1833, NY;D.CA. 1927;M. ? D.S.P.  
 [BY 2]  
 LUCELIA, B.SEP.20,1834, NY;D. FT. WAYNE, IN;M.WILLIAM J. BOND (PA,  
 1834-). [ISSUE]  
 THOMAS JEFFERSON, B. MAR.2,1836, NY;D.  
 ANNA VICTORINE, B.SEP.20,1838, NY;D.OCT.19,1838, NY  
 MARSHALL, B.NOV.14,1839, NY;D.SEP.25,1840, NY  
 JAMES CREIGHTON, B.JUL.26,1841, NY;D.JAN.12, 1916, IN;M. SALLIE LAIRD  
 BELL (DIV.), AND HAD A DAU.  
 WILLIAM CARRIER, B. JUN.22, 1845, HARTFORD, CT;D.JAN.24,1929, LOUIS-  
 VILLE, KY; M.1) EMMA A. KENDALL (1849-1871);M.2) ELIZA PORTER, AND  
 HAD:  
 [BY 1]  
 ALLYN KENDALL, B.MAR.28,1868, EVANSVILLE, IN;D.DEC.29,1890, LAS  
 VEGAS, NM, UNM.  
 SETH MARSHALL, B.JAN.17,1870, LOUISVILLE, KY;D.FEB.19,1958, SHELBY-  
 VILLE, KY; M. MARY EMMA YEAKLE (SPRINGFIELD, IL, DEC.2,1870-JAN.18,  
 1948, SHELBYVILLE), AND HAD: [B. LOUISVILLE, KY]  
 LYNN WILLIAM, B.DEC.29,1893;D.JAN.26,1981, SOQUEL, CA;M. NORMA  
 MADGE DYAL (TELFAR CO., GA, FEB.26,1896- ) AND HAD:  
 NORMA, B. JUN.22,1927, NY;M. WILLIAM PORTER IRWIN (SPRINGFIELD,  
 IL, SEP.22,1919- ), AND HAD: [B. REDWOOD CITY, CA]  
 RICHARD PORTER, B.JUL.22,1955  
 JEFFREY LYNN, B.DEC.24,1956;M. ELIZABETH GALLARDO (HONOLULU,  
 HI, AUG.13,1956- )  
 ROBERT BRUCE, B. JUL.29,1959  
 DOROTHY LAMB, B.AUG.31,1896;D.DEC.15,1972, LOUISVILLE;M. ELMER  
 HARRIS DOE (MONTCLAIR, NJ, MAY 26, 1885-DEC.11,1956, SHELBYVILLE,  
 KY) [ISSUE]

EDWARD KENDALL, B.OCT.25,1898;D.MAR.19,1959, SHELBYVILLE, UNM.  
 MARTHA ISABEL, B.JUL.27,1874, LOUISVILLE;D.APR.18,1954, LOUISVILLE,  
 UNM.  
 EDWARD PORTER, B.MAY 21, 1876, LOUISVILLE;D.JAN.13,1916, GALVESTON  
 BAY, TX;M. ELIZABETH MADDEN (LOUISVILLE, 1883-OCT.1963, REDWOOD,  
 MS), AND HAD:  
 ELIZABETH, B.FEB.3,1906, LITTLE ROCK, AR;D.SEP.9,1955, TAMPA,  
 FL;M.1) BLAIR BALLARD (DIV.);M.2)TOULMIN H. EWING (-1938);M.3)  
 HERBERT A. PAYNE (DIV.);M.4)HENRY W. CURTIN (DIV.), [ISSUE BY 2]  
 PAUL USHER, B.JAN.5,1915; M.MARY LOUISE NOWLIN, AND HAD:  
 ANN MADDEN, B.JAN.2,1949, HONOLULU, HI;M.MARLIE LYNN LANDRUM, OF  
 HATTIESBURG, MS.  
 CAROLYN PORTER, B.JAN.26,1952, KARACHI, PAKISTAN;M. TIMOTHY  
 JAMES DOLAN, OF METAIRIE, LA  
 MARY, B.JUL.23,1848; D. UNM.  
 ISABEL DE LEON, B.JUN.29,1851;D.JAN.15,1898, FT. WAYNE, IN;M. GEORGE  
 R. BOWEN, D.S.P.  
 CELESTINE, B. JUL.13,1854;D.APR. 19,1923, CLEVELAND, OH;M.EDWARD F.  
 BIEWEND (1853- ) [DIV.] [ISSUE]  
 JUDITH, B.CA.1761  
 DAVID, B.FEB.20,1762  
 RAPHAEL, B.JAN.21,1764  
 AARON, B.FEB.5,1765  
 ALEXANDRE/BENJAMIN ABRAHAM, B.MAR.1766, AND HAD:  
 SAMUEL BENJAMIN (GOV. OF ST. THOMAS), B.AUG.31,1809  
 BENJAMIN JONNATON, B.MAR.10,1767  
 ESTHER  
 JUDITH (NORMA NONES IRWIN, MENLO PARK, CA)

234. NUNEZ

MANOEL (MOSES), M. "BAT ABRAHAM" [=DAU. OF ABRAHAM, PROBABLY INDICATING A CONVERT].  
 THEY HAD:  
 SAMUEL, WHO HAD BY MARY SHARP:  
 DANIEL, B.1775, VA;D.1815;M. NANCY [BY ACT OF THE GA. LEGISLATURE, DEC.3,1805, THEY  
 CHANGED THEIR NAME FROM SHARP TO NUNEZ TO INHERIT PROPERTY]. THEY HAD:  
 ELIZABETH, B.1796;M.MAR.29,1814, STEPHEN BUGG  
 ALEXANDER, B.1798;M. SOPHIA  
 DANIEL A., B.1800, SC;M. SARAH ANN, DAU. OF WILLIAM D. COLE, AND HAD:  
 ALEXANDER E., B.1835  
 DAVID A., B.1837  
 COLE M., B.1839  
 WILLIAM W., B.1841  
 JEREMIAH S., B.1845  
 JULIA ANN, B.1847  
 JASPER W., B.1849  
 ISABELLA, B.JAN.1,1854;  
 HUGH, B.1801;D. JUL.31,1852. APPLING CO.,GA;M.1) SARAH V., DAU. OF RICHARD CART  
 JOHN CAMPBELL, BY 1 HE HAD:  
 PHILLIP HUGH (CSA), B.1823;D.MAY 15,1864;M. ELIZABETH WATTS [ISSUE]  
 NANCY RUTH, B.1825; M. STEPHEN MILLER [ISSUE]  
 ROBERT FLOURNOY (CSA), B.1827;D.1868, TAMPA, FL;M.ANNABELLE HOLT CRAFT  
 SARAH JANE, B.SEP.30,1830;D.AUG.19,1909;M. JOHN WILDES [ISSUE]  
 BY 2 HE HAD:  
 GEORGE W., B.1842;D. UNM.  
 FRANCES E., B.1844;M. ELBERT M. T. SMITH  
 MARY CAROLINE, B.1846;M. DAVID YOUNG  
 JASPER V., B.1847;M. RUTHY  
 NEWTON C., B.1848; M. ?  
 SARAH ANGELINE, B.1850;M. HENRY RUSH  
 HUGH C., [SPELLED HIS NAME EUNICE] B.1851;M. THEODOSIA, DAU. OF ABRAHAM  
 PATTERSON [ISSUE]  
 (MANOEL (MOSES) HAD CHILDREN BY MULATTO ROSE, [WHOM HE MANUMITTED]):  
 ROBERT  
 JAMES  
 ALEXANDER  
 FRANCES, M. GEORGE GALPHIN  
 (GALE A. BARKER-GREEN; DAVID R. MOORE; WILL OF MOSES NUNEZ; FOLKS HUXFORD, PIO-  
 NEERS OF WIREGRASS GEORGIA, V.5,P.319FF)

235. OPPENHEIM (1)

JOSEPH (JUDA) OPPENHEIM, D.1655, FRANKFURT A/M;M. FROMET BALLIN (-1649, FRANKFURT  
 A/M), AND HAD:  
 SIMON WOLFF OPPENHEIM, D.1664, FRANKFURT;M. EDEL, DAU. OF SAMUEL ZUM DRACHEN

(-DEC.14,1668, WORMS), AND HAD:

ABRAHAM OPPENHEIM, AND HAD:  
 DAVID OPPENHEIM, M.1) GNENDL, DAU. OF LEFMAN BEHRENS COHEN; HER BROTHER,  
 MOSES (HANOVER, 1654-JAN.19,1697, LEIPZIG;M. SIESE GUMPERZ, AND HAD: PRADE  
 (-1717), M. SIMON WOLFF OPPENHEIMER (BELOW). DAVID OPPENHEIM, M.2) SHIFRAH,  
 DAU. OF BENJAMIN WOLF SPIRA, WIDOW OF ISAAC B. SOLOMON (ZALMAN) BONDI.  
 SAMUEL WOLFF OPPENHEIMER, B.JUN.21,1630;D.MAY 3,1703, VIENNA;M. SANDELE  
 CARCASSONE (-JAN.16,1705), AND HAD:  
 EMANUEL, HAD:  
 LEA, B.1695;D.OCT.16,1742;M.1709, WOLF WERTHEIMER  
 7 OTHER CH.  
 SIMON WOLFF, B. VIENNA;D.NOV.10,1726;M.1) PRADE BEHRENS COHEN (ABOVE)

HERTZ WOLFF [HE AND HIS DESCENDANTS CALLED OPPENHEIM], HAD:

JOSEPH H. (CSA) HAD:  
 CATHERINE, B.FEB.2,1857;D.JAN.24,1933, ALBANY, GA;M.MAY 27,1890, JOACHIM  
 J.GRASS [NOT BARROWDAILE BROWN] (JAN.18,1862-MAR.25,1915, ALBANY, GA), AND  
 HAD:  
 STILLBORN, DEC.30,1891, SAV.  
 DAU., M. A. H. GODWIN, OF MIAMI, FL

BERNHARDT (BEN) MEYER [FRIEDMAN], D.JAN.19,1979 M.JAN.7,1936, MARJORIE KOHLMAN,  
 AND HAD:

TERRY ALLEN, M.JAN.7,1961, JOAN GROH, AND HAD:  
 ANTHONY J., B.NOV.18,1961  
 ROBERT STEPHEN, M.1)JUN.4,1966, DIANA FRISHMAN;M.2) OCT.29,1972, ANITA GAREY.  
 BY 1, HE HAD:  
 EDWARD, B.AUG.11,1969  
 BY 2, HE HAD:  
 ALEXANDER GAREY-FRIEDMAN, B.JAN.21,1974

JCAN [MEYER], M.1) ROSEN, AND HAD:

BARBARA ANN, M.JUN.30,1965, LEONARD RICHMAN, AND HAD:  
 SCOTT, B.MAY 14,1967  
 STEPHANIE, B.MAY 8,1970

RAPHALL (RALPH) BENJAMIN [OPPENHEIM], M. HENRIETTA SCHULHOFER (-JUL.12,1964, NY)  
 AND HAD:

FERDINAND SCHULHOFER, D.SEP.28,1980, NY;M. ESTHER DORIS HIRSCH (-JUN.6,1961,  
 NY), AND HAD:  
 ALFRED PHILIP, D. OCT.12,1987, NY;M.1) SARAH ROSE BLUM (DIV.);M.2) MAY 12,  
 1959, GREAT NECK, NY, ENID FREED. BY 1 HE HAD:  
 GAIL IRIS, M. RAJAHPOHL SHANTARAM (DIV.), AND ADOPTED:  
 ANCOPA, B.DEC.1,1972, INDIA  
 BY 2, HE HAD:  
 ADELA F. L., B.APR.2,1864, NY  
 JUSTIN SABLE, M. JOYCE I. MARRITS (JUN.14,1928- ), AND HAD:  
 JANET SUE, M.JUN.4,1974, NY, BARRY WEXLER, AND HAD:  
 ABIGAIL JEAN, B.SEP.16,1980, PH  
 JILL SABLE, B.JAN.25,1985, PH  
 JEFFREY SABLE, B.JAN.31,1962, NY  
 MONA HIRSCH, ADOPTED:  
 HENRY FERDINAND, B.JUN.20,1982,BROOKLYN

LOUIS MICHAEL, D.MAY 1,1970;M. SYLVIA KLEVE (JAN.5,1902-JAN.29,1988), AND HAD:

ELLEN SUE, M. DAVID M. LIEBOWITZ (JAN.12,1921- ), AND HAD:  
 MICHAEL JULIAN, M.AUG.26,1979, BAMBI LYNN WARE (NOV.2,1954- ), AND HAD:  
 BAMBI LYNN WARE, B.JUL.6,1985  
 (JEFFREY S. OPPENHEIM; A. GREEN OF SYDNEY, AUSTRALIA; ENCYCLOPAEDIA JUDAICA;MRS.  
 DONALD A. KOLE OF SAV.;MARJORIE K. FRIEDMAN; JUSTIN S. OPPENHEIM; DAVID M. LIEBOWITZ)

240. PEIXOTTO I (1)

EDGAR COHEN, M. HANNAH RACHMIL (-OCT.10,1972,ATL; SHE M.2) KAHN), AND HAD:  
 ZELMA, D.APR.29,1980, ATL.  
 SOLOMON COHEN, M. SHIRLEY THALER OF BROOKLYN, AND HAD: [B.PH]  
 JOANNE, M. ROSEN, AND HAD:  
 DEBORAH SUZANNE, B.JUL.23,1971, PH  
 HOWARD JEFFREY, B.FEB.1,1974, NY  
 ROBERT EDWARD, M. SUE STALLER OF EL CAMPO, TX, AND HAD: [B. AUSTIN,TX]  
 DAVID ALAN, B.DEC.27,1983  
 MICHAEL JAY, B.FEB.6,1986  
 HORTENSE, D.MAR.11,1978, CORAL GABLES, FL;M.2) JOSEPH ALPERT OF ATLANTA  
 (SOLOMON C. PEIXOTTO)





263. SEIXAS (1)  
ABRAHAM MENDES, M.MAY 27,1840, CURACAO, HANNAH M. DE ISAAC PARDO, JR.  
 (I. & S. EMMANUEL, HISTORY OF THE JEWS OF THE NETHERLANDS ANTILLES, V.II,P.992)
264. SEIXAS (2)  
JOSHUA, M. HENRIETTA RAPHAEL [VID. JACOBS V(1), ABOVE]
265. SEIXAS (3)  
JOSEPH ELEAZER, B.NOV.27,1831  
SOLOMON, B.JAN.30,1834 (E. S. LAZARUS MOHEL REC.)
266. SEIXAS (4)  
JAMES MADISON, HAD:  
JULIA, M. GRIGGS, AND HAD:  
PAULINE (PAULINE GRIGGS)
272. SOHER  
JOSEPH, B.JUL.2,1829, NY (E. S. LAZARUS MOHEL REC.)65
275. SOLIS(4)  
LEON [SOLIS-COHN], M.D., M. MARIAN MANSBACH (-APR.20,1988), AND  
 HAD:  
LEON, JR., D. , AND HAD:  
SARA [DEL H] EMILY [SALLY], M.AUG.8,1985, PETER RABINOWITZ (CHANGED HIS NAME  
 TO SOLIS-COHN) (PETER RABINOWITZ SOLIS-COHN)
276. SOLOMONS I  
ELIZABETH (BETSY), D.JUN.15,1832  
 (DAVID ROME, "ON THE EARLY HARTS...", CANADIAN JEWISH ARCHIVES)
278. SOLOMONS IV(2)  
ABRAHAM ALEXANDER, B. GEORGETOWN, SC [NOT SAV.], HAD:  
REBECCA ELLA, M. CH [NOT SAV.]  
ISAIAH ABRAHAM, D.MAR.14,1929 (MEMOIRS OF REBECCA ELLA SOLOMONS ALEXANDER)
280. SORIA  
AARON AUGUSTUS, B.DEC.20, 1827, NY (E. S. LAZARUS MOHEL REC.)
281. SPIRO  
PHILIP JACOB, HAD:  
ESTHER, M. WILLIAM SALINGER, AND HAD:  
ADELE, D. UNM.  
CARRIE, D. UNM.  
THERESA, M. S. M. PEYSER, AND HAD:  
EUGENE  
IRVING  
SERENA, M. ADOLPHUS SALINGER, AND HAD: ONE CHILD  
ANTOINETTE, M. ABRAHAM SELIG, AND HAD:  
FLEURETTE, M. WILLIAM DUNK, AND HAD:  
HOWARD  
LEONARD, M. [ISSUE]  
JEFFERSON, M. HENRIETTA  
ELIZABETH VICTORIA, M. ADOLPH MARCUS LEWIN, AND HAD:  
BIANCA  
ORIZABA  
CORINNE FLORENCE, B. COLUMBUS, MS.; M. LOUIS L. LOEB, AND HAD:  
ELIZABETH VERA ("EVELO"), M. RABBI RICHARD STERN; S.P.  
SYLVIA IRMA, M. HERBERT WEIL, AND HAD:  
KATE, M. ELLIS KOLCHIN, AND HAD:  
PETER, M. [ISSUE]  
ELLEN  
LAWRENCE [CHANGED HIS NAME TO LORING], M. MARGARET KEITH, AND HAD:  
KEITH, M. CLAUDETTE [ISSUE]  
HANNAH, M.1] SELIG;M.2) BERTRAND RAUH OF CINCINNATI. BY 1 SHE HAD  
MARJORIE, M. JOSEPH STEINER, AND HAD:  
JOHN  
ELIZABETH, D.UNM.  
 (DEL.) DAVID, B. UNM.  
LEWIS P.  
HARRY J., M. ROSALIND MOSS, AND HAD:  
MARY ELIZABETH, M. GOLDSMITH, AND HAD:  
 3 DAUS.

282. STERN II(1)  
MILDRED STERN [LANGSFELD], M. RICHARD SIMON (MAY 22,1903-), AND HAD:  
ELLEN, M.1) EUGENE RUBIN (DIV.);M.2) ALBERT BEARMAN [DIV.]  
RICHARD MORTON, M.1 FREDDA JEAN OSBORNE (DIV.);M.2) 1986, VICKY  
MORTON A. [LANGSFELD], JR., HAD:  
MORTON A. III ("MICKY"), HAD:  
BENJAMIN KORMAN, B.SEP.23,1978  
ROBERT DAVID, M.1] GERALDINE MARKS (DIV.);M.2) SAN DIEGO, CA, TERRY.  
 ---  
BOBETTE SYLVIA, M. NATHAN SCHLEZINGER (COLUMBUS, OH, JUN.2,1908-), AND HAD:  
NAN, M. RONALD J. SMOLOW, AND HAD:  
LAUREN MEREDITH, B.JAN.18,1976  
 [TWINS]  
ANDREA, B.FEB.12,1979  
JESSICA, B.FEB.12,1979  
CHARLES J., JR. ("JERRY"), HAD:  
BOBBY JANE, M. THOMAS JONES [DIV.]  
JEANETTE MARIE, M.MAY 6,1978, WESTFIELD, NJ., JOHN LLEWELLYN TANSEY  
 ---  
SADIE, D.MAY 23,1978;M. STANLEY H. GOLDSMITH, AND HAD:  
STANLEY H., JR. D.1987, S.P.  
CAROL DENE, D. MAR.25,1967;M.2) BERNHARD BLUMENTHAL, AND HAD:  
JUDITH FRANCES, M. LEON FERN(ANDES) [DIV.]  
ANNE, M.1) JOHN BLANKLEY (DIV.);M.2)1976, JAMES PROFFIT [DIV.]  
 ---  
LUCIEN [KATZENBERG], B.JUN.8,1882, PH;D.DEC.4,1961, ELKINS PARK, PA, AND HAD:  
LUCIEN JR., B.AUG.1,1913, PH; M. EMILIE ROSENBAUM, AND HAD:  
RICHARD, AND HAD:  
ANNE RACHEL, B.OCT.19,1973  
DANIEL, B.JAN.10,1976  
DENE M. EDGAR BERNSTEIN, AND HAD:  
PHILIP, HAD:  
ANNE, B.OCT.12,1978  
BARBARA, M.2) IRWIN BERGER, AND HAD:  
JEREMY, B.APR.14,1975  
MILTON, B.JUL.24,1884, PH;D.SEP.21,1981, TUCSON, AZ, AND HAD:  
WILLIAM, HAD:  
MICHAEL, M. LINDA PRESCOTT, AND HAD:  
TYLER PRESCOTT, B.JUL.8,1982, MONTPELIER, VT  
BESSIE, M.1) PHILIP KIND AND HAD:  
SAMUEL, M.OCT.6,1942, DOROTHY WEINBERGER  
EDITH, M. DAVID STERN, AND HAD:  
DENE M. DAVID B. MAYER, AND HAD:  
LISA DENE, B.JAN.28,1958;M.SEP.28,1980, LEONARD BERNARD KLEINMAN  
PETER LEE, B.JAN.25,1960  
 (MALCOLM H. STERN, DENE K. BERNSTEIN, LUCIEN KATZENBERG, JR.)
283. STERN II(2)  
SOPHIA, D.1954;M. LEON HOFFMAN (-1930), AND HAD:  
BLANCHE, B.1895;D.1974;M. SIGMUND KLEINMAN (-1970), D.S.P.  
BESSIE, B.1898;D.1980;M.1) 1926, ELKAN PALMBAUM (DIV.);M.2) 1952, MILTON  
WALDORF (-1954);M.3)1956, MELVIN O. MARCUS (-1971). BY 1 SHE HAD:  
SELMA LOUISE, B.1928; M.1952, ARTHUR BARON, AND HAD:  
JOANNA LEE, B.1957;M.1979, MARK GOLDBERG  
MARIAN, B.1903;M.1928, AARON M. KRAMER, AND HAD: (DEL.M.2) WALDORF  
LEE HOFFMAN, B.1929;M.1955, EMILY R. FELMAN (DIV.1971), AND HAD:  
JODI SUF, B.1957;M.1980, FREDERICK F. MAILMAN  
BETSY LYNN, B.1960 (ARTHUR BARON)
283. STERN II(3)  
MORTON ("BUCK"), B.1889;D.SEP.1981, NEWARK, NJ  
HARRY, HAD:  
HARRY, JR.
- 284 STERN III  
JULIUS, M. HENRIETTA ADLER, AND HAD:  
JULIUS DAVID, HAD:  
J. DAVID, JR., M. JULIET LIT (1887-NOV.9,1981)  
ROSA, B.1843  
WILLIAM ADLER, HAD:  
HENRIETTA MARY ("MME. MAJESKA"), M.2) MORRIS DALLETT, JR. [DIV.]  
 ---  
WERNER DAVID AMRAM, HAD:

DAVID WERNER, HAD:  
 PHILIP WERNER, M. EMILIE SALLER [WEYL], D.AUG.1,1981,PH, AND HAD:  
 DAVID W. III, M.JAN.7,1979, LORA LEE ECOBELLI, AND HAD:  
 ALANA ASHA, B.JUL.31,1979  
 ADIRA ALIZA, B.MAR.17,1981  
 ADAM A., B. 1984  
 GALE, B.1868  
 CAROLINE, B.1870  
 (U.S. CENSUS 1850,1870; N.Y.TIMES OBIT. FOR JULIET L. STERN; F. J. DALLET;  
 BARNA OSTERTAG)

284. STIX(1)  
 THOMAS L., JR., M. DOROTHY KERSTEIN, AND HAD:  
 JULIE, D.AUG.27,1986  
 CARL (DR. RICHARD D. PLOTZ)

287. STIX(4)  
 EDITH, M. JOSEPH WASSERMAN AND HAD:  
 MARGARET, M. LIONEL FARADAY LEVY (SEP.13,1884-) AND HAD:  
 JOAN, M. EDGAR BELLEVILLE COALE  
 KATHERINE STIX, M. SHELBY CULLOM DAVIS (PEORIA, IL, APR.1,1909-)  
 ERNEST WILLIAM, HAD:  
 THOMAS HOWARD, HAD:  
 SUSAN SHERWIN, M.JUN.15,1986, CHARLES AVERY FISHER (F. J. DALLET')

290. SULZBERGER(1)  
 FRIEDA, M. CHARLES ROSENTHAL, AND HAD:  
 ISALAH, M. BLANCHE FULD, AND HAD:  
 STEVEN  
 CHARLES  
 SON, D. YOUNG  
 ROSE, M. ISAAC BRAND, AND HAD:  
 CHARLES, M. LUCILLE GANS, AND HAD:  
 JILL, M. MARTIN ROSENZWEIG, AND HAD:  
 LISA  
 ANDREA  
 EDNA, M. HARVEY MANN, AND HAD:  
 JOHN, M. CAROLA, AND HAD:  
 ROBERT  
 SUSAN  
 LISA  
 2 OTHERS  
 PEGGY, M. HOULTON, AND HAD:  
 BETSY  
 JENNIFER  
 BELLE, M. FRED FLEISHMAN, AND HAD:  
 FRED, JR., D.S.P.  
 HATTIE, M. SAM FLESHMAN [BRO. OF FRED] AND HAD:  
 DORIS, M. EDWARD BERNAYS  
 BEATRICE  
 3 OTHERS  
 FRANCES, M. MOSES BRAND [BRO. OF ISAAC], AND HAD:  
 FRIEDA, M. AUBREY MORRIS, AND HAD:  
 DAU.  
 JAMES, M. ? AND HAD:  
 DAU.  
 HOWARD, D.S.P.  
 DOROTHY, D.S.P.  
 NORA, M. SIDNEY KOLLER, AND HAD:  
 CH. (LUCILLE G. BRAND)

295. TIM (1)  
 ESTHER (HESTER), M. MOSES HERMAN, AND HAD:  
 LOUIS, B.OCT.17,1862, MOBILE;D.AUG.30,1914, TROY, NY;M.DEC.15,1904, LILLIAN  
 [NOT EVA] GARSON, AND HAD:  
 LOUIS GARSON, B.AUG.19,1906, TROY, NY;M.MAR.6,1930, CLEVELAND, OH, CHARLOTTE  
 HIBSHMAN, AND HAD: [B. CLEVELAND]  
 L. ROBERT, JAN.28,1932, M.JAN.10,1954, DOLORES DAVIS, AND HAD:  
 TOM MICHAEL  
 PAMELA SUE  
 RICHARD D.  
 JAMES G., B.AUG.18,1936;M.JUN.21,1958, CAROLYN MINDEL, AND HAD:  
 ANDREW M.

STEPHEN JAMES  
 JOHN EDWARD (LOUIS G. HOFFMAN)

296. TIM(2)  
 ELISE [KOHN], M. PAUL FRIEDMAN, AND HAD:  
 PETER BERNARD, M.AUG.27,1976, SKOKIE, IL, ANDREA LEVIN, AND HAD:  
 MARGOLIT DEVORAH, B.JUN.29,1979, CHICAGO (PETER B. FRIEDMAN)

300. TOURO  
 JUDAH, B.APR.28,1785 (BERNIE CUSINITZ)

301. UMSTADTER  
 BEZALEL LEVY HAD:  
 MEIR LEVY [CHANGED HIS NAME TO MYER SARLOUIS], B.1780/3, HESSE;D.JUN.8,1867,  
 NORFOLK;M. BELAH PRICE, AND HAD:  
 [CAROLINE/GNENIL/KAILINE IS NOT THEIR DAUGHTER]  
 FANNY, M. JACOB UMSTADTER, AND HAD:  
 MICHAEL, AND HAD:  
 DIANA, M. MORRIS TURK, AND HAD:  
 EMILY, B.1918;M.1943, HAROLD A. OBST (1917- ), AND HAD:  
 ANTHONY, B.1945;M.1967, PATRICIA MEDCALF (1945- ), AND HAD:  
 SUZANNE, B.1974  
 VICTORIA, B.1977  
 LAWRENCE, B.1978  
 DIANA, B.1981  
 CYNTHIA, B.1983  
 MARY, B.1947;M.1970, WILLIAM H. STEIN (1947-1975)  
 JAMES, B.1953  
 BETZALEL [OF BALTIMORE], M.1) AMELIA ROSENBAUM;M.2) SARAH OPPENHEIM  
 BERTHA (BETSY), M. MOSES MYERS, AND HAD: [B. NORFOLK]  
 VIRGINIA, B.JAN.21,1847;D.SEP.27,1905;M.MAY 30,1866,NFK, BERNARD ROSE  
 CHARLES, B.JUN.9,1849;D.SEP.5,1911, NFK;M. ANNIE COHEN [Q.V.V]  
 MINA (MENDEL), B. SCHLUECHTERN, KURHESSEN; M.OCT.17,1854, NFK, JULES  
 BAUMGARTEN [DIV. AND TOOK BACK MAIDEN NAME], AND HAD:  
 BETTIE (BERTHA) [SARLOUIS]

-----  
 BETH SUSAN [NUSBAUM], M. RAND MARSHALL CURTISS, AND HAD:  
 LAURA MEREDITH, B. APR.5,1980  
 CATHERINE ASHLEY, B.JUN.13,1983  
 CHARLES SILBERMAN, 1985, NFK., NANCY HORTON

-----  
 ROBERT COLLIER [NUSBAUM], M.1) (BETTY) LOUISE SCHLOSS [DIV.];M.2) SEP.6,1987, NFK,  
 LINDA LAIBSTAIN. BY 1 HE HAD:  
 ROBERT C., JR., AND HAD:  
 JESSICA LYNN, B.FEB.4,1979, GROTON, MA  
 WILLIAM, M.AUG.28,1983, NFK, SHARON KURTZ  
 VIRGINIUS H., JR. ("POOCH"), HAD:  
 ALAN BEE, M. ANN, AND HAD:  
 ANDREW SCOTT, B.DEC.18,1980, NFK.  
 (EMILY T. OBST; HEBREW CEMETERY, NFK. EPITAPHS; U.S. CENSUS, 1860/1870)

302. WAAG(E)  
 MOSES (FLOURISHED 1529-51), M.CA.1545, FRAIDCHEN (-1577/8), AND HAD:  
 PHAIBUSH URI BACHARACH ZUR WAAGE, D.1588;M.CA.1560, FRAIDLIN  
 ISAAK, D.1585;M. ESTHER (-1609) [ANCESTORS OF THE ROTHSCHILD FAMILY]  
 ABRAHAM  
 BRENDL  
 DAVID (A. GREEN OF SYDNEY, AUSTRALIA)

303. WOLF II  
 SOPHIA, M. GOTTHILF MOEHRING, M.D., AND HAD:  
 JOSEPHINE, M.NOV.18,1857, PH, ALPHONSE STEPHANI  
 ("PHILADELPHIA MARRIAGES & OBITUARIES", TYPESCRIPT IN NYG&B)

304. WOLFE II  
 SIMON, B.DEC.24,1828, ROGASSEN PRUSSIA;D.MAY 8,1901, CAMDEN, SC

305. WOLFF  
 JACOB HISQUIAC ROBLES, HAD:  
 2 CHILDREN  
 REBECCA, M. MOSES WOLFF, B. BERTSTOF, AND HAD:  
 RALPH (RAPHAEL), B.JAN.30,1799, ST. KITTS, AND HAD:  
 MOSES, B.MAY 14,1833, SANTO DOMINGO

SARAH, B. JUN. 4, 1835  
AARON, M. RACHEL CAPPE [BELOW], AND HAD:  
JACOB BENJAMIN, B. MAY 22, 1815  
MOSES, B. SEP. 23, 1816, M. REBECCA JOSEPHINE LEVY, AND HAD: [B. ST. THOS.]  
DAVID, B. JAN. 20, 1842  
RACHEL, B. SEP. 3, 1844  
JULIUS RUBEN, AND HAD:  
JCHN BENJAMIN, AND HAD:  
RALPH FULLER, B. 1911; M. 1) LUCY GEOGHEGAN; M. 2) MARGARET LYON  
SCHEUER PEARL [VID. LYON II]  
SOLOMON, B. JUN. 8, 1818, ST. THOS  
MIRIAM, B. JUL. 4, 1821  
ELIAS, B. DEC. 24, 1822  
REBECCA, B. MAR. 15, 1826  
ALEXANDER R., B. APR. 1, 1828  
HANNAH, B. SEP. 2, 1829  
REUBEN JULIUS, B. MAR. 4, 1834

-----  
BENJAMIN [HUENIG] (SIMON AARON CAPPE), B. KUETTENTHAL, AND HAD:  
MOSES, B. MAY 7, 1795, ST. EUSTATIUS  
JUDAH, AND HAD: [B. ST. THOS.]  
SAMUEL AARON, B. NOV. 18, 1833  
MIRIAM, B. MAY 17, 1823  
REBECCA, B. MAY 17, 1824  
RACHEL, B. NOV. 28, 1825  
BENJAMIN HONIG, B. MAY 16, 1839 (ST. THOS. BIRTH REC.; ENA; MARY PEARL)

# *Index*





**AARON**

See also Aaron(s), Aarons, Arons  
 Hannah (see Aaron, Hinda (Hannah))  
 Hinda (Hannah) 145  
 Lydia 11  
 Sophie 308

**AARON(S)**

See also Aaron, Aarons, Arons  
 Aaron (b. 1826) 1, 183  
 Henrietta Levy 1, 183  
 Jacob (m. 1825) 1  
 Rachel Soesman 1

**AARONS**

See also Aaron, Aaron(s), Arons  
 Aaron (b. 1812) 1  
 Adaline 1  
 Eliza (see Aarons, Golah (Eliza))  
 Emily 1  
 Esther (b. 1772) 1  
 Esther (d. 1772) 1  
 Golah (Eliza) (1786-1857) 1  
 Hannah (1789-1865) 1, 8  
 Hartog 1  
 Jacob of Guadeloupe 1  
 Louisa 1  
 Mariana 1  
 Rachel (1767-1828) 1, 214  
 Sarah 1

**ABBOT**

Ethel Austin 199

**ABBOTT**

Gertrude 249

**ABDY**

Helen Diana Bridgeman 79  
 Robert Edward Henry 79

**ABFCASSIS**

Abraham R. Brandon (b.1856) 27  
 Judah S. (1827-1896) 27  
 Lavinia Brandon 27  
 Rachel Isaacs 326A  
 Solomon (b. 1855) 27  
 Victor Emile (b.1861) 27, 326A

**ABENATAR**

Abigail Lopez (Da Fonseca) 178  
 Isaac 178

**ABENDANONE**

Abigail (b. 1738) 1  
 Abigail (m. Leon) 1  
 Abigail Cohen Delmonte 1  
 Grace (1782-1857) 1, 320A  
 Grace Abendanoone 1  
 Grace Cohen Delmonte 1  
 Hannah (ca. 1796-1865) 178  
 Haym (see Hyam (Haym))  
 Hyam (Haym) (m. 1807) 1  
 Hyam (m. 1736) 1  
 Joseph (d. 1815) 1  
 Rebecca 1  
 Simon (m. 1736) 1  
 Solomon (b. 1737) 1

**ABERCROMBIE**

Martha 91  
 Mary Irene 322A

**ABERDARE**

Lord (see Bruce, Henry Campbell,  
 Lord Aberdare)

**ABLE**

Eileen 147, 328B

**ABRAHAM**

See also Abrahams, Abrams  
 Abraham (b. 1812) 2, 135  
 Abraham (father of Hezekiel) 5  
 Abraham (father of Jacob Abrahams)  
 (1784-1866) 6  
 Abraham (in London, 1729) 2  
 Ada 2  
 Ann Powers 2  
 (Avigdor) Victor 2  
 Benjamin 2  
 'Betty' (see Abraham, Elizabeth  
 ('Betty'))  
 Caleb (Rabbi), (-1599) 324B  
 Carol 2

Carrie Oppenheimer 238  
 Chapman (see Chapman, Abraham)  
 Charles (b. 1852) 3  
 Charles (b. 1865) 2  
 Charles (b. 1941) 3  
 Charles Victor (b. 1911) 3, 8  
 Charlotte 2

Clara 2  
 David 2  
 Dee 3  
 Dorothy Clair (b. 1915) 51  
 Edith D'Azevedo Daniels 51  
 Edna Schoenfeld 3  
 Eliza 2  
 Eliza Judah 142, 218  
 Elizabeth ('Betty') 3  
 Emma 2  
 Emma Dreyfoos 3  
 Esmé 2

Evelyn Nathan 2, 3  
 Fanny (b. 1809) 2  
 Fanny (b. 1855) 3, 190  
 Geoffrey 2  
 Hannah (b. 1800) 3  
 Hannah (d. at 21/2) 3  
 Harriet Boss 2  
 Herbert 2  
 Hetty 2  
 Hetty Adelia Mayer 2, 190

Isaac ? 2  
 Isabella 2  
 Jane 2  
 Jeffrey 3  
 Joan 3  
 Joel 303  
 John D. 2, 3  
 John De Young 2, 3  
 Joseph (b. 1817) 2, 3  
 Joseph C. 51

Judah (see Abraham, Levi (Judah))  
 Judah or Abraham Judah 141  
 Kate 3  
 Kathleen 2  
 Laura Cohen 2  
 Lawrance 2  
 Lawrence (son of Herbert) 2  
 Leonora (see Braham, Leonora  
 (Abraham))  
 Levi (Judah) 115  
 Lewis 2, 190  
 Lily 2  
 Louis 303  
 Louisa 2  
 Mame 2  
 Marie 2

Marion Ronsheim Mathis 3  
 Mathilda 2  
 Michael H. 238  
 Mordecai ('Mord') 4  
 Nell 2  
 Ouida 2  
 Philip (1803-1890) 2  
 Phoebe (b. 1826) 2  
 Phoebe (m. Samuel Hollander) 2  
 Rachel Moise 163  
 Rebecca (dau. of Abraham) 2  
 Rebecca Levy 2  
 Rhoda 2  
 Richard (b. 1945) 3  
 Richard David (b. 1910) 51  
 Rose 2  
 Rose Mosler 3, 8  
 Rosina Nathan 2, 3  
 Samuel (b. 1827) 2  
 Samuel (b. 1859) 3  
 Sara H. 2  
 Sara H. De Young 2, 3  
 Sara Phillips 2  
 Sarah (London) 303  
 Sarah (m. 1802) 229  
 Sarah Van Norden 2  
 Scott 3  
 Selina 2

Selina Emma Johnson Ezekiel 2, 135  
 Shina Vogg (see Abraham, (Shina)  
 Jane Vogg)  
 (Shina) Jane Vogg 2  
 Simeon 2  
 Solomon (b. 1828) 2  
 Solomon (son of Philip) 2  
 Stella 3  
 Takeuchi 2  
 Therese 3

Uri (see (Abraham, (Uri) Philip)  
 (Uri) Philip 2  
 Victor (b. 1861) 2  
 Victor (m. Esmé) 2  
 Victor 3  
 Victor M. (1855-1912) 2  
 Walter 3  
 Winifred 2

**ABRAHAMS**

See also Abraham, Abrams

Abby Susan 296  
 Abraham (1798-1819) 4  
 Abraham 65  
 Abraham De Lyon (b. 1772) 7  
 Abraham Isaac (1720-1796) 4, 179  
 Ada 46  
 Adolphus Alexander Hezekiel 5, 320A  
 Adolphus H. (1830-1872) 5  
 Alexander 4, 139  
 Alexander H. (1864-1865) 5  
 Alexander H. (1872-1934) 5  
 Alexander H. 5  
 Alexander Hezekiel (1801-1871) 5, 210  
 Alice (1789-1839) 4, 277  
 Alma Fox 122  
 (Anna) Hannah (d. 1832) 233  
 Augusta (b. 1820) 6  
 Barbara Babcock 296  
 Bella (1760-1854) 4  
 Benjamin (1806-1881) 6  
 Blanche Emanuel 122  
 Caroline 65  
 Catherine (Gitlah) Eitlah Dyer Polock  
 6

Catherine (Kate) Abrams 4, 5, 320A  
 Catherine (Kitty) Polock 4, 252  
 Cecilia Perla 5  
 Cecilia Solomons 3, 277  
 Charles Drayton (1892-1941) 5  
 Charles Joseph 3  
 Charlotte (1779-1839) 4  
 Charmian 122  
 Deborah (d. 1830) 4  
 Deborah (1776-1852) 7  
 Dorothea 7  
 Edmund H. (b. 1839) 5, 278  
 Edmund H. (b. 1881) 5  
 Edward S. H. 5, 278  
 Edward S. H., Jr. (d. 1938) 5  
 Eglah (b. & d. 1771) 4  
 Elias (1787-1851) 4, 333A  
 Elizabeth Joseph 4, 139  
 Elizabeth Langford 12  
 Elkaly Esther Louzada 4, 179  
 Ellen Robin 296  
 Emanuel (m. 1779) 4  
 Emanuel (Menahem Israel)  
 (1776-1839) 4

Emanuel (1748-1802) 4  
 Esther (b. 1779) 6  
 Esther (d. 1766) 4  
 Eudora R. Sampson 5, 259  
 Evelyn Kaufman 5  
 Fannie (b. ca. 1888) 5  
 Fanny (m. C. Mayer) 2, 190  
 Fanny L. Joseph 5  
 Florence Kohn 296  
 Frank 122  
 Gellah Adolphus 7  
 Gitlah Dyer Polock (see Abrahams,  
 Catherine (Gitlah) Eitlah Dyer  
 Polock)  
 Hanah (1797-1875) 130

Hannah (see also Abrahams, (Anna)  
 Hannah)

Hannah (1774-1838) 4  
 Hannah Edith (b. 1866) 5  
 Hannah Moses 5, 210  
 Henrietta (1832-1884) 5  
 Henry J. (1805-1878) 7  
 Hetty Adelia Mayer 2, 190  
 Hezekiel 5  
 Hezekiel Moses (1844-1872) 5  
 Hyam (Hyman) (1767-1802) 4  
 Hyman (see Abraham, Hyam (Hyman))  
 Isaac (1737-1832) 6, 227, 309A  
 Isaac A. (b. 1756) 4, 252  
 Isabel (dau. Elias) 4  
 Victor 3  
 Jack, see Abrams, Jacob M. (Jack)  
 Jacob (b. 1781) 6  
 Jacob (d. bef. May, 1825) 7  
 Jacob (1784-1866) 6  
 Jacob Levy (d. 1829) 4  
 Jacob Melvin 5, 259  
 Jacqueline 122  
 James Ormstead (1804-1881) 24  
 Jane Linds 91  
 Jesse Anderson (1818-1887) 4  
 Jessica Emanuel 7  
 Joan Jacobson 296  
 Johanna Lichtenfels 91  
 John (ca. 1797-1876) 7  
 Joseph (b. 1768) 4  
 Joseph (b. 1786) 6  
 Joseph (see also Andrews, Joseph)  
 Joseph (1749-1795) 7, 57  
 Judith De Lyon Cohen 7, 57  
 Judith Mordecai 4  
 Juley (b. 1811) 6  
 Julia (1837-1906) 7, 132  
 Kate A. Abrams (see Abrahams,  
 Catherine (Kate) Abrams)

Kitty Polock (see Abrahams, Catherine  
 (Kitty) Polock)  
 Lawrence Michael 91  
 Leah (1765-1828) 4  
 Leah (1808-1889) 6  
 Lewis 2, 190  
 Lillian Maud Peixotto 241  
 Lily 4  
 Lisa 296  
 Louise (b. 1867) 5  
 Lyon 232  
 Marion 5, 320A  
 Marjorie 296  
 Marks L. 232  
 Martha 320A  
 Martha (1757-1840) 308  
 Martha Haynes 308  
 Mary Davis 4, 48  
 Mary Frances Taylor 4  
 Mary Isabella (b. 1846) 4  
 Mary Rodman 296  
 Matilda Isaacs 124  
 Melvina H. 5

Menahem Israel (see Abrahams,  
 Emanuel (Menahem Israel))  
 Mildred 5  
 Mildred Lee Guckenheimer 5  
 Mordecai (Va.) 5  
 Mordecai (1735-1800) 4, 320A  
 Moses (Eag.) 308  
 Moses (m. 1834) 124  
 Moses (1762-1816) 4  
 Naomi 6  
 Nellie (d. 1951) 5  
 Nellie I. Solomons 5, 278  
 Olie Ehle 5  
 Perla S. (m. 1903) 5, 27  
 Rabbi Isaac ('Isaac Brisker') 4  
 Rachel (1756-1837) 4, 308  
 Rachel (1794-1849) 7  
 Rachel Nathan 6, 227  
 Rebecca (d. 1788) 7  
 Rebecca (m. Isaac) 7  
 Rebecca De Lyon 7, 57

Rebecca Tucker 4  
 Rebekah (b. 1814) 6  
 Reginald 122  
 Richard Irving 296  
 Rita Haiman 4  
 Robert Brown H. (1847-1854) 5  
 Robert David 296  
 Rodman David 296  
 Roger David 296  
 Rolland Schwartz 91  
 Rosa Haiman 4  
 Rosalind 122  
 Roselia (b. 1822) 6, 144  
 Samuel (b. 1784) 6  
 Samuel (1775-1848) 4  
 Samuel (1853-1929) 122  
 Sanders Long 91  
 Sarah (b. 1816) 6, 144  
 Sarah Deborah Morris 232  
 Sarah Levy 4, 320A  
 Sarah Teuby Ward 4  
 Simeon (1810-1867) 6  
 Solomon 4  
 Theodore (d. 1942) 5  
 Theodore H. (b. 1834) 5  
 Theodotia Armistead 4  
 Valerie McNamee 296  
 Zipporah (b. 1809) 7

**ABRAMS**

See also Abraham, Abrahams  
 Alexander (m. 1844) 4, 139, 320A

Alexander Hamilton 4, 320A  
 Alfred 4  
 Anna 4, 48  
 Annie 4, 30  
 Ansley 4  
 Belle (see Isabel (Belle))  
 Bertha 4  
 Blanche 4  
 Catherine Cohen 4, 333A  
 Catherine (Kate) 4, 5, 320A  
 Cecile (Lizzie) Myers 4  
 Cecile (1821-1894) 4, 186  
 Cecile 4  
 Corinne 4  
 Edward Sebring 5  
 Edwin 4  
 Elias 4, 333A  
 Elizabeth 4  
 Elizabeth Joseph 4, 139, 320A  
 Ellen 4, 320A  
 Esther (dau. Alexander) 4  
 Esther (dau. Elias) 4, 12, 272  
 Florence 4  
 Frances (dau. Alexander) 4, 320A  
 Frances (1916-1959) 5  
 Gertrude 4  
 Henrietta (m. 1853) 4, 139  
 Imogene Hegwood 5  
 Isaac 4, 48  
 Isabel (Belle) 4, 210, 320A, 334A  
 Jack 4 (see Abrams, Jacob M. (Jack))  
 Jacob (d. 1918) 4  
 Jacob M. (Jack) (1847-1887) 4, 320A  
 James Read (1882-1945) 5, 247  
 Jane 5  
 Jessie 4, 320A  
 Joseph M. 4, 320A  
 Julian (see Abrams, Moses (Julian))  
 Kate 4  
 Kate A. (see Abrams, Catherine  
 (Kate))  
 Levi (1769-1833) 320A  
 Lola 4  
 Lola Melasky 5, 247  
 Maria Mary (1811-1883) 320A  
 Maybelle 172  
 Miriam 4  
 Mord (see Abrams, Mordecai  
 ('Mord'))  
 Mordecai ('Mord') 4  
 Moses (Julian) 4  
 Nellie Read 5

Read (see Abrams, James Read)  
 Rebecca 4  
 Rita Haiman 4  
 Rosa Haiman 4  
 Rosalie Densel 4  
 Roseanna Linderman (1787-1848)  
 320A  
 Victor 4, 320A  
 Waverly (b. 1856) 4

**ABT**

Barbara 293  
 David 293  
 Lois Wiener 293  
 Norman 293  
 Raymond 293  
 Sheryl 293

**ACH**

Carol Workum 306  
 David (1916-1917) 306  
 David Laurence 306  
 Ernest M. 306  
 James Wyckliffe 306  
 Jane 306  
 Lawrence 306  
 Pauline 306  
 Pauline Workum 306  
 Roger 306  
 Roger Workum II 306  
 Samuel 306  
 Therese Workum 306

**ACHESON**

Mary Papin 209

**ACKFRMAN**

Edward 257  
 Ellen 13  
 Lucille Helen Karstendiek 257  
 Marlene 301

**ADAIR**

Mary 133

**ADAMS**

Adeline Mary De Leon 55  
 Anna Wilhelmine Lincke 55  
 Arabella (1806-1807) 158  
 Arabella J. 158  
 Arabella Jones (1811-1894) 158  
 Arabella Martha De Pau (b. 1878) 158  
 Blathwaite (b. & d. 1848) 158  
 Bushrod Washington (1820-1897) 158  
 Clara H. Hackstaff Macdonough 158  
 Dorothy Maybin (b. 1887) 158  
 Drury K. 241  
 Edward 29  
 Elfie Cardozo 29  
 Eliza Hutchinson (1849-1865) 158  
 Elizabeth C. 262  
 Elizabeth Dawson Morris 158  
 Francis Peters (b. 1865) 158  
 Grace 217  
 Harry Carlton (1854-1908) 158  
 Henry Morris (b. 1885) 158  
 James (b. 1807) 158  
 Joseph Henry (1818-1886) 55  
 Leah Jacobs 134  
 Louisa Catherine 80  
 Margaret (1808-1809) 158  
 Marion (b. 1905) 55  
 Marion De Leon (1853-1931) 55  
 Martha De Pau 158  
 Martha Levy (1813-1887) 158  
 Martha Levy Jones 158  
 Martha Morris 158  
 Mary 29  
 Mary Genevieve Griffiths 198  
 Mary Morris (1810-1838) 158  
 Matilda Maybin Hart (d. 1871) 158  
 Nora 199  
 Phoebe J. Hutchinson 158  
 Randolph 134  
 Robert (d. 1833) 158  
 Robert (1815-1894) 158  
 Robert III (b. 1884) 158  
 Robert, Jr. (1849-1906) 158  
 Sarah Hutchinson (b. 1852) 158

- Sarah Hutchinson (m. 1844) 158  
 William Hart (1845-1867) 158  
 William Horner (1819-1891) 158
- ADAMSON**  
 Margaret Bennett 77
- ADDINGTON**  
 Elizabeth Hays 325A  
 John 325A
- ADDESON**  
 Jonathan Daniel 330A  
 Laura Levy 330A
- ADELSDORFER**  
 Fannie 42
- ADELSHEIMER**  
 Leah 11
- ADELSON**  
 Julia Chuck 161
- ADES**  
 Ines Heffer 145
- ADIR**  
 Efram 284  
 Henrietta Mary (Mme. Majeska) Stern  
 Dannenbaum Dallett 284
- ADLER**  
 Alma 286  
 Barbara Fineshruber 296  
 Belle 291  
 Carrie May 145  
 Celia (d. 1932) 291  
 Craig Irving 296  
 Cyrus (1863-1940) 291  
 Edna (1901-) 328A  
 Elizabeth Sheler Cahn 50  
 Gladys (1893-1960) 327B  
 Hattie Livingston 145, 327B  
 Helen 102  
 Henrietta (1815-1897) 284, 313B, 339B  
 Herman 145  
 Irving (1899-) 328A  
 Joseph 145, 327B  
 Louis J. 296  
 Lynne 296  
 Marcus S. 50  
 Mathilda Kraus 145  
 Milton (d. 1911) 291  
 Rachel (Racie) Friedenwald 291  
 Racie Friedenwald (see Adler, Rachel  
 (Racie) Friedenwald)  
 Samuel (ca. 1827-1867) 291  
 Sarah 291  
 Sarah Sulzberger 291  
 Stella Fox 328A  
 William Louis 296
- ADOLPH**  
 Fanny Schloss 293  
 Jacob 293  
 Laura 293  
 Sally Rich Rose 255  
 William II 255
- ADOLPHUS**  
 Abigail (Golly) Levy 92  
 Abigail (1808-1888) 254  
 Benjamin Reine or Ephraim Reine 7  
 Charity Hays 7, 104  
 Emmeline Gomez 85  
 Ephraim Reine (see Adolphus,  
 Benjamin Reine or Ephraim Reine)  
 Esther 7  
 Ezekiel 7  
 Gellah 7  
 Golly Levy (see Adolphus, Abigail  
 (Golly) Levy)  
 Hannah 7  
 Hetty (d. 1783) 7, 104  
 Hetty (dau. Isaac) 7  
 Isaac (1726-1774) 7, 104  
 Isabella Hart 92  
 Jacob (son of Benjamin) 7  
 Jacob 92  
 Michael 7  
 Minche 7  
 Nathan 85  
 Philip 7
- Rachel (see Adolphus, Ritzel Hannah  
 (Rachel))  
 Rachel Hart 92  
 Raphael 7  
 Ritzel Hannah (Rachel) 7, 58
- APFFELDER**  
 Jeanne 83  
 Lewis 83  
 Margaret 83  
 Ruth Steppacher 83
- AGUILAR**  
 Flora Valery Lindo 115  
 Harold Felix 115
- AIHEARN**  
 Marian (1954-) 325B
- AINSWORTH**  
 Albert Childe 165  
 Alice Louise 165  
 Aline Mary 165  
 Amelia Marguerite Rhodes 165  
 Anne Corinne 165  
 Annie Elizabeth 165  
 Harry Martin 165  
 Isabel (Mathilda) Levy 165  
 Martin Luther 165  
 Mathilda Levy (see Ainsworth, Isabel  
 (Mathilda) Levy)
- AIRD**  
 Catherine (Kitty) Solomons 276  
 George 276  
 William 276
- ALBERGA**  
 Corinne 26
- ALBERTS**  
 David Alexander 9  
 David Charles 9  
 Julia Hays 9  
 Sally Alexander 9
- ALBRECHT**  
 Adelaide May (b. 1926) 257  
 Adelaide Schmidt 257  
 Althea Rita Rodriguez 257  
 Franklyn J. 257  
 Franklin J., Jr. (b. 1921) 257
- ALBRIGHT**  
 Catherine Marie Moise 196  
 Connie Moise 196  
 Glenn Allen 196  
 James F., Jr. 196
- ALCUS**  
 Cecilia Scherck 186  
 E. Leving 186  
 Ethel Mann 186  
 Fanny Kahn 186  
 Isaac 186  
 Lewis 186  
 Louise 186  
 M. Miriam Friedman 186  
 Richard S. 186  
 Suzanne 186
- ALDEN**  
 Leveitta S. Russell Lufburrow 256  
 Lucius D. 256
- ALDIGE**  
 Virginia Seixas 266
- ALEVY**  
 Esther De Gabriel 85  
 Sarah Behero 331B
- ALEXANDER**  
 Aaron (1812-1876) 8, 9, 210  
 Aaron, of Hamburg 44  
 Abraham (1840-1842) 9  
 Abraham 119  
 Abraham, Jr. (1771-1844) 1, 8  
 Abraham, Sr. (1743-1816) 8  
 Alan, Jr. (b. 1914) 9  
 Alan McFarland (b. 1883) 9  
 Alexander (b. 1813) 9, 94  
 Alexander (son of Isaac) 9, 134  
 Alice 115  
 Alice Flora 308  
 Alvin 107  
 Amanda (1839-1840) 9
- Amelia 54  
 Amelia Hart 308  
 Ann Sarah Huguenin Irby 8  
 Anna Katherine 8  
 Anna May 8  
 Annie Josephine Jackson 8, 130, 171  
 Arthur (son Eugene W.) 8  
 Arthur (son Jacob) 9  
 Belviden (Benvenida) 54  
 Benvenida (see Alexander, Belviden  
 (Benvenida))  
 Bertie Leinkauf 9  
 Catherine (1820-1885) 8  
 Cecil A., Jr. 9  
 Cecil Abraham (b. 1877) 9, 211  
 Cecilia 9  
 Charles 290  
 Charlotte 9  
 Diana Pyke 308  
 Dorothy 8  
 Dorothy Ann (1941-) 330A  
 Dorothy Levy 330A  
 Edith (1841-1871) 8, 66  
 Edward Albert 9, 249  
 Elda Jacobs 8  
 Eleanor (dau. Jerome) 8  
 Eleanor (1814-1885) 8, 84  
 Elise Moeller (see Alexander, Elsie  
 Moeller)  
 Elizabeth 8  
 Elsie Moeller 9, 249  
 Estelle Kaufman 8  
 Esther (b. 1841) 9, 66  
 Esther (b. 1930) 9  
 Eta 119  
 Eugene 332A  
 Eugene Walter 8  
 Eula Potter 9  
 Fanny Pollock 290  
 Florence Maud 308  
 Frances (m. 1822) 8, 139  
 Frances 54  
 Fred William 308  
 George (b. 1916) 9  
 George (son Jacob C.) 9  
 Georgina Eugenia Isaac 308  
 Gertrude 107  
 Gertrude Eleanor Hammerslough 9  
 Gitla 16, 54  
 Hannah Aarons 1, 8  
 Harriet (1851-1937) 85  
 Harry 119  
 Hays (b. 1943) 8  
 Henrietta (1806-1886) 8  
 Henry A., Jr. (b. 1922) 9  
 Henry Aaron (b. 1874) 9  
 Henry Eugene 9  
 Hermione Weil 9  
 Honey 308  
 Hortense (b. 1878) 9, 299  
 Irma 119  
 Isaac (b. 1843) 9, 130  
 Isaac 107  
 Jacob Clarence (b. 1841) 9  
 James 308  
 Jerome 8  
 John Bentley (1945-) 330A  
 John Frederick 9, 299  
 John Philip (b. 1951) 8  
 Joseph (son of Jacob & Rebecca) 9  
 Joseph 162  
 Joseph Albert (1837-1894) 9, 277  
 Joseph Bentley 330A  
 Josephine Jacobs 6, 134  
 Judah (1742-1804) 8  
 Judith (b. 1932) 9  
 Judith Marian 9  
 Julia (b. 1850) 9  
 Julia Moses 9, 211  
 Julius M., Jr. 9  
 Julius Mortimer (1844-1917) 9, 278  
 Leah (b. 1842) 9  
 Leon 308
- Leopold 8  
 Lewis 9  
 Lionel 107  
 Lucile (1876-1919) 9  
 Manya Zelmanova Kliuitzkaya 9  
 Mary Ann 182  
 Mary Elizabeth (1947-) 330A  
 Maurice John 308  
 Maybelle (b. 1887) 9  
 Mildred Haskell 119  
 Minnie Jacobs 107  
 Miriam 122  
 Mortimer Joseph 119  
 Moses 8  
 Patricia Schoen 9  
 Percival 8  
 Rachael (1817-1888) 8  
 Rachael 290  
 Rebecca (b. 1926) 9  
 Rebecca (m. Hyman Samuel) 44  
 Rebecca (1823-1892) 8  
 Rebecca Ella Solomons 9, 278  
 Rebecca Levy 9  
 Reuben 54  
 Rita 107  
 Rosa Hays Tobias 9, 299  
 Rose Constance Coleman 308  
 Rose Mosler 7  
 Sallie Nathans Solomons 9, 277  
 Sally (b. 1939) 9  
 Sally (see Alexander, Sarah (Sally)  
 Sarah (dau. Abraham, Jr.) 8  
 Sarah (Sally) 119  
 Sarah (1767-1843) 54  
 Sarah Harris Sampson 9, 94  
 Sarah Moses 8, 9, 210  
 Solomon 308  
 Stephanie Harriet 119  
 Therese Julia 9  
 Walter 8  
 Warren (1880-1930) 9
- ALFORD**  
 Audrey 88
- ALLEN**  
 Adele Strauss 10  
 Alfred Hart 10  
 Alice (1854-1856) 10  
 Amelia Johaveth (1824-1856) 10, 193  
 Amelia Johaveth (1856-1935) 10  
 Amelia Sommers 10  
 Anna (1859-1944) 10  
 Anna Florence (b. 1882) 10  
 Anna Marks 10, 185  
 Benjamin Wolff (b. 1833) 10  
 Bernadine Hirschfeldt 10  
 Carol Jane 295  
 Caroline (b. 1883) 10  
 Caroline (1857-1876) 151, 329A  
 Carolyn Tim Auerbach 295  
 Catherine Cox 75  
 Hortense (b. 1878) 9, 279  
 Charles Chauncey 10, 279  
 Charles Craig (b. 1921) 10  
 Clarence (1857-1930) 10  
 Clarence Mitchell (1875-1933) 10  
 Claus (b. 1927) 10  
 Cynthia 295  
 Ellen Lazarus 151, 329A  
 Emma Wetzel 10  
 Ernst (b. 1911) 10  
 Esther (1798-1872) 10, 193  
 Fannie Simon 10  
 Florence 10  
 Florine (b. 1881) 10  
 Frances (b. 1855) 10  
 Fred (b. 1910) 10  
 Fritz (b. 1907) 10  
 Grace Amelia (b. 1867) 10  
 Hamilton 295  
 Hamilton, Jr. 295  
 Hannah Emanuel 10  
 Hans Henry (b. 1900) 10  
 Harriet 10  
 Henry Greer (b. 1924) 10
- Henry Nathan (b. 1876) 10  
 Henry Samson (1828-1903) 10, 110  
 Isabel Thorndike 295  
 John 151, 329A  
 John Thorndike 295  
 Julia Spanier 10, 280  
 Julius (b. 1862) 10  
 Kurt (b. 1905) 10  
 Lena 269  
 Lewis (1762-1811/15) 10  
 Lewis, Jr. (1793-1841/44) 10, 185  
 Lewis IV (1852-1909) 10  
 Lewis V 10  
 Lewis Marks (1827-1870) 10, 13  
 Lewis S. (b. 1872) 10  
 Lillian 10  
 Louisa Sondheim 10, 279  
 Maria (1799-1848) 10, 92  
 Marie Christina 42  
 Michael (b. 1916) 10  
 Michael Mitchell (b. 1830) 10, 280  
 Minna Ruben 10  
 Miriam Arnold 10, 13  
 Mirjam (b. 1901) 10  
 Rosalie (b. 1874) 10  
 Rosalie Hendricks 10, 110  
 Rosalie May (1866-1872) 10  
 Ruth Evelyn (b. 1912) 10  
 Urner 151, 329A  
 Walter Charles (b. 1875) 10  
 Winona Wilkins 10  
 Zillah Beatrice (b. 1868) 10
- ALLEN (COONEY)**  
 Kevin Richard 239
- ALLIGER**  
 Celestine Aline Goldschmidt Burchell  
 84  
 F. T. (d. 1901) 84
- ALLISON**  
 Clara Augusta Unger 324B  
 H. Willard 324B  
 Rosalie Ottolengui 234  
 Thomas Birch 234
- ALMAN**  
 - 123
- ALMUND**  
 Rosetta 165
- ALOE**  
 Patricia 281
- ALOOF**  
 Judah 331B  
 Sarah 331B
- ALPERN**  
 Adrian Scott (1967-) 325A  
 Benay Eta (1965-) 325A  
 Darin Mitchell (1967-) 325A  
 Irving 325A  
 Jacqueline Lee Hecht 325A
- ALPERT**  
 Hortense Peixotto Blumberg 240, 337B  
 Joseph 337B
- ALSCHULER**  
 Eibel 327B
- ALSTEN**  
 Ellen (Nellie) Block 25  
 George 25  
 Nellie Block (see Alsten, Ellen  
 (Nellie) Block)
- ALTHHEIMER**  
 Bertha 125  
 Tallie 186
- ALTMAN**  
 Barry 134  
 Deborah Jean 134  
 Helen W. Jacobs 134  
 Iris 26  
 Isadore 229  
 Louis Gregory 134  
 Louise 229  
 Peter George 134  
 Victoria Nathans 229
- ALTOUNIAN**  
 Lynn Diane 333B
- ALTSCHUL**  
 Charles 307  
 Charles, Jr. 307  
 Dorothy 307  
 Frances Hoffheimer 307
- ALVARENGA**  
 Daniel Da Costa 191  
 Rebecca Mendes 191
- ALVARIS**  
 Ester 335A
- ALVAREZ**  
 Andrea Sar 215  
 Anita 59  
 Clara Jessurun (d. 1716) 273  
 Leona Ransobhoff 215  
 Maria Harby 93
- ALVATE**  
 Elizabeth 206
- AMBERG**  
 Eloise 101  
 Eva (see Correll, Eva (Amberg))  
 Fannie Hart 101  
 Florence 101  
 Henrietta Hart 101  
 Irwin 101  
 Lee 101
- AMBROSE**  
 Brother (see Moise, Charles ('Brother  
 Ambrose'))
- AMICO**  
 Mary 293
- AMMONS**  
 Ruby L. 53
- AMRAM**  
 Adam A. (1984-) 340A  
 Adelaide 210  
 Adira Aliza (1981-) 340A  
 Alana Asha (1979-) 340A  
 Bertha 210  
 Beulah Brylawski 284  
 Caroline (1870-) 340A  
 David 284, 340A  
 David W. III 284, 340A  
 Elinor 284  
 Emile 210  
 Emilie Saller Weyl 284, 340A  
 Emily Weyl 284  
 Gale (1868-) 340A  
 Hortense Levy 284  
 Leonora 210  
 Lora Lee Ecobelli 340A  
 Mariana 284  
 Philip Werner 284, 340A  
 Rosa Rosenfeld 210  
 Werner David 284, 340A
- AMSTERDAM**  
 Andrew 290  
 David 290  
 Rosalind Judith Brav 290  
 Susan 290
- AMYOT**  
 Colbert 276  
 Jessie Solomons Rousseau 276
- ANATHAN**  
 Adele 229, 334B
- ANCKER**  
 Abby (d. 1888) 11, 190  
 Abby (dau. of Hart) 11  
 Abigail 11  
 Abigail Sampson 11, 259  
 Abraham Phillips 11  
 Adele Goodman 11  
 Adelia (1847-1927) 11, 64  
 Adelia Phillips 11, 243  
 Adolph (b. 1841) 11  
 Adolph (m. 1869) 11  
 Adolph (1774-1850) 11, 243, 320A  
 Alfred 11  
 Anna Murphy 11  
 Anna Walton 9  
 Arthur 11  
 Bella 11  
 Bessie Mayer 11

Brinah De Young 11  
 Caroline 11  
 Caroline Loeb 11, 320A  
 Caroline Rose 11  
 Catherine Hyams 11, 120  
 Charles (son of Jacob) 11  
 Charles (1838-1869) 11  
 Clara 11  
 Clothilde 11  
 De Witt Clinton James 11  
 Edward (m. Bessie Mayer) 11  
 Edward 11  
 Elias (son of Mitchell) 11  
 Elias (1826-1852) 11  
 Eliza 11  
 Eliza Frances James 11  
 Elizabeth P. 11, 256, 338B  
 Eva 11  
 Flora 11  
 Frances Eleanor (b. 1894) 11  
 George (1848-1913) 11  
 Gertrude 11  
 Gustavus (son Samuel P.) 11  
 Gustavus V. 11, 120, 259  
 Gustavus Vasa (b. 1888) 11  
 Hannah Hyams 11, 120  
 Hart (son of Adolph) 11  
 Hart (son of Hart) 11  
 Henry (son of Hart) 11  
 Henry C. (1806-1839) 11  
 Hetty 9  
 Hetty Pettigrew 11, 243  
 Irma 11  
 Isabel (dau. of Adolph) 11  
 Isabel (dau. of Mitchell) 11  
 Jacob (b. 1808) 11, 243  
 Jacob (b. 1834) 11  
 Jaacob, Jr. 11  
 Jean 11  
 Joseph Theodore (1843-1844) 9  
 Judith 11  
 Julia Phillips 11, 243  
 Kate 11  
 Katherine P. (b. 1890) 11  
 Katie 11  
 Laurence 11  
 Leah Adelsheimer 11  
 Lillian Elizabeth 11  
 Lizzie 11  
 Loria 11  
 Lydia Davis 11  
 Maria 11  
 Mary Adele Goodman 11  
 Mary Magdalene 11  
 Mary (Miriam) McAllister 11  
 Milton 11  
 Miriam McAllister (see Ancker, Mary (Miriam) McAllister)  
 Mitchell (b. 1863) 11  
 Mitchell (son of Abraham) 11  
 Mitchell (son of Samuel P.) 11  
 Mitchell (1805-1863) 11, 243  
 Moses 11  
 Pinkney 11  
 Rachel 11  
 Rebecca Emily (1842-1843) 11  
 Samuel P. (son of Samuel P., Jr.) 11  
 Samuel P. (1817-1903) 11, 120  
 Samuel P., Jr. (b. 1857) 11  
 Samuel P., Jr. (son of Mitchell) 11  
 Sarah (dau. Adolph) 11, 255  
 Sarah Kahn 11  
 Theodore (d. 1855) 11  
 Theresa Dorothea 11  
 Theresa Kehrler 11  
 Theresa Rothenburg 11  
 Virginia (dau. of Hart) 11  
 Virginia (m. 1888) 11  
 Virginia Callanan 11

**ANDER**  
 Emma P. 213

**ANDERSON**  
 Ada Hewing 335B

Ada Louise (1944-) 335B  
 Anastasia Sadowsky 88  
 Beulah Catherine (Mamber) Kramer 238  
 Carol Beulah 238  
 Chapman Levy 169  
 Clarence 205  
 Clarence, Jr. 205  
 Corrie 313B  
 Duncan Maxwell 88  
 Edith Ismay Scobell 79  
 Edward H. 169  
 Eleanor Johnston Lopez 331B  
 Emma Baker 205  
 Flora Eliza Levy 169  
 Florence Baker 205  
 Irene Violet Hodgkin 201  
 Jennie Baker 205  
 John 335B  
 Joyce Janet Mabel 238  
 Lucy Ann 169  
 Minerva Campbell 88  
 Mollie Wilkes Lopez (1981-) 331B  
 Robert J. 331B  
 Stanlev Henry Walter 238  
 Terence 88  
 Terence Robert 88  
 Thomas Salmond 169  
 William Allan Campbell 79

**ANDRADE**  
 David Da Costa 191  
 Helen Elizabeth Davis 138  
 Hugh 138  
 Leah 178  
 Luna Julia Mendes 191  
 Reyna (1801-1871) 147  
 Sophia (d. 1870) 33

**ANDREWS**  
 Abraham 12  
 Adelaide Gottlieb 12  
 Albert Marion 163  
 Albert Marion, Jr. 163  
 Alice Mildred 199  
 Almata 269  
 Ann Sherwood (b. 1930) 12  
 Carole Prentice 238  
 Cary Barton 218  
 Catherine (Isabel) 12  
 Catherine 144, 201  
 Clarissa King 12  
 David Curran (1862-1913) 12  
 David Jonathan 12  
 David Zellner 12  
 Deborah (b. 1800) 12, 118  
 Eliezer Lewis (1812-1848) 12, 139  
 Eliza 115  
 Emily (1816-1819) 12  
 Emily Schwartz 12  
 Esther (1807-1894) 12  
 Esther Abrams 4, 12, 272  
 Ethel 12  
 Eve (1798-1884) 12, 64  
 Flora 12  
 Frances Lyon 12  
 Gail Prentice 238  
 George Levy 192  
 George Osgood (1866-1944) 12  
 Gordon Guelberth 163  
 Haym M. (b. 1803) 12  
 Helen Elizabeth 12  
 Helen Legg 163  
 Helen Rosenberg 12  
 Isabel (see Andrews, Catherine (Isabel))  
 Isabel Weiner 12  
 Jane 12  
 Jane Prentice 238  
 Jennifer Lynn 12  
 Jessy (Simha) Judah 12, 101  
 Joan Prentice 238  
 John L., Jr. 218  
 John Lowry 218  
 John S. 251

Joseph (1753-1824) 12, 257  
 Joseph Franklin 12  
 Joseph I. (or J.) (b. 1801) 12, 233  
 Joseph L., Jr. (b. 1938) 12  
 Joseph Lyon (b. 1902) 12  
 Joseph Samuel (1850-1920) 12  
 Joseph Sven 12  
 Katherine (see Andrews, (Katherine) Dale)  
 (Katherine) Dale 12  
 Katherine Louise New 12  
 Lelia Abernoon De Lima 12  
 Leonora Louise 12  
 Leroy J. (1864-1902) 12  
 Lewis (son of Zalegman) 12  
 Lillian Pinto 251  
 Louisa (b. 1859) 12  
 Lucille Menken Griffith 192  
 Lynn Francis (b. 1932) 12  
 Mabel Zellner 12  
 Margareta Langert 12  
 Mary Ellen 12  
 Mary Graham Myers 218  
 Miriam (1772-1847) 12  
 Miriam (1809-1880) 12, 272  
 Miriam Nones 12, 233  
 Montefiore J. (1854-1914) 12  
 Nellie (Nettie) Solomons Abrahams 12  
 Nettie Solomons Abrahams (see Andrews, Nettie) Solomons Abrahams)  
 Paul Revere 238  
 Paul Richard Prentice 238  
 Rachel (b. 1814) 12  
 Rachel (b. 1839) 12  
 Rachel (1753-1835) 5, 12, 205  
 Sallie Salomon 12, 257  
 Sally Adela (b. 1851) 12, 192  
 Salomon (1811-1848) 12  
 Samuel Elkin (1818-1846) 12  
 Sara Katherine 12  
 Solomon Franklin (1853-1910) 12  
 Theresa 198  
 Theresa Outlaw 198  
 Virginia Prentice Ettinger 238  
 Washington (1856-1873) 12  
 Zalegman (b. 1805) 4, 12, 272

**ANDREWS (ABRAHAM)**  
 Joseph (b. 1768) 4

**ANGEL**  
 Emanuel Moses (b. 1843) 303  
 Ida Johanna Wolf 303  
 Maurice 303

**ANGIER**  
 Caroline 206

**ANGLE**  
 Charles Cameron 269  
 Elaine Sheftall 269

**ANGULO**  
 Ana (-1879) 336A

**ANSBACHER**  
 Adele (b. 1877) 22, 144  
 Adolph B. (1831-1917) 22  
 Alan B. (b. 1904) 22  
 Alice (b. 1902) 22  
 Armonis Wilkins 22  
 Carolyn Lawnsen 22  
 Clara Wechsler 22  
 David (b. 1866) 22  
 Doris (b. 1909) 22  
 Elsie Oppenheimer 22  
 Frances V. Eger 22  
 Helena (b. 1866) 22  
 Louis 22  
 Marion (b. 1903) 22  
 Maurice (1861-1886) 22  
 Rosie or Rosalie 22, 145  
 Sally Curtis 22

**ANSELL**  
 Rebecca Cohen 180  
 Rev. Myer (1806-1866) 180  
 Sarah 180

**ANTWERP**

See Van Antwerp

**APPEL**  
 Charles L. III 22  
 Judith 255, 310B  
 Karyn Patricia 23  
 Kurt (1909-1973) 255, 310B  
 Margaret Kayton (b. 1909) 255, 310B  
 Patricia Linburn 22

**APPLEGATE**  
 Sarah 297, 314A

**APPLETON**  
 Mary 216

**ARBIB**  
 Edmund (Joseph Edgar) (1918-1945) 244  
 Harriet Natalie Brodie 244  
 Joseph Edgar (see Arbib, Edmund (Joseph Edgar))  
 René 244  
 Solita (b. 1916) 244  
 Sylvia Phillips 244

**ARCHER**  
 Caleb 329B  
 Fanny Henricks 159, 329B  
 Lida Frances 329B  
 Morton 329B

**ARLAS**  
 Rabel de Jacob Dias 52

**ARKINS**  
 Abigail (b. 1919) 231  
 Alex 231  
 Carolyn Babush 231  
 John (b. 1926) 231  
 Marguerite Newhouse 231  
 Robert (b. 1928) 231  
 Rowland (b. 1922) 231  
 Vivianne Kleinberg 231

**ARLITZ**  
 Eva Blankenburg 129  
 W. J. 129

**ARMSTEAD**  
 Theodotia 4

**ARMITT**  
 Malvina (Nina) Mapleson 226  
 Nina Mapleson (see Armit, Malvina (Nina) Mapleson)

**ARMSTRONG**  
 Edward 184  
 Elizabeth Gulick 184  
 Emmeline J. 332B  
 Henrietta J. Maraché 184, 332B  
 Thomas 184, 332B  
 Thomas, Jr. (1812-) 332B

**ARNEY**  
 Anne Caroline Unger 324B  
 William H. 324B

**ARNHEIM**  
 Joy Israel 121  
 Lucile (b. 1904) 121  
 Noma 174  
 William 121

**ARNOLD**  
 Aaron (of Ibenhausen) 13, 320A  
 Aaron (1840-1886) 13  
 Aaron Edwin (1835-1910) 13  
 Aaron (1840-) 320B  
 Abraham Clark (1872-1942) 320B  
 Abraham Clark, Jr. 320B  
 Abraham (1800-1872) 320A  
 Alan 13  
 Albert 13, 253  
 Alexander Duncan 157  
 Alice (b. 1846) 13  
 Amanda (1831-1853) 320B  
 Amelia Wolff 320B  
 Amelia (1843-1896) 320B  
 Behjar (Joy) Mansoor 268  
 Blanche H. (1865-1901) 13  
 Carrie Stettheimer 13  
 Catherine 320B  
 Clara (185-7) 320B  
 Clarissa (1830-1919) 13, 320A  
 Edgar M. 13

Edna 13  
 Edna Schiff 13  
 Edward (1845-) 320B  
 Edwin T. 268  
 Eli W. (1837-1897) 13  
 Elizabeth 13  
 Elizabeth Setaren 268  
 Emma 320B  
 Emma (1852-1873) 320B  
 Emma (1875-1925) 320B  
 Ethel Louise Price 13, 253  
 Evelina Nicholas 157  
 Ezra (1839-1882) 13, 320A  
 Famelia (1825-1917) 13  
 Fanny Bernheimer 13  
 Fanny Wolf 13, 303  
 Fanny (185-7) 320B  
 Fleurette Moran 13  
 Florence (1864-1919) 13, 174  
 Florine 13  
 Frances (dau. of Aaron) 13  
 Frances (1872-1936) 13  
 Fred 320B  
 Frieda Mayer 320B  
 Harry 13  
 Henrietta (m. A. P. Schoneman) 28  
 Henrietta (1842-1844) 13  
 Hester 320B  
 Hezekiah (1834-1890) 13, 83, 320A  
 Howard (d. 1918) 13  
 Isabella (1828-1892) 13, 320A  
 Isabella (1829-) 320B  
 Jane 320B  
 Joy Mansoor (see Arnold, Behjar (Joy) Mansoor)  
 Julia (1843-1894) 13  
 Julia Gans 13, 83  
 Laura Corinna Sheftall 268  
 Lavinia (1847-) 320B  
 Lazarus 185  
 Leah Marks 185  
 Leon 320B  
 Leon (Levi) (1887-1969) 320B  
 Levi (1833-) 320B  
 Levi (see Arnold, Leon (Levi))  
 Lewis (b. 1845) 185  
 Lewis Tracy (1874-1960) 320B  
 Lillian Goldstein 320B  
 Louise Schmidt 320B  
 Madeline 13  
 Mammie Goldsmith 13  
 Maria (Mary) Abrams (1811-1883) 320A  
 Mary E. Frost 320B  
 Mary Elizabeth 320B  
 Mary Hammett 13  
 Mary Haney 320B  
 Mayer (1785-1868) 13, 303, 320A  
 Mayer W. (1848-1927) 13  
 Miriam (1831-1915) 10, 13  
 Miriam (1835-) 320B  
 Miriam Kahn 13  
 Miriam Levi 320B  
 Miriam Louise Johnson 326B  
 Myra (1885-) 320B  
 Myrtle Schere 320B  
 Nancy 13  
 Oscar 13  
 Rebecca 13  
 Richard Myrten 320B  
 Roger Amir 268  
 Sadie 320B  
 Sandford 320B  
 Simon (1827-1885) 13  
 Simon J. 320B  
 Simon J. III 320B  
 Simon J. (1838-1889) 320B, 326B  
 Simon J., Jr. (1881-1950) 320B  
 Suzanne 13  
 Uriah (b. 1832) 13  
 Walter V. 268  
 Walter V., Jr. 268

**ARNSTEIN**

Amy Frances Torrance 65  
 Barbara Louise Torrance 65  
 Frances Theresa 65  
 Gertrude Agnes Sanguinetti 65  
 Isabella Chisholm Torrance 65  
 Joy Lorraine 65  
 Marion Charlotte Sanguinetti 65  
 Moritz 65  
 Pery Emanuel Sanguinetti 65  
 Rudolph Raphael 65

**ARNSTHAL**  
 Arthur 70  
 August 70  
 Carrie 70  
 Charles D. 70  
 Evelyn 70  
 Florence 70  
 Frank 70  
 Grace Ezekiel 70  
 Julius 70  
 Kate 70  
 Lion 70  
 Minna Minis 70  
 Murdock 70

**ARON**  
 Clara 293

**ARONOVITCH**  
 Carol 191  
 Jane Ellen 191  
 Katherine Louisa Silver 191  
 Lawrence Isaac 191  
 Michael 191  
 Stephen 191

**ARONOWITZ**  
 Katherine Louisa Silver 191  
 Michael 191

**ARONS**  
 See also Aaron, Aaron(s), Aarons  
 Elias Levi 1

**ARONS VAN BLITZ**  
 Belitze (d. ca. 1820) 1  
 Emanuel 1  
 Levi (d. 1792) 1

**ARONSON**  
 Augusta Abrahams 6  
 C. Minnie 6  
 Frederick H. 6  
 Harris 6  
 Harry 6  
 Julia 6, 102  
 Kitty 6  
 Naomi 6, 102  
 Rosalia 6, 102

**ASCH**  
 Carol Betty Binswanger 23  
 Charles J. 13  
 Clarissa Ulman 13  
 Essie (Rebecca) 13, 28, 271  
 Irma Clara (1875-1953) 13  
 Jeffrey Leo 23  
 Joseph M. (1802-1866) 13  
 Manuella Jackson Avezzano 13, 129  
 Marylon Jean (b. 1948) 23  
 Michael 23  
 Mitchell J. (1841-1888) 13, 129  
 Morris Joseph (b. 1833) 13  
 Moses M. 13  
 Myer (1831-1890) 13  
 Rebecca (see Asch, Essie (Rebecca))  
 Rosalie (m. 1853) 13

**ASCHEHOUG**  
 Frederikke Marjorie (b. Apr. 24, 1934) 310B  
 Marjorie Joseph 310B  
 Thorkil (m. May 23, 1931) 310B

**ASCHER**  
 Beatrice 60  
 David 60  
 Ernest 60  
 Gerhart (b. 1926) 10  
 H. 60  
 Herman S. G. 60  
 Mirjam Allen 10



Otto 10  
 Rachel De Sola 60  
 Rachel Judith De Sola 60  
 Violet 60  
**ASCHIMAN**  
 Charles 46  
 Esther Rosalie David 46  
**ASH**  
 Max 253  
 Viola Fonseca Da Silva Solis  
 Ritterband Powers 253, 277  
**ASHE**  
 Edward Cohen 200  
 George Devereux 200  
 Hazel Burgwyn 200  
 John Devereux 200  
 Margaret (Meta) Devereux 200  
 Margaret Mordecai 200, 333A  
 Mary Porter 209, 312A  
 Meta Devereux (see Ashe, Margaret (Meta) Devereux)  
 Col. Samuel 312A  
 Samuel 200  
 Thomas Samuel 200  
**ASHENHEIM**  
 Eliza De Cordova 52  
 Joseph Lewis 52  
 Judith 52  
 Leslie Erie 52  
 Lewis, 52  
 Lewis, M.D. 52  
**ASHER**  
 Adelaide Betty Levy 167  
 Baroa H. (b. 1882) 167  
 Baron Henry (b. 1925) 167  
 Caroline (1834-1909) 33  
 Erna Fromme 167  
 Eugene Samuel 167  
 Laura Hope 167  
 Laurie Lynn 167  
 Louisa (b. 1836) 147  
 Michael 170  
 Moses 167  
 Rabbi 221  
 Rachel 154, 170, 223  
 Richea (Rycha) (m. 1695, N. Y.) 154, 170, 311  
 Rycha (see Asher, Richea (Rycha))  
 Sarah (Sortah) Myers 221  
 Sophye Davidson 71  
 Sortah Myers (see Asher, Sarah (Sortah) Myers)  
**ASHIM**  
 Mathilda Adelaide Jacobi 117  
 Simoa 117  
**ASHIMORE**  
 Ruth 27  
**ASHTON**  
 Caroline N. 80  
**ASKEN**  
 Doris 90  
**ASQUITH**  
 Anne Marie Celestine Palairt 79  
 Clare Herpetoa Frances 79  
 Julian Edward George (1st Earl of Oxford) 79  
 Katherine Rose Celestine 79  
 Mary Annuziata 79  
**ASTOR**  
 Larue 335B  
**ATCHISON**  
 Charles 37  
 Juanita Sallie Davis 37  
 Sallie 37  
**ATKIN**  
 Alfred 15  
 Alfred, Jr. (b. 1949) 15  
 Mary Aufesser 15  
 Michael John (b. 1944) 15  
 Nelley Everett Keyser 140  
 Peter W. 140  
 Thomas (b. 1947) 15  
**ATKINS**

James 237  
 Johannah Lee Barbaum Brown 237  
 Susan V. 276  
**ATKINSON**  
 Calder (1915-1944) 329A  
 Helen Josephine Phillips 245  
 Henry Gladstone 245  
 Jackie Stockard (see Atkinson, Mary Johnson (Jackie) Stockard)  
 Margaret (Margo) 329A  
 Margo (see Atkinson, Margaret (Margo))  
 Mary 29  
 Mary Calder 329A  
 Mary Fullerton Calder 329A  
 Mary Johnson (Jackie) Stockard 329A  
 William Mayo 329A  
 William Mayo, Jr. (1911-) 329A  
**ATWATER**  
 Susan 112  
**ATWELL**  
 Maude 111  
**AUB**  
 Fannie 306  
**AUBERT**  
 Aristide Louis 201  
 Caroline Alice 201  
 Caroline Gertrude Mordecai 201  
 Edward Randolph Mordecai 201  
 Helen Gertrude 201  
**AUDLER**  
 E. M. 74  
 Helene Barnett 74  
 Rosina Florance 74  
 Sol 16  
 Solomon 16, 74  
**AUFERBACH**  
 Benjamin 261  
 Carolyn Tim 295  
 Clara 89  
 Dewey 295  
 Erwin 104  
 Helen 104  
 Helen Hays 104  
 Patty Pollitz 91  
 Rita Guggenheimer 89  
 Robert H. 91  
 Warren 89  
**AUFSESSER**  
 Adelaide Marks 15  
 Alma Isenberg 15  
 Bertram (b. 1886) 15  
 Bess De Beer 15  
 Dorothy (b. 1915) 15  
 Eleanor Spear 15  
 Elizabeth (b. 1921) 15  
 Elsa (1885-1916) 15  
 Elsa (1917-1919) 15  
 Ethel Levy 15  
 Ferd 11 (b. 1914) 15  
 Ferd M. (1848-1916) 15  
 Gates (b. 1888) 15  
 Helen (b. 1892) 15  
 Jane (b. 1922) 15  
 Jeanette (b. 1882) 15  
 Kenneth (b. 1953) 15  
 Mary (b. 1920) 15  
 Mollie Barne 15  
 Molly (b. 1924) 15  
 Moses (1878-1940) 15  
 Nanette Lehman 15  
 Paula (b. 1943) 15  
 Peter (b. 1947) 15  
 Rena (b. 1880) 15  
**AUGUST**  
 Charles 292  
 Madeline Friedman 292  
**AULDJO**  
 Susan Maria 96  
**AURIEMA**  
 Isabella 245  
**AUST**  
 Carrie Oppenheimer 239

John William 239  
**AUSTIN**  
 Catheryn 107  
 Fannie Wintz 52  
**AVERITT**  
 Henry G. 269  
 Sarah E. Sheftall 269  
**AVFRY**  
 Elizabeth Harby 93  
 Helen 176  
 Peter 325A  
 Rachel Hays 325A  
 Sara L. 80  
 Sarah (m. Jul. 7, 1927) 312B  
 William 93  
**AVEZZANO**  
 Manuella Jackson 13, 129  
 Peppina (d. 1926) 129  
**AXLER**  
 Anne 327B  
**AYERS**  
 Mary 313A  
 Minnie Hanff 313A  
 Raymond 313A  
 Robert 313A  
**AYLESWORTH**  
 Andrew J. (m. Oct. 14, 1855) 312B  
 Sarah L. Russell 312B  
**AYMER**  
 Alexander L. 227  
 Ann 227  
 May Rose Nathan 227  
**AYMOND**  
 Josephine 195  
**AZEVEDO**  
 See D'Azevedo  
**AZUBY**  
 Abraham (1738-1805) 13  
 Esther (1754-1805) 13  
**AZULAY**  
 Rachel 51  
**BABCOCK**  
 Barbara 296  
**BABELHEIMER**  
 Bruce 230  
 Brucella (b. 1937) 230  
 Elinor Tibbett 230  
**BABICKA**  
 Jaromir 238  
**BABINGTON**  
 Mary 82  
**BABUSHI**  
 Carolyn 231  
**BACH**  
 Albert (d. 1899) 13, 110  
 Albert, Jr. (b. 1887) 13  
 Alice Hendricks 13, 110  
 Amelia 13  
 Andrew Robert 13  
 Barbara Brisson 13  
 Clara Epstein 13  
 Cornelia Isaacs 125  
 Ellen Ackerman 13  
 Ellen Dorothy 13  
 Ellen Lewis 13, 171  
 Ferdinand Harold 125  
 Ferdinand Harold, Jr. 125  
 Gene Davis Darnell 125  
 Hannah 13, 171  
 Harry 13  
 Hazel Blum 13  
 Henry M. 13  
 Henry M. III 13  
 Henry Michael II 13  
 Irene Bronstein 13  
 Israel 13  
 Joseph 13, 171, 130  
 Jules 13  
 Justine Ellen (b. 1886) 13  
 Linda Ellen 13  
 Marie Mendelson 125  
 Mary Hendricks 13  
 Maude Nathan 13

Peter Michael 13  
 Robert (b. 1917) 13  
 Ruth Pollock 13  
 Sabina Mendelson 125  
**BACHARACH**  
 Cora 165  
 Dolze 89  
 Elizabeth 23  
 Miriam 283  
**BACHARACH ZUR WAAGE**  
 See also Waag  
 Phaiubush Uri 302, 340B  
**BACHE**  
 Florence Sheftel 144  
 Hazel 144  
 Jules Semon 144  
 Katherine 144  
**BACHMAN**  
 Annette Angeline Levy 167  
 Beatrice 323A  
 Jerome Nordlinger 167  
 Jerome, Jr. (b. 1913) 167  
**BACHRACH**  
 Addie Nattins 313B  
 Arthur 313B  
 Callie (Caroline) (1860-1920) 313A  
 Caroline (see Bachrach, Callie (Caroline))  
 Dorothy (b. 1898) 313B  
 Elise Klein 237  
 Emanuel (b. 1859) 313A  
 Emma (b. 1866) 313B  
 Erika Oppenheimer 237  
 Flora 134  
 Henry Milton 237  
 Jacob (1826-1897) 313A  
 Josef Ivan 237  
 Mary (b. 1854) 313A  
 Michael Keith 237  
 Rachel (b. 1857) 313A  
 Rebecca (b. 1862) 313B  
 Samuel (b. 1864) 313B  
 Sarah Tabitha Semon 313A  
 Simon (b. 1855) 313A  
 Warren Steven 237  
**BACKHOFF**  
 Harold 258  
 Lillian Alice Lusher 258  
 Patricia (1922) 258  
**BACCOAT**  
 Marie 207  
**BACON**  
 Allyn 103  
 Hannah Hart (d. 1863) 103  
**BAER**  
 Alma (b. 1914) 48  
 Alma Davis (m. 1914) 48  
 Charlotte 211  
 Daniel Robert 48  
 Gloria Blanche Lindsay Doran 48  
 Gloria Jane 48  
 Julius Bernard 48  
 Margot 237  
 Michelle Kathleen 48  
 Miriam 48  
 Victor 48  
**BAERWALD**  
 Ernst 277  
 Florence Martin 277  
**BAHR**  
 Emmie Baruc 17  
 Herman 17  
 Minnie 160  
**BAILEY**  
 Charlotte (1796-1848) 220  
 Isaac 36  
 Joseph Cohen 36  
 Mary 313A  
 Sarah Cohen 36  
**BAIRD**  
 Elmore 25  
 Estelle Block 25  
 Isabel 30

Joseph F. M. (1884-1917) 298  
 Kathleen Tobias 298  
 Montagu M. W. (1854-1915) 298  
 Stanley H. M. (b. 1890) 298  
**BAIZ**  
 Abraham (1816-1887) 225  
 Anita (b. 1869) 225  
 David Naar (1850-1851) 225  
 Emily Mendes Seixas 225, 263  
 Esther 225  
 Hannah (see Baiz, Nanette (Hannah))  
 Isaac (b. & d. 1859) 225  
 Jacob (b. 1843) 225, 263  
 Jacob (St. Thomas) 225  
 Joseph Levi (b. 1852) 225  
 Leah Oliveira Isidro 225  
 Leita (b. 1839) 224, 225  
 Mary Heineman 225  
 Moses (b. 1854) 225  
 Nanette (Hannah) (1844-1928) 225, 263  
 Rebecca 225  
 Samuel (b. 1861) 225  
 Sarah (1841-1856) 225  
 Sarah Miriam Naar 225  
 Zipporah (b. 1865) 225  
**BAKE**  
 Mary 39  
**BAKER**  
 Anna M. (1890-1913) 230  
 Betsy Ross 155  
 Bryan C. 268  
 Cora Estelle Nathans Middleton 230  
 Eliza Jane Moses 205  
 Emma 205  
 Frederikke Marjorie Aschehoug Klein 310B  
 Guelina Lawrence 182  
 Herbert Ross 155  
 Jane Moses 205  
 Lisa Kay 268  
 Mary Katherine Sheftall 268  
 Natalie Hammond Hunt 155  
 O'Neill 230  
 Richard 205  
 Richard Frank (m. Nov. 7, 1966) 310B  
 Richard Frank, Jr. (b. Nov. 1, 1967) 310B  
 Robert L. 155  
 Samuel Chandler 205  
 Sandra Ray 52  
 Thomas 205  
**BAKSI**  
 Gayle Louise Rhodes 237  
 Gerald S., Jr. 237  
 Gerald Steven 237  
 Sandra Lee 237  
**BALDORF**  
 Isabella Benswanger 21  
 Jacob 21  
 Louis C. (b. 1878) 21  
 Rena Isabelle (b. 1880) 21  
**BALDWIN**  
 Archibald Stewart 188  
 Bowman Noah 232  
 Caroline Marx 188  
 Caroline Marx Barton (m. 1856) 188  
 Dorothy Claire Sheftall 269  
 Edward M. 140  
 Edward M., Jr. (b. 1912) 140  
 Florence McLelland 188  
 John Mackay (1875-1958) 188  
 John, M.D. 188  
 Kate Mackay (1860-1940) 188, 218  
 Laurence M. (b. 1916) 140  
 Margaret Ellen Brasch 314A  
 Marianna Moore Laurence 140  
 Matilda Seixas 266  
 Moebly 232  
 Polly 188  
 R. Stuart 188  
 Robert Frederick 188  
 Robert H. 314A

William Barton 188  
 William P. 269  
**BALL**  
 Barbara Ann 283  
 Beatrice Harris 283  
 Bessie 283  
 Blanche 283  
 Carrie Hess 233  
 Dane 283  
 Daniel 283  
 Ethel 283  
 Hannah Isaacs 126  
 Herman 283  
 Jack 283  
 Jayne 283  
 Milton (son of Herman) 283  
 Milton (son of Milton) 283  
 Sarah Stern 283  
 Siella 283  
**BALLARD**  
 Blair 337A  
 Elizabeth Nones 337A  
**BALLENTINE**  
 Helen Ridgely 155  
 Helen Ridgely Morgan 155  
 John H., Jr. 155  
 John Holme 155  
**BALLIN**  
 Adelaide (1851-1895) 144, 147  
 Edwin Israel (1853-1857) 147  
 Eugene S. (1817-1885) 147  
 Frederick Eugene (b. 1849) 147  
 Fromet (-1649) 337A  
 Ludwig Eugene (b. 1847) 147  
 Miriam Kurnbeedt 147  
 Oscar Eugene (b. 1856) 147  
**BALMAIN**  
 Alexander 76  
 Charlotte Johnson 76  
**BAMBERGER**  
 Abraham 14  
 Abraham Isaac (1839-1922) 280  
 Alma S. 280  
 Babette Strauss 14  
 Beatrice 14  
 Bernard 14, 290  
 Betsy 14  
 Carola Beral 14  
 Caroline 14  
 David 14  
 Estelle Florette Souza 280  
 Ethel Kraus 14, 291  
 Eva 14  
 Frances 252  
 Gussie Erlanger 14  
 Henry 14  
 Hiram Naphtali 14  
 Jacob 14  
 Judith 14  
 Keilah 14  
 Michael 14  
 Mindelle 14  
 Miriam 14  
 Moses 14  
 Peggy (see Bamberger, Rifka S. (Peggy))  
 Rifka S. (Peggy) 14  
 Rose Herman 14  
 Ruth 14  
 Sarah Bookman 14  
 Sheila Lister 14  
 Sophie Herman 14  
 Steven Bernard 14  
 William 14  
 William Burk 14  
 Wolf 14  
**BANCROFT**  
 Elise Hope 158  
 Elise Milligan 158  
 Elizabeth Hope 158  
 F. Carter III 307  
 Frank Carter, Jr. 307  
 John Wallace 307



Jessie Samuel 260  
**BATEMAN**  
 Alice Cordelia 37  
 Elizabeth Anne 37  
 Elizabeth Bryan 37  
 Robert Edward 37  
 Virginia Jean 37  
**BATES**  
 Bates (b. 1927) 275  
 David Solis (b. 1928) 275  
 David Wolf 126  
 Harriet Maria Isaacs 126  
 Lillian Arabelle (b. 1905) 275  
**BATTE**  
 Dora 58  
**BATTEY**  
 Aimee 35  
 Alice 35  
 Belle 35  
 Belle O'Driscoll 35  
 Edith 35  
 Frank 35  
 Horace 35  
 William Henry 35  
**BAUER**  
 Addie 215  
 Edith 215  
 Eva Schiffer 215  
 Felix 215  
 Josie M. 215  
 Nettie 215  
 Paul 215  
**BAUERLE**  
 Martha 236  
**BAUGH**  
 Mahala 29, 309A  
**BAUGHAN**  
 F. I. 118  
**BAUGNIET**  
 Catherine Leslie Stewart 95  
 Jessica Leslie 95  
 Phyllis H. Freedman 95  
 Robert M. 95  
**BAUM**  
 Carol 320B  
 Charles 160  
 Jacob 160  
 Jennie Benjamin 160  
 Julia 102  
 Julius 160  
 Leonora Cohen 34  
 Louis 160  
 Luciel 71  
 Mannes (Camden, S. C.) 34  
 Mannes (m. Sophie S. Brunner) 102  
 Minnie 160  
 Norman 160  
 Pauline 120  
 Philip 160  
 Rosalie 34  
 Rose (dau. of Jennie Benjamin) 160  
 Sarah Deborah 34  
 Sophia Solomon Brunner 102  
**BAUMER**  
 Anna May (1896-1930) 259  
**BAUMGARTEN**  
 Betsy Bamberger 14  
 Emil 276  
 Gertrude Carrick 276  
 Jules 340B  
 Mina (Mendel) Sarlouis 340B  
 William 14  
**BAUSMAN**  
 Adeline 132  
 Mary (1786-1820) 182  
**BAXTER**  
 Calvin 330B  
 Marilyn Alice Marcus Rosen 330B  
**BAY**  
 Betty 287  
**BAYARD**  
 Barbara 141  
 Emily Jane Judah 141

George L. 141  
 George, Jr. 141  
**BAYER**  
 Javen 127  
**BAYLESS**  
 Helen (b. 1851) 172  
 John Clarke 172  
 Rosa Lewis 172  
**BAYLEY**  
 Marie 165  
**BAYNES**  
 Ethel Jackson Zimmerman Lockwood  
 129  
 George McL. 129  
**BAZAN**  
 Aloysis 176  
**BEACH**  
 Beverly (1921-1951) 324A  
 Georgette 327B  
**BEADIE**  
 Robert 95  
**BEALE**  
 Caroline 171  
**BEAN**  
 Edward 120  
 Irene 120  
 Joseph (son of Joseph) 120  
 Joseph 120  
 Mary 120  
 Rachel 120  
 Rebecca (dau. of Joseph) 120  
 Rebecca Hyams 120  
**BEAR**  
 Peggy Anne 34  
 Seraphine 273  
**BEARD**  
 Estell Louise 195  
**BEARDEN**  
 C. B. 240  
 Camille C. Peixotto McCartha 240  
 Charles 240  
 Warren Hayes II 240  
**BEARDSLEY**  
 Ada Samson 259  
 Anna Raymond 140  
 Charles Burton 259  
 Charlotte Judah 140  
 Gladys Heineman 109  
 James Wallace 109  
 Lewis Eddy 140  
 Michael 259  
**BEARMAN**  
 Albert 339B  
 Ellen Simon Rubin 339B  
**BEASLEY**  
 Harry Y. 269  
 Jennie Sheftall 269  
**BEASON**  
 Jean 208  
**BEATY**  
 Judith Loeb 211  
 Richard N. 211  
**BEAUMONT**  
 Adelaide 75  
 George Arthur Hamilton, 11th Bt. 78  
 Renee Muriel Northey 78  
**BECHSTEIN**  
 Mary Ann 105  
**BECK**  
 Gertrude A. Beck (1888-) 336B  
**BECKER**  
 Addie Schiffer 215  
 Ann Henry (b. 1944) 72  
 Ann Watters 255  
 Bertha M. 215  
 Charles 215  
 Dorothy Davega 45  
 Edith Larraway 215  
 Elizabeth Laib 149  
 Emma Schiffer 215  
 Helen 291  
 Helga Leeser 329B  
 Ida Marie Fleisher (b. 1914) 72

Jack 215  
 Jeffrey William 45  
 Leo 329B  
 M. Charles 215  
 Nancy Fleisher (b. 1941) 72  
 Nancy Gwen 45  
 Nathan 149  
 Pearl Worth 215  
 Ralph E. 255  
 Richard 72  
 Richard, Jr. (b. 1946) 71  
 Sandra Joan 45  
 Walter Schiffer 215  
 William 45  
**BECKETT**  
 Constance Mary 79  
 Hamilton 79  
 Henry 79  
 Henry Lyndhurst 79  
 James 79  
 Marianna 79  
 Mary Lyle 79  
 Sophia Clarence Copley 79  
**BECKMAN**  
 Dora Emily Stein 65, 323B  
 Dorothy Stein 65  
 Lester E., Jr. 65, 323B  
 Lester Emanuel 65, 323B  
 Patricia A. Durkin 323B  
**BECKWITH**  
 Belle Coben (dau. of George) 36  
 Belle Coben (dau. of Jacob) 36  
 Catherine Lopez 36  
 George 36  
 George Seymour 30  
 Jane Seymour 36  
 Sally Cohen 36  
**BECKNEL**  
 Madeleine Haydel 116  
 Pierre Antoine 116  
 Thomas 116  
**BEDDINGTON**  
 Esther 260  
**BEDELL**  
 Annie 209  
**BEDINGTON**  
 Rose 261  
**BEDTS**  
 See De Bedts  
**BEFBE**  
 Nancy Maguire 183  
**BEEBER**  
 Carrie 215  
 Frederica 285  
**BEER**  
 Flora Levy 165  
 Rudolph 165  
**BEERY**  
 Emelie Elizabeth Jenkins 298  
 William L., Jr. 298  
**BEGGS**  
 Irene 195  
 Louise 284  
**BEHREND**  
 David 260  
 Miriam Hess 260  
**BEHRENDT**  
 Esther (1817-1865) 160, 161  
**BEHRENS**  
 Ernest 2  
 Louise Fletcher 4  
**BEHRENS COHEN**  
 Gwendolyn (d. 1712) 235  
 Leffman (1630-1714) 235  
 Lehman 235  
 Miriel (d. 1771) 235  
 Moses Jacob 235  
 Prade (d. 1712) 235  
**BEHRINGER**  
 Betty Lou Honnett 125  
 Melissa Carol 125  
 William 125  
**BEIFELD**

Abram 116  
 Alex 116  
 Jacob 116  
 Joseph 116  
 Morris 116  
 Rosalie Herzog 116  
**BEILER**  
 Clara Cohen 186  
 Morton 186  
**BEIRS**  
 Albert 102  
 Grace Maude Hart 102  
 Mabel Hart 102  
**BEIZER**  
 Ruth 229  
**BEJALS**  
 Arnold 60  
 Catherine Lazarus 60  
 David 60  
 Dorothy 60, 191  
 Edward Orville 60, 191  
 Henry 60  
 Hortense Levy 60  
 Jacl De Sola 60  
 Rosetta Mendes 60, 191  
 Solomon 60  
**BELASCO**  
 Albert 321B  
 Alfred 95  
 Emanuel 321B  
 Eaa (Inez) 321B  
 Miriam Hadley ("Lalla") Hart 95  
 Miriam Lyons 321B  
 Viola 321B  
 Walter 321B  
**BELINPANTE**  
 Abigail Henriques 112  
 Eva Oppenheimer 60  
 Francis Cohen 112  
 Reyna Coben 273, 274  
**BELKNAP**  
 Alice 325B  
**BELL**  
 Jo Ann 283  
 John 128  
 Oswald Marmaduke D. 78  
 Phoebe Israel 128  
 Renee Muriel Northey Beaumont 78  
 Sallie Laird 336B  
**BELLE**  
 Nelle Christine 216  
**BELMONT**  
 Leo 149  
 Rosina Laib 149  
**BELPER**  
 3rd Baron (see Strutt, Algernon Henry,  
 3rd Baron Belper)  
**BELSER**  
 Katherine 207  
**BELT**  
 Lullie Wright 25  
**BELZINGER**  
 Grace Spatz 185  
 Joseph 185  
**BEN HAMU**  
 See Benjamin  
**BEN SIMON**  
 Angelina (Lena) Tucker 191  
 Lena Tucker (see Ben Simon,  
 Angelina (Lena) Tucker)  
 Raphael 191  
 Stella 191  
**BENATOR**  
 Barry 167  
 Gene 167  
 Laura Hope Asher 167  
 Morris 167  
**BENDEL**  
 Lena Rothgeiser Lescor Kletz (see  
 Bendel, Lillian (Lena) Rothgeiser  
 Lescor Kletz)  
 Lillian (Lena) Rothgeiser Lescor Kletz  
 237

Max Edward 237  
 Rita Marie 237  
**BENDHEIM**  
 Adrian 222  
 Adrian, Jr. 222  
 Ann Levy 222  
 Coralie 21  
 Delphine 331A  
 Isabelle Daisy Prag 222  
 Jeanne Benswanger 21  
 Joseph S. 21  
 Kathryn 21  
**BENDINER**  
 David Jeremy 215  
 Kathryn Moss Rosenberg 215  
 Margaret Ann (b. 1952) 215  
 Pauline Weil Myers 296  
 Robert 215  
 William (b. 1942) 215  
**BENEDICT**  
 Isabel Levy 163  
 Ludwig 163  
**BENENSON**  
 Dorothy 285  
**BENFORD**  
 David M. 296  
 Edward Bernard 296  
 Melissa 296  
 Olivia Yarrow 296  
 Scott Maurice 296  
 Stephen Yarrow 296  
**BENHAM**  
 Alice (1855-1890) 331B  
 Leon 331B  
**BENIOFF**  
 Alice Silverman 323A  
**BENISH**  
 Rebecca Jackson Levy 130  
**BENJAMIN**  
 Abigail Henriquez Moreno 61  
 Abraham Frederick 18, 48  
 Abraham (1829-) 321A  
 Ada (1860-1902) 19, 73  
 Ada R. Hart 254, 312B  
 Alexis (1840-) 321A  
 Alice 19  
 Alina Wolff 310  
 Amy Matilda (1861-1913) 19  
 Amy Matilda Benjamin 19  
 Ann 310A  
 Ansley J. 18  
 Arthur F. 18  
 Asher Lewis 171  
 Barbara Block Sanders 215  
 Benjamin (b. 1767) 62  
 Benjamin (son of Israel) 160  
 Bertha (see Benjamin, Betsy (Bertha))  
 Bertha (1867-1874) 19  
 Betsy (Bertha) 160  
 Bridget (see Benjamin, Brindella  
 (Bridget))  
 Brindella (Bridget) 261  
 Burton R. 310A  
 Casriel 160  
 Cecilia G. Heineman 19, 109  
 Charles 160  
 ---Chief Rabbi of Posen 261  
 Daisy 254  
 Daniel 18  
 David De Eliezer 51  
 David Henry (1854-1856) 19  
 David (1813-1890) 321A  
 David (1831-) 321A  
 Deborah Cortissoz 18  
 Duke 18  
 Edith Gertrude (b. 1862) 19  
 Edward A. 19  
 Elizabeth 19  
 Elizabeth Brody 160  
 Elvira (b. Mar. 10, 1853) 18  
 Elvira (b. 1842) 18  
 Emanuel 18, 321A  
 Emma Joseph 19

Esther (d. 1762) 18  
 Esther (m. 1784) 51  
 Esther (1789-1871) 18, 321A  
 Esther Coben D'Azevedo 51  
 Fanny (dau. of Henry) 19  
 Fanny (m. Henry) 19  
 Fanny (1849-1917) 160  
 Fanny Elizabeth (b. 1860) 19, 95  
 Florence (1866-1874) 19  
 Florence 18  
 Francis (Frank) (b. 1855) 19, 109  
 Frank (see Benjamin, Francis (Frank))  
 Gitlah (see Benjamin, Julia (Gitlah))  
 Grace 18  
 Graham 60  
 Hannah (d. 1820) 18, 321A  
 Hannah (see also Benjamin, Harriet  
 (Hannah) Mendes  
 Hannah De Leon 18, 321A  
 Hannah De Pinna 18, 321A  
 Hannah (1808-) 321A  
 Harriet (Hannah) Mendes (1809-)  
 321A  
 Harriet 160  
 Harriet Benjamin Mintz Nebenzaht  
 160  
 Henrietta Lewis (see Benjamin, Jane  
 (Henrietta) Lewis)  
 Henry (Canada) 19  
 Henry (son of Lionel) 254  
 Henry (1829-1893) 19  
 Henry Finley (1870-1874) 19  
 Ida 171  
 Irma Ancker 11  
 Isabel Geisenberger 8  
 Israel (m. Rachel Newman) 160  
 Israel (1862-1874) 19  
 J. Malvern 11  
 J. Malvern, Jr. 11  
 Jacob 18  
 Jacob Levy (b. 1818) 309A, 321A  
 Jane (dau. of Burton R.) 310A  
 Jane (Henrietta) Lewis (1822-1854)  
 171  
 Jane (m. Berthold Langner) 60  
 Jean 60  
 Jeffrey 312B  
 Jennie 160  
 Joel 11  
 Joseph (W. Indies) 18  
 Joseph (1794-1876) 19  
 Josephine (1864-1867) 19  
 Judah (d. young) 18  
 Judah (Virgin Islands) 18, 321A  
 Judah Philip (1811-1884) 18, 321A  
 Judith (1815-) 18  
 Julia (Canada) 19  
 Julia (Gitlah) 19  
 Julia (1819-1895) 19  
 Kate 19  
 Laura F. 326B  
 Leah (London) 19  
 Leah (1765-1780) 29, 62  
 Lewis (1825-1874) 19, 244  
 Lillian Langner 60  
 Lionel Nathan 254, 312B  
 Louisa 19  
 Marjorie Garrett 11  
 Mary Isabel 8  
 Michael 19  
 Michael Samuel (b. 1856) 19  
 Minnie 160  
 Miriam Esther 321A  
 Monroe 8  
 Monroe, Jr. 8  
 Mortara (1859-1874) 19  
 Moses (b. 1776) 18, 321A  
 Moses (son of Jacob) 18  
 Moses B. (see De Leon, Moses B.)  
 Murray 312B  
 Myer (see Myers, Benjamin or Myer  
 Benjamin)  
 Natalie St. Martin 18, 321A

Ninette (d. 1898) 18  
 Nona 312B  
 Peninah (1824-1903) 18  
 'Penny' (see Benjamin, Rebecca ('Penny'))  
 Philip (m. Hannah De Leon) 18, 321A  
 Philip (son of Judah) 18, 309A, 321A  
 ---Rabbi of Prague 305  
 Rachel (dau. of Jacob) 18  
 Rachel (Richmond) 181  
 Rachel (see also Benjamin, Richa (Rachel))  
 Rachel Cappé 18, 305, 321A  
 Rachel De Torres 62  
 Rachel Newman 160  
 Rachel (1810-) 321A  
 Ralph 171  
 Ray Grace 18  
 Rebecca (b. 1809) 18, 163  
 Rebecca (b. Mar. 10, 1853) 18  
 Rebecca (b. 1809) 18, 163  
 Rebecca (m. 1848) 18  
 Rebecca Davis 18, 48  
 Rebecca Jones Davis 18, 48  
 Rebecca Mendes 18, 309A, 321A  
 Rephael 18  
 Ribca de Judah Nunes Da Costa 61  
 Richa (Rachel) (1762-1847) 62, 151  
 Robert Albert 8  
 Rowland 254  
 Salomon (d. 1794) 18  
 Salomon (m. 1849) 18, 305, 321A  
 Sarah 321A  
 Sarah (b. 1830) 19  
 Sarah (1857-1898) 19  
 Sarah De Jacob Senior 61  
 Sarah (1814-) 321A  
 Solomon 18  
 Sophie (b. 1857) 19  
 Theodore 215  
 Todros 62  
 Wallace 18  
 William (d. Plymouth, Eng.) 19  
 William (1859-1860) 19  
 Ziporah (1817-) 321A  
 Ziporah (dau. of Philip) 18  
 Ziporah (1786-1812) 18, 54  
 Ziporah Phillips 19, 244

**BENJAMINS**  
 Reyna 51

**BENJISA**  
 Eleazer 171  
 Joshua 171  
 Julia 51, 171  
 Moses 171  
 Rachel Levy 171  
 Ziporah 171

**BENLY**  
 See Bulley

**BENNATON**  
 Amelia (1808-1876) 228  
 Joseph (1822-1902?) 228  
 Maurice (1824-1899) 228  
 Newton 228  
 Saul 228  
 Solomon (1805-1850) 228

**BENNET**  
 Elizabeth 254  
 Rebecca Benjamin 18

**BENNETT**  
 Charity 140  
 Della 81  
 Flora Levy 162  
 Henry 162

**BENOIT**  
 Amelia 264  
 Laura 117

**BENRIMO**  
 Abraham (b. 1840) 130  
 Barrow 47  
 Emma 47  
 Hannah Davies Pike 47  
 Rachel Jackson 117

**BENSADON**  
 Abigail Jacobs 131  
 Isabella (1842-1843) 131  
 Jacob 131  
 Joseph (b. 1819) 131  
 Judah 119, 131  
 Leah Hyams 119, 131

**BENSAKEN**  
 Joseph 19  
 Lunah Levy Berlandina 19  
 Samuel 19

**BENSON**  
 Agatha 24  
 Cynthia 24  
 Daisy Benjamin 254  
 Geoffrey 254  
 Gerald 254  
 Helen Kohn 24  
 Homer 24  
 Murray 254

**BENSUSAN**  
 Darrell 228  
 Dinah R. Levy 228  
 Julia Rose Valentine 228

**BENSWANGER**  
 See also Binswanger  
 Amy Mack 21  
 Bertha Hess 21  
 Betty Eiseman 21  
 Rowland 254  
 Edward (b. 1867) 21  
 Edward (b. 1926) 21  
 Eleanor F. Dreyfuss 21  
 Ellen Goldstein 21  
 Elsie Florence 21  
 Emanuel (b. 1838) 21, 231  
 Evelyn Clarre 21  
 Florence Rothschild 21  
 Frances Newhouse 21, 231  
 Isabella (b. 1845) 21  
 Isadore (1848-1849) 21  
 Jacob (1841-1886) 21  
 Jean (b. 1901) 16  
 Jeanne 21  
 Jessie 21  
 Leopold (b. 1850) 21  
 Louis (1840-1849) 21  
 Lynn Janet (b. 1953) 21  
 Mary (b. 1842) 21, 123  
 Matilda (b. 1868) 21  
 Nancy Weinberg 21  
 Rena (1868-1884) 21  
 Richa (Ricka) Binswanger 21  
 Richard 21  
 Richard III 21  
 Richard, Jr. 21  
 Samuel (b. 1800) 21  
 Samuel Louis (1866-1899) 21  
 Stella (b. 1871) 21  
 Susan 21  
 William D. (b. 1928) 21  
 William Edward (b. 1892) 21

**BENT**  
 David J. 332B  
 Emily Natalie Cardozo 23  
 Emmeline J. Armstrong 332B  
 Frances 332B  
 Frank 29  
 Harry Howard 332B  
 Rufus H. 184, 332B  
 Sarah Poindexter 332B

**BENVENISTE**  
 Judith 59  
 Ribca de Eliaiu 178

**BENWAY**  
 George 39  
 Jack 39  
 Larry (son of Larry L.) 39  
 Larry L. 39  
 Lillian (dau. of Larry L.) 39  
 Lillian Cohen 39

**BENZAKEN**  
 Abraham (b. 1766) 19

Ann 19  
 Anne 19  
 Eleazer 19  
 Esther (dau. of Joseph) 19  
 Esther (wife of Eleazer) 19  
 Hetty or Kitty 19  
 Isaac (b. 1764) 19  
 Jacob (b. & d. 1770) 19  
 Jacob (1772-1773) 19  
 Joseph (brother of Lunah) 19  
 Joseph (1763-1779) 19  
 Kitty (see Benzaken, Hetty or Kitty)  
 Lunah (d. bef. 1821) 19  
 Princeada (1774-1775) 19  
 Rachel 19  
 Samuel (d. 1821) 19  
 Simcha (see Benzaken, Syme (Simcha?))  
 Syme (Simcha?) (b.1769) 19

**BFNZIERY**  
 Jane 122

**BENZIGER**  
 Elizabeth 157

**BENZINGER**  
 August 304  
 Gertrude Lytton 304

**BERAL**  
 Carola 14

**BERG**  
 Abraham 290  
 Abram, Jr. 290  
 Allen 290  
 Allen, Jr. 290  
 Andrew 290  
 Betty Smith 290  
 Daniel 83  
 Eileen 290  
 Elsie Friedman 290  
 Graham 60  
 Jean 60  
 Jeanette 290  
 Jo Anna 290  
 Josephine 83  
 Judge 60  
 Laura Pollock 290  
 Leslie 328A  
 Lillian Langner 60  
 Lorna 290  
 Marline Herring 290  
 Rebecca (1904-1928) 290  
 Stanley 83  
 Sydell Wolf 290  
 Theresa Steinhardt Weiss 83

**BERGFR**  
 Barbara Bernstein Stone 282, 339B  
 Daniel (b. 1948) 71  
 David 52  
 Ellen Laramonda 276  
 Harriet Moyer Fleisher 71  
 Irvin 282, 339B  
 Jeremy (1975-) 339B  
 Jonathan (b. 1945) 52  
 Julia Christina 276  
 Philemon 276  
 Solomon Edgar 282

**BERGMAN**  
 Louise S. 282

**BERGQUIST**  
 Brenda 230

**BERGSTROM**  
 Joan Frederick Nathan 312B  
 Melvia R. 312B

**BERGWIN**  
 Edith May Levy 163  
 John H. K. 163

**BERKELEY**  
 Emma Baker Anderson 205  
 Rev. 205

**BERKOWITZ**  
 Etta (see Berkowitz, (Henri) Etta) (Henri) Etta (1886-1938) 281

**BERKSJURE**  
 Willie 36

**BERLANDINA**  
 Abraham (m. 1736) 19  
 David 19  
 Ester Levy 19  
 Lunah (m. 1776) 19  
 Lunah Levy 19  
 Mordecai (m. 1727) 19  
 Mordecai (son of David) 19  
 Simba 19  
 Simba Levy 19

**BERLIN**  
 Fannie Nathans 231  
 Hannah (1809-1897) 300  
 Henrietta 231  
 Jacob Gershon (d. 1830) 300  
 Leah (1816-1854) 300  
 Nathan 231  
 Rachel Baruc 17  
 Rachel M. 17  
 Ralph 231  
 Rebecca Valentine 300  
 Simon 17

**BERLINER**  
 Birdie (b. 1876) 230

**BERLOWITZ**  
 Betty 90

**BERMAN**  
 Barbara Lee Banks Soskin 202  
 Issachar Ha-levi 235  
 Joanna Golda (Rusty) 290  
 Julie Ebstein 282  
 Lallie (see Berman, Laura (Lallie))  
 Laura (Lallie) 253  
 Laura 229, 334B  
 Philip 202  
 Rusty (see Berman, Joanna Golda (Rusty))

**BERMAS**  
 Esther Kayton 143

**BERNARD**  
 Jennie (1853-1927) 327A  
 Laura 23  
 Laura Levy 163  
 Martha Binswanger 23  
 Peter 23  
 Rachel Cornelia (Sarah Rachel) (d. 1842) 162  
 Sarah Rachel (see Bernard, Rachel Cornelia (Sarah Rachel))

**BERNAYS**  
 Beatrice 340A  
 Doris Fleshman 340A  
 Edward 340A

**BERNEY**  
 Alice 91  
 Bertram Weber 91  
 Dorothy Long 91  
 Ellen 91  
 Ethel Weber 91  
 Margaret 91  
 Robert 91  
 Sidney 91

**BERNHAM**  
 Alfred 83  
 Clarence 83  
 Edgar 83  
 Jerome 83  
 Rae 83  
 Sidney 83

**BERNIARDT**  
 Lillie 290

**BERNHIM**  
 Arthur Stern (b. 1877) 20  
 Dora (b. 1867) 20  
 Edgar Johanson (b. 1882) 20  
 Elizabeth (1859-1867) 20  
 Elsie Dinsmore (b. 1880) 20  
 Frederick Brauer (b. 1869) 20  
 Hannah Ezekiel (b. & d. 1871) 20  
 Hattie 20  
 Ida 20  
 Ida Katherine (1850-1929) 20  
 Joseph (1861-1863) 20

Julia Moss 20, 215  
 Julian 20  
 Julian Norris (1866-1881) 20  
 Kate Moss (b. 1857) 20  
 Kate Theresa (1864-1889) 20  
 Leon 20  
 Levi Workum (1867-1868) 20  
 Lily Belle (b. & d. 1873) 20  
 Louis Isaac (1852-1924) 20  
 Morris (1823-1878) 20, 215  
 Mortimer 20  
 Moses Ezekiel (b. 1879) 20  
 Ralph W. Emerson (b. 1875) 20  
 Rosetta Goldsmith Ezekiel 20, 69  
 Samson 20  
 Samuel (m. 1864) 20, 69  
 Walter Ezekiel (b. 1866) 20  
 Walter Jacob (1855-1925) 20  
 William (1854-1895) 20

**BERNHHEIMER**  
 Aaron Albert (b. 1848) 13  
 Addie 322B  
 Amelia Franca (b. 1852) 13  
 Fannie R. Goetter 70, 324A  
 Fanny 13  
 Francis (d. 1851) 13  
 Isaac 13, 320A  
 Isabella Arnold 13, 320A  
 Jacques Arnold (b. 1847) 13  
 Julia Gans 83  
 Laura C. (b. 1891) 70, 324A  
 Leopold 83  
 Louis Goetter (b. 1894) 70, 324A  
 Sidney 70

**BERNSTEIN**  
 Alan 282  
 Alexander (1859-1924) 275  
 Aline 89  
 Allen Milton 89  
 Anne (1978-) 339B  
 Barbara 282, 339B  
 Beatrice 293  
 Benvenida V. H. Da S. Sonneborn 230, 335A  
 Bertha Moss Goldsmith 253  
 Charles 89  
 Dene Katzenberg 282, 339B  
 Dorothy Marguerite Hart 95  
 Edgar 282, 339B  
 Ellen (b. 1943) 71  
 Frances (1941-1942) 71  
 Ida 275  
 Irma Lewyn 89  
 Irving 230  
 Irwin L. 230, 335A  
 Janice Lynn (m. 1976) 312A  
 Joan (b. 1938) 71  
 Joanne Gitlin 282  
 Judith Simha 275  
 Kerry Lynn 282  
 Leon Myer (b. 1890) 275  
 Leslie Lee Squires 282  
 Lucile Fleisher 71  
 Lynn Whitlock (b. 1947) 230, 335A  
 Madeline 90  
 Michael Philip 282  
 Morris 71  
 Moses Montefiore 95  
 Patricia (b. 1947) 71  
 Peter Lewyn 89  
 Philip (m. 1968) 282, 339B  
 Salome Solis-Cohen (m. Alexander) 275  
 Salome Solis-Cohen (d. 1926) 275  
 Shirley Dowd 89  
 Steven Joseph 282  
 Theodore 253  
 Todd Whitlock 230  
 Zachary Nathan 282

**BERRENT**  
 Charlotte Jacobs 107  
 Herbert 107

**BERRIEN**

Josephine Hyams 119

**BERRY**  
 Adrian 291  
 Jessica Margaret 291  
 Marina Beatrice Sulzberger 291

**BFERRYMAN**  
 Fred 58  
 John 58  
 Susy Heydenfeldt 58

**BERTUCH**  
 Mildred 191

**BISLEY**  
 Howard 2  
 Ian 2  
 Marie Blumenthal 2

**BETHUNE**  
 Frank 136  
 Isabelle Jonas Ruiz 136

**BETTMAN**  
 Aimee 306  
 Alfred 292  
 Helen Raub 184  
 Jean 184  
 Lillian Wyler 292  
 Louise 189

**BETTS**  
 Carrie 140  
 Leila 140  
 Louise 140  
 Sarah Judah 140  
 William (m. Sarah) 140  
 William (son of William) 140

**BEYER**  
 Marion 82

**BEYPOUS**  
 Louisa Benjamin 19

**BEZEAU**  
 Adeline (later Adelaide) Cecilia (1818-1886) 257

**BLALAC**  
 Barbara 24  
 David 24  
 George 24  
 Ruth Kohn 24

**BICKFORD**  
 Belle Cohen 39

**BIDDLE**  
 Anne Bullitt Townsend 118  
 Nicholas Duke 118

**BIFILMAN**  
 Christine (b. 1951) 166  
 Donna Marie (b. 1953) 166  
 John 166  
 Joan, Jr. (b. 1955) 166  
 Rhoda May Fink 166

**BIERWITZ**  
 John Cocks 199  
 Marian (Marion) Gerdine Moise 199 (Marion) Gerdine 199

**BIEWEND**  
 Celestine Nones 337A  
 Edward F. (1853-) 337A

**BIGG**  
 Elizabeth Ann 79

**BIGLOW**  
 Jessie Cohen 39

**BLUR**  
 Henrietta Sondheim 279  
 Pauline Sondheim 279  
 Sophie Marks 187

**BILLET**  
 Inez Louise (1907-1909) 257  
 Mildred Virginia (b. 1904) 257  
 Violet Delia Schmidt 257  
 William Louis 257

**BILLIGHEIMER**  
 Boxie (see Billigheimer, Rebecca (Boxie))  
 David L. 69  
 Elmont (b. 1883) 69  
 Hannah W. (b. 1877) 69  
 Jacob E. (b. 1879) 69  
 Lee W. (b. 1876) 69

Rebecca (Boxie) 69  
Yetta Waterman Ezekiel 69  
**BINDEMAN**  
Carol Katzenberg 282  
David 282  
Debra Lee 282  
Robert David 282  
**BINGHAM**  
Janet McMillan 227  
**BINGLEY**  
Eather Nathan 164  
**BINSWANGER**  
Alan David 23, 309A  
Alec 21  
Barbara 23  
Barnett (1854-1914) 23  
Barnett, Jr. (1893) 23  
Bertha (m. 1857) 21  
Carol (see Binswanger, Ida (Carol))  
Carol Betty (b. 1924) 23  
Caroline Schloss 23  
Carroll Goldstein (b. 1894) 23  
Clara (d. 1889) 21, 22  
Clara (1860-1901) 23  
Clara Guggenheimer 23, 90  
Cornelia (1850-1928) 23  
Daniel 21  
David Robert 23  
Deborah Claxton 309A  
Doris Graw 23  
Doris Jane Gram 23, 309A  
Dorothy Feldstein 23  
Eleazar 21  
Elias 21  
Elizabeth (see Binswanger, Julia S. (Elizabeth))  
Elizabeth Bacharach 23  
Elizabeth Sophia Polock 21, 23, 252  
Eva De Boaz 23  
Eve (b. 1952) 23  
Fanny (1815-1897) 21, 22  
Fanny (1862-1948) 23  
Frances Turner 23, 309A  
Frank G., Jr. (b. 1928) 23  
Frank Goldstein (b. 1902) 23  
Frank III 23  
Fredrica Johnson 21  
George Loeb (b. 1920) 23, 309A  
Henry Gram (b. 1950) 23, 309A  
Hyman Polock (1851-1938) 23  
Ida (Carol) 23  
Isadore 21  
Isidor (1820-1890) 21, 23, 252  
Isidore (m. 1922) 23, 90  
Jack (see also Binswanger, Jacob Goldstein (Jack))  
Jack Ferdinand (b. 1924) 23, 309A  
Jack Turner (b. 1952) 23  
Jacob Goldstein (Jack) (b. 1888) 23  
John 23  
Julia S. (Elizabeth) (b. 1896) 23  
Lenora 42  
Lewis (b. 1812) 21  
Lewis (1855-1856) 23  
Louis 21  
Louis Clarence (b. 1898) 23  
Louis, Jr. 21  
Louise Klein 23  
Lumberie 21  
Martha 23  
Martha Goldstein 23  
Miriam (1852-1909) 23, 198  
Morris (1857-1859) 23  
Olga Loeb 23  
Pauline (1889-1916) 23  
Pauline Jane (Polly) (b. 1919) 23  
Polly (see Binswanger, Pauline Jane (Polly))  
Rebecca (b. 1859) 23  
Richa (Ricka) (1810-1899) 21  
Richard Frank 23  
Ricka (see Binswanger, Richa (Ricka))  
Robert Barnett 23

Samuel Lemuel (1770-1857) 21  
Simon 21  
Solomon 21  
Suzanne Hirsh 23  
Thomas William (b. 1951) 23  
Virginia Dorothy (b. 1949) 23, 309A  
**BIRCKHEAD**  
Solomon 170  
Susan Levy Oldden 170  
**BIRGEL**  
Anne Wortham Cone 91  
Buddy (see Birgel, Richard Alan (Buddy))  
Richard Alan (Buddy) 91  
**BISCHOP**  
Theresa 67  
**BISCHOFF**  
Barbara 306  
Christopher 306  
Nancy Ann Krohn 306  
Thomas 306  
Thomas Michael 306  
**BISCOE**  
Alexander Kemper 23  
John Alexander Hollway 23  
Mark Benjamin 23  
Virginia Wolf 23  
**BISHOFF**  
Lena 91  
**BISHOP**  
Hope Bancroft 158  
James Hams 158  
Maria 162, 329B  
Sally Palmer 158  
**BITTERMAN**  
Adolph 11  
Alfred 309A  
Arthur 309A  
Corinne Kahn 309A  
Delia 11, 309A  
Florence (d. 1915) 309A  
Florence (d. 1915) 309A  
Jack 11, 309A  
Janice 309A  
Janice James 309A  
Jean 309A  
Julia 11, 309A  
Leonore (d. 1970) 309A  
Rachel Ancker 11, 309A  
Rosebud 309A  
Theodore 309A  
**BITTKER**  
Anne Stern 285  
Boris I. 285  
Daniel 285  
Susan 285  
**BLACK**  
Evangeline 288  
Leonora Schwab 187  
Margaret Bethune 79  
**BLACKBURN**  
Jane W. 158  
**BLACKFORD**  
Frank 188  
Polly Baldwin 188  
**BLACKMAN**  
Eleanor Jackson 130  
Henry 130  
**BLACKWELL**  
Miriam Hart 100  
Montague 100  
**BLADE**  
Allen 188  
**BLAIR**  
H. Sherwood 70  
Lucy Anderson Rockefeller 88  
Peter H., Jr. 88  
Peter Heyliger 88  
Sally Sprague Lee 88  
**BLAKE**  
Leila Heydenfeldt Hellings 58  
Mary Lou 147  
**BLANCHET**

Frank 97  
Lillian Constance Hart 97  
Marie 97  
**BLAND**  
Robert B. 264  
Seraphine Seixas 264  
**BLANDING**  
Ella Pauline 198  
**BLANE**  
Oida 195  
**BLANK**  
Belle Elias 63  
Isadore 63  
Rachel Davies 47  
**BLANKENBURG**  
Alphonse 129  
Eva 129  
Eva Rachel Jackson Pyke 129  
Grace 129  
**BLANKENSEE**  
Georgiana 122  
**BLANKLEY**  
Anne Blumenthal 282, 313, 339B  
John 282, 339B  
**BLANKMAN**  
Esther 170  
**BLATNER**  
Rose (1856-1917) 14, 16, 321A  
Rose M. 91  
**BLAUBAUM**  
Marion 332A  
**BLAUSTEIN**  
Andrea 138  
Andrea Irene Fanny 138  
Esther Irene Wolff 138  
Henry 138  
Miriam Unstadter (1873-1957) 301  
Montefiore Wolff 138  
(Rabbi) David (1866-1912) 301  
Ray Judith (see Blaustein, Rebecca (Ray) Judith)  
Rebecca (Ray) Judith 138  
**BLETCHLEY**  
Keith 122  
Sadie Ingram 122  
Susan 122  
**BLEVINS**  
Eather 335B  
**BLIGHT**  
George 158  
Katherine Milligan 158  
**BLIMLINE**  
See Blumlein  
**BLITZ**  
See Arous Van Blitz  
**BLOCH**  
Abigail (see Bloch, Sarah Phila (Abigail))  
Alex 89  
Amelia Davis 331A  
Amelia Leyens 43  
Beracha 324B  
Brian 138  
Carey Dennis 43  
Charlotte Springer 89  
Claire 331A  
Clarence 149  
David (London) 75  
Elias M. 24, 190  
Emanuel 43  
Enid Beryl Joseph 138  
Eugene 174  
Frank 43  
Freidel (Frummet) (-1744) 324B  
Frummet (see Bloch, Freidel (Frummet))  
Gertrude Lichtenstein 174  
Gitel 87  
Harriet Mayer 24, 190  
Helene Landauer 43  
Hirsch 87  
Ira 149  
Jacob (Koppel) (Rabbi) (-1680) 87,

324B  
Jacques 89  
Jonathan (Rabbi) (1640-1722) 324B  
Juliet 24  
Koppel (see Bloch, Jacob (Koppel) (Rabbi))  
Leib 87  
Louis 331A  
Mabel Mordaunt 24  
Matilda Laib 149  
Mauri Levi 43  
Melanie Leyens 43  
Michael 149  
Norman L. 43  
Paul 138  
Peter 138  
Ralph 89  
Rosalie 43  
Ruth 331A  
Samuel 43  
Sarah Phila (Abigail) (1662-1695) 75  
Sigma 149  
William N. 24  
William, Jr. 24  
Zevi Hirsch 87, 324B  
**BLOCK**  
Abby 25  
Abigail De Paz 25, 58, 321B, 323A  
Abraham (b. 1780) 25, 127, 321B  
Abraham (b. 1851) 25  
Alexander Eleazer 326A  
Almeda Clark Trimble 25  
Anna Conway 25  
Augustus 25, 136  
Barbara (b. 1925) 215  
Barbara (m. Simon J.) 24  
Beatrice 135  
Bertha 25, 190  
Bridessa 321B  
Charles 326A  
Clara Kessler 230  
Clara Levi 326A  
David 25  
David Judah 321B  
Delia 25, 321B  
Delia Block 25, 321B  
Dolene Guggenheimer Stein 90  
Dora 25  
Dorothy Lowengrund 215  
Eleanor 25, 321B, 328B  
Eleanor Pool (see Block, Helen (Eleanor) Pool)  
Eleazer 25, 58, 321B, 323A  
Elinor 25, 210, 321B  
Elizabeth 321B, 338A  
Elizabeth Levi 326A  
Ellen (Nellie) 25  
Ellen 25  
Emil 215  
Emmeline 25  
Estelle 25  
Eugene 25  
Eugene H. (1864-1940) 230  
Flora 25  
Frances 25  
Frances Isaiah Isaacs 25, 126  
Frederick 25  
Gordon A., Jr. (b. 1914) 71  
Gordon Alexander 71  
Gustave 25  
Hanna 24  
Helen (Eleanor) Pool 60  
Henrietta 24  
Henry 25  
Herman (b. 1841) 25, 321B  
Herman (m. Dolene Guggenheimer) 90  
Hester 25  
Ida Fleisher (b. 1911) 71, 72  
Isaacs 25  
Isabella 130  
Jacob (-1835) 321B  
Jenny Sampson 321B

Josephine 25, 136, 321B  
Josephine A. 24  
Judah 24  
Juliana 25  
Juliet 25  
Juliet Pauline 25  
Laura 25  
Lenora Tunstall 25  
Levi 321B  
Levi (d. 1872) 24  
Louisa (dau. Simon, Jr.) 25  
Louisa (m. 1829) 25, 136, 321B  
Louisa Salome (1846-1847) 25, 321B  
Louise 25  
Lucia Jonas 25, 136  
Lyon 24  
M. S. 24  
Matilda 326A  
Moses 25  
Myer 24  
Myer J. 24  
Nancy (1854-) 321B  
Nellie (see Block, Ellen (Nellie))  
Phineas 25, 321B  
Rachel 25  
Reba Teller Fleisher 71  
Rehine David 321B  
Rosalie 25, 136, 321B  
Rosanna 25  
Rose (1893-) 327B  
Rosina (b. 1816) 25  
S. S. 24  
Sally 321B  
Sarah 25, 136, 321B  
Sarah Tunstall 25  
Simon (b. Va. 1815) 25  
Simon (Md.) 25  
Simon J. (d. 1869) 24  
Simon, Sr., (bef. 1742-1832) 321B  
Simon, Jr. (d. ca. 1825) 25, 321B  
Solomon 25  
Solomon J. 326A  
Susan 25  
Susanna Hudson 321B  
Thomas G. 326A  
Virginia 25  
Virginius 25  
Walter Trimble 25  
Dora 25  
William (see Block, Wolf (William))  
Wolf (William) 321B  
Zalma 25  
Zipporah 25  
**BLOCKLEY**  
Bruce 122  
Constance 122  
Edward 122  
Judith 122  
Judith Hyman 122  
Lorraine White 122  
**BLOK**  
Arthur 60  
Buena Pool 60  
Geoffrey David 60  
Helen Pool 60  
Olive 60  
**BLOODWORTH**  
Mary Miles 208  
**BLOOM**  
Alan Schiele 236  
Camille Pauline Meyer 236  
Edgar Isidore 236  
Edgar, Jr. 236  
Fanny Corinne Peixotto 241  
Isaac (see Bloom, Isidor (Isaac))  
Isidor (Isaac) 236  
Isidore 241  
Jack 241  
Julia 236  
Martha Bauerle 236  
Nancy Grace 236  
Nathan 241  
**BLOOMBERG**  
Alice Ezekiel 70

Alma 70, 222  
Amy (1887-1968) 70, 323B  
Claire Kahn 70  
Clarence 70  
Edith 70  
Edna Vivian 70, 174  
Georgie Ruth Thomas 70  
Harold S., Jr. (see Blair, H. Sherwood)  
Harold Solomon 70  
Lillian 70  
Louis 70  
Miriam Hirsh 70  
Nance 70  
Sol L. 70  
**BLOOMFIELD**  
Harriet 138  
**BLOOMINGDALE**  
Adeline 24  
Alfred (1869-1934) 24  
Augustus 24  
Belle Scherzer 24  
Benjamin (1845-1892) 24  
Blanche 24  
Blanche Remington 24  
Caroline (b. 1848) 24  
Caroline (dau. Augustus) 24  
Caroline Elfelt 24, 28  
Catherine 24  
Charles (son Charles) 24  
Charles (1814-1903) 24, 28  
Esther (1850-1937) 24, 321B  
Eva (1862-1949) 24, 215  
Eva Ezekiel 24  
Florence (1852-1928) 24, 321B  
Gertrude (b. 1858) 24  
Grace Hughes 24, 321B  
Henry (1888-1940) 24, 321B  
Lazarus (1847-1872) 24  
Lewis (b. & d. 1867) 24  
Louise 285  
Marion Holt 24  
Matilda 24  
**BLOOMQUIST**  
Emma 189  
**BLUCH**  
Jonas Hirschel 87  
Leah Gratz 87  
**BLUM**  
Blanche 72  
Clara 312B  
Hazel 13  
Lillian Helen 71  
Sarah Rose 235, 337B  
**BLUMBERG**  
Edward C. (b. 1951) 240  
Hilda 222  
Hortense Peixotto 240, 337B  
Jack 240  
**BLUMENFELD**  
Andrew David 287  
Emil J. III 235  
Emily Ann 287  
James Mark 287  
Jane Alice 287  
Joan 235  
John A., Jr. 287  
John Allan 287  
Laura Newman Schwab 287  
Miriam 235  
**BLUMENTHAL**  
Abraham 21  
Adolph (son of Arthur) 2  
Adolph 2  
Agatha 2  
Anne (b. 1947) 282, 313B, 339B  
Arthur 2  
Bernhard 282, 339B  
Carol Dene Goldsmith Kagan 282, 339B  
Carolyn Kohn 15  
David (b. 1942) 15  
Dolly Nathan 2  
Dorothy Hast 21

Eddie 2  
 Jay W. (b. 1944) 15  
 Lee (see Blumenthal, Leo Dobin (Lee))  
 Leo Dobin (Lee) 281  
 Louise 21  
 Margaret (Peggy) 71  
 Marie 2  
 Mathilda Abraham 2  
 Matilda Sondheim 271  
 Paul (b. 1950) 15  
 Peggy (see Blumenthal, Margaret (Peggy))  
 Peggy 2  
 Richard 288  
 Robert 271  
 Rose Zachary 2  
 Sally Kay (b. 1939) 15  
 Samuel 15  
 Susan Hurd Stix 288  
 Thomas 271  
 Walter 2  
 William 271

**BLUMLEIN**  
 Adeline 219  
 Catherine Myers 219  
 Edward 219  
 Emmanuel 219  
 Harry 219  
 Henrietta (1828-1892) 219  
 Isadore 219  
 Joseph 219

**BOARDMAN**  
 Annie Julia Hort 96  
 George C. 96

**BOAS**  
 Frances Nathan Cullman Jacobs 285  
 Percy E. 285

**BOATNER**  
 Josephine 199

**BOATRIGT**  
 Alice London 329A

**BOCHROCH**  
 Flora 134

**BODENHEIMER**  
 Hannah 320B

**BODLEY**  
 Laura Cary 88

**BODYCHAN-SPARROW**  
 Zaidée Emily Iseult 77

**BOEHN**  
 Fannie Nones 335B  
 William 335B

**BOFILL**  
 Laura 163  
 Mary Beatrice Levy 163  
 Miguel 163

**BOGAT**  
 Ettie Levy 161

**BOGERT**  
 Miriam Pyke 129  
 Viola 129

**BOGIN**  
 Agnes Moise 141  
 William D. 198

**BOHART**  
 James Thurman 238  
 Jean Prentice Powers 238

**BOICE**  
 Margaret Elisa 320A

**BOLKE**  
 Lillian Oppenheimer 239  
 Salomon 239

**BOLSTEIN**  
 David (see Bolton, David)

**BOLSTER**  
 Marion Olive 238

**BOLTON**  
 Bruce Dennis (see Gunn, Bert)  
 David 45  
 David Barrett 45  
 Michael Dean (see Gunn, Michael Dean)

Ruth Davega 45

**BOMFISLER**  
 Charles 26, 254  
 Edwin 26  
 Elizabeth (b. 1874) 26  
 Elizabeth M. 26  
 Esther Rowland 26, 254  
 Evelyn (1829-1917) 26  
 Joseph (1797-1878) 26  
 Josephine (dau. of Theodore) 26  
 Josephine (1825-1851) 26  
 Louis (1790-1856) 26  
 Maria S. (1790-1877) 26  
 Michael 26  
 Nathan Loebel 26  
 Paltiel (b. 1863) 26  
 Rachel Rowland 26, 254  
 Rebecca Heller 26  
 Siegfried (1784-1864) 26  
 Theodore 26, 254

**BONAMI**  
 Flora Haskell 195

**BOND**  
 Elizabeth 31  
 Lucelia Nones 336B  
 Wilhelmina V. 179  
 William J. (1834-) 336B

**BONUON**  
 See Bonyon

**BONITA**  
 Aliae Lucile 165  
 Bertha Levy 165  
 Corinne 165  
 Daisy 165  
 Edmond 165  
 Frederick A., Jr. 165  
 Frederick Alexander 165  
 Pearl 165  
 Sarah Edwitha 165  
 Walter 165

**BONITTO**  
 Deborah 134

**BONNER**  
 Douglas Griswold 105  
 Ethel Sanders Hays 105  
 Lois 39

**BONNIT**  
 Andrew 83  
 David F. 83  
 Mildred Steppacher 83  
 Nancy S. 83  
 Willard R. 83  
 Willard, Jr. 83

**BONNOIT**  
 Laura E. 117

**BONNY**  
 Grace 58

**BONNYSTEEL**  
 Barbara 125

**BONO**  
 Gregory Lewis (b. 1947) 258  
 Lewis 185  
 Myrtle Nellita Lusber 258  
 Robert John (b. 1950) 258

**BONOVITZ**  
 Christopher 72  
 Eric 72  
 Jill Fleisher 72  
 Sheldon Michael 72

**BONSER**  
 Dorothy 78

**BONVILLE**  
 Norma 310A

**BONYON**  
 Mary 51

**BONYUN**  
 Sophia Mary 51

**BOOKER**  
 Juliet Bluck 25  
 Paul Robert 25  
 Pauline 25

**BOOKMAN**  
 Alma Levy 159

Nancy Marion (b. 1930) 159  
 Pamela H. (b. 1926) 159, 329B  
 Robert 159  
 Sarah 14

**BOONE**  
 Charles Louis 80  
 Daniel Carroll 80  
 Isabel Barney Harris 80  
 Mary Hamilton 80

**BOORSTIN**  
 Jon 326A  
 Leni Isaacs 326A

**BOOTH**  
 Annie 110  
 Elizabeth Harding 310A  
 Florence Noah 232  
 Harold Simeon 34  
 Helen St. Clair 34  
 Junius Brutus 232  
 Wyndham Joseph 34

**BORDEAU**  
 Audrey Virginia Levy 330A  
 Lary 330A

**BORKOW**  
 Albert, Jr. 229  
 Dorothy Olivia Steel Barenkopf 229

**BORNWORTH**  
 Kathy 208

**BORREN**  
 Abraham 238  
 Benjamin 238  
 Bessie 238  
 Carolina Goldsmith 238  
 Charlotte E. Beebe Brewster 238  
 Emanuel (Matt) 238  
 Emily Lea Van Druff 238  
 Fannie 238  
 Hannah 238  
 Harry 238  
 Joseph 238  
 Kauman 238  
 Matt (see Borren, Emanuel (Matt))  
 Saul 238  
 Sol (Saul) 238

**BORKIN**  
 Augusta Agnes Isaacs 125  
 Barbara 125  
 Barbara Bonnysteel 125  
 Benjamin Dwight 125  
 Betty Claire 125  
 Beverly Lawsky 125  
 Carolyn Wilson 125  
 David Bruce 125  
 David Newark 125  
 Doris Ruth Van Sant 125  
 Elise Rachael 125  
 Harry 125  
 Harry, Jr. 125  
 Jeffrey 125  
 Joseph Leonard 125  
 Michael Alexander 125  
 Mildred Donn 125  
 Mildred Elizabeth 125  
 Sylvia Ruth 125  
 William Wallace 125

**BOSEN**  
 Adelaide 109

**BOSENG**  
 Leah (d. 1772) 235  
 Philip Herschel 235  
 Sorchen 235

**BOSS**  
 Abraham Isaac 228  
 Juliet Nathan 228  
 Priscilla 228

**BOSWELL**  
 Anna Maria 87, 88

**BOTHWELL**  
 Katherine Church 276

**BOTINEZ**  
 Abraham 20  
 Miriam (d. 1806) 20

**BOTINEZ (LEVY)**

Isaac 20

**BOUCHIELLE**  
 J. F. 172  
 Rose Lansdowne 172

**BOURNE**  
 Laura Virginia 269  
 Laura Virginia Sheftall 269  
 Oren Tinsley 269

**BOWEN**  
 George R. 337A  
 Isabel De Leon Nones 337A  
 Katherine Essex 88

**BOWER**  
 Christopher C. 205  
 Mary Moses 205

**BOWERS**  
 Catherine 163

**BOWMAN**  
 A. L. 69  
 Anita Phillips 70  
 Arthur, Jr. 70  
 Blanche 301  
 Bob (see Bowman, Robert (Bob))  
 Caroline Bamberger 14  
 Daisy 207  
 Daisy C. Peixotto 240  
 Francis Marshall (son of Charles Eldridge) 133  
 Francis Marshall (son of Samuel) 133  
 Gladys 70  
 Hannah W. Billigheimer 69  
 J. Schloss 70  
 Julius 14  
 Margaret E. 200  
 Mary W. Sheftall 267  
 Meyer Manuel 240  
 Rebecca 222  
 Rebecca Semon 313C  
 Robert (Bob) 70  
 Samuel H. 267  
 Solomon Manuel 240  
 Thelma Leola 240

**BOWRING**  
 Lorna 122

**BOYD**  
 Rosalie Morrison 204

**BOYER**  
 Zoe 286

**BOYKIN**  
 Charles Eldridge 133  
 Clarence T., Jr. 133  
 Clarence Taylor 133  
 Daisy (see Boykin, Florence (Daisy))  
 Douglas 133  
 Eleanor 133  
 Fannie Taylor 133  
 Florence (Daisy) 133  
 Grace Eldridge 133  
 Henry Marshall 133  
 Juliet Marks 133  
 Mary Adair 133  
 Miriam Taylor 133  
 Octavia Virginia 133  
 Rosa Harris 133  
 Sallie Epes 133  
 Samuel 133  
 Virginia McGilvra 133  
 William 133  
 William Jacquelin 133

**BOYLE**  
 Marietta (-1969) 329B

**BRACKEN**  
 James 47  
 John 47  
 Judith P. Davies 47  
 Katherine 47  
 Richard 47

**BRACKENHOFF**  
 Bruce (m. 1952) 310A  
 Noel Henriques (b. 1932) 310A

**BRACKETT**  
 Arthur Loring 76  
 Florence Gertrude Bulley 76

**BRADBURY**  
 Mary Kent 96

**BRADFIELD**  
 Edward 14  
 Ruth Bamberger 14

**BRADPORD**  
 5th Earl of (see Bridgeman, Orlando)  
 Kate 77

**BRADLEY**  
 Charity 140

**BRADSHAW**  
 Edith Charlotte Maitland 79  
 Humphrey Ion 59

**BRADY**  
 Ada 211  
 Adeline Moses 210  
 Adolph J. 210  
 Anne 209  
 Edwin 210  
 Ida (1855-1938) 167  
 Isabel Abrams 210, 320A, 334A  
 Isaiah 210, 320A, 334A  
 Joan Roselyn 239  
 Lillie (b. 1867) 5, 210  
 Matilda 210  
 Rosa Rebecca 209

**BRAEZTLE**  
 Drew 119  
 Mattie Hyams 119

**BRAGGIOTTI**  
 Gloria 67

**BRAHAM**  
 Leonora (Abraham) 2

**BRAINARD**  
 Elizabeth (1811-1900) 270

**BRAMLEY**  
 Elaine 202

**BRAND**  
 Charles 340A  
 Dorothy 340A  
 Edna 340A  
 Frances Rosenthal 340A  
 Frieda 340A  
 Howard 340A  
 Isaac 340A  
 James 340A  
 Jill 340A  
 Lucille Gans 340A  
 Moses 340A  
 Rose Rosenthal 340A

**BRANDAO**  
 Joanna 273

**BRANDON**  
 Abigail (Barbados) 27  
 Abigail (d. 1815) 26  
 Abraham R. (d. 1831) 27  
 Abraham Rodrigues (father of Daniel Brandon Seitas) 263  
 Abraham Rodriguez (d. 1818) 26  
 Abraham Rodriguez (1826-1860) 27  
 Agatha (1839-1909) 26  
 Agathe (1853-1932) 26  
 Aleitha (b. 1879) 26  
 Aleitha (Jessie) (1827-1854) 26, 53  
 Alfred De Cordova (1881-1894) 26  
 Alice (1866-1936) 26  
 Alice Hendricks 26, 111  
 Ann Elizabeth De Fonseca 26  
 Arabella Wolfe 26  
 Benjamin (Bennet) 26  
 Bennet (see Brandon, Benjamin (Bennet))  
 Beryl (b. 1916) 26  
 Caroline (1795-1851) 26  
 Clara Ann (1870-1907) 26  
 Clare Goldstein 26  
 Constance Evelyn 27  
 Corinne Alberga 26  
 David Israel (of London) 26  
 David Pereyra 58  
 Donald 102  
 Dorothy 102  
 Edith (dau. Abraham Rodriguez) 27

Edith (1869-1945) 26  
 Edward James (1834-1893) 26, 53  
 Edward James (1894-1942) 26  
 Edward Joseph (1829-1903) 26, 111  
 Emil (b. 1892) 26  
 Emil (b. 1916) 26  
 Emma (1831-1906) 26, 111  
 Ester Rodrigues 51  
 Esther (dau. Abraham R.) 27  
 Esther (1791-1871) 26  
 Esther 134  
 Esther Da Fonseca 26  
 Esther Pereira 233, 312B  
 Fannie Joseph 26  
 Fanny Hendricks (b. 1873) 26  
 Florence (1864-1916) 26  
 Gabriel Israel (d. 1804) 26  
 Harriet 141  
 Helen Goldstein 102  
 Henriette Nones 233  
 Henry 141  
 Hezekiah Joshua Israel (1720-1772) 26  
 Irene 46  
 Iris Altman 26  
 Isaac Lopez (1792-1855) 27, 209  
 Jacob Da Fonseca (1764-1843) 26  
 Jacob Israel (d. 1802) 26  
 Jacob Pereira 233  
 Jacob R. 27  
 Jacl (d. 1837) 27  
 James (1805-1873) 26  
 James (1865-1939) 26  
 Jesse De Symons 26  
 Jessie (London) 26  
 Jessie (see also Brandon, Aleitha (Jessie))  
 Jill 102  
 Joseph (1808-1884) 26, 55  
 Joseph Israel 26  
 Joseph Rodriguez 27  
 Joshua (b. 1792) 26  
 Joshua (London) 26  
 Julia 27  
 Lavinia 27  
 Lavinia Moses 27, 209  
 Lavinia Reyna (Leah) (1828-1830) 27  
 Leah (d. 1805) 26  
 Leah (see also Brandon, Lavinia Reyna (Leah))  
 Leah Brandon 26  
 Linda Corinaldi 26  
 Loris Sliaman 26  
 Lyman (b. 1886) 26  
 Maria Eliza (1804-1897) 26  
 Maria Rodriguez De Pass 58  
 Mary (b. 1855) 27  
 Maud (b. 1876) 26  
 Miriam (b. 1905) 26  
 Miriam (m. V. M. Moses) 206  
 Miriam Smith 27  
 Montague (1883-1900) 26  
 Moses Israel 26  
 Moses R. 27  
 Norman (b. 1924) 26  
 Norman Dudley (b. 1896) 26  
 Rachel (1723-1768) 273  
 Rachel (1745-1795) 26  
 Rachel Brandon 26  
 Rachel Correa 26, 55  
 Reyna De Leon 26  
 Robert Earl (b. 1930) 26  
 Rosalie Solomon 102  
 Sarah (m. Joseph) 27  
 Sarah (1799-1828) 27, 209  
 Sarah (1838-1842) 26  
 Sarah Adde (b. 1891) 26  
 Sarah Delegado 26, 53  
 Sarah Esther Lopez 27  
 Sarah Mendes Da Costa 26  
 Simha (d. 1770) 26  
 Vivian I. 102

**BRANDSTATTER**  
 Helene B. 22

**BRANDT**  
 Adelaide Myers 219  
 Adolph 219  
 Bertha 219  
 Blanche Salomonsky 219  
 Caroline Leterman 219  
 Corinne 219  
 Dessa Alexina 219  
 Harry M. (d. 1925) 219  
 Harry M. 219  
 Jerome E. 219  
 M. (m. Caroline Leterman) 219  
 Mary Pauline Howard 219  
 Maurice A. 219  
 Maurice A. II 219  
 Mildred Rosenfeld 219, 227, 228

**BRANEY**  
 Joan Orlich 23

**BRANNON**  
 Joseph 304  
 Rebecca Cecilia Wolfe 304

**BRANTON**  
 Mary M. 176

**BRASCH**  
 Catherine A. T. Tobias 314A  
 Edward 297, 314A  
 Margaret Ellen 314A  
 Nancy Ann (b. 1930) 297, 314A

**BRATLAND**  
 Inger 27

**BRAUER**  
 Adeline Hyneman Ezekiel 27, 69  
 Adeline Mailert 27  
 Annie Purvis 27  
 Ezekiel M. (b. 1877) 27  
 Flora G. 27  
 Frederick C., Jr. (1869-1911) 27  
 Frederick Casper 27, 69  
 Grace (Rosa) 27  
 I. Mendez 27  
 Jacob Warner 27  
 John 27  
 John Beauregard (d. 1886) 27  
 Josephine Ezekiel 27, 69  
 Levi Workum (b. 1872) 27  
 Marie Therese (see Brauer, Mary Elizabeth (Marie Therese))  
 Mary Elizabeth (Marie Therese) (b. 1873) 27  
 Mary June 27  
 Robert Coleman 27  
 Rosa (see Brauer, Grace (Rosa))  
 Sallie Israel (b. 1869) 27  
 Sarah 27  
 Sarah Catherine 27  
 Walter Ezekiel (b. 1866) 27  
 William Henry (b. 1841) 27, 69  
 William Henry, Jr. (1875-1950) 27  
 William W. 27

**BRAUNSTEIN**  
 Adrienne 160  
 Frederick 160  
 Marilyn Ellison 160  
 Robert 160

**BRAV**  
 Aaron 290  
 Arnold Zachary 290  
 Candice 290  
 Cecile S. 290  
 Joanna Goida (Rusty) Berman 290  
 Rebecca S. 290  
 Rosalind Judith 290  
 Rusty Berman (see Brav, Joanna Goida (Rusty) Berman)  
 Sarah 290  
 Sophie Pollock 290

**BRAVO**  
 Eliza 112  
 Jacob de Moses 52  
 Simha 52

**BRAVY**  
 Daniel 158  
 Daniel, Jr. 158

Dorothy Adams 158  
 Dorothy Maybin Adams 158  
 Edith L. 158  
 Marion 29  
 Virginia Gillardon 158

**BREASTED**  
 Fanny Hart 272

**BREGMAN**  
 Cynthia (Toni) 288  
 Toni (see Bregman, Cynthia (Toni))

**BREIDENBACH**  
 Leon 118  
 Rosalie Walsh 118  
 Ruth 118

**BREIPL**  
 Anne Story 251  
 Harold 251  
 William Philip (b. 1941) 251

**BREMERMAN**  
 Frances Naar 224  
 Henry 224

**BREN**  
 Adelaide Rosenfeld 210  
 Lee 210  
 Marie 210  
 Mordecai 210  
 Robert 210

**BRENAMAN**  
 Anne 133  
 Hugh Crawford 133  
 Julia Blair 133  
 Miriam Boykin 133  
 Miriam Boykin Norment 133

**BRENNAN**  
 Betty Ann (1939-) 327A  
 Edward (1917-) 327A  
 Grace Massy 327A  
 Joe 327A  
 Joseph (1941-) 327A  
 Selma Levi 327A  
 William (1940-) 327A

**BRENNER**  
 Amalie 90  
 Ann 90  
 Barbara 90  
 Betty Berlowitz 90  
 Flora Guggenheimer 90  
 Henrietta 90  
 Joseph 90  
 Lynn 90  
 Morton 90  
 Moses 90  
 Rica Schiff 90  
 Richard 90  
 Ruth 90  
 Solomon 90

**BRES**  
 Jo Leigh 199

**BRESH**  
 See Brush

**BRETT**  
 Catherine 97

**BRETZFELDER**  
 Betsy 327A

**BRETZFELD**  
 Barbara Drucker 102  
 Carol Ann 102  
 Maurice John 102  
 Samuel 102

**BREVOORT**  
 Harriet Mantel 141  
 John M. 141  
 Maude Emison 141  
 William H. 141

**BREWSTER**  
 Charlotte E. Beebe 238  
 James G. 87

**BRICKA**  
 Ethel Leontine Hays 105  
 George W. 105

**BRICKNER**  
 Benvenida (b. 1877) 27, 48  
 David (1840-1908) 27, 253

Edwin Solis (b. 1871) 27  
 Helena De Cordova (b. 1901) 27  
 Kathryn (b. 1907) 27  
 Margaret (b. 1904) 27  
 Myra De Cordova 27  
 Perla S. Abrahams 5, 27  
 Sally Ritterband (see Brickner, Sarah (Sally) Ritterband)  
 Samuel 27  
 Sarah (Sally) Ritterband 27, 253  
 Walter M. (1875-1930) 5, 27

**BRIDGEMAN**  
 Anne Pamela 79  
 Gerald Michael Orlando, Viscount Newport 79  
 Helea Diana 79  
 Joan Serena 79  
 Margaret Cecilia Bruce 79  
 Orlando 79  
 Ursula Mary 79

**BRIDGES**  
 Phyllis 240

**BRIESEN**  
 See Von Briesen

**BRILL**  
 Alfred 167  
 Rachel 70  
 Rosa Marcus 167

**BRIMSON**  
 Florence ('Mme. Toronto') 46

**BRINK**  
 Cecilia Blanche Moise 196  
 Doris Hewing 335B  
 Earl 335B  
 Walter B. 196

**BRISKER**  
 Isaac (see Abrahams, Rabbi Isaac (called 'Isaac Brisker'))

**BRISSON**  
 Barbara 13

**BRITENSTOOL**  
 Caroline M. 236, 239

**BRITTIN**  
 Abraham 25  
 Abraham Ludlow 25  
 Adele 25  
 Alice 231  
 Celeste 25  
 Edward 25  
 Emma Shaw 25  
 Fannie (see Brittin, Frances (Fannie))  
 Frances (Fannie) 25  
 Rosina Block 25  
 William Isaacs 25

**BROADHURST**  
 Geoffrey 183  
 Philippa Jane Lyons 183

**BROCK**  
 J. 119

**BROCKENBROUGH**  
 Anne Gordon 217

**BRODEY**  
 Jean Lisette Israel 134  
 Kenneth 134  
 Lisette Jean 134  
 Robert 134

**BRODIE**  
 Harriet Natalie 244  
 Rachel 127

**BRODSKY**  
 Barbara Banks 202  
 David M. 202  
 Fay 219  
 Katherine 202  
 Peter Samuel 202

**BRODY**  
 Antonia Rose 127  
 Elizabeth 160  
 Helen 255  
 Jean Israel 134  
 Jean Rich (see Brody, Jeanne Rich)  
 Jeanne Rich 127, 326A  
 Marian Rich Isaacs 127, 326A

Philip 127, 326A  
 Rachel 127, 326A  
 Robert 134

**BROFMAN**  
 Julia Weiglin 125

**BROGLIO**  
 Anthony 119  
 Catherine Hyams Plomer 119

**BROHM**  
 William Lewis 172

**BROIDO**  
 Alan 107  
 Anne Hecht 107  
 Joseph 107  
 Leonard 107  
 Susan 107

**BROFMAN**  
 Adam Rodgers 211  
 Ann Margaret Loeb 211  
 Edgar Miles (b. 1929) 211  
 Edgar Miles, Jr. 211  
 Holly Dorothy 211  
 Matthew 211  
 Samuel Miles II 211

**BRONNER**  
 Elaine Rosenberg 16  
 Etta Hadra 16  
 James (b. 1944) 16  
 Julia (b. 1912) 16  
 Leonard 16  
 Mollie (dau. of Leonard) 16  
 Mollie (m. Moses Barnett) 15, 16  
 Morris (b. 1882) 16  
 Morris, Jr. (b. 1914) 16  
 Pauline Schiff 16  
 Robert 16  
 Victoria Maud Peizotto 241

**BRONSON**  
 Julia Ann Marks 184  
 Michael 184

**BRONSTEIN**  
 Irene 13

**BROOKE**  
 Haller Gross Horwitz Ponsonby 118  
 Ronald George 118

**BROOKS**  
 Agnes 75  
 Gertrude 55  
 Lula 25  
 Marion 167  
 Mary Franks 75  
 Susan Oliver 79  
 William Gray 79

**BROTHERS**  
 Al 328B  
 Alma Kokernot 328B  
 Lee 328B  
 Robert Lee 328B

**BROU**  
 Florestan 116  
 Marie Emeronthe 116  
 Pierre Antoine 116  
 Valsin 116

**BROUGHTON**  
 Alexander 84  
 Clare 327A  
 Irene 84  
 Rose Marion Goldsmith 84  
 William 84

**BROUILLET**  
 Brad 106  
 Elizabeth Hays Pencorton 106  
 Elizabeth McKenney 106  
 Mary Louise (1781-1829) 106

**BROUN**  
 Armentine 201  
 Charles 201  
 Elizabeth 201  
 Mary Ellen Mordecai 201  
 Mordecai 201

**BROWMAN**  
 Eva 140

**BROWN**

See also Pardo  
 Agatha 241  
 Albert Eger (son of Albert Eger) 117  
 Albert Eger (son of Samuel) 117  
 Alexander Gardner 49  
 Alexander Gardner, Jr. (1874-1877) 67  
 Annie (b. 1861) 253  
 Annie (m. J. H. Levy) 167  
 Barbara 117  
 Beverly 27  
 Chet 237  
 Dora Irene Harper 213  
 Elizabeth Georgia Sheftall 269  
 Emma 203  
 Ericka Tillman 119  
 Esther (d. 1708) 240  
 Esther de Jacob Israel Monsanto 240  
 Fannie May (b. 1885) 117  
 Fanny Leona 42  
 Frances Maria Hertz 117  
 Frank L. 80  
 Harriet Etting 67  
 Henrietta Mikell 205  
 Henriette 101  
 Henry 205  
 James George 269  
 Jean Fontaine 117  
 Jesse Weaver 117  
 Johannah Lee Barnbaum 237  
 John 205  
 John A., Jr. 67  
 John Hertz 117  
 Joseph (d. 1690) 240  
 Joseph (d. 1704) 240  
 Kathleen 117  
 Kathleen Sanders 117  
 Letitia (Lettie) Field Moise 197  
 Lettie Field Moise (see Brown, Letitia (Lettie) Field Moise))  
 Louie 119  
 Lyle 205  
 Martha Helen (Sally) 198  
 Mary Ann 257  
 Mary Ellen Mordecai 201  
 Matt Haden Moise 197  
 Patricia Grace 198  
 Philippa Etting 67  
 Philippa Etting Brown 67  
 Rachel B. (b. 1893) 117  
 Rosalie Evans 80  
 Sally (see Brown, Martha Helen (Sally))  
 Sam T. 213  
 Samuel Claudius (b. 1899) 80  
 Samuel Claudius (m. 1884) 80  
 Sarah (Curacao) 240  
 Sarah (d. 1690) 240  
 Saul (d. 1702) 240  
 Sibyl 76  
 Stella 140  
 Sylvia 286  
 Urith Lawrence 197  
 William Meade 197

**BROWNE**  
 Agnes Sarah 81  
 Barrowdail 235  
 Catherine Oppenheimer 235  
 Cornelia Ridgely (1868-1882) 155  
 Esther Winkler 265  
 Florence Elizabeth (b. 1875) 155  
 Herbert 265  
 John Ross (1870-1871) 155  
 Lucy Mitchell (b. 1873) 155  
 Lucy Serena Croghan 155  
 Maude K. Mitchell 129  
 Spencer C., Jr. (b. 1885) 155  
 Spencer Cochrane 155

**BROWNING**  
 Elizabeth Hays 105  
 John Scott 105  
 John Scott, Jr. 105

**BROWNSEN**  
 Anna (1891-1968) 330A

**BRUCE**  
 Camilla Antoinette Clifford 79  
 Clarence Napier 79  
 Constance Mary Becket 79  
 Constance Pamela Alice 79  
 Cynthia Juliet Grant-Duff 79  
 Daphne Juliet 79  
 Eva Isabel Marian 79  
 Gilliam Constance 79  
 Gwyneth Margaret 79  
 Henry Campbell 79  
 Henry Lyndhurst 79  
 John Hamilton 79  
 Margaret 79  
 Margaret Bethune Black 79  
 Margaret Cecilia 79  
 Marjorie Hubbard 157  
 Mildred Mary Petre 79  
 Morys George Lyndhurst 79  
 Nigel Henry Campbell 79  
 Robert 79  
 Rosalind Louise Balfour 79  
 Victor Austin 79  
 Violet 79

**BRUML**  
 Adeline Cohn 110  
 Benedict 110  
 Gary 110  
 Lisa 110  
 Marilyn 110  
 Michael 110

**BRUMMIGAN**  
 Ada Moss 215  
 Harvey 215

**BRUNNER**  
 Arnold 143  
 Arnold William 102  
 Emma Beatrice Kaufman 102  
 Isabella Solomon 102  
 Samuel 102  
 Sophia Solomon 102  
 William 102

**BRUNSON**  
 Ansley Davis 207, 333B  
 Armida 207, 333B  
 Armida Davis Moses 207, 333B  
 F. Newton 84  
 Josiah William 207, 333B  
 Maude Goldsmith 84  
 Mildred 84  
 Nellie 207, 333B  
 Rose 84

**BRUNT**  
 Caroline Janet 233, 336B  
 Eliza Estelle Cohen 233, 336B  
 Helen Janet Wheeler 233  
 Jonathan Peter 233  
 Kathryn Wendy (1976-) 336B  
 Kimberly Ann 233  
 Kristine Aida Ries 233  
 Lydia Ann 233  
 Peter Wheeler 233, 336B  
 Shane Gonzalez 233  
 Thomas B. III 233  
 Thomas B. IV 233  
 Thomas B., Jr. 233, 336B  
 Thomas Bayard 233, 336B  
 Timothy Wheeler (1978-) 336B  
 Wendy Ries 233

**BRUSH**  
 Clara 27  
 Emily Isabelle Hendricks 6, 111  
 Isidore 27  
 Jacob (James) 27  
 James (see Brush, Jacob (James))  
 Joshua 6, 111  
 Lillie S. 6, 144  
 Louis S. 6  
 Marcus 27  
 Martin 27  
 Pauline (b. 1854) 6, 221  
 Richard 27  
 Rosa 27



Sarah Kroleck 27, 144  
 Sarah Silver 6, 22  
 Sophie 27  
 Sylvester (b. 1820) 6, 27  
 Zettie 27

**BRY**  
 Charlene 293  
 Elizabeth Richman 293  
 Irwin 293  
 Irwin J. 293  
 Lisa 293  
 Nancy Dryer 293  
 Richman 293  
 Terry 293

**BRYAN**  
 Abbie St. Anne 206  
 Alice Caroline 37  
 Alice Cohen 36, 37  
 Alice Louisa 206  
 Allan C. 181  
 Andrena Moses 206  
 Caroline C. 88  
 Catherine Marie 206  
 Catherine Moses 206  
 Charles 206  
 Clara Ersak 206  
 Elizabeth 206  
 Elizabeth Trowel 206  
 Emma Lyon 181  
 Enid Parker 206  
 Frances Maria Myers 216  
 Frank Jay 206  
 Goode 216  
 Gustavus Werber 206  
 Harry 206  
 Henrietta Campbell 205, 333B  
 Henry Claremont (son of Henry Claremont) 206  
 Henry Claremont (son of William Alfred) 206  
 Henry Randolph 206  
 James C., Jr. 206  
 James Carsen 206  
 John 206  
 Judy 206  
 Mary 184  
 Nettie Marlow 206  
 Pendleton 181  
 Reid Whitford 36, 37  
 Sara Richberg 206  
 Sarah 206  
 Susan 206  
 Susan Carsen 206  
 William (son of Henry Randolph) 206  
 William (son of James Carsen) 206  
 William Alfred 206  
 William, Jr. 206

**BRYANT**  
 Anne Moen Louise 118  
 Marie Adele Levy 166  
 Owen (b. 1950) 166  
 Stephen (b. 1952) 166  
 Warren 166

**BRYCE**  
 Buford 205  
 C. H. 205  
 Charles Buford 205  
 Emma Moses 205  
 Helen 215

**BRYDGES**  
 Anne Bresnahan 133  
 Hugh Bresnahan 133  
 Margaret Blair 133  
 Richard George 133

**BRYLAWSKI**  
 Beulah 284

**BUCHANAN**  
 Clem 208  
 Eliza Peters 180  
 Florence 190

**BUCHSBAUM**  
 Coralie 307

**BUCK**

Emily Ottilie Zempel 199

**BUCKLE**  
 Archie Stewart 78  
 Mildred Louisa Northey 78

**BUCKLEY**  
 Anne Louise Cary 206  
 Evelyn 15

**BUCKMAN**  
 Rosa 28

**BUDA**  
 Elizabeth Doris 32

**BUDIANSKY**  
 Arye (see Bortin, Harry)

**BUDRIE**  
 Frederick 111  
 Louise Hendricks 111

**BUDWIG**  
 Beulah 293  
 Edward 293  
 Esther (Ester) Hays 293  
 Georgiana 293  
 Gilbert 293  
 Lillian 293  
 Rolinda 293

**BUELL**  
 Hilda Hermann 295  
 Leon 295

**BUGG**  
 Elizabeth Nunez 337A  
 Stephen 337A

**BULEMAN**  
 D. C. 208  
 Dorothy Phelps 208

**BULOER**  
 Imelda 140

**BULLARD**  
 Mary 126

**BULLEY**  
 Charles 76  
 Florence Gertrude 76  
 Frederick 76  
 Gertrude 76  
 John Orrok 76  
 Mary Oakes 76

**BULLEY (BENLYT)**  
 Gershom Grant 76

**BULLITT**  
 A. Ernesta Drinker 118  
 Anne 118  
 Anne Moen Louise Bryant Reed 118  
 Emily Tatham 118  
 John C. 118  
 John Christian 118, 217  
 Lelia Myers Wardwell 118, 217  
 Louisa 325B  
 Louise Gross Horwitz 118  
 Orville Horowitz 118, 325B  
 Orville H., Jr. 118  
 Orville H. III 118  
 Rita S. 118  
 Shelby Thayer 118  
 Susan B. Ingersoll 118  
 Thayer 118  
 William C., Jr. 118  
 William Christian 118

**BULLOWA**  
 Anne (b. 1922) 233  
 Elizabeth (b. 1914) 233  
 James (b. 1911) 233, 336A  
 Jane (1951-) 336A  
 Jean (b. 1917) 233  
 Jesse Godfrey Moritz 233, 336A  
 Lillian Wucher 336A  
 Margaret (b. 1909) 233, 336A  
 Ralph (1953-) 336A  
 Sadie Floy Nones (see Bullowa, Sarah)  
 (Sadie) Floy Nones  
 Sarah (Sadie) Floy Nones 233, 336A  
 Susan (1949-) 336A

**BULTMAN**  
 Deuward G. P. III 208  
 Deuward G. P., Jr. 208  
 Deuward George Frederick 208

Dorothea Rosalie 208  
 Dorothy Kathryn 208  
 Dorothy Phelps 208  
 Elizabeth Hardwick Thorne 208  
 Elizabeth Wylly 208  
 Ernst Phelps 208  
 Helen Wylly Murray 208  
 Meredith Morgan 208  
 Phelps Herbert 208  
 Susan Lachlan 208  
 Thomas Murray 208

**BUNDY**  
 Emily 91

**BUNN**  
 Rachel Myers-Cohen 223  
 Rose (1727-1796) 223, 271, 313B  
 Solomon Haim 223

**BUNTAN**  
 Cacouna 96

**BUNTEN**  
 Arline 42

**BURCHELL**  
 Celestine Aline Goldschmidt 84  
 John 84

**BURDEN**  
 Margaret Livingston Partridge 155  
 William A. M., Jr. 155

**BURGESS**  
 Daisy 207  
 Nelda Jo 52

**BURGETT**  
 J. A. 255  
 Sadie Myers 255

**BURGHIER**  
 Helen 16, 321A

**BURKE**  
 Claire Agnes 311A  
 Eleanor Ruth 206  
 Juanita Russell (b. 1920) 313A  
 William E. (m. 1950) 313A

**BURKENROAD**  
 Nancy 186

**BURKS**  
 Dulce Cecile Harper Morris 213  
 Roy Elliott 213

**BURNET**  
 Emma C. 141

**BURNETT**  
 James 141  
 Marion Wurtell Judah 141

**BURNS**  
 Jessie Gertrude (1895-1955) 330A

**BURRAGE**  
 Meta 218

**BURRIS**  
 Charles A. 330A  
 Lynda Catherine Levy 330A

**BURROUGHS**  
 Charlotte Wilson (b. 1915) 199  
 Charlotte Wilson (b. 1948) 199  
 Martha Ann Logan 199  
 Sara Moise 199  
 Sidney Moise 199  
 Stiles B., Jr. 199  
 Stiles Brown 199

**BURSTEIN**  
 Hilda 23  
 Merla 294  
 Molly 253

**BURTON**  
 Lucile Wolfe 304

**BURWELL**  
 Louise Jane 309B  
 Mary 184

**BUSCHOFF**  
 Elaine Terry 278  
 Lee Roy 278  
 Lorraine Gladys Lovestein 278  
 Robert L. 278

**BUSH**  
 Abraham (b. 1768/9) 28  
 Ann Marshall 28  
 Anne Head (b. 1918) 230

Arthur Phillips 230  
 Arthur Phillips, Jr. (b. 1921) 230  
 Caty Catherine (see Bush, Hyah (Caty) (Catherine))  
 Cecilia 278  
 David (1762-1823) 28  
 Deblais (b. 1916) 230  
 Elkaleh (Nellie) 28, 267  
 Hannah (b. 1760) 28  
 Helen (b. 1915) 230  
 Helen Cadbury 230  
 Hyah (Caty) (Catherine) 28, 223  
 Isaiah (1763-1806) 28  
 Joseph (b. 1776) 28  
 Margaret (see Bush, Pier Margaret (Peggy?))  
 Martha Comfort (b. 1922) 230  
 Mathias (son of Solomon) 28  
 Mathias (1722-1790) 28, 160  
 Nancy Marshall (see Bush, (Nancy) Ann Marshall)  
 (Nancy) Ann Marshall 58  
 Nathan (b. 1756) 28  
 Nellie (see Bush, Elkaleh (Nellie))  
 Peggy (see Bush, Pier Margaret (Peggy?))  
 Perle Chertolo 230  
 Pier Margaret (Peggy?) (1770-1799) 28  
 Rachel (b. 1758) 28  
 Rebecca Myers-Cohen 28, 223  
 Riccarda 230  
 Richea (1765-1844) 28  
 Samuel (1754/55-1826) 28  
 Sarah (b. 1774) 28  
 Solomon (b. 1753) 28  
 Tabitha Means 28, 190

**BUSHINELL**  
 Ann Eliza 15

**BUSICK**  
 David 209  
 Israel 209  
 Jonas 209  
 Sander 209

**BUTCHER**  
 Christine Lynn 45  
 George Edward, Jr. 45  
 Gregory Scott 45  
 Patricia Anne Davega 45  
 Thomas Jay 45

**BUTKIN**  
 Carole Janette 42

**BUTLER**  
 Ada (1911-) 325A  
 Hannah Hays 325A  
 Howard Russell 105  
 J. Boudine 174  
 Margaret Ward 81  
 Virginia Hays 105  
 Walter 325A

**BUTT**  
 Harlan Faulkner 111, 325B  
 Jaclyn Kim (1985-) 325B  
 Robia Weber 111, 325B

**BUTTERS**  
 Charles 117  
 Jessie Hertz 117

**BYUS**  
 Brenda 331A

**CABELL**  
 Charlotte Ridgely (b. 1906) 155  
 Charlotte Schott 155  
 Mary Ellet 128  
 Mary Virginia Ellet 128  
 Walter Coles 155  
 William H. (m. Mary Ellet) 128  
 William H. 128

**CAACIAPUOTI**  
 Giorgio Alberto 88  
 Mary Alford Gratz 88

**CADBURY**  
 Celene C. McCabe 230  
 Earl Shinn (b. 1889) 230  
 Helen (b. 1886) 230

Helen Virginia Nathans 230  
 Katherine W. Barnes 230  
 Leah T. (b. 1892) 230  
 Richard T., Jr. (b. 1885) 230  
 Richard Tepper 230

**CADET**  
 Adelaide 28  
 Beppo 28  
 Carlos 28  
 Charles 28  
 Cherie 28  
 Clara (1814-1876) 28  
 Elizabeth M. (1796-1856) 28  
 Frances (Tina) (1766-1866) 28  
 Judah (b. 1808) 28  
 Rachel (1800-1888) 28, 271  
 Simon De Lyon (1754-1845) 28  
 Tina (see Cadet, Frances (Tina))

**CADWELL**  
 Frances 253

**CAHEN**  
 Michele Nadine 91

**CAHN**  
 See also Kahn  
 Albert 121  
 Cyra Grace Renwick 236  
 Edith 313A  
 Elizabeth Sheler 50  
 Emanuel S. 313A  
 Frederick Hanke 236  
 Gertrude (Guldah) Davis 50  
 Gertrude Hanff (b. 1876) 313A  
 Guldah Davis (see Cahn, Gertrude (Guldah) Davis)  
 Helen Blackhall Olsen 236  
 Helene 313A  
 Isabelle Israel 121  
 Joseph 50  
 Julia Elizabeth Hofeller 236  
 Julius Hofeller 236  
 Marion 313A  
 Mary Ann Hanke 236  
 Mary Elizabeth 236  
 Morton D. II 236  
 Morton D., Jr. 236  
 Morton David 236

**CAIN**  
 See also Le Cain  
 Joan Meyer Rosen 235  
 John 235

**CALAGORPOPOULOS**  
 Sandra Gomez Dreyfous 320A

**CALDER**  
 Alice London Boatright 329A  
 Alice (1920-) 329A  
 Athaliah Keith 329A  
 Barbara Dozier 329A  
 Catherine Theodosia (Kate) (1840-1863) 329A  
 Edwin Keith (1874-1901) 329A  
 Hugh Courtney (1891-) 329A  
 Kate (see Calder, Catherine Theodosia (Kate))  
 Mary Fullerton (1875-1951) 329A  
 Milton (1881-1948) 329A  
 Phila Cohen Lazarus 151, 311, 329A  
 Phila Lazarus (1871-1959) 329A  
 Robert Edward II (1884-1947) 329A  
 Robert Edward (1842-1888) 329A  
 Sue Brent Prince 329A  
 Sue Brent (1918-) 329A  
 Theodore (1878-1886) 329A  
 Washington Lazarus (William, Jr.) 329A  
 William (1792-1844) 151, 329A  
 William Beach (1921-) 329A  
 William III (1853-1874) 329A  
 William Jr. (see Calder, Washington Lazarus (William Jr.))

**CALEYO**  
 Anita Marie (1957-) 330A  
 Darleen Susan Hay 330A  
 Joseph Lewis (1959-) 330A

Joseph Raymond (1927-) 330A  
 Mildred Heber Levy 330A

**CALHERN**  
 Louis 295  
 Natalie Schafer 295

**CALHOUN**  
 Louisa J. 52

**CALLAHAN**  
 Frederick Paul 231  
 Marguerite Rahr 231  
 Paul 231

**CALLANAN**  
 Virginia (1851-1883) 11

**CALLAWAY**  
 Gib 180  
 Oscar 180  
 Sloanie Couch 180  
 Stella Couch 180

**CALLOWAY**  
 Loris 42

**CALVERT**  
 Louise Doniphen 90

**CAMARRA**  
 Phyllis Langner 60

**CAMBLOS**  
 Ellen Lyle Morris 80  
 Ellen Morris 80  
 James Lyle 80  
 Margaret 80  
 Pierre 80  
 Rosalie Morris 80

**CAMERON**  
 Margaret 200

**CAMP**  
 Gladys A. 270

**CAMPBELL**  
 Alice Taney 67  
 Carrie Hiatt 176  
 Catherine Hinton Lopez 176  
 Edith May 195  
 Eliza (1799-1844) 82  
 Eliza Frances 82  
 Elizabeth Augusta (d. 1853) 155  
 Elodie 141  
 Estelle 257  
 Helen 140  
 Helen M. 140  
 John 337A  
 Mary (m. A. Haas) 88  
 Mary (m. W. S. Keyser) 140  
 Mary Franks 82, 324A  
 Robert 176  
 Robert, Jr. (b. 1892) 176  
 Ruth 320A  
 Sarah 337A  
 William 82, 324A

**CAMPE**  
 Abraham Emanuel 108  
 Bernard 108  
 Blanche 91  
 Cecil Rice 108  
 Elsa Cecilia 108, 325A  
 Louise Silverman 108  
 Minnie Lowenberg 108

**CAMPOS**  
 Hester Rachel (1695-1736) 85

**CANDIEE**  
 Jeanette De Forest 17

**CANNON**  
 Kate 322B

**CANSINO**  
 Cecile Carvalho 61  
 George 61  
 Ida Stella Pinto 61  
 Isaac 61  
 Jonathan 61  
 Manuel 61  
 Stella 61

**CANTER**  
 Abraham (1774-1858) 28  
 Augusta Georgia (ca. 1828-1889) 28, 97  
 Charlotte (Leah) 28, 262



Da Costa (d. inf.) 28  
 David (1776-1829) 28  
 David Emanuel (b. 1830) 28  
 Edwin (b. 1826) 28  
 Eliza Williams 28  
 Emanuel (1768-1829) 28, 309B  
 Emanuel De La Motta (1824-1889) 28  
 Hannah (1783-1826) 28  
 Ida Victoria 28  
 Isaac Da Costa (1831-1835) 28  
 Jack (see Canter, Jacob (Jack))  
 Jacob (Jack) 28  
 Jacob (1741-1785) 28, 54  
 Jacob De La Motta 28  
 John (Jonathan) 28  
 John (1782-1823) 28  
 Jonathan (see Canter, John (Jonathan))  
 Joshua (son of Emanuel) 28  
 Joshua (1767-1826) 28  
 Joshua 28  
 Judith (1771-1827) 28, 54, 309B  
 Judith (1827-1890) 28  
 Leah (see Canter, Charlotte (Leah))  
 Louisiana (b. 1830) 28  
 Rachel (d. ca. 1852) 28  
 Ralph (m. 1823) 28, 44  
 Rebecca (d. 1835) 28  
 Rebecca Alabama 28  
 Rebecca De La Motta 28, 54, 309B  
 Rebecca M. 28  
 Sally (see Canter, Sarah (Sally))  
 Sarah (Sally) (1776-1829) 28, 262  
 Sarah Da Costa (m. 1823) 28, 44

**CANTON**  
 Barry 52  
 Esther Emma Fanny De Cordova 52

**CANTWELL**  
 Ursula 299

**CAPADOSE**  
 Abraham 273  
 Rachel Da Silva 273

**CAPPÉ**  
 Benjamin Honig, (1839-) 341A  
 Huenig Benjamin (see Cappé, Simon Aaron)  
 Judah 305, 341A  
 Miriam (d. 1887) 305  
 Miriam (1823-1887) 305, 341A  
 Miriam Levy (b. 1767) 305  
 Moses (1795-) 341A  
 Rachel (m. 1849) 18, 305, 321A, 341A  
 Rachel (1792-1879) 305, 341A  
 Rebecca (b. 1824) 305, 341A  
 Rebecca Israel 305  
 Samuel Aaron (b. 1833) 305, 341A  
 Sarah Hobebe 305  
 Simon Aaron 305, 341A

**CAPRON**  
 Janet 284  
 Jill Stern 284  
 Paul 284

**CARABO**  
 Madeleine 91

**CARACCILO**  
 Alberto 246  
 Francesco 246  
 Giovanna 246  
 Mario 246  
 Ortensia Lumbroso 246

**CARCASSONE**  
 Saadele (-1705) 235, 337B

**CARDOZA**  
 See Cardozo

**CARDOZO**  
 Aaron (1802-1804) 29  
 Aaron N. (son of Moses) 29  
 Aaron Nunez (d. 1800) 29  
 Abigail N. (1802-1870) 29, 266  
 Abraham (son of Isaac) 29  
 Abraham 29  
 Abraham H., Jr. (b. 1856) 29  
 Abraham Hart (1826-1897) 29, 241  
 Abraham N. (b. 1792) 29

Abraham Nunez (1758-1816) 29  
 Adeline (b. 1868) 29  
 Adelina Rachel (1833-1912) 29  
 Albert J., Jr. (1857-1909) 29  
 Albert Jacob (1828-1885) 29, 226  
 Algernon Jarvis (b. 1868) 29  
 Algernon, Jr. 29  
 Alice Carol 309B  
 Alice Corneille 29, 309A  
 Alice Rebecca 29, 309A, 321B  
 Anita Rosalie (b. 1909) 29, 321B  
 Ann 29  
 Augustus (Gustavus) David 29  
 Barbara 29  
 Barbara Herron 29, 309A  
 Barbara Schaffer 29, 321B  
 Benjamin Mordecai (b. 1915) 29, 321B  
 Benjamin Nathan (1870-1938) 29  
 Benjamin Pollard (b. 1875) 29  
 C. Danforth 29, 202  
 Carol 29  
 Carol Alice Wilcox 309B  
 Caroline Adelia (b. 1823) 29  
 Christopher (son of D. Henry, Jr.) 29  
 Christopher (son of Richard Henry) 29  
 Clara Lieber 29, 174  
 Clare (b. 1927) 29  
 Constance G. (dau. of Randolph Burwell) 309B  
 Constance Gooding 309B  
 Constance Mordecai 29, 202  
 D. Henry III 29  
 D. Henry, Jr. (b. 1887) 29  
 Danforth, Jr. (b. 1924) 29, 309A  
 Daniel Henry (1852-1931) 29, 174  
 David (b. & d. 1804) 29  
 David (son of Isaac N.) 29  
 David N. (d. 1825) 29  
 David Nunez (1753-1835) 29, 36, 62  
 David Nunez 29  
 Eden Rebecca 321B  
 Edward (b. 1888) 29  
 Edward S., Jr. 29  
 Edward Samuel (1825-1887) 29  
 Edwin Joseph (b. 1859) 29  
 Elfie 29  
 Elizabeth Clayton (1867-1917) 29  
 Elizabeth Samuel (b. 1878) 29  
 Ellen (b. 1855) 29  
 Ellen 29  
 Ellen Hart 29, 183  
 Ellen Ida (1859-1929) 29  
 Ellen Schaffer 321B  
 Emily Natalie (1870-1922) 29  
 Emily Rebecca Wolff 29, 305  
 Enid 29  
 Ernest Abraham (b. 1879) 29, 305, 309A  
 Esther N. (1804-1869) 129  
 Esther Riveiro 29  
 Eva (b. 1859) 29  
 Eva Mordecai 29, 202  
 Frances (1788-1849) 29  
 Frances R. (b. 1823) 29  
 George Hart (b. 1920) 29  
 Gillah Moses 29  
 Grace Amy (1860-1885) 29  
 Gustavus David (see Cardozo, Augustus (Gustavus) David)  
 Hallowell 29  
 Harmon Hart (b. 1913) 29, 174  
 Hedy 29  
 Isaac Demetrius (b. 1830) 29  
 Isaac N. (b. ca. 1788) 29  
 Isaac N. (1793-1853) 29  
 Isaac N. (m. 1693) 29  
 Isaac N. III (1821-1881) 29, 265  
 Isaac Nathan (b. 1857) 29  
 Isaac Nunez (1751-1832) 29, 103  
 Isabel Haslem 29  
 Jacob N. (son Moses) 29  
 Jacob N. (1786-1873) 29  
 Jacob Nunez 29

James Scott 309B  
 Jennie Housman 29  
 Jonathan 29  
 Judith Leon 29  
 Judith M. Catina 29  
 Judith N. (1790-1854) 29  
 Judith N. (1809-1865) 29  
 Judith Nunez (b. 1747) 29  
 Julia Aline 29, 313B, 321B  
 Julia Louisa 321B  
 Junius Mosby (b. 1876) 29  
 Kate Garrett (b. 1880) 29  
 Kate Harris Talley 29  
 Lavinia Abigail (1835-1913) 29  
 Leah (1797-1802) 29  
 Leah Benjamin 29, 62  
 Lewia Burwell (son of Mosby Gooding) 309B  
 Lewis Burwell (son of Randolph Burwell) 309B  
 Lewis Burwell (son of William A.) 309B  
 Louise Jane Burwell 309B  
 Lucile Lehair 29, 174  
 Mahala Baugh 29  
 Margaret 29  
 Margaret Pratt 29  
 Maria Louisa (1820-1907) 29  
 Marion Bray 29  
 Mary Atkinson 29  
 Mary Carney 29  
 Mary Eliza (b. 1820) 29, 309A  
 Mary Ellen Kayton 29, 309A  
 Mary Louise (b. 1873) 29  
 Mary Wingfield Scott 309B  
 Michael A. 29  
 Michael H. III (b. 1881) 29, 97  
 Michael H. IV (b. 1910) 29, 309A, 321B  
 Michael H. V 29, 309A, 321B  
 Michael Hart (1800-1865) 29, 103  
 Michael Hart, Jr. (1851-1906) 29, 98  
 Mildred 29  
 Mosby Gooding 309B  
 Moses N. 29  
 Moses Nunez (1755-1818) 29  
 Nancy (b. 1919) 29  
 Nancy (dau. of George Hart) 29  
 Nancy (m. Peter, Jr.) 29, 321B  
 Nancy Caryn Cogut 29  
 Pamela 309A  
 Patricia Fitzsimmons 309A  
 Patricia Lynch 309A  
 Peter Sterling 29, 309A  
 Peter, Jr. 29, 321B  
 Rachel (1854-1923) 29  
 Rachel Mizrahi 29  
 Rachel N. (dau. of Moses) 29  
 Rachel N. (1799-1887) 29, 30, 243  
 Rachel Nunez (b. 1743) 29  
 Rachel Nunez (1795-1860) 29, 266  
 Rachel Rosalie Hart 29, 98  
 Rachel Seixas 29, 265  
 Randolph B. (1956-1976) 309B  
 Randolph Burwell (Jr.) 309B  
 Randolph Burwell (son of William A.) 309B  
 Rebecca (d. 1766) 29  
 Rebecca Bacon Pollard 29  
 Rebecca Seixas (1857-1912) 29  
 Rebecca Washington Nathan 29, 226  
 Richard (son of Harmon Hart) 29  
 Richard 29  
 Richard Henry (b. 1920) 29  
 Rosalie Hart 29, 97  
 Rose Levy 29  
 Russell Wilcox 309B  
 Sally N. 29  
 Samuel N. 29  
 Sarah (1780-1837) 29, 163  
 Sarah Cohen 29, 36  
 Sarah Hart (1763-1823) 29, 103  
 Sarah Hart (1824-1903) 29

Sarah Naar Peixotto 29, 241  
 Sarah Navaro 29  
 Sarah Nunez Navaro 29  
 Sarah Rebecca Garrett 29  
 Scott 29  
 Sidney Benjamin (b. 1888) 29, 202  
 Sidney Benjamin (b. 1916) 29  
 Solomon 29  
 Susan 29  
 Susan Strong 309A  
 Suzanne Solomon 309A  
 Thomas Clow G. 309B  
 Virginia Adelaide (b. 1828) 29  
 Washington Irving (b. 1833) 29  
 William A. 309B  
 William Benjamin (1865-1940) 29  
 William Bowditch 29  
 William Harvey (b. 1826) 29

**CAREY**  
 Florence 24

**CARLISLE**  
 Esther Wood 268

**CARLOS NERY (VERY?)**  
 See Da Silva, Diogo Pinto (Carlos Nery (Very?) or Isaac (Israel?) Da Silva Solis)

**CARLSON**  
 Carmen De Cordova 52

**CARLTON**  
 John H. 304

**CARMODY**  
 Hatty Clara 245  
 Juliet Block 24  
 Muriel Leslie 24

**CARNEY-ARBUTHNOT**  
 Matilda 81

**CARNES**  
 Hulda Jane 146

**CARNEY**  
 Mary 29

**CARNICK**  
 Edgar 276  
 Ella 276  
 Gertrude (dau. of John) 276  
 Gertrude Solomons 276  
 John 276  
 Wallace 276

**CARNSEW**  
 Emma Marion 77  
 Florence Hilda 77  
 Frances 77  
 Frances Hallett Honeywood 77  
 John Honeywood (b. 1872) 77  
 Mary Gertrude 77  
 Thomas Stone 77  
 Walter Henry (b. 1862) 77

**CARPENDER**  
 Cary Nicholas (b. 1924) 157  
 Elizabeth Ridgely Nicholas Greene 157  
 Moncure Conway 157

**CARPENTER**  
 Edward W. 120  
 Jennie De Forest 147  
 Maggie 120  
 Mattie 120  
 Rachel Bean 120  
 W. W. 120

**CARR**  
 Barbara 88  
 Edythe Given 74  
 Herbert 74  
 Inez 208  
 Lucien 88  
 Maria Howland (see Carr, Marion Howland (Maria) Gratz)  
 Marion Howland (Maria) Gratz 88  
 Russell 88  
 Victoria Henrietta Ezilda 83

**CARRIAGI**  
 Augusto Manfredi 107  
 Blanche Hecht Cosolvo 107

**CARRINGTON**  
 Emma Louise Phillips Cohen 247

Mary Jett 25  
 Walter 247  
 Walter C. 25

**CARROLL**  
 David 84  
 Irene Broughton 84  
 Sarah Gough 158

**CARSON**  
 Ann Ellen 87  
 Carey 180  
 Charles Wheatly 180  
 Corinne 180  
 Elvie Isabell 180  
 Ginevra Belle Wood 180  
 Harold Watt 180  
 James W. 180  
 Jim 180  
 Joanne 180  
 John M. 180  
 John Marshal 180  
 Sallie Janette Willis McLeary 180  
 Willie May 180  
 Willie Willis 180  
 Windrow Burdette 180

**CARTE**  
 Georgina Caroline 75

**CARTER**  
 Clair Fred (b. 1883) 257  
 Claire Freda (b. 1923) 257  
 Claire Freda Carter 257  
 Eda 133  
 Ella 146  
 Evelyn Arnstahl 70  
 Fred 70  
 Gilbert Bruce (b. 1946) 257  
 Gracia Louise 140  
 Jacob Monroe 25  
 James William (b. 1915) 257  
 James William III (b. 1943) 257  
 Jessie 164  
 Katheline 39  
 Marjorie 141  
 Muriel Adelaide Schaeffer 257  
 Muriel Joy 146  
 Muriel Joy Kokernot 146  
 Pauline Booker 25  
 Randolph R. 146  
 Richard 337A  
 Russell Huntman (b. 1949) 257  
 Sarah V. 337A  
 Sue Wolff 107  
 Vera Ernestine 265  
 William 107

**CARTLAND**  
 James Bertram Falkner 79  
 Mary Hamilton Scobell 79

**CARTON**  
 Beatie 52  
 Harry 52  
 Jane ('Jerry' or 'Jennie') De Cordova 52  
 Mary 52  
 William (m. 1867) 52

**CARVALHO**  
 Adele 30  
 Annette Philbrick 30  
 Annie Abrams 5, 30  
 Bathsheba 30  
 Bertram N., Jr. 30  
 Bertram Nunez 30  
 Caroline A. Woolf 30, 305  
 Cecile 61  
 Charity Solis (1853-1945) 30  
 Claire 30  
 Clara M. 322A  
 Claudius (b. 1848) 30  
 Curtin Balton Pierce 30  
 Daten 30  
 David 30  
 David N. II 30  
 David Nunez (1784-1860) 30, 51, 322A  
 David Nunez (1842-1843) 30  
 David Nunez (1848-1925) 4, 30

Dayton Nunez 30  
 Elizabeth Henry 115  
 Emanuel Nunez (1771-1817) 30  
 Emanuel Nunez (1817-1883) 30, 305  
 Harold Nunez 331B  
 Helen (dau. of Solomon) 30  
 Helen Cusack 30  
 Isaac (d. 1835) 30  
 Isaac Nunez (m. 1803) 30  
 Isaac Woolf Nunez (b. 1848) 30  
 Jacob Solis (1852-1937) 30  
 Jessica Pierce 30  
 Judith Henriques Pimentel 30  
 Julia (1819-1887) 30  
 Leslie Russell Nunez 30  
 Maie Nunez 30  
 May 30  
 Melba Wyckoff 30  
 Miriam N. (1838-1910) 30  
 Rachel Castello 331B  
 Rebecca (m. David) 30  
 Rebecca (m. 1800) 30  
 Samuel Nunez 115  
 Sarah (dau. of Emanuel Nunez) 30  
 Sarah (1823-1842) 30  
 Sarah Cohen D'Azevedo 30, 51, 322A  
 Sarah Miriam Solis 30, 274  
 Sarah Moreira 30  
 Solomon Nunez (m. 1765) 30  
 Solomon Nunez (1815-1897) 30, 274  
 Solomon Solis (b. 1856) 30  
 Suzanne Walker 30

**CARVER**  
 Barbara Henriques 310A  
 Eugene 310A

**CARY**  
 Grace Morris 80  
 Julia Augusta Moise 197  
 William Standerwick 197

**CASHDOLLAR**  
 Caryl Lester Gruen Hoffman 237  
 Cynthia Ann 237  
 Roger Everett 237  
 Russell Everett 237

**CASPAR**  
 Frances 311A  
 Jacob 121  
 Matilda Hyman 121

**CASS**  
 Annie 107

**CASSATT**  
 Louis 21  
 Matilda Benswanger 21

**CASSE**  
 David Alexander (b. 1894) 257  
 Lillian Ethel (b. 1922) 257  
 Lillie Hanties Karstendiek 257  
 Meriam Amelia (b. 1917) 257  
 Welbur Conrad (b. 1919) 257

**CASSERES**  
 Abigail Brown 240  
 Samuel De Benjamin 240

**CASTELLO**  
 Alice Benham 331B  
 Amy Sarah (1865-1865) 331B  
 Baruch (1829-1868) 331B  
 Benjamin Woolf 331B  
 Daniel (1831-1883) 331B  
 Daniel 180, 332A  
 Daniel Nunez (d. 1868) 180, 331B  
 Dorothy Helena Sutro 331B  
 Edith Miriam De Castro 332A  
 Edith Sarah Franklin 331B  
 Elias 26  
 Elizabeth Bilha Magnus 331B  
 Emanuel Nunez (1741/2-1818) 180, 331B  
 Emanuel Nunez (1824-) 332A  
 Esther Nunez (1825-) 332A  
 Esther Valentine (1771/2-1847) 180, 331B  
 Esther (1828-1890) 331B  
 Florence 332A

Hannah (1835-1906) 332A  
 Isaac (1745-1822) 332A  
 Jacob Nunes 180, 331B  
 Jacob (1856-1905) 331B  
 Jacob (1864-1864) 331B  
 James (1863-1928) 331B  
 Laura Ethel Sonnenthol 331B  
 Leon Benham (1881-1948) 331B  
 Manuel (1827-1905) 180, 331B  
 Manuel (1879-) 331B  
 Nina (1909-) 331B  
 Percy (1865-1918) 332A  
 Rachel Levy 180  
 Rachel (1884-) 331B  
 Renee Dreyfus 331B  
 Sarah Aloof 331B  
 Sarah Bebero Alevy 331B  
 Sarah Franklin 331B  
 Sarah Levy 180  
 Simon Magnus 331B  
 Solomon (1837-) 332A  
 Sophia Woolf 331B  
 Winfred Claire Marsden 331B

**CASTLE**  
 Derek (b. 1906) 297, 314A  
 Doreen (b. 1917) 297, 314A  
 Florence Tobias (m. 1904) 297, 314A  
 Horatio Montefiore (Schloss) 297, 314A  
 Nancy (b. 1904) 297, 314A  
 Norman (b. 1912) 297, 314A  
 Patricia 285

**CASTLEBERG**  
 Grace 290

**CASTRO**  
 See also De Castro  
 Rebecca Del Myda Abendanone 1

**CASWELL**  
 Cynthia 149

**CAUBLE**  
 David Z. III 164  
 David Zimari 164  
 Edna Sue 164  
 Lillian Cobb 164  
 Lillian Myrick Cobb 164

**CAUCHOIS**  
 John 114  
 Julia V. Henriques 114

**CAUFFMAN**  
 See also Kauffman  
 Bessie (see Cauffman, Elizabeth (Bessie))  
 Clara (1821-1880) 30  
 Elizabeth (Bessie) 152  
 Esther Cardozo (1820-1895) 30  
 Joseph (1720-1807) 30  
 Rachel N. Cardozo 29, 30, 243  
 Sarah Cardozo (1817-1896) 30  
 Simon 29, 30

**CAULFIELD**  
 Amie B. Isaacson 328B  
 Bridget 338A  
 Ignatius 328B

**CAVE**  
 Brenian Eckley O. IV 88  
 Judith Cary Gratz 88

**CAVERLY**  
 Mabel Vera 199

**CAYTON**  
 Bert (1879-) 327B  
 Herbert (1882-) 327B  
 Irma Spitzer 327B  
 Margaret Joy (1910-) 327B  
 Martha Zauger 327B  
 Robert Jim (1915-) 327B

**CEAL**  
 Annie Henriques 310B  
 George W. 310B

**CECIL**  
 Lady Elizabeth (1716-) 324A

**CELESTE**  
 Marie 49

**CELIA**

Antonio Fonseca 336A

**CERP**  
 Eugenie Levy 159  
 Idelia 159  
 James 159  
 Julius Benoit 14  
 Mindelle Bamberger 14  
 Minkella (1783-1858) 280  
 Sophia 159  
 Uriah 159

**CERPENSLEI**  
 Sophia (b. 1915) 166

**CHAFFEE**  
 Ann Eisendrath 313B  
 Carolyn 313B  
 Ellen 313B  
 John B. 313B  
 John B., Jr. 313B

**CHAMBERLAIN**  
 Ada (1892-1972) 335B

**CHAMBERS**  
 Inez Sheftall 269  
 James Albright 269  
 Meredith 222

**CHAMBLIS**  
 Alfred P., Jr. 205  
 Alfred Parks 205  
 Clarence Saxley 205  
 Emma Baker Anderson Berkeley 205

**CHAMBRE**  
 Cilia 236, 237

**CHAN**  
 Alan Hofeller 236  
 Eric Olsen 236

**CHANCE**  
 Ginger Faye 53

**CHAPMAN**  
 Rebecca Leigh (1958-) 334B

**CHAPMAN**  
 Abraham 141, 218  
 Ada Jacobs 134  
 Edward 134  
 Edwin 308  
 Eliza Judah 141, 218  
 Hannah Yates 308  
 Mamie Trousdale 180  
 Mary Ella (1819-1847) 218  
 Moses 308  
 Phillip 180

**CHAPPELL**  
 Catherine 220

**CHARLEBOIS**  
 Karen 324B

**CHARLES**  
 Amy Benjamin Michaels 193

**CHART**  
 Roseanne 335B

**CHASE**  
 Anita Weinberg 208  
 Beverly Huntington Seaman 309B  
 Emma Benrimo 47  
 George III 208  
 George, Jr. 208  
 Hollis H. (b. 1916) 309B  
 Jane 157  
 Jeanne-Nicole Ledoux (b. 1946) 309B  
 Kenneth Huntington (b. 1944) 309B

**CHASSIN**  
 Simone 324B

**CHENERY**  
 Hetty Taylor 133  
 Tate 133

**CHENEY**  
 Julia De F. 155

**CHERTOLO**  
 Perie 230

**CHESEBRO**  
 Frederick Sackett 147  
 Myrtle Kurnbeedt 147

**CHESEBROUGH**  
 Ellen 84

**CHESELEY**  
 Beattie David 238

Paula Dale Oppenheimer 238

**CHESNUT**  
 David III 5  
 David O., Jr. 5  
 Nellie Read Abrams 5

**CHESSMAN**  
 Maude Evelyn Polack 60  
 Rev. H. 60

**CHESTER**  
 George Miller 270  
 Margaret Marwood Sheftall 270

**CHESTNUT**  
 Frances G. 5

**CHESTON**  
 Beacie L. Cooke 80  
 Caroline Calvert Morris 80  
 Caroline Morris 80  
 Caroline N. Ashton 80  
 Charles S., Jr. 80  
 Charles Steele 80  
 Charlotte Murray 80  
 Cornelia 80  
 Cornelia Carter Leidy 80  
 E. Calvert 80  
 Elizabeth Morris (dau. of Morris) 80  
 Elizabeth Morris (dau. of Radcliffe) 80  
 Eugene Morris 80  
 Eugenia Morris 80  
 Frances Drexel 80  
 Frances Drexel Fell 80  
 George Frazier 80  
 George Morris (son of Radcliffe) 80  
 George Morris (son of Radcliffe, Jr.) 80  
 Harriet Frazier 80  
 Harriet M. Frazier 80  
 Helen M. Shipley 80  
 James Hamilton 80  
 James IV 80  
 James, Jr. 80  
 Mary Lincoln 80  
 Morris 80  
 Radcliffe 80  
 Radcliffe, Jr. 80  
 Sydney Ellia 80  
 Sydney H. Ellis 80

**CHEW**  
 John Calhoun 264  
 Theodora Seixas 264

**CHILARO**  
 Judith Loeb Beaty 211  
 Marco 211

**CHILD**  
 Charlotte De Lancey 76  
 Marion 216

**CHILDERS**  
 Bertha Morris 322A  
 Elwood 322A

**CHILDS**  
 Anna S. 234  
 Elizabeth Simmons 242  
 Frances L. Simpson 250  
 Mary R. 234  
 Solomon 250  
 William 242

**CHRISTIAN**  
 Elizabeth Palmer 183

**CHUCK**  
 Bella 161  
 Bertha Simon 161  
 Bertram 161  
 Julia 161  
 Esther (dau. of Henry) 161  
 Henry 161  
 Hilda 161  
 Isidore 161  
 Julia 161  
 Leah 191, 333A  
 Minnie 161  
 Miriam 161  
 Rachel Levy 161

Raymond 161  
 Sadie 161  
 Sophia Levy 161  
 Theresa 161  
 William 161

**CHUMACIRO**  
 Eudora Sampson Abrahams 259  
 Rev. Joseph H. M. 259

**CHURCH**  
 Grace Blankenburg 129  
 Mary Jane 335B  
 Reginald 129

**CHURCHILL**  
 Pamela Beryl Digby 79  
 Randolph 79

**CHESLER**  
 Frances M. Naar 224  
 William 224

**CLAFLIN**  
 Ann Benjamin 310A  
 Robert D. 310A

**CLAGGETT**  
 Cordelia 52

**CLAPP**  
 Adele B. Wolfe 304  
 Devereux 304

**CLARA**  
 Esther 115

**CLARK**  
 A. Wayne 157  
 Adele 94  
 Betty Lieber 174  
 Brenda 107  
 Catherine Rosalie Myers 221  
 Charles 221  
 Charles Heber (b. 1913) 157  
 Collingswood S. 76  
 Dorthy 88  
 Donald Story 76  
 Edith 94  
 Eleanor Lawlor Nicholas (b. 1914) 157  
 Elizabeth A. (1817-1888) 215  
 Estelle Goodman 94  
 Gertrude 94  
 Gordon Story 76  
 John Nicholas (1911-1911) 157  
 Mary 138  
 Mary Lawlor Nicholas 157  
 Parthenia 58  
 Paul 174  
 Robert 94  
 Roberta 194  
 Ruth 94  
 S. Mabel 31  
 Sally Bethia Marks 184  
 Sibyl Edna Story 76  
 Urania 251  
 Virginia Schoonmaker Moore 264  
 William H. 264

**CLARKE**  
 Alice Judah 141  
 Amanda Philipson 338A  
 Amelia (1742-1803) 10  
 Brandon 141  
 Carrie Kayton 327B  
 Clarissa Hartow (1796-1882) 326A  
 Edmund 247  
 Fleur De Marie 247  
 Franklin (m. 1863) 141  
 Franklin (son of Franklin) 141  
 George M. III (1930-) 322A  
 George Miller 322A  
 John Samuel (1936-) 322A  
 Julia L. 39  
 Lucinda 141  
 Mamie 141  
 Maude Melasky 247  
 Morville (1864-1925) 327B  
 Rosa Kayton 327B  
 Vaden 327B  
 Victoria Billups Cohen 322A  
 William H. 338A

**CLARKSON**

Lev 53  
 Louise Ward 53

**CLARRE**  
 Evelyn 21

**CLARY**  
 Amanda Jane 338A  
 Charles Philipson 338A  
 Esther Philipson 338A  
 Henry Emmet 338A  
 Maria Louise 338A  
 Robert E. Jr. 338A  
 Robert Emmet 338A

**CLASS**  
 Jay Bernard 164  
 Marion Frances Schwartz 164

**CLAVA**  
 Benjamin Moses (d. 1785) 30  
 Moses 30

**CLAVEL**  
 Anne Solomon 247  
 Caroline 247  
 Pierre (b. 1963) 247  
 Pierre (m. 1960) 247  
 Thomas 247

**CLAVERT**  
 Andrea 215  
 Donato 215  
 Earl 215  
 Ellen Espen 215  
 Nicola Mar 215

**CLAXTON**  
 Deborah 309A

**CLAY**  
 Anna Gratz 88  
 Thomas Hart 88

**CLAYBURG (H)**  
 Bellina (1854-1870) 233  
 Edward (b. 1856) 233  
 Simeon Henry (1851-1853) 233

**CLAYBURGH**  
 Albert H., (1909-) 336A  
 Albert (1863-1946) 336A  
 Alma Eveline (1915-) 336A  
 Alma Lackenbruch 336A  
 Barbara Corlies 336A  
 Corlies (1934-) 336A  
 Emanuel (b. 1818) 233, 336A  
 Eveline Nones (d. 1912) 233, 336A  
 James Dorr (1949-) 336A  
 Jill (1944-) 336A  
 Julie Dorr 336A  
 Lee 336A  
 Ludella 336A  
 Ludella Faydeen 336A  
 Marie 336A

**CLAYCOMBE**  
 Blanche Agnes 196

**CLAYELLO**  
 Daniel 180, 332A

**CLAYTON**  
 Rose Marshall 25  
 William 25

**CLEARY**  
 Elizabeth Ann Lyons 183  
 Ross W. 183

**CLEMENTSON**  
 Wanda Mae 257

**CLEPHANE**  
 Malcolm Wolcott 190  
 Mona Mundel 190

**CLERGUE**  
 Jane Johnson 81

**CLERHUE**  
 See Clergue

**CLEVE**  
 Anna Rose 157

**CLIFF**  
 Aliae Memmert 310A  
 William 310A

**CLIFFORD**  
 Camilla Antoinette 79

**CLIFTON**  
 Elise McFadden Williams 208

Hideko Takahisa 208  
 James Dickey 208  
 Kathy Bornworth 208  
 Mittie 269  
 Perry Austin 208  
 Robert Dale 208  
 Robert McFadden 208

**CLINE**  
 Martha 248

**CLOWES**  
 Florence Evangeline Colette Northey 78  
 John Leigh 78

**CLYDE**  
 Helen (see Levin, Constance ('Helen Clyde'))

**COALE**  
 Edgar Belleville 287, 340A  
 Hannah 287  
 Harriet Cohen Jackson 129  
 Howard 287  
 Isaac, Jr. 129  
 Joan Levy 287, 340A  
 Ned (see Coale, Edgar Belleville)  
 Sidney 287  
 William 287

**COATES**  
 Lloyd Morris, Jr. 118  
 Lucy 195  
 Marian Newhall Horwitz 118

**COATS**  
 Sarah (1776-1854) 154

**COBB**  
 Anne G. 49  
 Edna Levy 164  
 Edna Sydney 164  
 George S., Jr. 164  
 George Sydney 164  
 Kenneth 49  
 Kenneth R. 49  
 Lillian Myrick 164  
 Lillian Shannon Edmondson 164  
 Marie Celeste 49  
 Marie Celeste Pizzini 49  
 Sarah Owen 164

**COBBIER**  
 Charles 199  
 Rita Louise Moise 199

**COBBS**  
 Ida Woodfin 4  
 John Lewis 4

**COBURN**  
 Adah Montefiore 115  
 Alan 115  
 Arthur 115  
 Bella 115  
 Charles 115  
 Dorothy Henry 115  
 Frank 115  
 Henry Isaac 115  
 Mary 115  
 Oliver 115

**COCHRAN**  
 Edith 289

**COCKBURN**  
 Ethel Butler 262

**CODDINGTON**  
 Fannie 129

**ODDY**  
 Albert (1903-1977) 335B  
 Virginia Nones 335B

**COFFEE**  
 Shirley 262

**COGOSWELL**  
 Ruth 215

**COGUT**  
 Nancy Caryn 29

**COHEN**  
 See also Cohn, Coleman, Kohn, Myers-Cohen, Solis-Cohen  
 Aaron (b. 1843) 280  
 Aaron (father of Jacob) 33  
 Aaron (son of David) 36

Aaron (1750-1830) 285  
Aaron (1808-1862) 36  
Aaron N., Jr. (m. 1850) 34, 38, 309B, 322A  
Aaron Nathan (1777-1862) 38, 322A  
Abraham (1739-1800) 35  
Abraham (1782-1809) 93  
Abraham (1787-1859) 223  
Abraham (1791-1793) 35  
Abraham Hyam (d. 1841) 180  
Abraham Sarzedas 38  
Abram (son of Joseph) 36  
Abram (1826-1833) 36  
Abram Seixas 36  
Adela Isaacs 38, 120  
Adeline (m. 1860) 34, 249  
Adeline Brady Levy 167  
Adeline Myers (1839-1889) 32, 281  
Adrian (b. 1905) 167  
Adrian, Jr. (b. 1929) 167  
Agnes (1857-1934) 38, 124  
Alan M. III (b. 1920) 32  
Alan M., Jr. (b. 1895) 32  
Alan Mordecai (1872-1913) 32  
Albert (son of Andrew Jacob) 31  
Albert (son of Benjamin) 295  
Albert Andrade (b. 1860) 33  
Albert Gleaves (b. 1927) 33  
Albert Morris (b. 1883) 33  
Alfred (son of Jacob) 34  
Alfred (son of Samuel) 34  
Alfred M. (1837-1858) 32  
Alice (b. 1882) 37  
Alice (dau. of Henry Russell) 39  
Alice (dau. of Moses) 36  
Alice Cooper 38  
Alice Gertrude (d. 1900) 36, 231  
Alice Hale 36  
Alice Rebecca (Minnie) 36  
Alozo 39  
Ambrose Ransone 39  
Amelia Jackson 130  
Andrew Jacob (1833-1890) 31, 74  
Andrew Jacob (1860-1914) 31  
Ann (m. 1841) 38  
Anna Honig 305  
Anna Maria (1849-1914) 32  
Anna Maria (1863-1891) 32, 194  
Anna Maria Denny 32  
Anne 233  
Anne Nelson 37  
Annie (m. 1875) 233, 336A  
Annie (1855-1933) 34, 322A, 340B  
Annie Cohen 233, 336A  
Annie H. Reid 233  
Ansley D., III 37  
Ansley Davis (b. 1884) 36, 37, 198  
Ansley Davis (1848-1916) 36, 198  
Ansley Davis, Jr. (b. 1923) 37  
Armida (m. 1880) 35, 66  
Armida Harby 35, 93  
Arthur (son of Maurice) 191  
Arthur (son of Philip) 39  
Arthur M. (1833-1885) 32  
Arthur S., (1891-) 336A  
Asher 322A  
Asher D. (1838-1904) 35, 98  
Asher Samuel (1849-1884) 34, 244  
Augusta Copelan 322A  
Augusta Leonora 37  
Augusta Myers 32, 218  
Augustus Philip (son of Philip) 39  
Barnet 39  
Barnet Owens 39  
Barnet Solomon 33  
Barrow A. 39  
Barry 11  
Bella (1785-1863) 309B  
Bella A. 39  
Belle (Bella) Moses 35, 205  
Belle (dau. of Gershon) 39  
Belle (dau. of Jacob) 36  
Belle (dau. of Solomon) 35

Benjamin (b. & d. 1824) 32  
Benjamin (son of Henry) 30  
Benjamin (son of Herman) 295  
Benjamin (1792-1858) 101  
Benjamin (1817-1858) 38  
Benjamin (1834-1835) 33  
Benjamin Denny (1845-1847) 32  
Benjamin Franklin (b. 1854) 233, 336A  
Benjamin I. (1797-1845) 32, 67  
Benjamin I. (1852-1915) 32  
Benjamin Philip Owens 39  
Benjamin W. 280  
Bert see Cayton, Bert  
Bertha (b. 1838) 32  
Bertha (Bettie) Kayton 327B  
Bertha Kahn 275  
Bertha Munson 34  
Bessie M. 336A  
Beth (1876-) 46  
Betsy (see also Cohen, Elizabeth Virginia (Betsy))  
Betty Jane Price 11  
Betty Adeline (b. 1934) 167  
Beverly 39  
Bilah (b. 1785) 57  
Blanche (b. 1868) 39  
Blanche Florance (b. 1889) 31  
Bobette Eileen 282  
Bonina (Tobah) Morais 193  
Bonner 39  
C. Henry (m. Nora Sneed) 39  
C. Henry (son of John J.) 39, 322B  
Carol 207  
Caroline (m. 1883) 35  
Caroline Asber 33  
Caroline Harris 38, 94  
Caroline Moise 36, 198  
Caroline Moses 285  
Caroline Myers 33, 217  
Caroline R. (1838-1898) 38  
Caroline Tim 295  
Carrie (dau. of Philip) 39  
Carrie Hess Ball 233  
Carrie Israel 39  
Catherine (dau. of Liepman) 309B  
Catherine (1781-1862) 38, 120  
Catherine (1795-1851) 4, 333A  
Catherine (1822-1883) 38  
Catherine (1833-1888) 32  
Catherine A. Sullivan (d. 1940) 309B  
Cecil (son of Joseph) 36  
Cecile (dau. of George Lion) 186  
Cecile (1765-1839) 202  
Cecilia (dau. of Solomon) 35  
Cecilia E. 36, 176  
Cecilia Eliza Levy 32, 164  
Celia Raphael 275  
Charity Hays 33, 104  
Charity Solis (1844-1943) 275  
Charles (son of Henrietta Myers) 306  
Charles (1835-1836) 32  
Charles Joseph (1847-1927) 31, 33  
Charles M. 297  
Clara (dau. of Aaron) 38, 249  
Clara (dau. of George Lion) 186  
Clara (dau. of Herman) 295  
Clara Harris 38, 94, 322A  
Clara Nathan (1812-) 322A  
Clarence 38  
Clarence H. (b. 1901) 167  
Clarence H., Jr. (b. 1938) 167  
Claudia C. (1890-) 336A  
Clotilda Florance (b. 1883) 31  
Clotilda Florance (b. 1930) 33  
Clotilda Florance (1832-1915) 31, 74  
Clotilda Florance (1860-1928) 31, 33  
Clotilda Florance Cohen (1860-1928) 31, 33  
Colin S. (b. 1862) 33  
Columbus Davega 39  
Cosendal Moses 285  
Constance Loeb 211

Cordelia (dau. of Melvin) 39  
Cordelia M. (dau. of Philip Melvin) 39, 176  
Cordelia S. Moise 39, 195  
Cornelia (1805-1886) 35, 151  
Cornelia Alice 39, 206  
Cornelia Ann Jacobs 39, 132  
Cornelia C. (dau. of John) 39  
Cornelius (son of John J.) 39  
D. B. 2  
Daniel (b. 1869) 233, 336B  
Daniel (b. 1955) 275  
Daniel Hays 291  
Daniel Seixas (1827-1907) 38, 120  
David (Vienna) 305  
David Daniel (m. 1830) 35, 98  
David Daniel, Jr. 35, 260  
David Elias 63  
David Hays III 275  
David I. (1800-1847) 31, 32  
David I. (1870-1871) 32  
David Lopez (1820-1893) 36, 195  
David Mendes (1826-1891) 32, 281  
David Solis (1850-1928) 275  
David Solis II (b. 1899) 275  
De Leon 207  
Deborah (Dorothea) 285, 286, 287  
Deborah (m. 1967) 72  
Deborah (1776-1848) 180, 212  
Deborah (1795-1883) 285, 286, 287  
Deborah Marks 34, 185  
Deborah Sarah (b. 1692) 185  
Dinah 34, 322A  
Dinah Comgile or Congue 35  
Divinah (1787-1874) 35, 194  
Donah (d. 1878) 101  
Donald Pirrie (b. 1922) 31  
Dora Moise 36  
Dorothea (see Cohen, Deborah (Dorothea))  
Dorothy Dryfus 322A  
Douglas (b. 1875) 35  
Douglas (1886-1887) 31  
E. H. (see Cohen, Eleazer Hart)  
Edith (d. 1860) 38  
Edith Beatrice 33  
Edith Eugenia Tice (1867-1941) 309B  
Edith Martha (1846-1890) 33, 41  
Edward (b. 1864) 33  
Edward (son of George) 32  
Edward (1835-1888) 32, 217  
Edward (1875-1877) 295  
Edward B. 63  
Edward Everett 233, 336A  
Edward I. (1802-1803) 32  
Edward R. (1882-) 336A  
Edwin (b. 1855) 38  
Eleanor (dau. of Andrew Jacob) 31  
Eleanor (dau. of Solomon) 35, 176  
Eleanor (1823-1879) 38, 265  
Eleanor A. (m. 1845) 38, 63  
Eleanor Florance (b. 1885) 33  
Eleanor H. (1841-1874) 39, 265  
Eleanor J. 283  
Eleanor Moses 38, 39, 205  
Eleanor S. (1776-1849) 36  
Eleanor Septima (b. 1858) 32  
Eleazer Hart 36, 322A  
Eleazer Isaac (1862-) 322A  
Elias (b. Ger.) 309B  
Elielzer (d. 1873) 223  
Eliza (dau. of Jacob) 36  
Eliza (m. 1878) 35, 207  
Eliza (1800-1811) 35  
Eliza Bell Foster 322A  
Eliza Emory (b. & d. 1837) 32  
Eliza Estelle 233, 336B  
Eliza M. (dau. of Marx E.) 207  
Eliza M. (1829-1904) 32  
Eliza Virginia Moise 39, 197  
Eliza Virginia Moise (see also Cohen, Virginia Elizabeth)  
Elizabeth (d. 1873) 38

Elizabeth (Esther) Whitlock Mordecai 32, 200  
Elizabeth (m. A. J. Henriques) 112, 113  
Elizabeth (m. 1851) 38, 322A  
Elizabeth Bond 31  
Elizabeth Cohen (see Cohen, Elizabeth Cohen)  
Elizabeth Doris Buda 32  
Elizabeth K. 36  
Elizabeth Kohn 15  
Elizabeth Myers 33  
Elizabeth Virginia (Betsy) 275  
Elizabeth (1802-) 322A  
Elkaleh M. (1785-1875) 223  
Ella (b. 1859) 8  
Ella (m. George Harris) 306  
Ella Cox 322A  
Ella Levy Solomon 160  
Ella Moses Hart 97  
Ellen 180  
Ellen G. Wright 39  
Ellen Gertrude (b. 1845) 33  
Ellen Gertrude (dau. of Barnet) 33  
Ellen Loria Mordecai 32, 203  
Ellen Mordecai 32, 203  
Ellen (Nellie) Jackson Lewis 34, 130, 171  
Elliott St. P. 207  
Elsie Coon 34  
Emanuel 103  
Emily (b. 1862) 38  
Emily (dau. of Barnet Owens) 39  
Emily (dau. of Barnet) 33  
Emily (1809-1841) 137  
Emily Clara (1866-1903) 32  
Emily Elizabeth Montgomery 32  
Emily Johnston 32  
Emma (d. 1813) 180  
Emma 39  
Emma Louise Phillips 35, 247  
Ernestine (Esther) Lyons 34  
Eadaile P. (d. 1856) 31, 106  
Eadaile P., Jr. (b. 1882) 31  
Eadaile Philip (b. 1856) 31  
Easie (d. 1881) 36  
Estelle (b. 1865) 38  
Esther (b. 1849) 39  
Esther (dau. of Melvin) 39  
Esther (Hetty) Moses Moise 31, 145, 195  
Esther (Hetty) 180  
Esther (1748-1826) 35, 216  
Esther (1769-1855) 103, 180, 324B  
Esther (1782-1859) 261  
Esther (1784-1816) 38, 151  
Esther (1832-1897) 34, 259  
Esther (1850-1929) 34, 301  
Esther Isaacs 125  
Esther Lyons (see Cohen, Ernestine (Esther) Lyons)  
Esther Sampson 38, 259  
Ethel 36  
Ethel Sophia (1875-1920) 33  
Eudora Esther (1840-1841) 39  
Eugene Yancey 115  
Eugenia (1831-1859) 38  
Eunice Veronica Gibbens 31  
Eva (dau. of George) 32  
Eva (dau. of Isaac S.) 36  
Evelina Gleaves 33  
Evlyna 115  
Fanny (b. 1873) 35  
Fanny (dau. of Herman) 295  
Fanny (dau. of Isaac) 36  
Fanny (1815-1888) 33, 260  
Fanny M. (see Cohen, Frances (Fanny M.))  
Fanny Yates (b. 1840) 35  
Fanny (see also Cohen, Frances (Fanny) Cohen, Frumet (Fanny) Fishel 34  
Fishel Hartwig 34

Flora A. Henry (b. 1938) 33  
Flora Henry (1837-1898) 115  
Florence 38  
Florence Augusta (b. 1853) 39, 265  
Florence (1877-) 327B  
Foster E. 36, 322A  
Frances (d. 1890) 36, 243  
Frances (dau. of Barnet) 33  
Frances (Fanny M.) (1833-1913) 31, 74  
Frances (Fanny) Cohen 34, 38  
Frances (Fanny) (d. 1920) 34, 38, 309B  
Frances (Fanny) (dau. of Moses) 36  
Frances (m. Alfred) 34  
Frances (m. 1842) 70, 101  
Frances (1821-1899) 70, 101, 324B  
Frances Hays 31, 106  
Frances Sheftall (d. 1880) 36, 117  
Francis (b. 1858) 38  
Frederick (m. Flora Henry) 115  
Frederick (Samuel) (b. 1840) 33  
Frederick (1866/8-1954) 233  
Frederick George 32  
Fredericka (1848-1878) 17  
Frumet (Fanny) (d. 1793) 150  
George (b. 1847) 32  
George (m. Constance Loeb) 211  
George (son of Herman) 295  
George Lion 186  
George Washington 233, 336A  
George, Jr. 211  
Georgiana (1834-1905) 32  
Georgie (1856-1871) 32  
Georgina Bryant (b. 1841) 35, 247  
Gershon (1748-1802) 38, 262  
Gershon (1818-1885) 39  
Gershon (d. 1852) 39  
Gershon (m. Cecile) 202, 332A  
Gershon (1748-1802) 38  
Gertrude (b. 1858) 38  
Gertrude (Gettie) (m. 1893) 135, 306  
Gertrude Martha Samuel 35, 260  
Gettie 135, 306  
Gitlah (b. 1769) 33  
Gladys Lorraine Dodge (b. 1893) 309B  
Gwendl Lefman 337B  
Golda Rothschild 254  
Goodhour (see Cohen, Hora Bueno (Goodhour, Goody))  
Goody (see Cohen, Hora Bueno (Goodhour, Goody))  
Grace Seixas (1786-1865) 263  
Grace Seixas (1794-1866) 38, 266  
Graz (1845-1865) 35  
Gussie 36  
Gussie Ickelheimer 295  
H. Russell III 39  
Hadassa Barnett 16  
Hannah (b. 1848) 39  
Hannah (1806-1885) 65  
Hannah Jean Sleator 31  
Hannah Jean Weaver 32  
Hannah Moses 33  
Hannah Samuel 261  
Harriet (m. 1841) 38, 322B  
Harriet (1801-1889) 31, 32  
Harriet Allen 10  
Harriet Cohen 31, 32  
Harriet Lizzy Lieber 36, 174, 331A  
Harriet M. Newcombe 39  
Hartwig (1783-1861) 34, 185  
Hartwig A. (b. 1856) 38  
Helen (1872-) 327B  
Helene Anderson Lehman 233  
Helene S. Fineman 167  
Henrietta (dau. of Octavus) 35  
Henrietta Louise 180  
Henrietta Myers 306  
Henrietta Seixas (b. 1858) 36  
Henrietta Yates Levy 35, 169  
Henry (m. Madeline Sulzbacher) 285  
Henry (son of Andrew Jacob) 31  
Henry (son of John J.) 39, 322B

Henry (1810-1879) 33, 260  
Henry (1828-1888) 32  
Henry (1865-) 233, 336B  
Henry Barnet (1881-1915) 33  
Henry L. (1864-1932) 309B  
Henry Luria (1825-1829) 180  
Henry Russell 39  
Henry Russell, Jr. 39  
Henry S. (son of Abram S.) 36, 324B  
Henry S. (1817-1855) 38, 94, 259, 324B  
Herbert (b. 1851) 32  
Herbert (son of Edwin) 38  
Herbert (1846-1847) 35  
Herbert (see Cayton, Herbert)  
Herman 295  
Hester (Hetty) 180  
Hettie 33  
Hetty (dau. of Octavus) 36  
Hetty (m. 1826) 36, 280  
Hetty (see also Cohen, Esther (Hetty))  
Hora Bueno (Goodhour, Goody) (1767-1848) 180  
Horatio Seymour 233, 336B  
Hortense Solomons 277  
Howard 34  
Howard Jacob (b. 1869) 38  
Howard (1881-) 336A  
Hyam (son of Philip) 39  
Hyam (1789-1850) 38, 205  
Hyman 113  
Hyman Emanuel (1841-1863) 280  
I. 44  
Ida Beatrice 167  
Ida Florance (1857-1894) 31, 123  
Inez (b. 1871) 35  
Inez Lopez 36, 176  
Ira 34, 227, 322A  
Ira Helstein 91  
Irene Nelson 36, 37  
Isaac (b. 1842) 36  
Isaac (d. ca. 1787) 35, 36  
Isaac (Lancaster, 1747) 150  
Isaac (m. 1816) 36, 267  
Isaac (m. 1818) 221  
Isaac (see also Deshon, Isaac)  
Isaac (son of Melvin) 39  
Isaac (son of Samuel) 34, 130  
Isaac (1791-1846) 261  
Isaac (1793-1871) 36, 267  
Isaac (1794-1800) 35  
Isaac Barrett (1840-1865) 17, 36  
Isaac F. 36  
Isaac Harris (1874-1938) 167  
Isaac Henry (1859-1863) 36  
Isaac Leeser (b. 1861) 275  
Isaac Phillips (1883-1933) 34  
Isaac S. (m. 1894) 39  
Isaac S. (1801-1865) 36, 48  
Isabel (b. 1854) 38, 191  
Isabel (dau. of Asher) 35  
Isabel De Leon (1843-1892) 39, 206  
Isabel Emanuel (1848-1940) 275  
Isabella 39  
Isabella Levy 34  
Isabelle (dau. of Isaac S.) 36  
Isabelle (1827-1829) 180  
Isabelle Henry 115  
Isidore (1873-) 327B  
Israel (1820-1875) 32, 164  
Israel Barnet (d. 1873) 233, 336A  
Israel I. (1750/1-1803) 32  
Israel (1877-) 336A  
J. Barrett (son of Jacob) 36  
Jacob (b. 1825) 10  
Jacob (England) 34, 322A  
Jacob (father of Sarah Da Costa) 44  
Jacob (m. Rachel Workum) 306  
Jacob (m. 1849) 130  
Jacob (son of Aaron) 33, 104  
Jacob (son of Joseph) 36  
Jacob (son of Samuel) 34, 38, 322A  
Jacob (1741-1808) 35

Jacob (1792-1858) 103  
Jacob (1796-1871) 17, 35, 36, 176  
Jacob (1810-1814) 180  
Jacob (1829-1862) 101, 324B  
Jacob Barrett (d. 1885) 36  
Jacob H. 137, 326B  
Jacob I. (see also Cohen, John J. (Jacob I))  
Jacob I. (1744/7-1823) 200, 234  
Jacob I. (1784-1849) 38, 266  
Jacob I. (1789-1869) 32  
Jacob I. (1841-1920) 32, 203  
Jacob Quiatus 36  
Jacob Quiatus, Jr. 36  
Jacob Raphael (1738-1811) 180  
Jacob, Jr. (m. 1836) 36, 195, 243  
Jacquelyn Handler 11  
James (b. 1945) 15  
James Barnett 11  
James Matthew (see Rosenschein, James Matthew)  
Jane (dau. of Liepman) 309B  
Jane (1789-1843) 202, 272  
Janet Elizabeth (b. 1921) 31  
Jeanette Elias 63  
Jeanne 38  
Jennie 33  
Jennie Foster 36  
Jennie Lee 36  
Jennie Lee Kirkland 36  
Jessica 36  
Jessie (b. 1842) 39  
Jessie (dau. of Gershon) 39  
Jeute Oppenheim 235  
Joel Fineman 167  
Joel Pimental 44  
John Groves 36  
John III 39  
John IV 39  
John J. (Jacob I.) (1806-1884) 39, 132, 322B  
John Jacob (1823-1825) 32  
John Moss (1861-1892) 33  
John S., Jr. 39  
John Sanford 39  
John, Jr. (son of John J.) 39, 322B  
Joseph (m. 1858) 17, 36  
Joseph (son of Joseph) 36  
Joseph (son of Solomon) 35  
Joseph (1745/6-1822) 33  
Joseph (1832-1835) 33  
Joseph (1848-1853) 35  
Joseph B. 33  
Joseph Cecil (1848-1853) 35  
Joseph Joel (Rome, Ga.) 8  
Joseph Simon (1791-1858) 223  
Joshua (b. & d. 1788) 32  
Joshua (1720-1771) 32  
Joshua I. (1801-1870) 32  
Joshua I. (1860-1885) 32  
Josie Eisler 295  
Judah 150  
Judah Lewis (see Cohen, Walter (Judah) Lewis)  
Judith (dau. of Joseph) 33  
Judith De Lyon (m. 1779) 7, 57, 309B  
Judith I. (1827-1829) 32  
Judith I. Solomon 32  
Judith Lyon 35, 36  
Judith Peixotto Sulzberger Rosenschein 291  
Judith Simha Solis 274, 275  
Julia (dau. of John) 39  
Julia (m. Hammerschlag) 284  
Julia (1819-1906) 101  
Julia Aline 29, 313  
Julia Estell Nones 233, 336A  
Julia Jones 137, 326B  
Julia L. Clarke 39  
Julia Moss 39  
Julia Pike 250  
Julia Russell 39  
Julie 167

Justina Nathan 32, 226  
Kate (b. 1833) 279  
Kate (see Cohen, Katherine Emily (Kate))  
Kate Frances (1832-1890) 32  
Katharine Myrtilia (1859-1914) 33  
Katheline Carter 39  
Katherine (dau. of C. Henry) 39  
Katherine (dau. of Eugene Y.) 115  
Katherine Emily (Kate) 275  
Katherine Van Allen McHarg 36  
Kitty (1854-1856) 32  
Kitty Etting (1799-1837) 32, 67  
L. 298  
Laura (dau. of Isaac) 36  
Laura 2  
Laura Malvina 36  
Lavinia Cohen 34, 38  
Lavinia (1844-) 34, 38, 322A  
Lawrence (son of Philip) 39  
Lawrence (son of Samuel) 34  
Lawrence L., Jr. (1842-1870) 39  
Lawrence Ludlow (1815-1847) 39, 55  
Lazarus Esaias 254  
Leah (m. Hyman Cohen) 113  
Leah (m. 1909) 226  
Leah (see also Cohen, Lee (Leah))  
Leah Lazarus 35, 151  
Leah Tobias Harby 298  
Lee (Leah) (b. 1849) 35, 93  
Leeser Raphael Solis (1893-1920) 275  
Lena 329A  
Leona 167  
Leona Cohen 167  
Leonora (dau. of Aaron) 38  
Leonora (1827-1856) 34  
Leopold I. (b. 1904) 167  
Leopold I., Jr. (b. 1937) 167  
Levi 278  
Levy (d. 1774) 150  
Levy (see also Cohen, Lewis J. (Levy))  
Levy 110  
Levy Barent 137  
Lewis (1857-1915) 33  
Lewis J. (Levy) (1800-1868) 33  
Lewis Samuel 34  
Liepman (b. Ger.) 57, 309B  
Lillian (dau. of John Jay) 39  
Lillian (Liby) B. 295  
Lillian Arabella Bates 275  
Lillian Stinson 39  
Lillie E. Mueller 233, 336A  
Lily (dau. of Isaac S.) 36  
Lily B. (see Cohen, Lillian (Lily) B.)  
Lily Young 36  
Lionel H. (1888-1934) 309B  
Lois Bonner 39  
Lois Petashnick 167  
Louis (m. Samuella Levy) 330B  
Louis Le Hardy 277  
Louis (1870-1939) 327B  
Louise (m. Daniel) 336B  
Louise 194  
Lucile 37  
Lucretia (1807-1888) 35, 200, 201  
Lucy A. Dunn 233, 336A  
Lyna Schlezinger 282  
Mabel L. (1887-) 336A  
Mabel Lynch 38  
Madeleine 295  
Madeline (dau. of George) 295  
Madeline (dau. of Jacob) 34, 202  
Madeline Sulzbacher 285  
Madison (d. 1809) 93  
Margaret (1837-1902) 32  
Margaret Fox 39  
Margaret M. Meyer 34, 227  
Margery 191  
Maria (b. 1853) 32  
Maria (1830-1905) 32, 176  
Maria I. (1794-1821) 32  
Mariadina 322A  
Marian Edith (1860-1863) 36

Marie Bacoat 207  
Marie Young (dau. of Jacob) 36  
Marie Young 36  
Marietta (see Cohen, Seixas (Marietta))  
Marion (b. 1866) 36  
Marion (1875-1877) 36  
Marion L. 207  
Marion Young 36  
Marx E., Jr. (1839-1865) 35  
Marx Edwin (1810-1882) 35, 93  
Marx Edwin 207  
Marx Edwin, Jr. 207  
Mary Jane (1834-1856) 35  
Mary (dau. of Liepman) 309B  
Mary (dau. of Samuel) 34  
Mary (m. Lewis S.) 34  
Mary 57, 98  
Mary Clarke 39  
Mary Cohen 34  
Mary Eunice Bargmann 37  
Mary Hart 35, 98  
Mary Isaacs 33  
Mary Jane (1834-1856) 35  
Mary M. (1854-1911) 33  
Mary Thomas 39  
Matilda Samuel 33, 260  
Matilda Stern 32, 281  
Maurice 191  
Maurice Samuel 34, 249, 322A  
Mcduff (son of David) 35  
Melvin M. (m. 1857) 39, 197  
Mendes (1831-1915) 32, 226  
Mendes I. (1796-1879) 32  
Meyer (b. ca. 1700) 32  
Michael 35  
Michael Eliezer (d. 1835) 128  
Minnie (see Cohen, Alice Rebecca (Minnie))  
Miriam (dau. of Solomon) 35  
Miriam (1825-1906) 38, 73  
Miriam (1835-1891) 32  
Miriam Gratz (m. James Dent) 35  
Miriam Gratz Moses 35, 209  
Miriam Hart 35, 98  
Miriam Louisa De Leon 39, 55  
Miriam Seixas 36  
Mordecai (1763-1848) 35, 151  
Mordecai 69  
Morris 282  
Morris B. 10  
Moses (b. 1730) 285  
Moses (b. 1761) 33  
Moses (b. 1790) 35  
Moses (of Leavenworth, Kan.) 285  
Moses (1709-1762) 35  
Moses (1747-1790) 57, 309B  
Moses (1768-1829) 36, 212  
Moses A. 39  
Moses of Bristol, Eng. 39  
Moses Sheftall 36, 266  
Murray T. 11  
Myer David (1811-1865) 274, 275  
Myer Hyman 183  
Myer M. (son of Philip) 39  
Nathan A. (d. 1876) 38, 94, 322A  
Nathan A., Jr. 38  
Nellie Jackson 34, 130  
Nellie Lewis (see Cohen, Ellen ("Nellie") Lewis)  
Nellie Sheftall (1831-1865) 36, 117  
Nelson Phillips (b. 1917) 34  
Nora 39  
Nora Sneed 39  
Norman 38  
Octavia (b. 1844) 35, 206  
Octavia (dau. of Isaac) 36, 322A  
Octavia Cohen 36, 322A  
Octavia (b. 1843) 35, 247  
Octavus (son of Joseph) 36, 234  
Octavus (1814-1876) 35, 169  
Octavus (1850-1858) 36  
Octavus Phillips 35  
Octavus Roy (b. 1891) 36, 176  
Octavus Roy, Jr. (b. 1916) 36

Patricia Helen 11  
Patsy 125  
Pauline Barrett 17, 36  
Pearla (b. 1858) 16  
Peggy 125  
Peggy Anne Bear 34  
Percival 36  
Peslah (1723-1797) 32  
Peter 11  
Peter B. 207  
Phila Moise 36, 195  
Phila(h) (1787-1805) 38, 195  
Philip (d. 1786) 309B  
Philip (m. 1878) 36, 174, 322A, 331A  
Philip (1781-1866) 38, 39, 205  
Philip (1810-1837) 36  
Philip (1833-1896) 38  
Philip I. (1793-1852) 32, 218  
Philip L., Jr. 39  
Philip Lawrence (son of John) 39  
Philip Melvin (1808-1879) 39, 195  
Philip Percival (1844-1848) 39  
Phillip (see Cohen, Philip)  
Phillipe Oppenheimer 235  
Philippa (d. 1851) 39  
Phoebus 235  
Phyllis (b. 1918) 37  
Phyllis (dau. of Ralph) 125  
Porter 39  
Prade Behrens 337B  
Priscilla (1815-1860) 39  
Priscilla (1822-1833) 36  
Priscilla L. 39  
Priscilla Phillips 34, 249  
Rachael Harby 93  
Rachel (b. 1818) 36  
Rachel (b. 1838) 36  
Rachel (dau. of Barnett) 33  
Rachel (dau. of Isaac) 36  
Rachel (dau. of Joseph) 33  
Rachel (dau. of Moses) 35  
Rachel (m. Aaron Hart) 99  
Rachel (1777-1838) 180, 183  
Rachel (1783-1850) 223  
Rachel (1790-1851) 38, 322A  
Rachel Alexander 8  
Rachel B. H. (1801-1866) 39  
Rachel Etting (1825-1913) 32  
Rachel Jacobs 32, 234  
Rachel Lopez 35, 36, 176  
Rachel Moses 36, 212  
Rachel Shanon 101  
Rachel Tim 295  
Rachel Workum 306  
Ralph 125  
Ralph, Jr. 125  
Rebecca (b. 1782) 223  
Rebecca (b. 1791) 38  
Rebecca (d. 1840) 223  
Rebecca (dau. of Isaac) 36, 117  
Rebecca (b. 1857) 36, 322A  
Rebecca (dau. of Solomon I.) 36  
Rebecca (m. 1853) 38  
Rebecca (1797-1876) 36, 120, 322A  
Rebecca (1800-1884) 39, 195, 196  
Rebecca (1808-1880) 180  
Rebecca (1816-1871) 38  
Rebecca (1844-1899) 32, 130  
Rebecca Alice (1850-1852) 36  
Rebecca Benjamin Sheftall 36, 267  
Rebecca Catherine 39, 195, 196  
Rebecca Florence Otologui 36, 234  
Rebecca Luria 180  
Rebecca Myers 221  
Rebecca Phillips 36, 243  
Rebecca S. 36, 117  
Rebecca Sarzedas 38, 262  
Reider (son of George) 32  
Reinah (Rinah) (Rhina) (1783-1853) 203, 309B  
Rhode, Betty Green 167  
Rica Mendes 191  
Richard (b. 1944) 15

Richard N. 291  
Richa Edith 180  
Rinah S. (1799-1876) 36  
Robert V. 15  
Roddy 39  
Rodney S. 322B  
Rodney, Jr. 322B  
Rosa (dau. of Hartwig) 34  
Rosa Ellen (b. 1859) 36  
Rosa Ellen (d. 1833) 36  
Rosa Ellen (1839-184-?) 36  
Rosalie L. (1832-1893) 35  
Rosalie Meyer 34, 249, 322A  
Rosalie Myers 34  
Rosaline (1825-1871) 36  
Rose (dau. of Solomon) 33  
Rose (mother of Rachel) 99  
Rose Barnett 33  
Russell Pirrie (b. 1884) 31  
Russell Pirrie II (b. 1910) 31  
S. Mabel Clark 31  
Sallie (see Cohen, Sarah (Sallie))  
Sally (Sarah) (1776-1849) 33  
Sally (see Cohen, Sarah Emily (Sally))  
Sally Ella Harper 32  
Salome Solis 275  
Salomon (1846-1894) 320A  
Salomon Isaac (Zalma Rehine) (see Rehine, Zalma)  
Salvador (see Salvador)  
Salvadora 35, 309B  
Samuel (b. 1833) 250  
Samuel (d. 1864) 223  
Samuel (see also Cohen, Frederick (Samuel))  
Samuel (son of Barnett) 39  
Samuel (son of Jacob) 34, 322A  
Samuel (to U. S., 1832) 34  
Samuel Barnett (1857-1909) 322A  
Samuel Howard (b. 1881) 34  
Samuel M. (b. 1799) 223  
Samuella Levy 330B  
Sandford (son of John J.) 39, 322B  
Sarah (dau. of Benjamin) 101  
Sarah (dau. of Jacob) 103  
Sarah (dau. of Jacob) 36  
Sarah (dau. of Joseph) 36  
Sarah (m. Fishel Cohen) 34  
Sarah (m. 1720) 44  
Sarah (Sallie) 36, 37  
Sarah (see also Cohen, Sally (Sarah))  
Sarah (1732/7-1784) 185  
Sarah (1766-1853) 29, 36  
Sarah (1779-1848) 223  
Sarah (1791-1828) 38, 195  
Sarah (1810-1852) 36  
Sarah (1827-1892) 34, 304  
Sarah Barrett 17, 36  
Sarah Barrett (1809-1885) 17, 35, 36  
Sarah Cohen Moise 36, 195  
Sarah Emily (Sally) 275  
Sarah Ezekiel 69  
Sarah Henrietta (d. 1836) 36  
Sarah Henrietta (1799-1886) 35, 216, 245  
Sarah Hyatt (b. 1842) 34  
Sarah Janette Picken (see Cohen, (Sarah) Jane (or Janette) Picken)  
Sarah Judith Solomons 278  
Sarah Nathan (1829-1907) 38, 109  
Sarah Picken (see Cohen, (Sarah) Jane (or Janette) Picken)  
Sarah Samuel 261  
Sarah Soria 280  
(Sarah) Jane (or Janette) Picken 180  
Savannah Barrett 39  
Savannah Crawford 39  
Seixas (Marietta) 36  
Selig (Germany) 235  
Selig (m. 1850) 16  
Semmy (1841-1918) 327B  
Septima (b. 1829) 36  
Shirley Shapiro 167

Simha 39  
Solomon (London) 137  
Solomon (see also Deshon, Solomon)  
Solomon (son of Isaac S.) 36  
Solomon (1756-1835) 97  
Solomon (1757-1835) 35, 205  
Solomon (1776-1864) 261  
Solomon (1782-1854) 33  
Solomon (1802-1875) 35, 209  
Solomon (1816-1862) 36  
Solomon Barnett (1852-1855) 33  
Solomon Etting (1822-1878) 32  
Solomon Etting (1843-1847) 32  
Solomon I. (b. 1791) 32  
Solomon I. (1777-1850) 36  
Solomon L. (1835-1907) 33  
Sophia (b. 1863) 33  
Sophia Andrade 33  
Sophie 115  
Stanley (b. 1858) 33  
Stella 8  
Stella (1875-) 327B  
Susan 39  
Susan Lyons 183  
Sylvester (see Coleman (Cohen), Sylvester)  
Sylvester 40  
Thomas (b. 1942) 15  
Uri 38  
Victor Emanuel 233, 336A  
Victoria Billups (1906-) 36, 322A  
Virginia (1831-1834) 32  
Virginia Elizabeth (Eliza Virginia) Moise 39, 197  
Virginia Jacqueline (1845-1850) 36  
Virginia Jane Davis 36, 48  
Virginia Seixas (dau. of Moses) 36  
Virginia Zipporah Seixas (1854-1876) 36, 266  
Walter (Judah) Lewis (1856-1858) 30  
Whitfield 36  
William Henry 233  
Wolf Henry 33  
Zalegman (1840-1841) 36  
Zillah Phillips 34, 244  
Zipporah (d. 1838) 38, 322B  
Zipporah (1778-1810) 322A  
Zipporah (1804-1892) 36, 280  
Zipporah (1820-1878) 38, 280  
Zitella Esther (1852-1932) 275  
**COHEN (KOHEN)**  
Elizabeth Cohen 38  
Leopold 38  
**COHEN (NELSON)**  
Nelson Phillips (see Nelson, Nelson Phillips)  
**COHEN D'AZEVEDO**  
Abigail (b. 1768) 51  
Abigail (b. 1808) 51  
Abigail (m. 1722) 59  
Abigail de Moses 51, 58  
Alexander (1856-1863) 51  
Alfred 51  
Aron (b. 1773) 51  
Benjamin (b. 1764) 51  
Benjamin (b. 1815) 51  
Benjamin de Moses 51, 58  
Daniel (b. 1799) 51  
Daniel (b. 1840) 51  
Daniel (father of Moses) 51  
Daniel (son of Moses) 51  
Deborah (d. 1896) 51  
Ester Rodrigues Brandon 51  
Esther (dau. of Moses) 51  
Hannah Henriques 19  
Hannah Samuels 51  
Isaac (b. 1759) 51  
Isaac (b. 1799) 51, 305  
Joseph 59  
Joseph de Aaron 19  
Judith de Abraham De Paz 51  
Judith De Pass 51, 58  
Julia 51

Julia Benlisa 51, 171  
 Lea de Joseph 59  
 Moses (b. 1720) 51  
 Moses (b. 1790) 51  
 Moses (m. 1858) 51, 171  
 Rachel (m. 1786) 51  
 Rachel de Abraham Salom 51  
 Rachel de Jacob Lindo 51  
 Rachel Woolf 51, 305  
 Rebecca (b. 1771) 51  
 Reyna Benjamins 51  
 Samuel (b. 1770) 51  
 Sarah (b. 1793) 30, 51, 322B  
 Sarah (m. David Naar) 224, 225  
 Sarah (m. Joshua) 224  
 Sarah (m. 1800) 224, 225  
 Sarah (m. 1804) 51  
 Sarah (m. 1814) 30, 51  
 Sarah de Abraham Henriques Farro 51  
 Sophia (1814-1879) 51  
**COHEN DEL MONTE**  
 See Del Monte  
**COHN**  
 See also Coha, Colton, Kohn, Lewis  
 Abraham E. 320B  
 Adeline (b. 1903) 110  
 Albert (d. 1921) 110  
 Albert Einstein 253  
 Alice 320B  
 Alice Hendricks 111  
 Anne Frankenthaler 111  
 Barbara Lee 111  
 Betty Ann 252  
 Clara Arnold 320B  
 Edward Daniels (b. 1911) 51  
 Elizabeth Cohen 322A  
 Elizabeth Senabach 51  
 Eather K. Hagen 125  
 Fleurette Pizzi Daniels 51  
 Frederick 125  
 Fritz 89  
 Gertrude Springer 89  
 Harley Alma Lewis 171  
 Harry Reginald 51  
 Henry 111  
 Henry S. Cohn 13  
 Herman (Little Rock) 309A  
 James 270  
 Leopold 322A  
 Madeleine Isabel 125  
 Madeline Arnold 13  
 Margaret Ann 111  
 Marjorie Sidenberg 91  
 Meriam Sheftall Stroebel 270  
 Mildred Eather Clara 125  
 Pierre Danielle 89  
 Rachel 99  
 Ralph Frederick (see Colton, Ralph Frederick)  
 Richard James (see Lewis, Richard James (Cohn))  
 Rosebud Bitterman 309A  
 Rowena Hendricks 110  
 Ruth Walker Price 253  
 Sarah 145  
 Virginia Ellen (b. 1943) 51  
**COLBY**  
 Rebecca C. Hertz 117  
**COLE**  
 Albert 88  
 Antoinette Charles 208  
 Carolyn Dauby 294  
 David 294  
 Ellen Gries 294  
 Frances Moran Harby 208  
 Holly Dubose 208  
 Jean 88  
 Marguerite Haas 88  
 Marian Knight 208  
 Martha Lucinda 208  
 Peggy 88  
 Richard S. 294  
 Robert 88

Samuel N., Jr. 208  
 Samuel Norton 208  
 Sarah Ann 337A  
 Thomas Richard 294  
 William D. 337A  
**COLEMAN**  
 Bertha Weinreich 40  
 Carrie Victor 229, 334B  
 Charles 229, 334B  
 Charles Jay (1951-1954) 229, 334B  
 Doris 211  
 Dorothy Wiesen 229, 334B  
 Elinor 89  
 Eugenia Emma Nathans 229, 334B  
 Goldie 40  
 Gregory Robert 52  
 Harris 40, 229  
 Helene Stern 229, 334B  
 Isabella Nathans 40, 229  
 Isaiah 40  
 Jack (b. 1921) 229, 334B  
 Judith 40  
 Julia (b. 1894) 275  
 Kenneth Wayne 52  
 Leo Charles (1885-1951) 229, 334B  
 Leo, Jr. (b. 1915) 229  
 Lester, Jr. (b. 1936) 229, 334B  
 Mabeth Hallmark 52  
 Mark Allen 52  
 Nancy Lee 229, 334B  
 Olivia Marie (b. 1892) 229, 334B  
 Philip (b. 1954) 229, 334B  
 Philip Nathans (b. 1882) 229, 334B  
 Ray Kauffman 229, 334B  
 Rosalie 40  
 Rose Constance 308  
 Rufus Ezekiel Lester (b. 1889) 229, 334B  
 Sara Olivia (b. & d. 1884) 229  
 Sarah Amelia 308  
**COLEMAN (KOHLEMAN)**  
 Harris 40, 229  
**COLETE**  
 Anne Evangeline 78  
**COLLETT**  
 Louis 265  
 Pauline May Seixas 265  
**COLLIER**  
 Alfred A. 69  
 Anna 69  
 Armistead 10  
 Charles Willard 69  
 Eleanor Leighton Johnson 164  
 Miriam Allen De Ford 10  
 Rebecca Ezekiel 69  
 Sydney 164  
 William 164  
**COLLINS**  
 Abraham 254  
 Billy (see Collins, William (Billy))  
 Edith Tudor 138  
 Eugene Joseph 81  
 Frances Shaw 81  
 Georgina ("Kitty") Kathleen 138  
 Henry 138  
 Ian Reginald Grant 138  
 Ian Tudor 138  
 Katherine 58  
 "Kitty" (see Collins, Georgina ("Kitty") Kathleen)  
 Louise 268  
 Mary 138  
 Maude Evelyn 138  
 Miriam Isabelle Moss 214  
 Pere 138  
 Rebecca Gratz (Rhea) Joseph 138  
 Rhea Joseph (see Collins, Rebecca Gratz (Rhea) Joseph)  
 Sarah Hyams 120  
 Thomas S. 215  
 Tudor 138  
 Vere 138  
 William (Billy) 138

William 138  
 William Maunsell 138  
**COLLIS**  
 Amelia 164  
 Charles 164  
 Charles T. H. 164  
 Lloyd 164  
 Septima Maria Levy 164  
**COLOCHO-BOSQUE**  
 Andres Wade (1987-) 330A  
 Jaimes Andres (1960-) 330A  
 Sally Levy Foss 330A  
**COLTON**  
 Elsie Florence Gerrard 125  
 Ralph Frederick 125  
**COMPEAUX**  
 J. L. 46, 96  
 Katie Hart 96  
**COMPILE OR CONGUÉ**  
 Dinah 35  
**COMMINS**  
 Emilie Agnes 299  
**COMPTON**  
 Henrietta 215  
 Juanita Inez 52  
**CONAWAY**  
 Mary Faris Pancoast (-1930) 325B  
**CONE**  
 Adelaide 91  
 Alan Frank 91  
 Alan Wolf 91  
 Alan, Jr. 91  
 Albert 91  
 Alfred 91  
 Anne Wortham (b. 1939) 91  
 Barbara 91  
 Barbara Day Poinier 91  
 Barbara Sternberger 91  
 Benjamin (b. 1899) 91  
 Benjamin, Jr. 91  
 Bernard M. 91  
 Bertha Gomprecht 91  
 Bertha Lindau 91  
 Bessie Skutch 91  
 Betty 91  
 Blanche Campe 91  
 Caesar H. 91  
 Carol Spector 91  
 Caroline Koenig 91  
 Carrie 91  
 Cesar 91  
 Cesar II 91  
 Cesar III 91  
 Clarence N. 91  
 Clarence, Jr. 91  
 Claribel (1864-1929) 91  
 Claribel II (b. 1947) 91  
 Donald Frank 91  
 Edward Toner 91  
 Edwin 91  
 Elaine 91  
 Elaine Wolf 91  
 Elizabeth Gaitber 91  
 Ellen Guggenheimer (see Cone, Hellena (Ellen) Guggenheimer)  
 Emily 91  
 Emily Bundy 91  
 Etta (1870-1949) 91  
 Frank 91  
 Frederick 91  
 Frederick W. (1878-1944) 91  
 Harold 91  
 Hellena (Ellen) Guggenheimer 90  
 Herman (1828-1897) 90, 91  
 Herman (1895-1955) 91  
 Herman III 91  
 Herman, Jr. 91  
 Isabel 91  
 Isabel Frank 91  
 Jamie Carroll 91  
 Jeanette Boorman 91  
 Jeanette Siegel 91  
 John Oliver 91

Julius W. 91  
 Julius W., Jr. 91  
 Katherine Pease 91  
 Laura Weill Stern 91  
 Laurence Martin 91  
 Loretta Ray Lovier 91  
 Louis Williams 91  
 Louise Wolf 91  
 Madeleine Carabo 91  
 Marian Jones 91  
 Marjorie 91  
 Marjorie Sidenberg Cohn 91  
 Martha 91  
 Martha Abercrombie 91  
 Maxwell 91  
 Michele Nadine Caben 91  
 Monroe 91  
 Moses H. 91  
 Nancy 91  
 Peter 91  
 Richard 91  
 Robert Clarence 91  
 Robert K. 91  
 Rose M. Blatner 91  
 Sadie Frank 91  
 Samuel 91  
 Steven Bundy 91  
 Sydney M. 91  
 Sydney M. III (Teddy) 91  
 Sydney M., Jr. 91  
 Teddy (see Cone, Sydney M. III (Teddy))  
 Thomas Edward 91  
 Timothy 91  
**CONGER**  
 Laverne 211  
**CONGUÉ**  
 Dinah (see Congile or Congué, Dinah)  
**CONKLIN**  
 Frances Cole Donovan 130  
 Michael 130  
**CONKLING**  
 Abigail Hays 104  
**CONNALLY**  
 Katherine 119  
**CONNELLY**  
 Alice 313A  
**CONNOR**  
 Carol 283  
**CONNORS**  
 May 245  
**CONRAD**  
 Adrienne Cecile Rich 42  
 Alfred Haskell 42  
 Barnaby 155  
 David (b. 1955) 42  
 George Mather 199  
 Helen Upshur Hunt 155  
 Jacob (b. 1959) 42  
 Marie Aline Moise 199  
 Marion Kitchin 155  
 Paul (b. 1957) 42  
 William Hunt 155  
**CONROY**  
 Catherine 105  
 Katherine (1776-1812) 104, 105  
**CONSOLVO**  
 Blanche Hecht 107  
 Charles Hardy 107  
 Charles Swanson 107  
**CONTENT**  
 Adrienne Oberdorfer 40  
 Angeline 40  
 Augusta Lyons 6, 40  
 Blanche 40  
 Charles R. 40  
 Deborah 40  
 Estella 40  
 Esther 40  
 Florence 40  
 Florine 40  
 Hannah 40

Harold (son of Washington) 40  
 Harold (1887-1944) 40  
 Harry 40  
 Isabelle (d. 1920) 40  
 Isaiah 40  
 Marjorie (dau. of Harry) 40  
 Marjory (dau. of Washington) 40  
 Minnie Gallinger 40  
 Moses 40  
 Nancy 40  
 Noah 6, 40  
 Rebecca 40  
 Rosa (b. 1863) 40  
 Rosa (1834-1848) 40  
 Rosa 40, 322B  
 Simon 40  
 Solomon 40  
 Walter 40  
 Washington 40  
 Yetta 40  
**CONWAY**  
 Anna 25  
 Anne Augusta Giles 217  
 Jean Benton 208  
 Joel Dyer, Sr. 25  
 Rosina Block 25  
**COOK**  
 Edward Jeffery 238  
 Eileen Ann 237  
 Eather Moses Elsbree Wilkins 312B  
 Gussie Fox 238  
 Howard 270  
 Ida Sheftall Diaz 270  
 Kathleen 233  
**COOKE**  
 Bessie L. 80  
 Gertrude (b. 1869) 81  
 H. Whiteside 81  
 Millicent Hamilton Johnson 81  
**COOL**  
 Frederick 265  
 Pauline May Seixas Collett 265  
**COOLEY**  
 Frances Celestine Forster 45  
 Vincent (son of Vincent) 45  
 Vincent 45  
**COOMBS**  
 Mary Louise (1826-1904) 97  
**COON**  
 Elsie 34  
**COONEY**  
 Audrey Ellen Whitaker 239  
 Evelyn 239  
 Hattie H. Oppenheimer 239  
 Joan Roselyn Brady 239  
 Joseph Raymond 239  
 Kevin Richard (see Allen (Cooney), Kevin Richard)  
 Mary Cutler 239  
 Micalyn Celia Florence 239  
 Peter Albert 239  
 Richard Albert 239  
 Roslyn Lucille 239  
 Virginia Carroll (see Maxwell (Cooney), Virginia Carroll)  
 Virginia Dorothy Brown Manning 239  
 Walter Julian (see Maxwell (Cooney), Walter Julian)  
 William Patrick (see Maxwell (Cooney), William Patrick)  
**COOPER**  
 Alice 38  
 Ana Louise 196  
 Anna Rose Cleve 157  
 Anne Kameya-lyate 77  
 Annie Gaillard 268  
 Betty Anne Moise 196  
 Drury W., Jr. (b. 1901) 157  
 Drury Walls 157  
 E. M. 328B  
 Eddie Lee, Jr. 196  
 Edward Biddle 41  
 Edward Richard (b. 1921) 41

Edward Williams 41  
 Elizabeth (b. 1906) 157  
 Elizabeth Josepha 77  
 Esther Nicholas (b. 1900) 157  
 Esther Stevenson Nicholas 157  
 Eva Cromline 41  
 Fairlie 216  
 Isabella Ann 77  
 Isabella Bell Franks 75, 77  
 Jacob (b. 1908) 157  
 John Nicholas (b. 1910) 157  
 Lee Derrick 196  
 Madeline Cohen Mordecai Harris 34, 202  
 Maria 285  
 Marie Charlotte Evans Walsh 41  
 Mary Anne 77  
 Mary Linn (b. 1904) 157  
 Raymond 34  
 Richard Lawlor (b. 1914) 157  
 Steven Humphreys (b. 1898) 41  
 Theodore Woolsey (b. 1913) 157  
 William H. 75, 77  
 William Henry (m. 1787) 75, 77  
 William Henry (son of W. H.) 77  
**COPE**  
 George L., Jr. 156  
 Harris Goodwin (b. 1880) 156  
 Hunter (b. 1883) 156  
 Mary Clayton Law 156  
**COPFLAN**  
 Augusta (1877-1979) 322A  
**COPLEY**  
 Sophia Clarence 79  
**COPPE**  
 Edith Vivian 204  
**COPPEL**  
 Charles 260  
 Kate Hess 260  
**COPPELS**  
 Irene (b. 1921) 166  
**CORCORAN**  
 Anita Marie Caley 330A  
 Stephen Allen (1952-) 330A  
**CORD**  
 Ann Elizabeth Emory 158  
**CORDOVA**  
 See De Cordova  
**COREY**  
 Caryl 288  
 Donna 72  
**CORINALDI**  
 Linda 26  
**CORISTINE**  
 Claudia W. 183  
**CORLIES**  
 Barbara 336A  
**CORN**  
 Florence Beatrice Hays 104  
 Joseph J. (d. 1947) 104  
**CORNELIE**  
 Alice 29, 309A  
**CORNELL**  
 Catherine M. Roth 237  
 Deborah 237  
 James (son of James) 237  
 James 237  
 Richard 237  
**CORONEL Y FONSECA**  
 Antonia De Paz 273  
**CORREA**  
 Aaron 55  
 Gracia Alvares 178  
 Pardo 225  
 Rachel (1807-1890) 26, 55  
 Rachel Israel 178  
 Rose de Moses Marius A. 62  
 Sarah De Leon 55  
**CORRELL**  
 Eva (Amberg) 252  
**CORSE**  
 Lena Burr 80  
**CORTISSOZ**

Deborah 18  
**COSGROVE**  
 Austin Brennan 253  
 Stella Beavenida Ritterband Hennekins 253  
**COSHMAN**  
 - (1750-1808) 285  
**COTHMAN**  
 Mary Anne Jenkins 298  
 Samuel Bynum 298  
**COTTON**  
 John B. 248  
 Rosina Phillips 248  
 Sophia Phillips 248  
**COUCH**  
 Alice 266  
 Hallie McLeary 180  
 Jessie (Male) 180  
 Kate 180  
 Nettie 180  
 Sloan 180  
 Sloanie 180  
 Stella 180  
**COULTER**  
 B. W. 119  
**COURSELLE**  
 Michel 276  
**COUTINHO**  
 Rachel de Isaac Henriquez 178  
**COWELL**  
 Hannah Marache 184  
 John V. 184  
**COWEN**  
 Elfrida (b. 1888) 275  
 Ella Theresa O'Neill 298, 299  
 Erica 102  
 Isabel(la) (1807-1880) 298  
**COWLES**  
 Adeline 94  
 Edith Clark 94  
 Julius D. 94  
 Nancy Cardoza Egelson 29  
 Russell 29  
**COX**  
 Anye 52  
 Catherine Louise 299  
 Coleen Robin (1961-) 322B  
 Ella 322A  
 Ethel Irene 228  
 Janice Marie Thoeni 322B  
 Karen Michelle (1972-) 322B  
 Kevin Timothy (1959-) 322B  
 Leila Davega (1866-1926) 322B  
 Lynda Marie (1970-) 322B  
 Mary 188  
 Rebecca Ann Wolf 322B  
 Robert Edward (1932-) 322B  
 Rose Goldsmith Mortimer 125  
 Thomas Williams 125  
 Tiffany Theodora (1982-) 322B  
 Vivian De Cordova 52  
 W. B. 322B  
 William A. 52  
**CRADDOCK**  
 Katherine 276  
**CRAFT**  
 Annabelle Holt 337A  
**CRAIGER**  
 Benjamin 237  
 Irving 182  
 Miriam Polak 182  
 Raynor 182  
 Tillie Wasch Rothgeiser 237  
**CRAIG**  
 Catherine 295  
 Mary Elizabeth (1864-1943) 257  
**CRAIG**  
 Jane Boyden 183  
**CRAIGG**  
 Honor Daniels 51  
 John William Lackland 51  
**CRAMER**  
 Hannah Rebecca Sheftall 267

Mary W. Sheftall Bowman 267  
 Robert Godwin 267  
**CRAMER (7)**  
 Sarah Solomon Neal 273  
**CRAMPTON**  
 Laura Stanley 197  
**CRANE**  
 Frances Seixas 265  
**CRANO**  
 See De Crano  
**CRASTO**  
 See De Crasto  
**CRAVEN**  
 Alfred Edmiston (b. 1855) 157  
 Amy McDonald (b. 1881) 157  
 Augustus C. (1841-1863) 157  
 Ellen Travers (b. 1850) 157  
 Lois Tibbets Whittlesey 157  
 Louis Stevenson (1845-1888) 157  
 Maria Louise Stevenson 157  
 Marie Louise (b. 1886) 157  
 Mary A. 157  
 Mañilda C. McDonald 157  
 Nelda (b. 1892) 157  
 Tunis Augustus Macdonough 157  
**CRAWCOUR**  
 Arthur (1861-1873) 74  
 Clarence 74  
 Isaac Lionel (1825-1886) 74  
 Myrtila Florance 74  
 Sarah 74  
**CRAWFORD**  
 Andrew W., Jr. (b. 1909) 31  
 Andrew Wright 31  
 Anna 158  
 Clotilda Florance Cohen 31  
 Clotilda Randolph (1907-1909) 31  
 Edith C. De Hoff 31  
 Harriet Cutler Henriques 112  
 John Yocum Randolph (b. 1915) 31  
 Joseph Ury 112  
 Savannah 39  
 Serita 112  
**CRAWLEY**  
 Charlene Gayle 163  
 Eleanor Charlene Faught 163  
 Eleanor Louise 163  
 Louise Crawley 163  
 Lulie Levy 163  
 Patricia Grace 163  
 Patricia Hennessey 163  
 Robert J., Jr. 163  
 Robert Jocelyn 163  
**CREAGAN**  
 Leroy J. 239  
 Roslyn Lucille Cooney 239  
**CREAMER**  
 Bertha A. Levin 233  
 James E. 267  
 Raymond 233  
 Sarah Florence Sheftall 267  
**CREASY**  
 Isabella (d. 1943) 201  
**CRENSHAW**  
 Mary Wise 188  
 Parker 188  
**CRENSHORE**  
 Frank H. 30  
**CRESS**  
 Margarita 155  
**CRIBB**  
 Annabel 206  
 Emily Ann 198  
**CRISTALAR**  
 Aaron 130, 326A  
 Alexander M. 130, 326A  
 Anna Jackson 130, 326A  
 David 130, 326A  
 Jehiel (1835-) 326A  
 Sophia 130, 170  
**CRITWELL**  
 Effie Hart (see Critwell, Mary Edith

(Effie))  
 Mary Edith (Effie) Hart 96  
**CROCKIN**  
 Barbara Lynn 108  
 Betty Van Os 108  
 Emily Ellen 108  
 Melvin Lee 108  
 Susan 108  
 Susan Lee 108  
**CROFTON**  
 Florence Evangeline Colet Northey  
 Clowes Martin 78  
 Richard Cecil Milman 78  
**CROGHAN**  
 See also Cromlien, Cromline  
 Adeline (or Amelia) 41  
 Albiona Solis 41, 274  
 Amelia (see Cromelien, Adeline (or Amelia))  
 Betsy 47  
 David (1780/1-1843) 41  
 Edith Martha Cohen 33, 41  
 Esther 41, 250  
 Hannah 41, 280  
 Henriette Nathan(s) 41  
 Mary 47  
 Rosalie (1839-1887) 41, 43  
**CROMER**  
 Marguerite 198  
**CROMLINE or CROMLIEN**  
 See also Cromelien  
 Adeline (1831-1909) 41  
 Agnes (1877-1920) 41  
 Alexander (b. 1814) 41  
 Alfred 33, 41  
 Amelia (dau. of David) 41  
 Amelia (Emily) Judah 41, 139  
 Amelia Isaacs Steinfeld 41  
 Amelia Judah 42  
 Charlotte (b. 1813) 41  
 David (b. 1845) 41, 189  
 Deborah (1840-1841) 41  
 Elizabeth (1830-1844) 41  
 Esther (b. 1810) 41, 250  
 Esther (b. 1825) 41  
 Eugene (b. 1850) 41  
 Eva (b. 1865) 41  
 George (1812-1879) 41  
 Hannah (b. 1809) 41, 281  
 Hannah Naomi (1827-1832) 41  
 Henrietta (1833-1895) 41  
 Isaac Henry Clay (1848-1854) 41  
 Isador (1851-1894) 41  
 Jacob (Washington) 41, 274  
 James Monroe (b. 1835) 41  
 Jessy (1829-1832) 41  
 Josephine (1837-1848) 41  
 Leon (b. 1807) 41  
 Maud (b. 1872) 41  
 Monroe (see Cromline, Morris (Monroe))  
 Morris (Monroe) (b. 1805) 41  
 Pauline (b. 1816) 41  
 Pauline (b. 1847) 41, 42  
 Rachel (1823-1904) 41, 174  
 Rosalie Salomons 41  
 Rowland (b. 1804) 41, 139  
 Sally Marx 41, 189  
 Washington (see Cromline, Jacob (Washington))  
**CRONE**  
 Diane 326A  
**CRONIN**  
 May 172  
**CRONK**  
 Grace 215

**CROSBY**  
 Miriam Gratz 88  
 Pierce 88  
**CROUCH**  
 Jennie Harby 207  
 M. T. 207  
**CROWDER**  
 Kitty 312B  
**CROWN**  
 Catherine Calder (1954-) 329A  
 John Albert 329A  
 John Albert, Jr. (1950-) 329A  
 Sue Brent Calder 329A  
 Sue Brent (1949-) 329A  
 Treadwell Rice (1952-) 329A  
**CRUGER**  
 Anne De Lancey 76  
 John Harris 76  
**CRUM**  
 John Wesley 98  
 Priscilla Hart 98  
**CRYSTAL**  
 Bernard 311A  
 Marjorie Henriette Herne (m. 1936) 311A  
 Rose 305  
 Thomas Herne (b. 1938) 311A  
**CUBBEDGE**  
 Clarence H. 216  
 Cooper M., Jr. 216  
 Cooper Myers 216  
 Nelle Christine Belle 216  
 Sarah Henrietta 216  
 Mary 47  
**CUELLAR**  
 Adolph C. 196  
 Dora Moise (see Cuellar, Theodora Gregoria (Dora) Moise)  
 Eloisa 196  
 Theodora Gregoria (Dora) Moise 196  
**CULLMAN**  
 Alexandra Miriam 285  
 Beatrice A. 285  
 Bradley A. 285  
 Brian Henry 285  
 Candice Carol 285  
 Carolyn Sue 285  
 Cecilia Stein 285  
 Daniel Hugh 285  
 Dorothy Benenson 285  
 Dorothy C. 285  
 Dorothy M. (b. 1939) 285  
 Duncan T. 285  
 Edgar M., Jr. 285  
 Edgar Meyer (b. 1918) 285  
 Elissa 285  
 Elsie Gottheil 285  
 Frances N. Wolff 285, 305  
 Frances Nathan (b. 1910) 285  
 Georgia Brady 285  
 Howard Stix (b. 1891) 285  
 Hugh 285  
 Hugh, Jr. 285  
 Jeffrey Scott 285  
 Joseph F. III (b. 1912) 40, 285  
 Joseph F., Jr. (1881-1955) 285, 305  
 Joseph Ferdinand (b. 1854) 285  
 Katherine Victoria 285  
 Laurel Caroline 285  
 Lena 285  
 Lewis Benjamin (b. 1919) 285  
 Louise Bloomingdale 285  
 Lucy 285  
 Marguerite Patricia ('Peggy') 285  
 Marguerite Wagner 285  
 Nan Ogburn 285  
 Paul Thomas 285  
 Peggy (see Cullman, Marguerite Patricia ('Peggy'))  
 Peter A. 285  
 Richard L. 285  
 Steven Howard 285  
 Susan Lehman 40, 285  
 Susan R. 285

Thais MacBride 285  
 William A., Jr. (b. 1939) 285  
 William Arthur (b. 1914) 285  
 Zillah Stix 285  
**CULP**  
 Alta Lenore (Elenor) 173  
 Elenor (see Culp, Alta Lenore (Elenor))  
 Emma Eger Hertz 117  
 J. B. 117  
**CULVER**  
 Henry 13  
 Irma Clara Asch 13  
**CUMMING**  
 Elizabeth Northey (b. 1910) 78  
 Ina Mary (b. 1914) 78  
 Malcolm 78  
 Malcolm Edward Durant (b. 1907) 78  
 Mary Northey 78  
**CUMMINGS**  
 Carolyn 83  
 Marion Barnet 15  
 Maud 216  
 Maunie Mildred 216  
 Robert 15  
**CUNNINGHAM**  
 Ann Moses 312A  
 Douglas 312A  
 Margaret Amanda 50  
 May 135  
 Thomas 312A  
 William 312A  
**CURIEL**  
 Abigail (m. Abraham Lopez Da Fonseca) 178  
 Abigail (m. Isaac Lopez Da Fonseca) 178  
 Isaac de Jacob 178  
 Jacob 250  
 Ribca Gama 250  
 Ribca Lopez (Da Fonseca) 178  
 Sarah de Joseph 178  
**CURLAND**  
 Bettie 329B  
**CURLY**  
 Bevenida Valentina Henriquez Da Silva Solis Sonneborn 335A  
 Denis Michael 335A  
 Lynn Whitlock Bernstein 335A  
**CURTIN**  
 Elizabeth Nones Ballard Ewing Payne 337A  
 Henry W. 337A  
**CURTIS**  
 Buford Bryce 205  
 Cynthia Grinsley 205  
 Franklin James 205  
 Henry (son of Henry) 205  
 Henry 205  
 Josephine Seabrook 57  
 Leila Tobias 298  
 Lonnie Buford 205  
 Lonnie Hake 205  
 Marion Howard 221  
 Richard B., Jr. 205  
 Richard Brice 205  
 Sally 22  
 Thomas B. 298  
 Zella Cherry 125  
**CURTISS**  
 Beth Susan Nusbaum 301, 340B  
 Catherine Ashley (1983-) 340B  
 Charles M. 180  
 Henry Finer 180  
 Laura Meredith (1980-) 340B  
 Mabel Estelle 80  
 Rand Marshall 301, 340B  
 Rosa Finer 180  
**CUSACK**  
 Helen 30  
**CUSHFLL**  
 Fanny (1749-1809) 150  
**CUTLER**

Evelyn ? 239  
 Jane 166  
 Mary 239  
 Teenie 296  
**CUTSON**  
 Michael 207  
 Robin Leigh Moses 207  
**DA COSTA**  
 Aaron (Amsterdam) 44  
 Aaros (Charleston) 44  
 Abigail 44  
 Abraham (Amsterdam) 44  
 Abraham (Charleston) 44  
 Abraham (Jamaica) 178  
 Abraham Mendes 258  
 Adele Lopez 178  
 Alice 297  
 Benjamin Mendes 305  
 C. Mendes 305  
 David (son of Abraham) 44  
 David (son of Solomon) 44  
 Elias Charles Mendes 305  
 Elkah Wolff 305  
 Esther de Abraham Moses Mendes 61  
 Esther de Benjamin Gomes 58  
 Esther de Pass 28, 44, 58  
 Gabriel (see Da Costa, Uriel (Gabriel))  
 Isaac (Brazil) 44  
 Isaac (d. 1830) 44  
 Isaac (father of Abigail) 44  
 Isaac (Portugal) 44  
 Isaac (son of Joseph) 44  
 Isaac (1721/22-1783) 44  
 Isaac, Jr. (1746-1809) 44  
 Jacob (d. 1780) 106  
 Jacob de Abraham Mendes 258  
 Jacob Mendes (England) 258  
 Jacob Mendes (m. 1843) 305  
 Jane Samuel (see Da Costa, (Schoenche) Jane Samuel)  
 Jonathan Mendes 171  
 Joseph (Brazil) 44  
 Joseph (Joao Perez De Cunha) 44  
 Joseph (son of Isaac) 44  
 Joseph (1759-1809) 44, 58  
 Joshua de Jacob de Abraham Mendes 258  
 Leah Wolff 305  
 Luna (1813-1860) 178  
 Maria Eliza Brandon 26  
 Maurice 26  
 Miriam Wolff 305  
 Mordechai (Miguel Esteves De Pina) 44  
 Moses (son of Isaac, Jr.) 44  
 Moses de Jacob Mendes 258  
 Moses Mendes 258  
 Moses Pimienta (Pimental) 44  
 Obadiah M. (d. 1848) 26  
 Rachel (m. 1775) 298  
 Rachel (m. 1778) 44, 262  
 Rachel (m. 1783) 106  
 Rachel de Moses Mendes 258  
 Rachel Mendes 258  
 Rachel Mendez (see Mendez, Anna de Antonio (Rachel Mendez Da Costa))  
 Rachel Nunes 44  
 Rahma Levy 171  
 Rebecca (dau. of Isaac, Jr.) 44  
 Rebecca (Judith) Salvador 258  
 Rebecca de Pass (m. 1768) 44, 58  
 Rebecca Pimental 44  
 Rebecca Salvador 258  
 Ribca de Judah Nunes 61  
 Samuel (son of Solomon) 44  
 Samuel (1762-1794) 44, 58  
 Sarah (m. 1779) 44  
 Sarah (m. 1823) 28, 44  
 Sarah (1767-1816) 44, 262  
 Sarah Adde Brandon 26  
 Sarah Cohen 44



Sarah Mendes 26  
 Sarah Pimental (d. 1793) 44  
 (Schoenbe) Jane Samuel 44  
 Solomon (Lond.) 44  
 Uriel (Gabriel) (1585-1640) 44  
**DA FONSECA**  
 David Nunes 178  
 Esther (d. 1787) 26  
 Joseph 26  
 Joshua 26  
 Sarah Miranda 26  
**DAGAMA**  
 See Gama  
**DAGILE**  
 Mavia 258  
**DAHL**  
 Gertrude Agnes 201  
**DAHLMAN**  
 Jacob 50  
 Rosetta Davis 50  
**DAILEY**  
 Louise 30  
**DALE**  
 Dorothy Davis 153  
 Evelyn 153  
 Graham 153  
 Marjorie Ethel 153  
**D'ALEMBERT**  
 Alfred 245  
 Madeline Phillips 245  
**DALFANDRO**  
 Barbara 270  
**DA LIMA**  
 Duarte 273  
 Rebecca De Duarte 273  
**DALLA MURA**  
 Emily Tobias Figg 299  
 Richard 299  
 Sallie (b. 1953) 299  
**DALLETT**  
 Henrietta Mary ('Mme. Majeska') 284,  
 339B  
 Morris, Jr. 284, 339B  
**DALLOFF**  
 Margaret 287  
**DALSIMER**  
 Annette Estner 28  
 Charles Estner (b. 1934) 28  
 Clara Cadette Schoneman 28  
 Emma Snaidman 28  
 James Edward (b. 1952) 28  
 John (b. 1937) 28  
 Paul (b. 1905) 28  
 Walter 28  
 Walter II 28  
**DALTON**  
 Marguerite (1788-1854) 228  
**DAMON**  
 Lilabel 281  
**DANA**  
 Lizzie 52  
**D'ANCONA**  
 Mildred 286  
**DANDO**  
 Ida May 230  
**DANIEL**  
 Catharine Winnifred Judah 141  
 Charlotte 285  
 Elvira Augusta Stuart 128  
 Henry Martin 141  
**DANIELS**  
 Alfred Benjamin (1847-1915) 51  
 Anna (see also Daniels, Hannah  
 Sophia (Anna))  
 Anna Marie (b. 1882) 51  
 Arthur Benjamin D'Azevedo (b. 1889)  
 51  
 Bernard 182  
 Benjamin D'Azevedo Elias (b. 1872)  
 51  
 Blanche Caroline (b. 1885) 51  
 Blanche Sophia 51  
 Clarence D'Azevedo (1887-1954) 51

Edith D'Azevedo (b. 1883) 51  
 Edna Sophia (b. 1883) 51  
 Edward S. (d. 1905) 51  
 Ethel Florence (1889-1924) 51  
 Faany Herzberg 51  
 Fleurette D'Azevedo 51  
 Fleurette Finzi (b. 1885) 51  
 Fleurette Miriam (1853-1916) 51  
 Florence D'Azevedo (see Daniels,  
 Fleurette D'Azevedo)  
 Hannah Sophia (Anna) (1845-1900) 51  
 Honor (1875-1957) 51  
 Jane (Judith) (1840-1920) 51  
 Jonathan 182  
 Joshua (see Daniels, Julius (Joshua)  
 Judith (see also Daniels, Jane (Judith))  
 Judith Deborah 51  
 Julius (Joshua) (1841-1907) 51  
 Mary Bonyon 51  
 Michael 182  
 Minnie Japeth 51  
 Raynor Crager 182  
 Ronna Ludgen 182  
 Samuel Elias (b. 1877) 51  
 Samuel Elias (d. 1853) 51  
 Sophia D'Azevedo 51  
 Sophia Mary Bonyon 51  
 Stanley D'Azevedo (b. 1887) 51  
 Stephen W. H. D. 51  
**DANKWERT**  
 Moses 235  
 Sarah Miriam (1698-1728) 235  
**DANNENBAUM**  
 Alexander W. III 284  
 Alexander W., Jr. 284  
 Alexander Wilfred 284  
 Dorothy Katzenberg 284  
 Genevieve Ryan 284  
 Henrietta Mary ('Mme. Majeska')  
 Stern 284  
 Joan Ellen 284  
 Margaret 23  
 Mary Anne 284  
 Paul 284  
 Stephen 284  
**DANZIGER**  
 Rosalie 332A  
**DANZINGER**  
 Charles 115  
 Dorothy 115  
 Flora Henry 115  
 Lucy 115  
 Lucy Cullman 285  
 Marcus 115  
 Michael 285  
**DARBY**  
 Elaine 23  
**DARCHE**  
 Eleonore V. 322B  
**DARGAN**  
 Mary S. 147  
**DARLICH**  
 Marlene Lois Fox 236  
**DARLING**  
 Clarence L. 143, 327A  
 Dorothy Dobbins 327B  
 Jessie Greenebaum 143, 327A  
 Walter L. (1911-) 327B  
**DARIS**  
 Elizabeth 232  
**DARNELL**  
 Gene Davis 125  
**DA SILVA**  
 Andreas 273  
 Beatrice Pinto 273  
 Branca (Da Solia?) Dias 273  
 Branca Mendes (Rachel Da Silva) 273  
 Catherina 273  
 Catherina Henriques Jorge 273  
 Cuglielmo (Joao Da Silva or Daniel  
 Da Silva Solis) 273  
 Diogo Pinto ('Carlos Nery' (Very?) or  
 Isaac (Israel?) Da Silva Solis)

(1629-1676) 273  
 Diogo Pinto (Didacus Pinto De Sylva)  
 273  
 Duarte (Portugal) 273  
 Duarte (1596-1688) 273  
 Francisco 273  
 Joao (see Da Silva, Cuglielmo (Joao  
 Da Silva or Daniel Da Silva Solis))  
 Josuah 62  
 Miguel Pacheco (see Seixas, Abraham  
 Mendes)  
 Moses 62  
 Rachel (dau. of Josuah) 62  
 Rachel (m. 1683/4) 273  
 Rachel (see also Mendes, Branca  
 (Rachel Da Silva))  
 Rachel Del Sotto 273  
 Rachel Nunez 273  
 Rebecca (in N. Y. 1729) 62  
 Rebecca (m. Abraham Salvador) 258,  
 338B  
 Rebecca De Duarte Da Lima 273  
 Samuel 62  
 Simba (dau. of Josuah) 62  
 Simha (1677-1746) 62  
 Simon 273  
**DA SILVA Y CASTRO**  
 Abraham (see Da Silva Y Castro,  
 Antonio or Fernando (Abraham Da  
 Silva Y Castro))  
 Antonio or Fernando (Abraham Silva  
 Y Castro) (b. 1667) 273  
 Eleonora (Sarah) 273  
 Ester (see Da Silva Y Castro, Juana  
 Blanca (Ester))  
 Fernando (see Da Silva Y Castro,  
 Antonio or Fernando (Abraham Da  
 Silva Y Castro))  
 Gracia Del Sotto 273  
 Juana Blanca (Ester) 273  
 Maria Voa Der Does 273  
 Sarah (see Da Silva Y Castro,  
 Eleonora (Sarah))  
**DA SILVA Y SOLIS**  
 Francisco (b. 1633) 273  
 Philippa De Castro 273  
**DA SOLIS**  
 Isabella 273  
**D'ASSERGIO**  
 Alice Gross Horwitz 118  
**DATER**  
 Henry 105  
 Mary Hays 105  
**DAUBY**  
 Lillian 294  
 Lucile 294  
**DAUGHTON**  
 Chester 270  
 Mildred Shefall 270  
**DAUGHTREY**  
 Muriel McMahon 192  
**DAUGHTRY**  
 Fannie Mae 52  
**DAUTERIVE**  
 Bernard Frederick 199  
 Lucille Moise 199  
**DAVEGA**  
 Abraham Henry (1823-1897) 45, 322B  
 Abram David 45, 322B  
 Alexandrina 322B  
 Amanda (1831-1838) 45  
 Benjamin Franklin (1819-1891) 45,  
 322B  
 Cecilia Alice Joseph 322B  
 Columbus (1829-1882) 45  
 Cordelia Alice Seixas 45, 265  
 David (1818-1822) 45  
 Dora 45, 210  
 Dorothy 45  
 Dorothy Wilhelmina Roth 45  
 Eleonore V. Darche 322B  
 Eliza J. McClure 45, 322B  
 Eliza Jane (1869-) 322B

Florence (1870-) 322B  
 Grace Labatt 45, 148, 322B  
 Grace (1873-1940) 322B  
 Harold 45  
 Harry Sidney 45  
 Hope Weiss 45, 322B  
 Irene (1864-1945) 322B  
 Isaac (b. 1825) 45, 211  
 Isaac (1796-1835) 45, 148, 322B  
 Isaac (1860-1921) 45, 322B  
 Isaac (1863-1907) 322B  
 Jefferson Edgar (1862-1931) 322B  
 Jessie 322B  
 Joseph (1861-1913) 322B  
 Kate Cannon 322B  
 Leila (1866-1926) 322B  
 Marie 45, 322B  
 Mary (1871-) 322B  
 Moses (ca. 1760-1833) 45  
 Moses (1816-1838) 45  
 Nadine Cecilia (1909-1982) 322B  
 Nadine Hargreaves (1885-1918) 322B  
 Patricia Anne 45  
 Rachel J. (1801-1865) 17, 45  
 Rebecca Louise Moses 45, 211, 322B  
 Richard (son of Abram) 45, 322B  
 Richard (son of Richard) 45, 322B  
 Roslyn Louise 45  
 Ruth 45  
 Sadie Delmonte 45, 322B  
 Sarah J. Moses 45  
 Selina (d. 1886) 45  
 Sol (1771-1828) 45  
 Solomon 45, 265  
 Solomon Barrett 45, 265  
 Sumter McClure (1860-1902) 322B  
 Virginia 45  
**DAVENPORT**  
 Hannah Israel 128  
 William 128  
**DAVID**  
 Aaron Hart (b. 1883) 46  
 Aaron Hart (1812-1882) 46, 138  
 Ada 46  
 Ada Abrahams 46  
 Aleyda Eliza Winifred (1852-1917) 46  
 Amy Lillian Ernestine (1854-1858) 46  
 Arthur (1870-1903) 46  
 Arthur Mamara 46  
 Arthur Meredith (Florence) 46  
 Arthur Montrose (b. 1867) 46  
 Arthur Willard (b. 1920) 46  
 Augustus (1848-1850) 46  
 Bertram (b. 1879) 46  
 Brandeie Abigail (Brandy) 46, 106,  
 322B  
 Brandy (see David, Brandeie Abigail  
 (Brandy))  
 Caleb 201  
 Carolo Grimaldi 46  
 Caryl Douglas Bradshaw (b. 1886) 46  
 Catherine Gertrude (Kitty) 46, 110  
 Catherine Joseph 46, 138  
 Charlotte 46  
 Charlotte Gwendoline (1857-1858) 46  
 Charlotte Hart 46, 95  
 Cilla 121  
 Claude (b. 1875) 46  
 Claudine Joseph 46, 137  
 Cuthbert 46  
 David (1764-1833) 46, 322B  
 David (1840-1874) 46  
 Dinah Comgile (or Congue) Cohen 35  
 Dorothy Maw 46  
 Edith (1850-1864) 46  
 Edith Ollendorf 46  
 Edmund (1844-1846) 46  
 Edna (1880-1933) 46  
 Eleazar (b. 1811) 46  
 Eliza Evelyn (Minnie) 46  
 Eliza Lock Walker Harris 46  
 Elizabeth (b. 1876) 46  
 Elizabeth Mordecai 201

Ernest Wilfred (1843-1862) 46  
 Esdaile Cohen (1849-1890) 46  
 Esther Rosalie 46  
 Fanny (see also David, Frances  
 (Fanny))  
 Fanny (1846-1907) 46  
 Fanny E. Herchinger 46  
 Fanny Michaels (see David, Frances  
 (Fanny) Michaels)  
 Florence (see David, Arthur Meredith  
 (Florence))  
 Florence 46  
 Frances (Fanny) Michaels 46, 96  
 Frances (Fanny) (b. 1770) 46, 104,  
 323A  
 Frances 46  
 Frances J. Little 46  
 George B. 110  
 Gertrude Sophia (b. 1840) 46  
 Gertrude Virginia Joseph 46, 137  
 Gladys 46  
 Golda Adela (b. 1846) 46  
 Gwendoline Sillian (1888-1912) 46  
 Harline (b. 1851) 46  
 Harold Spry (b. 1892) 46  
 Harry Percy (see David, Henry (Harry)  
 Percy)  
 Henry (b. 1838) 46  
 Henry (Harry) Percy 46, 153  
 Hilda Edna (1850-1858) 46  
 Isoline (1853-1944) 46  
 Jaime (1955-) 322B  
 Jennie Betty 46  
 Joas Willard (1874-1875) 46  
 Joseph (b. 1850) 46  
 Joseph (Charleston) 35  
 Katherine (Kitty) 46, 110  
 Kitty (see David, Catherine Gertrude  
 (Kitty))  
 Laurence (1848-1878) 46  
 Laurens Joseph 46  
 Lazarus (Eleazer B. David) 46, 322B  
 Mabel (1876-1920) 46  
 Mamie (see David, Marye)  
 Marietta Beatrice (1849-1858) 46  
 Mary 46  
 Marye 168, 311B  
 Meta Hart Levin 46, 153  
 Michael 235  
 Mianie (see also David, Eliza Evelyn  
 (Minnie))  
 Minnie Phillips (see David, (Minnie)  
 Miriam Phillips)  
 (Minnie) Miriam Phillips 46, 244  
 Moses (b. 1767) 46, 69  
 Moses (see also David, (Moses)  
 Edmund)  
 (Moses) Edmund 46  
 Moses Eleazer 46, 74  
 Moses Samuel (1816-1854) 46, 137  
 Nina (1847-1853) 46  
 Orland B. 121  
 Pamela (1970-) 322B  
 Phoebe (1818-1903) 46, 95  
 Phoebe Samuel 46, 322B  
 Robert Marvin (b. 1918) 46  
 Robert Sullivan (Sully) 46  
 Rosalie (b. 1890) 46  
 Rosina Florence 46, 74  
 Samuel (b. & d. 1823) 46  
 Samuel (b. 1837) 46, 137  
 Samuel (1766-1824) 46, 95, 323A  
 Sarah Hart 46, 95  
 Sarah Matilda (1842-1921) 46, 95  
 Sophia (1824-1866) 46, 138  
 Sorchen Boeing 235  
 Sully (see David, Robert Sullivan  
 (Sully))  
 Trish 322B  
 Tucker (1843-1891) 46, 244  
 Tucker Henry (b. 1915) 46  
 Vera (dau. of George) 110  
 Vera Hendricks 110

Virginius Andrew 46  
 Walter Phillips (b. 1886) 46  
 Watson Cuthbert (b. 1890) 46  
**DAVIDOFF**  
 Bill Irvin 43  
 Charles Eugene 43  
 Lynn 24  
 Melanie 43  
 Melanie Green 43  
 Phyllis Lynn 43  
**DAVIDOW**  
 Betty 104  
 Leonard 104  
 Marjorie 104  
 Ruth Hays 104  
 William 104  
**DAVIDS**  
 Aaron 50  
 Amy 156  
 Michel (Myer) 50  
 Polly 50  
 Sarah 50  
**DAVIDS (PRAGER)**  
 Benjamin 50  
**DAVIDSON**  
 Alice Ansbacher 22  
 Arthur Lionel 164  
 Augusta (1846-1912) 123  
 Deborah 216  
 Douglas 43  
 Frances Marian Levy 164  
 Francis Marion 164  
 Janet 194  
 Louis S. 22  
 Melanie Reva Schwartz 43  
 William J., Jr. 164  
 William Joseph 164  
**DAVIES**  
 Agnes (see Davies, (Agnes) Kathleen  
 (Agnes) Kathleen)  
 Alan V. 47  
 Albert 47  
 Alice 47  
 Andrew B. 47  
 Andrew M. (Ansbel) 47  
 Ansbel (see Davies, Andrew M.  
 (Ansbel))  
 Barry L. 47, 136  
 Bernard 47  
 Betsy Cromelien 47  
 Clara 47  
 Clara Moss 47  
 Clarissa 47  
 David (b. 1794) 47, 102  
 David (b. 1833) 47, 249  
 Eliza 47, 249  
 Elizabeth (b. 1836) 47  
 Elizabeth Staus 47  
 Esther 47  
 Florence R. 47  
 Gertrude Micholl 47, 192  
 Hannah (b. 1830) 47  
 Helen Louise Wolfe 47  
 J. Clarence 47  
 J. Clarence III 47  
 J. Clarence, Jr. 47  
 James 47  
 John Myer 47  
 John P. 47  
 Joseph 47  
 Judah H. 47  
 Judith P. 47  
 Laurence 47  
 Lillian 47  
 Lionel 47  
 Lizzie 47  
 Lizzie M. 47  
 Lottie E. Slater Stein 47  
 Louisa Micholl (m. Rowland) 47, 120,  
 127, 280  
 Luisa Joachimsen 47, 136  
 Maria L. 47  
 Maria Luisa 47

Maria Phillips 47, 249  
Mary Cromelia 47  
Michel (Myer) (see Davids, Michel Myer)  
Morland Micholl 47  
Myrtilla J. 47  
Phoebe M. Hart 47, 102  
Rachel (b. 1841) 47  
Rachel (b. 1869) 47  
Ralph Israel (see Davies, Rowland (Ralph) Israel)  
Ray 47  
Rosalie Loewi 47  
Rose 47  
Rowland (b. 1828) 47, 120, 127, 208  
Rowland (b. 1840) 47  
Rowland (Ralph) Israel 47  
Sarah 47  
Sarah Harris(e) 50  
Sophia 47  
Sophie 47  
Valentine Loewi 47

#### DAVIS

Abel 189  
Abigail 60  
Abram (1833-1842) 192  
Adelaide Lane 50  
Adele 331A  
Adeline (1839-1853) 192  
Ainslee S. (1848-1908) 48, 207  
Albert (d. 1956) 293  
Albert (son of Benjamin) 49  
Alice Gertrude (1870-1936) 48, 192  
Aline Julia 49  
Alma 48  
Alma F. 49  
Alma Liberman 186  
Amanda 60  
Amelia LeGrange 50  
Amelia (1875-) 331A  
Amy 49  
Andrew 48  
Andrew M., Jr. 48  
Andrew Mortimer (b. 1853) 48, 198  
Anna (dau. of Benjamin) 49  
Anna (dau. of James Perry) 75  
Anna Abrams 4, 48  
Ansel (Anasley) (1796-1863) 48  
Ansel (see also Davis, Ansel (Anasley))  
Ansel George (b. 1851) 48, 198  
Ansel George (b. 1890) 48  
Armida Moses 48, 207  
Arthur P. 49  
Augusta Lee 36  
Barbara Hartman 48  
Benjamin (1807-1879) 48, 49, 274  
Benjamin A. 48  
Benjamin Michael 50  
Benvenida Brickner 27, 48  
Bertha Raynor Straus 48  
Betty 294  
Betty Morange 192  
Beulah (1861-1938) 238  
Beulah Osborn Woodworth 50  
Blume Morange 192  
Burnett Maduro 48  
Burrowsina Solis 48, 49, 274  
Carol 48  
Caroline Hanent 161  
Catherine 48  
Cecil (m. Sophia Lesley Joseph) 138  
Cecil (son of George) 48  
Celeste 27  
Celia 61  
Charles (m. Julia Yates) 308  
Charles (1903-1939) 306  
Charles H. 75  
Charles Howard 186  
Charles Joseph (b. 1877) 138  
Charles L. 49  
Clara Senior 306  
Connie 2

Constance Miriam (1867-1923) 48, 202  
Cope (see Davis, Lewis (Cope))  
Corinne 48, 165, 323A  
Daniel S. (1835-1917) 102, 331A  
David (1750-1833) 48, 323A  
David M. 50  
Deborah 50  
Deborah Prager 87  
Diana Cullom 287  
Dolores 340A  
Dora (see Davis, Dorothy (Dora))  
Dorothy (Dora) 50  
Dorothy Ruddock 48  
E. Lyon 48  
Edith Rebekah 138  
Edna 48  
Edward 75  
Elias David 50  
Eliza 135  
Estelle (1875-1898) 48  
Estelle Cecilia Ruddock 48  
Esther (dau. of Solomon) 49  
Esther (1850-1893) 50  
Esther 153  
Esther Barnet 48  
Esther C. (d. 1878) 48  
Esther Levy 102, 331A  
Esther Mordecai (Morris?) (1774-1844) 48, 323A  
Esther Morris see Davis, Esther Mordecai (Morris?)  
Esther Virginia (b. 1900) 27  
Ethel 48  
Eugene George 48  
Eva L. (b. 1868) 48  
Eva L. Davis 48  
Fannie (see Davis, Frances (Fannie))  
Fanny (Frances) (1814-1878) 48, 272  
Fanny (see Davis, Frances (Fanny))  
Fanny Barnett (1815-1862) 48  
Flora 192  
Florence Naomi (b. 1880) 138  
Florence P. 48  
Florence Solomons 49  
Frances (Fannie) 50  
Frances (Fanny) (1814-1878) 48, 272  
Francis 306  
Frank A. 49  
G. Richard 89  
George (b. 1839) 48  
George (son of Albert) 293  
George (son of George H.) 48  
George (1802-1870) 48  
George Ansley (1818-1910) 48, 137  
George Ansley 48  
George F. 30  
George H. (1835-1907) 48, 323A  
George P. (son of George P.) 48  
George P. (son of George) 48  
Georgia Moise 48, 198  
Gertrude (Guldah) 50  
Goodman (1797-1862) 48, 185  
Goodman (1844-1915) 48  
Goodman R., Jr. (b. 1904) 48  
Goodman Richard (1876-1900) 27, 48  
Guldah (see Davis, Gertrude (Guldah))  
Hannah (see Davis, Henrietta (Hannah))  
Hannah Ephraim 50  
Hannah Levy Hart Delieben 98, 309B  
Helen Elizabeth (b. 1883) 138  
Helen Elizabeth Davis 138  
Helen Elizabeth Joseph 138  
Helen Virginia (b. 1896) 48  
Henrietta (Hannah) 50  
Henrietta Phillips 48  
Henry (b. 1808) 48, 323A  
Henry (d. 1865) 48  
Henry (m. D. Prager) 87  
Henry (son of Philip) 161  
Henry (1808-1871) 48  
Henry Benjamin 50  
Hugh 27

Humphrey 50  
Hyman 138  
Irma 48  
Irma Lewyn Bernstein 89  
Isabelle Prag 48  
Jacob (see Davis, John M. (Jacob))  
James Perry 75  
Jane Cecile 186  
Jane Eliza 50  
Jane Hanent 161  
Jane Hinton Lopez 176  
Jane Victoria 50  
Janet Hays 48  
Jeanne-Yvonne Gouriou 48  
Jennie Barnes 48  
Jessica 48, 49  
Jessica Jones 48, 133  
John (b. 1927) 48  
John (m. 1932) 176  
John H. 75  
John J. (1878-) 331A  
John M. (Jacob) 50  
John Ruddock 48  
John, Jr. (b. 1933) 176  
Joseph (b. 1931) 294  
Joseph (m. Alma Liberman) 186  
Joseph Mortimer 186  
Juanita Sallie 37  
Julia Minzbeimer 49  
Julia Yates 308  
Julie Wertheim 48  
Juliet 64  
Kalani 113  
Kate (Catherine) (1832-1885) 48  
Kate (see Davis, Kate (Catherine))  
Katherine Stix Wasserman 287, 340A  
Kathleen 138  
Kathy 294  
Laura Adolph 293  
Laura Jeanette 48  
Lawrence Henry 161  
Lewis (Cope) 50  
Louis 138  
Louis Latham 27  
Louis 135  
Louisa Micholl 47, 280  
Lucy 133  
Lydia 11  
M. Pope 48  
Mabel Mac Kenzie 331A  
Mable 48, 171  
Margaret Amanda Cunningham 150  
Maria (1800-1873) 48, 323A  
Maria (1833-1856) 48  
Maria L. 47  
Marie Young 37  
Mark (b. 1961) 294  
Mark (son of George) 48  
Mark (1805-1877) 48  
Martha Gries 294  
Mary 322A  
Mary (b. 1822) 50  
Mary (dau. of Ansel (Anasley)) 4, 48  
Mary (dau. of Henry) 48  
Mary Augusta Huffnagle 75  
Mary Elizabeth (Marie Therese)  
Brauer 27  
Maude Johnston 49  
Michael B. 50  
Michael M. III 48  
Michael Marks (1832-1925) 48, 241  
Michael Marks, Jr. (b. 1879) 48  
Miriam (1872-1873) 48  
Miriam Maduro Peixoto 48, 241  
Moses (1759-1843) 98, 309B  
Myrtilla Jessica (b. 1845) 48, 241  
Myrtle Lord Livesay 48  
Nancy Benjamin Polack 50  
Patricia 48  
Paul Sprague 48  
Percy Lionel (1856-1930) 48  
Percy, Jr. 48  
Philip 161

Philippe John 48  
Priscilla 50  
Priscilla Alden 287  
Priscilla Davis 50  
Rachel (dau. of David) 48  
Rachel de Meir 58  
Rebecca (d. 1915) 48  
Rebecca (dau. of Henry) 48  
Rebecca Benjamin 18, 48  
Rebecca Jones (b. 1858) 18, 48  
Rebecca Marks 48, 185  
Rebecca Moise 48, 198  
Rebecca Stein 48  
Richard Benjamin 50  
Rosalie 48, 207  
Rose Lazarus 48  
Rose Yates 48  
Rosetta 50  
Rosetta Hart 50  
Sadie Chuck 161  
Sallie Cohen (see Davis, Sarah (Sallie) Cohen)  
Sam D. (1874-1946) 331A  
Samuel 50  
Sarah (d. 1836) 192  
Sarah (dau. of James P.) 75  
Sarah (Sallie) Cohen 36, 37  
Sarah (1797-1858) 48  
Sarah (1819-1882) 50  
Sarah Gratz 138  
Shelby Cullom 287, 340A  
Shelby Moore Cullom 287  
Solomon (1788-1855) 50  
Solomon (1818-1876) 4, 48  
Solomon Menken (see Menken (Davis), Solomon)  
Solomon, Jr. 49  
Sophia 161  
Sophia Joseph 138  
Sophia Lesley 138  
Sophia Lesley Joseph 138  
Susan Frank 189  
Thomas 306  
Violette Anne French 30  
Virginia (1843-1915) 48, 162  
Virginia Jane (1820-1895) 36, 48  
Walter Alan (b. 1902) 48  
Walter Juan 36, 37  
Washington Irving (1859-1936) 48  
William 49  
William Benjamin 50  
William P. 48  
Zadoc A. 192

#### DAVISON

Anna Huffnagle 75  
Edward Allen 75  
Mary 75

#### DAWKINS

Edward Charles Honeywood 77  
Edward Henry 77  
Edward Henry Frederick 77  
Elizabeth Cooper 77  
Elizabeth Cooper Dawkins 77  
Ethel Louise 77  
George Augustus Frederick 77  
Kate Bradford 77  
Louisa Maria Barnett 77  
Percy Henry 77

#### DAWN

Hazel 313

#### DAY

Charles 160  
Doris Ann Weyl 284  
Frank Miles 284  
Kenneth 284  
Mammie 295  
Sarah Shaeberg 160  
Susanna 284

#### D'AZEVEDO

See Cohen D'Azevedo

#### DE BEAULIEU

Gladys (b. 1906) 275  
Jessie Myra Solis-Cohen 275

Joseph Alphonse Litelier De St. Giusti Hudon 275  
Theodora Benvenida Justine (b. 1905) 275

#### DE BEDTS

Alice Benjamin 19  
August Emil 19  
Beatrice (b. 1878) 19  
Florence (b. 1879) 19  
Henry Lewis (b. 1875) 19  
Lewis Samuel (b. 1881) 19

#### DE BEER

Adelaide 16, 321A  
Bea (b. 1890) 15

#### DEBELIEUX

Lucile Hyams 119

#### DE BIVAR

Izabel De Veiga Caetana (see Nunez, Rachel)  
Jacob Soares (see De Bivar, Rodrigo (Jacob) Soares)  
Rodrigo (Jacob) Soares 234

#### DEBLINGER

Ann 333A

#### DE BOAZ

Eva 23

#### DEBOTT

Johanna Marie 248

#### DE BOUSIGNAC

Henri 18  
Ninette Benjamin 18

#### DE BUYS

Eugenie 116

#### DE CAMPO

Anais Rachel Gomez 86

#### DE CARLO

Francesca Maria (1946-) 328B

#### DE CASSERES

Abigail Pardo 240  
Samuel Hezekiah 240  
Samuel Idanha 240  
Sarah De Solomoh 178  
Simbah Pardo 240

#### DE CASTRO

Alice, see De Castro, Zipporah Alice  
Catherine (1818-1891) 69  
Clara (1863-1863) 323A  
David Jefferson (1861-1862) 323A  
Edith Miriam (1865-1945) 332A  
Esther Ellen 61, 323A  
Grace 61, 191, 323A  
Hannah De Sola 61, 323A  
Hannah Pepper 69, 303  
Isaac 69  
Jacob de Moses 85  
Jacob (Louis) 69  
Jacob Osorio 61, 323A  
Joseph 332A  
Leah 69  
Louis (see de Castro, Jacob (Louis))  
Minnie Reeka (Rebecca) 69  
Philippa 273  
Rachael 69  
Rachel Rosafina de Jacob Haim Osorio 62  
Rebecca (see also De Castro, Minnie Reeka (Rebecca))  
Rebecca (1819-1901) 69  
Serenia 69  
Zipporah Alice 61, 323A

#### DECAZES

Comie Louis Frederic Marie René Edouard 304  
Edith Helene Germaine Marie 304  
Elie Ludovic Henri Christian, 5th Duc Decazes 304  
Gabrielle Sylviane Marie Francoise 304  
Marie Isabelle Pierrette Therese Louise 304  
Severine Marie Yveline Gabrielle 304  
Solange-Rose-Lucille Du Temple, 5th

Duchesse Decazes 304

#### DECIOMOIO

Caroline Pascual 225

#### DE CORDOVA

Abraham (m. Simha) 52, 323A  
Abraham (1766-1852) 52  
Abraham (1801-1802) 52  
Abraham Haim 52  
Alfred 53  
Allan Irvin 52  
Anna M. (Annie) 53  
Annie (see De Cordova, Anna M. (Annie))  
Annie 52  
Arthur 53  
Barbara Jean 52  
Bertha Switch 52, 53  
Bessie Vivian 53  
Buford 53  
Carmen 52  
Cary 52  
Cecil Charles (b. 1876) 52  
Cecil R. 52  
Charles (b. 1854) 52  
Clara (-1740) 323A  
Clarence Torrey 52  
Clariece Elaine 53  
Cordelia Claggett 52  
Diane Michele 52  
Donna 52  
Eliza 52  
Elizabeth 52  
Ella Maggie Sherrill 53  
Ella Nicholas 52  
Emma Wilgus 52, 53  
Esther (1754-1794) 52  
Esther Emma Fanny (b. 1856) 52  
Esther (-1700) 323A  
Fannie Mae Daughtry 52  
Fanny Blume Nathan 52, 308  
Flora 53  
Flora Nathan 52, 308  
Florence McCulley 52  
Francis Curtis 52  
Frank Harold 52  
Frank Henry 52  
Frank Richard 53  
George (1852-1872) 52  
Golda Hannah Night 53  
Gonsalvo 52  
Gonsalvo J. 52  
Gus W. 53  
H. Osmund 52  
Helen (Moody) 52  
Helen Hart Taylor 52  
Helen Marie 52  
Henry M. (b. 1838) 52  
Henry M., Jr. 52  
Irvin 52  
Irvin, Jr. 52  
Isaac (son of Abraham) 52  
Isaac Hezekiah 52  
Jack M. 53  
Jacob 52  
Jacob Haim (d. 1714) 52, 323A  
Jacob Haim (son of Abraham) 52  
Jacob Raphael (1808-1868) 52  
James Raymond (b. 1902) 53  
Jemima Delgado 52, 53  
Johnnie Mae Parrish 53  
Joshua Haim 52  
Joshua Hezekiah 52  
Joshua Raphael (b. 1799) 52  
Joshua Raphael (1835-1871) 52  
Joshua Raphael (1875-1915) 53  
Joshua Raphael, Jr. 52  
Juanita Inez Compton 52  
Judith 52  
Judith Ashenheim 52  
Julian P. J. (b. 1851) 52  
Kenneth Fuqua (b. 1917) 53  
La Juna (1888-1963) 53  
Leah 52



Leo Wilgus (1890-1940) 53  
 Lester Irvin 52  
 Lillian Ward 52  
 Lizzie Dana 52  
 Lois Miller 52  
 Lori Lynn 53  
 Louisa J. Calhoun 52  
 Maggie Nix 53  
 Mallie Lou 53  
 Mary Vance Ogden 52  
 Michael (b. 1833) 52  
 Minnie Maude Walthal 53  
 Minnie Pamela Miller 52, 53  
 Moses Raphael 52, 323A  
 Moses (-1701) 323A  
 Myra 27  
 Myrtle 52  
 Nano Naylor 53  
 Oscar V. 52  
 Phineas (b. 1819) 52, 53  
 Priscella Dene Yeats 53  
 Rahel de Jacob Dias Arias 52  
 Randall Barry 53  
 Raphael (d. 1794) 52  
 Raphael Francis (b. 1904) 53  
 Raphael Joshua (b. 1824) 52, 308  
 Raphael, Jr. (1770-1846) 52  
 Ray Steven 52  
 Rebecca L. 52  
 Rebecca Sterling 52  
 Reginald Perry 53  
 Rena J. 53  
 Roger Ogden 52  
 Roger 53  
 Rollie Mauricee 53  
 Ronita 52  
 Rose Pelphrey 53  
 Ruby L. Ammons 53  
 St. Elmo 53  
 Samuel D. 53  
 Samuel E. 52  
 Sandra Ray Baker 52  
 Sherry Lynn McCray 53  
 Simba (dau. of Jacob Haim) 52  
 Simba (m. Abraham) 52  
 Simba (1768-1846) 52  
 Sterling Garvin (d. 1957) 53  
 Teresa Lynne 52  
 Tom Ernest 52  
 Tom Green 52  
 Vera 53  
 Vivian 52  
 Walter 52  
 William 53  
 William A. 52, 53  
 William Clarence 53  
 William Fenton (b. 1901) 53  
 William Fenton (b. 1914) 53  
 William Francis (1845-1918/9) 52, 53

**DECOATEAU**  
 Mary Elizabeth Alexander 330A  
 Murray Andrew 330A  
 Patricia Alexander (1948-) 330A  
 Van Andrew (1973-) 330A

**DE CRANO**  
 Felix F. 87

**DE CRASTO**  
 Abigail Lopez (Da Fonseca) 178  
 David de Isaac Namias 178  
 Elias de Raphael Namias 240  
 Grace Peixotto 240  
 Hannah de Samuel 241  
 Jacob Lopes 51  
 Judith 51  
 Leah Peixotto 240  
 Rachel 51  
 Ralph 51  
 Samuel 241  
 Zipporah De Pass 51

**DE CUEVAS**  
 John David Alexander 49  
 Phyllis Nahl 49

**DE DURPORT**

Beatrice Victoire 304  
 Comtesse Cecile Le Jeune 304  
 Guy 304  
 Jacques-Henri 304  
 Jean 304

**DEE**  
 Peggy 191

**DEEM**  
 Sharron 335B

**DEER**  
 Benjamin F. 94  
 Gertrude Clark 94

**DE FELIX**  
 Emma Clemence 237

**DE FLEURY**  
 Adrian 232  
 Esmé 232  
 Eva Noah 232  
 Roy 232

**DE FONSECA**  
 Ann Elizabeth 26  
 Miriam Levy 305  
 Rebecca Robles Levy 305

**DE PONTANOY**  
 Bartlett 180  
 Charles 180  
 Clara 180  
 Edith 180  
 Henry Mel 180  
 John 180  
 Nellie 180  
 Nellie Mann 180

**DE FORD**  
 Alice Rosalie (b. 1890) 10  
 Allen Vanard (b. 1893) 10  
 Barbara Frances 10  
 Doris Jean 10  
 Dorothy Oettinger 10  
 Frances Allen 10  
 Miriam Allen (b. 1888) 10  
 Moise 10  
 Robert O. 10

**DE FRIES**  
 Abraham 75  
 Rachel Franks (see De Fries, Richa (Rachel) Franks)  
 Richa (Rachel) Franks 75

**DE GROOT**  
 Rachel 242

**DE HOFF**  
 Edith C. 31

**DE HON**  
 Diane Grant 190  
 Frederic T. 190  
 Frederick T., Jr. 190  
 Patricia Berto Grant 190

**DE HUNT**  
 Bella Ancker 11

**DEICH**  
 Sylvia 61

**DEICHES**  
 Margaret Fuller Goldsmith 253  
 Peter 253

**DEITCH**  
 Florence 285

**DE JONG**  
 Leonore Bitterman Wollenberg Pfaelzer 309A  
 Merritt 309A

**DE LA CORONA**  
 Eleanora (Sarah) Da Silva Y Castro 273

**DE LA FAYA**  
 Abraham 240  
 Esther 240  
 Sarah 240

**DE LA MOTTA**  
 Charlotte (1809-1833) 54, 309B  
 Charlotte Lazarus 54, 151  
 Clara (1795-1864) 54, 267, 309B  
 Emanuel (1760-1821) 28, 54, 309B  
 Emanuel (1803-1838) 54  
 Isaac (1726-1794) 54

Isaac (1750-1802) 54  
 Isaac (1791-ca. 1793) 54  
 Isabelle 54  
 Jacob (ca. 1801-1856) 54  
 Jacob (m. Zipporah Benjamin) 18, 54  
 Jacob Canter (1789-1845) 54, 151  
 Jacob Emanuel (b. 1836)  
 Judith Canter 28, 54, 309B  
 Julia (d. 1839) 54  
 Juliet 54  
 Leonora (b. 1800) 54, 57, 309B  
 Moses (1755-1800) 54  
 Rachel (b. 1768) 54, 58, 309B  
 Rachel (1815-1844) 54, 309B  
 Rebecca (1793-1856) 28, 309B  
 Rebecca (1798-1829) 54, 57  
 Sally Canter (see De La Motta, Sarah (Sally) Canter)  
 Sarah (1792-1844) 54, 267, 268, 309B  
 Sarah (Sally) Canter 28, 262  
 Sarah (1728-1790) 54  
 Sarah (1754-1811) 54, 268  
 Zipporah (1817-1881) 178  
 Zipporah Benjamin 18, 54  
 Zitella 113

**DE LANCEY**  
 Ann Maria 76  
 Anne 76  
 Charles Fitzroy 76  
 Charlotte (dau. of Oliver) 76  
 Charlotte (dau. of Stephen) 76  
 Cornelia Barclay 76  
 Emma 76  
 Magdalen Hall 76  
 Maria (dau. of Oliver) 76  
 Maria (dau. of Stephen) 76  
 Oliver (son of Oliver) 76  
 Oliver (1717/8-1785) 75, 76  
 Phila (dau. of Oliver) 76  
 Phila (dau. of Stephen) 76  
 Phila Franks 75, 76  
 Stephen 76  
 Susannah (dau. of Oliver) 76  
 Susannah (dau. of Stephen) 76  
 William Howe 76

**DE LAND**  
 Rebecca Levy 166  
 Theodore L. 166

**DE LANGE**  
 Fanny (d. 1825) 53  
 Jacob 53  
 Jonas Lucas (1826-1852) 53  
 Leo H. 53  
 Louis (1855-1906) 215  
 Lucas (1792-1828) 53  
 Martha 53  
 Selma Mantell 215  
 Simon J. (d. 1857) 53

**DE LANGLEY**  
 Helen Haas Sadowsky 88  
 Ruffin 88

**DE L'ANNE ET DE LA GEORGETTE**  
 Selina Florance Moise 74, 196

**DELAPHINE**  
 Jane 287

**DE LEO**  
 See De Lyon

**DE LEDESMA**  
 Abraham (see De Ledesma, Ralph (Abraham))  
 Moses 54  
 Ralph (Abraham) 54

**DE LEE**  
 Frank Joseph (b. 1945) 282  
 James Joseph (b. 1949) 282  
 Nancy Jo 282, 313B  
 Natalie Stern 282  
 Sol 282

**DE LEON**  
 Abigail (see also De Leon, Sarah (Abigail))  
 Abigail (1783-1850) 55, 112  
 Abraham (b. 1702) 55, 234

Abraham (b. 1790) 55  
 Abraham (son of Moses) 55  
 Abraham (1734-1786) 55  
 Abraham (1790-1847), M.D. 55, 233  
 Abram (see De Leon, Albert (Abram))  
 Adelaide (1805-1839) 55  
 Adeline Mary (d. 1877) 55  
 Agnes (b. 1852) 55, 211  
 Agnes (d. 1902) 55  
 Albert (Abram) (b. 1857) 55, 196  
 Alma (b. 1882) 55  
 Almeria (1798/9-1879/84) 55, 159  
 Almeria (1839-1882) 55  
 Amanda Moise 55, 196  
 Anna (dau. of O. H. P. Moses) 207  
 Anna (1816-1888) 55, 207  
 Benjamin (b. 1771) 55  
 Benjamin (1854-1910) 55  
 Benjamin Charles 207  
 Benjamin Nones (1823-1853) 55  
 Bilha (Isabella) Nones 55, 233  
 Caroline (Lena) (b. 1855) 55  
 Caroline (1797-1875) 56, 233  
 Caroline Agnes Moise 56, 196  
 Charles (1854-1876) 207  
 David (b. 1751) 55  
 David Camden (1816-1872) 55  
 Deborah 85  
 Dorothy Irene (b. 1909) 55  
 Edwin (1818-1891) 55  
 Edwin 224  
 Edwin Warren (1868-1918) 55, 197  
 Edwin, Jr. 224  
 Eleazer (see Leon, Eleazer)  
 Elinor (Nell) Jones 55  
 Ellen Mary Nowlan 55  
 Esther (1740-1785) 55  
 Esther (1785-1803) 55  
 Eugenia John Gober 55  
 Eveline (1805-69) 56, 233  
 Frances Emma Moise 55, 197  
 Hannah 18, 321A  
 Hannah Hendricks 55, 110  
 Harmon (1860-1928) 55  
 Harmon Hendricks (1829-1901) 55, 196  
 Henrietta (dau. of Jacob) 55  
 Henrietta (1820/1-1912) 55, 266  
 Hetty (1833-1891) 55  
 Ida Maude Moise 55, 196  
 Isaac (b. 1738) 55  
 Isabel (1858-1927) 55, 198  
 Isabel Nones (1828-1896) 55, 198  
 Jacob (b. 1746) 55  
 Jacob (London) 26  
 Jacob (prob. Amsterdam) 55  
 Jacob (son of Moses) 55  
 Jacob (1764-1828) 55, 110  
 Jacqueline (b. 1863) 55  
 Joseph M. (1803-1882) 56  
 Leah 112  
 Leah Abigail (b. 1779)  
 Lena (see De Leon, Caroline (Lena))  
 Louisa 55  
 Margery Mae (b. 1902) 55  
 Maria (b. 1872) 55  
 Maria Louisa (1820-1901) 55  
 Marie Moise 55, 198  
 Mary (dau. of Abraham) 55  
 Mary (1866-1867) 55  
 Miriam (1871-1881) 55  
 Miriam Louisa (1822-1869) 39, 55  
 Moise (1862-1866) 55  
 Moise (1867-1915) 55, 196  
 Mordecai Hendricks (1791-1848) 55, 176  
 Moses (b. 1736) 55  
 Moses (son of Jacob) 55  
 Moses (1775-1828) 56, 309B  
 Nell Jones (see De Leon, Elinor (Nell) Jones)  
 Nell Jones 55  
 Paul Anthony Jones 55, 198

Paul, Jr. 55  
 Perry (1841-1922) 207  
 Rachel (b. 1749) 55  
 Rachel (1780-1811) 55  
 Rebecca (b. 1748) 55  
 Rebecca (b. 1765) 55  
 Rebecca (1801-1851) 55  
 Rebecca Lopez 55, 176  
 Reyna 26  
 Roger Moise (b. 1904) 55  
 Roger, Jr. 55  
 Sarah (Abigail) (1743-1803) 55  
 Sarah (1768-1841) 55  
 Sarah Frances Naar Naar 224  
 Thomas Cooper (1839-1914) 55  
 Uriah (1806-1883) 55  
 Walter Jones 55

**DE LEON (BENJAMIN)**  
 Moses B. 18

**DE LEON (SILVA)**  
 Rebecca 85

**DELGADA**  
 Gershon 115  
 Sophie Cohen 115

**DELGADO**  
 Albert 26, 53  
 Aleitha (Jessie) Brandon 26, 53  
 Blanche 269  
 Clara Milhado 53  
 Estelle Hart 53  
 Gladys Estelle (1905-1911) 53  
 Isaac 53  
 James (1868-1905) 53  
 Jemima 52, 53  
 Menasseh de Isaac 51  
 Rachel Cohen D'Azevedo 51  
 Sarah 26, 53

**DELGAR**  
 Willie 56

**DELIEBEN**  
 Hannah Levy Hart 98, 309B  
 Israel (1748-1807) 98, 309B

**DE LIMA**  
 Grace Cohen Peixotto 240  
 Hannah Abinun 59, 61  
 Hannah de Haim Abinun 61  
 Hetty Abinun 59  
 Lelia Abernood 12  
 Mordechay de David de Mordechay  
 Abinun 240  
 Sarah A. 59  
 Sarah de Eliav Abinun 62

**DE LISI**  
 Emma Clemence (Felix) 237  
 Felix (see De Lisi, Emma Clemence (Felix))

**DE LISSER**  
 Cecil 26  
 Sarah Adde Brandon Da Costa 26

**DELL**  
 Percival Randolph Moise 195

**DELMAR**  
 Alexander (1836-1861) 54, 137  
 Algernon Percy (b. 1870) 54  
 Belviden (Benvenida) Alexander 54  
 Benvenida Alexander (see Delmar, Belviden (Benvenida))  
 David (b. 1841) 54  
 Emanuel (b. 1838) 54  
 Emily Joseph 54, 137  
 Eugene (b. 1864) 54  
 Fanny (see Delmar, Frances (Fanny))  
 Frances (Fanny) (b. 1868) 54  
 Harry (b. 1866) 54  
 Jacob Coutinho 54  
 Maud 54  
 Moses (1834-1835) 54  
 Sarah 54  
 Walter (b. 1862) 54  
 William 54

**DEL MONTE**  
 Roger 161  
 Sophia Davis 161

**DELMONTE**  
 Abigail Cohen 1  
 David Cohen 1  
 Grace Cohen 1  
 Hannah Cohen 1  
 Isaac 1  
 Isaac Cohen 1  
 Rachel 1  
 Sadie 45, 322B

**DEL MYDA**  
 Abraham 2  
 Haym 1  
 Judith Virginia 1  
 Rebecca Abendanone 1  
 Sipporah 1

**DE LOACHE**  
 Freelove P. (1839-1887) 58

**DE LONDRES**  
 Flora Tevis 74  
 Henry Gouget 74

**DEL SOTTO**  
 Gracia 273  
 Rachel 273

**DE LUCENA**  
 Abraham (New Amsterdam) 56  
 Abraham Haim (d. 1725)  
 Antonio Ribeiro Sanchez 234  
 Esther (Hester) 56  
 Hester (see De Lucena, Esther (Hester))  
 Jacob 56  
 Judith 56  
 Mandel Henriques 234  
 Maria Caetana (see Nunez, Zipporah)  
 Moses (Amsterdam) 56  
 Moses (b. 1723) 56  
 Moses (New Amsterdam) 56  
 Rachel 56  
 Rebecca (1713-1801) 56, 85  
 Samuel (b. 1711) 56

**DE LYON**  
 Abigail 57  
 Abraham (d. 1830) 57  
 Abraham (d. 1835) 57, 267  
 Abraham I. (d. 1835) 57, 234, 309B  
 Abraham I. (1793-1840) 57  
 Anna (see De Lyon, Hannah (Anna))  
 Benjamin (1796-1802) 57  
 Clarence Abraham (1829-1854) 57  
 Elizabeth Josephine 57  
 Esther (b. 1762) 57  
 Esther Nunes (see De Lyon, Theresa (Esther) Nunes)  
 Esther Nunez 57, 234  
 Eveline (d. 1836) 309B  
 Hannah (Anna) (1798-1873) 57  
 Hannah 57  
 Hannah Sheftall 57, 267  
 Isaac (b. 1739) 57, 298  
 Isaac (1786-1856) 57  
 Isaac M. 57  
 Jacob (b. & d. 1795) 57  
 James Wayne 57  
 Joseph (b. 1800) 57  
 Josephine Seabrook Curtis 57  
 Judith (b. 1764) 7, 57, 309B  
 Leonora 57  
 Leonora De La Motta 54, 57  
 Leonora Rebecca (1824-1888) 57, 93  
 Leonorean 57  
 Leonorean D. 57  
 Levi Sheftall 54, 57  
 Margaret (1831-1837) 309B  
 Mordecai S. (1809-1856) 57, 309B  
 Rachel (d. 1792) 57, 103  
 Rebecca (b. 1806) 57  
 Rebecca (dau. of James Wayne) 57  
 Rebecca De La Motta 54, 57  
 Rebecca 7, 57  
 Rina 57  
 Rinah Tobias 57, 298  
 Samson 57  
 Sarah (m. 1806) 57, 256

Sarah (1787-1874) 57, 309B  
Sarah Sheftall 57, 267, 309B  
Sipra (Zipporah) 57, 203  
Theresa (Esther) Nunes 57, 234  
Zipporah (see De Lyon, Sipra (Zipporah))

#### DE MARK

Juda Pereira 242  
Judic Meyer 242

#### DE MEIRELLES

Edith Haas Loring 88  
Luis 88

#### DE MENDES

See Mendes

#### DE MERCADO

Jessie Leonore Wetzler 124  
Michael (b. 1867) 124

#### DE MESQUITA

Abraham (d. 1715) 57  
Benjamin Bueno (d. 1683) 57  
Esther (d. bef. 1708) 57  
Joseph Bueno (d. 1708) 57  
Rachel Dervali (Dovale) 57  
Sarah (d. 1708) 57  
Sarah de Moses Gomes 51

#### DE MILLE

Henry Churchill 260  
Matilda Beatrice Samuel 260

#### DE MIRANDA

Esther 180

#### DE MONTEBELLE

Comte Lannes 304  
Comtesse Edith Helene Germaine Marie Decazes 304

#### DE MORIENCOURT

Joseph Lewis Salvador 258

#### DEMOUX

See Doumoux

#### DEMUTH

Maria Ancker 11

#### DENISON

Alexander 119  
Charles 119  
Clotilda Nordhaus 119  
Eddie 119  
Henry 119

#### DENMAN

Bryan 146  
Ruth Kokernot 146

#### DENNE

Emma Mary Honeywood 77  
R. Alured 77

#### DENNING

Carrie Pinto (1869-1929) 251  
Emma Jane Pinto 251  
Samuel A. (1841-1895) 251

#### DENNISON

Fanny 126

#### DENNY

Anna Maria 32

#### DE NOGUEIRA

Abraham de Isaac Pinheiro 178  
Sarah Lopez (Da Fonseca) 178

#### DENSEL

Rosalie 4

#### DENT

Gratz Cohen 35  
James O. 35  
James T. 35  
Marion (Miriam) Gratz 35  
Miriam Gratz (see Dent, Marion (Miriam) Gratz)  
Miriam Gratz Cohen 35  
Ophelia 35

#### DENTON

Aaron Grady 269  
Ida Belle Sheftall Barnett 269

#### DENTY

Jonathan F. 27  
Mary June Brauer Millhiser Lishman 27

#### DENZER

Ruth Graff (m. 1931) 310B

#### DE PAIBA

Abigail Salvador 258  
Jacob Pereira 258

#### DE PASS

Aaron 58  
Abigail 58, 321B, 323A  
Abraham (m. 1765) 58  
Abraham (m. 1784) 54, 58, 59  
Abraham (1787-1828) 58  
Abraham Alvarez 58  
Abraham Daniel 58  
Albert (son of Albert H.) 58  
Albert Hamilton (1845-1921) 58  
Alice Hyams 58  
Ann (see also De Pass, Hannah (Ann))  
Ann Watson Smith 58  
Beulah 58  
Catherine 58  
Corinna 180, 332A  
Daniel (m. Ann Watson Smith) 58  
Daniel Alfred 58  
David 58  
David Lopez 51  
Desiré 58  
Dora Bate 58  
Dora Henry 58  
Elias (son of Aaron) 58  
Elias (son of Daniel) 58  
Eliza (1842-1880) 58  
Eliza Perriman 58  
Esther (d. 1763) 58  
Esther (m. 1792) 28, 44, 58  
Esther (m. 1828) 58  
Esther de Benjamin Gomes Da Costa 58

#### DE PAUL

Francis 158  
Francis Amédée (1798-1854) 158  
Martha A. 158  
Martha Levy Adams 158  
Robert A. (1844-1852) 158

#### DE PAUL

Asher Michaels 170  
Rebecca Falk 170

#### DE PAZ

See also De Pass  
Abigail (see De Pass, Abigail)  
Judith de Abraham (m. 1789) 51  
Ralph (see De Pass, Ralph)  
Sally Judah (see De Paz, Sarah (Sally) Judah)  
Sarah (Sally) Judah 58, 140, 327A

#### DE PEW

Alice 183  
Chauncey M. 116

#### DE PINNA

Grace 61  
Hannah 18, 321A

#### DE PRES

Egnius 261  
Elizabeth Samuel 261

#### DE QUIROS

Esther de Moses Portello 258  
Juana Blanca (Ester) Da Silva Y Castro 273  
Manuel Da Silva 273  
Moses Portello 258

#### DE RIBAS

Anita 265  
Clementia 265  
Esther Seixas 265  
Florencio 265  
Francesco 265  
Hortensia 265

#### DERKHEIM

Abram (b. 1791) 59  
David 59  
Eliezer (b. 1789) 59  
Eliza 59  
Marcus (see Derkheim, Mordecai (Marcus))  
Mayer Salomon (b. 1799) 59  
Mordecai (Marcus) (b. 1788) 59  
Moses (b. 1774) 59  
Myer (1748-1818) 59  
Rachel 58, 59  
Sarah (1754-1825) 59

#### DE RUSSY

Augusta Campbell Nicholas 157  
Charles Amédée (b. 1871) 157  
Edward 157  
Edward Nicholas (b. 1911) 157  
Helen Elizabeth Edgar (b. 1904) 157

Pass, Ribca (Rebecca) de Samuel Torres)

Rebecca Lopes (see De Pass, Ribca (Rebecca) Lopes Pereira)

Ribca (Rebecca) de Samuel Torres 58  
Ribca (Rebecca) Lopes Pereira 58

Ribca de Jacob Dias 58  
Ronald 60

Sally (Sarah) (1785-1788) 58, 323A  
Samuel (b. Bordeaux) 58  
Samuel (b. 1736) 58

Samuel (son of Aaron) 58  
Samuel (1833-1906) 58

Sarah (dau. of Albert H.) 58  
Sarah (dau. of Daniel) 58  
Sarah (m. Jacob) 58

Sarah J. (1848-1872) 58  
Sarah Kershaw (b. 1846) 58

Sarah (see also De Pass, Sally (Sarah))  
Vickie (dau. of Albert H.) 58  
Victoria (dau. of Daniel) 58

William K. 58  
William K., Jr. 58  
William Lambert (1836-1881) 58

Zipporah 51

DE PAU  
Francis 158  
Francis Amédée (1798-1854) 158  
Martha A. 158  
Martha Levy Adams 158  
Robert A. (1844-1852) 158

DE PAUL  
Asher Michaels 170  
Rebecca Falk 170

DE PAZ  
See also De Pass  
Abigail (see De Pass, Abigail)  
Judith de Abraham (m. 1789) 51  
Ralph (see De Pass, Ralph)  
Sally Judah (see De Paz, Sarah (Sally) Judah)  
Sarah (Sally) Judah 58, 140, 327A

DE PEW  
Alice 183  
Chauncey M. 116

DE PINNA  
Grace 61  
Hannah 18, 321A

DE PRES  
Egnius 261  
Elizabeth Samuel 261

DE QUIROS  
Esther de Moses Portello 258  
Juana Blanca (Ester) Da Silva Y Castro 273  
Manuel Da Silva 273  
Moses Portello 258

DE RIBAS  
Anita 265  
Clementia 265  
Esther Seixas 265  
Florencio 265  
Francesco 265  
Hortensia 265

DERKHEIM  
Abram (b. 1791) 59  
David 59  
Eliezer (b. 1789) 59  
Eliza 59  
Marcus (see Derkheim, Mordecai (Marcus))  
Mayer Salomon (b. 1799) 59  
Mordecai (Marcus) (b. 1788) 59  
Moses (b. 1774) 59  
Myer (1748-1818) 59  
Rachel 58, 59  
Sarah (1754-1825) 59

DE RUSSY  
Augusta Campbell Nicholas 157  
Charles Amédée (b. 1871) 157  
Edward 157  
Edward Nicholas (b. 1911) 157  
Helen Elizabeth Edgar (b. 1904) 157

Helen Morris 157  
Henry Morris (b. 1911) 157  
John Jay Cisco (1869-1905) 157  
John Schuyler (b. 1905) 157  
Julia Wells (b. 1875) 157  
Madeleine Emily (b. 1907) 157  
René Amédée (b. 1902) 157

DERVALL (DOVALE)  
Rachel (m. J. B. De Mesquita) 57  
Rachel 57  
Samuel 57  
Saul 57

DE SADOWSKA  
Katherine 241

DE SAUSSURE  
John 195  
John M. 195  
John M., Jr. 195  
Louisa (dau. of John) 195  
Louisa Alice Moise 195

DE SHIRA (TEXEIRA)  
See Hart, Myer

DESHON  
Daniel 17, 36  
Isaac 36  
Pauline Barrett Cohen 17, 36  
Solomon 36

DE SILVERA  
Luna 240

DE SIQUERA  
André 234  
Frances Soares Da Veiga 234  
Gracia (Rebecca) 234  
Izabel Maria 234  
Rebecca (see De Siquera, Gracia (Rebecca))

DESLONDE  
Marie Julia 266

DE SOLA  
Aaron (son of Isaac Haim) 61  
Aaron (St. Croix) 61  
Aaron (To London, 1749) 59  
Aaron (1770-1821) 60  
Aaron (1823-1895) 60  
Aaron David Meldola (1853-1918) 60  
Aaron Enrique (d. 1280) 59  
Aaron Meldola 60, 261  
Abigail (dau. of Jacob) 59  
Abigail C. Henriquez 59  
Abigail D'Azevedo 59  
Abigail de Daniel Cohen Henriquez 62  
Abigail Henriquez Moreno 61  
Abigail Lopez (Da Fonseca) 178  
Abraham (b. Lisbon 1739) 59  
Abraham (d. 1753)  
Abraham (m. 1900) 62  
Abraham (13th century Spain) 59  
Abraham (1825-1892) 62, 138  
Abraham Charles Meldola (Bram) (b. 1890) 60  
Amanda Davis 60  
Anita (b. 1866) 59  
Anita Alvarez 59  
Annette (b. 1837) 60  
Bartolomeu (see De Sola, Baruch (Bartolomeu))  
Baruch (see also De Sola, Don Bartolomé (Baruch))  
Beatrice Myer 59  
Belle Maud Goldsmith 60  
Benjamin (b. 1837) 59  
Benjamin (m. before 1733) 61  
Benjamin (son of Isaac Haim) 61  
Benjamin (son of Isaac) 61  
Benjamin (son of Jacob) 59  
Benjamin (1735-1816) 59  
Benjamin (1818-1882) 59  
Benjamin 61  
Benjamin Edward (b. 1867) 59  
Bertram (see Langner, Berthold (Bertram))

Bram (see De Sola, Abraham Charles Meldola (Bram))  
Carlos (b. 1595)  
Clarence Isaac (1858-1920) 60  
Daniel 62  
David (b. Amsterdam) 60  
David (b. 1670) 59  
David (son of Jacob) 62  
David (13th century Spain) 59  
David (1727-1797) 59, 60  
Deborah Beatriz de Arnaldo Jacob Salas 62  
Dolores Eraso 59  
Don Bartolomé Baruch 59  
Edgar 62  
Eleanor 59  
Eleonor de Benjamin De Sola 61, 62  
Elias (London) 59  
Elias (son of Jacob) 61  
Elias (1826-1902) 59  
Eliau 61  
Elijah (b. 1420) 59  
Eliza (1829-1904) 60, 191  
Eliza (1959-) 333A  
Elizabeth Louisa Samuel 60  
Elizabeth Nedras 60  
Esther (dau. of Jacob) 59  
Esther (dau. of Jacob) 62  
Esther (m. Simeon Langner) 60  
Esther de Abraham Moses Mendes Da Costa 61  
Esther de Jacob Maraché 61  
Esther de Moses Hisquiao Monsanto 61  
Esther de Samuel Mendes 178  
Esther Joseph 60, 138  
Esther Leah 60  
Esther Levy 61  
Esther Monsanto (d. 1802)  
Frederic (m. 1897) 61  
Frederic de Elias 62  
Frederick (b. 1871) 59  
Gabriel (Oliviera) (d. 1930) 60  
Gabriel (Portugal) 59  
Graham (1860-1902) 60  
Grace De Pinna 61  
Graham De Sola 60  
Haim (1810-1830) 59  
Haim Solomon (b. 1832) 59  
Haim Solomon (m. 1865) 62  
Hannah (dau. of Jacob) 62  
Hannah (1831-1897) 61, 323A  
Hannah Abinun De Lima 59  
Hannah de Haim Abinun De Lima 61  
Harry (b. 1869) 59  
Hetty Abinun De Lima 59  
Isaac (b. Amsterdam) 60  
Isaac (b. 1459) 59  
Isaac (b. 1728) 61  
Isaac (b. 1774) 60  
Isaac (m. 1902) 62  
Isaac (son of Benjamin) 61  
Isaac (1675-1734) 59  
Isaac (1803-1888) 61  
Isaac (1827-1865) 60  
Isaac de Benjamin 59  
Isaac de Samuel Mendes 178  
Isaac Haim 61  
Isaac (see also De Sola, Juan (Isaac))  
Jacob (b. 1730) 59  
Jacob (b. 1832) 60  
Jacob (b. 1858) 59  
Jacob (m. 1826) 61, 62  
Jacob (son of Benjamin) 61  
Jacob (son of Benjamin, Jr.) 62  
Jacob (13th century Spain) 59  
Jacob (1800-1867) 59  
Jacob Alfonso 59  
Jacob Charles (b. 1865) 59, 61  
Jacob Charles de Elias 62  
Jacob Haim (m. 1899) 61  
Jacob Haim (1769-1788) 61  
Jael (1824-1890) 60

Jaime Herman 62  
Jemima Lindo Henry 60, 115  
Jeosuah 61  
Jessica 60  
Joseph (1857-1904) 60  
Joseph Mendes 59  
Joshua (b. 1828) 59  
Joshua (m. 1859) 62  
Joshua (1774-1839) 59  
Joshua Francis (1863-1894) 59  
Joshua (1962-) 333A  
Juan (Isaac) (1795-1860) 61  
Judah (son of Isaac) 61  
Judith (see De Sola, Julia (Judith))  
Judith Benveniste 59  
Juena 61  
Julia (Judith) 60  
Katherine Samuel 60, 261  
Kathleen Quain 60  
Lea de Joseph Coben D'Azevedo 59  
Leah (b. 1801) 59  
Leah (dau. of Haim Solomon) 59, 62  
Leah Coben Henriquez 59  
Leah de Elias Jesurun Henriques 61  
Leah de Haim Sol 61  
Leah de Jacob Senior 62  
Leah de Selomoh Coben Henriques 62  
Leah De Sola 59, 62  
Leah Jessurun Henriquez 59  
Maria (b. 1833) 60  
Marie Madeleine De Laurens Luckman 62  
Michel 62  
Moses (b. 1772) 60  
Moses (b. 1835) 59  
Mosshe 59  
Mozes 62  
Oliviera (see De Sola, Gabriel (Oliviera))  
Pamela Ann 60  
Rabbi David (1796-1860) 60  
Rachel (b. 1732) 59  
Rachel (dau. of Isaac Haim) 61  
Rachel (dau. of Jacob) 59  
Rachel (m. 1705) 59  
Rachel (m. 1759) 61  
Rachel (1855-1886) 60  
Rachel de Samuel Mendes 178  
Rachel De Sola 61  
Rachel Judith 60  
Rachel Pinto 61  
Rachel Ribeiro Eurtado 61  
Rachel Rosalina de Jac. Haim Osorio 62  
Raphael (1828-1833) 60  
Raphael David 60  
Raphael Samuel Mendes 59  
Raquel Rosalvina De Moises Jesurun 62  
Rebecca (dau. of Judah) 61  
Rebecca (Rica) Meldola 60  
Rebecca (see also De Sola, Rica (Rebecca))  
Ribca de Judah Nunes Da Costa 61  
Rica (Rebecca) 60, 191  
Rosalvina Osorio 59  
Rosalvina Jessurun 59  
Rose de Moses Marius A. Correa 62  
Rosetta (b. 1822) 60, 61  
Samuel (b. 1776) 60  
Samuel (b. 1839) 60, 115  
Samuel (b. 1844) 59  
Samuel (m. 1864) 115  
Samuel (Zerahlah?) 59  
Samuel (1839-1860) 60  
Samuel Maduro 62  
Samuel, Jr. 60  
Sarah (b. 1799) 60  
Sarah (b. 1820) 60  
Sarah (dau. of Isaac) 61  
Sarah (dau. of Jacob) 62  
Sarah (1865-1870) 60  
Sarah A. De Lima 59

Sarah de David Ricardo 61  
 Sarah de Eliau Abinun De Lima 62  
 Sarah de Isaac Namias Torres 60  
 Sarah de Mordecai L. Maduro 62  
 Sarah Jessurun D'Oliveira 59, 60  
 Sarah Senior 59  
 Solomon 59  
 Stella (b. 1821) 60  
 Theodore 62  
 Walter 62  
 Zerahlah (see De Sola, Samuel  
 (Zerahlah?))  
 Zipporah Hoheb 61

**DE SOUZA**  
 Constancia de Jacob Henriques 19  
 Daniel de Jacob Henriques 19  
 Esther Amanda 253  
 Sarah Henriques 19

**DES PORTES**  
 Fay Allen 304  
 Sarah Wolfe 304  
 Ulysse Ganvier 304

**DESPOUEY**  
 Adele Delilah Karstendiek 257  
 Alvin Joseph (b. 1899) 257

**DESSAU**  
 Alvin H. 102  
 Benjamin Hart 102  
 Henry 102  
 Herbert Spencer 102  
 Heth Vaill 102  
 John H. 102  
 Mary Hart 102  
 S. Henry 102

**DESSAULNIERS**  
 Lizette Solomons 276  
 Louis 276

**DE STENCH**  
 Harriet Henry 115  
 Nils H. 115

**DESTIN**  
 Rosalee Sheftall 269

**DE SYLVA**  
 Didacus Pinto (see Da Silva, Diogo  
 Pinto (Didacus Pinto De Sylva))

**DE SYMONS**  
 Jesse 26  
 Lyon 26

**DETMOLD**  
 Fredericke Oppenheim 235  
 Herman 235

**DE TORRES**  
 Abigail 62  
 Daniel (1684-1770) 62  
 Jacob (d. 1696) 62  
 Joseph (Moses) (d. 1724) 62  
 Mordecai (d. 1739) 62  
 Moses (see De Torres, Joseph  
 (Moses))  
 Rachel (m. 1760) 62  
 Rebecca (d. 1693) 62  
 Rebecca (1701-1725; 62, 85  
 Simha Da Silva 62

**DETWELER**  
 Elizabeth 162

**DEUTSCH**  
 Aaron 166  
 Alexander 166  
 Alexander, Jr. 166  
 Bella Rosenbaum 166  
 Bernard 192  
 Blanche 166  
 Charlotte (1874-1940) 166  
 Clara 166  
 Creston (b. 1895) 166  
 Cyril (b. 1902) 166  
 Earl (b. 1896) 166  
 Edward 166  
 Emma Landsburg 166  
 Hannah Lowenstein 166  
 James 166  
 Joseph (b. 1872) 166  
 Joseph, Jr. 166

Josephine Rosina Menken Guedalia  
 192  
 Julia Kelly 166  
 Miriam L. (b. 1886) 166  
 Morris 166  
 Rachel 166  
 Rebecca Virginia Levy 166  
 Rosa 166  
 Sara Jane (b. 1889) 166  
 Selma 166  
 Sigmund (1841-1906) 166  
 Sigmund, Jr. (b. 1883) 166  
 Violet (b. 1898) 166  
 Virginia (dau. of Alexander) 166  
 Virginia (dau. of William) 166  
 William 166  
 William, Jr. 166

**DE VAHL**  
 Baron (see Meir, Frank, Baron De  
 Vahl)

**DEVEREUX**  
 Anne Lane 201  
 Catherine Johnston 200  
 Ellen 200  
 John (m. 1842) 200, 201  
 John II 200  
 Laura M. 200  
 Margaret (Meta) 200  
 Margaret Lane Mordecai 200, 201  
 Mary (b. 1862) 200  
 Meta (see Devereux, Margaret (Meta))  
 Thomas Pollock 200

**DE VINNE**  
 Grace 84

**DE VRIES**  
 Belle (1848-1916) 155

**DEWEY**  
 Isidor Binswanger 23

**DE WINDT**  
 Adrian 327A  
 Rose L. Goldman 327A

**DE WOLFE**  
 Harold Copland 310B  
 Marie Louise Henriques 310B

**DE WORMS**  
 Baron Henry, 1st Lord Pirbright 246  
 Baron Solomon Benedict 261  
 Henrietta Samuel 261  
 Louisa Esther Samuel 261  
 Nora Winifred Samuel 261  
 Percy George 261  
 Sarah Phillips 246

**DEY**  
 Joseph C., Jr. 158  
 Rosalie M. Knapp 158

**DE YOUNG**  
 Amelia (Michelle) Morange 192  
 Betsy Morange (see De Young,  
 Elizabeth (Betsy) Morange)  
 Brinah 11  
 Catherine (Gitlah) (1799-1890) 248  
 Deborah Davis 50  
 Edward B. 50  
 Elizabeth (Betsy) Morange 192  
 Emanuel J. 121  
 Esther 248  
 Gitlah (see De Young, Catherine  
 (Gitlah))  
 Harriet Esther Souza 280  
 Isaac 192  
 Joseph 121  
 Julia 121  
 Michael 192  
 Michelle Morange (See De Young,  
 Amelia (Michelle) Morange)  
 Moses J. 3  
 Philip 280  
 Rachel Hyman Hyneman 121  
 Samuel 248  
 Sara H. 2  
 Sophie 109  
 Sophie 109

**DIAMOND**

Ruth 108

**DIAS**  
 Abigail Cohen D'Azevedo 51  
 Abigail de Moses Cohen D'Azevedo  
 51, 58  
 Abraham de Jacob 58  
 Branca (Da Solis?) 273  
 Francesco 273  
 Hannah de Jacob 58  
 Hannah De Pass 58  
 Isaac Haim 51, 58  
 Isaac Haim de Abraham de Jacob 51  
 Jane Phillips 65  
 Joanna Brandao 273  
 Ribca de Jacob 58  
 Sarah de David de Jacob Lopes 241

**DIAZ**  
 Al 270  
 Ida Sheftall 270

**DIBBLE**  
 Eliza Emma Ottolengui 234  
 Marion W. 234

**DIBLIN**  
 Georgiana (1813-1833) 336B

**DICKIE**  
 Celestine Aline Goldschmidt Burchell  
 Alliger 84  
 R. C. 84

**DICKIE**  
 Ethel 88

**DICKSON**  
 Anna 76  
 Jane 76  
 Maria (dau. of Robert) 76  
 Maria De Lancey 76  
 Phila 76  
 Robert 76

**DIETZ**  
 H. W. 117  
 Nellie Hertz 117

**DIGBY**  
 Constance Pamela Alice Bruce 79  
 Constance Sheila 79  
 Edward Henry Kenelm 79  
 Edward Kenelm 79  
 Jaquetta Mary Theresa 79  
 Pamela Beryl 79

**DIGEN**  
 Moses 250  
 Rachel Pike 250

**DILS**  
 Ella 93

**DILWORTH**  
 Alma 328A  
 C. Emory, Jr. 328A  
 Coke Emory 328A  
 Fannie Kokernot 146, 328A  
 James Colwell 146, 328A  
 James Colwell, Jr. 328A  
 Lenore 328A  
 Lenore (Nora) Kokernot 328A  
 Matalie 328A  
 Nora Kokernot (see Dilworth, Lenore  
 (Nora) Kokernot)

**DIMMOCK**  
 Carrie May 69

**DIMON**  
 Susan Isaacs 126

**DINEL**  
 Alison 338B  
 Barbara Lee 253, 338B  
 Cecil (1864-1864) 323A  
 Edith Rheinstein 253  
 Edward 253, 338B  
 Edward II 338B  
 Gerald P. 323A  
 Helen Rosenbaum 253  
 Henry (1863-) 253, 323A, 338B  
 Joyce 338B  
 Leon (b. 1897) 253, 338B  
 Leon (1866-1878) 323A  
 Pauline Price 253, 323A, 338B  
 Richard 253, 338B

**DINGUS**  
 Marie Angela 237

**DI NISCEMI**  
 Conrad Valguarnera 172  
 Margaret Hirsh 172

**DINKELSPIEL**  
 Beatrice Bachman 323A  
 Edgar 322, 323A  
 Edgar Ned (1915-) 323A  
 Ethel F. Seligman 322B, 323A  
 Feist 323A  
 Frieda (-1914) 323A  
 Gerald P. (see Dinel, Gerald P.)  
 Hannah 334A  
 Hattie 323A  
 Henry (see Dinel, Henry)  
 Joseph 323A  
 Lazarus (1824-1900) 323A  
 Lloyd 323A  
 Melville 323A  
 Pauline Hess 323A  
 Samuel 323A  
 Sophie 323A  
 Theresa 323A

**DINKINS**  
 Philip T. Waties 196  
 Sarah Ann Moise 196  
 Thomas Jefferson 196  
 Thomas Waties 196

**DISHMAN**  
 Catharine 241

**DISNEY**  
 Fannie (d. 1928) 15

**D'ISRAELI**  
 Judith 172

**DIVINE**  
 Agnes 16

**DIX**  
 Kate Ruth 147

**DIXON**  
 Dan Hubbard 37  
 Davis Reed 37  
 George Ann 37  
 Louise 201  
 Robert Reed 37  
 Sallie Atchison 37

**DOBAK**  
 Alexander A., Jr. 164  
 Alexander Andrew 164  
 Anne Helen 164  
 Isabel Adeline Levy 164  
 John Daniel 164

**DOBBINS**  
 Dorothy 327B

**DOBRES**  
 Amalie Brenner 90  
 Robert 90  
 Sally Elizabeth 90

**DOBRIN (DUBLIN)**  
 Bettie Lichtenstein 174  
 Morris 174

**DOBRINER**  
 Daisy Hyman 121  
 Miriam (b. 1901) 121

**DODD**  
 Allison Margueretta 82

**DODDS**  
 Diane 330B

**DODES**  
 Dorothy Bardach 108  
 I. 108  
 Pamela 108

**DOE**  
 Dorothy Lamb Nones 336B  
 Elmer Harris (1885-1956) 336B

**DOLAN**  
 Carolyn Porter Nones 337A  
 Timothy James 337A

**D'OLIVEIRA**  
 David (b. Portugal) 298  
 David (d. 1763) 298  
 Isaac 298  
 Jacob Lopez (d. 1751/2) 298

Judica (Judith) Velha 298  
 Judith Velha (see D'Oliveira, Judica  
 (Judith) Velha)  
 Leah (1715-1778) 298  
 Sarah Jessurun 43, 59, 60

**DOLL**  
 Hannah 283

**DOLNICK**  
 Edward Ishmael 291  
 Lynn Iphigene Golden 291

**DOLOWITZ**  
 Alexander S. 71  
 Ann Moskowitz 71  
 David A. 71  
 David Peter 71  
 David Sander (b. 1940) 71  
 Frances Marie Fleisber 71  
 Fridolyn 71  
 Julia Louise (b. 1942) 71  
 Susan Reda 71  
 Dolma Florence (b. 1947) 71

**DOLWIG**  
 Marjorie 83

**DOMENIE**  
 Anne Mahaken 115  
 Holly (b. 1954) 115  
 Johan 115

**DONN**  
 Mildred 125

**DONNELL**  
 Eleanor Leighton Johnson 311B  
 James Lowe 311B  
 Mary Chesley 156

**DONNELLY**  
 Jennie Edith Somerville Moss 214

**DONOVAN**  
 Deborah (Delia) Salomon 130, 257  
 Delia Salomon (see Washington,  
 Deborah (Delia) Salomon)  
 Edigh Ada 130  
 Eliza Jackson (see Donovan, Lydia  
 ("Eliza") Jackson)  
 Frances Cole 130  
 Henry 130  
 J. W. 257  
 Katharine Byvanck 130  
 Lydia ("Eliza") Jackson 130  
 Mary Noble 130  
 Thomas Washington 130, 257

**D'ONZANO**  
 Adolfo 336A  
 Delia Nones 336A

**DORAN**  
 Andrena Moses Bryan 206  
 Eddie 206  
 Gloria Blanche Lindsay 48

**DORENBAUM**  
 Adele Muriel (b. 1927) 64  
 Augusta Evelyn Elkin 64  
 Myra Elkin (b. 1921) 64  
 William (b. 1888) 64

**DORFER**  
 Freda 257

**DORFVILLE**  
 Celeste 145

**DORFMAN**  
 Benjamin 276  
 Edith Marian Lilienthal 276  
 Richard Nathan 276  
 Roger 276

**DORIA**  
 Alma 324A

**DORMAN**  
 Dorothy 293

**DORN**  
 See also Van Dorn  
 Betty Gries 294  
 Mary 294  
 Nancy 294  
 Randy 294  
 Robert M. 294  
 Tony 294

**DORR**

Julie 336A

**DORTCH**  
 Gavin 200  
 Margaret Lane Turk 200

**DOS PASSOS**  
 Elizabeth Hamlyn Holdrige 105  
 Grace 105  
 John David 105  
 John R., Jr. 105  
 John Randolph 105  
 John Rodrigo 105  
 Katherine F. Swift 105  
 Louis Hays (1876-1957) 105  
 Lucy 105  
 Lucy Addison Sprigg 105  
 Mary Hays 105

**DOUBLEDAY**  
 Minnie (1867-1953) 297, 314A

**DOUD**  
 Edna Isaacs 124  
 Gorda C. 35  
 Isabel 35

**DOUGLAS**  
 Campbell (d. 1872) 298  
 Elizabeth 183  
 Pamela Dodes 108  
 Rose 298  
 Ruth 135  
 Sarah Anne Tobias 298  
 Selina Johnson 135

**DOUMOUX**  
 Anita Rosalie Cardozo 29, 321B  
 Diane Gabrelle 29, 321B  
 Emily Anita 29  
 Frances Anna 29  
 Jerome M., Jr. 29  
 Jerome Miles 29, 321B  
 Laura Danielle 29  
 Laurie Ferguson 29, 321B

**DOVALE**  
 See Dervall (Dovale)

**DOWD**  
 Shirley 89

**DOWLING**  
 Alexander Scott 215  
 Alexander Scott, Jr. 215  
 Amy 215  
 Cordelia 240  
 Hatie 240  
 Jennifer 215  
 Joan Expen 215  
 Juliet 240  
 Kim 215  
 Michael 215  
 Miriam C. Peixotto 240  
 Preston 240  
 Preston, Jr. 240  
 Robert 240  
 Stuart 215

**DOWN**  
 Aline Hart 97, 310A  
 Bessie 75  
 Norma Aline 310A  
 William (son of William Henry) 310A  
 William Henry 97, 310A

**DOWNEY**  
 Celia (b. 1910) 166

**DOWNING**  
 Fanny Cohen (see Downing, Frances  
 (Fanny) Cohen)  
 Frances (Fanny) Cohen 36  
 Georgia 36

**DOWNS**  
 Content Marks 184  
 James 184

**DOYBY**  
 Elizabeth 93  
 John 93

**DOYLE**  
 Brian Frederick 237  
 Jane Louis Isaacs 326A  
 Robert Edward 237  
 Robert Ellis 237

Sheryl Leslie Rhodes 237  
Sulu Mae 257  
Tim Aaron 326A  
**DOZIER**  
Barbara 329A  
Cornelia 269  
**DRAKE**  
Kate Hays 105  
Simeon Joseph 105  
**DRAPER**  
Constance Knowles 141  
Dawn 108  
Harriot Judith Hart 95, 96  
Harry 108  
Jesse 141  
Kenneth 108  
Norma Lee Oberdorfer 108  
Susannah De Lancey 76  
W. H. 95  
William 76  
**DREIFUS**  
Albert 63  
Eleanor Elias 63  
Mathilde Kay 63  
Richard Albert 63  
**DREIFUSS**  
Bessie Rebecca Hays 104  
Herman 21  
Paul 104  
**DREXEL**  
Patricia Geyelia 328B  
Victor L. 328B  
**DREY**  
Margaret 292  
**DREYFOOS**  
Emma 3  
**DREYFOUS**  
Adelaide (d. 1837) 12  
Adele (1859-1879) 12  
Albert (b. 1874) 12, 320A  
Alida Gomez 12, 85  
Alma Esther (1871-1941) 12  
Alma Esther Dreyfous 12  
Anne Wacker 320A  
Carol Vera 186  
Cecilia (b. 1826) 242  
Christopher Paul 320A  
Clifford Gomez (1873-1875) 12  
Edward Aaron (1870-1871) 12  
Emanuel (1834-1902) 12, 85  
Emile (1879-) 327B  
Emilie Andrews (1835-1914) 12  
Emma Price 253  
Esther Andrews 12  
Fannie Vera Scherck 186  
Felix Emanuel (b. 1825) 242  
Felix John 186  
Felix Julius 186  
Florence Cohen 327B  
Florence Eather (b. 1868) 12  
Gertrude (b. 1862) 12  
Hannah (1837-1910) 12  
Helen Clare Barker 186  
Herbert Gomez (b. 1863) 12  
Hetty Seixas (b. 1828) 242  
Howard 12, 320A  
Isaac (b. 1828) 242  
Jeffrey Scott 320A  
Joseph 242  
Joseph Andrews (1832-1891) 12, 85  
Joseph G. 253  
Lee Hendricks 320A  
Leslie Helene 186  
Lucilla Gomez 12, 85  
Maud Heckman 320A  
Patricia Wang 320A  
Paul Gomez 320A  
Rebecca Pesa 242  
Ruth Campbell 320A  
Sandra Gomez 320A  
Simeon (1798-1878) 12  
Walter Aaron (1861-1924) 12  
**DREYFUS**

Carol 186  
Emma Price 253  
Francoise Christianne (Ninette) 82  
Jacques 331B  
John 186  
Joseph G. 253  
Julius 186  
Mary 253  
Maude Rice Shienker 42  
Moses 42  
Renee 331B  
Vera Scherck 186  
**DREYFUSS**  
See also Dryfuss  
David 90  
Delia A. Guggenheimer 90  
Eleanor F. (b. 1898) 21  
**DRINKER**  
A. Ernesta 118  
**DRISCOLL**  
Frederick (m. H. Seixas) 264  
Frederick (son of Frederick) 264  
Harriet Seixas 264  
Marjorie 264  
**DROVIN**  
Bessie Cauffman (see Drovina,  
Elizabeth (Bessie) Cauffman)  
Elizabeth (Bessie) Cauffman 152  
**DRUCKER**  
Anna (b. 1841) 30  
Augusta (b. 1848) 30  
Barbara 102  
Caroline 38  
Jonathan Morris (1968-) 328A  
Clara (b. 1843) 30  
David (b. 1895) 307  
Deborah 261  
Edward (b. 1842) 30  
Eleazer (Siegmond) (1845-1846) 30  
Elizabeth 307  
Estelle S. 102  
Fannie 307  
Flora Ann (1945-1968) 328A  
George W. 102  
George, Jr. 102  
Gershom 30  
Helen Julia 102  
Henry (b. 1847) 30  
Henry (son of Morris J.) 102  
James B. 102  
Julia E. 102  
Larry Mark (1954-) 328A  
Leou Mark (1943-) 328A  
Levy 38  
Marie S. 102  
Maud H. 102  
May 102  
Michael (b. 1839) 30  
Morris 307  
Morris J. 102  
Myra Livingston 328A  
Rebecca Cohen 38  
Rose Wolf 307  
Ruth Pfbaum 102  
Sarah Cardozo Cauffman 30  
Sarah Solomon 102  
Sidney 328A  
**DRUCKERMAN**  
Jane Seligsberg 322B  
Leonard 322B  
**DRYER**  
Nancy 293  
**DRYFOOS**  
Eitel Marks 293  
Herbert 293  
Jacqueline Hays 291  
James David 291  
Marian Effie Sulzberger 291  
Mary 253  
Orville Eugene 291  
Robert Ochs 291  
Susan Warmas 291  
Victoria Ann 291  
**DRYFUS**

Dorothy 322A  
Maude Rice Shlenker 42  
**DRYFUSS**  
Barney Joachim (1879-1950) 311A  
Cele McNulty Peterman (d. 1923) 311A  
Christopher John (b. 1972) 311A  
Claire Agnes Burke (1878-1921) 311A  
Claire Diane (b. 1942) 311A  
Clara Levy 311A  
Frieda Mary Teller (b. 1910) 311A  
Henry 311A  
Isabel Singer (b. 1892) 311A  
John A., Jr. (b. 1940) 311A  
John Augustus (b. 1907) 311A  
Margaret E. Flood (b. 1942) 311A  
Mayme (1882-1962) 311A  
Rosanne Claire (b. 1929) 311A  
**DUBACK**  
Natalie Rahr 231  
Paul 231  
Stephen (b. 1945) 231  
**DUBLIN**  
Bettie Lichtenstein (see Dobrin  
(Dublin), Bettie Lichtenstein)  
Morris (see Dobrin (Dublin), Morris)  
**DUBMAN**  
Andrew James (1954-) 328A  
Charles (1928-) 328A  
Edna Adler 328A  
Janie Leslie (1963-) 328A  
Joan Goldstein 328A  
Jonathan Morris (1968-) 328A  
Lita Lipschutz 328A  
Marty 328A  
Morton (1932-) 328A  
Nina Jo (1955-) 328A  
**DUBOFF**  
Cordelia Moise Lopez 331B  
Florence Marian 331B  
William 331B  
**DUBOIS**  
Elizabeth Louise 276  
**DUBROW**  
Florence 229  
**DUCIT**  
Joseph (d. 1759) 261  
**DUCKWORTH**  
Carol Hudson 5  
Jo Ann 5  
William H., Jr. 5  
William III 5  
**DUFE**  
Miriam Boykin Brenaman 133  
Stewart Mills 133  
**DUFFY**  
Eleanor Theresa 196  
**DUGAS**  
Charles De Vallon 199  
Louise Hubert Moise 199  
**DUJARDIN**  
Judith Henriques (b. 1940) 310A  
Paul 310A  
**DUKE**  
Dorrie 269  
Frances Sheftall Grafft 269  
Hannah (1804-1876) 147  
J. J. 269  
Jeanne 234  
Philip 234  
Rosalie Moise Ottolengui 234  
**DULANY**  
Benjamin Joseph 199  
Emily Clare Mary Moise 199  
**DULLES**  
Natalie 118  
**DUMAS**  
Joanne Carson 180  
William 180  
**DUNCAN**  
Fanny (1821-1883) 156  
Nancy 108  
**DUNDAS**

Charlotte De Lancey 76  
David 76  
**DUNGAN**  
Joseph B. 158  
Mary Morris Adams 158  
**DUNHAM**  
Elizabeth Cooper 157  
Robert Secrest 157  
**DUNK**  
Fleurette Selig 281, 339A  
Howard 339A  
Leonard 339A  
William 281, 339A  
**DUNLAP**  
William 126  
**DUNLOP**  
Sophia Lewis 197  
**DUNN**  
Bessie Sheftall Owsley 269  
Claud 269  
Lucy A. 233, 336A  
Minnie 74  
Virginia 306  
**DUNSTAN**  
Arlene Patricia 102  
Barbara Einstein 102  
Eric Charles 102  
Joan Catherine 102  
**DURHAM**  
Henrietta Melton 84  
Ross 84  
**DURKIN**  
Patricia A. (1943-) 323B  
**DURRING**  
Mari 284  
**DURST**  
Deborah Sue Koch 329B  
Stuart 329B  
**DUSANQUE**  
Benjamin 276  
Sophie Solomons 276  
**DUSCHNES**  
Elsie Harris 280  
Gustave S. 280  
**DUSENBERRY**  
B. L. 129  
Louise Pyke 129  
**DUSHINSKY**  
Brenda (Lilla) De Sola Pinto 61  
Charles 61  
Lilla De Sola Pinto (see Dushinsky,  
Brenda (Lilla) De Sola Pinto)  
**DUSSELDORF**  
Leiser 235  
**DU TEMPLE**  
Comtesse De Rougemont (see Du  
Temple, Edith Devereux Clapp)  
Edith Devereux Clapp 304  
Jean-Louis 304  
Louis Francois René 304  
Louise Le Jeune 304  
Solange-Rose-Lucile 304  
**DUTTON**  
Grayson 58  
Mary Heydenfeldt 58  
Robert 58  
William 58  
**DUVAL**  
Alice May (1883-1884) 214  
Burr Grayson 214  
Ella Amelia Moss 214  
Kate Isabella (b. 1880) 214  
**DUZER**  
See Van Duzer  
**DWIGHT**  
Mary Woolsey 126  
Timothy 126  
**DWYER**  
Eleazer Walter (b. 1877) 248  
Rachel Steinberg 248  
**DYAL**  
Norma Madge (1896-) 336B  
**DYDE**

Florence 46  
Golda Adela David 46  
John S. 46  
**DYDO**  
Karen 290  
**DYER**  
Amelia Ann Lewis 62  
Babette Nachman Gershom 62  
Barney 62, 323A  
Bettgen Gerson (see Dyer, Isabella  
Nachmann)  
Carrie 62  
Catherine (Gitlah) Eitlah 6  
Edward R. 62  
Frances Polock Ellis 6, 62, 64, 323A  
Gitlah (see Dyer, Catherine (Gitlah)  
Eitlah)  
Hannah 323A  
Isabella Nachmann (1785-1826) 323A  
Isadore 62, 323A  
Jacob M. (1843-1866) 62  
John Maximilian (1779-1842) 6, 62,  
323A  
John Napier (1877-1954) 106  
Joseph 323A  
Joseph Osterman (1849-1883) 62  
Joseph Osterman (b. 1864) 62  
Leon (1807-1883) 62, 323A  
Leon (b. 1846) 62  
Louie W. 62  
Marion Sims McKenney 106  
Rosanna (d. 1852) 62  
Rosanna (d. 1866) 62, 309B  
Rosanna (Rosine) 323A  
Rosine (see Dyer, Rosanna (Rosine))  
Sara Nachmann 62, 323A  
Sarah (1851-1852) 62  
Solomon 323A  
**DYKES**  
Lillian Elise Levy 330A  
Osborne Jefferson (1944-) 330A  
**DYKMAN**  
Jackson A. 330A  
Susan Brewer Merrick 330A  
**DYSON**  
Ella 81  
**EARLE**  
Frances Minis 194  
Guy 194  
Guy Harman III (b. 1950) 194  
Richard Dakin (b. 1953) 194  
**EARTH**  
Kenneth Jones 275  
Theodora Beavenada Justine De  
Beaulieu 275  
**EASTLAKE**  
Alice Eleanor 164  
Caroline Moise Levy 164  
Donald E., Jr. 164  
Donald Eggleston 164  
**EASTMAN**  
Casias M. 139  
Cecile Joseph 139  
**EASTON**  
Charles D. 105  
I. David 287  
Margaret Hays 105  
**EATON**  
Bessie A. Moses 209  
Claire Diane Dryfusa 311A  
George K. 209  
Jennifer Diane (b. 1967) 311A  
William E., Jr. (b. 1942) 311A  
**EBERHARDT**  
Katherine Isaacs 93  
William 93  
**ECKMAN**  
Helen 110  
**ECKSTINE**  
Julie B. 28  
**ECOBELLI**  
Lora Lee 340A  
**EDEL**

Albert 222  
Albert, Jr. 222  
Dansey Greenwald 222  
Delia 222  
Delia Myers 222  
Elfrieda 222  
Fannie 222, 312B  
Frieda Myers 222  
Helen 222  
Herman 222  
Jacob 222  
Julius 222  
Lee Reinsberg 222  
Leonore 222  
Riette Levy 222  
Virginia 222  
**EDELMAN**  
Beverly 40  
Isabella Saffer 40  
Murray 40  
Phyllis 40  
**EDER**  
Elizabeth Benjamin 19  
**EDEY**  
Charles C. 124  
Frances Zelmira Isaacs Wetzler 124  
**EDMONDSON**  
Donna De Cordova 52  
E. E. 52  
Lillian Shannon 164  
Lillian Shannon Edmondson Cobb 164  
**EDSON**  
Carol Ann Roth Stone Puglia 237  
Stanley Morton 237  
**EDWARDS**  
Anne 158  
Anne Randolph Reynolds 299  
Elliott Oliveros 299  
Florence D'Azevedo Daniels 51  
Marjorie Edith 320A  
Mary (m. Eustace Lee Florance) 74  
Mary (m. Humberto Parravicino) 51  
Robert Allen 66  
Virginia McIntosh Emanuel 66  
**EGELSON**  
James 29  
Nancy Cardozo 29  
**EGER**  
Asher 22  
Bertram (son of David) 22  
Cecilia (b. 1845) 22  
Clara 22  
Clara Binswanger 21, 22  
David (1801-1862) 21, 22  
Delia Goldsmith 22  
Florence (b. 1852) 22  
Frances V. (1841-1921) 22  
Mabel Mitchell 22  
Maurice D. (1846-1928) 22  
Miriam (1846-1926) 22  
**EGERER**  
Shirley Ann 322B  
**EGERHART**  
Jacob (see Hertz (Egerhart?), Jacob)  
**EHLBERT**  
Lena (see Ehlbert, Pauline (Lena))  
Pauline (Lena) 189  
**EHLIE**  
Olie 5  
**EHRENBACHER**  
Joseph M. 308  
Theresa Sophia Isaac 308  
**EHRENFEST**  
Sophie Schwab 137  
**EHRLICH**  
Adelaide Schiffer Price 253  
Annamarie Hoskin 253  
Cornelia C. Sampson 259  
Dona J. Goetter 70  
Doris Kennedy 253  
Edith Barnes 253  
Edward Price 253  
Eleanor Jane (dau. of William J., Jr.)

253  
 Elspeth Thexton 253  
 Holly Ann 253  
 Jane Rhodes 253  
 Judith Ann (b. 1939) 253  
 Louis S. 259  
 Manfred W. 70  
 Robert 253  
 William J., Jr. 253  
 William Joseph (m. 1901) 253

**EHRlich**  
 Ann 247  
 David M. 117  
 Edwina E. Hertz 117  
 Nettie 21

**EinRICH**  
 Selma 293

**EINSTEIN**  
 Alma Stix 287  
 Amy 173  
 Barbara 102  
 Caroline Fatman 173  
 Cecilia 173  
 David (1839-1909) 173  
 Edwina 111, 173  
 Fanny Hendricks 111, 173  
 Helen Ralli 173  
 Henry (1849-1918) 173  
 I. David (see Easton, I. David)  
 Judith Lewis 173  
 Kate Solomon 102  
 Lena (see Einstein, Zirlah (Lena))  
 Lewis (b. 1877) 173  
 Lewis (m. 1838) 173  
 Marie (1802-1878) 291  
 Mary Small (b. 1904) 287  
 Matilda 125  
 Millie (1883-1916) 173  
 Milton I. D. 287  
 Moise 102  
 Rachel (1841-1903) 173  
 Selma 16, 321A  
 Sophia 290  
 Zirlah (Lena) (d. 1854) 290, 291

**EISEMAN**  
 Alice Stix (b. 1899) 286, 313B  
 Aurelia Stix 286  
 Betty 21  
 Carol Vera Dreyfous 186  
 David (b. 1892) 286  
 David (m. 1883) 286  
 Etta Alice (b. 1887) 286  
 F. Lee 186  
 Florence 292  
 Florence Aurelia (b. 1885) 286  
 Fred 186  
 Helen Louise (b. 1891) 286  
 Helen Louise (b. 1921) 286  
 Jonathan A. 186  
 Mildred D'Ancona 286  
 Nancy V. 186  
 Richard Stix (b. 1894) 286  
 Sylvia Brown 286  
 Thomas J. 186  
 Virginia (b. 1920) 286

**EISEN**  
 Charles 253  
 Eleanor Jane Ehrich 253  
 Judith 253  
 Nancy 253  
 Robert 253

**EISENDRATH**  
 Ana 313B  
 Benjamin Cardozo 29, 313B, 321B  
 Charles R. 29, 313B, 321B  
 Ellen 313B  
 Erna Sarah Rice 313B  
 Julia Aline Cardozo 29, 313B, 321B  
 Mark W. 313B, 321B  
 William 313B

**EISENMAN**  
 Abram 313A  
 Georgia Russell (b. 1914) 313A

Jennie Hecht 107

**EISLER**  
 Josie 295

**EISNER**  
 Sarah Phillips 244  
 Zodik L. 244

**ELAM**  
 Fannie 146  
 Una 257

**ELBERT**  
 Hannah Jeannette Hoffman 33  
 Isabel E. (b. 1932) 23  
 Mordecai 23  
 Nick (b. 1939) 23  
 Nieli 23  
 Yael (b. 1935) 23

**ELDER**  
 Nina Poe 194  
 William V. 194

**ELDRIDGE**  
 Ann Louise 215  
 Charles Colin 215  
 Charles H. 215  
 Grace 133  
 Grace Ann Moss 215  
 Katherine Andrews (see Eldridge, (Katherine) Dale Andrews)  
 (Katherine) Dale Andrews 12  
 Maurice 12

**ELIASER**  
 Isaac (1695-1768) 329A  
 Magdalene Jacob 329A

**ELIAZER**  
 ---- (d. N. Y., 1777) 150

**ELIAZER (LAZARUS)**  
 ---- (N. Y., 1748) 150

**ELFELT**  
 Alfred 28  
 Augustus Benjamin 13, 28  
 Caroline (1833-1887) 24, 28  
 Charles 28  
 Clara 28  
 Edwin I. (b. 1821) 28  
 Elizabeth M. Cadet 28  
 Essie (Rebecca) Asch Shoyer 13, 28, 271  
 Esther Asch 28  
 Rebecca Asch Shoyer (see Elfelt, Essie (Rebecca) Asch Shoyer)  
 Simon (1784-1855) 28

**ELIAKUM (RUDEN)**  
 Moses 254

**ELIAS**  
 Aaron David 63  
 Abraham 323B  
 Abraham 95  
 Annette Hart Holder 95  
 Annie 63  
 Belle (see Elias, Isabelle)  
 Caroline (1854-1855) 323B  
 Clarence 63  
 Clarice 63  
 Clarice (see also Elias, Gladys Frances)  
 Daria 323B  
 David 38, 63  
 David Simon 63  
 David (-1892) 323B  
 David (1860-1917) 323B  
 Edmund 63  
 Eleanor 63  
 Eleanor A. Cohen 38, 63  
 Elkan 323B  
 Elkan 63  
 Elkan (b. 1846-1893) 323B  
 Eugene (b. & d. 1881) 63  
 Evelyn Rich Huber 63  
 Frances 63  
 Gertrude Melnicov 63  
 Gladys Frances 323B  
 Hattie Miller 63  
 Helen Grausman 323B  
 Henrietta Emma 63

Henry Hirsh 63  
 Isabelle (1862-) 63, 323B  
 Janis Felsenfeld 63  
 Jeanette (1846-1868) 63  
 Jeanette (1853-1893) 323B  
 Kate I. Schriver 63  
 Kerry Price 63  
 Koop (N. C.) 63  
 Lawrence 63  
 Levy (1800-1877) 63, 323B  
 Levy Sidney (1876-1878) 63  
 Lewis, Jr. (see Louis, Jr.)  
 Lily (1873-1874) 63  
 Lizzie 63  
 Louis, Jr. 63, 323B  
 Marian (b. 1851) 63, 323B  
 Marian Elias (d. 1913) 63  
 Markus (1852-) 323B  
 Miguel 323B  
 Morris (1875-1881) 63  
 Nancy Judith Levy 330A  
 Percy 63  
 Phoebe Wynn 81  
 Rachel (b. 1848) 63  
 Rachel (m. 1879) 63, 323B  
 Rachel Loeb 63  
 Ralph (see Elias, Raphael (Ralph))  
 Raphael (Ralph) (1847-1907) 63, 323B  
 Raymond Joseph (1939-) 330A  
 Rebecca (1839-1896) 323B  
 Robert Derin (1965-) 330A  
 Rosa L. 63, 323B  
 Ruth 95  
 Sabina Samuel 63  
 Sadie Lee 323B  
 Schontze Koopman 323B  
 Simon Miller 63  
 Sol 63  
 Sterling Price 63  
 Sterling Price, Jr. 63, 323B

**ELIEZER**  
 ---- 153  
 ---- of Alsace 261  
 ---- (son of Eliezer of Alsace) 261  
 ---- (son of Joseph Ducit) 261

**ELIAH**  
 ---- 59

**ELIZER**  
 Billah (b. 1765) 63  
 Eleazer (1761-1821) 63  
 Fanny (see Elizer, Frances (Fanny))  
 Frances (Fanny) (1774-1796) 63  
 Hannah (b. 1763) 63  
 Isaac (ca. 1718-1809) 63, 120  
 Josie 63  
 Moses (1772) 63  
 Priscilla (1777-1796) 63  
 Ricke Isaacs 63, 120

**ELKAN**  
 ---- (of Boppard) 302

**ELKIN**  
 Abby 138  
 Abraham (d. 1867) 12, 64  
 Adelia Ancker 11, 64  
 Augusta Evelyn (b. 1889) 64  
 Barbara Lissner 138  
 Brahm Andrade 138  
 Chantal 138  
 Charlotte Emily 261  
 Dantell(aje) 138  
 Douglas Victor 138  
 Eve Andrews 12, 64  
 F. Victor 138  
 Felice 138  
 Gitel Hiltzen (see Elkin, Gwen (Gitel) Hiltzen)  
 Gwen (Gitel) Hiltzen 138  
 Irene Fanny 138  
 Jacob Joseph 138  
 Jonathan 138  
 Jonathan Keith De Sola 138  
 Joseph (d. 1824) 64  
 Julia Kate (b. 1888) 64

Leila Muriel Joseph 138  
 Lisa Michelle 138  
 Marilyn Fern 138  
 Myer 11, 65  
 Paul (m. 1973) 138  
 Priscilla 64  
 Rosetta Maud Wolff 138  
 Samuel 64  
 Samuel Joshua 138  
 Seymour 95  
 Shalom Zion Victor 138  
 Tova Hilzen 138  
 Vera Esther Hart 95

**ELKIN(S)**  
 Eve Andrews 12, 64

**ELKUS**  
 Beije (1839-) 329A  
 Christopher James (b. 1941) 281  
 Hartog 329A  
 James Hess (b. 1909) 281  
 Jonathan Harold (b. 1948) 281  
 Lea Leeser 329A  
 Leffmann 329A  
 Leonore B. Rosenbaum 281  
 Peggy Hulda (b. 1948) 281  
 Sophie (1836-) 329A

**ELLEGOOD**  
 Jacqueline Ellen Levy Harby 163  
 Joseph A. 163

**ELLENBERG**  
 Rachel 325B

**ELLERBE**  
 Louisa 299

**ELLERMAN**  
 Esther Leah De Sola 60  
 John Reeves 60

**ELLET**  
 Alfred W. (1820-1895) 128  
 Amy Woodruff Padgett (1849-1920) 128  
 Annie 128  
 Bertha (b. 1875) 128  
 Charles 128  
 Charles, Jr. 128  
 Cornelia T. 128  
 Edward Carpenter (b. 1845) 128  
 Edward Carpenter (son of Charles) 128  
 Ellie 128  
 Elvira Augusta 128  
 Elvira Augusta Stuart Daniel 128  
 Frances Van Dorn 128  
 Irene Tyler 128  
 John Israel 128  
 Lydia Little 128  
 Margaret Frakes 128  
 Mary 128  
 Mary Israel 128  
 Mary Jane Skillman 128  
 Mary Virginia 128  
 Pauline 128  
 Sarah Jane Roberts 128  
 Thomas Carpenter 128  
 William Henry (1848-1915) 128  
 William Padgett (b. 1877) 128

**ELLMAN**  
 Edyth C. 158

**ELLIOTT**  
 Alfred 268  
 Alice Frances (m. 1923) 268  
 Anne Beatrice (b. 1918) 311B  
 Letheria Steinberg 268  
 Wanda 268  
 Wayne 268

**ELLIS**  
 Aaron 160  
 Arthur 160  
 Augusta 64  
 Barbara 253  
 Bertha Benjamin (see Ellis, Betsy (Bertha) Benjamin)  
 Betsy (Bertha) Benjamin 160  
 Eli 160

Esther Joel 64  
 Esther Levin 64  
 Esther Louise Nathan 64, 228  
 Frances Polock 6, 64, 323A  
 Isaac 160  
 Isadore L. J. (1849-1928) 64  
 Joseph P. J. (1814-1885) 64, 228  
 Josiah (d. 1798) 64  
 Margaret 299  
 Marguerite Nathan 64, 228  
 Millie 160  
 Myer J. (1794-1829) 6, 64  
 Noah J. 64  
 Percy F. C. (ca. 1867-1924) 64, 228  
 Sydney H. 80

**ELLISON**  
 Al 160  
 Hattie Wagner 160  
 Marilyn 160  
 Minnie Newman 160  
 Morton Maurice 160  
 Nona Sue 160  
 Norman 160  
 Robin Diane 160  
 Rose 160  
 Ruth Emith Ferdinand 160

**ELLS**  
 Cora 245  
 Esther Phillips 245

**ELSBREE**  
 David 312A  
 Esther D. Harby 207, 312A  
 John 312A

**ELSON**  
 Frances Jean 226

**ELSWORTH**  
 Florence 84

**ELWIDGE**  
 Evelyn 42

**ELWELL**  
 David 138  
 Ethel Olive Joseph 138  
 Richard 138  
 Richard, Jr. 138

**ELZAS**  
 Annie Samuel 261  
 Barnett A. 261  
 Sybil 261

**EMANUEL**  
 Abby Gomez (b. 1819) 66, 278  
 Abraham 65  
 Abraham Hyman 65  
 Ada 64, 186  
 Adeline M. Jacobs 66, 132  
 Adeline Wineman (b. 1862) 66, 272  
 Armida Cohen 35, 66  
 Arthur 122  
 Bella Nathan 228  
 Benjamin 64, 186  
 Blanche 122  
 Blanche Estelle 65, 323B  
 Charlotte Jane (1799-1820) 66  
 Charlotte Virginia (b. 1889) 66, 206  
 Charlotte Virginia (1840-1881) 66  
 Clarissa C. MacFarland 65  
 Daisy McIntosh (b. 1906) 66  
 Daisy McIntosh (m. 1901) 66  
 David (son of Mark) 64  
 Diana 174  
 Dinah Julia (d. 1924) 65, 309  
 Edith Alexander 8, 66  
 Edmond Lopez (b. 1834) 66  
 Eliza 65  
 Elizabeth Hyman 122  
 Ellen McIntosh (b. 1904) 66  
 Emanuel (b. 1824) 66  
 Emanuel (m. Judith Solis) 274  
 Emily Gertrude Sanguinetti 65  
 Esther Alexander 9, 66  
 Esther Sarah (b. 1871) 66  
 Ethel Woolf 122  
 Eveline 65  
 Fanny (dau. of Mark) 64

Fanny 65  
 Flora (1817-1889) 66  
 Flora Emanuel 66  
 Flora Levy 309B, 310A  
 Florence Beatrice Goodhart 65, 323B  
 Florence M. (1857-1890) 66  
 Florence May (b. 1891) 66  
 George 122  
 Hannah (dau. of Mark) 64  
 Hannah (m. Manly) 65  
 Hannah (m. 1887) 10  
 Hannah Cohen 65  
 Harry 122  
 Heiman Kaminsky (b. 1908) 66  
 Henrietta 66, 278  
 Henrietta Eugenia Simpson 66, 272  
 Henrietta S. (b. 1836) 66, 278  
 Hetty (1831-1840) 66  
 Jessica (1813-1873) 7  
 Jessie Pough 122  
 Joel (son of Michael) 66, 310A  
 Joel (1829-1886) 66  
 Jonathan 65  
 Jonathan Manly (1838-1910) 65, 323B  
 Joseph 122  
 Judith (see Emanuel, Juliet (Judith))  
 Judith Solis 274  
 Julia Esther Marks 64, 186  
 Juliet (Judith) (1827-1842) 66  
 Juliet Davis 64  
 Kate 274  
 Lafayette Gomez (1824-1908) 66, 132  
 Lavinia Hoffman 122  
 Leonard 122  
 Levy 65  
 Lewis (son of Mark) 64  
 Lily 122  
 Linda Sue 65  
 Louis Manly (1834-1868) 65  
 Louisa Jacobs 64, 132  
 Lyon Levy (1837-1877) 65  
 Manly (1795-1880) 65  
 Manly Gerold 65  
 Manly Lyon 65, 323B  
 Manly Woodrow 65, 323B  
 Margaret Emily 65  
 Marion (b. 1882) 66, 233  
 Marion (1849-1855) 66  
 Mark (1791-1851) 64  
 Mary Eleanor Seixas 66, 265  
 Maurice (see also Emanuel, Morris (Maurice))  
 Maurice (1852-1895) 66, 265  
 Michael (d. 1801) 66  
 Michael (son of Michael) 310  
 Michael 66, 309B, 310A  
 Miriam (1867-1941) 122  
 Morris (Maurice) (b. 1892) 66  
 Morris (Vicksburg) 66  
 Nathan (b. 1901) 66  
 Nathan (son of Michael) 66, 85  
 Nathan (1812-1888) 66, 272  
 Nathan (1854-1939) 66  
 Peter 122  
 Philip 65  
 Plowdon Weston (1861-1881) 66  
 Rachel 274  
 Rebecca 64  
 Richard 122  
 Richard Alan 65  
 Rose 66  
 Sarah (b. 1800) 66, 139  
 Sarah (1800-1883) 65  
 Sarah Francis Emanuel 65  
 Sarah Gomez (1793-1852) 66, 85  
 Sarah Gomez (1846-1886) 66  
 Simeon (son of Mark) 64, 132  
 Simon 310A  
 Solomon (1842-1921) 8, 35, 66  
 Solomon 66  
 Thom 122  
 Timothy 122  
 Viola Leffert (Lefkowitz) 65

Viola Lefkowitz (see Emanuel, Viola  
Lefkert (Lefkowitz))  
Virginia McIntosh (b. 1903) 66  
Washington (1844-1864) 66

**EMBRY**

Annie De Cordova 52  
Glen P. 52

**EMDEN**

Esther 290  
Isadora Labatt 148  
Saul 148

**EMERONTHIE**

Marie 116

**EMERSON**

Carlota 310A

**EMISON**

Maude 141

**EMORY**

Ann Elizabeth 158  
Griselda Holmes 158  
Mary Rogers 158

**EMPTASSE**

Rosemarie 17

**EMSHHEIMER**

Henry 130  
Muriel Jackson 130

**ENDELL**

Fanny 93

**ENES**

John 203  
Sipora Mordecai 203

**ENGEL**

Caroline (1827-1898) 174  
Elaine Reichel 253  
George (m. M. A. Goldsmith) 253  
George (son of George) 253  
George C. 253  
George C., Jr. 253  
John R. 253

Margery Alice Goldsmith 253  
Montefiore 264  
Myrilla Seixas 264  
Susan Price 253  
Susie 253

**ENGELBERG**

Mabel 283

**ENGELL**

Kate Benjamin 19

**ENGS**

Ann 168  
William 168

**ENOCH BEN HAI**

--- 59

**EPES**

Sallie 133

**EPHRAIM**

Hannah 50

**EPILE**

Linda (1864-1914) 166

**EPSTEIN**

Abigail Frois 85  
Bella Hunt 118  
Clara 13  
David 118  
Dinah (b. 1864) 118  
Flo Fox 278  
Jacob (b. 1831) 85  
Jacob (see also Epstein, David)  
Jean Ann Goldstein 278  
Joseph L. 278  
Joseph, Jr. 278  
Laura 187  
Miriam D. Lovenstein 278  
Richard 278  
Stephen 278  
Tracy 278  
Tracy, Jr. 278  
Virginia (1862-1922) 312B  
Wendi 324B

**ERASO**

Dolores 59

**ERBER**

Charles S. 320B

Charles S., Jr. 320B  
Emma Arnold 320B  
Lois Estelle 320B  
Simon Arnold 320B

**ERDMAN**

Elizabeth 253  
Julia Bernd 253  
Julia Price 253  
Martin 253  
William 253  
William, Jr. 253

**ERDRICH**

Harry J. 138  
Nancy Sebag-Montefiore 100

**ERLANDER**

Rose (1871-) 327A

**ERLANGER**

Fanny Thorman 293  
Gussie 14  
Joseph 293  
Meyer 14  
Peggy Bamberger (see Erlanger, Rifka  
S. (Peggy) Bamberger)  
Rifka S. (Peggy) Bamberger 14

**ERLEBACHER**

Adrienne Herzberg 125  
Albert 125

**ERSAK**

Clara 206

**ERSTEIN**

Kitty Aronson 6  
Moses 6

**ERWIN**

Hannah (1757-1813) 128  
Nettie 88

**ESAR**

Joseph 138  
Rachel Alexandra Wolff 138

**ESDRA**

Aurelia 115  
Esther Clara 115  
Esther Lucile 115  
Joseph Eugene (b. 1816) 115  
Joseph Eugene (1851-1854) 115  
Pauline 115

**ESHNER**

Anne 28  
Annette 28

**ESPEN**

Edward 215  
Ellen 215  
Ida 90  
Joan 215  
Joyce Lowengrund 215  
Kitty (b. 1871) 92

**ESPINOZA**

Jacob de Moses Haim Jessurun 302

Leah Valverde 302

**ESSENHEIM**

Joseph 172  
Sarah Lewis 172

**ESSRIG**

Cecile Isabel Waterman 90  
Cecile Lee 90  
Marvin 90  
Marvin Jerome 90

**ESTES**

Ethel Miriam Schwartz 266  
Stuart 266

**ESTEVE DE PINA**

Miguel (see Da Costa, Mordechai  
(Miguel Esteves De Pina))

**ETHERIDGE**

Cecil 208  
Virginia Harby 208

**ETENSON**

June Edda 230

**ETTENHEIMER**

Clara 222  
Rose 15

**ETTER**

Burt 195  
Mazie Moise 195

**ETTING**

Alice Taney Campbell 67  
Asher 67, 131  
Barnard Gratz (1806-1862) 67  
Benjamin (d. 1778) 67  
Benjamin (1798-1875) 67, 88  
Bilah (1785-1786) 67  
Charles Edward (1844-1910) 67  
Clara C. Newman Fitzsimmons 67  
Clara Lavine Wock 67  
D. Harriet Marx 188  
Edward Johnson (1803-1862) 67, 194  
Edward Johnson II (1840-1896) 67  
Elijah (b. 1771/4) 67, 68, 223  
Elijah (1724-1778) 67, 223  
Elijah (1784-1854) 67  
Elijah Gratz (1795-1849) 67  
Elizabeth (b. 1773) 68  
Ellen (1802-1877) 67  
Ellen Hays 67, 106  
Emlen P. III (m. 1938) 67  
Emlen P., Jr. (b. 1903) 67  
Emlen Pope (1869-1905) 67  
Esther (Hetty Asser) (d. 1793) 67, 10  
323B

Fanny (Frances) Gratz 67  
Fanny (1766-1828) 67  
Florence A. Lucas 67  
Frances (dau. of Benjamin) 67  
Frances Gratz (m. Reuben Etting) 67  
8

Frances Gratz (see Etting, Fanny  
(Frances) Gratz)

Frances Marx (b. 1841) 116  
Frances Marx (1812-1841) 67, 188  
Frances Marx (1864-1949) 67  
Frank Marx (1833-1890) 67  
Frank Marx (1867-1932) 67  
Frederick Henry (1834-1835) 67  
Gratz (1850-1884) 67  
Harriet (1865-1940) 67  
Henry (1799-1876) 67  
Henry Frank (1856-1857) 67  
Hetty (1770-1847) 67  
Hetty Asser (see Etting, Esther (Hetty  
Asser))

Horatio (1805-1891) 67, 88  
Isabella (1796-1800) 67  
Isabella (1801-1855) 67  
Jeanette Verplanck 67  
Joseph (1778-1781) 67  
Joseph (1788-1856) 67  
Joseph Marx (1836-1915) 67  
Josephine (1830-1914) 67  
Kitty (1768-1837/8) 67  
Kitty (1799-1837) 32, 67  
Margaretta Emmelie Pope 67  
Maria New Bold 67  
Miriam (1787-1808) 67, 218  
Miriam Gratz (1807-1878) 67  
Moses (d. 1778) 67  
Philippa (1848-1893) 67  
Philippa Minis 67, 194  
Rachel Gratz 67, 87  
Rachel Jacobs 67, 131  
Rebecca (1798-1799) 67  
Reuben (father of Asher) 67  
Reuben (1750/6-1770) 67  
Reuben (1762-1848) 67, 87  
Reuben (1794-1804) 67  
Reuben (1842-1911) 67  
Reyna (Rachel) Simon 67, 271  
Richea Gratz (1792-1881) 67  
Sally (1776-1863) 67  
Samuel (1796-1862) 67, 106  
Samuel Marx (1839-1888) 67  
Sarah E. Smyth 67  
Shinah (1803-1878) 67  
Shinah Solomon 67, 68, 223  
Solomon (1764-1847) 67, 87, 271  
Solomon II (b. 1839) 67  
Solomon Minis (b. 1846) 67  
Thomas Newbold (1863-1914) 67

**ETTINGER**

Barbara March Lyons 238  
Barbara Prentice 238  
Christian Prentice 238  
Christopher Wadsworth Prentice 238  
Deborah Wadsworth Prentice 238  
Denise March 238  
Elaine Prentice 238  
Elsie Phyllis Oppenheimer 238  
Heidi Prentice 238  
Leland 238  
Linda May McNeal 238  
Pamela Prentice 238  
Richard P., Jr. 238  
Richard Prentice 238  
Richard Prentice III 238  
Sharon Whitaker 238  
Virginia Prentice 238  
Wendy Wadsworth Prentice 238

**EUADALY**

Violet 326B

**EUNICE**

Hugh C. (1851-) 337A  
Theodosia Patterson 337A

**EURTADO**

Rachel Ribeiro 61

**EUSTIS**

Adele Britin 25  
Allan 25

**EVANS**

Anne G. Pizzini 49  
Anne Russell 262  
Cadwallader 80  
Edith Corse 80  
Ellen Kuhn 80  
Ellen Lyle (dau. of Manlius G.) 80  
Ellen Lyle (m. Mahan) 80  
Hartman Kuhn 80  
James 112  
Jessie Hunt Henriques 112  
Mabel Estelle Curtiss 80  
Manlius Glendour 80  
Margaret (1720-1780) 75  
Mary Campbell 262  
Mary 49  
Rhoda 75  
Rosalie 80

**EVERETT**

Elbert 167  
Karen 167  
Laura Hope Asher Benator 167

**EVINS**

Agnes Isaacs 126  
Jermia 126

**EWART**

Susan Ellen 81

**EWING**

Ann Madden (1949-) 337A  
Elizabeth Nones Ballard 337A  
Frank A. 251  
Mary Louise Nowlin 337A  
Paul Usher (1915-) 337A  
Rose A. Pinto 251  
Toulmin H. (-1938) 337A

**EXUM**

Beverly Goodman 108, 325B  
William 108, 325B

**EZECHIEL**

Leah Joseph 137

**EZEKIEL**

Aaron Augustus (b. 1875) 70  
Abraham 136  
Abraham Tobias (1816-1880) 70, 101,  
324A  
Abraham Tobias (1865-1881) 70  
Adeline (1815-1899) 69, 123  
Adeline Hyneman (1843-1915) 27, 69  
Alan Wayne (1967-) 323B  
Albert Abraham (b. 1848) 70, 324A  
Alice (1860-1907) 70  
Alice Martha 70, 323B  
Amelia (m. 1836) 70, 323B  
Amy Bloomberg 70

Annie 136  
Ansel Leo (b. 1873) 70  
Arthur 70, 324A  
Asher Lewis 16, 70, 324A  
Belle Myers 70  
Belle Russ 70  
Benjamin 136  
Bertha 70, 324A  
Bertram Edgar 70  
Blanche Marie 70  
Carrie May Dimmock 69  
Catherine De Castro 69, 323B  
Catherine (1851-1853) 323B  
Cecilia Lichten 70, 324A  
Charles Arnstahl (1872-1937) 70  
Charles David (1871-1912/13) 70  
Chester J. (b. 1888) 70  
Clara J. (b. 1880) 70  
David (Clarksville, Tenn.) 310A  
David (m. Kate Sohner) 135  
David (son of Walter Naphtali) 70  
Dorena Sarah (b. 1877) 70  
Edward Tobias (1846-1882) 3, 70,  
324A

Edwin Allison 70, 162  
Edwin J. (b. 1887) 70  
Edwin N., Jr. 70, 323B  
Edwin Naphtali 70, 323B  
Edwin Tobias (b. 1859) 70  
Eleazer (b. 1817) 69  
Eleazer (b. 1847) 135  
Elizabeth (1755-1837) 141  
Emma Grubb 70  
Esther Eudora (1812-1841) 99, 169  
Eather Virginia (1857-1952) 69  
Eva (1825-1858) 24  
Eva Lee (1865-1938) 70  
Eva M. (b. 1884) 70  
Ezekiel Abraham 136  
Ezekiel Barent 131  
Ezekiel Jacob (1788-1831) 69, 128  
Ezekiel Michael (1841-1912) 69  
Fanny Seifert 70  
Florence (1855-1920) 70  
Florence E. (b. 1882) 70  
Frances Cohen 70, 101  
Frances Solomon 70  
Frank (son of Gerald, Jr.) 70, 323B  
Frank (1853-1863) 70  
George Samuel (1867-1904) 70  
Georgiana Barnett 16, 70  
Gerald Abraham 70, 323B  
Gerald, Jr. 70, 323B  
Gloria Braggiotti 67  
Grace 70  
Grace Rich 69  
Gustavus Flegenheimer (b. 1889) 70  
Hannah (1836-1922) 69, 306  
Hannah Eloise (b. 1861) 70  
Hannah Isaacs 69, 70, 127  
(Hannah) Rebecca Israel 69, 128  
Harriet Lamm 70, 323B  
Helen Constance (b. 1881) 70, 323B  
Henry B. (1844-1916) 135  
Henry Clay 69, 306  
Herbert 70  
Herbert Tobias (1863-1938) 70  
Howard Solomon 70, 324A  
Jacob (Schreiber, Yacob) 69  
Jacob (1812-1899) 69, 323B  
Jacob (1818-1860) 70  
Jacob (1857-1931) 70, 324A  
Jacob Harry (1869-1874) 70  
Jessie Myers 69, 306  
Jonathan (Seattle, Wash.) 310A  
Jonathan (Theodore) (1823-1864) 70  
Joseph (Balto) 69  
Joseph (Jamaica) 169  
Joseph (son of Walter) 70  
Josephine (b. 1848) 27, 69  
Josephine I. Stuart 70  
Josephine V. (b. 1903) 70  
Julia 80

Julia May Sommers 70  
Julia Rachel Samuels 69  
Kate (b. 1861) 70  
Kate McConnick 70  
Kate Sohner 135  
Leah (b. 1823) 70  
Leah Morenu 169  
Lena Burr Corse 80  
Lena Cadwallader 80  
Leonora R. (1844-1916) 70, 324A  
Leslie R. (b. 1897) 70  
Louis Poznanski (1850-1930) 69  
Lucille Finsterwald 70, 310A  
Lynn 324A  
Margaret 324A  
Margaret (Chevy Chase, Md.) 310A  
Martha (1809-1886) 69, 162  
Martha (1849-1890) 70, 323B  
Martha (1859-1861) 69  
Martha Levy 70, 162  
Matilda (1821-1865) 231  
Mordecai J. (1899-1974) 70, 310A  
Moses (son of Tobias Jacob) 70, 324A  
Moses Jacob (1844-1917) 69  
Naphtali Judah (1819-1891) 70, 162,  
323B

Percy Levy 70, 323B  
Rachel Brill 70  
Rachel Flegenheimer 70  
Raphael 70, 323B  
Rebecca (b. 1838) 69  
Rebecca (m. Ezekiel Abraham) 136  
Rebecca (m. Jacob) 69  
Rebecca (m. 1840) 70, 323B  
Rebecca Levy 70, 162  
Rebecca Solomon 70  
Rebecca Tobias 69  
Rosetta Goldsmith (b. 1840) 19, 69  
Sarah (dau. of Jacob) 69  
Sarah (dau. of Moses) 70  
Sarah (m. 1834) 70  
Sarah Israel (1861-1945) 69  
Sarah R. (b. 1890) 70  
Sarah Ritzen 70  
Selena 96  
Selina Emma Johnson 2, 135  
Sharon 70, 323B  
Solomon 70  
Susie Hiner 70  
Theodora Rachel (1863-1867) 70  
Theodore (see Ezekiel, Jonathan  
(Theodore))  
Theresa Bischof 69  
Tobias 69, 70, 127  
Tobias Jacob (1786-1832) 69, 70, 127,  
323B  
Walter Ambrose (b. 1853) 69  
Walter Naphtali 70  
Yetta Waterman (1855-1886) 69

**EZZEL**

Betty 268

**FABACHER**

Lillian 199

**FABIANI**

John 335A  
Joseph Sonneborn (1982-) 335A  
Marcia Whitlock Sonneborn 335A  
Michael Sonneborn (1985-) 335A

**FABRIKANT**

Carrie 127

**FAGIN**

Daniel 3  
David 3  
Margaret Straus 3  
Richard 3  
Steven 3

**FAHNESTOCK**

Helen Morgan Moran 158  
Snowden Andrews 158

**FAINSOD**

Elizabeth Stix (b. 1909) 287  
Elizabeth Stix (dau. of Merle) 287  
Mary Lewis 287

Merle 287  
**FAINSTEIN**  
 Carol 3  
**FAITHCLOTH**  
 Evelyn 58  
**FAITHCLOTH (PREER)**  
 Maud 58  
**FALCK**  
 Alberta 48  
 Edna Davis 48  
 Edward 48  
 Edward Albert 48  
 Jon Edward 48  
 Ruth McGee 48  
**FALCONER**  
 Comegys 331A  
 Elizabeth Levy 170, 331A  
 George 331A  
 George Comegys 331A  
 Henry Ervin 331A  
 John Peregrine 331A  
 Margaret Burney 331A  
 Peregrine 170, 331A  
 Septimus 331A  
 William Andrew 331A  
 William Charles 331A  
**FALK**  
 Abraham (b. 1828) 5  
 Abraham (b. 1884) 5, 222  
 Adeline Brady 5  
 Alexandra A. (1872-1873) 5  
 Alice 172  
 Ann Findeison 5  
 Arla Fey 5, 309A  
 Cissie (see Falk, Sarah (Cissie))  
 Daisy A. (b. & d. 1873) 5  
 David 222  
 David B. (1891-1917) 5  
 David B. 5, 309A  
 David Beauregard (1861-1916) 5, 278  
 Doris Joan Lippman 5, 222  
 Doris V. 5  
 Ellen 222  
 Ellen Waterloo Samuel Solis 260  
 Eunice Merle Lippman 5, 222  
 Fannie Edel 222, 312B  
 Fanny Lewis 172  
 Fradel Sulzberger 290  
 Georgiana Sarah Jacobi 117  
 Hannah 5  
 Henri A. (1886-1888) 5  
 Henrietta 5  
 Henrietta Abrahams 5  
 Isaiah M. 5, 279  
 Jacob 290  
 Jacob Melvin (b. & d. 1866) 5  
 Jacob W. 172  
 Janie Solomon(s) 5, 279  
 Josephine Sonneborn 312B  
 Joshua A. (1856-1857) 5  
 Katherine Sonneborn 222, 312B  
 Lawrence Lippman 5  
 Lee Richard 5  
 Leon (1870-1928) 222, 312B  
 Leon, Jr. 222, 312B  
 Leslie Ann 5, 327B  
 Lillie Brady 5, 210  
 Lily Rachel 5  
 Lucille Kotler 5  
 Marjorie 312B  
 Millie Einstein 173  
 Moritz (1814-1871) 260  
 Myron S. 173  
 Rabbi Jerachmeel (see Van Der Wilden, Valentijn Valck)  
 Rebecca (b. 1869) 172  
 Richard Brady 5  
 Rita J. 5  
 Roberta 125  
 Sara 222  
 Sarah (b. 1872) 172  
 Sarah (Cissie) 5  
 Sarah (1859-1938) 5, 278

Sarah Judith (Cissy) Solomons 5, 278  
 Sigo 222  
 Stella 172  
 Susannah 222  
 Vickie 5  
 Walter 5  
 Walter J. 5  
 Washington (b. 1864) 5, 210  
 Washington III 5  
 Washington, Jr. 5, 222  
 William 172  
 Willie A. (1869-1872) 5  
 Zachariah 117  
 Zipporah 5  
**FALKSON**  
 Rosa Brush 27  
**FALLON**  
 Cecelia M. 312B  
**FARBMAN**  
 Douglas 61  
 Ellen De Castro 61  
 Howard 61  
 Jack 61  
 Leonard 61  
 Paula 61  
**FARGASON**  
 Anna Lafae 270  
**FARKUS**  
 Freddie 270  
**FARMER**  
 Cecil 308  
 Edith Rose Isaac 308  
 Harold 308  
 Herbert 308  
 Leopold 308  
 Mabel 308  
 Nan 213  
**FARO**  
 Benjamin 57  
 Bilhah Gabay (d. 1694) 57  
 Esther De Mesquita 57  
 Isaac Gabay 57  
 Jacob 57  
 Simha Berlandina 19  
 Solomon 57  
 Solomon de Abraham 19  
**FARQUHAR**  
 Caroline 264  
**FARQUHARSON**  
 Jessie 140  
**FARRELL**  
 Albert Johnson 199  
 Mathilda Vaughn Moise 199  
**FARRINGER**  
 Laura Josephine Cottenbrock 123  
**FARRO**  
 Sara de Abraham Henriques 51  
**FATMAN**  
 Caroline 173  
 David 206  
 Elizabeth Angier Moses Banks 206  
**FAUDEL**  
 Rachel 246  
**FAUGHT**  
 Eleanor Charlene 163  
**FAULK**  
 Alice Sarah (Lea) Harper 213  
 James Monroe 213  
 Lea Harper (see Faulk, Alice Sarah (Lea) Harper)  
**FAUSTY**  
 Andrea Forster 266  
 Dean 266  
 Joshua H. 266  
**FAUTH**  
 John J. 265  
 John J., Jr. 265  
 Lillian Seixas 265  
 Margaret Morgan 265  
 Victoria 265  
**FAYDEEN**  
 Ludella 336A  
**FEAVER**

George W. 310B  
 Jane Lewis 310B  
 Ralph M. 310B  
**FECHHEIMER**  
 Alice Stix 286  
 Cora 306  
 Edith 286  
 Helen 286  
 Marcus (b. 1897) 286  
 Nathan Stix (1900-1918) 286  
 Samuel Marcus 286  
**FEDERMAN**  
 Julia 209  
**FEEMAN**  
 Emily R. 339B  
**FEIBELMAN**  
 Elsie 125  
 Kathleen 313B  
**FEIDELSON**  
 Adeline 5  
 Adeline Brady Falk 5  
 Catherine Van Raalte 5  
 Charles N. 5  
 Charles N., Jr. 5  
 David Falk 5  
**FEINBLATT**  
 Fridolyn Baum 71  
 Leon 71  
**FEINGOLD**  
 Annie Winter 10  
 Gert 10  
 Heinrich 10  
 Stefan 10  
**FEINSTEIN**  
 Frances Louise Isaacs Silverstone 125  
 Leon 125  
**FEIST**  
 Emanuel Gershom (see Dyer, John Maximilian)  
**FEIWEL OF GLOGAU**  
 — 261  
**FELBEL**  
 Ada Benjamin 19, 73  
 Dinah Blanche (1862-1864) 73  
 Eugenie (b. 1859) 73, 125  
 Frank Julius (1889-1918) 73  
 Gertrude (1864-1935) 73  
 Grace (1851-1893) 73  
 Henry (1866-1867) 73  
 Isador 73  
 Jacob (Julius) (1823-1904) 38, 73  
 Jacob (1857-1938) 19, 73  
 Julius (see Felbel, Jacob (Julius))  
 Miriam Cohen 38, 73  
 Rosalie (1853-1934) 73  
 Tessie Hyman Freeman 73  
**FELDBLUM**  
 Sophie 145, 328A  
**FELDER**  
 Frances 146  
 J. L. 146  
 J. L., Jr. 146  
 Johannie Kokernot 146  
**FELDMAN**  
 Albert Joseph 287  
 Bea 327A  
 Beverly Newman 160  
 David Jonas 287  
 Ellen M. Jonas 287  
 Emily Louise 287  
 Grace Maude Hart Beirs 102  
 Louis 160  
 Louise Metzenbaum 102  
 Muriel 242  
 Rachel Ann (b. 1956) 287  
 Robert H., Jr. 102  
 Robert Hart 102  
 Ruth Elizabeth 195  
 Samuel J. 102  
 Thomas Myron 102  
**FELDON**  
 Richard A. 310A  
 Ruth Frankenthaler Lewisohn 310A

**FELDSTEIN**  
 Dorothy 23  
 Rachel 145  
**FELL**  
 Eola 164  
 Frances Drexel 80  
**FELLEMAN**  
 Betsy (b. 1867) 182  
 David (1882-1898) 182  
 Eleazer (b. 1868) 182  
 Gershom (b. 1872) 182  
 Harriet 332B  
 Israel (b. 1870) 182, 332B  
 Phillip 332B  
 Phillip Israel (1842-1896) 182, 332A  
 Rose Lyons 182, 332A  
**FELLHEIMER**  
 Babette 282  
 Henry 149  
**FELSENFELD**  
 Janis 63  
**FELSENTHAL**  
 Dorothy Jacobs 125  
 Flora 231  
**FENN**  
 Anna 184  
**FENSKE**  
 Margaret (Nicky) Hockman 191  
 Nicky Hockman (see Fenske, Margaret (Nicky) Hockman)  
 Robert 191  
**FENSTER**  
 Alan (b. 1947) 15  
 Albert 15  
 Katherine Stein 15  
 Mary Ann (b. 1954) 15  
 Nancy (b. 1944) 15  
**FENSTERWALD**  
 Alice 107  
 Myra Westheimer 107  
 Myra, Jr. 107  
 Ralph 107  
 Ralph, Jr. 107  
 Renee 107  
**FENTON**  
 Ida Pinto 251  
 John 251  
**FERDINAND**  
 Ruth Emith 160  
**FERDON**  
 Barbara Gould 331A  
 Ben 331A  
 W. L. 331A  
 Will 331A  
**FERGUSON**  
 Allan B. III 201  
 Allan Bernard, Jr. 201  
 Helen Norwood Mordecai 201  
 J. Smith 74  
 Jane Ellen Rothschild 222, 312B, 334B  
 Jason Frederick 312B, 334B  
 Joseph 222, 312B, 334B  
 Laurie 29  
 Margaret Florence 74  
 Maria B. 140  
 Violet 78  
**FERKO**  
 Richard Michael 237  
 Sandra Lee Rhodes 237  
**FERN**  
 Gary J. 282  
 Judith Frances Kagen 282  
 Karen Rebecca 282  
 Leon 282, 339B  
 Marilyn 138  
**FERNANDES**  
 Leon (see Fern, Leon)  
**FERNANDEZ**  
 Rose 335A  
 Sarah de Samuel 178  
**FERNBACH**  
 Henrietta Julia Michaelis 136  
 Henry (b. 1830) 136  
 Isaac 136

Termina Pinsk Joachimssen 136  
**FERNBERGER**  
 Edward 149  
 Edward, Jr. 149  
 Ellen Weiler 149  
 Eve Wallerstein 149  
 Henry 149  
 Herman Weiler 149  
 Hortense Gannebaum 149  
 James Moyer 149  
 John Marshall 149  
 John, Jr. 149  
 Julia Weiler 149  
 Linda Margolies 149  
 Marilyn Friedman 149  
 Peter Baldwin 149  
 Samuel Weiler 149  
**FERNE**  
 Bette 282  
 Henry 149  
**FERRE**  
 Elizabeth C. 256, 312B  
**FERST**  
 Mildred 167  
**FEUCHTWANGER**  
 Augusta Levy 159, 303  
 Charles (1847-1848) 159  
 Ella Carrick 276  
 Emma (1842-1920) 159  
 Henry 276  
 Joseph Washington (1840-1874) 159  
 Lewis 159, 303  
 Oscar Uriah (1836-1849) 159  
 Rebecca (1838-1906) 159  
 Rosina Levy 159  
**FEY**  
 Arla 5, 309A  
**FFRENCH**  
 Adele Carvalho 30  
 Ernest G. 30  
 Geoffrey Earnest 30  
 Jonathan 30  
 Violette Anne 30  
**FIDANQUE**  
 Joshua Vivian 10  
 Ruth Evelyn Allen 10  
**FIDIAM**  
 Dorothy Grace 238  
**FIDLER**  
 Mildred 133  
**FIELD**  
 Nannie Bell 197  
**FIGG**  
 Amy Elizabeth 299  
 Catherine Emily 299  
 Catherine Louise Cox 299  
 Emily Tobias (b. 1931) 299  
 Jefferson Tobias (b. 1936) 299  
 Mary Elizabeth Johnson 299  
 Paul Settle 299  
 Robert III (b. 1928) 299  
 Robert McCormick IV 299  
 Robert McCormick, Jr. 299  
 Sallie Alexander Tobias 299  
 Susan Tracy 299  
**FINA**  
 Beatrice Fina 230  
 Beatrice Nathans 230  
 Ramon 230  
**FINDEISON**  
 Ann 5  
**FINE**  
 Beatrice Nathans 230  
 Ramon 230  
**FINEBERG**  
 Barry Zack 110  
 Dene Vera Lillienstern 110  
**FINEMAN**  
 Heline S. 167  
 Joel (see Cohen, Joel Fineman)  
**FINESHRIBER**  
 Barbara 296  
 Christa 296  
 Frank William 296

Howard Wallerstein 296  
 Judy Kohn (see Fineshriber, Julia (Judy) Kohn)  
 Julia (Judy) Kohn 296  
**FINESTONE**  
 Eric 122  
 Lillie 122  
 Louis 122  
 Mabel Hyman 122  
**FINGERHUT**  
 Charlotte 162  
**FINK**  
 Barbara L. (b. 1945) 166  
 Betty Hill 166  
 Betty Jane (b. 1938) 166  
 Betty Sullivan 166  
 Carol Ann (b. 1943) 166  
 Celia Downey 166  
 Charlotte R. (b. 1923) 166  
 Frank Morris (1918-1946) 117  
 Irene Coppels 166  
 John (b. 1941) 166  
 John Edward (b. 1914) 166  
 John T. (b. 1946) 166  
 John, Jr. (b. 1936) 166  
 Judy (b. 1952) 166  
 Lewis (b. 1927) 166  
 Lewis, Jr. (b. 1954) 166  
 Louise Irene (b. 1947) 166  
 Mary Ann (b. 1939) 166  
 Rebecca Virginia (b. 1915) 166  
 Rhoda May (b. 1934) 166  
 Robert Sigmund (b. 1920) 166  
 Ruth Virginia 285  
 Sara Jane Deutsch 166  
 Sophia Cerpenslei 166  
 Walter (1881-1938) 166  
 Walter, Jr. (b. 1911) 166  
 William Frank (b. 1947) 166  
 William Marcus (b. 1913) 166  
 William Walter (b. 1941) 166  
**FINKLE-SACKHEIM**  
 Ben 290  
 Rebecca Berg 290  
**FINLEY**  
 Faith 257  
**FINN**  
 Marie 214  
**FINNERTY**  
 Elizabeth 330B  
**FINNY**  
 Emily Samuel 261  
 St. John 261  
**FINSTERWALD**  
 Lucille 70, 310A  
**FINZI**  
 Abraham (b. 1800) 51  
 Blanche Sophia 51  
 Clara Solis 273  
 Joseph de Mordecai de Solomon (1780-1786) 273  
 Judith D'Azevedo 51  
 Mordecai de Solomon 273  
 Rachel Azulay 51  
 Samuel Isaac 51  
 Sarah (b. 1798) 51  
 Solomon 273  
**FIRTH**  
 Benvenida Solis Ritterband 253  
 Emil 253  
**FISCHEL**  
 Pauline 285  
**FISCHER**  
 Anna Mae 195  
 Isabel C. 160  
 Julia R. Newman 160  
 Margaret 307  
 Max C. 160  
 Rose J. 160  
**FISCHL**  
 Eleanor Rose 43  
 Melanie Leyens Bloch 43  
 Phillip 43



**FISH**

Anna Marie 237  
Fay 125

**FISHEL**

Addie Bauer 215  
Bea Moss 215  
Carl 215  
Charlton 215  
Helen 215  
Josie M. Bauer 215  
Leo 215  
Patricia 215  
Penelope 215

**FISHELL**

Anna E. 252

**FISHER**

Adele 72  
Arthur 295  
Charles Avery 340A  
Ellen Lindsay (1846-1916) 155  
Ethel Herman 295  
Helen 141  
Kemper 268  
Lucy Maria Woodruff Phillips 168  
Miriam 173  
Phineas 168  
Rachel Einstein 173  
Samuel 168  
Seig S. 173  
Susan Sherwin Stix 340A  
Teressa (b. 1876) 299

**FISHKIN**

Judith Selma 43

**FISKE**

Aleyda Eliza Winifred David 46  
Elizabeth (d. 1940) 257  
John J. 46

**FITTER**

Jean 305

**FITZGERALD**

Barbara Carol Hargrove 125  
Caroline Augusta Kokernot 146  
Gerald Joseph 125  
Lynn 222  
Michael Timothy 125  
Milam M. 146

**FITZPATRICK**

Galathe Menken Lewis 192  
Jessica 284  
Mariana Amram 284  
Paul 284  
Susan 284

**FITZSIMMONS**

Allen 249  
Anne M. Mayer Haley (see Fitzimmons, Emma Kass (Anne M.) Mayer Haley)  
Clara C. Newman 67  
Emma Kass (Anne M.) Mayer Haley 249  
Patricia 309A  
Renne Marie 249

**FLAGG**

George 112  
Louisa Henriques 112

**FLAMENGO**

Abigail de Benjamin de Menasse 85  
Hester Gomez 85  
Jacob 85  
S. 85  
Solomon Nunes 85

**FLANNERY**

Dorothy Claire Sheftall 269  
William Jackson 269

**FLAEGENHEIMER**

Rachel 70

**FLAISCHMAN**

Gladys 285

**FLEISHER**

Adele Fisher 72  
Alfred (b. 1940) 72  
Alfred (son of Henry) 72  
Alfred W. ("Nick") 72

Alice Hannah Teller 71, 92  
Aline Julia Davis 49  
Andrew Roy 72  
Ann (b. 1942) 71  
Arthur A. III 72  
Arthur Adler (b. 1932) 71  
Arthur Adler (1876-1949) 71  
Barbara Ann (b. 1936)  
Barbara Harris (b. 1942) 24, 71  
Beatrice Naomi Rosenzweig 71  
Benita S. 72  
Benjamin Wilfred (b. 1870) 72  
Benjamin Wolf (1810-1845) 71  
Benjamin Wolf (1845-1925) 71, 92  
Bertha Loeb 71, 72  
Betsy (see Fleisher, Rebecca Ann (Betsy))

Beverly 72  
Blanche Blum 72  
Caroline Beth 72  
Cecilia Hofheimer 71, 72  
Charles Harris (b. 1946) 24, 71  
David (b. 1949) 24, 71  
David Teller (1878-1943) 71  
Dorothy Alice (b. 1913) 71  
Edwin Adler (b. 1877) 72  
Elise Teller (b. 1893) 71  
Elizabeth Hirsch 71, 172  
Ellen (dau. of Howard) 72  
Eric W. 72  
Florence Kohn 24, 71  
Frances Marie (b. 1913) 71  
Francine Queen 72  
Frank Teller (1889-1890) 71  
Frederick 72  
Frederick Eliot 72  
Fridolyn Baum (b. 1940) 71  
Fridolyn Mastbaum Gimbel 71  
Greta Sundberg 72  
Hannah Tuchaer 71  
Harriet Moyer (b. 1917) 71  
Helen 72  
Henry A. (1843-1881) 71, 72  
Henry H., Jr. (1908-1940) 71  
Henry Hackenburg (b. 1883) 71  
Herbert Kohn (b. 1913) 24, 71  
Horace Teller (b. 1887) 71, 172  
Howard 72  
Ida Marie 71, 72  
Ida Marie Teller 71, 72, 92  
Janet Schafer 72  
Jean (b. 1914) 71  
Jill (b. 1940) 72  
Joanne 72  
John (b. 1938) 71  
Lillian Helen Blum 71  
Louise Marguerite Warner 71  
Luciel Baum 71  
Lucile (b. 1910) 71  
Margaret James (b. 1925) 71  
Marion 72, 287  
Martin 72  
Mary Leffler 71  
Mary Louise (b. 1928) 71  
Mathilda Adler (1893-1918) 71  
Maurice Tracy (1885-1938)  
Maurice Tracy, Jr. (b. 1916) 71  
May Henrietta Friedman 71  
Michael Samuel 71  
Moyer (1842-1924) 71, 92  
Nancy 72  
Nancy Kohn (b. 1915) 24, 71  
Nick (see Fleisher, Alfred W. ("Nick"))  
Nora (dau. of Howard) 72  
Oscar T., Jr. (b. 1926) 72  
Oscar Teller (b. 1897) 71, 72  
Reba Teller (1886-1941) 71  
Rebecca Ann (Betsy) 72  
Richard Roger (b. 1911) 71  
Robert 72  
Ruth (b. 1916) 71  
Ruth Harris 24, 71  
Ruth Schecter 72

Ruth Shafer 71  
Samuel Stuart (1872-1944) 72  
Selma Gerstley 72  
Simon B. (1840-1919) 71, 72  
Simone 72  
Sophye Davidson 71  
Susan Elizabeth (b. 1919) 71  
Suzanne 72  
Theresa (1868-1954) 72  
Tracy David (1881-1883) 71  
Walter Adler (b. 1876) 24, 71  
Walter S. 49  
Wilfred 72  
Willis T., Jr. (b. 1908) 71  
Willis Teller (b. 1879) 71

**FLEISHMAN**

Belle Rosenthal 340A  
Ellen Abrams 320A  
Fanny Cohen 295  
Fred 340A  
Fred, Jr. 340A  
Harry 295  
Irving 295  
Mina 295  
Sam 295

**FLEMING**

Anna Erwin 167  
Bunny 174  
Sally Cohen Beckwith 36  
Eric W. 72

**FLORENCE**

Jahna 149

**FLORESHEIMER**

Doris 340A  
Hattie Rosenthal 340A  
Sam 340A

**FLETCHER**

Louise 2  
Sam 2  
Theresa Nathan 2

**FLOERSHEIMER**

Barbara Susan (b. 1950) 22  
Constance Jedelis 22  
Hannah Samelsdorf 259  
John (b. 1922) 22  
John Stewart (b. 1953) 22  
Joseph H. 22  
Margery Katz 22  
Myer 259

**FLOOD**

Margaret E. 311A

**FLORENCE**

Anna Stirling 74  
Annie Augusta (1842-1878) 74, 226, 227  
Augusta Stearns 74  
Benjamin (m. 1836) 74, 147  
Blanche (b. 1836) 74  
Blanche (d. 1863) 74  
Claude (d. 1885) 74  
Clotilda (1832-1915) 31, 74  
Corinna (1839-1863) 74, 129  
Daisy (b. 1870) 74  
Edwin Jacob (b. 1843) 74  
Edwin Jacob (1868-1872) 74  
Emily (b. 1870) 74  
Emily Hannah Isaacs 74, 124  
Emma 74  
Ernest Touro (1854-1918) 74  
Esdaille (son of Florian) 74  
Esdaille (son of Washington) 74  
Eustace Lee (b. 1866) 74  
Eustace Lee, Jr. 74  
Fanny 74  
Florian 74  
Florian Hart (1838-1899) 74, 110  
Frances (Fanny M.) Cohen 31, 74  
Hadassa Seixas (see Florence, Myrtilla (Hadassa) Seixas)  
Hannah Levy 74, 183  
Henry (m. Mary) 74, 183  
Henry (son of Henry) 74  
Jacob Levy (1803-1867) 74, 183  
James (1882-1917) 74

John (son of Eustace) 74  
John Dunn 74  
Lavinia (b. 1825) 74, 194  
Lavinia (dau. of Henry) 74  
Lavinia (dau. of Zachariah) 74  
Lewis 74, 324A  
Lillian H. (1864-1939) 74  
Lily 74  
Louis (d. 1863) 74  
Lucien Gershom (1845-1898) 74, 124  
Margaret 74  
Mary (dau. of Eustace) 74  
Mary Edwards 74  
Mary Levy 74, 183  
May 74  
Minnie Dunn 74  
Myrtilla (b. 1861) 74, 111  
Myrtilla (Hadassa) Seixas 74, 268  
Myrtilla (1839-1896) 74  
Rebecca Kursheedt 74, 147  
Rosalie (dau. of Eustace) 74  
Rosalie (1870-1876) 74  
Rosalie Nathan 74, 226  
Rosina (m. 1827) 74  
Rosina (1827-1850) 46, 74  
Rowena (b. 1842) 74  
Ruth 74  
Sally 74  
Sarah Hendricks 74, 110  
Sarah Levy 74  
Selina 74, 196  
Sylvia (1874-1937) 74, 137, 310B  
Theodore J. (1836-1914) 74, 226  
Washington Zachariah (1829-1881) 31, 74  
William (son of William) 74  
William (1805-1882) 74, 264  
William Herbert (b. 1863) 74  
Zachariah (d. 1832) 74

**FLORENCE**

Micalyn Celia 239

**FLOTTE**

Mary Lee (1940-) 330A

**FLOWERS**

Gloria Louise Mark 86  
Joan Earle 86  
Joseph Earl 86  
Miriam 86  
Susan Ellen 86

**FOERSTER**

Mary 296

**FOIGNET**

Leontine 88

**FOLK**

Ann Elizabeth 196

**FOLZ**

Blanche Marks 83  
Clara Belle Esther 311B  
George 83  
Hannah Simon 311B  
Stanley 83  
Theodore (1861-1939) 311B

**FONSECA**

See also Da Fonseca, De Fonseca  
Abraham 73  
Ester de Simon Halphon 73  
Esther (France) 262  
Esther (Jamaica) 73  
Isaac (m. 1730) 73  
Jacob (d. ca. 1729) 73  
Jacob Da Silva (1709-1790) 273  
Joseph 73  
Judith 73  
Judith Da Silva Solis 273  
Rachel 73  
Rebecca 73  
Sarah 73

**FONTANOY**

See De Fontanoy

**FOOTDALE**

Dave Alan (1955-) 323B  
Nancy Sue Stein 323B

**FOOTERALL**

(see Foterall)

**FORBES**

Caroline (Lena) De Leon 55  
Jack H. 56  
Marguerite Sheldon 56  
Robert Belmont 56  
Robert Sheldon 55, 56  
Willie Delgar 56

**FORCHEIMER**

Donah Cohen 103  
John 103

**PORCHHEIMER**

David 259  
Henrietta Samson 259

**PORD**

Cleo 102  
Cordelia Henriques 113  
Earl B. 262  
Evelyn Pence 88  
James Alexander 270  
Julia Stevens Sheftall 270

**PORDHAM**

Jeremiah 126  
Sarah Isaacs 126

**FOREMAN**

James Walter 306  
Kate Magrish 306  
Richard 306  
Sally 306  
Sarah Pool (d. 1873) 105

**FOREST**

Juanita (see Cohen, Ethel Sophia)

**FORGOTSON**

Herman (1855-1933) 273  
James Morris (b. 1899) 273  
Nellie Weltman 273

**FORMAN**

Eugenia Minis 194  
Lynn 194  
Max 194

**PORSCH**

Florence Esther Levy 159  
Herbert 159  
Lillian Robin 159  
Lois (b. 1929) 159

**PORSHEE**

Adele (dau. of Eugene) 207, 333B  
Adele Moses 207, 333B  
Eugene 207, 333B  
Graham 207, 333B

**PORSHHEIMER**

Estelle 259  
Henrietta Samson 259

**PORST**

Abraham 180  
Clara 180  
Deborah 180  
Leah 180  
Rebecca (1814-1815) 180  
Richea Edith Cohen 180

**PORSTER**

Andrea 266  
Bernhard 189  
Byron 45, 322B  
Byron Davega 45  
Frances Celestine 45  
Henrietta 189  
Irwin 266  
Jean Caro Seixas 266  
Lee Seixas 266  
Marie Davega 45, 322B  
Marie Louise 45  
Mary 189  
Sophie Frank 189

**POSS**

Arthur Wade (1925-) 330A  
Jessie Burns Levy 330A  
Linda Catherine (1953-) 330A

**POSSETT**

Elizabeth 126

**POSS-GRANT**

Andrew Phillip (1987-) 330A  
Samuel (1985-) 330A

**POSTER**

Eliza Bell 322A  
Jennie 36

**POTTERALL**

Carol 338B

**POWLER**

Alexander 265  
Frances Seixas Crane 265  
Mildred Brunson Power 84  
Raymond 84  
Virginia Lee 52

**FOX**

Alice 93  
Alma 122  
Amy 27  
Arthur 149  
E. 305  
Edith (1879-1881) 250  
Fanny Laib 149  
Flo 278  
Hannah Boren 238  
Herman 149  
Isaac 238  
John 93  
Julia 149  
Lena 93  
Leonora Pike 250  
Lottie 305  
Margaret 39  
Mary Ann Hallahan 209  
Maurice 149  
Norman 149  
Rai (b. 1870) 184  
Robert 149  
Samuel 149  
Samuel G. 250  
Sarah Elizabeth 269  
Stella 328A  
Walter 149

**POKWORTH**

Carolyn Harby 207  
G. M. 207

**ROY**

Georges 6  
Gwen Elizabeth 330B  
Inez 6  
Marcel 6

**FRACCI**

Rosalinda 95

**FRAID**

Norma 95

**FRAIDLEN**

340B

**FRAKES**

Margaret (b. 1878) 128

**FRALEY**

Sadie 286

**FRAMPTON**

Averil 122  
Eileen Brown 122  
George 122  
James 122  
Jane Benziery 122  
Michael 122  
Miriam Emanuel 122  
Ruth 122  
Sarah 122

**FRAMPTON (FRIDENBERG)**

Samuel 122

**FRAN**

Adam 284  
David 284  
Ethan 284  
Mary Goldsmith 284  
Paul 284

**FRANCE**

Sophie Pike 47

**FRANCEK**

Nellie 257

**FRANCO**

Jacob de Moses 258  
Moses 258  
Moses de Jacob de Moses 258



Sarah Salvador 258  
**FRANK**  
 Ada Myers-Cohen 223  
 Adam 127, 326A  
 Adam, Jr. 127, 326A  
 Adolph Sanger 164  
 Alan 127  
 Alan, Jr. 127  
 Alexander 219  
 Amalie Baruch 17  
 Anna M. Baker 230  
 Benjamin S. 282  
 Bernhardt 189  
 Brinah Hart 99  
 Caroline Sachs 189  
 Carrie (1869-1880) 189  
 Carrie 174  
 Charles 93  
 Clara 291  
 Daniel 189  
 Daniel Jacob (b. 1976) 313B  
 Diane Crone 326A  
 Doris Anspacher 22  
 Edward 230  
 Eleanor Charlotte 164  
 Ernest 189  
 Estelle Isaacs 127, 326A  
 Ethel Hendricks 110  
 Felix 97  
 Frederick 189  
 Geoffrey Adam (see Frank, Jeffrey Adam)  
 Hannah 189  
 Harby 93  
 Harold 164  
 Hattie 293  
 Helen B. 276  
 Henry (b. 1838) 250  
 Henry (1836-1916) 189  
 Herman 189  
 Isabel 91  
 J. W. 93  
 Janet (dau. of Adam) 127  
 Janet Elizabeth 127, 326A  
 Jeffrey Adam 127, 326A  
 Joanne Schneck 17  
 John Mayer 189  
 Josephine Hart 97  
 Judy Thorman 293  
 Julia Myers 219  
 Julius (b. 1925) 164  
 Kevin 17  
 Lawrence 110  
 Lee Hart 282, 313B  
 Leo 164  
 Leonard I. 172  
 Leonore Pike 250  
 Lewis J. 223  
 Linda (b. 1947) 22  
 Louise Bettman 189  
 Love Hart 99  
 Margaret 127  
 Marian Frances Sanger 164  
 Marjorie 127, 326A  
 Mary 189  
 Mayer 189  
 Melanie Mayer 189  
 Miriam Friedman 172  
 Nancy Jo De Lee 282, 313B  
 Octavia 93  
 Patricia 189  
 Perry B., Jr. 17  
 Perry Belmont 17  
 Rachel (m. 1851) 237  
 Rachel (1799-1883) 145  
 Rachel Brody 127  
 Rebecca Harby 93  
 Richard L., Jr. (b. 1942) 22  
 Richard Lionel (son of Julius) 164  
 Richard Lionel 22  
 Rosalie 189  
 Rosina 189  
 Sadie 91

Samuel Arthur 282  
 Samuel Moses 99  
 Sarah Sanger 164  
 Sophie 189  
 Sue 282  
 Susan 189  
 Thomas (1973-) 326A  
 Tillie 223  
 Zerta 93  
**FRANKEL**  
 Alan Richard 167  
 Claire Levy 167  
 Clara Freiberg 307  
 David 11  
 Flora Ancker 11  
 Jonas 307  
 Leah Rosenblatt Heskes 238  
 Phyllis 241  
**FRANKEN**  
 Arthur 276  
 Marian Frank Solomons 276  
 Ruth 276  
**FRANKENTHAL**  
 Maria Linda 47  
 Milton H. 47  
 Myrtila J. Davies 47  
**FRANKENTHALER**  
 Anne 111  
 George 111  
 Jane 111  
 Marion Hendricks 111  
 Ruth 111, 310A  
**FRANKFORD**  
 Harriet Cohen 38, 322B  
 Simeon 38, 322B  
**FRANKFURT**  
 Minnie Lowenberg 108  
 Nathan 108  
 Stella 108  
**FRANKFURTER**  
 Dorothy 95  
**FRANKLIN**  
 Abraham G. 331B  
 Ann 86  
 Barbara Simonson 230  
 Carol Levy 287  
 Cathy 86  
 Colin 287  
 Courtney V. (b. 1906) 230  
 Courtney V., Jr. (b. 1941) 230  
 Edith Sarah (1866-1907) 331B  
 Elinor Tibbett Babelheimer 230  
 Ellis A. 331B  
 Elsie (Elizabeth) Nathans 230  
 Horace A. III (b. 1904) 230  
 Ida May Dando 230  
 Juliet Ruth Mark 86  
 Melvin M. (1874-1938) 230  
 Melvin M., Jr. (b. 1899) 230  
 Morton 86  
 Richard Hustace (b. 1939) 230  
 Sadie Arnold Rohr 320B  
 Sarah 331B  
**FRANKS**  
 Aaron (d. bef. 1785) 75  
 Aaron (1692-1777) 75, 92  
 Aaron (1732-1738) 75  
 Abigail (d. ca. 1765) 75  
 Abigail (perhaps "Poyer") 75  
 Abigail (1744-1798) 75, 79  
 Abigail (1754-1814) 75  
 Abigail Bloch (see Franks, Sara Phila (Abigail) Bloch)  
 Abraham (d. 1748) 75  
 Abraham B. (1721-1797) 75, 77  
 Abraham (1713-) 324A  
 Agnes 75  
 Anna Maria Lord 75  
 Beatrice 82  
 Benjamin (ca. 1649-1716) 75  
 Benjamin (son of Benjamin) 75  
 Beverly Beach (1921-1951) 324A  
 Bilhah Abigail Levy 75, 154, 324A

Bilhah Hart 75, 92  
 Catherine 75  
 Charles Ingersoll 75  
 Charlotte 75  
 David (d. 1794) 75  
 David (son of John (Jacob)) 75  
 David (1720-1793) 75  
 David Salisbury (Solebury) 82, 324A  
 Edward G. 75  
 Elizabeth Wilkerson 324A  
 Elizabeth Wilks 55  
 Ellen 75  
 Emma 75  
 George Henry (1810-1867) 75  
 Georgina Caroline Carte 75  
 Grace 82  
 Heartsey (see Franks, Naphtali (Heartsey))  
 Helen Phillips 249  
 Henry Isaac (1724-1797) 75  
 Herbert H. (1919-) 324A  
 Isaac (d. 1736) 75, 92  
 Isaac (1759-1822) 75  
 Isabella Bell (1769-1855) 75, 77  
 Jacob (1687-1769) 75, 154, 324A  
 Jacob (1747-1814) 75  
 Jacob (1766-1840) 83, 276  
 Jacob Henry (1759-1840) 75  
 Jacob (1728-) 324A  
 Jacob (1780-1868) 324A  
 James Potter (b. 1844) 75  
 John (Jr.) (1842-1883) 324A  
 John (Canada) 82  
 John Alex (1877-1955) 324A  
 John Frederick (d. 1785/6) 75  
 John (1810-1872) 324A  
 John, Jr. (Montreal, 1799) 82  
 Joy (Tabitha) 190  
 Lady Elizabeth Cecil 324A  
 Margaret (dau. of James) 75  
 Margaret (England) 75  
 Margaret Evans 75  
 Margaret Raper 75  
 Margaret Strickland 324A  
 Mary (b. 1806) 75  
 Mary (b. 1840) 75  
 Mary (dau. David Salisbury (Solebury)) 82, 324A  
 Mary (dau. of James) 75  
 Mary (Polly) (1748-1754) 75  
 Mary (Polly) Solomons 83, 276  
 Mary Davison 75  
 Mary Fanny Paulk 324A  
 Mary Jacob 75  
 Michael (1733-) 324A  
 Moses (b. ca. 1743) 75  
 Moses (d. 1716) 75  
 Moses (son of John) 82  
 Moses (1718/9-1789) 75  
 Moses B. (ca. 1717-1792) 75  
 Naphtali (Heartsey) (b. 1715) 75  
 Naphtali (Henry) Benjamin (d. 1758) 75  
 Naphtaly Hart (Abraham) (d. 1708/9) 75  
 Nehemiah (1730-) 324A  
 Phila (d. 1802) 75  
 Phila (dau. of Abraham) 75  
 Phila (1715-1765/9) 75  
 Phila (1722-1811) 75, 76  
 Phila Franks (m. Moses) 75  
 Phila Franks (m. Naphtali) 75  
 Polly (see also Franks, Mary (Polly))  
 Polly Solomons (see Franks, Mary (Polly) Solomons)  
 Poyer (see Franks, Abigail (perhaps "Poyer"))  
 Priscilla (d. 1832) (dau. Aaron) 75  
 Priscilla Franks 75  
 Rachel (m. Benjamin) 75  
 Rachel (m. Capt. John Lawe) 83  
 Rachel (see also Franks, Richa (Rachel))

Rachel (1762-1818/9) 75, 109, 257  
 Rebecca (b. 1742) 75  
 Rebecca (1760-1823) 75, 81  
 Richa (Rachel) 75  
 Richard Rush 75  
 Samuel Davidson (1783-1831) 75  
 Samuel J. (son of Theodore) 75  
 Sara (1731-1733) 75  
 Sara Beth (see Franks, Sara Eliza (Beth))  
 Sara Eliza (Beth) (m. 1806) 75  
 Sara Phila (Abigail) Bloch 75  
 Sarah (d. 1767) 75  
 Sarah (dau. of James) 75  
 Sarah (dau. of Samuel) 75  
 Sarah (dau. of Theodore) 75  
 Sarah (Sairy) (1755-1809) 324A  
 Sarah (Sairy) Franks 324A  
 Sarah Ann Tucker 75  
 Sarah Elizabeth 75  
 Sarah May 75  
 Sarah Phila (Abigail) Bloch 75  
 Simha Frances Hart 75, 92  
 Tabitha (see Franks, Joy (Tabitha))  
 Theodore 75  
 Thérèse De Guere 83  
 Viannah Perry 324A  
**FRANZREB**  
 Emma 147  
**FRASER**  
 Eleanor Kevan (d. 1950) 157  
 Florence 144  
 Jane 178  
**FRATTALONE**  
 Jane Prentice Andrews (see Talon (Frattalone), Jane Prentice Andrews)  
 Mark (see Talon (Frattalone), Mark)  
**FRAWLEY**  
 Frances Veronica 245  
**FRAZIER**  
 Harriet M. 80  
**FREED**  
 Ellen 321A  
 Enid 337B  
**FREEDMAN**  
 Albert 95  
 Andrew 47  
 Annette 95  
 Betty 95  
 Cecilia Eger 22  
 Clara (b. 1867) 21, 22  
 Daniel Barrow 47  
 David 95  
 Elizabeth Davies 47  
 Ella (m. 1903) 22, 321B  
 Goldie Coleman 40  
 Isabella 47  
 Jacob J. 47  
 Janice 95  
 Joseph 47  
 Louis 22  
 Mabel Ruth Hart 95  
 Mimi (see Freedman, Miriam Judah (Mimi))  
 Miriam Judah (Mimi) 95  
 Phyllis H. 95  
 Samuel I. (b. 1914) 95  
 Solomon 40  
 Vera Bromilow Barnaby 95  
**FREELAND**  
 George 156  
 Josephine Law 156  
 Josephine Payton (b. 1875) 156  
**FREEMAN**  
 Ada Louise Anderson 335B  
 Elizabeth 93  
 Ella 221  
 Henry 93  
 Henry Francis John 158  
 Marian L. 157  
 Mark 335B  
 Priscilla Elkin 64  
 Sarah Hutchinson Adams 158

Tessie Hyman 73  
**FREER**  
 Maud (see Faithcloth (Freer), Maud)  
**FREIBERG**  
 Albert 307  
 Clara 307  
 Duffie Workum 307  
 Grace 286  
 Julius (1823-1905) 307  
 Julius Walter (1858-1921) 307  
 Julius Walter, Jr. 307  
 Martha Pritz 307  
 Maurice J. 307  
 Minnie 307  
 Nettie 307  
 Nettie Freiberg 307  
 Sally 307  
 Stella Heinsheimer 307  
**FREIDENBERG**  
 Nell Kessler 230  
 Sol (1863-1921) 230  
**FRENCH**  
 Adele Carvalho 30  
**PREST**  
 Joyce Ida Jessie Montague 82  
 Oliver Harry 82  
 Timothy Oliver 82  
**FREUND**  
 Gustave 235  
 Rebecca Mayer 235  
**FREY**  
 Anne Hampton 198  
 Aurelia Swarts Friedman 292  
 Hans Kraft 292  
**FRIBOURG**  
 Ernest 329B  
 Leon 329B  
 Louisa 329B  
 Meriam Hendricks 159, 329B  
**FRIEDENBERG**  
 Brendella Isaacs 124  
 Ceral 124  
 Dena 124  
 Elizabeth Louise 261  
 Julius 124  
 Miriam Barnett 123  
 Mitchell 124  
 Paul Edward (see Perez, Paul Edward)  
 Robert (m. 1895) 123  
 Robert (see Perez, Robert)  
 Samuel (see Frampton (Fridenberg), Samuel)  
 Solomon 124  
**FRIEDENBERG**  
 Benjamin 321A  
 Miriam Esther Benjamin 321A  
 Rachel 160  
 Sylvia 321A  
**FRIEDENWALD**  
 Ethel Sophia Cohen 33  
 Herbert 33  
 Rachel (Racie) 291  
 Racie (see Friedenwald, Rachel (Racie)) 291  
**FRIEDLANDER**  
 Ada (b. 1851) 308  
 Agneta 312B  
 Arthur Jonas 312B  
 Carl Iglauer (b. 1907) 285  
 Catherine 285  
 Clara 286  
 Estelle 65  
 Ethel L. 174  
 Gladys Fleischman 285  
 Hiram 65  
 Hugo 254, 312B  
 Isabella Hart 254, 312B  
 Jane Tim Schaefer (see Friedlander, Jennie (Jane) Tim Schaefer)  
 Jennie (Jane) Tim Schaefer 295  
 Joan 285  
 John Walter (b. 1902) 285  
 John Walter II 285

Judith 285  
 Kenneth 312B  
 Kiki 65  
 Louis ("Lou Landers") 65  
 Louise Oppenheimer 285  
 Maria Cooper 285  
 Mary (b. 1910) 285  
 Mary Ann 285  
 Mary Kennedy 285  
 Olive Hogg 312B  
 Patricia 312B  
 Rebecca Levi 65  
 Rebecca Lieber 174  
 Walter John (m. 1901) 285  
 Zillah Iglauer 285  
**FRIEDMAN**  
 Abraham 287  
 Adeline Cromline 41  
 Agnes Dinah (b. 1902) 287  
 Alex 247  
 Alexander 172  
 Alexander (1974-) 337B  
 Alfred (son of Isaac) 187  
 Alfred (son of Israel Moses) 60  
 Alice 60  
 Alicia 41  
 Alicia Hortense 41  
 Alma Snyder 60  
 Alvin 172  
 Amelia 43  
 Amelia Judah (1865-1918) 41, 243  
 Andrea Levin 340B  
 Anita Garey 337B  
 Anthony J. (1961-) 337B  
 Arline 41  
 Aurelia Swarts 292  
 Ben (see Friedman, Bernhardt (Ben) Meyer)  
 Bernhardt 235  
 Bernhardt (Ben) Meyer 235, 337B  
 Carol Michaels (see Friedman, Emma Caroline (Carol) Michaels)  
 Cecilia (Cissie) Langner 60  
 Celia Marks 187  
 Cissie Langner (see Friedman, Cecilia (Cissie) Langner)  
 Clara 21  
 Clarence 172  
 Cora Stix 287  
 Corinna (b. 1863) 41  
 Craig Edward Arthur 193  
 David 60  
 Diana Frishman 337B  
 Doris Selma 211  
 Dorothy Weil 172  
 Edith Stix (b. 1914) 287  
 Edward (1969-) 337B  
 Edwin 187  
 Elinor W. Rogers 60  
 Elise Kohn 296, 340B  
 Elise Teller Fleisher 71  
 Ellen 296  
 Ellen Elise (b. 1931) 71  
 Elliott 296  
 Elsie 290  
 Elsie T. 187  
 Emma Caroline (Carol) Michaels 193  
 Fannie Levy 161  
 Ferdinand 41  
 Ferdinand Solomon (1870-1873) 41  
 Florian (1858-1908) 41  
 Frederick (Michael) Douglas 193  
 Frederick 193  
 Gail Kropaick 193  
 Gertrude 172  
 Harold 41  
 Harry (b. 1890) 172  
 Harry (son of Isaac) 187  
 Henry Clay (1854-1920) 41  
 Hortense 41  
 Isaac 187  
 Israel Moses 60  
 J. W. ("Chub") 172

Jan Solomon 247  
 Jane (b. 1920) 172, 222  
 Janice 95  
 Janice Ruth 43  
 Joan 276  
 Joan Groh 337B  
 John Stix (1899-1900) 287  
 Judith Selma Fishkind 43  
 Julien (b. & d. 1856) 41  
 Kathryn 60  
 Kiturah 60  
 Lee Max 187  
 Leonard 247  
 Linda Carol Michaels 193  
 Lisa 247  
 Louis (b. 1872) 292  
 Louis (m. 1887) 172  
 Louise (b. 1892) 292  
 Louise 187  
 Madeline (1870-1894) 292  
 Marc Harris 247  
 Margolit Devorah (1979-) 340B  
 Marilyn 149  
 Marjorie Kohlman 235, 337B  
 Mary Foerster 296  
 Matilda Marks 187  
 Matilda Rebecca Meyer 235  
 Max (1825-1901) 41  
 Max 187  
 May Fleisher (b. 1928) 71  
 May Henrietta 71  
 Maybelle Abrams 172  
 Melanie 43  
 Michael Belais 60  
 Michael Douglas (see Friedman,  
 Frederick (Michael) Douglas)  
 Mildred 236  
 Miriam (d. 1945) 172  
 Morris 292  
 Nathan L. 43  
 Paul 296, 340B  
 Peter 296, 340B  
 Peter Foerster 296  
 Rachael 107  
 Rachel (1855-1922) 325A  
 Rebecca Falk 172  
 Robert Eugene 235  
 Robert Stephen, 337B  
 Rosalie Bloch 43  
 Rosalie Joy 43  
 Ruth 104  
 Samuel G. 71  
 Samuel William 43  
 Sara Scheuer 41  
 Sarah Falk 172  
 Solana Belais 60  
 Sophie M. 187  
 Stacy Ruth Ann 193  
 Stephen (b. 1940) 193  
 Stephen 296  
 Stephen B. 60  
 Sylvia 60  
 Terry Allen 337B  
 Theresa (1851-1933) 41, 144, 257  
 William Stix (b. 1900) 287

**FRIEDMANN**  
 Hilda Oppenheimer 237  
 Karla 237  
 Samuel 237

**FRIEDSAM**  
 Rita Julienne 125

**FRIEDWALD**  
 Amy 253  
 Barbara Lee Dinel 253, 338B  
 Emily 253  
 Martin 253, 338B  
 Paul (1968-) 338B

**FRIEND**  
 Alan David (1944-) 328A  
 Beatrice Livingston 145, 328A  
 Florence Shapiro 328A  
 Irvin 104  
 Judith Fay (1947-) 328A

Myron (1917-) 328A  
 Nathan 145, 328A  
 Ruth Hays Davidow 104  
 Sylvia (1914-1947) 328A

**FRIENDLY**  
 David 296  
 Ellen 296  
 Henry 296  
 Joan 296  
 Sophie Stern 296

**FRIES**  
 Harriet 8

**FRIPP**  
 E. A. 120  
 Rebecca Linley 120

**FRIISHMAN**  
 Diana 337B

**FROHMAN**  
 Bercie Karlsruhe 15  
 Hortense Barnet 15  
 Jack (b. 1923) 15  
 Nathan 15

**FROIS**  
 Abigail (1829-1861) 85  
 Cynthia Gomez 85  
 Mordecai (1796-1865) 85  
 Morris (1817-1823) 85  
 Moses 61  
 Rachel (1827-1855) 85, 241  
 Rachel De Sola 61

**FROMM**  
 Joan Grosner 321A  
 Stephen Grosner 321A  
 Thomas 321A  
 Timothy Allen 321A

**FROMME**  
 Erna 167

**FRONT**  
 Ann 108  
 Beth 108  
 Edwin 108  
 Ellen Van Os 108  
 Henri 108  
 Henry Van Os 108  
 Samuel Edward 108

**FROOMBERG**  
 James 122  
 Juliet Anne Gould 122  
 Martin 122  
 Michael 122

**FROST**  
 Harriet Mordecai 201  
 John N. 201  
 Mary E. 320B

**FRYBACK**  
 Barbara Maas 5  
 Dwight 5  
 Patricia 5

**FUCHS**  
 Alan 16, 321A  
 Carol Barnet 16, 321A  
 Daniel Adam 321A  
 Douglas Steven 321A

**FUERST**  
 Shirley 191

**FUERSTES**  
 Ada 192

**FUERTH**  
 Beveneda Solis Ritterband 253  
 Emil 253  
 Mildred 253

**FURHRMAN**  
 Carol Fox 291

**FULD**  
 Blanche 340A  
 Hattie 328A  
 Hattie 30  
 Rena 290

**FULLER**  
 Lela Ophelia 195

**FULTON**  
 David Roger 13  
 Edward S. 57

Nancy Jean 13  
 Rebecca De Lyon 57

**FUNKHOUSER**  
 Raymond Joseph 241

**FUQUA**  
 Harriet Louise (1875-1958) 330A

**FURCHGOTT**  
 Charles M., Jr. 278  
 Charles Max 278  
 Constance Jane 278  
 Jane Solomons 278

**FURMAN**  
 Alice 150

**FURST**  
 Arnold 29  
 George N. 250  
 Janet Pike 250  
 Mildred Cardozo 29  
 Rosalie 171

**FURSTNER**  
 Adolph 27  
 Clara Brush 27  
 Otto 27  
 Stephanie 27

**FURTMULLER**  
 Carl 230  
 Leah T. Cadbury 230

**FUSCHS**  
 Charlotte 208

**GABEL**  
 Barbara Jean 134  
 Bruce George 134  
 Ivan H. (b. 1932) 134  
 Joanne Faye 134  
 Ruth Flora Israel 134

**GABRIEL**  
 Ada 122  
 Adelaide Van Stratten 122  
 Alice 122  
 Arnold 122  
 Caroline 122  
 Chief Rabbi of Mecklenburg 261  
 John (b. 1914) 122  
 John 122  
 Leon 122  
 Lorna Bowring 122  
 Maud Hyman 122  
 Verity 122

**GADSBY**  
 Augusta 156

**GAPP**  
 Florence Brimson ("Mme. Toronto") 46

**GAGE**  
 Leona 213

**GAIL**  
 Judith 3

**GAINES**  
 Flora Block 25  
 James J. 25  
 Mamie 25  
 Richard 25  
 Rose Jett 25

**GAITHER**  
 Elizabeth 91

**GALE**  
 Elaine Fay Mills 86  
 Louis M. 86  
 Robert 86

**GALEP**  
 Bennett 322B  
 Susan Seligsberg 322B

**GALEN**  
 John 331A

**GALESKI**  
 Barbara 108  
 Ruth Lowenberg 108  
 Walter 108

**GALLARDO**  
 Elizabeth (1956-) 336B

**GALLINGER**  
 Minnie 40

**GALPHIN**  
 Frances Nunez 234, 337A

George 337A

**GAMA**  
 Abraham 250  
 Ishak Mendes 250  
 Lea Jesurun 250  
 Ribca 250  
 Sara Hana Pinheiro 250

**GAMBATTI**  
 Annie 117  
 Florrie 117  
 Mabel 117  
 Mary Hertz 117  
 May 117  
 Olympia 117

**GAMSE**  
 Nance Bloomberg 70  
 Nat 70

**GANDY**  
 Camilla Phillips 168  
 Carol Elizabeth Fisher 168  
 Edith 207  
 Marshall H., Jr. 168  
 Marshall Harvey 168

**GANG**  
 Marjorie 333A

**GANNENBAUM**  
 Hortense 149

**GANS**  
 Aaron 83  
 Adele 83  
 Barbara 125  
 Bertha 83  
 Bertie 83  
 Betti Leberman 83, 152  
 Bettie 83  
 Caroline 83  
 Caroline Hochstadter 83  
 Carrie 83  
 Charles (see Gans, Jacob (Charles))  
 Clarence (b. 1857) 83  
 Cornelia 83  
 Daniel 83  
 David S. 83  
 Elinor (1885-1947) 245  
 Emanuel 87  
 Emanuel S. (1855-1919) 271  
 Emma 83  
 Hartley 271  
 Howard 83  
 Jacob (Charles) 83  
 Jeanette 83  
 Jennie E. 83  
 Joseph (b. 1820) 83  
 Joseph (b. 1859) 271  
 Josephine 83  
 Julia (b. 1857) 83  
 Julia (m. 1870)  
 Julia (1838-1934) 13, 83  
 Leah (Lillie) 83, 324A  
 Leon 83, 324A  
 Leona 83  
 Levi S. (1850-1914) 271  
 Lillian 305  
 Lillie, see Gans, Leah (Lillie)  
 Louis 83, 324A  
 Lucille 340A  
 Meyer 83  
 Milton Henry 83  
 Miriam 271  
 Moses (b. 1860) 83  
 Moses (1811-1885) 83  
 Moyer (1861-1863) 271  
 Pearl 83  
 Robin Adair 194  
 Sarah Shoyer 271  
 Sigmund J. 83  
 Sigmund Leon 83  
 Sigmund M. 83  
 Simeon 83  
 Solomon (1804-1896) 83, 152  
 Solomon (1813-1871) 271  
 Theresa E. Hamburger 324A  
 Theresa W. 83, 324A

Walter Simon 83

**GANT**  
 Charles (d. 1945) 233  
 Edith C. Levin 233

**GANTT**  
 Mary Virginia 289

**GARCELAN**  
 M. J. 251  
 Margaret S. Pinto 251

**GARCIA**  
 Maria 336A

**GARDERE**  
 Heloise Marie 199

**GARDNER**  
 Celestine Aline Goldschmidt Burchell  
 Alliger Dickey 84  
 Gladys Da Silva Solis Ritterband 253  
 H. G. 84  
 Lenore 91  
 Mayo 269  
 Sanford (Goldberg) (b. 1883) 253  
 Sarah Eleanor 140  
 Valerie Sheftall 269

**GARESCHÉ**  
 Virginia McBlair (dau. of William)  
 156  
 Virginia McBlair 156  
 William H. J. 156  
 William McBlair 156

**GAREY**  
 Anita 337B

**GARNER**  
 Miriam Elise 86  
 Susan Ellen Flowers 86  
 Theodore 86

**GARRET**  
 Ellen Jacqueline Mordecai 201  
 Lewis Collins 201

**GARRETT**  
 Marjorie 11  
 Sarah Rebecca (1843-1930) 29

**GARRIS**  
 Betty Anne 198

**GARRISON**  
 Dorothy Jean Sheftall 268  
 George Leonard 268  
 Leanne 268  
 Michael Eugene 268  
 Norfolk 156  
 Paul Edward 268  
 Virginia Hartstone McBlair 156

**GARSIA (DE PAZ)**  
 Esther Brandon 134

**GARSON**  
 Amy 293  
 Eva 295  
 Lillian 340A

**GASSOWAY**  
 Susan 126

**GASTON**  
 Mary 199

**GATES**  
 Alice Ann 219  
 Marcelle Hofflin 219  
 Sydney 219

**GATLIN**  
 Barbara Jean De Cordova 52  
 Elmer Jack 52

**GAULT**  
 Mary 251

**GAY**  
 Bee 305  
 H. Burton 188  
 Louis Allen Marx 188

**GAZAN**  
 Beatrice 295

**GEBKLE**  
 Lena 258

**GEDDINGS**  
 Henry D. 205  
 Mary Moses Bower Taft 205

**GEEN**  
 Oenid (b. 1898) 206

Amelia Burns Sheftall 270  
 Lawrence Easter 270

**GEISENBERGER**  
 Albert, Jr. 8  
 Elyse 8  
 Isabel Newman 8

**GEISLER**  
 Betty Hamburger 15  
 Edna Jean (b. 1928) 15  
 Joan (b. 1932) 15  
 William 15

**GELDREN**  
 See Von Geldren

**GELSTON**  
 Julia N. 140

**EMBERLING**  
 John Samuel 321A  
 Stephen 321A  
 Susan B. Stern 321A

**GEORGE**  
 Ethel Herman Fisher 295  
 Mildred Heber Levy Caley 330A  
 Scotney Charles (1926-) 330A  
 Siegfried Victor 295  
 Victoria Minetree 218

**GERDINE**  
 Marian Cobb 199

**GERRARD**  
 Elsie Florence 125

**GERSHOM**  
 Babette Nachman 62

**GERSON**  
 Bettgen, see Nachmann, Isabella  
 Caroline King 148  
 Harriet 148  
 Henry 148  
 Jessel, see Nachmann, Joseph

**GERST**  
 Edna Sara 61  
 Virgie G. 222

**GERSTLE**  
 Clara Guggenheimer 89  
 Herman 89  
 Solomon 89

**GERSTLEY**  
 Selma 72

**GERVAIS**  
 Claudina V. 162, 329B

**GEWIRZ**  
 Norma 219

**GEYELIN**  
 Henry Rawle (see Geyelin, Henry  
 Ross)  
 Henry Ross 150, 311A, 328B  
 Margaret Gladys Marks 150, 311A,  
 328B  
 Patricia 311A, 328B  
 Peter 311A, 328B

**GIBB**  
 Arthur III 90  
 Arthur, Jr. 90  
 Mary Medley Guggenheimer 90  
 Timothy Dwight 90

**GIBBENS**  
 Eunice Veronica 31

**GIBBS**  
 Aline 136

**GIBSON**  
 Alcinda 188  
 Charles Shac 208  
 Donnie Charles 208  
 Elfrida Muriel Oakes Story 76  
 Jessie 52  
 John Neison 76  
 Meredith Elizabeth 208  
 Virginia Phelps Maris 208

**GIDEON**  
 Amalee Dorothea (b. 1948) 24, 71  
 John 71  
 Nancy Kohn Fleisher 71  
 Samuel 71  
 William G., Jr. (b. 1947) 71

A

B

C

D

E

F

William Gottschalk 71  
**GIERASCH**  
 Matthew Paul 89  
 Miriam Walters 89  
 Nina Rudman 89  
 Paul 89  
 Paula 89  
 Stephen 89  
**GIESECKE**  
 Joan Janney 104  
 Lewis 104  
**GIFFORD**  
 Frances Kingsland 200  
**GILBERT**  
 Armida Jennings 206  
 Audry Loeb 144  
 Becky 311B  
 Bertha (Patsy) (1867-1937) 311B  
 Cecilia C. Levy Werner 311B  
 Dora 216  
 Elizabeth 144  
 Flora Lichtenstein 174  
 Gerald Barry 174  
 Henry 311B  
 Joseph 206  
 Katherine Armida Jennings 206  
 Louis (d. ca. 1937) 311B  
 Patsy (see Gilbert, Bertha (Patsy))  
 Rachael E. Jacobs 125  
 Ruth 313A  
 Seymour 144  
 Thomas 144  
**GILDEN**  
 Julie 326A  
**GILETTE**  
 Alfred S. 87  
**GILINSON**  
 Betsy Jane 11  
 Joseph 11  
 Marsha Ann 11  
 Peggy Ruth Price 11  
 Peter Scott 11  
**GILL**  
 Joseph 268  
 Mary C. 195  
 Sarah Virginia Sheftall 268  
 Walter 268  
**GILLARDON**  
 Virginia 158  
**GILLIGAN**  
 May 15  
**GILMORE**  
 Edna May 266  
**GILMOUR**  
 Millicent Ann 183  
**GILNER**  
 Louisa Porter 194  
**GIMBEL**  
 Fridolyn Mastbaum (b. 1891) 71  
**GINGUS**  
 Joan B. Stern 321A  
 Joel 321A  
**GINSBERG**  
 Eli 5  
 Jacky 189  
 Joe 189  
 Natalie Joel 189  
 Ronnie 189  
 Ruth Szold 5  
 Susie 189  
**GINSBURG**  
 Alice Ann Gates 219  
 Bertha Kohn 24  
 Eva Kohn 24  
 Florence Mary (b. 1903) 24  
 Gladys (b. 1906) 24  
 Harry 24  
 Jacob 24  
 Jan 219  
 Jill 219  
 Lynn (see Ginsburg, Jill)  
 Martin 219  
**GIST**

Maria Cecil 87, 88  
**GITLIN**  
 Joanne 282  
**GITTLESON**  
 Eleanor 284  
**GIVEN**  
 Edythe 74  
 Joseph 74  
 Myrtle 74  
 Sarah Crawcour 74  
**GLASS**  
 Celeste 142  
 Gordon (son of Gordon) 142  
 Gordon 142  
 Ogden 142  
 Sarah Cane Judah 142  
**GLAUBER**  
 Cynthia Marshall Rich 42  
 Jeffrey Marshall 42  
 Roy J. 42  
**GLAZER**  
 Amelia Solomon 61  
**GLEASON**  
 Harriett Lucile 198  
**GLEAVES**  
 Evelina 33  
**GLEEKMAN**  
 Harvey William 71  
 Susan Kohn 71  
**GLICKMAN**  
 Adam Michael 71  
 Joan Bernstein 71  
 Jonathan Mark 71  
 Joseph 71  
**GLICKSTEIN**  
 Arnold 333A  
 Susan Hurwitz 333A  
**GLOVER**  
 Clara Sanger 164  
 Georgina ("Kitty") Kathleen Collins 138  
 James 138  
 "Kitty" Collins (see Glover, Georgina) ("Kitty") Kathleen Collins)  
 Leonard Lindsay 164  
**GLUCK**  
 Bruce Robert 283  
 Judy Thalheimer 283  
 Larry 283  
 Robert 283  
 Susy Thalheimer 283  
 Wendy 283  
**GLUCKEL**  
 of Hameln 92  
**GLUECK**  
 Barbara Weinberg 307  
 Charles Jonathan 307  
 Helen Iglauer 307  
 Nelson 307  
**GOBER**  
 Eugenia John 55  
**GODCHAUX**  
 Emile 70  
 Mabel V. Goetter 70  
**GODFREY**  
 Harriet Louise 197  
 Priscilla (1824-1893) 136  
**GODFRIED**  
 Joan 285  
**GODSICK**  
 Aileen Hendricks Lewisohn 310A  
 Anthony L. 310A  
 Peter A. 310A  
 Victoria 310A  
**GODWIN**  
 Betty (Fanny) Kayton 143  
 Edward 143  
 Edwina 143  
 Fanny Kayton (see Godwin, Betty (Fanny) Kayton)  
 Sarah Elizabeth 19  
**GOETTER**  
 Allan Joseph (b. 1895) 70

Dona J. (b. 1878) 70  
 E. Baldwin (b. 1883) 70  
 Emile Godchaux 70  
 Fannie R. (b. 1869) 70, 324A  
 Joseph (1845-1901) 70, 324A  
 Leon Joseph (b. 1865) 70  
 Leonora R. Ezekiel 70, 324A  
 Lois F. (b. 1898) 70  
 Mabel V. (b. 1880) 70  
 Nathalie V. (b. 1899) 70  
 Nellie V. Myers 70  
 Sidney J. (b. 1867) 70, 324A  
 Vivienne (b. 1885) 70  
**GOETZ**  
 See also Yates  
 Albert (b. 1850) 150  
 Eliakim 308  
 Ella Lazarus 150  
 Emily 253  
 Julius (b. 1825) 150  
**GOHLMAN**  
 Harry D. 313B  
 Harry, Jr. 313B  
 Raymond 313B  
 Rebecca Bachrach 313B  
**GOLD**  
 Blanche 108  
**GOLDBAUM**  
 Edith E. 12, 320A  
 Emil J. 12  
 Erma Katherine 149  
 Jacob Samuel 149  
 Louisa Andrews 12  
 Miriam 12  
 Nellie Virginia Laib 149  
 Ruth Dene 149  
**GOLDBERG**  
 See also Gardner  
 Alvina Nusbaum 301  
 Angela Elizabeth Russell 313A  
 Barnet 159  
 Benedict S. 167  
 Essie Levy 167  
 Etta (Louise) 239  
 Harry 290  
 Joanna Lee Baron 339B  
 Joseph 313A  
 Josephine Levy 159  
 Leon Nussbaum 301  
 Louise (see Goldberg, Etta (Louise))  
 Mark 339B  
 Rachael Alexander Straus 290  
 Rose Lewis 171  
 Sally 290  
 Samuel 171  
 Sandra 335A  
 Sanford (see Gardner, Sanford (Goldberg))  
**GOLDBERGER**  
 Fay 313B  
**GOLDBURGER**  
 Gertrude 174  
**GOLDEN**  
 Anne Barnes 291  
 Arthur Sulzberger 291  
 Ben Hale 291  
 Betty Lehman 236  
 Bruce Edward (1942-) 328A  
 Deborah Lynn 253  
 Diane Joan (1946-) 328A  
 Irving 328A  
 June Tauber 291  
 Lynn Iphigene 291  
 Michael Davis 291  
 Nancy Helen 253  
 Philip 253  
 Robert Lee (1938-) 328A  
 Ruth Rachel Sulzberger 291  
 Stephen Arthur Ochs 291  
 Susan Price Engel 253  
 Sylvia Friend 328A  
**GOLDHAAR**  
 Hortense Tobias 295

John 295  
 Toby Ann 295  
**GOLDMAN**  
 Abraham (1872-1919) 143, 327A  
 Anne Elizabeth 107  
 Arthur (1896-) 327A  
 Bella 143, 327A  
 Betsy Bretzfelder 327A  
 Blanche 172  
 Carrie K. (1875-1932) 143, 327A  
 Clare Broughton 327A  
 E. C. Loeb 327A  
 Edward (1838-1901) 143, 327A  
 Edward Alan 107  
 Edward P. (1902-) 327A  
 Elyse (1921-) 327A  
 Florence 202  
 Gus 143, 327A  
 Hanna Kayton 143, 327A  
 Harry 143, 327A  
 Hazel (1913-) 327A  
 Helen (1884-1888) 143, 327A  
 Helen (1927-) 327A  
 Jack 107  
 Lewis 143, 327A  
 Lillian Lyon 327A  
 Martin E. (1894-) 327A  
 May 286  
 Melanie Prince 327A  
 Michael 107  
 Rebecca 143, 327A  
 Robert H. 327A  
 Rose Erlanger 327A  
 Rose L. (1917-) 327A  
 Shirley Jacobs 107  
 Sylvia L. (1915-) 327A  
**GOLDSCHMIDT**  
 Aaron (see Goldsmith (Goldschmidt), Adam (Adolph, Aaron))  
 Adolph (see Goldsmith (Goldschmidt), Adam (Adolph, Aaron))  
 Aline Lefebvre 84  
 Arnold, see Goldsmith, Arnold  
 Celestine Aline (b. 1867) 84  
 Clestine Judah 84, 139  
 Edward (b. 1856) 84  
 Ellen Chesebrough 84  
 Fannie Samuel (see Goldschmidt, Fromet (Fannie) Samuel)  
 Florence (1883-1900) 84  
 Florence Elsworth 84  
 Fromet (Fannie) Samuel 238  
 George B. (1840-1912) 84  
 Grace Kingman 84  
 Hildegard (b. 1885) 84  
 Hirsch (see Goldsmith (Goldschmidt), Henry (Hirsch))  
 John Myer (1801-1877) 84, 139  
 John, Jr. (1839-1891) 84  
 Joseph 238  
 Julia S. Levy 331A  
 May (1842-1920) 84  
 Samuel Anthony (b. 1848) 84  
 Sprinz (see Goldsmith, Jeanetta (Sprinz))  
**GOLDSCHMITT**  
 Abraham 238  
**GOLDSHINE**  
 Joseph 50  
 Sarah Davis 50  
**GOLDSMID**  
 Albert Edward Williamson 82  
 Allison Margueretta Dodd 82  
 Amy Reynolds 82  
 Arthur Powys Willoughby 82  
 Bartle George 82  
 Bartle Henry Seaton 82  
 Benjamin 82  
 Betsy (1759-1848) 136  
 Blanche 82  
 Cathrine Frere 82  
 Cecil Albert 82  
 Edward Moses 82

Eliza Frances Campbell 82  
 Eliza Mary 82  
 Emma Blanche Harrison 82  
 Everard Vaughan 82  
 Frances Caroline Elphinstone 82  
 Frances Emmeline Rowsell 82  
 Francis Frederick 82  
 Frederic John 82  
 Frederick 82  
 Frederick Le Stock 82  
 George Stuart 82  
 Gladys Helen Rachel 82  
 Guy 82  
 Gwendolyn Beatrice 82  
 Henry Edward 82  
 Ida Stuart Hendries 82  
 Jessie Heron 82  
 Jessie Solomons 82  
 Jessy Sarah 82  
 Jessy Sarah Goldsmid 82  
 Johanna (1788-1859) 136  
 Lionel Frederick 82  
 Lionel Prager 82  
 Marion Beyer 82  
 Mary Stuart 82  
 Muriel Ethel Carmel 82  
 Patricia Stuart 82  
 Philip 136  
 Reginald 82  
 Rose 82  
**GOLDSMIDT**  
 Jeanetta (Sprinz) 236, 238, 239  
**GOLDSMIT**  
 See also Goldsmith  
 Adeline 184  
**GOLDSMITH**  
 Aaron 284  
 Aaron L. 301  
 Abraham Alexander (1840-1906) 8, 84, 259  
 Adele Anathan 229, 334B  
 Aida Rivera 253  
 Albert Sidney 84  
 Alice Lederer Price 253  
 Amelia 125  
 Anne Sampson 84, 259  
 Arnold (1854-) 331A  
 Arnold 102  
 Barbara 294  
 Barbara J. 253  
 Belle Maud 60  
 Bertha Binswanger 21  
 Bertha Moss (b. 1908) 253  
 Bertha Umstadter 301  
 Bettie 301  
 Carlotta Greenfield 282  
 Carol Dene (b. 1918) 282, 313B, 339B  
 Carolina 238  
 Caroline (Guentl, Kailine) Levy 301  
 Catherine 84, 259  
 Cecilia 21  
 Charles 21  
 Charles, Jr. 21  
 Clara Freedman 21, 22  
 Daisy 207  
 David J. (1891-) 331A  
 Delia 22  
 Delphine Bendheim 331A  
 Edgar 21  
 Edith Joseph 294  
 Edna Strauss 21  
 Edward (m. 1898) 48  
 Edward (son of Aaron) 284  
 Edward H., Jr. 84  
 Edward Hilzheim 84  
 Edwin M., Jr. 134  
 Edwin III 134  
 Eleanor 84  
 Eleanor Alexander 8, 84  
 Eleanor Price (b. 1909) 253  
 Eleazer (m. 1857) 21  
 Eleazer (son of Levi) 128  
 Eli 21

Elinor 21, 22  
 Eliza (see Goldsmith, Lila (Eliza))  
 Eliza L. 84  
 Elizabeth (b. 1919) 294  
 Elizabeth (dau. of Edward) 48  
 Elizabeth 284  
 Ellen A. 253  
 Ellen Holman 282  
 Emily Goetz 253  
 Estelle Davis 48  
 Esther Isaacs 125  
 Eugenia (1882-1949) 229  
 Eva Maas 84  
 Fannie 128  
 Fanny Triest 84  
 Felix L. 301  
 Frances (d. 1905) 84  
 Frances (dau. of Edward) 48  
 Frances (dau. of Felix) 301  
 Frances (Fanny) Phillips 84, 247  
 Frederick (m. 1887) 101  
 Frederick Platt (b. 1946) 282  
 George 284  
 Gerald 22  
 Gneutl Levy (see Goldsmith, Caroline (Gneutl, Kailine) Levy)  
 Hannah A. (d. 1903) 84, 235  
 Harry B. (1877-1958) 253  
 Harry Price (b. 1915) 253  
 Helen (dau. of Moses Marcus) 84  
 Helen (m. M. Katzenberg) 282  
 Helen Jacobs 134  
 Helen Roth 284  
 Henrietta (Hettie) 123  
 Henrietta Eleanor 84  
 Henrietta Halff 101  
 Henry (m. 1857) 41  
 Hettie (see Goldsmith, Henrietta (Hettie))  
 Hortense 301  
 Irene Mae (1868-1913) 84  
 Irene Taraza 253  
 Irene Winstock 21  
 Isaac (son of Abraham A.) 84  
 Isaac (1774-1821) 84, 247  
 Isaac M. 84  
 Isaac Phillips 84  
 Isabel Kulzer 284  
 Isabel Loney 284  
 Isabella 301  
 James A. (d. 1950) 253  
 James A., Jr. (b. 1906) 253  
 James III 253  
 John 294  
 John, see Galen, John  
 Joseph J. (son of Isaac) 84  
 Joseph J. (son of Moses) 84  
 Judith Peixotto Hays 104  
 Julia S. Levy 102  
 Kailine Levy (see Goldsmith, Caroline (Gneutl, Kailine) Levy)  
 Kate Moss Price (see Goldsmith, Katharine (Kate) Moss Price)  
 Katharine (Kate) Moss Price 253  
 Katherine (b. 1901) 253  
 Katherine (dau. of Abraham A.) 84  
 Katherine Alexander 84  
 Lauren Jill 134  
 Lee Felix 301  
 Leonora Amelia (1885-) 331A  
 Levi M. (1781-1849) 128  
 Lewis 21  
 Lila (Eliza) 84  
 Lillian Maas 84  
 Lillian Platt 282  
 Lillian Rose 84  
 Lina 301  
 Linda 294  
 Lois 21  
 Louis 21  
 Maidie 301  
 Mamie 13  
 Manuel 101

Manuwel 238  
 Margaret Fuller (b. 1902) 253  
 Margery A. (b. 1912) 253  
 Mari Durring 284  
 Marie Lutz 294  
 Marjorie Bartwink 134  
 Martha (d. 1826) 128  
 Mary (dau. of James A., Jr.) 253  
 Mary (dau. of Ralph) 284  
 Mary 284  
 Mary Ann 253  
 Mary Dryfoos 253  
 Mary Elizabeth Lewin 339A  
 Maude 84  
 Maurice 84  
 Max 104  
 Mayer 229  
 Melissa Blake 253  
 Meyer 125  
 Mikell Myers (1847-1864) 84  
 Minna 301  
 Moses (1815-1884) 8, 84  
 Moses (1848-1854) 301  
 Moses Marcus 84  
 Nancy 21  
 Nettie Ehrlich 21  
 Oliver Clifton 84  
 Olivia Georgia Nathans 229  
 Pauline Cromline 41  
 Peggy 296  
 Perla (1877-1949) 229  
 Philip (see also Goldsmith, Henry)  
 Philip Nathans (1876-1952) 229, 334B  
 Rachel (d. 1826) 128  
 Ralph 284  
 Raphael Benjamin (1850-1852) 84  
 Rebecca (d. 1882) 84  
 Rebecca (dau. of Levi) 128  
 Robbie Dawn (1965-) 334B  
 Robert 294  
 Rosa (b. 1865) 21  
 Rose (b. 1882) 21  
 Rose (1889-1959) 125  
 Rose Hiltzheim 8, 84  
 Rose Marion 84  
 Rosetta Israel 128  
 Sadie Stern 282  
 Samuel (b. 1820) 238  
 Samuel (m. Clara Friedman) 22  
 Samuel (son of Eleazer) 21  
 Sarah Ann (1841-1913) 84, 235  
 Sarah Cohen Lovin 101  
 Stanley 84  
 Stanley H., Jr. (b. 1912) 282, 339B  
 Stanley Hexter 282, 339B  
 Stephen P. 253  
 Stephen R. 134  
 Susan 294  
 Sylvia Weyl 284  
 Vivian 84  
 W. Henry 84  
 Walter (b. 1888) 101  
 Walter (1876-1949) 294  
 Walter 284  
 Walter A. 294  
**GOLDSMITH (GOLDSCHMIDT)**  
 Adam (Adolph, Aaron) 238  
 Henry (Hirsch) 238  
 Jeannetta (Sprinz) 238, 239  
**GOLDSTEIN**  
 Alan Davis 23  
 Clara Hobenfels 118  
 Clare 26  
 Ellen (b. 1931) 21  
 Emily Ellen Crockin 108  
 Helen 102  
 Jean Ann 278  
 Jerry 307  
 Joan 328A  
 Joseph 278  
 Julius (see Gould (Goldstein), Julius)  
 Lillian 320B  
 Mariya Hochstadter 307

Martha (1861-1931) 23  
 Nancy (b. 1928) 274  
 Robert David 307  
 Sadie 160  
 Stephen Mark 108  
 Sue Ellen 72  
 Virginia Peace 23  
**GOLDSTEN**  
 Adeline Carol Wolff 278  
 Adeline Henrietta Wolff 211  
 Carol 211  
 Joseph 278  
 Joseph, Jr. 211  
**GOLDSTONE**  
 Aaron (1839-1896) 116  
 Adelaide 116  
 Alfred H. (b. 1874) 116  
 Aline May Lewis 116, 171, 310B  
 Barbara L. (1911-) 330B  
 Benjamin 116  
 Caroline Kronberg 116  
 Carrie 116, 310B  
 Effie Goodman 116  
 Frances G. (b. 1888) 116  
 Frederick (b. 1873) 116  
 Harmon Hendricks (b. 1911) 116  
 Helen Teller 116  
 Isaac 116  
 James 116  
 Jean S. (d. 1970) 116, 310B  
 Julius (b. 1867) 116  
 Katherine (b. 1909) 116  
 Lafayette A. (1876-1956) 116, 171, 310B  
 Lea D. (b. 1868) 116  
 Leo W. (1873-1957) 330B  
 Mabel Amelia Levy 330B  
 Mary 116  
 Michael (1824-1894) 116  
 Morris (1836-1925) 116  
 Nathaniel 116  
 Rebecca 116  
 Richard (b. 1914) 116  
 Richard Stanley (see Gould, Richard Stanley)  
 Rosetta (b. 1878) 116  
 Sarah Stock 116  
 Sigismund K. (b. 1871) 116  
 Simon (1830-1889) 116  
 Sophia Wertheim 116, 310B  
**GOLDSTROM**  
 Frances Lyon(s) 292  
 M. S. 292  
**GOLDWASSER**  
 David M. 288  
 Edwin L. 288  
 Elizabeth Weiss 288  
 John L. 288  
 Katherine 288  
 Michael 288  
 Richard 288  
**GOLLIBART**  
 Olivia 97  
**GOLLIN**  
 Edith 260  
 Fanny 260  
**GOMBOS**  
 Elizabeth G. 22  
**GOMEX**  
 Marie (see Gomez, Miriam (Marie))  
**GOMEZ**  
 Aaron Lopez (d. 1860) 85, 110  
 Abigail Lopez 85, 175  
 Abraham (of Bordeaux) 86, 110  
 Abraham (1742-1808) 85  
 Alexander Rich 324B  
 Alma Doria 324A  
 Anais (m. David Mills) 86  
 Anais (m. Lehman) 86  
 Anais Rachel 86  
 André D. III 324A  
 André Daniel 86, 324A  
 André Daniel, Jr. 86, 324A

Arney (Earnest) 86  
 Barry Jack 324B  
 Benjamin (1710/11-1772) 85  
 Benjamin (1769-1828) 85, 110  
 Benjamin Franklin 86  
 Brian Jay 324B  
 Bridget Marie 324B  
 Bruce Jack 324B  
 Charlotte Hendricks 85, 110  
 Cynthia (1795-1874) 85  
 Daniel (1695-1780) 62, 85  
 Daniel (1759-1784) 85  
 David (b. 1761) 85  
 David (1697-1769) 85  
 Deborah (1766-1783) 85  
 Deborah De Leon 85  
 Earnest (see Gomez, Arney (Earnest))  
 Ellenor (see Gomez, Leonora (Ellenor))  
 Emmeline 85  
 Ernest (m. Rosina Goodman) 86  
 Esther (m. Isaac) 85  
 Esther (m. 1782) 85, 324A  
 Esther (see also Gomez, Hetty (Esther))  
 Esther (1739-1822) 85  
 Esther (1768-bef. 1807) 85  
 Esther Abigail 85  
 Esther Gomez 85  
 Esther Lopez 85, 175  
 Esther Marques (Marcheze) 85, 185  
 Esther Mathilda (1798-1893) 85  
 Esther Rachel Nunes 85  
 Eve Esther (1743-1775) 85, 110  
 Feliz 86  
 Frances 85  
 George Washington 86  
 Gertrude Kahn 86  
 Harriet Alexander 85  
 Helen 86  
 Hermione 85  
 Hester (dau. of Moses) 85  
 Hester Rachel Campos 85  
 Hetty (Esther) (1791-1871) 85, 266  
 Hetty (Henrietta) Hendricks 85, 110  
 Hetty Maria (1822-1869) 85, 98, 99  
 Horatio (see Gomez, Joshua (Horatio) Horacio)  
 Isaac (b. Spain, d. France) 85  
 Isaac (Jr.) (1768-1831) 85, 175  
 Isaac (1705-1770) 85  
 Isaac (1718-1764) 85, 324A  
 Isaac (1763-1764) 85  
 Isaac (1767-1810) 85  
 Jack (see Gomez, Oscar, Jr. (Jack))  
 Jacob (d. 1722) 85  
 Jacob (d. 1763) 85  
 Joseph (1729-1734) 85  
 Joseph De Torres (1766-1769) 85  
 Joseph Edwin (ca. 1860-1926) 85  
 Joseph Edwin (1829-1897) 85  
 Joshua (Horatio) Horacio 85  
 Juliet (1802-1891) 85, 242  
 Karen Charlebois 324B  
 Lana Lane 324B  
 Leonora (Ellenor) (1663-1740) 85  
 Leslie 324A  
 Lewis (1795-1827) 85  
 Lewis (1823-1828) 85  
 Lotta 86  
 Louis Lopez (b. ca. 1864) 85  
 Lucilla (b. 1842) 12, 85  
 Luis (Lewis) (1654/60-1740) 85, 185  
 Madelaine 85  
 Marguerite (Leah) Ryan 85  
 Marianne (see Gomez, Mary Ann (Marianne))  
 Marie Schloss 86, 324A  
 Mary Ann (Marianne) 85, 175  
 Mathias (d. 1833) 85  
 Matthias (1742/3-1786) 85  
 Miriam (Marie) 85, 241  
 Monica Marie 324B

Mordecai (b. 1786) 85  
 Mordecai (son of Isaac) 85  
 Mordicia (1688-1750) 56, 85  
 Moses (b. 1772) 85  
 Moses (d. 1743) 85  
 Moses (d. 1795) 85  
 Moses Daniel (1728-1789) 85  
 Moses Emanuel (1804-1878) 85  
 Moses Lewis (1817-1822) 85  
 Moses Mordicia (d. 1744) 85  
 Moses Mordicia, Jr. (1744/5-1826) 85, 175  
 Oscar J. 86, 324A  
 Oscar, Jr. (Jack) 86, 324A  
 Rachel (d. 1776) 85  
 Rachel (1739-1809) 85, 302  
 Rachel (1800-1881) 85, 139  
 Rachel Gomez 85  
 Rachel Hendricks (see Gomez, Richa (Rachel) Hendricks)  
 Rachel Louise (1804-1809) 85  
 Rachel Louise 85  
 Rebeca (see Gomez, Rebecca (Rebca))  
 Rebecca (Rebca) (1761-1762) 85  
 Rebecca De Leon (Silva) 85  
 Rebecca De Lucena 56, 85  
 Rebecca De Torres 62, 85  
 Ribca de Jacob de David Jesurun 85  
 Richa (Rachel) Hendricks 86, 110, 324A  
 Richard Jack 324B  
 Rosalie (see Gomez, Roselane (Rosalie))  
 Rosalie Ruth (b. 1871) 85  
 Roselane (Rosalie) 85, 226  
 Rosina Goodman 86  
 Santa H. Marcuse 324A  
 Sarah (b. 1763) 85  
 Sarah (1793-1852) 66, 85  
 Sarah Kahn 86  
 Sebana (b. 1770) 85  
 Simone Chassin 324B  
 Stacy Michelle 324B  
 Wendie Epstein 324B  
 William Harrison 86  
**GOMPERTS**  
 Bathsheba (see Gomperts, Betsy (Bathsheba))  
 Benjamin 131  
 Betsy (Bathsheba) (1781-1817) 131  
 David I. 131  
 Gompert S. (son of Solomon) 131  
 Gomperts Salomons (1768-1831) 131  
 Hannah (1790-1826) 131  
 Julia 131  
 Rebecca 131, 254  
 Samuel (d. 1814) 131  
 Sarah (dau. of Solomon) 131  
 Sarah Jacobs 131  
 Solomon (1797-1844) 131  
**GOMPERTZ**  
 Elias 235  
 Marguerite 288  
 Sarah Oppenheim 235  
**GOMPRECHT**  
 Bertha 91  
**GOOD**  
 Barbara 290  
 David 290  
 Jay 290  
 Jeanette Berg 290  
 Joan B. 290  
 Laurence 290  
 Philip 290  
 Ruth 290  
 Sally Miller 290  
 Sidney S. 290  
 Sidney, Jr. 290  
**GOODAY**  
 Doris 122  
 George 122  
 Jacob 122  
 Margery Lawes 122

Maud Hyman 122  
**GOODFELLOW**  
 Mary 155  
**GOODHART**  
 Augustus Charles (b. 1876) 136  
 Bertha Joachimssen Levy \*36  
 Florence Beatrice (1918-) 65, 323B  
 Lawrence George (b. 1872) 136  
 Morris (b. 1838) 136  
 Morris, Jr. (b. 1874) 136  
 Philip H. 47  
 Priscilla Estelle (b. 1878) 136  
 Rose Davies 47  
 Wm. Alfred (b. 1875) 136  
**GOODING**  
 Constance 309B  
**GOODMAN**  
 Abraham 222  
 Alice 47  
 Amelia Harris 94  
 August 293  
 Augusta Wilma Straus 108, 162, 325A  
 Belle Wilkinson 293  
 Benjamin Franklin 94  
 Betty (see Goodman, Elizabeth ("Betty"))  
 Beverly 108, 325B  
 Campe (see Goodman, Robert Campe III)  
 Catherine (Kate) Amelia 94, 226  
 Cecile 94  
 Cecile Cohen 186  
 Clara 108  
 Cordelia 94  
 Corinne 94  
 Daniel (m. 1828) 94  
 David Hamilton 108, 325B  
 David Hirschler 108, 325A  
 Doria 95  
 Dorothy L. (1894-) 327A  
 Edward (b. 1888) 47  
 Edward (m. Minna Goldsmith) 301  
 Edward T. 254  
 Effie 116  
 Elizabeth ("Betty") 108  
 Elizabeth 108  
 Elsa Cecilia Campe 108, 325A, 325B  
 Emily P. Rosengarten 254  
 Emma (1842-1923) 94, 228, 312B  
 Estelle (b. 1847) 94  
 Ferdinand, Jr. 222  
 George Washington 94  
 Gerson 288  
 Gerson, Jr. 288  
 Gertrude 108  
 Hubert 293  
 Hubert, Jr. 293  
 Ida-Helen Kaufman 222  
 Isabelle 94  
 Israel 191  
 J. 191  
 J. Hanson 186  
 John 108  
 John M. 47  
 Kate (see also Goodman, (Kate) Amelia)  
 Kate Abraham 2  
 Kate Myers 222  
 (Kate) Amelia 94, 226  
 Leslie 108  
 Louis 2  
 Louisiana 94  
 Lucy Huffaker 47  
 Lynn (m. John Rouse) 108  
 Maria Susan 108  
 Marian Ahearn (1954-) 325B  
 Marjorie Jacobs 162  
 Martha Jacobs 108, 325A  
 Mary 108  
 Mary Adele 11  
 Mary Ellen Weiss 288  
 Minna Goldsmith 301  
 Miriam Gertrude 108, 293

Nancy 288  
 Nathan 222  
 Phila Augusta Moise McIndoe 195  
 Ray Davies 47  
 Richard 108  
 Richard, Jr. 108  
 Robert Campe 108, 162, 325A  
 Robert Campe III (1973-) 108, 325A  
 Robert Campe, Jr. 108, 325A  
 Rosina 86  
 Rowland 47  
 Sally 186  
 Samuel 254  
 Stephen 288  
 Valentine Terry 195  
 Vera Mendes 191  
 Victor 2  
 Virginia 94  
 Yalah Thorman 293  
**GOODRICH**  
 Caspar F. 106  
 Sarah Minis Hays 106  
**GOODWIN**  
 Abby Josephine (1824-1870) 155, 156  
 Abigail Levy 154, 155  
 Addie 215  
 Alexander Taylor (b. 1836) 155  
 Annie Booth 155  
 Augusta 266  
 Belle De Vries 155  
 Benjamin (1786-1811) 155  
 Charles Ridgely (see also Ridgely, Charles Goodwin)  
 Charles Ridgely (1834-1837) 155  
 Charles Ridgely (1842-1894) 155  
 Elizabeth (1790-1826) 155, 157  
 Elizabeth Anne Taylor 155  
 Elizabeth Augusta Campbell 155  
 Elizabeth Taylor (b. 1864) 155  
 Elizabeth Taylor (b. 1872) 155  
 Frank Greenwood (1844/5-1863) 155  
 Henry (1787-1805) 155  
 James (1794-1810) 155  
 Julia Clayton (b. 1831/2) 155, 156  
 Letitia (b. 1868) 155  
 Lionel Lyde (1782-1845) 155  
 Lionel Lyde (1828-1892) 155  
 Lyde (1718-1755) 155  
 Lyde (1754-1801) 154, 155  
 Maria (1792, 1878) 155, 157  
 Mary Elizabeth (1826-1905) 155, 156  
 Mary Randolph Mordecai 201  
 Mary Wager (m. Alexander) 155  
 Mary Wager (1866-1873) 155  
 Pleasance (1780-1837) 155, 156  
 Pleasance Ridgely 155  
 Rachel (1781-1781) 155  
 Robert Morris (1796-1861) 155  
 Robert Morris, Jr. (1838-1840) 155  
 Thomas Partin (1791-1820) 155  
 Thomas Rutherford Le Baron 201  
 William (b. 1788) 155  
 William (1789-1808) 155  
 William De Vries (b. 1874) 155  
 William Taylor (1822-1829) 155  
**GORDON**  
 Agnes 295  
 Armyne Evelyn 246  
 Byron 127  
 Clara Popper 127  
 Douglas C. 71  
 Isabella Levy 92  
 Lockhart 92  
 Mary Hamilton Kuhn 80  
 Patricia Clare 127  
 Peggy Fleisher Margolies 71  
 Rowland Huntley 80  
 Ruth 15  
 William 127  
 William John 127  
**GORE**  
 John 76  
**GORHAM**

Amelia 168  
 Caroline Fisher 168  
 Carrie 168  
 Daniel Barlow 168  
 J. L. 168  
 M. A. J. 168  
 Mumford 168  
 William J. 168  
**GORSON**  
 (see Garson)  
**GOTTESMAN**  
 Ruth 226, 334B  
**GOTTHEIL**  
 Elsie 285  
**GOTTHEIM**  
 Amelia K. Levy 331A  
 Irving 331A  
 Juliet Theresa 331A  
**GOTTLIEB**  
 Abraham 192  
 Adaline 192  
 Adelaide 12  
 David 192  
 Flora Davis 192  
 Isaac 192  
 Jacob 192  
 Josephine 192  
 Minnie 192  
**GOTTSCHALK**  
 Billa 329A  
 Felix 202  
 Frances ("Sissy") Mordecai 202  
 Isaac 329A  
**GOTTSCHALKSON**  
 Sarah (Sally) Hays 106  
 Solomon 106  
**GOULD**  
 Barbara 331A  
 Bob 331A  
 Brenda Byus 331A  
 Cathy 331A  
 Chris 331A  
 Diane Dodds 330B  
 Elizabeth Finnerty 330B  
 Frank 122  
 John 330B  
 Juliet Anne 122  
 Rebecca Mary 331A  
 Richard Stanley 330B  
 Rita 122  
 Tim 331A  
 Tom 330B  
 Valerie Steele 122  
**GOULD (GOLDSTEIN)**  
 Julius 122  
**GOULDER**  
 Janice E. 294  
 Kathleen 294  
 Mary Joseph 294  
 Richard 294  
**GOULDING**  
 Ann 138  
**GOURIOU**  
 Jeanne-Yvonne 48  
**GOW**  
 Harry (see Gow, Henry (Harry))  
 Henry (Harry)  
**GOWEN**  
 Alan Roy 36  
 Bradford Paul (b. 1946) 36  
 Dora Moise Cohen 36  
 Ethel Marie Riley 36  
 Eve 36  
 John K. IV 36  
 John K., Jr. 36  
 John Knowles III 36  
 Kevin Riley 36  
 Mary Anne 36  
 Mary Elizabeth Thatcher 36  
 Paul Roy 36  
**GRABENHEIMER**  
 Bertha 125  
**GRACE**

Adeline 188  
 Archibald 188  
 Archibald, Jr. 188  
 Josephine Marx 188  
**GRADY**  
 Harold 203  
 Harold, Jr. 203  
 Margaret Bandy (Marie Roderick) 203  
**GRAEME**  
 Rachel Jean Schlesinger 60  
**GRAFF**  
 Abraham M. 244  
 Clarence Lafayette (b. 1874) 46  
 Edwin David (b. 1868) 244  
 Ella Haas 46  
 Eva Phillips 244  
 Florence Brimson 46  
 Gertrude Virginia (b. 1915) 46  
 Horace Mordecai (b. 1874) 244  
 Irene Brandon 46  
 Isaac Phillips (b. 1869) 244  
 Isoline David 46  
 John David 46  
 Lafayette 46  
 Leslie 46  
 Roger Stanley 46  
 Stanley 46  
**GRAFFT**  
 Frances Sheftall 269  
 Roger 269  
 William 269  
**GRAHAM**  
 Elizabeth Logan 81  
 George M. (d. 1944) 229  
 Perla Goldsmith 229  
**GRAM**  
 Doris Jane 23, 309A  
**GRANDIN**  
 Blanche Lawrence 232  
 Elmer R. 232  
**GRANT**  
 Barbara 291  
 Beatrice Theresa Morrison Hopkins 204  
 Clara 198  
 Ian Reginald 138  
 J. Russell 204  
 Linda Catherine Foss 330A  
 Lorraine 182  
 Patricia Berto 190  
 Philip Robert (1953-) 330A  
 Richard Hatch 190  
 Rosa Mayer 190  
 Ruth Pincus 182  
**GRANT-DUFF**  
 Cynthia Juliet 79  
**GRASS**  
 Catherine Oppenheim 337B  
 Joachim J. (1862-1915) 337B  
 M. A. H. Godwin 337B  
**GRATH**  
 Edward, Jr. 310A  
 Elizabeth Oxholm 310A  
**GRATTON**  
 Elizabeth 81  
**GRATZ**  
 Alexander Hamilton (b. 1860) 88  
 Alexander Hamilton II 88  
 Alexander Howerton 88  
 Alfred (son of Edward) 87  
 Anderson (b. 1852) 88  
 Anderson (1913-1921) 88  
 Ann Ellen (dau. of Theodore) 87  
 Ann Ellen Carson 87  
 Anna (b. 1847) 88  
 Anna Maria Bonwell 87, 88  
 Archibald Cary (b. 1891) 88  
 Arthur S. 238  
 Audrey Alford 88  
 Barnard 324B  
 Barnard (1738-1801) 87, 223  
 Benjamin (1792-1884) 87, 88  
 Benjamin (1821-1830) 88

Benjamin III (1851-1939) 88  
 Benjamine 88  
 Birdie Virginia Ogden 88  
 Caroline (1803-1870) 87  
 Caroline C. Bryan 88  
 Caroline Vandever 87  
 Cary Gist (1829-1861) 88  
 Cary Ogden 88  
 Catherine Essex Bowen 88  
 Charles Cunningham 87  
 Clifford Bryan (1886-1934) 88  
 Colette Audrey 88  
 Cora 87  
 Dorthy Clark 88  
 David (d. 1861) 87  
 David (son of Edward) 87  
 Edward (d. 1869) 87  
 Edward (son of Edward) 87  
 Elizabeth (d. 1908) 87  
 Ella 87  
 Ella Haggard 88  
 Emily Farquhar 87  
 Emma C. 87  
 Ethel Dickie 88  
 Evelyn Pence Ford 88  
 Fanny (b. 1761) 87  
 Feigle Orgler 324B  
 Frances (1771-1852) 67, 87  
 Frank (son of Theodore) 87  
 Gitel (see Gratz, Judith (Gitel))  
 Helen (b. 1900) 88  
 Henry Howard (1824-1913) 88  
 Henry M. 87  
 Hermine Cary (b. 1855) 88  
 Hermine Cary (b. 1884) 88  
 Horace (b. 1882) 88  
 Horace (son of Simon) 87  
 Howerton (b. 1891) 88  
 Hyman (Germany) 87  
 Hyman (1776-1857) 87  
 Hyman Cecil (1826-1866) 88  
 Isabel Sturgis Templeton 87  
 Jacob (1789-1856) 87  
 Jeanette (Janet) Oppenheimer 238  
 Jonathan (Germany) 87  
 Jonathan (son of Michael) 87  
 Joseph (1785-1858) 87  
 Judith (Gitel) 87  
 Judith Cary 88  
 Laura Cary Bodley 88  
 Laura J. Hamilton 88  
 Leah 87  
 Lizzie A. Stiles 324B  
 Lizzie M. 87  
 Louisa (1801-1888) 87  
 Maria (see Gratz, Marion Howland (Maria))  
 Maria Cecil Gist 87, 88  
 Marion Howland (Maria) (b. 1898) 88  
 Marion Thompson 88  
 Mary (d. 1841) 87  
 Mary Alford 88  
 Mary Cecil (1848-1907) 88  
 Mary Smith 87  
 Mason Brown (1845-1846) 88  
 Michael (1740-1811) 87, 271  
 Michael Bernard (1822-1839) 88  
 Minerva Campbell Anderson 88  
 Miriam (1844-1873) 88  
 Miriam Simon 87, 271  
 Nettie Erwin 88  
 Nicholas Warfield 88  
 Rachel (1764-1831) 67, 87  
 Rachel (1783-1823) 87, 209  
 Rebecca (1781-1869) 87  
 Rebecca (1854-1856) 88  
 Rebecca (1885/8-1890) 88  
 Ricbea (1774-1858) 87, 106  
 Ricbea Myers-Cohen 87, 223  
 Robert Henry (1829-1877) 87, 324B  
 Rodney Warfield 88  
 Sallie Vaughan 88  
 Salomon Ben Meyer 324B

Sarah (1779-1817) 87  
 Sarah Campbell 87  
 Simon (son of Edward) 87  
 Simon (son of Theodore) 87  
 Simon (1773-1839) 87  
 Simon (1807-1865) 87  
 Solomon (Shelomo Zalman of Langendorf) 87, 324B  
 Solomon (1770-1772) 87  
 Theodore (1811-1863) 87  
 Thomas Donelson 87  
 Warfield (b. 1887) 88  
 Warfield, Jr. 88  
**GRAUBERT**  
 Bruce Stanley 18  
 Sally Mierson 18  
 Stanley Carol 18  
**GRAUCH**  
 Adelene Fisher 168  
 Robert R. 168  
**GRAUER**  
 Albert (1886-) 327A  
 Anthony Millard (1942-) 327A  
 Dorothy L. Goodman 327A  
 Edwin B. (1916-) 327A  
 Edwin (1889-) 327A  
 Elain McKenzie 327A  
 Hattie A. Schack 327A  
 Joan Wolf 327A  
 Lois H. (1930-) 327A  
 Millard F. (1927-) 143, 327A  
 Milton (1887-) 327A  
 Miriam Jacoby 327A  
 Rebecca Goldman 143, 327A  
 Rose Leipheimer 327A  
 Wendy 327A  
 William 327A  
 William S. (1913-) 327A  
**GRAUMAN**  
 Elaine 220  
 Fannie Jessel 220  
 Helen Rose Sulzer 220  
 Roger (1893-1914) 220  
 Samuel 220  
**GRAUPE**  
 Augusta 303  
**GRAUSMAN**  
 Helen 323B  
**GRAVES**  
 Ella 211  
 Frances Elizabeth 236  
 Jane 313A  
 Lula 211  
**GRAY**  
 Doris (see Gram, Doris Jane)  
**GRAY**  
 Abigail Brandon 27  
 Bowman 183  
 Bowman, Jr. 183  
 Camille 203  
 Catherine 203  
 Dorothea Hertzberg 141  
 Duncan 141  
 Elizabeth Palmer Christian 183  
 Gordon 183  
 Gwendolyn Marjorie 77  
 Heather Lynn 71  
 James Ronald 71  
 Jane Boyden Craige 183  
 Jean Kohn 71  
 Nancy 203  
 Nancy Maguire Beebe 183  
 Natalie Fontaine Lyons 183  
 Robert 27  
 Ruth 199  
 Susan Catherine 275  
**GRAYSON**  
 Benjamin David 208  
 David 208  
 Natalie Jane 208  
 Wendy Lou Weinberg 208  
**GREEN**  
 Amy Davis 49

Andrew (b. 1952) 91  
 Anna 251  
 Anna Mary Harper 213  
 Bill I. (1910-1960) 43  
 Bill Irvin (b. 1961) 43  
 Carl 128  
 Carolyn Lichtenfels 91  
 Charles Eugene Davidoff 43  
 Coley Stephen 43  
 Donald Stanley 276  
 Edith Josephine Solomons 276  
 Edna Augusta 91  
 Eleanor Rose Fischl 43  
 Eric 276  
 Florence Alma 49  
 George N. 91  
 Hal Leslie 43  
 Herbert 49  
 Herbert, Jr. 49  
 Janie 216  
 Joan Friedman 276  
 Kate 25  
 Mark 276  
 Mary Riley 43  
 Melanie 43  
 Melissa Lee 43  
 Pauline Ellet 128  
 Pauline Gumpertz 303  
 Pearl (1914-) 330A  
 Phyllis Lynn 43  
 Rhode Betty 167  
 Rita Mary Riley 43  
 Robert 43  
 Sarah Davies 47  
 Stanley 276  
 Sylvia Dorothy 297  
 Teresa 17  
 Virginia Helen 276  
 Walter Thomas 213  
 Woolf 47  
**GREENBAUM**  
 See Greene  
**GREENBERG**  
 Bella 167  
 Florence Oppenheimer 60  
 Naomi 60  
**GREENBERGER**  
 George 89  
 Jane Guggenheimer 89  
 John 89  
 Ruth 89  
**GREENE**  
 Babette Kayton 143, 327A, 327B  
 Elizabeth Ridgely Nicholas 157  
 Flora Andrews 12  
 Harmon Kayton 143, 327B  
 Mari Koretz 327B  
 Moses S. (1867-) 143, 327A, 327B  
 William Stewart 157  
**GREENE (GREENBAUM)**  
 Samuel 12  
**GREENEBAUM**  
 Anne Axler 327B  
 Bernard 283  
 Carrie 143, 327B  
 Diana 283  
 Evelyn (1921-) 327B  
 Helen Loeb 283  
 Henrietta 84  
 Henrietta Kayton 143, 327B  
 Isabel 143, 327B  
 Jennie 143, 327B  
 Jessie 143, 327B  
 Kenneth 283  
 Loretta 283  
 Marcia 283  
 Milton 283  
 Moses S. (see Greene, Moses S.)  
 Nancy 283  
 Robert 283  
 Ruth (1916-) 283, 327B  
 Sadie 143, 327B  
 Samuel (m. Stella Ball) 283

Samuel (m. Henrietta Kayton) 143, 327B  
 Samuel (son of Samuel) 283  
 Shirley 283  
 Stella Ball 283  
 Stephen 283  
 Walter Kayton 143, 327B  
**GREENFIELD**  
 Carlotta 282  
 Enid (Joan) 253  
 Joan (see Greenfield, Enid (Joan))  
 Miriam Umstadter Blaustein 301  
 Samuel 301  
**GREENSPON**  
 Carolyn Dryfoos 291  
 Jacqueline Hays Dryfoos 291  
 Michael Stuart 291  
 Stuart Prince 291  
**GREENWALD**  
 Alice Solomon 243  
 Anna May Alexander 8  
 Danys 222  
 Frank 8  
 Gabriel 243  
**GREENWOOD**  
 Alice Lloyd (b. 1835) 157  
 Augustus Goodwin (1832-1874) 157  
 Charles Ridgely (1828-1844) 157  
 Charlotte 81  
 Francis William (1826-1847) 157  
 Francis William Pitt (1797-1843) 155, 157  
 Maria Goodwin 155, 157  
 Mary Langdon (1829-1889) 157  
**GREGG**  
 Anthony (b. 1948) 24  
 Charles (b. 1915) 24  
 Dennis (b. 1949) 24  
 Gail 291  
 Harriet Kelly 24  
 Harry (b. 1916) 24  
 James 24  
 Jeffrey 24  
 John (b. 1904) 24  
 Lynn Davidoff 24  
 Margaret 203  
 Peter 24  
 Rosemary Mallery 24  
 Sandra (b. 1947) 24  
**GRESHAM**  
 Lewis 39  
 Mary (1874-1954) 166  
 Mary Ellen Orme 39  
**GREUBER**  
 Hazel 195  
**GREW**  
 Alma Eveline Clayburgh 336A  
 Alma (1941-) 336A  
 Edward Sturgis (1944-) 336A  
 James Hooper (1906-) 336A  
 James Hooper, Jr. (1948-) 336A  
 Priscilla Perkins 336A  
**GRIBBIN**  
 Francis Harold 224  
 Joseph 224  
 Lillian Naar 224  
**GRIES**  
 Betty 294  
 Beverly Stern 294  
 Caroline Frances 294  
 Cheryl 294  
 David 294  
 Donald Selig 294  
 Ellen (b. 1936) 294  
 Frances (Fannie) Hays 293, 294, 303  
 Freda Hamberger 294  
 Jean 294  
 Joan Selig 294  
 Lillian Dauby 294  
 Lincoln Hays 294  
 Lucile Dauby 294  
 Martha 294  
 Moses J. 293, 294

Peggy Lucile 294  
Robert D. 294  
Robert Hayes 294  
Robert, Jr. 294  
Sarah Proudfoot 294  
Susan Dauby 294  
Tome 294

**GRIEVE**

George 47  
Sophie Pike France 47

**GRIFFEN**

Annie (d. 1938) 17

**GRIFFITH**

David Maurie 295  
Eleanor 24  
Lucille Menken 192  
Margaret Ann 295  
Mary Rice Vogel 295  
Robert 295  
Victoria 295

**GRIGGS**

Julia Seixas 266, 339A  
Margaret C. Trowbridge 325B  
Pauline 339A

**GRIMES**

Alfred 201  
Bessie (see Grimes, Elizabeth Davis  
(Bessie))

Betty 201  
Bryan 201  
Edward Waller 201  
Elizabeth Davis (Bessie) 200, 201  
Ellen 201  
G. E. 225  
George Washington 201  
Henry Lane 201  
Mabel Naar 225  
Margaret Lane 201  
William 201

**GRINSLEY**  
Cynthia 205

**GRISWOLD**

Alfred D. 264  
Anna 97  
Charles 264  
Charlotte Myers 216  
Frank 264  
Harrison 264  
Matilla 264  
Myrilla Seixas 264  
Rufus W. 216  
William 26

**GROH**

Joan 337B

**GRONER**

Anais 86  
Carolyn Kahn Mark 86  
Lee Harold 86  
Lynn 86  
Mark 86

**GROO**

Hazel Elizabeth Seixas 266  
Lawrence 266

**GROFFER**

Elaine 134

**GROSSFIELD**

Joseph 43

**GROSNER**

Joan 321A  
Sylvan 321A  
Sylvia Friedenberg 321A

**GROSS**

Alfred 290  
David 293  
Janet Moos 293  
Jerome 293  
Joan B. Good 290  
Kathleen 293  
Louise E. 118  
Maria 118  
Philip 290  
Robert 290

**GROSSFIELD**

Eleanor Rose Fischl Green 43

**GROSSIUS**

Bill (d. 1911) 257  
Marguerite Lionne Karstendiek 257

**GROSSMAN**

Anita 282  
Barry Glenn 43  
David Michael 43  
Ellen Michael Miller 207  
Fred Lee 43  
Janice Ruth Friedman 43  
Paul B. 207  
Shari Lynn 43

**GROVE**

Anne Solomons 75  
Swart 75

**GROVER**

Elizabeth 125

**GRUBB**

Emma 70

**GRUBER**

Herbert 107  
Lawrence Steven 107  
Lona Sherrick 107  
Marion Anspacher Klopfer Hart 22  
Marvin 22  
Maurice 22  
Mitchell Aaron 107

**GRUEN**

Caryl Lester 237  
Charlotte Schwartz 237  
Emma Clemence Felix De Lisi 237  
Gertrude Ruth (Goldie Schmitka) 237  
William Milton 237

**GRUEN (GRUENEBAUM)**

Lester 237

**GRUENEBAUM**

Henry 237  
James Jacob 311A  
Lester (see Gruen (Grünebaum),  
Lester)  
Mayne Dryfus 311A  
Regina Oppenheimer 237  
William Milton (see Gruen, William  
Milton)

**GRUMBACH**

Edna Reckford 144  
Elizabeth (b. 1918) 144  
George (b. 1915) 144  
Louis 144  
Louise (b. 1912) 144

**GRUMBINE**

Robert (1915-) 327B  
Ruth Greenebaum 327B

**GRUNEBAUM**

Betty (b. 1844) 237  
Betty (Redche) 236

**GRUNTAL**

Sarah 227

**GRUSHEIM**

Betz Schwabacher 11  
Myron 11

**GUBBAY**

Alice Pinto 61  
Yorke 61

**GUCKENHEIMER**

Mildred Lee 5

**GUDEL**

Alfred O. 237  
Beth Joy 237  
Hannah Springer 237  
Morton Donald 237  
Shirley Helen Rosenberg 237

**GUDMANN**

Johanne 237

**GUEDALLA**

Josephine Rosina Menken 192  
Jules 192

**GUEDALLA**

Abraham Herbert (b. 1874) 74  
Grace 147  
Joseph (b. 1847) 74  
Judah Florence (b. 1873) 74

Rowena Florance 74  
Ruth Agnes (b. 1875) 74

**GUEDES**

Abigail De Leon (1704-1781) 273

**GUGGENHEIM**

Benita 322B  
Benjamin 40, 322B  
Clara 23  
Edmond 253  
Eve 211  
Fleurrette Seligman 40, 322B  
Hazel 322B  
Jack Albert 286  
James 211  
James Robert 211  
Jean 211  
Jeanne Touro Wolff 211  
Marron Bertha Price 253  
Myer 21  
Natalie 253  
Peggy 40, 322B  
Ruth Stix 286

**GUGGENHEIMER**

Abraham 89  
Adelaide 91  
Adele 89  
Agnes Maas 89  
Aimee 90  
Albert 89  
Alfred (m. Bertha Gomprecht) 91  
Alfred (m. Rebecca Levine) 89  
Alice Myers 90  
Alvin 89  
Amelia (see Guggenheimer, Pauline  
(Amelia))  
Anne 90  
Anne Salfeld 89  
Barbara 90  
Barbara Day Poinier 91  
Bertha Gomprecht 91  
Bertha Varina Rosenbaum 89, 222  
Beslah Springer Levi 89  
Betty 91  
Blanche 89  
Blanche Campe 91  
Blanche Spiegelberg 89  
Caesar (Suskind) 89, 90  
Caesar 89  
Caesar H. 91  
Carl 89  
Carlyne (Carrie) 90, 255, 338B  
Carmelita 90  
Caroline Koenig 91  
Carrie (see Guggenheimer, Carlyne  
(Carrie))  
Carrie Hamburger 90  
Cecile Isabel 89  
Charles (son of Randolph) 89  
Charles M. IV 90  
Charles M. III (b. 1920) 90  
Charles M., Jr. 90  
Charles Max 90, 222  
Charles Michael 90  
Charles, Jr. 89  
Cilla 90, 301  
Cilla Guggenheimer (b. 1897) 90, 301  
Cilli (b. 1834) 89, 90  
Cilli (dau. of Leo) 89  
Cilli Guggenheimer 89, 90  
Claire 89  
Clara (b. 1855) 89  
Clara (m. Solomon Gerstle) 89  
Clara (m. 1922) 23, 90  
Clara Auerbach 89  
Clara Hirsch 90  
Clarence 90  
Daisy I. 90  
David 89  
Delia 89  
Delia A. 90  
Dolene (b. 1866) 90  
Dolene (d. 1915) 90

Dolze Bacharach 89  
Ruth Agnes (b. 1875) 74  
Dora (m. August Reiser) 89  
Dora (m. Julius Oettinger) 89  
Dora (m. Solomon Jafha) 89  
Leon 273  
Dorothy E. Overbeck 90  
Dorothy Eugenia 90  
Edwin 91  
Eleanora Steinhart 89  
Elinor Coleman 89  
Eliza Katzenberg 89  
Ella 90

Ellen (see also Guggenheimer, Hellen  
(Ellen))

Ellen 90  
Emily 91  
Emma Leerberger 90, 91  
Estelle (m. Barnet L. Solomon) 102  
Etta 91

Fanny (see also Guggenheimer,  
Frances (Fanny))

Fanny 89, 222  
Flora (m. Ira Helstein) 91  
Flora (1851) 90  
Flora (1872-1952) 90  
Florence 90  
Frances (Fanny) 89  
Fred (b. 1835) 90  
Fred (son of Jacob) 90  
Fred (son of Sylvan) 90  
Frederick 91  
Fredrica Lowenberg 89  
Hanchon Newberger 90  
Harry (son of Randolph) 89  
Harry (son of Samuel) 89  
Harry (son of Simon) 89  
Hattie 89  
Hattie Haaf 90  
Hellen (Ellen) 90, 91  
Henrietta Obermayer 89, 90  
Henry (b. 1839) 90, 91  
Henry (m. Yetta Springer) 89  
Henry (son of Abraham) 89  
Herbert 89

Blanche 89  
Hortense (1854-1936) 90  
Hortense (1874-1918) 90  
Hosea Miguel 90  
Ida Eapen 90  
Irma Hoffman 90  
Isaac 90  
J. Caesar 90  
Jacob 90  
Jane 89  
Jeanette Hecht 90  
Joan 89  
John 89  
John Capron 90  
"Jr." (see Guggenheimer, Max ("Jr."))  
Julia 90  
Katherine Pease 91  
Klara 89  
Klara Barbier 89  
Laura Shire 89  
Lena Maier 89  
Lenah 89  
Leo 89, 90  
Louise Doniphen Calvert 90  
Lucy Manney 90  
Madeline Bernstein 90  
Marcus 89  
Marjorie 91  
Marjorie Sidenberg Coben 91  
Mary Medley 90  
Mary Strickland 90  
Maurice (son of Jacob) 90  
Maurice (1837-1885) 90  
Max ("Jr.") 89, 222  
Max (b. 1821) 89  
Max III 90  
Max, Jr. (b. 1903) 90  
Max, Jr. (b. 1936) 90  
Melville 89

Michael 90  
Milton 89  
Minna 90  
Minnie Lee Rosenbaum 90, 222  
Minnie Schaefer 89  
Moses B. 89  
Nathaniel S. 90  
Nathaniel Sidney 89, 90  
Newton 89  
Pat 90  
Paul Myer 90  
Pauline (Amelia) 89, 90  
Randolph (b. 1848) 89  
Randolph (m. 1932) 89  
Randolph II 89  
Rebecca Levine 89  
Richard 91  
Rita 89  
Robert K. 91  
Robert Sidney 90  
Rose (m. Jacob Hochstadter) 89  
Rose (m. Joseph Walters) 89  
Rose M. Blatner 91  
Samuel (son of Abraham) 89  
Samuel (1870-1936) 91  
Sara 89  
Seligman 89  
Seymour 89  
Sidney N. 90  
Sigmuud 89  
Simon (m. 1863) 89  
Simon (son of Sigmund) 89  
Solomon 89  
Sophie 89  
Suskind (see Guggenheimer, Caesar  
(Suskind))

Sydney 90  
Sylvan 90  
Sylvia Lesser 89  
Therese 89  
Yetta Springer 89

**GUHRING**  
Doris 208

**GUIDRY**

Adele Cecile 199

**GUILD**

Maud 212

**GULDEN**

Jill Lehman 236  
Joanne Lehman 236

**GULICK**

Elizabeth 184

**GULLESON**

Alice 171

**GULLETT**

Louisiana Canter 28

**GUMBEL**

Spriaz 291

**GUMBERTS**

Ferd A. (1871-1960) 309A  
Florence Bitterman 309A  
Helen Florence 309A  
Richard A. 309A  
William A. 309A

**GUMPPEL**

—62

Hale 235  
Jachet 235

**GUMPERT**

Abraham 123  
David 91  
Helen Lichtenfels 91  
Miriam Hecht 109  
Rebekah (1812-1875) 123  
Rudolf 91  
Sarah (1811-1864) 123  
Susan 91

**GUMPERTZ**

Pauline 303  
Sarah Abraham 303

**GUNDELFINGER**

Tammy 11

**GUNDERSHEIM**

Katey Joseph 139  
Solomon Moses 139

**GUNDERSHEIMER**

Emma 123

**GUNDRY**

Charles 276  
Eldon P. 276  
George 276  
James H. 276  
John L. 276  
M. Philomene Leramonda 276  
Mary Jane 230, 276  
Robert 276  
Thomas C. 276

**GUNN**

Bert (see Bolton, Bruce Dennis)  
Gilman Carlton, Jr. 45  
Glen Harry 45  
Michael Dean 45  
Ruth Davega Bolton 45

**GUNST**

Eleanor 16  
Mary 16, 321A  
Minnie 162

**GUNTRUND**

Dorothy 335B

**GURNEY**

Dorothy Nora 81

**GUSDORFF**

Barbara Ann (b. 1945) 23  
Lewis 23  
Pauline (Polly) Jane Binswanger 23  
Richard Binswanger (b. 1943) 23

**GUSOFF**

Ann Vera Lillienstern 110  
Arnold 110

**GUSTIN**

Alfred James 256  
Elizabeth Scott Russell 256  
Janie Russell (d. 1937) 256, 313A

**GUTHM**

Emilie G. Jones 137  
James Koppel 137

**GUTMAN**

Bertha Kayton 143  
Carrie 143  
Claire Stern 284  
Ella 143  
Helen 143  
Joel 143  
Lewis 143  
Lisa 284  
Nathan 143  
Pauline 143  
Samuel 284  
Samuel, Jr. 284

**GUITERES**

Sarah 112

**GUTTMAN**

Elizabeth (1837-1854) 300  
Henry 300  
Jacob (b. & d. 1834) 300  
Joseph (b. & d. 1845) 300  
Leah Berlin 300  
Moses (b. 1839) 300  
Rebecca (b. 1835) 300

**GUY**

Elizabeth Harby 289  
George V. 289  
John L. (b. 1955) 289  
John Lewis (b. 1932) 289  
Linda Douglass 289  
Ruth Octavia Rosenberg 289

**GUYOL**

Rose Emilie Hubert Moise 199  
Sidney Louis 199

**GWYN**

Jessie 207

**GWYNN**

Catherine Josephine Mackay 200  
Lenoir 200

**HAACK**

Mary 224

**HAAS**

Adolph G. 120  
 Alexander (b. 1858) 88  
 Alexander, Jr. 88  
 Alma 88  
 America 70  
 Anna Lafayette Russell 256  
 Annette 70  
 Benjamin P. 88  
 Carol Sylva (see Klein, Carol Sylva)  
 Christina (m. Benjamin P.) 88  
 Christina Johanna Frederica  
 (1860-1862) 88  
 Edith 88  
 Ella 46  
 Florence Isaacs 125  
 Frederick (b. 1868) 88  
 Frederick (son of Harold) 88  
 Gloria 125  
 Harold Levy Seixas (see Haas, Hyman  
 (Harold) Levy Seixas)  
 Hartog (b. 1902) 88  
 Hartwig Bernard (1826-1879) 266  
 Hester Hyams 120  
 Hyman (Harold) Levy Seixas (b. 1863)  
 88  
 Leonard J. 70  
 Leonie 88  
 Leontine Foignet 88  
 Leopold (b. 1818) 256  
 Marguerite 88  
 Mary Campbell 88  
 Nannie 205  
 Philip 70  
 Sadie 49, 159  
 Sarah (dau. of Alexander) 88  
 Sarah (dau. of Frederick) 88  
 Sarah Abigail 88  
 Sarah Ezekiel 88  
 Sarah Frederica (b. 1854) 256  
 Sarah Harriet 88  
 Sarah Hynes 88  
 Sarah Seixas 88, 266  
 Sophia Pike 250  
 Sylvan 125

**HABER**  
 Margery 294  
 Nathan 248  
 Rosina Phillips 248

**HACHAR**  
 Catherine 193

**HACKENBURG**  
 Gershom (d. 1836) 92  
 Henry (1839-1849) 92  
 Isaac E. 92  
 Jacob Eleazer (1826-1827) 92  
 Judah Lazarus (1788-1862) 10, 92  
 Lewis Allen (1832-1836) 92  
 Louis Allen (d. 1836) 92  
 Maria Allen 10, 92  
 Rebecca Allen (1832-1902) 92, 310A  
 William Bower (b. 1837) 28, 92, 310A

**HACKES**  
 Yetta (1829-1905) 285

**HACKSTAPP**  
 Clara H. 158

**HACOHEN**  
 Rachel De Sola 61

**HACOHEN (ELLIS)**  
 Eli 64

**HADASSAH**  
 Rebecca 131

**HADEN-GUEST**  
 Angela 82  
 Baron Leslie 82  
 Christopher 82  
 David 82  
 Elissa 82  
 Jeannette Pauline Hines 82  
 Muriel Ethel Carmel Goldsmid 82  
 Nicholas 82  
 Peter 82

**HADRA**

Etta 16

**HAES**  
 Adele Vallentine 228  
 Arthur 228  
 David 261  
 Oswald 228  
 Sarah Samuel 261

**HAGAMAN**  
 Andrew 139  
 Gertrude Sharrett 139

**HAGEDORN**  
 Annette 306

**HAGEN**  
 Esther K. 125  
 Jeremiah 125  
 Mary Louise Isaacs 125

**HAGER**  
 Earnest Brevard 270  
 Gloria Vivian Clair Sheftall 270

**HAGGARD**  
 Ella 88

**HAHN**  
 Clara Mayer 190  
 Frederick 190  
 Gertrude (1863-1952) 162, 190  
 Henry 190  
 Lita Claire 275  
 Ray 294  
 Theodore 190

**HAI**  
 Ben Michael 59

**HAILE**  
 Alice 168

**HAIMAN**  
 Rita 4  
 Rosa 4

**HAKE**  
 Lonnie 205

**HALBERSTAD**  
 Mietje 242

**HALE**  
 Alice 36

**HALEVY**  
 Esther (?) Samuel 261  
 (?), Phineas 261

**HALEY**  
 Alex 101  
 Annie M. Mayer (see Haley, Emma  
 Kass (Anne M.) Mayer)  
 Emma Kass (Anne M.) Mayer 249  
 Henrietta 101  
 Henry 101  
 Lillie 101  
 Meyer 101  
 Rachel Hart 101

**HALL**  
 Anna Maria Cohen Leland 32  
 Claude Haines 151  
 Ellen Lazarus 151  
 Fergus 35  
 John A. 32  
 Magdalen 76  
 May (d. 1936) 234

**HALLE**  
 Ferdinaand 259  
 Rachel Samson 259

**HALLETT**  
 Mary 77

**HALLEY**  
 Hannah Davis (see Halley, Henrietta  
 (Hannah) Davis)  
 Henrietta (Hannah) Davis 50  
 Rudolph 50

**HALLMARK**  
 Cordelia Ann 52  
 Cordelia Rebecca De Cordova 52  
 Donald Rogers 52  
 Ethel Ann 52  
 Joe Irvin 52  
 Mabeth 52  
 Martha Dee Wade 52  
 Michael Rogers 52  
 Peggy June 52

Ray 52

**HAES**  
 Roy 52  
 Steven Addison 52  
 T. C. 52  
 Tom Russell 52

**HALPERT**  
 Edwin 293  
 Ester Katz 293  
 Joan 293  
 Stuart 293

**HALPHON**  
 Ester De Simon 73

**HALSEY**  
 Ashley 84  
 Ashley, Jr. 84  
 Eleanor Loeb 84  
 Eugene 84  
 Henry 4  
 William Melton 84

**HALTON**  
 Hannah Constance 95, 96

**HAMBLETON**  
 Adelaide R. McAlpin 158  
 Anna Crawford 158  
 Arabella Stansbury 158  
 Frank Sherwood 158  
 John A. 158  
 Thomas Edward (d. 1930) 158  
 Thomas Edward 158  
 Thomas Edward, Jr. 158

**HAMBURGER**  
 Aaron 63  
 Amanda 108  
 Amy 326A  
 Betty (b. 1905) 15  
 Carrie 90  
 Christopher Joseph (b. 1940) 15  
 Clare Shindler 15  
 David (b. 1905) 15  
 David (1835-1902) 15  
 David Elias 63  
 Dorothea (1855-1935) 15  
 Dorothy (b. 1904) 15  
 Edna (b. 1899) 15  
 Ernestine Steinert 15  
 Esther (1879-1938) 15  
 Esther Kraft 15  
 Evelyn Buckley 15  
 Fanny Disney 15  
 Freda 294  
 Freudchen Hameln 92  
 Gates (b. 1870) 15  
 Hartwig Moses 92  
 Hattie Morse 15  
 Helen (b. 1907) 15  
 Herman 63  
 Irving (b. 1876) 15  
 Isabella Goldsmith 301  
 Jacob Wolf (1795-1884) 15  
 Jeanette 63  
 Joe (b. 1874) 15  
 Joe, Jr. (b. 1908) 15  
 Jonas 90  
 Julia Guggenheimer 90  
 Loebel Moses 92  
 Marcus (Mordecai) 92  
 Margaret 284  
 Marian Elias 63  
 Mary 284  
 Mary Catherine (b. 1942) 15  
 Meta Mendelson 15  
 Michael 92  
 Mildred (b. 1885) 15  
 Mordecai (see Hamburger, Marcus  
 (Mordecai))  
 Moses 92  
 Nannette Kahn 16  
 Peggy Weisberly 15  
 Rebecca (1825-1905) 15  
 Rose Barnet 15  
 Rose Ettenheimer 15  
 Ruth (b. 1902) 15  
 Sigmund 16

Simon (b. 1872) 15  
 Solomon 301  
 Susannah Moses 92  
 Theresa E. 324A  
 Virginia 108  
 Walter (b. 1901) 15  
 William 15

**HAMELI**  
 Caroline (b. 1853) 248

**HAMELN**  
 Freudchen 92

**HAMILTON**  
 Abigail Franks 75, 79  
 Amelia Samuel Samuel 261  
 Andrew (son of Andrew) 79  
 Andrew III (17423-1784) 75, 79  
 Ann 79  
 Edith Raphael Seixas 264  
 Elizabeth Urquhart 79  
 Emma Levy 169  
 Fanny 251  
 Franks 79  
 George William, 6th Earl of Orkney  
 261  
 Henry 75, 79  
 James 79  
 Jessica 95  
 Jessica Leslie 95  
 Joseph 95  
 Laura J. 88  
 Margaret 79  
 Mary 79  
 Mary Ann 79  
 Ralph B. 264  
 Rebecca 79  
 Samuel Prioleau 169  
 Susan 95

**HAMMÉ**  
 Frederick 298  
 Sophie Jenkins 298

**HAMMER**  
 Beatrice 89

**HAMMERSCHLAG**  
 Beatrice Weyland 296  
 Howard 296  
 Julia Cohen 284  
 Sandra Ann 296  
 Solomon 284  
 Suzanne 296  
 Sylvia Tim 296  
 Timothy Bernard 296  
 Timothy Bernard, Jr. 296

**HAMMERSLOUGH**  
 Dorothy Ida Rosenbaum 222  
 Gertrude Eleanor 9  
 Walter 222

**HAMMETT**  
 Mary (1832-1912) 13

**HAMON**  
 Eugene (b. 1863) 280  
 Leah Spanier 280  
 Lewis (b. 1866) 280  
 Renee 228  
 Siegmund 280

**HANCOCK**  
 Denis 60  
 Joyce Langner 60

**HAND**  
 Catherine Maria Isaacs 126  
 Josiah 126  
 Laura Bofill 163  
 William Henry 163

**HANDLER**  
 Jacquelyn 11

**HANDSCHBERGER**  
 Tillie (dau. of Brina) 124  
 Tillie (dau. of Tillie) 124

**HANENT**  
 Caroline 161

**HANEY**  
 Mary 320B

**HANF**  
 Hattie 90

**HANFF**  
 Alice Connelly 313A  
 Alma Yerger 313A  
 Arthur J., Jr. 313A  
 Arthur Joseph (1882-1949) 313A  
 August 313A  
 Callie (Caroline) Bachrach 313A  
 Carol Marjorie (1941-1951) 313A  
 Cecile (b. 1886) 313B  
 Dorothy 313A  
 Edward Albert 313A  
 Elias (1853-1939) 313A  
 Elias, Jr. (b. 1891) 313A  
 Eva (b. 1884) 313A  
 Gertrude (b. 1876) 313A  
 Helene (dau. of Arthur Joseph) 313A  
 Jane 313A  
 Jane Graves 313A  
 Jeffrey (b. 1951) 313A  
 Joseph Arthur (b. 1882) 313A  
 Joseph, Jr. 313A  
 Linda 313A  
 Mary Bachrach 313A  
 Minnie (b. 1879) 313A  
 Miriam Levy (d. 1959) 313A  
 Peggy Jo 313A  
 Ruth Gilbert 313A  
 Sadie (b. & d. 1878) 313A  
 Sally (b. 1945) 313A  
 Sharon Connelly (b. 1947) 313A  
 Sophie Wolf 313A  
 Susan 313A  
 Wendy (b. 1947) 313A

**HANKE**  
 Mary Ann 236

**HANLEY**  
 Bryant M., Jr. 91  
 Laura Cone 91  
 Nancy Cone 91

**HANLO**  
 Bea Moses Fishel 215  
 Eveline 215  
 George 215  
 Jack 215

**HANNA**  
 Mary Caroline (1924-1966) 311B

**HANSEL**  
 Julie 108

**HANSEN**  
 Christine 11  
 Dorothy Reichman 11  
 Jack 11  
 Mark 11

**HANSHAW**  
 Ina C. 335B

**HANSON**  
 Hanse Andrew (m. 1937) 313A  
 Perla Sheftall Russell Mendel Sawyer  
 313A

**HAPGOOD**  
 Cyrus Stow 238  
 Elaine Prentice Ettinger Powers 238

**HARBY**  
 A. Tobias (1836-1860) 93  
 Adeline Wineman Emanuel 66, 207  
 Alice 207  
 Alice Fox 93  
 Alice L. 93  
 Alina 207  
 Anita M. 198, 207  
 Ann 312A  
 Ansley D. 207  
 Armida (d. 1917) 93  
 Armida (1820-1895) 35, 93  
 Arthur S. (1891-1929) 93  
 Augusta I. 207  
 Benjamin (b. 1745) 93  
 Berenice 207  
 Betty 207  
 Caroline De Litchfield (1801/2-1876)  
 93  
 Carolyn 207  
 Charles (son of Henry J.) 93

Charles (son of Henry Jefferson) 93  
 Charles Neil 208  
 Coral Weathers 208  
 Cyrilla Isaacs 93  
 Daisy Bowman 207  
 Daisy Burgess 207  
 Daisy Goldsmith 207  
 Donovan B. 207  
 Edith Gandy 207  
 Edward (son of Henry J.) 93  
 Elizabeth Knight 208  
 Ella Dils 93  
 Emma H. Solomons 207, 279  
 Estelle Mouton 208  
 Esther D. 207, 312A  
 Eugene H. III 208  
 Eunice 207  
 Frances Levy 93  
 Frances Moran 208  
 Freddie Farkus 207  
 George Washington (1797-1862/3) 93  
 Gertrude A. 207  
 Hal W. 207  
 Harry 93  
 Henry (son of Henry Jefferson) 93  
 Henry J. (b. 1858) 66, 207  
 Henry J. (son Levi C.) 93  
 Henry J., Jr. 93  
 Henry Jefferson (1799-1851) 93, 298  
 Horace (d. 1917) 93  
 Horace (son of Horace) 207  
 Horace (son of Jackson M.) 207  
 Horace (1817-1864) 93  
 Horace (1846-1905) 207, 279  
 Horace De Litchfield 207  
 Isaac (son of Henry Jefferson) 93  
 Isaac (son of Horace) 207, 312A  
 Isaac (1788-1828) 12, 93, 203  
 Isaac 93  
 Isabel W. Solomons 207, 312A  
 Israel (b. 1742) 93  
 Jack D. 93  
 Jackson 207  
 Jackson M. 207  
 Jacob De La Motta 35, 93  
 Jacqueline Ellen Levy 163, 207  
 Jeanne 207  
 Jennie 207  
 Jennie Sutherland 207  
 John Dowlin 208  
 Josephine Sutton 93  
 Joshua Joseph (1866-1937) 208  
 Julian (b. 1815) 93  
 Julian (b. 1857) 207  
 Kenneth 207  
 Leah Tobias 93, 298  
 Lee (Leah) Cohen 35, 93  
 Lena 93  
 Lena Fox 93  
 Leonora 93  
 Leonora Rebecca De Lyon 57, 93  
 Levi Charles (1793-1870) 57, 93  
 Lila Lee 93, 324B, 326A  
 Lucy Ladd 207  
 Mabel (1871-1878) 207  
 Margaret Maybin 93  
 Marguerite 207  
 Maria (b. 1760) 93  
 Marie Ulalie Pouillot 93  
 Marx Edwin (b. 1871) 93  
 Mary Emma (1871-1891) 207  
 Mary Levin 207  
 Mary Olivia Lucas (d. 1834) 93  
 Mary Zelime 207  
 May Levin 49, 153  
 Miles Moran 208  
 Octavia (dau. of Samuel) 93  
 Octavia (1823-1904) 93, 207  
 Betty 207  
 Rachael (1791-1812) 93  
 Rachael Mordecai (1782-1827) 12, 93  
 Rebecca (dau. of Levi Charles) 93  
 Rebecca (1841-1884) 196, 207  
 Rebecca Moses 93, 205



Richard 93  
Rosalie 93  
Rosalie Malbron 93  
Rosalie May (b. 1902) 207  
Rose Phillips 93  
Rosemary Kicklighter 208  
Samuel (son Jackson M.) 207  
Samuel (1813-1862) 93  
Samuel Dacosta (1795-1799) 93  
Sarah Levy 93  
Solomon (son of Henry Jefferson) 93  
Solomon (1762-1805) 93, 205  
Solomon (1811-1830) 93  
Sophia 93  
Stephen 312A  
Virginia 208  
Virginia S. 207  
Walter Irving (b. 1860) 163, 207  
William M. 312A

#### HARD

Frances 37

#### HARDIE

Elizabeth Kokernot 146  
Jot Gunter 146

#### HARGREAVES

Nadine (1885-1918) 322B

#### HARGROVE

Ann Augusta 125  
Barbara Carol 125  
Carolyn Wilson Bortin 125  
Rebecca 125  
Robert H. 125  
Sarah 125  
Steven Donald 125

#### HARLAM

Freda 116  
Gretchen (1797-1885) 116  
Judah 116

#### HARLOW

Marjorie 295

#### HARMDIN

Blanche Kokernot 146  
D. E. 146

#### HARMON

Martha Elizabeth 174

#### HARNER

Sally E. Westheimer 307  
Wayne A. 307

#### HARPER

Alice Sarah (Lea) (b. 1885) 213  
Ammie Nunez 213  
Anna Mary (b. 1881) 213  
Callie Esther Panther 213  
Charles H. (b. 1894) 213  
Charley Philip (Jack) 213  
Clifton Henry (b. 1891) 213  
Dora Irene (b. 1886) 213  
Dulce Cecile 213  
Edward (b. 1882) 213  
Edward (m. Amy) 213  
Edward Nunez 213  
Frances M. Russell Ruhl 313A  
Ida Mathilda (b. 1892) 213  
Jack (see Harper, Charley Philip (Jack))  
Lea (see Harper, Alice Sarah (Lea))  
Leona Gage 213  
Lula 213  
Mary 146  
Nan Farmer 213  
Raphael Cortez 213  
Sally Ella 32  
Thomas J. 313A  
Willie Oscar (b. 1889) 213

#### HARRINGTON

James 269  
Jeanette Sheftall 269

#### HARRIS

Aaron (1822-1869) 94  
Abigail (b. 1923) 94  
Abraham (1735-1827) 94  
Abraham C. (b. 1844) 94  
Abraham Hyam (1805-1868?) 94

Adriel 93  
Alexander (b. 1843) 94  
Alexander (1817-1869) 94  
Amelia (1813-1888) 94  
Amelia J. (b. 1846) 94  
Arthur 94  
Arthur Knight (b. 1917) 280  
Beatrice 283  
Caroline (1813-1838) 38, 94, 324B  
Catharine Nathan 94, 228  
Catherine 94  
Cecile (1850-1932) 94  
Clara 38, 94  
Cordelia 16, 94, 305  
Corinne (m. 1879) 202  
Corinne (1836-1837) 94  
Cornelius Hartman Kuhn 80  
E. J. Thompson 94  
Edith A. Treat 80  
Edith Cahn 313A  
Edwin 94  
Eliza Loch Walker 46  
Ella Cohen 306  
Elsie 280  
Emanuel Knight (b. 1890)  
Erica (b. 1921) 93  
Erna Krohn 306  
Ethel Crothers Heberton 80  
Florence Nightingale Knight 280  
George (m. Ella Cohen) 306  
George (m. Erna Krohn) 306  
Hamilton Kuhn 80  
Henriette Lynn 94  
Henry (b. 1809) 94  
Hyam (Hyman) (1774-1828) 94, 228  
Hyam Dalton 94  
Hyman (see Harris, Hyam (Hyman))  
Isabel Barney 80  
Isabelle (1819-1907) 94, 214  
Jacob (b. 1811)  
Jacob, Jr. (1766-1837) 94  
James Hamilton 80  
Jane Seymour Beckwith 36  
Jean Naome 42  
Joan (b. 1918) 93  
Joseph Conkling 80  
Joseph Ridgely 80  
Judith (b. 1926) 93  
Kate 188  
Kathryn F. Peace 80  
Laura 94  
Levy Judah (1815-1891) 94, 240  
Lois 213  
Louise Jonas 94  
Lucille (1949-) 327B  
Lydia (1841-1866) 94  
Lynda Catherine (1858-1930) 330A  
Madeline Cohen Mordecai 34, 202  
Marian Silberberg 280  
Marie Antoinette Cecile Lamarleré 94  
Marion 125  
Marjorie 306  
Mary 121, 214  
Mary Hamilton 80  
Mary Hamilton Kuhn 80  
Maude 110  
Maude Pearl 195  
Mildred 186  
Moses (1807-1877) 94  
Natalie Plough 93  
Rachford 306  
Rebecca (1801-1883) 94  
Rebecca Myers 94, 240  
Rosa 133  
Ruth 24, 71  
S. Marcus 280  
Sarah (m. Alexander Alexander) 8  
Sarah (1776-1821) 185  
Sarah (1801-1883) 9, 94  
Tom 306  
Walter 313A

#### HARRIS(S)

Sarah (m. 1810) 50

#### HARRISON

Annie Bathurst 214  
Anthony John 138  
Charles 269  
Emma Blanche 82  
Florence Patterson Mordecai 203  
George Law 203  
George Law, Jr. 203  
Isabel Fanshawe 138  
Katherine 22  
Sarah Catherine Sheftall 269

#### HARRITT

Pauline McFadden Moise 198  
William Lowell 198

#### HARROW

Benjamin 274  
Caroline Solis 274  
Peggy 274

#### HART

Aaron (London) 99  
Aaron (Moshe Uri B. Yehezkel) 95, 141  
Aaron (Rabbi Uri Phoebus) (1670-1756) 92  
Aaron (to Jamaica, ca. 1780) 92  
Aaron Asher (1783?-1800/2) 100  
Aaron Ezekiel 46, 95  
Aaron Moses (see Hart, Areli Blake (Aaron Moses))  
Aaron Philip (1811-1843) 96  
Abe 311B  
Abigail (1815-1870) 97  
Abigail Minis Sheftall 267  
Abigail Sarah (b. 1856) 254, 312B  
Abraham (m. Stella Benswanger) 21  
Abraham (son of Aaron) 92  
Abraham (1766-1849) 103  
Abraham (1779-1820) 99  
Abraham (1810-1885) 99, 120  
Abraham Kitzinger (b. 1811) 95  
Abraham Levy 97  
Abraham Luria (1789-1872) 16, 103, 325A  
Ada R. 254, 312B  
Adelaide Fanny Samuel 98, 260  
Adele (b. 1863) 97  
Adolphus Mordecai (1814-1879) 95, 96  
Alan Judah 95  
Albert L. (1870-1928) 101  
Alec (see Hart, Guy Alexander ('Alec'))  
Alexander ('Bay') 95  
Alexander (Asher) (1782-1835) 95  
Alexander (d. 1838) 103  
Alexander (m. 1842) 28, 97  
Alexander (1777-1839) 101, 146  
Alexander (1839-1911) 101, 162  
Alexander Moses (d. 1797) 97  
Alexander Thomas (1804-1852) 95, 141  
Alfred (1848-1864) 272  
Alice Victor 101  
Aline (1877-1906) 97, 310A  
Allen 102  
Allyn Bacon 103  
Alma Ruth (b. 1910) 95  
Amanda Malviana 267  
Amelia 330B  
Amelia (Minkie) 102, 170, 330B  
Amelia (1802-1865) 101, 250  
Amelia Samson 259  
Amy Coleman (1873-1954) 101  
Andrew 181, 332A  
Ann 138  
Anna Augusta Kursbeedt 147  
Anna Griswold 97  
Annie 98  
Annie Julia 96  
Areli Blake (Aaron Moses) 95  
Arthur (b. 1887) 101  
Arthur (son of Bernard) 97  
Arthur Daniel (b. 1886) 95  
Arthur Hendricks (b. 1891) 97  
Arthur Vail (b. 1913) 97  
Arthur Wellington (1813-1891) 96  
Asber (b. 1850) 95  
Asber (b. 1853) 95  
Asber (see also Hart, Alexander (Asher))  
Augusta Georgia Canter 28, 97  
Augusta Lyon 181, 332A  
Augusta Solomon 102  
Augustus (1842-1843) 95  
Barbara 22  
Barnet S. 102  
Barnet (see Hart, Baruch (Barnet))  
Barney Barnett 103  
Baruch (Barnet) 103, 325A  
Baruch Frederick Weber 96  
'Bay' (see Hart, Alexander ('Bay'))  
Bayle 99  
Bella Levy 98, 99  
Benjamin (b. 1800) 98  
Benjamin (London) 272  
Benjamin (son of George) 272  
Benjamin (son of Michael) 272  
Benjamin (1779-1855) 96, 100  
Benjamin J. (1888-1934) 102  
Benjamin Moses (b. 1820) 96  
Benjamin Seizas (b. 1869) 97  
Benjamin Seizas (1811-1866) 97, 110  
Benjamin Wolfe J. (b. 1820) 102, 204, 324B  
Benjamin Wooley 147  
Bernard (1763-1855) 97, 266  
Bernard (1814-1843) 97, 135  
Bernhard (b. 1924) 97  
Bertha Livingston 22  
Bessie Walters 101  
Betsey 97  
Betsy Levy Kokernot 101, 146  
Betsy Van Der Beugel Kokernot 95, 146  
Bettie Hollis 101  
Betty (m. Moses F. Nathan) 227  
Betty Whyte 95  
Bilhah (d. 1748) 75, 92  
Bilhah (see also Hart, Elizabeth (Bilhah) (1783-1840))  
Bilhah Levy 165  
Blanche Alice 101  
Blanche J. 101  
Bluma 99  
Blume 101  
Briah (b. 1761) 99  
Cacouna Buntan 96  
Carol 95  
Caroline (dau. of Henry N.) 96  
Caroline Augusta Solomons 98  
Caroline E. (1808-1890) 99  
Caroline Phoebe Pollard 97  
Caroline Solomons (b. 1894) 98  
Caroline Solomons (m. Samuel N., Jr.) 98  
Caroline (1811-1877) 324B  
Carolyn Athalia (1807-1883) 95  
Catherine (b. 1845) 99  
Catherine (dau. of Ezekiel) 95  
Catherine (Katy) 95, 141  
Catherine (1863-1932) 98  
Catherine Brett 97  
Cecil Mordecai (1883-1940) 95  
Charles Henry (b. 1847) 103  
Charles Theodore 96  
Charles Theodore Auldio 96  
Charlotte (b. 1777) 46, 95  
Clara (b. 1887) 101  
Clara (m. 1887) 101  
Clarence (b. 1850) 99  
Claude Benjamin (b. 1881) 95  
Constance (b. 1817) 100  
Constance (1858-1941) 97  
Constance Hart 97  
Cornelia Rebecca (1853-1872) 99  
Cyril (b. 1901) 95  
Daniel (b. 1906) 97

Daniel (d. 1811) 98, 99  
Daniel Samuel 98, 176  
Daniel Seizas (1826-1904) 97, 114  
David (b. 1836) 272  
David (son of Benjamin J.) 102  
David (son of Julian) 22  
David (1785-1854) 98  
David A. (d. 1844) 95  
David Alexander (b. 1844) 46, 95  
David B. 102  
David Davids (1819-1888) 97  
David Judah 305  
David Lopez (b. 1866) 98, 163  
Delphine 98  
Dena Fridenberg 124  
Dora (see Hart, Sophia David (Dora))  
Doris Goodman 95  
Dorothea (1855-1927) 95  
Dorothea Catherine (b. 1828) 96  
Dorothea Catherine Judah 95, 141  
Dorothy (b. 1896) 97  
Dorothy (b. 1898) 21  
Dorothy Elizabeth 22  
Dorothy Ewer (b. 1893) 98  
Dorothy Frankfurter 95  
Dorothy Marguerite 95  
Edith (b. 1876) 96  
Edith Marie 96  
Edith Presto 96  
Edith Tudor 138  
Edna 100  
Edward Carey (1836-1846) 99  
Edward Henry (b. 1903) 95  
Edward John (b. 1861) 254  
Edward Morris 100  
Edwin 102  
Effie (see Hart, Mary Edith (Effie))  
Eleazer (see Hart, Eliezer (Eleazer))  
Eliezer (Eleazer) 99  
Elinor Goldsmith 21  
Eliza (d. 1847) 297  
Eliza (dau. of Henry) 97  
Elizabeth (Bilhah) (1783-1840) 95  
Elizabeth (m. Ivan) 138  
Elizabeth (m. 1864) 101, 306  
Elizabeth (see also Hart, Sheprah (Elizabeth))  
Elizabeth (1785-1845) 103  
Elizabeth Barnett 16, 103  
Elizabeth Emily (1913-) 332A  
Elizabeth Johnson 96  
Elizabeth Joseph Barnett 321A  
Elizabeth Rebecca Ostrander 97  
Elizabeth Stringer 96  
Elizabeth Tudor 96  
Elizabeth Weston (b. 1829) 96  
Ella (1787-1860) 98, 257  
Ella Moses 97  
Ellen (1802-1881) 29, 103  
Elmira T. 96  
Elon 95  
Elvira (see Lyon, Elvira)  
Emanuel Bernard (1809-1897) 97  
Emile Abraham 95, 265  
Emily 103  
Emily Abigail (b. 1822) 96  
Emma 95  
Ephraim (son of Benjamin) 96  
Ephraim (1747-1825) 100, 232  
Ernest W. 272  
Estelle 53  
Estelle K. Wright 272  
Esther (ca. 1766-1843) 103  
Esther (Hester) 98  
Esther (Hetty) Levy 100, 154  
Esther (Hetty) (1766-1843) 103  
Esther (Hetty) (1792/3-1858) 98, 186  
Esther (m. Moses) 98  
Esther Cohen 103, 180  
Esther Elizabeth 95  
Esther Eudora Ezekiel 99, 169  
Cyril (b. 1901) 95  
Esther Solomons 95, 276

Ethel (b. 1906) 101  
Ethel (b. 1906) 103  
Ethel (dau. of Francis) 97  
Ethel Muriel (b. 1882) 95, 193  
Etienne Joucla Pelous 96  
Eudora Jane (b. 1854) 97  
Eudora M. (1843-1874) 98, 226  
Eugenia Murtella 226, 267, 312  
Eva Vineberg 95  
Ezekiel (1770-1843) 95, 100  
Fannie 101  
Fanny (b. 1874) 98  
Fanny (dau. of George) 272  
Fanny Augusta (b. 1844) 96  
Fanny Davis (see Hart, Frances (Fanny) Davis)  
Fanny Elizabeth Benjamin 19, 95  
Fanny Michaels David (see Hart, Frances (Fanny) Michaels David)  
Fleurette 174  
Florance (b. 1881) 97  
Florence (m. Charles Haim Pinto) 61  
Florence (1861-1862) 102  
Florence Grace (1848-1927) 97, 137  
Florence Stella (b. 1859) 99, 196  
Florrie 61  
Frances (Fanny) Davis 48, 272  
Frances (Fanny) Michaels David 46, 96  
Frances (1740-1820) 98, 267  
Frances (1807-1849) 96  
Frances Elizabeth 101  
Frances Horatia (b. 1811) 100  
Frances Isabel (1857-1942) 98  
Frances Lazarus (m. Ezekiel Hart) 95, 100  
Frances Lazarus (1850-1922) 95, 153  
Frances Noah 100, 232  
Francis Bret (1836-1902) 97  
Francis King 97  
Frederick 138  
Frederick L'Estrange (Levey) 96  
Frederick Levey (see Hart, Frederick L'Estrange (Levey))  
Geoffrey 332A  
George (b. 1860) 97  
George (b. 1900) 97  
George (d. 1883) 95  
George (m. Helen Little) 272  
George (1853-1904) 101  
George Ezekiel 95  
George Washington (b. 1819) 100  
Georgina E. B. (1861-1890) 97  
Gerald Ephraim (b. 1849) 95  
Gertrude (1867-1945) 101, 162  
Gladys Judith (b. 1890) 95  
Gordon David (b. 1904) 95  
Grace Isaacs 124  
Grace Maude 102  
Grace Rose (b. 1823) 97, 221  
Griswold (d. 1901) 97  
Gustave Adolphus (b. 1815) 100  
Guy Alexander ('Alec') 95  
Handel 97  
Hanel (see Hart, Hannah (Hanel))  
Hannah (b. 1822) 102, 170  
Hannah (b. 1849) 102  
Hannah (b. 1879) 97, 226  
Hannah (d. 1863) 103, 325A  
Hannah (Hanel) 98  
Hannah (m. Judah) 101  
Hannah (m. 1813) 58  
Hannah (m. 1830) 101  
Hannah Cecilia (b. 1820) 100  
Hannah Constance Halton 95, 96  
Hannah Hendricks 97, 111  
Hannah J. 102, 170, 312A  
Hannah Levy (1761-1850) 98, 309B  
Hannah Polock 252  
Harmon Hendricks (1851-1907) 97  
Harold 102  
Harold Harmon (b. 1885) 97  
Harold Harmon (b. 1916) 97  
Harriet (dau. of Ezekiel) 95



Harriet (m. William Wolff) 102  
Harriet Blanche 96  
Harriette (1813-1871) 297  
Harriette Morrison 102, 204  
Harriot Judith (b. 1786) 95, 96, 100  
Harriot Judith (b. 1852) 95, 96  
Harriot Judith Hart 95, 96, 100  
Harry J. 171  
Hart Moses (1764-1795) 97  
Helen (b. 1912) 97  
Helen Little 272  
Helen Vail 97  
Henri John 254, 312B  
Henrietta (dau. of Benjamin) 96  
Henrietta (dau. of Isaac) 103  
Henrietta (1804-1897) 99  
Henrietta (1843-1860) 98  
Henrietta (1860-1883) 101  
Henrietta Victor 101  
Henriette Brown 101  
Henry (b. 1873) 98  
Henry (d. 1842) 95  
Henry (see also Hart, Naphtali (Henry))  
Henry (son of Ezekiel) 95  
Henry (son of Henry) 97  
Henry (son of Michael) 272  
Henry (son of Rev. Judah) 101  
Henry (Zeby) (b. 1820) 165, 330A  
Henry (1797-1834) 97  
Henry (1800-1845) 97  
Henry (1817-1850) 97  
Henry (1845-1865) 98  
Henry (1852-1893) 97  
Henry IV 22  
Henry J. 102, 280  
Henry Joseph 276  
Henry N. (b. 1817) 96  
Henry S. (son of Abe) 311B  
Henry S. (1796-1841) 103, 325B  
Henry Sampson (1833-1839) 99  
Hermione (1849-1850) 97  
Hermione (1852-1857) 97  
Hester (see also Hart, Esther (Hester))  
Hester (Hamburg, Ger.) 97  
Hettie (dau. of Jacob) 103, 324B  
Hetty (dau. of Samuel) 103, 203, 325A, 333B  
Hetty (see also Hart, Esther (Hetty))  
Hetty Levy (see Hart, Esther (Hetty) Levy)  
Hetty Maria Gomez 85, 98, 99  
Hildegard Simon 311B  
Horace Beverly (1879-1948) 103  
Horace Beverly 101  
Hyam (son of Aaron) 99  
Hyam (1710-1738) 92  
Hyman M. (1805-1842) 103, 325A  
Hyman N. (1816-1859) 85, 98  
Hymoa (d. 1791) 98, 309B  
Ida (b. 1884) 101  
Ida (1869-1929) 98  
Ida Margolius 101  
Ida Samson 259  
Ida Schwartz 95  
Ilma (b. 1885) 98  
Imogene 272  
Ira James Henry Craig (1809-1883) 95  
Irma Jacobs 97, 135  
Isaac (b. 1763) 99  
Isaac (b. 1794) 103, 325A  
Isaac (b. 1814) 103  
Isaac (b. 1850) 102  
Isaac (d. 1780) 252  
Isaac M. 99  
Isabel (b. 1868) 98  
Isabel (dau. of Samuel) 103  
Isabel Lazarus 98, 99  
Isabella (b. 1854) 254, 312B  
Isabella (b. 1855) 102  
Isabella (dau. of Moses) 92  
Isabelle Lewis 171  
Israel (1852-1859) 98

Israel (1861-1891) 98, 163  
Israel Daniel 98, 163  
Ivan 138  
Jacob (d. 1784) 100, 154  
Jacob (Naphtali) (1746-1822) 98, 227  
Jacob (1781-1836) 98  
Jacob 103, 324B  
Jacob W. 103  
Jacqueline (b. 1900) 98  
Jacqueline Harby 98  
Jael 96  
Jael Julia (b. 1823) 100  
James (b. 1849) 102  
Jane (1795-1858) 99  
Jane (1816-1865) 98, 169  
Jane (1825-1895) 179  
Jane Smith 95  
Jane Warner (1851-1874) 98, 151  
Jessamy (d. 1906) 97  
Joan (b. 1918) 97  
Jochabed 92  
Joel (1784-1842) 100  
John (m. Bilbah Levy) 165  
John (1857-1858) 102  
John Alan 101  
John I. (son of Judah) 101, 102, 170  
John I. III (son of Joseph S.) 102  
John Isaac (1865-1907) 102  
John Stephen 22  
John, Jr. 22  
Jonathan (b. 1821) 97  
Joseph (son of Hart of Manheim) 38  
Joseph (1802-1817) 98  
Joseph (1813-1819) 97  
Joseph M. 168  
Joseph S. (ca. 1844-1912) 102, 185  
Josephine (1857-1942) 97  
Joshua (d. 1787) 98  
Joshua L. (1843-1901) 98, 129  
Judah 101  
Judah S. 102  
Judith (dau. of Naphtali) 92  
Judith (Julia) Veill 102, 204, 280  
Judith (1706-1803) 92  
Judith (1762-1844) 103, 243  
Julia (dau. of Ezekiel) 95  
Julia (see Hart, Yitlah (Julia))  
Julia Cohen 101  
Julia I. (d. 1880) 102  
Julia Veill (see Hart, Judith (Julia) Veill)  
Julian (b. 1894) 21  
Julian (b. 1907) 101  
Julian B. (b. 1894) 102  
Julian B. 102  
Julie Aimee Delia Eleonore Kleykowska 96  
June 95  
Kate 101  
Katie (b. 1865) 96  
Katy (see Hart, Catherine (Katy))  
'Lalla' (see Hart, Miriam Hadley ('Lalla'))  
Laura 102  
Laura Louise Levy 98, 163  
Lavinia Mariamne (b. 1813) 100  
Lawrence Ezra (b. 1906) 95  
Leah 103, 324B  
Leah Jackson Hertz 129  
Leah Marks 103, 185  
Leah Nathan 98, 227  
Leon (see Hart, Lyon (Leon))  
Leonora Levy 101, 162  
Levi Sheftall 267  
Levy (Hamburg) 97  
Levy (1792-1853) 267  
Lewis (b. 1846) 98  
Lewis 272  
Lewis Alexander (Leslie) (b. 1910) 95  
Lewis Alexander (1847-1923) 19, 95  
Lillian Constance (b. 1888) 97  
Loni 332A  
Louis Alexander (b. 1913) 101

Louisa (dau. of Alexander (Asher)) 95  
Louisa (dau. of Moses) 95  
Louisa Barnett (1803-1874) 103, 325A  
Louisa Elizabeth (m. ca. 1834) 103, 183, 310A, 325A  
Louisa Leven 100  
Louise Henning 102  
Louise Silverstone 95  
Love (b. 1762) 99  
Lucie J. 96  
Lulu Wells 95  
Lynn 332A  
Lyon (Leon) (1797-1869) 98  
Mabel Ruth (b. 1884) 95  
Madeline (b. 1865) 97, 310A  
Mae Woodall 101  
Mahettibel 99  
Margaret (dau. of Simeon) 103  
Margaret 97  
Margoles 92  
Marguerite (b. 1892) 97  
Maria 102  
Maria Levy 101, 102, 170  
Marie Blanchet 97  
Marie Leroy 272  
Marion Anspacher Klopfer 22  
Mary 324B  
Mary (dau. of Nathan) 35, 98  
Mary (m. S. K. Jones) 272  
Mary (see also Hart, Miriam (Mary))  
Mary (1871-1922) 98  
Mary 35, 102  
Mary Edith (Effie) 96  
Mary H. (m. S. Henry Dessau) 102  
Mary H. (1895-1896) 102  
Mary Jane Fisher 168  
Mary Keat Bradbury 96  
Mary Louise Coombs 97  
Mary McBee Mikell 333B  
Mary Thompson 103, 324B  
Matilda Maybin (d. 1871) 158  
Maude (b. 1872) 97, 310A  
May Sarah 102  
Menachem 97  
Michael (m. Marie Leroy) 272  
Michael (1738-1813/5) 103, 180, 185, 324B  
Michael (1802-1861) 272  
Michael G. 103  
Minkie (see Hart, Amelia (Minkie))  
Miriam (b. 1753) 100  
Miriam (b. 1772) 95  
Miriam (b. 1840) 35, 98  
Miriam (d. 1793) 99  
Miriam (dau. of Ezekiel) 95  
Miriam (m. Edward Syles) 101  
Miriam (m. Uriah) 95  
Miriam (Mary) (1792-1828) 99  
Miriam Hadley ('Lalla') (b. 1854) 95  
Miriam Judah 95, 141  
Miriam Levy 154  
Miriam Marks 102, 185  
Molcha (Molly) Rubenstein 95  
Molly Rubenstein (see Hart, Molcha (Molly) Rubenstein)  
Mordecai (b. 1791) 103, 325B  
Morris (b. 1845) 101  
Morris (b. 1877) 98  
Moses (b. 1748) 100  
Moses (b. 1783) 98  
Moses (d. bef. 1796) 97  
Moses (d. 1790) 92  
Moses (New York) 154  
Moses (son of Ezekiel) 95, 276  
Moses (son of Judah) 101  
Moses (The Hague) 98  
Moses (1676-1756) 92, 114  
Moses (1768-1852) 95, 142  
Moses 95, 142  
Moses A. 101  
Moses Alexander (b. 1841) 95  
Muriel Wilson 95  
Myer (1779-1779) 124

Myer 57, 103  
Myrtilla (b. 1885) 98  
Myrtilla Eudora (b. 1841) 99, 193  
Myrtilla Florence Jackson 98, 129  
Naphtali (d. 1829?) 92  
Naphtali (Henry) (1800-1832) 99, 213  
Naphtali (1716-1786) 99  
Naphtali (1768-) 321A  
Naphtali (1775-1828) 16, 103, 324B  
Natalie Seixas 95, 265  
Naphtali (see also Hamburger, Hartwig Moses; Hart, Jacob (Naphtali)); Moses, Hartwig (Hart, Naphtali))  
Nathan (b. 1849) 101  
Nathan (ca. 1784-1841) 98, 99  
Nathan (m. Grace Isaacs) 124  
Nathan (son of Isaac) 103  
Nathan (1797-1857) 98  
Nathan (1848-1897) 98  
Nathan Samuel (b. 1841) 98, 260  
Neville Gordon 181, 332A  
Nina (b. 1882) 98  
Norma Fraid 95  
Oliver James (1892-1978) 333B  
Olivia Gollibart 97  
Orobio 95  
Owen 96  
Patricia 61  
Patricia Anne 36  
Pauline Moses 101  
Percy 138  
Philip (1727-1796) 97  
Philip Beyfus 95  
Philip D. 102  
Philip Levy 97  
Philip W. 272  
Phineas A. 101, 166  
Phoebe David 46, 95  
Phoebe J. 102  
Phoebe M. 47, 102  
Phoebe Rosa (1807-1814) 97  
Priscilla (b. 1892) 98  
Priscilla Lopez 98, 176  
Priscilla Meyer 102  
Prudence Heilbuth 92, 114  
Rachel (d. 1930) 102, 192  
Rachel (dau. of Aaron) 99  
Rachel (m. 1750) 92  
Rachel (Ray) 102, 192  
Rachel (1790-1869) 98, 99  
Rachel (1795-1889) 98, 132  
Rachel (1800-1815) 103, 325A  
Rachel Cohen 99  
Rachel De Lyon 57, 103  
Rachel Georgina Henriques 97, 114  
Rachel Hart 98, 99  
Rachel Isaacs 92  
Rachel Levy 97  
Rachel Rosalie (1851-1881) 29, 98  
Rachel Shannan 101  
Rachel Solomons 276  
Ray (see Hart, Rachel (Ray))  
Rebecca (b. 1766) 99  
Rebecca (d. 1788) 98  
Rebecca (d. 1799) 103, 325A  
Rebecca (m. Simon Moses Jacobus) 92  
Rebecca (1768-1836) 103  
Rebecca (1791-1866) 98, 244, 245  
Rebecca B. Seixas 97, 266  
Rebecca Cohen Isaacs 99, 120  
Rebecca D. 103  
Rebecca Levy 101, 166  
Rebecca Seixas (b. 1870) 97, 310A  
Rebecca Tor(r)es Levy 305  
Reginald Joseph (b. 1882) 95  
Reinah (see Hart, Reyna (Reinah))  
Reuben (son of Moses) 95  
Reuben (1824-1825) 96  
Reyna (Reinah) 98  
Richard (1920-1925) 97  
Richard Bret (d. 1925) 97  
Richea 98, 263  
Rita (b. 1905) 95

Robert Augustus Baldwin 96  
Rosalie (1847-1909) 97, 221  
Rosalie (1883-1933) 29, 97  
Rosalie Cecile Levy 98, 163  
Rosalie Sober 272  
Rosalie Theodora 102  
Rosalinga Fracci 95  
Rosetta (dau. of Samuel Nathan) 98  
Rosetta (m. 1871) 50  
Roslyn Ezra (b. 1879) 95  
Sallie 101  
Sally 97  
Samuel (b. Manheim) 98  
Samuel (b. 1749) 100  
Samuel (b. 1773) 103  
Samuel (b. 1774) 95  
Samuel (b. 1798) 103, 325B  
Samuel (b. 1813) 97  
Samuel (d. 1795) 100  
Samuel (see also Hart, Arthur Wellington (Samuel))  
Samuel (son of Aaron) 99  
Samuel Becancour 95  
Samuel Judah (1789-1802) 95  
Samuel N. (1808-1880) 98, 99  
Samuel N., Jr. (1865-1917) 98  
Samuel, Sr. (1805-1896) 99, 169  
Sarah (b. 1765) 99  
Sarah (b. 1852) 95  
Sarah (1763-1823) 29, 103  
Sarah (1784-1831) 46, 95  
Sarah (1847-1889) 272  
Sarah Harline (b. 1842) 96  
Sarah Jane (dau. of Lewis Alexander) 95  
Sarah Jane Rowland 254, 312B  
Sarah Judah 95, 142  
Sarah Levy (1822-1871) 102  
Sarah Matilda David 46, 95  
Sarah Moses 99, 213  
Sarah Stork 99  
Selena Ezekiel 96  
Shankey (1766-1804) 98, 131  
Sheprah (Elizabeth) 99  
Sidney A. 103  
Sidney A. III 101  
Sidney A., Jr. 101  
Sidney Abram 101  
Simeon (b. 1851) 101  
Simeon (d. 1846) 103, 324B  
Simha Frances (1705-1754) 75, 92  
Simon (1814-1894) 100  
Simon Moses (1763-1840) 97  
Solomon (d. 1768) 92  
Solomon J. (b. 1817) 102  
Solomon Seligman (d. 1738) 92  
Sophia 102  
Sophia David (Dora) (1856-1907) 95  
Stanley David (b. 1905) 95, 310A  
Stella Benswanger 21  
Susan Maria Auldjo 96  
Susanna 92  
Sybil Heiman 22  
Sydney David 95  
Theodore (b. 1903) 97  
Theodore (1816-1891) 46, 96  
Theodore (1821-1872) 97  
Thomas 22  
Uriah (b. 1771) 95  
Vera Esther (b. 1913) 95  
Vere Collins 138  
Viola (1849-1896) 28  
Vivian Samuel (b. 1878) 95  
Walter Emanuel 101  
Walter, Jr. 101  
William B. (b. 1907) 95  
Yitlah (Julia) 101  
Zeby (see Hart, Henry (Zeby))  
Zipporah (m. Meir Waag(e)) 92, 302  
Zipporah (1789-1875) 98, 150  
Zipporah (1808-1891) 97  
**HART DE SHIRA (TEXIRA)**  
Myer (d. 1797) 57, 103

Rachel De Lyon 57, 103  
**HART OR HERZ**  
Samuel 100  
**HARTER**  
Muriel Nortbey 78  
Oswald Birley 78  
**HARTFORD**  
Mary 128  
**HARTIG**  
Benjamin George 23  
Howard 23  
Leslie Margaret 23  
Mary Wolf 23  
**HARTMAN**  
Barbara 48  
Margery Caroline 83  
**HARTI**  
Frances Dell 208  
**HARTITER**  
Anna Augusta 269  
**HARTUNG**  
Marie 327B  
**HARVEY**  
Annie Johnson 81  
Henry 81  
Henry, Jr. 81  
**HARWOOD**  
Alma Hendricks Isaacs 111, 325B  
Charles 111, 325B  
Charles, Jr. 111, 325B  
**HASKELL**  
Mary 194  
Mildred 119  
**HASLE**  
Lois 208  
**HASLEM**  
Isabel 29  
**HASPIEL**  
Elizabeth Lee Waldman 325A  
Joseph Berl 325A  
Sarah Judith (1987-) 325A  
**HASSELBACH**  
Arthur 130  
Blanche J. Jackson 130  
**HASSEN**  
David 220  
Hannah Myers 220  
**HAST**  
Abraham 21  
David G. 22  
Dorothea Elizabeth 22  
Elinor Goldsmith 21, 22  
Julian 21, 22  
Lawrence M. 22  
Stella Benswanger 21  
Sybil Heiman 22  
**HASTREITER**  
Dominic 252  
Eleanor Lorraine Lusber 252  
Mary Jane (b. 1923) 252  
Sue Eleanor (b. 1931) 252  
**HATCH**  
Bessie Vivian De Cordova Wallace 53  
Ira Aron 53  
James Michael 53  
Rita Marie Reiminger 53  
Truett Robert 53  
**HATCHETT**  
Trevia Jo 330B  
**HAUGHTON**  
Dorothy Rebecca Michaels 193  
James 193  
**HAUSEY**  
John Dunbar 199  
Julie Josephine Moise (b. 1897) 199  
Julie Josephine Moise (1920-1941) 199  
**HAVENS**  
Kate 126  
**HAVILAND**  
Adine A. 288  
**HAVRE**  
Hortense Goldsmith 301  
Sam 301

**HAWKINS**

Elizabeth 189

**HAWLEY**

Clara R. Noah 232  
 Rebecca Marka 332B  
 Richmond 332B  
 Sarah A. Moses 334A  
 W. Gray 232

**HAY**

Darleen Susan (1961-) 330A

**HAYNES**

Martha 308

**HAYS**

A. B. 325A

Aaron Burr (1800-1881) 105  
 Abigail (dau. of David) 104  
 Abigail (dau. of Jacob) 104, 106  
 Abigail Hays 104, 106  
 Abigail Levy 106, 169  
 Abigail Von Geldren 104  
 Abraham (see also Hays, Cadwallader Colden (Abraham))  
 Abraham (son of Michael (Jechiel)) 104, 325A  
 Abraham (1794-1877) 293  
 Adeline Rebecca (1815-1825) 106  
 Alexander M. (1839-1883) 105  
 Alice (b. 1868) 13  
 Amanda Fitzallen Myers 105  
 Andrew (son of Michael (Jechiel)) 104  
 Andrew (1742-1840) 46, 106  
 Andrew II (son of Moses Judah) 106, 325A  
 Anne KISSAM 105  
 Anne Maria Wright 106  
 Anne Zemansky 104  
 Annie (dau. of Jacob, Jr.) 105  
 Annie Bradford 106, 325A  
 Arthur Moore (b. & d. 1881) 105  
 Asher (b. 1775) 104  
 Asher (1760-1761) 106  
 Augusta 181  
 Austin 105  
 Barnard Gratz (1809-1810) 106  
 Baruch (Barrak) (d. 1845) 106  
 Baruch Isaac (b. 1819) 106  
 Basha (Bertha) (1737-1741) 104  
 Belle 293  
 Benjamin (son of Gilbert) 105  
 Benjamin (d. 1816) 104, 325A  
 Benjamin Etting (1779-1858) 104, 220  
 Benjamin Etting, Jr. (1838-1906) 104  
 Benjamin Franklin (1857-1938) 104  
 Benjamin J. (1796-1872) 105  
 Bertha (see Hays, Basha (Bertha))  
 Bertha Hexter 293  
 Bessie Rebecca (b. 1889) 104  
 Brandeie Abigail (Brandy) David 46, 106  
 Brandy David (see Hays, Brandeie Abigail (Brandy) David)  
 Brendel 293  
 Cadwallader Colden (Abraham) (1821-1830) 106  
 Carolyn 105  
 Carrie 13  
 Catharine (b. 1819) 105  
 Catherine (1776-1854) 104  
 Catherine (1780-1861) 106, 325A  
 Catherine Conroy (1776-1812) 105  
 Catherine Conroy (1815-1900) 105  
 Caty 104, 131, 262  
 Charity 325A  
 Charity (1722-1773) 7, 104  
 Charity (1732-1839) 104, 274  
 Charity (1740-1813) 33, 104  
 Charles Hammond (1858-1886) 105  
 Cora Florence (1870-1871) 104  
 Daniel P. 2d (b. 1917) 104  
 Daniel Peixotto (1854-1923) 104  
 David (d. 1778) 104, 190  
 David (son of Jacob) 105  
 David (1732-1812) 67, 104

David Solis (b. 1881/2) 104  
 David Solis (1820-1897) 104, 241, 325A  
 David Solis, Jr. (1863-1939) 104  
 De Witt Clinton (d. 1853) 105  
 De Witt Clinton (son of Charles) 105  
 De Witt Clinton (1818-1895) 105  
 Drucilla 105  
 Edith Maud McClellan 105  
 Edward St. John (d. 1914) 105  
 Edwin Daniel (b. 1884) 104  
 Elinor E. (1770-1858) 104  
 Elizabeth 325A  
 Elizabeth (dau. of Jacob) 105  
 Elizabeth (Lizzie) Thorman 293, 294  
 Elizabeth (m. L. K. Levy) 167  
 Elizabeth (1810-1895) 106  
 Elizabeth Elliott 106  
 Elizabeth Rosa (1803-1855) 106, 188  
 Ella 105  
 Ellen (dau. of Aaron Burr) 105  
 Ellen (1800-1855) 67, 106  
 Ellen Mathew 105  
 Ellen Quiggle 104  
 Emma Wood 106  
 Esther 325A  
 Esther (dau. of Benjamin) 104  
 Esther (Hetty Asser) Etting 67, 104  
 Esther (see also Hays, Yitlah (Esther))  
 Esther E. (dau. of Jacob) 105  
 Ethel Leontine (1890-1919) 105  
 Ethel Sanders 105  
 Eugene De Lancey (b. 1861) 105  
 Fannie (see Hays, Frances (Fannie))  
 Fannie (1794-1796) 106  
 Florence (b. 1882) 106  
 Florence Beatrice (1882-1904) 104  
 Frances (d. 1829) 31, 106  
 Frances (Fannie) 293, 294, 303  
 Frank (son of Moses Judah) 106, 325A  
 Frank (1841-1918) 106  
 Frank KISSAM (b. 1865) 105  
 George 106  
 George Davis (b. 1859) 104  
 Georgianna 105  
 Gilbert (son of Gilbert) 105  
 Gilbert (son of Jacob) 105  
 Gitlah (b. 1772) 106  
 Gitlah (see also Hays, Yitlah (Gitlah))  
 Grace 105  
 Grace Mears Levy 104, 154, 190  
 Grenville Arthur (1875-1876) 105  
 Hannah 325A  
 Hannah (b. 1768) 104, 220  
 Hannah (dau. of Jacob) 105  
 Hannah (1817-1890) 104  
 Harriet Hobey 105  
 Helen (b. 1891) 104  
 Helen Auerbach 104  
 Henrietta Minis (1838-1919) 106  
 Henry (1807-1874) 106  
 Hetty (d. ca. 1803) 104, 126  
 Hetty Adolphus 7, 104  
 Ida J. Preston 105  
 Irene 13  
 Isaac (d. 1765) 104, 106, 139  
 Isaac (1796-1879) 106, 194  
 Isaac Minis (1847-1925) 106  
 Isabel (b. 1886) 104  
 Jacob (d. 1874) 105  
 Jacob (d. 1760) 7, 104, 325A  
 Jacob (1768-ca. 1819) 106  
 Jacob (1772-1850) 104, 105  
 Jacob (1791-1801) 106  
 Jacob (1826-1888) 104  
 Jacob (1846-1857) 105  
 Jacob, Jr. (d. 1858) 105  
 James McClaane (b. 1848) 105  
 Jane (1803/4-1850) 106  
 Janet (m. 1907) 48  
 Jechiel (see Hays, Michael (Jechiel))  
 Jochabed (Josy) (d. 1808) 104, 251  
 John (b. 1768) 106

John Jacob (1766/70-1836) 106  
 Joseph 293  
 Joseph Gratz (1835-1890) 106  
 Joseph Lopez (1792-1834) 106  
 Josephine (b. 1884) 105  
 Josephine Morse 105  
 Josy (see Hays, Jochabed (Josy))  
 Judah (1703-1764) 104, 193  
 Judah (1770-1832) 104  
 Judith (1767-1804) 104, 217  
 Judith Peixotto (1881-1933) 104  
 Judith Salzedo Peixotto 104, 241  
 Elizabeth 325A  
 Julia Arnold 13  
 Julia Quiggle 106  
 Justine Randolph 104  
 Kate (b. 1842) 105  
 Katherine 105  
 Katherine Conroy 104, 105  
 Katherine F. Lauderback 105  
 Kaufman (1835-1916) 293, 294  
 Kitty (b. 1817) 106  
 Kitty (1784-1872) 106  
 Laura (dau. of Jacob) 105  
 Laura (dau. of William) 105  
 Lizzie Thorman (see Hays, Elizabeth (Lizzie) Thorman)  
 Louisa 105  
 Mabel Ray (b. 1886) 104  
 Malcha (see Hays, Reyna (Malcha))  
 Margaret (b. 1908) 104  
 Margaret (1887-1913) 105  
 Mary (d. 1914) 105  
 Mary (dau. of Edward St. John) 105  
 Mary (dau. of Frank) 105  
 Mary (1844-1910) 105  
 Mary Ann (b. & d. 1867) 105  
 Mary Ann Bechstein 105  
 Mary Ann Levy 106  
 Mary Catherine 105  
 Mary Cornelia (d. 1868) 105  
 Mary Elizabeth KISSAM 105  
 Mary Holmes 105  
 Mary J. Lauderback 105  
 Mary Louise Brouillet 106  
 Mary N. Sanders 105  
 Mary Post 104, 105  
 Mary Van Emburgh Moore 105  
 Maud (b. 1893) 104  
 May Jacobs 104  
 Meleg (Michael) 104  
 Meyer Judah (d. 1859) 106  
 Michael (b. 1750) 106  
 Michael (d. 1799) 104  
 Michael (Jechiel) (d. 1740) 104, 106  
 Michael (see also Hays, Meleg (Michael))  
 Michael 104  
 Michael Solomon 104, 106  
 Mildred Hammond (1887-1909) 105  
 Miriam Gratz (1798-1826) 106  
 Moses (son of Jacob) 104  
 Moses (son of Moses Judah) 106  
 Moses Erting (1789-1857) 104  
 Moses I. (son of Isaac) 106  
 Moses Judah (1789-1861) 106, 169, 325A  
 Moses Michael (1739-1805) 104, 217  
 Nathan 13  
 Nettie 293  
 Peter (d. 1798) 105  
 Phila (1738-1808) 104, 234  
 Philip Hoofsteter 106  
 Phoebe (1779-1841) 106, 300  
 Prudence 106  
 Rachel 325A  
 Rachel (d. 1768) 104  
 Rachel (1765-1848) 104, 220  
 Rachel (1782-1844) 106, 325A  
 Rachel (1826-1831) 106  
 Rachel Da Costa 106  
 Rachel Hershfield 104  
 Rachel Myers 104, 217  
 Rachel Peixotto (1861-1938) 104

Rebecca (1769-1802) 104  
 Rebecca (1812-1815) 106  
 Rebecca Judah 104, 106, 139  
 Rebecca Michaels 104, 193  
 Rebecca Touro (b. 1855) 104  
 Reyna (Malcha) (1743-1787) 104, 300  
 Reyna (1757-1835) 106  
 Richea Gratz 87, 106  
 Robert Griffith (1852-1859) 106  
 Rolinda (1864-1935) 293, 294  
 Ruth (b. 1896) 104  
 Ruth Friedman 104  
 Sally (see Hays, Sarah (Sally))  
 Sally Myers (see Hays, Sarah (Sally) Myers)  
 Samuel (son of Michael (Jechiel)) 104  
 Samuel (1764-1838) 87, 106  
 Sara Ann Minis 106, 194  
 Sarah (dau. of Aaron Burr) 105  
 Sarah (dau. of Gilbert) 105  
 Sarah (dau. of Jacob, Jr.) 105  
 Sarah (dau. of Judah) 104  
 Sarah (Sally) Myers 104, 220  
 Sarah (Sally) (1772-1832) 104, 217  
 Sarah (1755-1799) 106  
 Sarah Ann (1805-1894) 106, 200  
 Sarah Minis (b. 1873) 106  
 Sarah Minis (dau. of Isaac) 106  
 Sarah Pool Foreman 105  
 Sarah Rosalie (b. 1852) 104  
 Sloe (1779-1836) 104  
 Solomon (b. & d. 1775) 104  
 Solomon (b. 1770) 106  
 Solomon (d. 1780) 104, 106  
 Solomon 104  
 Theodore Minis (1840-1840) 106  
 Thomas 106  
 Thomas De Witt 105  
 Virginia 105  
 William Benjamin (b. 1876) 104  
 William Dewees (1836-1866) 106  
 William H., Jr. 105  
 William Henry (son of Jacob) 105  
 William Henry (1869-1918) 105  
 William J., Jr. (bro. of Austria) 105  
 William J., Jr. (bro. of Edward St. John) 105  
 William Jacob (son of Aaron Burr) 105  
 William Jacob (1813-1886) 105  
 Yitlah (Esther) (1774-1816) 106, 277  
 Yitlah (Gitlah) (b. 1778) 104  
 Zeppah, see Hays, Zipporah  
 Zipporah 104, 325A

**HAYWARD**

Frances Beat 332B  
 Phyllis June 199

**HAZELTINE**

Beryl 122  
 Robert 122  
 Virginia Leland Winn 122

**HEBERTON**

Ethel Crothers 80

**HEBRARD**

Alfred 168  
 Gertrude Fisher McCausland 168

**HECHT**

Ada Butler 325A  
 Alan 107  
 Anne (m. Leonard Broido) 107  
 Bertha (d. Inf.) 107  
 Blaache 107  
 Cecilia (1844-1902) 107, 108  
 Clara 109  
 David 107  
 Edgar 107  
 Edgar Jerome 107  
 Edgar, Jr. 107  
 Eliza 107  
 Florence Myers 107, 222  
 Franciska 107  
 Franziska Knothe 107  
 Gladys Marquis 107

Hattie Leterman 325A  
 Helen Cecilia (1897-1901) 325A  
 Helen Cecilia (1930-) 325A  
 Henrietta (see Hecht, Jettchen (Henrietta, Jane))  
 Ida 107  
 Ida Felicia Wooten 325A  
 Jacob 107  
 Jacqueline Lee (1935-) 325A  
 Jane (see Hecht, Jettchen (Henrietta, Jane))  
 Jeanette (m. 1919) 90  
 Jennie (dau. of Solomon) 107  
 Jennie (see Hecht, Virginia (Jennie))  
 Jerome Leterman (1900-1941) 325A  
 Jettchen (Henrietta, Jane) 107  
 Jill 107  
 Jonas 107  
 Joseph Benedict 107, 222  
 Joseph (1865-1919) 107, 325A  
 Joseph, Jr. (1907-1907) 325A  
 Judith (Julia) Monzheimer 109  
 Leigh (1882-1914) 325A  
 Leroy Cleveland 107  
 Lyla 107  
 Mabel Stern 107, 108  
 Maud Estelle 107  
 Mina 107  
 Miriam 109  
 Morton E. 108  
 Morton E., III 107  
 Morton E., Jr. 107  
 Morton Eugene 107, 108  
 Rachel Friedman 107, 325A  
 Sanna (Sanne) Moritz 107  
 Solomon 107, 325A  
 Sophie De Young 109  
 Susan 107  
 Virginia (Jennie) 107, 108  
 Virginia 107, 108

**HECKER**

Emma Franks 75  
 Henry Teusch 75

**HECKMAN**

Maud 320A

**HEDGES**

Mary (1720-1805) 126

**HEENAN**

Adah Theodore (Adah Isaacs) Menken 192

**HEGA**

Rachel Mendez (1781-1839/44) 280

**HEGGE**

Erna Lillian 236

**HEGWOOD**

Imogene 5

**HEIDELBERG**

Edward (see Hyde, Edward (Heidelberg))

**HEIDT**

Caroline E. Sheftall 267  
 William T. 267

**HEIL**

Johanna 236

**HEILBERT (HEILBUTH)**

Samuel 114

**HEILBRON**

Bernard 15  
 David 75, 109  
 Hannah (1787-1866) 109  
 Jonas (Jonathan) (1799-1808) 109  
 Jonathan (see Heilbron, Jonas (Jonathan))  
 Nancy (b. 1928) 15  
 Rachel Franks Salomon 75, 109, 257  
 Ronald (see Hilton, Ronald)  
 Ruth Hamburger 15  
 Sophie 257

**HEILBRONER**

Dora Teiser 174  
 Moses 174  
 Simona Morris 174

**HEILBRONNER**

Irmgard 61

**HEILBUT**

Handel 254

Joseph 254

**HEILBUTH**

Hendele (see Heilbuth, Hitechele (Hendele, Isabel))  
 Hitechele (Hendele, Isabel) 92  
 Isabel (see Heilbuth, Hitechele (Hendele, Isabel))  
 Prudence 92  
 Samuel (see Helbert, Samuel Heilbuth)

**HEILPRIN**

Eliezer 261

**HEIM**

Feist Emanuel, see Dyer, Leon  
 Philipp, see Dyer, John Maximilian

**HEIMAN**

Sybil 22

**HEINE**

Adolph Louis 148  
 Amelie Kohn 145  
 Armand 145  
 Arnoldyne 148  
 Catherine Levy 148  
 David Cohn 148  
 Goldie Williams 148  
 Isaac 145  
 Marie Alice 145  
 Marie Celeste Amelie Miltenberger 145  
 Michel 145

**HEINEMAN**

Abigail Irene (b. 1864) 109  
 Adelaide 109  
 Adelaide Bosen 109  
 Agnes 109  
 Arthur 109  
 Benjamin Warren 109  
 Cecil 109  
 Cecile 109  
 Cecilia G. (1855-1901) 19, 109  
 Celia 109  
 Charles Florian 109  
 Clarence (b. 1869) 109  
 David (1828-1909) 38, 109  
 Dorothy 109  
 Dorothy Heller 42  
 Edna 109  
 Ethel 109  
 Eugenia Florence (1869-1945) 109, 280  
 Florence 109  
 George Washington (b. 1867) 109  
 Gladys 109  
 Grace (b. 1868) 109  
 Grace (dau. of Walter) 109  
 Harold 109  
 Henry (b. 1863) 109  
 Herbert 109  
 Hiram 109  
 Ida (1861-1862) 109  
 Jacob 109  
 Mary 225  
 Ruth 109  
 Sarah Nathan Cohen 38, 109  
 Therese 109  
 Victor 109  
 Walter Raleigh (b. 1866) 109

**HEINEMANN**

Bertha 236, 237  
 Eva Plaut (see Heinemann, Hewe (Eva) Plaut)  
 Hewe (Eva) Plaut 237  
 Myer 237

**HEINMAN**

Sybil 22

**HEINSHTEIMER**

Duffie 307  
 Duffie Freiberg 307  
 Edward L. 307  
 Emma 307  
 Sally Freiberg 307

A

B

C

D

E

F

Stella 307  
**HEINSTEIN**  
 Matilda (b. 1841) 311A  
**HEISKELL**  
 Andrew 291  
 Marian Effie Sulzberger Dryfoos 291  
**HEITER**  
 Marie Louisa Nathans 230  
**HELBERT**  
 See also Goldschmidt  
 Behla 114  
 Elsworth (b. 1888) 84  
 George Kingman (b. 1882) 84  
 Grace De Vinne 84  
 Hannah 114  
 Hendele (Hitchbele, Isabella) (see Heilbuth, Hitchbele (Hendele, Isabel))  
 Isaac 114  
 Jacob 114  
 Moses 114  
 Philip 114  
 Prudence 92, 114  
 Rebecca 114  
 Samuel Heilbuth 114  
 Sarah (d. 1749) 114, 139  
 Theodore De Vinne (b. 1920) 84  
**HELBURN**  
 Hannah Peyser 281  
 Julius 281  
 Theresa 281  
**HELIGER**  
 Ida Sheftall Diaz Cook 270  
 Tom 270  
**HELLEBRAND**  
 John 72  
 Nancy Fleisher 72  
**HELLER**  
 Betty Davidow 104  
 Cecile (dau. of Max Heller) 186  
 Cecile L. (dau. of James Gutheim) 186  
 Claire J. 184  
 Dorothy 135  
 Edna 257  
 Edward M. 186  
 Helen Rauh Bettman 186  
 Howard Udell 104  
 Ida Marks 186  
 Isaac S. (b. 1893) 186  
 James Gutheim (b. 1892) 186  
 Jean Bettman 186  
 Joan E. 186  
 Max (1860-1929) 186  
 Mildred Harris 186  
 Rebecca 26  
 Ruth 186  
 Theo M. 186  
 William Eaplin (b. 1953) 104  
**HELLINGS**  
 Breilsford 58  
 Cyril 58  
 Daisy Heydenfeldt 58  
 Desirée 58  
 Edith 58  
 Grayson 58  
 Harold 58  
 Leila Heydenfeldt 58  
 Lloyd 58  
**HELLMAN**  
 Alice Stix Eiseman 286, 313B  
 Edna Hochstadter 83  
 Helen Schwab 187  
 Max B. (b. 1923) 313B  
 Milton 286, 313B  
 Nancy (b. 1919) 286  
 Richard Eiseman (b. 1920) 286  
**HELLSTERN**  
 Eileen 82  
**HELLWITZ**  
 Charlotte Oppenheim 235  
**HELMAN**  
 Samuel 261  
**HELMKEN**  
 John Cord, Jr. 269

Sarah Elizabeth Sheftall 269  
**HELSTEIN**  
 Flora Guggenheimer 91  
 Ira 91  
 Kathy 91  
 Lenore Gardner 91  
 Richard (son of Ira) 91  
 Richard (son of Richard) 91  
**HELTON**  
 Ruth Irene 53  
**HEMMINGS**  
 Ester 126  
 Julia Ann Isaacs 126  
**HEMPHILL**  
 Lucille Frances 238  
**HENDRICKS**  
 Aaron (b. 1772) 110  
 Aaron (d. 1771) 110  
 Abram 110  
 Adelaide Justina (1829-1902) 111, 298  
 Adele (b. & d. 1860) 110  
 Adele (b. 1849) 110  
 Agnes (1846-1899) 110, 305  
 Aileen 310  
 Albert (1848-1917) 110, 257  
 Alice (b. 1863) 13, 110  
 Alice (1838-1892) 26, 111  
 Alma 111, 124, 325B  
 Almeria De Leon Salomon 110, 257  
 Arthur David (b. 1897) 110  
 Arthur Tobias (1851-1902) 110  
 Beatrice (1862-1942) 110, 244  
 Beatrice Vera Newburger 110  
 Benedict 110  
 Bertram (b. 1878) 110  
 Blanche (1852-1915) 110, 111  
 Blanche Hendricks 110, 111  
 Brandon 111  
 Carol (b. 1925) 110  
 Catherine Gertrude (Kitty) David 46, 110  
 Cerinna (Selina) (1823-1888) 110  
 Chaim 110  
 Charles (1851-1924) 110, 257  
 Charlotte (1773-1849) 85, 110  
 Claudine Mildred (1893-1929) 110  
 Clifford 111  
 Clifford Brandon (1862-1901) 111  
 Constance (1843-1907) 111, 182  
 Dalia 110  
 Edgar (1842-1843) 110  
 Edgar (1857-1895) 111, 115  
 Edith (1848-1921) 111  
 Edmund A. (Edward) (1834-1909) 111  
 Edward (see Hendricks, Edmund A. (Edward))  
 Eleanor (Helen) (1837-1908) 110  
 Eliza Levy 159  
 Elmer (b. 1865) 110, 244  
 Emily Grace (1815-1879) 110, 226  
 Emily Isabelle (1850-1915) 6, 111  
 Emma (1830-1915) 111  
 Emma Brandon (1831-1906) 26, 111  
 Ernest 110  
 Esther (Hetty) (1775-1848) 110, 139  
 Esther Phillips 247, 338A  
 Ethel (b. 1884) 110  
 Eve Eather Gomez 85, 110  
 Fanny (b. 1883) 110, 151  
 Fanny (1847-1906) 111, 173  
 Fanny Tobias 110, 111, 297  
 Florian (b. 1867) 110  
 Frances Henrietta (1813-1817) 110  
 Frances Isaacs 110, 124  
 Frances Solomons Mayer 247, 277  
 Francis (1836-1912) 111  
 Francis Goddard (1871-1915) 46, 110  
 Frank Q. 46, 110  
 Guy 110  
 Hannah (dau. of Chaim) 110  
 Hannah (m. 1758) 110  
 Hannah (m. 1845) 167, 247, 338A  
 Hannah (1768-1839) 55, 110

Hannah (1817-1854) 97, 110  
 Hannah (1832-1834) 159  
 Harmon (man) (d. ca. 1769) 110  
 Harmon (1771-1838) 110, 124  
 Harmon (1838-1912) 110, 111  
 Harmon (1840-1841) 111  
 Harmon Washington (1846-1928) 111  
 Harriet Tobias 110, 297  
 Hava 110  
 Helen (see Hendricks, Eleanor (Helen))  
 Helen 110  
 Helen Eckman 110  
 Helen Ida (1843-1915) 111  
 Helen Myers 111  
 Henrietta (see Hendricks, Hetty (Henrietta))  
 Henrietta Luna (1827-1902) 111, 257  
 Henry (1804-1861) 110, 297  
 Henry Harmon (1859-1904) 74, 111  
 Henry Solomon (b. 1892) 111, 226, 325B  
 Hermoine (1825-1891) 110, 297, 314  
 Hetty (Henrietta) (1801-1865) 85, 110  
 Hetty (see also Hendricks, Esther (Hetty))  
 Hyam 110  
 Ida Whittemore 111  
 Irene Amelia (1846-1923) 110, 112  
 Isaac (b. 1870) 110  
 Isaac (m. Rachel Sampson) 247, 259  
 Isaac (Uriah A.) (1831-1887) 110  
 Isaac (1770-1848) 247, 338A  
 Joan (b. 1921) 111  
 Jochabed Sarah (1766-1821) 110  
 Joseph (b. 1837) 159  
 Joshua (1806-1808) 110  
 Joshua (1832-1893) 26, 111  
 Judith 110  
 Juliana (1834-1885) 110  
 Justina (1832-1906) 110, 115  
 Justina Brandy (Jessie) Isaacs 110, 124  
 Justina Brandy (1809-1823) 110  
 Lillian Henry 111, 115  
 Louisa Salomon 110, 257  
 Louise (b. 1894) 110  
 Lucien (1870-1872) 110  
 Mabel (1880-1883) 110  
 Madeleine (1845-1915) 111  
 Marion 111  
 Marjorie Randall 111  
 Matilda 110  
 Maude Atwell 111  
 Maude Harris 110  
 Mildred (1893-1895) 110  
 Mildred Schwartz 110  
 Miriam (1843-1929) 110, 226  
 Montague M. (1811-1884) 110, 226  
 Montague Naphtali (b. 1893) 110  
 Mordecai Gomez (b. 1769) 110  
 Mortimer M. (1837-1912) 110, 124  
 Myrtila Florance 74, 111  
 Nathan 110  
 Rachel (see Hendricks, Richa (Rachel))  
 Rachel Sampson 247, 259  
 Rachel Seixas Nathan 110, 226  
 Rebecca Eve (1764-1829) 110, 159  
 Rebecca Lopez 110, 175  
 Richa (Rachel) (b. 1763) 86, 110  
 Rosalie (b. 1891) 111  
 Rosalie (1840-1923) 10, 110  
 Rosalie Eliza (1842-1881) 111, 272  
 Rosalie Gomez Nathan 111, 226  
 Roselane (1820-1840) 110, 297  
 Rosina 167, 247  
 Rosy 110  
 Rowena (b. 1861) 110  
 Rowena (dau. of Florian) 110  
 Ruth (b. 1921) 111, 325B  
 Sally Solis (b. 1924) 111, 325B  
 Sarah (1840-1924) 74, 110

Sarah Wolff 159  
 Selina (see Hendricks, Cerinna (Selina))  
 Solomon (see Hendricks, Solomon)  
 Sophia Phillips 110, 244  
 Uriah (1737-1798) 110, 175  
 Uriah (1802-1869) 110, 111, 297  
 Uriah A. (see Hendricks, Isaac (Uriah A.))  
 Vera 110  
 Walter (1859-1868) 110  
 Washington (1807-1841) 110  
 Washington (1841-1848) 110  
**HENDRIES**  
 Ida Stuart 82  
**HENKEL**  
 Elmer 328A  
 Lenore Dilworth 328A  
 Martha Jane 328A  
**HENLY**  
 Linda 327B  
**HENNECART**  
 Ellen Dorothy Bach Saunders Perry 13  
**HENNEKINS**  
 Frederick William 253  
 Stella Benvenida Ritterband 253  
**HENNESSEY**  
 Patricia 163  
**HENNIG**  
 Helen Kohn 84  
 Julius Henry 84  
**HENNING**  
 Hans 118  
 Helen Kohn 84  
 Irene K. 84  
 Jacqueline Haller 118  
 Julius H., Jr. 84  
 Julius Henry 84  
 \*Moyra Blanche May Diana Ponsoy 118  
 Moyra Christine 118  
 Peter Ronald 118  
**HENRICKS**  
 Anna 247  
 Benjamin 329B  
 Benjamin Franklin (ca. 1828-1910) 247, 277  
 Carter 247  
 Eather Phillips 247  
 Fanny 159, 329B  
 Frances Levine 247  
 Franklin 247  
 Hannah 167, 247  
 Henry 247  
 Isaac (Augusta, Ga.) 247  
 Isaac (Texas) 247, 259  
 Jacob (d. ca. 1854) 247  
 Jacob (son of Benjamin Franklin) 247  
 Kate 247  
 Maude (1865-1950) 247  
 Meriam 159, 329B  
 Nellie 247  
 Rachel Sampson 247, 259  
 Rosina 167, 247  
 Solomon 159, 329B  
 Zipporah (1860-1937) 247  
**HENRIQUES**  
 Aaron (son of Abraham Bernal) 114  
 Aaron 113  
 Aaron J. (1816-1896) 112, 113  
 Aaron N. 241, 338A  
 Abigail (dau. of Benjamin) 113  
 Abigail (London) 112  
 Abigail (1811-1886) 112  
 Abigail (1814-1880) 113, 114, 310B  
 Abigail De Leon 55, 112  
 Abigail Henriques (m. Ebenezer) 112  
 Abigail Henriques (m. George) 113, 114, 310B  
 Abigail Mesquita 112, 113  
 Abigail Quixano 112  
 Abaer 112  
 Abraham (son of Benjamin) 113

Abraham (son of Joseph) 112  
 Abraham (son of Moses) 112  
 Abraham Alexander (b. 1845) 114  
 Abraham Bernal 114  
 Abraham Gomez (1708-1762) 302  
 Abraham Pretto 171  
 Abraham Quixano 112  
 Adam Q. (b. 1914) 297  
 Adelaide (b. 1850) 114  
 Albert (1847-1914) 114  
 Albert Washington (1831-1894) 113  
 Alexander (1822-1845) 113  
 Alexander Florian (1818-1889) 114, 310A, 310B  
 Alexander Florian III (b. 1895) 310A  
 Alexander Florian, Jr. (1861-1929) 310A  
 Alexander M. 114  
 Alfred (son of Joseph Augustus) 112  
 Alfred (son of Joseph G.) 112  
 Alfred Augustus 112  
 Alice Barlow 310A  
 Alice Oakley 113  
 Alice Rose Lucas 112  
 Amanda (b. 1835) 114  
 Amos 113  
 Anita O'Beirne 310A  
 Anna (w. of Charles) 310A  
 Anne 297  
 Annie (m. 1875) 310B  
 Arthur 113  
 Arthur Q. 112  
 Barbara (b. 1932) 310A  
 Beatrice Julia 261  
 Beatrice Rachel 246  
 Benjamin (son of Abraham Bernal) 114  
 Benjamin (son of Moses) 112, 113  
 Carlota (b. 1935) 310A  
 Carlota Emerson (m. 1930) 310A  
 Charles (1864-1911) 310A  
 Charles Ransom (1891-1938) 310A  
 Charles Theodore (b. 1878) 113  
 Charlotte 113  
 Charlotte K. Werner 114  
 Clarence Augustus 112  
 Clarence I. 110, 112  
 Claude Augustus 112  
 Constancia de Jacob Henriques De Souza 19  
 Cordelia 113  
 David (Curacao) 241  
 David (son of Abraham Bernal) 114  
 David (son of Abraham Quixano) 112  
 David (son of Moses) 113  
 David (1844-1878) 114  
 David Israel (1783-1859) 112, 113  
 David M. 114  
 David Mendes (b. 1834) 112  
 David Q. 112  
 Decima Adeline (b. 1829) 113, 325B  
 Diana 310A  
 Dorothy Rebecca 310A  
 Ebenezer 112  
 Edgar (b. 1864) 113  
 Edmund 113  
 Edward (b. 1838) 113  
 Edward (1839-1911) 112  
 Edward (1852-1938) 114  
 Edward Cutler 112  
 Elias (London) 19  
 Elias (dau. of Benjamin) 263  
 Elias De Jacob 19  
 Eliza 112  
 Eliza Bravo 112  
 Eliza de David Nunes 114  
 Eliza Victoria (b. 1834) 113, 171  
 Elizabeth 310A  
 Elizabeth Coben 112, 113  
 Elizabeth Harding Booth 310A  
 Elizabeth Whaley 112  
 Ella (1864-1881) 112  
 Emanuel Martinez 112

Emily (dau. of Edward) 112  
 Emily (1836-1914) 112, 221  
 Emily Watson 310  
 Estelle (1870-1923) 112  
 Esther (b. 1836) 114  
 Esther de Samuel Lopes 240  
 Esther Levy Maduro 241  
 Esther Nunes (1792-1864) 112, 113  
 Esther Nunes Henriques 112, 113  
 Ethel Tobias 297  
 Eudora (b. 1828) 113, 325B  
 Eudora (1874-1877) 113  
 Eugene (b. 1866) 113  
 Eugenia (1824-1863) 113  
 Eugenie 113  
 Euphemia (b. 1828) 112  
 Eureka Otera 112  
 Florence Corinna (b. 1854) 114  
 Florinda Montgomery 112  
 Francis (1828-1889) 310B  
 Frederick 112  
 Frederick A. 112  
 Frederick Lester 112  
 George (1811-1873) 113, 114  
 George M. 113, 114, 310B  
 George Washington (1842-1890) 114, 310B  
 Gladys 112  
 Gloria (b. 1940) 310A  
 Gloria Ros 310A  
 Hannah (m. 1835) 19  
 Harriet Cutler 112  
 Harriet Dagget Hunt 112  
 Harry Percy (1868-1930) 310A  
 Harry Percy III (b. 1927) 310A  
 Harry Percy, Jr. (b. 1904) 310A  
 Henry Alphonso (b. 1861) 113  
 Herbert De Leon (1860-1893) 113  
 Hersilia (dau. of Frederick) 112  
 Hersilia (1846-1860) 112  
 Horatio (b. 1826) 113  
 Iona Lauretta (b. 1876) 113  
 Irene 112  
 Irene Amelia Hendricks 110, 112  
 Irene Augusta 112  
 Isaac 112  
 Jacob (d. 1758) 112  
 Jacob (m. 1804) 114  
 Jacob (son of Abraham Quixano) 112  
 Jacob B. (b. 1763) 112  
 Jacob M. (1806-1854) 114  
 Jacob Nunes 112  
 Jael Valverde (1715-1769) 302  
 James Emanuel 112  
 Jeffrey B., Jr. (b. 1934) 310A  
 Jeffrey Barlow (b. 1908) 310A  
 Jessie Hunt (dau. of Emanuel & Harriet) 112  
 Joseph (son of Benjamin) 113  
 Joseph (1777-1868) 55, 112  
 Joseph Augustus 112, 178  
 Joseph Gutierrez 112  
 Joseph M. 114  
 Josephine Luna (1836-1856) 113, 305  
 Judith (b. 1940) 310A  
 Judith Delvalle 178  
 Julia V. 114  
 Justine (1837-1839) 114  
 Kalani Davis 113  
 Katherine Loeber 310A  
 Laurence B., Jr. (b. 1944) 310A  
 Laurence Barlow (b. 1906) 310A  
 Lavina 114  
 Leah 112  
 Leah de Elias Jesurun 61  
 Leah De Leon 112  
 Leah de Selomoh Cohen 62  
 Leah Lemira 112  
 Leah Quixano 112  
 Leon (b. 1866) 112  
 Leonora Felicia (b. 1857) 114  
 Lila 310B  
 Lillian Marrow 113

Lorenzo Joseph (b. 1868) 113  
 Lorraine 11.  
 Louisa 112  
 Louisa Leah Lopez 112, 178  
 Louise Augusta 112  
 Luna de Aaron N. 241, 338A  
 Lunah Berlandina 19  
 Marie Louise 310B  
 Marjorie Rera 310A  
 Marlene Utz 310A  
 Mary Ann Adah (1840-1841) 114  
 Medora (b. 1849) 114  
 Michael Q. 297  
 Moses (b. 1740) 113  
 Moses (b. 1809) 112, 240  
 Moses (son of Abraham Bernal) 114  
 Moses (son of Abraham Quixano) 112  
 Moses (son of Benjamin) 113  
 Moses (1784-1857) 114  
 Moses (1815-1891) 113  
 Moses Joseph 112, 240  
 Nathaniel 113  
 Nina Louise (b. 1862) 113  
 Noel (b. 1932) 310A  
 Norma Bonville 310A  
 Peter Ros (b. 1937) 310A  
 Philip Joseph Gotterez 246  
 Prescott (d. 1976) 310A  
 Quentin Quixano 297  
 Rachel (dau. of Benjamin) 113  
 Rachel (dau. of Moses) 112  
 Rachel (m. 1727) 114  
 Rachel De Menaaseh Jesurun 178  
 Rachel Georgina (1838-1909) 97, 114  
 Rachel Levy 171  
 Rachel M. 114  
 Rachel Sylvera 114  
 Rebecca (dau. of David) 113  
 Rebecca (dau. of Emanuel) 112  
 Rebecca (dau. of Moses) 112  
 Rebecca Henriques 113  
 Rebecca Josephine (b. 1839) 114, 310A, 310B  
 Rebecca Josephine Henriques 310A  
 Rebecca Lindo (1871-1876) 113  
 Rebecca Lucas 112  
 Sarah (dau. of Abraham Bernal) 114  
 Sarah (dau. of Abraham Quixano) 112  
 Sarah (dau. of Moses) 112  
 Sarah (m. Moses) 114  
 Sarah (m. 1806) 19  
 Sarah Gutteres (dau. of Emanuel) 112  
 Sarah Gutteres (m. Jacob B. Henriques) 112  
 Sarah M. 114  
 Sarah Mendez 112  
 Sarah Palache 112, 240  
 Sarah Russ 112  
 Sarah Seixas 263  
 Susan Atwater 112  
 Susan Housener 114  
 Sylvia Dorothy Green 297  
 Valentine Lawrence 113  
 Viola 112  
 William (1831-1914) 310B  
 Zitella (b. 1869) 113  
 Zitella De La Motta 113

**HENRIQUES DE SOUZA**  
 See De Souza

**HENRIQUEZ**  
 Abigail C. 59  
 Abigail de Daniel Cohen 62  
 Jeudah de David Cohen 178  
 Jobebed Moreno 178  
 Leah C. 59  
 Leah Cohen 59  
 Leah Jessurun 59

**HENRY**  
 Alexander (1791-1832) 115  
 Alexander (1825-1911) 115  
 Alfred 115  
 Alice 115  
 Alice Belknap 325B

Alice Ellen (1906-) 325B  
 Amelia (see also Henry, (Ann) Amelia)  
 Amelia Isaacs 115  
 Ann (see Henry, (Ann) Amelia)  
 (Ann) Amelia (1750-1825) 115  
 Anna Myers 114, 216  
 Annie McKee 325B  
 Arthur Richard 115  
 Barbara Whitney 325B  
 Barklie McKee (1902-) 325B  
 Bamed (Bernard) 114  
 Bernard (see Henry, Bamed (Bernard))  
 Bernard, Jr. 114, 325B  
 Betty 115  
 Bilhah Lindo 115  
 Catherine (d. 1812) 115  
 Charles 115  
 Charles Israel (1857-1923) 115, 194  
 Cordelia 115  
 Cyril Alfred 115  
 David 87  
 Denah 115  
 Dorothy 115  
 Dorothy Danzinger 115  
 Edward (Elias) 115  
 Edward 115  
 Elias (see Henry, Edward (Elias))  
 Eliza 115  
 Eliza Andrews 115  
 Elizabeth 115  
 Emily (dau. of Richard Loew) 115  
 Emily (m. Charles Harvey Palairet) 279  
 Emma C. 114  
 Emma Lyon 115  
 Esther (1787-1823) 115  
 Esther Lindo 115  
 Esther Lucile Eadra 115  
 Flora (1837-1898) 115  
 Flora A. (b. 1838) 33  
 Florence (b. 1864) 115  
 Floretta 115  
 Freda Joseph ("Jean Woods") 115  
 Frederick William 115  
 Frumatt 87  
 George 115  
 Gertrude Vanderbilt Whitney 325B  
 Gitel 87  
 Harold S. 325B  
 Harriet 115  
 Helen 114  
 Helen Maude (b. 1860) 115  
 Henry Solomon (1826-1890) 110, 115  
 Hirsch 87  
 Isaac (1785-1843) 115, 216  
 Isabelle (b. 1863) 115  
 Jack 87  
 Jacob (b. 1782) 114, 216  
 Jacob (d. 1761) 87  
 Jacob (Koppel) 87  
 Jacob (son of Joel) 115  
 Jacob P. 114, 216  
 Jane Caroline (d. 1842) 115  
 Jemima Lindo 60, 115  
 Jessie Kisch 115  
 Joel (d. 1830) 115  
 Joel 115  
 Jonathan 87  
 Joseph Joachim (1763-1793) 87  
 Judah 115  
 Judith (Gitel) Gratz 87  
 Julia 115  
 Justina Hendricks 110, 115  
 Koppel (see Henry, Jacob (Koppel))  
 Lavinia Florence Minis 115, 194  
 Lavinia Minis (dau. of Charles I.) 115  
 Leib 87  
 Lillian (1858-1925) 111, 115  
 Lucy 115  
 Lyon 114, 252  
 Mabel Amelia (b. 1870) 115, 194  
 Margaret C. Trowbridge Griggs 325B  
 Margot 115

Marie (Marian) Myers 114, 216  
 Mary Faris Pancoast Conaway 325B  
 Mary Miller Jackson 114  
 Mary Regina 114  
 Meta Howlett 115  
 Michael (b. 1885) 115  
 Michael (1830-1875) 115  
 Michael Leon 115  
 Morton J. (1869-) 325A  
 Morton Pearson 114, 325B  
 Moses (d. 1763) 87  
 Pauline E. Van Der Kamp 325B  
 Philip 87  
 Philip Jacob (1808-1842) 115  
 Philip Minis (1789-1799) 114  
 Rebecca 115  
 Rebecca A. Morison 325A  
 Rebecca Georgina 115  
 Rebecca Lyon 115  
 Richard Loew 115  
 Richard M. 325B  
 David 87  
 Rosetta 115  
 Samuel (son of Jacob (Koppel)) 87  
 Samuel (son of Jacob) 115  
 Saphiro 115  
 Sarah 115  
 Sarah Lindo 115  
 Sarah Polock 114, 252  
 Simeon Alexander (1836-1906) 115  
 Solomon (England) 87  
 Susan Aurora 114  
 Theresa (Tracey) 87  
 Tracey (see Henry, Theresa (Tracey))  
 Valery 115  
 William Barklie II 325B  
 William Barklie (1867-1930) 325B  
 Zevi Hirsch Bloch 87

**HENRY (ABRAHAMS)**  
 Israel (1796-1858) 216

**HEPPNER**  
 Brian Rice (1978-) 331B  
 Catherine Johnston (1973-) 331B  
 Donald Frank 331B  
 Eleanor Lopez (1976-) 331B  
 Marcella Rice Lopez 331B

**HERBERT**  
 Allen 124  
 Barbara Gay 124  
 Dorothy Isaacs 124

**HERCHINGER**  
 Fannie 46

**HEREFORD**  
 Julia Josephine 199

**HERMAN**  
 Allen 247  
 Alma Baer 48  
 Andrew M. 340B  
 Arthur N. 247  
 Benjamin 295  
 Carolyn Mindel 340B  
 Charlotte Hibshman 340A  
 Clarice 293  
 Dolores Davis 340A  
 Elizabeth 48  
 Essie Kolin (see Herman, Jacqueline (Essie) Kolin)  
 Esther (Hester) Tim 295, 340A  
 Esther Virginia Ezekiel 69  
 Ethel 295  
 Ethel 296  
 Fanny 295  
 H. 247  
 Hester Tim (see Herman, Esther (Hester) Tim)  
 Isaac 69  
 Jacqueline (Essie) Kolin 296  
 James G. (1936-) 340B  
 John A. (m. Marjorie Kiam) 296  
 John A., Jr. 296  
 John Edward 340B  
 Justin 48  
 Justine Baer 48

L. Robert (1932-) 340A  
 Lillian (Lilly) B. Cohen 295  
 Lillian Garson 340A  
 Lily B. Cohen (see Herman, Lillian (Lily) B. Cohen)  
 Louis (son of Moses) 295, 340A  
 Louis Garson (1906-) 340A  
 Mammie Day 295  
 Marjorie Kiam 296  
 Mary Jane (b. 1938) 296  
 Moses 295, 340A  
 Pamela Sue 340A  
 Richard 247  
 Richard D. 340A  
 Seymour (1856-1914) 295  
 Sophie 14  
 Stephen James 340B  
 Sue Reid Solomon  
 Tom Michael 340A

**HERMANN**  
 Adele Longer 116  
 Alice 116  
 Beatrice Gazan 295  
 Esther (Essie) (1879-1886) 296  
 Eugenie De Buys Tricou 116  
 Fanny (1874-1962) 295  
 Henrietta Tim (1850-1918) 295  
 Hilda (b. 1889) 295  
 Louis Florian 116  
 Louise 116  
 Lucien 116  
 Marie Emeronthe Brou 116  
 Marie Virginia 116  
 Max (1844-1927) 295  
 Samuel (1777/8-1853) 116  
 Samuel Edmond (Samuel, Jr.) 116  
 Samuel, Jr. (see Hermann, Samuel Edmond (Samuel, Jr.))  
 Seymour (d. 1949) 295  
 Stanford (b. 1913) 295  
 Stanford, Jr. 295  
 Suzanne 295  
 Sylvia Klanfeld 295

**HERNE**  
 Clarence H. 311A  
 Lucille Dorothy 211  
 Marjorie Henriette 311A  
 Violet Frances Leman 311A

**HEROY**  
 Frank M., Jr. (b. 1927) 257  
 Frank Melville 257  
 Mildred Virginia Billett 257  
 Patricia Ann (b. 1932) 257

**HERRICK**  
 Helen Isaacs Wurzbarger Joseph 127, 326A  
 Loek Van Dyl 326A  
 Michael 127, 326A  
 Snowden 127, 326A  
 Susan Rebecca (1978-) 326A

**HERRING**  
 Marline 290

**HERRMAN**  
 Cynthia 287

**HERRMANN**  
 Emma 229

**HERRNSTADT**  
 Gerald E. 46  
 Gertrude Virginia Graff 46

**HERRON**  
 Barbara 309A

**HERSCH**  
 Helen Virginia Davis 48  
 Lee Freeman 48

**HERSHFELD**  
 Sylvia Berdie 244

**HERSHFIELD**  
 Aaron 104  
 Rachel 104

**HERTS**  
 Sophie R. 170

**HERTY**  
 Dorothea 194

**HERTZ**  
 Adele Mathewes 117  
 Albert Eger 117  
 Albert Eger, Jr. (b. 1855) 117  
 Alexander (1774-1822) 117  
 Catherine R. 117  
 Daniel 117  
 Edna E. Bonnoitt 117  
 Edward (1834-1867) 129  
 Edwin Eger 36, 117  
 Edwina E. 117  
 Emma Eger (dau. of Isaac) 117  
 Emma Eger (1817-1832) 117  
 Esther Peixotto 240  
 Frances Maria (1864-1945) 117  
 Frances Shefall (b. 1856) 117  
 Frances Shefall Cohen 36, 117  
 Frederick Eger (1829-1868) 36, 117  
 Goodwin Eger (1863-1885) 117  
 Handel Moses (1778-1840) 117  
 Harriet M. 117  
 Harry 117  
 Hayman (son of Solomon) 159  
 Hester Eger 117  
 Hyman 117  
 Isaac C. 117  
 Isaac Eger (b. 1859) 117  
 Isaac Eger (1812-1877) 36, 117  
 Isabella (1769-1824) 117  
 Jacob (b. 1860) 117  
 Jessie 117  
 Jessy (Simha) Judah Andrews 12, 117, 139  
 John Anderson (1856-1926) 117  
 Joseph 117  
 Julia 117  
 Laura E. Bonnoitt 117  
 Leah Jackson 129  
 Lewis (m. 1839) 240  
 Louisa E. Jenkins 117  
 Maria S. Solana 117  
 Mary (1858-1939) 117  
 Matthew Solana (son of Albert Eger, Jr.) 117  
 Matthew Solana (1862-1927) 117  
 Nellie 117  
 Nellie Shefall Cohen 36, 117  
 Nelly Cohen (b. 1857) 117  
 Rachel 117  
 Rebecca C. 117  
 Rebecca Mordecai 117, 200  
 Rebecca S. 117  
 Rebecca S. Cohen 36, 117  
 Reyna 159  
 Richa (Rischa) Levy Moses 159  
 Sarah N. (1804-1865) 117, 231  
 Solomon 159  
 Thaddeus Eger (1832-1880) 117  
 Theodore (1816-1894) 117, 139

**HERTZ (BOERHART)**  
 Jacob (ca. 1776-1846) 117, 200

**HERTZBERG**  
 Dagmar 141  
 Dorothea 141  
 Dorothy Hope 141  
 Peder 141

**HERTZFELD**  
 Harriet Morange 192

**HERZ**  
 Caroline 130  
 David Wolff 235  
 Dora 107  
 Marcus Samson 235  
 Mathilde Oppenheim 235  
 Samuel (see Hart or Herz, Samuel)  
 Sarah Oppenheim 235

**HERZBERG**  
 Adrienne 125  
 Benjamin Lewis 125  
 Bessie 229, 335A  
 Beth Lynn 125  
 Blanche Krauskopf 229, 334B  
 Caroline 143, 327A

Fanny (1863-1929) 51  
 Harry (1866-1947) 229, 334B  
 Hettie Krauskopf 229  
 Mildred Esther Clara Cohn 125  
 Robert 125  
 Roberta Falk 125  
 Stephen 125  
 Susan 125

**HERZOG**  
 Abraham (b. 1852) 116, 310  
 Anton (1830-1876) 116  
 Belle Adler (b. 1859) 291  
 Joseph 291  
 Katherine (1820-1890) 116, 310B  
 Rosalie 116  
 Rose 291  
 Rosetta 116

**HESS**  
 Annie Wilkinson 260  
 Bertha (d. 1921) 21  
 Carrie 135  
 Charles Henry 260  
 Constance Emily Hoult 260  
 Edith Gollin 260  
 Emma Nathan (m. 1854) 260, 308  
 Esther 260  
 Fanny (dau. of Samuel) 260  
 Fanny (m. May 4, 1847) 260  
 Fanny Gollin 260  
 Flora Miriam 260  
 George Ralph 260  
 Henry (b. 1799) 260  
 Henry (1818-1864) 260, 308  
 Ida 147  
 Israel 260  
 John Arthur 12  
 Joseph (m. Fanny Gollin) 260, 308  
 Joseph (1793-1853) 260, 308  
 Judith Samuel 260  
 Louisa E. Jenkins 117  
 Kate 260  
 Leonard Orel 260  
 Levi 323A  
 Marcus 320B  
 Mary Ellen Andrews 12  
 Mary Ellen Zellner 12  
 Miriam (Polly) 260  
 Miriam 260  
 Miriam Arnold 320B  
 Pamela Anne 12  
 Pauline (1843-1907) 323A  
 Percy Phineas 260  
 Polly (see Hess, Miriam (Polly))  
 Rachel 260  
 Ralph 260  
 Richard A. 12  
 Robert Alan 12  
 Rosetta Samuel 260  
 Samuel (m. 1792) 260  
 Samuel (son of Israel) 260  
 Samuel Yates (m. 1854) 260  
 Sarah (b. July 11, 1803) 260  
 Sarah Yates 260, 308  
 Saul 260  
 Sophia 260  
 Sophie Matilda 260  
 Therese 323A  
 Winifred 260

**HESSE**  
 Emily Samuel 260  
 Max 260

**HESSELEIN**  
 Stella De Jonge 296

**HEUSTIS**  
 James Fountain 183  
 "Lala" Lyons (see Heustis, Rachel ("Lala") Lyons)  
 Patty 183  
 Rachel ("Lala") Lyons 183

**HEWING**  
 Ada Chamberlain 335B  
 Ada (1914-1968) 335B  
 Alvin N., III (1942-) 335B

Alvin N., Jr. (1909-) 335B  
Alvin Nones (1880-1949) 335B  
Ann 335B  
Catherine Peregoy 335B  
Cynthia Carol (1974-) 335B  
Doris (1920-) 335B  
Dorothy Guntrund 335B  
George Thomas (1852-1922) 335B  
Isabella D. Nones 335B  
Nancy (1947-) 335B  
Roseann Chart 335B  
Shani 335B  
Sharron Deem 335B  
Susan Carol (1944-) 335B  
Virginia (1939-1945) 335B  
William B., Jr. (1947-) 335B  
William Banks (1915-) 335B  
**HEWITT**  
Floride 155  
Floride Louisa Hunt 155  
H. Kent 155  
**HEXTER**  
Bertha 293  
Henrietta Semon 313B  
Levi (1833-1909) 313B  
Mary 313B  
Rose 313B  
**HEYCOCK**  
Henrietta Norah Faudel 246  
Percy 246  
**HEYDENFELDT**  
Angelique (1824-1896) 58, 167  
Daisy 58  
Desirée 58  
Edwin 58  
Elcan (b. 1821) 58  
Elizabeth Howard 58  
Ella 58  
Eather Desirée De Pass 58  
Evelyn 58  
Evelyn Faithcloth 58  
Frederick 58  
Grace 58  
Grace Bonny 58  
Iae (son of Iae) 58  
Iae (son of Solomon) 58  
Jacob (d. ca. 1825) 58  
John 58  
Katherine Collins 58  
Leila 58  
Mary 58  
Maud Faithcloth (Freer) 58  
Mercedes 58  
Rizpah 58  
Roderick 58  
Samueline (b. 1819) 58  
Sarah Jones 58  
Sol 58  
Solomon (d. 1895) 58  
Solomon (Silesia) 58  
Solomon (1816-1890) 58  
Susy 58  
Thomas 58  
Tom 58  
Zeilah 58  
**HEYDON**  
Elsa Swarts 292  
Howard Raymond 292  
**HEYMAN**  
Alfred Jacob (1845-1918) 214, 228  
Alice Moss 214, 228  
Carl Erik 228  
Dora Werner 228  
Edward Jacob 228  
Edward James 228  
Eilin Werner 228  
Erik Jacob Ivan 228  
Ethel Irene Cox 228  
Gladys 228  
Harald Ernest 228  
Herman 21  
Kurt Alfred 228  
Louisa Nathan 228

Pauline 120  
Renee Hamon 228  
Rose Goldsmith 21  
Sixtine 228  
Walter Oscar 228  
**HEYMANN**  
Hilda Chuck 161  
Lenah Guggenheimer 89  
**HEYNEMAN**  
Bertha (see Heinemann, Bertha)  
**HEZEKIEL**  
---- (d. 1847) 5  
**HIBBERT**  
Angela Mary 81  
**HIBSHMAN**  
Charlotte 340A  
**HIERO**  
Rebecca (1666-1731) 273  
**HIGGINBOTHAM**  
Florence Dyde 46  
Harry Thomson 46  
**HIGHETT**  
Clare Joanna 82  
Jean Mary Montague 82  
Linthorn Trevor 82  
Paul Linthorn 82  
Stephanie Jane 82  
**HIGHT**  
Gladys 195  
Sherman 195  
Virginia Lee Moise 195  
**HILB**  
Jean 215  
**HILBRONER**  
Leon (1854-1919) 271  
Matilda Shoyer 271  
**HILDEBRAND**  
Alice McBlair 156  
David 275  
Lee B. 156  
Polly Elizabeth Keller 275  
**HILEMN**  
Adelaide May Albrecht 257  
Craig (b. 1950) 257  
Henry Hal, Jr. 257  
**HILL**  
Betty 166  
Charles P. 247  
Clarence Clifford 269  
Fanny Phillips 247  
Rosalie Cohen Sheftall 269  
W. A. 119  
Winifred Mena 81  
**HILLER**  
See also Goldstone  
Alfred E. 165  
Alice Levy 165  
Edwin J. 148  
Fredericka (b. 1833) 116  
Gladys Simon 148  
Gretchen Harlam 116  
Julian 165  
Julius (Kurnick, Ger.) 116  
Julius Nathan (1796-1856) 116  
Lipman 116  
Nathan (1760-1854) 116  
Richard J. 165  
**HILLMAN**  
Eleanor Florance Cohen 33  
Henry L. 33  
**HILLS**  
Arthur S. 264  
Helen Seixas 264  
Irene H. 236  
**HILTNER**  
Isabel 214  
**HILTON**  
Dorothy De Sola 61  
Dorothy Pinto 61  
Ronald 61  
**HILTZEN**  
Gittel (see Hiltzen, Gwen (Gittel))  
Gwen (Gittel) 138

**HILZHEIM**  
Alexander Marcus (1846-1864) 8  
Henrietta Alexander Naumann 8  
Rose 8, 84  
**HIMES**  
Abraham 189  
Rosina Frank 189  
**HIMMELSTERN**  
Eleanor Mosler 8  
Ellen M. 8  
Robert J., Jr. 8  
Robert Julius 8  
**HINDES**  
Jeannette Pauline 82  
**HINER**  
Susie 70  
**HINES**  
Cecilia Lopez 176  
Francis Joseph (b. 1908) 176  
John Howard (b. 1909) 176  
Joseph 176  
**HINSDALE**  
Annie L. D. 200  
Elizabeth Christopher 200  
Ellen Devereux 200  
Ellen Theodosia 200  
John W. (m. 1869) 200  
John Wetmore (b. 1879) 200  
Margaret Devereux 200  
Samuel J. 200  
**HINTON**  
Catherine D. (1814-1843) 176  
Martha 200  
**HINTON (HEILBRON)**  
Ronald (see Hilton, Ronald)  
**HIRSCH**  
Arthur 234  
Babette Sartorius 307  
Betty Emilie 307  
Blanche 188  
Clara 90  
David Eiseman (b. 1913) 286  
Donald (see Hirst, Donald)  
Edith (b. 1886) 245  
Edward F., Jr. 307  
Edward Felix 307  
Effie Wyler 292  
Elinor Gans 245  
Elizabeth Workum 307  
Ellen Carol 307  
Elsie May (b. 1894) 245  
Emilie Laura 307  
Emily (b. 1880) 245  
Emily (b. 1909) 286  
Eather 235  
Eather Doris (b. 1889) 235, 337B  
Eva 116  
Florence Aurelia Eiseman 286  
Gordon Bennett (b. 1883) 245  
Harriet Mordecai 201  
Harriet Sarah Hirsch (1895-) 332A  
Helen C. Ottolengui 234  
Isaac Willard 201  
John M. 305  
Joshua Stanley (b. 1888) 245  
Katherine (b. 1912) 292  
Laura Anne 307  
Laura Senior Workum 307  
Leonard B. 286  
Louis (1851-1906) 245  
Maud (b. 1881) 245  
Max 292  
May Connors 245  
Melvin J. (d. 1903) 153  
Miriam Gomez Phillips 245  
Miriam R. Woolf 305  
Nettie Louise Levin 153  
Sadie (see Hirsch, Harriet Sarah Hirsch)  
Sarah Mae (1891-1975) 311B  
Stanley Joshua 245  
Susan Lee 307  
**HIRSCHEL**

Eliezer (d. 1736) 261  
**HIRSCHFELDT**  
Bernadine 10  
**HIRSCHFIELD**  
Carol D. Monash 47  
Eda 235  
**HIRSCHLAND**  
Edward Charles 91  
Ellen Berney 91  
Nancy Louise 91  
Paul Michael 91  
Roger Berney 91  
**HIRSCHLER**  
Adele 108  
Bertha Schloss 108  
Bertram 108  
Brian Ries 108  
David 108  
Dorothy 107, 108  
Ernestine 108  
Gail Ann 108  
Gary 108  
Gertie 108  
Hattie Ries 108  
Irma Strasburger 108  
June 108  
Leslie Jo 108  
Lewis 108  
Lewis David 108  
Louis 108  
Milton 108  
Nancy Stern 108  
Ruth 108  
**HIRSH**  
Adeline Hyneman 123  
Corinne Omega Rosenbaum 222  
Edward W. (1897-1916) 172  
Edwin Hampton 123  
Elizabeth (b. 1893) 71, 172  
Harry B. 172  
Jim (see Hirsch, Rose (Jim))  
Margaret 172  
Minnie F. Rosenberg 172  
Miriam 70  
Rose (Jim) (d. 1951) 172  
Sidney 222  
Suzanne 23  
**HIRSHENSON**  
Tamar 60  
**HIRSHHEIMER**  
Yetta (see Straus (Hirschheimer), Yetta)  
**HIRST**  
Donald 296  
Dorothy Kiam Lee 296  
**HITSYKO**  
Maigo 2  
Saeichi Takeuchi 2  
**HITT**  
Carrie 176  
**HIX**  
Johannie Sue 328A  
**HOALE**  
Laura 293  
**HOBART**  
Adeline Marx 188  
**HOBEY**  
Harriet 105  
**HOCHSTADTER**  
Albert 83  
Alma Seligman Seligsberg 322B  
Arthur 89  
Caroline 83  
Charles 307  
Edna 83  
Elizabeth 89  
Elizabeth Drucker 307  
Emma Gans 83  
Harry 83  
Jacob 89  
Leonard 83  
Leonard, Jr. 83  
Marilyn 307

Marion Kohn 89  
Mildred 83  
Robert 89  
Rose Guggenheimer 89  
Sidney 83  
Walter 322B  
**HOCKMAN**  
Elise 191  
John 191  
Lily Lightstone 191  
Margaret (Nicky) 191  
Nicky (see Hockman, Margaret (Nicky))  
**HOCKSTADTER**  
Clara Shoyer 271  
Ida Fannie (1860-1866) 271  
Isadore 271  
**HODGES**  
Jeanette Dellilah 269  
Louise 312B  
Sarah Ida 269  
**HODGSON**  
Harriet A. (1837-1882) 336B  
Lucile 148  
Sally Avril 222  
**HOENIGMANN**  
Frank William 28  
Mary Florence Sax 28  
Nancy Julia 28  
William Joseph 28  
**HOES**  
Annie Nicoll 220  
Elizabeth Nicoll 220  
Ernest P. 220  
Henrietta Myers 220  
John Spotswood 220  
Louise Nisbet 220  
Louise W. Hutcheson 220  
Peter Swart 220  
Pierre Van Buren 220  
William Myers 220  
**HOELLER**  
Adele 236  
Joan 236  
Julia Elizabeth 236  
Julia Oppenheimer 236  
Julius 236  
Mildred Friedman 236  
Robert 236  
**HOFFBERGER**  
Alice Berney 91  
Carol Sue 91  
Charles Jerrold 91  
David Berney 91  
Peter 91  
Richard Joseph 91  
**HOFFHEIMER**  
Anne 306  
Florence Sales 307  
Frances 307  
Herbert, Jr. 306  
Janet Seasongood Tippet 306  
Juliet Workum 307  
Laurence 307  
Lawrence 307  
Samuel S. 307  
Susan 307  
**HOFFLIN**  
Dessa Alexina Brandt 219  
Isabel 219  
Marcelle 219  
Marcellus 219  
**HOFFMAN**  
A. J. 240  
Abigail Grace Kursheedt (b. 1912) 147, 328B  
Ada 215  
Alicia Rosalie De Carlo (1972-) 328B  
Aline (b. 1931) 23  
Ann Teller 71  
Asher Charles 147  
Baesh 122  
Bessie 283, 339B

Blanche 283, 339B  
Carol 285  
Carolyn 71  
Carolyn Frances (b. 1928) 23  
Caryl Lester Gruen 237  
Charles I. (1868-1948) 23, 321B  
Charles Stewart, Jr. 71  
Daniel Neale (b. 1926) 23  
Deborah 122  
Doris Gooday 122  
Eileen Able 147  
Elsie Jandorf 160  
Fanny Binswanger 23  
Florence 293  
Frances Alisa 23  
Frances Loeb 23  
Francesca Maria De Carlo 328B  
Gail (see Hoffman, Rebecca Barnett (Gail))  
George Seixas (b. 1941) 147, 328B  
Georgiana Magdalene (1876-1933) 257  
Gilbert Russell 237  
Harriet A. (1837-1882) 328B  
Hannah 328A  
Hannah Jeannette (b. 1902) 23  
Harold G. 215  
Hilda Burstein 23  
Hope 215  
Irma 90  
Isidor Binswanger Dewey (b. 1898) 23  
Jane Abigail 147, 328B  
Jeffrey Alan 71  
Joan Orlich Braney 23  
Lavinia 122  
Lawrence 122  
Lee (see Hoffman, Leon (Lee))  
Leona Francis (b. 1900) 23  
Leona (Lee) 283, 339B  
Lily 215  
Lily Moss 215  
Mara Cecelia Abigail De Carlo (1977-) 328B  
Margaret 212  
Marian 283, 339B  
Mary Kay Johnson 147  
Mary Lou Blake 147  
Miriam Louise (b. 1924) 23  
Monte Kursheedt (b. 1941) 147, 328B  
Moses David (b. 1894) 23  
Nathan (1906-1962) 147, 328B  
Nathan Richard (b. 1969) 147  
Rachel Kursheedt 147  
Rachel Myers 240  
Rebecca Barnett (Gail) (b. 1896) 23  
Richard David (b. 1929) 23  
Rudyard Kipling 160  
Ruth Jean (b. 1922) 23  
Ruth Scheuel 23  
Sophia Stern 283, 339B  
Stephanie Reitzes 147  
Susan 71  
William Lawrence 71  
Winifred Malnick 122  
**HOPFHEIMER**  
Cecilia 71, 72  
Clay 301  
Elise 301  
Elise Nusbaum 301  
Henry Clay II 301  
Linda 301  
**HOPSTADLER**  
Shirley 189  
**HOPSTETTER**  
Catherine Hays Solomon 325A  
Phillip 325A  
**HOGAN**  
Katherine Ann 164  
**HOGG**  
Olive 312B  
**HOGLAN**  
Mary Ann (1821-1863) 335B  
**HOHEP**  
Abraham 18

Perla 224  
Rebecca Benjamin 18  
Sarah 305  
Zipporah 61  
**HOHENFELS**  
Albert Asher (Asher B. Hayim) 118  
Albert Asher (b. 1851) 118  
Clara 118  
Clara Telschen (1844-1864) 118  
Dora 118  
Edna 118  
Eugene Isaac (b. 1849) 118  
Matilda Sarah (b. 1847) 118  
Miriam 118  
Miriam Dinah (1842-1872) 118, 166  
Moses Julius (b. 1845) 118  
Rosetta (Rosa) Lyons 118, 153, 182  
Sarah Levy 118  
Selig (1808-1852) 118, 182  
**HOLOMB**  
Ruth Frances Ure 265  
**HOLDER**  
Annette Hart 95  
Elizabeth Hamlyn Holdridge 105  
Norman 95  
**HOLE**  
Lemuel Homer 56  
Marguerite Sheldon Forbes 56  
**HOLLAND**  
Gladys Lee 216  
**HOLLANDER**  
George 2  
Philip 2  
Phoebe Abraham 2  
Rachelle 287  
Samuel 2  
**HOLLINGS**  
Beverly 91  
Marjorie Cone 91  
Marjorie Guggenheimer 91  
Powell 91  
**HOLLINGSWORTH**  
Nancy P. 150  
**HOLLINS**  
Alice McKim 157  
**HOLLIS**  
Bettie 101  
**HOLLISTER**  
Mary Fuller 305  
**HOLMAN**  
Alfred 307  
Alfred Paul 307  
David 307  
Elizabeth (Libby) 307  
Ellen 282  
Libby (see Holman, Elizabeth (Libby))  
Lyda Sweeney 307  
Marion 307  
Rachel Florence Workum 307  
Robin 307  
**HOLMBERG**  
A. William, Jr. 291  
Ruth Rachel Sulzberger Golden 291  
**HOLMES**  
Anthony 307  
Elizabeth (Libby) Holman Reynolds 307  
Elizabeth Stansbury 158  
Griselda 158  
Libby Holman Reynolds (see Holmes, Elizabeth (Libby) Holman Reynolds)  
Mary 105  
Ralph 307  
Timothy 307  
Victor 158  
**HOLOHAN**  
Brian 237  
Florence Marie Roth Kunz 237  
Marie Angela Dingus 237  
Mary Kathryn 237  
Matthew 237  
Maureen Angela 237  
Thomas Vincent 237

Vincent Thomas 237  
**HOLSTEIN**  
Suzanne 15  
**HOLT**  
Marion 24  
**HOLZ**  
Erna 27  
**HOLZMAN**  
Alfred (see Holman, Alfred)  
John Paul 307  
John Workum 307  
Kenneth Fischer 307  
Margaret Fischer 307  
Mary Elizabeth 307  
Maxine Moss 307  
Peter Moss 307  
Robert 307  
Wallace (1874-1915) 307  
Wallace Ross 307  
**HOMAIER**  
Ann 294  
Edward (Teddy) 294  
Jean Gries 294  
Lon 294  
Lynn 294  
Teddy (see Homaier, Edward (Teddy))  
**HOMESTON**  
Katherine 138  
**HONIG**  
Anna 305  
Jacob Ben 305  
Simon Ben 305  
**HONIGSTEIN**  
Baron (see Honig, Simon Ben)  
**HONNETT**  
Bertel O. 125  
Betty Lou 125  
Carol Sylva Klein 125  
Florence 125  
**HONSENER**  
Susan 114  
**HONYWOOD**  
Ann Marie Paynter 77  
Annie Mabel 77  
Arthur 77  
Caroline 77  
Cecil Robert 77  
Constance Mary Pixell 77  
Courtney John 77  
Edward 77  
Edward Fenton 77  
Elizabeth Josepha 77  
Emma Mary 77  
Filmer Courtney William 77  
Flora Victoria 77  
Florence Elizabeth 77, 78  
Frances Hallett 77  
Guy 77  
Helea Hudson 77  
Hilda Catherine 77  
Isabelle Charlotte 77  
John Courtney 77  
John Edward 77  
John William 77  
Louisa Anne 77  
Louisa Lucy 77  
Margaret Bennett Adamson 77  
Marion Grace 77, 78  
Mary Anne Cooper 77  
Mary Anne Elizabeth 77  
Mary Hallett 77  
Maud Naylor Wilson 77  
Philip Courtney 77  
Philip Frederick 77  
Philip Sidney 77  
Rachel Gray Jones 77  
Reginald Ernest 77  
Roselind Iseult Mary 77  
Thomas Guy 77  
Victoria Henrietta Ezilda Carr 77  
Violet Constance Evelyn 77  
William 77

William Wynne 77  
Wyndham 77  
Zaidée Emily Iseult  
Bodychan-Sparrow 77  
Zaidée Maud Elsie 77  
Zaidée Violet 77  
**HOOD**  
Donne 37  
**HOOPNAGLE**  
Kate Garrett Cardozo 29  
William H. 29  
**HOOPSTETER**  
Philip 106  
Rachel Hays 106  
**HOOPES**  
Edward 290  
Karen 290  
Lisa 290  
Lorna Berg 290  
**HOOPER**  
Dorothy Blanche 269  
**HOPKINS**  
Alan 204  
Beatrice Theresa Morrison 204  
**HOPKINSON**  
Cecily Maude 79  
**HOPPIN**  
Mary G. 156  
**HORKHEIMER**  
Pauline 61  
**HORNER**  
Betty Pfaeizer 296  
Cornelia Livingston Croghan 155  
Dorothy Stern 284  
Harry 296  
Horace Kenneth (1892-1968) 284  
Horatio George 155  
Mary Sophia (b. 1870) 155  
**HORNLEIN**  
Belle Evelyn Levy 164  
Lionel 164  
**HOROWITZ**  
Abigail Seixas 266  
Charles (see Harwood, Charles)  
Mark 266  
Phineas 261  
**HORT**  
Alfred 96  
Annie Julia 96  
Dorothea Catherine Hart 96  
Emily Abigail 96  
Emily Abigail Hart 96  
Harriet Frances 96  
**HORTON**  
Eberle Roscoe, Jr. 4  
Nancy 340B  
Rita Haiman 4  
Rita Laura 4  
**HORWITZ**  
Adele 118  
Alice Gross 118  
Amelia Read (Leila) (1866-1912) 118  
Benjamin F., Jr. 118  
Benjamin Franklin 118  
Caroline Norris (m. Phineas) 118  
Caroline Norris (1861-1862) 118  
Caroline Norris (1902-1908) 118  
Carolyn Norris (dau. of Theophilus) 118  
Deborah Andrews 12, 118  
Eugene 118  
Florence Gross 118  
George Dulles 118  
George Quintard (1868-1916) 118  
Haller Gross (d. 1932) 118  
John (see Horwitz, Jonas (Jonathan, John))  
John Meredith Read (b. 1865) 118  
Jonas (Jonathan, John) (d. 1852) 12, 118  
Jonathan (see also Horwitz, Jonas (Jonathan, John))  
Jonathan (son of Peter Orville) 118

Joseph Parker (1858-1860) 118  
Leila (see Horwitz, Amelia Read (Leila))  
Louise E. Gross 118  
Louise Gross 118  
Maria Gross 118  
Marian Newhall 118  
Mary Barroll (dau. of Theophilus) 118  
Mary R. Barroll 118  
Natalie Dulles 118  
Orville (m. Maria Gross) 118  
Orville (1860-1913) 118  
Peter Orville (b. 1909) 118  
Phineas Jonathan (1822-1904) 118  
Samuel Gross 118  
Theodore (1856-1877) 118  
Theophilus Byron (son of Jonas) 118  
Theophilus Byron (son of Phineas) 118  
Thomas Lloyd Norris (1863-1900) 118  
**HOSKIN**  
Ann Marie 253  
**HOSKINAN**  
Elise 191  
Joel H. 191  
Lily Lightstone 191  
**HOUGHTALING**  
Leah Agnes 211, 334A  
**HOUGHTON**  
Barbara Jean 193  
Dorothy Rebecca Michaels 193  
James 193  
Marion Elizabeth 193  
**HOUE**  
Anna (1973-) 330A  
Charles 330A  
Dorothy Ann Alexander 330A  
Mary Bentley (1970-) 330A  
**HOULDSWORTH**  
Lillian 27  
**HOULT**  
Constance Emily 260  
**HOULTON**  
Betsy 340A  
Jennifer 340A  
Peggy Mann 340A  
**HOUSMAN**  
Jennie 29  
**HOUSTON**  
Edward Cecil 176  
George C. 176  
George, Jr. 176  
Rosalie Cecilia Lopez 176  
Theodora Lopez 176  
**HOWARD**  
Bernard Marmaduke Fitzalan 79  
Dinah Six Wasserman 287  
Elizabeth 58  
Gertrude Sophia David 46  
Lavinia Mary Strutt 79  
Mary Lloyd 156  
Mary Pauline 219  
May 255  
Morton 287  
T. Palmer 46  
Thomas 46  
**HOWE**  
Alice Lloyd Greenwood 157  
George Dudley 157  
**HOWELL**  
Agnes Naar 224  
Alfred E. 269  
Fred 224  
Grayson Dutton 58  
Joe 58  
Marie Sheftall 269  
**HOWLAND**  
Charles F. 150  
Virginia Lazarus 150  
**HOWLETT**  
Meta 115  
**HOWTH**  
Leonora De Lyon (b. 1849) 57  
Leonora De Lyon (dau. William E.)

57  
William E. 57  
**HOYT**  
Barbara 158  
Edwin C., Jr. 158  
Edwin Chase 158  
Jane Dickson 76  
John Terrell 269  
Marguerite Sheftall 269  
Marie Louisa Moran 158  
Nancy 158  
Rosalie C. 158  
Silas 76  
**HUBBELL**  
Caroline Pinto 251  
Harvey 251  
**HUBER**  
Evelyn Rich 63  
**HUBERT**  
Louise 199  
**HUBERTH**  
Anne Morningstar 241  
**HUCHBERGER**  
Caroline Wilson 295  
Elaine 295  
Fanny 295  
Harry 295  
Lehman 295  
Owen 295  
Pauline Leerberger 295  
Robert 295  
Sarah Tim 295  
**HUCHS**  
Lena R. 312  
**HUDELSON**  
Ura Mae Ammerman 311B  
**HUDSON**  
Carol 5  
Charles E. 5  
Frances Abrams 5  
Helen 77  
Jo Ann 5  
Susanna 321B  
Turner 321B  
**HUEBSCH**  
Daniel A. 293  
Nettie Hays Lippman Richman 293  
**HUENIG**  
Benjamin Moses 305  
**HUFFAKER**  
Lucy 47  
**HUFFNAGLE**  
Adelaide Beaumont 75  
Alfred (b. 1823) 75  
Allen Augusta 75  
Anna 75  
Benjamin Franklin (1818-1842) 75  
Bessie Down 75  
Catherine Cox Allen 75  
Charles (1808-1860) 75  
Ellen 75  
George Washington (son of John) 75  
George Washington (1821-1895) 75  
Horatio Nelson 75  
John (m. 1806) 75  
John (son of George W.) 75  
Mary Augusta (1814-1888) 75  
Mary Louisa 75  
Rhoda Evans 75  
Sara (Beth) Franks (see Huffnagle, Sara Eliza (Beth) Franks)  
Sara Eliza (Beth) Franks 75  
William Kirkpatrick (1810-1854) 75  
**HUGHES**  
Annie (1838-1876) 265  
Grace 321B  
**HUGHSON**  
Bessie 207, 333B  
**HUGUENIN**  
Ann Sarah 8  
**HULIN**  
Stella 258  
**HULL**

Mae 201  
**HULSMAN**  
Lorraine 328A  
**HUMES**  
Myrtle 252  
**HUMPHREY**  
Agnes Cromline 41  
James Morgan 41  
Janet Birge 41  
**HUMPHREYS**  
Rebecca Walters 180  
William T. 180  
**HUMPHRIES**  
Laura Schuyler Norment 133  
Mary 215  
Ralph 133  
**HUNGERFORD**  
Flavia 197  
Gerard Joseph 195  
Roena Parkinson Moise 195  
**HUNT**  
Abigail Hart 97  
Abraham S. (1834-1855) 118, 310B  
Bella 118  
Catherine Howland 155  
Catherine Howland Hunt 155  
Celia Pratt 155  
Charles 118, 181  
Constant 97  
Cornelia Ridgely (b. 1861) 155  
Diana, see Hunt, Dinah (Diana)  
Dinah (Diana) 325B  
Dinah 118  
Eleanor B. 155  
Elizabeth Augusta Ridgely 155  
Elizabeth Ridgely (b. 1883) 155  
Emanuel 118  
Emilie Radcliffe 155  
Floride Louisa (b. 1887) 155  
Frances Isabel 183  
Gaillard (b. 1862) 155  
Gaillard (1884-1886) 155  
Gaillard, Jr. (b. 1903) 155  
George (b. 1860) 97  
Gertrude Livingston (b. 1898) 155  
Gertrude Upshur 155  
Harriet Dagget 112  
Helen Jewett 155  
Helen Upshur (b. 1889) 155  
Henry Goodfellow (b. 1907) 155  
Jeanette 285  
Josephine (b. 1857) 97  
Julia De F. Cheney 155  
Livingston (b. 1859) 155  
Livingston, Jr. (b. 1894) 155  
Margarita Cress 155  
Mary C. 155  
Mary Goodfellow 155  
Maxwell (1888-1889) 155  
Natalie Hammond (b. 1889) 155  
Rachel Cohen Peixotto 118  
Radcliffe (1881-1886) 155  
Randall (1856-1898) 155  
Ridgely (b. 1854) 155  
Ridgely, Jr. (b. 1887) 155  
Sarah Elizabeth Lyon 118, 181  
Solomon Emanuel (1792-1846) 118, 325B  
Thomas (b. 1855) 155  
Virginia (b. 1891) 155  
Virginia Delancey Kearney 155  
Virginia Livingston (b. 1890) 155  
William Henry (b. 1857) 155  
William Henry (1824-1884) 155  
William Henry (1882-1886) 155  
William Henry, Jr. (b. 1886) 155  
**HUNTER**  
Clara Ivanetta Sargent (d. 1947) 237  
Edith 35  
Edith O'Driscoll 35  
Edward (m. Clara Sargent) 237  
Edward (m. Nona Myers) 216  
Fanny O'Driscoll 35



Frank O'Driscoll 35  
 Hammond 35  
 Harold 35  
 Jeanne 35  
 John (m. Fanny O'Driscoll) 35  
 John (son of Wright) 35  
 Lenora 35  
 Nona Myers 216  
 Wright 35  
**HURWITZ**  
 Alma 70  
 Alma Rosenbaum 222  
 Barbara 191, 333A  
 Daniel Nathan 191, 333A  
 Fredi 321A  
 Joan Lewengrub 333A  
 Lynn 71  
 Philip 191, 333A  
 Ruth Mendes 191, 333A  
 Susan 191, 333A  
**HUTCHESON**  
 Louise W. 220  
**HUTCHINGS**  
 Cornelia T. Ellet 128  
 Samuel B. 128  
**HUTCHINS**  
 Imogene D. 247  
**HUTCHINSON**  
 Elizabeth (1817-1893) 251  
 Kate 141  
 Mary Glascock 241, 312B  
 Phoebe J. 158  
 Sarah 158  
**HUTKIN**  
 Diane Rose 12  
 Hilda W. 12  
 James Romberg 12  
 Jane Andrews 12  
 Marcus D. 12  
 Stephen Marc 12  
**HUTZLER**  
 Claire Levy 162  
 Ella Gutman 143  
 Harriet 162  
 Ida 222  
 Maurice 162  
**HYAMS**  
 Adelaide Jones 120, 137  
 Adeline 119  
 Alice 58  
 Andrew Jackson (1818-1870) 119  
 Annie (see Hyams, Hannah (Annie))  
 Augustus 120  
 Caroline (b. 1802) 119, 148  
 Caroline Matilda Thompson 119  
 Catherine (b. 1834) 11, 120  
 Catherine (d. 1844) 119  
 Catherine (dau. of David) 120  
 Catherine (1785-1831) 119  
 Catherine Jacobs 119, 132  
 Clara Carvalho 322A  
 David (son of Moses 44, 119, 120)  
 David (son of Solomon M.) 119  
 David N. C., Jr. 322A  
 David Nunes Carvalho 322A  
 E. A. Way 120  
 Eleazer Levy (1810-1860) 119  
 Eliza (1808-1837) 19, 120  
 Elizabeth (b. 1843) 120  
 Fernella 322A  
 Gainie 119  
 Godfrey M. (1859-1927) 322A  
 H. P. 119  
 Hamilton 120, 137  
 Hannah (Annie) (1813-1890) 119, 273  
 Hannah (b. 1813) 119  
 Hannah (dau. of Moses David) 11, 120  
 Hannah (dau. of Moses) 119  
 Henry (son of Mordecai) 119  
 Henry (1793-1852) 119  
 Henry Michael (1806-1875) 119  
 Hester (m. 1858) 120  
 Isaac (1762-1830) 119

Isaac D. (1829-1837) 120  
 Isaac Leo (d. 1846) 120  
 Isaac Robert 119  
 Isabel 322A  
 Joseph (b. 1767) 119  
 Josephine (1871-1923) 119  
 Josephine Joseph 119, 139  
 Judah (b. 1768) 119  
 Judith (1796-1883) 119  
 Judith (1800-1840) 119  
 Judith Isaacs 119  
 Julia 119  
 Kosciusko Ravenscamp 119  
 Laura Smith 119  
 Leah (dau. of Henry) 119, 131  
 Leah (dau. of Solomon M.) 119  
 Lucile 119  
 Mamie 119  
 Mary (m. Joseph Barnett) 16  
 Mary (m. 1848) 119  
 Mary Irene Abercrombie 322A  
 Mattie 119  
 Miriam 119  
 Miriam Levy 18, 119  
 Mordecai (m. Josephine Joseph) 119, 139  
 Mordecai (1787-1817) 119  
 Moses (b. Poland) 119, 325B  
 Moses (son of Solomon M.) 119  
 Moses David (m. 1887) 120  
 Moses David (1798-1868) 120  
 Moses Kosciusko (1798-1836) 119  
 Pauline Baum 120  
 Pinckney A. (1831-1860) 120  
 Rachel 119  
 Rebecca 120  
 Rebecca Maysor 44, 119, 120  
 Rosetta (Rosina) 120  
 Rosina (see Hyams, Rosetta (Rosina))  
 Sallie (d. 1863) 120  
 Sally (see Hyams, Sarah (Sally))  
 Samuel (1766-1843) 18, 119  
 Samuel Myers (b. 1813) 119  
 Sarah 322A  
 Sarah (dau. of David) 120  
 Sarah (m. 1807) 119  
 Sarah (Sally) 119  
 Solomon (son of Solomon M.) 119  
 Solomon M. (1753-1837) 119, 131  
 Solomon Michael 322A  
 Susan (b. 1841) 120  
 Susanna Jackson 120  
 Thaddeus Street (1837-1854) 120  
 Viola Straus 119  
 William Palmedo 119  
**HYATT**  
 Sarah 34, 322A  
**HYDE**  
 Aide Solomon 102  
 Edward (Heidelberg) 102  
 Gladys 102  
**HYMAN**  
 Abraham (son of Henry S.) 121  
 Abraham (son of Samuel) 121  
 Amelia Isaacs 51  
 Anna Semon 313  
 Betsey Moses (see Hyman, Elizabeth (Betsey))  
 Betsy Nathan 121  
 Catherine Davis 48  
 Charlotte (dau. of Samuel) 121  
 Charlotte (1847-1903) 121, 244  
 Cilla David 121  
 David 51  
 David D. 51  
 Edna Sophia Daniels 51  
 Elizabeth (b. 1838) 121, 259  
 Elizabeth (Betsey) Moses 121, 214  
 Elizabeth (1842-1933) 122  
 Esther Myers Le Jeune 220  
 Eve 121  
 Florence 138  
 Georgiana Blankensee 122

Henrietta 220  
 Henry S. (1808-1866) 16, 121, 162  
 Hettie Isaacs 121, 277  
 Hyman (son of Samuel) 121, 122  
 Isabella 220  
 Isadore 313  
 Jacob 220  
 Joseph 121  
 Judith 122  
 Julius 51  
 Lewis (1821-1899) 121, 162  
 Mabel 122  
 Marjorie 51  
 Mary Louisa Levy 121, 162  
 Mary Matilda (1843-1915) 121  
 Matilda 121  
 Maud (b. 1846) 122  
 Maud (b. 1877) 122  
 Minnie 121  
 Miriam Pyle 121, 162  
 Moseley 121  
 Nathan 121  
 Rachel (1835-1914) 121, 123  
 Rachel Phillips 121, 245  
 Rebecca (1832-1849) 121  
 Rebecca Barnett 16, 121  
 Rebecca Levy Pyle 121, 162  
 Rosabel L. 179  
 Rosina 121  
 Samuel (b. 1836) 121, 277  
 Samuel (son of Jacob) 220  
 Samuel (1771-1839)  
 Samuel (1845-1916) 122  
 Samuel Lewis (1856-1926) 121, 245  
 Sarah Johnson 121  
 Solomon (b. 1847) 121  
 Solomon (m. Catherine Davis) 48  
 Solomon (1823-1879) 121  
 Zipporah Jacob 121, 122  
**HYMEN**  
 Anna Maria Moise 197  
 Edith Schwartz 197  
 Everett (b. 1912) 197  
 Irba Amedee (b. 1883) 197  
 Jerome Caryl (b. 1882) 197  
 Joseph Charles 197  
**HYNDMAN**  
 Isabelle Chalmers Seixas 264  
 William H. 264  
**HYNEMAN**  
 Adeline (b. 1872) 123  
 Adeline Ezekiel 69, 123  
 Alice (b. 1840) 123  
 Alice (1880-1921) 123  
 Annie 123  
 Augusta Davidson 123  
 Barton 123  
 Benjamin (b. 1806) 123  
 Charles (1852-1854) 123  
 Edwina I. (b. 1869) 123  
 Elias (1765-1845) 123, 166  
 Elias Leon (1837-1865) 123  
 Elias Leon (1865-1925) 123  
 Grace Aguilar (1850-1853) 123  
 Grace Marks 123, 185  
 Henrietta (Hettie) Goldsmith 123  
 Henry (1847-1850) 123  
 Henry Isaac (b. 1886) 123  
 Herman Naphtali (1849-1907) 123  
 Hettie Goldsmith (see Hyneman, Henrietta (Hettie) Goldsmith)  
 Ida Florance Coben 31, 123  
 Isaac (1804-1886) 69, 123  
 Jacob (b. 1809) 123  
 Jacob Ezekiel (1843-1922) 123  
 Julia (d. 1825) 123  
 Julia (1835-1856) 123  
 Laura Josephine Cottenbrock Farringer 123  
 Leon (1808-1879) 123  
 Leona ('Leona Moss') 123, 215  
 Levy Leon (1839-1900) 123, 185, 310B  
 Lewis 121, 123

Louis Hendricks (1892-1948) 123  
 Marie Louise (Minnie) 123, 277  
 Mary Benswanger 21, 123  
 Mary Louise Sullivan 123  
 Minnie (see Hyneman, Marie Louise (Minnie))  
 Miriam Rebecca (1845-1857) 123  
 Moses (1808-1890) 123  
 Moses Leon (b. 1833) 21, 123  
 Rachel (b. 1841) 123  
 Rachel Hyman (1835-1914) 121, 123  
 Rachel Pollock 123, 167  
 Raphael (b. 1849) 123  
 Rebecca (b. 1848) 123  
 Rebecca (b. 1872) 123  
 Rebecca (1806-1875) 123, 325B  
 Rebekah Gumpert 123  
 Samuel 123  
 Samuel Barton 123  
 Samuel Morais (1854-1914) 31, 123  
 Samuel Moses (b. 1867) 123  
 Sarah Gumpert 123  
**HYNEMAN (KLEEBURG)**  
 Simon Lucas (1765-1849) 123  
**HYNES**  
 Roma May 196  
 Sarah 88  
**IBN DAUD**  
 Aaron 59  
 Baruch 59  
 Shalom 59  
**ICKELHEIMER**  
 Gussie 295  
 Jennie 144  
**IDANHA**  
 Samuel 240  
 Simbah Brown 240  
**IFFLA**  
 Rachel Henriques 113  
**IGLAUER**  
 Arnold 306  
 Bruce Harry 306  
 Carl 285  
 Carl 306  
 Charles Arnold 307  
 Charles Sumner 306  
 Clara M. Senior 306  
 Delia 306  
 Florence (b. 1881) 285  
 Gail 306  
 Harriet Susan Salinger 306  
 Helen 307  
 Helen Sara Ransoboff 307  
 John 306  
 Josephine 307  
 Laura 306  
 Richa 285, 286  
 Rosa Stix 285  
 Ruth 306  
 Samuel 307  
 Virginia Duna 306  
 Zillah (b. 1877) 285  
**IGSTADTER**  
 Blanche Guggenheimer 89  
 Sidney 89  
**ILBERG**  
 John 191  
 Karen 191  
 Penelope (Penny) Dale 191  
 Penny Dale (see Ilberg, Penelope (Penny) Dale)  
 Stephanie 191  
**ILLAVA**  
 Joseph (see Morningstar, Joseph (Illava))  
 Mary B. 241  
**ILLOWAY**  
 Miriam Ruth 244  
**IMBURG**  
 Catherine 29  
 Clare Cardozo 29  
 Irving 29  
 Nancy Elizabeth 29

Susan 29  
**INGERSOLL**  
 Susan B. 118  
**INGLEDEW**  
 Gwen Ellen 82  
**INGRAM**  
 Ada Gabriel 122  
 Elizabeth Jacobs 107  
 Howard 107  
 Jonathan 122  
 Sadie 122  
 Susan 122  
 Walter 122  
**INGRAM (ISAACS)**  
 Sidney 122  
**INKSON**  
 Mary 81  
**INMAN**  
 Cornelia Barrett 39  
 George, Jr. 39  
**IONS**  
 Cecile Goodman Nevins 94  
 Clarendon 94  
 Robert N. 94  
 Willoughby 94  
**IORNS**  
 Lepha 172  
**IRBY**  
 Ann Sarah Huguenin 8  
 Mary K. 260  
**IRVIN**  
 See Isaacs  
 Esther Ritzwoller 125  
 Irving C. 125  
**IRVING**  
 Amy Davis 37  
 David Kenneth 37  
 Grace Judith Naar 225  
 Harry 145  
 James 225  
 Jules 37  
 Katherine Marie 37  
 Maude Rosalie Kraus Sloan Pach 145  
 Priscilla Marie Pointer 37  
**IRWIN**  
 Elizabeth Gallardo (1956-) 336B  
 Jeffrey Lynn (1956-) 336B  
 Norma Nones 336B  
 Richard Porter (1955-) 336B  
 Robert Bruce (1959-) 336B  
 William Porter (1919-) 336B  
**ISAAC**  
 Ben Elijah (d. 1216) 59  
 Benjamin Richard 308  
 Blanche Elizabeth 308  
 Edith Rose 308  
 Effie Robson 308  
 Ellen Moses 308  
 Esther Flora 308  
 Feist Dinkelspiel 323A  
 Flora Yates 308  
 Florence Maud 308  
 Frederick 308  
 Georgina Eugenia 308  
 Gladys 308  
 Isaac Ibn Daud 59  
 Isaac Ibn Giat 59  
 John Raphael 308  
 John Robert 308  
 Marjorie 308  
 Moerle 323A  
 Nellie Elizabeth 308  
 Percy Lewis 308  
 Rafaelle 308  
 Ralph 308  
 Rose Amelia 308  
 Sarah Amelia Coleman 308  
 Sophie Aaron 308  
 Theresa Sophia 308  
**ISAACS**  
 See also Isaacs  
 Abraham (1737-1815) 127  
 Catherine Cohen 38, 120

Esther (m. 1824) 127  
 Fanny Cusbell Lazarus 120, 150  
 Frances (Frumet) 120, 272  
 Frumet (see Isaacs, Frances (Frumet))  
 Getlah (b. 1775/6) 127  
 Hannah 69, 70, 127  
 Isaac (b. 1774) 127  
 Isaac (d. 1839) 120  
 Isabella 127  
 Isabelle Goodman 94  
 Jacob (b. 1785) 120  
 Jacob (1793-1831) 127  
 Janette 127  
 Jeanette 120  
 Joseph 127  
 Judah M. 120  
 Judith 119  
 (Judith) Rachel Mears 120, 190  
 Julian M. 94  
 Magdalen Sidell 127  
 Margaret 127  
 Moses 127  
 Rachel (see Isaacs, Richea (Rachel))  
 Rebecca Cohen 36, 120  
 Rebecca Mears 120, 190  
 Rebecca Simson 120, 272  
 Richea (Rachel) 127  
 Sarah Haya 127  
**ISAACS**  
 Aaron (b. 1752) 126  
 Aaron (d. inf.) 125  
 Aaron (1724-1798) 126  
 Aaron Clarence (1849-1901) 124, 129  
 Aaron Lopez (b. 1778) 120  
 Abigail (1782-1855) 120  
 Abraham (b. 1828) 125  
 Abraham (b. 1840) 127  
 Abraham (d. 1743) 120  
 Abraham (d. 1835) 36, 120  
 Abraham (son of Aaron) 125  
 Abraham Mears (1765-1814) 120, 272  
 Abraham, Jr. (d. 1815) 120  
 Abram S. (see Isaacs, Abram Samuel)  
 Abram Samuel (1851-1920) 93, 127, 324B, 326A  
 Adela (1832-1890) 38, 120  
 Agnes 126  
 Agnes Cohen 38, 124  
 Albert (b. 1876) 124  
 Albert (b. 1920) 124  
 Albert M. (1852-1923) 124  
 Alene Parsons 125  
 Alice (1872-1946) 127  
 Alice Gabriel 122  
 Allan (b. 1918) 124  
 Alma Hendricks 111, 124, 325B  
 Amelia (b. 1843) 277  
 Amelia (m. Julius Hyman) 51  
 Amelia (1792/1800-1868) 115  
 Amelia Loeb (see Isaacs, Emilie (Amelia) Loeb)  
 Amy 246  
 Amy Hamburger 326A  
 Amy Loeb 125  
 Arthur S. (see Harby, Arthur S.)  
 Asher 124  
 Augusta Agnes 125  
 Barbara Ann 125  
 Belle 125  
 Benjamin (b. 1737) 126  
 Benjamin (son of Benjamin) 126  
 Benjamin Franklin 125  
 Bernard 124  
 Bertha Altheimer 125  
 Bertha Grabenheimer 125  
 Bertha Shucart Schwartz 125  
 Brandy Lazarus (1830-1833) 124  
 Brendella 124  
 Brian 124  
 Brindella 124  
 Carol 127  
 Carol Fabricant 127  
 Carol Hermine 127, 326A

Caroline Newmark 125  
 Carrie (see also Isaacs, Carol Fabricant)  
 Carrie Fabrikant 127  
 Carrie Marks 125  
 Casey (see Isaacs, Helen (Casey))  
 Catherine (b. 1751) 126  
 Catherine (b. 1835) 127  
 Catherine (1781-1854) 120  
 Catherine Maria (1785-1842) 126  
 Cecilia Carolina (1808-1862) 120  
 Charlotte 126  
 Clarence (1885-1938) 111, 124, 325B  
 Clarissa (b. 1846) 125  
 Clifford (b. 1879) 124  
 Cornelia 125  
 Cornelia Myer 125  
 Cyril 93  
 Cyrilla 93  
 David (1760-1837) 126  
 David Isaiah 126  
 Dawna 108  
 Dorothy (b. 1911) 124, 325B  
 Edith Juliet Rich 127  
 Edith Somborn 127, 326A  
 Edna (b. 1882) 124  
 Edwin (b. 1913) 124  
 Edwin J. 73  
 Elaine (b. 1913) 124  
 Elizabeth (b. 1755) 126  
 Elizabeth (1764-1809) 126  
 Elizabeth Fossett 126  
 Elizabeth Grover 125  
 Elkaleh Kurnsheed 124, 147  
 Emilie (Amelia) Loeb 125  
 Emily Hannah (1845-1918) 74, 124  
 Ernest R. (b. 1883) 124  
 Essie 124, 125  
 Essie Isaacs 124, 125  
 Estelle (1876-1934) 127, 326A  
 Estelle Solomon 102, 127, 326A  
 Esther (b. 1832) 127  
 Esther (dau. of Abraham, Jr.) 120  
 Esther (m. 1824) 125  
 Esther (1730-1756) 126  
 Esther (1762-1848) 126  
 Esther (1780-1841) 120, 212  
 Esther (1861-1937) 125  
 Esther Levy 124, 162  
 Esther Mulford 126  
 Ethel (b. 1900) 160  
 Ethel Miriam 124, 266  
 Ethelreda Warner 93  
 Eugene 125  
 Eugene Jackson (b. 1874) 124  
 Eugene Loeb II 125  
 Eugenia Van Duzer 124  
 Eugenie Felbel 73, 124  
 Fanny (dau. of Abraham) 120, 252  
 Fanny Dennison 126  
 Fay 160  
 Florence (m. Jacob I. Cohen Souza) 280  
 Floreance (1872-1944) 125  
 Frances (1774-1848) 120, 272  
 Frances (1783-1854) 110, 124  
 Frances Isaiah 25, 127  
 Frances Louise 125  
 Frances Pyle 125, 162  
 Frances Zelmira (1842-1916) 124  
 Frederick 126  
 Frieda Spiegel 160  
 George (1772-1842) 124  
 George (1829-1925) 125, 162  
 Gertrude Adelaide (1851-1912) 124, 174  
 Getlah (b. 1776) 120  
 Grace (b. 1743) 126  
 Grace (d. 1781) 124  
 Grace (dau. of Isaac S.) 127  
 Grace (dau. of Jacob) 120  
 Grace (1788-1848) 124  
 Grace (d. 1879) 127, 326A

Gustavus Joseph (1836-1910) 124  
 Hannah (b. 1837) 127  
 Hannah (d. 1798) 120, 247  
 Hannah (d. 1870) 120  
 Hannah (Hindlah) Levy 124, 154  
 Hannah (m. 1810) 69, 70, 120  
 Hannah (1769-1837) 120  
 Hannah (1792-1867) 124  
 Hannah Mears 120  
 Hannah Solomons 277  
 Harriet Maria (1787-1825) 126  
 Harry 160  
 Hays 126  
 Hays Isaiah 126  
 Helen (Casey) 127, 326A  
 Helen Rothchild 124  
 Helen Salant 127, 326A  
 Henry (b. 1765) 126  
 Henry (b. 1909) 124, 325B  
 Henry (Zeby) (b. 1765) 120  
 Henry Clay 73, 124  
 Hermine 127, 326A  
 Hettie (b. 1847) 121, 277  
 Hetty Hays 104, 126  
 Hindlah Levy (see Isaacs, Hannah (Hindlah) Levy)  
 Horace 126  
 Howard 108  
 Irving C. (see Irwin, Irving C.)  
 Isaac (b. 1732) 126  
 Isaac (b. 1774) 120  
 Isaac (b. 1838) 127  
 Isaac (son of Abraham) 120  
 Isaac (1764-1809) 126  
 Isaac A. (1825-1897) 38, 124, 162  
 Isaac S. (son of Solomon) 124  
 Isaac Samuel 102, 127, 326A  
 Isaac Wickham 126  
 Isabel 127, 326A  
 Isabelle 125  
 Isaiah (1747-1806) 104, 126  
 Isobel 127  
 Israel (b. 1800) 127  
 Jacob (b. 1843) 127  
 Jacob (bro. of Isaiah) 126  
 Jacob (ca. 1718-1798) 120, 190  
 Jacob (son of Aaron) 124  
 Jacob (1785-1786) 120  
 Jacob (1793-1831) 120  
 Jacob Levi 125  
 Jacob Loeb 125  
 Jane 126  
 Jane Louis 127, 326A  
 Jane Symmons 127, 326A  
 Jeanne 125  
 Jessie (see Isaacs, Justina Brandly (Jessie))  
 Jochabed (Johavith) (1767-1852) 220, 185  
 Jochabed (dau. of Abraham Mears) 120  
 Johavith (see Isaacs, Jochabed (Johavith))  
 John (b. 1758) 126  
 John (son of Aaron) 126  
 John (son of Myron) 127  
 John David 127, 326A  
 Jonas (1810-1873) 277  
 Joseph (b. 1763) (son of Isaac) 120  
 Joseph (b. 1763) (son of Isaiah) 126  
 Joseph (1659-1737) 124  
 Joseph (1782-1783) 124  
 Joseph (1898-1950) 160  
 Josey (dau. of Jacob) 120  
 Joshua (d. 1744) 124, 154  
 Joshua (1744-1810) 124, 150  
 Joshua (1832-1883) 124  
 Judah (b. 1775) 120  
 Judah (son of Abraham) 120  
 Judah M. (son of Jacob) 120  
 Judith (1723-1802) 120  
 Judith (dau. of Joseph) 124  
 Julia Ann 126

Julie Gilden 326A  
 Julien 127, 326A  
 Justina Brandly (Jessie) (1839-1885) 110, 124  
 (Justina) Brandly Lazarus 124, 151  
 Kate Havens 126  
 Katherine 93  
 Kitty 124  
 Lena Bishoff 124  
 Leni (1950-) 326A  
 Lewis (son of Aaron) 125  
 Lewis (1836-1837) 124  
 Lewis B. 127  
 Lewis M., Jr. 127, 326A  
 Lewis Myer (Montefiore) 127  
 Lily Lee Harby 93, 324B, 326A  
 Lola Tishman 124  
 Louis William 125  
 Lucretia Wickham 126  
 Marcus Cornelius 125  
 Maria Solomon (see Isaacs, Phoebe (Maria Solomon))  
 Marian 127  
 Marion Alene 125  
 Marion Harris 125  
 Mariene 160  
 Mary (b. 1728) 126  
 Mary (b. 1754) 126  
 Mary (b. 1768) 126  
 Mary (d. 1861) 33  
 Mary (m. Solomon) 124, 145  
 Mary Bullard 126  
 Mary Constance Jackson 124, 129  
 Mary Hedges 126  
 Mary Louise 125  
 Mary (Molly) 126  
 Mary Pyle 124, 162  
 Mary Rumsey 162  
 Matilda 124  
 Matilda Einstein 125  
 May Bernice Meyer 125  
 Michael 120, 150  
 Milton 160  
 Minnie 127, 326A  
 Minnie Newman 160  
 Molly (see Isaacs, Mary (Molly))  
 Montefiore (see Isaacs, Lewis Myer (Montefiore))  
 Moses (b. 1807) 120  
 Moses (d. 1827) 120  
 Moses (1737-1798) 120, 190  
 Moses Montefiore (1841-1902) 124  
 Moses S. (b. 1810) 120  
 Myer Samuel (1841-1904) 102, 127, 326A  
 Myer Samuel 127, 326A  
 Myron S. 127, 326A  
 Nancy West 126  
 Newmark 125  
 Ninny 127  
 Olivia (b. 1852) 125  
 Patricia 125  
 Patricia Bardach 108  
 Patsy Isaiah 126  
 Pauline 160  
 Philip (b. 1836) 277  
 Phoebe 126  
 Phoebe Maria Solomon 102, 127, 326A  
 Phoebe Miller 126  
 Rachel (dau. of Joseph) 124  
 Rachel (m. Solomon Hart) 92  
 Rachel (1781-1803) 120  
 Rachel Cornelia 125  
 Rachel Lewis 172  
 Rachel Sarah 124  
 Rachel (1858-1904) 326A  
 Ralph (b. 1741) 126  
 Ralph (m. 1725) 126  
 Raymond 160  
 Rebecca (b. 1845) 127  
 Rebecca (b. 1850) 124  
 Rebecca (dau. of Aaron) 125

Rebecca (m. 1722) 124, 272  
 Rebecca (N. Y., 1695) 124  
 Rebecca (1772-1775) 120  
 Rebecca (1860-1868) 125  
 Rebecca Abraham 2  
 Rebecca Cohen (1814-1880) 99, 120  
 Rebecca (-1887) 326A  
 Richa (b. 1784) 120  
 Richard 108  
 Richard Mordecai (1783-1810) 126  
 Riche (1733-1796) 63, 120  
 Richea (m. 1810) 120  
 Robert 160  
 Robert Harris 125  
 Robin Ann 125  
 Rosalie Felbel 73  
 Rosalind 125  
 Rose 160  
 Ruth (b. 1771) 126  
 Ruth (dau. of Samuel) 125  
 Sally Raphael 124  
 Sampson (1790-1791) 124  
 Sampson Mears (1777-1859) 31, 120  
 Samson M. (b. & d. 1783) 120  
 Samson M. (1779-1780) 120  
 Samuel (b. 1726/7) 126  
 Samuel (b. 1766) 126  
 Samuel (m. Mary Bullard) 126  
 Samuel (son of Aaron & Esther) 126  
 Samuel (son of Aaron) 125  
 Samuel (son of Samuel) 126  
 Samuel Myer (1804-1878) 127, 326A  
 Sarah (b. 1735) 126  
 Sarah (d. 1872) 126  
 Sarah (dau. of Aaron) 125  
 Sarah (Molly) 120  
 Sarah (m. Benjamin) 126  
 Sarah (1760-1807) 126  
 Sarah Cohen 127  
 Sarah Haya (1790-1811) 120  
 Sarah Kahn/Cohen 127  
 Sarah Lopez (1770-1860) 120, 217  
 Saul 160  
 Sidney (see Ingram (Isaacs), Sidney)  
 Solomon (d. 1757) 124, 145  
 Solomon (d. 1793) 124  
 Solomon (m. Hannah Meyers) 124  
 Solomon (son of Asher) 124  
 Solomon J. (1786-1855) 124, 147  
 Sophie Ruth 125  
 Stanley 127  
 Stanley Myer (b. 1882) 127, 326A  
 Stanley Salant 127  
 Susan (b. 1921) 125  
 Susan (m. 1875) 126  
 Susan Gassoway 126  
 Theodore Edwin (b. 1816) 120  
 Thomas (son of David) 126  
 Thomas (son of Samuel) 126  
 Tucker 126  
 Victor 73  
 Virginia Grace (1834-1881) 124  
 Walter 122  
 Walter Scott (b. 1857) 124  
 Washington 120  
 Washington Samsom (1847-1919) 124  
 William Bradford 125  
 William E. (b. 1809) 126  
 Zeby (see Isaacs, Henry (Zeby))  
**ISAACS (VAN BRUND)**  
 Aaron 124, 162  
 Robert (b. 1910) 124  
**ISAACSON**  
 Alfred Henry (1833-) 328B  
 Amie B., 328B  
 Belle McVea 328B  
 Catherine 233  
 Hannah Caroline 233  
 Harry Jr. 328B  
 Harry (see Isaacson, Henry M.)  
 Henry M. 150, 328B  
 Kate Marks 150, 328B  
 L. Daniel 328B

Morris (d. 1839) 150, 328B  
 Rebecca Lazarus 150, 328B  
 Victoria 328B  
**ISEMAN**  
 Gladys Baruch 47  
 Lucile 207, 333B  
 Polly Grumble 208  
**ISENBERG**  
 Alma (b. 1890) 15  
**ISIDRO**  
 Leah Oliveira 225  
**ISRAEL**  
 Abigail 128  
 Abraham 121  
 Abraham Eliezer (1776-1852) 16, 128  
 Arabella 128  
 Carrie 39  
 Corinna Florance Moses 210  
 Daisy 121  
 Eliezer Joseph (1751-1818) 128  
 Eliza (1784-1860) 114, 139  
 Eliza Taggart 128  
 Elizabeth (dau. of Leon) 121  
 Elizabeth (dau. of Samuel) 128  
 Flora 215  
 George I. 134  
 George I. III 134  
 George I., Jr. 134  
 Gomperts 131  
 Hannah (dau. of Israel) 128  
 Hannah (see also Israel, (Hannah) Rebecca)  
 Hannah (1743-1825) 131  
 Hannah Erwin 128  
 Hannah H. 128  
 Hannah Helbert 114  
 (Hannah) Rebecca (ca. 1788-1818) 69, 128  
 Henry 121  
 Isaac Eliezer (d. 1818) 128  
 Isabelle (1881-1907) 121  
 Israel (son of Eliezer Joseph) 128  
 Israel (son of Samuel) 128  
 Israel (1744-1822) 128  
 Israel, Jr. (d. 1808) 128  
 James Hutchinson (d. 1832) 128  
 Jean Lisette 134  
 John 114  
 John Samuel 128  
 Joseph (d. 1804) 128  
 Joy (b. 1860) 121  
 Leah (b. 1878) 121  
 Leon (1836-1913) 121  
 Letitia 128  
 Lisette B. Jacobs 134  
 Mabel 121  
 Margaret Jones 121  
 Marion J. Kerr 134  
 Martha (dau. of Abraham Eliezer) 128  
 Martha (dau. of Eliezer Joseph) 128  
 Martha (m. Eliezer Joseph Israel) 128  
 Mary (dau. of Israel) 128  
 Mary Hartford 128  
 Mary J. Paxton 128  
 Mary L. 128  
 Mary Matilda Hyman 121  
 Melvin M. 210  
 Melvin, Jr. (d. 1911) 210  
 Menahem (see Abrahams, Emanuel (called Menahem Israel))  
 Michael (in Phila.) 128  
 Michael E. (d. 1840) 128  
 Michelle 134  
 Minnie 121  
 Miriam (b. 1884) 121  
 Morris 323B  
 Phineas (see Johnson, Phineas Israel)  
 Phoebe 128  
 Rachel (b. 1882) 121  
 Rachel (dau. of Rosy Israel Levy) 170  
 Rachel (sister of Joseph I. Levy) 170  
 Rebecca 323B  
 Rebecca (1864-1944) 121

Rosetta (1786-1854) 128  
 Rosey 170  
 Ruth Flora 134  
 Samuel (d. 1835) 128  
 Samuel (in N. Y. 1783-1786) 170  
 Samuel (son of Leon) 121  
 Sarah Barnett (1794-1884) 16, 128  
 Susan (dau. of Samuel) 128  
 Susan (dau. of William) 128  
 William 128  
**ISRAELS**  
 Rebecca 305  
**ITTELESON**  
 Roslyn 90  
**IZEMAN**  
 Lucile 207  
 P. G. 208  
**JACKS**  
 Ben 326A  
 Caroline 326B  
 Hannah 326A  
 John W. 326A  
 Mae 326A  
 Morris 326A  
 Phineas 326A  
 Trephenia Johnson 326A  
**JACKSON**  
 Abraham (b. 1820) 130  
 Abraham (b. 1825) 130  
 Abraham (1813-1814) 119  
 Abraham I. (1815-1877) 129  
 Abraham J. 129  
 Abraham W. 130  
 Abram Eugene 130  
 Ada (1845-1924) 130, 202  
 Adele R. 129  
 Alice 129  
 Amelia (b. 1830) 130  
 Anna 130, 326A  
 Annie Josephine (b. 1850) 8, 130, 171  
 Annie Miller (see Jackson, Helen ('Annie') Miller)  
 Benjamin (b. 1861) 129  
 Benjamin (m. Eleanor S. Solomons) 276  
 Bertha 130  
 Blanche J. 130  
 Caroline H. (b. 1875) 130  
 Caroline Herz 130  
 Caroline Seimas 264  
 Cecil 122  
 Charlotte Louise 220  
 Charlotte Myers 220  
 Clifford 130  
 Corinna Florance 74, 129  
 Corinne (b. 1866) 129  
 Daniel (d. 1906) 129  
 Daniel (Gedalya) (ca. 1780-1841) 129, 310B  
 David 130  
 Delia 130  
 Eleanor 130  
 Eleanor Alexander 8  
 Eleanor Susan ('Toai') Solomons 276  
 Eleazer (b. 1834) 130  
 Elias 130  
 Eliza (see also Jackson, Lydia ('Eliza'))  
 Eliza (1864-1933) 130  
 Elizabeth (dau. of John Joseph) 130  
 Elizabeth (m. Louis A.) 129  
 Ellen ('Nellie') 34, 130, 171  
 Emily P. Goodman 254  
 Esther (b. 1861) 125  
 Ethel (b. 1877) 129  
 Eugene (1844-1853) 130  
 Eugene J. (1833-1883) 32, 74, 129  
 Eva Maria (d. 1888) 129  
 Eva Rachel (b. 1838) 129  
 Evelyn 130  
 Fannie Coddington 129  
 Fanny (1869-1940) 130  
 Frances Alice 220



Gedalya (see Jackson, Daniel (Gedelya))  
 George B. 130  
 Gladys Helen 199  
 Hanah Abrahams (b. 1797) 130  
 Hannah (m. Joseph) 130  
 Hannah (m. Washington) 130  
 Hannah Hyams 119  
 Harold Benjamin 130  
 Harriet 129, 243  
 Harriet Cohen (b. 1872) 129  
 Helen ("Annie") Miller 130  
 Henry 130  
 Henry W. 130  
 Irene (1855-1898) 129  
 Irma Weinstock 130  
 Isaac M. 130  
 Isabella Block 130  
 Isidore 130  
 Jean 130  
 Jessica 129  
 Jessica D. 129  
 John (b. 1796) 130  
 John (son of Leopold) 130  
 John Daniel (son of William Ward) 129  
 John Daniel (1807-1880) 129, 257  
 John Joseph (b. 1815) 130  
 John Miller 130  
 Joseph (b. 1791/2) 130  
 Joseph (b. 1853) 130  
 Joseph (son of John Joseph) 130  
 Joseph (son of Leopold) 130  
 Joseph A. (1811-1873) 129, 137  
 Joseph Jacob (b. 1825) 130, 171  
 Judah (b. 1824) 130  
 Kate B. 129  
 Katherine 276  
 L. W. 219  
 Leah (1840-1907) 129  
 Leonora Myers 219  
 Leopold 130  
 Lillie Finestone 122  
 Lloyd 129  
 Louis A. (d. 1917) 129  
 Louisa 130  
 Lydia ("Eliza") 130, 257  
 Major Noah (1853-1877) 129  
 Manuella (1842-1910) 13, 129  
 Maria 129  
 Mariam ("Mary") 130  
 Martha 130  
 Mary (see also Jackson, Mariam ("Mary"))  
 Mary 130  
 Mary Aaron 129  
 Mary Constance (1851-1922) 124, 129  
 Mary Miller 114  
 Mary Phillips 129, 310B  
 Maurice (see Jackson, Morris (Maurice))  
 May C. (b. 1867) 129  
 May Imman 129  
 Maybelle 130  
 Meiba 15  
 Michael 130  
 Miriam 130  
 Montague 119  
 Morris (Maurice) 130  
 Morris 130  
 Muriel 130  
 Myrtilla Florence (b. 1860) 98, 129  
 Naphtali Hart (d. 1882) 129  
 Nellie (dau. of Daniel) 34, 130, 171  
 Nellie (dau. of Joseph J.) 129  
 Nellie (see also Jackson, Ellen ("Nellie"))  
 Nigel 122  
 Orton P. 254  
 Percival Ephraim 130  
 Percy Florence (1859-1860) 129  
 Philip N. 129  
 Rachel (b. 1851) 13, 130

Rachel Rosalie 13, 130  
 Rebecca (b. 1866) 130  
 Rebecca (dau. of Joseph J.) 130  
 Rebecca (1836-1888) 129, 210  
 Rebecca Coben 32, 129  
 Rebecca E. (1810-1866) 129, 232  
 Rosetta Lewis 130, 171  
 Rosette Ritterband 130  
 Samson 130  
 Samuel (b. 1837) 130  
 Samuel (1807-1857) 129  
 Sarah Louisa Salomon 129, 158  
 Sarah Rebecca Jones 129, 137  
 Sarah Waldman 130  
 Susanna 120  
 Simeon 130  
 Solomon 129  
 Solomon Henry (b. 1865) 130  
 Solomon Henry (d. 1846) 130  
 Susanna 120  
 Sylvia N. 130  
 Thomas Reed 220  
 Washington 130  
 Wellington 130  
 William H. 130  
 William Noble 264  
 William S. (1835-1890) 130  
 William Ward (d. 1922) 129  
 William Ward, Jr. 129

**JACOB**  
 Alfred (b. 1846) 13  
 Bertha Frances (b. 1844) 13  
 Ephraim (b. 1845) 13  
 Famelia Arnold 13  
 Grace Augusta Zuntz 308  
 Jemima Lindo De Sola 115  
 Julia Ann Seixas 264  
 Julius 13  
 Laurence 115  
 Magdalene 329A  
 Marcus 308  
 Miriam Alexander 122  
 Moritz (b. 1824) 264  
 Nathan (1843-1916) 122  
 Zipporah 121, 122

**JACOBI**  
 Abraham 58  
 Alice 311A  
 Edward Jacob 117  
 Edyth 311A  
 Elizabeth Elenor 117  
 Emile 310B  
 Georgiana Sarah 117  
 Hester Eger Hertz 117  
 Lester 311A  
 Louis 117  
 Mathilda Adelaide 117  
 Nathaniel 117  
 Priscilla Rebecca Barnet 117  
 Sadie 311A  
 Samueline Heydenfeldt 58  
 Saaford 311A  
 Sarah Simon 148, 310B  
 Wolf Jacob (1799-1866) 117

**JACOBOWITZ**  
 Lois Clarice Levy 167  
 Theodore J. 167

**JACOBS**  
 Abigail (d. 1847) 131  
 Abigail (sister of J. I. Levy) 170  
 Abraham (Alfred) (1824-1849) 132  
 Abraham (son of Simon) 309B  
 Abraham 134  
 Abraham (Abram) (1755-1834) 98, 131  
 Ada 134  
 Adelaide 131  
 Adele Anspacher (1831-1917) 22  
 Adeline (dau. of Samuel) 134  
 Adeline H. (b. 1896) 134  
 Adeline Hyneman (d. 1959) 134  
 Adeline H. (1896-1959) 134  
 Adeline Hyneman Levy 134, 162  
 Adeline M. (1820-1862) 66, 132

Albert 125  
 Alexander E. 107  
 Alexena 107  
 Alfred (see also Jacobs, Abraham (Alfred))  
 Alfred (son of Ephraim) 107  
 Alfred (1865-1866) 132  
 Alice Arnold 13  
 Amanda Isabel 132, 196  
 Angel (1795-1850) 98, 132  
 Angel Phillip (1864-1946) 132  
 Angelique Charlotte Jacinthe Verneuille 135  
 Angelique Masse 135  
 Anna Richie 134  
 Annie Cass 107  
 Annie Virginia 133  
 Augusta (1799-1800) 131  
 Barbara E. (b. 1939) 285  
 Barent (see Jacobs, Bernard (Barent, Bear))  
 Bear (see Jacobs, Bernard (Barent, Bear))  
 Benjamin (b. 1786) 131  
 Benjamin (brother of J. I. Levy) 170  
 Benjamin (son of Moses) 135  
 Benjamin (son of Rosey Israel Levy) 170  
 Benjaminia (1661-1739) 131  
 Benjamin (1738-1811) 131  
 Benjamin (1744-1824) 131  
 Benjamin, Jr. (son of Jacob) 131  
 Bernard (Barent, Bear) 132  
 Bernard (son of Solomon) 133  
 Bernard Marshall 133  
 Bernice (1881-1936) 313A  
 Bertha (1842/3-1906) 215, 253  
 Bilhah Polock 131, 252  
 Birdye 107  
 Blanche Marguerite Joel 189  
 Carol 296  
 Caroline (1836-1910) 132  
 Caroline Jay 132, 151, 326A  
 Catherine (m. Joseph) 132  
 Catherine (m. Lewis Samuel) 261  
 Catherine (1785-1831) 119, 131  
 Catherine Lewis 172  
 Cathy Dianne 189  
 Caty Hays Sarzedas 104, 131, 262  
 Charlotte (dau. of Moses) 135  
 Charlotte (m. Herbert Berrent) 107  
 Clara C. 132  
 Coleman R. 75  
 Constance (b. 1861) 132, 186  
 Corinna Phillips 132, 245  
 Cornelia Ann 39, 132  
 Daniel (son of Benjamin) 131  
 Dasha S. 134  
 David (d. 1771) 131, 272  
 David (m. 1916) 195  
 Deborah Bonitto 134  
 Dora Herz 107  
 Dora Lichtenstein 174  
 Dorothy 125  
 Edwin Mervin 189  
 Elaine Gropper 134  
 Elda 8  
 Eliza Emma 132, 234  
 Eliza Hecht 107  
 Elizabeth (Bessie) Lewis 134, 171  
 Elizabeth (m. Philip) 309B  
 Elizabeth (1794-1811) 132  
 Elizabeth G. Gombos 22  
 Elizabeth H. Weil 134  
 Elizabeth Lansberg 107  
 Ella (d. 1917) 134  
 Emilie Van Beil 134  
 Emma Bloomquist 189  
 Emma H. Moss 215  
 Ephraim (b. 1873) 107  
 Esther (Hetty) Nones 132, 133, 233  
 Esther (m. Moses) 135  
 Esther (1814-1896) 119

Ethel 107  
 Eugenie Joseph 107  
 Eva (m. Louis Trager) 134  
 Eva (1859-1953) 132, 274  
 Felix 135  
 Flora Bochroch 134  
 Frances (1789-1874) 131  
 Frances Nathan 285  
 Frances Nathan Cullman 285  
 Frances Polock (1784-1857) 131  
 Francis Boykin 133  
 Francis Marion Marks 186, 132  
 Frederick C. 132, 183  
 Frederick, Jr. 132  
 George (son of Samuel) 134  
 George (1834-1884) 134, 162  
 George (1871-1886) 134  
 George B. 134  
 George Washington (1831-1896) 7, 132  
 Georgiana (Judith) (1791-1859) 131  
 Hannah Israel 131  
 Harry 134  
 Helen (dau. of George) 134  
 Helen (dau. of Henry) 134  
 Helen Carney Winsor 158  
 Helen Spertling 125  
 Helen W. 134  
 Helene B. Brandstatter 22  
 Henrietta (Tony) 107  
 Henrietta 132  
 Henry (Jamaica) 134  
 Henry (m. Rachael Mesquita) 134  
 Henry (son of George) 134  
 Henry (son of Catherine) 172  
 Henry Harold (see Russell, Henry Harold)  
 Henry Hart 84  
 Henry S. (1827-1893) 134  
 Henry Samuel (b. 1827) 134  
 Herman (b. 1926) 189  
 Irma 97, 135  
 Isaac (1783-1784) 131  
 Isabel (m. 1849) 132, 250  
 Isabel De Leon 133  
 Isabel Maude 134  
 Isabell (dau. of George) 134  
 Israel (son of Rosey Israel Levy)  
 Israel (1714-1810) 234  
 Israel Benjamin 131  
 Jacob (b. 1742) 104, 131, 262  
 Jacob (b. 1764) 131  
 Jacob (d. 1797) 104, 131  
 Jacob (Naphtaly) (1823-1874) 132, 244  
 Jacob (son of Benjamin) 131  
 Jacob (son of Moses) 135  
 Jacob (to N. Y. 1808) 309B  
 James Levy 135  
 Jean Baptiste 135  
 Jennie 134  
 John (son of Moses) 135  
 Jonas 134  
 Joseph (b. 1770) 132  
 Joseph (d. 1867) 215  
 Joseph (son of Myer) 125  
 Joseph (1746-1831) 131, 252  
 Josephine 8, 134  
 Judica Levy (ca. 1732-1815) 132  
 Judith (see Jacobs, Georgiana (Judith))  
 Judith Hadassah (1759-1832) 131, 221  
 Julia Abrahams 7, 132  
 Julia Matilda Lyon 134  
 Juliet 135  
 Katherine 261  
 Katherine Alexander Goldsmith 84  
 Laura Louise 132  
 Leah (b. 1857) 132, 250  
 Leah (dau. of Philip) 134  
 Leah Catherine 261  
 Leopold 134, 171  
 Levi 131  
 Lewis (son of Leopold) 134  
 Lewis (son of Philip) 134  
 Lisette B. 134

Louisa (b. 1835) 64, 132  
 Louisa Elizabeth Lyons (b. 1842) 132  
 Mae W. 125  
 Margaret Eleanor 189  
 Maria (Ritcha) (1795-1876) 131  
 Marianne (Marie Anne) 135  
 Marie 132  
 Marie Anne (see Jacobs, Marianne (Marie Anne))  
 Marie Genevieve (Polly) 135  
 Marie Josette Audet Lapoint 135  
 Marjorie 162  
 Martha 108, 325A  
 Martha J. 134  
 Mary Franks 75  
 Maud Eleanor 189  
 May 104  
 Menachem (see Jacobs, (Menachem) Manis)  
 (Menachem) Manis 135  
 Michael (m. 1864) 13  
 Michael (1792-1804) 135  
 Mildred (b. 1902) 22  
 Mildred Paelzer 296  
 Mina Margaret Wheeler 189  
 Minnie 107  
 Miriam Nones 133  
 Montefiore 125  
 Morris 174  
 Mortimer (1867-1870) 132  
 Moses (b. 1749) 135  
 Moses (son of Alexander E.) 107  
 Myer (m. Rebecca Isaacs) 125  
 Myer (1791-1861) 132, 151  
 Myron (son of Montefiore) 125  
 Naphtaly (see Jacobs, Jacob (Naphtaly))  
 Nathan (1833-1871) 132  
 Norma Jean Parker 189  
 Octavia Virginia Boykin 133  
 Percy (b. 1866) 132  
 Perla (b. 1798) 131  
 Philip (d. 1818) 309B  
 Philip 134  
 Polly (see Jacobs, Marie Genevieve (Polly))  
 Rachael E. 125  
 Rachel (dau. of Benjamin) 67, 131  
 Rachel (dau. of David) 131  
 Rachel (dau. of Moses) 135  
 Rachel (1754-1821) 32, 234  
 Rachel (1793-1870) 16, 131  
 Rachel Hart 98, 132  
 Rachel Mesquita 134  
 Ralph (see Jacobs, Raphael (Ralph))  
 Ralph 125  
 Ralph L, Jr. 189  
 Ralph Isaac (see Jacobs, Raphael (Ralph) Isaac)  
 Ralph J. 22, 144  
 Raphael (Ralph) Isaac 189  
 Raphael (Ralph) (1711-1796) 131, 272  
 Raphael (Ralph) (1782-1845) 131  
 Raphael (1801-1802) 131  
 Rebecca (b. 1868) 132  
 Rebecca (d. 1858) 134  
 Rebecca (dau. of Leopold) 134  
 Rebecca (1860-1952) 134  
 Rebecca Garnia 134  
 Rebecca Hadassah 131  
 Rebecca Isaacs 125  
 Rebecca Lazarus 132, 151  
 Reed 132  
 Regenia Marx 189  
 Richa (m. Daniel) 131  
 Richa (m. David) 131  
 Richa Simson 131, 272  
 Richard 296  
 Ritcha (see Jacobs, Maria (Ritcha))  
 Robert 296  
 Robert Al, Jr. 285  
 Robert Allan 285  
 Robert Allen 189

Robert H. B., Jr. 158  
 Rose (dau. of Leopold) 134  
 Rose (m. Victor Lewia) 2  
 Sadie 237  
 Samuel (b. 1864) 134  
 Samuel (m. Jennie) 135  
 Samuel (son of George & Elizabeth) 134  
 Samuel (son of George) 134  
 Samuel (1767-1810) 119, 131  
 Samuel, Jr. 135  
 Sarah (b. 1762) 31  
 Sarah (d. 1849) 131  
 Sarah (dau. of Moses) 135  
 Sarah (1786-1861) 131  
 Sarah (1793-1864) 234  
 Sarah (1869-1958) 143  
 Sarah Simson 131, 272  
 Shankey Hart 98, 131  
 Shirley 107  
 Shirley Hofstadler 189  
 Simon (b. 1888) 174  
 Simon (d. 1807) 309B  
 Sipporah 134  
 Solomon (1777-1827) 132, 233  
 Solomon Bernard (b. 1828) 133  
 Stanley Ralph (b. 1898) 22, 309A  
 Stella (1863-1934) 132  
 Susan Elizabeth Moise 195  
 Suzanne (b. 1909) 255, 310B  
 Thelma 107  
 Therese 135  
 Thomas 135  
 Thomas Matthew 158  
 Tony (see Jacobs, Henrietta (Tony))  
 Trisha Marie 158  
 Victoria (b. 1837) 132, 250  
 Virginia (d. 1827) 133  
 Virginia (dau. of George) 134  
 Virginia Brandon 134  
 Washington 132  
 William Charles 189  
 Yitlah (b. 1769) 131  
 Zillah (b. 1873) 132  
 Zipporah Nunez Machado 234

**JACOBSEN**  
 Jane Ellen Rothschild Ferguson 334B  
 Robert 334B

**JACOBSON**  
 Arthur 100  
 Edna Hart 100  
 Joan 296  
 Martin (Moses) Lazarus (1817-1880) 69  
 Moses Lazarus (see Jacobson, Martin (Moses) Lazarus)  
 Rebecca De Castro 69

**JACOBUS**  
 Hester 92, 221  
 Rebecca Hart 92  
 Rebecca Mannahan 58  
 Simon Moses 92  
 Susannah Moses Hamburger 92

**JACOBWITZ**  
 Ann Claire 167  
 Charles 167  
 Ellen Sue 167

**JACOBY**  
 Alice Louise (b. 1952) 275  
 David Alexander (b. 1948) 275  
 Deborah Davidson 215  
 Donald L. 215  
 Edith Sharon (b. 1950) 275  
 Eva Maria Jackson 129  
 George Washington 215  
 Geppy 129  
 Helen Moss Lowengrund 215  
 Kathe Solis-Coben 275  
 Kathryn Moss 215  
 Levi Harold 129  
 Marvin E. 275  
 Max (d. 1910) 129  
 Miriam (1917-) 327A

Oswald N. 129  
**JACQUES**  
Harriet 233  
**JADD**  
Phyllis Lefcowitz 236  
**JAFFA**  
Adele Rosa Solomons 276  
Aileen (b. 1900) 276  
Edward Moss (b. 1896) 276  
Myer E. 276  
Robert 276  
Sylvia Roberts 276  
**JAFFE**  
Alex (b. 1911) 43  
Henrietta Marks 186  
Ludwig (b. 1844) 186  
Melanie Friedman (b. 1913) 43  
**JAFFER**  
Ada Virginia 162, 329B  
Aubrey 162, 329B  
Harold 162, 329B  
Joel 162, 329B  
Martin Samuel (1984-) 329B  
Roberta Mills 329B  
**JAFHA**  
Dora Guggenheimer 89  
Edna May 89  
Frank 89  
Solomon 89  
Suzanne 89  
**JAMES**  
Eliza Frances 11  
Janice 309A  
**JANDORF**  
Blanche 160  
Clarence 160  
Elsie 160  
Grace 160  
Harry 160  
Louis 160  
Pfeiffer 160  
Rachel Shneberg 160  
Sadie 160  
Sidney 160  
**JANNEY**  
Joan 104  
Maud Hays 104  
Nelson 104  
**JAPETH**  
Minnie (1858-1924) 51  
**JAPHA**  
Ephraim 160  
Samuel 160  
**JARVIS**  
Fannie E. 336B  
**JECHIEL**  
Noah Moses 324B  
**JEDDIS**  
Constance 22  
Constance Floersheimer 22  
**JEDJES**  
Constance 22  
**JELENKO**  
Minna Rosenheim 255  
Nanette 255  
Victor 255  
**JELINEK**  
Heloise 327B  
**JENKINS**  
Cheryl Jean Rubenstein 311B  
David Nunez 213  
Edgar M. 220  
Elizabeth 298  
Elizabeth Dicens Smith 298  
Elizabeth Tobias 298  
Emelie Elizabeth 298  
Frances Myers 220  
Kelli Dee Ann 311B  
Louisa E. 117  
Mary Anne 298  
Nelda Margaret 164  
Raphael Henry 213  
Reon I. Nunez 213

Sophie 298  
William E. 298  
William E. III 298  
William E., Jr. 298  
William McKenzie III 311B  
William McKenzie IV 311B  
W. Leslie 213  
W. Leslie, Jr. 213  
**JENNINGS**  
Anne 208  
Armida Moses 206  
Arthur 206  
Chester 25  
Claudia Wannamaker 208  
Clem Buchanan 208  
Dell H. 208  
E. B. 25  
Earnest 25  
Frances Dell Hartt 208  
Frederick 88  
Gertrude Olivia (b. 1813) 168, 311B  
Jean Cole 88  
Jean Harvey Stroman 208  
Juliet Pauline Block 25  
Katherine Armida 206  
Octavia Harby Moses 208  
Orville 25  
Robert H. IV 208  
Robert H. III 208  
Robert Hastine 208  
Robert Hastine, Jr. 208  
**JENSEN**  
Barbara Judah 140  
Frederick 140  
**JEREMIAH**  
Louise 184  
**JESSIE**  
Fannie (b. 1859) 220  
Hattie 172, 220  
John (1817-1896) 220  
Rosina Le Jeune 220  
**JESSILSON**  
Florence (b. 1880) 253  
**JESSUP**  
Charlotte 140  
Edward (d. 1808) 140  
Edward Conroy 140  
Esther Judah 140  
Mary (1813-1869) 265  
**JESSURUN (JESURUN)**  
Francis 241  
Jacob 241  
Leah Peixotto 241  
Levine (b. 1863) 241  
Moses de Jacob 241  
Moses de Moses 241  
Ribca de Jacob de David 85  
Rosavina 59  
Solomon 16  
**JESSURUN RODRIGUES**  
Joseph (see Salvador (or Jessurun  
Rodrigues), Joseph)  
**JESURUN**  
Edward 241, 338A  
Leonie 241, 338A  
Luna (Lunita) Peixotto 241, 338A  
Mortimer 241, 338A  
Moses de Moses 241, 338A  
**JETT**  
Almedia 25  
Benjamin J. 25  
Benjamin P. 25  
Charles 25  
Edwin D. 25  
Emma 25  
Eugene 25  
Hester Block 25  
Irene Royston 25  
Kate Green 25  
Lula Brooks 25  
Lulie Wright Belt 25  
Mary 25  
Rose 25

Sevier 25  
William Augustus 25  
**JEWEL (OR JUHEL)**  
Elizabeth (1759-1835) 300  
**JEWELL**  
Rachel Lyons 183  
Wilson 183  
**JEWETT**  
Helen 155  
**JOACHIMSEN**  
Caroline Cohen 35  
Joseph P. 35  
**JOACHIMSSSEN**  
Adelaide 136  
Bertha (1821-1880) 136  
Eleazer (see Joachimssen, Henry  
(Eleazer))  
Hannah 136  
Henry (Eleazer) (b. 1833) 136  
Johanna Goldsmid 136  
Louis (1791-1870) 136  
Luiza 47, 136  
Phillip Joseph (1816-1890) 136  
Priscilla Godfrey 136  
Rachel (d. 1832) 136  
Sarah (d. 1855) 136  
Ternina Pinsk (1794-1874) 136  
**JOCHANAN**  
Rachel 139  
**JOICHEM**  
Charles 166  
Dorothy Levy McCloud Pitts 166  
**JOEL**  
Betsy Van Ronkel 189  
Blanche Marguerite 189  
Caroline 121  
Edwin Mandel 189  
Elbert 189  
Elbert, Jr. 189  
Elizabeth 121  
Esaac 64  
Esther (1846-1895) 64  
Isabella 121  
Isiah 64  
Joseph 121  
Lazarus 1  
Lena Ehlbert (see Joel, Pauline (Lena)  
Ehlbert)  
Mariana Aarons 1  
Moses 189  
Natalie 189  
Pauline (Lena) Ehlbert 189  
Polly Davids 50  
Rachel 16  
Rosina Hyman 121  
Samuel 121  
Sol 121  
Tarris 189  
Tarris Maas 189  
**JOHNSON**  
Abraham 64  
Agnes Sarah Browne 81  
Alice Mitchel 81  
Allen 81  
Allen Anthony 81  
Allen Bayard 81  
Allen Edwin 81  
Allen Ralph 81  
Allen Victor 81  
Alured Clarke 81  
Alured Fitzowen 81  
Angela Mary Hibbert 81  
Annie 81  
Archibald Acheson 81  
Arnold Burgess 129  
Arthur 81  
Arthur Acheson 81  
Arthur Cyril Beaumont 81  
Augusta Ellis 64  
Barbara Patty 81  
Beatrice 81  
Belle Levy 135  
Bertha 81

Betsy Milnor 81  
Blanche Rosenfeld 135  
Buffy (1974-) 323B  
Elizabeth (1759-1835) 300  
Catherine Delicia Walters 81  
Cecilia Pollock 135  
Charles Cooper 81  
Charles Dwight 326B  
Charles Edward 81  
Charles Robert 81  
Charles W. (1846-) 326A  
Charlotte 76  
Charlotte Elizabeth Phillipse 81  
Christopher Allen 81  
Clara H. (1836-1839) 326B  
Clara (1864-) 326B  
Clarissa Harlow Clarke 326A  
Corinne Jackson 129  
Cyril Martin Hugh 81  
Daphne Letitia 81  
David (m. Estella Rosenham) 255  
David (m. Fanny Sturm) 135  
David I. 135, 326B  
David Israel (b. 1795) 135, 326B  
David Porter 135  
David (1850-1867) 326B  
Della Bennett 81  
Diana Evelyn (b. 1935) 81  
Dorothy Nora Gurney 81  
Edgar M. 135  
Edgar M. III 306  
Edgar N. 135  
Edward C. (1819-) 326A  
Edward I. 135  
Edward Israel 135  
Edwin Beaumont 81  
Eileen Mothersill Johnstone 81  
Eleanor Leighton 311B  
Eleanor Marjorie Levy 164, 311B  
Eleanor Moses (dau. Edward I.  
Johnson) 135  
Eleanor Moses 135  
Eliot Phillipse 81  
Eliza 135  
Eliza Davis 135  
Elizabeth (m. Baruch Frederick Weber  
Hart) 96  
Elizabeth (m. 1936) 128  
Elizabeth Alexander 8  
Elizabeth Schlessinger 8  
Elizabeth (1842-1908) 326A  
Ella Dyson 81  
Ella Gertrude 135  
Emma Patty Barclay 81  
Estella Rosenham 255  
Eather Phoebe (1848-1903) 326B  
Eather Rosenhaus 135  
Ethel Dora Row 81  
Evelyn Leng 81  
Fanny Sturm 135  
Fleurette 135  
Frances 81  
Frances Block 25  
Frances M. Johns 135  
Frances Ralph 81  
Frances Rebecca 81  
Fred L. 135  
Frederica 21  
Frederick 135  
Frederick A. III 135  
Frederick Augustus 135, 326B  
Frederick Augustus, Jr. 135  
Frederick Pigot 81  
Frederick William 135  
George Harris 135  
George Pigot (son of Henry) 81  
George Pigot (son of Thomas) 81  
George Vanderbeyden 81  
George W. (1866-) 326B  
George Washington (1827-1886) 326B  
Georgina Orde-Powlett 81  
Gertrude (Gettie) Cohen 135, 306  
Gettie Cohen (see Johnson, Gertrude  
(Gettie) Cohen) 135

Gilbert Ward 81  
Gordon 326B  
H. W. 8  
Harold Albert 81  
Harriet Maria 81  
Harrison William 8  
Hart 326B  
Henry 75, 81  
Henry Allen 81  
Henry Allen Beaumont 81  
Henry Allen William 81  
Henry Davis 135, 326B  
Henry Franks Frederick 81  
Howell Hardin (1863-) 326B  
Hugh Walters Beaumont (b. 1865) 81  
Isabella 81  
James W. 135, 326B  
Jane (dau. of Frederick) 135  
Jane (m. Clergue) 81  
Jane Leake 81  
Jane Lees 135  
Jane Webb Rafferty 326A  
Jemima Anne Frances Martin 81  
John S. (1844-1844) 326B  
Joseph 64  
Joseph Milnor 81  
Joyce Thais 208  
Judith Emily 323B  
Julia H. Magee 80  
Julia Moses 135  
Kate V. Nelson 135  
Katherine Avery 80  
Laura Benjamin F., 326B  
Laura Louis 135  
Lawrence 135  
Lawrence Edward 80  
Leighton 164  
Lewis S. (1824-1867) 326B  
Lillian Ethel Casse 257  
Lionel Pigot (b. 1867) 81  
Louisa Charlotte 81  
Louisa Davis 135  
Louisa Mary 81  
Louise Emily 135  
Lucinda 81  
Madeline 80  
Margaret 135  
Margaret Louise 81  
Margaret Ward Butler 81  
Maria Jane 81  
Marie M. Roaney 80  
Marion Trustlove 81  
Mary 76  
Mary Anne Kelley 326B  
Mary Elizabeth 299  
Mary Inkson 81  
Mary Kay 147  
Mary Louise 135  
Matilda Carnegie-Arbutnot 81  
Matilda Marion 326A  
Mattie L. (1875-) 326B  
Maud Taylor 81  
May Cunningham 135  
Michael J. 238  
Millicent Hamilton 81  
Miriam Louise (1852-1930) 326B  
Molly Payne 81  
Monica Lena 81  
Morris Winder 80  
Muriel Charlotte 81  
Nancy Ann Threlkeld 311B  
Ned (1869-) 326B  
Nellita F. (1866-1943) 258  
Olivia Elizabeth 81  
Oswald Carnegie 81  
Patricia Danino 81  
Paul (1944-) 323B  
Percy Eliot 81  
Phineas I. Jr., M.D. (1829-1876) 326B  
Phineas Israel 135, 326A  
Phineas (1847-1847) 326B  
Phoebe Wyna Elias 81  
Phyllis Ida 81

Rachel Walton 81  
Ralph 326B  
Ralph 81  
Rebecca Franks 75, 81  
Richard Cardozo 164, 311B  
Richard Huston 135  
Richard W., Jr. 164, 311B  
Richard Woodhouse 164  
Robert W. III 80  
Robert W., Jr. 80  
Robert Winder 80  
Roberta Joanna Portinger 81  
Roberta Wood 157  
Robin Eliot (b. 1929) 81  
Rosalie Eugenia 80  
Rosalie Morris 80  
Sallie 189  
Samuel F. (1838-1877) 326B  
Samuel J. 135, 326B  
Samuel J. III 135  
Samuel J., Jr. 135  
Sara L. Avery 80  
Sarah 121  
Selina 135  
Selina Emma 135  
Simeon Moses 135, 306, 326B  
Sophia Missouri (1854-1927) 326B  
Susan 76  
Susan Ellen Ewart 81  
Susan Marie Stedman 238  
Susannah De Lancey 76  
Theresa Workum 306  
Theresa (1867-) 326B  
Thomas 81  
Thomas Robert 81  
Timothy Ben (1971-) 323B  
Victor George Ralph (b. 1861) 81  
Victor Phillipse Hill 81  
Violet Eudaly 326B  
W. P. 293  
Walter Pierce 81  
Wilbur August (b. 1920) 257  
William (m. Susannah De Lancey) 76  
William (son of Allen Ralph) 81  
William Davies 25  
William Victor 81  
Winifred Mena Hill 81  
Zanetta Appolina (1861-1940) 326B  
**JOHNSTON**  
Bertine (Birdie) Thorman 293  
Birdie Thorman (see Johnson, Bertine  
(Bertha) Thorman)  
Dorothy Irene De Lea 55  
Ellen S. (1822-1852) 336B  
Emily 32  
Jesse Roy, Jr. 55  
Marguerite 276  
Maude 49  
**JOHNSTONE**  
Annie Lazarus 150, 328B  
Eileen Mothersill 81  
Hermine Cary 88  
Hermine Cary Gratz 88  
John 88  
John Humphrey 150, 328B  
Juliet Block Carmody 24  
**JONAS**  
Abraham 25, 136  
Alice Rachel Schwab 287  
Aline Gibbs 136  
Alroy 136  
Anne Elizabeth 136  
Annie (b. 1839) 136, 209, 211  
Annie Ezekiel 136  
Baruh 136  
Benjamin 136  
Benjamin F. 25, 136  
Benjamin Franklin (b. 1834) 25, 136  
Benjamin Franklin (son of Benjamin  
Franklin) 136  
Charles Henry 25  
Charles Henry, Jr. 136  
Daniel Saal 287

David Saal 287  
Edward (son of Benjamin) 136  
Edwin 136  
Ellen M. 287  
Eva 183  
George (son of Abraham) 136  
George (son of Benjamin) 25, 136  
Hannah 246  
Harriet 136  
Isabelle 136  
Jessie (1736/8-1818) 139  
Joseph (1792-1869) 136, 264, 326B  
Joseph B. (1858-1887) 136  
Josephine Block 25, 136  
Julian 136  
Lee (see Jonas, Leon, Jr. (Lee))  
Lee Ann (b. 1964) 287  
Leon (b. 1887) 287  
Leon, Jr. (Lee) 287  
Louisa Block (m. 1829) 25, 136  
Louise 136  
Lucia 25, 136  
Lucy Orah Seixas 136, 264  
Martha Oppenheim 136, 326B  
Michael Benjamin (b. 1843) 136, 326B  
Millicent Saal 287  
Rachel Seixas 136, 264  
Rosalie (dau. of Abraham) 136  
Rosalie Block 25, 136  
Rosetta (1841-1917) 136, 211  
Samuel 136  
Samuel Alroy 136  
Sarah (b. 1846) 136, 235  
Sarah (ca. 1795-1846) 136, 210  
Sarah Block 25, 136  
Teresa Barbara 136  
William Stix 287

#### JONES

Adelaide 120, 137  
Al 237  
Alfred Timons (1822-1888) 137, 182, 326B  
Andrew Abner (b. 1850) 137  
Andrew Abner (1777-1850) 137, 185  
Arabella Levy 154, 158  
Benjamin G. 166  
Bertha 137  
Bobby Jane Stern 282  
Charles Nelson 112  
Chris William (b. 1946) 257  
Current 196  
David 137  
Dorothy 11  
E. Lee 158  
E. C. 137  
E. D. 137  
Edith (1847-1856) 137  
Elinor (Nell) 55  
Elisha 126  
Eliza 137  
Elizabeth 327B  
Elizabeth Isaacs 126  
Emilie G. 137  
Emmaline Levy 166  
Esther 137, 326B, 333B  
Florence 166  
Florrie Gambatti 117  
Floyd 129  
Frank (1856-1923) 129  
George L. 200  
Helen Elizabeth 33  
Henrietta 205  
Henrietta Mikell Brown 205  
Ida (b. 1853) 129, 326B  
Israel 137, 326B  
Jack Lee (b. 1950) 257  
Jacqueline Harby Hart (1900-1954) 98  
James Morris 154, 158  
Jessica (1824-1902) 48, 137  
Jessica Lyons 137, 182  
John 205  
Julia 137, 326B  
Kate Mayer 20

Kendall P. 336A  
'La Velle' Rothgeiser (see Jones, Rose ('La Velle') Rothgeiser)  
Louise (Lula) Moise 196  
Margaret 121  
Margaret E. 156  
Margaret Mackay 200  
Marian 91  
Marjorie Fletcher Nones 336A  
Martha Adams Moran 158  
Martha Levy (1788-1849) 158  
Mary A. 137  
Mary Hart 272  
Miriam (Maria) Marks Barnett 16, 137, 185  
Miriam Jessica (b. 1878) 137  
Nell (see Jones, Elinor (Nell))  
Nell 55  
Oscar 137  
Peppina Avezzano Silverman 129  
Rachel 201  
Rachel Gray 77  
Rebecca 137  
Rebecca Hart (1849-1894) 137, 243, 326B  
Rebecca Touro (1823-1857) 137  
Rebecca Zellner 137  
Robert Alexander 98  
Rolly 20  
Rose ('La Velle') Rothgeiser 237  
Roy 129  
S. J. 137  
S. K. 272  
Samuel (d. 1809) 137  
Samuel (son of Elisha) 126  
Sarah (b. 1835) 137  
Sarah (m. Solomon Mannahan) 58  
Sarah (m. Solomon Weiner) 137  
Sarah A. Henry 114  
Sarah Amanda 137  
Sarah Gutteres Henriques 112  
Sarah Rebecca (1809-1880) 129, 137  
Shirley Mary Schaefer 125  
Solomon I. 137  
Thomas 282  
Una Adelaide Schmidt 257  
Walter E., Jr. (b. 1944) 257  
Walter Edwin, Jr. 257

#### JONGH

See De Jongh

#### JORDAN

F. Carrick 324B  
Leah Elizabeth Kline 324B  
T. C. 103

#### JORDY

Frederick J. 165

#### JORGE

Catherina Henriques 273  
Fernaõ 273  
Marquessa Lopes 273

#### JORGENSON

Bettie Ann 268

#### JOSEPH

See also Josephs

Abraham (d. 1886) 46, 138  
Abraham (son of Naphtali) 138  
Abraham H. (1815-1886) 46, 138  
Abraham Pinto (1883-1922) 138  
Ada 138  
Adele 294  
(Agnes) Kathleen (see Joseph, (Agnes) Kathleen Davies)  
(Agnes) Kathleen Davies 13  
Alan 138  
Alfred (see Joseph, (Alfred) Hugh)  
(Alfred) Hugh 138  
Alfrida 34  
Alice Falk 172  
Amy 18  
Andrew 138  
Andrew Cohen (1852-1921) 138  
Anita Rosner 138  
Ann Goulding 138

Annabel (Isobel) 139  
Annette Pinto 61, 138  
Antony 138  
Arthur (b. 1904) 172  
Arthur (son of Lizar H.) 139  
Arthur (1838-1841) 137  
Arthur Wellesley (d. 1916) 34  
Audrey 138  
Augustus Lazarus (b. 1826) 137  
Avery 139  
Barbara 137, 310B  
Barbara Moore 172  
Benjamin Solomons (1811-1820) 138  
Billy (see Joseph, William Kenneth (Billy))  
Brian (b. 1926) 2  
Carey Gratz Horace 138  
Caroline Murat 138  
Caroline Weil 294  
Catherine (dau. of Lizar H.) 139  
Catherine (dau. of William K.) 138  
Catherine (1810-1876) 46, 138  
Catherine Lazarus 326B  
Catherine Octavia (1854-1916) 61, 138  
Cecile 139  
Cecilia Alice (-1893) 322B  
Celine Lyons 138  
Charles (son of Israel) 34  
Charlotte 139  
Christopher Edward 138  
Clara 321A  
Clara 139  
Clarisse Louise Myers 138  
Claudine (1840-1916) 46, 137  
Cornelia 139  
Crimea Harriet (1855-1941) 61, 138  
Daniel 139  
David (m. 1922) 21  
David (son of William Kenneth) 138  
David III 307  
David, Jr. 307  
Debra Ann (b. 1953) 275  
Delia 138  
Donald Robert (b. 1947) 275  
Doris (b. 1897) 294  
Doris (m. Montefiore Lyons) 138  
Dorothy (b. 1902) 137, 310B  
Eddie (see Joseph, Edward Cecil (Eddie))  
Edith (b. 1892) 294  
Edith (m. J. Dudley Phillips) 249  
Edward (son of Abraham Pinto) 138  
Edward (son of Montefiore) 138  
Edward Cecil (Eddie) 138  
Edward David 138  
Edward Hooper 138  
Eleanor (1794-1856) 139, 277, 278  
Eleazer (Lazarus) (1763-1817) 137  
Elizabeth 4, 139  
Elsie 172  
Emily (b. 1844) 54, 137  
Emily (1839-1842) 139  
Emily Cohen 137  
Emma (1827-1885) 19  
Eaid Beryl 138  
Esther (1823-1898) 61, 138  
Esther (1838-1858) 137  
Esther Eudora 137  
Esther Lindo Henry 115  
Ethel Mary Walkem 138  
Ethel Olive 138  
Eudora (b. 1828) 137  
Eunice Phillips 138  
Fannie 26  
Fanny (dau. of Israel) 34  
Fanny (m. Edward S. Abrahams) 5  
Fanny David (1847-1928) 138  
Fanny H. (1796-1841) 166  
Fanny L. 5, 278  
Florence Grace Hart 97, 137  
Florence Hyman 138  
Frances (m. 1851) 139, 278  
Frances Alexander 8, 139

Frances Levy 137, 169  
Frank (b. 1904) 294  
Georgina Petteson 138  
Gershom 138  
Gershon (1800-1832) 139  
Gershon (1821-1893) 138  
Gertrude (1769-1842) 137  
Gertrude Virginia (1825-1914) 46, 137  
Gratz 138  
Hannah 235  
Hannah Rosenthal 172  
Hannah (1777-1837) 326B  
Harriet Bloomfield 138  
Harriet Crimea 61, 138  
Harry (b. 1904) 172  
Harry (see also Joseph, Henry (Harry))  
Harry (1874-1958) 172  
Helen 307  
Helen Elizabeth (1854-1883) 138  
Helen Isaacs Wurzbarger 127  
Henrietta 139  
Henrietta Abrams 4, 139  
Henry (b. 1806) 138  
Henry (b. 1850) 138  
Henry (b. 1856) 138  
Henry (Harry) (1775-1832) 138, 276, 326B  
Henry (son of H. T. Gratz) 138  
Henry (son of Joseph L.) 137  
Henry A. (1795-) 326B  
Henry Gratz 138  
Horace (b. 1857) 138  
Horace (son of Abraham Pinto) 138  
Horace Moses 138  
Hortense Ury 138  
Hugh (son of Andrew Cohen) 138  
Hugh (son of William Kenneth) 138  
Ira B. 275  
Irene Rachel (1885-1940) 138  
Irene Rachel 138  
Isaac Aron 115  
Isabel F. Lindsley 138  
Isabella Hyman 220  
Isabelle 139  
Isabelle Joseph 139  
Isobel (see Joseph, Annabel (Isobel))  
Israel (b. 1840) 34  
Israel (1733-1804) 98, 139, 309B  
Jacob Francis (b. 1836) 137  
Jacob Henry (1814-1907) 138, 209  
Jacob Judah (d. 1862) 139  
Jacob Judah (son of Lizer) 66, 139  
Jane 210  
Jean 21  
Jesse (b. 1858) 138  
Jesse (1817-1904) 138  
Joseph (m. Rachel Marks) 103  
Joseph (m. 1822) 8, 139  
Joseph (son of Judah) 139  
Joseph (son of Lizer) 139  
Joseph Lazarus (1797-1858) 137, 169  
Josephine 119, 139  
Josephine Iglauer 307  
Judah (London) 139  
Judah (son of Naphtali) 138, 326B  
Karen Peterson 138  
Karl A. 294  
Katey 139  
Katherine Homeston 138  
Kathleen Abraham 2  
Kathleen Davis 138  
Kenneth 138  
Kenneth A. 294  
Kenneth De Sola (b. 1892) 138  
Kenna (1830-1905) 137  
Laurens (1837-1886) 97, 137  
Lawrence Kenneth (b. 1942) 275  
Lazarus (see Joseph, Eleazer (Lazarus))  
Leah 137  
Leila Muriel 138  
Leonard 18  
Lepha Iorns 172

Leslie 2  
Levy (1808-1809) 138  
Levy L. 139  
Lillian Budwig 293  
Lizer (1800-1832) 139  
Linda (dau. of Michael, Jr.) 293  
Lizar H. 4, 139  
Lizer (1762-1827) 139  
Lizette (Lizzie Lee) (b. 1851) 138  
Lizzie Lee (see Joseph, Lizette (Lizzie Lee))  
Lizzie Samuel 260  
Louise 138  
Lucy Hannah (1839-1887) 137  
Madeleine (b. 1834) 137  
Margaret 138  
Marguerite Maud 138  
Marjorie Grace Solis-Cohen 275  
Marjorie (b. 1903) 137, 310B  
Marjory Low 172  
Martha 294  
Martha Joseph 294  
Martha Maud (b. 1965) 138  
Mary 294  
Mary Blanche 34  
Mary Clark 138  
Matilda (b. 1807) 138  
Matilda Innis (b. 1854) 138  
Matilda (Maud) 138  
Maud (see Joseph, Matilda (Maud))  
Michael (m. Helen Isaacs) 127  
Michael (m. Lillian Budwig) 293  
Michael James 293  
Michael Morehouse 127  
Michael, Jr. 293  
Miriam (1791-1863) 210, 211  
Miriam Levy 98, 139, 309  
Molcie (Molsey) 139, 277  
Molcie (1841-1910) 139  
Molsey (see Joseph, Molcie (Molsey))  
Monte (see Joseph, Montefiore (Monte))  
Montefiore (Monte) (1851-1943) 61, 138  
Montefiore Lyons 138  
Moses 139  
Muriel 138  
Myer 220  
Naphtali 95, 138, 326B  
Nathan S. 260  
--- (of Manheim) 139  
Patricia 293  
Patricia Leeds 293  
Pauline Evelyn Lyons 138  
Peggy Sussman 18  
Philip 172  
Phyllis Annette 138  
Rachel 246  
Rachel Marks 103  
Rachel Sarah (1848-1938) 138  
Rachel Solomons 138, 276, 326B  
Ralph S. 294  
Ray Hahn 294  
Rebecca (b. 1849) 138  
Rebecca (1813-1880) 138  
Rebecca Gratz (Rhea) 138  
Rhea Gratz (see Joseph, Rebecca Gratz (Rhea))  
Robert 293  
Rolinda Hays 293, 294  
Ronald 138  
Rosetta (b. 1894) 138  
Rupert Laurens 137, 310B  
Ruth Graff Denzer 310B  
Samuel (son of Israel) 34  
Samuel (1803-1832) 138  
Sarah (dau. of Henry) 138  
Sarah (dau. of Lizer) 139  
Sarah (1819-1903) 138  
Sarah (1823-1824) 139  
Sarah Emanuel 66, 139  
Sarah Gratz Moses 138, 209  
Sarah Henriques (1832-1918) 137, 265

Sarah Hyatt Cohen 34  
Sarah Judah 139  
Serka 139  
Sigmund 293, 294  
Simeon (see Booth, Harold Simeon)  
Solomon (son of Moses) 139  
Solomon (1815-1844) 139  
Solomon Arthur (1842-1891) 137  
Solomon I. (1799-1866) 137  
Sophia 138  
Sophia Celine (b. 1860) 138  
Sophia Celine Joseph 138  
Sophia David 46, 138  
Sophia Lesley 138  
Sophia Lesley Davis 138  
Stephen 138  
Steven W. 294  
Stewart Scott (b. 1862) 138  
Susan 138  
Sybil Matilda 138  
Sylvia Florence 74, 137, 310B  
Theodore Harold (1875-1950) 74, 137, 310B  
Thomas 138  
Thomas Alan (b. 1950) 274  
Valerie 18  
Walter 172  
Walter, Jr. 172  
Wilfred (d. 1916) 2  
Wilfred (1883-1884) 137  
Wilfrid (son of Rupert L.) 137  
William Kenneth (Billy) 138  
William Ralph 294  
Winifred Abraham 2  
**JOSEPHI**  
Beatrice 291  
**JOSEPHS**  
See also Joseph  
Aaron (d. 1831) 131  
Aaron R. 131  
Amy May (b. 1924) 21  
David 21  
Elizabeth Nathans 231  
Frances Polock Jacobs 131  
Jean Benschwanger 21  
S. J. 231  
Sarah Henriques 112  
Sarah M. 231  
Walter 112  
**JOSEPHSON**  
Manuel (1729-1796) 139  
Rachel (Ritzel) Judah 139  
Ritzel Judah (see Josephson, Rachel (Ritzel) Judah)  
**JOSHUA**  
Eva 308  
**JUDAH**  
Aaron (son of Baruch) 139  
Aaron (1775-1834) 85, 139  
Aaron Hart (1801-1836) 139  
Abigail (dau. of Baruch H.) 140  
Abigail (1816-1898) 140, 147  
Abigail Judah 140  
Abigail Seixas 101, 102, 189  
Abraham (b. 1781) 141  
Abraham (of Breslau) 141  
Abraham (see also Abraham, Judah)  
Abraham (son of Samuel) 141  
Abraham (son of Uriah) (1714-1782) 141  
Abraham (1715-1784) 139  
Abraham (1774-1827) 140  
Abraham (1810-1825) 141  
Adeline (1809-1831) 139  
Alfred N. (1812-1858) 141  
Alice (1837-1915) 141  
Amelia (Emily) (1806-1877) 41, 139  
Amelia (1761-1849) 139  
Amelia (1808-1863) 139  
Amy S. 141  
Ann Patterson 141  
Anna 139, 327A  
Annie (see Judah, Hannah

(Annie/Nancy)  
Arline Kimber 141  
Barbara (b. 1911) 139  
Barnebas S. (see Judah, Bernard Samuel (Barnebas S.))  
Baruch H. (Bernard H.) (1763-1830) 140  
Bella (1770-1847) 139  
Benjamin 140  
Benjamin S. (1760-1831) 114, 139  
Bernard H. (see Judah, Baruch H.)  
Bernard Samuel (Barnebas S.) (1777-1831) 95, 141  
Bilah 139  
Caroline (1829-1849) 141  
Carter Marcus 140  
Cary Jekuthiel (1766-1837) 139  
Cary Jekuthiel (1819-1850) 139  
Catharine Winnifred 141  
Catherine (Katy) Hart 95, 141  
Catherine (1788-1860) 141  
Catherine (1830-1876) 141  
Cecil Floyd 140  
Celestine (1813-1898) 84, 139  
Charity Bennett 140  
Charity Bradley 140  
Charles (d. 1829) 140  
Charles B. (b. 1872) 141  
Charles B., Jr. 141  
Charles D. 140  
Charlotte 140  
Chester (b. 1906) 140  
Chester Applegate 140  
Christine 140  
Clarisse Vezina 141  
David (d. 1833) 140  
David (son of Abraham) 139  
David (son of David) 140  
David Waterford 141  
De Witt Clinton 139  
Doris M. Trotter 141  
Dorothy Catherine (1747-1827) 141  
Dorothy Hope 141  
Dorothy Patterson 141  
Douglas 140  
Dunlop 141  
Edward (1806-1883) 139  
Eleanor (1909-1930) 140  
Elinor E. Hays 104  
Eliza (1763-1823) 218  
Eliza 141, 218  
Eliza Israel 114, 139  
Elizabeth (b. 1795) 140  
Elizabeth Ezekiel 141  
Elmira Elizabeth Smith 140  
Elodie Campbell 141  
(E) Manuel (1769-1834) 140, 264  
Emanuel (d. 1839) 139  
Emily (see Judah, Amelia (Emily))  
Emily Jane 141  
Emma C. Burnet 141  
Ernest Lionel 141  
Ernest Woodward 141  
Esther (b. 1785) 140  
Esther (Hetty) Hendricks 110, 139  
Esther Taylor 140  
Eva Brownman 140  
F. R. 141  
Falk (see Judah, Walter Jonas (Falk))  
Fanny (Frumet) (1771-1833) 139  
Fanny 141  
Florence 140  
Floyd Smith 140  
Francis 141  
Francis Thomas 141  
Frederick Thomas 141  
Frumet (see Judah, Fanny (Frumet))  
Gardner (b. 1904) 140  
Gelston Marcus 140  
George (1828-1856) 139  
Gershom 140  
Gershom Seixas (b. 1767) 140  
Gertrude Simonson 139

Grace Seixas (1780-1867) 140, 185  
Grace Seixas (1789-1826) 140, 264  
Gracia (b. 1928) 140  
Gracia Louise Carter 140  
Hannah (Annie/Nancy) 141  
Harriet 140  
Harriet Brandon 141  
Helen 141  
Helen Fisher 141  
Helen M. Campbell 140  
Henrietta (dau. of Naphtali Hart) 139  
Henrietta (1806-1868) 139  
Henry 140  
Henry Hage 141  
Henry Moses 140  
Henry R. (b. 1794) 140  
Henry Raymond 140  
Henry Raymond, Jr. 140  
Hetty 140  
Hetty Sayres 140  
Hillel (Hilliard) (ca. 1730-1815) 139, 140, 264  
Hilliard (see Judah, Hillel (Hilliard))  
Horatio (b. 1837) 139  
Ida 141  
Imelda Bulger 140  
Isaac (Brother of Uriah) 141  
Isaac 141  
Isaac H. 140  
Jacob (b. 1765) 140  
Jacob (d. 1783) 139  
Jacob I, 139  
Jacob Samuel (1767-1783) 139  
Janice 140  
Jessie Jonas 139  
Jessy (Simha) (1822-1913) 12, 117, 139  
John Jacob (1816-1829) 139  
John Lionel 141  
John M. 141  
Jonathan (b. 1803) 141  
Julia N. Gelston 140  
Kate Hutchinson 141  
Katherine Patterson 141  
Katy Hart (see Judah, Catherine (Katy) Hart)  
Louisa C. (1818-1838) 141  
Louisa C. L. 141  
Louisa Leah (d. 1838) 140  
Mansfield 140  
Manuel (see also Judah, (E) Manuel)  
Manuel (son of Baruch H. (Bernard H.))  
Maria (1810-1899) 139  
Maria B. Ferguson 139  
Marian (Miriam/May) 141  
Marion Wurtell 141  
Marjorie Carter 141  
Martha Raymond 140  
Mary 141  
Mary Benedicta 141  
Mary Gelston 140  
Mary Jane (d. 1872) 140  
Mary L. (1845-1878) 141  
May (see Judah, Marian (Miriam/May))  
Michael (d. 1786) 140  
Mildred Savory 140  
Miriam (see also Judah, Marian (Miriam/May))  
Miriam (1807-1887) 95, 141  
Miriam Nathan 139, 226  
Moses (d. 1851) 140  
Moses (1735-1822) 139  
Moses H. (1779-1838) 140  
Nancy (see Judah, Hannah (Annie/Nancy))  
Naphtali Hart (1774-1855) 110, 139  
Nelby 140  
Noble Brandon (1851-1918) 141  
Noble Brandon, Jr. (b. 1884) 141  
Noel Fulton 141  
Oscar Stewart 223  
Patty (b. 1781) 102

Philip Norborne 140  
R. Rider 140  
Rachel (Ritzel) (1732-1797) 139  
Rachel (1768-1770) 101  
Rachel (1772-1836) 139  
Rachel (1772-1863) 140, 153  
Rachel (1819-1866) 140, 266  
Rachel Gomez 85, 139  
Rachel Jochanan 139  
Rebecca (1725/7-1817) 104, 106, 139  
Rebecca (1765-1846) 139  
Rebecca (1782-1867) 140, 266  
Reinah (see Judah, Rynne (Reinah))  
Reynold S. 141  
Richea 139  
Richea Ann (1814-1857) 139, 264  
Ritzel (see Judah, Rachel (Ritzel))  
Ruby Whitham 140  
Rynne (Reinah) 140  
Sally (Sarah) (1760-1842) 58, 140, 327A  
Samuel (1725-1789) 141  
Samuel (1728-1781) 139  
Samuel (1799-1869) 141  
Samuel B. Helbert 139  
Samuel B., Jr. (1875-1892) 141  
Samuel B. H. (1804-1876) 139  
Samuel Brandon (b. 1845) 141  
Samuel N. (1803-1849) 139, 226  
Sarah (b. 1762) 139  
Sarah (b. 1794) 140  
Sarah (see also Judah, Sally (Sarah))  
Sarah (1763-1795) 139, 217  
Sarah (1776-1820) 139  
Sarah (1776-1826) 95, 142  
Sarah Cane 141  
Sarah Eleanor Gardner 140  
Sarah Elizabeth Schoyer 141  
Sarah Helbert 114, 139  
Simha (see Judah, Jessy (Simha))  
Sutherland 139  
Theodore (b. 1911) 139  
Theodore D. 139  
Thomas Storrs 141  
Thillie Frank 223  
Uriah (b. 1782) 141, 142  
Uriah (son of Judah Leib of Breslau) 139  
Uriah (1714-1782) 141, 142  
Uriah Hendricks (b. 1810) 139  
Virginia Scarth 142  
Walter Henry (1825-1852) 139  
Walter Jonas (Falk) (1778-1798) 139  
Washington (1814-1853) 141  
William (b. 1797) 139, 140  
William Henry 140

#### JUDELL

Agnes Hendricks Levy 159  
Andrea 83  
Barbara (b. 1924) 159  
Debra 83  
Doris Steppacher 83  
Louis 159  
Robert (m. 1949) 83  
Terry 83

#### JUDSON

Corinne B. Newman 160  
Corinne J. 160

#### JUHEL

Elizabeth (see Jewel (or Jubel), Elizabeth)

#### JULIAN-JAMES

Cassie Mason Myers 220

#### JULIAO

David de David Henriquez 241  
Esther De Pass 58  
Esther Maduro 241  
Moses de Haiim David Henriques 58

#### JULIEN

Caroline 245

#### KAAN

Harriet B. 237

#### KAGAN

See Kagen

#### KAGEN

Carol Dene Goldsmith 282, 313B, 339B  
Judith Frances (b. 1939) 282, 339B  
Kenneth 282, 313B, 339B

#### KAHN

See also Cahn

Adeline Feidelson 5  
Albert M., Jr. (b. & d. 1916) 286  
Albert Michael 286  
Alberts 15  
Alphonse 6  
Anne De Leon Levin 18  
Arthur (m. Jessica A. Springer) 137  
Arthur (son of James) 6  
Beatrice Block 135  
Beatrice Josephi Sulzberger 291  
Belle 6  
Bertha 275  
Bina (1803-1886) 236  
Carl 285  
Claire 70  
Clara 320B  
Clara 6  
Clarence B. 309A  
Corinne 309A  
Cornelia Binswanger 23  
David (1759-1825) 236  
Sarah (b. 1762) 139  
Delia Bitterman 11, 309A  
Edgar 190  
Edgar Myron 18  
Edgar Myron II 18  
Edgar, Jr. 190  
Edwin 137  
Eleanor 190  
Eli Jacques 291  
Elizabeth 285  
Elizabeth Stix 286  
Elliott 135  
Emmanuel 320B  
Eva Pool 60  
Eva Prager 60  
Fanny 186  
Fanny Arnold 320B  
Felix Louis (b. 1918) 286  
Flora 239  
Frances 137  
George 6  
Gertrude 86  
Gertrude Workum 306  
Gidele Marx (see Kahn, Klara (Gidele) Marx)  
Herman (see Cone, Herman)  
Hugo 6  
Ida Marie Fleisher Becker 72  
Inge Schleier 18  
Jacob (1837-1876) 23  
James (b. 1827) 6  
James 5  
Janet 229  
Jean 6  
Jonathan 288  
Journet 285  
Judith 285  
Julia Abraham (see Kahn, Scheila (Sheina, Julia) Abraham)  
Julia Simon 135  
Katherine 6  
Kenneth E., Jr. 18  
Kenneth Edgar 18  
Klara (Gidele) Marx 91  
Lena Kuttner 239  
Leon 72  
Lisa Ann 18  
Louis 6  
Magda (see Kahn, Mohla (Magda))  
Maomi 137  
Margaret (Peg) Stern 288  
Margaret 285  
Margery 309A  
Marion Holman 307  
Marjorie Anne 18

Maurice 135  
Michael 307  
Mike 306  
Miriam 13  
Miriam Silver 6  
Mohla (Magda) 236  
Moses 91  
Myron 307  
Nannette 16  
Naphtali (d. 1833) 236  
Paul (son of James) 6  
Paul (son of Ulysses) 6  
Peg Stern (see Kahn, Margaret (Peg) Stern)  
Polly 307  
Renée Olson 18  
Sara Mayer 190  
Sarah (b. 1865) 11  
Sarah (m. André Daniel Gomez) 86  
Scheila (Sheina, Julia) Abraham 236  
Sheina Abraham (see Kahn, Scheila (Sheina, Julia) Abraham)  
Simone 6  
Stanley 5  
Stephen 285  
Ulysses 6  
William 239

#### KALINCOHEN

Jacob 127  
Sarah 127

#### KAISER

Rosa 311B

#### KALISHER

Edward 323A  
Theresa Dinkelspiel 323A

#### KALMAN

Calvin 191  
Judith Matilda Miller 191  
Samuel Adam De Sola 191

#### KAMER

Cecelia 311

#### KAMHOLZ

Babette Sondheim 271  
Barbara 271  
Jack 271  
John 271

#### KAMINS

Jean 8  
Marian Magnus 8  
Maurice 8  
Maurice, Jr. 8  
Paul 8

#### KAMINSKI

Charlotte Virginia Emanuel 66  
Cleo Ford 102  
Edwin Washington (b. 1868) 66  
Esther Sampson 66, 259  
Heiman (m. Rose Baum) 34  
Heiman (m. 1867) 66  
Joseph (b. 1874) 66, 259  
Julia Baum 102  
Linah Charlotte (b. 1870) 66  
Nathan (m. Julia Baum) 102  
Nathan Emanuel (b. 1871) 66  
Nathan III 102  
Nathan, Jr. 102  
Nora Morgan 102  
Richard 102  
Rosalie Baum 34

#### KAMM

Amy Yates 308  
Edward 308  
Emil 308  
George Emil 308  
Josephine 308

#### KANE

Amelia Seixas 264  
Eliza Henriques 112  
Elizabeth (b. 1905) 255  
John B. 264  
John C. 112

#### KANN

Elizabeth 310B

#### KAPLAN

Rose 11  
Sophia 16  
KARAGORY  
Carol Beulah Anderson 238  
Craig John 238  
John 238  
Kevin George 238

#### KARFORD

Blanche Levy 166  
William K. 166

#### KARGER

Ann P. 253  
Eleanor Price Goldsmith 253  
John 253  
Thomas S. 253

#### KARLSRUHR

Bercie 15

#### KARPE

Charles 108  
Eleanor 108  
Eleanor Pincus 108  
Sol 108

#### KARSMAN

Rae 268

#### KARSTENDIEK

Adelaide Anna (1858-1939) 257  
Adele Delilah (1904-1943) 257  
Delia Cecilia Salomon 257  
Delia Helen (1862-1917) 257  
Edward F. (b. 1888) 257  
Freda Dorfer Thebault 257  
Georgiana Magdalene Hoffman 257  
Harry Schommer (1886-1944) 257  
Henry (see Karstendiek, Lewis Huntman (Henry))  
Henry Salomon (1856-1909) 257  
Irene Trondale 257  
Jeanette Hortense (b. 1892) 257  
Lewis Henry, Jr. (b. 1906) 257  
Lewis Huntman (Henry) (1864-1937) 257

Lillie Hatties (b. 1898) 257  
Lucille Helen (1889-1927) 257  
Marguerite Lionne (b. 1885) 257  
Marian Delia (1891-1913) 257  
Marjorie Clare (b. 1923) 257  
Mary Elizabeth Craig 257  
Mary Lorraine (b. 1925) 257  
Mary M. Schommer 257  
Otto Henry (1860-1928) 257  
Otto Henry (1823-1883) 257  
Pearl Celia (b. 1895) 257  
Violet C. (1893-1894) 257

#### KARTISHER

Miriam Louisa E. 335A

#### KASSLER

Norma 268

#### KATON

Mary Ellen (see Kaytoa, Mary Ellen)

#### KATSKY

Aileen Jaffa 276  
Jarmila 276  
Joan 276  
Lawrence M. 276  
Miltona 276  
Thomas Emerson 276

#### KATZ

André Daniel 86  
Andrew 333A  
Barbara Hurwitz 333A  
Bernard 237  
Bess Walker 86  
Cynthia Nusbaum 301  
Emily Frances Oppenheim 237  
Ester 293  
Ethel Porcelo 22  
Florence Selman 293  
Grete 235  
Harold 86  
Helen Anspacher 22  
Helen Gomez 86  
Herbert (b. & d. 1893) 22

Herman 86  
 Jack 293  
 Jill Rosenthal 15  
 Julian 86  
 Lawrence (b. 1944) 15  
 Lincoln 293  
 Lotta Gomez 86  
 Louis (1912-1945) 15  
 Margery (b. 1899) 22  
 Molly Wallerstein 15  
 Mordecai 290  
 Norman 293  
 Richard (b. 1895) 22  
 Richard (m. 1892) 22  
 Ruth 86  
 Sarah 290  
 Sarah Wiener 293  
 Thomas Lawrence 15  
 Violet Vale 22

**KATZENBERG**  
 Alice Machol 282  
 Anne Rachel 282, 339B  
 Audree 282  
 Bessie 282, 339B  
 Betty 282  
 Carol (m. 1967) 282  
 Caroline Pollack 282  
 Daniel (1976-) 339B  
 Denah Stern (1859-1934) 282  
 Dene 282, 339B  
 Dorothy 284  
 Edith 282, 339B  
 Eliza 89  
 Elva Stein 282  
 Emilie Rosenbaum 282, 339B  
 Helen Goldsmith 282  
 Isaac (1854-1932) 282  
 Jay 282  
 Linda Prescott 339B  
 Lucien 282, 339B  
 Lucien, Jr. 282, 339B  
 Marc 282  
 Marc Richard 282  
 Marjorie 282, 292  
 Michael 339B  
 Milton 282, 339B  
 Nancy 282  
 Patricia Aloe 282  
 Richard 282  
 Sue (m. Jay) 282  
 Susan Ellen Schweitzer 282  
 Tyler Prescott (1982-) 339B  
 William 282, 339B

**KATZENBERGER**  
 See also Katzenberg  
 Fanny 282  
 Louis 282  
 Michael Cohen 282

**KATZENLIJENBOGEN**  
 Samuel Judah (1521-1597) 261

**KATZKY**  
 Madelyn 255

**KAUDERS**  
 James Theodore 172  
 Jane Newburger 172  
 Margaret Theresa (Peggy) 172  
 Peggy (see Kauders, Margaret Theresa (Peggy))

**KAUFFMAN**  
 Ray (1888-) 334B

**KAUFFMANN**  
 Allan (1893-1971) 255, 310B  
 Anne R. (b. 1971) 255, 310B  
 Elizabeth (b. 1973) 255, 310B  
 Emil 152, 303  
 Jane Shapiro (b. 1941) 255, 310B  
 John (b. 1931) 255, 310B  
 Karen (b. 1966) 255, 310B  
 Ruth Kayton (1904-1971) 255, 310B

**KAUFMAN**  
 Amy Louise Nathan 143, 226  
 Carrie (1858-1951) 282  
 Carrie Kline 283

Clare 301  
 Clementine Lazaron 61  
 Deborah Wolfe 304  
 Edgar J. (1890-1933) 222  
 Edgar J. (1918-1939) 222  
 Edward (Teddy) 301  
 Edward S. 143, 226  
 Elizabeth Steiner 13  
 Emma 143  
 Emma Beatrice 102  
 Estelle 8  
 Ethel Pyke 308  
 Eva Adelaide 304  
 Evelyn 5  
 Floribel Rosenbaum 222  
 Francis Marion 304  
 Frank 61  
 Fred, Jr. 13  
 Frederick 13  
 George Maasbach 301  
 Gerald Lynton (b. 1893) 143  
 Gerald Lynton, Jr. (b. 1926) 143  
 Gladys Ginsburg 24  
 Hellen 281  
 Henrietta Spagat (b. 1896) 174  
 Henry Morris (b. 1897) 174  
 Ida-Helen 222  
 Isabel V. Fischer 160  
 Jacob 281  
 Jacob H. 304  
 Jeanette (1803-1891) 281  
 Jessie 143  
 Joan 13  
 Julie F. 160  
 Laura 143  
 Leo 24  
 Linda Hofheimer 301  
 Linda Leberman 152, 303  
 Louis 135  
 Mamie Sherwood 143  
 Marie Thérèse Mackiewicz 143  
 Mary Louise Johnson 135  
 Michael David 174  
 Michael David, Jr. (b. 1907) 174  
 Pearl Morris 174  
 Richard S. 160  
 Rosalie Mayer 143, 190  
 Samuel 143, 190  
 Teddy (see Kaufman, Edward (Teddy))  
 Virginia R. 275  
 Walter 143

**KAUFMANN**  
 Dorothy Milius 287  
 Katherine (b. 1920) 287  
 Sidney Walter 287

**KAY**  
 Florance Mead 74  
 James Murray 74

**KAYSER**  
 Byron 313B  
 Caroline Samuels 313B  
 Roy 313B

**KAYSER**  
 Nina Myers 230

**KAYTON**  
 See also Rosenheim  
 Abe 143  
 Abraham 143  
 Abraham H. 143, 327B  
 Abraham L. 143  
 Allan D. (b. 1900) 255, 310B  
 Andrew (b. 1961) 255, 310B  
 Babette 143, 327A  
 Barbara L. (b. 1935) 255, 310B  
 Benno 143, 327B  
 Bernhard (b. Geinhausen, Hesse) 143  
 Bernhard (1826-1877) 143  
 Bert (dau. of Lewis) 143, 255, 310B, 327A, 338B  
 Bertha (Bettie) (1850-1940) 143, 327B  
 Bertha (m. Joel Gutman) 143  
 Bettie (see Kayton, Bertha (Bettie))  
 Betty (Fanny) (b. 1858) 143

Caroline Herzberg 143  
 Carrie (1891-) 143, 327B  
 Caryl (1935-) 327B  
 Deborah (b. 1959) 255, 310B  
 Donald J. (b. 1931) 255, 310B  
 Dorothea 143  
 Edith 143  
 Elizabeth Kann 255, 310B  
 Emilie 143  
 Esther (b. Norfolk) 143  
 Esther Kneip 143  
 Fanny (see Kayton, Betty (Fanny))  
 Fanny Straus 143  
 Georgette Beach 327B  
 Gertrude Mayer 143  
 Gustav 143, 327A  
 Hanna (b. 1845) 143, 327A  
 Hannah (m. Claude E. Schools) 143  
 Harmon 143, 327A  
 Harold 143, 327B  
 Henrietta 143, 327B  
 Henry (b. Norfolk) 143  
 Henry (1809-1902) 143, 327A  
 Herbert (son of Lewis) 143, 310B, 327B  
 Howard 143  
 Jacob 143  
 Jacob Lewis 143  
 James R. (b. 1946) 255, 310B  
 Jean A. (b. 1929) 255, 310B  
 Jennie Bernard 327A  
 John H. (b. 1906) 255, 310B  
 Joseph 143  
 Josephine 143, 327B  
 Lewis (son of Henry) 143, 327A  
 Lewis 143, 327B  
 Lewis Jr. (1931-1948) 327B  
 Louise Strahl 327B  
 Lucile Solomon 327B  
 Lucille (dau. of Abraham L.) 143  
 Madora 143  
 Margaret (b. 1909) 255, 310B  
 Marie Hartung 327B  
 Marjorie Klempner (b. 1935) 255, 310B  
 Mark (b. 1967) 255, 310B  
 Mary 143  
 Mary Ellen 29, 309A  
 Michael Ludlow 143  
 Virginia 143  
 Rebecca 143, 327B  
 Rebecca Riglander 327A  
 Robert (b. 1904) 255, 310B  
 Rosa 143, 327B  
 Rose 143  
 Ruth (1904-1971) 143, 310B, 327A  
 Sallie 143, 327B  
 Sarah Jacobs 143  
 Suzanne Jacobs (b. 1909) 310B  
 Tess R. Rosenheim 255, 310B, 327B  
 Wilhelm 143  
 William 143

**KAZIS**  
 Joel D. (1953-) 334B  
 Joshua Aaron Nathan (1985-) 334B  
 Sara Nathan 334B

**KEARNEY**  
 Virginia Delancey 155

**KEELY**  
 Barbara 284

**KEENE**  
 Grace 261

**KEENE (KUEHN)**  
 Frederick A. 24  
 Muriel Leslie Carmody 24

**KEEPERS**  
 Elizabeth 251

**KEHRER**  
 Theresa 11

**KEILEY**  
 Anthony M. (d. 1905) 48  
 Charles 48  
 Gertrude Mary 81

Gertrude Shaw 81  
 John D., Jr. (d. 1928) 81  
 John Denis 81  
 Kate Lathrop Lyon 81  
 Marie 48  
 Marie Lee 81  
 Rebecca Davis 48  
 Stephen Thomas 81

**KEITH**  
 Athaliah (1842-1876) 329A  
 Margaret 339A

**KELLER**  
 Adam (b. 1951) 275  
 Agnes De Leon 56  
 George D. 275  
 Jacqueline De Leon 55, 56  
 Joseph 320B  
 Julie Ann (b. 1943) 275  
 Mary Solis-Cohen 275  
 Miriam Arnold Hess 320B  
 Polly Elizabeth (b. 1945) 275  
 Samuel Litt 55, 56

**KELLEY**  
 Audrey 268  
 Mary Anne 326B  
 Myra 107

**KELLY**  
 Colleen Marie 195  
 Dave 255  
 David (b. 1969) 310B  
 Donna (b. 1964) 255, 310B  
 Eugene (b. 1944) 255, 310B  
 Harriet 24  
 Helen 241  
 Judith Appel 255, 310B  
 Julia 166

**KEMEYS-TYNTIE**  
 Anne 77

**KEMP**  
 Charles Bartlett 163  
 Eileen M. O'Brien 163  
 Frank LaGrange 163  
 Frederick N. 163  
 Frederick R. 163  
 John Randolph 163  
 Mary Virginia Levy 163  
 Susan Adele 163

**KEMPER**  
 Alan H. (m. Margaret Loeb) 211  
 Alan H. (son of Alan H.) 211  
 Alan H., Jr. 211  
 Carl 211  
 Carl Loeb 211  
 Doris Coleman 211  
 Elinor 23  
 Kathryn 211  
 Margaret 211  
 Margaret Loeb 211  
 Nan Schlesinger 211  
 Sandra Stark 211  
 Thomas Lenox 211  
 Thomas, Jr. 211

**KEMPNER**  
 Alan H. III 211  
 Alan H., Jr. 211  
 Alan Horace 211  
 Elizabeth Brody Benjamin 160  
 Louis 160  
 Margaret Loeb 211  
 Murray 160  
 Rosa Content 40  
 Ruth 160

**KENDALL**  
 Elvira Augusta Ellet 128  
 Emma A. (1849-1871) 336B  
 Leon D. 146  
 Rebecca Kokernot 146

**KENDIS**  
 Alyn 293  
 Ethel Wiener 293  
 James 293  
 Robert 293

**KENNEDY**

Ann 236  
 Ann Oppenheimer 236  
 David D., Jr. 236  
 David Doherty 236  
 David Douglas 236  
 Doris 253  
 Duncan 155  
 Duncan, Jr. 155  
 Elizabeth Augusta Croghan 155  
 Melissa 236  
 Suzanne 236

**KENNETT**  
 Adrienne C. Peixotto 240  
 Isabel 240  
 Scott 240  
 Vestal 240

**KENT**  
 Anna 147  
 Clement F. 117  
 Clement Fisher (b. 1927) 117  
 Fannie May Brown 117  
 Helen De Cordova Brickner 27  
 James David 27  
 John Roger 27  
 Lillian Houldsworth 27  
 Sallie 168  
 Stephen Curtis 27

**KENT (KOHN)**  
 Newton 27

**KERLEY**  
 See Keiley

**KERN**  
 Barbara 301  
 Beth Ann 237  
 Donna 237  
 Dorothy 301  
 James 237  
 James W. 237  
 Lina Goldsmith 301  
 Margaret 237  
 Margaret Theresa Roth 237  
 Patrice 237  
 Samuel 301

**KERR**  
 Anthony Hugh 168  
 Karen Marshall Rabenhorst 168  
 Marion J. 134

**KERSTEIN**  
 Dorothy 285, 340A

**KESLER**  
 Barbara Anne 307  
 Deborah Jane 307  
 Dorothy Altschul 307  
 Robert 307

**KESSLER**  
 Adolph (b. & d. 1870) 230  
 Albert (b. & d. 1872) 230  
 Anna Maria 324B  
 Austin Ranier 230  
 Beavenida Valentina (1880-1882) 230  
 Birdie Berliner 230  
 Brenda Bergquist 230  
 Charlotte (1867-1872) 230  
 Clara (b. 1871) 230  
 David 284  
 Edwin (1874-1933) 230  
 Edwin III 230  
 Edwin, Jr. (b. 1903) 230  
 Elizabeth 284  
 Elizabeth Goldsmith 284  
 Florence (1900-1909) 230  
 Helen Virginia Nathans 230  
 Irene (b. & d. 1885) 230  
 Jay (see Keasler, Jonas (Jay))  
 John Whitlock 230  
 Jonas (Jay) 230  
 Lionel L. (1875-1883) 230  
 Lottie C. Mangier 230  
 Mary 284  
 Nell (1868-1927) 230  
 Robert 284  
 Rosa Weil 230  
 Samuel (1835-1909) 230

Susan 72

**KEY**  
 Alicia (b. 1867) 156  
 Beatrice Tiffany 156  
 Charles 156  
 Edward 118  
 Edward Lloyd (b. 1853) 156  
 Elizabeth Lloyd 156  
 Florence Gross Horwitz 118  
 Francis Scott (b. 1861) 156  
 Mary Taylor (b. 1855) 156  
 Philip Barton (1858-1862) 156

**KEYS**  
 Abraham Israel (1780-1828) 27  
 Daniel B. (1821-1837) 27  
 Jacob (b. 1815) 27  
 Jael Brandon 27  
 Joseph (b. 1824) 27  
 Julia (b. 1811) 27  
 Nathaniel (b. 1823) 27

**KEYSER**  
 Ainslee H. M. (1901-1913) 140  
 Asser 260  
 Augusta Tobias 297, 314  
 Campbell Dirck (b. 1926) 140  
 Catherine (Frau Getele) (1766-1848) 69  
 Charles Ralph 297, 314  
 Chava (Eve) 69  
 Elizabeth (dau. of John) 140  
 Elizabeth (dau. of William) 140  
 Elizabeth Judah 140  
 Eve (see Keyser, Chava (Eve))  
 Frau Getele (see Keyser, Catherine (Frau Getele))  
 Hannah (b. 1840) 308  
 Harriet C. Swift 140  
 Isabel Samuel 260  
 Jacob 69  
 Jessie Farquharson 140  
 John (b. 1907) 297, 314  
 John (of Pensacola) 140  
 John H. 140  
 Katherine Turquand (1897-1905) 140  
 Lewis 69  
 Mary Campbell (m. William S.) 140  
 Mary Campbell (1894-1911) 140  
 Nathan 69  
 Nelley Atkin (b. 1889) 140  
 Nelley Everett (d. 1914) 140  
 Richard L. C. (b. 1893) 140  
 Solomon 69  
 Stella Brown 140  
 Taegle 69  
 William (1821-1877) 140  
 William Judah (b. 1891) 140  
 William Swift (son of William) 140  
 William Swift (1895-1898) 140

**KIAM**  
 Dorothy (1906-1974) 296  
 Edward (1863-1930) 296  
 Fannie Tim 296  
 Marjorie 296

**KICKLIGHTER**  
 Rosemary 208

**KIEFER**  
 Julia Rosenham 255  
 William 255

**KIEPOVER**  
 Florence Hays 106  
 John, Jr. 106

**KILHAM**  
 Jeanette 310

**KILLER**  
 Sophie 215

**KIMBER**  
 Arline 141

**KIMBRO**  
 Clariece Elaine De Cordova 53  
 Gary Wendell 53  
 Ginger Faye Chance 53  
 John Michael 53  
 John Washington 53

- KIMSEY**  
Louise Wimberly 270
- KINCAID**  
Earle 322A  
Earle, Jr. 322A  
Isabella Jane (ca. 1800-1860) 200, 201  
Marilyn Dee Barnbaum 237  
Robert 237  
Virginia Earle 322A  
Virginia Morris 34, 322A
- KIND**  
Andrew Henry 282  
Bessie Katzenberg 282, 339B  
Christina Alicia 282  
Constance 282  
Dorothy Weinberger 282, 339B  
Kathryn 282  
Kenneth Arnold 282  
Laura Beth 282  
Milton 282  
Patricia Van Ameringen 282  
Philip 282, 339B  
Philip, Jr. 282  
Samuel 282, 339B  
Valerie Kay 282
- KINDALL**  
Catherine Wolff 102  
John 102  
Nancy 102  
Steven 102
- KING**  
Abigail Seixas 265  
Ada May Schlessinger 102  
Adelaide Ballia 144, 147  
Anna Langtry 102  
Anthony (b. 1834) 41, 154  
Augusta 102, 144  
Austin A. 188  
Barnet 6  
Beatrice 144  
Benjamin 6, 144  
Bennett J. 6, 144  
Bertha (1859-1924) 327B  
Billy Jack 237  
Carol Therese Weiss 285  
Caroline 148  
Charles (see Kroleck, Charles)  
Charissa 12  
Cynthia (Toni) Bregman 288  
David J. 6  
David James (1843-1919) 144, 147  
Dorothy Irene De Leon Johnston 55  
Edward B. 144  
Edward Judah 6, 144  
Edward Judah, Jr. 144  
Edwin William 55  
Eleanor Moise Levy Levy 164  
Eliezer (b. 1804) 145  
Elizabeth Terry 144  
Fanny (1796-1864) 144  
Frank (Solomon) 102  
Fred B. 164  
Frederick 164  
Frederick, Jr. 164  
George 13  
Gordon B. 288  
Gordon Congdon 285  
Grace 144  
Hannah 144  
Harry (b. 1872) 145  
Hattie, (-1924) 327B  
Henrietta 145  
Henry (m. Abigail Seixas) 265  
Henry (m. Hinda (Hannah) Aaron) 145, 327B  
Hinda (Hannah) Aaron 145  
Isaac (1799-1824) 145  
Jacob (1774-1824) 124  
Jay 144  
Jennie Ickelheimer 144  
Jonathan 285  
Judah (b. 1805) 145  
Katherine Richardson 164  
Kathryn Ann 55  
Kitty 144  
Lawrence De Leon 55  
Lemuel 265  
Leopold 145, 327A  
Lillie S. Brush 6, 144  
Louise (b. 1871) 144  
Mark J. 144  
Mary Isaacs 124, 145  
Miller 164  
Nathaniel 288  
Pincus 193  
Rachel Lyon 6, 144  
Rebecca Mitchell 193  
Constance 282  
Rosalia Abrahams 6, 144  
Rosalie Asch 13  
Rubinstein 145  
Sarah 327B  
Sarah (b. 1850) 144  
Sarah Abrahams 6, 144  
Sim 144  
Solomon 144  
Sophie 144  
Theresa Friedman 41, 257  
Toni Bregman (see King, Cynthia (Toni) Bregman)  
Victoria Marie Barnbaum 237  
William 265
- KING (KROLECK)**  
Fanny 144
- KINGMAN**  
Grace 84
- KINGSBACHER**  
Alvin 293  
Erna 287  
Eibel Marks Dryfoos 293
- KINGSBACHER (DRYFOOS)**  
Elaine 293
- KINGSBURY**  
Annie De Cordova 52  
William G. 52
- KINGSLAND**  
Jean 245  
Marjorie 144
- KINLEY**  
Ida Belle Sheftall 269  
Max Wilbur 269
- KINSLER**  
Agnes De Leon Keller 56
- KIRBY**  
Gail 236
- KIRK**  
Tessie (b. 1884) 166
- KIRKLAND**  
Jennie Lee 36
- KIRSCHNER**  
Phyllis 16
- KIRSHBAUM**  
Alan 284  
Ann 284  
David Alan (1929-1939) 284  
Emilie 284  
Emily 284  
Louise Weyl 284
- KISCH**  
Jessie 115
- KISER**  
Miero 272  
Rose Simson 272
- KISSAM**  
Mary Elizabeth 105
- KITCHEN**  
Dorothy Louise 269
- KITCHIN**  
Marion 155
- KITSON**  
Olive 81
- KLARMAN**  
Mary Eleanor 241
- KLARSPFELD**  
Sylvia 295
- KLAU**  
James 91
- Michael 91  
Phyllis 91  
Susan Levy 91
- KLEP**  
Erna Lillian Hegge 236  
Herbert Abe 236  
Herbert, Jr. 236  
Joan Hofeller 236  
Kevin 236  
Michael 236  
Raili Pohjola 236  
Tracey Alison 236
- KLEBERG**  
Gordon A. P. 170  
Rosalia H. Levy 170  
Philip 170
- KLEEBURG**  
Simon Lucas (see Hyneman (Kleeberg) Simon Lucas)
- KLEEMAN**  
Betty Adeline Cohen 167  
Hilmar 167
- KLEIMENHAGEN**  
See Hagen
- KLEIN**  
Adeline 28  
Alfred (1859-1940) 28  
Carol Sylva (Haas) 125  
Clara Potsdamer 28  
Edward Thorkil (b. 1955) 310B  
Ella 125  
Eise 237  
Florence Isaacs Haas 125  
Frederikke Marjorie Aschehoug 310B  
Henry 125  
John Arvid 310B  
Katherine Laura (b. 1957) 310B  
Louise 23  
Regina 293  
Wayne Eric (b. 1957) 310B
- KLEINBERG**  
Vivianne 231
- KLEINMAN**  
Blanche Hoffman 283, 339B  
Leonard Bernard 339B  
Lisa Dene, Mayer 339B  
Sigmund 283, 339B
- KLEMPNER**  
Marjorie (b. 1935) 255, 310B
- KLETZ**  
Charles, Jr. 237  
Lena Rothgeiser Lescor (see Kletz, Lillian (Lena) Rothgeiser Lescor)  
Lillian (Lena) Rothgeiser Lescor 237
- KLEVE**  
Sylvia 235, 337B
- KLEYKOWSKA**  
Julie Aimee Delia Eleanore (Nellie) 96  
Nellie (see Kleykowska, Julie Aimee Delia Eleanore (Nellie))
- KLIGERMAN**  
Louise Minster 292
- KLINE**  
C. Mahlon 103, 324B  
Deborah Lynn (b. 1954) 219  
Fay Brodsky 219  
Irving B. 219  
Isabel Hofflin 219  
Isadore C., 324B  
Isadore Emilie Unger 103, 324B  
James 219  
Leah Elizabeth 324B  
Norma Gewirtz 219  
Richard 219  
Sondra Pilzer 219  
Susan Jennifer 219
- KLING**  
Geraldine 287
- KLINITZKAYA**  
Manya Zelmanova 9
- KLOPFER**  
Donald 22
- Lois 22  
Marion Anspacher 22
- KLOTZ**  
Marie Ann 189
- KLYMAN**  
Abby Ancker 11  
Hetty Ancker 11  
Julius 11
- KNAPP**  
Annette Morris 322A  
Edward S., Jr. 158  
Edward Spring 158  
Edyth 158  
Edyth C. Elliman 158  
Herbert 322A  
Rosalie Emily Moran 158  
Rosalie M. 158
- KNAUPPT**  
Eliza Hart 97  
F. F. 97
- KNEELAND**  
Helen 312B
- KNEIP**  
Eather 143
- KNIGHT**  
Emanuel 280  
Florence Nightingale (1872-1925) 280  
Marian 208  
Rose Alexis 221  
Sarah Micholl 280
- KNIPHAUSEN**  
Count 265  
Judith 265
- KNOPP**  
Irma 81
- KNORR**  
Clara Johanna 254
- KNOTHE**  
Franziaska 107
- KNOWLES**  
Clarence 141  
Clarence, Jr. 141  
Constance (dau. of Clarence) 141  
Constance (dau. of Clarence, Jr.) 141  
Fanny Judah 141  
Marian 141  
Mary Helen Woody 141
- KOBER**  
Muriel June 320B  
Myra Arnold 320B  
Samuel 320B
- KOCH**  
Audrey H. Straus 162, 329B  
Deborah 162, 329B  
Irene 162, 329B  
Nina 162, 329B  
Reinhard 162, 329B  
Reinhard William (1920-) 329B
- KOEHLER**  
Bertha Shalek 334A  
Herman 334A
- KOENIG**  
Caroline 91  
Irene 229, 334B  
Nancy 321B
- KOENIGSWERTHER**  
Albert 144  
Albert, Jr. 144  
Grace Ding 144  
Lisette 144
- KOETHEN**  
Herz 143
- KOGAN**  
Kate Levine 191
- KOHLEMAN**  
See Coleman
- KOHLMAN**  
Marjorie 235, 337B
- KOHN**  
See also Cohen, Cohn  
Abigail Sarah Hart 254, 312B  
Amelie 145  
Andrew 71  
August (1868-1930) 84  
August III 84  
August, Jr. 84, 196  
Bernard (1876-1941) 296  
Bernard Abeles 296  
Bernhardt (1847-1936) 24  
Bertha (b. 1879) 24  
Bertha (m. Louis Tim) 296  
Carl 145  
Carolyn (b. 1914) 15  
Charles C. (1874-1888) 24  
Clara Elfelt 28  
Clara White 145  
Donald 296  
Dorita Cecilia Moise 84, 196  
Edouard 145  
Eleanor Griffith 24  
Elise 296, 340B  
Elizabeth (b. 1911) 15  
Elizabeth Cohen 38  
Elsa Aufsesser 15  
Elsa Leberman 296  
Eather Bloomingdale 24  
Eugene (b. 1880) 24  
Eva (dau. of Bernhardt) 24, 215  
Eva (dau. of Morris) 24  
Florence (b. 1884) 24, 71  
Florence (dau. of Irving) 296  
Florence Bloomingdale 24  
Florence Carey 24  
Gail Liebensberger 296  
Hannah 296  
Heinrich (d. 1911) 254, 312B  
Helen (b. 1896) 84  
Helen (b. 1907) 24  
Helen De Cordova Brickner 27  
Henrietta Greenebaum 84  
Herbert 24  
Hermann 145  
Irene Mae Goldsmith 84  
Irving 296  
Isaac (see Kuhn, Isaac)  
Jane Weil 296  
Janet 296  
Jean (b. 1918) 24  
Jeffrey Donald 296  
Joachim 145  
Joan Patricia Richmond 296  
Joseph 145  
Joseph Gustave 145  
Judy (see Kohn, Julia (Judy))  
Julia (Judy) 296  
Julia Tim 296  
Kivy/Eva Lobl 145  
Laura (b. 1966) 296  
Laura (b. 1967) 296  
Lee 28  
Leonard (b. 1878) 24  
Leopold (see Cohn, Leopold)  
Lewis 296  
Lowy 145  
Marie Louise (b. 1920) 24  
Marie Thalie Martin 145  
Marion (b. 1884) 24  
Marion (m. Arthur Hochstadter) 89  
Mary Alice 84, 164, 196  
Max 71  
Michael 196  
Morris (1835-1920) 24  
Morris (1877-1951) 24  
Nathan (Schimmel) 145  
Newton (see Kent (Kohn), Newton)  
Patricia Weil 296  
Pauline Weil Myers Bendiner 296  
Rachel Feldstein 145  
Rebekah Liveright 296  
Richard (1838-1959) 296  
Robert (b. 1935) 296  
Ruth (b. 1909) 24  
Ruth Fleisher 71  
Ruth Miller 24  
Sadie Haschesk (see Kohn, Sarah (Sadie) Haschesk)  
Sally (b. 1944) 71  
Samuel (1783-1853) 145  
Samuel (1853-1912) 296  
Samuel Arthur 145  
Sarah (Sadie) Haschesk (d. 1961) 312B  
Seligman (b. 1786) 145  
Simon (b. 1781) 145  
Simon Isaac 296  
Susan (b. 1941) 71  
Theodore (b. 1902) 84  
Timothy Richard 296  
Von Embden 145  
Walter (b. 1879) 15  
Yetta Tuckner 296
- KOHNER**  
Bertha Ezekiel 70, 324A  
Constance 70  
Josephine 70, 324A  
Maurice 70, 324A
- KOKERNOT**  
Alma 146, 328B  
Betsy Levy 101, 146  
Blanche 146  
Bloomie Amanda 146  
Caroline Augusta 146  
Caroline Dittmar Maley 146  
Clarissa 146  
David Crockett 146  
David L. (b. 1805) 146  
David L. 146, 328A  
David L., Jr. 328A  
Edna 146  
Elizabeth (b. 1832) 146  
Fannie 146, 328A  
Fannie Elam 146  
Frederick David 146  
George W. 146  
Glenn 146  
Golda Rixon 146  
Herbert L., Jr. 146  
Herbert Lee 146  
Hulda Jane Carnes 146  
John W. 146  
John William (1853-1924) 146  
Johnnie 146  
Johnnie Sue Hix 328A  
Josephine 146, 328A  
Julian 146  
Katherine Webb 146  
Lee 146  
Lee Glenn 146  
Lee M. (Levi Moses) 1836-1914) 146, 328A  
Lenore (Nora) 146, 328A  
Levi Moses 146  
Levi Moses (see also Kokernot, Lee M. (Levi Moses))  
Lola 146  
Louis 146  
Lucy Moss 146  
Margart 146  
Mary Anne 146  
Mary Elizabeth Vanham 146  
Mary Harper 146  
Mary M. 146  
Mattie Josephine 146  
Maud 146  
Miriam 146  
Muriel Joy 46  
Nancy Van Ostern 146  
Nora (see Kokernot, Lenore (Nora))  
Rebecca 146  
Robert L. 146  
Rubie Stuard 146  
Rufus 146, 328A  
Ruth 146  
Ruth Spooner 146  
Sam Max 146  
Sarah Littlefield 146  
Susan K. 328A  
Virginia Smith 146  
Walter H., Jr. 146  
Walter Hutson 146, 328A

**KOLA**  
See Koehler

**KOLCHIN**  
Ellen 339A  
Ellis 339A  
Kate Loeb 339A  
Peter 339A

**KOLIN**  
Essie (see Kolin, Jacqueline (Essie))  
Jacqueline (Essie) 296

**KOLLER**  
Nora Rosenthal 340A  
Sidney 340A

**KÖNIG**  
Abraham 252  
Gietele Polock 252

**KONINSKI**  
Adele Stix 286  
Sigfried 286

**KONZELMAN**  
Arthur 201  
Ethel Seago 201

**KOOPMAN**  
Schontze 323B

**KOOTZ**  
Jane Stix Ogden 285  
Samuel 285

**KOPPEL**  
Fanny (1871-1954) 167

**KOPPER**  
Eliza Caroline 264

**KORETZ**  
Mari (1913-) 327B

**KORMAN**  
Judith Miriam 282

**KORN**  
Carol Simon 121  
James Alexander 121  
John Raymond 121  
Peggy Lashanska Rosenbaum Lehman 281  
Richard Kaye (b. 1908) 281  
Robert 121

**KORNBLUM**  
Ely Winter 10  
Ernst (b. 1918) 10  
Hans 10

**KOSCHERAK**  
Justine Ellen 13  
Justine Ellen Bach 13  
Mildred 13  
Otto L. 13

**KOSTER**  
Adele Hirschler 108  
Ernestine Hirschler 108  
Fred 108

**KOTLER**  
Lucille 5

**KOTZEN**  
Daniel Jacob 12  
David Andrews 12  
Deborah Kaha 12  
Elinor Louise 12  
Lynn Frances Andrews 12  
Marvin S. 12

**KRAFT**  
Aurelia Swartz Friedman 292  
Doris C. 270  
Esther (1794-1878) 15  
Hans 292  
Irma 330A

**KRAVAN**  
Arthur C. 333A  
Robert (1945-) 333A  
Suzanne Mendes 333A

**KRAMER**  
Aaron M. 339B  
Albert Frank 238  
Betty Lynn (1960-) 339B  
Beulah Catharine (Mamber) 238  
Emily R. Feeman 339B  
Jodi Sue (1957-) 339B  
Lee Hoffman (1929-) 339B

Mabel Oppenheimer Mamber 238  
Marian Hoffman 339B

**KRAUS**  
Belle (b. 1861) 145  
Bessie 290  
Carrie May Adler 145  
Carrie Sulzberger 290  
Celia 145  
Ethel 14, 291  
Francis Van Praag (b. 1920) 145  
Grace Castleberg 290  
Harry Z., 145  
Henrietta (b. 1853) 145  
Ines Heffes Adès 145  
Jean 290  
Jean Kraus 290  
John Walter (b. 1918) 145  
Leah 290  
Lena Stromberg 145  
Marcus (Max) (b. 1829) 145  
Marcus Mordecai (1792-1845) 145  
Marian Florence Nathan 145, 227  
Mathilda 145  
Maude Rosalie (b. 1887) 145  
Max (see Kraus, Marcus (Max))  
Max William (b. 1855) 145  
Minnie Lauer 145  
Morris 290  
Rachel Frank 145  
Rosalie (Rosie) Anspacher 22, 145  
Sidney 290  
Sidney A. (b. 1904) 290  
Sophie Marks 187  
Walter Max (1889-1944) 145, 227  
William (1823-1899) 145  
William (1893-1920) 145

**KRAUSE**  
Arlene Eleanor Sheftall 270  
Roland Otto 270

**KRAUSKOPF**  
Blanche 229, 334B  
Hettie 229  
Levi 229  
Rachel Tobias Nathans 229

**KRAUTH**  
Hannah Berlin 300

**KRECHMER**  
Joan 229, 334B

**KREUTZ**  
Mary Pauline 277

**KREVITZ**  
James Gary 125  
Leonard 125  
Leonard Charles, Jr. 125  
Susan Isaacs 125  
Winifred Marion 125

**KRUN**  
Reuben Simon 1

**KROELER**  
Cynthia (b. 1965) 311B  
Margery Morgenstern 311B  
Roger (b. 1939) 311B  
Sharon (b. 1969) 311B

**KROHN**  
Alice 306  
Annette Hagedorn 306  
Arthur 23  
Carrie Monheimer 306  
Charles 306  
Cora Feckheimer 306  
Edith 306  
Erna 306  
Harry 306  
Helen 306  
Irwin M. III 306  
Irwin M., Jr. 306  
Irwin Michael 306  
Kathryn Deborah (b. 1951) 23  
Laura 306  
Lawrence David (b. 1947) 23  
Louis 306  
Mary 306  
Miriam Louise Hoffman 23

Nancy Ann 306  
Richard Daniel (b. 1949) 23

**KROLECK**  
Charles (see King, Charles)  
David 144  
Sarah 27, 144  
Sophia (see Kroleck, Sprinze (Sophia))  
Sprinze (Sophia) 144

**KRONACHER**  
Regine J. 285

**KRONBERG**  
Caroline (1844-1925) 116  
Katherine Herzog 116  
Sigismund (1815-1847) 115

**KRONHEIMER**  
Fannie 174

**KRONTHAL**  
Stella Baer 239

**KROPNICK**  
Gail 193

**KROUSE**  
See Kraus

**KRULSCHIE**  
See Kroleck

**KRUPP**  
Sadie 160

**KRUTSCHNITT**  
Ernest 18  
John (d. 1892) 18  
Julius 18  
Peninah Benjamin 18  
Rebecca De Mendes 18

**KUEHN**  
See Keene (Kuehn)

**KUH**  
George Edward 286  
Helen Stix 286

**KUHN**  
Abraham 296  
Bella Lipman 296  
Charles (son of Hartman) 80  
Charles (son of Mary) 80  
Cornelius Hartman 80  
David 275  
Donald 72  
Dorothy (b. 1896) 292  
Elizabeth (dau. of Hartman) 80  
Elizabeth (m. George C. Morris) 80  
Elizabeth Ella 80  
Ellen (dau. of Hartman) 80  
Ellen (dau. of Mary) 80  
Ellen Lyle 79, 80  
Emma (b. 1904) 292  
Frederick 80  
Gertrude 249  
Grace Morris Cary 80  
Hamilton 80  
Hartman (m. Ellen Lyle) 79, 80  
Hartman (m. Mary) 80  
Hartman (son of Hartman) 80  
Isaac (m. Sarah Phillips) 249  
Isaac (1823-1891) 296  
James Hamilton 80  
Jane 307  
Jill 72  
John Charles 72  
Julie Ann Keller 275  
Laura Baker Whelen 80  
Louisa Catherine Adams 80  
Louise (1897-1920) 292  
Mary 80  
Mary Denkla Mason 80  
Mary Hamilton (dau. of Charles) 80  
Mary Hamilton (dau. of Mary) (1845-1886) 80  
Mary Kuhn 80  
Nancy Fleisher Becker 72  
Rosalie 80  
Samuel (b. 1894) 292  
Sarah Phillips 249  
Settie Swartz 292  
Simon 292  
Sophia 80

William 80

**KUHNE**  
George 176  
Rosa Lopez 176

**KUHR**  
Mildred Lee Guckenheimer Abrahams 5  
Paul T. 5

**KULZER**  
Isabel 284

**KUMIN**  
Gershon 327A  
Hazel Goldman 327A  
Howard A. 327A

**KUNZ**  
Florence Marie Roth 237  
Walter 237

**KURLAND**  
Harold 12  
Hilda W. Hutkin 12  
Jerry A. 12  
Linda Sue 12

**KURSHEIDT**  
Abigail Grace (b. 1912) 147, 328B  
Abigail Judah 140, 147  
Albert Edward (b. 1889-1973) 147, 310B  
Alexander (1811-1884) 147  
Alexander E. (b. 1843) 147  
Alphonse Hart (1854-1936) 147  
Anna Augusta (d. 1876) 147  
Anna Kent 147  
Asher (1808-1893) 140, 147  
Besie Kurtz Schellenberg Samuels 147, 310B  
Edith (b. 1867) 147  
Edmund Baer (1861-1952) 147, 310B  
Edwin Israel (1838-1906) 147, 162  
Edwin Mendez (b. 1882) 147  
Edwin Mendez, Jr. (b. 1913) 147  
Elkaleh (1805-1883) 124, 147  
Emma Franzreb 147  
Ethel (1880-1902) 147  
Frederick Adolph (1845-1906) 147  
Gershom (1817-1863) 147, 328B  
Gershom Mendes (1858-1859) 147  
Grace Eloise (1847-1935) 147  
Grace Guedalla 147, 328B  
Grace Guedalla Kurbheedt 147  
Hannah Duke 147  
Helen Maxwell (b. 1919) 147  
Hilda (b. 1878) 147  
Ida Hess 147  
Irma (b. 1875) 147  
Isaac Mendes (1813-1886) 147  
Israel Baer (1766-1852) 147, 264  
Israel Baer (1852-1897) 147  
Jeanette (1807-1901) 147  
Jennie De Forest Carpenter 147  
Jennie Schellenberg 147, 310B  
Jessie Constance (b. 1881) 147  
Lawrence G. (b. 1868) 147  
Lilian (1873-1894) 147  
Lionel Judah (1856-1932) 147, 310B  
Mae 310B  
Manuel Augustus (1840-1923) 147  
Mary S. Dargan 147  
Mary Valiquete 147  
Miriam (1821-1866) 147  
Moses Montefiore (1858-1942) 147, 310B  
Myrtle (1871-1919) 147  
Rebecca (1819-1875) 74, 147  
Roland Simeon (1860-1927) 147, 310B  
Sarah Abigail 147, 264  
Sarah Levy 147, 162  
Serena (1850-1935) 147  
Theresa Seixas 147

**KUTTNAUER**  
Caroline Miller 239  
Samuel 239

**KYLE**  
Eliza Mordecai 201

Elmer 201  
Mary Terry 190

**LABADIE**  
Ethel Fleda Mordecai 201

**LABATT**  
Abraham Cohen (1802-1899) 119, 148, 328B  
Adelaide 148, 328B  
Amelia (Minky) Marks 148, 185  
Caroline 148  
Caroline Hyams 119, 148  
Catherine (1773-1846) 148  
Cora 148  
David (Charleston, 1800) 148  
David (son of Abraham Cohen) 148, 328B  
David (1826-1830) 148  
Eleanor Block 25, 328B  
Emily B. 148  
Grace (1799-1872) 45, 148  
Grace (1830-1908) 148  
Henry J. 25, 328B  
Isaac Cohen (1804-1870) 148, 185  
Isadora (1837-1914) 148  
Jackson 328B  
Jacob 328B  
Leon (Judge) 148  
Minky Marks (see Labatt, Amelia (Minky))  
Miriam 148  
Rosina 148  
Sarah 148  
Urnula 148

**LABE**  
Marion Gimbel (b. 1895) 275

**LA BOMBARDA**  
Blandina 224

**LACHENBRUCH**  
Irving 104  
Mabel Ray Hays 104

**LACKENBRUCH**  
Alma (1882-1958) 336A

**LADA**  
Marina Tatiana 291

**LADD**  
Lucy 207

**LA FAR**  
Phyllis Cohen 37  
Wesley George 37  
Wesley George, Jr. 37

**LA FRAGE**  
Charles Eugene 196  
Rebecca Moise 196

**LAIB**  
Albert 147  
Alvia 149  
Charles 149  
Dene 149  
Edna 149  
Elizabeth 149  
Esther Liebenstein 149  
Ethel Loeb 149  
Eva Lienthal 149  
Fanny 149  
Henry (b. 1859) 149  
Henry 149  
Herbert M. 149  
Janet 149  
Jeanne Mahler Lowenthal 149  
Kate Meyer 149  
Lily 149  
Matilda (b. 1857) 149  
Matilda (b. 1890) 149  
Max 149  
Minnie Liebenstein 149  
Morris 149  
Nellie Virginia 149  
Rosina 149  
Samuel 149  
Sarah Lang 149  
Solomon 149  
Walter Joel 149

**LAIBSTAIN**

Linda 340B

**LAIMBERG**  
Augusta Laurretta Pinto 251  
Francis E. 251  
John 251  
William 251

**LAITNER**  
Averil Frampton 122  
Basil 122  
Jonathan 122  
Nicholas 122  
Richard 122  
Suzanne 122

**LAMARLERÉ**  
Marie Antoinette Cecile 94

**LAMBERT**  
Elizabeth 58  
Rachel De Pass Moses 58  
Rosalie (d. 1835) 58  
Samuel 58  
Solomon W. (1836-1841) 58  
William C. 58

**LAMBERTON**  
Edith 262

**LAMERT**  
Esther (1791-1860) 228  
Isaac 228  
Mary Barrows 228  
Matthew 228  
Rachel (d. 1842) 228

**LAMM**  
Harriet 70

**LA MOTTA**  
See De La Motta

**LAMPHERE**  
Maude Burrows 157

**LAMPLEY**  
Martha 154

**LANDAUER**  
Anna (1835-1898) 311A  
Helene 43  
Klara Guggenheimer 89

**LANDAY**  
Horace J. 257  
Horace, Jr. 257  
Salomon 257

**LANDE**  
Adele Florence Rosenau 236  
Harold Julian 236

**LANDERS**  
Lou (see Friedlander, Louis)

**LANDMAN**  
Gella 287

**LANDREAUX**  
Joseph Urin 116  
Marie Virginie Hermann 116

**LANDRETH**  
Eleanor Gummey Manchester 67  
Frances Marx Eiting 67  
Lucius S., Jr. (b. 1892) 67  
Lucius Scott 67  
Maria Walsh Madeira 67  
Marie Eiting (b. 1888) 67  
Marie Steketee 67  
Rodney (d. 1954) 67  
Rodney Newbold (b. 1927) 67  
Scott (b. 1952) 67

**LANDRIGAN**  
Angelique Solomons 276  
Thomas 276

**LANDRUM**  
Alice 266  
Ann Madden Ewing 337A  
Marie Lynn 337A  
Samelia Mildred Seixas 266  
William W. 266

**LANDSBERGER**  
Annie Winter Feingold 10  
Babette 222  
Ernst 10  
Heinrich A. 10  
Phyllis Newburger 222  
Robert Solon 222



Solon 222  
**LANDSBURG**  
Emma (b. 1870) 166  
Semon (see Lansburgh, Simon)  
**LANE**  
Adelaide 50  
Anne Willis 200  
Margaret (d. 1821) 200  
Mervin I. 10  
Mervin L., Jr. 10  
Rosalie A. Lyons 10  
**LANG**  
James 146  
Jessie 209  
Julian Kokernot 146  
Sarah (m. Clifton Harby Levy) 165  
Sarah (1822-1910) 149  
**LANGBERG**  
Meredith Stern 284  
Michael David 284  
**LANGE**  
See De Lange  
**LANGERT**  
Margaret 12  
**LANGFORD**  
Elizabeth 122  
**LANGLEY**  
Bessie Louise Roe 257  
Craig Allen (b. 1950) 257  
Elizabeth Fiske 257  
Jeanette Hortense Karstendiek 257  
Preston 257  
Richard Preston (b. 1910) 257  
Richard Preston, Jr. (b. 1947) 257  
**LANGNER**  
Annie (Nanny) 60  
Armina Marshall 60  
Basil 60  
Berthold (Bertram) 60  
Berthold 60  
Bertie (see Langner, Herbert (Bertie))  
Braham 60  
Cecilia (Cissie) Langner Friedman 60  
Cecilia (Cissie) 60  
Cissie (see Langner, Cecilia (Cissie))  
Cissie Langner Friedman (see Langner,  
Cecilia (Cissie) Langner Friedman)  
D'Arcy 60  
David 60  
Enid Pinto 60  
Ernest 60  
Estelle Roeger 60  
Eather De Sola 60  
Gladys 60  
Gordon 60  
Herbert (Bertie) 60  
Jane Benjamin 60  
Jennie 60  
Joyce 60  
Julian 60  
Julius 60  
Laurence (b. 1890) 60  
Lillian 60  
Nanny (see Langner, Annie (Nanny))  
Philip 60  
Phyllis Adair 60  
Ruth 60  
Simeon (Simon) 60  
Simeon 60  
Stella De Sola 60  
Valerie 60  
**LANGSFELD**  
Anita Grossman 282  
Benjamin Korman (1978-) 339B  
Bessie Stern 282  
Elizabeth 282  
Geraldine Marka 282, 339B  
Jodi Michelle 282  
Judith Miriam Korman 282  
Mark David 282  
Micky (see Langsfeld, Morton A. III  
"Micky")  
Mildred Stern 282, 339B

Morton A. III "Micky" 282, 339B  
Morton A., Jr. 282, 339B  
Morton Arthur (1882-1957) 282, 339B  
Robert David 282, 339B  
Terry 339B  
**LANGSTADTER**  
Fanny Hermann 295  
Isaac 295  
**LANGTRY**  
Anna 102  
**LANTIER**  
Elizabeth Clark 195  
Jane E. Sheftall 267  
William M. 267  
**LANSBERG**  
Elizabeth 107  
**LANSBURGH**  
Anna Maria Mitchell 193  
Edith 145  
Jane 145  
Percy W. 145  
Simon 193  
Stella Simm 145  
**LANSLOWNE**  
George 172  
Helen 172  
Helen Bayless 172  
Marie 172  
Rose 172  
**LANSILL**  
Cary Ogden Gratz 88  
Charles Wellington Burt 88  
Clay Burt 88  
Gary Scott 88  
**LANT**  
Frank P. 265  
Katherine 265  
Stella Rebecca Seixas 265  
**LAPAT**  
Betty 222  
Frances 255  
**LAPOINT**  
Marie Josette Audet 135  
**LA PRATT**  
Amy Elizabeth 299  
Elizabeth Sutton Reynolds 299  
Kimberly Paige 299  
Robert Lee 299  
**LARENDO**  
Aaron (b. 1840) 311  
Anais Padeloup 311  
Edwin 311  
Florence 311  
George 311  
Gersbon (m. 1862) 311  
Gustavus (b. 1844) 311  
Joshua 311  
**LARGE**  
Lillian Naar Gribbin 224  
**LARRAWAY**  
Edith 215  
**LARSON**  
Christina 164  
**LASH**  
Carolyn Frances Hoffman 23  
Elizabeth 292  
Robert Joel (b. 1955) 23  
Walter A. 23  
**LASHANSKA**  
Hulda (b. 1890) 281  
**LATZ**  
Doris Ann Wertheimer 293  
William 293  
**LAUB**  
Albert 137  
Frances Kahn 137  
Mary 249  
**LAUDERBACK**  
Katherine F. 105  
Mary J. 105  
**LAUPER**  
Minnie (1831-1913) 145  
**LAUNCE**

Mary 329A  
**LAURENCE**  
Ann (b. 1920) 140  
Anna Raymond Beardsley 140  
Beardsley 140  
Beardsley, Jr. (b. 1914) 140  
Helen 140  
Herbert 140  
Marienna Moore 140  
**LAURU**  
Mary 311  
**LAVENBERG**  
Amelia Bach 13  
Samuel 13  
**LAVENTALL**  
Edward 15  
Margaret Levi 15  
**LAVERTON**  
Caroline Mabel 79  
**LAVIN**  
Jane 284  
Jeffrey Michael 108  
Jodi Marlene 108  
Joseph Mayer 108  
Justine Martha Lowenberg 108  
**LAW**  
Abby Josephine Goodwin 155, 156  
Ada Caroline (b. & d. 1852) 156  
Amy Davida 156  
Charles Fabian (1858-1910) 156  
Elizabeth Taylor (1848-1854) 156  
Josephine (b. 1853) 156  
Josephine (dau. of Charles) 156  
Katherine 156  
Mary Clayton (b. 1856) 156  
Ralph 156  
Robert Morris Goodwin (1847-1847)  
156  
William (b. 1849) 156  
William (m. 1846) 155, 156  
**LA WALL**  
Amelia Myers 219  
Marchand H. 219  
**LAWE**  
Elizabeth 83  
George (d. 1816) 83  
John (1779-1846) 83  
John 83  
John James 83  
Mary 83  
Rachel Franks 83  
Rebecca 83  
Theresa Rankin 83  
William (d. 1813) 83  
**LAWES**  
Margery 122  
**LAWLESS**  
Marie Russell 313A  
Thomas 313A  
**LAWLEY**  
Alma Dilworth 328A  
Everett 328A  
Everett L., Jr. 328A  
**LAWLOR**  
Mary Stuart 157  
**LAWRENCE**  
Alfred Moss (1866-1924) 147  
Amy Lillian (b. 1872) 147  
Arthur Moss (b. 1859) 147  
Benjamin (1829-1900) 147  
Blanche (b. 1864) 147  
Blanche (m. Walter N.) 232  
Catherine 232  
Charles L. (Lazarus) 232  
Charles L., Jr. (1868-1883) 232  
Edith Emily (b. 1875) 147  
Edwin Abraham (b. 1871) 147  
Elizabeth Nicholl Hoes 220  
Emily 147  
Eather Ella (b. 1862) 147  
Hannah 61  
Ida Van Buren 232  
Jean Sellers 241

John M. (d. 1888) 147  
John Otho 138  
Kate Ruth Dix 147  
Laurie Burrage 218  
Laurie Philip (b. 1864) 147  
Lawrence (d. 1855) 147  
Lionel Emil (1863-1914) 232  
Lizette (Lizzie Lee) Joseph 138  
Louisa Asher 147  
Louise (b. 1866) 147  
Mabel Louise (b. 1872) 147  
Maud (b. 1877) 147  
Meeta Graham 218  
Meeta Graham Myers 218  
Moss 147  
Percy (1859-1924) 232  
Phineas (1831-1918) 147  
Raynor Andrade (b. 1869) 147  
Reuben B. 241  
Reyna Andrade 147  
Reyna Emily (b. 1861) 147  
Roger Dix (b. 1868) 147  
Valentine 113  
Walter N. (1857-1920) 232  
Walton (b. 1869) 147  
William Simmons 218  
Zipporah Noah 232  
**LAWRENCE (LAZARUS)**  
Charles L. (1833-1890) 147  
**LAWSEN**  
Carolyn 22  
**LAWSKY**  
Beverly 125  
**LAWSON**  
Ann Maria De Lancey 76  
Barclay 76  
Charlotte 76  
Emma 76  
Fanny Barr 76  
George 76  
Henrietta 76  
Leonora Amelia Goldsmith 331A  
Oliver 76  
Stephen 76  
Susan 76  
William 76  
William De Lancey 76  
William John 331A  
**LAYCOCK**  
Celeste 196  
**LAZARON**  
Alice Z. De Castro (see De Castro,  
Zipporah Alice)  
Anita 61, 323A  
Bertha 61, 323A  
Clementine 61  
Edna Sara Gerst 61  
Edward Gerst (b. 1950) 61  
Harold Victor 61  
Hilda Rothschild Rosenblatt 61  
Louis 61  
Morris S., Jr. (b. 1917) 61  
Morris Samuel (b. 1888) 61  
Pauline Horkheimer 61  
Polly (b. 1952) 61  
Samuel Louis 61, 323A  
Zipporah Alice De Castro 61, 323A  
**LAZARUS**  
See also Lawrence  
Aaron (b. 1840) 151, 311A, 328B  
Aaron (1777-1841) 38, 151, 200, 311A,  
328B  
Abram 305  
Adeline (1802-1865) 151  
Agnes (b. 1856) 150, 328B  
Albert (1848-1879) 98, 151  
Alice Furman 150  
Almeria Emma (b. 1814) 151, 311A,  
329A  
Amelia Bamed Tobias 150, 297  
Anais Padeloup 328B  
Angelina Green (1809-1887) 151, 207,  
311A, 329A

Annie Humphrey (b. 1859) 150, 328B  
Barnard (see Levy, Barnet (Barnard  
Lazarus or Baer))  
Benjamin (b. 1779) 151  
Benjamin (1805-1806) 311A  
Benjamin Dores (1800-1875) 35, 151  
Benjamin Dores, Jr. (b. 1842) 151  
Bernard (1827-1832) 150  
Brandy (see Lazarus, (Justina)  
Brandy)  
Carol 285  
Caroline (1790-1818) 151, 247  
Caroline Jay Jacobs 132, 151, 326A  
Caroline Sarah 102  
Catherine (dau. of Simon) 326B  
Catherine 60  
Charles L. (see Lawrence, Charles L.  
(Lazarus))  
Charlotte (1804-1894) 54, 151  
Clifford (b. 1882) 151  
Cornelia (b. 1841) 151  
Cornelia Cohen 35, 151  
Daniel (b. 1795) 151  
Daniel (son of Jacob, Jr.) 99  
Edgar Marks (1836-1884) 151, 203  
Edgar Marks, Jr. (b. 1868) 110, 151  
Edward (son of Benjamin D.) 151  
Edward (son of Eric) 102  
Edwin 311A, 328B  
Eleazer (N. Y., 1748) 150  
Eleazer Frank (1851-1929) 150  
Eleazer Samuel (1788-1844) 98, 150,  
328B  
Ella (1826-1850) 150  
Ellen (b. 1825) 151, 329B  
Ellen (b. 1875) 151  
Elsie Weston 150, 325B  
Emily (1852-1895) 150  
Emma (1798-1865) 151  
Emma (1849-1887) 150  
Eric 102  
Erica Cowan 102  
Eather Cohen 38, 151  
Eather Lyons 150, 182  
Eather Nathan 150, 226  
Fanny (see also Lazarus, Frances  
(Fanny))  
Fanny Cusbell 120, 150  
Fanny Hendricks 110, 151  
Fay 326A  
Florence 311A, 328B  
Frances (Fanny) (1817-1882) 150  
Frances 100  
Frumet (Fanny) Cohen 150  
George 311A, 328B  
George Gaines (b. 1836) 150  
Gershon Larendon (b. 1804) 132, 151,  
311A, 326A, 328B  
Gladys Hyde 102  
Gustavus 151, 311A, 328B  
Hannah (1783-1835) 151, 205, 207  
Henry (Charleston, Mobile) 150  
Henry (1806-1868) 150, 214  
Hetty Maria Gomez Hart 85, 98, 99  
Isaac (d. 1779) 150  
Isaac (Philadelphia, Mobile) 150, 182  
Isabel (b. 1873) 151  
Isabel (1820-1893) 98, 99  
Isabella (1785-1862) 151, 247  
Jacob Hart (1822-1891) 150, 297, 328B  
Jacob, Jr. (1781-1834) 99  
Jane 151  
Jane Warner Hart 98, 151  
Jill 285  
John 102  
Josephine (1819-1822) 150  
Josephine (1846-1910) 150  
Joshua (b. 1838) 151, 311A, 328B  
Joshua (b. 1866) 151  
Joshua (1796-1861) 151, 308  
Joshua E. P. (1821-1889) 85, 99  
Julia Judith (1830-1873) 151  
(Justina) Brandy (1752-1825) 124

Leah (1778-1844) 35, 151  
Leila 151, 311A, 328B  
Leila Burnwell 151  
Louisa 150  
Margoles Hart 92  
Maria Cecilia (b. 1811) 151, 329A  
Marks (1757-1835) 62, 151  
Marks Hubert 151, 169  
Marx Edgeworth (1822-1896) 151, 169,  
311A, 329A  
Mary (b. 1847) 150  
Mary Beatrice Barrett 151  
Mary Catherine (1828-1850) 151,  
311A, 329A  
Mary Launce 329A  
Mary Laru 311  
Maurice (Robert) 285  
Merriam (Mary) Moss 150, 214  
Michael (1786-1862) 151  
Michael (Charleston) 151  
Michael Washington (b. 1844) 151,  
311A, 328B  
Minnie (b. 1869) 151  
Minnie (Rachel) Mordecai 151, 203  
Miriam (Mary) Hart 99  
Miriam (1821-1893) 150, 328B  
Mordenai Charlotte Blair Levy 151,  
169  
Moses (son of Eleazer) 150  
Moses (son of Jacob, Jr.) 99  
Moses (1813-1885) 150, 226, 328B  
Naphtali (see Lazarus, Jacob Hart)  
Phebe Yates (b. 1871) 151  
Phila (1806-1888) 151, 311A, 329A  
Phoebe Yates (1794-1870) 151, 308  
Rachel (1781-1785) 151  
Rachel (1807-1883) 151, 311A  
Rachel Mordecai (see also Lazarus,  
Minnie (Rachel) Mordecai)  
Rachel Mordecai 151, 200  
Rebecca (1791-1869) 132, 151  
Rebecca (b. 1808) 150, 328B  
Richa (Rachel) Benjamin 62, 151  
Robert (see Lazarus, Maurice (Robert)  
Rosamond 99  
Rosamond 99  
Rose (b. 1838) 48  
Rosetta 99  
Sampson 150  
Samuel (d. 1798) 150  
Samuel (1811-1868) 150  
Sarah (1842-1910) 150, 328B  
Simon 326B  
Simon (d. 1764) 92  
Solomon David (1793-1808) 151  
Sophia 178  
Theodore (1815-1831) 150, 328B  
Virginia (m. Charles P. Howland) 150  
Virginia (1908-1957) 255  
Walter 151, 311A, 329A  
Washington (1808-1831) 151A, 311A,  
329A  
Yates (1881-1883) 151  
Zipporah Hart 98, 150  
**LEAGUE**  
Mary Linda 42  
**LEAHE**  
Lelah Merritt Fisher 168  
William Stone 168  
**LEAKE**  
Jane 81  
**LEARNED**  
Ellen Travers Craven 157  
Franklin P. 157  
**LEAZERY**  
Kate Henricks 247  
**LEBAIR**  
See also Lieber  
Benjamin (1819-1898) 41, 174, 331A  
Constance (b. 1914) 174  
Florence Arnold 13, 174  
Harold S. (b. 1890) 174, 202  
Lucile (b. 1916) 29, 174



Lucile Mordecai 174, 202  
Margaret (Peggy) (b. 1920) 174  
Moreau 13, 174  
Peggy (see Lehair, Margaret (Peggy))

**LEBENBAUM**

Joan 274  
Matthew 274  
Peggy Harrow 274  
Peter 274

**LEBERMAN**

Betti 83, 152  
Elsa 296  
Linda 152, 303

**LEBOWITZ**

Florence Mary Ginsburg 24  
Jonathan (b. 1932) 24  
Sidney 24

**LE CAIN**

Anna Dickson 76  
David 76

**LECHENGER**

Barbara Weiner (b. 1925) 311B  
Bertha (Patsy) Gilbert 311B  
Gilbert C. (1887-1951) 311B  
Laura (b. 1949) 311B  
Louis (b. 1860) 311B  
Louis (b. 1920) 311B  
Mary Caroline Hanna 311B  
Patricia (b. 1951) 311B  
Pauline (b. 1916) 311B  
Raphael B. 311B  
Rosa Kaiser 311B  
Sarah Mae Hirsch 311B

**LECHTMAN**

Albert (1902-1962) 328A  
Benjamin 145, 328A  
Benjamin S. (1940-) 328A  
Goldie Livingston 145, 328A  
Henrietta (1905-) 328A  
Ira (1908-) 328A  
Judith Lee (1937-) 328A  
Lillian Singer 328A  
Sophie Schneider 328A

**LE CORGNE**

Sydney Cecile 199

**LEDERER**

Albert 161  
Carrie Levy 161  
Charles 161  
Ephraim (1862-1925) 231  
Grace Myrtila Newhouse 231  
Howard 161  
Joyce 161

**LEDESMA**

See De Ledesma

**LEDoux**

Jeanne-Nicole (b. 1946) 309B  
Modeste 16

**LEE**

See also De Lee  
Barbara (b. 1918) 202  
Benjamin 265  
Benjamin M. III 265  
Benjamin Markley 265  
Benjamin Markley, Jr. 265  
Benjamin Mordecai (William) 202  
Caroline (1977-) 332A  
Clarence 202  
Cynthia 296  
Diamond 61  
Dorothy Kiam 296  
Edmund 312A, 332A  
Elaine Bramley 202  
Elizabeth Lynn Maxwell 312A, 332A  
Eugene Orson 199  
James G. C. 41  
Jeffrey 202  
Katherine (b. 1926) 202  
Katherine (dau. of James G. C.) 41  
Katherine Mordecai 202  
L. S., Jr. 258  
Leonard 296  
Luella Mae 265

Mary Eleanor Seitz Emanuel 265  
Mary Moise 199  
Matthew 312A, 332A  
Maud Cromline 41  
Mazie Moise 195  
Patricia Backhoff 258  
Robert 196  
Ruth Frances Ure Holcomb 265  
Sally Sprague 88  
Timothy 202  
Vera Ernestine Carter 265  
Virginia 296  
William (see also Lee, Benjamin Mordecai (William))  
William 312A, 332A

**LEEDS**

Herbert R. 170  
Patricia 293

**LEERBERGER**

Emma 90, 91  
Pauline 295

**LEES**

Jane 135

**LEESER**

Abraham 153, 329A  
Billa Gottschalk 329A  
Eliezer Isaac (1737-1816/21) 329A  
Eva (1780-1853) 329B  
Gitla Leffmann 329A  
Helga 329B  
Hermann 329B  
Hyman 153, 329B  
Isaac (1806-1868) 153, 329A  
Isaac (1769-1854) 329A  
Jacob (d. 1834) 153, 329A  
Jacob (son of Eliezer) 153, 329A  
Lea 153, 329A  
Leffmann 329A  
Leffmann, see also Leeser, Uri (Leffmann)  
Pauline Solomon 329A  
Rhea Zondervan 329B  
Rosalie Spiegel 329A  
Uri (Leffmann) 153, 329A

**LEESON**

Barney 311A  
Daniel Nathaa 311A  
Martha Stella 311A  
Rosanne Claire 311A

**LEFEBRE**

Aline (d. 1869) 84

**LEFFERT (LEFKOWITZ)**

Viola 65

**LEFFLER**

Abram 278  
Adolph 278  
Adolph, Jr. 278  
David Lee 278  
Etta Lovenstein 278  
Helen Peck 278  
John Warren 278  
Lee 278  
Louise Romig 278  
Margaret Ann 278  
Mary 71

**LEFFMANN**

Gitla 329A

**LEFKOWITZ**

Viola (see Leffert (Lefkowitz), Viola)

**LEGG**

Helen 163

**LEGRANGE**

Amelia 50  
Herman 50  
Jane Victoria Davis 50

**LEGRIS**

Josephine 276

**LEHMAIER**

Martin H. 47  
Rachel Davies 47

**LEHMAN**

Anais Gomez 86  
Cecile Seligman 40

David 283  
Frances 211  
Frank 191  
Harold 40  
Helene Anderson 233  
Laura 321B  
Margery Cohen 191  
Mark Jacob 86  
May Stern 283  
Mina (b. 1844) 229  
Miriam Gross 86  
Nanette 15  
Peggy Lashanska Rosenbaum 281  
Penelope (b. 1940) 281  
Peter Gerald (1917-1944) 281  
Richard 191  
Susan 40, 285  
Wendy (b. 1942) 281

**LEIB**

Judah 139

**LEIBSON**

Henrietta Rosenheim 255  
Jacob 255  
Nanette Jelenko 255

**LEIDLUFF**

Herman 45  
Selina Davega 45

**LEIDY**

Cornelia Carter 80

**LEIFERT**

Harriet 61

**LEIGHTON**

Lawrence 285  
Marianna Stroock 285

**LEINKAUF**

Bertie 9

**LEION**

Anna (see Leion, Hannah (Anna Minis))  
David (b. 1799) 194  
Hannah (Anna) Minis 194

**LEIPHIMER**

Carrie K. Goldman 327A  
Hazel C. (1912-) 327A  
Helen Lowenstein 327A  
Louis 327A  
Louis 327A  
Rose (1902-) 327A

**LE JEUNE**

Anne 304  
Bernard 220  
Cecile 304  
Eather Myers 220  
Francois 304  
Guy 303  
Lauré 304  
Louise 304  
Rachel (1830-1834) 220  
Rebecca 220  
Rosina (1832-1898) 220

**LELAND**

Anna Maria Cohen 32  
Anne Leslie 122  
Barney (b. 1878) 32  
Benjamin Luther 32  
Carolyn 122  
Katherine 122  
Margaret 333A  
Margery Lawes Gooday 122  
Meta Clara 32  
Michael 122  
Solomon Eting 32  
Virginia 122  
William 122

**LEMAN**

Emanuel (b. 1746) 311A  
Frances Caspar 311A  
Francis Frederick (1860-1933) 311A  
Henriette Pecare 311A  
Lionel (b. 1776) 311A  
Matilda Heinstein 311A  
Michael L. (1807-1889) 311A  
Moses Henry (1834-1913) 311A

Violet Frances (m. 1912) 311A

**LEMARIE**

Audrey Marie 196

**LEMLE**

Bertha Simon 148  
Gottlieb 148

**LEMMON**

Edgar G., Jr. 125  
Edgar Guy 125  
Ginabeth 268  
James H. 268  
James H., Jr. 268  
John M., Jr. 125  
John Michael 125  
Peter Gerald 125  
Rosalind Isaacs 125  
Sarah Virginia Sheftall 268  
Valerie 268

**LEMOND**

Earl 309A  
Janice Bitterman 309A

**LENG**

Evelyn 81

**LENOIR**

Louise (b. 1891) 198

**LENOX**

Arlene 17

**LEO**

Annette (Hannah) Lewis 152, 171  
Ansel (1806-1878) 152, 272  
Ellen (Nellie) 152  
Florence Stines 152  
Hannah Lewis (see Leo, Annette (Hannah) Lewis)  
Henry (b. ca. 1809) 152, 171  
Jessica (Jochebed) Simson 152, 272  
Lewis (1809-1876) 152  
Minnie Esther Stines 152  
Nellie (see Leo, Ellen (Nellie))  
Sampson Simson (b. 1853) 152  
Simoa 152  
Simon Newton (b. 1843) 152

**LEON**

See also De Leon  
Abigail Abendanone 1  
Adrian Z. 60  
Ailsa 115  
Alexander (1813-1863) 33  
Alice Montefiore 115  
Arthur 115  
Elaezer (d. 1837) 33, 309B  
Esther Abrahams 6  
Ethel 115  
Guy Ewart 115  
Helen Twyford 115  
Isaac Rodriguez 29  
Judith 29  
Kenneth 115  
Lillian Levy 115  
Naomi Pool 60  
Peter 115  
Philip 115  
Sally (Sarah) Cohen 33  
Vera Stackpool 115  
Wilfred 115

**LEONARD**

David 332A  
Laurence 332A  
Marcia Polak 332A  
Mark 332A  
Andrew 149  
Cynthia Caswell 149  
Dene 149  
Erma Katherine Goldbaum 149  
Esador 219  
Howard 149  
Jahna Flesher 149  
Lawrence 149  
Linda 3  
Rachel Myers 219

**LERAMONDA**

Albert J. 276

Daniel 276  
Ellen 276  
James 276  
Joseph 276  
Joseph, Jr. 276  
Julia Christina Berger 276  
M. Philomene 276  
Marguerite Solomons 276  
Marie A. 276  
Ouillette 276

**LEROY**

Marie 272

**LESCOR**

Barnard 237  
Lena Rothgeiser (see Lescor, Lillian (Lena) Rothgeiser)  
Lillian (Lena) Rothgeiser 237

**LESLA**

Lender 261

**LESSER**

Adolph 327B  
Adolph 174  
Adrienne Helene (1965-) 328A  
Annie Rintels 174  
David (1953-) 328A  
Frank (1928-) 328A  
Gladys Adler 327B  
Hannah Hoffman 328A  
Herbert 174  
Joanne (1959-) 328A  
Lorraine Hulsman 328A  
Marjorie 296  
Max Meyer (1924-) 328A  
Richard (1963-) 328A  
Roselle 174  
Simon 174  
Susan (1956-) 328A  
Sylvia 89

**LESTER**

Daniel Brinson 256  
Margaret E. 256  
Margaret Isabelle Russell 256  
Myra Cooke 256  
Richard 256

**LETELLIER**

Ella Theresa Tobias 299  
Louis S. 299

**LETTERMAN**

Caroline 219  
Hattie (1874-1936) 325A  
Leonora 108

**LEVER**

Alice 164  
Alice Landis Place 164  
Edward B. 164  
Edward B. III 164  
Edward B., Jr. 164  
Grace Shepherd 164  
John Aubrey 164  
Joseph L. 164  
Lilly Shepherd 164  
Lionel 164  
Lucious 164  
Lucious, Jr. 164  
William Aubrey (1884-1906) 164

**LEVENE**

Rita 207

**LEVENSON**

John Jacob, Jr. 245  
Louise Honori Phillips 245

**LEVER**

John 12

**LEVY**

See also Levy  
Augustus A. 102  
Emanuel (1779-1876) 100  
Esther 100  
Phoebe J. Hart 102

**LEVI**  
See also Levy  
Alberta Kahn 15  
Ann Levy 65, 170, 174, 310A, 312A

Annie Josephine 65  
Arthur 65, 310A  
Barbara (b. 1946) 15  
Bertha (b. 1891) 313A  
Beslah Springer 89  
Bess Feldman 327A  
Charles 65, 170, 310A, 312A, 331A  
Clara (1849-1900) 326A  
David 121  
Dinah Julia Emanuel 65, 310A, 331A  
Dorothy Bella 228  
Edna G. (1902-) 327A  
Ethel A. ("Ethel Dale") 49, 65, 153  
Eve Hyman 121  
Florence (b. 1881) 313A  
Florence 231  
George (d. 1855) 174  
Gotcheau 13  
Hannah (Anne) Levy (see Levi, Ann Levy)  
Harold G. (1910-) 327A  
Henry C. (see Lytton, Henry C.)  
Isaac (Ike) 65, 310A  
Jack (Jacob) (b. 1845) 65, 310A  
Jeanette Aufesser 15  
John Delano 13  
Joseph (d. 1925) 65, 310A, 331A  
Judith (d. 1843) 174  
Julia Wertheimer 228  
Justine Ellen Koscherak 13  
Leo N. (1856-1904) 313A  
Malcolm (1935-) 327A  
Marcia (b. 1953) 15  
Margaret (b. 1906) 15  
Matilda Marion Johnson 326A  
Mauri 43  
Minnie (b. 1879) 313A  
Miriam 320B  
Moses 327A  
Rachel Bachrach 313A  
Rachel Sarah 65  
Ray 285  
Rebecca (b. 1843) 65, 310A  
Richard (b. 1908) 15  
Selma (1899-) 327A  
Sol (1865-1938) 15  
Solomon Julius (1815-1877) 326A  
Trepheia (1843-1917) 326A

**LEVI (LEVINGER)**

Elias Solomon 21  
Saphira (1784-1864) 21

**LEVIE**

Mynthe 242

**LEVINE**

Louisa 100

**LEVIN**

Alfred (d. 1882) 153  
Alfred Clayton (d. ca. 1929) 233  
Andrea 340B  
Ann Sampson 153, 259  
Anne De Leon 18  
Bertha A. 233  
Charles Davis 49, 65, 153  
Charlotte A. Woolf 153, 305  
Clara Ivanetta Sargent Hunter 233  
Constance ("Helen Clyde") 153  
Edeline Deborah (b. 1873) 153  
Edith C. 233  
Eliza Isabella (b. 1841) 153  
Eliza T. Woolf 153, 305  
Elizabeth 49, 153  
Ernest Aaron Hart (b. 1879) 153  
Esther (Charleston) 64  
Esther Davis 49, 153  
Ethel A. Levi (Ethel Dale) 49, 65, 153  
Ethel Hart (b. 1877) 153, 244  
Flora 153  
Florence Benjamin 18  
Frances Lazarus Hart 95, 153  
Gustav (1841-1923) 95, 153  
Hattie Newman 153  
Henry (d. 1883) 233  
Herbert Jacob (b. 1884) 153

Herbert, Jr. (1913-1929) 153  
Hilda Sarah (b. 1875) 153  
Ida Leon Nones 233  
Isabel (d. 1850) 153  
J. Siegmund (b. 1866) 233  
Jacob (1802-1874) 153, 203, 259  
Jacob I. 153  
Jane 18  
Jennie Y. Stein 330B  
Judith Mordecai 153, 203  
L. T. (1818-1892) 153, 305  
Lewis (b. 1842) 153  
Lewis (1793-1829) 153  
Lewis C. 153, 203  
Lewis, Sr. (1765-1817) 153  
M. 153, 305  
Malcolm H. (b. 1916) 153  
Mary 207  
Mary Carol 49, 153  
Mary Moses 153, 213  
May (dau. of Solomon Moses) 49, 153  
May (1871-1920) 207  
Meta Hart (b. 1882) 46, 153  
Mortiz 153, 305  
Nathaniel (1816-1899) 153, 213  
Nettie Louise 153  
Ruth 153  
Sadie Haas 153  
Solomon Davis 49, 153  
Solomon Moses 49, 153, 309B  
Walter Lawrence 18  
Walter S. 18  
Walter Scott (son Solomon Moses) 49  
153

#### LEVINE

Alma Mendes 191  
Amelia 153, 300  
Ann Samuel 261  
Benjamin 153  
David (m. 1857) 153, 182  
Edmund 191  
Ethel Levi 174  
Frances 247  
Helen 191  
Julia 153  
Kate 191  
Marian De Sola (see Mendes, Marian  
De Sola)  
Mary Lois (Tallent) 237  
Rebecca 89  
Rosetta (Rosa) Lyons Hohenfels 118,  
153, 182  
Tallent (see Levine, Mary Lois  
(Tallent))

#### LEVINGER

See Levi (Levinger)

#### LEVINSON

Anna H. 47  
Budd 291  
Esther 327B  
John J. 47  
Judith Peixotto Sulzberger Rosenschein  
Cohen 291  
Lieb 327B  
Lizzie M. Davies 47  
Louis 47  
Marie O. 47  
Marie Waldman 47  
Max L. 47  
Walter 47  
Walter Clarence 47

#### LEVY

See also Botnez (Levy), Levey, Levi,  
Lytton, Yulee  
A. Charles (1847-1933) 166  
Aaron (Amsterdam) 166  
Aaron (son of Benjamin) 166  
Aaron (1742-1815) 166  
Aaron (1771-1852) 159, 209  
Aaron F. 307  
Aaron, Jr. (son of Aaron) 166  
Aaron, Jr. (1774-1852) 166  
Abbie 182

Abigail (b. 1700) 92  
Abigail (b. 1718) 154  
Abigail (Bilhah) (see Levy, Bilhah  
Abigail)  
Abigail (dau. of Jabeca (Polly)) 170  
Abigail (Golly) 92  
Abigail (1760-1820) 154, 155  
Abigail (1803-1840) 106, 169  
Abigail Sampson 259  
Abraham (Amsterdam) 120  
Abraham (b. & d. 1767) 159  
Abraham (m. 1810) 127  
Abraham (1769-1852) 162, 329B  
Abraham (1831-1894) 162, 329B  
Abraham (1846-1851) 183  
Abraham G., Jr. 136  
Abraham Isaac (d. 1882) 162  
Abraham L. (1796-1829) 18, 163  
Abram (son of Jacob) 167  
Abram (1820-1879) 167, 247  
Abram (1875-1937) 167  
Abram Gustavus (1818-1897) 311A  
Abram III 167  
Abram, Jr. (b. 1900) 167  
Adah Virginia (1862-1899) 162, 329B  
Adam Giffen (1883-1955) 330A  
Addie L. C. Moses 165, 209  
Addie Solomon 167  
Adelaide 166  
Adelaide Betty (b. 1856) 167  
Adele (dau. of Edward L.) 165  
Adele (1849-1920) 165, 207  
Adele Bowes Reeves 164  
Adele R. Jackson 129  
Adeline Brady (1877-1934) 167  
Adeline Hyneman 134, 162  
Adolph A. 116  
Agnes Ester 330B  
Agnes Hendricks (b. 1895) 159  
Alan 102  
Alan M. (1957-) 327A  
Albert (m. 1960) 125  
Albert (son of Joseph) 161  
Albert (son of Solomon Lazarus) 164  
Albert (1879-1883) 163  
Albert Eugene 163  
Albert Gervais (1840-1853) 329B  
Albert M. 163, 164  
Albert Marion (see Andrews, Albert  
Marion)  
Albert Smith 162  
Albertina 162  
Alex Ritzwoller Schaul 125  
Alexander (son of Uriah P.) 159  
Alexander (1818-1866) 165  
Alexander (1852-1919) 305  
Alfred B. 290  
Alfred L. (b. 1823) 163  
Alice (dau. of Daniel Deronda) 165  
Alice (dau. of Solomon L.) 163, 249  
Alice (1825-1827) 159  
Alice (1849-1920) 233  
Alice (1853-1900) 170, 249  
Alice (1860-1927) 167, 330B  
Alice Murray 166  
Alice Pollock (see Levy, (Cecile) Alice  
Pollock)  
Alice Simon 148  
Alicia Martin 330A  
Alma (b. 1902) 159  
Almeria (Minnie) Moses 165, 211  
Almeria 165  
Almeria De Leon 55, 159  
Alvin 309A  
Amanda Octavia (1843-1897) 164, 214  
Amanda Phillips 163, 247  
Amelia (b. 1862) 159  
Amelia (dau. of Morton) 159  
Amelia (Minkie) Hart 102, 170, 330B  
Amelia (1793-1867) 159  
Amelia K. (1893-) 331A  
America Muniz 162  
Andrew (b. 1852) 47

Andrew (see also Levy, Lev (Perhaps  
Andrew))  
Angela 127  
Angelique Heydenfeldt 58, 167  
Ann (b. ca. 1815) (m. Charles Levi)  
65, 170, 174, 310A, 312A  
Ann (m. Richard Bendheim) 222  
Ann Maria (1840-1841) 163  
Anna (see also Levy, Nanine (Anna))  
Anna Brownsen 330A  
Anna Erwin Fleming 167  
Anna Florence Allen 10  
Anna Landauer 311A  
Anna Maria Moses 163, 164, 207  
Anna Schultz 161  
Annabella Myers 169, 216  
Anne (see Levy, Hannah (Anne))  
Anne Maggs 154  
Annette Angelique (b. 1886) 167  
Annie Brown 167  
Ansell Samuel 170  
Arabella (1761-1810) 154, 158  
Arabella Myers (see Levy, Belle  
(Bilhah) (Arabella) Myers)  
Arthur (b. 1904) 162  
Arthur (m. Esther Chuck) 161  
Arthur (son of Ezekiel Jacob) 162  
Arthur (unm.) 161  
Arthur Crawcour (1880-1942) 164  
Carlotta (see Levy, Lotta (Carlotta))  
Carol 287  
Arthur Saul 170  
Arthur Saul, Jr. 170  
Asabel 159  
Asher (b. 1699) 154  
Asher (d. 1785) 154  
Asher Samuel 169  
Asser (d. 1682) 170  
Audrey 125  
Audrey Talley 330A  
Audrey Virginia (1941-) 330A  
Augusta (1801-1870) 159, 303  
Augusta Singer 330B  
Augustus Abraham (b. 1846) 162  
Baer (see Levy, Barnet (Barnard  
Lazarus or Baer))  
Barbara 167  
Barbara Lee Smith 327A  
Barbara Weil 166  
Barnard Lazarus (see Levy, Barnet  
(Barnard Lazarus or Baer))  
Barnet (Barnard Lazarus or Baer) 57  
Barton Epley (b. 1898) 166  
Bayle Hart 99  
Beila (d. 1697) 154  
Bella (m. Will Levy) 161  
Bella (1762-1851) 98, 99  
Bella Greenberg 167  
Bella Levy 161  
Belle (Bilhah) (Arabella) Myers 169,  
218  
Belle (d. 1893) 163  
Belle 135  
Belle Evelyn 164  
Belle Evelyn Saunders 164  
Belle Goldman 143  
Benjamin (b. 1782) 170, 331A  
Benjamin (b. 1786) 165  
Benjamin (b. 1806) 166  
Benjamin (b. 1878) 166  
Benjamin (in London, 1664) 170  
Benjamin (m. 1834) 101  
Benjamin (son of Benjamin) 166  
Benjamin (son of Michael) 159  
Benjamin (son of Simeon) 165  
Benjamin (1692-1787) 165  
Benjamin (1726-1802) 154  
Benjamin (1728-1749/50) 92  
Benjamin Franklia 166  
Benjamin H. III 320A  
Benjamin H., Jr. (b. 1948) 5  
Benjamin Hirsch S. 320A  
Benjamin J. 166

Benjamin Wolf (1664-1704) 92, 114  
Benjamin Wolfe 170  
Benjamin, Jr. 166  
Bennett 164  
Bernard (1789-1869) 228, 289  
Bernard A. 311B  
Bertha 165  
Bertha Joachimsen (b. 1849) 136  
Bertha S. (d. 1944) 283  
Bertha Strauss 330B  
Berthold W. 290  
Betsy 236  
Bettie 338B  
Bezalel 340B  
Bila 159  
Bilah (dau. of Moses) 92  
Bilah (1742-1781) 165  
Bilah Myers (see Levy, Belle (Bilhah  
Arabella) Myers)  
Bilhah (dau. of Simeon) 165  
Bilhah (see also Levy, Abigail  
(Bilhah))  
Bilhah Abigail (1696-1756/65) 75, 154,  
311A, 324A  
Billie 162  
Blanche (b. 1888) 166  
Blanche E. 166  
Blume Hart 101  
Calhoun 163  
Carlotta (see Levy, Lotta (Carlotta))  
Carol 287  
Carol Sharlin 127  
Carolina Turo (1850-1852) 167  
Caroline (Gnenti, Kailine) 301  
Caroline Agnes (d. 1834) 164  
Caroline Jacobs 132  
Caroline Moise 164  
Carrie 161  
Carrie (18617-1911) 311A  
Carrie Negbauer 166  
Catharina 305  
Catherine 148  
Catherine Bowers 163  
Cecile Alice Pollock 290  
Cecilia C. (b. ca. 1835) 311B  
Cecilia Eliza (1830-1916) 32, 164  
Celia (1849-1922) 167  
Chapman (1787-1849) 169  
Charles (b. 1882) 166  
Charles (son of Charles Ferdinand)  
163  
Charles (son of Eugene Henry) 165  
Charles (son of Robert) 326B  
Charles Albert (1890-1921) 330A  
Charles Albert (1917-) 330A  
Charles Ferdinand (1828-1901) 17, 163  
Charles Gillette (1845-1858) 330A  
Charles J. 166  
Charlotte (d. 1765) 154  
Cherie Moise 163  
Christina Larson 164  
Claire (dau. of Abram, Jr.) 167  
Claire (dau. of Henry Hyman) 162  
Claire (dau. of Theodore) 162  
Clara (1859-1939) 311A  
Clara 148  
Clara Belle Esther Folz 311B  
Clara Mundachein 165, 330B  
Clarence (son of Abraham) 162  
Clarence (son of Esther Chuck) 161  
Clarence E. (1839-1872) 163  
Clarence Phineas (1869-1939) 166  
Claudina Gervais 162, 329B  
Claudina Gervais (1885-1954) 330A  
Clifford 162  
Clifton Harby 165  
Columbus Moise 164  
Cora Bacharach 165  
Cordelia (b. 1831) 163  
Cordelia (dau. of Charles Ferdinand)  
163  
Cordelia Moise 163  
Corinne Davis 48, 165

Cornelius (son of Abraham Isaac) 162  
Cornelius (1842-1865) 162  
Daisy Inez 163  
Daniel (b. 1766) 154  
Daniel (of London) 249  
Daniel (son of Isaac A.) 162  
Daniel Deronda 165, 211  
David (b. 1856) 161  
David (father of Sarah) 306  
David (son of Alan) 102  
David (son of Harry) 161  
David (son of Louis) 287  
David (1841-1842) 163  
David A. (b. 1859) 102  
David A. (1860-1939) 331A  
David C. 164  
David C., Jr. (1837-1863) 164  
David Cardozo (1805-1877) 163, 164,  
207  
David Cardozo, Jr. 164  
David H., 330A  
David J. 170  
David Jacobs (d. 1771) 131, 272  
Deborah Ethel Tanner 330A  
Debra Ann (1965-) 330A  
Dinah (Diana) (1785-1815) 182  
Dinah R. 228  
Dora 164  
Dora Alice Moise 164, 196  
Dorita 161  
Dorothy 166  
Dorothy Ida (b. 1904) 167  
Dorothy Wolff 102  
Dorothy (1917-) 330A  
Edgar (b. 1916) 10  
Edgar (m. Isobel) 127  
Edgar (son of Edgar) 127, 326A  
Edgar (1846-1889) 162  
Edgar A. 127, 326A  
Edith (d. 1974) 287  
Edith (m. Leon) 161  
Edith F. (1940-) 320A  
Edith May 163  
Edmund Hyman 165  
Edna 164  
Edna G. Levi 327A  
Edward (m. Rebecca Jackson) 130  
Edward (see also Levey, Edward)  
Edward (son of Benjamin) 166  
Edward (1911-) 320A  
Edward Anderson (d. 1848) 169  
Edward D., Jr. (1937-) 320A  
Edward J. 165  
Edward S. 84  
Edwin (b. 1854) 167, 330B  
Eleanor (b. 1886) 166  
Eleanor Marjorie 164, 311B  
Eleanor Moise 163, 164, 195  
Eleanor Moise Levy 163, 164, 195  
Eleanor Wolff (b. 1847) 171  
Eleazar (Amsterdam & Charleston) 18  
Eleazar (d. 1811) 159  
Eleazer (m. Sarah Levy) 159  
Eliakum 170  
Elias (1702-1750) 92  
Elias Henry (b. 1867) 166  
Elias L. (b. 1802) 171  
Elias P. (1791-1856) 163, 195  
Elias P. (1810-1852) 171  
Elias P., Jr. 166  
Elias Phineas (1836-1891) 118, 166,  
330B  
(Elias) 171  
Elinor Steel 229, 334B  
Eliza (dau. of Hart) 183  
Eliza (dau. of Michael) 159, 329B  
Eliza Aarons (see Levy, Golah (Eliza)  
Aarons)  
Eliza Henrietta (b. 1821) 169  
Elizabeth (b. 1906) 162  
Elizabeth (dau. of Edgar) 127  
Elizabeth (dau. of Emanuel) 309B  
Elizabeth (m. Joseph A. Price) 167

Elizabeth (m. Peregrine Flaconer) 170,  
331A  
Elizabeth Ann 127, 326A  
Elizabeth Detweiler 162  
Elizabeth Hays 167  
Elizabeth J. (dau. of Mordecai M.)  
170  
Elizabeth Jean 320A  
Elizabeth Lee Reinheimer 290  
Elizabeth Lewis 183  
Elizabeth Pue 154  
Elizabeth Workum Hirsch 307  
Ella (Memphis) 1  
Ella (1783-1865) 160  
Ella Hoke 164  
Ella Smith 166  
Ellen 163  
Ellen Alice Moise 163, 164, 197  
Ellen Frances Smith 166  
Elmer Maximilian (1904-1985) 330B  
Elsie 296  
Emanuel (b. Eng.) 167, 309B, 312A,  
330B  
Emil 10  
Emilie Prieur 165  
Emma (m. Albert S.) 162  
Emma (1832-1873) 169  
Emma Bachrach 313B  
Emmaline 166  
Emmaline Rumsey 166  
Erica 287  
Ernest Coleman (1868-1938) 162  
Ernst Moritz (b. 1908) 10  
Essie (dau. of Abram) 167  
Essie (dau. of Jacob) 167  
Ester 19  
Esther (b. 1850) 102  
Esther (dau. of Abraham) 124, 162  
Esther (dau. of Manasseh) 161  
Esther (England) 310A  
Esther (Henrietta) 154  
Esther (Hetty Grace) (1793-1826) 159  
Esther (Hetty) 100, 154  
Esther (m. Aaron De Sola) 61  
Esther (m. Joseph) 154  
Esther (m. 1786) 57  
Esther (see also Levy, Hetty (Esther))  
Esther (1721-1785) 100, 154  
Esther (1789-1871) 228  
Esther (1790-1843) 170, 330B  
Esther Behrendt 160, 161  
Esther Blankman 170  
Esther Caroline Raphall 163  
Esther Chuck 161  
Esther H. 170, 312A  
Esther Moreau 169  
Esther Solomon Lyons 183  
Esther (1851-1920) 331A  
Ethel (b. 1894) 15  
Etta Guggenheimer 90  
Ettie (dau. of Joseph) 161  
Ettie (m. Albert) 161  
Ettie (m. Mitchell) 161  
Ettie Levy 161  
Eugene 211  
Eugene Henry (b. 1840) 165, 207,  
330A  
Eugene Henry (son of Clifton Harby)  
165, 211  
Eugene Henry, Jr. 165, 330B  
Eugenia (dau. of Eugene Henry) 165  
Eugenia (1820-1901) 169, 247  
Eugenie 159  
Eva (b. 1910) 10  
Eva 18, 309A, 312A  
Evangeline 165  
Eveline (b. 1855) 47  
Everleen (Eveline) 163  
Ezdra L. 163, 247  
Ezekiel Jacob (1833-1908) 48, 162  
Ezra (b. 1810) 163, 247  
Fannie (dau. of Manasseh) 161  
Fannie Levy 166

Fannie Newberger 167  
Fanny (dau. of Benjamin) 166  
Fanny (dau. of Elias Henry) 166  
Fanny (dau. of Jacob Clarisse) 169  
Fanny (m. Benjamin Yates) 308  
Fanny (see also Levy, Frances (Fanny))  
Fanny (1852-1922) 305  
Fanny Emma (1831-1925) 164, 195, 197  
Fanny H. Joseph 166  
Fanny Wolff (see Levy, Frances (Fanny) Wolff)  
Fanny Yates 169, 308  
Fannye Koppel 167  
Figlah 272  
Flora (dau. of Abraham Isaac) 162  
Flora (dau. of Ezra) 163  
Flora (dau. of Jacob of New Orleans) 165  
Flora (dau. of Mordecai) 309B, 310A  
Flora (m. Henry) 161  
Flora (m. 1872) 145, 327B  
Flora (1803-1823) 169  
Flora Eliza (1823-1851) 169  
Florence Esther (b. 1897) 159  
Florine 148  
Frances (dau. of Benjamin, Jr.) 166  
Frances (Fanny) (1804-1857) 159, 179  
Frances (Fanny) Allen Mitchell 159, 193  
Frances (Fanny) Wolff (b. 1893) 159, 171  
Frances (m. 1842) 93  
Frances (Memphis) 1  
Frances (1806-1856) 137, 169  
Frances (1812-1837) 163  
Frances Goldsmith 84  
Frances Marian 164  
Frances Marion (b. 1874) 164  
Frances Phillips 181  
Frandele 92  
Frank 164  
Frank La Grange 163, 164  
Frank La Grange, Jr. 163  
Frank M. 167  
G. Washington (1847-1848) 167  
Gary Michael (1942-) 5, 320A  
George (son of Judah Mears) 165  
George (1820-1832) 159  
George D. (1867-1902) 101, 162  
George Davis 165  
George Moses 130, 170  
Gertrude Hahn 162, 190  
Gertrude Hart (1867-1945) 101, 162  
Gervais F. (1870-1948) 330A  
Gervais F. (1896-1958) 330A  
Gervais (1927-1927) 330A  
Gitlah Lyons 183  
Gladys 163  
Gladys Loring 167  
Gnaatl (see Levy, Caroline (Gnaatl, Kailine))  
Golah (Eliza) Aarons 1  
Goldye 101  
Golly (see Levy, Abigail (Golly))  
Grace Aguilar 330B  
Grace Labatt 148  
Grace Mears (1694-1740) 104, 154, 190  
Grace Mears (1742-1817) 165, 190  
Haim (Hiam) (1739-1795) 165, 190  
Hannah (Ann) Solis 162, 274  
Hannah (Anne) (see Levy, Ann (b. 1815))  
Hannah (d. 1772) 168  
Hannah (d. 1870) 74, 183  
Hannah (Hannah) Myers 221  
Hannah (Hindlah) (1723-1751) 124, 154  
Hannah (m. Moses Elias) 171  
Hannah (1755/8-1849) 132, 182  
Hannah (1761-1850) 98, 309B  
Hannah (1783-1863) 165

Hannah (1810-1850) 166  
Hannah (1851-1919) 160, 161  
Hannah de Samuel De Crasto 155  
Hannah Hart 101  
Hannah Hendricks 167, 247  
Hannah J. Hart 102, 170, 312A  
Hannah Lyons 161  
Hannah Naomi (d. 1813) 169  
Hannah Simson 154, 272  
Harmon Hendricks (1828-1829) 159  
Harold Alexander (b. 1894) 305  
Harriet Louise Fuqua 330A  
Harry 326B  
Harry 161  
Hart (1781-1866) 183  
Haya Sara (1768-1855) 159  
Haya Sarah (d. 1763) 159  
Hayim 170, 313B, 331A  
Hayman (1721-1789) 159, 217  
Helen (b. 1906) 116  
Helen (d. 1916) 246  
Helen (dau. of Eugene Henry) 165  
Helen (m. Francis Mendes) 191  
Helen Smith 162  
Hendle 159  
Henrietta (b. 1836) 1, 183  
Henrietta (m. Manasseh) 161  
Henrietta (see also Levy, Esther (Henrietta))  
Henrietta King 145  
Henrietta Maria (1792-1860) 154  
Henrietta Schwartz 166  
Henrietta Yates 169  
Henry (b. 1844) 136  
Henry (b. 1869) 311B  
Henry (m. Flora) 161  
Henry (m. Sipporah Jacobs) 134  
Henry (son of Moses) 165  
Henry Hyman (1850-1920) 162, 190  
Henry Judah 170  
Henry Marian (1852-1894) 167  
Henry S. 167  
Herbert 229, 334B  
Herbert Fies 42  
Herman (m. Alice Simon) 148  
Herman (m. Minnie Chuck) 161  
Hester Pollock 171  
Hester Sarde 155  
Hetty (dau. of Joshua) 165, 168  
Hetty (Esther) (1768-1780) 154  
Hetty (1761-ca. 1816) 154  
Hetty Barrett (1858-1897) 163  
Hetty Grace (see Levy, Esther (Hetty Grace))  
Hetty Levy 165, 168  
Hindele 92  
Hirsh Power 159, 160  
Hitchele Heilbuth 92  
Hortense (d. 1923) 240  
Hortense (d. 1970) 60  
Hortense (m. Amram) 284  
Hyman 134  
Hyman Joseph (1865-1883) 166  
I. Clarence (son of J. Willie) 367  
I. Clarence (1850-1897) 167  
Ida (1853-1873) 162  
Ida Brady 167  
Ida Paasch 166  
Ida Augusta 164  
Ida Mae Weil 167  
Ira 161  
Irma (b. 1886) 90  
Irma (1884-1904) 164  
Irma Kraft 330A  
Irma Lester (b. 1896) 313B  
Isaac (b. 1761) 168  
Isaac (b. 1800) 159  
Isaac (bro. of Michael) 159  
Isaac (d. 1695) 154  
Isaac (father of Benjamin) 165  
Isaac (father of Simba) 19  
Isaac (Germany) 92  
Isaac (m. Emma Bachrach) 313B

Isaac (m. 1879) 63  
Isaac (son of Hirsh Power (Levy)) 160  
Isaac (son of Jacob H.) 167  
Isaac (son of Joseph of London) 154  
Isaac (son of Joseph of N. Y. & S. C. 154  
Isaac (son of Moses) 159  
Isaac (son of Samuel) 148  
Isaac (1706-1777) 154  
Isaac (1735-1764) 132  
Isaac (1809-1871) 58, 167  
Isaac (1886-1888) 166  
Isaac Clarence 167  
Isaac H. (b. 1842) 311B  
Isaac H. (1763-1854) 159  
Isaac Henry (b. 1849) 171  
Isaac J. (1842-1864) 162  
Isaac Jacob 171  
Isaac S. (1816-1849) 162, 274  
Isaac Tobias (1792-1811) 163  
Isaac, Jr. 154  
Isabel (see also Levy, (Isabel) Mathilda)  
Isabel 163  
Isabel A. Moses 164, 212  
Isabel Adeline 164  
Isabel Cone 91  
Isabel Isaac 127, 326A  
(Isabel) Mathilda 165  
Isabella (b. 1861) 47  
Isabella (m. Samuel Cohen) 34  
Isabella (1731-1754) 92  
Isabella (1849-1925) 159  
Isabelle (b. 1900) 163  
Isabelle (dau. of Samuel) 148  
Isabelle Adeline Moses 164, 212  
Isidore 161  
Isidore Henricks (b. 1852) 167  
Isobel Isaacs 127  
J. Willie 167  
J. S. 119  
Jabeca (Polly) 170  
Jacob (b. 1764) 272  
Jacob (father of David Jacobs) 272  
Jacob (m. Rachel Michaels Myers-Cohen) 193  
Jacob (m. Rosey Israel) 170  
Jacob (New Orleans) 165, 185, 330A  
Jacob (Wilmington, N. C.) 175, 312B  
Jacob (1793-1814) 163  
Jacob A. (b. 1831) 311B  
Jacob Abraham (1804-1878) 69, 162  
Jacob Barrett (1856-1858) 163  
Jacob Clariase (or Clavius) (1788-1875) 169, 308  
Jacob Franks (b. 1762) 154  
Jacob H. 167  
Jacob P. 330B  
Jacob R. (1846-1865) 167  
Jacob, Jr. (1753-1837) 169, 330B  
Jacqueline Ellen (d. 1896) 163, 207  
Jacqueline Ellen (dau. of Elias P.) 163  
James D. 169  
James Herbert 42  
Jane (dau. of Mordecai) 309B  
Jane 127  
Jane Brady 166  
Jane Delaphine 287  
Jane Eileen (1953-) 330A  
Jane Hart 98, 169  
Jane Bitterman 309  
Jean McLaughlin 127  
Jean William 167  
Jeannette Victor 167  
Jechiel (see Levy, Michael (Jechiel))  
Jefferson Moaroe (Michael) (1852-1924) 159  
Jeffrey Talley (1958-) 330A  
Jennifer Leigh (1974-) 320A  
Jerrold 127  
Jesse Gertrude 295  
Jessie Burns (1923-) 330A  
Jessie Gertrude Burns 330A

Jill 236  
Joan (b. 1942) 5  
Joan (dau. of Lionel) 287, 340A  
Joan Levy 5  
Joanna 171  
Jochebed (1746/7-1828) 165, 263  
Jochebed (1797-1820) 165  
Joella Haweis Loy 127  
John 127  
John B. (1956-) 327A  
John Edward (1882-1948) 330A  
John Edward (1913-) 330A  
John Edward (1950-) 330A  
John Jacob (b. 1824) 297  
John Jonah 102, 170, 330B  
John Victor 307  
Jonas Phillips (1807-1883) 159, 193  
Jonathan 5  
Jonathon 127  
Jonathon Bayer 127  
Joseph (b. 1758) 154  
Joseph (England) 154, 272, 310A  
Joseph (m. 1850) 145  
Joseph (son of Albert) 161  
Joseph (son of Benjamin) 166  
Joseph (son of Louis Myer) 166  
Joseph (1728-1772) 154  
Joseph (1779-1813) 170, 331A  
Joseph (1787-1833) 170, 330B  
Joseph (1802-1885) 103, 166  
Joseph (1823-1903) 305  
Joseph (1848-1881) 160  
Joseph (1848-1914) 171  
Joseph Calhoun (d. 1862) 165  
Joseph Israel (d. 1785) 170  
Joseph J. (b. 1846) 102  
Joseph J. (b. 1847) 136  
Joseph J. (1847-1900) 330B  
Joseph M. (Baltimore) 159  
Joseph M. (Philadelphia) 166  
Josephine 159  
Joshua 168  
Judah (Richmond) 162  
Judah (1849-1850) 170  
Judah Mears (1778-1813) 165  
Judd 162  
Judica 132  
Judith (dau. of Julius Willie) 167  
Judith (m. Eleazar) 18  
Judith (1700/2-1788) 165  
Judith (1769-1833) 165  
Judith (1793-1870) 169, 265  
Judith Hart 92  
Julia (b. 1832) 171  
Julia (dau. of Judah) 165  
Julia (m. 1821) 162  
Julia (1789-1862) 165, 276  
Julia Rosalie (1840-1931) 311B  
Julia S. 102  
Julia S. (1858-1945) 331A  
Julian (son of Julian Hillel) 165  
Julian C. (1833/4-1862) 159  
Julian Hillel 48, 165, 323A, 330B  
Julian Hobson 330A  
Julian Hobson (1947-) 330A  
Julian Hobson (1898-1978) 330A  
Julien 127, 326A  
Juliet (1802-1886) 159, 214  
Juliet Lopez 175  
Julius 90  
Julius Willie 167  
Kailine (see Levy, Caroline (Gnaatl, Kailine))  
Karen Dydo 290  
Katherine O. 329B  
Katherine Pollak 127  
Kim Rey 127  
Kristia 127  
L. 259  
La Grea Veale 167  
Laura 163  
Laura Louise (b. 1866) 98, 163  
Laura Louise Barrett 17, 163

Laura Virginia (1843-1903) 329B  
Laura (1916-) 330A  
Lea D. Goldstone 116  
Leah (Germany) 92  
Leah (1802-1821) 163  
Leah Tobias 163, 298  
Lee (1933-) 330A  
Lenore 161  
Leon 161  
Leona 159  
Leonard (see Lee, Leonard)  
Leonora (m. 1866) 101, 162  
Leopold (1920-) 327A  
Leslie Anne 290  
Lev (b. 1762) 170  
Lev (perhaps Andrew) 170  
Levy Andrew (b. 1734) 170, 331A  
Levy Simon (1806-1833) 1  
Lewis (son of Abraham) 162  
Lewis (son of Manasseh) 161  
Lewis (1802-1866) 167  
Lewis A. (1799-1861) 311A, 329B  
Lewis Fisher 162, 329B  
Lewis Harris (1888-1957) 330A  
Lewis Harris (1917-) 330A  
Lewis Johnness (1951-) 330A  
Lewis L. (m. 1851) 297  
Lewis L. (1840-1845) 136  
Lewis/Louis (1798-1861) 311A  
Lillian 115  
Lillian Elise (1946-) 330A  
Lillian Gans 305  
Lillian Hendricks Wolff 159, 305  
Lillian Shulkind 160  
Lillie H. (d. 1925) 232  
Linda Epley 166  
Lionel 287, 340A  
Lionel C. 164  
Lionel C., Jr. (1847-1906) 164, 212  
Lionel Cardozo 163, 164, 195  
Lionel Clarence 164  
Lionel Faraday 287  
Lionel J. 171, 232  
Lionel K. (b. 1902) 167  
Lisa 127  
Lita Saunders 164  
Lois 22  
Lois Clarice (b. 1911) 167  
Lotta (Carlotta) 160  
Louis (d. Cuba) 159  
Louis (see also Levy, (Lewis/Louis))  
Louis (see also Levy, Lewis Fisher)  
Louis (son of Lionel Faraday) 287  
Louis (1800-1878) 101  
Louis Myer (1867-1939) 166  
Louis Myer II (1900-1920) 166  
Louis Napoleon (1854-1921) 159, 305  
Louisa 47  
Louisa Barnard 170  
Louisa Moise 163, 164  
Louisa Moise Levy 164  
Louise (b. 1846) 136  
Louise (d. 1943) 159  
Louise, Lowenstein 320A  
Lucia De L. 165  
Lucille Marie (1897-1958) 330A  
Lucy Wren Pilcher 330A  
Ludwig 327A  
Lulie 163  
Lunah 19  
Lynda Catherine Harris 330A  
Lynda Catherine (1887-1958) 330A  
Lyon (1764-1835) 29, 163, 298  
Lyon (1803-d. bef. 1835) 163  
Lyon J. 65  
M. 143  
Mabel Amelia (1878-) 330B  
Madria Strawn 330A  
Malika (Molby) 160  
Manasseh 161  
Manuel 170  
Marcus H. 160, 161  
Margaret Elizabeth 42

Margaret Maria (b. 1794) 154  
Margaret Mary Thompson 154  
Margaret Wasserman 287  
Mergie Sisk 164  
Maria (b. 1791) 102, 170  
Maria (b. 1856) 102  
Maria (d. 1819) 170, 331A  
Maria (1790-1870) 101, 102, 170  
Maria Bishop 162, 329B  
Maria Levy (see also Levy, Miriam (Maria) Levy)  
Maria (1853-1926) 331A  
Marian Frances 164  
Marie Adele (b. 1918) 166  
Marie Bayley 165  
Marion (dau. of Lionel C.) 164  
Marion (m. Zelma Peixotto) 240  
Marion C. 163  
Marjorie Edith Edwards 320A  
Marjorie Falk 312B  
Marjorie K. (b. 1900) 116  
Marjory Hoke Sisk 164  
Mark (son of Alan) 102  
Mark (son of David) 161  
Martha (b. 1884) 166  
Martha (m. 1880) 70, 162, 329B  
Martha Ezekiel 69, 162  
Martha Lampley Thompson 154  
Martha Mary Ann (1798-1889) 154, 158  
Martha Sarah (d. 1886) 169  
Mary (b. 1848) 311B  
Mary (d. 1834) 1  
Mary (dau. of Hart) 74, 183  
Mary (Matjie Asser) (1779-1841) 169, 182  
Mary (see also Levy, Miriam (Mary))  
Mary (1805-1884) 159, 214  
Mary A. (1800-1888) 311A  
Mary Ann (b. 1801) 106  
Mary Ann (dau. of Morton P.) 159  
Mary Ann Soares 228, 289  
Mary Antonio (see Kohn, Mary Alice)  
Mary Beatrice 163  
Mary Coben 309  
Mary Coben 57, 98  
Mary E. 163  
Mary Frances 159  
Mary Gresham 166  
Mary Hannah 169  
Mary Jane 169  
Mary Katherine Murdock 330A  
Mary Lee Flotte 330A  
Mary Louisa (1814-1844) 121, 162  
Mary Louisa (1845-1859) 162  
Mary Louise 162  
Mary Lynne 42  
Mary Lynne Weil 42  
Mary (Matjie Asser) (1779-1841) 169, 182  
Mary Nel Melton 167  
Mary Pearce 154  
Mary Simon 170, 313B, 331A  
Mary Violet 82  
Mary Virginia 163  
Matilda 326B  
Matthew 154  
Matjie Asser (see Levy, Mary (Matjie Asser))  
Mears 165  
Mehrle (Murya) (1809-1810) 166  
Meir 301, 340B  
Meir (see also Sarlous, Myer)  
Melinda 165  
Melvin Carter (b. 1849) 167  
Menachem (see also Levy, Emanuel)  
Menachem (1686-1708) 92  
Merrill A. (1929-) 327A  
Michael (Jechiel) 154  
Michael 92  
Michael (see also Levy, Jefferson Monroe (Michael))

Michael (son of Moses Hamburger) 92  
Michael (1755-1812) 159, 243  
Michel (m. Nathan) 154  
Michel (1741-1826) 154  
Mildred 163  
Mildred Ferst 167  
Mildred Heber (1927-) 330A  
Millie (dau. of Joseph) 305  
Millie (m. Charles) 166  
Minkie Hart (see Levy, Amelia  
(Minkie) Hart)  
Minnie (see also Levy, Myrel  
(Minnie))  
Minnie Chuck 161  
Minnie Gunst 162  
Minnie Moses (see Levy, Almeria  
(Minnie) Moses)  
Miriam (b. 1767) 305  
Miriam (d. 1814) 16, 166  
Miriam (d. 1959) 313A  
Miriam (dau. of Joseph) 154  
Miriam (m. Asser) 170  
Miriam (Maria) Levy 170  
Miriam (Maria) Lopez (m. 1805) 175,  
312A  
Miriam (Maria) 165  
Miriam (Mary) Tobias 297  
Miriam (Mary) 165  
Miriam (1720-1748/9) 154  
Miriam (1752-1815) 98, 139, 309B  
Miriam (1780-1821) 18, 119  
Miriam (1793-1880) 165  
Miriam Andrews 12  
Miriam Dinah Hobenfels 118, 166  
Miriam E. (dau. of Benjamin) 166  
Miriam E. (dau. of Louis Myer) 166  
Miriam Grace 165  
Miriam Pyle 162  
Miriam Rebecca (1872-1897) 166  
Mitchell (b. 1836) 159  
Mitchell (m. Etie Levy) 161  
Mitchell Abraham Cass (1863-1928)  
159  
Mitchell M. 159  
Modesta 127  
Molly (see Levy, Malka (Molly))  
Mordecai (Lond.) 309B, 310A  
Mordecai 57, 98  
Mordecai M. (1808-1850) 98, 169,  
309B  
Mordocia 47  
Mordenai Charlotte Blair 151, 169  
Morris 159  
Mortimer 161  
Morton (see Phillips, Morton Levy)  
Morton Phillips 151  
Moses ("Rontzkupf") 221  
Moses (b. 1763) 168  
Moses (b. 1772) 165  
Moses (b. 1803) 167  
Moses (Fernholz, Hanover) 159  
Moses (m. bef. 1619) 241  
Moses (m. 1670) 155  
Moses (m. 1718) 190, 205  
Moses (Memphis) 1  
Moses (Raphael) (1665-1728) 154, 170,  
190, 311A  
Moses (see also Hamburger, Loebel  
Moses)  
Moses (see also Moses, Loebie (Levy,  
Moses))  
Moses (son of Marcus H.) 161  
Moses (1704-1792) 165  
Moses (1756-1826) 154, 158  
Moses (1834-1835) 166  
Moses (1849-1885) 305  
Moses A. (see also Russell, Edward  
A.)  
Moses Albert 162, 329B  
Moses Clava (1750-1839) 169  
Moses Elias (b. 1781) 171  
Moses Haym (see Pollack, Moses  
Haym)

Moses Nathans (see Nathans, Moses)  
Moses Phillips 245  
Moses S. 167  
Murya (see Levy, Mehrle (Murya))  
Myer (son of Simon) 169  
Myer (1798-1877) 169  
Myer Alexander (m. 1842) 128  
Myer Samuel (1839-1909) 166  
Myra 166  
Myrel (Minnie) 160  
N. Elcan (1840-1864) 167  
Nancy 121  
Nancy Elizabeth (1954-) 330A  
Nancy Judith (1945-) 330A  
Nanine (Anna) 65  
Nathan (b. 1777) 170  
Nathan (Charleston) 167  
Nathan (1704-1753) 154, 311A  
Nathan (1754-1756) 154  
Nathan (1759-1846) 154  
Nette 148  
Niis J. 164  
Olivia (1814-1837) 163  
Orlando R. (1822-1906) 163  
Oscar Straus 129  
Pat 127  
Pearl Green 330A  
Pena 167  
Penina Septima Moses 163, 207  
Percival R. (1860-1884) 164  
Peregrine Falconer 170  
Peter (b. 1909) 10  
Philadelphia (b. 1749) 154  
Philadelphia (1736-1738) 154  
Phillip (1807-1819) 163  
Phillips (b. 1819) 163  
Phoebe 169  
Phoebe Esther 170  
Phyllis Marie Louise Williams 330A  
Polly (m. Joseph Israel Levy) 170  
Polly (see also Levy, Jabeca (Polly))  
Polly (1745-1803) 260  
Q. A. (see Levy, Isabelle A. Moses)  
Rachael 168  
Rachel (b. 1799) 171  
Rachel (b. 1841) 170  
Rachel (dau. of Isaac) 159  
Rachel (dau. of Mordecai M.) 169  
Rachel (dau. of Morton P.) 159  
Rachel (dau. of Moses Elias) 171  
Rachel (m. Jerachmeel Falk) 170  
Rachel (m. London, 1823) 180  
Rachel (m. Reuben Julius Wolff) 305  
Rachel (m. Simon Moses Hart) 97  
Rachel (m. William Chuck) 161  
Rachel (sister of Moses Elias Levy)  
171  
Rachel (1719-1797) 154, 263  
Rachel (1739-1794) 154  
Rachel (1768-1843) 168  
Rachel (1771-1862) 154  
Rachel (1841-1842) 136  
Rachel Anne (1981-) 330A  
Rachel Asher 154, 170, 223  
Rachel Cornelia (d. 1911) 162  
Rachel Cornelia (Sarah Rachel)  
Bernard 162  
Rachel Cornelia 121, 162, 329B  
Rachel Cornelia Levy 162, 329B  
Rachel Deborah (b. 1761) 159  
Rachel Deborah (1762-1821) 159  
Rachel E. Moise 163, 195  
Rachel Elias (m. 1879) 63  
Rachel Isaacks (see Levy, Richea  
(Rachel) Isaacks)  
Rachel Levy (1739-1794) 154  
Rachel Michaels 154, 193  
Rachel Michaels Myers-Cohen 193  
Rachel Miriam 305  
Rachel Moise (1796-1872) 195  
Rachel Moise (1803-1833) 163, 195  
Rachel Moise Abraham 163  
Rachel Phillips (d. 1810) 166

Rachel Phillips (1769-1839) 159, 243  
Rachel Pollock 103, 166  
Rae 161  
Rahma 171  
Ralph Victor 167  
Raphael (see Levy, Moses (Raphael))  
Rasky (b. 1812) 166  
Rasky (Rischky or Richea) 166  
Rebecca (b. 1850) 47  
Rebecca (b. 1858) 102  
Rebecca (d. 1762) 168  
Rebecca (dau. of Isaac) 159  
Rebecca (dau. of Lionel Cardoza) 164  
Rebecca (dau. of Myer Samuel) 166  
Rebecca (dau. of Uriah P.) 159  
Rebecca (m. Jacob Clarence  
Alexander) 9  
Rebecca (m. 1817) 195  
Rebecca (m. 1833) 101, 166  
Rebecca (1782/4-1864) 2  
Rebecca (1785-1878) 297  
Rebecca (1804-1888) 166  
Rebecca (1805-1861) 121, 162  
Rebecca (1829-1887) 70, 162  
Rebecca (1841-1889) 305  
Rebecca Benjamin 18, 163  
Rebecca Eve Hendricks 110, 159  
Rebecca Hendricks (1832-1915) 159,  
262  
Rebecca Jackson 130  
Rebecca Jacobs 134  
Rebecca Josephine (1841-1889) 305,  
341A  
Rebecca Phillips 159  
Rebecca Tor(r)jes 305  
Rebecca Virginia (1841-1926) 166  
Rebecca Wolff 305  
Rebecca (1855-1936) 331A  
Regina (1872-1912) 311B  
Regina Lyons 161  
Reuben (1759-1828) 12  
Reyna (Hanover, Ger.) 159  
Reyna (1753-1824) 159, 209  
Richa (Rischa) 159, 209  
Richa Simson 272  
Richea (Rachel) Isaacks 127  
Richea (Rycha) Asher 154, 170, 311A  
Richea (Rysche) Moses 159, 209  
Richea (see also Levy, Rasky (Rischky  
or Richea))  
Richea (1770-1778) 159  
Richea Isaacs 120  
Riette 222  
'Rintzkupf' (see Levy, Moses  
(Rintzkupf))  
Rischa (see Levy, Richa (Rischa))  
Rischky (see Levy, Rasky (Rischky or  
Richea))  
Robert 326B  
Robert Allen 290  
Robert E. 22  
Robert Edward 307  
Robert Julian (1975-) 330A  
Robert K. III 236  
Robert Kaichen, Jr. 236  
Robert Kayton (1958-) 327A  
Robert Morris (b. 1763) 154  
Roberta Jean Owens 330A  
Rochelle B. 169  
Rosa 160, 161  
Rosabell (1864-) 330B  
Rosalie (1863-1927) 98, 154  
Rosalie Alice (1824-1861) 159, 257  
Rosalie Cecile 98, 163  
Rosalie Virginia 165, 207, 208  
Rose (m. D. Henry Cardozo, Jr.) 29  
Rose Crystal 305  
Rosebud 167  
Rosetta Almund 165  
Rosey Israel 170  
Rosina (1809-1828) 169, 309B  
Rosina (1846-1906) 159  
Rosina Hendricks 167, 247

Rosina Levy 169  
Russell Leonel 42  
Ruth 161  
Rycha Asher (see Levy, Richea  
(Rycha) Asher)  
Rysche Moses (see Levy, Richea  
(Rysche) Moses)  
Sally (1966-) 330A  
Sally Oppenheimer 236  
Sam 91  
Samson (1722-1781) 154  
Samson, Jr. (1764-1831) 154, 158  
Samuel 331A  
Samuel (m. Rachel Asher) 154, 170  
Samuel (Plymouth, Eng.) 148  
Samuel (1746-1842) 169  
Samuel (1818-1851) 1  
Samuel (1821-1889) 167, 247, 330B  
Samuel Asher 169, 218  
Samuel Earl (b. 1916) 166  
Samuel M. (b. 1880) 166  
Samuel Yates (1827-1888) 169, 216  
Samuel Zanzill (1666/7-1719) 154, 193  
Samuella 330B  
Sarah (b. 1833) 1  
Sarah (convert) (m. David Levy) 161  
Sarah (d. 1805) 159  
Sarah (dau. of Lionel) 164  
Sarah (m. Abraham Myers-Cohen) 223  
Sarah (m. Albert A. Hobenfels) 118  
Sarah (m. London 1828) 180  
Sarah (m. Mordecai) 4  
Sarah (m. Zachariah Levy Florance) 74  
Sarah (m. 1851) 93  
Sarah (1762-1763) 272  
Sarah (1767-1858) 169  
Sarah (1781-1822) 167  
Sarah (1798-1883) 306  
Sarah (1822-1871) 102, 170  
Sarah (1841-1910) 147, 162  
Sarah Ann (1808-1809) 175  
Sarah Cardozo 29, 163  
Sarah Coats 154  
Sarah Edwitha Marks 165, 185  
Sarah Elizabeth (1977-) 330A  
Sarah Emanuel 65  
Sarah Hannah (1838-1907) 164, 210  
Sarah J. Southwall 166  
Sarah Joachimsen 136  
Sarah Lang 165  
Sarah Levy 159  
Sarah Moses 169  
Sarah Myers 136  
Saul J. (b. 1818) 102, 170, 312A  
Septima Maria (1834-1912) 164  
Simeon (1748-1825) 165, 168  
Simha 19  
Simon (Canada, 1760) 169  
Simon (d. 1833) 1  
Simon Jonas 99  
Simon Magruder 170  
Sipporah Jacobs 134  
Sloe (Slowey) Myers 159, 217  
Sol (1884-1945) 311B  
Solomon 326B  
Solomon (d. 1865) 159  
Solomon (father of Moses Pike) 250  
Solomon (1764-1841) 110, 159  
Solomon B. 159  
Solomon J. (1849-1908) 102, 330B  
Solomon Lazarus (m. 1894) 164, 196  
Solomon Lionel (b. 1808) 163, 197  
Solomon Seligman (d. 1738) 92  
Sophia (b. 1841) 161  
Sophia (1791/2-1831/2) 154, 158  
Sophia Cerf 159  
Sophia Cristalar 130, 170  
Sophia Davies 47  
Sophia Phillips 245  
Sophia Tobias 297  
Sophie R. Herrs 170  
Slacy 287  
Susan (b. 1935) 91

Susan (dau. of Edward I.) 165  
Susan (m. Edgar) 127  
Susan (m. 1803) 170, 331A  
Susan Anita (1953-) 330B  
Susannah 170  
Tessie Kirk 166  
Theodora Moise 164, 196  
Theodore 161  
Theodore Jacob 162  
Theresa 161  
Theresa Zekind 331A  
Thomas Wilson 236  
Tillie 167  
Tracy 167  
Tracy, Jr. 167  
Uriah H. (1801-1861) 159  
Uriah P. (son of Morton) 159  
Uriah Phillips (1792-1862) 159, 179  
Victor (b. 1839) 183  
Virginia (dau. of Arthur) 162  
Virginia (dau. of Solomon Lazarus)  
164  
Virginia Alice 163  
Virginia Davis 48, 162  
Virginia Lopez 159, 179  
Walbert 159  
Walter Heydenfeldt (1854-1900) 167  
Walter Heydenfeldt, Jr. (b. 1881) 167  
Waverly Bertram 165  
Will 161  
William 161  
William Alfred 290  
Winifred V. Rees 166  
Wolfgang (b. 1915) 10  
Yehuda (see Levy, Lewis/Louis)  
Zachariah (see Florance, Zachariah)  
Zanetta Appolina Johnson 326B  
Zelma Peixotto 240  
Zipporah (1760-1832) 159, 263, 265

**LEVYNO**  
Elsye Geisenberger 8  
Gerald 8  
Joan 8

**LEWAD**  
Sarah 235

**LEWICK**  
George 299  
Isabel Diane (b.1933) 299  
Isabel Tobias 299

**LEWENGRUB**  
Joan 333A

**LEWIN**  
Adolph Marcus 339A  
Bennett Nelson (Barry) 191  
Bianca 339A  
Clifford 2  
Connie Davis 2  
Corinne Florence 339A  
Diane Dushole 323B  
Dolly 2  
Elizabeth Victoria 339A  
Eaid 2  
Esther Margolin 2  
Florence Mendes 191  
Geraldine 191  
Hannah 339A  
Harry J., 339A  
Jane Abraham 2  
Jean Wener 191  
Lawrance 2  
Lewis P. 339A  
Linda Ruth Ross 191  
Lisa Beth 191  
Mary Elizabeth 339A  
Nathan 2  
Orizaba 339A  
Penelope (Pennay) Dale 191  
Robert (Ted) 191  
Robert Newton 191  
Rosalind Moss 339A  
Rose Jacob 2  
Shirley Fuerst 191  
Stanley 191

Stanley 2  
Ted (Lewin, Robert (Ted))  
Victor 2  
Wilfred 2  
Willard J. 191

**LEWINE**  
Sol 161  
Theresa Chuck 161

**LEWINSON**  
Ellen Levy 163  
Louis 163

**LEWIS**  
See also Goldstone  
Agnes Moses 211  
Albert 171  
Albert Frederick (1833-1923) 113, 171  
Alexander (1810-1877) 172, 220, 338A  
Alexander Samuel (b. 1831) 171, 249  
Alice (b. 1882) 172  
Alice Gulleson 171  
Aline May (b. 1878) 116, 171  
Amelia Ann 62  
Amelia Collis 164  
Annette (Hannah) 152, 171  
Anthony 172  
Arthur 123  
Belle Cohen Beckwith 36  
Bessie (see Lewis, Elizabeth (Bessie))  
Caroline Beale 171  
Catherine (dau. of Alexander) 172  
Catherine (Kate) Menken 171, 192  
Catherine (1813-1827) 172  
Charles (m. Ethel Davis) 48  
Charles (1856-1886) 171, 312A  
Danie Edell 196  
David (1763-1839) 172  
David H. 171  
Donald McL. 171  
Edgar L. 171  
Edith Rosalie Tobias 171, 297  
Edna Josephine 196  
Edwin 164  
Edwin Newton (b. 1902) 171  
Edwin W., Jr. 171  
Edwin Warren 171  
Eliza Victoria Henriques 113, 171  
Elizabeth (b. 1846) 183  
Elizabeth (Bessie) (b. 1827) 134, 171  
Elizabeth Lipes 211  
Elizabeth Mayer 171  
Ella (d. 1931) 171  
Ellen ("Nellie") 34, 130, 171  
Ellen (b. 1820) 13, 171  
Esther Philipson 338A  
Ethel Davis 48  
Eugene 171  
Evelyn Frances (b. 1916) 171  
Fannie (see also Lewis, Frances  
(Fannie))  
Fanny (Frances) (1844-1905) 172  
Frances (Fannie) (1823-1875) 172  
Frances (Fanny) Wolff Levy 159, 171  
Francis (b. 1866) 171  
Francis (Frank) 171  
Frank M. 171  
Frederick 171  
Galathe Menken 171, 192  
Grace Mogrian 171  
Guy H. 213  
Hannah (b. 1818) 152, 171  
Hannah (see also Lewis, Annette  
(Hannah))  
Hannah Bach 13, 171  
Harley Alma 171, 312A  
Harley Alma Lewis 171, 312A  
Harold Lewis (b. 1880) 159, 171  
Harry 171  
Harry Windsor 171, 192  
Hattie Jessel 172, 220  
Helen Forbes 257  
Henri 172  
Henrietta (see Lewis, Jane (Henrietta))  
Henry (b. 1825) 172

Henry (1829-1888) 13, 171  
Hyman Philip (1851-1881) 171, 297  
Ida Mathilda Harper 213  
Ira M. 36  
Isaac Newton 48, 171, 192  
Isabelle 171  
James Hendricks (m. 1976) 312A  
Jane (dau. of John) 116, 310B  
Jane (Henrietta) 171  
Jane (1822-1854) 171  
Janet Lieb 171  
Janice Lynn Bernstein 312A  
Jeanette Kilham 116, 310B  
John (b. 1909) 116, 310B  
John Daniel (1858-1882) 171, 312A  
John Newton 171  
Joseph (son of Alexander) 171  
Joseph 172, 220  
Joseph C. (1816-1864) 172  
Josephine Luna (1858-1939) 171, 297, 314A  
Judith (1818-1873) 172  
Judith D'Israeli 172  
Kate Menken (see Lewis, Catherine (Kate) Menken)  
Leila 171  
Lewis (son of Alexander) 171  
Lewis (son of Frederick) 171  
Lewis (1795-1861) 171  
Lewis, Jr. 171  
Lillian Mann 171  
Lizzie Moyer 171  
Mable Davis (m. 1903) 48, 171  
Madeline 171  
Madge McLied 171  
Margaret Lynn 211  
Margaret Schinnler 171  
Margarette 171  
Marjorie Rice 123  
Mary 171  
McCrary 171  
Michael 171  
Mildred (d. 1917) 171  
Mildred (dau. of Albert) 171  
Mildred (dau. of Samuel Alexander) 171, 312A  
Mildred (Milly) 171  
Minnie (1852-1932) 171, 312A  
Moses (b. 1821) 172  
Nellie (see Lewis, Ellen ('Nellie'))  
Philip (b. 1923) 171  
Philip (son of Lewis) 171  
Rachel (b. 1831/2) 172, 173, 331A  
Rachel (dau. of Alexander) 172  
Rachel Salomon 172, 173  
Rebecca Powers 172, 220  
Richard James (Cohn) 171, 312A  
Robert Newton (b. 1905) 171  
Rosa (b. 1819) 172  
Rosalie Furst 171  
Rose 171  
Rosetta (1820-1853) 130, 171  
Ruth McCrary 171  
Samuel Alexander 171, 249, 312A  
Samuel H., Jr. (b. 1907) 211  
Samuel Hance 211  
Sarah 172  
Sophia Phillips 171, 249, 312A  
Susan Solomon 171  
William 171  
**LEWISOHN**  
Adele Guggenheimer 89  
Aileen Hendricks 111, 310A  
Brandon Kermit 310A  
Clifford Herman 111  
Heather Haley 310A  
Philip 89  
Richard 111, 310A  
Richard III 111, 310A  
Ruth Frankenthaler 111, 310A  
Sandra K. Saine 310A  
**LEWYN**  
Adolph 89

Alfred Thomas 89  
Delia Guggenheimer 89  
Irma 89  
John 89  
Oswald 89  
Tom 89  
**LEYENS**  
Amelia 43  
Ella 43  
Henry (Lyons?) 41, 43  
Irene 43  
Lilly 43  
Rosalie Cromelien 41, 43  
Samuel 43  
Walter S. 43  
**LIBERMAN**  
Alma 186  
Ann (Esther) 186  
Ernestine Scherck 186  
Esther (see Liberman, Ann (Esther))  
Ethel 186  
Mortimer G. (1954) 186  
**LIBERTY**  
Bradford Hart 95  
Duncan 95  
**LICHTEN**  
Leila 171  
**LICHTENPELS**  
Cecilia 70, 324A  
**LIEDER**  
Edna Muriel Long 91  
Frances 91  
Gustav 91  
Helen 91  
Johanna 91  
Joseph 91  
Josephine Palais 91  
Patricia Ann 91  
**LICHTENSTAD**  
Issachar 246  
Rebecca Phillips 246  
**LICHTENSTEIN**  
Alfred (b. 1882) 70, 174  
Alice Edith (b. 1906) 174  
Bettie 174  
Caroline Engel 174  
Carrie Frank 174  
David (b. 1854) 174  
David, Jr. (b. 1890) 174  
Dora (b. 1864) 174  
Edna Vivian Bloomberg 70, 174  
Emma Schultz 174  
Eather Tischler 174  
Fannie (b. 1862) 174  
Fannie Schultz 174  
Flora (b. 1863) 174  
Florence (b. 1893) 174  
Gaston (b. 1879) 174  
Gertrude (b. 1886) 174  
Hannah (b. 1853) 174  
Hannah Zander 174  
Hirsch Meyer 174  
Ira Julian (b. 1889) 174  
Isaac (b. 1856) 174  
Isadore (d. 1867) 174  
Jacob (b. 1857) 174  
Joseph (b. 1860) 174  
Joseph, Jr. (b. 1895) 174  
Julian (b. 1886) 174  
Leib 174  
Leigh (b. 1881) 174  
Leon (b. 1883) 174  
Lewis (b. 1887) 174  
Lewis (1826-1883) 174  
Lyon (1864-1866) 174  
Martha Elizabeth Harmon 174  
Moses (1856-1904) 174  
Pearl (b. 1888) 174  
Pearl (m. Leib Lichtenstein) 174  
Rebecca Schultz 174  
Rosa 174  
Sarah (b. 1851) 174  
Simon (b. 1885) 174  
Simon (1812-1885) 174  
Valentine (b. 1890) 174

**LIEB**  
Janet 171  
**LIEBENSBERGER**  
Gail 296  
**LIEBENSTEIN**  
Esther 149  
Minnie 149  
**LIEBER**  
Alice Schutz 174  
Benjamin (see Lehair, Benjamin)  
Benjamin Franklin (1853-1915) 174  
Betty 174  
Betty Schutz 174  
Bunny Fleming 174  
Charles (see Levi, Charles)  
Clara (b. 1857) 29, 174  
David (1845-1925) 124, 174  
Edith Osenten 174  
Essie 28, 174  
Ethel (dau. of W. Ralph) 174  
Fleurette (1847-1937) 174, 214  
Fleurette Hart 174  
Florence 174  
George Levi (1849-1898) 174  
Gertrude Adelaide Isaacs 124, 174  
Gertrude Goldburger 174  
Harriet Lizzy 36, 174, 331A  
Harry 174  
Harry, Jr. 174  
Henry (son of Charles) 174  
Henry (son of Isaac) 174  
Isaac (son of Charles) 174  
Isaac (son of George) 174  
Isadore 174  
J. Boudine Butler 174  
Jacob (son of Charles) 174  
Jacob (son of George) 174  
Jacob Washington (1851-1921) 174  
Juliet (1844-1932) 174, 231  
Louisa 174  
Margaret 174  
Marie Louise (Dolly) Isaacs Simons 174  
Matilda 174  
Matta E. McCann 174  
Miriam Williams 174  
Moreau Lesser (1862-1931) 13, 174  
Moreau Sidney (b. 1897) 174  
Rachel Cromline 41, 174  
Ralph, Jr. 174  
Rebecca 174  
Robert 174  
Rose Greenfield Wurms 174  
Ruth (b. 1895) 174  
W. Ralph 174  
Walter (d. 1891) 174  
Walter S. 174  
Walter Scott (1854-1945) 174  
**LIEBOWITZ**  
Ann Marcia (b. 1948) 235  
Bambi Lynn Ware 337B  
Bambi Lynn Ware (1985-) 337B  
David Michael 235, 337B  
Ellen Sue Oppenheim 235, 337B  
Michael Julian (b. 1951) 235, 337B  
**LIPSCHITZ**  
Sheila (see Lister (Lifschitz), Sheila)  
**LIGHTSTONE**  
Elise Tucker 191  
Fred 191  
Ira 191  
Lily 191  
**LILIENTHAL**  
Arthur Gentle 276  
Edith Marian (b. 1920) 276  
Eva 149  
Katherine Manuel Solomons 276  
Katherine May (b. 1918) 276  
**LILIE**  
See Lilly  
**LILIENTERN**  
Ann Vera 110  
Dene Vera 110

Richard David 110  
Vera David 110  
**LILLY**  
Joseph 215  
Linda 215  
Margaret Lowengrund 215  
**LIMA**  
See De Lima  
**LINBURN**  
Carol 22  
Jo Ann 22  
Mildred Jacobs 22  
Richard 22  
**LINCE**  
Elaine Kingsbacher 293  
**LINCHE**  
Anna Wilhelmine 55  
**LINCOLN**  
Abraham 119  
Mary Todd 119  
Rose Emanuel 66  
W. P. 66  
**LINDAU**  
Bertha 91  
Leopold 150  
Mary Lazarus 150  
**LINDAUER**  
Juda (1797-1863) 291  
Seligman Lob (1750-1839) 291  
Sophia 290, 291  
Sprinz Gumbel 291  
**LINDER**  
Margery Stone 122  
Steven 122  
Stuart 122  
**LINDHEIM**  
Cilla Natalie 90  
Daniel 90  
Donald R. 90  
Dorothy Warhaftig 90  
Helen Weil 90  
Hortense Amy 90  
Hortense Guggenheimer 90  
Irma Levy 90  
Judith 90  
Mary 90  
Nora 90  
Norvin R. 90  
Norvin R., Jr. 90  
Reuben 90  
Richard W. 90  
Roslyn Ittleson 90  
Sidney J. 90  
Stephen W. 90  
Susan 90  
**LINDO**  
Amelia Worms 228  
Benjamin 115  
Edgar 228  
Flora Valery 115  
Henry Elias 115  
Michael Alexander 115  
Rachel de Jacob 51  
Saphiro Henry 115  
Sarah (m. 1850) 228  
Sarah (1814-1868) 115  
Solomon 115  
Zipporah De La Motta 178  
**LINDSAY**  
Phyllis 162, 329B  
**LINDSLAY**  
Hannah Wolff 305  
R. 305  
**LINDSLEY**  
Isabel F. 138  
**LINDY**  
Julia Grace Oppenheim 235  
Mortimor 235  
**LINK**  
John 329B  
John (son of John) 329B  
Katherine O. Levy Barrett 329B  
Lewis 329B

Richard 329B  
**LINLEY**  
Archibald 120  
John Westly 120  
Rebecca 120  
Rebecca Hyams Bean 120  
**LION**  
Diana Gay 138  
Edgar 138  
Edward 138  
Hortense Maxine 84  
Phyllis Annette Joseph 138  
**LIPES**  
Elizabeth 211  
**LIPKE**  
Alan 285  
Barbara Stix 285  
Herbert 285  
Marian 285  
Paul 285  
Peter 285  
**LIPMAN**  
Bella 296  
Catherine (b. 1816) 312A  
Emil (b. 1831) 250  
Esther (ca. 1781-1832) 312A  
Frances L. Simpson Childs 250  
Hart (b. 1810) 312A  
Heltrey (b. 1806) 312A  
Henry (b. 1804) 312A  
Jacob (b. 1781) 312A  
Lewis (b. 1823) 312A  
Matilda (b. 1805) 312A  
Moses (b. 1813) 312A  
Rachael (b. 1820) 312A  
Raphael (Ralph) (b. 1808) 312A  
Rebecca (b. 1817) 312A  
Samuel (b. 1814) 312A  
Solomon (b. 1812) 312A  
**LIPPER**  
Andrea Ruth 138  
David Adrian 138  
Gregory Wolff 138  
Irene Fanny Elkin 138  
Stephen (John) 138  
**LIPPMAN**  
Arla Fey 5  
Betty Szold 5  
David II 5  
Deborah 5  
Doris Joan 5, 222  
Emma Semon 313B  
Eunice Merle 5, 222  
Florence Virginia Rosenbaum 222  
Gladys Ruth 222  
Lawrence 222  
Louis 293, 313B  
Louis, Jr. 313B  
Miriam 313B  
Morton 5  
Nettie Hays 293  
Ruth 293  
**LIPSCHUTZ**  
Lily Schloss 293  
Lita 328A  
Nathan 293  
**LINSBERGER**  
Charles (b. 1949) 15  
Daniel 15  
Emily 15  
Jane Aufsesser 15  
Janet 15  
Joann (b. 1953) 15  
Katherine (b. 1953) 15  
Linda (b. 1951) 15  
Martha (b. 1953) 15  
Molly Aufsesser 15  
Nancy (b. 1951) 15  
Stephen (b. 1949) 15  
Theodore 15  
**LISBURN**  
Michael (b. 1933) 22  
Mildred Jacobs 22

Patricia (b. 1939) 22  
Richard 22  
**LISHMAN**  
Mary June Brauer Millhiser 27  
**LISMAN**  
Frederick J. 38  
Leonora Coben 38  
**LISS**  
Olivia Shwartz 125  
Peter S. 125  
Seymour A. 125  
**LISSAK**  
Adolphus N. 6  
Juley Abrahams 6  
**LISSER**  
Barbara 138  
**LISTER**  
Sheila (Lifschitz) 14  
**LIT**  
Juliet 284  
**LITHAUER**  
Adelaide Joachimssen 136  
Isaac (b. 1848) 136  
Jacob 136  
Johanna (b. 1850) 136  
Sara 136, 279  
**LITTLE**  
Frances J. 46  
**LITTLE**  
Burke Haywood 200  
George 200  
Helen 272  
Henry Mordecai 200  
Lydia 128  
Margaret Lane Mordecai 200  
William (b. 1875) 200  
William (m. 1870) 200  
**LITTLEFIELD**  
Hudson B. 146  
Mary M. Kokernot 146  
Sarah 146  
**LITWIN**  
Patricia Hendricks Bookman 329B  
Ruth Elias 95  
Shlomo 95  
Wallace (1914-) 329B  
**LIVERIGHT**  
Rebekah 296  
**LIVESAY**  
Myrtle Lord 48  
**LIVINGSTON**  
Ada Simon 145, 328A  
Alexander 8  
Beatrice 145, 328A  
Bertha 22  
Cornelia Louisiana (1802-1830) 155  
David 145  
Dorothy Alexander 8  
Edwin 145, 328A  
Flora Levy 145, 327B  
Gladys Blossom (b. 1896) 230  
Goldie 145, 328A  
H. M. 303  
Hattie 145, 327B  
Henry 145, 328A  
Isadore 145, 328A  
Leon 145, 328A  
Lillie 145, 328A  
Lottie Winter 145, 328A  
Marjorie (1920-) 328A  
Meyer 145, 327B  
Myra (1920-) 328A  
Philip (1907-) 328A  
Rebecca Waterman 303  
Sarah A. (1807-1892) 194  
Sarah Cohn 145  
Sophie Feldblum 145, 328A  
**LEWELIN**  
Archie 312B  
Patricia Friedlander 312B  
**LOYD**  
Alice (b. 1832) 156  
Alicia (b. 1855) 156

Alicia Thompson McBlair 156  
Barton 218  
Charles Howard (b. 1859) 156  
Charles Tilghman (1842-1863) 156  
Constance R. Matlack 156  
De Coucy 156  
Edward (b. 1857) 156  
Edward (m. 1824) 156  
Edward (1837-1839) 156  
Edward III (1853-1854) 156  
Edward, Jr. (b. 1825) 156  
Edward, Jr. (m. 1935) 156  
Elizabeth (b. 1827) 156  
Elizabeth Campbell McBlair 156  
Elizabeth Howard (b. 1868) 156  
Elizabeth R. Robinson 156  
Hubard 218  
Hubard, Jr. 218  
James Murray 156  
John 218  
John Eager (b. 1865) 156  
Louisa Marx Myers 218  
Marguerite Theobald 156  
Mary 156  
Mary Chesley Donnell 156  
Mary Lloyd Howard 156  
McBlair (b. 1862) 156  
McBlair (1830-1846) 156  
Murray (1840-1861) 156  
Sally Scott (b. 1834) 156

#### LOBDELL

Bell 168

#### LOBO

Abigail Cohen D'Azevedo 51  
Daniel (b. 1840) 51  
Daniel de Moses (1803-1849) 51  
Isaac (b. 1807) 51  
Meriam (b. 1839) 51  
Moses (b. 1836) 51  
Moses Finzi (1834-1904) 51  
Sarah Finzi 51

#### LOCKWOOD

Benoni, Jr. 129  
Ethel Jackson Zimmerman 129

#### LODGE

Francis Greenwood (1862-1866) 157  
James 157  
John Ellerton (1857-1860) 157  
Mary Langdon Greenwood 157

#### LOEB

Adeline Klein 28  
Adeline Moses 211, 334A  
Agnes Stern 284  
Alexandra 334A  
Amelia (see Loeb, Emilie (Amelia))  
Ann Margaret 211  
Anne 211  
Arlene Friedman 41  
Arthur 211  
Arthur Price 13  
Audry 144  
Barbara Kase Rodgers 284  
Barbara Keely 284  
Beatrice King 144  
Bertha 71, 72  
Carl III 211  
Carl L., Jr. 211  
Carl M., Jr. 211, 334A  
Carl M., Jr. 211  
Caroline 11, 320A  
Charles G. (b. 1842) 256  
Constance 211  
Corinne Florence Lewin 339A  
Corinne Luria 281  
David S., Jr. 284  
David S., Jr. 284  
Deborah (b. 1965) 284  
Deborah Frances 211  
Don 312B, 334A  
E. C. 327A  
Eleanor 84  
Eliza L. Goldsmith 84

Elizabeth 211  
Elizabeth Vera ("Evelo") 339A  
Emilie (Amelia) 125  
Ethel 149  
Eugene (1880-1899) 84  
Evelo (see Loeb, Elizabeth Vera  
"Evelo")  
Florence Moskowitz 284  
Frances 23  
Frances Lehman 211  
Frank 222, 312B, 334A  
Frederick 222, 312B, 334B  
Fritz 144  
Gentile Morais 103  
Harold 40  
Helen (dau. of Samuel Greenebaum)  
283  
Helen (m. Charles Marks) 187  
Henrietta (see Loeb, Netta (Henrietta))  
Henry Alfred 211  
Herman 103  
Howard 222, 312B, 334A  
Jacob H. (1846-1893) 84  
Jean A. 211  
Jeanette Loeb 236  
Jennifer 284  
Jill 294  
John (son of John L.) 211  
John (son of Morton) 28  
John L., Jr. 211, 334A  
John Langeloth 211, 334A  
Joseph J. 8  
Judith 211  
Judith Ann 284  
Julie 284  
Kathryn 294  
Kitty 312B, 334B  
Laura Ann Reiger 13  
Lawrence (see Loring, Lawrence)  
Lewis 284  
Louis L. 281  
Louise Steinhardt 211  
Lucille Schamberg 211  
Ludwig 284  
Margaret (b. 1899) 211  
Margaret (b. 1946) 294  
Marjory Content 40  
Moritz 320A  
Morton 28  
Nancy Arnold 13  
Netta (Henrietta) 84  
Nicholas 334A  
Nina Sunby 334A  
Olga 23  
Patricia 294  
Peter Kenneth 211  
Prudence 28  
Rachel (1854-1894) 63  
Rachel Cornelia Isaacs 125  
Robert 312B, 334B  
Ruth 312B, 334A  
Sarah Frederica Haas 256  
Sophie 284  
Stella (wife of Frederick) 312B  
Stella Cohen 8  
Stella Myers 222, 312B, 334A  
Susan 284  
Susan 312B, 334A  
Susan Goldsmith 294  
Sylvia Irma 339A  
William 13  
William J. 294

#### LOEBER

Katherine 310A

#### LOESCH

Arthur 330B  
Barbara 330B  
Barbara L. Goldstone 330B  
Bruce 330B  
Donald 330B  
Gary 330B  
Jeannette 330B  
Lisa 330B

#### LOEW

Abraham 115  
Alice Alexander 115  
Rolinde Zellerbach 294  
Stephen, Jr. 294

#### LOEWENSTEIN

Caroline Bloomingdale 24

#### LOEWI

Caroline 279  
Catherine Popper 102  
Jette 279  
Rosalie 47  
Simeon 279

#### LOEWNER

Mildred 107

#### LOEWY

Caroline 10

#### LOGAN

Martha Ann 199

#### LOMAN

Naomi Mitchell 129

#### LOMBARD

Edward H. 329B  
Katherine Lewis (1868-1957) 329B  
Laura Virginia Levy 329B  
Minerva 329B

#### LONDON

Dorothy 86  
Jane 86  
Marcus 86  
Ruth Katz 86  
Shirley 86

#### LONEY

Isabel 284

#### LONG

Carrie Cone 91  
David Grigaby 129  
David Leslie 208  
Dorothy 91  
Edith 241  
Edna Muriel 91  
Eugene Jackson (1909-1938) 129  
Getta (b. 1864) 92  
Henrietta Louise Cohen Willis 180  
Hugh Blair G. (b. 1911) 129  
Irving 91  
May C. Jackson 129  
Moses David 91  
Sarah 284  
Virginia Williams Maris 208  
William Ashley 208  
William Thornton 180

#### LONGER

Adele 116

#### LONGINI

Adele 286  
Emma 320B  
Lavinia Arnold 320B  
Leon 320B  
Moyas 320B

#### LONGSTREET

James 304

#### LONGSTRETH

Frank Hosmer 230  
Martha Comfort Bush 230

#### LONSBURG

Sara 194

#### LOOCKERMAN

Mathilde 156

#### LOPES

Abraham 159, 179  
Antonio, 3rd Baron Suasso 258, 338B  
Frances (Fanny) Levy 159, 179  
Judica (1690-1763) 335A  
Leonora (Rachel) 258, 338B  
Marquesa 273  
Miriamde (Miryam) 335A  
Miryam (see Lopes, Miriamde  
(Miryam))  
Rachel (d. 1766) 241  
Rachel (see also Lopes, Leonora  
(Rachel))

#### LOPEZ

Aaron (b. 1757) 175  
Aaron (b. 1807) 175  
Aaron (Edward) (1731-1782) 175  
Aaron (1800-1874) 35, 176  
Aaron (1828-1829) 176  
Aaron Edwin (1838-1872) 175  
Aaron M. (b. 1848) 39, 176, 177, 331B  
Aaron Moise, Jr. 331B  
Aaron, Jr. 176  
Abigail (Anna) (1726-1762) 175  
Abigail (dau. of Moses) 175  
Abigail (Joanna) 175  
Abigail (1771-1851) 85, 175  
Abigail (1831-1906) 179, 242  
Abigail Louisa (1810-1890) 176, 195  
Abraham (Jamaica) 159, 179  
Abraham (Michael) (b. 1711) 154  
Abraham (son of Moses) 154  
Abraham Moise (1847-1848) 176  
Adela Emma 178  
Adele (1841-1867) 178  
Adeline Luna 179  
Agnes Jane (1844-1911) 178  
Aloysia Bazan 176  
Anna (see Lopez, Abigail (Anna))  
Betty Sue 331B  
Caroline 178  
Caroline Agnes Moise (b. 1854) 176,  
196  
Catherine (Sarah) 175, 191  
Catherine D. Hinton 176  
Catherine Hinton (b. 1863) 176  
Cecile Ottolengui 176, 234  
Cecilia (b. 1872) 176  
Cecilia E. Cohen 36, 176  
Charles Da Costa (1840-1881) 178  
Charles Hinton (1842-1843) 176  
Christopher (1981-) 331B  
Clarence Cecil 179  
Cohen 176  
Columbus (1850-1851) 176  
Constance Geraldine 178  
Cordelia 176  
Cordelia M. Cohen 39, 176  
Cordelia Moise 331B  
Daniel (b. & d. 1798) 176  
Daniel (son of Moses) 175  
David (Gabriel) (d. 1797) 175  
David (Jr.) (1750-1811) 175, 176, 205  
David (son of Aaron) 176  
David (son of Isaac) 178  
David (1750-1812) 175, 176, 205  
David (1809-1884) 176, 195  
David (1860-1872) 176  
David Hinton (b. 1865) 176, 196  
David, Jr. (1834-1862) 176  
Deborah 175  
Delia (1773-1843) 175  
Diego Jose 175  
Duarte (see Lopez, Moses (Duarte))  
Edmund (1836-1921) 178  
Edna Hinton (1884-1885) 176  
Edward (b. 1871) 176  
Edward (see also Lopez, Aaron  
(Edward); Lopez, Moses (Edward))  
Edward Hinton (1853-1914) 176, 234  
Eleanor (1803-1880) 176, 298  
Eleanor Cohen 35, 176  
Eleanor Johnston 331B  
Elias Hiam (1814-1876) 178  
Eliau (b. 1648) 178  
Eliau (d. 1737) 178  
Eliau (b. 1773) 178  
Eliau (b. 1803) 178  
Eliau (b. 1807) 178  
Eliau (d. 1769) 178  
Eliau (d. 1781) 178  
Elizabeth (d. 1755) 175  
Elizabeth Lopez 175  
Emily A. (1849-1896) 178  
Emma Nunez Vaz 178  
Esther (1692-1759) 273  
Esther (1753-1811) 85, 175

Esther Amy 178  
Esther de Samuel Mendes De Sola 178  
Ethel Maud 178  
Eugene (1849-1873) 176  
Eugene Rice 331B  
Florence 176  
Frances (Fanny) Levy 159, 179  
Frances Jane (b. 1868) 178  
Gabriel (see Lopez, David (Gabriel))  
George Washington 179  
Gladys (b. 1891) 176  
Gracia (d. 1839) 175  
Hannah (dau. of Elias Hiam) 178  
Hannah (1767-1848) 175  
Hannah Abendanone 178  
Helen Avery 176  
Henrietta (Hetty) Barrett Rice 177  
Henry (Moses, Jr.) 175  
Henry 175  
Hetty (1805-1885) 176, 195, 197  
Hetty Barret Rice 176  
Inez (b. 1882) 36, 176  
Irene (b. 1893) 176  
Irene Moise 176, 196  
Isaac (b. 1762) 175, 331B  
Isaac (son of Elias Hiam) 178  
Isaac (1780-1854) 178  
Isaac (1834-1905) 178  
Israel Cohen (1855-1858) 176  
Jacob (b. & d. 1762) 175  
Jacob (Joao) 175  
Jacob (John) (1750-1822) 175  
Jacob (1717-1789) 175  
Jacob (1755-1764) 175  
James Irvine 331B  
Jane Fraser 178  
Jane Hinton (b. 1911) 176  
Joanna (see Lopez, Abigail (Joanna))  
Joao (see Lopez, Jacob (Joao))  
John (see also Lopez, Jacob (John))  
John H., Jr. (1863-1881) 176  
John Hinton (b. 1895) 176  
John Hinton (1833-1884) 32, 176  
John L., 331B  
Jose (see Lopez, Moses (Jose))  
Jose (see Lopez, Samuel (Jose))  
Joseph (see also Lopez, Samuel  
(Joseph))  
Joseph (son Aaron) 176  
Joseph (1756-1822) 175  
Joshua (1768-1845) 85, 175, 300  
Judith (dau. of Aaron) 175  
Judith (1815-1870) 178  
Judith Seizas 175, 263  
Juena De Sola 61  
Julian Lee (b. 1852) 176, 196  
Juliet (1772-1852) 175  
Kate (b. & d. 1858) 176  
Katherine Smith 176  
Louisa Leah 112, 178  
Luna Da Costa 178  
Lynn Sadler 331B  
Marcella Rice 331B  
Margaret May Waybrandt 176  
Maria (see Lopez, Miriam (Maria))  
Maria Cohen 32, 176  
Marina 206  
Mary Ann (Marianne) Gomez 85, 175  
Mary Ann 178  
Mary M. Branton 176  
Maryann (May) Vaz 178  
May Vaz (see Lopez, Maryann (May)  
Vaz)  
Melvin 176  
Michael (see Lopez, Abraham  
(Michael))  
Miriam (Maria) (d. 1812) 175, 312A  
Miriam 176  
Mortimer Alexander (b. 1866) 178  
Moses (Duarte) (1739/44-1830) 175  
Moses (Jose) (1706-1767) 175, 331B  
Moses (1796-1849) 176  
Moses (1829-1830) 176

Moses E. (1836-1907) 36, 176  
Moses E., Jr. (1874-1934) 176  
Moses, Jr. (see Lopez, Henry (Moses,  
Jr.))  
Octavia (1836-1837) 176  
Philip Melvin 331B  
Priscilla (1807-1839) 176, 199  
Priscilla (1839-1882) 98, 176  
Priscilla Moses 175, 176, 205  
Rachel (1758-1789) 175  
Rachel (1794-1833) 35, 36, 176  
Rachel Da Fonseca (d. 1699) 178  
Rachel Lopez 175  
Rebecca (b. & d. 1878) 176  
Rebecca (b. & d. 1888) 176  
Rebecca (1760-1844) 110, 175  
Rebecca (1794-1868) 55, 176  
Rebecca Cohen Moise 176, 195  
Rebecca Hays Touro 175, 300  
Rebecca Moise 176, 195  
Rebecca Rivera 175, 331B  
Robert F. 176  
Rosa 176  
Rosa Ellen (1832-1835) 176  
Rosalie Cecilia (1886-1918) 176  
Sally (see Lopez, Sarah (Sally))  
Samuel (d. 1831) 175, 263  
Samuel (Jose) 175  
Samuel (Joseph) (b. 1743) 175  
Sarah (b. 1806) 175  
Sarah (dau. of Moses) 175  
Sarah (Sally) (1806-1902) 176  
Sarah (see also Lopez, Catherine  
(Sarah))  
Sarah de Jeudah Cohen Henriquez 178  
Sarah de Joseph Curiel 178  
Sarah Elizabeth (1984-) 331B  
Sarah Esther (d. 1823) 27  
Sarah Ottolengui 176, 234  
Sarah Rivera 175  
Simha de Moseh Lopez Da Fonseca  
178  
Sophia Lazarus 178  
Theodora 176  
Virginia (1835-1925) 159, 179  
William 176  
Zipporah De La Motta Lindo 178

#### LOPEZ DA FONSECA

Abigail (b. 1782) 178  
Abigail (m. 1949) 178  
Abigail Curiel 178  
Abigail Curiel Da Fonseca 178  
Abraham (d. 1722) 178  
Abraham 178  
Aron (b. 1758) 178  
Aron (b. 1796) 178  
Aron (d. 1734) 178  
Aron (d. 1746) 178  
Batsheba 178  
Batsheba Lopez Da Fonseca 178  
Benjamin 178  
Charlotte de Samuel Prado 178  
David (b. 1730) 178  
David (d. 1707) 178  
David (d. 1783) 178  
David (d. 1807) 178  
David Hisquiao 178  
Elias Raphael 178  
Elias, Jr. 178  
Ester Hana 178  
Esther (d. 1841) 178  
Esther (dau. of David) 178  
Esther Baruch Louzada 178  
Gracia Alvares Correa 178  
Gracia de Imanuel Hiquiao Pinedo  
178  
Hannah 178  
Hannah Abendanone 178  
Immanuel 178  
Isaac (b. 1780) 178  
Isaac (b. 1807) 178  
Isaac (d. 1742) 178  
Isaac (d. 1774) 178



Isaac (son of Moses Hezekiah) 178  
 Jacob (b. & d. 1800) 178  
 Jacob (b. 1736) 178  
 Jacob (b. 1754) 178  
 Jacob (b. 1792) 178  
 Jacob (d. 1765) 178  
 Jacobo 178  
 Jahacob 178  
 Jocabet 178  
 Johebed Morenu Henriquez 178  
 Judith Delvalle Henriquez 178  
 Lea 178  
 Leah (b. 1736) 178  
 Leah (d. 1722) 178  
 Leah (d. 1772) 178  
 Leah (dau. of Jacob) 178  
 Leah Andrade 178  
 Leah de Jeosuah Touro 178  
 Leah Henriquez Pereyra 178  
 Menasseh 178  
 Miriam Naphtali 178  
 Miryam 178  
 Moseh Hezekiah 178  
 Moses (b. 1775) 178  
 Rachel (d. bef. 1812) 178  
 Rachel (d. 1762) 178  
 Rachel (d. 1781) 178  
 Rachel (d. 1819) 178  
 Rachel de Isaac Henriques Coutinho 178  
 Rachel de Menasseh Jesurun Henriquez 178  
 Rachel de Samuel Mendes De Sola 178  
 Rachel Israel Correa 178  
 Ragel 178  
 Rebecca (dau. of David) 178  
 Ribca 178  
 Ribca de Eliau Benveniste 178  
 Salomoh 178  
 Samuel Haim 178  
 Sara Hana 178  
 Sarah (b. 1771) 178  
 Sarah de Samuel Fernandez 178  
 Sarah de Selomoh De Casseres 178  
**LORCH**  
 Arthur 274  
 Blanche Ellen 274  
 Elvira Frances Solis 274  
 Helen Blanche 274  
**LORD**  
 Anna Maria  
**LORING**  
 Claudette 339A  
 Edith Haas 88  
 Gladys 167  
 Keith 339A  
 Lawrence 339A  
 Lee 88  
 Margaret Keith 339A  
**LORYEA**  
 Aaron 179  
 Abraham 179  
 Esther 179  
 Isaac 179  
 Jane Hart 179  
 Joseph 179  
 Minnie 179  
 Zelda 179  
**LOTH**  
 Kate Theresa Bernheim 20  
 Sidney A. 20  
**LOTTIMER**  
 Barclay 217  
 Edmund Preston 217  
 Elizabeth Myers Preston 217  
 Jane Hazlitt 217  
 John Barclay 217  
 Myrtila Florance Jackson Hart 130  
 William 130  
**LOU**  
 Mallie 53  
**LOU LANDERS**

See Friedlander, Louis  
**LOUCHHEIM**  
 Aline Bernstein 89  
 Ann 72  
 Ann Sammet 284  
 Anna Louisa 72  
 Betty Jane Meinel 72  
 Cecile 72, 83  
 Cynthia D. 284  
 Dene Meyer 72  
 Donald 89  
 Frank 72  
 Harry Allen 89  
 Jerome III 284  
 Jerome, Jr. 284  
 John 72  
 John Pfeiffer 72  
 Joseph 89  
 Joseph A. 72  
 Julia Louise Neuman 72  
 Marie Louise 72  
 Mary Anne Dannenbaum 284  
 Patricia Phelps 284  
 Peter A. 284  
 Peter A., Jr. 284  
 Robert Alan 284  
 Rose 301  
 Steven Jay 284  
 Stuart 72  
 Stuart Frank 72  
 Stuart Meinel 72  
 Theresa Fleisher 72  
**LOUIN**  
 Sarah Cohen 103  
**LOUIS**  
 Adolph (m. Juliet Mayer) 190  
 Adolph (son of Adolph) 190  
 Antonio M. 143  
 Bernhard 143  
 Eliza D. Johnson Simon 135  
 Esther 143  
 Frederick 190  
 George 135  
 George II 135  
 George III 135  
 Helen 135  
 Jacob 143  
 Juliet Mayer 190  
 Laura (dau. of Adolph) 190  
 Laura (m. Edgar M. Johnson) 135  
 Leopold 143  
 Leslie 143  
 Lillian B. 143  
 Madora Kayton 143  
 Rebecca 242  
 Rosa 143  
**LOURCEY**  
 Ruby Carolyn Webb 198  
**LOUZADA**  
 Aaron (1693-1764) 179, 193  
 Abigail (dau. of Moses) 179  
 Abigail (m. David) 179  
 Benjamin 179  
 Blume Michaels 179, 193  
 Catherine (b. ca. 1756) 179  
 David (ca. 1760-1800) 179  
 Elkahy Esther (1722-1789) 4, 179  
 Esther Baruch 178  
 Hannah 179  
 Jacob (d. 1729) 179  
 Jacob (d. 1791) 179  
 Moses (d. 1750) 179  
 Rachel (d. 1790) 179, 218  
 Sarah 179  
**LOVE**  
 David Robert 195  
 John Robert 195  
 Marilyn Richards Moise 195  
**LOVENSTEIN**  
 Etta 278  
 Joel 278  
 Joseph S. 278  
 Katie Solomons 278

Lee Roy 278  
 Lorraine Gladys 278  
 Miriam D. 278  
**LOVIE**  
 Lehman (m. 1864) 313A  
 Rachel C. Semon (d. 1899) 313A  
**LOVIER**  
 Loretta Ray 91  
**LOVIN**  
 Sarah Cohen 101  
**LOVING**  
 Edith Magnolia Moise 195  
 George Richard 195  
**LOVITT**  
 Elsa 3  
**LOVOY**  
 Joy Rose 42  
**LOW**  
 Marjory 172  
**LOWE**  
 Adelheid (Adeline) Oppenheimer Rothgieser 236  
 Edward William Howe De Lancey 76  
 Hudson 76  
 Ira 236, 237  
 Mary Zenobia 270  
 Susannah De Lancey Johnson 76  
**LOWE-DONNELL**  
 Eleanor Leighton Johnson Collier 164  
 James 164  
 James L., Jr. 164  
**LOWELL**  
 Charlotte Winslow 220  
 Kate Bailey Myers 220  
 Robert Traill Spence 220  
**LOWENBERG**  
 Amanda Hamburger 108  
 Benjamin 108  
 Bernard 108  
 Bernhard 108  
 Bertha 108  
 Bobette 108  
 Bruceton 108  
 Caroline 108  
 Cecil Hecht (1903-1952) 108  
 Cecilia Hecht (1844-1902) 107, 108  
 Celea (dau. Joseph Bernard) 108  
 David (1913-1973) 108, 293  
 David Bernard (1834-1909) 107, 108  
 David If 108, 293  
 David Milton (b. 1906) 108  
 David, Jr. (1920-1944) 108  
 Eloise 108  
 Eugene 108  
 Eugene, Jr. 108  
 Felice Elkin 108  
 Frances McLean 108  
 Fredrica 89  
 Gertrude Goodman 108  
 Gladys 108  
 Hanchen 108  
 Harry Lee 108  
 Hattie 108  
 Hilda 139  
 Isaac 139, 189  
 Jacob B. 108  
 Jennie Hecht (see Lowenberg, Virginia (Jennie) Hecht)  
 Jettie 108  
 Joseph Bernard 108  
 Justine (b. 1900) 108, 301  
 Justine Martha 108  
 Leonora Leterman 108  
 Lois 108  
 Lois Ann 108  
 Lu Ries 108  
 Lucille 108  
 Lulu Ries 108  
 Minnie (b. 1866) 108  
 Minnie (b. 1867) 108  
 Miriam Gertrude Goodman 108, 293  
 Molcie Joseph 139  
 Ophelia Mayer 189

Regina Sennig 108  
 Ruth 108  
 Ruth Diamond 108  
 Sallie 139  
 Stella 108  
 Susan 108  
 Trudi Ann 108  
 Virginia (Jennie) Hecht 107, 108  
 Virginia 108  
 Will 108  
**LOWENGRUND**  
 Aaron (see Lowengrund, Ernest (Aaron))  
 Alfred (1854-1883) 215  
 Alfred J. 215  
 Alice 215  
 Amelia 215  
 Constance 215  
 Daisy (1872-1930) 215  
 Dorothy (b. 1901) 215  
 Edith 215  
 Emma (1848-1891) 215  
 Ernest (Aaron) 24, 215  
 Ernest (b. 1858) 24, 215  
 Eva Bloomingdale 24, 215  
 Eva Kohn 24, 215  
 Helen Frances Vendig 215  
 Helen Moss (b. 1882) 215  
 Isaac Moss (1862-1908) 24, 215  
 Jacob Samuel (1846-1873) 123, 215  
 Joyce (b. 1906) 215  
 Lee (see Lowengrund, Leopold (Lee))  
 Leona ("Leona Moss") Hyneman 123, 215  
 Leopold (Lee) 215, 334A  
 Louis Isaac 215  
 Margaret (b. 1904) 215  
 Rebecca Joyce Moss 215  
 Robert 215  
 Robert Joyce 215  
 Samuel (1813-1894) 215  
**LOWENSTEIN**  
 Anthony Price 253  
 Dora Richardson 253  
 Edith E. Goldbaum 10, 320A  
 Hannah 166  
 Helen 327A  
 Hugh Price 253  
 Jacob Peres 12, 320A  
 James Gordon 253  
 Jane Wray 253  
 Katherine Goldsmith 253  
 Laurinda Vinson 253  
 Louise (1913-) 320A  
 Margaret Mosley 253  
 Melvyn 253  
 Mendel 24  
 Michael Gordon 253  
 Nina 253  
 Nina Marguerite Price 253  
 Oscar 253  
 Peter David 253  
 Price Gordon 253  
 Susan Ellen Miller 253  
**LOWENTHAL**  
 Arthur 309A  
 Constance Lowengrund 215  
 Edwin 309A  
 Ella 306  
 Harry 11, 309A  
 Jack 309A  
 Jeanne Mahler 149  
 Joan 314  
 Julia Bitterman 11, 309A  
 Leonard 215  
 Philip 11, 309A  
**LOWENTHALL**  
 Bendix (b. 1912) 297  
 Benjamin 297, 314A  
 Elise Tobias 297, 314A  
 Joan (d. 1914) 297, 314A  
**LOWERY**  
 Dolye 42

**LOWMAN**  
 Bertha Stix 286  
 Dorothy (b. 1895) 286  
 Erna Frances (b. 1899) 286  
 Leo James 286  
**LOWNES**  
 Kate 236  
**LOWY**  
 Alan (1939-) 327B  
 Alfred P. (1911-) 327B  
 Lorrain Meister 327B  
**LOXLEY**  
 Abraham 179  
 Catherine Louzada 179  
**LOY**  
 Joella 127  
**LUBENSTEIN**  
 See Von Lubenstein  
**LUCAS**  
 Alice Rose 112  
 Florence A. 67  
 Mary Olivia 93  
 Rebecca 112  
 Sarah Phillips 244  
**LUCENA**  
 See De Lucena  
**LUCHS**  
 Alvin 191  
 Helen Levine 191  
 Rosalie 266  
**LUCK**  
 Graham 321A  
 Jonathan 321A  
 Mary 321A  
 Sally Nathan 321A  
**LUCKMAN**  
 Marie Madeleine 62  
**LUCKSTONE**  
 Lena 219, 334A  
**LUDGEN**  
 Ronna 182  
**LUDLOW**  
 Ann G. 156  
 Charles Baylis (b. 1864) 156  
 George C. 155, 156  
 George C., Jr. 156  
 George Cornelius (1859-1861) 156  
 George Craig (b. 1893) 156  
 Josephine R. Swift 156  
 Mary Elizabeth Goodwin 110, 112  
 Mary G. 156  
 Mary G. Hoppin 156  
 Thomas S. 156  
 William G., Jr. 156  
 William Goodwin (b. 1862) 156  
**LUDY**  
 Jessie (1877-1955) 335B  
**LUFBURROW**  
 Levieta S. Russell 256  
 Matthew 256  
**LUMBROSO**  
 Alberto 246  
 Giacomo 246  
 Lia Basso 246  
 Maria 246  
 Maria Todros 246  
 Ortensia 246  
**LUMLEY**  
 Belle M. 101  
 Benjamin 101  
 Edward 101  
 Eliza Betsy 101  
 Isaac 101  
 Lewis 101  
 Morris 101  
 Rosa Julia 101  
 Yitlah (Julia) Hart 101  
**LUNSPORD**  
 Patricia Marie 72  
 Richard G. 72  
**LURIA**  
 See also Lewin  
 Abraham (m. London, 1738) 180, 331B

Abraham (m. 1807) 180, 332A  
 Abraham (son of Jacob) 180, 332A  
 Albert Moses (1843-1862) 212  
 Anita 61  
 Anita De Sola 59  
 Arthur Sylvester (Moses) 212  
 Bella Silveira 180, 331B  
 Corinna De Pass 180, 332A  
 Deborah 180, 331B  
 Ernest 59  
 Esther 180, 332A  
 Esther Nunes Miranda 180, 331B  
 Isaac (d. 1726) 180  
 Isaac 180  
 Israel (-1780) 332A  
 Jacob 180, 332A  
 Jacob 180, 332A  
 Joseph 180, 332A  
 Rachel 180, 332A  
 Rachel Esther (-1737) 331B  
 Rebecca (1740-1814) 180, 331B  
 Sarah 332A  
 Sarah Hannah (d. 1888) 180, 332A  
 Sarah Salo 332A  
**LUSCHER**  
 Norma 195  
**LUSHER**  
 Arthur Robert (b. 1887) 258  
 Augusta Camilia Salomon 257, 258  
 Carabel Miles 258  
 Cecilia Adeliza (1856-1863) 158  
 Earle Wiswell (1889-1919) 258  
 Eleanor Lorraine (b. 1898) 258  
 Gloria (b. 1925) 258  
 Joel (b. 1953) 258  
 John Robert (1860-1928) 258  
 John Robert III (b. 1923) 258  
 John Robert, Jr. (b. 1900) 258  
 Joseph Arthur (1854-1856) 258  
 Keith Michael (b. 1948) 258  
 Lena Gebkle 258  
 Lillian Alice 258  
 Lionel Gustave (1902-1925) 258  
 Mary Alice (1852-1863) 258  
 Mavis Dagele 258  
 Myrtle Nellita (b. 1922) 258  
 Myrtle Wigley 258  
 Nellita F. Johnson 185  
 Robert Mills (1823-1890) 257, 258  
 Roy Mills (b. 1897) 258  
 Roy Mills, Jr. (b. 1922) 258  
 Scott Jeard (b. 1952) 258  
 Stella Hulin 258  
 Theresa Augusta (b. & d. 1859) 258  
**LUTH-MARSHALL**  
 Jean Marcia 82  
**LUTZ**  
 Marie 294  
**LYLE**  
 Ann Hamilton 79  
 Ellen 79, 80  
 James 79  
 Joseph Lawrence 201  
 Mary 79  
 Rosina Ursula Mordecia 201  
**LYNCH**  
 Mabel 38  
 Patricia 309A  
**LYNN**  
 Henriette 94  
**LYON**  
 See also De Lyon, Lyon(s), Lyons  
 Abigail 134  
 Adelaide 181  
 Adeline Judah Phillips 244  
 Annie Schwartz 181  
 Augusta 181, 309A, 332A  
 Augusta Hays 181  
 Belle T. (1833-1910) 181  
 Caroline 181  
 Catherine (dau. of Richard) 19  
 Catherine (m. George) 181  
 Charity Solis 181, 274

Charles (see Lyon, Henry M. (Charles))  
 Clifford Douglas 138  
 Diana 138  
 Dinah Mawson 181  
 Edgar 138  
 Edmund Robert (1850-1930) 181, 273  
 Eliza White 181  
 Elizabeth 332A  
 Elvira (1878-1977) 181, 312A, 332A  
 Emma (1788-1870) 115  
 Emma 181  
 Esther (1837-1917) 48, 197, 198  
 Esther 48, 197, 198  
 Eugene 103  
 Fanny (see Lyon, Frances (Fanny))  
 Felice Mayer 20  
 Frances (Fanny) (1810-1909) 181  
 Frances (1869-1913) 12  
 Frances Annette (b. 1913) 181  
 George (Judah) 181, 332A  
 George (1803-1871) 48  
 George Belmore 134  
 Gerald 181  
 Gilbert Augustus 134  
 Gustav Adolphus 181  
 Hannah 181  
 Hart 181  
 Henry 181  
 Henry M. (Charles) 6  
 Isaac (father of George (Judah)) 181, 332A  
 Isaac (son of George (Judah)) 181  
 Isaac (son of Jacob (Poznanski)) 181  
 Jacob (Poznanski) (1777-1851) 181  
 James Lawrence 181  
 Joseph (d. 1824) 181  
 Judah (see Lyon, George (Judah))  
 Judith (1748-1816) 35, 36  
 Julia Matilda 134  
 Kate Lathrop 81  
 Letitia 6, 144  
 Lillian (1889-) 327A  
 Margaret 20  
 Mary Anne 181, 182  
 Meriam 181  
 Moses 134  
 Phyllis Annette Joseph 138  
 Rachel (dau. of Gustav Adolphus) 181  
 Rachel (dau. of Jacob (Poznanski)) 181  
 Rachel (m. 1866) 6, 144  
 Rachel Davis (d. 1845) 48  
 Rebecca 115  
 Rebecca Morais 103  
 Rebekah Abrahams 6  
 Richard 20  
 Robert (son of Gerald) 181, 244  
 Robert (1810-1858) 181  
 Samuel 181  
 Sarah Elizabeth (1835-1897) 118, 181  
 Thaddeus Kosciuszko 181  
 Thomas White (1815-1891) 181  
 Walter 181  
 William Henry 134  
 Zipporah (1813-1841) 181

**LYON(S)**  
 Frances 289  
 Louis (m. Rebecca Schweria) 289  
 Louis (son of Louis) 289  
 Rebecca (Sarah) 183  
 Rebecca Schweria 289  
 Ruth (dau. of Louis) 289  
 Sarah (see Lyon(s), Rebecca (Sarah))  
 Solomon 183

**LYONS**  
 See also Lyon, Lyon(s)  
 Abigail (b. 1854) 182  
 Abraham (b. 1841) 183  
 Albert 289  
 Alberta Schweria 289  
 Alexander (d. 1885) 182  
 Alfred (Vienna) 34, 322A

Alfred (1848-1915) 182  
 Alfred E. 121  
 Alfred Julius 10  
 Alice De Pew 183  
 Ann Elizabeth ('Bessie') Maffitt 183  
 Annie (1827-1908) 182  
 Asher (b. 1804) 182  
 Asher S. (b. 1815) 181, 182  
 Augusta (d. 1910) 6, 40  
 Augusta Content 6, 40  
 Barbara March 238  
 Benjamin (b. 1801) 183  
 Benjamin (b. 1838) 6  
 Bessie Maffitt (see Lyons, Ann Elizabeth ('Bessie') Maffitt)  
 Bilah 183  
 Catherine (1792-1868) 182, 214, 215  
 Celine 138  
 Charles 183, 332B  
 Constance Hendricks 111, 182  
 Daisy Hyman Dobriner 121  
 Dinah (Dianna) Levy 182  
 Edwin Jacques (1873-1926) 182  
 Eleazer (b. 1813) 182  
 Eleazer (see also Lyons, Ellis (Eleazer))  
 Eleazer (1729-1816) 132, 182  
 Elizabeth Ann 183  
 Elizabeth Douglas 182  
 Elizabeth Wolff (m. 1842) 183, 332B  
 Ellis (Eleazer) (1811-1861) 182  
 Ellis 182  
 Ernestine (Esther) 34, 322A  
 Esther (dau. of Alfred) 34  
 Esther (1786-1846) 150, 182  
 Esther Hart (1850-1883) 183, 332B  
 Esther Solomon 183  
 Eva Jonas 183  
 Fanny (b. 1845) 182  
 Florine Allen 10  
 Frances Isabel Hunt 183  
 Gershom (b. 1849) 182  
 Gitlah (d. 1833) 183  
 Grace Nathan 182, 226  
 Guelina Lawrence Baker 182  
 Hannah (dau. of Judah E.) 182  
 Hannah (m. Joseph Levy) 161  
 Hannah (1840-1886) 182, 332A  
 Hannah Levy (m. 1776) 132, 182  
 Henrietta (Rhetta) 183  
 Henry (1805-1858) 183, 332B  
 Henry (1807-1849) 182  
 Henry M. 6  
 Hyman (m. 1828) 16  
 Hymen Hart 183, 332B  
 Isaac (1774-1843) 180, 183  
 Isaac (1813-1837) 183  
 Isaac Lazarus 183, 332B  
 Isaac Montgomery 183  
 Isabel 183  
 Isabel R. 103, 183, 332B  
 Isabel Rebecca 183, 203  
 Isabella (b. 1813) 182  
 Isabella (1835-1927) 182, 332A  
 Jack (see Lyons, Jacob C., Jr.)  
 Jacob C., Jr. 183, 332B  
 Jacob Cohen 103, 183, 332B  
 Jacques Judah (1813-1877) 182, 226  
 Jane (1824-1898) 183, 250  
 Jeannette Pinner 180, 183  
 Jessica (1822-1894) 137, 182  
 Joseph (brother of Isaac) 183  
 Joseph (son of Judah Eleazer) 182  
 Joseph (1813-1839) 183, 332B  
 Judah (b. 1818) 182  
 Judah (m. Gitlah) 183  
 Judah Eleazer (1779-1849) 169, 182  
 Julius Judah (1843-1920) 111, 182  
 Kate 182  
 Lala (see Lyons, Rachel ('Lala'))  
 Lawrence (b. 1816) 182  
 Levy (b. 1830) 183  
 Levy (d. 1835) 183

Lipman (b. 1863) 183  
 Louisa Elizabeth (b. 1840) 183  
 Louisa Elizabeth (b. 1842) 132, 183  
 Louisa Elizabeth Hart 103, 183  
 Lucien Eugene 180, 183  
 Madge Hamilton 183  
 Mary (Martje Asser) Levy 169, 182  
 Mary (1835-1889) 182, 332A  
 Mary Ann Alexander 182  
 Mary Anne Lyon 181, 182  
 Mary Bausman 182  
 Miriam 321B  
 Mordecai (1792-1845) 182  
 Moses 183  
 Nathalie Fontaine 183, 332B  
 Pauline Evelyn 138  
 Phebe Phillips 183  
 Philip Douglas (1881-1957) 183  
 Philippa Jane 183  
 Phineas (Solomon) (1834-1880) 183  
 Rachel ('Lala') 183  
 Rachel (m. 1824) 183  
 Rachel Cohen 180, 183  
 Randolph (1844-1863) 183  
 Rebecca (1777-1864) 182, 214  
 Rebekah Abrahams 6  
 Regina 161  
 Rhetta (see Lyons, Henrietta (Rhetta))  
 Roger A. (b. 1915) 10  
 Rosa (see Lyons, Rosetta (Rosa))  
 Rosalie 182  
 Rosalie A. (b. 1905) 10  
 Rose (1845-1897) 182, 332A  
 Rose Cecile 289  
 Rosetta (Rosa) (1812-1866) 118, 153, 182  
 Rudolph (b. 1816) 182  
 Ruth 269  
 Samuel 321A  
 Samuel (b. 1809) 182  
 Samuel (1781-1858) 182, 185  
 Samuel Jacob (b. 1843) 182  
 Sarah (b. 1827) 183  
 Sarah (1845-1934) 182  
 Sarah Benjamin 19, 321A  
 Sarah Hyatt 34, 322A  
 Sarah Marks 182, 185  
 Sarah Polak 182  
 Sheva Barnett 16  
 Solomon (see Lyons, Phineas (Solomon))  
 Susan (1807-1869) 183  
 Theodore H. (1849-1926) 183, 332B  
 Theodore Hart (1817-1837) 183  
 Theodosia Shann 182  
 Uriah (1784-1832) 182  
 Zaligman 183  
 Zipporah Ella (b. 1841) 182

**LYTTON**  
 Beaumont 304  
 George 304  
 Gertrude 304  
 Henry Charles (b. 1846) 65, 304, 310A  
 Rose Eva Wolfe 64, 304  
 Walter 304

**MAAS**  
 Agnes 89  
 Amie T. 5  
 Barbara 5  
 Bill 5  
 Edward L. 5  
 Eva 84  
 Fannie Abrahams 5  
 Helen McKenna 5  
 Jeannette 5  
 Lillian 84  
 Robert 5  
 Tarris 189  
 Ted 5

**MACBETH**  
 Charles Lyons 183  
 Charles William 183  
 Claudia W. Coristine 183

John Douglas 183  
 Madge Hamilton Lyons 183  
 Millicent Ann Gilmour 183

**MAC BRIDE**  
 Thais 285

**MAC DONALD**  
 Clotilda Florence Cohen 30  
 Cynthia Lee 296  
 Elmer Cranston 296  
 Jennifer Tim 296  
 John W. 30  
 Scott Thurston 296

**MAC DONOUGH**  
 Clara H. Hackstaff 158

**MAC DOUGALL**  
 Caroline A. 203

**MAC DOWELL**  
 Don 13  
 Suzanne Steiner 13

**MAC FARLAND**  
 Clarissa C. 65

**MAC GRUDER**  
 George 129  
 Leah Jackson Hertz Hart 129

**MACHADO**  
 David Mendes (d. 1747) 234  
 Rebecca (1746-1831) 234, 243  
 Sarah (1747-1810) 212, 234  
 Zipporah Nunez 234

**MACHLER**  
 Harry (1833-1913) 22  
 Miriam Eger 22

**MACHOL**  
 Alice 282

**MACK**  
 Amy 21  
 Celia Kraus 145  
 Hermann 145  
 John 135  
 Louise Emily Johnson 135

**MACKAY**  
 Alice Myers Guggenheimer 90  
 Bessie Mordecai (see Mackay, Elizabeth Davis (Bessie) Mordecai)  
 Catherine Johnston Devereux 200  
 Catherine Josephine 200  
 Charles De Saussure 200, 201  
 Daniel R. 90  
 Elizabeth Davis (Bessie) Mordecai 200, 201  
 Joseph (b. 1891) 200  
 Joseph Jenkins 200  
 Margaret 200  
 Roger D. 90  
 Susan Anderson 90  
 Thomas Pollock 200

**MAC KENDREE**  
 Daisy Mary Jane Sheftall 267  
 Seaborne Marshall 267

**MAC KENZIE**  
 Mabel 331A

**MACKENZIE**  
 Donald G. 157  
 Kenneth Campbell Beveridge 49  
 Marian Nahl 49  
 Mary 49  
 Robert 49  
 Roberta Johnson Nicholas 157

**MACKEY**  
 Margaret Sturgis 52

**MACKIEWICZ**  
 Marie Therese 143

**MACKLER**  
 Natalie Stern De Lee 282  
 Saul Allen 282

**MAC KUBBIN**  
 D. N. 332B

**MAC LACHLIN**  
 J. Kevin 265  
 John T. 265  
 Victoria Fauth Sutton 265  
 Victoria Laura 265

**MAC LENNAN**

Frank 241  
 Mary C. Morningstar 241

**MACLEOD**  
 Gwendolyn 305

**MACNAMEE**  
 Holly Ann Ehrich Ochs 253  
 Robert 253

**MAC PIKE**  
 Linda 321A

**MACY**  
 Julia K. 157

**MADDEN**  
 Elizabeth (1883-1963) 337A

**MADEIRA**  
 Maria Walsh 68

**MADURO**  
 Abraham de Selomoh Samuel Levy  
 Maduro 185  
 Esther 241  
 Esther de Salomon Levy 185  
 Esther de Solomon Levy 240  
 Esther Vieyra 241  
 Grace Levy (1771-1860) 241  
 Jacob de Solomon Levy 240  
 Leah Cohen Peixotto 240, 241  
 Moses de Samuel Levy 178  
 Moses Levy (d. 1766) 241  
 Rachel Levy 240, 241  
 Rachel Lopes 241  
 Rachel Lopez Da Fonseca 178  
 Rachel Marques 185  
 Rachel Rodrigues 241  
 Ribca de Jacob de Solomon Levy 240  
 Samuel Levy (m. bef. 1706) 241  
 Samuel Levy (1747-1790) 240, 241  
 Sarah de Mordecai L. 62  
 Selomoh de Samuel Levy 178  
 Shirley Brandon 209  
 Solomon Levy 240

**MAFFITT**  
 Ann Elizabeth ('Bessie') 183

**MAGEE**  
 Julia H. 80

**MAGGS**  
 Anne 154

**MAGINNIS**  
 Eugene Joseph 238

**MAGNUS**  
 Abraham (Edward) 239  
 Alexander 8  
 Belle Platzner 239  
 Edith Metzger 8  
 Edward (see Magnus, Abraham (Edward))  
 Eleanor (Ellen) Oppenheim 8, 235  
 Eleazer (see Magnus, Louis (Eleazer))  
 Elizabeth Bilha (-1894) 331B  
 Ellen Oppenheim (see Magnus, Eleanor (Ellen) Oppenheim)  
 Esther 239  
 Esther Cohen 239  
 Harriet Fries 8  
 Herman 8  
 Jean 8  
 Joseph 8  
 Joseph Alexander (d. 1927) 8, 84, 235  
 Julian A. 8  
 Julian, Jr. 8  
 Louis (Eleazer) 239  
 Lucille 239  
 Marcus (m. Esther Cohen) 239  
 Marcus (1871-1874) 239  
 Marian 8  
 Marjorie 8, 306  
 Matilda Finsie 239  
 Moses (Murray) 239  
 Rachel Oppenheimer 239  
 Rebecca Alexander 8  
 Rose 8  
 Ruth 239  
 Saul 8

Simon 331B  
 Sol 8  
 William S. 8

**MAGRISH**  
 Edith Krohn 306  
 James L. 306  
 Kate 306  
 Mary 306

**MAGUIRE**  
 Carter 117  
 Frances 117  
 Frances Ashton Moore 117  
 Judith 117  
 Margaret Elizabeth 237

**MAHAN**  
 Alfred T. 80  
 Alfred Thayer 80  
 Ellen Kuhn 80  
 Ellen Lyle Evans 80  
 Helen Evans 80  
 Lyle Evans 80  
 Madeline Johnson 80

**MAHLKE**  
 Eleanor 282

**MAHNKEN**  
 Anne (b. 1929) 115  
 Charles Henry (b. 1931) 115  
 Harold J. 115  
 Lavinia Minis Henry 115

**MAHON**  
 Charlotte Virginia 206  
 John M., Jr. 206  
 John Mattison 206  
 Mary Octavia Moses 206  
 Richard Mattison 206  
 Susan Gray 206

**MAHONEY**  
 Margaret 194

**MAIER**  
 Lena 89

**MAILERT**  
 Adeline Goldsmit 184  
 Augustus 184

**MAILHES**  
 Mary Lillian 199

**MAILMAN**  
 Frederick F. 339B  
 Jodi Sue Kramer 339B

**MAIRS**  
 Elizabeth (1769-1845) 184  
 Fanny (1804-1870) 184  
 Levy (1801-1849) 184  
 Seligman (1799-1883) 184  
 Simon (1765-1835) 184

**MAITLAND**  
 Alfred Henry 79  
 Edith Charlotte 79  
 Edith Scobell 79  
 Henry 79  
 Nora Beatrice 79

**MAJESKA**  
 Mme. (see Stern, Henrietta Mary ("Mme. Majeska"))

**MAJOR**  
 Anna Serena McCauley 256  
 John 256

**MALBRON**  
 Rosalie (1827-1880) 93

**MALEY**  
 Caroline Dittmar 146

**MALFIATRE**  
 Ruth Mitchell 129

**MALINA**  
 Luba 290

**MALITSON**  
 Harriet Hutzler 162  
 Helen Gail 162  
 Irving H. 162  
 Paul Henry 162

**MALL**  
 Fiorance Minis 194  
 Leonard 194  
 Leonard Walter Isaac (b. 1953) 194



**MALLERY**  
Rosemary 24  
**MALLON**  
Kate Noble 141  
U. C. 141  
**MALNICK**  
Winifred 122  
**MALONE**  
Ella Moses 209  
Louis 209  
**MALUENDA**  
Angela Maria (see Maluenda, Anna  
Phillipa or Angela Maria (Judith  
Maluenda))  
Anna Phillipa or Angela Maria (Judith  
Maluenda) (1678-1750) 273  
Judith (see Maluenda, Anna Phillipa  
or Angela Maria (Judith Maluenda))  
**MALUENDA Y BARBARON**  
Antonia De Paz Coronel Y Fonseca  
273  
Gaspar 273  
**MANBER**  
Beulah Catharine (see Kramer, Beulah  
Catharine (Mamber))  
Frank 238  
Mabel Oppenheimer 238  
**MANCHESTER**  
Eleanor Gumme 67  
**MANDEL**  
Alfred 274  
Alice Solis 274  
Eric 274  
**MANDELICK**  
Adelina (b. 1870) 16  
Clara Cecilia (b. 1870) 16  
Elizabeth Catherine Barnett 16  
Joseph (1828-1880) 16  
**MANER**  
Lula F. 269  
**MANFORD**  
Guy 237  
Rose ('La Velle') Rothgeiser Jones 237  
**MANGET**  
Eliza De Pass 58  
Victor 58  
**MANGIER**  
Lottie C. 230  
**MANKIEWICZ**  
Rose 193  
**MANN**  
Adrian J. (b. 1907) 285  
Albert 180  
Anne Paine 168  
Beatrice 17  
Carola 340A  
Clara Forst 180  
Dorothy Gudrun (b. 1895) 285  
Edna Rosenthal 340A  
Ernest 168  
Ethel 186  
Frances (Frankie) Stix 288  
Harvey 340A  
John 340A  
Jonas F. 285  
Leah Forst 180  
Lewis T. 261  
Lewis, Jr. 261  
Lillian 171  
Lily 180  
Lisa 340A  
Margaret (Percy) Lehair 174  
Morris B. 180  
Nellie 180  
Peggy 340A  
Percy Lehair (see Mann, Margaret  
(Percy) Lehair)  
Philip 180  
Robert 340A  
Ruth Fidone (b. 1898) 285  
Susan 340A  
Sybil Elzas 261  
**MANNAHAN**

Esther Desirée De Pass Heydenfeldt  
58  
Henrietta 58  
Rebecca (b. 1832) 58  
**MANNERING**  
Harriot Judith Hart Dreaper 95  
James 95  
**MANNING**  
Virginia Dorothy Brown 239  
**MANSBACH**  
Marian (b. 1893) 275  
**MANSOOR**  
Behjar (Joy) 268  
**MANTEL**  
Caroline Judah 141  
Hermann 80  
John R. 141  
**MANTELL**  
Silma 215  
**MANUEL**  
Catherine (1768-1852) 141, 276  
David 141  
Dorothea 141  
Hannah (Annie/Nancy) 141, 263, 264  
Marian (Miriam/May) Judah 141  
**MARACHÉ**  
Benjamin 184  
Esther (see also Maraché, Hetty  
(Esther))  
Esther de Jacob 61  
Hannah 184  
Henrietta J. (m. 1806) 184, 332B  
Hetty (Esther) 184, 200  
Jacob 184  
Jacobus (d. 1735) 184  
Judith (1770-1855) 184  
Mary 184, 332B  
Meers (see Maraché, Mosseh (Meers))  
Moses 184  
Mosseh (d. 1761) 184  
Mosseh (Meers) (d. 1750) 184  
Nichelson 184  
Raquel 184  
Rebecca Myers (184, 217)  
Ribca 184  
Solomon 184, 217, 332B  
**MARCHANT**  
Edward H. (b. 1860) 184  
George 184  
Henry 184  
Lester (1858-1936) 184  
Louise Jeremiah 184  
Nancy Wilkerson 184  
Rachel Phillips 184, 244  
Sophie 184, 244  
William (1833-1926) 184, 244  
**MARCHAZE**  
Esther (see Marques (Marchaze),  
Esther)  
**MARCHESANI**  
June Virginia Sheftall 270  
Louis 270  
**MARCUS**  
Abram Solomon (1876-) 330B  
Adrienne 186  
Alice Levy 167, 330B  
Asher Joseph (1878-1941) 330B  
Bessie Hoffman Palmbaum Waldorf  
339B  
Cecile L. Heller 186  
Clarence (1889-) 330B  
Donald Clarence (1923-) 330B  
Donald James (1956-) 330B  
Gerrie (1954-) 330B  
Gwen Elizabeth Foy 330B  
Jacqueline 186  
Jennie Y. Stein Levin 330B  
Madison Joseph (1854-1897) 167,  
330B  
Madison Joseph (1921-) 330B  
Madison (1888-) 330B  
Mariya Alice (1930) 330B  
Marion Brooks 167

Matthew (see Marcus, Madison  
Joseph)  
Melvin O. (-1971) 339B  
Rosina 167, 330B  
Simmie 167, 330B  
Theodor R. 186  
Treva Jo Hatchett 330B  
**MARCUSE**  
Santa H. 324A  
**MAREL**  
Julia Smith 163  
**MARELLI**  
Joan Romilda 216  
**MARET**  
Charlotte Murray Cheston 80  
Hermann 80  
**MARGOLIES**  
Bernard 71  
James Teller (b. 1948) 71  
Janet 71  
Jean Fleisher 71  
Linda 149  
Lynn Hurwitz 71  
Peggy Fleisher (b. 1944) 71  
Robert Fleisher (b. 1942) 71  
**MARGOLIN**  
Esther 2  
**MARGOLIUS**  
Benjamin 107  
Benjamin Wallace 107  
Elsie 107  
Elsie F. Weill 107  
Elsie Lee 107  
Ida 101  
Leroy Hecht 107  
Maud Estelle Hecht 107  
Russ Wade 107  
Scott Benjamin 107  
Susan Straus Oberdorfer 107  
**MARIS**  
Jack 208  
Virginia Phelps 208  
Virginia Williams 208  
**MARK**  
Carolyn Kahn 86  
Gloria Louise 86  
Hetty Cohen 33  
Isaac C. 165  
Juliet Ruth 86  
Henry 184  
Miriam Gross Lehman 86  
Muriel 33  
Sarah Edwitha Bonita 165  
Solomon 33  
**MARKENS**  
Anna Weiskopf 181  
Charles (b. 1853) 181  
Elias (1809-1860) 181  
George Washington (b. 1855) 128  
Henry (b. 1857) 181  
Isaac (1846-1928) 181  
Rachel Benjamin 181  
Rosetta Friedlander Winter 181  
Zipporah 128  
Zipporah Lyon 181  
**MARKHAM**  
Algernon Augustus 77  
Anne Winifred 77  
Constance Margaret 77  
Estelle 264  
Hope Seymour Dorothy 77  
Katherine Mary 77  
Winifred Edith Barne 77  
**MARKHEIM**  
Elizabeth Israel 121  
Joseph 121  
Leon 121  
**MARKS (MARX)**  
Abraham 264  
**MARKS**  
See also Marx  
Abigail (1819-1913) 185, 231  
Abraham (b. 1765) 184

Abraham (b. 1792) 185  
Abraham (1856-1860) 187  
Ada Emanuel 64, 186  
Adah Esther 150  
Adelaide (1888-1920) 15  
Agnes Lazarus 150, 328B  
Alexander (1788-1861) 98, 186, 332B  
Alexander 186, 332B  
Alfred (b. 1803) 185  
Alfred Jacobs (b. 1853) 64, 186  
Alma Vendig 83  
Amelia (Minky) 148, 185  
Ann (Esther) Liberman 186  
Ann L. 332B  
Anna (1800-1888) 10, 185  
Anna Fenn 184  
Arthur Eliot (see Marsh, Arthur Eliot)  
Barham (1822-1833) 186  
Belle Hays 293  
Bertha 187  
Blanche 83  
Carolyn Cummins 83  
Carrie 125  
Carrie Gans 83  
Cecil (b. 1857) 186  
Cecile Abrams 4, 186  
Celia 187  
Charles (b. 1869) 187  
Charles (b. 1915) 83  
Charles, Jr. 83  
Clara 103, 242  
Clara Sugarman 187  
Clarence 83  
Clarence, Jr. 83  
Clarissa Palmiter 184  
Comfort 184  
Constance Jacobs 132, 186  
Constance Fyke 308  
Content (dau. of Zachariah) 184  
Content 184  
Content Merwin 184  
Cynthia White 150  
David (b. 1818) 187  
David (son of Alexander) 186, 332B  
Deborah (1801-1888) 34, 185  
Dorothy Brandon 102  
Eda 187  
Edith 335B  
Edward (son of Frederick) 332B  
Edward 184  
Edward B. 161  
Edward F. (1818-1830) 186  
Edwin (b. 1838) 186, 332B  
Edwin L. 187  
Eileen Alice 308  
Elias (1790-1886) 186  
Eliza (see also Marks, Elizabeth  
(Eliza))  
Eliza Hyams 19, 119  
Eliza Levy 183  
Elizabeth (bapt. 1730) 184  
Elizabeth (bapt. 1742) 184  
Elizabeth (dau. of Frederick) 332B  
Elizabeth (Eliza) (m. 1844) 186, 332A  
Elizabeth Hawkins 184  
Elizabeth Yorieu 185  
Ella 187  
Emanuel 83  
Emogene 19  
Estelle 264  
Esther (Hetty) Hart (b. 1766) 103  
Esther (Hetty) Hart (m. 1816) 98, 186  
Esther (1846-1916) 186, 332B  
Esther H. Seixas 264  
Esther Tolles Tuttle 184  
Ethel 293  
Fanny 186, 332B  
Ferdinand 171  
Florence 293  
Frances (b. & d. 1817) 186  
Frances (dau. of Frederick) 332B  
Frances (1763-1850) 186  
Francis Marion 132, 186

Frederick 186, 332B  
Frederick H. 186, 332B  
Frederick Humphrey 332B  
George 186  
Geraldine 282, 339B  
Godwin 19  
Grace (1845-1928) 123, 185  
Grace Seixas Judah Myers 140, 185  
Guy 264  
Hannah (1835-1890) 276  
Harold 186  
Harriet Mitchell 185  
Harry 182  
Hart (1798-1860) 103  
Hayman (Hyman) 140, 185  
Helen Loeb 187  
Helene 83  
Henrietta (1851-1923) 186  
Henry (Zvi Hirsch) (1726-1809) 185  
Henry 187  
Henry Hyman (1811-1849) 185  
Herbert E. 161  
Herbert J. 102  
Hettie Cohen 33  
Hetty Hart (see Marks, Esther (Hetty)  
Hart)  
Hetty or Kitty Benzaken 19  
Hezekiah 184, 332B  
Hillel (1813-1899) 185  
Humphrey (Mordecai) (1760-1838) 186  
Hyman (see Marks, Hayman (Hyman))  
Ida (b. 1865) 186  
Isaac (b. 1732/41) 185  
Isaac (m. 1797) 103  
Isaac (son of Alexander) 186  
Isaac (1796/8-1810) 186  
Isaac D. 187  
Isaac Judah (1825-1881) 185  
Isaac N. 186, 332B  
Isabel (1829-1833) 186, 332B  
J. Stephen II 186  
Jacob 187  
Jacob Washington 186, 332B  
Jane Barham 186  
Jennie 187  
Jochabed (Johavith) Isaacs 120, 185  
John (son of Abraham) 184  
John (son of Julian David) 150  
John B. (1827-1833) 186  
John Herbert 105  
Joseph 187  
Joseph Benzaken (1811-1851) 19, 119  
Joseph Harrod (1850-1871) 186  
Joseph Hart (1818-1907) 4, 186, 332B  
Josephine 19  
Julia 186  
Julia Ann 184  
Julia Esther 64, 186, 332B  
Julia Pierpont Warne 186  
Julian David 150  
Juliet 133  
Kate 150, 328B  
Katherine (1845-1911) 186, 202  
Laura Epstein 187  
Leah (b. 1806/8) 185  
Leah (dau. of Mayer) 185  
Leah (1753-1786) 103, 185, 324B  
Leonora (b. 1831) 186, 332B  
Levi (1792-1880) 184  
Levy (b. 1797) 185  
Levy (Lipman) 185, 223, 332B  
Lipman (see Marks, Levy (Lipman))  
Mabel Edna 186  
Margaret Gladys 150, 311A, 328B  
Maria (see Marks, Miriam (Maria))  
Marion 186, 332B  
Marjorie 186  
Mark (1778-1834) 19  
Martin A. 293  
Mary 184  
Mary Bryan 184  
Mary Burwell 184  
Matilda (b. 1850) 187

Matilda (1799-1870) 103  
Mayer 185  
Meyer Hart (1798-1860) 103, 324B  
Michael (1761-1829) 120, 185  
Minky (see Marks, Amelia (Minky))  
Miriam (b. 1846) 102, 185  
Miriam (Maria) (1798-1877) 16, 137,  
185, 321A  
Miriam (1764-1822) 185, 233  
Miriam (1769-1784) 185  
Miriam (1822-1896) 185  
Miriam 102, 185  
Miriam Chuck 161  
Miriam Simpson (or Simons) 185  
Montague 150, 328B  
Mordecai (see also (Marks, Humphrey  
(Mordecai))  
Mordecai (1706-1771) 184  
Mordecai, Jr. (1739-1797) 184, 332B  
Moses (b. 1790) 185  
Muriel 285  
Myer (b. 1772) 185  
Nancy Jean 150  
Nancy P. Hollingsworth 150  
Nehemiah 184  
Olivia Polock 186  
Oscar 332B  
Paul 186  
Peggy Ann 186  
Philip (d. 1915) 150  
Philip, Jr. 150  
Rachel (ca. 1747-1797) 185  
Rachel (dau. of Isaac) 103  
Rachel Polak 182  
Rachel Solomon 185, 223  
Rai Fox 186  
Rebecca (dau. of Fredericks) 332B  
Rebecca (dau. of Isaac) 103  
Rebecca (1810-1891) 48, 185  
Rebecca H. (see Marks, Ann L.)  
Rebecca M. (d. 1855) 186  
Robert 187  
Rose Lewis Goldberg 171  
Sally Bethia 184  
Samson (b. 1794) 185  
Samuel Mandel (1762/4-1804) 185  
Samuel Tobias (1817-1867) 185  
Sarah (1788-1857) 182, 185  
Sarah Anne 184  
Sarah Cohen 185  
Sarah Edwitha (1815-1876) 165, 185,  
332B  
Sarah Elizabeth Godwin 19  
Sarah Harris 185  
Solomon (b. 1774) 185  
Solomon (1766-1824) 185  
Solomon, Jr. (d. 1827) 185, 332B  
Sophie (dau. of Isaac D.) 187  
Sophie Wertheimer 187  
Stephen III 186  
Susan 150  
Susan Joan 102  
Suzanne 83  
Theodore 186, 332B  
Thomas Humphrey 332B  
Vera 186  
Walter 308  
Warrick (b. 1857) 264  
Washington (see Marks, Jacob  
Washington)  
William 184  
Zvi Hirsch (see Marks, Henry (Zvi  
Hirsch))  
Zachariah 184  
Zanvil 185  
Zephaniah 184  
**MARKSTEIN**  
Fannie (1810-1887) 295  
**MARLOW**  
Nettie 206  
**MARONI**  
Maria Lombroso 246  
Palo 246

**MARQUES**  
Esther 185  
Esther de Salomon Levy Maduro 185  
Isaac Rodriguez (d. 1706/7) 185  
Jacob Rodriguez (1698-1725) 185  
(Jacob?) Rodriguez 185  
Rachel (b. 1677) 185  
Rachel (d. 1733) 185  
Rachel (m. 1743) 185  
Rebecca (d. 1697) 185  
**MARQUES (MARCHAZE)**  
Esther (ca. 1689-1718) 85, 185  
**MARQUIS**  
Gladys 107  
**MARRITS**  
Joyce I. 235, 337B  
**MARROW**  
Lillian 113  
**MARSDEN**  
Herbert P. 331B  
Winfred Claire 331B  
**MARSH**  
Arthur Eliot 186  
Margaret 117  
**MARSHALL**  
Ana 28  
Armina 60  
Ella Gratz 87  
Flora 25  
Henry Clay 87  
Mamie 25  
Maria (1789-1864) 251  
Mary Louise (-1897) 336B  
(Nancy) Ann 58  
Rose 25  
**MARSHUETZ**  
Adolph (b. 1840) 30  
Adolph G. (b. 1908) 30  
Charity Solis Carvalho 30  
Eibel 30  
Isabel Baird 30  
Jules Carvalho 30  
Richard Jones (b. 1942) 30  
Rita J. (b. 1916) 30  
Rosemary Stanislaus Murray 24  
Sarah Nunes 30  
Solomon Nunes Carvalho 30  
Sophie 30  
William Baird (b. 1936) 30  
**MARTIN**  
Abigail (1799-1827) 220, 277  
Abigail (1838-1926) 277  
Alicia 330A  
Anna Serena 256  
Beryl 18  
Betty Lou Polia 283  
Carl 283  
Cecilia Blanche Moise Brink 196  
Clifton Joseph 196  
Elsa Rosenberg 277  
Emanuel 277  
Esther (Hester) Solomons 277  
Florence (b. 1889) 277  
Florence Evangelis Colete Nortbey  
Clowes 78  
Frederick L. (1847-1935) 123, 277  
Harold (b. 1886) 277  
Henry (b. 1842) 277  
Humphrey Trice 78  
Jemima Anne Frances 81  
Lazarus Y. (1802-1877) 277  
Marie Louise (Minnie) Hyneman 123,  
277  
Marie Thalie 145  
Mary Pauline Kreutz 277  
Morris (1842-1843) 277  
Nancy 222  
Simon (1837-1890) 277  
Stella (1873-1874) 277  
Stephen 299  
Susan Elizabeth McKee 299  
**MARTINEZ**  
Angela Haden-Guest 82

Maria De Los Angeles 336A  
Orlando 82  
**MARVEL**  
Margaret Porter 157  
**MARX**  
See also Marks  
Adelaide 188  
Adelheid (1822-1916) 282, 283  
Adeline (1808-1879) 188  
Asher 188  
Betty (1830-1863) 282  
Blanche Hirsch 189  
Caroline (1800-1883) 188  
Catherine Stout 188  
Charles (1806-1859) 106, 188  
D. Harriet (1802-1880) 67, 188  
Elizabeth Rosa Hays 106, 188  
Emma (d. 1859) 188  
Emma (1822-1844) 188  
Frances (1750-1819) 188  
Frances (1812-1841) 67, 188  
Francis (son of George) 188  
Frank 189  
Frederick (1804-1887) 188  
Gabriela Whitlock 188  
George (d. bef. 1858) 188  
George (son of Francis) 188  
Gidele (see Marx, Klara (Gidele))  
Hanna 293  
Hannah (1820-1899) 282  
Henrietta (d. 1819) 188  
Henry Carroll (d. 1848) 188  
John L. 188  
Joseph (1772-1840) 188, 217  
Judas (1781-1876) 282  
Judith (m. 1826) 188, 218  
Klara (Gidele) 91  
Louisa (1795-1849) 188, 218  
Marie Ann Klotz 189  
Mary Cox 188  
Moses 189  
Phillip 189  
Pierre 189  
Rachel 304  
Regenia 189  
Richea Myers 188, 217  
Sallie Johnson 189  
Sally 41, 189  
Samuel (1796-1860) 188  
Samuel (1859-1888) 236  
Selina (1797-1826) 188  
Simon (Sissel) 236  
Sissel (see Marx, Simon (Sissel))  
Venie Simpson 189  
Wilhelmina (1788-1836) 188  
Wilma (b. 1888) 162  
**MASELLA**  
Bartholomew 282  
Patricia Stern 282  
**MASON**  
Catalina 220  
Frances Colquhoun 217  
Frances Colquhoun Wellford 217  
John 105  
John T. III 217  
John Tenney, Jr. 217  
Katherine Parke 217  
Mary Catherine Hays 105  
Mary Denkla 80  
Theodorus Bailey Myers 220  
**MASSE**  
Angelique 135  
**MASSEL**  
Jean Magnus 8  
Joan 8  
Lynnann 8  
Mark 8  
**MASSELL**  
Shirley 278  
**MASSY**  
Grace (1918-) 327A  
**MASTERS**  
Carrie Betts 140

**MATALES**  
Jean Leah Phillips 244  
Simon 244  
**MATEMAN**  
Ella 248  
**MATHEW**  
Eileen 105  
**MATHEWS**  
Edel 311B  
Virginia 222  
**MATHIS**  
Marion Ronsheim 3  
**MATLACK**  
Constance R. 156  
**MATSUMOTO**  
Tsungi Takeuchi 2  
**MATSUOMINA**  
Maruko 2  
**MATT**  
Bertha 239  
**MATTHEWS**  
Adele 117  
**MATTHEWS**  
Blanche Samuel 260  
Robert Edwin (m. 1888) 260  
**MAULE**  
Mae 335B  
**MAURY**  
Beatrice 224  
**MAY**  
Dorothy 46  
**MAYSON**  
Carol 259  
Dinah 181  
**MAXWELL**  
Charles R. 181, 312A, 332A  
Edward Wesley 257  
Elizabeth Emily Scheuer 181, 312A,  
332A  
Elizabeth Lynn (1943-) 312A, 332A  
John Worthen (1946-) 312A, 332A  
Lynne (b. 1946) 257  
Virginia Newland 257  
**MAXWELL (COONEY)**  
Virginia Carroll 239  
Walter Julian 239  
William Patrick 239  
**MAY**  
Ada (see Schlessinger, Ada May)  
Charles 10  
Emita Wolff 305  
Fanny 295, 305  
Josephine 305  
Lewis 305  
Rosalie Allen 10  
Sarah 75  
**MAYBAUM**  
Dorothy 295  
Florence Tim 295  
Jack 295  
**MAYBIN**  
Margaret 93  
**MAYCOCK**  
Alan 2  
Enid Lewia 2  
Jill 2  
**MAYER**  
Abby Ancker 11, 190  
Adelaide 189  
Adele 235  
Adele Mayer 235  
Adele Wolff 8  
Adeline Hackenburg Teller 92  
Adolph Henry (1827-1869) 190, 338A  
Alfred (1861-1940) 92  
Anne M. (see Mayer, Emma Kass  
(Anne M.))  
Arthur P. 190  
Augusta Kyle 190  
Benjamin 189  
Bertha Block 25, 190  
Bessie 11  
Bessie Gwendolyn Herzberg 229, 335,

Betty 20  
Carrie (Caroline) 189  
Catherine 20  
Cathy Ann (1955-) 335A  
Charles E. 3, 190  
Clara 190  
Claude 2  
Clementine 189  
Cornelia Poor 68  
David B. 282, 339B  
Dene Stern 282, 339B  
Edgar S. 190  
Edmonia 190  
Edmonia Toney 190  
Edward (son of Elias) 190  
Edward (son of Louis H.) 190  
Edwin 249  
Eleanor Louisa (Ella) (b. 1860) 189,  
312A  
Elias (1795-1886) 11, 190  
Elizabeth 171  
Ella (see Mayer, Eleanor Louisa  
(Ella))  
Emma 189  
Emma Kass (Anne M.) 249  
Emma Roos 189  
Fannie Abrahams 190  
Fanny Abraham 3, 190  
Fanny M. (b. & d. 1854) 68  
Fanny M. 68  
Felice 20  
Florence Buchanan 190  
Frances Poor 68  
Frances Solomons 247, 277  
Frieda 320B  
Gertrude 143  
Harriet 24, 190  
Harry Albert (1927-) 335A  
Hennie 189  
Henry 190  
Henry Clay 190  
Herbert (1889-) 190  
Herbert J. (1901-) 334B  
Herman (d. 1928) 22  
Hetty Adelia 2, 190  
Hilda Marie 261  
Ida Katherine Bernheim 20  
Ionie Poor (b. 1851) 68  
(Jacob) John (1806-1882) 189  
Jeanette Reis 189  
Jennie Rosenbach 22  
Joan 16  
John S. 190  
John, Jr. 189  
Joseph Eggleston Johnson (b. 1822)  
189, 312A  
Josephine Bomeisler 26  
Julia (1847-1925) 26  
Julia Moss (b. 1876) 20  
Juliet 190  
Kate (dau. of Adolph H.) 190  
Kate (m. Rolly Jones) 20  
Katharine (1847-1923) 26  
Laura Schwed 190  
Laurence L. 247  
Lazarus 26  
Leo Adolph 190  
Leonard Bernard (b. 1874) 20  
Lillian M. Phillips 249  
Linda Gwen (1959-) 335A  
Lisa Dene (1958-) 339B  
Louis Alexander 190  
Louis H. 190  
Louise 16, 321A  
Mae 189  
Mary Jane 247  
Mary Terry Kyle 190  
Maurice 189  
Melanie 189  
Millicent 190  
Minnie (1849-1915) 26  
Morris (from Berlia) 235  
Morris (from Hanover) 235

Morris (son of S. Bernard) 20  
Morris S. 9  
Ophelia (dau. of John) 189  
Ophelia (dau. of Simon) 189  
Oscar Solomon (1850-1854) 26  
Peter Lee (1960-) 339B  
Phineas M. 25, 190  
Raphael 277  
Rebecca 235  
Rebecca Teller (b. 1893) 92  
Richard 20  
Richard, Jr. 20  
Rosa 190  
Rosa Adelaide Philipson 190, 338A  
Rosa Goldsmith 21  
Rosalie 143  
Rose Abraham 2  
Roslyne 190  
S. Bernard (d. 1926) 20  
Sandra Goldberg 335A  
Sara 190  
Sarah Gertrude Oppenheim 235  
Sarah Henry Solomon 247  
Simon 189  
Susana 16  
Theresa 189  
Therese (1867-1930) 306  
Walter Scott (son of Adolph Henry)  
190  
Walter Scott (son of Leo Adolph) 190  
William 21  
**MAYERSFIELD**  
Gail (1959-) 328A  
Irving 328A  
Judith Lee Lechtman 328A  
Mark 328A  
**MAYHOFF**  
Amelia Levy 159  
Bernard 26  
Charles (1852-1923) 159  
Edith Brandon 26  
Moaroe (1897-1941) 159  
Virginia (b. 1892) 159  
**MAYNARDIER**  
Sally Sandford 200  
**MAYO**  
Adeline (b. 1842) 188  
Adelinae Marx 188  
Arthur R. 188  
Edward 188  
Edward Carrington (d. 1852) 188  
Edward Carrington (m. Kate Harris)  
188  
Emma Carrington 188  
George W., Jr. 188  
George Washington 188  
Harriet Etting 188  
John 188  
John W. 37  
Josephine 188  
Julia Cabell 188  
Kate 188  
Kate Harris 188  
Lewis Randolph 188  
Lottie 174  
Louisa 188  
Louisa Allen 188  
Louisa Randolph 188  
Maria 188  
Mary Johnson (Jackie) Stockard 333A  
Robert Randolph 188  
Roberta Davis Ogg 37  
Sarah 188  
Sarah Wise 188  
William 333A  
William Carrington 188  
**MAYSOR**  
David (d. 1780) 44  
Rebecca (1777-1852) 44, 119, 120  
Sarah Da Costa 44  
**MAZERAT**  
Rita Louise 199  
**MAZONOWICZ**

Douglas H. 314A  
Susan Warme Sulzberger 314A  
**MC ALLISTER**  
Edith 116  
Hall 116  
James Ray (Jimmy) 173  
Louise Hermann 116  
Mary (Miriam) 11  
**MC ALPIN**  
Adelaide R. 158  
**MC BEE**  
Martha Turner (-1952) 333B  
**MC BLAIR**  
Alexander McDonald (b. 1850) 156  
Alice (b. 1852) 156  
Alice (dau. of William) 156  
Alice Switzer 156  
Alicia (1845-1855) 156  
Alicia Thompson (1806-1833) 156  
Andrew Jackson (b. 1852) 156  
Augusta Gadsby 156  
Augustus (1816-1817) 156  
Caroline (1860-1862) 156  
Charles Henry 156  
Charles R., Jr. (b. 1888) 156  
Charles Ridgely (b. 1849) 156  
Charles Ridgely (1848-1879) 156  
Duncan (1841-1867) 156  
Elizabeth Campbell (b. 1818) 156  
Emily Augusta (1822-1900) 156  
Eugenia 156  
Fanny Duncan 156  
Florence Parr 156  
George Myers (b. 1850) 156  
Harry (1855-1856) 156  
John Gadsby (b. 1836) 156  
John H. Jr. (b. 1843) 156  
John Hollins (b. 1812) 156  
Julia Ten Eyck (b. 1847) 156  
Louisa Pleasance (b. 1846) 156  
Lyde Goodwin (b. 1802) 156  
Lyde Goodwin (1804-1860) 156  
Margaret (b. 1843) 156  
Mary Pleasance (b. 1849) 156  
Mary Walsh 156  
Mathilde Loockerman 156  
Michael (ca. 1776-1861) 155, 156  
Pleasance Goodwin 155, 156  
Pleasance Maria (b. 1819) 156  
Robert Walsh (1848-1874) 156  
Samuel Marx (b. 1856) 156  
Thomas Parkin (1810-1857) 156  
Virginia (dau. of William) 156  
Virginia (m. 1870) 156  
Virginia Gadsby 156  
Virginia Hartstone (b. 1863) 156  
Virginia Myers 156, 218  
William (b. 1848) 156  
William (1807-1863/5) 156, 218  
**MC BRIDE**  
Charles 26  
Josephine Bomeisler 26  
**MC BURNEY**  
Bridget 158  
Helen Dorothy Moran 158  
Malcolm 158  
Norma 158  
**MC CABE**  
Celene C. 230  
**MC CALLAN**  
Hannah 335B  
**MC CANN**  
Matia E. 174  
**MC CARTHA**  
Camille C. Peizotto 240  
Harry 240  
Harry Cohen 240  
**MC CARTHY**  
Mary Jane Riesenfeld 111, 310A  
Vincent P. 310A  
**MC CAULEY**  
Anna Serena 256  
George Marion 256

Janie Russell Gustin 256  
 William Francis 256  
**MC CAUSLAND**  
 Gertrude Fisher 168  
 Marcus 168  
 Nellie 168  
 Ross 128  
 Ruth Roberta Robinson 128  
**MC CLELLAN**  
 Edith Maud 105  
**MC CLELLAND**  
 Florence 188  
**MC CLENAHAN**  
 Jane Dorcas 205  
 John L. 118  
 John S. 118  
 Rita S. Bullitt 118  
 Susan S. 118  
**MC CLOUD**  
 Dorothy Levy 166  
 William C. 166  
**MC CLURE**  
 Alexander K. 87  
 Cora Gratz 87  
 Eliza J. 45, 322B  
**MC COMAS**  
 Sarah 158  
**MC COMMON**  
 Mary Nettie Sheftall 270  
 Thomas Jefferson 270  
**MC CONNICK**  
 Kate 70  
**MC CORD**  
 John 276  
 John Samuel 276  
 Sarah (Sally) Solomons 276  
 Thomas 276  
 William King 276  
**MC CORKLE**  
 Minnie 268  
**MC CORMICK**  
 Elvie Isabell Carson 180  
 Gus 180  
**MC COY**  
 Anna Pearl Stone 237  
 Dan W. 237  
**MC CRARY**  
 Ruth 171  
**MC CRAY**  
 Sherry Lynn 53  
**MC CULLEY**  
 Florence 52  
**MC CULLOUGH**  
 Mary 298  
**MC CUTCHERON**  
 Betty Elizabeth 37  
**MC DAVID**  
 John Royal 4  
 Lee Horton 4  
 Rita Laura Horton 4  
**MC DONALD**  
 Louise 196  
 Matilda C. 157  
**MC DONNELL**  
 Beverly R. 288  
**MC DONOUGH**  
 Henry 140  
 Julia Raymond 140  
 Louis R. 140  
**MC DOWELL**  
 E. 257  
**MC ELHENEY**  
 Carol Davis 48  
 Eve 48  
 John Vern 48  
 Thomas Owen 48  
 William Alson 48  
**MC ELVEEN**  
 Henry Moody Jr. 84, 164  
 Mary Alice Kohn 89  
**MC GEE**  
 Edward 201  
 Josephiae Mordecai 201

Ruth 48  
**MC GILL**  
 Alice Hyneman 123  
 William R. 123  
**MC GILVRA**  
 Virginia 133  
**MC GLASHAN**  
 Anne Willis Mendes-Seixas 168  
 Peter 168  
**MC GREGOR**  
 Jessie Louise 199  
**MC GUNAGLE**  
 Edith C. Levin Gant 233  
 John 233  
**MC HARG**  
 Katherine Van Allen 36  
**MC ILRANEY**  
 Elizabeth 206  
**MC INDOE**  
 Charles 195  
 Charles Leslie 195  
 Philah Augusta Moise 195  
**MC INTOSH**  
 Alma De Leon Merrill 55  
 Daisy 66  
 James Lucas 55  
**MC KAY**  
 Edgeworth 195  
 Josephine Banks 270  
**MC KEE**  
 Annie 325B  
 Dorothy M. 129  
 Frances 94  
 Frank 129  
 Jessie Randolph Tobias 299  
 John 129  
 Margaret Eleanor 299  
 Lucy Stone 205  
 Randolph (b. 1944) 229  
 Randolph Lowe 299  
 Ruth 129  
 Samuel 129  
 Samuel, Jr. 129  
 Susan Elizabeth 299  
 Thomas 299  
 Thomas Lowe 299  
**MC KENNA**  
 Helen 5  
**MC KENNEY**  
 Arabella D. Wise 106  
 Elizabeth 106  
 Hays 106  
 James 106  
 Jane Hays 106  
 Marion Sims (b. 1877) 106  
 Richard James (b. 1827) 106  
 Samuel Tompleham (1800-1835) 106  
**MC KENZIE**  
 Elaine 327A  
**MC KESSON**  
 Catherine Lawrence 232  
**MC KIMMIE**  
 Christine Elizabeth 138  
**MC KNIGHT**  
 George 133  
 Isabel Taylor 133  
 Miriam 133  
**MC LAUGHLIN**  
 Jean 127  
**MC LEAN**  
 Frances 108  
**MC LEARY**  
 Hallie 180  
 Sallie Janette Willis 180  
**MC LEOD**  
 Augusta Samuel 261  
**MC LIED**  
 Madge 171  
**MC LORY**  
 Flora Montefiore 115  
 Sidny 115  
**MC MAHON**  
 Jan Ann Moise 196

John Terence 196  
 Lorette 237  
 Muriel 192  
 Nettie Davis Menken 192  
**MC MANNUS**  
 Augusta Myers Stern 281  
 Edward Davenport 281  
**MC MANUS**  
 Berenice Harby 207  
 Margaret 298  
 W. 207  
**MC MILLAN**  
 Howard Osgood 176  
 Howard, Jr. (b. 1919) 176  
 Irene Lopez 176  
 Patricia Anne (b. 1923) 176  
 Virginia (b. 1917) 176  
**MC NAMARA**  
 Mary Lawe 83  
 Thomas M. 83  
**MC NAMEE**  
 Valerie 296  
**MC NEAL**  
 Linda May 238  
**MC NEEL**  
 Lola Kokernot 146  
 P. J. 146  
 P. J., Jr. 146  
**MC NULTY**  
 Dora Irene Harper Brown 213  
 James Martin, Jr. 213  
**MC NUTT**  
 Joan Sturhahn 30  
 Marshall 30  
**MC SWAIN**  
 Jeannie Baker 205  
 Jennie Baker Anderson 205  
 Lucy Stone 205  
 William Campbell 205  
**MC SWEENEY**  
 Mary 231  
**MC VEA**  
 Belle 328B  
**MC VEE**  
 Mattie (see McBee, Martha Turner)  
**MC WILLIAMS**  
 Arthur E. 268  
 Georgia Nathans Sheftall 268  
**MEAD**  
 Barbara 264  
 Edward W. 264  
 Esther Hays 325A  
 Fanny Florance 74  
 Florence 74  
 Helen 264  
 Hulda 325A  
 Nehemiah 325A  
 Selina Brandon Seixas 264  
 Spencer 74  
**MEADE**  
 Charlotte Williams 201  
**MEANS**  
 J. D. 322B  
 Jessie, Davega (1868-) 322B  
**MEARES**  
 Fannie Taylor Boykin 133  
 Thomas 133  
**MEARS**  
 Catherine (Caty) (b. 1735/6) 190, 217  
 Elkaleh (Joyce) 190, 217  
 Grace (1694-1740) 104, 154, 190  
 Grace (1742-1817) 165, 190  
 Hannah (d. 1745) 120  
 Hannah Robles 190  
 Jacob 190  
 Jochabed Michaels 190, 193  
 Joy (Tabitha) Franks 190  
 Joyce (Elkaleh) (1737-1824) 190, 217  
 Judah (d. 1762) 190, 193  
 (Judith) Rachel (1747-1819) 120, 190  
 Rebecca 120, 190  
 Sampson (ca. 1670-Ca. 1711) 190  
 Samson (d. 1786/7) 190

Sarah 190, 272  
 Tabitha 28, 190  
**MEDCALP**  
 Patricia (1945-) 340B  
**MEEKS**  
 Edward, Jr. 85  
 Esther Gomez 85  
**MEGREMIS**  
 David Peter 238  
 Joyce Janet Mabel Anderson 238  
 Laura Anne 238  
 Lydia Key 238  
 Peter Lambros 238  
**MEINEL**  
 Betty Jane 72  
**MEINHARD**  
 Alice 255  
 Amelia Rosenheim 255  
 Isaac 255  
**MEIR**  
 Denis, Baron De Vahl 261  
 Frank, Baron De Vahl 261  
 Henrietta Esther Salomons 261  
 Naphtali 261  
 Naphtali Hirsch 261  
**MEISTER**  
 Clarence H. 143, 327B  
 Jennie Greenebaum 143, 327B  
 Lorraine (1913-) 327B  
**MELASKY**  
 Frances 247  
 Harris (m. Helen McDonald) 247  
 Harris (m. 1880) 247  
 Helen McDonald 247  
 Lola S. 247  
 Maude 247  
 Zipporah Henricks 247  
**MELDOLA**  
 Rebecca (Rica) 60  
**MELLOR**  
 Jessica De Sola De Pass 60  
 John 60  
**MELNICOVE**  
 Gertrude 63  
**MELTON**  
 Henrietta 84  
 Mary Nel 167  
 Netta (Henrietta) Loeb 84  
 William D. 84  
**MELTZER**  
 Jean Sulzberger 291  
**MELVORN**  
 Hugh 327A  
 Jeffrey 327A  
 Lois H. 327A  
 Richard 327A  
**MEMMERT**  
 Aline 310A  
 Maude Hart 97, 310A  
 Otto 97, 310A  
**MENACHEM BEN MICHAEL**  
 ---59  
**MENAL**  
 Margaret Priscilla 261  
**MENCKEN**  
 Sally Adela Andrews 12, 192  
**MENDEL**  
 Edith 283  
 Georgia Ann (1857-1919) 313A  
 Malka Menachem (-1646) 324B  
 Menachem (1520-1599) 324B  
 Perla Sheftall Russell 313A  
**MENDELSON**  
 Eileen Brown 122  
 Lionel 122  
 Meta 15  
 Rita Gould 122  
 Sabina 125  
**MENDELSSOHN**  
 Barbara 3  
 Elizabeth ("Betty") Abraham 3  
 Gertrude Bloomingdale 24  
 Harry 3

Steven 3  
**MENDENHALL**  
 Janice Kay 333B  
**MENDES**  
 A (Braham) Piza (1894-1976) 191  
 Abigail 191  
 Abraham (Bram) 191  
 Abraham (son of Jacob P.) 191  
 Abraham (son of Samuel Pereira) 175, 191  
 Abraham O. (nat. 1750) 191  
 Abraham Pereira (son of Leah) 175, 191  
 Abraham Pereira (1825-1893) 60, 191  
 Adam Piza 191  
 Aijr Elizabeth 191  
 Allen 191  
 Alma (dau. of Frederick) 191  
 Alma 191, 332B  
 Alvin Piza, Jr. 191, 332B  
 Ann 338B  
 Ann Piza 191  
 Arthur 191  
 Babette 191, 332B  
 Barbara 60  
 Bram (see Mendes, Abraham (Bram))  
 Branca (Rachel Da Silva) 273  
 Calico (1973-) 333A  
 Carol 191  
 Catherine (Sarah) Lopez 175, 191  
 Daniel (b. 1755) 191  
 Daniel (son of Samuel) 191  
 David (d. 1849) 191, 333A  
 David (son of Daniel) 191  
 David (son of Samuel) 191  
 David (1860-1932) 191, 333A  
 David De Sola (1860-1932) 333A  
 David Martin (1888-) 333A  
 David Pereira (1740-1786) 191  
 Dora 191, 332B  
 Dorothy Belais 60, 191  
 Edith 191  
 Edith Fidele Wise 191  
 Eliza De Sola 60, 191  
 Estelle 191, 333B  
 Esther (dau. of Samuel) 191  
 Esther (m. Jacob P.) 191  
 Eva Levy 18, 309A, 312A  
 Florence 191  
 Francis 191  
 Frank 191  
 Frederick De Sola (1850-1927) 38, 191, 333A  
 Grace 191  
 Grace De Castro 61, 191  
 Haim 191  
 Hannah 191  
 Harold 191  
 Heber Piza (b. 1891) 191  
 Helen Levy 191  
 Henry (Hiam) Pereira 191  
 Henry 191, 333A  
 Irma 191  
 Isaac (b. 1726) 191  
 Isaac (b. 1750) 191  
 Isaac (b. 1785) 191  
 Isaac (son of Abraham) 191  
 Isaac (son of Leah) 191  
 Isaac (son of Samuel) 191  
 Isaac Philipe (1853-1904) 61, 191, 332B  
 Isabel Cohen 38, 191  
 Jacob (bro. of Samuel) 191  
 Jacob (son of Abraham) 191  
 Jacob P. 191  
 Jesse 191  
 John (1948-) 333A  
 Jonathan (b. 1946) 191  
 Jonathan 191, 333A  
 Jonathon 60  
 Joseph (son of Isaac P.) 191, 333A  
 Joseph (son of Isaac) 191  
 Joseph (son of Leah) 191

Joseph (son of Samuel Pereira) 191  
 Joy 191, 333A  
 Judith 191  
 Julia 191  
 Leah 191  
 Leah Chuck 191, 333A  
 Leonard P. (1862-1943) 60, 191  
 Luna Julia 191  
 Margaret Leland 333A  
 Margot 191  
 Marguerite Rachel 191  
 Maria 191  
 Marian De Sola Levine 191  
 Marjorie Gang 333A  
 Mary Ellen Rosenbluth 333A  
 Meredith 191  
 Mildred Bertuch 191  
 Mildred Straus 191  
 Mina 191  
 Nellie 191  
 Noni Schneider 191  
 Norah Schneider 60  
 Patricia (1955-) 333A  
 Peggy Dee 191  
 Petra Watson 333A  
 Rachel 191  
 Raymond 191  
 Rebecca (m. Philip Benjamin) 18, 309A, 321A  
 Rebecca 191  
 Rebecca De Sola (see Mendes, Rica (Rebecca) De Sola)  
 Rebecca Hannah 191  
 Reva Rothenberg 191  
 Rica (Rebecca) De Sola 60, 191  
 Rica 191  
 Rica Miriam De Sola 191  
 Richard (b. 1921/2) 60, 191  
 Richard (b. 1938) 191  
 Rosalie Lopez de Samuel Piza 191  
 Rosetta (1859-1943) 60, 191  
 Ruth 191, 333A  
 Ruth Wasser 191  
 (Samuel) Pereira (m. Dorothy Belais) 60, 191  
 Samuel (b. 1776) 191  
 Samuel (son of David) 191  
 (Samuel) Pereira (m. Leah) 191  
 Solomon 18, 309A  
 Stella (dau. of Abraham) 191  
 Stella (dau. of David) 191  
 Susie 191  
 Suzanne 191, 333A  
 Vera 191  
 William (1956-) 333A  
 Zipporah 191, 333A  
**MENDES DA COSTA**  
 Jonathan 171  
 Moses (Philip) 338B  
 Rachel (-1789) 338B  
**MENDES-SEIXAS**  
 Adolphus (1809-1825) 168  
 Angelina 168  
 Anne Willis 168  
 Benjamin 168  
 Edward (son of Edward) 168  
 Edward (1799-1871) 168  
 Hulda S. Smith 168  
 Jacob (1759-1821) 168  
 Moise (1751-1817) 168  
 Rachel Levy Phillips 168  
**MENDEZ**  
 Anna De Antonio (Rachel Mendez Da Costa) 258  
 Sarah 112  
 Serena (1840-1889) 130  
**MENDOZA**  
 Florence Myers Hecht 107, 222  
 Louis D. 222  
**MENICE**  
 Alex 17  
 Catherine O. Baruc 17  
**MENKEN**

Ada Fuertes 192  
Adah Theodore (Adah Isaacs) 192  
Alexander Isaac 192  
Alice Gertrude Davis 48, 192  
Amelia (b. 1841) 192  
Arthur Von Briesen 192  
Catherine (Kate) (1874-1901) 171, 192  
Cordelia (b. 1850) 192  
Cornelia Rhine 192  
Galatbe (b. 1871) 171, 192  
Galatbe Morange 192  
Gertrude Micholl Davies 47, 192  
Gretchen Von Briesen 192  
Harold Davis (b. 1895) 192  
Harriet Sinton 192  
Jacob S. 102, 192  
Josephine Rosina (b. 1875) 192  
Jules A. (b. 1899) 192  
Jules A. (1836-1890) 192  
Kate (see Menken, Catherine (Kate))  
Kenneth 192  
Lucille 192  
Marihyn (b. 1924) 192  
Mary Scott 192  
Mortimer M. (1867-1930) 48, 192  
Nathan 192  
Nathan Davis (1837-1878) 12, 192  
Nathan Davis, Jr. (d. 1922) 192  
Nattie Davis (b. 1880) 192  
Percival Solomon (1865-1908) 47, 192  
Rachel (Ray) Hart 102, 192  
Ray 192  
Ray Hart (see Menken, Rachel (Ray) Hart)  
Rosina (b. 1824) 192  
Samuel Stanwood (b. 1870) 192  
**MENKEN (DAVIS)**  
Solomon (1787-1853) 192  
**MERCADO**  
See De Mercado  
**MERCER**  
Edward Clifford Anderson 156  
Josephine Payton Freeland 156  
**MERCHANT**  
Ruby 208  
**MERCIER**  
Caroline Amelia 270  
**MEREDITH**  
Eva Newhouse 231, 335A  
Katherine (b. 1916) 140  
Nelley Atkin Keyser 140  
Sam 231, 335A  
William M., Jr. (b. 1919) 140  
William Morris 140  
**MERETINIA**  
Per Werner Heyman 228  
Ripon 228  
Tapiian 228  
**MERIT**  
Edna 160  
Grace 160  
John Joseph 160  
Rose Isaacs 160  
Vincent 160  
Vincent, Jr. 160  
**MERRICK**  
Edwin Thomas (1859-) 329B  
Edwin Thomas (1892-1907) 330A  
Katherine Lewis 329B  
Katherine Lombard (1897-1904) 330A  
Laura (1890-1969) 329B  
Susan Brewer (1893-) 330A  
**MERRILL**  
Alma De Leon 55  
Barbara Weiss 288  
David R. 288  
Eleanor Judah 140  
James V. 288  
Joseph B. 288  
Lita Saunders Levy 164  
Louisa 140  
Nathaniel Jewett 248  
Ralph Howard 55

Robert S. 288  
Rosina Phillips 248  
Walter Scott 164  
**MERRIMAN**  
Sheila Jeanne 261  
**MERRIMON**  
Augustus Summerfield 198  
Jessica Davis Moise 198  
**MERRITT**  
Fidelia 168  
**MERTON**  
Amelia Nathan 228  
**MESQUITA**  
See also De Mesquita  
Abigail 112, 113  
Rachel 134  
**MESSING**  
Abraham J. 11  
Alan J. 11  
Florence Schwabacher 11  
**METZENBAUM**  
Louise 102  
**METZGER**  
Carole Wallack 108  
Edith 8  
Elsa Claire 148  
Jennifer Anne 108  
Lu Ries Lowenberg 108  
Nathan 108  
Nathan III 108  
Nathan, Jr. 108  
Pamela Ries 108  
Rebecca Rea 108  
Susan 108  
**MEUNIER**  
Vivian Frances 196  
**MEYER**  
Adele 286  
Adolph 136  
Alfred (b. 1854) 227  
Annie Florance Nathan 227  
Bertha Franziska 238  
'Bobbie' Wheatley (see Meyer, Esther ('Bobbie') Wheatley)  
Camille Pauline 236  
Catherine 36  
Cecilia Marie Russell (b. 1929) 313A  
Claia Phillips 249  
Dene 72  
Eda Hirschfield 235  
Edith 235  
Emil J., III 235  
Emil Joseph 235  
Emil Joseph, Jr. (d. 1930) 235  
Emily 235  
Emily Frederika Oppenheim 235  
Esther ('Bobbie') Wheatley 125  
Henriette 292  
Isaac 249  
Joan 235, 337B  
Joan Rosen 337B  
Kate 149  
Leonard Julian (d. 1949) 313A  
Lucille 286  
Margaret M. 34  
Marjorie 287  
Mary Phillips 249  
Matilda Rebecca 235  
May Bernice 125  
Miriam Blumenfeld 235  
Mollie 237  
Morris 36  
Priscilla 102  
Robert Allan (b. 1954) 125  
Rosalie 34, 249, 322A  
Rosalie Jonas 136  
Sarah Cohen 36  
Sigmund T. 249  
William J., Jr. 125  
William John 125  
**MEYERS**  
See also Myers  
Andrew Lee 202

Catherine Cohen 32  
Charles D. (1813-1884) 32  
Elizabeth Jones 327B  
Ernest (1919-) 327B  
Essie Levy 167  
Ethel Aischuler 327B  
Fredrick (1917-) 327B  
Gail 202  
Hannah 124  
Herbert 327B  
Katherine Lee 202  
Linda Henly 327B  
Meyer 167  
Milton (1882-) 327B  
Miriam C. (1873-1900) 32  
Morton, Jr. 202  
Rebecca Kayton 327B  
Richard (1923-) 327B  
Rosalie 280  
Rose (1884-) 327B  
Sigmund 327B  
Simona Baruch 17  
Thomas 202  
**MEYERSBERG**  
Adolph 236  
Regina (Rachel) Oppenheimer 236  
Rose 236  
**MEYLER**  
See also Mailert  
Amos 184  
Charles Lucius 184  
Jacob 184  
Michael 184  
S. 184  
**MICHAEL**  
Barbara Siegel 278  
Cecil (b. 1919) 278  
Cecilia Moses Solomons 278  
Elias 286  
Isaac 174  
Lena 174  
Lloyd David 278  
Max (m. 1911) 278  
Max III 278  
Max, Jr. (b. 1916) 278  
Noma Arnheim 174  
Patricia Ann Middlemas 208  
Paul Ramsay 278  
Rachel Stix 286  
Robert Oliphant 278  
Robert Steele 208  
Selma (1887-1894) 286  
Simon (1922-1944) 278  
Thomas D. 208  
William (b. 1871) 174  
**MICHAELIS**  
Adele (b. 1850) 136  
Bertha Joachimssen 136  
Branlah (b. 1852) 136  
Elietzer (Ludwig) (b. 1863) 136  
Henrietta Julia (b. 1845) 136  
Isabella (1858-1911) 136  
Joanna (1846-1912) 136, 253  
Julius (1841-1912) 136  
Ludwig (see Michaelis, Elietzer (Ludwig))  
Morris (1811-1883) 136  
Philip (1857-1860) 136  
Rebecca Alice (b. 1877) 136  
Sara Elizabeth (1848-1929) 136  
Sara Elizabeth Michaelis 136  
**MICHAELS**  
Amy Benjamin (b. 1913) 193  
Blume 179  
Carol (see Michaels, Emma Caroline (Carol))  
Catherine Hachar 193  
Sigmund T. 249  
Dorothy Rebecca (b. 1915) 193  
Emma Caroline (Carol) (b. 1910) 19  
Eibel Muriel Hart 95, 193  
Fayle (b. 1762) 104  
Frances (Fanny) David 46, 104, 323,

Jochabed 190, 193  
John 193  
John Lewis 193  
Levy (1723-1815) 104  
Michael (d. 1736/7) 193  
Michael A. (b. 1882) 95, 193  
Moses (1677-1740) 193  
Myer (1760-1815) 46, 104, 323A  
Rachel (1690-1732) 154, 193  
Rachel (1707-1749) 193, 223  
Rachel Hays 104  
Rebecca (b. 1766) 104  
Rebecca (d. 1801) 104, 193  
Richea (Rycha) (d. 1716) 154, 193  
Sarah Misell 193  
**MICHAELSON**  
Helen Grace 65, 323B  
**MICHAL**  
See Michaels  
**MICHOLI**  
Abraham (b. 1837) 280  
Esther Isaacks 127  
Hetty 127  
Louisa 47, 127  
Maria 127  
Morland 127, 280  
Rachel 127, 280  
Rebecca Soria 127, 280  
Sarah 280  
Yitta 120  
**MICKLE**  
Elizabeth (b. 1852) 68  
Elizabeth Eting 68  
Etting (b. 1801) 68  
Fanny (b. & d. 1854) 68  
John (1796-1819) 68  
Robert 68  
Robert III (b. 1851) 68  
Robert, Jr. (b. 1798) 68  
Sally (b. 1803) 68  
Shinah (1809-1819) 68  
William (1800-1816) 68  
**MIDDLECOFF**  
Flora Marshall 25  
**MIDDLEMAS**  
Patricia Ann 208  
Robert Steele 208  
Rosalie Weinberg 208  
**MIDDLETON**  
Cora Estelle Nathans 230  
Frank 311B  
Mary (Mollie) 311B  
Wetherill 230  
**MIERSON**  
Augustus 18  
Jane Levin 18  
Sally 18  
**MIKAL**  
See Michaels  
**MIKELL**  
Emily 205  
Frank 205  
Franklin (son of Franklin) 205  
Franklin (son of Thomas P.) 205  
Harry (see Mikell, Henry (Harry) Judah)  
Henrietta (dau. of Franklin) 205  
Henrietta (dau. of Henry (Harry)) 205, 333B  
Henrietta Campbell Bryan 205, 333B  
Henry (Harry) Judah 205, 333B  
Jane 205, 333B  
Lucy Trezvant 205  
Martha Turner McBee 333B  
Mary 205, 333B  
Mattie McVee 205  
Nancy 205  
Nannie Haas 205  
Rebecca Moses 205, 333B  
Thomas (son of Thomas P.) 205, 333B  
Thomas (son of William E.) 205  
Thomas P. 205  
William 205, 333B

William E. 205, 333B  
**MILES**  
Alice Calder 329A  
Carabel 258  
Charles Edward (b. 1837) 68  
David Rhys (1950-) 329A  
Edward Mickle (b. 1843) 68  
Elizabeth (b. 1826) 68  
Elizabeth (1824-1826) 68  
Fred B. (b. 1835) 68  
George H. (b. 1824) 68  
Joel Edward (1952-) 329A  
Josepha Mickle (b. 1847) 68  
Mary (b. 1839) 68  
Prudence Ann (1954-) 329A  
Robert (1831-1839) 68  
Robert Edward III (1922-) 329A  
Robert Mickle (b. 1841) 68  
Sally Mickle 68  
Stuart Calder (1956-) 329A  
Ward Clarkson 329A  
William (m. 1823) 68  
William, Jr. (1828-1830) 68  
**MILEY**  
John David 200  
John David, Jr. 200  
Nancy Coadit 200  
Sally Maynadier 200  
Sara Hays Mordecai 200  
William Maynadier 200  
**MILHADO**  
Benjamin 58  
Clara (d. 1878) 53  
Hannah (Ann De Pass) 58  
Sarah 58  
**MILIUS**  
Dorothy (b. 1894) 287  
Evelyn (b. 1887) 287  
George 287  
Heien Dinah (b. 1896) 287  
Pauline Stix 287  
William Stix (b. 1889) 287  
**MILK**  
AJ 328A  
Benjamin L. (1938-) 328A  
Hattie Fuld 328A  
Henrietta Lechtman 328A  
Rosale Berg 328A  
Richard H. (1942-) 328A  
**MILKMAN**  
Edith Hirsch 245  
Emilie Schiele 245  
Evelyn Phillips 245, 338A  
Howard L. Jr. 245  
Howard Louis (b. 1911) 245  
Jean Kingsland 245  
Jerome Frederick 245  
John (b. 1910) 245  
Linda 245  
**MILLER**  
Adele Marie Moses 207, 333B  
Alice 290  
Alice Meinhard 255  
Allen 290  
'Annie' (see Miller, Helen ('Annie'))  
Benjamin 322B  
Caroline 239  
David Clarence 52  
Dorothy Nones 335B  
Ellen Michael 207, 333B  
Evelyn Alice Silver 191  
Evelyn Graham 245  
Fannie 133  
Florence 293  
Gilbert H. 144  
Gustave 255  
Harvey E. 147  
Hattie 63  
Helen ('Annie') 130  
Isaac Jay 290  
Jack Kenneth 207, 333B  
Jamie Lisa (1980-) 333B  
Jessie Constance Kursbeedt 147

Jonathan Lyon Mendes 191  
Judith Matilda 191  
Katherine Bacbe 144  
Lois 52  
Lucille 255  
Manuel 191  
Minnie Pernela 52, 53  
Miriam Pollock 290  
Mitchell N. 207, 333B  
Mitchell N., Jr. 207  
Nancy Ruth Nunez 337A  
Paula Shuchat 191  
Phoebe 126  
Ronita De Cordova 52  
Ruth 24  
Ruth Good 290  
Ruth Margaret 118  
Sally 290  
Shelley Russia 333B  
Stephen 337A  
Susan Ellen 253  
Susan Seligsberg Galef 322B  
Tracy Dawn 52  
Walter Parker 335B  
**MILLHISER**  
Amy Fox 27  
Charles II 27  
Claire June 27, 70, 222  
Joseph 27  
Mildred 27  
**MILLIGAN**  
Darah Gough Carroll 158  
Elise 158  
George Baldwin (1825-1889) 158  
John Jones (b. 1862) 158  
John Jones (m. 1820) 154, 158  
Katherine 158  
Martha Elizabeth 158  
Martha Mary Ann Levy 154, 158  
Mary Levy 158  
Robert 158  
Sophia Carroll (d. 1914) 158  
**MILLIKEN**  
Cecile Isabel Guggenheimer 89  
Edward Fullerton 89  
Martha E. 157  
**MILLIN**  
Itzick 209  
**MILLINGTON**  
Gertrude 206  
**MILLS**  
Anais Gomez 86  
David 86  
Elaine Fay 86  
Juliet Theresa Gottheim 331A  
Morton 331A  
Roberta (1953-) 329B  
**MILNER**  
Willis 36  
**MILNOR**  
Betsy 81  
**MILTENBERGER**  
Alphonse 145  
Celeste Dorville 145  
Marie Celeste Amelie 145  
**MIMNAUGH**  
Ethel G. 299  
**MINDEL**  
Carolyn 340B  
**MINIS**  
Abigail (1698/1701-1794) 194  
Abigail (1775-1835) 194  
Abraham (1691/6-1757) 194  
Abraham (1778-1801) 194  
Abram (1820-1889) 74, 194  
Abram (1859-1939) 32, 115, 194  
Abram, Jr. (b. 1903) 194  
Alice 194  
Anna (see Minis, Hannah (Anna))  
Anna Maria Cohen 32, 194  
Annie 194  
Augusta Medora 194  
Carol Edward 194

Carol Eugene (1889-1953) 194  
 Carolina (b. 1928) 194  
 Cecilia (b. 1832) 194  
 Charles Spalding 194  
 David 194  
 Divinah Cohen 35, 194  
 Dorothea (b. 1940) 194  
 Dorothea Herty 194  
 Eleanor 194  
 Eliza (b. 1809) 194  
 Ellen (b. 1849) 194  
 Emily (b. 1815) 194  
 Emily Tobias 194, 298  
 Estelle Livingston 194  
 Esther (ca. 1731-1793) 194  
 Esther (Hetty) (1782/84-1864) 194  
 Eugenia 194  
 Eugenia Phillips Myers 194, 216  
 Fanny (see Minia, Frances (Fanny))  
 Florence (b. 1922) 194  
 Florence Powell 194  
 Frances (dau. of Isaac, Jr.) 194  
 Frances (Fanny) (b. 1776) 194, 216  
 Frances (Fanny) (b. 1822) 194  
 Frances (1776-1827) 194, 216  
 Hannah (Anna) (1744-1798) 194  
 Henrietta (b. 1807) 194  
 Henry Holmes (b. 1946) 194  
 Henry P., Jr. (b. 1945) 194  
 Henry Philip (b. 1908) 194  
 Hetty (see Minia, Esther (Hetty))  
 Isaac (1780-1856) 35, 194  
 Isaac (1857-1803) 194, 216  
 Isaac, Jr. (b. 1887) 194  
 Isaac Livingston 194  
 Jacob Florance (b. 1852) 194  
 James 194  
 Janet Davidson 194  
 Joseph (1738-1758) 194  
 Judith (1742-1826) 194  
 Judith Polock 194, 252  
 Kim 194  
 Lavinia Florance (b. 1864) 115, 194  
 Lavinia Florance (m. 1851) 74, 194  
 Leah (ca. 1726-1802) 194  
 Leila Livingston 194  
 Louisa Porter Gilner 194  
 Louise Cohen 194  
 Mabel Amelia Henry 115, 194  
 Margaret Mahoney 194  
 Marguerite Anne (b. 1945) 194  
 Maria (b. 1853) 194  
 Maria (1829-1853) 194  
 Mary Haskell 194  
 Minia (1736-1771) 194  
 Minna (m. August Arnsthal) 70  
 Philip (b. 1805) 194  
 Philip (Uri) (1734-1789) 194, 252  
 Philip Henry 194  
 Philip, Jr. 194  
 Philippa (1818-1881) 67, 194  
 Phillipa (1789-1865) 194  
 Rebecca Gratz (b. 1830) 194  
 Robert B. 194  
 Robert Powell (b. 1943) 194  
 Roberta Clark 194  
 Robin Adair Gans 194  
 Rosina Florance (b. 1855) 194  
 Sallie 194  
 Sally (see Minia, Sarah (Sally))  
 Samuel (b. 1740) 194  
 Sara Ann (b. 1811) 106, 194  
 Sarah (Sally) (b. 1748) 194  
 Sarah A. Livingston 194  
 Sarah Lousberg 194  
 Simeon 194  
 Simon 194  
 Susan (b. 1942) 194  
 Theodora 194  
 Theodore (1826-1850) 194, 298  
 Uri (see Minia, Philip (Uri))  
 William 194

#### MINSTER

Benjamin K. 292  
 Dorothy Kuhn 292  
 Joe 292  
 Leonard 292  
 Louise 292

MINTZ  
 Harriet Benjamin 160  
 Sylvia 40

MINZ  
 Abraham 261  
 Hannah (d. 1546) 261  
 Judah 261

MINZESHEIMER  
 Celia Adler 291  
 S. 291

MINZHEIMER  
 Julia 49

MIRANDA  
 See also De Miranda  
 Abigail 180  
 Emanuel Nunes 180  
 Esther Nunes 180, 331B  
 Jacob Nunes 26  
 Ribca Esther Nunes (see Miranda, Esther Nunes)  
 Sarah 26

MISSELL  
 Sarah 193

MITCHEL  
 Alice 81

MITCHELL  
 Amelia Johaveth 10, 193  
 Anna Amelia (1854-1921) 33  
 Anna Maria (1838-1885) 193  
 Belle 129  
 Benjamin Westley 299  
 Clarence 193  
 Cordelia Ann Hallmark 52  
 David (b. 1913) 299  
 David Earl 52  
 David Westley 299  
 Edith Winona Tobias 299  
 Eloise Maria (1850-1908) 193  
 Emma Taylor 215  
 Estelle Zillah (b. 1861) 193  
 Esther Allen 10, 193  
 Fanny Allen (see Mitchell, Frances (Fanny) Allen)  
 Flora 58  
 Frances (Fanny) Allen (1823-1893) 159, 193  
 Harriet 185  
 Helen Carney 158  
 Henry 193  
 Hermyne 206  
 Irving Abraham (b. 1864) 193  
 Jackson 129  
 John (1915-1918) 299  
 John David 52  
 John Westley 299  
 Johnny Dean 52  
 Leon (b. 1871) 129  
 Leslie 215  
 Lewis Allen (1829-1900) 99, 193  
 Lewis Allen (1851-1919) 193  
 Mabel 22  
 Maria Jackson 129  
 Maude K. 129  
 Mitchell Allen (1822-1875) 10, 193  
 Moses (1837-1885) 193, 333A  
 Myrulla Eudora Hart 99, 193  
 Naomi 129  
 Noah 129  
 Percival Allen (1873-1902) 193  
 Rebecca (b. 1825) 193  
 Rebecca Esther (1852-1916) 193  
 Rose Mankiewicz 193  
 Ruth 129  
 Susanne S. M. 254

MITTENTHAL  
 Adrienne 311B

MITTLER  
 Kiki Friedlander 65

MIZRACHI  
 Jacob (father of Palomba) 175  
 Jacob (father of Rachel) 29  
 Palomba 175  
 Rachel 29

MOALE  
 Augusta 157

MOCCATA  
 Sarah 261

MOCK  
 Annie E. 269  
 Charles W. 312B  
 Elizabeth C. Russell 312B  
 Eugene W. 85  
 Frances Gomez 85

MOCKETT  
 Douglas 296  
 Ellen Friedman 296

MODIANO  
 Daisy 6  
 Isabelle 6  
 Robert 6

MOEHLER  
 Harry 22  
 Miriam Eger 22  
 Nina 22

MOEHRING  
 Gotthilf (1802-1881) 303, 340B  
 Josephine 340B  
 Sophia Wolf 303, 340B

MOELLER  
 Elsie 9, 249  
 Frederick 249  
 Hannah 249  
 Henry (Harry) 249  
 Philip 249  
 Rachel Kate Phillips 249

MOEREL  
 Adolph 33  
 Rachel Cohen 33

MOFFAT  
 Abbot Low 55, 56  
 Anna (Nancy) Adams 56  
 Burnham (b. 1929) 56  
 Jane Kerin (b. 1931) 56  
 Marion Adams 55, 56

MOGRIAN  
 Grace 171

MOHE  
 Jane (Hanchen) Wolf 303

MOISE  
 Aaron (1783-1852) 38, 195  
 Aaron Wellborne (see Moise, Albert (Aaron) Wellborne)  
 Aaron, Jr. (1820-1880) 195  
 Abigail Louisa Lopez 176, 195  
 Abraham (d. 1809) 195  
 Abraham (1799-1869) 195, 196, 207  
 Abraham H. (1857-1861) 196  
 Abraham Hyam (1869-1941) 196  
 Abram, Jr. (1809-1852) 176, 195  
 Adele Cecile Guidry 199  
 Adolphus (see Moise, Cicero Dolphu (Adolphus))  
 Agnes (b. 1866) 198  
 Agnes (1858-1863) 198  
 Albert (Aaron) Wellborne (b. 1846) 195  
 Albert De Leon (b. 1935) 198  
 Albert L., Jr. (b. 1912) 198  
 Albert Luria (1872-1940) 198  
 Albert S., Jr. 195  
 Albert Sidney (1874-1946) 195  
 Albert Wellborne (b. 1908) 195  
 Alfred (b. 1879) 196  
 Alfred Adrian (Rudolph) 196  
 Algernon Sidney (b. 1862) 197  
 Algernon Sidney (1840-1842) 195  
 Alice Gertrude 198  
 Alice Marie 198  
 Alice Mildred Andrews 199  
 Alice Mouton 199  
 Ailyn Bernard 199

Amanda (1858-1899) 55, 196  
 Amanda Isabel Jacobs 132, 196  
 Amelia O'Neal 199  
 Anita M. Harby 198, 207  
 Ann Elizabeth Folk 196  
 Anna Mae Fischer 195  
 Anna Maria (1858-1917) 197  
 Anna T. Morris 195  
 Anne Hampton Frey 198  
 Annette 196  
 Anthony Kenneth 199  
 Audrey Marie 196  
 Audrey Marie Lemarie 196  
 Augusta Fuller 195  
 Barbara Ann 195  
 Benjamin (1790-1824) 195  
 Benjamin Claycombe (b. 1896) 196  
 Benjamin Claycombe II 196  
 Benjamin Franklin (1830-1887) 132, 196  
 Benjamin Franklin, Jr. (m. 1884) 99, 196  
 Benjamin Jules 196  
 Bessie Cornelia Neidlinger 196  
 Betty Anne 196  
 Betty Anne Garris 198  
 Bill 197  
 Blanche Agnes Claycombe 196  
 Blanche Pulliam 197  
 Caldwell 197  
 Camillus 195  
 Camillus T. (1817-1844) 195  
 Campbell 199  
 Carlyle 199  
 Caroline (b. 1861) 36, 198  
 Caroline (Carrie) 196  
 Caroline (d. 1870) 196  
 Caroline Agnes (1828-1899) 55, 196  
 Caroline Agnes (1854-1885) 176, 196  
 Caroline Agnes Moses 195, 196, 207  
 Carrie Debora (Prudy) Eck Riley 196  
 Catherine Marie 196  
 Catherine Rose Vernon 198  
 Catherine O'Malley 195  
 Cecile F. 196  
 Cecile Rosenberg 198, 289  
 Cecile Virginia 198  
 Cecilia (b. 1836) 195  
 Cecilia Blanche (b. 1903) 196  
 Cecilia Frances Moses 199, 207  
 Cecilia Francis (b. 1855) 196  
 Cecilia Woodville 199  
 Cecilia Woolf 195, 199, 205  
 Celeste Laycock 196  
 Charles (b. 1868) 198  
 Charles (son of Charles H.) 196  
 Charles Henry (Brother Ambrose) 199  
 Charles Henry (1829/30-1896) 196, 199  
 Charles Henry, Jr. (1859-1898) 196  
 Cherie (Cherry) (1781-1823) 38, 195, 205  
 Cicero Dolphus (Adolphus) 196  
 Clara Grant 198  
 Clare McCutchen 198  
 Clifford (see Moise, Howard Cohen (Clifford))  
 Clifton (b. 1881) 198  
 Colin Godfrey (Jeff) 197  
 Colleen Marie Kelly 195  
 Columbus (son of Aaron, Jr.) 195  
 Columbus (1809-1871) 164, 195, 197  
 Columbus Garnet 195  
 Columbus III (b. 1895) 197  
 Columbus, Jr. (1855-1895) 197  
 Cora Louise 197  
 Cora Washington 197  
 Cordelia (1810-1869) 39, 195  
 Cordelia S. 39, 195  
 Danie Edell Lewis 196  
 David (son of Abram, Jr.) 195  
 David (son of Charles H.) 196  
 David Calboun (1847-1887) 196  
 David De Leon 198

David Levy 196  
 Davis 198  
 Davis De Leon (b. 1880) 198, 207  
 Diana Lynn 195  
 Dora (see Moise, Theodora Gregoria (Dora))  
 Dora Alice 164, 196  
 Dorita Cecilia 84, 196  
 Dorothy Helen 195  
 Dorothy Todd 199  
 Dorothy Yost 199  
 Dulcie (see Moise, Rebecca (Dulcie))  
 Edgeworth McKay 195  
 Edith 197  
 Edith Magnolia 195  
 Edith Margaret Moore 199  
 Edith May 195  
 Edith May Campbell 195  
 Edna Josephine Lewis 196  
 Edwin 197  
 Edwin E., Jr. 199  
 Edwin Eleanor 196  
 Edwin Evariste 199  
 Edwin F., Jr. 196  
 Edwin Francis 196  
 Edwin Henry (d. 1883) 197  
 Edwin W., Jr. (1911-1944) 198  
 Edwin Warren (b. 1810/11) 176, 199  
 Edwin Warren (b. 1853) 199  
 Edwin Warren (b. 1865) 196  
 Edwin Warren (b. 1889) 199  
 Edwin Warren (1832-1902) 48, 196, 198  
 Edwin Warren (1883-1945) 198  
 Edwin Warren, Jr. (b. 1870) 198  
 Eleanor (b. 1908) 197  
 Eleanor (m. 1847) 163, 164, 195  
 Eleanor Jane (1829-1833) 333A  
 Eleanor Theresa Duffy 196  
 Eliza Virginia (see Moise, Virginia Elizabeth (Eliza Virginia))  
 Elizabeth (Elsie) 195  
 Elizabeth Clark 195  
 Elizabeth Clark Lanier 195  
 Elizabeth Parkinson 195  
 Elizabeth Scott 198  
 Ella (b. 1855) 196  
 Ella Pauline Blanding 198  
 Ellen Alice 163, 197  
 Eloisa Cuellar 196  
 Elsie (see Moise, Elizabeth (Elsie))  
 Emily Clare Mary 199  
 Emily Otilie Zempel Buck 199  
 Estell Louise Beard 195  
 Esther (Hetty) Moses 195, 205  
 Esther Lyon 48, 196, 198  
 Ethel Austin Abbot 199  
 Ethel June 199  
 Ethel McCutcheon Rainville 198  
 Eugene Edwin 195  
 Eugene Lafayette 195  
 Eugene Lafayette, Jr. 195  
 Eva Nathans 198, 231  
 Evelyn Moore 195  
 Fairfax W. 197  
 Fanny Emma (b. 1869) 55, 195  
 Fanny Emma Levy 164, 195, 197  
 Flavia Hungerford 197  
 Flora Geraldine 195  
 Flora Haskell Bon Ami 195  
 Florence Stella Hart 99, 196  
 Frances Emma 55, 197  
 Frances Munneryn White 198  
 Frances Saunders Spear 198  
 Francis Davis 198  
 Francis M. III 198  
 Francis M., Jr. (b. 1918) 198  
 Francis Marion (b. 1893) 198  
 Francis Marion, Jr. (b. 1920) 198, 289  
 Frank Vaughn 199  
 Frederic S. 197  
 Garner Hillhouse 199  
 Gaston 199

Gayle Wusthoff 196  
 Gene Dolphia 196  
 George Bel 196  
 George Lawrason 199  
 Georgie (b. 1863) 48, 198  
 Gerald Anthony 195  
 Gladys Helen Jackson 199  
 Harmon De Leon (1867-1943) 196  
 Harold (b. 1897) 198  
 Harold (m. Florence May Emanuel) 66  
 Harold (son of Isaac Randolph) 197  
 Harold (son of Marion) 198  
 Harold Alexander 199  
 Harold Edwin 198  
 Harold II (b. 1918) 198  
 Harold Milton 198  
 Harriet Louise Godfrey 197  
 Harry (1861-1912) 199  
 Harry Edward 199  
 Hattie Rosendorf 196  
 Hazel Greuber 195  
 Helen Short 195  
 Heloise Marie Gardere 199  
 Henry Lenoir 198  
 Herbert Lyndon (1861-1883) 196  
 Hettie 197  
 Hetty Lopez 176, 195, 197  
 Hetty Moses (see Moise, Esther (Hetty) Moses)  
 Howard Cohen (Clifford) 196  
 Hyam (1785-1811) 195, 205  
 Ida Maude (1871-1928) 55, 196  
 Io Leigh Bres 199  
 Irene Beggs 195  
 Irene Maie (1867-1890) 176, 196  
 Isaac (1800-1857) 176, 195, 197, 333A  
 Isaac, Jr. 197  
 Isabel Nones De Leon 55, 198  
 Jacob (1798-1837) 39, 195, 196, 333A  
 Jacob, Jr. 196  
 Jacqueline Marie 196  
 James Campbell (1849-1901) 199  
 James Campbell (1875-1936) 199  
 James D., Jr. 198  
 James De Leon 198  
 Jan Ann 196  
 Jane Edell 196  
 Jean Victor 195  
 Jeanette Ann 195  
 Jeff (see Moise, Colin Godfrey (Jeff))  
 Jefferson (1856-1860) 196  
 Jessica (b. 1876) 198  
 Jessica Davis 198  
 Jessie Louise McGregor 199  
 John Grant 198  
 John N., Jr. 197  
 John Norton 197  
 John Vernon 198  
 Joseph E., Jr. 195  
 Joseph Eugene 195  
 Joseph Russell De La Salle 199  
 Josephine Aymond 195  
 Josephine Boatner 199  
 Judith Elizabeth 197  
 Judy Blanche 196  
 Julia Augusta (b. 1835) 197  
 Julia Josephine Hereford 199  
 Julian Sidney (1834-1835) 333A  
 Julie Josephine 199  
 Julie Thibodoux 199  
 Justine Anna Tunze 195  
 Karena Ann 196  
 Kate 195  
 Kim Ilene 195  
 La Nier (Lenier) Campbell 195  
 Lafayette Aaron 195  
 Landon 195  
 Laura (b. & d. 1865) 196  
 Laura Stanley Crampton 197  
 Lawrence L. III 195  
 Lawrence L., Jr. 195  
 Lawrence Lee 195  
 Leicester 197

Lela Ephelia Fuller 195  
Lenoir 198  
Leonard Compton 199  
Leonard Sidney 199  
Letitia (Lettie) Field 197  
Lewis Augustus 196  
Lillian Fabacher 199  
Lillie Belle Singleton 196  
Lionel (b. 1899) 197  
Lionel (1856-1933) 197  
Lionel C., Jr. (b. 1928) 195  
Lionel Calhoun (b. 1852) 195  
Lionel Calhoun (b. 1903) 195  
Lionel Calhoun, Jr. (b. 1889) 195  
Lionel, Jr. (b. 1904) 197  
Lois 167  
Lottie Huggins Barrineau 196  
Louisa 163, 164  
Louisa Alice 195  
Louise (Lula) 196  
Louise 199  
Louise Hubert (b. 1827) 199  
Louise Hubert (b. 1891) 199  
Louise Lenoir 198  
Louise McDonald 196  
Lucille 199  
Lucius Clifton 198  
Lucy Coates 195  
Lulu (see Moise, Louise (Lula))  
Lyle A. (see Moise, Marshall  
Wellborne (Lyle A.))  
Mabel Vera Caverly 199  
Margaret Clark Taylor (b. 1908) 198  
Margaret Pearl Pope 196  
Margaret Taylor (b. 1945) 198  
Marguerite Cromer 198  
Marian (Marion) Gerdine 199  
Marian Cobb Gerdine 199  
Marie (b. 1886) 55, 198  
Marie 196  
Marie Aline (b. 1857/8) 199  
Marie Coriane (b. 1851) 199  
Marie Regina Mouton 199  
Marie Virginia 198  
Marilyn Mae 195  
Marilyn Richards 195  
Marion (b. 1879) 198  
Marion (b. 1881) 198  
Marion (son of Davia) 198  
Marion (1855-1910) 55, 198  
Marjorie Joe 199  
Marshall Wellborne (Lyle A.) 195  
Martha Helen (Sally) Brown 198  
Martha Louise 198  
Mary 199  
Mary Alice 196  
Mary Aline Sompayrac 199  
Mary C. Gill 195  
Mary Catherine 198  
Mary Elizabeth Urcheler 199  
Mary Emily Campbell 199  
Mary Frances 198  
Mary Gaston 199  
Mary Genevieve Griffiths Adams 198  
Mary Helen Williams 197  
Mary Jane 197  
Mary Jane Richards 195  
Mary Lillian Mailbes 199  
Mary Roseline 199  
Maryon Mount 197  
Mathilda Bopier 199  
Matilda Jane Vaughn (1825-1899) 199  
Matilda Vaughn (b. 1890) 195  
Matt Haden 197  
Maude Josephine 195  
Maude Pearl Harris 195  
Mazie (d. 1899) 195  
McFadden 198  
McFadden, Jr. 198  
Mildred Garvia 196  
Mildred Julia Walter 199  
Mildred Yoat 199  
Mona Dean 199

Nancy 197  
Nannie Bell Field 197  
Nora Adams 199  
Norma Luscher 195  
Octavia (1863-1864) 195  
Octavus 199  
Olda Blane 195  
Patsy 167  
Paul De Leon 198  
Pauline McFadden 198  
Penina (b. 1874) 198, 208  
Penina (1797-1880) 195  
Percival Edgeworth 195  
Percival Randolph (b. 1889) 195  
Percival Randolph (son of Aaron, Jr.)  
195  
Percival Randolph (1828-1849) 195  
Percy Harrison 199  
Phila (1818-1884) 36, 195  
Phila Augusta (1850-1921) 195  
Phila Cohen (m. 1805) 38, 195  
Philip Augustus (b. 1885) 196  
Philip Augustus (1824-1887) 74, 196  
Philip Harby 198  
Phyllis June Hayward 199  
Priscilla (1837-1839) 195  
Priscilla Lopez 176, 199  
Prudy (see Moise, Carrie Debora  
(Prudy) Eck Riley)  
Rachel (1796-1872) 195  
Rachel E. 195  
Ralph Beardsley 195  
Raphael Septimus 196  
Raymond 196  
Raymond Henry 195  
Rebecca (b. 1857) 48, 198  
Rebecca (dau. of Howard) 196  
Rebecca (Dulcie) 196  
Rebecca (1814-1858) 176, 195  
Rebecca Cohen (m. Jacob Moise) 39,  
195, 196  
Rebecca Cohen (1814-1858) 176, 195  
Rebecca Elizabeth (Eliza Virginia) 39,  
195  
Rebecca H. 195  
Rebecca Harby 196, 207  
Rebecca Levy 195  
Richard Wellborne 195  
Ridgely 199  
Rita Louise 199  
Rita Louise Mazerat 199  
Robert 195  
Robert Blanding 198  
Robert Christian 198  
Robert Hereford 199  
Robert Lee 195  
Robert McFaddin 198  
Robert Raeburn 199  
Robert Vaughn 199  
Robeson Secrest 197  
Roch Compton 199  
Roena Parkinson 195  
Roma May Hynes 196  
Ronald Lee 195  
Rosalie Cecile (1835-1914) 196, 234  
Rose Emilie Hubert 199  
Roy Aubuchon 195  
Roy McGregor 199  
Ruby Carolya Webb Lourcey 198  
Rudolph (see Moise, Alfred Adrian  
(Rudolph))  
Ruth Beryl Stanfill 197  
Ruth Elizabeth Feldman 195  
Ruth Gray 199  
Sallie (dau. of Howard) 196  
Sallie Lopez 199  
Sally (b. 1839) 195  
Sally Brown (see Moise, Martha Helen  
(Sally) Brown)  
Samuel L., Jr. 198  
Samuel Lenoir 198  
Sandra Lee 195  
Sara 199  
Sara Deal Purnell 198

Sarah (1762-1842) 195  
Sarah Ann 196  
Sarah Anne 196  
Sarah Cohen (m. 1807) 38, 195  
Sarah Cohen (m. 1842) 36, 195  
Sarah Elizabeth 196  
Sarah Louisa 195  
Sarah Priscilla 195  
Sarah V. 197  
Scott Douglas 195  
Selina Florance 74, 196  
Shirley Inez 197  
Sidney 195  
Sidney Howard (b. 1887) 197  
Sophia Lewis Dunlop 197  
Spencer 199  
Stanley Crampton (b. 1905) 197  
Susan Elizabeth 195  
Sydney Cecile Le Corgne 199  
Ted Lewis 196  
Theodora Sidney Moise 199  
Theodore 196  
Theodore J. 195  
Theodore Lopez 199  
Theodore S. III (b. 1930) 199  
Theodore Sidney (b. 1808) 199, 207  
Theodore Sidney (b. 1893) 199  
Theodore Sidney (b. 1862) 199  
Theodore Sidney (d. 1885) 147, 195  
Theodore Sidney, Jr. (b. 1851) 199  
Theodore Sydney (b. 1861) 196  
Theodora Gregoria (Dora) 196  
Theresa 196  
Theresa Outlaw Andrews 198  
Thomas Garland 199  
Thomas Jefferson (b. 1872) 196  
Thomas Jefferson (1826-1869) 196, 207  
Thomas Richard 198  
Todd 197  
Victor Ambrose 199  
Virginia (b. 1909) 198  
Virginia (dau. of Lionel) 197  
Virginia Elizabeth (Eliza Virginia) 39,  
197  
Virginia Lee (1866-1941) 195  
Vivian Frances Meunier 196  
Walter (b. 1860) 197  
Warren 195  
Warren Hubert 199  
Wellborne 195  
William Lionel (b. 1905) 196  
William Lionel (see also Moise,  
Williamson (William) Lionel)  
William Lloyd 195  
William Parkinson 195  
William Randolph 199  
William Wallace 195  
Williamson (William) Lionel 196  
**MOJO**  
Caroline Pascual 225  
**MOLE**  
Annie Minis 194  
**MOLLER**  
Elsie 8  
**MOLLNOW**  
Dorothy Sheftall 269  
Marvia Albert 269  
**MONAHAN**  
Frank 158  
**MONASH**  
Andrew Davies 47  
Carol D. 47  
Lillian Davies 47  
Mark E. 47  
**MONDSCHWEIN**  
Clara 330B  
**MONETT**  
Edith Josephine Moss Rickoff 214  
Elliott T. 214  
**MONHEIMER**  
Carrie 306  
Clara 306  
Clara Workum 306

Ella Lowenthal 306  
Henry 306  
Isaac 306  
Isadore 306  
Jacob (see Monheimer (Monheimer),  
Jacob)  
Laura 306  
Leonard 306  
Levi 306  
Rachel 306  
**MONNHEIMER**  
Hannah Heilbron 109  
Haym 109  
Jacob (Monheimer) 109  
Joseph 109  
Judith (Julia) 109  
Julia (see Monheimer, Judith (Julia))  
Rachel 109  
**MONROE**  
Janice 328A  
**MONSANTO**  
Eliao Mendes 61  
Esther (d. 1802) 59, 62  
Esther de Jacob Israel 240  
Esther de Moses Hisquiao 61  
Jacob 240  
Judith De Sola 61  
**MONTAGU**  
Florence Castello 332A  
Gerald 332A  
**MONTAGUE**  
Anthony Trevor Samuel 82  
Theresa 196  
Charles Edgar Samuel 82  
Deirdre Bridget Senior 82  
Denis Charles Samuel 82  
Eileen Hellstern 82  
Ewen Edward Samuel 82  
Fiona Yvonne 82  
Francoise Christianne (Ninette)  
Dreyfus 82  
Georgina Mary 82  
Gladys Helen Rachel Goldsmid 82  
Gwen Ellen Ingledew 82  
Iris Rachel Solomon 82  
Ivor Goldsmid Samuel 82  
Jean Marcia Luth-Marshall 82  
Jean Mary 82  
Jennifer Iris Rachel 82  
Jeremy Peter Samuel 82  
Joyce Ida Jessie 82  
Louis Samuel 82  
Mary Violet Levy 82  
Nicola Mary 82  
Rachel Mary 82  
Robert Anthony Samuel 82  
Sarah Ruth 82  
Simon Joseph Samuel 82  
Stuart Albert Samuel 82  
**MONTE**  
See Del Monte  
**MONTEFIORE**  
Adah 115  
Alice 115  
Alice Henry 115  
Arthur 115  
Christine Elizabeth McKimmie 138  
Daphne Celine 138  
David 138  
Edith 115  
Flora 115  
Harriet 115  
Henrietta 261  
Hosea Alexander Israel 115  
Joan Webster 138  
Kathleen 138  
Langton 115  
Leslie 115  
Robert Horace 138  
William Sebag 138  
**MONTELEONE**  
Ralph 125  
**MONTFORT**  
Agnes Jane Lopez 178

Marquis de (see Da Silva y Solis,  
Francisco)  
Matthew M. 178  
**MONTGOMERY**  
Alexander 220  
Emily Elizabeth 32  
Florinda 112  
Judith Myers 220  
**MOODY**  
Helen (see De Cordova, Helen  
(Moody))  
Nancy 71  
**MOOG**  
Caroline 41  
**MOORE**  
Alice Harby 207  
Aline Harby 207  
Barbara 172  
Buhl 8  
Edith Margaret 199  
Elsie 269  
Ethel Souza 280  
Evelyn 195  
Frances Ashton (b. 1929) 117  
Harrie B. 138  
Henry 156  
Henry Bennett 138  
Jeannette Frances 117  
Kathleen Mathilda 138  
Leland 207  
Lucy C. 207  
Margaret Marsh 117  
Mary Van Emburgh (d. 1887) 105  
Matilda Innis Joseph 138  
Nellie King 202  
Ollie 280  
Pleasance Maria McBlair 156  
Rachel B. Brown 117  
Ronald 158  
Sandy Winsor 158  
Virginia Schoonmaker 264  
W. Allan III (b. 1921) 117  
W. Allan IV 117  
W. Allan, Jr. 117  
**MOOTY**  
Alice Caroline Bryan 37  
Bonnie Bryan 37  
Mark Taylor 37  
**MORAIS**  
Bona 103  
Bonina (Tobah) ("Nina") 103  
Clara Esther Weil 103  
Gentile (b. 1865) 103  
Henry S. (1863-1935) 103  
Leon David (b. 1869) 103  
Matilda Esther (b. 1861) 103  
Miriam Adele (b. 1867) 103  
Rebecca (b. 1863) 103  
Sabato (1823-1897) 103  
Samuel 103  
Tobah (see Morais, Bonina (Tobah)  
("Nina"))  
**MORALES**  
Leah 44  
**MORAN**  
Amédée De Pau (b. 1852) 158  
Amédée De Pau (b. 1853) 158  
Andrena 206  
Arabella Jones (b. 1872) 158  
Arabella Jones Adams 158  
Arabella Phillips Moses 206  
Charles (b. 1878) 158  
Charles (m. 1841) 158  
Charles Adrian (1846-1888) 158  
Charles Francis (1845-1846) 158  
Charles, Jr. 158  
Daniel Comyn (b. 1843) 158  
Eleanor Berger (b. 1875) 158  
Fleurlette 13  
Frances G. 208  
Francis Elois Berger (b. 1848) 158  
Helen Dorothy (b. 1889) 158  
Helen Louise (1877-1879) 158

Helen Morgan (dau. of Charles) 158  
Helen Morgan (m. 1876) 158  
Hermyn Mitchell 206  
Jane W. Blackburn 158  
Josephine D. Taylor 158  
Marie Louisa (b. 1881) 158  
Martha Adams (b. 1842) 158  
Martha De Pau Adams 158  
Miles 206  
Patrick 206  
Robert A. 158  
Rosalie Emily (b. 1882) 158  
William 206  
William, Jr. 206  
**MORANGE**  
Amelia (Michelle) 192  
Bella 192  
Benjamin (France) 192  
Benjamin (son of Lambert) 192  
Betty 192  
Blume 192  
Elizabeth (Betsey) 192  
Galathe (1814-1850/9) 192, 333A  
Harriet 192  
Henry Hart (1826-1829) 192  
Lambert 192  
Liza 192  
Michelle (see Morange, Amelia  
(Michelle))  
Nathan (b. 1829) 192  
Rosa Solomon 192  
**MORDAUNT**  
Mabel 24  
**MORDECAI**  
See also Mordica  
Abraham B. (1811-1841) 202  
Abraham F. 203  
Ada 203  
Ada Jackson 130, 202  
Alfred (1804-1887) 106, 200  
Alfred (1883-1899) 200  
Alfred III 200  
Alfred, Jr. (1840-1920) 200  
Aline 202  
Allen Lewis (1841-1908) 186, 202  
Amos (1860-1881) 201  
Andrew (b. 1834) 201  
Anna Tutill 201  
Anne Ryan 203  
Anne Willis Lane 200  
Annie (b. 1853) 202  
Armentine Granville 201  
Arthur Levy (1856-1858) 202  
Augusta (1841-1939) 201  
Augustus (1806-1847) 200, 201  
Augustus (1847/8-1918) 200  
Barbara Colquhoun 201  
Benjamin (b. 1865) 48, 202  
Benjamin (1809-1893) 202  
Bertha Lee 201  
Bessie (see Mordecai, Elizabeth Davis  
(Bessie))  
Betty Grimes 201  
Brooke Fisher 201, 217  
Caroline (1794-1862) 200  
Caroline Gertrude (b. 1844) 201  
Caroline Louisa Westermeyer 203  
Caroline Myers Preston 201, 217  
Caroline Preston 201  
Caroline Waller 200, 201  
Catherine (Isabel) Andrews 12  
Cecile (b. 1848) 202  
Cecilia (1812/3-1833) 202  
Cecilia Eva (1868-1890) 202  
Celim J. (b. 1870) 201  
Champe Monacure Robinson 203  
Charlotte Williams Meade 201  
Clara (1873-1919) 93, 201  
Clara Polock 202  
Constance (b. 1895) 202  
Constance Miriam Davis 48, 202  
Coriane Harris 202  
Cornelia (b. 1841) 201

Cornelia (1844-1869) 201  
David (1781-1818) 57, 203, 309B, 333B  
David Henry (b. 1818) 203, 325A, 333B  
David Henry (b. 1833) 203  
David Henry (b. 1882) 203  
Dorothy (b. 1929) 202  
Dorothy E. Schlemm 203  
Edward (1825-1866) 201  
Edward Randolph 201  
Elias Polock (1855-1858) 202  
Eliza 201  
Eliza Kennon (1809-1861) 200, 217  
Elizabeth (Esther) Whitlock 32, 200  
Elizabeth 201  
Elizabeth Brooke 201  
Elizabeth Davis (Bessie) 200, 201  
Elizabeth Onan 201  
Ellen (1790-1884) 200  
Ellen (1837-1915) 32, 203  
Ellen Jacqueline 201  
Ellen Loria 32, 203  
(Elma) Dora Varney 200  
Emma (b. 1844) 200  
Emma (1812-1906) 200  
Emma Brown 203  
Esther (b. 1762) 203, 256  
Esther (b. 1811) 200  
Esther (1774-1844) 48  
Esther Cohen (b. 1843) 201  
Esther Maraché (see Mordecai, Hetty (Esther) Maraché)  
Ethel Lenoir (b. 1889) 201  
Ethelfleda 201  
Eugene 34, 41, 202  
Eva (1890-1976) 29, 202, 312A  
Fanin 203  
Fanny (see Mordecai, Frances (Fanny))  
Florence Goldman 202  
Florence Patterson 203  
Frances ('Sissy') (1845-1927) 202  
Frances (Fanny) (1804-1858) 202  
Frances Kingland Gifford 200  
Frank (ca. 1841-ca. 1843) 200  
George P., Jr. 203  
George Patterson (b. 1880) 203  
George W., Jr. 201  
George Washington (1801-1871) 200  
George Washington (1844-1920) 201  
Georgia Elizabeth 203  
Gertrude Agnes Dahl 201  
Goodman (Gomez) 202  
Goodman II 130, 202  
Gratz (1849-1902) 200  
Hannah Hendricks 110  
Hannah Moses 201, 210  
Harriet (b. 1810) 200  
Harriet (b. 1828) 201  
Harriet (1845-1868) 201  
Helen Alves Norwood (m. 1875) 201  
Helen Norwood (b. 1911) 201  
Henry (b. 1819) 200  
Henry (1847-1920) 202  
Herbert Q. 202  
Herman Corlew (b. 1894) 201  
Hetty (Esther) Maraché 184, 200  
Hetty Hart 103, 325A, 333B  
Hortensia 203  
Ida Nathans 41, 202  
Irene Violet Hodgkin Anderson 201  
Isaac (b. 1764) 200, 256, 333A  
Isaac (b. 1805) 200  
Isaac (son of Isaac) 200, 333A  
Isaac (son of Mordecai Moses) 203  
Isaac D. (1805-1864) 203  
Isaac J. R., Jr. 203  
Isaac John Randolph (1835-1895) 203  
Isaac Whitlock (b. 1840) 201  
Isabel 203  
Isabel Andrews (see Mordecai, Catherine (Isabel) Andrews)  
Isabel Rebecca Lyons 183, 203

Isabella Creasy 201  
Isabella Jane Kincaid 200, 201  
Jacob (b. 1821) 200  
Jacob (James) Granville 201  
Jacob (1762-1838) 200, 217  
James Morrison 203  
Jane Coben 202, 272  
John (m. Mary Price) 201  
John (son of Isaac) 200, 333A  
John Brooke (b. 1878) 201  
John Brooke (1839-1873) 201  
John Robinson 203  
Joseph (1766-1839) 184, 200  
Josephine 201  
Judith (d. 1820) 200  
Judith (m. 1850) 153, 200, 201  
Judith (1763-1847) 4  
Judith (1807-1880) 153, 203  
Judith Ellen (b. 1820) 200, 201  
Judith Myers 200, 217  
(Judith) Ellen Mordecai 200, 201  
Julia (Judith) (1799-1852) 200  
Katherine (b. 1899) 202  
Katherine Marks 186, 202  
Laura (b. 1837) 200  
Laura (b. 1872) 200  
Laura (1818-1839) 200  
Laura A. 203  
Laura H. Taylor 201  
Leah Coben (b. 1836) 201  
Leon A. (1843-1925) 202  
Lewis Snowdon 203  
Libby Adele 201  
Louise (b. 1819) 201  
Louise (b. 1880) 201  
Louise Dixon 201  
Lucile (b. 1891) 174, 202  
Lucretia (b. 1872) 201  
Lucretia Cohen (1807-1888) 35, 200, 201  
Madeline Cohen 34, 202  
Mae Hull 201  
Margaret 201  
Margaret Baldwin 200  
Margaret Cameron 200  
Margaret E. Bowman 200  
Margaret Gregg 203  
Margaret Lane (b. 1850) 201  
Margaret Lane (m. Moses) 200  
Margaret Lane (1824-1910) 200  
Margaret Lane (1848-1918) 200  
Marina Rebecca (1779-1808) 202  
Martha ('Patty') (b. 1860) 200  
Martha Hinton 200  
Mary A. Smith 333A  
Mary Brooke (b. 1837) 201  
Mary Brooke (b. 1846) 201  
Mary Brown 203  
Mary Ellen (b. 1830) 201  
Mary Magill Randolph 201  
Mary Price 201  
Mary Randolph 201  
Mary Willis (b. 1858) 200  
Mathilda Eliza 203  
Minnie (Rachel) 151, 203  
Miriam Gratz (b. 1843) 200  
Mordecai Moses 57, 203  
Moses (son of Henry) 200  
Moses (1707-1781) 32, 200  
Moses (1785-1824) 200  
Moses Cohen (1804-1888) 183, 203  
Nellie King Moore 202  
Nettie (dau. of Thomas) 201  
Nettie Richards (b. 1892) 201  
Norwood 201  
Patty (see Mordecai, Martha ('Patty'))  
Philip 203  
Philip M. (b. 1844) 203  
Philip M. (son of Lionel) 203  
Rachael 12, 93  
Rachael 93, 203  
Rachel (see also Mordecai, Minnie (Rachel))

Rachel Jones 201  
Rebecca (b. 1842) 201  
Rebecca (dau. of Isaac) 203  
Rebecca (1791/3-1833) 117, 200  
Rebecca Mears Myers 200, 217  
Rebecca Nathans 203  
Reinah (Rinah) Coben 57, 203, 309  
Reinah Cordelia 203  
Robert E. Lee (1870-1923) 202  
Rosa (b. 1839) 200  
Rosa Hays (1832-1897) 203, 298, 299  
Rosalind Redlich 202  
Rosina 201  
Rosina Ursula (b. 1912) 201  
Rosina Ursula Young (1818-1906) 200, 201  
Rubey Thornton (b. 1897) 201  
Sally Sandford Maynardier 200  
Sampson (b. 1783) 12  
Samuel (son of Isaac) 200, 333A  
Samuel (1751-1819) 12  
Samuel (1786-1865) 200  
Samuel Fox (1829-1852) 200, 201  
Samuel Fox, Jr. (1852-1927) 201  
Samuel M. (1775-1829) 203, 333B  
Sara Hays (b. 1869) 200  
Sarah (b. 1839) 201  
Sarah Ann Hays 106, 200  
Sarah Ann Pitman 203  
Sipora 203  
Sipora De Lyon (see Mordecai, Zipporah (Sipora) De Lyon)  
'Sissy' (see Mordecai, Frances ('Sissy'))  
Solomon (1792-1869) 200, 201  
Solomon Joseph (1790-1843/50) 200, 201  
Susan (b. 1837) 201  
Susan Alice 201  
Susan Dixon 201  
Susanna (b. 1843) 201  
Tennessee Ann 333A  
Theodore 203  
Thomas (1831-1912) 201  
Thomas Moultrie (b. 1855) 201, 210  
Thomas Norwood 201  
Thomas Waller (ca. 1832-1863) 201  
Thomas Whitlock 35, 200, 201  
Thomas Whitlock, Jr. (1839-1861) 201  
Waller Thompson 201  
Walter C. 202  
Washington (b. 1820) 201  
William (b. 1823) 201  
William (1827-1879) 201  
William (1873-1893) 200  
William Anderson (1867-1943) 201  
William Maynardier 200  
William Norwood 201  
William W. 201  
William Young (1836-1900) 201  
Zaidee Vivian (1868-1878) 201  
Zipporah (Sipora) De Lyon 57, 203  
Zipporah 203  
Zipporah Russell 200, 256

**MORDICA**  
James (1841-1889) 312A  
Mary Stone 312A  
Polina 312A  
Washington (b. 1820) 312A

**MOREIRA**  
Benjamin Rodrigues 30  
Sarah (d. 1831) 30

**MOREL**  
Anne Valeau 201  
Calhoun T. 201  
Ellen 201  
John 201  
Margaret 201  
Margaret Lane Mordecai 201  
Mary Pendleton 201  
T. C. 201  
William 201

**MORENO**  
Abigail Henriquez 61

**MORENU**  
Aaron 169  
Esther (d. 1836) 169  
Leah (b. 1787) 169

**MOREWITZ**  
Louise Ann Rosenbaum 70

**MORGAN**  
Ashton 94  
Cecile Harris (1850-1932) 94  
Doreen 313A  
Douglas 94  
Emma Jett 25  
George W. (1830-1903) 94  
George, Jr. 94  
Helen 158  
Helen Ridgely (b. 1896) 155  
James L., Jr. 155  
James Lancaster 155  
John H. 25  
John Hill 217  
Katherine 295  
Katherine Isabel Oakes 76  
Lelia 217  
Lelia Augusta Myers 217  
Letitia Goodwin 155  
Lydia Harris 94  
Marcia (1855-1915) 274  
Margaret 265  
Nora 102  
William 94  
Wright V. 76

Sipora De Lyon (see Mordecai, Zipporah (Sipora) De Lyon)

**MORGENSTERN**  
Carol (b. 1943) 311B  
Gerard Joseph (1908-1959) 311B  
Joan Ellen (b. 1945) 311B  
Margery (b. 1940) 311B  
Patsy Lynn (b. 1947) 311B  
Pauline Lechenger 311B

**MORISON**  
Matilda (1820-1896) 223  
Rebecca A. 325A

**MORTIZ**  
Edythe 244  
Sanna (Sanne) 107

**MORIUCHI**  
Caroline Janet Brunt 233, 336B  
Christopher Naoji (1975-) 336B  
Fred 233, 336B  
Seiji Harold (1979-) 336B  
Takashi Bayard 233

**MORMAN**  
Lucy Phelps Williams 208  
William 208

**MORNINGSTAR**  
Agatha Brown 241  
Ann Scott 241  
Anne 241  
Anne Wood 241  
Benjamin 241  
Edith Long 241  
Edna Elizabeth 241  
Faith 241  
Flora (see Morningstar, Peggy (Flora))  
Helen L. 241  
Jessie 299  
Joseph (Illava) 241  
Joseph II (son of Percy) 241  
Joseph William 241  
Joseph, Jr. (son of Joseph (Illava)) 241  
Judith Eugenia Salzedo Peixotto 241  
Karl Illava 241  
Karl Richard 241  
Lauretta Wood 241  
Martha 241  
Mary C. 241  
Mary Eleanor 241  
Mary Eleanor Klarman 241  
Peggy (Flora) 241  
Percy 241  
Richard 241  
Susan Marie 241  
Thomas W., Jr. 241  
Thomas Wood 241

**MORRIS**  
Irene I. 251

**MORRIS**  
Aaron (b. 1875) 174  
Anna T. 195  
Annette 322A  
Arthur 34, 322A  
Aubrey 340A  
Auer 213  
Bertha 322A  
Bertie Myers 34, 322A  
Blanche E. Levy 166  
Caroline Calvert 80  
Delia (b. 1883) 174  
Dora 34, 322A  
Dulce Cecile Harper 213  
Edward 322B  
Elizabeth Dawson (d. 1910) 158  
Elizabeth Kuhn 80  
Ellen Lyle 80  
Emma Virginia 119  
Esther (see Mordecai, Esther (1774-1844))  
Eugenia 80  
Fannie Kronheimer 174  
Fannie Lichtenstein 174  
Francis E. 129  
Frieda Brand 340A  
George Calvert 80  
Grace Elliott 194  
Hannah Florine 119  
Hartman Kuhn 80  
Hattie Shueberg 160  
Helen 157  
Henry 174  
Henry H. 119  
Isaac Noah 232  
Isadore (b. 1882) 174  
Jane Seigsberg Druckerman 322B  
Judy (b. 1950) 166  
Julia 80  
Leonora K. (b. 1903) 174  
Lottie Mayo 174  
Louis 160  
Mabel (b. 1887) 174  
Mamie (see Morris, Mary (Mamie))  
Maria Davis 48  
Mary (Mamie) (1877-1921) 174  
Michael 232  
Myer 174  
Owen J. 166  
Pearl (b. 1871) 174  
Phoebe Myers 2  
Rachel Noah 232  
Rosalie 80  
Samuel 232  
Sarah Deborah 232  
Sarah Lichtenstein 174  
Simon (b. 1885) 174  
Simona (b. 1885) 174  
Simpson 48  
Viola Bogert 129  
Virginia 34, 322A  
Warren (b. 1952) 166

**MORRISON**  
Adelaide 204  
Alice (1857-1881) 204  
Beatrice Theresa 204  
Caroline Solomons Hart 98  
Charles P. Daly 204  
Constance (b. 1869) 204  
Edith 204  
Edith Vivian Coppé  
Edward (b. 1821) 204, 272  
Edward (son of Edward) 204  
Edward Stewart 204  
Frances Freidenberg (1858-1866) 204  
Frank Henry (1870-1906) 204  
Gertrude (b. 1861) 204  
Grace (1856-1859) 204  
Harriette 102, 204  
Henry (m. Judith Veill Hart) 204, 280  
Henry (m. Rachel Andrews) 12

Henry, Jr. 204  
Joseph 204  
Josephine (1862-1863) 204  
Judith (Julia) Veill Hart 102, 204, 280  
Julian Issac (1853-1894) 204  
Leslie 269  
Lewis M. (1819-1862) 204, 226  
Lewis W. 204  
Lewis, Jr. (1855-1856) 204  
Moses 204  
Rachel Andrews 12  
Rosalie (b. 1859) 204  
Rose Goldsmith 125  
Rowena Nathan 204, 226  
Sarah (m. Joseph) 204  
Sarah (1799-1872) 204  
Sarah M. 204  
Wesley Willingham 98  
Zipporah Sober 204, 272

**MORSE**  
Dorothy Ida Levy 167  
Hattie 15  
Josephine 105  
Leon 167  
Mildred Hochstadter 83

**MORTEIRA**  
Saul Levi 240

**MORTIMER**  
Philip Henry 125

**MORTON**  
Hannah Lyons 182, 332A  
Hyman (b. 1844) 182, 332A  
Jeremiah Rogers 88  
Mary Cecil Gratz 88  
Michael (b. 1874) 182  
Sarah (-1976) 332A

**MOSBY**  
Benjamin C. 29  
Junius C. (1843-1915) 29  
Rachel N. Cardozo 29

**MOSELEY**  
Charlotte 76  
Charlotte Payne-Gallwey 76  
John (m. Charlotte Payne-Gallwey) 76  
John Gallwey 76  
Julia 308  
Richard 76

**MOSELY**  
Elizabeth Louisa Samuel De Sola 60  
Elizabeth Singer 60  
George Henry 60  
Gillian 60  
Jennifer 60  
John (b. 1933) 60  
John De Sola 60  
Louise De Sola 60

**MOSENFELDER**  
Dorothy Jane (b. 1914) 287  
Evelyn Milius 287  
Robert A. (b. 1916) 287  
Simon 287

**MOSER**  
Abraham 160  
Carl H. IV 222  
Carl Herndon II 222  
Cathy Myers 222  
Eithel Isaacs 160  
Helene Weil 327B  
Isabel 160  
Martin 160  
Michelle Myers 222  
Mortimer 327B

**MOSES**  
A. De Leon (1842-1901) 35, 207  
A. Monetta (b. 1832) 212  
A. Monetta (b. 1833) 212  
Aaron I. (1817-1893) 210, 234  
Abigail 213  
Abraham (b. 1828) 136, 210, 211  
Abraham (d. 1796) 212  
Abraham (m. Mary Harris) 121, 214  
Abraham (son Isaac) 212  
Abraham I. 136, 209, 211



Abraham Rodriguez Brandon (1820-1882) 209  
Ada Brady 211  
Addie 207, 333B  
Addie L. C. (b. 1873) 165, 209  
Adele (dau. of Andrew Jackson, Jr.) 207, 333B  
Adele (dau. of William) 207  
Adele Levy 165, 207  
Adele Marie (1921-1944) 207, 333B  
Adele (1916-) 207, 334A  
Adeline (b. 1826) 159  
Adeline (d. 1873) 159, 160, 213, 334A  
Adeline 211, 334A  
Adeline Moses 210, 211, 213  
Adeline Winthrop 211  
Agnes (b. 1878) 211  
Agnes De Leon 55, 211  
Agnes Doris 208  
Agnes E. Spencer 211  
Albert (see also Luria, Albert)  
Albert L. (b. 1866) 211, 213  
Albert L., Jr. (b. 1888) 211  
Albert Lawrence 209  
Albert Luria (m. 1885) 213  
Albert Luria (1862-1881) 207  
Albert Luria (1866-1945) 211, 334A  
Albert Raphael (b. 1873) 212  
Aldred H. Jr. (1875-) 334A  
Alexander 338A  
Alfred (b. 1829) 209  
Alfred (1819-1910) 48  
Alfred 49, 207  
Alfred Huger 211, 334A  
Alice (b. 1870) 211  
Alice (dau. of W. Moses) 207  
Alice (dau. of Wilfred Moultrie) 211, 334A  
Alice Runyon 209  
Almeria (Minnie) 211, 165  
Almeria Emma 165, 207, 333B  
Altamont (son of Altamont) 206  
Altamont (1846-1905) 35, 206  
Amelia A. 210  
Andrena Werber 206  
Andrew Jackson (1815-1877) 93, 207  
Andrew Jackson III 207, 333B  
Andrew Jackson IV 207  
Andrew Jackson, Jr. (b. 1847) 165, 207, 333B  
Angelina Lazarus 151, 207  
Anita (see Moses, Anna Maria (Anita))  
Anna 312  
Anna De Leon 55, 207  
Anna Green (1875-1914) 211  
Anna Green Moses 211  
Anna Hay Sneed 39, 206  
Anna Maria (Anita) (1865-1881) 207  
Anna Maria (dau. of Charles) 207, 212, 213  
Anna Maria (1805-1899) 163, 164, 207  
Anna Mirree Phillips 338A  
Anna Springer (b. 1900) 311B  
Annabel Cribb (dau. of Herbert) 206  
Annabel Cribb (m. Herbert Moses) 206  
Anne Louise Cary Buckley 206  
Annie Bedell 209  
Annie Jonas 136, 209, 211  
Arabella Phillips (b. 1878) 206  
Arabella Phillips (1839-1907) 206  
Arbuckle 48  
Ariel (b. 1829) 209  
Armida (b. 1884) 206  
Armida (1850-1902) 49, 207  
Armida Davis 207, 333B  
Arthur Sylvester (see Luria, Arthur Sylvester (Moses))  
Ashley 209  
Azile 207  
B. Hughson 207, 333B  
Balti (see Moses, Richard (Balti))

Barbara Carter 208  
Barnard (m. 1777) 57  
Beatrice 212  
Belle (Bella) (d. 1862) 35, 205  
Belle 211, 334A  
Benjamin 209  
Benjamin Frederick (1827-1870) 209  
Bessie A. 209  
Betsey (see Moses, Elizabeth (Betsey))  
Blanche (1859-1946) 209  
Bonnie Rosen 208  
Brandon (1864-1933) 209  
Brandon, Jr. 209  
Carol 207  
Carol Elizabeth 206  
Caroline (b. 1738) 285  
Caroline (1855-ca. 1904) 207, 211, 333B  
Caroline Agnes (1808-1880) 195, 196, 207  
Caroline Angier 206  
Carolyn Strange 208  
Catherine (b. 1820) 212  
Catherine (b. 1887) 206  
Catherine (1802-1890) 213, 235  
Catherine Davis (see Moses, Kate (Catherine))  
Catherine Esther (1852-1938) 206  
Catherine Phillips 205, 206, 243  
Cecil 211  
Cecil H. 211  
Cecil S. 211  
Cecile Frances (b. 1852) 207, 289  
Cecilia (1815-1882) 210, 278  
Cecilia Frances (1806-1844) 199, 207  
Celeste 207, 333B  
Charles (son of A. De Leon) 207  
Charles (son of Robert S.) 211  
Charles B., Jr. 207  
Charles Brown (1810-1854) 151, 207  
Charles Clifton (b. 1872) 211  
Charles Clifton (son of Robert S.) 209  
Charlotte Baer 211  
Charlotte Banks 206  
Charlotte Virginia (b. 1953) 206  
Charlotte Virginia (1916-1921) 206  
Charlotte Virginia Emanuel 66, 206  
Clifton (see Moses, I. Clifton)  
Clifton (1848-1852) 207  
Coendal (1752-1827) 285  
Corianna Florance (d. 1902) 210  
Cornelia Alice (b. 1881) 206  
Cornelia Alice Cohen 39, 206  
Cornelius F. II (b. 1920) 206  
Cornelius Franklin (1866-1938) 39, 206  
Dana Lucile 207, 333B  
Daniel (b. 1765) 213  
Daniel L. 213  
David (1776-1858) 209  
David L. (1848-1882) 207  
David Machado (d. 1858) 212, 266  
Deborah Cohen 180, 212  
Dora Davega 45, 210  
Doris (b. 1904) 206  
Doris Geen (b. 1927) 206  
Douglas M. III 208  
Douglas M., Jr. 208  
Douglas Moran 208  
Duncan 209  
Edith D. 209  
Edmund (b. 1815) 209  
Edna Elizabeth (1920-) 333B  
Edward (d. 1908) 210  
Edward (son of A. De Leon) 207  
Edwin E. (b. & d. 1873) 211  
Edwin L. 209  
Eleanor (dau. of Abraham I.) 211  
Eleanor (dau. of Franklin J.) 206  
Eleanor (m. Edward I. Johnson) 135  
Eleanor (1778-1857) 38, 39, 205  
Eleanor Ruth 206  
Eleanor Ruth Burke 206

Elinor Block 25, 210  
Eliza 207  
Eliza Coben 35, 207  
Eliza Jane (b. 1829) 205  
Eliza Matilda (1812-1892) 207, 212  
Eliza Matilda Moses 207, 212  
Elizabeth (Betsey) 121  
Elizabeth 115  
Elizabeth Alvate 206  
Elizabeth Angier 206  
Elizabeth McIlraney 206  
Ella 209  
Ella Graves 211  
Ellen 308  
Ellen Iseman (1916-) 333B  
Emile Phillips (b. 1880) 206  
Emily Phillips, Jr. 206  
Emily 211, 334A  
Emma 205  
Emma Buford Richardson 205  
Enid Anna (b. 1919) 206  
Enid Anna Moses 206  
Esther (dau. of Isaac Harby) 312  
Esther (Hetty) Phillips 205, 243  
Esther (Hetty) (1784-1860) 38, 195, 205  
Esther De Lyon 57  
Esther Isaacs 120, 212  
Esther Jones 137, 326B  
Eibel 209  
Eugene H. 208  
Eugene H., Jr. 208  
Eugene Henry 208  
Eva 211, 334A  
Ezra I. (1833-1877) 164, 210  
Felix Jacob (Inglesby) 55, 211  
Felix Maduro (b. 1920) 209  
Fisher (Fisher) 58, 212  
Fisher 212  
Flora (b. 1851) 210, 211, 334A  
Flora (dau. of Perry) 208  
Fontaine H. 211  
Frances G. Moran 208  
Frances Sampson 211  
Frank Carr 208  
Frank H., Jr. 208  
Frank Harby 198, 208  
Franklin (son of Franklin J., Jr.) 205  
Franklin (1810-1837) 212  
Franklin J. (1837-1907) 39, 206, 333B  
Franklin J., Jr. (1838-1905) 205  
Franklin Jay (1804-1877) 205  
Franklin Jay (1871-1953) 206  
Georgina Samuel 212, 260  
Gershom Arnold (b. 1861) 209  
Gertrude (1822-1823) 209  
Gertrude Millington 206  
Gidah 29  
Grace Aguilar 211, 334A  
Graham 207  
Graz A. 209  
Gwen Elizabeth (b. 1945) 206  
H. Claremont, Jr. 206  
Hampton H. 211  
Hannah (d. 1800) 33  
Hannah (d. 1928) 201, 210  
Hannah (1768-1846) 213  
Hannah (1809-1875) 5, 210  
Hannah Lazarus 151, 205, 207  
Hannah Maria (1840-1860) 210, 212  
Hannah Maria Moses 210, 212  
Hannah Marie 212  
Harold 209  
Harriet (b. 1812) 209  
Harriet De Leon 208  
Harriet Elizabeth Pace 206  
Harriett Evelyn Carter 208  
Harry 48  
Hart J. (1807-1860) 213  
Hartwig (Hart, Naphtali) 92  
Hayman Levy (1792-1846) 209  
Helen (b. 1918) 207, 333B  
Henry Altamont (1913-1921) 206

Henry Benton (b. 1900) 211  
Henry Claremont (1841-1905) 206  
Henry Clay 211, 334A  
Henry E., Jr. 208  
Henry Eugene 208  
Henry Phillips (b. 1954) 206  
Henry Phillips (1886-1945) 66, 206  
Herbert (b. 1923) 206  
Herbert A. (b. 1876) 206  
Herbert Stephen 206  
Hervey Hall (b. 1849) 211  
Hester (Hetty) (dau. of Lyon) 213  
Hester (m. 1754) 92, 221  
Hester (Hetty) Simons 271  
Hetty (1812-1892) 213  
Hetty Phillips (see Moses, Esther (Hetty) Phillips)  
Hetty Simons (see Moses, Hester (Hetty) Simons)  
Horace (1820-1893) 209  
Hortense Guggenheimer 90  
Hortensia (1815-1890) 205, 265  
Hyman (b. 1844) 182, 332A  
I. Clifton 207, 326B, 333B  
I. Harby, Jr. 208  
Inez Carr 208  
Isaac (b. & d. 1789) 212  
Isaac (son of Franklin) 212  
Isaac (son of Isaac Clifton) 207  
Isaac (1742-1818) 159, 209  
Isaac (1769-1831) 120, 212  
Isaac (1807-1847) 209  
Isaac C. (1837-1850) 212  
Isaac Clifton (1781-1835) 151, 205, 207  
Isaac Harby (b. 1920) 208  
Isaac Harby (son of Perry) 208  
Isaac Harby (1842-1900) 207, 312  
Isaac I. (b. 1822) 207, 210, 211, 212  
Isaac I. III 209  
Isaac I., Jr. (b. 1872) 211  
Isaac Jr. (1819-1889) 209  
Isaac L. 213  
Isabel 207  
Isabel A. (1820-1854) 207  
Isabel Adeline (see Moses, Isabelle Adeline)  
Isabel Alice (b. 1898) 211  
Isabel De Leon Cohen 39, 206  
Isabel W. Solomous (1891-1975) 207, 312  
Isabella Myers 213  
Isabelle Adeline (1850-1934) 164, 212  
Isaiah (1772-1857) 210, 247  
Isaiah (1858-1862) 211  
Isaiah Ezra 45, 210  
Isolene 48  
Israel (d. 1849) 180, 212  
Israel (1785-1801) 209  
Israel (1821-1870) 209  
Israel (see Nunez, Israel Moses)  
Issachar (b. 1762) 213  
Jacob (b. 1770) 213  
Jacob I. (1811-1854) 210, 211, 234, 334A  
Jacob Isaiah (b. 1855) 211  
Jacob M. 90  
Jane 205  
Jane Dorcas McClenahan 205  
Jane Joseph 210  
Jane McClelland (1866-1867) 207  
Jean Benton Conway 208  
Jeanette Nathans (see Moses, Jeanette Nathan)  
Jeannette Nathan 211, 334A  
Jeffrey Arthur 208  
Jessie Lang 209  
John Maria 206  
John S. 209  
John, Jr. 209  
Jonathan K., Jr. (1979-) 333B  
Jones West 207  
Joseph (Jousel) 121, 214

Joseph (1772-1814) 213  
Joseph Jonas 211  
Joseph Washington (1823-1865) 209  
Joseph Winthrop (1880-1927) 211, 334A  
Josephine Jonas 211  
Joshua (1780-1837) 27, 209  
Joshua Joseph (see Harby, Joshua Joseph)  
Joshua L. (d. 1865) 207  
Jousel (see Moses, Joseph (Jousel))  
Judah Touro 211, 334A  
Judith (Juddy) 277  
Judith A. Ottolengui 210, 234  
Julia (dau. of Judah Touro) 9, 211  
Julia (m. 1849) 135  
Julia Federman 209  
Julia Walker 211  
Juliette 210  
Julius L. (1828-1901) 129, 210  
Julius L., Jr. (d. 1929) 210  
Kate (Catherine) Davis 48  
Katherine (1874-1954) 206  
Katherine Adele 206  
Laura Elizabeth 206  
Laverne Conger 211  
Lavinia (1786-1828) 27, 209  
Lawrence Harry (b. 1870) 212  
Lawrence Sutherland (1933-) 334A  
Leah (b. 1760) 213  
Leah Agnes 211, 334A  
Lee Johnston (1878-9-) 334A  
Leila Tyndall 209  
Leon 207  
Leonora (b. 1820) 210  
Levy (Jamaica, L. I.) 213  
Levy (1773-1869) 139, 210  
Levy I. (1808-1876) 210, 211, 213, 334A  
Lilian (dau. of A. Jackson, Jr.) 207, 333B, 334A  
Lilian (dau. of M. J.) 207  
Lilian Moses 207  
Lionel (1825-1895) 209, 264  
Lionel B., Jr. 211  
Lionel Bel 211  
Lionel III 209  
Lionel, Jr. (1870-1931) 209  
Lois Hasle 209  
Lola Maude 208  
Lucile Iseman 207, 333B  
Lucille Dorothy Herne 211  
Lula Graves 211  
Lynn Diane Altounian 333B  
Lyon Moses 213  
Marcia Tessler 208  
Margaret Hoffman 209  
Margaret Lanier 209  
Margaret Taylor Moise 198, 208  
Maria (b. 1857) 212  
Marianne 212  
Marian Knight 208  
Marie (dau. of W. Moses) 207  
Marie (dau. of Wilfred Moultrie) 207, 334A  
Marie A. Raum 205  
Marie Luria 212  
Marina Lopez 206  
Martha 208  
Martha 207  
Mary (dau. of Franklin J., Jr.) 205  
Mary (see also Moses, Rachel Miriam (Mary))  
Mary (1819-1887) 153, 213  
Mary Alice (b. 1841) 207, 210, 211  
Mary Alice Moses 207, 210, 211  
Mary Ann Hallahan Fox 209  
Mary Asbe 209  
Mary Harris 121, 214  
Mary Louisa 206  
Mary Octavia (b. 1918) 206  
Mary Octavia (b. 1955) 206  
Mary Papin Acheson 209

Mary Porter Asbe 209, 312  
Mary Stanford (1865-1866) 211  
Mathilda Eliza (b. 1853) 212, 260  
Mathilde R. 211  
Maud Guild 212  
May Levin 207  
McDonaid 211  
Michael (b. 1708) 285  
Michelle De Leon 208  
Minche Adolphus 7  
Minnie (see Moses, Almeria (Minnie))  
Minnie Isabel (b. 1880) 206  
Miriam (b. 1767) 213  
Miriam Brandon 206  
Miriam Gratz (b. 1808) 35, 209  
Miriam Joseph 139, 210, 211  
Miriam L. (1866-1881) 210  
Miriam Seixas 212, 266  
Montefiore Jacob (b. 1871) 207, 211, 333B, 334A  
Montefiore Jacob (1841-1878) 136, 211, 334A  
Montgomery (1808-1886) 205, 206, 243  
Montgomery (1869-1930) 206  
Montrose (b. 1878) 211  
Montrose J. (1867-1873) 211  
Montrose James 211  
Montrose Jonas 211, 334A  
Montrose, Jr. 211  
Mordecai (1803-1805) 213  
Mordecai Lyon 211, 334A  
Morris 136, 210  
Mortimer (see Moser, Mortimer)  
Moses (b. 1768) 213  
Moses (son of Isaac) 212  
Moses (1818-1856) 210  
Moses L. (d. 1856) 213  
Moses L. (1819-1865) 209  
Moses Levy (1773-1843) 209  
Myer (1735-1787) 12, 205  
Myer (1779-1833) 205, 243  
Myer B. (1833-1889) 206  
Natalia M. Sloss 206  
Natalie Ann 206  
Nina 207  
Nina Blanche (b. 1877) 212  
Nina (1909-) 334A  
Octavia (1849-1851) 207  
Octavia (1853-1857) 207  
Octavia Coben 35, 206  
Octavia Harby (dau. of Perry) 208  
Octavia Harby (1823-1904) 93, 207  
Octavian 207  
Oenid Geen 206  
Oliver Hazard Perry (1813-1880) 55, 207  
Ottolengui Aaron (1846-1906) 210, 211  
Paige Diana (1974-) 333B  
Pauline 101  
Penina Septima (b. 1846) 211, 212  
Penina Septima (1821-1844) 163, 207  
Penina Septima Moses 211, 212  
Percival Robert (b. 1874) 212  
Percival Robert, Jr. 212  
Percival Sneed (b. 1891) 206  
Percy A. (1896-1966) 311B  
Perry (b. 1844) 165, 207, 208  
Perry (b. 1879) 208, 211  
Perry (b. 1906) 208  
Perry IV (b. 1942) 208  
Perry V (b. 1970) 208  
Perry, Jr. (1844-1862) 207  
Perry, Jr. (1878-1943) 208, 211  
Peter 207  
Philip 212, 234  
Phineas 25, 210  
Pier (Polly?) 213  
Pierre 207  
Polly (see Moses, Pier (Polly?))  
Priscilla (1775-1866) 175, 176, 205  
Rachel (dau. of Isaac) 212  
Rachel (dau. of Montgomery) 206



Rachel (1777-1848) 36, 212  
Rachel (1781-1860) 213  
Rachel Andrews 12, 205  
Rachel De Pass 58, 212  
Rachel Gratz 87, 209  
Rachel Miriam (Mary) (1754-1810)  
213  
Rachel Woolf (1811-1836) 205  
Raphael (b. 1876) 209  
Raphael Henry (b. 1868) 212  
Raphael J. (1812-1893) 207, 212  
Raphael J., Jr. (1844-1909) 212, 260  
Rebecca (dau. of Isaac) 212  
Rebecca (1768-1854) 93, 205  
Rebecca (1778-1864) 209  
Rebecca Gratz (1810-1891) 209, 226  
Rebecca Hannah (b. 1859) 211  
Rebecca Hannah Moses 211  
Rebecca Jackson 129, 210  
Rebecca Louise 45, 211, 322B  
Rebecca Phillips (1792-1872) 210, 247  
Rebecca Phillips (1806-1889) 205  
Rebecca Phillips (1843-1848) 206  
Rebecca R. (b. 1837) 205, 333B  
Reubea (1765-1850) 213  
Reyna (1817-1847) 209  
Reyna Levy 159, 209  
Richard (Balti) 90  
Richard 209  
Richard Altamont (b. 1926) 206  
Richea (Rysche) (1771-1848) 159, 209  
Rinah J. Ottolengui 210, 211, 234  
Rita Levene 207, 333B  
Robert Altamont (b. 1921) 206  
Robert C. 211  
Robert Emmet 209  
Robert S. 211  
Roberta 211  
Robin Leigh 207, 333B  
Rosa Nunez 211, 213  
Rosalie Davis 49, 207  
Rosalie Esther Ann (b. 1831) 205  
Rosalie Virginia (dau. of Andrew  
Jackson) 207, 211, 333B  
Rosalie Virginia (dau. of Perry) 208  
Rosalie Virginia Levy 165, 207, 208  
Rosalie Virginia Moses 207, 211, 334A  
Rosannah 211, 334A  
Rose Georgie (b. 1872) 212  
Rosetta Jonas 136, 211  
Ruby Merchant 208  
Rynear 211, 334A  
Rysche (see Moses, Richea (Rysche))  
S. Edith (dau. of Brandon) 209  
S. Edith (1858-1908) 209  
Sadie Pickett 209  
Sadie (b. 1882) 208, 211  
Sadie Moses 208, 211  
(Sally) Sarah 209  
Samson 212  
Sara Margaret 208  
Sarah (d. 1839) 169  
Sarah (dau. of Levy I.) 211, 334A  
Sarah (dau. of Raphael J.) 212  
Sarah (1792-1869) 213, 305  
Sarah (1806-1825) 99, 213  
Sarah (1813-1892) 8, 9, 210  
Sarah A. (1872-1928) 334A  
Sarah Brandon (1799-1828) 27, 209  
Sarah Gratz (b. 1817) 138, 209  
Sarah Hannah Levy 164, 210  
Sarah J. (m. Isaac Davega) 45  
Sarah Jonas 136, 210  
Sarah Machado 212, 234  
Sarah Matilda (1835-1838) 212  
Sarah Ottolengui 210, 234  
Sarah Rebecca (b. 1860) 210  
Selina (1874-1890) 209  
Selina Seixas 209, 264  
Shirley Brandon Maduro 209  
Simeon 210  
Simon 271  
Simon Gratz (1813-1897) 209, 312A,

333B  
Simon Jacob (d. 1764) 221  
Solomon (Cincinnati) 210  
Solomon (1774-1857) 87, 209, 333B  
Solomon, Jr. (1783-1857) 213  
Solomon, Sr. (1734-1828) 213  
Stanford E. (b. 1872) 211  
Stanford E., Jr. 211  
Stanford Hunter 211  
Stephen 312  
Theresa 210  
Thomas 208  
Vivian Mordaunt (b. 1878) 206  
Vivian Mordaunt (1923-1950) 206  
W. 207  
W. Graham III 207  
Walter (d. 1923) 210  
Walter (son of Alfred) 48  
Walter Aaron (b. 1870) 210  
Walter Cecil 209  
Walter Jonas (1869-1873) 211  
Walter Otto 209  
Willfred Moultrie 207, 211, 333B,  
334A  
William (son of A. J., Jr.) 207  
William (son of Gershom) 209  
William Graham, Jr. 207, 333B  
William Graham 207, 333B  
William M., III (b. 1899) 211  
William M., Jr. (1870-1914) 211  
William Moultrie (d. 1878) 211, 212,  
334A  
Williamson 207  
Zalegman Phillips (1835-1889) 39, 206  
**MOSKOVITZ**  
Ann 71  
Florence 284  
**MOSLER**  
Abraham 8  
Charles Victor 8  
Eleanor 8  
Henry 8  
Kate 8  
Kate Magnus 8  
Rose 3, 8  
**MOSQUERON**  
Sarah Sophia Naar 224  
Sebastian 224  
**MOSS**  
Ada (d. 1917) 215  
Ada (1831-1894) 215  
Addie Goodwin 215  
Alfred (1820-1889) 214  
Alfred Chapman (1870-1928) 215  
Alice (b. 1916) 216  
Alice (1853-1916) 214, 228  
Amanda Octavia Levy 164  
Ann (b. 1941) 214  
Ann Wilcox 215  
Annie Bathurst Harrison 214  
Barbara Jean (b. 1922) 215  
Beatrice (b. 1855) 215  
Belle 215  
Catherine (1853-1899) 215  
Catherine Lyons 182, 214, 215  
Charles (1841-1842) 214  
Charles Henry (d. 1928) 215  
Clara 47  
Clarissa (1802-1834) 214  
David Russel (b. 1924) 215  
Donald Ernest (b. 1901) 214  
Donald Laurie (b. 1917) 215  
Dora Gilbert 216  
Dorothy (b. 1918) 216  
Dorothy May 216  
Duval P., Jr. (b. 1917) 216  
Duval Fletcher (b. 1889) 216  
Duval Tuckerman (b. 1935) 216  
Edith (b. 1841) 214  
Edith Josephine (b. 1875) 214  
Edwin A. (b. 1825) 215  
Eleazer (Eugene) (1806-1871) 159, 214  
Eleazer (see also Moss, Ellis

(Eleazer)  
Elizabeth A. Clark 215  
Ella Amelia (1841-1911) 214  
Ellis (Eleazer) 215  
Elwood 215  
Emily 215  
Emma H. (1817-1875) 215  
Ernest Carlton (1874-1912) 214  
Ernest Goodman (1839-1901) 214  
Ernest José (b. 1893) 216  
Ernest Walter (1901-1918) 214  
Ernest Wilcox (1882-1886) 215  
Estelle (b. 1831) 214  
Esther (1808-1857) 214, 261, 262  
Ethel Doris (b. 1911) 214  
Eugene (see Moss, Eleazer (Eugene))  
Eugene Clifford (1862-1927) 215  
Evelyn Lawrence (b. 1906) 214  
Fleurante Lieber 174, 214  
Florence 215  
Florence Marks 293  
Florian (1837-1921) 214  
Frank (1837-1924) 214  
Gilbert (b. 1920) 216  
Gladys Lee Holland 216  
Grace Ann (b. 1892) 215  
Grace Cronk 154  
Gregory Carlton Arthur (b. 1900) 214  
Guilielma Frances Sargood 214  
Harry Alexander (b. 1857) 214, 216  
Helen (b. 1851) 214  
Henrietta Compton 215  
Henry 214  
Henry E. (1815-1880?) 215  
Henry Vincent (b. 1899) 216  
Herman 293  
Hilbert Wallace (b. 1893) 215  
Hilbert, Jr. 215  
Howard Wilcox (1888-1927) 215  
Hugo Harry Naegele (b. 1886) 614  
Irving Reid (b. 1890) 215  
Isaac Mora (1813-1885) 215  
Isabel Hiltner 214  
Isabelle Harris 94, 214  
Jacob (son of Joseph) 215  
Jacob (1793-1830) 182, 214, 215  
Jacob L. 47  
Janet 293  
Jennie Edith Somerville Donnelly 214  
Jessica (1815-1820) 214  
Joan Romilda Marelli 216  
John (England) 214  
John (son of Joseph L.) 215  
John (1771-1847) 182, 214  
John II (1840-1919) 174, 214  
Joseph (b. 1869) 214  
Joseph L. III (b. 1887) 215  
Joseph L., Jr. (b. 1851) 215  
Joseph Lafayette (1824-1906) 215  
Joseph Lyons (1804-1874) 159, 214  
Josephine (b. 1920) 216  
Josephine (1835-1899) 214  
Josephine Sanford 214  
Josephine Stephanie 216  
Julia (b. 1814) 39  
Julia (1827-1895) 20, 215  
Julia (1834-1912) 214  
Juliet Levy 159, 214  
Kenneth 215  
Laura (1840-1842) 214  
Leona (see also Hyneman, Leona  
(Leona Moss))  
Leona 215  
Lily 215  
Lionel Naegele (1887-1888) 216  
Lois Delphine 215  
Louis 223  
Louisa (1848-1914) 215  
Lucien (1831-1895) 164, 214, 226  
Lucien Herbert (1867-1872) 214  
Lucy 146  
Eleazer (Eugene) (b. 1909) 293  
Margaret R. (b. 1881) 215

Margaret Shadwick 216  
Maria Myers-Cohen 223  
Marie Finn 214  
Marie Josephine Ocquidant 214  
Marion Child 216  
Mary (Mollie) (1864-1914) 214  
Mary (see also Moss, Merriam (Mary))  
Mary Levy 159, 214  
Mary Moronha 214  
Maud Cummings 216  
Maude Morison 223  
Maunie Mildred Cummings 216  
Maxine 307  
May (b. 1849) 214  
May (m. Alfred C.) 215  
Merriam (Mary) (1800-1879) 150, 214  
Mildred Barr 215  
Mildred Newton 214  
Miriam Isabelle (b. 1903) 214  
Mollie (see Moss, Mary (Mollie))  
Myrtle 215  
Nina (b. 1935) 216  
Rebecca (1835-1899) 214  
Rebecca Joyce (1819-1876) 215  
Rebecca Lyons 182, 214  
Richard Holland (b. 1918) 216  
Rosalind 339A  
Rosina Rush 214  
Roxana Reid 215  
Ruth Cogswell 215  
Samuel (b. 1783) 214  
Samuel (father of Julia) 39  
Samuel Lyons (1811-1870) 94, 214  
Sanford A., Jr. (1908-1949) 153  
Sanford Alexander (1872-1946) 214  
Sanford III (b. 1939) 214  
Sarah (m. Frank H.) 226  
Sarah (1797-1848) 214, 245  
Sarah Nathan 214, 226  
Sophie Davies 47  
Sophie Killer 215  
Stella (1844-1889) 214  
Stephanie (b. 1928) 216  
Stephanie (b. 1937) 216  
Stephanie Marie Henrietta Karolina  
Naegele 214, 216  
Sybil (b. 1919) 216  
Theodore Butler (b. 1915) 215  
Walter Harris (1855-1914) 214  
Walter Russel (b. 1885) 215  
Walter Sidney (b. 1898) 216  
William (1833-1907) 214  
William C. 215  
William Penn (1858-1927) 215  
William, Jr. (b. 1871) 214  
**MOTT**  
Karl 16  
Patricia Barnet 16  
**MOTTA**  
See also De La Motta  
Jacob Ares 51  
Sarah Cohen D'Azevedo (m. 1804) 51  
**MOUNT**  
Maryon 197  
**MOUNTAIN**  
Armine Simcoe Henry 79  
Jennie 79  
Rebecca Jane O'Beirne 79  
**MOUTON**  
Alice 199  
Estelle 208  
Marie Regina 199  
**MOYAN**  
Dorothy 158  
**MOYER**  
Lizzie 171  
**MUELLER**  
Charles Edward 307  
Charles Z. 307  
Emilie Laura Hirsch 307  
Fred 249  
Laura Amy 307  
Lillie E. 233, 336A

Philip 249  
Rachel Kate Phillips 249  
**MUHFELDER**  
Barbara Hayes 321A  
James Leo 321A  
Joshua 321A  
**MUHLFELDER**  
Adelaide De Beer 16, 321A  
Eleanor (1918-1919) 16  
Grace Barnet 16, 321A  
Leo 16, 321A  
Lewis (b. 1914) 16, 321A  
Margaret (b. 1921) 16, 321A  
**MUHR**  
Henry 284  
Rebecca 284  
Sophie (1851-1890) 284  
**MULFORD**  
Esther 126  
**MULHOLLAND**  
Leonora Abraham (Abraham) Barnes 2  
**MULLIN**  
Louise Minster Kligerman 292  
**MULQUEENIE**  
Theresa 321A  
**MUMFORD**  
Alice Haile 168  
Amelia Jennings Phillips 168  
Amelia M. 168  
Camilla Paulfrey 168  
Edward R. 168  
Francis M. 168  
John Phillips 168  
Margaret Ellen 168  
Mary C. 168  
May 15  
Robinson (1801-1878) 168  
Robinson, Jr. (b. 1847) 168  
Walter H. 168  
**MUNDEL**  
Mona 190  
Roshne Mayer 190  
**MUNDSCHEN**  
Clara 165  
**MUNIZ**  
America 162  
**MUNN**  
Sarah Hays 105  
Silas 105  
**MUNRO**  
Lucretia Rebecca Sheftall 270  
Richard Ames 270  
**MUNSON**  
Bertha 34  
**MURA**  
Sallie 299  
**MURDOCK**  
Margaret L. 157  
Margaret Woerishoffer Nicholas 157  
Mary Katherine 330A  
Uriel Atwood 157  
**MURPHY**  
Angelique Solomons Landrigan 276  
Anna 11  
Harriet 222  
James 276  
John Vincent 269  
Madeline Katherine 238  
Mildred Sheftall Ryerson 269  
Rachel Levy 159  
**MURRAY**  
Alice 166  
Anna May Baumer 259  
Carol Mawson 259  
Edward Bion 259  
Edward Joseph (1890-1939) 259  
Helen Wyllie 208  
Henrietta Samson 259  
Joseph Edward 259  
Juanita Lillian Seixas Wells 266  
May Alice 253  
Michele 259  
R. J. 266

Ronald Edward 259  
Rosemary Stanislaus 30  
Theodore Bion 259  
**MUSSINA**  
Zachary 338A  
**MYER**  
Beatrice 59  
Cornelia 125  
**MYERS**  
See also Meyers  
Aaron (1774-1775) 217  
Aaron (1798-1845) 221  
Aaron (1860-1908) 221  
Abby Pettigrew 243  
Abe 125  
Abigail 220, 277  
Abraham (son of Benjamin) 220  
Abraham (son of Myer) 220  
Abraham (son of William E.) 306  
Abram (b. 1788) 218  
Abram (son of Abram) 216  
Abram (son of Mordicai) 35, 216  
Abram (1800-1821) 218  
Adela Pegram 217  
Adelaide 219  
Adelia 243  
Adeline (dau. of Simon) 243  
Adeline (1791-1832) 218  
Adeline (1854-1873) 218  
Adeline Mayo 218  
Agnes 217  
Aimee 334A  
Alexander (1865-1880) 219  
Alfred 243  
Alfred Henry 125  
Algernon Jarvis (1861-1918) 221  
Algernon Sidney 220  
Aline 221  
Allen Leslie 125  
Amanda Fitzallen 105  
Amelia (1868-1956) 219  
Angelo L. (1834-1900) 112, 221  
Angerous 216  
Ann Polock (see Myers, Hannah  
(Ann) Pollock)  
Anna 114, 216  
Anna Louisa Smith Stockton 218  
Annabella (1831-1887) 169, 216  
Anne Augusta Giles Conway 217  
Anne Hays (b. 1895) 217  
Anne Poore 222  
Annie Cohen 34, 322A, 340B  
Arabella (see Myers, Belle (Bilah,  
Arabella))  
Asher (d. 1789) 190, 217  
Audrey Levy 125  
Augusta (1797-1876) 32, 218  
Barbara Colquhoun Mordecai 201  
Barton (1853-1927) 188, 218  
Barton III 218  
Barton, Jr. 218  
Belle (Bilah, Arabella) (b. 1764) 169,  
218  
Belle (dau. of Abram) 216  
Belle (dau. of Jacob E.) 219  
Belle (dau. of Levy) 216  
Belle (m. B. E. Goetter) 70  
Belle (m. Bertram Edgar Ezekiel) 70  
Belle (1771-1854/5) 216, 262  
Belle Nathans 35, 216  
Benjamin (b. 1832) 220  
Benjamin (1755-1851) 104, 220  
Benjamin (1778-1835) 217  
Benjamin F. (son of Benjamin) 220  
Benjamin or Myer Benjamin 220  
Bernard (son of Jacob E.) 219  
Bernard E. (1839-1871) 219  
Bertha (Betsy) Sarlouis 340B  
Bertha (1833-1870) 222  
Bertha (dau. Joseph) 312B  
Bertha Shalek Koehler 334A  
Bertie 34, 322A  
Bilah (dau. of Shineiah) 221

Bilah (see Myers, Belle (Bilah, Arabella))  
Blanche (1853-1933) 274  
Brooke 201  
Bruce Harry 222  
Carola (b. 1900) 221  
Caroline (Lena) Phillips 216, 247  
Caroline (1844-1928) 32, 217  
Caroline (1856-1864) 218  
Caroline Barton (1892-1895) 218  
Caroline Marx 218  
Caroline Mayers 312  
Caroline Waterman 222, 312A  
Cassie Mason 220  
Catalina Mason 220  
Catharine (Caty) Mears 190, 217  
Catherine (1833?-1896) 219  
Catherine Altie 220  
Catherine Chappell 220  
Catherine Hays (1798-1874) 217  
Catherine Rosalie (b. 1856) 221  
Cathy 222  
Cecile (Lizzie) 4  
Charles (1849-1911) 34, 322A, 340B  
Charles Augustus 105  
Charles William 220  
Charlotte (dau. of Mordecai) 220  
Charlotte (dau. of Moses) 216  
Charlotte Bailey 220  
Clara 312B  
Clara Ettenheimer 222  
Clara Samuel 216, 262  
Clariase Louise 138  
Clifford 334A  
Cohen 216  
De Rosset 201  
De Rosset, Jr. 201  
Delia 222  
Dinah 2  
Dorothy (Tetzliah) 221  
(E) Manuel (d. 1799) 131, 221, 251  
Eddie 221  
Edel (Adeline) Waterman 219, 303  
Edmund T. D., Jr. (b. 1862) 217  
Edmund Trowbridge Dana (1830-1905) 217  
Edward Henriques (1861-1929) 221  
Edward Van Wyck 220  
Elaine Grauman 220  
Eleazer 240  
Elijah (b. 1846) 297  
Eliza Judah Abraham 141, 218  
Eliza Kennos (b. 1860) 217  
Eliza Kennos Mordecai 200, 217  
Elizabeth (m. B. S. Cohen) 33  
Elizabeth (1805-1827) 216  
Elizabeth Stubblefield 217  
Elkaleh (Joyce) Mears 190, 217  
Elkaleh Myers-Cohen 217, 223  
Ella C. (1808-1892) 217  
Ella Freeman 221  
Ella Hays 105  
Ellen Tobias 297  
(E) Manuel (d. 1799) 131, 221, 251  
Emanuel B. (b. 1859) 221  
Emanuel J. (son of Jacob E.) 219, 334A  
Emanuel J. (1781-1871) 219, 303  
Emily Henriques 112, 221  
Esther (1779-1865) 218  
Eather (1805-1874) 220  
Eather Cohen 35, 216  
Etta 216  
Eugenia Phillips (1863-1891) 194, 216  
Fairlie Cooper 216  
Fannie Colquhoun 217  
Fannie Colquhoun Trigg (see Myers, Frances (Fannie) Colquhoun Trigg)  
Fannie Stevens 221  
Fanny Guggenheimer 89  
Fanny Minis (see Myers, Frances (Fanny) Minis)  
Faybes (b. & d. 1760) 221

Florence 107, 222  
Florence I. (1860-1923) 219  
Frances (Fannie) Colquhoun Trigg 217  
Frances (Fanny) Minis 194, 216  
Frances 220  
Frances Maria (dau. of Mordicai) 216  
Frances Maria (1859-194?) 216  
Frances Stuart 218  
Frank M. 216  
Fred S. 222, 334A  
Frederic S. 222, 312  
Frederick (son of Gratz Cohen) 216  
Frederick (1796-1832) 218  
Frederick (1833-1908) 216, 247, 262  
Frederick, Jr. 216  
Frieda 222  
Gabriel (1768-1770) 217  
George Appleton 216  
George W. (1872-1904) 221  
Georgiana (1858-1901) 218  
Georgianna (1807-1862) 218  
Grace Adams 217  
Grace Rose Hart 97, 221  
Grace Seixas Judah 140, 185  
Gratz Cohen 216  
Gustavus Adolphus (1801-1869) 217  
Hannah (Ann) Polock 216, 252  
Hannah (Hannalah) 221  
Hannah 220  
Hannah Hays 104, 220  
Hannah Pepper De Castro 69, 303  
Hannalah (see Myers, Hannah (Hannalah))  
Harriet (1800-1882) 217  
Harriet Murphy 222  
Haym (see Myers, Hyam)  
Helen (b. 1900) 221  
Helen (m. Clifford Hendricks) 111  
Henrietta (dau. of Mordicai) 216  
Henrietta (dau. of William E.) 306  
Henrietta (m. P. S. Hoes) 220  
Henrietta Blumlein 216  
Henrietta Nathans 219  
Henry (b. 1865) 221  
Henry (Jacksonville) 216  
Henry (see also Myers, Hyam (Henry))  
Henry (son of Jacob E.) 219, 334A  
Henry (son of Simon) 243  
Henry (1806-1845) 217  
Herman (m. Isabel Rosenbaum) 255  
Herman (1829-1895) 230  
Herman J. 222  
Herman Nathan 222  
Hessie (d. 1876) 216  
Hessie (1807-1827) 216  
Hester Jacobus 92, 221  
Hester Moses 92, 221  
Heyward (son of Abram) 216  
Heyward (son of Levy) 216  
Horatio Gratz (1808-1834) 155  
Hyam (d. ca. 1801) 179, 218  
Hyam (Henry) (1801-1822) 218  
Isaac (son of Mordicai) 215  
Isaac (son of Moses) 2  
Isaac (1870-1949) 219  
Isabel Rosenham 255  
Isabella (b. 1825) 221  
Isabella (1794-1850) 213  
Isabelle 222  
Isadore 222  
Jack 230  
Jacob (d. 1782/3) 221  
Jacob (d. 1826) 67, 216  
Jacob (see also Myers, John (Jacob))  
Jacob E. (1818-1908) 219  
James E. Cooper 216  
James Hue Conway 217  
Jane 221  
Jane Friedman 172, 222  
Janie Green 216  
Jessie (d. 1929) 69, 306  
Jochabed (Johaveth) (b. 1775) 217  
John (b. 1847) 218

John (Jacob) (b. 1762) 218  
John (1787-1830) 218  
John H. 216  
John M. 170  
John Stephan 312  
Joseil (Youzel) 221  
Joseph (b. 1764) 217  
Joseph (ca. 1802-1862) 217  
Joseph (1802-1859) 222, 312A  
Joseph (England) 159  
Joseph (son of Jacob E.) 219  
Joseph (son of Solomon) 217  
Joseph (1758-1817) 217  
Joseph (1817-1885) 222, 312A  
Joseph Hart (d. 1823) 221  
Joseph Marx (1818-1863) 218  
Josephine (1835-1920) 216, 245  
Joshua 240  
Joyce Mears (see Myers, Elkaleh (Joyce) Mears)  
Judah (b. 1768) 217  
Judah (m. Grace S. Judah) 140  
Judah (1761-1831) 120, 217  
Judith (d. 1773) 217  
Judith (m. 1783) 220  
Judith (1762-1796) 200, 217  
Judith Hadassah Jacobs 131, 221  
Judith Hays 104, 217  
Judith Isabel S. Nathans 230  
Judith Marx 188, 218  
Julia (b. & d. 1885) 218  
Julia (dau. of Jacob E.) 219  
Julia (m. Henry E.) 215  
Julia (1803-1883) 217  
Julia (1860-1864) 218  
Julia Grammar Barton 188, 218  
Julian (son of Mordicai) 216  
Julian (1814-1827) 216  
Julian L. 6, 221  
Juliana 216  
Julien Lawrence (b. 1841) 6, 221  
Karl Jameson 218  
Kate (dau. of Julian) 216  
Kate (1840-1872) 222  
Kate Bailey 220  
Kate Barton 218  
Kate Mackay Baldwin 188, 218  
Katharine Barton 218  
Katherine (1802-1850) 221  
Katherine Baldwin 218  
Lawrence (m. Sarah Pike) 221, 250, 334A  
Lelia Augusta 217  
Lena Luckstone 219, 334A  
Leonora 219  
Le Roy 312B  
Levi J. (d. 1835) 69  
Levy (b. 1772) 217  
Levy (d. 1827) 194, 216  
Levy Julian (son of Julian) 216  
Levy Julian (1823-1897) 216, 298  
Lewis E. (son of Emanuel J.) 219, 229  
Lewis E. (son of Isaac) 219  
Lilburn Trigg (b. 1857) 217  
Lily (dau. of Abram) 216  
Lily (dau. of Levy) 216  
Lizzie (see also Myers, Cecile (Lizzie))  
Lizzie Wall 216  
Louisa (dau. of Simon) 243  
Louisa (1852-1953) 218  
Louisa Marx (dau. of Barton) 218  
Louisa Marx (m. 1816) 188, 218  
Louise (dau. of William E.) 306  
Louise (m. Moses C.) 230  
Lucile Stern 222  
Mabel Shaw 221  
Mandle (see Myers, Manuel (Mandle))  
Manuel (Mandle) 221  
Manuel (see also Myers, (E) Manuel)  
Maria 243  
Maria Louisa 220  
Marian (see also Myers, Marie (Marian))

Marian June 125  
Marie (Marian) 114, 216  
Marion Howard Curtis 221  
Marion Twigg 216  
Mary Appleton 216  
Mary Ella Chapman 218  
Mary Graham 218  
Mary Phillips 249  
Matilda 243  
Matty Saul 217  
Max 312B  
Meeta Graham Burrage 218  
Meta Burrage 218  
Michael (b. 1763) 247  
Miriam (1774-1775) 217  
Miriam (1868-1871) 219  
Miriam 2  
Miriam Etting 67, 216  
Miriam Pinto 221, 251  
Mordecai (son of Benjamin) 220  
Mordecai (1776-1814) 220  
Mordicai (1727-1788) 35, 216  
Mordicai (1794-1865) 35, 216  
Mordicai Cohen (1803-1835) 216  
Moses (b. 1762) 217  
Moses (b. 1794) 218  
Moses (m. Bertha (Betsy) Sarliouis) 340B  
Moses (son of Jacob E.) 219  
Moses (son of Moses) 219  
Moses (1752-1835) 141, 218  
Moses (1772-1821) 216, 252  
Moses (1842-1882) 219  
Moses C. (1865/6-1942) 230  
Moses II (1817-1881) 188, 218  
Moses Mears (1771-1860) 104, 217  
Moss 2  
Myer (d. 1791) 218  
Myer (1723-1795) 190, 217, 223  
Myer (1793-1877) 188, 218  
Myer Aaron (1822-1893) 97, 221  
Myer B. (b. 1800) 220  
Naphtali Hart 92  
Nathan (b. 1774) 217  
Nathan (b. 1842) 221  
Nellie Simmons 222  
Nellie V. 70  
Nina 230  
Nona 216  
Octavus Cohen 216  
Olivia Jeanne 125  
Orlando Leopold (1871-1929) 230  
Pauline Brush 6, 221  
Pauline Sarah (b. 1862) 221  
Phillip 216  
Phoebe (dau. of Moss) 2  
Phoebe Esther Levy 170  
Polly 220  
Priscilla Lopez Tobias 216, 298  
Rachel (dau. of Jacob E.) 219  
Rachel (dau. of Mordecai) 216  
Rachel (m. 1857) 240  
Rachel (see also Myers, (Rachel) Ritzel)  
Rachel (1738-1810) 220  
Rachel (1836-1861) 219  
Rachel 219  
Rachel Ella 217  
Rachel Hays (1765-1848) 104, 220  
Rachel Hays (1808-1862) 217  
Rachel Hays Myers 217  
Rachel Louzada 179, 218  
Rachel Peixotto 240  
Rachel Phillips 247  
Rachel Salomonsky 219  
Rachel Workum Cohen 306  
(Rachel) Ritzel 217  
Rebecca (d. 1819) 221  
Rebecca (dau. of Solomon) 184, 217  
Rebecca (m. 1857) 94, 240  
Rebecca (1776-1863) 200, 217  
Rebecca (1801-1883) 94  
Rebecca Bernice (b. & d. 1874) 219

Rebecca Hays (1803-1877) 217  
Rebecca Mears 200, 217  
Rebecca N. (1852-1946) 219, 229  
Recbea (1769-1837) 188, 217  
Rhae (1871-1902) 219  
Ritzel (1760-1761) 217  
Robert (son of Mordicai) 216  
Robert (son of Octavus Cohen) 216  
Robert Baldwin 218  
Rosalie 34  
Rosalie Hart 97, 221  
Rose Alexis Knight 221  
S. G. 249  
Sadie 255  
Sadie Shwarts 125  
Sally Hays (see also Myers, Sarah (Sally) Hays)  
Sally Avril Hodgson 222  
Samson (b. 1766) 216  
Samson Mears (17723-1803) 216  
Samuel (son of Simon) 243  
Samuel (1755/4-1836) 104, 139, 216  
Samuel (1790-1829) 188, 218  
Samuel Charles (1886-1907) 34  
Samuel Hays (1799-1849) 200, 217  
Sarah (b. 1770) 217  
Sarah (dau. of Mordicai) 216  
Sarah (dau. of Solomon) 217  
Sarah (m. Jos. J. Levy) 136  
Sarah (Sally) Hays (1772-1832) 104, 217  
Sarah (Sorlah) 221  
Sarah (1795-1864) 104, 220  
Sarah H. Abraham 2  
Sarah Henrietta (dau. of Frank) 216  
Sarah Henrietta (dau. of Frederick) 216  
Sarah Henrietta Cohen 35, 216, 245  
Sarah Judah 139, 217  
Sarah Lopez Isaacs 120, 217  
Sarah Nathans 219, 229  
Sarah Peterson 219  
Sarah Pike 221, 250, 334A  
Seligman (1821-1885) 222, 312A  
Shinelah 221  
Sigmund 89  
Sigmund T. 34  
Sigo 222  
Simhon Hart (b. 1763) 221  
Simon 243, 338A  
Sloe (Slowey) 161, 217  
Solomon (m. Judith) 217  
Solomon (son of Mordicai) 216  
Solomon Etting (1807-1844) 216  
Solomon Mears (1753-1791) 217  
Sophie 221  
Sorlah (see Myers, Sarah (Sorlah))  
Stanley 220  
Stella 222, 312B, 334A  
Stella St. John 221  
Susan 220  
Sylvan (Van) Jr. 172, 222  
Sylvan E. 222, 334A  
Tetzliah (see Myers, Dorothy (Tetzliah))  
Theodore 243, 338A  
Theodore Walter (1844-1918) 97, 221  
Theodoros Bailey 220  
Theodosius 216  
Valerie 222, 334B  
Van (see Myers, Sylvan, Jr. (Van))  
Victor 2  
Victoria Minetree George 218  
Virgie G. Gerst 222  
Virginia (b. 1822) 156, 218  
Virginia (1847-1905) 340B  
Wentworth Paul 217  
William Bailey 220  
William Barkdale (1839-1873) 217  
William Barton (1867-1891) 218  
William E. 306  
William W. 216  
Youzel (see Myers, Joseil (Youzel))

#### MYERS-COHEN

Abraham 223  
Ada (1850-1892) 223  
Adelia (b. 1822) 223  
Adelina (b. 1815) 223  
Belle Simon 223, 271  
Bilah 223  
Deborah Salomon 223, 257  
Elkaleh (d. 1765) 217, 223  
Elkaleh (1735-1765) 217, 223  
Elkaleh (1749-1785) 223, 263, 264  
Emanuel 223  
Esther 223  
Ezekiel (b. 1808) 223  
Haymon (Haim) (1806-1833) 160  
Henry (b. 1811) 223  
Hiah 223  
Louise 223  
Maria (b. 1847) 223  
Matilda (b. 1818) 223  
Matilda Morrison 223  
Myer 223  
Myer S. (1805-1879) 223  
Rachel 223  
Rachel Asher Levy 159, 170, 223  
Rachel Michaels 193, 223  
Rebecca (dau. of Samuel) 223  
Richea (1731-1801) 87, 223  
Samson 223  
Samuel (b. 1813) 223  
Samuel (1708-1743) 170, 193, 223  
Sarah (Levy) 223  
Simon 223, 257  
Solomon (1744-1798) 160, 194  
Theodore (b. 1820) 223

#### MYRICK

Susan Dixon Mordecai 201

#### NAAR

Abraham 224  
Abraham D'A. 224, 225  
Abraham D'Azevedo (b. 1842) 224  
Abraham D'Azevedo (1802-1858) 224  
Ada (b. 1960) 224  
Adelaide 224  
Adele Miriam Seixas 225, 263  
Adolph 224  
Agnes 224  
Albert 224  
Alfred Theodore 225  
Alfreda 225  
Beatrice 225  
Beatrice Maury 224  
Benjamin (m. 1831) 224, 241  
Benjamin (son of David) 225  
Benjamin (son of Joshua) 224  
Caroline (b. 1846) 224, 225  
Caroline (dau. of Abraham) 224  
Caroline Naar 224, 225  
Charles H. 224  
Clara 224  
Constance 225  
Daniel 224  
Darrel 224  
David (1800-1880) 224, 225  
David B. 225  
David D'Azevedo 224  
David Pretto (b. 1833) 224, 225  
Dawn 224  
Derek 224  
Dorothy 224  
Edgar 225  
Edith K. 224  
Eleanor (b. 1837) 224  
Ernest 224  
Esther (b. 1873) 224, 225  
Esther (dau. of Abraham) 225  
Eather Naar 224, 225  
Esther Pretto (b. 1839) 224, 241  
Ethel Smith 224  
Florence 224  
Frances 224  
Frances M. 224  
George 224

George H. 224, 225  
 Grace 224  
 Grace Josephine (b. 1840) 224  
 Grace Judith 225  
 Hananel De Leon (1846-1858) 224  
 Henry D. 224  
 Henry Kelsey 225  
 Herbert 224  
 Isaac Lopez 224  
 Joseph L. 225  
 Joseph Levi 224, 225, 263  
 Josephine 224  
 Joshua (son of David) 225  
 Joshua (1768-1834) 224  
 Joshua David (b. 1834) 224  
 Judith Rosalie (b. 1834) 224  
 Judith Rosalie Naar 224  
 Kate Stryker 225  
 Leita Baiz 224, 225  
 Lester L. 224  
 Lester Metcalf 224  
 Lillian 224  
 Mabel 225  
 Manfred 224  
 Mary Haack 224  
 Mary Louise Price 224  
 Mary Reicher 224  
 Mildred 225  
 Moses D. (d. 1856) 224, 225  
 Moses Daniel (b. 1836) 224  
 Nanette (b. 1871) 224  
 Pardo Correa 225  
 Percy Seixas 225  
 Perla Hobebe 224  
 Rachel (b. 1848) 225  
 Rachel (1885-1910) 225  
 Rachel Miriam (b. 1866) 224  
 Rachel Pretto 224  
 Raphael 224  
 Raphael Peixotto (b. 1845) 224  
 Rebecca 224, 225  
 Rebecca Baiz 225  
 Rebecca Naar 224, 225  
 Rebecca Naar Naar 224, 225  
 Sadie (see Naar, Sarah R. (Sadie))  
 Samuel Grey 224  
 Sarah Cohen D'Azevedo 224  
 Sarah D'Azevedo 224, 225  
 Sarah Frances (b. 1832) 224, 225  
 Sarah Frances Naar 224, 225  
 Sarah Miriam (1822-1900) 225  
 Sarah Peixotto 224, 241  
 Sarah R. (Sadie) 224  
 Sarah Sophia (b. 1836) 224  
 Talbot Jacques (1866-1944) 224, 225  
 Theodore 224  
 William (son of Benjamin) 225  
 William Jacques 224  
 William Peixotto 224  
 Zipporah (b. 1865) 225  
 Zipporah (1871-1941) 225  
 Zipporah Naar (b. 1839) 225

#### **NACHMAN**

Benjamin 250  
 Ida Pike 250

#### **NACHMANN**

David (see Nachmann, Gerson David)  
 Gerson (David) 62, 323A  
 Isabella (1785-1826) 323A  
 Joseph 323A  
 Sara 62, 323A

#### **NAEGLÉ**

Stephanie Marie Henrietta Karolina  
 (1859-1917) 214, 216

#### **NAHL**

Arthur Charles 49  
 Jessica Davis 49  
 Margery 49  
 Marian 49  
 Phyllis 49

#### **NAHM**

Elinor Amram 284

#### **NAPHATALI**

Miriam 178

#### **NATHAN**

See also Nathan(s), Nathans  
 Aaron Edgar (1987-) 334B  
 Alan Hart (b. 1913) 226  
 Alice (dau. of Charles) 312B  
 Alice (dau. of Edward) 312B  
 Alice (1849-1923) 227  
 Amelia (b. 1820) 228  
 Amelia (see also Nathan, Milco  
 (Amelia))  
 Amelia (1819-1895) 228  
 Amy Louise (b. 1866) 143, 226  
 Ann Cohen 38  
 Anna (1852-1853) 227  
 Annette Florence (1866-1895) 226  
 Annie Augusta Florence 74, 226, 227  
 Annie Florence (b. 1867) 227  
 Arthur Edgar (b. 1951) 226  
 Asher (1785?-1863?) 228  
 Asher (1826?-1895?) 228  
 Augustus (1856-1906) 227  
 Barbara (b. 1926) 15  
 Bell 2  
 Bell Nathan 2  
 Bella 228  
 Belle (1876-1879) 228  
 Benjamin (Reading, Pa) 312B  
 Benjamin (1849-1914) 226  
 Benjamin (1863-1883) 226  
 Benjamin (1871-1905) 226  
 Benjamin S. (1813-1870) 110, 226  
 Betsy 121  
 Betty Hart 227  
 Caroline Webb 227  
 Catharine (1781-1845) 94, 228  
 Catherine (Kate) Amelia Goodman 94,  
 228  
 Catherine (m. Abraham) 6  
 Catherine Yates 308  
 Cecilia 38  
 Charles (see also Nugent (Nathan),  
 Charles)  
 Charles (son of Charles) 312B  
 Charles (son of Washington) 226  
 Charles (1825-1910) 94, 228, 312B  
 Christine Marie 226  
 Clara (1825-1902) 226  
 Clara Blum 312B  
 Clarence Seixas (1856-1924) 226, 274  
 Constance (1869-1927) 226  
 Constance Miriam (b. 1919) 226  
 Cordelia Alberger Pollock 228, 289  
 Cyril James (b. 1889) 227  
 David (b. 1929) 15  
 David Joshua 226, 334B  
 Dolly 2  
 Dorothy Michaels 227  
 Dorothy Stride 226  
 Dorothy Wheler 226  
 Eave 228  
 Edgar Joshua (1860-1929) 226, 274  
 Edgar Joshua III (b. 1919) 226, 334B  
 Edgar Joshua, Jr. (b. 1891) 226, 334B  
 Edmund 226  
 Edward 312B  
 Elkaleh Constance (1848-1849) 227  
 Elvira (1826-1912) 226, 274  
 Elvira Nathan Solis 229  
 Emily Grace Hendricks 110, 226  
 Emily Solis (b. 1907) 226  
 Emma (m. 1854) 260, 308  
 Emma Goodman 94, 228, 312B  
 Estelle (1846-1874) 226  
 Esther (b. 1769) 227  
 Esther (1819-1874) 150, 226  
 Esther Etting Solis 226, 274  
 Esther Lamert 228  
 Esther Levy 228  
 Esther Louise (1867-1922) 64, 228  
 Esther Stiner 227  
 Eudora M. Hart 98, 227  
 Eugene 16, 321A

Eugene, Jr. (b. 1942) 16  
 Eva Joshua 308  
 Evelyn 2, 3  
 Fanny (1820-1884) 52, 308  
 Fanny Cohen 36  
 Fanny Seligman (see Nathan, Frances  
 (Fanny) Seligman)  
 Flora (b. 1826) 52, 308  
 Florence (1845-1890) 227  
 Frances (Fanny) Seligman 40, 227  
 Frances (1854-1933) 226  
 Frances Jean Elson 226  
 Frances Louisa (b. 1856) 226, 305  
 Frank Henry (1870-1906) 226  
 Frederic Da Silva Solis 226  
 Frederic Da Silva Solis, Jr. 226  
 Frederick (1844-1918) 226, 227  
 Gene (1942-1963) 321A  
 George (1824-1887) 94, 228  
 George W. McLane (1859-1868) 227  
 Gershom S. (1821-1864) 85, 226  
 Gertrude Wile 303  
 Goodman McDowell 312B  
 Grace (1809-1887) 182, 226  
 Grace Seixas 226, 263  
 Grace Stuart 227  
 Gratz (1843-1915) 98, 226  
 Hannah Dinkelspiel 334A  
 Hannah Hart 97, 226  
 Harmon Hendricks (1843-1924) 110,  
 226  
 Harold (b. 1865) 227  
 Harriet 208  
 Helen Kneeland 312B  
 Henrietta L. Wolfe 304  
 Henry (Hyman) (b. 1828) 228  
 Henry (1790-1837) 228  
 Henry (1812-1872) 228  
 Henry (1816-1876?) 228  
 Henry C. 255  
 Henry Hendricks (b. 1868) 97, 226  
 Henry Hutchinson (1847-1902) 228,  
 289  
 Isaac 148  
 Isaac Edmund (1851-1923) 227  
 (Isaac Mendes) Seixas (1785-1852)  
 226, 266  
 Isabella (1820-1897) 228, 289  
 Isabelle 228, 289  
 Israel Robert Weeks (1831-1888) 74,  
 226, 227  
 Ivan 226  
 Janet McMillan Bingham 227  
 Jean Elson 226  
 Jeannette (1849-1919) 334A  
 Jeffrie (b. 1897) 15  
 Joan Frederick (b. 1915) 227, 312B  
 John (1830-1837) 228  
 Jonathan (1811-1863) 209, 226  
 Jonathan (1845-1917) 226  
 Jonathan Mendez (1864-1924) 227  
 Joseph (1790-1876) 228  
 Joseph 312B  
 Judah (England) 226  
 Julia Solomon 228  
 Julian (son of Washington) 226  
 Julian (1850-1936) 226  
 Juliet (1774-1862) 228  
 Justina (1839-1918) 32, 226  
 Kate Amelia Goodman (see Nathan,  
 Catherine (Kate) Amelia Goodman)  
 Kendrick 312B  
 Leah (1760-1854) 98, 227  
 Leah Cohen 226  
 Leah Cohen Peixotto 228, 240  
 Lena Barnet 15  
 Levi Hart 227  
 Levine 2  
 Levy Nathan Fisher (b. 1833) 228  
 Lewis (1814-1888) 228  
 Louisa (dau. of Phineas) 308  
 Louisa (1813-1886) 228  
 Louise (1847-1852) 226

Louisa Abraham 2  
 Louise (1861-1894) 227  
 Lucien (son of Jonathan) 226  
 Lucien (1857-1915) 227  
 Lucien Seixas (1853-1854) 226  
 Lucy Lee Hall Skelding 227  
 Lyon (Reading, Pa.) 227, 312B  
 M. 38  
 Mabel Unterberg 226  
 Madeline (1854-1914) 227  
 Malvina (Nina) Armit 226, 241  
 Margaret 312B  
 Marguerite (1829-1899) 64, 228  
 Marguerite Dalton 228  
 Marguerite Rahr Callahan 231  
 Marion (b. 1905) 15  
 Marion Florence (1897-1931) 145, 227,  
 334B  
 Martin 305  
 Mascha Tauson 228  
 Mathilda 2  
 Maud (m. 1934) 13  
 Maud (1862-1946) 226, 227  
 Maud Nathan 226, 227  
 Maude 13  
 May Rose (b. 1901) 227  
 Mendez (see Nathan, (Simon) Mendez  
 Milco (Amelia) 228  
 Millie Levy 305  
 Minna (b. 1947) 231  
 Minna Barnet 16, 321A  
 Miriam (1823-1879) 139, 226  
 Miriam (1825?-1900) 228  
 Miriam Hendricks 110, 226  
 Miriam Olga (b. 1894) 305  
 Morris 334A  
 Moses 228  
 Moses F. 227  
 Moses Henry (1821-1875) 228, 240  
 Moses Lewis 228  
 Moses Nathan (1807-1883) 228, 334B  
 Myer 38  
 Myer S. 228  
 Myrtille Seixas (1833-1895) 226  
 Nancy Wilson 227  
 Nathan ('Scribe of Amsterdam') 228  
 Nathan (1776-1828) 228  
 Nina Mapleson Armit (see Nathan,  
 Malvina (Nina) Armit)  
 Per Werner 228  
 Percy 312B  
 Phineas 308  
 Rachel (1760-1802) 227  
 Rachel Gratz (1851-1936) 226  
 Rachel Seixas (1815-1885) 110, 226  
 Rachel Yates 308  
 Rebecca (dau. of Levine) 2  
 Rebecca (1766-1848) 227  
 Rebecca (1813-1879) 228  
 Rebecca Gratz Moses 209, 226  
 Rebecca Leigh Chaplan 334B  
 Rebecca Solomons 226, 227, 276  
 Rebecca Washington (1828-1879) 29,  
 226  
 Robert Florence (b. 1859) 40, 227  
 Robert Florence, Jr. (b. 1895) 227  
 Robert Gruntal (b. 1894) 227, 312B  
 Rosa (1810-1878) 228  
 Rosalie (1842-1887) 74, 226  
 Rosalie (1869-1938) 226  
 Rosalie Gomez (b. 1825) 85, 226  
 Rosalie Gomez (b. 1894) 111, 226,  
 334B  
 Rosalie Gomez (m. 1853) 85, 226  
 Roselane (Rosalie) 85, 226  
 Rosina 2, 3  
 Rowena (1830-1901) 204, 226  
 Ruth Gordon 15  
 Ruth Gottesman 226, 334B  
 Sally (b. 1938) 16  
 Sally (see also Nathan, Sarah (Sally))  
 Samuel (m. Eva Joshua) 308  
 Samuel (m. 1891) 304

Samuel (1824-1878) 228, 240  
 Samuel C. 38  
 Sara Ellen (b. 1953) 226, 334B  
 Sarah (Sally) (1764-1820) 227  
 Sarah (1837-1883) 214, 226  
 Sarah (1846-1909) 227  
 Sarah Cohen Peixotto 228, 240  
 Sarah G. Friedman Sommers 226  
 Sarah Gruntal 227  
 Sarah Labatt 148  
 Sarah Lindo 228  
 Sarah Moss 226  
 Sarah Nathan Solis 226, 274  
 Sarah Seixas 226, 266  
 Seixas (see also Nathan, (Isaac  
 Mendes) Seixas)  
 Seixas (1842-1911) 226  
 Simon (1746/50-1822) 226, 263  
 Simon (1835-1875) 228  
 (Simon) Mendez (1817-1890) 226, 227,  
 276  
 Solomon 36  
 Sophie Rosenheim 255  
 Stella (1857-1933) 226  
 Theresa 2  
 Victor 2  
 Virginie 312B  
 Walter 231  
 Washington (1848-1892) 221  
 William (b. 1827) 228  
 William Edgar 226  
 Zipporah S. (1812-1819) 226

#### **NATHAN(S)**

See also Nathan, Nathans  
 Henriette (1788/9-1858/9) 41  
 Jacob 41

#### **NATHANS**

See also Nathan, Nathan(s)  
 Abigail H. (d. 1866) 230  
 Abraham (d. 1864) 229  
 Abraham (1815-1871) 229, 256, 298  
 Alex 231, 335A  
 Alice Gertrude Cohen 36, 231  
 Amelia (1855-1858) 229  
 Amelia (1857-1864) 41  
 America Laura (1852-1902) 229, 334B  
 Anna (b. & d. 1864) 230  
 Anna M. (Sarah) Wilson 230  
 Annabel (Isobel) Joseph 139  
 Arabella Johnson Woolford 230  
 Avery J. 139  
 Barbara (Sarah) (d. 1804) 229  
 Beatrice (b. 1890) 230  
 Belle 35, 216  
 Benvenida Valentina (1847-1870) 230  
 Benvenida Valentina (1858-1882) 230  
 Benvenida Valentina Solis 229, 230,  
 274  
 Betty Hart 229  
 Camillus Levi (1840-1870) 229  
 Carrie 229  
 Clara Corinna (b. 1852) 230  
 Columbus Samuel (b. 1853) 229  
 Cora Estelle (1858/9-1929) 230  
 Courtney S. (1884-1886) 230  
 David (California) 231  
 David (1793-1817) 229, 256  
 David (1793-1878) 229, 256  
 David (1854-1878) 230  
 David (1869-1878) 230  
 Edith May (1877-1879) 231  
 Elizabeth (m. 1854) 231  
 Elizabeth (see also Nathans, Elsie  
 (Elizabeth))  
 Ella Cornelia (1850-1891) 230  
 Ella Victoria (1860-1881) 41  
 Elsie (Elizabeth) (b. 1878) 230  
 Emily Touro Moses 211  
 Emma Herrmann 229  
 Emma M. 229  
 Ernest 231  
 Esther (1832-1893) 231, 277  
 Esther Tobias (m. 1851) 229, 298

Eugenia Emma (1855-1935) 229, 334B  
 Eugenia Murrella Hart (m. 1858) 226,  
 267, 312  
 Eva (1878-1948) 198, 231  
 Fannie 231  
 Fanny 231  
 Fice (see Nathans, Philip (Fice))  
 Franklin Isaiah (1853-1856) 229  
 Georgia A. Russell 256, 267  
 Georgiana Wilson 230  
 Gwendolyn Ayres 230  
 Harry (b. 1857) 229, 335A  
 Helen 230  
 Helen Virginia (1842-1911) 230  
 Helen Virginia (1863-1907) 230  
 Henrietta (b. 1851) 229  
 Henrietta (m. Lewis E. Myers) 219  
 Henrietta (1833-1875) 229  
 Henrietta Cromline 41  
 Henrietta Joseph 139  
 Henrietta Russell 229, 256  
 Horace A. II (b. 1861) 230  
 Horace A. IV 230  
 Horace Augustus (1840-1903) 230, 259  
 Ida (m. Horace A. Nathans II) 230  
 Ida (1870-1903) 41, 202  
 Irene (1863-1939) 229, 268  
 Irene Ella 229, 268  
 Isaac (1822-1896) 219, 226  
 Isaac (1833-1893) 41  
 Isaac (1858-1915) 229  
 Isaac Leiser (b. 1858) 230  
 Isabella (d. 1861) 229  
 Isabella (1821-1896) 40, 229, 254  
 Isaiah (son of Moses) 229  
 Isaiah (1766-1843) 229, 256  
 Isaiah (1831-1863) 229  
 Isaiah Moses (1835-1902) 230  
 Isobel Joseph (see Nathans, Annabel  
 (Isobel) Joseph)  
 Jacob (1790-1866) (son of Moses) 22  
 Jacob (1796-1866) (son of Isaiah) 229  
 Jacob N. (1837-1914) 36, 231  
 Jacob N., Jr. 231  
 James 139  
 Jeanette 211  
 Jefferson 139  
 Joseph (b. 1795) 229  
 Judith Isabel S. (1842-1910) 230  
 Judith Russell 229, 256  
 Laura Augusta (1855-1936) 230  
 Levi Hart (1793-1867) 229  
 Levy 231  
 Lewis 211  
 Louisa 229  
 Lucretius Isaac (b. 1844) 229  
 Mabel Estelle (b. 1878) 230  
 Maria (d. 1820) 229  
 Maria (Sarah) 229  
 Marie Louise 230  
 Marie Louise Samson 230, 259  
 Meta (1859-1860) 230  
 Mina Lehman 229  
 Miriam Louisa E. Kartsher 335A  
 Moses (son of David) 229  
 Moses (1749-1815) 229  
 Moses (1811-1873) 229, 230, 274  
 Moses 164  
 Moses Norman (1881-1884) 230  
 Nathan (m. Annabel Joseph) 139  
 Nathan (1782-1854) 117, 231  
 Nathan (1798-1877) 229  
 Olivia Georgia (1848-1923) 229, 334B  
 Orlando Daniel (1843-1909) 230  
 Pearl R. (b. 1893) 229  
 Perla Russell (1842-1877) 229  
 Philip (b. 1887) 229  
 Philip (Fice) (1810-1864) 229, 256,  
 334B  
 Philip (m. Emma M.) 229  
 Philip Samuel (b. 1852) 230  
 Rachel Cohen 35  
 Rachel Tobias (b. 1853) 229

Rebecca 203  
 Rebecca N. Myers 219, 229  
 Rebecca Russell 229, 256  
 Salomon Cornelius Octavius (1845-1905) 230  
 Samuel (b. 1840) 229  
 Samuel (d. 1893) 229  
 Samuel G. (b. 1840) 226, 267, 312B  
 Samuel, Jr. (d. 1864) 229  
 Sarah (see also Nathans, Barbara (Sarah))  
 Sarah (see also Nathans, Maria (Sarah))  
 Sarah (1815-1830) 229  
 Sarah (1834-1906) 229  
 Sarah Abraham 229  
 Sarah Anna Shaw 230  
 Sarah M. Josephs 231  
 Sarah M. Russell 229, 256  
 Sarah N. Hertz 117, 231  
 Sarah Osmond 230  
 Sarah S. Russell 229, 256  
 Simon M. (1834-1852) 231  
 Sophia 229  
 Sophie Samuel 229  
 Victoria 229  
 Virginia 298  
 Virginia Judith 298  
 Virginius Moses (1846-1896) 229  
 Waring P. 229  
 Waring Russell (b. 1854) 230

**NATION**  
 Dagmar Hertzberg 141  
 John 141

**NATTINS**  
 Addie 313B

**NAUMANN**  
 Henrietta Alexander 8  
 Isabel 8  
 Janie E. Tobias 299  
 Ralph E. 299

**NAUMBURG**  
 Cecile Louchheim Steppacher 72  
 George Washington 72

**NAUSS**  
 Minnie Ethel 76

**NAVARO**  
 Isaac Nunes (d. 1759) 29  
 Jacob Nunes 29  
 Rebecca Cardoza 29  
 Sarah 29  
 Sarah Nunez (1722-1761) 29

**NAVARRO**  
 Aaron 302  
 Rebecca 302

**NAYLOR**  
 Cynthia Caroline Sheftall 270  
 Nabo 53  
 Winford Caldwell 270

**NEAL**  
 Sarah Solomon 273  
 Thomas 273

**NEBENZAHL**  
 Harnet Benjamin Mintz 160

**NEDRAS**  
 Elizabeth 60

**NEEDHAM**  
 Helen Bridget Phillips 246  
 Jack Richard Patrick, 5th Earl of Kilmoray 246

**NEEDLE**  
 Charles 255  
 Katherine J. 255  
 Richard 255  
 Rosalind R. Rieser 255

**NEELY**  
 Frank H. 8  
 Rachel Schlesinger 8

**NEGBAUER**  
 Carrie 166

**NEGRON**  
 Flor M. 336A

**NEGUS**

Emma L. 336B

**NEIDLINGER**  
 Bessie Cornelia 196

**NEILL**  
 Mary 188

**NEILSON**  
 Alberta Reath 254  
 Benjamin R. 254  
 Clara Augusta Rosengarten 254  
 Harry R., Jr. 254  
 Harry Rosengarten 254  
 Judith Rawie 254  
 Lewis 254  
 Susanne S. M. Mitchell 254

**NEILMS**  
 Helen Annie Sheftall 269  
 Robert 269

**NELSON**  
 Edwina 298  
 Irene 36, 37  
 Joseph 166  
 Joseph F. Tobias 298  
 Kate V. 135  
 Ken 301  
 Leah Amanda Tobias 298  
 Lorin 301  
 Nelson Phillips 34  
 Peggy Anne Bear 34  
 Rachel Deutsch 166

**NESBIT**  
 Edith 141

**NETTER**  
 Claire 286

**NEUBERGE**  
 Fannie 167

**NEUBERGER**  
 Beatrix (Trixie) 60  
 Charles 60  
 Dick (see Neuberger, Richard (Dick))  
 Fred 60  
 Richard (Dick) 60  
 Trixie (see Neuberger, Beatrix (Trixie))  
 Violet Oppenheimer 60

**NEUFELD**  
 Freda 229  
 Milton 149  
 Ruth Dene Goldbaum 149

**NEUGAS**  
 Belle Isaacs 125  
 William 125

**NEUGROSCHER**  
 Ester Edith 230

**NEUMAN**  
 Julia Louise 72

**NEUMANN**  
 Charles 192  
 Gladys Sheftall 270  
 Liza Morange 192  
 Thomas 270

**NEUMARK**  
 Arthur J. (b. 1897) 21  
 Elsie Florence Benswanger 21  
 John (b. 1935) 21  
 Kathryn B. Weiss 21  
 Margaret (1900-1922) 21  
 Peggy Ann (b. 1931) 21  
 Solomon (1868-1942) 21

**NEUSTADT**  
 Caroline Gans 83

**NEVINS**  
 Alexander A. 94  
 Bert 313A  
 Cecile Goodman 94  
 Marion Cahn 313A

**NEW**  
 Clara 255  
 Katherine Louise 12

**NEUBERGER**  
 Hancock 90

**NEWBOLD**  
 Maria 67

**NEWBURGER**  
 Beatrice Vera 110

Billy Max 222  
 Blanche Goldman 172  
 Celia 172  
 David 172  
 Elaine 172  
 Elleonora Phillips 248  
 Frank 172  
 Frank William 172  
 Gertrude Oberdorfer 172  
 Gladys Ruth Lippman 222  
 Harry W. (1886-1941) 104  
 Isabel Hays (dau. of Harry) 104  
 Isabel Hays (m. 1886) 104  
 James Monroe (1874-1950) 172  
 Jane 172  
 Lois 222  
 Louis 222  
 Marjorie 172  
 May Cronin 172  
 Phyllis 222  
 Simon 248  
 Virginia Mathews 222  
 William 172  
 William Hays 104

**NEWBURY**  
 Eli 172  
 Yetta Straus 172

**NEWELL**  
 Adah Theodore (Adah Isaacs) Menken  
 Heenan 192  
 Edward 29

**NEWMAN**  
 Emily Anita Demoux 29  
 Estelle 249  
 Lisa 29  
 Randall Edward 29

**NEWHALL**  
 Marian 118

**NEWHOUSE**  
 Abigail Marks 185, 231  
 Adelia (Adele) 231  
 Alan Simeon 231  
 Alfred L. (Eliezer) (1842-1906) 231  
 Alice Brittin 231  
 Benjamin (b. 1863) 231  
 Bessie 231  
 Charles (1851-1880) 231  
 Clara (1858-1861) 231  
 Delia 231  
 Delia Rowland 231, 254  
 Dorothy 231  
 Edgar 231  
 Edgar L. (b. 1915) 231  
 Edgar L. (1865-1927) 231  
 Eliezer (see Newhouse, Alfred L. (Eliezer))  
 Elvira Solis (d. 1936) 231  
 Eva 231, 335A  
 Flora Feisenthal 231  
 Florence (dau. of Walter S.) 231  
 Florence (1855-1936) 231  
 Florence (1859-1860) 231  
 Florence Levi 231  
 Florence M. (d. 1950) 231, 335A  
 Florence Oberdorfer 231  
 Frances (1846-1903) 21, 231  
 Frank (1854-1935) 231, 335A  
 Gerald 231  
 Grace Myrtila (1857-1942) 231  
 (Harding) Hardwig 231  
 Henry 231  
 Henry J. 231  
 Hyman 231, 254  
 Isaac (b. 1847) 231  
 Isaac (b. 1861) 231  
 Isabella 231  
 John 231  
 Jonathan (b. 1852) 231  
 Joseph (1812-1892) 185, 231  
 Juliet Lieber 174, 231  
 Kathleen 231  
 Louis (d. 1863) 231  
 Marguerite 231  
 Mary McSweeney 231

Matilda (dau. of (Harding) Hardwig) 231  
 Matilda Ezekiel 231  
 Miriam Eve (1860-1949) 231  
 Morris (b. 1863) 231  
 Moses (1854-1857) 231  
 Nellie (1864-1881) 231  
 Nettie Nusbaum 231, 335A  
 Oscar Benjamin (1866-1917) 231  
 Paltiel Rowland (1866-1919) 231  
 Robert 231  
 Simeon (Bavaria) 231  
 Simeon H. 174, 231  
 Simon (1855-1877) 231, 335A  
 Theodore 231  
 Walter S. (b. 1872) 231  
 Walter, Jr. 231

**NEWKIRK**  
 Susan Marie 238

**NEWLAND**  
 George B. 257  
 Jack (b. 1917) 257  
 Marguerite Lionne Karstendiek Grossius 257  
 Virginia (b. 1913) 257

**NEWLANDS**  
 Edith McAllister 116  
 Francis Griffith 116

**NEWLIN**  
 Janet 254

**NEWMAN**  
 Abraham (b. 1852) 116, 310B  
 Amelia 160  
 Andrew Warren (1971-) 335B  
 Barnett 160  
 Bertram 160  
 Beverly 160  
 Blanche Jandorf 160  
 Carrie Goldstone 116, 310B  
 Casriel (Unm.) 160  
 Casriel (1790-1862) 160  
 Casriel (1864-1911) 160  
 Catherine Janette (1974-) 335B  
 Charles 335B  
 Charles I. 160, 161  
 Corinne B. 160  
 Edward 160  
 Elijah 160  
 Ella (1869-1937) 160  
 Ella (1878-1937) 160  
 Elsy 8  
 Esther (1869-1943) 160  
 Ettie 160  
 Frances 287  
 Frederic 160  
 Gabriel 160  
 George A. (b. 1879) 116  
 Hannah Levy 161  
 Harris 160  
 Harry B. 160  
 Harry N. 160  
 Hattie 153  
 Henrietta 27  
 Ilene 160  
 Isaac 160  
 Isaac H. 160  
 Isabel 8  
 Israel (b. 1867) 160  
 Israel (son of Norman) 160  
 Jacob (d. 1879) 160, 161  
 Jacob (m. Katherine Herzog) 116, 310B  
 Joseph 160  
 Joy H. Shalit 160  
 Julia R. 160  
 Katherine Herzog Kronberg 116, 310B  
 Koppel 160  
 Lewis 8  
 Lina 269  
 Malvina (Molly) 160  
 Margo 160  
 Mark (1861-1885) 160

Mark (1883-1884) 160  
 Matthew 160  
 Maude Riser 8  
 Milton 116  
 Minnie (d. 1942) 160  
 Minnie (dau. of Israel) 160  
 Minnie (1874-1922) 160  
 Minnie 160, 183  
 Minnie Bahr 160  
 Minnie Levy (see Newman, Myrel (Minnie) Levy)  
 Minnie (m. Julius Polak) 160, 182  
 Molly (see Newman, Malvina (Molly))  
 Moses 160  
 Myrel (Minnie) Levy 160  
 Norman (1822-1880) 160  
 Norman (1880-1960) 160  
 Norman C. 160  
 Rachel (1825-1885) 160  
 Rachel Strauss 160  
 Ralph (b. 1892) 160  
 Ralph (son of Abraham) 116  
 Robert G. (b. 1912) 116  
 Rosa 160  
 Rosa Levy 161  
 Rosalie 160  
 Rose 160  
 Rose J. Fischer 160  
 Rose Raphael 160  
 Roseita Goldstone 116  
 Sadie Goldstein 160  
 Sadie Krupp 160  
 Samuel 160  
 Susan  
 Susan Carol Hewing 335B

**NEWMARK**  
 Caroline 125

**NEWPORT**  
 Viscount (see Bridgeman, Gerald Michael Orlando, Visc. Newport)

**NEWSOME**  
 Neomi 299

**NEWTON**  
 Cornelia Ridgely Hunt 155  
 Mildred 214  
 William Kelly 155

**NICHOLAS**  
 Alfred Dimitri 224  
 Alice Elizabeth (b. 1875) 157  
 Alice McKim Hollins 157  
 Alida M. 157  
 Anne Cary (b. 1909) 157  
 Anne White (1876-1920) 157  
 Augusta Campbell (1833-1901) 157  
 Augusta Moale 157  
 Barbara Anne (b. 1920) 157  
 Barbara Bragdon Preston 157  
 Beatrice Francis May (b. 1891) 157  
 Blandina La Bombarda 224  
 Bruce Storey (b. 1925) 157  
 Carroll Randolph (b. 1917) 157  
 Carry Anne (1879-1918) 157  
 Cary Anne (1834-1912) 157  
 Charles Ridgely (b. 1882) 157  
 Cornelia (1838-1838) 157  
 Daisy Hollins (b. 1877) 157  
 Daisy Hollins Nicholas 157  
 David Dimitri 224  
 Dimitri 224  
 Dorothy Snow 157  
 Edith K. Naar 224  
 Eleanor Kavan Fraser 157  
 Eleanor Lawlor (1878-1881) 157  
 Elizabeth Goodwin (1838-1840) 157  
 Elizabeth Ridgely (b. 1883) 157  
 Elizabeth Teackle (b. 1872) 157  
 Elizabeth Teackle Purdy 157  
 Ella 52  
 Elsie (b. 1880) 157  
 Esther Smith Stevenson 157  
 Esther Stevenson (b. 1874) 157  
 Evelina (b. 1895) 157  
 Frederick S., Jr. 157

Frederick Snow (b. 1910) 157  
 George S. (b. 1870) 157  
 George Stevenson (b. 1924) 157  
 George Stevenson (1840-1922) 157  
 George Stevenson (1882-1914) 157  
 Grosvenor T., Jr. (b. 1912) 157  
 Grosvenor Teackle (b. 1874) 157  
 Harry I. (b. 1882) 157  
 Harry I., Jr. (b. 1908) 157  
 Harry Ingersoll (1847-1901) 157  
 Harry Wadsworth (1871-1875) 157  
 Henry Moale (b. 1869) 157  
 Jane Chase 157  
 John Burke (1879-1881) 157  
 John Patterson (b. 1867) 157  
 John Purdy (1869-1870) 157  
 John Smith (m. 1833) 157  
 John Smith (1839-1905) 157  
 Lois Rohl 224  
 Margaret Woerishoffer (b. 1886) 157  
 Marguerite (1884-1885) 157  
 Marjorie A. Trowbridge 157  
 Marjorie Hubbard Bruce 157  
 Martha E. Milliken 157  
 Mary Lawlor (b. 1881) 157  
 Mary Patterson (b. 1874) 157  
 Mary Patterson (1867-1870) 157  
 Mary Stuart Lawlor 157  
 Maud Louise (b. 1879) 157  
 Maude Burrows Lamphere 157  
 Nancy (b. 1914) 157  
 Nancy (dau. of Frederick) 157  
 Olivia Deborah 224  
 Peter H. 157  
 Philip Norborne (b. 1877) 157  
 Richard David 224  
 Robert C., Jr. (b. 1908) 157  
 Robert Carter (b. 1875) 157  
 Robert Carter (1857-1857) 157  
 Robert Carter II (b. 1915) 157  
 Roberta Johnson (b. 1905) 157  
 Samuel Moale 157  
 Sarah Elizabeth (1878-1878) 157  
 Talbot Jacques 224  
 Talbot Jacques II 224  
 Thomas Jefferson Randolph (b. 1885) 157  
 Virginia Morris (1873-1889) 157  
 Virginia Teackle (b. 1886) 157  
 William Stuart (b. 1888) 157  
 Wilson Carey (1836-1908) 157  
 Wilson Cary (b. 1885) 157  
 Wilson Cary II (b. 1920) 157  
 Wilson Cary, Jr. (b. 1870) 157

**NICHOLS**  
 Carol Ann Stedman 238  
 George Robert (b. 1949) 311B  
 Henry Baldwin 238  
 Josephine Mordecai McGee 201  
 Patsy Lynn Morgenstern 311

**NICOLL**  
 Annie 220

**NICOLLS**  
 Maurice Heriot 118  
 Moyra Blanche May Diana Ponsonby Henning 118

**NIEHMANN**  
 Cordelia Anastasia 88  
 Cornelia Seizas Sadowsky 88  
 Donald Edward Wesley 88  
 Hendricks Frederick Clark 88  
 Kenneth Seizas 88  
 Liza 88

**NIEROP**  
 See Van Nierop

**NIGHT**  
 Golda Hannah 53

**NILES**  
 Elsie C. 157  
 George Casper 157  
 Marian L. Freeman 157  
 Marjorie Louise (b. 1914) 157  
 Maud Louise Nicholas 157

Nicholas (b. 1910) 157  
**NISBET**  
 Louise 220  
**NIX**  
 Adam Bradstreet (1979-) 332A  
 Augusta Lyon Pearl 312A, 332A  
 Elliot Patterson (1977-) 332A  
 Hamilton 36  
 Maggie 53  
 William Patterson 312A, 332A  
**NIXON**  
 Louise Jonas 136  
 Oscar, Jr. 136  
**NIXON-ECKERSALL**  
 Florence Eleanor Scobell 79  
 Frederick Eckersall 79  
**NOAH**  
 Abraham (see Noah, Robert P. (Abraham))  
 Beatrice (d. 1922) 232  
 Bowman 232  
 Carrie 232  
 Catherine (1772-1849) 232  
 Clara R. 232  
 Daniel Jackson (1837-1846) 232  
 Elias (1766-1824) 232  
 Eliza B. 232  
 Elizabeth Daris 232  
 Ettie (d. 1919) 232  
 Eva 232  
 Florence (b. 1859) 232  
 Frances (1768-1843) 100, 232  
 Harry T. 232  
 Henry (1839-1885) 232  
 Horace M. (b. 1857) 232  
 Jacob J. (1830-1874) 232, 335A  
 John 232  
 Judith (1789-1868) 232  
 Lillie H. Levy 171, 232  
 Lionel J. (b. 1843) 171, 232  
 Lionel J., Jr. (b. 1884) 232  
 Manuel (1755-1822) 232, 243  
 Manuel Mordecai (1828-1874) 232, 335A  
 Margaret B. 232  
 Minnie 232  
 Miriam Solomon 232  
 Mordecai Manuel (1785-1851) 129, 232  
 Rachel 232  
 Rebecca E. Jackson 129, 232  
 Robert L. 232  
 Robert P. (Abraham) (1832-1901) 232  
 Samuel (1779-1871) 232  
 Sarah (1803-1830) 232  
 Uriah 232  
 William Glossinger (1768-1844) 232  
 William H. (d. 1902) 232  
 Zipporah (1835-1890) 232  
 Zipporah Phillips 232, 243  
**NOBLE**  
 Catherine Judah 141  
 Edith Nesbit 141  
 Harriet (1851-1879) 141  
 Kate (b. 1864) 141  
 Lazarus (b. 1870) 141  
 Lazarus (m. 1850) 141  
 Mary 130  
**NOLAN**  
 Isabella Newhouse 231  
**NONES**  
 Aaron Achille 233  
 Aaron B. (b. 1798) 56, 233, 336A  
 Aaron (1714-) 335A  
 Aaron (1745-) 335A  
 Aaron (1765-) 337A  
 Abraham 335A  
 Abraham (m. Josefine) 336A  
 Abraham (d. 1796) 233, 335A  
 Abraham B. (1794-1835) 233, 336A  
 Abraham Benjamin (Benjamin Abraham) (1757-1826) 185, 233, 335B

Abraham (1766-) 335A  
 Abraham (1862-1903) 336A  
 Adelaide I. (1849-1938) 335B  
 Adelaide I. (1883-1898) 335B  
 Albert Cooper (1883-) 336B  
 Albert Smith (1840-1887) 336B  
 Alberto 336A  
 Alexander 233  
 Alexander Hamilton (1835-1892) 233, 336A  
 Alexandre (1842-1908) 233  
 Alexandre/Benjamin Abraham (1766-) 337A  
 Alfred 336A  
 Alfred Benjamin (m. 1862) 233, 312B  
 Alice Levy 233  
 Allyn Kendall (1868-1890) 336B  
 Amelia Eveline (b. 1881) 233  
 Ana 336A  
 Ana Angulo 336A  
 Ana T. 336A  
 Ana T. Troconis 336A  
 Angela 336A  
 Angelina (-1853) 335B  
 Anna (1836-1886) 233, 305  
 Anna A. Thayer 336A  
 Anna M. Rino 336B  
 Anna Victorine (1838-1838) 336B  
 Anna Virginia (1833-1833) 336B (Anna) Hannah 233  
 Anna (1845-1933) 335B  
 Anne Marie (Marie Anne or Miriam) (1756-1835) 233, 335B  
 Annie (1850-1913) 335B  
 Antonio Fonseca Celia 336A  
 Benjamin 336A  
 Benjamin (d. 1823) 233  
 Benjamin (see also Nones, Abraham Benjamin (Benjamin Abraham))  
 Benjamin Herbert (1883-1889) 233  
 Benjamin I. (1841-1847) 335B  
 Benjamin Jonnaton (1767-) 337A  
 Benjamin (1752-) 335A  
 Bertha (dau. of William I., Jr.) 335B  
 Bertha (m. William I., Jr.) 335B  
 Bessie 335B  
 Bilha (Isabella) (1792-1871) 55, 233  
 Blanche Evelina (b. 1871) 233  
 Carlos Enriques 336A  
 Caroline De Leon 55, 233  
 Caroline Leonora (1829-1921) 233  
 Carolyn Porter (1952-) 337A  
 Catherine (-1864) 335B  
 Catherine Isaacson 233  
 Celestine (1854-1923) 337A  
 Charles Alfred (b. 1872) 233  
 Charles D. (1825-1903) 335B  
 Cheryl Lynn (1961-) 335B  
 Clara (Clariasa) (1798-1801) 233  
 Constant J. (1863-) 335B  
 Daniel (1723-) 335A  
 David 335A  
 David B. (1783-1837) 233, 335B  
 David Nones (1708-1780) 335A  
 David (1762-) 337A  
 David (1774-) 335A  
 Delia 336A  
 Domitilia Ramirez 336A  
 Dorothy Lamb (1896-1972) 336B  
 Dorothy (1916-) 335B  
 Earl Rino (1886-1887) 336B  
 Edith Marks 335B  
 Edward Kendall (1898-1959) 337A  
 Edward L. (1873-1874) 335B  
 Edward Porter (1876-1916) 337A  
 Edwin (1847-1905) 335B  
 Eleazer (see Nones, Solomon B. (Eleazer))  
 Elias Adolphe 233  
 Eliza Porter 336B  
 Elizabeth Madden 337A  
 Elizabeth Slater 336B  
 Elizabeth (1906-1955) 337A

Ellen S. Johnston 336B  
 Emily Adele (1845-1927) 233  
 Emily Adele Nones 233  
 Emma (1873-) 335B  
 Emma 233  
 Emma A. Kendall 336B  
 Emma L. Negus 336B  
 Emma (1886-1887) 335B  
 Ester Alvares 335A  
 Ester (1753-1753) 335A  
 Esther 337A  
 Esther (Hetty) (b. 1790) 132, 233  
 Esther Blevins 335B  
 Esther Pereira Brandon 233, 312B  
 Eveline (b. 1827) 233, 336A  
 Eveline De Leon 56, 233  
 Fannie (1889-1967) 335B  
 Fannie E. Jarvis 336B  
 Federico (1860-1895) 336A  
 Federico (1890-1946) 336A  
 Flor M. Negron 336A  
 Frank Walter (1890-1966) 335B  
 George T., Jr. (1881-) 335B  
 George Wilkins (1885-1889) 336B  
 Georgiana Diblin 336B  
 Gertrude A. Beck 336B  
 Grace (1795-1798) 233  
 Graciela 336A  
 Hannah (1816-) 335B  
 Hannah Caroline Isaacson 233  
 Hannah McCallan 335B  
 Harriet A. Hodgson 336B  
 Harriet Jacques 233  
 Harry D. (1894-) 335B  
 Henrietta A. M. (-1887) 335B  
 Henriette 233  
 Henry B. (1804-1868) 233, 336B  
 Henry Beauchamp 233, 336B  
 Henry Benjamin (1870-1918) 336B  
 Henry S. (1839-1912) 335B  
 Hetty (see Nones, Esther (Hetty))  
 I. Strickland 335B  
 Ida Leon (b. 1834) 233  
 Ida Virginia (1865-1914) 335B  
 Ida Wella 336B  
 Ida (1889-1929) 336B  
 Ina C. Hanshaw 335B  
 Isaac 335A  
 Isaac (Moses) (1788-1805) 233  
 Isaac D. (1817-1888) 335B  
 Isaac (1763-) 335A  
 Isabel 336A  
 Isabel De Leon (1851-1898) 337A  
 Isabella (see also Nones, Bilha (Isabella))  
 Isabella (1830-1858) 233  
 Isabella D. (1850-1924) 335B  
 Iolana 336A  
 Jacob (1720-) 335A  
 James Creighton (1841-1916) 336B  
 James H. 335B  
 Jefferson (Jeffourne) (b. 1805) 233, 336B  
 Jefferson (1803-1869) 336B  
 Jefferson 233, 336B  
 Jessie Ludy 335B  
 John I. (1847-1853) 335B  
 John McInnis (1834-1859) 336B  
 Jose Rafael 336A  
 Josefine 336A  
 Josefine Sucre 336A  
 Joseph A. (b. 1873) 233  
 Joseph B. (1797-1887) 56, 233, 336A  
 Joseph D. (1813-) 335B  
 Judah (Leon Aaron) (b. 1826-1897) 66, 233, 336A  
 Judica Lopes 335A  
 Judique (1761-) 335A  
 Judith 335A  
 Judith 337A  
 Judith (1761-) 337A  
 Julia Estell (1832-1911) 233, 336A  
 Kathleen Cook 233

Larue Astor 335B  
 Laura (1856-1856) 335B  
 Leah (1772-) 335A  
 Leon A. (see Nones, Judah (Leon Aaron))  
 Lillie (1878-) 336B  
 Lizzie L. Cooper 336B  
 Lucelia (1834-) 336B  
 Lyle B. (1860-1881) 336A  
 Lynn William (1893-1981) 336B  
 Mabel Weidner 336B  
 Mae Maule 335B  
 Mardoche (1757-) 335A  
 Mardochee (1739-) 335A  
 Maria De Los Angeles Martinez 336A  
 Maria Garcia 336A  
 Marie Anne (see Nones, Anne Marie (Marie Anne or Miriam))  
 Marion Emanuel 66, 233  
 Marjorie 233, 336A  
 Marshall (1839-1840) 336B  
 Martha Isabel (1874-1954) 337A  
 Mary Ann Hoglan 335B  
 Mary D. 335B  
 Mary Emma Yeakle 336B  
 Mary G. (1889-1956) 335B  
 Mary Jane Church 335B  
 Mary Josephine (1885-1903) 335B  
 Mary Kirby (1842-1897) 336B  
 Mary Louise Marshall 336B  
 Mary Sherman 335B  
 Mary Taylor 335B  
 Mary (1842-1885) 335B  
 Mary (1848-) 337A  
 Mirande 335A  
 Miriam (see Nones, Anne Marie (Marie Anne or Miriam))  
 Miriam (1824-1899) 12, 233  
 Miriam Marks 185, 233  
 Miriam (1754-) 335A  
 Miriande (Miryam) Lopes 335A  
 Miriande (Miryam) Lopes Nones 335A  
 Miryam Lopes (see Nones, Miriande (Miryam) Lopes)  
 Moses (see also Nones, Isaac (Moses))  
 Moses Leon (b. 1832) 233  
 Norma Madge Dyal 336B  
 Norma (1927-) 336B  
 Pedro (1868-) 336A  
 Rachel (-1796) 335A  
 Rachel (1785-1820) 233  
 Rachel Nones 335A  
 Rachel (1753-) 335A  
 Rafael 336A  
 Rafael (1830-1912) 336A  
 Rafael (1858-1893) 336A  
 Ramon 336A  
 Ramon 336A  
 Raphael Nones (1688-1748) 335A  
 Raphael (1755-) 335A  
 Raphael (1764-) 337A  
 Rebecca (1764-) 335A  
 Rebecca (1769-) 335A  
 Robert H., Jr. (1887-1970) 336B  
 Robert Hodgson (1864-1936) 336B  
 Roberts A. III (1962-) 335B  
 Roberts A., Jr. (1936-) 335B  
 Roberts Ashton (1914-) 335B  
 Rose Fernandez 335A  
 Sadie (see Nones, Sarah Floy (Sadie))  
 Sadie (1886-1910) 335B  
 Sallie Laird Bell 336B  
 Samuel Benjamin 233, 337A  
 Samuel Smith (1837-1915) 336B  
 Sara 335A  
 Sara 335A  
 Sara Pereyre 335A  
 Sara (1756-) 335A  
 Sarah Floy (Sadie) (1880-1942) 233, 336A  
 Sarah Ann (1833-1927) 336B  
 Selomo (1765-) 335A  
 Serena (1827-1889) 233

Seth Marshall (1870-1958) 336B  
 Sipora (1777-) 335A  
 Solomon B. (Eleazer) (1787-1819) 233  
 Solomon D. (1820-1869) 335B  
 Sophie 233  
 Sophie F. Payne 336A  
 Sue Robinson (1845-1845) 336B  
 Susan G. Richardson 336B  
 Suzie C. Wilkins 336B  
 Theodore Emanuel (b. 1850) 233, 336A  
 Thomas Jefferson (1836-) 336B  
 Thomas (1893-1893) 335B  
 Virginia (1860-) 335B  
 Virginia (1913-) 335B  
 Walter 233, 336A  
 Walter Marks (b. 1874) 233, 336A  
 Washington (1827-1853) 336B  
 William Carrier (1845-1929) 336B  
 William I. (1865-1943) 335B  
 William I., Jr. (1883-1964) 335B  
**NONT**  
 Adelaide Maria Oakes 76  
 Isaac 76  
**NORDHAUS**  
 Alexander 119  
 Clotilda 119  
 Edna Wells 119  
 Elizabeth Campbell 119  
 Emma Virginia Morris 119  
 Franklin Levison 119  
 George 119  
 George E., Jr. 119  
 Halle Lucille 119  
 Hannah Florine 119  
 Hannah Hyams 119  
 Henry Franklin 119  
 Jefferson Davis 119  
 Katherine Connaly 119  
 Morris Alexander 119  
 Sylvan 119  
**NORDIO**  
 Antonio 55  
 Maria De Leon 55  
**NORDLINGER**  
 Nancy 301  
**NORFLEET**  
 A. T. 180  
 Ellen Walters 180  
**NORPOLK**  
 16th Duke of (see Howard, Bernard Marmaduke Fitzalan, 16th Duke of Norfolk)  
**NORMAN**  
 Belle Mitchell 129  
**NORMENT**  
 Henry B., Jr. 133  
 Henry Blair 133  
 Jacquelin Boykin 133  
 Laura Schuyler 133  
 Lucy Davis 133  
 Mildred Fidler 133  
 Miriam Boykin 133  
 Miriam Taylor Boykin 133  
 Robert Hunt (m. 1901) 133  
 Robert Lindsey 133  
**NORONHA**  
 Mary 214  
**NORRIS**  
 Caroline 118  
 Sarah (1800-1851) 274  
 William 325A  
**NORTHEY**  
 Alfred Herbert 78  
 Anne Evangeline Colete 78  
 Charles Henry (b. 1873) 78  
 Denis Vernon 78  
 Edward (b. 1868) 78  
 Edward George Vernon 78  
 Edward William 77, 78  
 Florence Elizabeth Honeywood 77, 78  
 Florence Evangeline Colete 78  
 Florence Isobel 78

Francis Vernon (b. 1881) 78  
 Gwendolen 78  
 Hilda Coroline 78  
 Isobel Frances 78  
 Mary 78  
 Mildred Louisa 78  
 Muriel 78  
 Renée Muriel 78  
 Rudolf William Anson 78  
 Violet Ferguson 78  
 William (b. 1876) 78  
 William Edward 78  
**NORTHROP**  
 Edward 70  
 Sarah Ezekiel 70  
**NORTHWAY**  
 Edward 331B  
 Florence Marian Duboff 331B  
 Linda Louise 331B  
 Michael John (1971-) 331B  
 Rachel Elizabeth (1978-) 331B  
 Rebekah Marie (1981-) 331B  
 Sheila Pata 331B  
 Terry Michael 331B  
**NORWAY**  
 Dorothy 222  
**NORWOOD**  
 Helen Alves 201  
**NOWLAN**  
 Ellen Mary 55  
**NOWLIN**  
 Mary Louise 337A  
**NOYES**  
 D. Raymond 158  
 Helen Dorothy Moran McBurney 158  
**NUGENT (NATHAN)**  
 Charles 308  
**NUNES**  
 Abraham Israel 302  
 Anna De Lucena 234  
 Antonio Nunes Ribeiro Sanchez 234  
 David (Jamaica) 114  
 Eliza de David 114  
 Esther (m. Isaac Peixotto) 240  
 Esther Rachel 85  
 Fernandes 258  
 Jacob Franco (1646-1726) 302  
 Jael Valverde 302  
 Junah (b. 1707) 302  
 Luna (d. 1706) 302  
 Lunah (dau. of Abraham & Esther) 302  
 Manoel 234  
 Moses de Jacob Franco 302  
 Moses Israel 240  
 Rachel (Barbados) 302  
 Rachel (m. London, 1707) 240  
 Rachel (m. Solomon Da Costa) 44  
 Rachel de Moses Israel 240  
 Rachel Franco 302  
 Rachel Henriques 114  
 Rachel Salvador 258  
 Rachel Valverde 302  
 Simao 234  
 Simha Franco 302  
**NUNEZ**  
 Albert Luria 213  
 Alexander (1798-) 234, 337A  
 Ammie 213  
 André (Daniel) 104, 234  
 Anna 234  
 Anna Maria Moses 207, 212, 213  
 Annabelle Holt Craft 337A  
 Cecilia Maria (b. 1871) 213  
 Charles (1860-1862) 213  
 Charles Brown 213  
 Clifton Moses (1880-1959) 213  
 Cole M. (1839-) 337A  
 Daniel (see Nunez, André (Daniel))  
 Daniel A. (1800-) 337A  
 Daniel (1775-1815) 337A  
 David A. (1837-) 337A  
 David Ezra 213

Dulce (1875-1888) 213  
Elizabeth 213  
Elizabeth Watts 337A  
Elizabeth (1796-) 337A  
Emma P. Ander 213  
Esther (see Nunez, Theresa (Esther))  
Frances 234, 337A  
Frances E. (1844-) 337A  
Frank 213  
George W. (1842-) 337A  
Gracia (Rebecca) De Siquera 234  
Holly Samblin 213  
Hugh (1801-1852) 337A  
Isabella (1854-) 337A  
Israel Moses (1838-1905) 207, 213  
Izabel De Veiga Caetana (Rachel) 234  
James 234, 337A  
Jasper V. (1847-) 337A  
Jasper W. (1849-) 337A  
Jeremiah S. (1845-) 337A  
Joseph (see also Nunez, Rodrigo  
Lopes (Joseph))  
Joseph 234  
Julia Ann (1847-) 337A  
Lizzie Powers 213  
Lois Harris 213  
Manoel (Moses) 234, 337A  
Maria Caetana (Zipporah) 234  
Mary Caroline (1846-) 337A  
Moses (see Nunez, Manoel (Moses))  
Nancy 337A  
Nancy Ruth (1825-) 337A  
Newton C. (1848-) 337A  
Patience 234  
Phila Hays 104, 234  
Phillip Hugh (1823-1864) 337A  
Rachel (d. 1669) 273  
Rachel (see also Nunez, Izabel De  
Veiga Caetana (Rachel))  
Rachel Fernandez 258, 338B  
Raphael M. (1868-1924) 213  
Rebecca 234  
Rebecca De Siquera (see Nunez,  
Gracia (Rebecca) De Siquera)  
Robert 234, 337A  
Robert Flournoy (1827-1868) 337A  
Robert Patrick (see Nunis (Nunez),  
Robert Patrick)  
Rodrigo Lopes (Joseph) 234  
Rosa (b. 1866) 211, 213  
Rose 234, 337A  
Roy J. 213  
Roy Thomas (see Nunis (Nunez), Roy  
Thomas)  
Ruth (1902-1965) 213  
Ruthy 337A  
Samuel 234, 337A  
Sarah Angeline (1850-) 337A  
Sarah Ann Cole 337A  
Sarah Campbell 337A  
Sarah Jane (1830-1909) 337A  
Sarah V. Carter 337A  
Sophia 337A  
Theresa (Esther) 57, 234  
Viola Pickle 213  
William W. (1841-) 337A  
Williamson Moses 213  
Zipporah (see Nunez, Maria Caetana  
(Zipporah))  
**NUNIS (NUNEZ)**  
Robert Patrick 213  
Roy Thomas 213  
**NUSBAUM**  
Alan Bee 301, 340B  
Alvina 301  
Andrew Scott (1980) 340B  
Ann 340B  
Arthur A. (1851-) 320A  
Barbara 301  
Bee (see Nusbaum, Virginius Harding)  
Benjamin 301  
Bertram S., Jr. 301  
Bertram Spagat (b. 1895) 90, 301

Beth Susan 301, 340B  
Bettie Goldsmith 301  
(Betty) Louise Schloss 301, 340B  
Blanche Bowman 301  
Charles G. 301  
Charles Guggenheimer 301  
Charles Silberman 301, 340B  
Cilla Guggenheimer 90, 301  
Clarissa Arnold 13, 320A  
Cynthia 301  
Edgar (1858-) 320A  
Elise 301  
Ernest 13, 320A  
Faith Wilkoff 301  
Fanny (1856-) 320A  
Henny Spagat 301  
Henrietta (1860-) 320A  
Isabel 301  
Jessica Lynn (1979-) 340B  
John Myers 301  
Justine Lowenberg 108, 301  
Lois Silberman 301  
Loria (see Nelson, Loria)  
Louise Schloss (see Nusbaum (Betty)  
Louise Schloss)  
Maidie Goldsmith 301  
Marlene Ackerman 301  
Max 301  
Mayer Arnold (1852-) 320A  
Moses 301  
Nancy Horton 340B  
Nancy Nordlinger 301  
Nettie 231, 335A  
Pooch (see Nusbaum, Virginius H., Jr.  
"Pooch")  
Robert C., Jr. 301, 340B  
Robert Collier 301, 340B  
Sidaey Leon 301  
Solomon 335A  
Stella Ullman 301  
Virginius H., Jr. "Pooch" 301, 340B  
Virginius Harding 108, 301  
William 301, 340B  
**NUS(S) BAUM**  
Lewis 301  
**NUSSBAUM**  
Edgar (1884 (?) -1957) 311B  
Florence Springer (1890-1965) 311B  
**NYE**  
Joseph Keith 329A  
Phila Lazarus Calder 329A  
**NYSTROEM**  
Gladys Heyman 228  
Gosta 228  
Joy 228  
Liliane 228  
Mona 228  
**O'BEIRNE**  
Anita 310A  
Armine James 79  
Charles Burgogae 79  
Emily 79  
Eveline Fannie Amelia 79  
Francis Lewis 79  
Hamilton Kuhn 79  
Henrietta Francis 79  
James Hamilton 79  
Lewis Ormsby 79  
Rebecca Hamilton 78  
Rebecca Jane 79  
Thomas Ormsby 79  
William Henry Delancey 79  
**O'BRIEN**  
Eileen M. 169  
Kathryn Antoinette Peirano 238  
**O'CONNOR**  
John M. 11  
Martha Ann Gilinson 11  
**ODRISCOLL**  
Aimee 35  
Belle 35  
Belle Cohen 35  
Edith 35

Fanny 35  
Francis 35  
**OFERRAIL**  
Anne Bullitt Townsend Biddle 118  
Roderic 118  
**O'MALLEY**  
Catherine 195  
Dennis Sean 17  
Rosemary Louise Baruch 17  
**O'NEIL**  
Amelia 199  
Matilda A. 266  
**O'NEILL**  
Adela Pegram Myers 217  
Ella Teresa (1860-1932) 298, 299  
Richard F., Jr. (b. 1903) 217  
Richard Frothingham 217  
**O'REILLY**  
Marion 77  
**OSULLIVAN**  
Molly 123  
**OAKES**  
Adelaide Maria 76  
Alison Hartman 83  
Andra 83  
Ann 76  
Cynthia 83  
Eliza Turner 76  
Henry 76  
Isabelle Emma 76  
Israel 76  
John Bertram 83  
John Hartman 83  
John O. 76  
Katherine Isabel 76  
Margery Caroline Hartman 83  
Maria Dickson 76  
Mary 76  
Mary Elizabeth 76  
Milledge 76  
Milledge Aubrey 76  
Robert Dickson 76  
Sibyl Brown 76  
Stephen De Lancey 76  
William Baldwin 76  
**OAKLEY**  
Alice 113  
**OBENDORFER**  
Adrienne 40  
David 172  
Elias N. 172  
Elizabeth Arnold 42  
Elizabeth Arnold Weil 42  
Florence 231  
Frances (Fannie) Lewis 172  
Gertrude 172  
Henry 172  
John Louis 42  
Katherine Lee 42  
Louis Faulk 42  
Rose (1849-1892) 172  
Thomas Lee 42  
William Louis 42  
**OBERHAUER**  
Herbert 21  
Rosa Goldsmith Mayer 21  
**OBERLEDER**  
Howard S. (b. 1913) 242  
Leslie Pesca (b. 1908) 242  
Muriel Feldman 146  
Rosalie Pesca 242  
William 242  
**OBERMAYER**  
Abraham 90  
Henrietta 89, 90  
Leah Kraus 290  
Leonard 290  
Leonard, Jr. 290  
Schönle 90  
Teresa (Tiny) 290  
**OBERNDORFER**  
See also Oberon  
Ada 40

Gladys Lowenberg 108  
Gladys Mae 108  
Jefferson 108  
Norma Lee 108  
Pamela Douglas 108  
Susan Straus 107  
**OBERON**  
David 108  
Lindi 108  
Mildred 108  
**OBST**  
Anthony (1945-) 340B  
Cynthia (1983-) 340B  
Diana (1981-) 340B  
Emily Turk 340B  
Harold A. (1917-) 340B  
James (1953-) 340B  
Lawrence (1978-) 340B  
Mary (1947-) 340B  
Patricia Medcalf 340B  
Suzanne (1974-) 340B  
Victoria (1977-) 340B  
**OCHS**  
David 253  
Holly Ann Ehrich 253  
Iphigene Bertha (b. 1892) 291  
**OCHS-OAKES**  
See also Oakes  
Bertie Gans 83  
George Washington 83  
George Washington, Jr. 83  
**OCQUIDANT**  
Marie Josephine 214  
**ODENHEIMER**  
Babette 290  
**ODENTZ**  
Gates (b. 1931) 15  
Lawrence (b. 1929) 15  
Marion Nathan 15  
Myer 15  
**ODOM**  
Clifford 326B  
Enid 326B  
Garland 326B  
Helen 326B  
John 326B  
Johnnie 326B  
Emily Frederica (b. 1837) 235  
Enid Freed 337B  
**OETTINGER**  
Beatrice Hammer 89  
Dora Guggenheimer 89  
Dorothy 10  
Elmer R. 174  
Fred 89  
Julius 89  
Lynn Eve 89  
Mildred 255  
Pearl Lichtensteina 174  
**OGBURN**  
Nan 285  
**OGDEN**  
Addie Beeber Stix 285  
Birdie Virginia 88  
Dorothy Hamburger 15  
Ira C. 146  
Jane Stix (b. 1905) 285  
Margaret 146  
Margaret Stix (1904-1905) 285  
Margaret Kokernot 146  
Mary Jane (b. 1928) 15  
Mary Vance 52  
Paul 285  
S. Zachary 15  
**OGG**  
Frances Hard 37  
Marie Young Davis 37  
Robert Andrew 37  
Roberta Davis 37  
Walter Thomas 37  
**OKO**  
Adolph Siegmund 292  
Dorothy Kuhn Minister 292

**OLDEN**  
David 170  
George James 170  
Susan Levy 170  
**OLIPHANT**  
Robert 277, 278  
**OLIVA**  
Stella Ben Simon 191  
**OLLENDORF**  
Edith 46  
**OLSHO**  
Edward 174  
Ethel Lieber 174  
**OLSON**  
Renee 18  
**ONAN**  
Elizabeth 201  
**OPDYCKE**  
John B. 281  
Theresa Helburn 281  
**OPPENHEIM**  
See also Ogden, Oppenheimer  
Abraham ("Zur Kanne") (d. 1692) 235,  
337B  
Adela F. L. (1864-) 337B  
Adeline (dau. of Herman Detmold)  
235  
Alfred Philip (b. 1922) 235, 337B  
Bernard 235  
Catherine (dau. of Joseph H.) 235,  
337B  
Catherine (1865-1866) 235  
Catherine Moses 213, 235  
Charlotte (m. Hellwitz) 235  
Clarence J. (b. 1901) 235  
David (1664-1736) 235, 337B  
Edel Wertheimer 235  
Edel Zum Drachen 337A  
Edith (b. 1910) 293  
Edwin Hertz (d. 1918) 235  
Eleanor (Ellen) (1863-1944) 8, 235  
Eleanor 235  
Ellen (see Oppenheim, Eleanor  
(Ellen))  
Ellen Sue (b. 1926) 235, 337B  
Emil 235  
Emily Frances (1876-1923) 235  
Emily Frederica (b. 1837) 235  
Enid Freed 337B  
Eather Doris Hirsch 235, 337B  
Eather Hirsch 235  
Ferdinand (b. 1893) 235, 337B  
Frances 235  
Fredericke 235  
Fritz (see Oppenheim, Hertz Wolff  
(Fritz))  
Fromet Ballin 337A  
Gail Iris (b. 1947) 235, 337B  
Gnendl (d. 1734) 235  
Gnendl (dau. of Joseph) 235  
Gnendl Behrens Cohen 235, 337B  
Gnendl Lefman Cohen 337B  
Greta Katz 235  
Gutrad (d. 1811) 235  
Hale Gumpel 235  
Hannah A. Goldsmith 84, 235  
Hannah Joseph (d. 1911) 235  
Helen 235  
Henrietta Schulhofer 235, 337B  
Henry Ferdinand (1982-) 337B  
Henry Hertz (d. 1888) 235  
Herbert 235  
Herbert Smith (b. 1906) 235  
Herman 235  
Herman Detmold (d. 1896) 136, 235  
Hertz 235  
Hertz W. 235  
Hertz Wolff (Fritz) (1786-1853) 213,  
235, 337B  
Isaac Philip 235  
Jachet Gumpel 235  
Jacob 235  
Janet Sue (b. 1952) 235, 337B

Jeffrey Sable (1962-) 337B  
Jeute (d. 1786) 235  
Joseph (d. 1739) 235  
Joseph (Juda) (-1655) 337A  
Joseph (son of Joseph H.) 235  
Joseph H. (d. 1901) 235  
Joyce I. Marrits 235, 337B  
Juda (see Oppenheim, Joseph (Juda))  
Judith Mears (b. 1954) 235  
Judith Nevada (b. 1939) 235  
Julia Grace (1903-1945) 235  
Julius Hertz (1835-1903) 84, 235  
Julius Hertz (1870-1927) 235  
Justin Sable (b. 1923) 235, 337B  
Leah Bosing 235  
Lilian (dau. of Julius H.) 235  
Lilian (m. 1938) 235  
Lisette 235  
Louis Michael (b. 1898) 235, 337B  
Martha (1800-1867) 136, 326B  
Mathilda Rebecca (1830-1877) 17, 235  
Mathilde 235  
Maude 235  
Mayer (d. 1759) 235  
Michael (b. 1942) 235  
Mikell Mears Goldsmith (1867-1929)  
235  
Miriel Behrens Cohen 235  
Mona 235  
Mona Hirsch (b. 1925) 235, 337B  
Moses (d. 1781) 235  
Moses (Lond.) 110  
Moses (son of Samuel Hertz) 235  
Nettie 235  
Nevada (Vaddie) Smith 235  
Noah Samuel (d. 1721) 235  
Phillip 235  
Phillipe 235  
Phyllis (b. 1941) 235  
Rachel (unm.) 235  
Rachel 235  
Ralph (see Oppenheim, Raphael  
(Ralph) Benjamin)  
Raphael (Ralph) Benjamin (1868-1940)  
235, 337B  
Rebekka Sheffra Reiningdum 235  
Roy Hendricks (m. Moses) 110  
Ruth Mae (b. 1935) 235  
Samuel (d. 1860) 235  
Samuel (son of Herman) 235  
Samuel (son of Joseph H.) 235  
Samuel Hertz (d. 1910) 84, 235  
Sarah 340B  
Sarah (dau. of Simon Jacob) 235  
Sarah (dau. of Simon W.) 235  
Sarah Ann (b. 1908) 235  
Sarah Ann Goldsmith 84, 235  
Sarah Gertrude 235  
Sarah Jonas 136, 235  
Sarah Lewad 235  
Sarah Miriam Dankwert 235  
Sarah Rose Blum 235, 337B  
Shifrah Benjamin Wolf Spira 337B  
Simon Jacob (son Simon Wolff) 235  
Simon Wolff 235, 337B  
Stella (dau. of Herman Detmold) 235  
Sylvia Kleve 235, 337B  
Telze Wertheimer 235  
Wolf (b. 1822) 235  
Wolff (d. 1797) 235  
Wolff (son of Moses) 235  
'Zur Kanne' (see Oppenheim, Abraham  
'Zur Kanne')  
**OPPENHEIMER**  
See also Oppenheim  
Abraham (Abe) (b. 1871) 237  
Abraham (b. & d. 1879) 237  
Abraham (b. 1841) 236  
Abraham (b. 1850) 238  
Abraham (1765-1841) 236  
Abraham (1849-1914) 239  
Abraham B. (b. 1877) 239  
Adele Hofeller 236



Adelheid (Adeline) 236, 237  
Adelheid (b. 1875) 237  
Adelheid (m. Samuel) 237  
Adolph Joseph 237  
Alan D., Jr. 236  
Alan David 236  
Albert 239  
Alex 60  
Alfred (1867-1916) 236  
Ann 236  
Aryeh (see Oppenheimer, Lob (Aryeh, Levi, Leib))  
Babette 285  
Beatrice (unm.) 60  
Beatrice 127  
Beatrice Fannie 237  
Bedche Grunebaum (see Oppenheimer, Betty (Bedche) Grunebaum)  
Benjamin Meyer 237  
Berta Weissman 237  
Bertha Franziska Meyer 238  
Bertha Heineman 236, 237  
Bertha Matt 239  
Beryl Frances Barnes 238  
Betty (Bedche) Grunebaum 236, 237  
Betty Lehman Golden 236  
Beulah Davis 50, 238  
Carl Kirby 236  
Caroline M. Britenstool 236, 239  
Carrie (1857-1884) 238  
Carrie (1883-1928) 238  
Carrie (1885-1947) 239  
Cecilia (Cissie) 60  
Cilta Chambré 236, 237  
Cissie (see Oppenheimer, Cecilia (Cissie))  
Constance Stevens 237  
David (1835-1902) 236  
David Doherty 236  
David L. 236  
Deborah 237  
Edith Caroline 236  
Edward D. 236  
Eileen Ann Cook 237  
Eleanor Williams 133, 188  
Elias (1832-1916) 30  
Eliza Pool 60  
Ella Freedman 22, 321B  
Ellen Wise 188  
Elsie 22  
Elsie Phyllis 238  
Emanuel 337B  
Eric 60  
Erika 237  
Eather Cardozo Cauffman 30  
Eta (Louise) Goldberg 239  
Eva 60  
Fannie 238  
Florence (dau. Alex) 60  
Florence (1869-1960) 236  
Frances Elizabeth Graves 236  
Frances Mary Steenbeke 238  
Frank (b. 1912) 22, 321B  
Frank Weil 191  
Gail Kirby 236  
Gordon 60  
Gussie Wolf 239  
Harriet B. Kaan 237  
Harry (b. 1946) 237  
Harry (1873-1946) 237  
Hatye H. 239  
Helen Blackhall 236  
Helena May Shire 236  
Henrietta (Hester) 236  
Henry 133, 188  
Herman (1845-1921) 236, 237  
Hester (see Oppenheimer, Henrietta (Hester))  
Hilda 237  
Irene H. Hills 236  
J. Robert (1904-1967) 22, 309A  
Jack Carl 125  
Jacqueline Quana 22

James W., Jr. 236  
James Walter 236  
Janet (see Oppenheimer, Jeanette (Janet))  
Jean Loeb 236  
Jeanetta (Sprinz) Goldschmidt 236, 238, 239  
Jeanette (Janet) 238  
Jeannette Bertha 236  
Jeannette Loeb 236  
Jenny Sandel 237  
Jesse 236  
Jesse D. 101  
Jesse Davis (see Stedman, John)  
Jill 60  
Johanna Heil 236  
John Louis 236  
Joseph (1849-1913) 239  
Joseph A. 236  
Judah the Cohen (see Oppenheimer, Julius (Juda the Cohen))  
Judith (b. 1940) 22, 321B  
Judy Wilson 236  
Julia (b. 1872) 236  
Julius (Juda the Cohen) 236, 238, 239  
Julius (1871-1937) 22, 309A, 321B  
Kate Lowmes 236  
Katherine Harrison 22  
Katherine T. (b. 1944) 22  
Kenneth Harold (b. 1917) 238  
Kenneth Howard 238  
Kenneth Russell 238  
Lazarus 236  
Lea (1695-1742) 337B  
Leib (see Oppenheimer, Lob (Aryeh, Levi, Leib))  
Lena Kuttmauer Kahn 239  
Levi (see Oppenheimer, Lob (Aryeh, Levi, Leib))  
Levi 239  
Levi B. 50, 238  
Lillian (1883-1944) 239  
Lillie Halff 101  
Lob (Aryeh, Levi, Leib) 236  
Louis (Ludwig) 237  
Louise 285  
Louise Goldberg (see Oppenheimer, Etta (Louise) Goldberg)  
Ludwig (see Oppenheimer, Louis (Ludwig))  
Mabel 238  
Margot Baer 237  
Margot Mendes 191  
Marion (see Oppenheimer, Mary (Marion))  
Mark 237  
Mariene Lois Fox Darlich 236  
Mary (Marion) 236  
Mary Ellen Silverstone 125  
Max 237  
Meyer (see Oppenheimer, Rachel (Meyer))  
Michael (b. 1943) 22, 321B  
Michel 60  
Minnie L. Stern 236  
Mollie Meyer 237  
(Mrs.) M. L. Prescott 235  
Myer (Meier) 236, 239  
Nancy Doherty 236  
Nathan (1867-1949) 236  
Nathan, Jr. 236  
Paul (see Ogden, Paul)  
Paul Lowmes 236  
Paulina 237  
Peter (b. 1941) 22  
Peter John 236  
Philip Victor 236  
Phyllis Lefcowitz Jadd 236  
Piza 191  
Prade Behrens Cohen 337B  
Rachel (Meyer) 237  
Rachel (see also Oppenheimer, Regina (Rachel))

Rachel (see also Oppenheimer, Reina (Rachel))  
Rachel (1846-1897) 238, 239  
Rachel Frank 237  
Regina (Rachel) 236  
Regina (see also Oppenheimer, Rosa (Reina, Regina))  
Regina (1877-1937) 237  
Reina (Rachel) (1774-1838) 236  
Reina (see also Oppenheimer, Rosa (Reina, Regina))  
Robert Stephen, Jr. 238  
Rosa (Reina, Regina) (1839-1924) 236  
Rosa (1872-1935) 239  
Rosalie Oppenheimer (see Oppenheimer, Rose (Rosalie) Oppenheimer)  
Rose (Rosalie) (1869-1943) 236  
Rose (Rosalie) Oppenheimer 236  
Rose (1865-1955) 236  
Rose (1880-1952) 236, 237  
Ruth Saperston 236  
Ruth Weitzenkorn Ullman 236  
Sadie 239  
Sadie Jacobs 237  
Sally (b. 1884) 237  
Sally (b. 1930) 236  
Samuel (1877-1918) 237  
Samuel Wolff (d. 1703) 235, 337B  
Sandele Carcasone 337B  
Sarah Wise 188  
Siegbert 237  
Simon Wolff (-1726) 337B  
Sprinz Goldschmidt (see Oppenheimer, Jeanetta (Sprinz) Goldschmidt)  
St. Julien 188  
Stella (1878-1926) 239  
Stella Baer Kronthal 239  
Suzanne 236  
Suzanne Wendy 239  
Violet 60  
Walter (Wolf) 236  
William T. 188  
Wolf (see Oppenheimer, Walter (Wolf))  
Wolf (1850-1929) 236, 237  
**ORDE-POWLETT**  
Georgina 81  
**ORGLER**  
Feigele 324B  
Freidel (Frummet) Bloch 324B  
Jechiel Michael (-1733) 324B  
**ORKIN**  
Alfred 138  
Martia 138  
Philip 138  
Sarah Florence Wolff 138  
**ORME**  
Charles 39  
Julia C. 39  
Mary Clarke Cohen 39  
Mary Ellen 39  
**ORNOFF**  
Helen Schools 143  
Jeffrey 143  
Michael 143  
Robert E. 143  
**ORR-EWING**  
Viola 77  
**ORSAY**  
Blanche (Dolly) 60, 61  
Jennie Langner 60  
Leopold 60  
Manuel 60  
Margaretta 60  
Pedro 60  
Stella (dau. of Leopold) 60  
Stella (m. 1910) 61  
**ORTMAN**  
Vita 288  
**ORTON**  
May 307  
Rachel (see also Oppenheimer, Regina (Rachel))

Gladys Sheftall Neumann 270  
Joseph 270  
**OSBORNE**  
Fredda Jean 282, 313B, 339B  
Joseph 270  
Neva 269  
**OSENTEN**  
Edith 174  
**OSHER**  
Elizabeth Goldsmith 294  
Harold 294  
James 294  
Thomas 294  
William 294  
**OSMOND**  
Sarah 230  
**OSORIO**  
Ellen (ca. 1870-1954) 30  
Hattie Fuld 30  
Isador (1840-1914) 30  
J. Newton (1876-1948) 30  
Miriam N. Carvalho 30  
Rosalfine 59  
**OSTERHOUT**  
Joseph (b. 1799) 62  
Miriam B. 254  
Rosanna Dyer 62  
V. H. 62  
**OSTERWEIL**  
Alice Weichselbaum 327B  
Irving (1901-1974) 327B  
John (1942-) 327B  
Leslie Ann Falk 327B  
**OSTLER**  
Henry Edmund 117  
Julia Hertz 117  
**OSTRANDER**  
Elizabeth Rebecca 97  
**OTERA**  
Eurelia 112  
**OTTENSOSER**  
Gutta 333A  
**OTTOLENGUI**  
Abraham (b. 1831) 234  
Abraham (1790-1850) 234  
Abraham (1849-1852) 234  
Abraham (1854-1894) 234  
Amanda Isabel (b. & d. 1874) 234  
Anna S. Childs 234  
Benjamin A. Rodriguez (1861-1937) 234  
Cecile 176, 234  
Cornelia Alice 234  
Daisy (b. & d. 1873) 234  
Daniel 234, 254  
Eliza Emma 234  
Eliza Emma Jacobs 132, 234  
Ella 234  
Esther Sarah 234, 277, 278  
Florence Dombey 234  
Franklin Moise (b. 1871) 234  
Helen C. 234  
Helen Rosalie Rodriguez 234, 254  
Hetty J. (1818-1886) 17, 234  
Isa (b. & d. 1865) 234  
Isaac 234  
Israel (1832-1895) 196, 234  
Israel, Jr. 234  
Jacob (1819-1900) 132, 234  
Jessie 234  
Judith A. (1816-1883) 210, 234  
Mary R. Childs 234  
May Hall 234  
Miriam 234  
Mordecai (d. 1794) 234  
Mordecai (son of Abraham) 169  
Mordecai H. 234  
Nina Alice 234  
Rachel 234  
Rebecca 234  
Rebecca Florence 36, 234  
Rinah (d. 1810) 234  
Rinah J. (1813-1845) 210, 211, 234

Rosalie 234  
Rosalie Cecile Moise 196, 234  
Rosalie Moise 234  
Roy Edward 234  
Sarah (dau. of Abraham) 210, 211, 234  
Sarah (1793-1864) 234  
Sarah (1855-1877) 176, 234  
Sarah Jacobs 234  
**OUCHTERLONEY**  
Donald 109  
Ethel Heineman 109  
James Delgarens 109  
James F. 109  
Robert 109  
**OUSTA**  
Charlotte Hyman 121  
**OUTERBRIDGE**  
Archibald M. 134  
Leah Jacobs Adams 134  
**OVERBECK**  
Dorothy E. 90  
**OWEN**  
Barbara M. 241  
Judith P. 241  
Margaret R. 241  
Peggy (Flora) Morningstar 241  
Paul Burry 241  
**OWENS**  
Benjamin 39  
Catherine 39  
Daniel 39  
Frances 39  
John 39  
Roberta Jean (1945-) 330A  
Sarah (dau. of Benjamin Philip) 39  
**OWSLEY**  
Albert Eugene 269  
Bessie Sheftall 269  
**OXFORD**  
Earl of (see Asquith, Julian Edward George (1st Earl of Oxford))  
**OXHOLM**  
Carl (m. 1922) 310A  
Carl, Jr. (b. 1923) 310A  
Dorothy Rebecca Henriques (b. 1899) 310A  
Eleanor Cunningham 310A  
Elizabeth (b. 1925) 310A  
**PAASCH**  
Ida 117  
**PACE**  
Harriet Elizabeth (m. 1945) 206  
**PACH**  
Al 145  
Maude Rosalie Kraus Sloan 145  
**PACHECO**  
Benjamin Mendes (see Pacheco, Rodrigo)  
Judith Seixas (d. 1738) 263  
Rodrigo 263  
**PACKARD**  
Lauretta (1796-1839) 251  
**PADGETT**  
Amy Woodruff (1849-1920) 128  
**PAGE**  
Adeline Springer 237  
Edward George 237  
Gloria Alfreda 237  
Gordon Prince (1850-1893) 55  
Marion De Leon Adams 55  
**PAGGI**  
Florie Gambatti Jones 117  
**PADNE**  
Angelina Mendes-seixas 168  
Anne 168  
Charles 168  
Edward 168  
Thomas S. 168  
**PAINTER**  
A. R. 207  
Eliza Moses 207  
**PALACHE**  
Alexander (1779-1851) 240

Eliza 240  
Esther (1798-1863) 240  
Judith (1812-1884) 240  
Luna De Silvera 240  
Mordecai 240  
Rachel (1809-1894) 240  
Sarah (1812-1878) 112, 240  
**PALAIRET**  
Anne Marie Celestine 79  
Anthony Michael 79  
Caroline Mabel Laverton 79  
Charles Andrew Hamilton 79  
Charles Harvey 79  
Charles Michael 79  
Charlotte Ellen Rooke 79  
Edith 79  
Elizabeth Ann Bigg 79  
Emily Henry 79  
Emily Katherine Scobell 79  
Henry Edward Hamilton 79  
Henry Hamilton 79  
Henry Septimus 79  
Lionel Charles Hamilton 79  
Marie Dominique Tripier 79  
Mary Ann Hamilton 79  
Mary De Vere Studd 79  
Pual Cameron North 79  
**PALAIS**  
Josephine 91  
**PALMBAUM**  
Bessie Hoffman 283, 339B  
Elkan 283, 339B  
Selma 283, 339B  
**PALMER**  
Alexander Winsor 158  
Alice Hermann 116  
Denison Scott 158  
Eleanor Carroll 158  
Elise Hope Winsor 158  
Ella May 238  
Henry 116  
Hope 158  
Sally 158  
Sanford Denison, Jr. 158  
Wendy Holman Slater 158  
**PALMISTER**  
Clarissa 184  
Content Marks 184  
Cyrus 184  
**PANTESE**  
Margaret Phillips 245  
**PANTHER**  
Callie Esther 213  
**PARDEE**  
Comfort Marks 184  
Joseph 184  
**PARDO**  
See also Brown  
Abigail (d. 1742) 240  
Abraham 240  
David (d. ca. 1702) 240  
David (d. 1657) 240  
David (d. 1716/17) 240  
Eather de Jacob Israel Monsanto 240  
Hannah M. 263, 339A  
Isaac 240  
Isaac Jr. 339A  
Joseph (d. 1677) 240  
Joseph (d. 1619) 240  
Joseph (d. 1704) 240  
Joseph (see also Brown, Joseph)  
Josiah (1694-1755) 240  
Josiah 240  
Judith 175, 331A  
Michael 175, 331A  
Rachel Sanchez 240  
Sarah Rebecca (d. 1764) 240  
Saul (see also Brown, Saul)  
Saul 240  
Simbah (d. 1768) 240  
**PARERA**  
See Pereira  
**PARISS**

Daniel Nathan (1980-) 328B  
Jane Abigail 328B  
Jennifer Esther (1986-) 328B  
Philip Steven (1945-) 328B

#### PARLA

Ana Nones 336A  
Romulo 336A

#### PARIS

Marjorie Joan Polak 332A  
Mark Lyle (1954-) 332A  
Marvin Lyle 332A  
Robert Owen (1957-) 332A

#### PARKE

Barbary Mary 249  
Carol Adaline Phillips 249  
Jill Phillips 249  
Stephen P. 249

#### PARKER

Benjamin 8  
Daniel 9  
Enid 206  
Eve 9  
Harriett Anne Solomons 198  
John T. III 198  
John Theodore, Jr. 198  
Leigh Anne 198  
Mary Dorsey 156  
Nathan 9  
Norma Jean 189  
Rachel Eve 9  
Rachel Eve Neely 9

#### PARKINSON

Elizabeth 195

#### PARR

Florence 156

#### PARRAVICINO

Humberto 51  
Judith Deborah Daniels 51  
Mary Edwards 51  
Noreen 51  
Robert 51  
V. 51

#### PARRISH

Johannie Mae 53

#### PARRY

Harriett Emily 269  
Martha Alice 269

#### PARSONS

Alene 125  
Cordelia Lopez Seixas 265  
PARTRIDGE  
Margaret Livingston (b. 1909) 155  
Margaret Ridgely Schott 155  
William Ordway 155

#### PASCUAL

Beatrice Naar 225  
Caroline 225  
Juan 225

#### PASDELOUP

Anaise 311A, 328B

#### PASEY

Fanny Marks 186

#### PASS

See also De Pass  
Aaron 58  
Hannah de Jacob Dias 58

#### PASSAMORE

Frank 166  
Martha Levy 166

#### PASTERNAK

Amy Schloss 125  
David Michael 125  
Joseph 125  
Judith 125

#### PATA

Sheila (1954-) 331B

#### PATCH

Gertrude Mary Keiley 81  
Roderick Stanley 81

#### PATE

Frank 5  
Jo Ann Hudson 5

#### PATERSON

Patty Heustis 183  
W. B. 183

#### PATIN

John Stephen 257  
Marjorie Clare Karstendiek 257

#### PATTERSON

Abraham 337A  
Dorothy 141  
Gloria Henriques 310A  
John L. 310A  
Theodosia 337A

#### PATTISON

Ellie Ellet 128  
George H. 128

#### PAUL

See also De Paul  
Alexander M. 49  
Anne V. 49  
Donald 310A  
Elizabeth Henriques 310A  
Ian Thomas 108  
Lucille Pizzini 49  
Matty 217  
Susan Lowenberg 108  
Susan Metzger 108  
Todd Sullivan 108  
Wayne 108

#### PAULK

Mark Fanny (1876-1943) 324A

#### PAVOT

Evelyn Weber 111, 325B  
Jean 111, 325B

#### PAWSON

Cordelia Lopez Seixas 265  
Harold 265

#### PAXTON

Ann Sberwood Andrews 12  
Barbara Dale 12  
Harold D. 12  
Katherine Ann 12  
Mary J. 128  
Richard Joseph 12

#### PAYNE

Brooke McBlair 156  
Elizabeth Nones Ballard Ewing 337A  
Eugenia McBlair 156  
Georgia Elizabeth Mordecai 203  
Gladys Margaret 78  
Herbert A. 337A  
James K., Jr. 156  
James Keith 156  
John Howard 126  
Matthew E. 203  
Molly 81  
Nancy McBlair 156  
Sarah Isaacs 126  
Sophie F. (1883-1978) 336A  
William 126

#### PAYNE-GALLWEY

Charlotte 76  
Phila De Lancy 76  
Stephen 76

#### PAYNTER

Ann Maria 77

#### PAYSON

Mary M. 23

#### PAZ

See De Pass (Paz)

#### PEABODY

Homer 104  
Maud Hays Janney 104

#### PEACE

Kathryn F. 80

#### PEARCE

Mary 154

#### PEARCY

Adeline H. Jacobs 134  
Gordon M. 134

#### PEARL

Augusta Lyon (1947-) 312A, 332A  
Carleton Day (1943-) 332A  
George Carleton 181, 312A, 332A  
Judith Ann Weatherston 332A

Margaret Lyon Scheuer 181, 305,  
312A, 332A, 341A  
Mary Coriiss (1950-) 312A, 332A

#### PEASE

Katherine 91

#### PECARE

Henriette 311A

#### PECK

Abigail (1748-1798) 251  
Alfred 310A  
Alfred, Jr. 310A  
Ben 328A  
Helen 278  
Josephine 328A  
Josephine Kokernot 328A  
Josephine Suarez 310A  
Thankful 251

#### PEISER

Caroline Pine 250  
Jacob (b. 1842) 250

#### PEIXOTTO

Abigail Lopez 179, 242  
Abraham 240  
Abraham Cohen (d. 1781) 240  
Adrian 240  
Adrienne C. 240  
Alexander 242  
Antonio Mendes (see Peixotto, Joshua  
Cohen (Antonio Mendes)  
Beatrice (b. 1867) 241  
Benjamin Franklin (1834-1890) 241  
Bridget Caulfield 338A  
Camille C. 240  
Caroline C. 240  
Caroline Solomons 240, 277  
Catharine Dishman 241  
Daisy C. 240  
Daniel (b. 1789) 240  
Daniel (b. 1831) 241, 338A  
Daniel (son David) 240  
Daniel Cohen (b. 1789) 240  
Daniel Cohen (d. 1769/70) 240  
Daniel Levy Maduro (1799-1843) 241,  
266  
Daniel Levy Maduro (1854-1898) 241,  
276  
Daniel M. 241  
David Alan (1983-) 337B  
David Cohen (son of Diego Mendes)  
240  
David Cohen (1816-1897) 179, 242  
David E. Cohen (1815-1897) 240, 277  
Deborah Sarah Cohen 185  
Diego Mendes 240  
Edgar 241  
Edgar Cohen (1884-1940) 240, 337B  
Edgar J. Davis (b. 1867) 226, 241  
Ernest Clifford (b. 1869) 241, 312B  
Ernest Dishman 241  
Ether (d. Amsterdam) 240  
Ether (d. 1853) 240  
Ether (Hetty) (1821-1890) 241, 244  
Ether de Jacob Cohen 240  
Ether De La Faya 240  
Ether de Samuel Lopes Henriques  
240  
Ether de Solomon Levy Maduro 240  
Ether (Hetty) (1821-1890) 241, 244  
Ether Nunes 240  
Ether Pretto Naar 224, 241  
Eustace (b. 1887) 241  
Eustace Maduro 241  
Fanny Corinne 241  
Florian (Frank) (1870-1910) 241  
Francis Raphael (b. 1833) 241  
Francis Raphael 241, 338A  
Frank (see Peixotto, Florian (Frank))  
Frederick Louis Napoleon 241, 338A  
Frederick Naar (b. 1836) 241  
George Da Maduro 241  
Grace (b. 1809) 241  
Grace (b. 1817) 240  
Grace (m. 1817) 240

Grace Cohen (b. 1775) 240  
Gracia Campos Pereira 240  
Hannah Rachmil 240, 337B  
Hannah Strauss 241  
Helen 241, 338A  
Helen Kelly 241  
Herman (b. 1832) 224, 241, 338A  
Hetty (see Peixotto, Esther (Hetty))  
Hortense (1924-1978) 240, 337B  
Hortense Levy 240  
Ida Judith Solomons 241, 276  
Irma Rachel Levy Maduro (b. 1881)  
241  
Irving 241  
Isaac 240  
Isaac Levy Maduro (b. 1773) 241  
Jack 241  
James L. (b. 1920) 241  
James Maduro 241  
Jean Small 241  
Jessica Blanche (1864-1941) 241, 312B  
Joanne (b. 1949) 240, 337B  
Joseph Cohen 240, 241  
Joshua 185  
Joshua Cohen (Antonio Mendes) 240  
Joshua Cohen (b. 1810) 240  
Joshua Cohen (m. 1773) 240  
Josuah (b. 1663) 240  
Judith (b. 1712) 185  
Judith (dau. of Benjamin) 241  
Judith Eugenia Salzedo 241  
Judith Lopez Salzedo Maduro 241  
Judith Salzedo (1823-1881) 104, 241  
Jules 240  
Katherine De Sadowska 241  
Katia Sadowsky 241  
Leah (b. 1790) 241  
Leah (m. 1824) 241  
Leah (m. 1837) 240  
Leah Cohen (1743-1827) 240, 241  
Leah Cohen (1822-1909) 228, 240  
Lillian Maud (b. 1898) 241  
Luna (Lunita) (b. 1838) 241, 338A  
Luna de Aaron N. Henriques 241,  
338A  
M. Percy (b. 1862) 241  
Mabel Louise (b. 1869) 241  
Malvina Nathan 226, 241  
Marie Gomez (see Peixotto, Miriam  
(Marie) Gomez)  
Mark Percy Da Maduro 241  
Mary G. Lascock Hutchinsonson 241, 312  
Michael Jay (1986-) 337B  
Miriam (Marie) Gomez 85, 241  
Miriam C. 240  
Miriam Maduro (1842-1923) 48, 241  
Morris 242  
Moses (1825-1827) 241  
Moses Cohen (m. Deborah Sarah  
Cohen) 185  
Moses Cohen (son of Diego Mendes)  
240  
Moses Levy Maduro (1767-1828) 241  
Moses Levy Maduro II (1830-1890) 85,  
241  
Mozes Cohen 240  
Myrtilia Jessica Davis 241  
Nina Mapleson 241  
Phyllis Frankel 241  
Rachel (Aboab) 240  
Rachel (dau. of Abraham C.) 242  
Rachel (1813-1843) 240  
Rachel Cohen 240  
Rachel Cohen Peixotto 240  
Rachel de David de Isaac Soares 240  
Rachel de Isaac Jansurun Sasportas  
Maduro 241  
Rachel de Moses Israel Nunes 240  
Rachel Frois 85, 241  
Rachel Levy Maduro 240, 241  
Rachel Luisa (1820-1870) 241  
Rachel Marques 185  
Rachel Nunes 240

Rachel Seixas 241, 266  
Raphael (1805-1842) 241, 338A  
Raphael (1837-1905) 241  
Rebecca (Ribca) 240  
Rebecca (1820-1837) 240  
Rebecca (1822-1895) 241, 244  
Rebecca (1832-1835) 241  
Ribca de Jacob de Solomon Levy  
Maduro 240  
Robert (b. 1952) 240, 337B  
Rolland Eustace 241  
Samuel (1793-1843) 85, 241  
Sarah (b. 1807) 224, 241  
Sarah Cohen (m. 1777) 240  
Sarah Cohen (1826-1904) 228, 240  
Sarah de David de Jacob Lopes Dias  
241  
Sarah Naar (1828-1900) 29, 241  
Semuel 241  
Shirley Thayer 240, 337B  
Sidney S., Jr. 241  
Sidney Salzedo (b. 1866) 241  
Simha C. (1807-1892) 242  
Solomon C. (b. 1918) 240, 337B  
Solomon C. (d. 1905) 240  
Solomon Cohen (1785-1837) 240  
Sue Staller 337B  
Victoria Maud 241  
Virginia (1860-1925) 242  
Zelma (b. 1917) 240, 337B  
Zipporah (1826-1889) 241, 266

#### PELHAM

David 44  
James 60  
Olive Blok 60

#### PELLITIERE

Ezekiel (b. 1799) 276  
Isidore 276  
Sophie Solomons 276

#### PELOUS

Edith Marie Hart 96  
Etienne Joucla 96

#### PELLPHREY

Rose 53

#### PELT

See Van Pelt

#### PELLTIER

See Pellitiere

#### PELTON

Bunford Samuel (b. 1927) 262  
Clifford L., Jr. (b. 1929) 262  
Clifford Livingston 262  
Dorothea Samuel 262

#### PELTZ

Frances Annette Lyon 181  
Lawrence 181

#### PEMBER

Phoebe Levy 169  
Thomas Noyes 169

#### PENCORTON

Elizabeth Hays 106

Lorent 106

#### PENDLETON

Joanne 83

#### PENNINGTON

Florence M. Newhouse 231, 335A  
Nobel 231, 335A

#### PENROSE

Christine 254

#### PEPPER

Catherine (Frau Getele) Keyser 69  
Ether (d. 1874) 69  
Ezekiel 69  
Hannah (1802-1888) 69, 303  
Isaac (1762-1822) 69  
Josephine (Jocbebed) 69  
Lipe (Louis) (1799-1881) 69

#### PERAIRE

Edward 262  
Zelmire Sasportas 262

#### PERCIVAL

Margaret Louisa Rosalind 77

#### PERCY

Constance Lehair 174

#### PEREGOY

Catherine (1908-1964) 335B

#### PEREIRA

Aaron Israel 258  
Abigail de Benjamin de Menasse 85  
Abraham 242  
Abraham Haim 242  
Abraham Rodriguez 242  
Aron 242  
Branca Querido 242  
Brenka 242  
Daniel Fernandes 58  
Eleazer 242  
Fanny 242  
Frumet 242  
Gracia Campos (d. 1788) 240  
Isaac 242  
Jacob 242  
Juda 242  
Mary ( see Pereira, Mirjam (Mary))  
Mietje Halberstad 242  
Mirjam (Mary) 242  
Mynitie Levie 242  
Rachel De Groot 242  
Rachel De Pass 58  
Rebecca Lopes (see Pereira, Ribca  
(Rebecca) Lopes)  
Ribca (Rebecca) Lopes 58  
Ribca de Isaac Israel 302  
Salomon (Pareira) (b. 1809) 242  
Sarah Rodrigues 242

#### PERERA

Caroline Allen 10  
Charles Allen (b. 1904) 10  
George A. (b. 1911) 10  
Lionel Cantoni (b. 1909) 10  
Lionello (b. 1871) 10  
Lydia (b. 1917) 10  
Nina (b. 1907) 10

#### PEREYRA

Leah Henriquez 178

#### PEREYRE

Sara 335A

#### PEREZ

Barbara Blakeslee 123  
Henry Sealey White 123  
Mary White 123  
Molly O'Sullivan 123  
Paul Edward 123  
Paul Powers 123  
Robert 123

#### PEREZ DE CUNHA

Joao (see Da Costa, Joseph (Perez De  
Cunha, Joao))

#### PERKINS

Priscilla 336A

#### PERLE

Amelia Newman 160  
Max 160

#### PERFICH

Cathy Jean Sulzberger 314A  
Joseph G. 314A

#### PERRIMAN

Eliza (1810-1853) 58

#### PERRON

Pelagie 135

#### PERRY

Beaumont 212  
Catherine Whyte 212  
Ellen Dorothy Bach Saunders 13  
Mamie Alice Seixas 266  
Patricia 13  
Viannah (1866-1902) 324A  
William 266

#### PESICKA

Louise Rocco 237

#### PESOA

Abraham (1799-1834) 242  
Abraham Phillips 242  
Clara Marks 103, 242  
Cynthia Frois (1840-1842) 242  
David (1801-1865) 103, 242



Elizabeth Simmons Childs 242  
 Florance Gomez (1875-1917) 242  
 Gustavus I. (1805-1842) 85, 242  
 Hetty (1809-1886) 242  
 Isaac (1762-1809) 242, 243  
 Isaac Gomez (1833-1901) 242  
 Josephine Phillips 242  
 Juliet Gomez 85, 242  
 Miriam Rosina (Rosalie) (1837-1929) 245  
 Oscar Abraham (1835-1901) 242  
 Phila Phillips 242, 243  
 Rachel (1798-1856) 242  
 Rebecca 242  
 Rebecca Louis 242  
 Rosalie (b. 1883) 242  
 Rosalie (see also Pesoa, Miriam Rosina (Rosalie))  
 Samuel I. (1843-1919) 242  
**PETASHNICK**  
 Lois 167  
**PETERFREUND**  
 Selma Ruth 15, 320B  
**PETERMAN**  
 Cele McNulty 311A  
**PETERS**  
 Carolyn Babb Sheftall 268  
 Eliza 180  
 Esther (Hetty) Cohen 180  
 Hoyt M. 190  
 Hoyt M., Jr. 190  
 Isaac 180  
 John Clem 268  
 Mary Lea 268  
 Millicent Mayer 190  
 Patricia Ann 190  
 Ralph 180  
 Rebecca 180  
 Sally 180  
 Thomas (Baltimore) 180  
 Thomas (son of Thomas) 180  
 Timothy Mark 268  
**PETERSON**  
 Karen 138  
 Sarah (1876-1951) 219  
**PEIRE**  
 Mildred Mary 79  
**PETITGREW**  
 Abby 243, 338A  
 Hetty 11, 243  
 James (1756-1793) 103, 243  
 James (1785-1841) 243  
 John S. (1784-1820) 243  
 Judith Hart 103, 243  
 Maria 243  
 Rachel (1788-1863) 243  
 Samuel 243  
**PETZELT**  
 Christopher 74  
 Frances 74  
 Frances Polk 74  
**PEYSER**  
 Caroline Hamell 248  
 David (b. 1848) 248  
 David (son of Theresa S.) 281  
 Eugene 339A  
 Eva Lee Ezekiel 70  
 Hannah 281  
 Irving 339A  
 Jane Phillips 248  
 Lewis 248  
 Mark W. 70  
 S. M. 339A  
 Samuel (b. 1849) 248  
 Theresa Spiro 281, 339A  
**PFÄELZER**  
 Betty (dau. of Morris) 296  
 Betty (m. Harry Horner) 296  
 Elaine 296  
 Elsie Levy 296  
 Fay 296  
 Frank 296  
 Henrietta (Hettie) 296

Leonore Bitterman Wollenberg 309A  
 Malcolm 309A  
 Marjorie Lesser 296  
 Mildred 296  
 Morris (m. Marjorie Lesser) 296  
 Morris (1848-1913) 296  
 Peggy Goldsmith 296  
 Peter 296  
 Richard 296  
 Sophie Kohn 296  
**PFEFFNER**  
 Molly A. 245  
**PFEIFFER**  
 Aaron (see Phillips, Aaron (Pfeiffer))  
**PFIFFER**  
 Sadie Arnold Rohr Franklin 320B  
**PFLAUM**  
 Ruth 102  
**PHADBUSCH**  
 Aaron 243  
 Phila Von Stein 243  
**PHILIPS**  
 Aaron 198  
 Aaron Cohen 198, 268  
 Albert 208  
 Albert C., Jr. 208  
 Albert Carroll 208  
 Arabella Solomons 279  
 Charlotte Fuchs 208  
 Charlotte Virginia 208  
 Arthur (1850-1903) 245  
 Asher (b. 1846) 38, 249  
 Asser (Asher) 248  
 Augustus K. (b. 1842) 311B  
 Austin Cooper 246  
 Barnet (son of Lawrence) 245  
 Barnet (1750-1817) 245  
 Barnet (1824-1876) 246, 261  
 Barnet (1826-1905) 216, 245  
 Barnet B. 245  
 Barnet III (b. 1876) 245  
 Barnet IV (b. 1917) 245  
 Beatrice Hendricks 110, 244  
 Beatrice Rachel 246  
 Benjamin (b. 1842) 243  
 Benjamin (son of Jonas) 245  
 Benjamin Jonas (1776-1830) 243, 266  
 Benjamin McCready 249, 285  
 Benjamin Samuel (Lord Mayor of Lond.) 246  
 Benjamin Samuel, 2d Baronet 246  
 Benjamin, Jr. (b. 1810) 243  
 Bernice Rosen 244  
 Boaz (b. 1847) 248  
 Brandley (Fanny) 246  
 Camilla Paulfrey Mumford 168  
 Carol Adaline (b. 1911) 249  
 Carol Elizabeth 168  
 Caroline (1820-1888) 168  
 Caroline (b. 1853) 168  
 Caroline Elizabeth Pope 168  
 Caroline (Lena) (b. 1841) 216, 247  
 Caroline Jullien (b. 1906) 245  
 Caroline Jullien (m. Barnett III) 245  
 Caroline Lazarus 151, 247  
 Caroline Pike 248, 250  
 Catherine (b. 1834) 248  
 Catherine (dau. of David) 243  
 Catherine (Gitlah) De Young 248  
 Catherine (see also Phillips, Gitlah (Catherine))  
 Catherine (1809-1885) 205, 206, 243  
 Catherine (1844-1889) 243  
 Cecilia 246  
 Charles (son of Alfred) 245  
 Charles (son of Samuel) 246  
 Charles I. (1843-1919) 137, 243, 326B  
 Charles Lex (b. 1846) 243  
 Charlotte Hyman 121, 244  
 Clara (dau. of Mark) 246  
 Clara (1835-1891) 243  
 Clara (1843-1867) 249  
 Clara Cohen 38, 249  
 Adolphus 245  
 Agnes 246  
 Alberta Falck Wolbach 48  
 Alexander (b. ca. 1776) 248  
 Alexander (see also Phillips, Israel J. (Alexander))  
 Alfred (m. Rebecca Samuel) 245, 261  
 Alfred (son of Alexander) 248  
 Alice Levy (m. 1872) 163, 249  
 Alice Phoebe 246  
 Allan 249  
 Alma Judith (b. 1883) 244  
 Altamont 243  
 Amanda (b. 1812) 163, 247  
 Amelia Jennings (1812-1884) 168  
 Amelia Judah Friedman 41, 244  
 Amy Isaacs 246  
 Amyne Evelyn Gordon 246  
 Angelica Susannah 168  
 Angelina L. (1818-1834) 168  
 Anita 70  
 Ann Engi 168  
 Ann Margaret 246  
 Ann Maria 168  
 Annabella (1871-1933) 245  
 Anne 249  
 Arabella Solomon 28, 223, 243  
 Arliza (son of Barnet) 246  
 Arthur (son of Octavus) 245  
 Arthur (1850-1903) 245  
 Asher (b. 1846) 38, 249  
 Asser (Asher) 248  
 Augustus K. (b. 1842) 311B  
 Austin Cooper 246  
 Barnet (son of Lawrence) 245  
 Barnet (1750-1817) 245  
 Barnet (1824-1876) 246, 261  
 Barnet (1826-1905) 216, 245  
 Barnet B. 245  
 Barnet III (b. 1876) 245  
 Barnet IV (b. 1917) 245  
 Beatrice Hendricks 110, 244  
 Beatrice Rachel 246  
 Benjamin (b. 1842) 243  
 Benjamin (son of Jonas) 245  
 Benjamin Jonas (1776-1830) 243, 266  
 Benjamin McCready 249, 285  
 Benjamin Samuel (Lord Mayor of Lond.) 246  
 Benjamin Samuel, 2d Baronet 246  
 Benjamin, Jr. (b. 1810) 243  
 Bernice Rosen 244  
 Boaz (b. 1847) 248  
 Brandley (Fanny) 246  
 Camilla Paulfrey Mumford 168  
 Carol Adaline (b. 1911) 249  
 Carol Elizabeth 168  
 Caroline (1820-1888) 168  
 Caroline (b. 1853) 168  
 Caroline Elizabeth Pope 168  
 Caroline (Lena) (b. 1841) 216, 247  
 Caroline Jullien (b. 1906) 245  
 Caroline Jullien (m. Barnett III) 245  
 Caroline Lazarus 151, 247  
 Caroline Pike 248, 250  
 Catherine (b. 1834) 248  
 Catherine (dau. of David) 243  
 Catherine (Gitlah) De Young 248  
 Catherine (see also Phillips, Gitlah (Catherine))  
 Catherine (1809-1885) 205, 206, 243  
 Catherine (1844-1889) 243  
 Cecilia 246  
 Charles (son of Alfred) 245  
 Charles (son of Samuel) 246  
 Charles I. (1843-1919) 137, 243, 326B  
 Charles Lex (b. 1846) 243  
 Charlotte Hyman 121, 244  
 Clara (dau. of Mark) 246  
 Clara (1835-1891) 243  
 Clara (1843-1867) 249  
 Clara Cohen 38, 249

Clare M. 246  
 Clavius (b. 1838) 35, 247  
 Coleman 246  
 Corinna (1829-1908) 132, 245  
 Cyril Katherine Faudel 246  
 David (b. 1842) 248  
 David (son of Lewis J.) 249  
 David (1791-1861) 248  
 David A. 129  
 David L. 249  
 David Machado (b. 1768) 243  
 Deliah (1820-1869) 248  
 Dinaah 243  
 Dolly Lewin 2  
 Dorothy 249  
 Edith 260  
 Edith Joseph 249  
 Edna 249  
 Edward (son of Reuben) 244  
 Edward (1810-1813) 243  
 Edward Finley (b. 1812) 168, 311B  
 Edward Finley (1849-1913) 168, 312A  
 Edward Jonas (b. 1883) 244  
 Edward Patrick (b. 1931) 245  
 Edwin (1840-1896) 243  
 Edythe Moritz 244  
 Eleasor (d. bef. 1794) 245  
 Eliza Adeline 246  
 Eliza D. (b. 1832) 168  
 Eliza Davies 47, 249  
 Elizabeth (dau. of Dudley) 249  
 Elizabeth (1846-1887) 243  
 Ella (dau. of Reuben) 244  
 Ella (1803-1875) 244  
 Ella Mateman 248  
 Ellen (1820-1891) 243  
 Ellen (1849-1913) 243, 262  
 Ellen Cardozo (1845-1922) 243  
 Ellen Honor Wilmot 159  
 Elleonora 248  
 Elmer Hendricks (1888-1938) 244  
 Emilie 249  
 Emily (b. 1843) 243  
 Emily (dau. of Jonas) 243  
 Emily (1822-1909) 243  
 Emma 246  
 Emma Louise (b. 1852) 35, 247  
 Estelle Newell 249  
 Esther (b. 1794) 247, 338A  
 Esther (dau. of Jonas) 245  
 Esther (dau. of Phineas) 246, 261  
 Esther (Hetty) Peizotto 241, 244  
 Esther (Hetty) Russell 243, 256  
 Esther (Hetty) 205, 243  
 Esther (m. Lawrence) 245  
 Esther (1778-1845) 205, 243  
 Esther (1835-1924) 245  
 Esther B. Seizas 243, 244, 266  
 Esther Samuel 245, 246, 261  
 Ethel 159  
 Ethel C. 149  
 Ethel Hart Levin 153, 244  
 Ethel Stix (b. 1906) 249  
 Etta (see Phillips, Henrietta (Etta) Myers)  
 Eugene (b. 1846) 247  
 Eugenia (1827-1829) 247  
 Eugenia Levy 169, 247  
 Eunice 138  
 Eva (1848-1909) 244  
 Eve 245  
 Ezdra L. Levy 163, 247  
 Fanny (b. 1840) 247  
 Fanny (see also Phillips, Brandley (Fanny), Phillips, Frances (Fanny))  
 Fanny Yates (1885-1976) 247, 312B  
 Felix 245  
 Fidelity Merritt 168  
 Florence 249  
 Florine (1905-1935) 244  
 Frances (dau. of Lawrence) 245  
 Frances (Fanny) (1790-1848) 84, 247  
 Frances (m. 1842) 181

Frances Cohen 36, 243  
 Frances Elizabeth (b. 1926) 245  
 Frances Rosenblatt 248  
 Frances Samuel (1794-1874) 261, 245  
 Frances Veronica Frawley 245  
 Frank Barnet (b. 1864) 245  
 Frederick I. (1853-1933) 245  
 Frederick Solomon 246  
 G. Marjorie 249  
 Gabriel (son of Jonas) 243  
 Gabriel (1815-1890) 243  
 Geoffrey Samuel (b. 1896) 244  
 George (b. 1903) 246  
 George (son of Lawrence) 245  
 George (son of Reuben) 244  
 George (son of Samuel) 246  
 George Faudel, 1st Baronet 246  
 George J. (b. 1850) 311B  
 George Lionel Lawson 246  
 George W. 249  
 Georgina Bryant Cohen 35, 247  
 Georgina Levy 247  
 Gertrude (b. 1844) 168  
 Gertrude Abbott 249  
 Gertrude Kuhn 249  
 Gertrude Olivia Jennings 168, 311B  
 Gertrude S. (b. 1849) 311B  
 Gitlah (Catherine) 243  
 H. Adrian 249  
 Halley (see Phillips, Rally or Halley)  
 Hannah 246  
 Hannah Isaacs 120, 247  
 Hannah Jonas 246  
 Harriet Jackson 129, 243  
 Harry 249  
 Hartwig I. 249  
 Hatty Clara Carmody 245  
 Haya (see Phillips, Lavinia (Haya))  
 Helen (dau. of Barnet) 246  
 Helen (dau. of David L.) 249  
 Helen Bridget 246  
 Helen Josephine (1895-1925) 245  
 Helen Levy (d. 1916) 246  
 Henrietta (d. aged 18) 249  
 Henrietta (dau. of Isaac) 249  
 Henrietta (Etta) Myers (b. 1867) 245  
 Henrietta (m. Benjamin A. Davis) 48  
 Henrietta Norah Faudel 246  
 Henrietta (1869-1964) 247  
 Henry (m. Alice Levy) 163, 249  
 Henry (m. Caroline Lyon) 181  
 Henry (m. 1794) 180  
 Henry (1839-1851) 243  
 Henry (1844-1907) 100, 163, 170  
 Henry B. (1819-1896) 243  
 Henry Faudel 246  
 Henry L. 249  
 Henry M. II (1838-1895) 243  
 Henry Mayer (1811-1884) 243  
 Henry Myers (b. 1863) 245  
 Herbert 246  
 Herman Samuel (1848-1912) 244  
 Hetty (b. 1821) 243  
 Hetty (see also Phillips, Esther (Hetty))  
 Hetty Russell (see Phillips, Esther (Hetty) Russell)  
 Hindlah (1771-1772) 243  
 Hora Bueno (Goodhour, Goody) Cohen 180  
 Imogene D. Hutchins 247  
 Irene 159  
 Isaac (d. 1851) 248  
 Isaac (m. Sophia Phillips) 129  
 Isaac (m. 1860) 34, 249  
 Isaac (son of Alexander) 248  
 Isaac (son of Reuben) 244  
 Isaac (1791-1851) 214, 245  
 Isaac (1812-1889) 244  
 Isaac Cardozo (1841-1842) 243  
 Isaac Franklin 41, 244  
 Isaac J. (1805-1884) 243, 256  
 Isaac, Jr. (1853-1887) 244

Isabel 249  
 Isabella Auriema 245  
 Isabella Lazarus 151  
 Israel (1806-1833) 244  
 Israel Benjamin (b. 1816) 129, 243  
 Israel J. (Alexander) (d. 1800?) 245  
 J. Donald 249  
 J. Dudley 249  
 Jacob (b. ca. 1750-1820) 120, 247  
 Jacob (1772-1848) 243  
 Jacob (1800-1822) 180  
 Jacob (1839-1894) 248  
 Jacob Campbell 249  
 James (son of Lawrence) 245  
 James (son of Morton Levy) 159  
 Jane (dau. of David M.) 243  
 Jane (dau. of Reuben) 244  
 Jane (m. Reuben) 244  
 Jane (1819-1893) 65  
 Jane (1825-1858) 248  
 Jean Armyne Eulalia 246  
 Jean Leah (b. 1906) 244  
 Jochebed (b. 1814) 244  
 Johanna Marie Debott 248  
 John (b. 1735) 168  
 John (d. 1759) 168  
 John (son of Octavus) 245  
 John (1787-1853) 168, 311B  
 John D. 249  
 John David (b. 1924) 245  
 John Isaac (b. 1869) 245  
 John Joseph (b. 1928) 245  
 John Joseph (1896-1933) 245  
 John K. (b. 1848) 311B  
 John Randolph (b. 1850) 247  
 John Walker (b. 1848) 247  
 Jonas (son of Lawrence) 245  
 Jonas (1735-1803) 234, 243  
 Jonas Altamont (1806-1862) 36, 243  
 Jonas Benjamin (1805-1867) 243  
 Jonas III (b. 1937) 244  
 Jonas N. (1816-1874) 241, 244  
 Joseph (1780-1854) 29, 243  
 Joseph Edgar (1850-1928) 184, 244  
 Josephine (1814-1896) 244  
 Josephine Myers (b. 1873) 245  
 Josephine Myers (b. 1909) 245  
 Josephine Myers (m. 1862) 216, 245  
 Joshua (1801-1880) 241, 244, 245  
 Judith (d. 1770) 243  
 Julia 11, 243  
 Lavinia (Haya) (1808-1901) 244  
 Lawrence 245  
 Leah Simon 245, 271  
 Leah Merritt 168  
 Lena (see Phillips, Caroline (Lena))  
 Leonora (Nonie) 249  
 Levi Solomon (1819-1825) 243  
 Levy (1754-1832) 245, 271  
 Lewis (b. 1864) 249  
 Lewis John 47, 249  
 Lillian M. 249  
 Lionel Lawson, 3d & last Baronet 246  
 Lloyd J. 249  
 Lloyd James 249  
 Lloyd Peizotto (b. 1901) 244  
 Louis A. 129  
 Louis Mordecai (b. 1885) 244  
 Louise Honori (b. 1914) 245  
 Lucy Maria Woodruff Fisher 168  
 Lucy Matilda (1851-1918) 168  
 Lula Torres 168  
 Madeline (b. 1820) 246  
 Madeline (1824-1896) 245  
 Madeline Speyer 245  
 Major Noah (1845-1846) 244  
 Mamie David 168  
 Manuel (d. 1826) 243  
 Marcus (b. 1865) 168  
 Margaret (dau. of Alfred) 245  
 Margaret (dau. of J. Dudley) 249  
 Margaret (m. Pantese) 245  
 Maria (d. 1828) 168

Adolphus 245  
 Agnes 246  
 Alberta Falck Wolbach 48  
 Alexander (b. ca. 1776) 248  
 Alexander (see also Phillips, Israel J. (Alexander))  
 Alfred (m. Rebecca Samuel) 245, 261  
 Alfred (son of Alexander) 248  
 Alice Levy (m. 1872) 163, 249  
 Alice Phoebe 246  
 Allan 249  
 Alma Judith (b. 1883) 244  
 Altamont 243  
 Amanda (b. 1812) 163, 247  
 Amelia Jennings (1812-1884) 168  
 Amelia Judah Friedman 41, 244  
 Amy Isaacs 246  
 Amyne Evelyn Gordon 246  
 Angelica Susannah 168  
 Angelina L. (1818-1834) 168  
 Anita 70  
 Ann Engi 168  
 Ann Margaret 246  
 Ann Maria 168  
 Annabella (1871-1933) 245  
 Anne 249  
 Arabella Solomon 28, 223, 243  
 Arliza (son of Barnet) 246  
 Arthur (son of Octavus) 245  
 Arthur (1850-1903) 245  
 Asher (b. 1846) 38, 249  
 Asser (Asher) 248  
 Augustus K. (b. 1842) 311B  
 Austin Cooper 246  
 Barnet (son of Lawrence) 245  
 Barnet (1750-1817) 245  
 Barnet (1824-1876) 246, 261  
 Barnet (1826-1905) 216, 245  
 Barnet B. 245  
 Barnet III (b. 1876) 245  
 Barnet IV (b. 1917) 245  
 Beatrice Hendricks 110, 244  
 Beatrice Rachel 246  
 Benjamin (b. 1842) 243  
 Benjamin (son of Jonas) 245  
 Benjamin Jonas (1776-1830) 243, 266  
 Benjamin McCready 249, 285  
 Benjamin Samuel (Lord Mayor of Lond.) 246  
 Benjamin Samuel, 2d Baronet 246  
 Benjamin, Jr. (b. 1810) 243  
 Bernice Rosen 244  
 Boaz (b. 1847) 248  
 Brandley (Fanny) 246  
 Camilla Paulfrey Mumford 168  
 Carol Adaline (b. 1911) 249  
 Carol Elizabeth 168  
 Caroline (1820-1888) 168  
 Caroline (b. 1853) 168  
 Caroline Elizabeth Pope 168  
 Caroline (Lena) (b. 1841) 216, 247  
 Caroline Jullien (b. 1906) 245  
 Caroline Jullien (m. Barnett III) 245  
 Caroline Lazarus 151, 247  
 Caroline Pike 248, 250  
 Catherine (b. 1834) 248  
 Catherine (dau. of David) 243  
 Catherine (Gitlah) De Young 248  
 Catherine (see also Phillips, Gitlah (Catherine))  
 Catherine (1809-1885) 205, 206, 243  
 Catherine (1844-1889) 243  
 Cecilia 246  
 Charles (son of Alfred) 245  
 Charles (son of Samuel) 246  
 Charles I. (1843-1919) 137, 243, 326B  
 Charles Lex (b. 1846) 243  
 Charlotte Hyman 121, 244  
 Clara (dau. of Mark) 246  
 Clara (1835-1891) 243  
 Clara (1843-1867) 249  
 Clara Cohen 38, 249

Maria (1838-1888) 171, 249  
Marie A. 249  
Mark 46  
Marshall 168  
Marshall Pope 168  
Martha Cline 248  
Mary (1780-1847) 129, 310B  
Mary (1832-1884) 249  
Mary Anna (1916-1917) 245  
Mary Bell Lobdell 168  
Mary G. Scott 168  
Mary Isert 168  
Mary Jane (b. 1851) 168  
Marye David (m. 1899) 312  
Mathilda Simmonds 249  
Maurice 246  
Maximilian 245  
May Beeber Stix 249, 285  
Michael (b. 1789) 245  
Michael (1830-1899) 248  
Minnie (see also Phillips, (Minnie) Miriam)  
Minnie 249, 272  
(Minnie) Miriam 46, 244  
Miriam (dau. of Reuben) 244  
Miriam (1852-1894) 46, 244  
Miriam Eugenia 243  
Miriam Gomez (1856-1937) 245  
Miriam Rosina (Rosalie) Pesca 242, 245  
Miriam Ruth Illoway 244  
Miriam Trimble 244  
Molly A. Pfeiffer 245  
Monroe (b. 1897) 159  
Montague A. 312B  
Mordecai Lewis 121, 244  
Morton Levy 159  
Moses (b. 1872) 245  
Moses (1822-1869) 248, 250  
Moses Mendes Seixas (1798-1854) 98, 244, 245  
Naphthali (1773-1870) 243, 244, 263, 266  
Naphthali J. (1817-1864) 243  
Naphthali Jacob (1827-1912) 242, 245  
Naphthali Taylor (b. 1868) 244, 276  
Nathaniel Pope (1879-1951) 168  
Nathaniel T. (b. 1856) 168  
Nellie (1849-1890) 168  
Nellie Cyril Faudel 246  
Nonie (see Phillips, Leonora (Nonie) Octavius 245  
Oscar (b. & d. 1818) 247  
Percy 245  
Peter 312B  
Phebe 183  
Phila (1766-1852) 242, 243  
Philip (b. 1796) 247  
Philip (b. 1853) 248  
Philip (son of Marc) 246  
Philip (1807-1884) 169, 247, 338A  
Philip (1816-1848) 169, 247  
Philip Lee (b. 1855) 247, 338A  
Phillips (b. 1843) 244  
Phillips Samuel 246, 261  
Phineas (d. 1822) 245, 246, 261  
Phineas (son of Phineas) 246  
Phoebe Maria 249  
Priscilla 34, 249  
Rachael 184, 244  
Rachael Levy (b. 1767) 168  
Rachel (b. 1809) 247  
Rachel (d. 1810) 166  
Rachel (dau. of David) 243  
Rachel (1752-1833) 245, 261  
Rachel (1769-1839) 159, 243, 338A  
Rachel (1786-1870) 247  
Rachel (1804-1814) 180  
Rachel (1825-1848) 245  
Rachel (1832-1840) 248  
Rachel (1836-1888) 184, 244  
Rachel (1845-1851) 248  
Rachel (1863-1934) 245

Rachel Faudel 246  
Rachel Joseph 246  
Rachel Kate 249  
Rachel N. Cardozo Cauffman 29, 30, 243  
Rachel Pettigrew 243  
Rachel Phoebe 249  
Rachel Rosalie (1846-1870) 244  
Rachel Seixas (m. 1797) 243, 244, 263  
Rachel Seixas (1828-1881) 244, 276  
Rally or Halley (d. bef. 1794) 245  
Rebecca (b. & d. 1818) 243  
Rebecca (dau. of Mark) 246  
Rebecca (dau. of Moses) 245  
Rebecca (dau. of Phineas) 246  
Rebecca (m. M. P. Levy) 159  
Rebecca (1792-1872) 210, 247  
Rebecca (1807-1840) 243  
Rebecca (1810-1882) 244  
Rebecca (1842-1899) 243  
Rebecca (1856-1857) 244  
Rebecca Hart 98, 244, 245  
Rebecca Hart Jones 137, 243, 326B, 338A  
Rebecca Machado 234, 243  
Rebecca Peixotto 241, 244  
Rebecca Samuel 245, 261  
Reginald 2  
Reuben (b. 1826) 244  
Robert (1789-1833) 35, 245  
Robert Edward (b. 1924) 245  
Robert Lionel 246  
Robert Myers (b. 1875) 245  
Robert W. 249  
Robinson Mumford (1862-1927) 168  
Robinson Mumford (1878-1928) 168  
Roald Hart (b. 1932) 244  
Rosalie Solomons 244, 276  
Rose 93  
Rosina (d. 1841) 248  
Rosina (m. 1846) 248  
Rosina Thomas 248  
Ruth 249  
Sallie (see also Phillips, Sarah Clara (Sallie))  
Sallie Kent (1876-1968) 168  
Sallie Kent (1908-) 168  
Sally (dau. of Jonas) 245  
Sally Clara (b. 1911) 245  
Salvadora (b. 1843) 247  
Samuel (b. 1807) 243  
Samuel (d. 1865) 245, 246, 261  
Samuel (son of John) 168  
Samuel (1819-1841) 248  
Samuel (1844-1845) 248  
Samuel Henry 246  
Samuel Mendez 249  
Samuel R. 243  
Sara 2  
Sarah (b. 1830) 244  
Sarah (b. 1851) 248  
Sarah (dau. of George) 244  
Sarah (m. Benjamin) 245  
Sarah (m. Isaac Kuhn) 249  
Sarah (m. Israel J.) 245  
Sarah (Sadie) Haschek Kohn 312B  
Sarah (1769-1770) 243  
Sarah Clara (Sallie) (b. 1866) 245  
Sarah Georgina White 246  
Sarah Hays Isaacks 127  
Sarah Henrietta Coben Myers 35, 216, 245  
Sarah Moss 214, 245  
Sarah, Lady Pirbright 246  
Selma Weigel 249  
Shirley Inez Moise 197  
Sidney Aaron (1860-1937) 153, 244  
Simha Solis 274  
Solomon (b. 1810) 247  
Solomon C. 129  
Sophia (d. 1855) 244  
Sophia (dau. of Barnet) 245  
Sophia (dau. of Mark) 246

Sophia (m. Isaac Phillips) 129  
Sophia (m. John B. Cotton) 248  
Sophia (1834-1903) 171, 249, 312A  
Sophia (1865-1917) 110, 244  
Sophia Phillips (1810-1855) 244  
Sophie 171, 249  
Sophie Marchant 184, 244  
Stella Josephine Faudel 246  
Susan (1793-1818) 168  
Susan Elizabeth Shumsky 245  
Susan Marion (b. 1842) 168  
Susan Sommers (m. 1809) 168, 311B  
Sutry 245  
Sydney 246  
Sylvia 244  
Sylvia Berdie Hershfeld 244  
Thomas Henry (b. 1898) 245  
Thomas Henry, Jr. (b. 1921) 245  
Thurber Cyrus 48  
Uriah (b. 1763) 243  
Uriah (1813-1814) 243  
Uriah Edward 243  
Victoria Rebecca (b. 1873) 245  
Virginia (1892-1893) 159  
Walter B. 246  
Walter E. (b. 1858) 110, 244  
Wendy 246  
William (1783-1829) 168  
William D. (b. 1853) 311B  
William D., Jr. (b. 1846) 168  
William Davis (1821/2-1895) 168  
William Davis (b. 1883) 168  
William Hallett (b. 1853) 247, 338A  
Zalegman (1779-1839) 223, 243  
Ziliah (1851-1915) 34, 244  
Zipporah (1764-1792) 232, 243  
Zipporah (1812-1894) 243  
Zipporah (1833-1907) 19, 244

**PHILLIPSE**  
Charlotte Elizabeth 81

**PHOEBUS**  
Uri Sberago 92

**PICARD**  
Hart (1746-1821) 227  
Priscilla 227  
Rebecca Nathan 227

**PICK**  
Bessie Kraus 290  
Louis 290

**PICKEN**  
(Sarah) Jane (or Janette) 180

**PICKLE**  
Viola 213

**PIERCE**  
Betty Hamburger Geisler 15  
Eric 15  
Helen Virginia Davis Hersch 48  
Jessica 30  
Mary Adams Blanks (1801-1870) 331  
Patricia (b. 1937) 15  
Watson O'Dell 48

**PIEUTORD**  
Jean Baptiste 135  
Marie Josette Audet Lapoint Jacobs 135  
Pelagie Perroa 135

**PIKE**  
Boaz (b. 1842) 250  
Boaz (d. bef. 1844) 250  
Boaz (1870-1874) 250  
Caroline (b. 1847) 250  
Caroline (m. 1844) 248, 250  
Catherine 250  
Charles (1859-1864) 250  
Clara Joseph 321A  
David 250  
Emanuel (1820-1874) 183, 250  
Esther 338A  
Esther Cromelien 41, 250  
Hannah Davies 47  
Henry (Zeby) 338A  
Henry Philip ('Harry') 47  
Ida 250

Jane Lyons 183, 250  
Janet 250  
Julia (b. 1841) 250  
Leonora 250  
Lipman (b. 1846) 250  
Moses 250, 338B  
Philip 47  
Rachel (m. Boaz) 250  
Rachel (m. 1829) 250  
Richea (b. 1857) 250  
Rosalie 47  
Samuel Naphthali (b. 1821) 250  
Sarah 221, 250, 334A, 338B  
Solomon (1855-1863) 250  
Solomon M. (m. 1831) 41, 250  
Sophia 250  
Sophie (dau. of Philip) 47  
Zeby (see Pike, Henry (Zeby))  
Zilla 250

**PILCHER**  
Lucy Wren (1894-) 330A

**PILKEY**  
Barbara Harris Fleisher 71  
Deborah 71  
Larry 71  
Walter David 71

**PILSBURY**  
Charles Alfred 312A, 332A  
Mary Corliss Pearl 312A, 332A

**PILZER**  
Sondra 219

**PIMENTAL**  
Aaron 44  
Joel 44  
Leah Morales 44  
Rebecca 44  
Sarah (d. 1793) 44

**PIMENTAL (PIMENTO)**  
Moses 44

**PIMENTEL**  
Judith Henriques 30  
Samuel Rodrigues 331A

**PIMENTO**  
See Pimental

**PIMENTA (PIMENTAL)**  
Moses 44

**PINCUS**  
Abbie Levy 182  
Alex Harry 27  
Annie Lyons 182  
Barbara 108  
Charles 107, 108  
Charles Lowenberg 108  
Clara Goodman 108  
Edith (b. 1906) 182  
Edward (1817-1900) 182  
Eleanor 108  
Eather Virginia Davis 27  
Finn David 27  
Floriam (1861-1931) 182  
Harry (1893-1974) 27, 309A  
Harry, Jr. (b. 1924) 27  
Hattie Lowenberg 108  
Inger Bratland 27  
Inger Theresa 27  
Jane (b. 1926) 27  
Kari Esther 27  
Martha Teweles 182  
Max 108  
Myra Fensterwald 107  
Paul Bratland (b. 1955) 27  
Ruth (1897-1930) 182  
Samuel Henry (1858-1915) 182  
Sarah (b. & d. 1857) 182  
Walter (1863-1932) 182

**PINEDO**  
Gracia de Imanuel Hizquiao 178

**PINHEIRO**  
Abraham (Amsterdam) 250  
Abraham (son of Isaac) 250  
Ester (Elizabeth) Pinheiro 250  
Ester (Elizabeth) 250  
Isaac (d. 1710) 250

Jacob 250  
Judith 250  
Luna 250  
Moses (1695?-1755?) 250  
Rachel 250  
Rebecca 250  
Rebekah 250  
Sara Hana 250  
Sarah (d. 1730) 250  
Sarah (dau. of Isaac) 250

**PINNER**  
Clara 180  
Deborah Forst 180  
Edward (b. 1847) 180  
Emma 180  
Grace 180  
Helen 180  
Henry 180  
Jeannette 180, 183  
Michael 180  
Rosa 180

**PINTO**  
Abigail Peck 251  
Abraham (b. 1757) 251  
Abraham (ca. 1697-ca. 1797) 251, 338B  
Abraham (1853-1933) 61, 138  
Abram 61, 138  
Alice (1866-1953) 61  
Alvah Sherman 251  
Anita Luria 61  
Anna Green 251  
Annette (1857-1921) 61, 138  
Arthur 251  
(Arthur) Enrico 61  
Audrey 61  
Augusta Lauretta 251  
Barbara (b. 1925) 61  
Beatrice 273  
Bertha 251  
Bertram (1859-1940/1) 61, 138  
Brenda (Lilla) 61  
Brenda 61  
Cad 251  
Caroline (b. 1819) 251  
Caroline Ripley (1847-1874) 251  
Catherine Octavia Joseph 61, 138  
Cecil 61  
Celia Davis 61  
Charles (son of Bertram) 61  
Charles (son of Samuel) 251  
Charles Haim 61  
Clarence 251  
Clariassa S. (1788-1844) 251  
Crimea Harriet Joseph 61, 138  
David (b. 1945) 61  
Diamond Lee 61  
Dollie M. 251  
Dorothy 61  
Edward (1854-1921) 61  
Eliza Ellen (1851-1852) 180  
Elizabeth Hutchison 251  
Elizabeth Keepers 251  
Elizabeth Richhart 251  
Elsie M. 251  
Emma Jane (1845-1876) 251  
Enid 60  
Enrico 61  
Ernest M. 251  
Estelle Sophia 61  
Esther (1850-1930) 61  
Fanny Hamilton 251  
Flora A. (b. 1855) 251  
Florence Hart 61  
Frances 251  
Frank De Sola 61  
Frederick David (b. 1887) 61  
Geoffrey (b. 1927) 61  
Hannah Lawrence 61  
Harold (son of Bertram) 61  
Harold (son of Charles) 61  
Harriet Crimea Joseph 61, 138  
Harry Hutchison (b. 1850) 251

Henry 60, 61  
Henry M. (1807-1891) 251  
Hilda (b. 1911) 61  
Horace H. 251  
Ida (dau. of Abraham) 61  
Ida (dau. of Samuel) 251  
Ida Stella 61  
Irene I. Morreis 251  
Irmgard Heilbronner 61  
Isaac (1720-1791) 251  
Isaac (1777-1858) 251  
Jacob (son of Samuel) 251  
Jacob (1724-1806) 251  
Jacob Abraham 251  
James Theodore 251  
Jessie (b. 1855) 61  
Jochabed (Joey) Hays 104, 251  
Joel 61  
Jonathan (d. 1930) 61  
José (Joseph) (1860-1940) 61  
Joseph (d. 1798) 104, 251  
Kate Peebles Sankey 251  
Laura 251  
Lauretta Packard 251  
Lawrence G. (b. 1865) 251  
Lilla (see Pinto, Brenda (Lilla))  
Lillian (b. 1853) 251  
Luna E. 251  
Mabel Sterling 251  
Mame 251  
Margaret Josephine 61  
Margaret Reade 251  
Margaret S. (1838-1895) 251  
Maria 251  
Maria Louise (1843-1878) 251  
Audrey 61  
Maria Marshall 251  
Mary Gault 251  
Mary M. (1841-1881) 251  
Miles Augustus (1832-1905) 251  
Minnie E. 251  
Miriam (1730-1781) 221, 251  
Octavia 61  
Patricia Hart 61  
Phyllis Ruth 61  
Rachel (d. 1832/7) 61  
Rachel (1722-1815) 251  
Ralph 61  
Rhoda Octavia 61  
Rica (1851-1932) 61  
Robert (b. & d. 1857) 251  
Rose A. (b. 1857) 251  
Rosetta 61  
Rosetta De Sola 60, 61  
Rowland D. 251  
Samuel (b. 1771) 251  
Samuel (son of Isaac) 251  
Samuel (1727/8-1764) 251  
Samuel, Jr. 251  
Sarah (b. 1780) 251  
Sarah (1698-1785) 251  
Sherman 251  
Solomon (b. 1725/6) 251  
Solomon (1758-1854) 251  
Sophia 61  
Stella Orsay 61  
Thankful (b. 1769) 251  
Thankful Peck 251  
Urania Clark 251  
Victoria (b. 1856) 61  
Violet Hilda 61  
Warren L. 251  
William (son of Jacob Abraham) 251  
William (son of Samuel) 251  
William (1760-1847) 251  
Winifred Webster 61  
Yvonne Pinto 61

**PIRBRIGHT**  
1st Lord (see De Worms, Henry, 1st Lord Pirbright)

**PITMAN**  
Sarah Ann 203

**PITTS**  
Charles W. 214

Dorothy Levy McCloud 166  
Edith Josephine Moss Rickoff Monett 214  
Frank 166  
Helen Dorsey 214  
Henry 214  
Kate Isabella Duval 214  
**PIVEC**  
John J. (1894-1964) 335B  
Mary G. Nones 335B  
**PIXELL**  
Constance Mary 77  
**PIZA**  
Ann 191  
Rosalie Lopez de Samuel (1868-1950) 191  
Samuel 191  
**PIZZINI**  
Albert A. 49  
Andrew 49  
Andrew J. 49  
Anna Davis 49  
Anne G. 49  
Carrie Pryor 49  
Edwin 49  
Ella Scott 49  
Estelle E. 49  
Florence Weber 49  
Irene Steinfeld 49  
Lucille 49  
Marie Celeste 49  
William B. 49  
**PLACE**  
Alice (1847-1885) 164  
Ethel 164  
Frank L. 164  
Gertrude 164  
Jessie Carter 164  
Lionel 164  
Rachel Levy 159  
Rebecca Levy 164  
William L. 159  
**PLANT**  
Andrew Saperston 236  
Edward M. III 236  
Edward M., Jr. 236  
Judy Wilson Oppenheimer 236  
**PLATT**  
Edward G. 22  
Lillian 282  
Margery Katz Floenheimer 22  
**PLATZNER**  
Belle 239  
**PLAUT**  
Carol Feinstein 3  
Daniel Abraham 3  
Deborah Maxine 3  
Elizabeth Straus 3  
Hewe (Eva) 237  
James Sachs 285  
Jonathan Victor 3  
Judith Gail 3  
Mary Friedlander 285  
Susan 285  
Thomas 285  
Wolfgang Gunther 3  
**PLOMER**  
Catherine Hyams 119  
**PLONT**  
Grace Simson 272  
Samuel 272  
**PLOUGH**  
Allen (b. 1905) 93  
Clara Mordecai 93, 202  
Fanny Endell 93  
Natalie (1897-1917) 93  
Octavia Harby 93  
S. Harby 93, 202  
**PLUNKETT**  
Achille (d. 1824) 200  
Alfred Charles (b. & d. 1823) 200  
Caroline Mordecai 200  
Charles Edward (1821-1823) 200

Frank Alfred (1824-1825) 200  
**PODELL**  
David L., Jr. 5  
David Louis 5  
Margaret 5  
Sarah (Cissie) Falk 5  
**POE**  
Alice Minis 194  
Elizabeth (b. 1906) 194  
Grace Elliott Morris 194  
Nelson 194  
Nina 194  
Philip Livingston 194  
Sarah 194  
**POHUOLA**  
Raiili 236  
**POINDEXTER**  
Adelaide Jacobs 133  
Isabel 133  
James 133  
John, Jr. 133  
Sarah 332B  
**POINTER**  
Barbara Day 91  
**POINTER**  
Augusta Leonora Davis 37  
Donne Hood 37  
John Davis 37  
Priscilla Marie 37  
**POKROSS**  
Charles 108  
Matthew Eugene 108  
Michelle Linn 108  
Trudi Ann Lowenberg 108  
**POLACK**  
See also Polack (Polock, Pollock), Polak, Pollack, Pollock, Pollock (Polock), Polock  
Adele Pool 60  
Henry Solomon 60  
Maude Evelyn 60  
Nancy Benjamin 50  
Sarah 60  
**POLACK (POLOCK, POLLOCK)**  
Cushman 234  
Rachel Jacobs 32, 234  
**POLAK**  
See also Polack, Pollack, Pollock, Pollock (Polock), Polock  
Adolph H. (1902-) 332A  
Albert V. 36  
Alice Rebecca Cohen 36  
Alice Virginia 36  
Ann 332A  
Archibald 332A  
Barbara 332A  
Benjamin F. (1864-1885) 182  
Cecilia Isabelle (1899-1968) 332A  
David (son of Julius) 182  
David (1878-1973) 332A  
David 182  
David Judah (1826-1910) 182, 332A  
Deborah 288  
Ellis Lyons (1860-1877) 182  
Harriet Sarah Hirsch 332A  
Henri Austin 36  
Holland R. 36  
Jacob (b. 1861) 182  
Jacob Rudolph 36  
Judah (b. 1857) 182  
Judith (1870-1871) 182  
Julian Seixas 36  
Julius 160, 182, 332A  
Marcia (1913-) 332A  
Marion Blaubaum 332A  
Marjorie Joan (1922-) 332A  
Mark Strause (1867-1930) 182, 332A  
Mary Lyons 182, 332A  
Minnie Newman 160, 182  
Miriam 182  
Rachel (b. 1888) 182  
Rosalie Danziger 332A  
Ruth 332A

S. Marks (see Polak, Mark Strause)  
Sarah (b. 1958) 288  
Sarah (1812-1891) 182  
Sarah 182, 332A  
Sylvia (1927-) 332A  
Willie Berkshire 36  
**POLIS**  
Beatrice Thalheimer 283  
Betty Lou 283  
Jo Ann Bell 283  
Louis 283  
Richard 283  
Robert 283  
**POLK**  
Frances 74  
John 74  
May Florence Wright 74  
**POLLACK**  
See also Polack, Polak, Pollock, Pollock (Polock), Polock  
Andrew Jackson (1979-) 333B  
Caroline 282  
Catherine (see Polock, Catherine (Kitty))  
Clara 202  
Mark 333B  
Robin Leigh Moses 333B  
**POLLAH**  
Elizabeth 288  
Katherine 127  
Katherine Weiss 288  
Louis H. 288  
Nancy 288  
Susan 288  
**POLLARD**  
Caroline Phoebe (1828-1906) 97  
James 133  
Rebecca Bacon 29  
Sherrard Wilcox 133  
**POLLIT**  
Elaine Kingsbacher Lince 293  
Suzanne Marie 293  
Walter 293  
**POLLITZ**  
Dionne 91  
Emily Guggenheimer 91  
George 91  
Patty 91  
**POLLITZER**  
Aline 285  
**POLLOCK**  
See also Polack, Polak, Pollack, Pollock (Polock), Polock  
Alice (see Cecile) Alice)  
Alice Rebecca (Minnie) Cohen 36  
Babette Nachman Gershom Dyer 62  
Benjamin (d. 1809) 166  
Carrie (b. 1840) 289  
Cecile) Alice (1889-1974) 290  
Cecilia 135  
Clarance (1842-1864) 289  
Cordelia Alberger (1852-1925) 228, 289  
Cushman (see Polack (Polock, Pollock), Cushman)  
Dalia Hendricks 110  
David 119  
Elias (Baltimore) 171  
Elias (1806-1895) 289  
Ella Carson 119  
Fanny 290  
Frances 6, 62, 323A  
Frank 35  
Henrietta 290  
Henry (m. Alice Cohen) 36  
Henry (son of Henry) 36  
Hester 171  
Inez Cohen 35  
Judah B. (1826-1889) 119  
Laura 290  
Levy 119  
Louis 290  
Mary C. 119

Mary Hyams 119  
Miriam 290  
Moses Haym 166  
Rachel (d. 1843) 123, 166  
Rachel Jacobs (see Polack (Polock, Pollock), Rachel Jacobs)  
Rachel (1809-1877) 103, 166  
Rebecca D. Hart 103  
Rebecca Sulzberger 290  
Rosalie 290  
Ruth 13  
Sarah Suares 289  
Seixas 36  
Sophie B. 290  
T. B. (1858-1875) 119  
Virginia Cohen 36  
**POLLOCK (POLOCK)**  
Elias (1755-1832) 103  
Rebecca Hart 183  
**POLLOCK**  
See also Polack, Polak, Pollack, Pollock, Pollock (Polock)  
Abigail Sarzedas 252, 262  
Abraham (1769-1790) 252  
Adeline Hyams 119  
Ann (see Polock, Hannah (Ann))  
Barnett H. (1815-1849) 252  
Biliah (1753-1826) 131, 252  
Catherine (Gitlah) Eitlah Dyer 6  
Catherine (Kitty) (b. 1756) 4, 252  
Clara (1819-1894) 202  
Cushman (see Polack, (Polock, Pollock), Cushman)  
David (b. 1778) 252  
Eitlah (see Polock, Catherine (Gitlah) Eitlah)  
Eitlah (see also Pollock (Polock), Elias)  
Elias C. 119  
Elizabeth Sophia (1829-1905) 21, 22, 252  
Fanny Isaacs 120, 252  
Frances (d. ca. 1834) 252  
Frances (1799-1868) 6, 64  
Frances (1848-1852) 119  
Frances Bamberger 252  
Gietele 252  
Gitlah Dyer (see Polock, Catherine (Gitlah))  
Hannah (Anna) (1782-1803) 216, 252  
Hannah (d. 1779) 252  
Hannah (see also Polock, Nana (Hannah))  
Hyman (1786-1870) 16, 252  
Isaac (b. 1766) 252  
Isaac (1700-1764) 120, 252  
Isabella (1834-1906) 252  
Jacob (b. & d. 1777) 252  
Jacob (1746-1782) 252  
Jacob (1825-1828) 252  
Joseph (b. & d. 1828) 252  
Joseph (b. 1820) 252  
Joseph (1802-1856) 6  
Judith (1745-1819) 194, 252  
Kitty (see Polock, Catherine (Kitty))  
Levi (1849-1852) 119  
Lewis H. (1819-1851) 252  
Miriam H. (1822-1919) 252, 303  
Moses (1817-1903) 252  
Moses S. 252  
Myer (d. 1779) 252, 262  
Nana (Hannah) 252  
Olivia 186  
Phineas (Zelig) 252  
Pyricus 252  
Rachel (d. 1817) 252  
Rachel Jacobs (see Polack (Polock, Pollock), Rachel Jacobs)  
Rebecca H. Barnett 16, 252  
Sarah (d. 1790) 114, 252  
Sarah (1812-1899) 252  
Solomon (son of Phineas (Zelig)) 252  
Solomon (1813-1861) 252  
Wolfe 6

Zelig (see Polock, Phineas (Zelig))  
**PON**  
Edgar 322A  
Edna (1886-) 322A  
Lewis Cohen (1882-) 322A  
Maud Lucille (1883-1883) 322A  
Rebecca Cohen 36, 322A  
**PONECK**  
Adolph 157  
Esther Nicholas Cooper 157  
**PONSONBY**  
Claude A. C. 118  
Eric 118  
Haller Gross Horwitz 118  
Harold Ashley Curzon 118  
Jane Caroline 118  
John Ashley Charles 118  
Moyra Blanche May Diana 118  
Ruth Margaret Miller 118  
Sarah Haller 118  
**PONTEVES**  
Marie Isabelle Pierrette Therese Louise 304  
**POOL**  
Abigail Davis 60  
Adele 60  
Buena 60  
David De Sola (b. 1885) 60  
Elea (see Pool, Eliezar (Eleazar, Elea))  
Eleanor (see Pool, Helen (Eleanor))  
Eleazar (see Pool, Eliezar (Eleazar, Elea))  
Eliezar (Eleazar, Elea) 60  
Eliza 60  
Eva 60  
Helen (Eleanor) 60  
Ithiel 60  
Naomi 60  
Sarah De Sola 60  
Solomon 60  
Tamar Hirschenson 60  
**POOLER**  
Bertha Nevin 284  
**POOPER**  
Alice Isaacs (b. 1872) 127  
Clara 127  
Hermine Isaacs 127  
Robert L. 127  
William C. 127  
**POOR**  
Alfred (b. 1826) 68  
Constance Evelyn Brandon 27  
Cornelia (b. 1817) 68  
Cornelia (b. 1849) 68  
Frances (b. 1816) 68  
Henry W. 27  
Henry William 27  
Ioanie Taylor 68  
Isabella (1822-1823) 68  
John H. (1783-1856) 68  
John H., Jr. (b. 1821) 68  
Kate (b. 1819) 68  
Marion S. (b. 1854) 68  
Robert Taylor (1824-1825) 68  
Ruth Ashmore 27  
Virginia (b. 1828) 68  
**POORE**  
Anne 222  
**POPE**  
Caroline Elizabeth 168  
Corinne H. 156  
Josephine 298  
Margaret Pearl 196  
Margaretta Emmelie 67  
**PORCELO**  
Ethel 22  
**PORIES**  
Bernhard 182  
**PORTELLO DE QUIROS**  
Esther 258, 338B  
Moses 258, 338B  
**PORTER**

Alonzo (See, Potter, Alonzo)  
Clara 269  
Earl Sheffield 157  
Eliza 336B  
Elsie Nicholas 157  
Frances Murdock 157  
Harriet 58  
Henry Godman 157  
Julia K. Macy 157  
Lewis C. Murdock 157  
Lucilla Wylie 157  
Margaret 157  
Mary C. Whitney 157  
Wilson Cary 157  
**PORTERFIELD**  
Salvadora Cohen 309  
**PORTINGER**  
Roberta Joanna 81  
**POST**  
Catherine 105  
Esther E. Hays 105  
Marian Giroux 257  
Mary 104, 105  
Samuel L. 105  
**POTS DAMER**  
Clara (1868-1947) 28  
Hannah Schoneman 28  
Joseph 28  
Naphtali (1871-1875) 28  
Theodore B. 28  
**POTTER**  
Alonzo 157, 329B  
Eula 9  
**POTTSDAMER**  
Benvenida Valentina Nathans 230  
Clarence (b. & d. 1870) 230  
Martin 230  
Naphtali (1871-1875) 230  
**POUGH**  
Jessie 122  
**POUILLOT**  
Marie Ullalie 93  
**POULTNEY**  
Edgar Curzon 194  
Eugene 194  
John Livingston 194  
Leila Livingston Minis 194  
Samuel Eugene 194  
**POULYEFF**  
Elizabeth Samuel 262  
George 262  
**POWELL**  
Florence 194  
**POWER**  
Eugene 84  
Gene 84  
Josephine 268  
Mildred Brunson 84  
**POWERS**  
Abigail Martin 220, 277  
Alfred Waterman 172, 220  
Ann 2  
Bernard 220  
Carrie Hess 135  
Catherine 220  
Edgar (d. inf.) 135  
Edgar (son of Frederick) 135  
Elaine Prentice Ettinger 238  
Fleurette Johnson 135  
Fred 135  
Frederick A. 135  
Gerald 135  
Henrietta Hyman 220  
Henry (b. 1857) 220  
Henry (b. 1861) 220  
Henry (1861-1862) 277  
Ida 220  
James 135  
Jean Prentice 238  
John Gedroice 238  
John Prentice 238  
Lewis (b. 1855) 220  
Lewis (m. 1807) 277

Lewis (m. 1857) 220, 277  
 Lizzie 213  
 Lynn Prentice 238  
 Maurice Lazarus (1858-1920) 220, 253, 277  
 Michael 220  
 Morris (b. 1846) 220  
 Morris (m. 1867) 135  
 Rebecca 172  
 Rebecca Le Jeune 220  
 Samuel (b. 1814) 220  
 Samuel (son of Morris) 135  
 Sarah Louisa (1863-1864) 277  
 Viola Fonseca Da Silva Solis Ritterband 253, 277

**POYNTZ**  
 Ferdinand 93  
 Sarah 93

**POZNANSKI**  
 Esther G. Barrett 17, 252  
 Frederika 252  
 Gersbon (1818-1839) 252  
 Gustavus (ca. 1805-1879) 17, 252, 338B  
 Gustavus, Jr. (1842-1862) 252  
 Heiman (see Poznanski, Hyman (Heiman))  
 Hinde 252  
 Hyman (Heiman) 252  
 Isaac Barrett (1840-) 338B  
 Jacob (see Lyon, Jacob (Poznanski))  
 Joseph 252  
 Joseph (1841-1916) 338B  
 Leah 252  
 Rebecca 252  
 Sarah (d. 1836) 252  
 Sarah (1844-1874) 17, 252

**PRADO**  
 Charlotte de Samuel 178

**PRAG**  
 Aaron 222  
 Adele Rita Rosenbaum 222  
 Daisy Wise Estelle Rosenbaum 222  
 Hilda Blumberg 222  
 Isabelle 48  
 Isabelle Daisy 222  
 Margaret 222  
 Meredith Chambers 222  
 Motz 222  
 Peggy 222

**PRAGER**  
 Benjamin (see Davids (Prager), Benjamin)  
 Deborah 87  
 Getlah 87  
 Grace 87  
 Isaac (Amsterdam) 87  
 Sarah 261  
 Theresa (Tracey) Henry 87

**PRATT**  
 Bettie Curland 329B  
 Celia 155  
 Fanny 258  
 Gwendolyn (1917-1917) 329B  
 Katherine (1951-) 329B  
 Laura Merrick 329B  
 Laurian Dykman (1983-) 329B  
 Lawrence (1949-) 330A  
 Margaret 29  
 Marietta Boyle 329B  
 Melissa (1971-) 329B  
 Meredith (1976-) 329B  
 Merrick 329B  
 Merrick (1922-) 329B  
 Merrick (1974-) 329B  
 Sharon 329B  
 Stephen Loveland (1954-) 329B  
 Susan Pratt 330A  
 Susan (1950-) 330A  
 Theodore 329B  
 Theodore (1920-) 329B  
 Theodore (1949-) 329B

**PREIZ**

See Price

**PRESCOTT**  
 Linda 339B  
 M. L. 235

**PRESTO**  
 See Price  
 Edith 96

**PRESTON**  
 Ann Hughes 217  
 Anne Gordon Brockenbrough 217  
 Barbara Bragdon 157  
 Caroline Myers (b. 1893) 201, 217  
 Edmund Myers (b. 1898) 217  
 Edmund Randolph 217  
 Eliza Kennon Myers 217  
 Elizabeth Myers 217  
 Elizabeth Randolph (b. 1888) 217  
 Gladys Lorraine Dodge Seaman 309B  
 Ida J. 105  
 Jane Daves Strudwick 217  
 Mercer Brockenbrough 217  
 Roy Marvin (1887-1970) 309B  
 Thomas Lewis (b. 1897) 217  
 William Carruthers 217  
 William Colquhoun 217

**PRETTO**  
 Abraham (b. 1811) 224  
 Clarence 224  
 Eleanor Naar 224  
 Rachel 224  
 Rebecca 224

**PREUS**  
 Catherine Marie (b. 1952) 206  
 David Heide 206  
 Doris Geen Moses 206  
 Peter Moses (b. 1951) 206

**PRICE**  
 Adelaide (d. 1949) 253  
 Alice (b. 1877) 253  
 Alice Lederer 253  
 Barbara Ellis 253  
 Belah 340B  
 Bertha Jacobs 215, 253  
 Betsy Jane 11  
 Daniel Barnett 11  
 Elizabeth Levy 167  
 Emilie Kirschbaum 284  
 Emma (b. 1874) 253  
 Ethel (d. 1922) 13, 253  
 Ethel Louise 13, 253  
 Harris 40  
 Joseph (b. 1869) 253  
 Joseph A. 167  
 Joseph Daniel 11  
 Joseph Daniel, Jr. 11  
 Joseph, Jr. 167  
 Julia (b. 1875) 253  
 Julia Bernd 253  
 Katharine (Kate) Moss 253  
 Lillian 253  
 Louise 284  
 Marion 253  
 Marjorie 11  
 Marjorie (Stamilton) Taylor 11  
 Marron Bertha 253  
 Mary (m. John Mordecia) 201  
 Mary Louise (b. 1836) 224  
 Nina 253  
 Nina Marguerite 253  
 Pauline (1871-1952) 253, 323A, 338B  
 Peggy Ruth 11  
 Robert J. 284  
 Rosalie Coleman 40  
 Ruth Walker 253  
 Sarah (Sally) Ana 11  
 Thomas B. 40  
 Virginia Rose Reichman 11

**PRICE (PREIZ)**  
 Edward Alfred 215, 253

**PRIEST**  
 George 269  
 Jennie Sheftall Beasley 269

**PRIETTO**  
 Antonio 338A

Lavinia Philipson 338A

**PREJUR**  
 Emilie 165

**PREIZ**  
 See Price

**PRIMROSE**  
 Albert Edward Harry Mayer Archibald 79  
 Eva Isabel Marian Bruce Strutt 79  
 Neil Archibald 79

**PRINCE**  
 C. A. 207  
 Emma Heinsheimer 307  
 Leonore 17  
 Louis 207  
 Melanie 327A  
 Senior 307  
 Sue Brent 329A  
 Virginia S. Harby 207

**PRINGLE**  
 Priscilla 27

**PRITZ**  
 Carl S. 292  
 Dora Wertheimer 292  
 Mercer Brockenbrough 286  
 Martha 307  
 Mary (b. 1914) 292  
 Walter H. 286  
 Walter L. 286

**PRIVY**  
 Matilda Lieber 174

**PROCTOR**  
 Elizabeth Foss 296

**PROFIT**  
 Anne Blumenthal Blankley 313, 339B  
 James 313, 339B

**PRONT**  
 Gatzel Isaac 124  
 Isaac Gerrat (see Isaacs, George) (1772-1842)

**PROUDFOOT**  
 Sarah 294

**PRUDE**  
 Kate Couch 180

**PRYOR**  
 Carrie 49

**PUCTO**  
 Judith 305

**PUE**  
 Elizabeth 154

**PUGLIA**  
 Carol Ann Roth Stone 237  
 John Joseph 237

**PULLIAM**  
 Blanche 197

**PUNCH**  
 Clarice 326B  
 Dion 326B  
 Harry 326B  
 Morris 326B  
 Robert 326B  
 Rose 326B  
 Sophia Missouri Johnson 326B

**PURDY**  
 Charles Edward 37  
 Elizabeth Teackle 157  
 Juanita Sallie Davis Atchison 37

**PURNELL**  
 Sara Deal 198

**PURO**  
 Arlene Eleanor Sheftall Krause 270  
 Daniel Francis 270

**PURVES**  
 Annie (d. 1955) 27

**PYKE**  
 Alfred 308  
 Alice Flora 308  
 Constance 308  
 Corianna (1866-1867) 129  
 David Joel (1824-1866) 129  
 Diana 308  
 Dinah (b. 1863) 129  
 Edward 242

Ethel 308  
 Eva Rachel Jackson 129  
 Lewis Eleazer (1845-1868) 242  
 Louise (d. 1926) 129  
 Miriam 129  
 Rachel Peixotto 242

**PYLE**  
 Abraham (1834-1903) 162  
 Frances (m. 1856) 125, 162  
 Miriam (1822-1860) 162  
 Miriam (1836-1898) 121, 162  
 Rebecca Levy 121, 162  
 Wolfe B. (1798-1840) 162

**QUAIN**  
 Kathleen 60

**QUANN**  
 Jacquenaette (b. 1911) 22

**QUEENTH**  
 Francine 72

**QUERIDO**  
 Branca 242

**QUIGGLE**  
 Ellen 106  
 Julia (d. 1868) 106

**QUILLER**  
 Alice Moss 216  
 Frederick 216

**QUXANO**  
 Abigail 112  
 Abram Henriques 112  
 Alice Rose Lucas 112  
 Leah 112  
 Sarah 112

**RABB**  
 David 336A  
 Jill Clayburgh 336A

**RABENHORST**  
 Alvin Phillips 168  
 Amelia J. Fisher 168  
 Karen Marshall 168  
 Ollie 168

**RABINOWITZ**  
 Nathan (see Robbins (Rabinowitz), Nathan)  
 Peter (see Solia-Coben, Peter Rabinowitz)

**RACHMIL**  
 Hannah (b. 1899) 240, 337B

**RADCLIFFE**  
 Emilie 155

**RAPEL**  
 Joseph (b. 1814) 254  
 Sarah Ruden 254

**RAFFERTY**  
 Jane Webb 326A

**RAHR**  
 Delia Newhouse 231  
 Marguerite (b. 1911) 231  
 Natalie (b. 1914) 231  
 Niels Neilson 231

**RAINER**  
 Jill 285

**RAINEY**  
 Almedia Jett 25  
 William Samuel 25

**RAINVILLE**  
 Ethel McCutcheon 198

**RAISIN**  
 Aaron Solomon 151  
 Jacob S. (1878-1925) 151  
 Jane Lazarus 151  
 Mordenai L. 151  
 Rachel Maria 151

**RALPH**  
 Frances 81

**RALSTON**  
 Kate-Johns 255  
 Mary Kirby 336B  
 Rebecca De La Motta 57  
 Rebecca De Lyon 57  
 Richard W. 57  
 Robert Smith (1824-1884) 336B

**RAMEL**

Baron Claes 72  
 Benita S. Fleisher 72

**RAMIREZ**  
 Domitilia 336A

**RAMSAY**  
 Mary Isabel 81

**RANDALL**  
 Edward 57  
 Leonora Rebecca De Lyon Harby 57, 93  
 Marjorie 111

**RANDOLPH**  
 Justine 104  
 Kate 188  
 Katharine Rosalie 88  
 Katherine Essex Bowen 88  
 Louisa 188  
 Mary Magill 201  
 William F. 88  
 William Fitzhugh 88

**RANKIN**  
 Theresa 83

**RANSOHOFF**  
 Ada Moss 215  
 Doris 307  
 Eli (1840-1908) 215  
 Emil 215  
 Emma Lowengrund 215  
 Flora Israel 215  
 Helen Sara 307  
 Jane Kuhn 307  
 Joseph (son of Joseph Louis) 307  
 Joseph 307  
 Joseph Louis 307  
 Leona 215  
 Minnie Freiberg 307

**RANSOM**  
 Grace Ward 53  
 Henry (Harry) Lee 53

**RAOUL**  
 Marie Corinne Moise 199  
 Robert Griffin 199

**RAPER**  
 Margaret 75

**RAPHAEL**  
 Anna L. 132  
 Benjamin 132  
 Blanche 132  
 Celia (1862-1924) 275  
 Charlotte (d. 1811) 132  
 Clarissa Wolfe 132, 304  
 Edith Rosa Samuel 260  
 Henrietta (1804-1887) 264, 326A, 339A  
 Isaac 132, 304  
 Jacob 132  
 Naphtali 132  
 Nathaniel 132  
 Richard Henry 260  
 Rose 160  
 Solomon 132, 326A

**RAPHALL**  
 Esther Caroline 163

**RARUS**  
 Frank Andrew 236  
 Kim Jennifer 236  
 Nancy Grace Bloom 236  
 Timothy Bloom 236

**RASCHKE**  
 Gloria Alfreda Page 237  
 Richard E., Jr. 237  
 Richard Ernest 237  
 Robin Ellen 237

**RATHER**  
 Corinne Carson 180  
 James 180

**RAUH**  
 Albert 69  
 Bertrand 339A  
 Hannah Lewin Selig 339A  
 Rebecca (Boxie) Billigheimer 69  
 Samuel O. 69

**RAUM**

Marie A. 205

**RAUTTENBERG**  
 Anne Silver 191  
 Joseph 191

**RAVENNEL**  
 Adolph 245  
 Louisa 245

**RAVENSCHROFT**  
 Dale (b. 1934) 274  
 Enid (b. 1934) 274  
 Enid Solis 274  
 Hubert F. 274  
 Hugh Morgan (b. 1932) 274  
 Richard Strode (b. 1938) 274

**RAWLE**  
 Judith 254

**RAY**  
 Alice 237  
 Andrena Moran 206  
 John Courtenay 206

**RAYMOND**  
 Julia 140  
 Lewis 140  
 Martha 140  
 Patty Judah 140  
 Robert 140

**RAYNE**  
 Edith Winona Tobias Mitchell 299  
 H. A. 299

**RAYNOR**  
 Amalie 17

**READ**  
 Everett 88  
 Leonie Haas 88

**READE**  
 Albert 255  
 Betty 255  
 Frances Lapat 255  
 Margaret 251

**REATH**  
 Alberta 254

**RECKENDORFER**  
 See Reckford

**RECKPORD**  
 Adelaide (b. 1902) 144  
 Edna (b. 1890) 144  
 John (b. 1895) 144  
 Louis K. 144  
 Louise King 144

**REDLICH**  
 Rosalind 202

**REE**  
 Isaac Philip 179  
 Sarah Warburg 179  
 Virginia Lopez Levy 179  
 William (b. 1832) 179  
 William Lopez (b. 1867) 179

**REED**  
 Adam Lord 285  
 Anne Moen Louise Bryant 118  
 Elliott Williamson 269  
 Harold 18  
 Isaac 264  
 Jennifer 285  
 John M. 285  
 Julia 264  
 Julia Ann Seixas Jacob 264  
 Leslie 285  
 Marjorie Anne Kahn 18  
 Sadye Sheftall 269  
 Silas 118  
 Susan Plaut 285

**REES**  
 Winifred V. (b. 1886) 166

**REEVE**  
 Adele Bowers 164  
 Alma Sherrick Sternberg 107

**REEVES**  
 Caroline Russell 313A  
 George A. 313A

**REGENSBURGER**  
 Emilie Phillips 249  
 Melville H. 249

**REGENSTEIN**  
 Anna Lucile (1979-) 333B  
 Helen Lucile Moses 333B  
 Helen Moses 207, 333B  
 Janice Kay Mendenhall 333B  
 Jonathan Kent 207, 333B  
 Lewis Graham 207, 333B  
 Louis 207, 333B

**REGGAN**  
 Daniel A. 71  
 Frances 71  
 Julia Louise Dolowitz 71  
 William 71

**REGISTER**  
 John 250  
 Margaret E. Lester 256

**REGLI**  
 Hannah Falk 5  
 Werner 5

**REHINE**  
 Rachel Judah 140, 153  
 Zalma (1757-1843) 140, 153, 329A

**REHLING**  
 Mary ('Topsy') 108

**REHM**  
 Carolina Minis 194  
 Raymond M. III (b. 1950) 194  
 Raymond Maxim 194

**REICH**  
 Emanuel Adolph 239  
 Jacob Jerome (Jerry) 239  
 Judy Wilson Oppenheimer Plant 236  
 Louis Barmon 236  
 Mayne Ruth Arrington Strait 239  
 Rosa Oppenheimer 239  
 William L. 236

**REICHEK**  
 Elaine 253

**REICHER**  
 Mary 224

**REICHMAN**  
 Dorothy 11  
 Dorothy Jones 11  
 Hettie 11  
 Hettie Schwabacher 11  
 Samuel 11  
 Samuel T. 11  
 Virginia Rose 11

**REID**  
 Annie H. 239  
 C. A. 171  
 Roxana 215

**REIGER**  
 Laura Ann 13

**REILLY**  
 Emma Hamburger 15  
 Frank 15

**REIMINGER**  
 Rita Marie 53

**REINER**  
 Ann Deblinger 333A  
 David 191, 333A  
 Estelle Mendes 191, 333A  
 Nancy 191, 333A  
 Walter (-1983) 333A

**REINHARD**  
 Martha Israel 128  
 Michael 128  
 Moses (b. 1837) 128

**REINHARDT**  
 Gutta Ottensoser 333A  
 Susman 333A

**REINHEDMER**  
 Elizabeth Lee 293

**REININGDNUM**  
 Rebekka Sheffra (d. 1727) 235

**REINSBERG**  
 Lee 222

**REINSKOPF**  
 Helen (Nellie) Wolff 331A

**REIS**  
 Isaac 125  
 Isabelle Isaacs 125

Jeanette 189

**REISENFELD**  
 Mary Jane 310

**REISER**  
 August 89  
 Dora Guggenheimer 89

**REISKIN**  
 Allan (1936-) 334B  
 Edward David (1966-) 334B  
 Joan Carol Barenkopf 334B  
 Julie Anne (1964-) 334B

**REISS**  
 Al 332B  
 Harriet Felleman 332B

**REITER**  
 Emily Hirsch 245  
 Leon 245

**REITZES**  
 Stefanie 147

**REMINGTON**  
 Blanche 24

**RENNIE**  
 Arch 107  
 Maud Estelle Hecht Margolius 307

**RENSBURG**  
 Florence Samuel 260  
 Henry Edward 260

**RENSELAER**  
 See Van Rensselaer

**RENTON**  
 Ethel Louise Dawkins 77  
 W. Gordon 77

**RENWICK**  
 Cyra Grace 236

**RENZDORF**  
 See Reinskopf

**REPLIER**  
 Emma 169, 330B  
 Fanny Levy 169  
 George 169

**RERA**  
 Marjorie 310A

**RESOR**  
 Helen Lansdowne 172  
 Stanley 172

**REVSON**  
 Alfred F. III 12  
 Alfred Frank, Jr. 12  
 Helen Elizabeth Andrews 12  
 Sally Andrews 12

**REYNOLDS**  
 Amy 82  
 Anne Head Bush Robbins 230  
 Anne Randolph (b. 1944) 299  
 Caroline Anne Sullivan 299  
 Christopher Smith 307  
 Edith 141  
 Edwin G. III (b. 1949) 299  
 Edwin G., Jr. 299  
 Eleanor Elizabeth Tobias 299  
 Elizabeth (Libby) Holman 307  
 Elizabeth Sutton 299  
 Libby Holman (see Reynolds,  
 Elizabeth (Libby) Holman)  
 Wilson B. III 230  
 Wilson B., Jr. 230  
 Zachary Smith 307

**RHEINSTEIN**  
 Edith 253

**RHINE**  
 Alice Hyneman 123  
 Benjamin 123  
 Cornelia 192  
 Grace 123  
 Henry 123

**RHINEHART**  
 Lorena A. Wintz 52

**RHODES**  
 Amelia Marguerite 165  
 Carl Frederick 237  
 Carla Lynn 237  
 Cecile (b. 1890) 42  
 Catherine 96  
 Gayle Louise 237

Jane 253  
 Rita Marie Bendel 237  
 Sandra Lee 237  
 Sheryl Leslie 237

**RIBEIRO**  
 See also Nunez  
 Isaac Rodrigues 175

**RICARDO**  
 Ralph Israel 119  
 Sarah de David 61  
 Sarah Hyams 119

**RICE**  
 Adelaide Schiffer 253  
 Amelia Judah (Judith) 42  
 Ann Elvidge 42  
 Aurelia Stix 286  
 Carole Faye Stribling 42  
 Carolyn Ruben Wright 42  
 Charles Marcus (b. 1882) 286  
 Charles Stix (b. 1918) 286  
 Corinna 42  
 David (b. 1897) 42  
 David (m. Pauline Cromlein) 42  
 Dinah (d. 1927) 285, 287  
 Dorothy 123  
 Dorothy Heller Heineman 42  
 Edna 295  
 Erna Aurelia (1880-1895) 286  
 Erna Sarah (b. 1909) 286, 313B  
 Evelyn Elvidge 42  
 Fannie Adelsdorfer 42  
 Fanny Leona Brown 42  
 Florence Rutstein 42  
 Hannah 285, 286  
 Harry E. III 42  
 Harry Edward 42  
 Harry Edward, Jr. 42  
 Harry Jonathan (1875-1894) 286  
 Hattie 42  
 Hattie Rich 42  
 Henrietta (Hetty) Barrett 177  
 Henry 286  
 Hetty Barrett (see Rice, Henrietta  
 (Hetty) Barrett)  
 Isaac L., Jr. 123  
 Isaac Leopold 123  
 Jack S., Jr. 42  
 Jack Sigmar 42  
 Jay D. Goldman (b. 1911) 286  
 Jeffrey Jack 42  
 Jerry 328A  
 Jonathan 286  
 Jonathan Charles (b. 1916) 286, 313B  
 Judith (see Rice, Amelia Judah  
 (Judith))  
 Julia 123  
 Julia Barnett 123  
 Kathleen 313B  
 Kathleen Feibelman 313B  
 Leon 42  
 Lynn 42  
 Marion 123  
 Marjorie 123  
 Mark Edward 42  
 Maude (1875-1966) 42  
 May 313B  
 May Goldman 286  
 Muriel 123  
 Patricia Stamm 42  
 Pauline (b. & d. 1877) 286  
 Pauline Cromlein 41, 42  
 Rodney Stamm 42  
 Ruth Stamm 42  
 Sadie 42  
 Susan K. Kokernot 328A  
 Thomas Jefferson 313B  
 Winifred Stix 286

**RICH**  
 Abraham (b. 1875) 42  
 Adrienne Cecile 42  
 Arnold Rice 42  
 Cecile (b. 1890) 42  
 Cynthia Grace 42

Cynthia Marshall 42  
 David (b. 1955) 43  
 David Rice (1903) 42  
 Dollye Lowery 42  
 Edith Juliet (b. 1878) 127  
 Gayle Florence 42  
 Grace Woods 255  
 Hattie Rice 42  
 Helen Elizabeth Jones 42  
 Irene Leyens 43  
 James H. 42  
 James H. III 42  
 James H., Jr. 42  
 Joy Rose Lovoy 42  
 Katherine S. 255  
 Lenora Binswanger 42  
 Leon 42  
 Lorin Calloway 42  
 Mary Linda League 42  
 Mary Sterne 42  
 Michael P. (b. 1938) 255  
 Michael P., Jr. 255  
 Paul R., Jr. 42  
 Paul Rice 42  
 Richard H. 255  
 Richard II 255  
 Robin Lucy 42  
 Rosalind 255  
 Sadie Rice 42  
 Sally 255  
 Samuel 42  
 Virginia 255  
 Virginia Lazarus 255  
 Virginia M. 255

**RICHARD**  
 Maria Judah 139  
 Phillipine Eudora (1832-1899) 139  
 Stephen C. 139

**RICHARDS**  
 Adeline Mayo 188  
 Anne Hallowell (Nancy) 96  
 Barbara 144  
 Dorothy 144  
 Frederick L. 144  
 Harriet Etting Marx 188  
 Hazel Bacbe 144  
 Howard 188  
 Howard, Jr. 188  
 Mary Jane 195  
 Muriel 144  
 Nancy (see Richards, Anne Hallowell  
 (Nancy))  
 Sarah Lippincott 188

**RICHARDSON**  
 Dora 253  
 Elsie Florence 78  
 Emma Buford 205  
 Florence Isobel Northey 78  
 Francis Northey 78  
 Frank 78  
 George Edward 78  
 Katherine 164  
 Kathleen 78  
 Susan G. (1849-1929) 336B

**RICHBERG**  
 Sara 206

**RICHBOURG**  
 Blanche 205

**RICHELIEU**  
 Duchesse de (see Heine, Marie Alice)

**RICHHART**  
 Elizabeth 251

**RICHIE**  
 Anna 134

**RICHMAN**  
 Barbara Ann Rosen 337B  
 Edith Oppenheim 293  
 Elizabeth 293  
 George 293  
 Harry 293  
 Leonard 337B  
 Nettie Hays Lippman 293  
 Scott (1967-) 337B

Stephanie (1970-) 337B

**RICHMOND**  
 Joan Patricia 296

**RICKOFF**  
 Arthur R. 214  
 Edith Josephine Moss 214

**RIDDER**  
 Marie Wasserman 287  
 Walter 287

**RIDER**  
 R. 140

**RIDGELY**  
 Charles Goodwin (1784-1848) 155  
 Cora (1828-1829) 155  
 Cornelia Adelaide (1827-1857) 155  
 Cornelia Louisiana Livingston 155  
 Elizabeth Augusta (1825-1864) 155  
 Margaret Maria (1824-1863) 155  
 Pleasance 155

**RIEMAN**  
 Charles Ellett 155  
 Elizabeth Taylor Goodwin 155

**RIES**  
 Hattie 108  
 Henrietta Brenner 90  
 Kristine Aida 233  
 Lulu 108  
 Wendy 233

**RIESENFELD**  
 Jane Frankenthaler 111  
 John 111  
 Mary Jane 111, 310A  
 Robert John 111

**RIESER**  
 Charles 255  
 David J. 255  
 Helen Brody 255  
 John C. 255  
 Katherine Rosenheim 255  
 Robyn R. 255  
 Rosalind R. 255

**RIGLANDER**  
 Rebecca (1847-1929) 327A

**RILEY**  
 Carrie Debora (Prudy) Eck 196  
 Ebel Marie 36  
 Euther Armistead 81  
 Maria Jane Johnson 81  
 Mary 43  
 Prudy Eck (see Riley, Carrie Debora  
 (Prudy) Eck)  
 Rita Mary 43

**RINO**  
 Anna M. (1804-1887) 336B

**RINTELS**  
 Annie 174

**RINTZKUPF**  
 Hannah (Hannah) Myers 221  
 Moses Levy 221

**RISER**  
 Eta 8  
 Isabel Naumann 8  
 Maude 8  
 Simon 8

**RISNER**  
 Barbara Henriques Carver 310A  
 Kenneth 310A

**RISTEAU**  
 Sarah 155

**RITTER**  
 Maggie M. 267

**RITTERBAND**  
 Annie Brown 253  
 Benvenida Solis (b. 1869) 253  
 Benvenida Solis (m. 1835) 253, 274  
 Charity (1843-1857) 253  
 Daisy Solis 253  
 David Solis (1850-1926) 253  
 Dorothy Louisa (b. 1878) 253  
 Edward (b. 1877) 253  
 Edward Philip 253  
 Emily Esther (b. 1871) 253  
 Enid (Joan) Greenfield 253

Esther Amanda De Souza 253  
 Florance (b. 1876) 253  
 Florence Jessilson 253  
 Frances Cadwell 253  
 George (b. 1880) 253  
 Gladys Da Silva Solis (b. 1890) 253  
 Hannah 253  
 Jacob Solis (1836-1896) 136, 253  
 Jean Schlarlack 253  
 Joan Greenfield (see Ritterband, Enid  
 (Joan) Greenfield)  
 Joanna Michaelis 136, 253  
 Joseph (b. 1838) 253  
 Julian Hart Solis (1885-1950) 253  
 Laura (Lallie) Berman 253  
 Leon (son of Leon) 253  
 Leon (son of Moses) 253  
 Leon Manness (1809-1860) 253, 274  
 Lola 253  
 Lucia Manness (1840-1928) 253, 275  
 Mannus 253  
 Marion Frances 253  
 May Alice Murray 253  
 Molly Burstein 253  
 Morris 253  
 Moses (1848-1921) 253  
 Moses Maness 253  
 Philip 253  
 Richard 253  
 Richard Leon 253  
 Robert Maness 253  
 Rosette 130  
 Sarah (Sally) (1846-1915) 27, 253  
 Stella Benvenida 253  
 Viola Fonseca Da Silva Solis (b. 1883)  
 253, 277  
 Viola S. 220, 253

**RITZEN**  
 Sarah 70

**RITZWOLLER**  
 Alexander (1871-1940) 125  
 Clarissa Isaacs 125  
 Esther (1873-1955) 125  
 Fay Fish 125  
 Jeanne 125  
 Josephine Van Brunt 125  
 Julia Weiglin Brofman 125  
 Oliver Cornelius 125  
 Richard 125  
 Sigismund (b. 1835) 125  
 Susanne Brofman 125  
 Zella Cherry Curtis 125

**RIVEIRO**  
 Abraham Nunes 29  
 Esther 29

**RIVERA**  
 Aaron (1793-1838) 175, 312A, 331A  
 Abraham (1762-1823) 175, 331A  
 Abraham Rodrigues De (d. 1765) 175,  
 331A  
 Aida 253  
 Hannah Lopez 175  
 Hannah Pimentel Sasportas 175, 331A  
 Isaac Rodrigues De (-1715) 331A  
 Jacob (1717-1789) 175, 331A  
 Jacob (1790-1827) 175  
 Judith Pardo 175, 331A  
 Manuel (1796-1797) 175  
 Mary Adams Blanks Pierce 331A  
 Palomba Mizrahi 175  
 Rachel (d. 1731) 175  
 Rebecca (d. 1793) 175, 331B  
 Sarah (d. 1727) 175  
 Sarah (1747-1840) 175  
 Sarah (1788/91-1820) 175  
 Sarah Lopez (1833-1923) 331B

**RIXON**  
 Golda 146

**RIZZA**  
 Elizabeth Virginia (Betty) Cohen 275

**ROADHOUSE**  
 Chester L. 140

Christine Judah 140  
 Donald 140  
 Frances 140  
 Katherine 140  
**ROANEY**  
 Marie M. 80  
**ROBB**  
 M. Amilla 262  
**ROBBINS**  
 Addie Ward 53  
 Anne Head Bush 230  
 Marion Charlotte Sanguinetti Arnstein 65  
 Richard Cadbury 230  
 Shelby 53  
 William Oliver Rush 230  
**ROBBINS (RABINOWITZ)**  
 Nathan 65  
**ROBELOT**  
 Amadée 94  
 Eva Trepagnier 94  
 Milton 94  
**ROBERTS**  
 Alexis Eve 42  
 Brian 72  
 Catherine 72  
 Douglas 72  
 Gayle Florence Rich 42  
 Heather Ann 42  
 Helen C. 284  
 John K. 42  
 Lisa 72  
 Ralph 72  
 Ralph, Jr. 72  
 Rose A. Sands 312A  
 Sarah Jane (1818-1875) 128  
 Suzanne Fleisher 72  
 Sylvia 276  
**ROBERTSON**  
 Margaret 15  
**ROBINS**  
 Alan Rudolph 65  
 William Lewis 65  
**ROBINSON**  
 Adele Horwitz Stevens 118  
 Amasa Read 128  
 Anne 262  
 Annie Ellet 128  
 Bertha Ellet 128  
 Beverly M. 118  
 Carol Fotherall 262, 338B  
 Champe Moncure 203  
 Christine 133  
 Christopher 262  
 Edward Chaplin 262  
 Eliza Taylor 133  
 Elizabeth 262  
 Elizabeth R. 156  
 Ellen McIntosh Emanuel 66  
 Francis 262  
 Francis III 262  
 Francis, Jr. 262  
 Hugh K. S. 252  
 Ida May Wartenby 274  
 J. C. 128  
 John A. 66  
 Katherine 133  
 Louisa Law 262  
 Marie Lansdowne 172  
 Mary M. Pinto 251  
 Rebecca Emanuel 64  
 Rebecca Samuel 262  
 Ruth Roberta 128  
 Samuel S., Jr. 262  
 Samuel Snowden (b. 1913) 262, 338B  
 Shirley Coffee 262  
 Taylor 133  
 V. Gilpin 274  
 W. H. 172  
 William Chaplin 262  
**ROBISON**  
 Alexander 212  
 Penina Septima Moses Moses 212

Walter (b. 1883) 212  
**ROBLES**  
 Catharina Levy 305  
 Hannah 190  
 Jacob Hisquiao 305, 340B  
 Rebecca 305, 340B  
**ROBLUS**  
 See Robles  
**ROBSON**  
 Effie 308  
**ROCHE**  
 Arthur Wellesley 81  
 Gladys 81  
 Louisa Mary Johnson 81  
 Mary Isabel Ramsay 81  
 Rosamund Isabel (b. 1919) 81  
 Victor Wellesley 81  
**ROCHELLE**  
 Ruben L. 254  
**ROCKEFELLER**  
 Anderson 88  
 Audrey 88  
 Benjamin 88  
 Godfrey S. 88  
 Godfrey, Jr. 88  
 Helen Gratz 88  
 Lucy A. 88  
 Peter 88  
**ROCKISS**  
 Blanche Deutsch 166  
**RODDY**  
 Coleman 159  
 Coleman E. 159  
 Estelle Rothschild 159  
 Gertrude 159  
 Jane Carol 114, 311A  
 Johanna 159  
 Louise Levy 159  
 Lynn Louise 159  
 Rolph 159  
 Rudolph Lynn 159  
 Uriah P. L. 159  
**RODERICK**  
 Marie (see Bandy, Margaret (Marie Roderick))  
**RODGERS**  
 Barbara Kane 284  
**RODMAN**  
 Mary 296  
**RODRIGUES**  
 See also Rodriguez  
 Abraham 262  
 Barbara E. 15  
 Daniel Jessurun (see Salvador, Daniel (Jessurun Rodrigues))  
 Joseph Jessurun (see Salvador, Joseph (Jessurun Rodrigues))  
 Joseph 262  
 Rebecca Sasportas 262  
**RODRIGUEZ**  
 Benjamin A. 254, 279  
 Cecilia Solomons 254, 279  
 Esther (1776-1838) 254  
 Esther Clara (1836-1839) 254  
 Helen Rosalie (d. 1866) 234, 254  
 Isaac de David 241  
 Leah Peixotto 241  
 Maria 58  
 Moise (1760/7-1830) 254  
 Sarah Salvador (see Salvador, Sarah Salvador)  
**RODRIGUEZ BRANDON**  
 See Brandon  
**RODRIQUEZ**  
 Althea Rita 257  
**ROE**  
 Bessie Louise 257  
**ROEGE**  
 Estelle 60  
**ROESSEL**  
 (Moses) 256  
**ROGERS**  
 Annette De Sola 60

Archibald 126  
 Bayard 126  
 Benjamin Woolsey 126  
 Dick 60  
 Elinor W. 60  
 Eliza 126  
 Elwyn (m. Benjamin Woolsey Rodgers) 126  
 Elwyn (son of Benjamin Woolsey) 126  
 Isabel 298  
 Jane (1901-1941) 299  
 Jim 60  
 Julia Anne 126  
 Lucius 87  
 Maurice 60  
 Moses (m. 1780) 126  
 Pendleton 126  
 Rica 60  
 Sarah 126  
 Sarah Campbell Gratz 87  
 Sarah Woolsey 126  
 Woolsey 126  
**ROHL**  
 Lois 224  
**ROHR**  
 Jacob 320B  
 Sadie Arnold 320B  
**ROLLE**  
 Alan P. 71  
 David 71  
 Elizabeth 71  
 James 71  
 May Fleisher Friedman 71  
 Sarah Jane 71  
**ROLLINSON**  
 Leigh 30  
**ROMIG**  
 Louise 278  
**ROOKE**  
 Charlotte Ellen 79  
**ROOS**  
 Emma 189  
**ROS**  
 Gloria 310A  
**ROSE**  
 Amanda 292  
 Bernard 340B  
 Diane 12  
 Elizabeth G. 255  
 Judith E. 255  
 Richard A. 255  
 Sally Rich 255  
 Virginia Myers 340B  
 William II 255  
**ROSEBERY**  
 6th Earl of (see Primrose, Albert Edward Harry Mayer Archibald)  
**ROSEFIELD**  
 Anita Moise 198, 333A  
 Herbert A., Jr. 198  
 Herbert Aaron 198  
 Virginia Moise 198  
**ROSEMONT**  
 Joseph 115  
 Rosetta Henry 115  
**ROSEN**  
 Barbara Ann 235, 337B  
 Bernice 175  
 Bonnie 208  
 Carol Mendes 191  
 Craig Russell 237  
 Deborah Suzanne (1971-) 337B  
 Elliott 191  
 Howard Jeffrey (1974-) 337B  
 Jennifer (1969-) 330B  
 Joann Meyer 235, 337B  
 Joanne Peixotto 337B  
 Leonard Louis London 237  
 Linda Gail Schwam 237  
 Linda Jenny (1958-) 330B  
 Marilyn Alice Marcus 330B  
 Mark Charles (1956-) 330B  
 Melvin 237

Robert Charles 330B  
 Steven Marc 237  
**ROSENAU**  
 Adele Florence 236  
 Herman 236  
 Rose Oppenheimer 236  
**ROSENBAACH**  
 Abraham Simon Wolf (1876-1952) 252  
 Adelaide (1868-1872) 252  
 Anna E. Fishell 252  
 Betty Ann Cohn 252  
 Caroline (1849-1931) 22  
 Clarissa (1851-1927) 22  
 Eva (Amberg) Correll 252  
 Fanny Binswanger 21, 22  
 Henry (1816-1884) 21, 22  
 Hyman Polock (1858-1892) 252  
 Isabella Hyman (b. 1914) 252  
 Isabella Polock 252  
 Isadore (d. 1926) 22  
 Jennie (1854-1924) 22  
 Lewis (d. 1920) 22  
 Miriam (1873-1926) 252  
 Miriam Polock (b. 1911) 252  
 Morris (1820-1885) 252  
 Morris L. (1865-1937) 252  
 Moses Polock (1870-1953) 252  
 Myrtle Humes 252  
 Philip H. (1863-1953) 252  
 Philip Humes (b. 1915) 252  
 Rebecca (1866-1926) 252  
 Solomon (d. 1920) 22  
**ROSENBAUM**  
 See also Rosa  
 Adele Rita 222  
 Albert S. (see Rosa, Albert S.)  
 Aline May 222  
 Alma (b. 1924) 222  
 Alma Bloomberg 70, 222  
 Amelia 340B  
 Ann 70  
 Bella 166  
 Bertha 89  
 Bertha S. Rosenheim 222, 255  
 Bertha Varina 89, 222  
 Claire June Millhiser 27, 70, 222  
 Corinne Omega 222  
 Daisy Wise Estelle 222  
 Dorothy Ida 222  
 Emilie 282, 339B  
 Florence Virginia 222  
 Floribel 222  
 Harold A. (1886-1926) 281  
 Helen 253  
 Hulda Lashanska 281  
 Ida Hutzler 222  
 Irma Belle 222  
 Isabelle Myers 222  
 Ivan Isaac 70, 222  
 Joseph Marx 222  
 Lenore B. (b. 1914) 281  
 Leonora Selig 281  
 Louise 70  
 Louise Ann (b. 1922) 70, 222  
 Merton Joseph 222  
 Merton, Jr. 22  
 Michael 222  
 Minnie 90, 222  
 Minnie Lee 89, 22  
 Morton Beauregard 222  
 Peggy Lashanska (b. 1919) 281  
 Rebecca Bowman 222  
 Robert (b. 1929) 27, 70, 222  
 Sara M. Straus 222  
 Selig 281  
 Sydney Beale 222, 255  
 Tess 222  
**ROSENBERG**  
 Anita Moise Rosefield 198, 333A  
 August 215  
 Bessie Borra 238  
 Cecile (b. 1919) 198, 289  
 Daisy Lowengrund 215

David 333A  
 Edith Cochran 289  
 Elaine 16  
 Elizabeth Ann (b. 1912) 215  
 Elsa 277  
 Emil Carl (1902-1922) 215  
 Fred 86  
 Frederick 264  
 George 289  
 Grace Donald 289  
 Grace Jandorf 160  
 Helen 12  
 Herbert Manning 289  
 Ira 198, 333A  
 Jenny Gantt 289  
 Kathryn Moss (b. 1914) 215  
 Lewis S. 71  
 Lilly 89  
 Lynn Groner 86  
 Margaret Lowengrund (1899-1951) 215  
 Mary Virginia Gantt 289  
 Mathilda Adler Fleisher 71  
 Matilla Griswold 264  
 Mindelle 333A  
 Minnie F. (1868-1923) 172  
 Myron Kauman 238  
 Octavia Schwerin 289  
 Patricia Cecile 289  
 Philip Harby 289  
 Robin Ruth 289  
 Rose Oberdorfer 172  
 Rudolph 238  
 Ruth Octavia 289  
 Sara Guggenheimer 89  
 Sig 89  
 Solomon H., Jr. 289  
 Solomon Herbert 289  
 Virginia 333A  
 William 172  
**ROSENBLATT**  
 Frances 248  
 Hilda Rothschild 61  
**ROSENBLUM**  
 Edith F., Levy 320A  
 Louise Natalie (1965-) 320A  
 Paul D. (1938-) 320A  
 Paul S. Jr. (1963-) 320A  
**ROSENBLUTH**  
 Cecile 282  
 Mary Ellen (1931-1988) 333A  
**ROSENDORF**  
 Hattie 196  
**ROSENFELD**  
 Adelaide 210  
 Adolph 210  
 Bernard (son of Israel) 219  
 Bernard (son of Michael) 219  
 Blanche 135  
 Edward 219  
 Ernst 255  
 Florette Rosenheim 255  
 Henrietta 219  
 Isaiah 210  
 Isidore 210  
 Israel 219  
 Jacob 210  
 Leonora Moses 210  
 Levy 210  
 Marie 210  
 Matilda Brady 210  
 Merrill (d. 1918) 219  
 Michael 219  
 Mildred (b. 1881) 219  
 Rebecca Stern 219  
 Rosa 210  
 Rose Stern 219  
**ROSENFELD**  
 Caroline H. Jackson 130  
 Joseph H. 130  
**ROSENGARTEN**  
 Adolph G. (1838-1862) 254  
 Adolph G., Jr. 254  
 Adolph George (b. 1870) 254

Ann S. 254  
 Bennet Harry (b. 1837) 254  
 Christine Penrose 254  
 Clara Augusta 254  
 Clara Johanna Knorr 254  
 E. Marion Sims 254  
 Elizabeth Bennet 254  
 Emily P. 254  
 Emma Sophia (b. 1847) 254  
 Fannie (b. 1833) 254  
 Francis Denis (b. 1843) 254  
 Frederick 254  
 Frederick, Jr. 254  
 George David (m. Elizabeth Bennet) 254  
 George David (1869-1936) 254  
 Harry Bennet 254  
 Janet Newlin 254  
 Joseph G., Jr. (b. 1875) 254  
 Joseph George (b. 1835) 254  
 Julia (1831-1840) 254  
 Marion S. 254  
 Mina Fleishman 295  
 Miriam B. Osterhout 254  
 Miriam S. 254  
 Mitchell (b. 1829) 254  
 Samuel George (b. 1827) 254  
 Susan E. Wright 254  
**ROSENHAM**  
 See also Rosenheim  
 Adella 255  
 Charles 255  
 Estella 255  
 Fannie 255  
 Heinrich (Henry) (b. 1816) 11, 255  
 Isabel 255  
 James 255  
 Julia 255  
 Julius 255  
 Kate-Johns Ralston 255  
 Louis 255  
 Sarah Ancker 11, 255  
**ROSENHAUS**  
 Esther 135  
**ROSENHEIM**  
 Amelia 255  
 Amelia Sternberger 255  
 Arlene 255  
 Bert Kayton (1874-1967) 143, 255, 310B, 327A, 338B  
 Bertha S. 222, 255  
 Caesar 255  
 Carlyne (Carrie) Guggenheimer 90, 255, 338B  
 Charles 255  
 Clara New 255  
 David (m. Rosalie Sulzberger) 291  
 David (son of Henry) 255  
 David (son of Isaac) 255  
 David J. 143, 255, 310B, 327A, 338B  
 De Witt 255  
 Delia 255  
 Ella 255  
 Florette 255  
 Heinrich (see Rosenham, Heinrich Henry)  
 Henrietta (Yetta) 255  
 Henrietta 255  
 Henry (son of Isaac) 90, 255, 338B  
 Henry (son of Nathaniel) 255  
 Herman 255  
 Ida Schonberg 255  
 Joseph M. 255  
 Katherine 255  
 Lazarus 255  
 Lee Roy 255  
 Leon 255  
 May Howard 255  
 Minna 255  
 Miriam 255  
 Nathaniel 255  
 Philip 255  
 Rebecca 255

Richard H. (see Rich, Richard H.)  
Rosalie Sulzberger 255  
Rosalind Rich 255  
Sophie 255  
Sylvan 255  
Tess R. 255, 310B, 327B  
Tillie Sternberger 255  
Yetta (see Rosenheim, Henrietta  
(Yetta))

**ROSENKRANZ**

Elias Victor 253  
Mildred Firth 253

**ROSENSCHEIN**

Daniel Hays (see Cohen, Daniel Hays)  
James Matthew 291  
Judith Peixotto Sulzberger 291  
Matthew, Jr. 291

**ROSENSTEEL**

David 135  
Dorothy Heller 135  
Eliza Johnson 135  
Louis 135  
Louise Emily 135  
Solon M. 135

**ROSENSTIEL**

Lewis S. 192  
Rosina Menken 192

**ROSENWEIG**

Beatrice Naomi (d. 1957) 71

**ROSENTHAL**

Alexander 182  
Ann Solis-Cohen 275  
Belle 340A  
Bertha Brandt 219  
Blanche Fuld 340A  
Charles 290, 340A  
Charles L. 275  
Corinne 219  
David Elyed (Elliot) 42  
Donald H. 21  
Doris 182  
Edith Pincus 182  
Edna 340A  
Esther H. Streusand 42  
Frances 340A  
Frieda Sulzberger 290  
Hannah 172  
Haskell Irvin 42  
Hattie 340A  
Helen Hamburger 15  
Herbert 219  
Isaiah 340A  
Jill 15  
John 83  
John Charles (b. 1950) 275  
Josephine Berg 83  
Judith-Ann Saks 42  
Kate 275  
Leslie 15  
Mary Ann (b. 1947) 275  
Nancy Goldsmith 21  
Nora 340A  
Robert 182  
Robert Leslie (b. 1937) 15  
Rose 340A  
Steven 340A  
Susan Helen (b. 1932) 15

**ROSENZWEIG**

Andrea 340A  
Jill Brand 340A  
Lisa 340A  
Martin 340A  
**ROSEWATER**  
Edward 15  
Harriet 28  
Molly Wallenstein Katz 15  
**ROSMEN**  
Anita 138  
**ROSNEAU (ROSENAU)**  
Shirley Jeannette 236  
**ROSNER**  
Anita 138  
Corinne J. Judson 160

Ellen J. 160  
Maura R. 160  
Stanley 160

**ROSOLIO**

Sadye (m. 1920) 278

**ROSOV**

Phyllis Edelman 40

**ROSS**

Albert 255  
Albert S. 259  
Barbara 222  
Betty Lapat 222  
Blanche Levy Karford 166  
Byron R. 45  
Charles A. 222  
Donald 222  
Dorothy Norway 222  
Edith Whitehead 222  
Elizabeth Samson 259  
Elsie Steiner 255  
Emily 222  
Evan Caskie 90  
Franklin D. 222  
Joseph M. 166  
Kenneth 222  
Laner 255  
Laurel 222  
Linda Ruth 191  
Lucy Manney Guggenheimer 90  
Lynn Fitzgerald 222  
Marie Louise Forster 45  
Michael Caskie 90  
Mildred Oettinger 255  
Nancy Martin 222  
Robert M. 45  
Ruth Zagat 222  
Sydney 222  
William W. 222

**ROSSHEIM**

Amy 296  
Anthony 296  
Mary Jane Herman 296  
Morris 296  
**ROSSHEIM**  
Elinor Jean Weyl 284  
Emilie 284  
Evan 284  
Jean 284  
Robert J. 284

**ROSSIGNOL**

Linda Louise Northway 331B  
Vincent 331B

**ROSSKAM**

Gail (b. 1946) 11  
George 11  
George Ancker (b. 1953) 11  
Loris Ancker 11  
Nancy (b. 1948) 11

**ROTH**

Adele 237  
Alice Ray 237  
Bella Smith 237  
Benjamin (see Rothgieser, Benjamin)  
Carol Ann 237  
Catherine M. 237  
Christine 237  
Dorothy (Daisy) Weiss 237  
Dorothy Wilhelmina 45  
Florence Marie 237  
Helen 284  
John 237  
Kathleen 237  
Loretta 237  
Loretta McMahon 237  
Margaret Theresa 237  
Mary Lois (Tallent) Levine 237  
Mildred Leah 237  
Mona 237  
Sadie Zeman 237  
Susan 237  
Tallent Levine (see Roth, Mary Lois  
(Tallent) Levine)  
**ROTH (ROTHGEISER)**

See also Rothgieser  
Charles 237  
Lester J. 237  
Martin Maurice 237  
Solomon 237

**ROTH GEISER (ROTHGESSER)**

George 237

**ROTHART**

Judith 191

**ROTHBAUM**

Ira 222  
Peggy Ann 222  
Stephen 222  
Virginia Edel 222

**ROTHENBERG**

Reva 191

**ROTHENBURG**

Theresa 11

**ROTHFEDER**

Alan Edward 268  
Andrew Emory 268  
Anne Sheftall 268  
Myrna Lea Sheftall 268

**ROTHGEISER**

See also Roth (Rothgieser)  
Abraham (Arthur) 237  
Adelheid (Adeline) Oppenheimer 236  
Adolph (Otto) 237  
Arthur (see Rothgieser, Abraham  
(Arthur))  
Benjamin 237  
Bertha (Birdie) 237  
George (Gerson) 236  
Gussie Fox 237  
Robert M. 45  
'La Velle' (see Rothgieser, Rose ('La  
Velle'))  
Lane Slocum (see Rothgieser, Nora  
(Lane) Slocum)  
Lena (see also Rothgieser, Lillian  
(Lena))  
Lena Springer 237  
Lillian (Lena) 237  
Margaret Elizabeth Maguire 237  
Mordecai 237  
Nora (Lane) Slocum 237  
Otto (see Rothgieser, Adolph (Otto))  
Rose ('La Velle') 237  
Samuel 237  
Sarah Wasch 237

**ROTHGIESSER**

Johanne Gudmann 237  
Salomon 237  
**ROTHMAN**  
Emil 222  
Leonore Edel 222  
Susan 222  
**ROTHSCHILD**  
Andrew John (1988-) 334B  
Bernhard (Berend) 254  
Cynthia 189  
Donald 189  
Dorothy Stein Beckman 65  
Ellen Jean Williams 312B, 334B  
Estelle 159  
Florence 21  
George 222, 334B  
Golda 254  
Handel Heilbut 254  
Helen 124  
Jacob Levin 254  
Jane Ellen 222, 312B, 334B  
Jennifer Erin (1983-) 334B  
Jill Ann 65  
Joel 189  
John Stephan 222, 312B, 334B  
Levin Jacob 254  
Maritz (Moses) 254  
Mary Frank 189  
Melville, Jr. 189  
Morton Arthur 65  
Moses (see Rothschild, Maritz  
(Moses))  
Rachel 254

Ruben L. (see Rochelle, Ruben L.)  
Susan Lee 65  
Tarris Joel 189  
Valerie Myers 222, 334B

**ROTHSTEIN**

Manuel 60  
Naomi Pool Leon 60  
Philip 60

**ROUSE**

John 108, 325A  
Lynn Goodman 108, 325A

**ROUSSEAU**

Charles 276  
Jessie Solomons 276

**ROW**

Ethel Dora 81

**ROWE**

Adella 311B  
Helen (1867-1942) 92  
Joseph 320A  
Margaret Elisa Boice 320A  
Martha Abrahams 320A  
Robert 320A  
**ROWLAND**  
Abigail Adolphus 254  
Delia (1847-1886) 231, 254  
Esther 26, 254  
Fanny (1834-1863) 254, 300  
Isabella Nathans 229, 254  
John (d. 1840) 229, 254  
John I. (1844-1890) 254  
Joseph G. 87  
Peter (Paltiel) S. (1808-1887) 254  
Rachel (b. 1837) 26, 254  
Sarah Jane 254, 312B

**ROWLEY**

Charlotte Moseley 76  
Joshua Ricketts 76

**ROWSSELL**

Frances Emmeline 82

**ROYSTON**

Irene 25

**RUBEN**

Harlene David 46  
Ludwig 46  
Minna 10

**RUBENSTEIN**

Adella Rowe 311B  
Anne Beatrice Elliott 311B  
Cecelia (b. 1958) 311B  
Cecilia Kamer 311B  
Cheryl Jean (b. 1947) 311B  
David (b. 1950) 311B  
Edel Mathews 311B  
Frances 311B  
Harold (b. 1957) 311B  
Harold Samuel (1893-1968) 311B  
Mathew S. (b. 1915) 311B  
Molcha (Molly) 95  
Rosa Simon 311B  
Sam (d. 1937) 311B  
Sam S. (b. 1920) 311B  
Samuel (b. 1960) 311B  
Stephen (b. 1964) 311B

**RUBIN**

Ellen Simon 282, 339B  
Eugene Alexander 282, 339B  
Jay Paul (Jack) 282  
Steven E. 282

**RUCKER**

Adele Levy 165

**RUDDOCK**

Estelle Cecilia 48

**RUDEN**

Alexander (b. 1838) 254  
Alexander (m. Hana) 254  
Esther Souza (b. 1840) 254  
Fanny Souza 254, 280  
Hana (d. 1823) 254  
Hannah (b. 1819) 254  
Hannah Emma (b. 1835) 254  
Jaques (1772-1806) 131, 254  
Jaques (1801-1856) 254, 280

Josephine (1852-1853) 254  
Moses (ca. 1792-1842) 131, 254  
Moses Eliakum (see Eliakum (Ruden),  
Moses)

**RACHEL**

Rebecca Gomperts 131, 254  
Samuel Souza (1845-1846) 254  
Samuel Souza (1846-1847) 254  
Sarah (b. 1825) 254  
Theodore (b. 1848) 254  
Walter Moses (b. 1855) 254

**RUDMAN**

Nina 89

**RUDOLPH**

Carl 327A  
Hazel C. Leipheimer 327A

**RUEB**

Sandra Ann Yarrow 296  
William 296

**RUEST**

Dorothy Maybaum 295

**RUFF**

Barbara 222  
Delia Edel 222  
Eva Catherine Rosine 285  
Gary 222  
Raymond 222

**RUHL**

Frances M. Russell 313A  
Frederick F. 313A

**RUIZ**

Eugenio 136  
Isabelle Jonas 136

**RUMOHR**

Elizabeth 295  
Madeleine Cohen 295  
William 295  
William, Jr. 295

**RUMSEY**

Emmaline 166  
Mary (1705-1770) 126

**RUNYON**

Alice 209

**RUPP**

Amelia Levy 159  
Robert 159

**RUSH**

Henry 337A  
Rosina 214  
Sarah Angeline Nunez 337A

**RUSKIN**

See also Reiskin  
Saul 12

**RUSS**

Belle (d. 1919) 70  
Sarah 112

**RUSSELL**

Abraham De Lyon (b. 1808) 256  
Adam 95  
Almira (d. 1837) 256  
Angela Elizabeth (b. 1930) 313A  
Anna Lafayette (b. 1830) 256  
Anna Serena Martin 256  
Augustus (1813-1822) 256  
Balaily (Si) 95  
Benjamin S. 312B  
Bernice Jacobs 313A  
Caroline (b. 1911) 313A  
Cecilia M. Fallon 312B  
Cecilia Marie (b. 1929) 313A  
Charles R. (b. & d. 1928) 313A  
Columbus Davega Cohen 39  
Cordelia 256  
Corrie Anderson 313A  
Doreen Morgan 313A  
Edward A. 311A  
Eliza Ancker 11  
Elizabeth C. (1871-1945) 312B  
Elizabeth C. Ferre 256, 312B  
Elizabeth Elvira (1837-1902) 256, 312B  
Elizabeth P. Ancker 11, 256, 338B  
Elizabeth Scott (b. 1841) 256  
Eileen S. (1879-1960) 313A

Emma Azalea Speir 312B  
Enid Geen (b. 1947) 205  
Esther (Hetty) (b. 1807) 243, 256  
Esther Mordecai 203, 256  
Frances M. (1879-1923) 313A  
Francis Carolyn Woods Usher 313A  
Frank Ford 39  
George Ford 39  
George R., Jr. 39  
Georgia (b. 1914) 313A  
Georgia A. (1820-1925) 229, 256  
Georgia Ann Mendel 313A  
Georgia C. (1882-1913) 313A  
Helen Leigh (b. 1950) 206  
Henrietta (1813-1841) 229, 256  
Henry Harold 84  
Henry M. (1797-1841) 256  
Hetty (see Russell, Esther (Hetty))  
Holly (b. 1974) 312B  
Hortense Maxine Lion 84  
Isaac (b. & d. 1875) 313A  
Isaac (1787-1845) 256, 267  
Isaac Abraham (1844-1884) 256, 312B  
Jacob (b. 1810) 256  
Eva Jacquelyn Juanita (1926-1938) 313A  
James H. 206  
Jane A. 256  
John M. 256  
Joseph Mathew (1907-1956) 312B  
Juanita (b. 1920) 313A  
Judith (1785-1868) 229, 256  
Julia 39  
Julian Milton (1878-1883) 313A  
Kate Gene 84  
Kitty Crowder 312B  
Laura Pinto 251  
Lena R. Huchs 312B  
Letheria Henrietta Sheftall (1842-1923)  
256, 268  
Levi Sheftall (1809-1876) 256  
Levieta S. 256  
Louise Hodges 312B  
Margaret Isabelle 256  
Margaret S. (1852-1853) 313A  
Marie (b. 1918) 313A  
Mary B. 39  
Mary Bake 39  
Mary S. 256  
Mary Selina (1850-1933) 313A  
Mildred 39  
Moses (b. 1791) 256  
Nell Ford 39  
Perla Sheftall (1788-1850) 256, 267  
Perla Sheftall (1857-1955) 256, 313A  
Philip (1812-1822) 256  
Philip Moses (1815-1902) 11, 256,  
312B, 338B  
Philip M. III (b. 1932) 313A  
Philip M., Jr. (1842-1890) 256, 312B  
Philip M., Jr. (1902-1964) 312B  
Philip Milton (see also Russell, Philip  
Moses)  
Philip Moses (1747-1830) 203, 256  
Philip Moses (1876-1955) 312B  
Phyllis Carolyn (b. 1962) 313A  
Rachel (1798-1887) 256, 298  
Rebecca (1794-1878) 229, 256  
Richard Lion 84  
Richard M. 256  
Richard Wayne (1847-1888) 256, 312B  
Richard Wayne (1884-1953) 313A  
Richard Wayne, Jr. (1909-1955) 313A  
Robert Eugene (b. 1942) 312B  
Robert T. III 312B  
Robert T., Jr. (1909-1959) 312B  
Robert Toombs (1880-1939) 312B  
Samuel (1783-1831) 57, 256  
Sarah Avery 312  
Sarah De Lyon (m. 1806) 57, 256  
Sarah L. (1840-1882) 256, 312B  
Sarah M. (1805-1840) 229, 256  
Sarah N. (1811-1866) 256  
Sarah S. (1818-1912) 229, 256



Selina Rebecca (1824-1850) 16, 256  
Si (see Russell, Balsilly (Si))  
Theresa Agnes 312B  
Thomas E. Lloyd (1861-1868) 313A  
Thomas S., Jr. (b. 1905) 313A  
Thomas Sheftall (1877-1952) 313A  
Vernon L. (b. 1921) 313A  
Vincent Eugene (b. 1967) 312B  
Virginia (1811-1901) 256, 268  
Virginia Epstein 312B  
Vivian Colleen (b. 1964) 313A  
Waring (1827-1914) 256, 268  
Waring (1854-1927) 256, 313A  
Waring (1885-1887) 313A  
Waring (1923-1933) 313A  
Zipporah (b. 1781) 200, 256

**RUSSELL (ROESSEL)**

(Moses) 256

**RUSSIN**

Shelley 333B

**RUSSY**

See De Russey

**RUTSTEIN**

Florence 42

**RUTTER**

Edward 75

Sarah Davis 75

**RYALS**

Mabry P. 213

Ruth Nunez 213

**RYAN**

Anne 203

Genevieve 284

Marguerite (Leah) 85

Mary 16

**RYDHOLM**

Marion 124

**RYERSON**

John 269

Mildred Sheftall 269

**RYTTENBERG**

Anita Lazaron 61

Charles 61

Clarkson Potter (b. 1881) 159

Isabella Levy 159

Markus George (1846-1906) 159

**SAAL**

Millicent 287

**SAARINEN**

Aline Bernstein Louchheim 89

Eames 89

Eero 89

**SABRAN PONTEVÉS**

Comte De 304

**SACHS**

Arlene Rosenheim 255

Caroline 189

Edward 332A

Edward Mark (1953-) 332A

John Robert 255

Madelyn Katzky 255

Nancy (1952-) 332A

Robert 255

Sol 255

Sylvia Polak 332A

**SACKEY**

David (b. 1938) 252

Deborah R. (b. 1946) 252

Isabella Hyman Rosenbach 252

Maurice 252

Phyllis R. (b. 1942) 252

**SADLER**

Armentine Granville Mordecai 201

Lynn (1953-) 331B

Richard Allen 201

**SADOWSKY**

Anastasia 88

Carl 88

Cornelia Seixas 88

Helen Haas 88

Jack 88

Katia 241

Sarah Harriet Haas 88

**SAPPER**

Clinton 40

Harry M. (m. Judith Coleman) 40

Harry M. (son of Clinton) 40

Isabella 40

Joyce Ann 40

Judith Coleman 40

Sylvia Mintz 40

**SAIDEL**

Dorothy Aufsesser 15

Mary (b. 1942) 15

Peter (b. 1939) 15

Willard 15

**SAINTE**

Sandra K. 310A

**SAKS**

Amelia Judah (Judith) Rice 42

Andrew Joseph 42

Elisabeth Bryan Wilkinson 42

Joseph 42

Judith-Ann 42

Julien David (b. 1906) 42

Lucy-Jane Watson 42

**SALANT**

Helen 127, 326A

**SALAS**

Deborah Beatriz de Arnaldo Jacob 62

**SALAS**

Florence 307

**SALFIELD**

Anne 89

**SALGADO**

Harvey 122

Judith Blockley 122

**SALINGER**

Adele 339A

Adolphus 339A

Carrie 339A

Estelle 281

Esther Spiro 281, 339A

Harriett Susan 306

Henry 281

Rosalie 281

Serena Spiro 281, 339A

William 339A

**SALLER**

Miriam 284

**SALMONSEN**

Eugenia Henriques 112

Frederick (1811-1849) 112

Frederick Waley (1849-1921) 112

Hester Eger Hertz Jacobi 117

Lillie Warner 112

**SALO**

Immanuel 332A

Sarah 332A

Rachel de Abraham 51

**SALOMON**

See also Salomons, Soloman, Solomon

Solomon(s), Solomons

Adeline (Adelaide) Cecilia Bezeau 257

Alexander De C. (1849-1892) 257

Alexander, Jr. (1882-1886) 257

Algernon 257

Alma Judith Phillips 244

Almeria De Leon (1851-1879) 110,

257

Arthur K. (b. 1877) 257

Augusta Camilla (1833/5-1872) 257,

258

Benjamin 171

Benjamin Franklin (1829-1865) 257

David (1820-1875) 111, 159, 257

Deborah (Delia) (1809-1895) 130, 257

Deborah (1783-1808) 223, 257

Delia Cecilia (1836-1865) 257

E. McDowell 257

Edna Heller 257

Edwin (see Salomon, Ezekiel (Edwin))

Ella (1853-1920) 257, 262

Ella Hart 98, 257

Estelle Campbell 257

Ezekiel (Edwin) (1815-1883) 257

Ezekiel (1778-1821) 257

Ferdinand II 257

Ferdinand L. (b. 1888) 257

Geraldine 257

Haym (1740-1785) 75, 257

Haym Moses (1785-1858) 98, 257

Haym Moses, Jr. (1812-1856) 257

Helen Forbes Lewis 257

Henrietta Luna Hendricks 111, 257

Herbert 257

Isaac 329A

Jacob (1825-1843) 257

Janet Thall 257

Joseph (1818-1821) 257

Lena Cohen 329A

Lewis George 257

Lewis Joseph (1838-1925) 41, 257

Louisa (1857-1934) 110, 257

Marian Giroux Post 257

Matilda 257

Mildred Lewis 171

Moses 172

Nellie Franck 257

Pauline 329A

Rachel (1794-1831/2) 172

Rachel Frank (1762-1818/9) 75, 109,

257

Rachel Franks (1823-1865) 257, 303

Rosalie Alice (1859-1935) 257

Rosalie Alice Levy 159, 257

Sallie (1779-1845) 12, 257

Samuel Napoleon (b. 1829) 257

Sara Rheine (1771-1814) 329A

Sarah Louisa (1813-1879) 129, 257

Sidney Hendricks (b. 1867) 257

Sophie Heilbron 257

Susannah Duncan Saw 257

Theresa Friedman King 41, 144, 257

William Jones (1852-1919) 257

**SALOMONS**

See also Salomon, Solomon, Soloman,

Solomon(s), Solomons

Benedictus (see Solomons, Benedictus)

Cecilia Samuel 261

David 261

Henrietta Esther 261

Philip J. 261

Rosalie 41

**SALOMONSKY**

Blanche 219

Rachel (1847-1909) 219

**SALTER**

Wendy Holman 158

**SALUS**

Christopher Jon 282

Eric Wieder 282

Kathryn Simon 282

Samuel Wieder (Skip) 282

**SALVADOR**

Abigail (dau. of Joseph) 258, 338B

Abigail (m. 1730) 258

Abraham 258, 338B

Ann Mendes 338B

Anna de Antonio Mendez (Rachel

Mendez Da Costa) 258

Anne (Esther) 258

Caroline Leonora 258, 338B

Daniel (see Salvador, Francis (Daniel))

Elisebah 258

Esther (dau. of Francis) 258

Esther (see also Salvador, Anne

(Esther))

Esther de Moses Portello De Quiros

258, 338B

Fanny Pratt 258

Frances Anne 258, 338B

Francis (Daniel) (d. 1754) 258, 338B

Francis (Daniel) (1747-1776) 258,

338B

Francis (Jacob) (d. 1736) 258, 338B

Francis 258, 338B

Isaac (son of Francis) 258, 338B

Isaac (son of Joseph) 258

Jacob (see also Salvador, Francis

(Jacob); Salvador John Lovell

(Jacob))

Jacob (son of Moses) 258

Jacob (d. 1749) 258, 338B

John Lovell (Jacob) 258, 338B

Joseph (see also Salvador (or Jessurun

Rodrigues), Joseph)

Joseph (son of Manuel) 258, 338B

Joseph (1716-1786) 258, 338B

Joseph 258, 338B

Joshua 258, 338B

Judith (see Salvador, Rebecca (Judith))

Leonora (dau. of Francis) 258

Leonora (Rachel) de Antonio Lopes

258, 338B

Leonora (Rachel) Suasso 258

Leonora (see also Salvador, Mary

(Leonora))

Manuel 258, 338B

Mary (Leonora) 258

Miriam (d. 1781) 258

Moses 258

Rachel (dau. of Joseph) 258

Rachel de Moses Mendes Da Costa

258, 338B

Rachel Fernandes Nunez 258, 338B

Rachel Lopes (see Salvador, Leonora

(Rachel) Lopes)

Rachel Mendes Da Costa 338B

Rebecca (d. 1781) 258, 338B

Rebecca (Judith) 258

Rebecca Da Silva 258, 338B

Samuel 338B

Samuel 258

Sarah (dau. of Joseph) 258

Sarah (d. 1756) 258, 338B

Sarah Salvador 258

Sarah Suasso 258

Susannah 258, 338B

**SALZEDO**

Samuel Lopez 241

Judith Lopez (1766-1835) 241

**SALZENSTIEN**

Henrietta 11

**SAMBLIN**

Holly 213

**SAMBOURN**



Gladys Elizabeth 261  
 Grace Keene 261  
 Hannah (d. 1871) 261  
 Hannah (Susannah) 261  
 Harold (1838-1890) 260  
 Harriet (1817-1820) 260  
 Harry 261  
 Harry Simon 261  
 Hart (see Samuel, Henry (Hart))  
 Henrietta (dau. of Samuel) 261  
 Henrietta (1810-1845) 261  
 Henrietta Esther Salomons 261  
 Henrietta Montefiore 261  
 Henrietta Samuel 261  
 Henry (Hart) (1775-1818) 260, 308  
 Henry (1817-1873) 260  
 Henry (1828-1893) 262  
 Henry Sylvester (1842-1898) 260  
 Herman 261  
 Hilary 122  
 Hilda Beatrice (b. 1877) 260  
 Hilda Marie Mayer 261  
 Horatio 261  
 Hyman 44  
 Isaac 261  
 Isaac Bunford 261  
 Isabel (b. 1843) 260  
 Israel (Brighton, Eng.) 245  
 Israel (son of David) 261  
 Jacob (1808-1832) 260  
 James 261  
 Jane (see Samuel, (Schoenche) Jane)  
 Jessie (b. 1848) 260  
 Joan Patricia (b. 1924) 262  
 Jochabed Yates 260, 308  
 John (son of Benjamin) 261  
 John (1829-1913) 159, 262  
 John (1900-1912) 262  
 John David (b. 1869) 262  
 John Henry (b. 1887) 260  
 Joseph Bunford (1853-1929) 243, 262  
 Josephine (1851-1886) 260  
 Joshua 261  
 Judah (see Samuel, Lewis (Judah))  
 Judith (1771-1803) 260  
 Julia (1824-1897) 260  
 Julien Henriques 261  
 Julienne Yates 261  
 Julius 122  
 Kate (m. A. D. M. De Sola) 60, 261  
 Kate (1810-1859) 260  
 Kate (1803-1880) 260, 308  
 Katherine 60, 261  
 Katherine Jacobs 261  
 Katie Solomon 261  
 Katy (Catherine) Yates 260, 308  
 Laura (b. 1837) 260  
 Leah Catherine Jacobs 261  
 Lewis (b. 1860) 260  
 Lewis (Judah) (1783-1854) 260, 308  
 Lewis (son of Samuel) 261  
 Lewis (1812-1854) 260  
 Lewis Solomon (1855-1933) 260  
 Lionel 261  
 Lionel Horace 261  
 Lionel Jacob 261  
 Lizzie (b. 1855) 260  
 Lois (b. 1902) 262  
 Louisa Esther 261  
 Lyon 261  
 M. Amilla Robb 262  
 Margaret Priscilla Menal 261  
 Marguerite (b. 1874) 260  
 Maria (b. 1801) 245, 246, 261  
 Maria (dau. of Isaac) 261  
 Maria (1815-1890) 260  
 Maria Burnett (1903-1950) 262  
 Mark (1858-1895) 260  
 Maria Jonathan 261  
 Mary Ann 261  
 Mary Buchanan 262  
 Mary Buchanan Snowden 262  
 Mary Campbell Evans 262

Mary K. Irby 260  
 Mary Rosina (b. 1847) 260  
 Mathilda 122  
 Mathilda Eliza Moses 212, 260  
 Matilda (dau. of Samuel) 261  
 Matilda (1820-1888) 33, 260, 338B  
 Matilda Beatrice (b. 1853) 260  
 Montague 261  
 Morris (son of Isaac) 261  
 Morris (son of Samuel) 261  
 Morris (1813-1878) 33, 260  
 Moses (b. 1742) 245, 261  
 Moses (son of David) 261  
 Moses (son of Lewis) 261  
 Nancy (Ann) 261  
 Nancy Elizabeth 231  
 Nora Winifred 261  
 Patricia Sheila 261  
 Phillipa 246, 261  
 Phineas (son of Moses) 261  
 Phoebe (m. Morris) 261  
 Phoebe (1736-1786) 46, 323A  
 Phyllis (1806-1844) 260  
 Phyllis Samuel 260  
 Polly Levy 260  
 Rachel (dau. of Benjamin) 261  
 Rachel Phillips 245, 261  
 Ralph (1738-1809) 260  
 Ralph (1809-1833) 260  
 Ralph (1815-1860) 260  
 Ralph Henry (1809-1886) 260  
 Rebecca (b. 1780) 245, 261  
 Rebecca (b. 1890) 262  
 Rebecca (dau. of Benjamin) 261  
 Rebecca (dau. of Frederick) 261  
 Rebecca Alexander 44  
 Rebecca Hendricks Levy 159, 262  
 Robert (b. 1837) 260  
 Robert (1845-1896) 212, 260  
 Rosa (1809-1848) 260  
 Rosa Samuel 260  
 Rose (dau. of Edward John) 261  
 Rose (1801-1882) 260  
 Rose Bedington 261  
 Rosetta (1780-1864) 260  
 Ruth Frampton 122  
 Sabina 63  
 Samuel (b. 1790) 44  
 Samuel (son of David) 261  
 Samuel (son of Lewis) 261  
 Samuel (1773-1796) 260  
 Samuel (1804-1846) 260  
 Samuel Moses 261  
 Sarah (d. 1879) 261  
 Sarah (dau. of Isaac) 261  
 Sarah (dau. of Lyon) 261  
 Sarah (dau. of Samuel) 261  
 Sarah Moccata 261  
 Sarah Prager 261  
 (Schoenche) Jane 44  
 Sheila Jeanne Merriman 261  
 Sidney 261  
 Simoa David (m. Esther Meir) 261  
 Simoa David (m. Esther Phillips) 246, 261  
 Simon Davis 261  
 Snowden (1893-1939) 262, 313A  
 Solomon (1785-1819) 260, 308  
 Stephen Francis 261  
 Susannah (see Samuel, Hannah (Susannah))  
 Sutry Phillips 245  
 Sylvester (1807-1884) 260  
 Sylvester Henry 260  
 Sylvester Lewis (1823-1882) 260  
 Walter (1846-1848) 260  
 Wilfred Henriques 261  
 William (b. 1909) 261  
 William (1840-1883) 260  
 Winifred 261  
**SAMUELI**  
 See Sanders  
**SAMUELS**

Barbara 24  
 Bessie Kurtz Schellenberg 147  
 Caroline 313B  
 Cecile Hanff 313B  
 Esther Adolphus 7  
 Esther Virginia Ezekiel Herman 69  
 Fanny King 144  
 Fanny Kroleck (see Samuels, Fanny King)  
 George 6, 144  
 Gerson 189  
 Hannah (1791-1849) 51  
 Hannah Frank 189  
 Henry (1872-1952) 313B  
 Hilary Samuel 122  
 James (m. 1840) 70  
 Jay 24  
 Jay, Jr. (b. 1946) 24  
 Julia Rachel (d. 1945) 69  
 Letitia Lyon 6, 144  
 Marie Louise Kohn 24  
 Michael 122  
 Rebecca Ezekiel 70  
 Seymour 69  
 Sophia 229  
 Vivienne 122  
**SANCHEZ**  
 Antonio Ribeiro 234  
 Rachel 240  
**SAND**  
 Ann Sulzberger 314A  
 David 314A  
 Leonard 314A  
 Peggy 314A  
 Robert 314A  
**SANDEL**  
 Jenny 237  
**SANDEMAN**  
 Arthur Adolphus 138  
 Martha Maud Joseph 138  
**SANDER**  
 See Sandor  
**SANDERS**  
 Barbara Block 215  
 Elizabeth (Beth) 215  
 Ellen 215  
 Joseph (Samueli) 215  
 Kathleen 117  
 Mary N. 105  
**SANDOR**  
 Marion Florance Nathan Kraus 227, 334B  
 Paul 227, 334B  
**SANDS**  
 Esther H. Levy 170, 312A  
 Julius 312A  
 Minnie A. 170  
 Rose A. 312A  
 Willard 170  
**SANFORD**  
 Josephine 214  
**SANGER**  
 Adolph L. (1842-1894) 164  
 Clara 164  
 Eleanor 164  
 Marian Frances 164  
 Marion 164  
 Sarah 164  
 Sarah Levy 164  
**SANGUINETTA**  
 Harriet Nathan 308  
 Isaac 308  
**SANGUINETTI**  
 Caroline Abrahams 65  
 Edward Eustace 65  
 Edward Manly 65  
 Elias (d. 1875) 65  
 Eliza 65  
 Emily Gertrude 65  
 Esther Marion 65  
 Gertrude Agnes 65  
 Jacob (d. 1800) 65  
 Jacob (d. 1870) 65

Jane Phillips Dias 65  
 Louisa 65  
 Percy Augustus 65  
 Philip C. 65  
 Sarah Francis 65  
**SANKEY**  
 Kate Peebles 251  
**SANLAUT**  
 Helen 127  
**SAPERSTON**  
 Edith Caroline Oppenheimer 236  
 Irving Leonard Wilson 236  
 Ruth 236  
**SARDE**  
 Hester 241  
**SARPATY**  
 Charity Hays (1853-1876) 274  
 Cora (1879-1898) 274  
 David de Moses (1828-1854) 274  
 David Hays (1877-1923) 274  
 Eva 274  
 Eva Jacobs 132, 274  
 Gertrude S. 274  
 Moses 274  
 Moses David (1851-1923) 132, 274  
 Phoebe Elizabeth Solis 274  
 Raymond 274  
 Stanley 274  
**SARGENT**  
 Bridget McBurney 158  
 Charles S., Jr. 158  
 Clara Ivanetta 233  
**SARGOOD**  
 Guiljelma Frances 214  
**SARLOUIS**  
 Amelia Rosenbaum 340B  
 Belah Price 340B  
 Bertha (Betsy) 340B  
 Bertha (see also Sarlouis, Bettie (Bertha))  
 Betsy (see Sarlouis, Bertha (Betsy))  
 Bettie (Bertha) 301, 340B  
 Betzalel 340B  
 Fanny (Frumet) 301, 340B  
 Mendel (see Sarlouis, Mina (Mendel))  
 Mina (Mendel) Levy 301, 340B  
 Myer 301, 340B  
 Sarah Oppenheim 340B  
**SARONI**  
 Adolph 47  
 Clara Davies 47  
**SARTORIUS**  
 Babette 307  
 Judith 266  
**SARZEDAS**  
 Abigail 252, 262  
 Abraham 104, 131, 262  
 Belle Myers 216, 262  
 Caty Hays 104, 131, 262  
 David (ca. 1760-1841) 44, 262  
 David, Jr. (1785-1828) 262  
 Judah (b. 1762) 262  
 Moses (b. 1767) 262  
 Moses (1768-1811) 216, 262  
 Rachael 262  
 Rebecca (1761-1840) 38, 262  
 Sarah Da Costa 44, 262  
**SASPORTAS**  
 Aaron (d. 1798) 262  
 Abraham 331A  
 Abraham (1753/6-1825) 28, 44, 262  
 Augustus 262  
 Charlotte (Leah) Canter 28, 262  
 Hannah Pimentel 175  
 Isaac (1791-1819) 262  
 Isaac de Raphael Jesurun 178  
 Jacob de Isaac Jesurun 240  
 Leah Canter (see Sasportas, Charlotte (Leah))  
 Rachel Da Costa 44, 262  
 Rachel Lopez (Da Fonseca) 178  
 Rebecca 262  
 Sarah 262

Sarah Cohen Peizotto 240  
 Zilmire 262  
**SAUCIER**  
 Julie Josephine Moise Haussey 199  
 Placide Valerian 199  
**SAUER**  
 Linda 71  
**SAUNDERS**  
 Belle Evelyn 164  
 Carl 13  
 Ellen Dorothy Bach 13  
**SAUSSURE**  
 See De Saussure  
**SAVORY**  
 Mildred 140  
**SAW**  
 Susannah Duncan 257  
**SAWYER**  
 Perla Sheftail Russell Mendel 313A  
**SAX**  
 Elizabeth Johnson 28  
 Harriet Rosewater 28  
 Helen Solis-Cohen Spiegel 28, 275  
 James Ezekiel 28, 275  
 Julius 2  
 Mary Florence 28  
 Mathilda Nathan 2  
 May Schoneman 28  
 Moseley Percival 28  
 Percy, Jr. 28  
 Robert 28  
**SAYRE**  
 Enoch Philip 125  
 Mary Ellen Silverstone Oppenheimer 125  
**SAYRES**  
 Hetty 140  
**SCARTH**  
 Virginia 141  
**SCHACK**  
 Hattie A. (1887-) 327A  
**SCHAEFER**  
 Jennie (Jane) Tim 295  
 Minnie 89  
**SCHAEFFER**  
 August Edward (1860-1940) 257  
 Delia Helen Karstendiek 257  
 Lawrence Edward (1885-1886) 257  
 Muriel Adelaide (b. 1886) 257  
 Otto James (b. & d. 1885) 257  
**SCHAEFER**  
 Adelina Tim 295  
 Catherine Craig 295  
 Charles (m. Jennie (Jane) Tim) 295  
 Charles (son of Charles) 295  
 Charles, Jr. 295  
 Clara Cohen 295  
 Fanny May 295, 305  
 Hazel 295  
 Janet 72  
 Jean 295  
 Jennie (Jane) Tim 295  
 Katherine Morgan 295  
 Leonard 295  
 Madeline 295  
 Madeline May 295  
 Margaret 295  
 Marjorie Harlow 295  
 Morgan 295  
 Myron 295, 305  
 Myron, Jr. 295  
 Natalie 295  
 Robert 295  
 Simon 295  
 Virginia Jane 295  
**SCHAEFFER**  
 Barbara 321B  
**SCHAMBERG**  
 Lucille 211  
**SCHAPIRO**  
 See also Shapiro  
 Ina Augusta Levy 164  
 Margie Ina 164

Saul Paul 164  
 Shirley 164  
 Shirley Adeline 164  
**SCHARLACK**  
 Jean 253  
**SCHATZKIN**  
 Dorothy Bachrach 313B  
 Harvey 313B  
**SCHAUL**  
 Alex Ritzwoller 125  
 Lewis Jay III 125  
 Lewis Jay, Jr. 125  
 Rita Julienne Friedsam 125  
 Susanne Brofman 125  
**SCHecter**  
 Ruth 72  
**SCHEN**  
 Lois Newburger 222  
 Meyer 222  
 Nancy 222  
 Stephen 222  
**SCHellenberg**  
 Bessie Kurtz 147, 310B  
 Jennie 147, 310B  
**SCHellenburg**  
 See Schellenberg  
**SCHERCK**  
 Cecilia (b. 1871) 186  
 Ernestine (1877-1932) 186  
 Esther Marks 186, 332B  
 Fannie Vera 186, 332B  
 Gordon 186  
 Henry 186  
 Henry Joseph (1867-1933) 186  
 Isaac (1833-1889) 186, 332B  
 Lewis (1869-1943) 186, 332B  
 Nancy Burkenroad 186  
 Tallie Alzheimer 186  
 Vera 186  
**SCHERE**  
 Myrtle 320B  
**SCHERZER**  
 Belle (1861-1928) 24  
**SCHUELL**  
 Ruth 23  
**SCHUELER**  
 Elizabeth Emily 181, 312A  
 Elvira Lyon 181, 312A, 332A  
 Margaret Lyon (1915-) 181, 312A, 332A  
 Percy Charles (-1923) 181, 312A, 332A  
 Sara 41  
**SCHIELE**  
 Emilie 245  
 Julia Bloom 236  
 Sigmund M. 236  
**SCHIFF**  
 Abraham 237  
 Edna 13  
 Jean Kohn 24  
 Pauline 16  
 Rica 90  
 Rose Oppenheimer 237  
 Vernon 24  
**SCHIFFER**  
 Ada Moss 215  
 Adeline 215  
 Amanda 215  
 Anthony 215  
 Carrie Beeber 215  
 Daniel 215  
 Edith Stein 215  
 Emma 215  
 Eva 215  
 Helen Bryce 215  
 Jack 215  
 Jacob 215  
 Jean Hilb 215  
 Jennie Wexelbaum 215  
 Jeremiah 215  
 Joseph 215  
 Kenneth (son of Jack) 215  
 Kenneth (son of Kenneth) 215

Mary Humphries 215  
 Myron 215  
 Myron, Jr. 215  
 Neil 215  
 Thomas 215  
 Timothy 215  
 Walter (son of Jack) 215  
 Walter (son of Jacob) 215

**SCHILLER**  
 Madeline Barnett 24  
 William 24

**SCHIMMEL**  
 Nathan (see Kohn, Nathan (Schimml))

**SCHINNLER**  
 Margaret 171

**SCHLEIFER**  
 Inge 18

**SCHLEMM**  
 Dorothy E. 203

**SCHLESINGER**  
 Alex 89  
 Alfred 11  
 Claire Guggenheimer 89  
 Edward (m. 1910) 60  
 Edward (son of Alfred) 11  
 Elizabeth 8  
 Ella Cohen 8  
 Gellah Sulzberger 290  
 Harry F. 8  
 Harry Lionel 8  
 Israel 290  
 Louisa 11  
 Louisa Levy 47  
 May B. 47  
 Nan 211  
 Rachel 8  
 Rebecca 47  
 Robert 89  
 Rose Kaplan 11  
 Sigmund 47  
 Violet Ascher (m. Edward) 60  
 Virginia Ancker 11

**SCHLESSINGER**  
 Ada May 102

**SCHLEZINGER**  
 Bobette Sylvia Stern 282, 339B  
 Joanne (b. 1943) 282  
 Lynn (b. 1942) 282  
 Nan (b. 1950) 282, 313B, 339B  
 Nathan 204, 339B

**SCHLOESSER**  
 Florence Kate Leon 115  
 Frank 115

**SCHLONGER**  
 Diane 293  
 Herman 293  
 Lee 293  
 Lenore Wertheimer 293  
 Ruth 293

**SCHLOSS**  
 See also Castle  
 Alexander Joseph 125  
 Amy 125  
 Bernard 108  
 Bertha 108  
 Bertha Lazaron 61  
 (Betty) Louise 301, 340B  
 Caroline 23  
 Chaim B. 108  
 Charles 293  
 Fanny 293  
 Florence Hoffman 293  
 Florence Miller 293  
 Hanchem Lowenberg 108  
 Harold 293  
 Harry 293  
 Hyman 145, 328A  
 J. 70  
 Janice Monroe 328A  
 John 125  
 Laura Thorman 293  
 Lawrence (1901-) 328A  
 Lillie Livingston 145, 328A

Lily 293  
 Louise see (Betty) Louise  
 Margaret 293  
 Marie 86  
 Melvin E. III 125  
 Melvin E., Jr. 125  
 Melvin Eli 125  
 Merwin (1895-) 328A  
 Morley 293  
 Norma 328A  
 Philip (b. 1915) 293  
 Philip (m. Laura Thorman) 293  
 Philip (son of Harry) 293  
 Philip, Jr. 293  
 Rosa 108  
 Ruth 293  
 Shirley Mary Schaeffer Jones 125  
 Sidney 293  
 Sophie Ruth Isaacs 125

**SCHLOSSBERG**  
 Alice Jacobi 311A  
 Arnold 311A  
 Eugene Meyer 240  
 Nathaniel 240  
 Phyllis Bridges 240  
 Thelma Leola Bowman 240

**SCHLOSSINGER**  
 Evelyn Frances Lewis 171  
 Frank 171  
 Gregory 171  
 Lewis Frank (b. 1941) 171

**SCHMIDT**  
 Adelaide (1894-1948) 257  
 Adelaide Anna Karstendiek 257  
 Craig Ziegler (b. 1909) 257  
 Craig Ziegler, Jr. (b. 1953) 257  
 Earle E. (1890-1953) 257  
 Faith Finley 257  
 Florence Sheftall 270  
 Grayce Maletta (b. 1930) 257  
 Harry W. 270  
 Harry Ziegler (1886-1951) 257  
 Irving Frances (1885-1892) 257  
 Isabelle McHardy Sheridan 257  
 James Jackson (1852-1920) 257  
 James Jackson, Jr. (1882-1944) 257  
 Karen Lee (b. 1953) 257  
 Lena Shofner 257  
 Louise 320B  
 Mary Ann Brown 257  
 Mildred Willowby 257  
 Philip Craig (b. 1940) 257  
 Richard Jeffrey (b. 1952) 257  
 Richard Morgan (b. 1911) 257  
 Sulu Mae Doyle 257  
 Una Adelaide (b. 1924) 257  
 Una Elam 257  
 Violet Delia (1879-1911) 257  
 Wanda Mae Clementson 257

**SCHMITKA**  
 Gertrude Ruth (Goldie) 237

**SCHMITT**  
 Ella Lewis 171  
 Maurice 171

**SCHNECK**  
 Joanne 17

**SCHNEIDER**  
 Leona Levy 159  
 Marx 159  
 Noni 191  
 Norah 60  
 Sophie 328A

**SCHNITZER**  
 Cordelia Menken 192  
 Jacob 192

**SCHOEN**  
 Patricia 9

**SCHOENEMAN**  
 Carl 141  
 Helena Judah 141

**SCHOENFELD**  
 Edna 3

**SCHOLEM**

Hattie 309

**SCHOLER**  
 Mary Ann Levy 159  
 Morris 159

**SCHOLLE**  
 Albert H. 40  
 Albert M. 40  
 Estella Content 40

**SCHOMMER**  
 Mary M. (1869-1937) 257

**SCHONBERG**  
 Ida 255

**SCHONEMAN**  
 Abraham P. 28  
 Adeline 28, 92  
 Ruth 293  
 Charles 28, 174  
 Charles L. C. (1841-1991) 28  
 Charles, Jr. 28  
 Clara Cadet 28  
 Clara Cadette (1876-1926) 28  
 Edie 28  
 Essie Lieber 28, 174  
 Hannah (1845-1904) 28  
 Henrietta Arnold 28  
 Joseph 28, 321B  
 Julie B. Eckstine 28  
 Laura Lehman 321B  
 Leon 28  
 May 28  
 Raphael Augustus 28  
 Rosa Buckman 28

**SCHOOLS**  
 Claude E. 143  
 Hannah Kayton 143  
 Helen 143

**SCHOONHAVEN**  
 See Van Schoonhaven

**SCHOONMAKER**  
 Carl 264  
 Henrietta Francis Seixas 264  
 Josephine Power 268  
 Lena 264  
 Lewis 268  
 Louise Collins 268  
 Virginia 264

**SCHOOR**  
 Mary 270

**SCHOTT**  
 Charles Ridgely (1847-1878) 155  
 Charlotte (b. 1877) 155  
 Ellen Lindsay Fisher 155  
 James (d. 1860) 155  
 Julian Ridgely (1874-1881) 155  
 Margaret Livingston (1853-1856) 155  
 Margaret Maria Ridgely 155  
 Margaret Ridgely (1872-1905) 155  
 Rebecca Cornelia (b. 1850) 155  
 Rebecca Cornelia Schott 155  
 Schuyler Livingston (1849-1875) 155  
 William Engles 155

**SCHOYER**  
 Albert Asher (b. 1845) 96  
 Arthur (see Schoyer, David (Arthur))  
 Benjamin Hart (b. 1836) 96  
 David (Arthur) (1839-1841) 69  
 Ernest 96  
 Frances Hart 96  
 Frank Ruben (b. 1848) 96  
 Raphael 96  
 Sarah Elizabeth 141

**SCHREIBER**  
 Jacob (see Ezekiel, Jacob (Schreiber, Jacob))

**SCHREIER**  
 Florence 280

**SCHRIER**  
 Elmira T. Hart 96  
 J. E. 46, 96

**SCHRIVER**  
 Kate I. 63

**SCHUFFMAN**  
 Edwin 107

Ethel Jacobs 107  
 Jan 107  
 Julie 107  
 Louis 107  
 Shirley Smiley 107

**SCHULHAFER**  
 Lena 278

**SCHULHOPFER**  
 Henrietta (b. 1870) 235, 337B

**SCHULMAN**  
 Francis Esther Solis-Cohen 275  
 John, Jr. 275  
 Marion 16  
 Nancy Joan (b. 1948) 275  
 Virginia Martha (b. 1950) 275

**SCHULSON**  
 Anne 111, 325B  
 David Hendricks (b. 1952) 111, 325B  
 Henry Hendricks (b. 1955) 111, 325B  
 Hyman 111, 325B  
 Jaimee 325B  
 Loree 325B  
 Rachel Ellenberg 325B  
 Ruth Hendricks 111, 325B  
 Sherree Starr 325B

**SCHULTES**  
 Mary 148

**SCHULTZ**  
 Anna 161  
 Emma 174  
 Fannie 174  
 Rebecca (1823-1894) 174

**SCHUMANN**  
 Eleanor Sanger 164  
 Henry 164  
 Sanger 174

**SCHUSTER**  
 Sophia S. 293

**SCHUTZ**  
 Alice 174  
 Betty 174

**SCHUYLER**  
 Mary Ann Levy 159  
 Nicholas 271  
 Shina Simon 271

**SCHWAB**  
 Alfred 306  
 Alice Rachel (b. 1902) 287  
 Anne Lauer 287  
 Anthony Frederick 150, 328B  
 Arthur 187  
 Barbara 287  
 Bertha Marks 187  
 Betty Bay 287  
 Bonnie 287  
 Caroline 287  
 Charles 306  
 Clara 306  
 Cynthia Herrman 287  
 David Herman 287  
 Diane Amy 287  
 Elise 287  
 Ella Marks 187  
 Ellen 287  
 Frances Helen (b. 1906) 286  
 Frances Jeanetta (1849-) 328B  
 Frances Newman 287  
 Gella Landman 287  
 Geraldine Kling 287  
 Hannah Workum 306  
 Helen 187  
 Helen Stix 187  
 Henry 306  
 Herbert 306  
 Isaac 187  
 Jacob 131  
 James L. III 287  
 James Leon (b. 1894) 287  
 James Leon, Jr. 287  
 Jerome 306  
 Joan 306  
 John 306  
 Julie Bay 287

Jull Ann 287  
 Laura Newman 287  
 Leon 287  
 Leon Jacob 287  
 Leon Jacob, Jr. (b. 1899) 287  
 Leonora 187  
 Lottie 306  
 Margaret Dalloff 287  
 Marjorie Meyer 287  
 Max 187  
 Miriam Lazarus 150, 328B  
 Nancy 306  
 Peter Martin 287  
 Rachel Monheimer 306  
 Rachel Stix 287  
 Rachelle Hollander 287  
 Richard 306  
 Richard Newman 287  
 Robert Louis 287  
 Robert Sidney (b. 1903) 286  
 Roger 287  
 Sidney Isaac 286  
 Sidney Isaac, M.D. 187, 286  
 Sophie 187  
 Walter Landman 287  
 Wendy 287  
 William S. III 287  
 William S., Jr. 287  
 William Stix (b. 1896) 287

**SCHWABACHER**  
 Albert 11  
 Florence 11  
 Hart 11  
 Henrietta Salzenstien 11  
 Henry 11  
 Hettie 11  
 Jake 11  
 Julius 11  
 Leo 11  
 Louie 11  
 Lydia Aaron 11  
 Mary Supera 11  
 Ned 11  
 Sophie Dinkelspiel 323A  
 Tammy Gundelfinger 11  
 Virginia Ancker 11

**SCHWABE**  
 Hannie 10

**SCHWALBE**  
 Douglas 253  
 Douglas, Jr. 253  
 James A. III 253  
 Mary Ann Goldsmith 253  
 Nina Rebecca 253  
 William Price 253

**SCHWAM**  
 Adele Roth 237  
 Caren 290  
 Carla Jan 237  
 Charles 290  
 Christopher 290  
 Edwin 237  
 Linda Gail 237  
 Sally Goldberg 290  
 Stuart A. 290

**SCHWARTZ**  
 Abraham 43  
 Alan Magnus 239  
 Albert 231  
 Albert, Jr. 231  
 Amelia Friedman 43  
 Andrew Eric 239  
 Ann Wiener 293  
 Annie 181  
 Bertha Shucart 125  
 Bessie Newhouse 231  
 Charlotte 237  
 Donald 293  
 Edgar Louis 164  
 Edith 197  
 Edward Magnus 239  
 Eleanor Charlotte Frank 164  
 Emily 12

Ethel Miriam 266  
 Gladys Malina 239  
 Helen Topilow 239  
 Henrietta (1869-1948) 166  
 Ida 95  
 Irving 239  
 Jack 266  
 Jane Carol 239  
 Julius Frank 164  
 Karl III 218  
 Karl Jameson 218  
 Katherine Baldwin Myers 218  
 Marion Frances 164  
 Melanie Reva 43  
 Mildred 110  
 Myra Rosalie Seixas 266  
 Nelda Margaret Jenkins 164  
 Ruth Magnus 239  
 Samuel William 43  
 Susan Margaret 164

**SCHWARZBAUM**  
 Leah Barnett 16

**SCHWEITZER**  
 Susan Ellen 282

**SCHWERIN**  
 Alberta 289  
 Bertha Stewart 289  
 Caroline Suares 289  
 Carrol (b. 1885) 289  
 Cecil 289  
 Cecile Frances Moses 207, 289  
 Edward 289  
 Francis 289  
 Genevieve 289  
 Harman 207, 289  
 Henry H. (b. 1889) 289  
 Herman (1852-1895) 207, 289  
 Herman (1876-1891) 289  
 Jacob Henry (1845-1849) 289  
 Julia (d. 1936) 289  
 Lydia Aaron 11  
 Julius (1812-1875) 289  
 Leopold S. 239  
 Octavia 289  
 Rebecca 289  
 Sadie Oppenheimer 239  
 Woodrow 289

**SCOBELL**  
 Cecily Maude Hopkinson 79  
 Charles John (1917-1918) 79  
 Edith 79  
 Edith Ismay (b. 1911) 79  
 Edith Palairt 79  
 Emily Katherine 79  
 Florence Eleanor 79  
 George Palairt (1913-1934) 79  
 John 79  
 Mary Hamilton 79  
 Melloney (b. 1924) 79  
 Melloney (dau. of Sanford) 79  
 Sanford G. T. 79  
 Sanford John 79

**SCOTT**  
 Alice Williams 133  
 Andrea 108  
 Ann 241  
 Ella 49  
 Elsa Campe Goodman 108, 325B  
 Ethel Margaret Shaw 81  
 H. B., Jr. 81  
 Henry Bernard 81  
 Howard 108  
 James 133  
 Jonathan 108  
 Malcolm Leake 81  
 Marcia Whitlock Sonneborn 230  
 Mary 192  
 Mary Ashe Moses 209  
 Mary G. 168  
 Mary Wingfield 309B  
 Robert 230  
 Wendy 230  
 William D. 209

**SCRANTON**

Helene Wittenberg 144  
Sam 144  
**SCUDDER**  
Barbara Binswanger 23  
Bessie Morris (1856-1890) 156  
Bessie Morris Scudder 156  
Charles (b. 1859) 156  
Charles (m. Barbara Binswanger) 23  
Charlotte Doremus (b. 1879) 156  
Clarence Goodwin (1869-1888) 156  
David 23  
Henry Martyr, Jr. 156  
Jared W., Jr. (b. 1863) 156  
Jared Waterbury 155, 156  
Julia (b. 1861) 156  
Julia Clayton Goodwin 155, 156  
Steven 23  
William Henry (b. 1858) 156  
**SEAGO**  
Ethel 201  
George Leslie 201  
Nettie Richards Mordecai 201  
**SEAMAN**  
Beverly Huntington (b. 1919) 309B  
Gladys Lorraine Dodge Cohen 309B  
Julian Huntington (1889-1942) 309B  
**SEARL**  
John 265  
Victoria Seixas Fauth 265  
**SEARLES**  
Lola 276  
**SEARS**  
Mary Aiden (1918-1968) 158  
**SEASONGOOD**  
Agnes Senior 306  
Janet 306  
Murray 306  
**SEAWELL**  
Benjamin Washington 328B  
Victoria Isaacson 328B  
**SEAYRES**  
Frances R. Cardozo 29  
John H. 29  
**SEBAG-MONTEPIORE**  
Betty 138  
Daphne 138  
Marguerite Maud Joseph 138  
Nancy 138  
Robert 138  
Sybil Matilda Joseph 138  
William (b. 1886) 138  
**SEGAL**  
Adrian 284  
George 329A  
Margo Atkinson 329A  
Sophie Loeb 284  
**SEIDENBACH**  
Nancy 283, 313B  
**SEIFERTH**  
Fanny 70  
**SEIXAS**  
Aaron (1796-1849) 266  
Abigail (b. 1783) 264  
Abigail (b. 1811) 265  
Abigail (b. 1822) 265  
Abigail (b. 1847) 263  
Abigail (b. 1950) 266  
Abigail (dau. of Solomon) 266  
Abigail (Mendes Seixas?) (d. 1738/9)  
263  
Abigail (1742-1819) 140, 141, 263  
Abigail (1779-1782) 266  
Abigail (1782-1854) 263  
Abigail (1784-1860) 243, 266  
Abigail N. Cardozo (1802-1870) 29,  
266  
Abigail Valencia 263  
Abraham (1741-1742) 189  
Abraham (1786-1834) 29, 266  
Abraham De Leon 266  
Abraham H. (1839-1902) 266  
Abraham Mendes (1750/1-1799) 98,  
263

Abraham Mendes (1810-1867) 263,  
339A  
Abraham Percival (b. 1870) 263  
Adele Miriam (b. 1871) 225, 263  
Adele Orah (1847-1868) 264  
Adele Wolfsohn 265  
Albert Terhune 265  
Alfred (b. 1844) 263  
Alice Couch 266  
Alma J. Tenner 266  
Altemont Samuel (1851-1852) 264  
Amelia 264  
Amelia Benoit 264  
Annie Hughes 265  
Arch McIntyre (b. 1827) 265  
Archibald Souza (b. 1876) 124, 266  
Arthur Wellington (b. 1865) 265  
Augusta Goodwin 266  
Bella (see Seixas, Bilhah Levy)  
Benjamin (b. 1813) 265  
Benjamin (b. 1826) 266  
Benjamin (b. 1863) 265  
Benjamin (son of Isaac) 263  
Benjamin (1775-1843) 263  
Benjamin (1783-1847) 264  
Benjamin (1811-1871) 265  
Benjamin B. (1832-1884) 39, 265  
Benjamin Hayman (1827-1885) 241,  
266  
Benjamin Herbert 266  
Benjamin II (1818-1840) 265  
Benjamin Mendes (1747-1817) 159,  
263, 265, 266, 313A  
Benjamin Pardo Mendes (1846-1901)  
225, 263  
Benjamin Solomon (1815-1866) 265,  
266  
Bertha 266  
Bilhah Levy (1781-1860) 263, 313A  
Camilla (1843-1892) 265  
Caroline (dau. of Gershom A.) 264  
Caroline (dau. of Isaac Mendes) 263  
Caroline Farquhar 264  
Catherine 266  
Clarence Adrian (b. 1868) 266  
Claretta Esther (b. 1875) 263  
Claude Benjamin (b. 1887) 265  
Clifford (1878-1881) 265  
Cordelia Alice (b. 1871) 45, 265  
Cordelia Lopez (b. 1886) 265  
Daniel (d. 1777) 265  
Daniel (1800-1865) 266  
Daniel (1848-1849) 265  
Daniel Brandon 263  
Daniel Mendes (d. 1758/65) 263  
David (1788-1864) 264  
David Cardozo (1823-1857) 55, 266  
De Leon (son of Abraham De Leon)  
266  
Dealonde (1867-1915) 266  
Edith Raphael 264  
Edna May Gilmore 266  
Edward 264  
Edward Bliss Foote (1866-1945) 266  
Edward Woodbridge (b. 1887) 266  
Eleanor Cohen 38, 265  
Eleanor H. Cohen 39, 265  
Eliza Caroline Kopper 264  
Elkaleh (d. 1831) 264, 276  
Elkaleh Myers-Cohen 223, 263, 264  
Emile 265  
Emily (1836-1858) 265  
Emily Mendes (b. 1848) 225, 263  
Emma 265  
Ernest Percival (b. 1876) 265  
Esther (b. 1837) 265  
Esther (see also Seixas, Hetty (Esther))  
Esther (sis. of Abraham Mendes  
Seixas) 263  
Esther (1818-1908) 265  
Esther B. (1789-1872) 243, 244, 266  
Esther Gomez (see Seixas, Hetty  
(Esther) Gomez)

Esther H. (b. 1825) 264  
Ethel Miriam Isaacs 124, 266  
Ethel Williams 266  
Eugene (1843-1883) 266  
Eugene E. (1844-1868) 264  
Eunice Elvira Torgenson 266  
Evelyn Hannah (1878-1946) 263  
Everett Moses (b. 1879) 266  
Everett Souza (b. 1910) 266  
Everett, Jr. 266  
Fanny (1855-1868) 266  
Fanny Mendes (b. 1787) 263  
Florence Augusta Cohen 39, 265  
Florian (b. 1853) 264  
Florian (b. 1863) 265  
Frances (b. 1845) 265  
Frances May (1873-1938) 263  
Frank Archibald (b. 1920) 266  
Franklin M. (1850-1887) 265  
Franklin Pierce (b. 1853) 266  
Frederick Benjamin (1869-1870) 266  
Frederick Lee 264  
George Augustus Hoppy 266  
Gershom (b. & d. 1784) 263  
Gershom (b. 1820) 265  
Gershom Arnold (1835-1919) 264  
Gershom Arnold, Jr. 264  
Gershom Mendes (b. 1859) 265  
Gershom Mendes (1746-1816) 141,  
223, 263, 264, 313A  
Gershom Mendez (b. 1819) 266  
Grace (b. 1827) 264  
Grace (1752-1831) 226, 263, 313A  
Grace (1786-1865) 140, 264  
Grace (1794-1866) 38, 266  
Grace (1852-1854) 265  
Grace Mendes (1785-1821) 263  
Hadassa (see Seixas, Myrtila  
(Hadassa))  
Hannah (Annie/Nancy) Judah 141, 263,  
264  
Hannah Baiz (see Seixas, Nanette  
(Hannah) Baiz)  
Hannah M. Pardo 263, 339A  
Harriet (dau. of Gershom A.) 264  
Harry King (1858-1859) 265  
Harry L. 266  
Hattie Warshauer 265  
Hayman L. (1829-1910) 137, 265  
Hayman Levy (1792-1865) 29, 266  
Hazel Elizabeth (b. 1906) 266  
Helen (1878-1920) 264  
Henrietta De Lea 55, 266  
Henrietta Francis (b. 1833) 264  
Henrietta Raphael 264  
Henry (b. 1856) 265  
Henry (1803-1822) 264  
Henry Evan (b. 1860) 192  
Hetty (Esther) Gomez) 85, 266  
Hetty (Esther) (1789-1854) 263, 313A  
Hillel Mendes (1814-1874) 38, 265  
Hortensia Josephine (b. 1883) 265  
Hortensia Moses 205, 265  
Howard H. L. (b. 1870) 266  
Isaac (b. 1776) 264  
Isaac (b. 1816) 265  
Isaac (b. 1849) 265  
Isaac (son of Daniel) 263  
Isaac (1779-1786) 263  
Isaac Benjamin (1781-1839) 140, 265,  
266  
Isaac Cardozo (b. 1858) 266  
Isaac Cardozo (1836-1914) 266, 280  
Isaac Gomez (b. 1817) 140, 266  
Isaac Mendes (1708/9-1780) 154, 263  
Isaac Mendes (1778-1826) 263  
Isaac Mendes (1829-1834) 266  
Isaac N. Cardozo 266  
Isabel (1857-1868) 266  
Isabelle Chalmers 264  
Isadore Israel (1855-1856) 264  
Jacob (b. 1854) 265  
Jacob B. (1795-1854) 266

Jacob Levy (1812-1901) 205, 265  
James Madison (1829-1889) 266, 339A  
Jean Caro 266  
Jean Florence (b. 1916) 266  
Jeannette (b. 1849) 263  
Jenny 263  
Jessica Davis (b. 1855) 266  
Jocheded Levy 165, 263  
Jonathan B. Yates (1824-1887) 265  
Joseph (b. 1794) 264  
Joseph (b. 1831) 265, 339A  
Joshua (b. 1781) 263  
Joshua (b. 1802) 264, 326A, 339A  
Joshua Mendes (b. 1788) 263  
Juanita Lillian 266  
Judah Theodore (b. & d. 1858) 265  
Judith (b. 1840) 265  
Judith (d. 1738) 263  
Judith (1777-1829) 175, 263  
Judith (1835-1904) 265  
Judith Levy 169, 265  
Judith Sartorius 266  
Julia 266, 339A  
Julia Ann (b. 1822) 264  
Katherine (1857-1863) 265  
Lawrence 266  
Lawrence Ludlow 266  
Leah (1805-1886) 266  
Leah Olga (b. & d. 1881) 263  
Leslie Pesca (1847-1849) 266  
Lewis Daniel (b. 1849) (son of  
Benjamin H.) 266  
Lewis Daniel (b. 1849) (son of Isaac  
G.) 266  
Lillian (b. 1867) 265  
Lucy Orah (1804-1825) 136, 264  
Madison 266  
Mamie Alice 266  
Marie Julia Desionde 266  
Marion 265  
Martha Washington (b. 1852) 266  
Mary 265  
Mary Eleanor (1869-1931) 66, 265  
Mary Jessup 265  
Matilda 266  
Matilda A. O'Neill 266  
Melvin 265  
Meyer L. (b. 1836) 39, 265  
Miriam (1802-1833) 212, 266  
Miriam (1834-1837) 266  
Montgomery (1861-1926) 265  
Moses (1744-1809) 165, 263  
Moses (1845-1861) 265  
Moses Benjamin (1780-1839) 169, 265,  
266  
Moses Mendes (b. 1793) 263  
Moses Mendes (1841-1852) 265  
Moses Mendes (1841-1861) 266  
Myer (1820-1842) 265  
Myer L., Jr. (b. 1893) 265  
Myra Rosalie (b. 1912) 266  
Myrtila (b. 1827) 264  
Myrtila (b. 1850) 264  
Myrtila (Hadassa) (1807-1859) 264  
Nanette (Hannah) Baiz 225, 263  
Natalie (b. 1860) 95, 265  
Noah Sartorius 266  
Norman (1843-1875) 266  
Pauline May (b. 1873) 265  
Pedro (d. 1772) 263  
Peter Carr 266  
Phillip (b. 1874) 265  
Rachel (b. 1782) 263  
Rachel (b. 1822) 29, 265  
Rachel (dau. of Solomon) 266  
Rachel (1773-1822) 243, 244, 263  
Rachel (1798-1861) 241, 266  
Rachel (1801-1827) 136, 264  
Rachel (1851-1938) 266  
Rachel Judah 140, 266  
Rachel Levy 154, 263  
Rachel Nunes Cardozo 29, 266  
Raphael (b. 1756) 263

Rebecca (b. 1861) 265  
Rebecca (dau. of Abraham) 263  
Rebecca (dau. of Daniel) 263  
Rebecca B. (1782-1868) 97, 266  
Rebecca Judah 140, 266  
Rebecca M. (b. 1780) 263  
Rebecca Mendes (1780-1867) 264  
Rebecca Seixas (m. Daniel B.) 263  
Rebecca Seixas (m. Daniel M.) 263  
Ribca (dau. of Abraham Mendes) 263  
Ribca (daughter of Daniel Mendes)  
263  
Ribca Seixas (m. Daniel Brandon  
Seixas) 263  
Ribca Seixas (m. 1733) 263  
Ricbea Ann Judah 139, 264  
Richea Hart 98, 263  
Rosalie Luchs 266  
Rosalie Souza 266, 280  
Rosina (d. 1911) 266  
Samelia Mildred 266  
Samuel (1793-1852) 264  
Sarah (b. 1841) 265  
Sarah (dau. of Isaac) 263  
Sarah (1791-1834) 226, 266  
Sarah (1825-1917) 88, 266  
Sarah (1839-1907) 265  
Sarah (1852-1859) 263  
Sarah Abigail (1778-1854) 147, 264  
Sarah Henriques Joseph 137, 265  
Saraphine (b. 1840) 264  
Selina (1806-1883) 264, 276  
Selina (1838-1917) 209, 264  
Selina Brandon (1865-1909) 264  
Sloe Virginia (b. 1826) 265  
Solomon (1787-1840) 85, 266  
Solomon (1832-1867) 266  
Solomon (1834-1895) 265, 339A  
Solomon Pesca (b. 1842) 266  
Stella Rebecca (b. 1854) 265  
Theodora 264  
Theodore Griswold 264  
Theodore J. (1803-1882) 139, 264  
Theresa 147  
Victor Montefiore (1875-1876) 265  
Victoria (1838-1870) 265  
Victoria Seixas 265  
Violet (b. & d. 1868) 265  
Virginia (b. 1829) 264  
Virginia (b. 1847) 265  
Virginia (1848-1849) 265  
Virginia (dau. of James M.) 266  
Virginia Zipporah (1854-1876) 36, 266  
Washington (b. & d. 1852) 265  
Zipporah (b. 1795) 263  
Zipporah (b. 1816) 265, 266  
Zipporah (dau. of Solomon) 266  
Zipporah (1814-1902) 265  
Zipporah (1833-1852) 266  
Zipporah Levy 159, 263, 265  
Zipporah Peixotto 241, 266  
Zipporah Seixas 265, 266  
**SELDIN**  
Daniel Thomas 215  
Elizabeth Ann Rosenberg 215  
Gilbert Roy 215  
Jonathan Paul 215  
Roy 215  
**SELDNER**  
Aaron Beauregard 301  
Henrietta Umstadter 301  
Hubert Alan 301  
Lester Henly 301  
Michael 301  
Rose Louchheim 301  
Samuel Winfred 301  
Samuel Wolf 301  
**SELIG**  
Abraham (m. Sarah Stern) 283  
Abraham (m. 1861) 281  
Alan 283, 313B  
Andrew 313B  
Antoinette Spiro 281

Carrie Kline Kaufman 283  
Cathy 313B  
Elizabeth 339A  
Fleurette (d. 1952) 281  
Florence 283  
Gertrude 283  
Hannah Lewin 339A  
Jeanne 313B  
Joan 294  
Jonathan 313B  
Justin 283  
Leonora 281  
Mabel Engelberg 283  
Marjorie 339A  
Milton 283  
Miriam Bacharach 283  
Nancy Seidenbach 283, 313B  
Ralph 283  
Robert William 283  
Sarah Stern 283  
Thomas 313B  
**SELIGMAN**  
Addie Bernheimer 322B  
Alfred 13  
Alma 322B  
Angeline 40  
Cecile 40  
David (see Seligman, De Witt (David)  
J.)  
De Witt (David) J. 40, 322B  
Ethel 322B  
Ethel F. 323A  
Eugene 322B  
Eugene 40  
Fanny (see Seligman, Frances (Fanny))  
Fleurette 40, 322B  
Florine Arnold 13  
Frances (Fanny) 40, 227  
James (1824-1916) 322B  
James 40, 322B  
Miriam Szold 5  
Norman 5  
Rosa Content 40, 322B  
Samuel J. 40  
Samuel Jefferson 40  
Washington (b. 1857) 40  
Washington (son of James) 40  
**SELIGSBERG**  
Alma Seligman 322B  
Frank 322B  
Jane 322B  
Marjorie 322B  
Susan 322B  
**SELLERS**  
Irma Rachel Levy Maduro Peixotto  
241  
Jean 241  
Thomas Creighton 241  
**SELMAN**  
Florence 293  
**SEMON**  
Anna 313B  
Benjamin (1848-1865) 313B  
Emanuel (1798-1871) 313A  
Emma 313B  
Hazel Dawn 313B  
Henrietta (1831-1887) 313B  
Jacob 313B  
Joseph (1836-1880) 313B  
Judah 313B  
Larry 313B  
Mary Bailey 313A  
Rachel (b. ca. 1830-1899) 313A  
Rebecca 313B  
Rosa Belle 313B  
Sarah Tabitha (1835-1913) 313A  
William 313B  
Zerubabel 313B  
**SENIFF**  
Mary Anna (1827-1899) 298  
**SENIOR**  
Agnes 306  
Clara 306

Clara M. 306  
Deirdre Bridget 82  
Edward 306  
Fannie Aub 306  
Isaac Haim De Jacob 178  
Laura Monheimer 306  
Leah (m. Benjamin) 59  
Leah de Jacob 62  
Marjorie Magnus 8, 306  
Ribca Lopez (Da Fonseca) 178  
Robert 8, 306  
Robert Michael 306  
Robert, Jr. 8, 306  
Sarah 59  
Sarah de Jacob 61  
**SENNIG**  
Regina 108  
**SENSBACH**  
Elizabeth 51  
**SENTURIA**  
Ben 286  
Nancy Hellman 286  
**SERRA**  
Caroline Murat Joseph 138  
Teodorico 138  
**SEWALL**  
S. J. 219  
**SEWELL**  
Belle Myers 219  
Cyril 138  
Gertrude 138  
Maud Collins 138  
Maude Evelyn Collins 138  
Peter 138  
S. J. 219  
**SEYMOUR**  
Constance Adelaide 77  
**SHADWICK**  
Robert 81  
Margaret 216  
**SHAFER**  
Ruth 71  
**SHAKESPEARE**  
Dorothy 81  
Hope 81  
Olivia Tucker 81  
**SHALEK**  
Bertha Koehler 334A  
**SHALIT**  
Joy H. 160  
**SHANLEY**  
Daniel 267  
Rebecca Sheftall 267  
**SHANN**  
Theodosia 182  
**SHANON, OR SHANNON**  
Jacob (d. London) 103  
**SHANTARAM**  
Anoopa, (1972-) 337B  
Gail Iris Oppenheim 337B  
Rajahpohl 337B  
**SHAPIRO**  
See also Schapiro  
Florence 328A  
Howard (see Scott, Howard)  
Jane 255, 310B  
Margaret Lowengrund 215  
Norman 215  
Shirley 167  
**SHARLES**  
Amy Benjamin Michaels 193  
David William 193  
Frederick William 193  
John Michael 193  
**SHARLIN**  
Carol 127  
**SHARP**  
Aubrey E. 196  
Bety Katzenberg 282  
Mary 337A  
Mary Alice Moise 196  
Matthew 282  
Thomas 282  
**SHARPLESS**

Amelia Read (Leila) Horwitz 118  
S. Franklin 118  
**SHARRETT**  
Anna Judah 139, 327A  
Gertrude 139  
Washington 139, 327A  
**SHAW**  
A. E., Jr. 81  
Allen Haig 81  
Allen Ralph 81  
Allen Rothery 81  
Arthur Ernest 81  
Bruce (b. 1942) 51  
Cathleen 81  
Charlotte Greenwood 81  
Elizabeth Gratton 81  
Elizabeth Logan Graham 81  
Emma 25  
Ethel Margaret 81  
Frances 81  
Frances Rebecca Johnson 81  
Frederick Ralph 81  
Gertrude (b. 1874) 81  
Helen 51  
Irma Knopf 81  
James Graham 81  
John Allen 81  
Leonard Spenser (b. 1906) 51  
Mabel 221  
Margaret Louise Johnson 81  
Marie Lee Keiley 81  
Marjorie 81  
Olive Kitson 81  
Philip William 81  
Ralph 81  
Ralph Allen 81  
Ralph Henry 81  
Robert 81  
Rosa 81  
Sarah Anna 230  
Stephen-Allen 81  
Terry (b. 1941) 51  
William Johnson 81  
**SHAYNE**  
Rebecca Levy 159  
**SHEARMAN**  
Harriet 159  
Howard 159  
Humphrey 159  
Jefferson 159  
Rebecca Levy 159  
Virginia 159  
**SHEFFEL**  
David 51  
Dorothy Clair Abraham 51  
Judith 51  
Morton 51  
Susan Carol (b. 1942) 51  
**SHEFFIELD**  
Ann Margaret Phillips 246  
John Vincent 246  
**SHEFTALL**  
Abigail Minis (b. 1796) 267  
Abraham (b. 1832) 269  
Abraham (b. 1856) 269  
Abraham (m. 1851) 267  
Abraham (1795-1831) 54, 268  
Abraham (1877-1903) 270  
Adam Diehl 269  
Adam Diehl, Jr. 269  
Alice Frances Elliott 268  
Allen 269  
Allyson Kelley 268  
Almeta Andrews 269  
Amelia Burns 270  
Amelia Winberly 270  
Ann Hedwig 269  
Anna Augusta Hartter 269  
Anna Lafae 270  
Anna Lafae Fargason 270  
Annie E. Mock 269  
Annie Gaillard Cooper 268  
Annie Lea Wallace 268

Arlene Eleanor 270  
Audrey Kelley 268  
Barbara Dalesandro 270  
Benjamin (b. & d. 1807) 267  
Benjamin (b. 1771) 267, 270  
Benjamin (son of Thomas J.) 268  
Benjamin (1692-1765) 267, 313B  
Benjamin (1767-1794) 267  
Benjamin F. (1871-1926) 269  
Benjamin Franklin (b. 1849) 268, 269  
Benjamin Franklin (b. 1884) 268  
Benjamin Franklin (b. 1907) 268  
Benjamin Franklin (b. 1947) 268  
Bessie 269  
Bettie Ann Jorgenson 268  
Betty Ezell 268  
Blanche Delgado 269  
Caroline 270  
Caroline Amelia Mercier 270  
Caroline E. 267  
Carolyn Babb 268  
Catherine 267  
Charles Henry (b. 1858) 269, 270  
Charles Henry III 270  
Charles Henry IV 270  
Charles Milton 268  
Claire 270  
Clara De La Motta 54, 267, 269, 309  
Clara Porter 269  
Margaret Louise Johnson 81  
Clarence, Jr. (b. 1901) 269  
Cooper (1860-1947) 268  
Cornelia Dozier 269  
Cynthia Caroline 270  
Daisy Mary Jane 267  
Daniel F., Jr. 269  
Daniel Fox 269  
De La Motta (b. 1823) 268  
De La Motta (b. 1862) 268  
De La Motta (b. 1894) 268  
De La Motta II 268  
De La Motta III 268  
Dora 269  
Doris C. Kraft 270  
Dorothy (b. 1931) 269  
Dorothy Blanche Hoover 269  
Dorothy Claire (b. 1907) 269  
Dorothy Claire (b. 1924) 269  
Dorothy Jean 268  
Dorothy Louise Kitchen 69  
Dudley 268  
Dwight M., Jr. 269  
Dwight Moody 269  
Edward Carlisle 268  
Edward E. 267  
Edward Tatnall (1826-1863) 268  
Edward Tatnall (1857-1934) 268  
Edward Tatnall (1880-1944) 269  
Elaine 269  
Elias (b. & d. 1765) 267  
Elizabeth 267  
Elizabeth Brainard 270  
Elizabeth Georgia 269  
Elizabeth M. 270  
Elkaleh (Nellie) Bush 28, 267  
Eleanor Amelia 268, 269  
Eleanor Amelia Sheftall 268  
Elean 267, 268  
Ellen Sheftall 267, 268  
Elsie Moore 269  
Emanuel (b. 1811) 267  
Emanuel (1786-1818) 267  
Emily Bayard 270  
Emma 268  
Emory Speer 270  
Estelle 268  
Esther (1771-1828) 267  
Esther Wood Carlisle 268  
Florence 270  
Florida (b. & d. 1864) 268  
Frances (dau. of Lee Roy) 269  
Frances (1800-1816) 267  
Frances Hart 98, 267

Georgia 267  
Georgia Nathans 268  
Gertrude (1876-1883) 267  
Gertrude (1895-1897) 269  
Gibson 270  
Gladys 270  
Gladys A. Camp 270  
Gladys M. 269  
Gloria Vivian Clair 270  
H. Paul 268  
Hannah 57, 267  
Hannah Giffing Springer 270  
Hannah Rebecca 267  
Hannah Solomons 267  
Harriett Elizabeth 269  
Harriett Emily Parry 269  
Harris 267  
Helen Annie 269  
Henry C. (1841-1854) 267  
Henry Clay (1844-1858) 268  
Ida 270  
Ida Belle (b. 1898) 269  
Ida Belle (b. 1915) 269  
Inez 269  
Irene Ella Nathans 229, 268  
Isaac (1779-1780) 267  
Isabella F. Taylor 269  
J. B. Reed 269  
James 267  
James A. 267  
Jane E. 267  
Jane L. Theiss 267  
Jeanette 269  
Jeanette Dellilah Hodges 269  
Jennie 269  
John A. 269  
John Emanuel 267  
John McKay 270  
John Parry 269  
Joseph 270  
Josephine Banks McKay 270  
Josephine G. 267  
Joyce Marie 270  
Jr. (see Sheftall, Mordecai (Jr.))  
Judith (b. 1781) 267  
Judith (1833-1836) 268  
Julia 269  
Julia S. 269  
Julia Stevens 270  
June Virginia Marie 270  
Kathryn Babb 268  
Kathy (b. 1972) 268  
Kay White 268  
Kemper Fisher 268  
Kimberly 268  
Laura Corinna (b. 1837) 268  
Laura Corinna (b. 1883) 268  
Laura Virginia 269  
Lee Delgado 269  
Lee Roy 269  
Lee Roy, Jr. 269  
Lemuel Smith 270  
Lena Allen 269  
Leonard Julian 270  
Leslie Morrison 269  
Letheria Henrietta 256, 268  
Levi (b. 1819) 268  
Levi (1739-1809) 54, 267, 268  
Levi (1776-1796) 267  
Levi, Sr. (d. 1775) 267  
Lillian Black Warner 269  
Lillian Forrester Charles 269, 270  
Lilly Tharies 269  
Lina Newman 269  
Louisa Ann 267  
Louise Wimberly Kimsey 270  
Lucretia Rebecca 270  
Lula F. Maner 269  
Maggie M. Ritter 267  
Margaret Marwood 270  
Marguerite 269  
Marie (1882-1970) 269  
Marie (1887-1889) 269

Marie Spath 270  
Martha Alice Parry 269  
Martin Andrew 269  
Mary Ella Turner 267, 270  
Mary Katherine 268  
Mary Nettie 270  
Mary Schorr 270  
Mary W. 267  
Mary Zenobia 270  
Mary Zenobia Lowe 270  
Mathias Bush (b. 1802) 270  
Meriam 270  
Michelle 270  
Mildred (b. 1896) 269  
Mildred (1893-1968) 270  
Milton 269  
Minnie McCorkle 268  
Mittie Clifton 269  
Mordecai (b. 1793) 267  
Mordecai (d. 1854) 268  
Mordecai (Jr.) 270  
Mordecai (Sr.) (1783-1856) 256, 267, 268  
Mordecai (1735-1797) 98, 267  
Mordecai (1881-1939) 268  
Mordecai George 270  
Mordecai George Traylor 270  
Mordecai Giffing (1833-1862) 270  
Mordecai Giffing (1885-1947) 270  
Mordecia (1839-1854) 268  
Moses (1769-1835) 28, 267  
Moses (1814-1850) 267  
Myrna Ica (b. 1941) 268  
Myrna Lea 268  
Neil 269  
Nellie 270  
Nellie Bush (see Sheftall, Elkaleh (Nellie) Bush)  
Neva 269  
Neva Osborne 269  
Norma Kassler 268  
Pamela Susan 268  
Paul Raymond 270  
Peggy Bush (1804-1806) 267  
Perla (d. 1736) 267  
Perla (1763-1820) 267  
Perla (1788-1850) 256, 267  
Perla (1811-1897) 267, 278  
Rachel (b. 1778) 267  
Rae Karman 268  
Raymond 270  
Raymond Harris 268  
Rebecca (ca. 1810-1849) 267  
Rebecca (1775-1777) 267  
Rebecca Benjamin 36, 267  
Rebecca Jean 268  
Reid Gaillard 269  
Richard Clifton 270  
Richard Katz 282  
Robert Leonard Joseph 270  
Rosalee 269  
Rosalie Amanda Wilkens 267  
Rosalie Cohen 269  
Ruth 269  
Ruth Helene Muriel 270  
Ruth Lyons 269  
Sadye 269  
Sallie 269  
Sally Telfair 269  
Samuel (1863-1935) 269  
Samuel, Jr. 269  
Sarah (1769-1825) 267, 309B  
Sarah Catherine (1883-1953) 269  
Sarah De La Motta 54, 267, 268  
Sarah E. (1869-1891) 269  
Sarah Elizabeth (b. 1913) 269  
Sarah Elizabeth Fox (1836-1911) 269  
Sarah Florence (1851-1899) 267  
Sarah Ida Hodges 269, 270  
Sarah Ida 270  
Sarah Virginia (b. 1926) 268  
Sarah Virginia (1835-1885) 268  
Sarah Virginia (1890-1920) 268

Scott Dozier 269  
Sheftall (b. & d. 1734) 267  
Sheftall (1762-1849) 267  
Solomon (1741-1743) 267  
Solomon (1791-1868) 54, 267, 269, 309B  
Solomon (1809-1832) 267  
Solomon (1862-1919) 269  
Solomon, Jr. (1893-1910) 269  
Stanley W., Jr. 268  
Stanley Waring (b. 1938) 268  
Steven Paul (b. 1958) 270  
Tatnall Carlisle 268  
Thomas B. (b. & d. 1836) 267  
Thomas Charlton (1824-1825) 268  
Thomas Edward (b. 1928) 268  
Thomas J. (1854-1925) 229, 268  
Thomas Jefferson (b. 1885) 268  
Thomas Jefferson (1854-1925) 229, 268  
Tilly (b. & d. 1877) 267  
Tina (b. 1956) 269  
Valarie (b. 1952) 269  
Virginia (1903-1957) 270  
Virginia Russell 256, 267, 268  
Waring Russell (1881-1941) 268  
William Crumley (1855-1875) 267  
William Henry Cuyler 270  
William Hoover (b. 1970) 269  
William Layne (b. 1953) 268  
William Lowe (1890-1939) 270  
William Lowe, Jr. (b. 1922) 270  
William Lowe, Jr. (b. 1953) 270  
**SHEPTEL**  
Agnes 144  
Edward King 144  
Florence 144  
Florence Fraser 144  
Florence Sophia 144  
Herbert A., Jr. 144  
Herbert Adolph (d. 1914) 144  
Irene S. 144  
Marjorie Kingsland 144  
Sophie King 144  
Stuart Straus 144  
Vivien Straus 144  
Walter (1872-1917) 144  
**SHEPTEL (SCHEPTEL)**  
Adolph  
**SHELDON**  
Douglas 322A  
Judith 322A  
Margaret Vogel 322A  
**SHELOR**  
Alice 207  
Alice Harby 207  
Augusta I. Harby 207  
Gwyn 207  
Henry 207  
Jessie Gwyn 207  
Katherine 207  
Katherine Belser 207  
Robert (m. Alice Harby) 207  
Robert (m. Katherine Belser) 207  
Robert, Jr. 207  
W. R. 207  
**SHELTON**  
Elizabeth Marks 184  
**SHENK**  
Ida Belle Sheftall Kinley 269  
Norman M. 269  
**SHEPARD**  
Dana Lucile Moses 333B  
Louis 333B  
**SHEPHERD**  
Grace 164  
Lilly 164  
**SHERAR**  
Cora Estelle Nathans Middleton Baker 230  
Ernest 230  
Frank 230  
**SHERIDAN**  
Isabelle McHardy 257

**SHERMAN**

Mary (1835-) 335B

**SHERICK**Alexena Jacobs 107  
Alma 107  
Carol 107  
Catheryn Austin 107  
Charles Samuel 107  
Julia 107  
Lester 107  
Lona 107  
Mildred Loewner 107  
Samuel 107**SHERWIN**

Hazel Rose 287

**SHERWOOD**

Mamie 143

**SHIFF**David 97  
Jahasei 97  
Meyer 97**SHINDLER**

Clare 15

**SHINE**Gladys De Beaulieu 275  
Richard 275**SHIPLEY**Helen M. 80  
Maynard 10  
Miriam Allen De Ford Collier 20**SHIRE**Helena May 236  
Laura 89**SHLENKER**Andrea 42  
Arlene Buntin 42  
Carole Janette Butkin 42  
David J. (b. 1902) 42  
David Jacob (b. 1865) 42  
David James 42  
James David (b. 1958) 42  
Jean Naome Harris 42  
Lee Harris (b. 1957) 42  
Lisa Ann 42  
Marie Christina Allen 42  
Maude Rice 42  
Stephen Allen 42  
Stephen Amram 42**SHNEBERG**Hattie 160  
Malka (Molly) Levy 160  
Mary 160  
Molly Levy (see Shneberg, Malka (Molly) Levy)  
Moses 160  
Rachel 160  
Raphael 160  
Sarah 160**SHOCKERT**Nathan 9  
Rebecca Alexander 9**SHOENBERGER**Emily Farquhar Gratz 87  
Frederick C. 87**SHOFNER**

Lena 257

**SHOLER**Armida Brunson 207  
W. 207**SHOR**

Jacob 261

**SHORT**

Helen 195

**SHOUP**Arthur G. 159  
Ethel Phillips 159**SHOYER**Albert M. 271  
Barbara (1853-1912) 271  
Charles (1854-1927) 271  
Clara 271  
Daniel William (1860-1924) 271  
Easie (Rebecca) Asch 13, 28, 271Felix (1824-1893) 271  
Gabriel (1820-1891) 271  
Leopold 271  
Louis (1864-1920) 271  
Louise (1821-1893) 271  
Matilda (1862-1936) 271  
Mayer (1773-1850) 28, 271  
Rachel Cadet 28, 271  
Rebecca (Essie) Asch (see Shoyer, Easie (Rebecca) Asch)  
Richard 271  
Samuel (1848-1910) 271  
Sara (1826-1904) 271  
Sarah (1827-1902) 271  
William (1826-1865) 13, 271  
William Lionel (1865-1933) 271**SHRECKER**Daniel Edwin 23  
Ellen Rose Wolf 23  
John 23  
Michael Franz 23**SHRIER**Josephine Welt 293  
Jacob 293**SHUCHAT**

Paula 191

**SHUGART**Melissa Lynne 53  
Ted Lawrence 53**SHULKIND**

Lillian 160

**SHULMAN**

Margaret Podell 5

**SHULTZ**Charles H. 251  
Maria Louise Pinto 251**SHUMSKY**

Susan Elizabeth 245

**SHUSTER**

Clara Corinna Nathans 230

**SHUTT**Alfred 151, 329A  
Ellen Lazarus Allen 151, 329A  
George Washington 151, 329A  
Gertrude 151  
Lucile 329A  
Nellie 151, 329A  
Walter Witton 151, 329A**SHWARTZ**Aaron 125  
Ella Klein 125  
Ellen K. 125  
Elsie Feibelman 125  
Esther 125  
Gloria Haas 125  
John Forest 125  
Kalman 125  
Kalman, Jr. 125  
Leo 125  
Moses H. (b. 1837) 125  
Moses Henry 125  
Olivia 125  
Olivia Isaacs 125  
Olivia Rose 125  
Richard 125  
Ruth Elizabeth 125  
Sadie 125  
Simon 125**SICHER**John D., Jr. 285  
Susan R. Cullman 285**SIDELL**

Magdalen 127

**SIEGEL**Anita Elaine 293  
Barbara 278  
Barbara 278  
Ronald 45  
Jeanette 91  
Judith Tobias 299, 314A  
Kendra Diane 293  
Margaret Moss 293  
Martina 299, 314A  
Martina A. 293  
Norman 293Robert M. 293  
Sallie Hortense 299  
Toby Susan 314A  
Virginia 293**SIEVERS**C. Aubrey 86  
Mildred P. Mark 86**SILBERBERG**

Marian 280

**SILBERMAN**Ida Hart 101  
Lois 301  
Sidney 101**SILLS**Allen B. 101  
Anne 101  
Goldye Levy 101  
Henry H. 101  
Henry J. 101  
Jane E. 101  
John A. 101  
John S. 101  
Josephine Welt 101  
Lawrence 101**SILVA**

See Da Silva

**SILVEIRA**Bella 180, 331B  
Isaac De Saa 180**SILVER**Anne 191  
Asher (Jacob) (1835-1857) 6  
Ben D. 125  
Benjamin 191  
Benjamin L. (1841-1879) 6  
Carol Hermine Isaacs 127  
Evelyn Alice 191  
Henry Lissak (1843-1854) 6  
Jacob (see Silver, Asher (Jacob))  
Judith Rothart 191  
Katherine Louisa 191  
Leah Abrahams 6  
Leonard 191  
Lewis (1798-1846) 6  
Madeleine Isabel Cohn 125  
Margaret 191  
Marguerite Rachel Mendes 191  
Miriam (b. 1837) 6  
Roger N. 127  
Samuel 191  
Sarah (b. 1828) 6  
Sol Abrahams (b. 1830) 6**SILVERA**

See De Silvera

**SILVERMAN**Alice 323A  
Ann (1980-) 334B  
Barry (b. 1942) 311B  
Carol Morgenstern 311B  
Cass 70  
Cecilia Maria Nunez 213  
Edward Ira (1954-) 334B  
Florence Arnsthal 70  
Frieda Dinkelspiel 323A  
Louise 108  
Michal Charles (1982-) 334B  
Nancy Lee Coleman 334B  
Peppina Avezzano 129  
Robert 129  
Scott Gerard (b. 1968) 311B  
Sol 213  
Stacey (b. 1972) 311B**SILVERS**David D. 45  
Judith 45  
Robert 45  
Ronald 45  
Virginia Davega 45**SILVERSTEIN**Eli 11  
Elizabeth Leigh 27  
Jack 11  
Jane Pincus 27Margaret Davis 27  
Michael 11  
Patricia Helen Cohen 11  
Philip 27**SILVERSTONE**Frances Louise Isaacs 125  
Louise 95  
Marcia Frances 125  
Mark 125  
Mary Ellen 125**SIMM**Henrietta Kraus 145  
Isaac Abraham 145  
Stella 145**SIMMONDS**Dinah 34, 322A  
Isaac 322A  
Mary Davis 322A  
Mathilda 249**SIMMONS**Elizabeth (b. 1833) 242  
Elizabeth (dau. of Abraham) 152  
Ellen (Nellie) Leo 152  
Gerald 60  
Haannah 152  
Henry 152  
Julia 152  
Maud 152  
Nellie 222  
Nellie Leo (see Simmons, Ellen (Nellie) Leo)  
Valerie Langner 60**SIMON**Aaron 320B  
Aaron 221  
Abraham Isaac (1875-1876) 311B  
Ada 145, 328A  
Adrienne Mittenthal 311  
Alex Jacob (1864-1917) 311B  
Alexander (1825-1906) 311B  
Alice 148  
Alice Frances 311B  
Alvin Barry (b. 1894) 148  
Alvin Barry (b. 1952) 148  
Ann Winifred 121  
Anna 320B  
Arnoldyne Heine 148  
Belle (1755-1832/33) 223, 271  
Bertha (m. Gottlieb Lemle) 148  
Bertha (m. Isidore Chuck) 161  
Betsy (b. 1937) 121  
Brenda Jo Anne 282  
C. Minnie Aronson 6  
Cain W. (b. 1870) 311B  
Carol (b. 1927) 121  
Carroll (1888 (?) -1968) 311B  
Celeste Dorothy Weil 286  
Charles Joseph 135  
Clara Julia (1878-1899) 311B  
Clifford 148  
Cora 148  
David 148  
Donald (b. 1932) 121  
Donald Hendricks 13  
Ed 320B  
Edgar Julius (1886-1972) 311B  
Eliza D. Johnson 135  
Elizabeth (b. 1915) 286  
Ellen (b. 1937) 282, 339B  
Elsa Claire 148  
Elsa Claire Metzger 148  
Estelle 148  
Estelle Elaine 92  
Eugene W. (b. 1917) 286  
Fannie 10  
Franklin 320B  
Fredda Jean Osborne 282, 313B, 339B  
George Victor 305  
Gladys (b. 1890) 148  
Hannah (1869-1965) 311B  
Harold K. 13  
Harriet Gernon (1860-1936) 148  
Harriet Labatt 148Harry Edward (b. & d. 1877) 311B  
Helen Florence Gumberts 309A  
Helen Myers 221  
Henrietta Stiff 311B  
Henry 320B  
Henry Gerson (b. 1885) 148  
Henry Gerson (b. 1926) 148  
Henry Sisle 148  
Hester 271  
Hildegard (1892-1967) 311B  
Hyman (1747-1749) 271  
Ida (See, Simon, Ada)Irma Ray 148  
Isaac 135  
Isabella Arnold 320B  
Jacob (d. 1843) 271  
Jacob Hirsch (b. 1859) 148  
Jacob Hirsch (b. 1920) 148  
Jacob Hirsch (New Orleans) 148  
James Henry (1858-1925) 311B  
Jeff 282Joanne Schlezinger 282  
Joseph (b. 1824) 148  
Joseph (b. 1903) 148  
Joseph (son of Henry) 320B  
Joseph (son of Isaac) 135  
Joseph (1712-1804) 223, 271, 313B  
Joseph Cecil (1873-1874) 311B  
Julia 135  
Julia Rosalie Levy 311B  
Kathryn (b. 1941) 282  
Leah (1763-1842) 245, 271, 313B  
Leah C. (b. 1867) 311B  
Leah Hodgson 148  
Leslie 148  
Lester 121  
Lester, Jr. (1924-1933) 121  
Levi 320B  
Louis M. (1856-1914) 311B  
Lucile Arnheim 121  
Lucile Hodgson 148  
Maron J. 309A  
Mary (Mollie) 311B  
Mary 170, 331A  
Mary 313B  
Mary Schultes 148  
Mathew Aaron (b. 1976) 313B  
Melville 148  
Meyer 271  
Mildred 148  
Mildred Koscherak 13  
Mildred Stern Langsfeld 282, 339B  
Mina 135  
Miriam (1749-1808) 87, 271  
Mollie (see Simon, Mary (Mollie))  
Moses (1751-1816) 271, 313B  
Myer (d. 1825) 271  
Nancy Jean 13  
Nancy Levy 121  
Nette Levy 148  
Rachel (see Simon, Reyna (Rachel))  
Rachel Wolff 305  
Reyna (Rachel) (1764-1790) 67, 271, 313BRichard Katz 282, 339B  
Richard Morton (b. 1946) 282, 313A  
Robert Douglas 282  
Roger Hendricks 13  
Rosa (1861-1953) 311B  
Rose Bunn 223, 271, 313B  
Rosina Labatt 148  
Samuel 148  
Sarah 148, 310B  
Shinah (b. 1762) 271  
Ura Mae Ammerman Hudelson 311B  
Vicky 339B  
William 286Richard Katz 282, 339B  
Richard Morton (b. 1946) 282, 313A  
Robert Douglas 282  
Roger Hendricks 13  
Rosa (1861-1953) 311B  
Rose Bunn 223, 271, 313B  
Rosina Labatt 148  
Samuel 148  
Sarah 148, 310B  
Shinah (b. 1762) 271  
Ura Mae Ammerman Hudelson 311B  
Vicky 339B  
William 286Richard Katz 282, 339B  
Richard Morton (b. 1946) 282, 313A  
Robert Douglas 282  
Roger Hendricks 13  
Rosa (1861-1953) 311B  
Rose Bunn 223, 271, 313B  
Rosina Labatt 148  
Samuel 148  
Sarah 148, 310B  
Shinah (b. 1762) 271  
Ura Mae Ammerman Hudelson 311B  
Vicky 339B  
William 286**SIMONS**Abraham 152  
Bessie 152  
David (m. 1795) 4  
Deborah Abrahams 4  
Dolly Isaacs (see Simons, MarieLouise (Dolly) Isaacs)  
Eleazer 57  
Ellen Leo 152  
Esther Levy 57  
Figlah Levy 272  
Gershon (b. 1779) 272  
Hananel (1776-1778) 272  
Henry 271  
Hester (Hetty) 271  
Isaac (London) 271  
Isaac (son of Levi Sheftall) 57  
Joseph 272  
Marie Louise (Dolly) Isaacs 174  
Miriam (see Simpson (or Simons), Miriam)  
Montague (1752-1812) 271  
Moses (1768-1808) 271  
Rebecca (b. 1774) 272  
Sampson (1750-1811) 271  
Samuel (d. 1824) 271  
Sarah 271  
Saul (son of Montague) 271  
Saul (1757-1809) 271  
Simcha (b. 1772) 272**SIMONSON**Barbara 230  
Gertrude 139**SIMPKINS**

Rosalie Ann 288

**SIMPSON**Adeline (1810-1852) 272  
Angel J. (b. 1852) 132, 250  
Annie B. (1820-1905) 272  
Baruch L. 280  
Catherine (1806-1893) 272  
Catherine Pike 250  
Cecilia L. (b. 1837) 250  
Clara Souza Stuttgart 280  
Daniel L. (1828-1851) 250  
Elias L. (b. 1838) 250  
Ephraim (b. 1843) 250  
Esther Abrams Andrews 4, 12, 272  
Frances L. (b. 1831) 250  
Henrietta Eugenia (d. 1836) 66, 272  
Henry 272  
Isabel Jacobs 132, 250  
Jane Cohen Mordecai 143, 195  
Joel L. (b. 1833) 250  
Joseph 272  
Leah Jacobs 132, 250  
Leonard 272  
(Lissack) Harrison 132, 250  
Michael (1773-1833) 272  
Myer M. (b. 1823) 250  
Naftaly L. (b. 1835) 250  
Nancy (1791-1817) 272  
Percy 272  
Philip L. (b. 1841) 250  
Rebecca (1827-1904) 272, 279  
Rosalie (1850-1852) 250  
Solomon L. (b. 1830) 132, 250  
Venie 189  
Victoria Jacobs 132, 250**SIMPSON (OR SIMONS)**

Miriam 185

**SIMS**Dorothy Rice 123  
E. Marion 254  
Hal 123**SIMSON**Dyfie 272  
Ellen (Helena) (1773-1819) 272  
Frances (see also Simson, Frumet (Frances))  
Frances Isaacs 120, 272  
Frumet (b. & d. 1774) 272  
Frumet (Frances) (d. 1772) 272  
Grace 272  
Hannah 154, 272  
Helena (see Simson, Ellen (Helena))  
Isaac 272  
Jessica (Jocbebed) (1810-1886) 152, 272

Jocbed (Joice) (1771-1814) 272  
Joseph (1686-1787) 124, 272  
Joseph (1779-1842) 120, 272  
Nathan (d. 1725) 272  
Rebecca (1769-1854) 120, 272  
Rebecca Isaacs 124, 272  
Richa 131, 272  
Rose 272  
Sampson III 272  
Sampson, Jr. (1781-1857) 272  
Sampson, Sr. (1725-1773) 272  
Samson 272  
Samuel 272  
Sarah (d. 1835) 272  
Sarah (m. Samson) 272  
Sarah (sis. of Nathan) 272  
Sarah (1727-1762) 131, 272  
Sarah Meers 190, 272  
Solomon (b. 1807) 272  
Solomon (1738/22-1801) 190, 272  
**SINCLAIR**  
Elizabeth Elliott Hays 77  
William H. 106  
**SINGER**  
Augusta (1913-) 330B  
Elizabeth 60  
Isabel (b. 1892) 311A  
Lillian 328A  
**SINGLETON**  
Lillie Belle 196  
William F. 105  
**SINGLEY**  
Vivian 229, 334B  
**SINTON**  
Harriet 192  
**SION**  
Ann Hart 138  
**SIPLEY**  
Alice Gertrude Moise 198  
Louis Walton 198  
**SIQUERA**  
Theresa Eugenia 234  
**SISK**  
Marjory Hoke (1884-1929) 164  
**SISSON**  
Amos 311A, 328A  
Carrie 311A, 329A  
Charles 311A, 328A  
Leila Lazarus 151, 311A, 328B  
Vardy Pritchard 151, 328B  
**SKELDING**  
Lucy Lee Hall 227  
**SKILLMAN**  
Dianne Lyn (b. 1947) 166  
Earl C., Jr. (b. 1949) 166  
Earl Chilson (b. 1904) 166  
Mary Jane 128  
Rebecca Virginia Fink 166  
**SKINNER**  
Rebecca Pessoa Dreyfous 242  
**SKLARSKY**  
Anita Siver Vogel 322A  
Richard 322A  
**SKLOSS**  
Lawrence 164  
Marge Hoke Levy 164  
Marshall 164  
Stewart 164  
**SKUTCH**  
Bessie 91  
**SLATER**  
Elizabeth (1873-1939) 336B  
Lottie E. 47  
**SLAVIN**  
Kevin 296  
Marjorie Abrahams 296  
**SLEATOR**  
Hannah Jean 31  
**SLIGH**  
Irene Davega 322B  
**SLOAN**  
Aricato W. 145  
Charles 75

Charles B. 75  
Ellen Huffnagle 75  
Maude Rosalie Kraus 145  
Nellie 75  
**SLOCUM**  
Nora (Lane) 237  
**SLOMAN**  
Dinah 323B  
**SLOSS**  
David 276  
Deborah 276  
Laura 276  
Leon 276  
Michael 276  
Natalia M. 206  
Virginia Helen Green 276  
**SMALL**  
Allistair 174  
Eugene (m. Grace Workum) 306  
Eugene (son of Eugene) 306  
Grace Workum 306  
Hannah 306  
Jean 241  
John 306  
Richard (son of Allistair) 174  
Richard (son of Eugene) 306  
Ruth Lieber 174  
Wendy 174  
**SMALLWELL**  
Maud 111  
**SMILEY**  
Shirley 107  
**SMITH**  
Anita Rosalie Cardozo Demoux 29  
Ann Watson 58  
Barbara Lee (1935-) 327A  
Bella 237  
Benjamin E. 313A  
Betty 290  
Blossom 140  
Carol Frances 197  
Charlotte Lawson 76  
Clifford, Jr. 128  
David James 209  
Deborah (1963-) 327B  
Edith Haas Loring De Meirelles 88  
Edna Sydney Cobb 164  
Elbert M. T. 337A  
Eleanor Moise 197  
Elizabeth Dicena 298  
Ella 166  
Ellen Frances 166  
Elmira Elizabeth 140  
Eather 140  
Ethel 224  
Etta (ca. 1867-1950) 216  
Everleen (Eveline) Levy 163  
Frances E. Nunez 337A  
Frances H. 156  
Frances Henry 133  
Francis H., Jr. 133  
Frank (son of Frank) 140  
Frank (son of Jacob) 140  
Frank Earl, Jr. 197  
Georgia C. Russell 313A  
Gretchen Louise 197  
Helen 162  
Helen Ridgely Baillentine 155  
Henrietta Myers 216  
Henry Wadsworth 156  
Howard Crampton 197  
Huldah S. 168  
Ira A. B. 140  
Isaac Ambrose 119  
Jacob (m. Louise Betts) 140  
Jacob (m. Ruth Kayton) 143, 327A  
Jane (dau. of Thomas) 163  
Jane (m. Lewis Alexander (Leslie)) 95  
John Blair 119  
Josephine Wachtel 327A  
Julia 163  
Katherine 176  
Kayton III (1962-) 327B

Kayton (1907-) 327A  
Kayton, Jr. (1937-) 327B  
Ladson 163  
Laura 119  
Laurel 119  
Louise Betts 140  
Lucille Harris 327B  
Mae W. Jacobs 125  
Marjorie 297  
Mary (m. Frank) 140  
Mary (m. Simon Gratz) 87  
Mary A. 333A  
Mary L. Israel 128  
Miriam 27  
Nancy (1966-) 327B  
Natalie 133  
Nellie McCurdy 309A  
Nevada (Vaddie) (1865-1938) 235  
Phillip E. 29  
Pinckney 163  
Priscilla 163  
Renshaw 88  
Ruth Kayton 143, 327A  
Ruth Weiner 327B  
S. Edith Moses 209  
Sarah 140  
Stanley Moise 197  
Thomas (m. Everleen (Eveline) Levy) 163  
Thomas (m. Henrietta Myers) 216  
Vaddie (see Smith, Nevada (Vaddie))  
Virginia 146  
Virginia Gadsby McBlair 156  
Wadsworth Ramsay (b. 1864) 156  
Washington 163  
Wentworth 155  
William 76  
William D., Jr. 164  
William De Berry 164  
**SMOLOW**  
Andrea (1979-) 339B  
Jessica (1979-) 339B  
Lauren Meredith (b. 1976) 313B, 339B  
Nan Schlezinger 282, 313B, 339B  
Ronald J. 282, 313B, 339B  
**SMYTH**  
Sarah E. 67  
**SNERD**  
Anna Hay (1869-1945) 39, 206  
J. R. 39  
Nora 39  
Nora Cohen 39  
Penina 39  
Percival 39  
**SNELLENBURG**  
Deborah Cohen 72  
Donna Corey 72  
Ida Fleisher Block 71  
Jeffrey Gordon 72  
Judith Hart 72  
Milton Harry 72  
Milton Harry, Jr. (b. 1935) 72  
Roger Gordon (b. 1939) 72  
Scott Alan 72  
Sue Ellen Goldstein 72  
Susan Kessler 72  
**SNITKOFF**  
Leo Juda 239  
Lucille Magnus 239  
Stephen Magnus 239  
**SNOW**  
Dorothy 157  
**SNOWDEN**  
Mary Buchanan 262  
**SNYDER**  
Alma Haas 88  
Annie Gambatti Worsham 117  
Arthur 88  
Carol 108  
Carol Ann 108  
Douglas 108  
Douglas Scott 108  
Jack 98

Julius 108  
Julius J. 108  
Lois Ann Lowenberg 108  
Lois Lowenberg 108  
Myrtilla Hart 98  
William 117  
**SOARES DE BIVAR**  
Rodrigo (Jacob) 234  
**SOESMAN**  
Rachel I  
**SOHER**  
Alena (1872-1873) 272  
Joseph 272, 339A  
Le Roy 272  
Minnie 272  
Minnie Phillips 249, 272  
Miriam Andrews 12, 272  
Moses (Morris) (1834-1873) 111, 272  
Rodney 272  
Rosalie (b. 1829) 272  
Rosalie Eliza Hendricks 111, 272  
Solomon 12, 272  
Violet (1884-1887) 272  
W. Andrews (1836-1901) 249, 272  
Zipporah (b. 1831) 204, 272  
**SOHNER**  
Kate 135  
**SOLA**  
See De Sola  
**SOLANA**  
Maria S. (b. 1832) 117  
**SOLARI**  
Antonio Broglio, Marchese 119  
Catherine Hyams Plomer, Marchesa 119  
**SOLIS**  
Abigail De Leon Guedes 273  
Abraham (b. 1778) 273  
Abraham (b. 1792) 274  
Abraham Da Silva 273  
Albert Benjamin (1870-1950) 274  
Albionia 41, 274  
Alice 274  
Ann (see Solis, Hannah (Ann))  
Anna Phillips or Angela Maria Maluenda (Judith Maluenda) 273  
B. C. (d. 1826) 274  
Beatrice Stern 274  
Benvenida (b. 1805) 274  
Benvenida (1813-1892) 253, 274  
Benvenida de Isaac Henriques Valente 273, 274  
Benvenida Valentina (1815-1893) 229, 230, 274  
Beresinia (1827-1864) 274  
Blanche Myers 274  
Burrowsenia 48, 49, 274  
Caroline 274  
Charity (1853-1905) 181, 274  
Charity Hays 104, 274  
Clara (d. 1786) 273  
Clara (dau. of Jacob) 273  
Clara Jessurun Alvarez 273  
Daniel (d. 1792) 273, 274  
Daniel (son of Daniel) 274  
Daniel (1723-1790) 273  
Daniel (1784-1869) 274  
Daniel (1840-1909) 274  
Daniel Da Silva (see also Da Silva, Cuglielmo (Joao Da Silva or Daniel Da Silva Solis))  
Daniel Da Silva (1683-ca. 1750) 273  
David (b. 1789) 274  
David Da Silva (1699-1731) 273  
David Hays (1822-1882) 226, 274  
David Hays III (b. 1895) 274  
David Hays IV (b. 1927) 274  
David Hays V (b. 1952) 274  
David Hays, Jr. (1862-1936) 274  
Earl Morgan 274  
Elijah (Elias) (b. 1794) 274  
Elizabeth Charlotte 274  
Ellen Waterloo Samuel 260, 274

Elvira Frances 274  
Elvira Nathan (d. 1953) 274  
Elvira Nathan (1826-1912) 226, 274  
Emily Grace (1859-1936) 274, 275  
Enid (dau. of Isaac) 274  
Enid (m. 1930) 274  
Esther Ertung (m. 1901) 226, 274  
Esther Ertung (1815-1904) 274  
Esther Lopez 273  
Hannah (Ann) (1817-1878) 162, 274  
Isaac (d. 1792) 273  
Isaac (1782-1783) 274  
Isaac Nathan (1857-1909) 274  
Isaac (Israel?) Da Silva (see Da Silva, Diogo Pinto ("Carlos Nery (Very?)" or Isaac (Israel?) Da Silva Solis))  
Jacob (b. 1774) 273  
Jacob (b. 1781) 273  
Jacob (son Daniel) 274  
Jacob Da Silva (1652-bef. 1731) 273  
Jacob Da Silva (1780-1829) 104, 274  
Jacob Fonseca Da Silva (1854-1894) 274  
Jacob Solomon (1855/6-1894) 274  
Jon Andrew 274  
Joseph ("El Dorado") (b. 1780) 273, 274  
Joseph 274  
Joshua (1799-1800) 274  
Judith (b. 1770) 273  
Judith (d. 1777) 273  
Judith (dau. of Solomon) 274  
Judith Da Silva (b. 1712) 273  
Judith Simha (1817-1914) 274, 275  
Louisa 274  
Marcia (b. 1896) 274  
Marcia (dau. of Isaac) 274  
Marcia Morgan 274  
Mendes Cohen Da Silva (b. 1897) 274  
Moses 274  
Nancy Goldstein 274  
Phoebe Elizabeth (1827-1893) 274  
Rachel 273  
Rachel Brandon 273  
Reba M. Kohn Spears 274  
Rebecca (b. 1772) 273  
Rebecca Hiero 273  
Reyna Cohen Belinfante 273, 274  
Richard Albert (b. 1902) 274  
Samuel (b. 1797) 274  
Sarah Miriam (1824-1894) 30, 274  
Sarah Nathan (1863-1937) 226, 274  
Sarah Norris 274  
Scott Brett 274  
Simha (1786-1817) 274  
Solomon (b. 1776) 273  
Solomon (son of Daniel) 273  
Solomon (1819-1854) 260, 274  
Solomon Da Silva (1754-1847) 273, 274  
Theresa Wallenstein 274  
**SOLIS-COHEN**  
Ann (b. 1923) 275  
Barbara A. Samuel 275  
Bertha Florence (b. 1889) 275  
Daniel 275  
David Hays (b. 1888) 275  
David Hays, Jr. (b. 1917) 275  
Edith (b. 1893) 275  
Elfrida Cowen 275  
Elinor (b. 1885) 275  
Elizabeth Virginia (b. 1947) 275  
Ellen Sue (b. 1952) 275  
Emily Elvira (b. 1886) 275  
Emily Grace Solis 274, 275  
Emily Grace (1988-) 339A  
Erna Sultan 275  
Eather (1892-1893) 275  
Francis Eather (b. 1924) 275  
Francis Nathan (b. 1892) 275  
Gertrude (b. & d. 1880) 275  
Helen (b. 1915) 275  
Isadore Binswanger (1896-1925) 275

Jacob Da Silva (1838-1927) 23, 275  
Jacob Da Silva, Jr. (b. 1890) 275  
Jessie Myra (b. 1874) 275  
John Agas (b. 1874) 275  
Judith Simira (1876-1927) 275  
Julia Coleman 275  
Kathe (b. 1926) 275  
Katherine Emily (b. 1948) 275  
Leon (b. 1889) 275, 339A  
Leon (1840-1884) 253, 275  
Leon Manness (1881-1944) 275  
Leon, Jr. (b. 1920) 275, 339A  
Lita Claire Hahn 275  
Lucia Manness Ritterband 253, 275  
Marion Gimbel Labe 275  
Marion Mansbach 275, 339A  
Marjorie Grace (b. 1921) 275  
Mary (b. 1917) 275  
Miriam Binswanger 23, 275  
Miriam Fonseca (b. 1883) 275  
Myer (b. 1877) 275  
Paul Henry (b. 1949) 275  
Peter Rabinowitz 339A  
Rosalie Isabel (b. & d. 1887) 275  
Rosebud L. Teschner 275  
Sally (see Solis-Cohen, Sara Emily (Sally))  
Sara Emily (Sally) 275, 339A  
Solomon (1857-1948) 274, 275  
Solomon II (b. 1921) 275  
Sophia Rebecca (b. 1879) 275  
Virginia R. Kaufman 275  
**SOLOMAN**  
See also Salomon, Salomons, Solomon Solomon(s), Solomons  
Julia 228  
Susan (1794-1869) 171  
**SOLOMON**  
See also Salomon, Salomons, Solomon Solomon(s), Solomons  
Ada (see Solomon, Aida)  
Addie 167  
Adolph A. (1837-1903) 243  
Aida 102  
Alan 285  
Albert 102  
Alexander 223  
Alice 243  
Ann Erlich 247  
Anne 247  
Arabella 223  
Arthur W., Jr. 247  
Arthur Wellesley 247  
Augusta 102  
Augusta King 102, 144  
Barnet L. (m. Estelle Guggenheimer) 102  
Barnet L. (1806-1897) 102  
Beverly Edelman 40  
Bilah Myers-Cohen 223  
Burrowsina 274  
Catherine Hays 106, 325A  
Catherine Maynard (1858-1945) 273  
Catherine Popper Loewi 102  
Cathy Bush (see Solomon, Hyah (Cathy Bush))  
Chapman (son of Levy) 273  
Chapman (1769-1849) 273  
Clara (1856-1930) 273  
Clara Ann Brandon 26  
David Alan 285  
Edwin B. 102  
Elizabeth Phillips 243  
Ella Levy 160  
Estelle (d. 1879) 102, 127, 326A  
Estelle Guggenheimer 102  
Eather (1805-1883) 183  
Ezekiel (m. 1769) 273  
Frances (m. 1847) 70  
Frances Melasky 247  
Frances Nathan Jacobs 285  
Frank (see King, Frank (Solomon))  
Frank 102

Gertrude Zuntz 308  
 H. 246  
 Hannah (Annie) Hyams 119, 273  
 Harris A. 102  
 Harris B. 102  
 Helen Philips 246  
 Henry (d. 1833) 223  
 Henry (m. 1821) 162  
 Henry (1852-1931) 273  
 Hyah (Caty) Bush 28, 223  
 Iris Rachel 82  
 Isaac (1743-1798) 223  
 Isaac 273  
 Isaac Solomon 6, 102, 309A  
 Isabella 102  
 Jacob 308  
 James 106, 325A  
 Jan (1940-1960) 247  
 John I. 102  
 Jonathan David 40  
 Joseph (b. 1779) 223  
 Joseph (1710-1779/80) 223  
 Joseph A. 285  
 Judah 102, 144  
 Judith 277  
 Judith I. (1766-1837) 32  
 Julia Aronson 6, 102  
 Julia I. Hart 102  
 Julia Levy 162  
 Julian Charles 21  
 Kate (dau. of Simoa B.) 102  
 Kate (m. Lyon Samuel) 261  
 Katie 261  
 Leah (1844?-1930) 273  
 Levi (1788-1827) 273  
 Levi (To U. S. 1780) 273  
 Levi (1748-1827) 223  
 Levy (1812-1886) 119, 273  
 Lois Goldsmith 21  
 Louise Dubois (see Solomons, Elizabeth Louise Dubois)  
 Lucile (-1939) 327B  
 Maria 102, 127  
 Matthias 223  
 Maud 102  
 Meyer 106  
 Miriam (d. ca. 1927) 232  
 Myer 28, 223  
 Naomi Aronson 6, 102  
 Nathan (son of Levy) 273  
 Phoebe Marie 102, 127  
 Rachel (1747-1797) 185, 223  
 Rebecca (m. 1857) 70  
 Robert Lewis 102  
 Rosa 192  
 Rosalia Aronson 102  
 Rosalie 102  
 Sally (see Solomon, Sarah (Sally))  
 Samuel 223  
 Sarah (m. 1867) 102  
 Sarah (Sally) 223  
 Sarah (1840?-1925) 273  
 Sarah Henry 247  
 Seraphine Bear 273  
 Shinaah (1744-1822) 67, 68, 223  
 Simeon B. 6, 102, 309A  
 Solomon B. 6, 102, 309A  
 Sophia (1846-1922) 102  
 Sue Reid 247  
 Susie (b. 1869) 273  
 Suzanne 309A  
**SOLOMON(S)**  
 See also Salomon, Salomons, Soloman, Solomon, Solomons  
 Aaron (1826-1843) 270  
 Addie 279  
 Arabella (1859-1893) 279  
 Augusta I. 279  
 Augustus Aurelius 279  
 Aurelius A. (1857-1858) 279  
 Cecilia (m. 1835) 254, 279  
 David (1821-1847) 279  
 Edward (1822-1895) 279

Emma H. 207, 279  
 Esdaile (b. 1817) 279  
 Esdaile (b. 1860) 279  
 Esther (1818-1819) 279  
 Henrietta 279  
 Herbert 279  
 Jacob T. 279  
 Janie (m. 1880) 5, 279  
 Joseph (b. 1863) 279  
 Joseph (d. 1808) 277  
 Joseph R. (1824-1887) 254, 272, 279  
 Judith (Juddy) Moses 277  
 Julia (b. 1868) 279  
 Julia (1843-1882) 279  
 Kate C. 279  
 Kate Cohen 279  
 Mark (1787-1837) 279  
 Mary (1828-1882) 279  
 Nathan (Lond.) 277  
 Rachel (1799-1855) 279  
 Robert 279  
 Rosalie Eliza 279  
 Virginia (b. 1862) 279  
**SOLOMONS**  
 See also Salomon, Salomons, Soloman, Solomon, Solomons (s)  
 Aaron (1791-1851) 277  
 Abby Gomez Emanuel 66, 278  
 Abigail Franks 75  
 Abigail Myers (d. 1827) 220, 277  
 Abraham A., Jr. (1851-1852) 278  
 Abraham Alexander (b. 1884) 278  
 Abraham Alexander (1816-1899) 210, 278, 339A  
 Abraham Levy (1810-1832) 276  
 Adele Rosa (b. 1868) 276  
 Adolphus Asher (1805-1828) 276  
 Adolphus Simson (1826-1910) 244, 276  
 Alexander (1756-1836) 202  
 Alexander (1793-1823) 28  
 Alexis 276  
 Alice Abrahams 4, 277  
 Aline Esther (1859-1942) 276  
 Alma (1864-1888) 276  
 Alva 198  
 Angelique 276  
 Anne 75  
 Annie 276  
 Arabella (1786-1826) 28, 243  
 Arthur Francis (1853-1855) 278  
 Backky (see Solomons, Rebecca (Backky))  
 Benedictus 75  
 Benjamin (b. & d. 1777) 276  
 Benjamin (b. & d. 1892) 276  
 Benjamin Samuel (1786-1831) 264, 276  
 Betay (see Solomons, Elizabeth (Betay))  
 Carl H. (1890-1893) 278  
 Caroline (m. 1891) 98  
 Caroline (1812-1887) 240, 277  
 Caroline Augusta 98  
 Catherine (Kitty) (1782-1851) 276  
 Catherine (1826-1829) 276  
 Catherine Hays 106  
 Catherine Manuel (1768-1852) 141, 276  
 Catherine Manuel (1826-1829) 276  
 Caty, Catherine (see Solomons, Hyah (Caty) (Catherine) Bush)  
 Cecile Cohen 202  
 Cecilia Bush 5, 278  
 Cecilia Moses (b. 1887) 278  
 Cecilia Moses (1815-1882) 210, 278  
 Chapman (d. 1849) 277  
 Cissie (see Solomons, Sarah Judith (Cissie))  
 Clara 277  
 Colman 75  
 David 75  
 David Seixas (b. 1913) 276  
 Edith Josephine (b. 1904) 276  
 Edward A., Jr. 198

Edward Alva (1865-1899) 198  
 Edward Alva (1899-1926) 198  
 Eleanor Joseph 139, 277, 278  
 Eleanor Susan ("Toni") (b. 1911) 276  
 Elizabeth (Betsy) (b. 1779) 276, 339A  
 Elizabeth (dau. of William) 276  
 Elizabeth (m. Colman) 75  
 Elizabeth Louise Dubois 276  
 Elkanah Seixas 264, 276  
 Elkan (1820-1841) 278  
 Emma (dau. of Solomon) 277  
 Emma (1860-1939) 276  
 Ephraim 12  
 Esther (b. & d. 1784) 276  
 Esther (Hester) (1819-1908) 277  
 Esther (m. Moses Hart) 276  
 Esther Nathans 231, 277  
 Esther Sarah Ottolengui 234, 277  
 Evert 276  
 Ezekiel III 276  
 Ezekiel, Jr. 273  
 Fanny (b. ca. 1807) 277  
 Fanny (b. 1789) 276  
 Fanny Thibault 276  
 Filagh 75  
 Florence 49  
 Frances (1827-1866) 247, 277  
 Frances Joseph 139, 278  
 Frank Benjamin (b. 1875) 276  
 Gershom 276  
 Gershom Mendes Seixas (1828-1889) 276  
 Gertrude 276  
 Gertrude Marks (1866-1873) 276  
 Gertrude Moses (b. 1852) 278  
 Hannah (1699-1772) 267  
 Hannah (1817-1874) 277  
 Hannah Marks 276  
 Harriett Anne 198  
 Harriett Lucile Gleason 198  
 Helen B. Frank 276  
 Henri 276  
 Henri Cecil (1886-1903) 278  
 Henrietta S. Emanuel 278  
 Henry (d. 1833) 28  
 Henry (1787-1865) 276  
 Henry (1824-1825) 278  
 Henry (1855-1859) 276  
 Hester (dau. Benedictus) 75  
 Hester (see also Solomons, Esther (Hester))  
 Hortense 277  
 Hubert 276  
 Hyah (Caty, Catherine) Bush 28, 223  
 Ida Judith (1852-1933) 241, 276  
 Isaac 276  
 Isabel W. (1891-1975) 207, 312A  
 Isabelle (1853-1934) 276  
 Isaiah A. III 278  
 Isaiah Abraham 5, 278, 339A  
 Isaiah Alexander, Jr. 278  
 Israel (1770-1830) 139, 234, 277, 278  
 Israel (1847-1854) 278  
 Israella (1856-1924) 278  
 Jacob (1826-1827) 276  
 James 106  
 Jane (b. 1927) 278  
 Jessica (Jessie) (1785-1853) 276  
 Jessie (dau. of William) 276  
 John (son of Wellington) 276  
 John (1789-1858) 165, 276  
 Jona Abraham (b. 1823) 277  
 Joseph (b. 1779) 28  
 Joseph (son of Ezekiel) 277  
 Joseph (1809-1832) 277  
 Joseph M. (d. 1921) 277, 278  
 Joseph M. (m. 1848) 277, 278  
 Joseph M. (1891-1945) 278  
 Joseph R. 272, 279  
 Josephine Legris 276  
 Judah 278  
 Juddy 277  
 Julia (b. 1862) 276

Julia Levy 265, 276  
 Katherine Church Bothwell 276  
 Katherine Graddock 276  
 Katherine Manuel (b. 1897) 276  
 Katie 278  
 Kitty (see Solomons, Catherine (Kitty))  
 Lena Schulhafer 278  
 Leon Henry (b. 1915) 276  
 Leon Mendes (1873-1900) 276  
 Levy (b. 1818) 276  
 Levy (1771-1823) 141, 276  
 Levy (1824-1843) 276  
 Lewis (Louie) (1821-1900) 273  
 Lillie 276  
 Lizer 267, 278  
 Lizette 276  
 Lola Searles 276  
 Louie (see Solomons, Lewis (Louie))  
 Louise Freighley (1860-1870) 278  
 Lucius Levy (b. 1863) 276  
 Lucius Levy (Moses) (1830-1883) 276  
 Lucius Levy (1730-1792) 78, 276  
 Lucius Levy (1803-1830) 264, 276  
 Margaret 75  
 Marguerite 276  
 Marguerite Johnston 276  
 Marian (see Solomons, Miriam (Marian))  
 Marian Frank (b. 1907) 276  
 Marie 276  
 Marie Louise 276  
 Marie Strauss 278  
 Mark (1763-1870) 220, 277  
 Mark Elliott 198  
 Mary (m. 1760) 276  
 Mary (Polly) (1776-1826) 83, 276  
 Mary Jane (1818-1905) 276  
 Matthias (b. 1790) 28  
 Miriam (Marian) 75  
 Miriam (1858-1935) 278  
 Molcie (Molsey) Joseph 139, 277  
 Molcy (1856-1857) 278  
 Molsey Joseph (see Solomons, Molcie (Molsey) Joseph)  
 Mordecai 66, 278  
 Moses (see also Solomons, Lucius Levy (Moses))  
 Moses (son of Benedictus) 75  
 Moses (1799-1826) 277  
 Moses Joseph 66, 139, 278  
 Myer S. 58, 223  
 Nellie (Nettie) 12  
 Nellie I. (1851-1874) 5, 278  
 Patricia Grace Brown 198  
 Penina Moise 198  
 Perla Sheftall 267, 278  
 Philip (b. 1919) 278  
 Philip, Jr. 278  
 Polly (see Solomons, Mary (Polly))  
 Rachel (m. J. H. Hart) 276  
 Rachel (1780-1855) 138, 276, 326B  
 Rachel 277  
 Rachel Seixas Phillips 244, 276  
 Ralph Stewart 278  
 Rebecca (Backky) 276  
 Rebecca (dau. of Benedictus) 75  
 Rebecca (1822-1898) 226, 227, 276  
 Rebecca Ella (1854-1958) 9, 278, 339A  
 Rebecca Franka 276  
 Rebecca Simpson 272, 279  
 Rosalie (1866-1946) 244, 276  
 Rosette 276  
 Sadye Rosolio 278  
 Sallie (d. 1825) 277  
 Sallie Nathans (1854-1933) 9, 277  
 Sally (Sarah) 58  
 Sally (see also Solomons, Sarah (Sally))  
 Sally (1796-1844) 28  
 Sampson (1794-1832) 139, 277  
 Samson (1821-1901) 277  
 Samuel (son of Ezekiel) 276  
 Samuel (1783-1864) 28

Samuel (1807-1874) 277  
 Samuel David (1808-1869) 276  
 Sarah (dau. of Benedictus) 75  
 Sarah (Sally) (d. 1812) 276  
 Sarah (see also Solomons, Sally (Sarah))  
 Sarah Abigail (d. 1827) 277  
 Sarah F. (b. 1893) 278  
 Sarah F. 278  
 Sarah Falk 5, 278  
 Sarah Judith (Cissy) (b. 1860) 5, 278  
 Sarah Judith 278  
 Selina Seixas (1806-1883) 264, 276  
 Selina Seixas (b. 1862) 276  
 Shirley Massell 278  
 Solomon (son of Benedictus) 75  
 Solomon (1784-1836) 4, 277  
 Solomon Sampson (1825-1904) 231, 277  
 Sophia 297  
 Sophie (m. 1798) 276  
 Susan V. Atkins 276  
 Suzanne 278  
 Thaise 276  
 Theodore 276  
 Theodore Seixas (b. 1870) 276  
 "Toni" (see Solomons, Eleanor Susan ("Toni"))  
 Virginia (dau. of Isaiah A. III) 278  
 Virginia 278  
 Walter 278  
 Wellington 276  
 William 276  
 William, Jr. 276  
 Yitlah (Esther) Hays 106, 277  
 Zillah (1857-1917) 276  
 Zipporah 277  
 Zipporah Molsey (d. 1890) 277, 278  
 Zipporah Molsey Solomons 277, 278  
**SOMBORN**  
 Edith 127, 326A  
**SOMMERICH**  
 Clara Hart 101  
 Hugo 101  
**SOMMERS**  
 Amelia (1767-1834) 10  
 Amelia Clarke 10  
 Julia May 70  
 Levy 259  
 Peter (1740-1799) 10  
 Sarah G. Friedman 226  
 Sophia Samson 259  
 Susan (m. 1809) 168, 311B  
**SOMPAYRAC**  
 Marie Aline 199  
**SONDER**  
 Edward (b. 1928) 255, 310B  
 Jean A. Kayton (b. 1929) 255, 310B  
 Karen A. (b. 1956) 255, 310B  
 Leslie (b. 1959) 255, 310B  
**SONDHEIM**  
 Babette 271  
 Belle Kraus 145  
 Betsy 279  
 Caroline Janette 279  
 Caroline Loewi (1816-1881) 279  
 Caroline Loewi 10  
 Eleanor Elias Dreifus 63  
 Gernhon 279  
 Gloria Spector 271  
 Henrietta 279  
 Henry 271  
 Henry P. 145  
 Jo Ann 271  
 Louisa 10, 279  
 Louise (1853-1930) 10  
 Louise Welsch 271  
 Matilda 271  
 Myer 279  
 Nathan (b. 1815) 279  
 Nathan (m. Caroline Loewi) 10  
 Paul 271  
 Pauline 279

Richard 271  
 Samuel 279  
 Sara Lithauer 136, 279  
 Simon N. 136, 279  
 Susan Harriette 63  
 William (d. 1952) 271  
**SONN**  
 Charlotte Hyman Ousta 121  
**SONNEBORN**  
 Aaron (1851-1911) 230  
 Anne Whitlock (b. 1954) 230  
 Beavenida V. H. Da S. (b. 1919) 230, 335A  
 Dirk (b. 1954) 15  
 Elizabeth (b. 1950) 15  
 Elizabeth Aufasser 15  
 Ester Edith Newgroeschel 230  
 Gladys Bloesom Livingston 230  
 Isaac E. 230  
 James (b. 1947) 15  
 Joseph M. (1883-1954) 230  
 Joseph M. II (b. 1957) 230  
 Joseph M. M. (b. 1921) 230  
 Josephine 312B  
 June Edda Etsenson 230  
 Katherine 222, 312B  
 Laura Augusta Nathans 230  
 Marcia Whitlock (b. 1952) 230, 335A  
 Miriam (b. 1884) 230  
 Philip M. R. (b. 1927) 230, 335A  
 R. 15  
 Thomas (b. 1948) 15  
 Wendy 230, 335A  
**SONNENBERG**  
 Barbara Hart 22  
 John 22  
 Richard 22  
 Robert 22  
 Roger 22  
 William 22  
**SONNENFIELD**  
 Ann Cardozo 29  
 David 29  
 Jonathon 29  
 Nancy 29  
**SONNENTHOL**  
 Laura Eibel 331B  
 Richard 331B  
**SONSINO**  
 Ellen Schaffer Cardozo 321B  
 Isaac David 321B  
**SOERENTRUE**  
 Rosebud Levy 167  
 Simon 167  
**SORIA**  
 Aaron (b. 1845) 280  
 Aaron (1762-1852) 280  
 Aaron Augustus (b. 1827) 280, 339A  
 Abraham (b. 1847) 280  
 Abraham (d. 1839) 280  
 David (b. 1834) 280  
 David (son of Aaron) 280  
 Eloise (b. 1833) 280  
 Francis (1836-1839) 280  
 Henry Napoleon (b. 1834) 280  
 Hetty Cohen 36, 280  
 Isaac (b. 1838) 280  
 Isaac (son of Aaron) 36, 280  
 Joseph (1798-1877) 36, 280  
 Judith (d. 1826) 280  
 Morland Micholl (b. 1843) 280  
 Moses (b. 1831) 280  
 Moses (b. 1840) 280  
 Moses (1806-1833) 280  
 Rachel Mendez Hega (1781-1839/44) 280  
 Rebecca (m. 1834) 127, 280  
 Sarah (1810-1856) 280  
 Zipporah Cohen 36, 280  
**SOSKIN**  
 Barbara Lee Banks 202  
 Marjorie Hyman 51  
 Samuel D. 202



Sheldon 51  
**SCSSNOW**  
 Leon 16  
 Patricia Barnett Mott 16  
 Sara 16  
**SOTHERAN**  
 Alice Hyneman Rhine 123  
 Charles 123  
**SOUFRANT**  
 Mario 121  
 Miriam Dobriner 121  
**SOUSA**  
 Joy Lorraine Arnstein 65  
 John Phillip III 65  
**SOUTHWALL**  
 Sarah J. (1848-1924) 166  
**SOUZA**  
 Alva Marie (1892-1893) 280  
 Charles (b. 1858) 280  
 Clara 280  
 Dorothy Sherwin 280  
 Edgar Milton 280  
 Emily Sarah (1845-1853) 280  
 Estelle Florette (b. 1848) 280  
 Ethel 280  
 Eugenia Florence Heineman 109, 280  
 Fanny 254, 280  
 Florence (b. & d. 1855) 280  
 Florence Isaacs 280  
 Florence Schreier 280  
 Frederick William (b. 1856) 109, 280  
 Grace (1853-1862) 280  
 Harriet Esther (1823-1868) 280  
 Jacob I. Cohen (b. 1851) 280  
 Kitty Zachariah 280  
 Minkella Cerf 280  
 Moses (1818-1875) 38, 280  
 Rita Zipporah (1886-1889) 280  
 Rosalie (1847-1922) 266, 280  
 Samuel (b. 1849) 280  
 Samuel (d. 1837) 280  
 Samuel (1780-1861) 280  
 Samuel Henriquez 280  
 Viola Sola (b. 1893) 280  
 Zipporah Cohen 38, 280  
**SPAGAT**  
 Bertie (Bertha) Sarlouis 301  
 Henyee 301  
 Joseph Wolf 301  
**SPANIER**  
 Bernhard (b. 1843) 280  
 Bertha (1834-1843) 280  
 Emil (1836-1872) 280  
 Esther (1847-1893) 280  
 Julia (b. 1846) 10  
 Julius 280  
 Leah 280  
 Louis (1803-1864) 280  
 Rosalie Meyers 280  
**SPANIN**  
 Baker 205  
 Blanche 205  
 Blanche Richbourg 205  
 Elizabeth M. Sheftall 270  
 Emily Mikell 205  
 Franklin 205  
 Henry (son of Henry) 205  
 Henry (son of Robert) 205  
 Jane (dau. of Henry) 205  
 Jane (dau. of Robert) 205  
 Jerry 208  
 John Michael 270  
 Margaret De Leon 208  
 Rebecca 205  
 Robert (d. Young) 205  
 Robert (m. 1862) 205  
 Robert (son of Robert) 205  
 Robert Tomkins 208  
 Rosalie Esther Ann Moses 105  
 Rufus 205  
 Sara Margaret Moses 208  
 Wilson 205  
**SPATH**

Marie 270  
**SPATZ**  
 Abbie (d. 1926) 185  
 Bernard (d. 1888) 185  
 Blanche V. (d. 1908) 185  
 Caroline (1844-1907) 185  
 Gertrude (d. 1913) 185  
 Grace 185  
 Harry (d. 1881) 185  
 Miriam Marks 185  
 Sally 185  
**SPEAR**  
 Eleanor 15  
 Frances Saunders 198  
**SPEARS**  
 Reba M. Kohn (b. 1898) 274  
 Rita J. Marshuetz 30  
 Robert L. 30  
**SPECTOR**  
 Carol 91  
 Gloria 271  
**SPEIR**  
 Emma Azalea 312B  
**SPENCER**  
 Agnes E. 211  
 Allen (m. Catherine Hertz) 117  
 Allen (son of Allen) 117  
 Allen R. 117  
 Catherine Hyams 120  
 Catherine R. Hertz 117  
 Florina North (d. 1855) 117  
 Harriet Cooper (1826-1901) 45  
 John (son of Allen) 117  
 John (St. Augustine) 117  
**SPERLING**  
 Helen 125  
**SPERO**  
 Donald (b. 1937) 16  
 Julia Bronner 16  
 Richard (b. 1944) 16  
**SPEYER**  
 Deborah 61  
 Dennis Simon 61  
 Eleazer 245  
 Esther 245  
 Lawrence 61  
 Madeline (1759-1816) 245  
 Margaret Josephine 61  
**SPIEGEL**  
 Frieda 160  
 Rosalie 329A  
**SPIEGELBERG**  
 Blanche 89  
**SPIELBERGER**  
 Laura (b. 1877) 92  
**SPIGEL**  
 Frank Benjamin (b. 1943) 275  
 Helen Solis-Cohen 28, 275  
 Herbert (d. 1951) 275  
 James Herbert (b. 1951) 275  
 Robert Hays (b. 1946) 275  
 Susan Catherine Gray 275  
**SPINGARN**  
 Amy Einstein 173  
 Christopher Lewis Morison 173  
 Edward D. W. 173  
 Elizabeth Morison 173  
 Honor 173  
 Hope 173  
 Joel Elias 173  
 Phillida Morison 173  
 Stephen Joel 173  
**SPIRA**  
 Shifrah Benjamin Woolf 337B  
**SPIRO**  
 Albert 280  
 Antoinette (b. ca. 1831) 281, 339A  
 Carol 160  
 Caroline 281  
 David 281  
 Elizabeth 281, 339A  
 Esther 281, 339A  
 Hannah 280

Hannah Cromline 41, 281  
 Henrietta 339A  
 Jacob 280  
 Jefferson 281, 339A  
 Mildred 160  
 Nelson 281  
 Philip Jacob 41, 281, 339A  
 Sadie Jandorf 160  
 Serena 281, 339A  
 Theresa 281, 339A  
**SPLITZ**  
 Patricia Frank 189  
**SPLITZER**  
 Irma (1886-) 327B  
**SPLITZLER**  
 Andrew 276  
 David 276  
 John 276  
 Robert 276  
 Ruth Franken 276  
**SPOONER**  
 Ruth 146  
**SPRAGUE**  
 Estelle E. Pizzini 39  
 George 49  
 George E. 49  
 Lucille E. 49  
**SPRING**  
 Lucy Addison 105  
**SPRINGER**  
 Adeline 237  
 Amanda Arnold 320B  
 Anna (b. 1908) 311B  
 Arthur (1892-1896) 311B  
 Bertha (Birdie) 237  
 Charles 237  
 Charlotte 89  
 Cilli Guggenheimer 89  
 Edwin H. (d. 1911) 137, 326B  
 Florence (1890-1965) 311B  
 Fritz 89  
 Gertrude 89  
 Gladys (1896-1898) 311B  
 Hannah 237  
 Hannah Giffing 270  
 Ida Jones 137, 326B  
 Jessica A. (b. 1883) 137  
 Lena 237  
 Max (1854-1909) 311B  
 Regina Levy 311B  
 Sam 320B  
 Yetta 89  
**SPRINGLE**  
 Anna Augusta 142  
**SPRITZ**  
 Clara Senior Davis 306  
 Stanley 306  
**SPURLIN**  
 Alvin Doyle 52  
 Billy Jon 52  
 Bobby Don 52  
 Carl Li 52  
 Edwin D., Jr. 52  
 Edwin Doyle 52  
 Harold Ogden 52  
 Helen Marie De Cordova 52  
 Joan Dell 52  
 Laura Marie 52  
 Marie Suzanne 52  
 Michael Ogden 52  
 Neil Gentry 52  
 Nelda Jo Burgess 52  
 Robert Don 52  
 Stacy Ann 52  
 Stephanie 52  
 Thomas David 52  
 Virginia Lee Fowler 52  
**SPYER**  
 Esther Phillips 245  
 Joseph 245  
 Sally Phillips 245  
 Samuel 245  
 Solomon 245

**SQUIRES**  
 Leslie Lee 282  
**ST. AMAND**  
 Ashley 298  
 C. W. 298  
 Isabella Tobias 298  
 Jeanette 298  
 Sophia (1832-1874) 298  
**ST. CLAIR**  
 Helen 34  
**ST. JOHN**  
 Bloomie Amanda Kokernot 146  
 Carolyn Hays 105  
 Edward 146  
 Ellen 146  
 George, Jr. 158  
 Nancy Hoyt 158  
 Stella 221  
**ST. MARTIN**  
 Natalie (d. 1891) 18, 321A  
**ST. PIERRE**  
 Armand 160  
 Beverly Newman Feldman 160  
**STACK**  
 G. 30  
 Helen Carvalho 30  
**STACKPOOL**  
 Vera 115  
**STAHL**  
 (Sally) Ann Price (see Stahl, Sarah)  
 (Sally) Ann Price  
 Sarah (Sally) Ann Price 11  
**STALLER**  
 Sue 337B  
**STAMM**  
 Patricia 42  
 Ruth 42  
**STAMOS**  
 Fridolyn Baum Feinblatt 71  
 Milton 71  
**STAMPER**  
 Betty Sue Lopez 331B  
 Walter H. III 331B  
**STANFILL**  
 Ruth Beryl 197  
**STANFORD**  
 Alexandrina, Davega (1876-1943) 322B  
 Ross C. 322B  
**STANLEY**  
 Diane Michele De Cordova 52  
 Kenneth Wayne 52  
**STANSBURY**  
 Arabella 158  
 Dixon 154, 158  
 Edmund B. 158  
 Elizabeth 158  
 Samson L. 158  
 Sarah McComas 158  
 Sophia 158  
 Sophia Levy 154, 158  
 Thomas T. 158  
**STARK**  
 Herbert J. 284  
 Sandra 211  
 Sylvia Weyl 284  
**STARR**  
 Belle Victor 320B  
 Edna 320B  
 Harry 320B  
 Sadie 320B  
 Sherree 325B  
**STAVISKY**  
 Evan Marc 295  
 Leonard Price 295  
 Toby Ann Goldhaar 295  
**STEARNS**  
 Augusta 74  
 Marie Louise Henriques De Wolfe  
 310B  
 Theodore 310B  
**STEBBINS**  
 George Tobias 299  
 John Blodgett 299

John Blodgett, Jr. 299  
 Mary Emilie Tobias 299  
**STECKER**  
 Jack 72  
 John 72  
 Philip Jack 72  
 Phyllis 72  
 Simone Fleisher 72  
**STEDMAN**  
 Barbara 238  
 Carol Ann 238  
 Ella May Palmer 238  
 Franette 238  
 Jess Stephen 238  
 Jesse (b. 1914) 238  
 Jesse P. 238  
 John 238  
 Jon 238  
 Judith Ann 238  
 Loretta Helen 238  
 Lucille Frances Hemphill 238  
 Madeline Katherine Murphy 238  
 Mark Henry 238  
 Pat 238  
 Philip Stephan 238  
 Phillip P. 238  
 Robert P. 238  
 Robert Stephen, Jr. 238  
 Sallie Ardath Tolson 238  
 Susan Marie 238  
 Susan Marie Newkirk 238  
**STEEG**  
 Rebecca 303  
**STEEL**  
 Adam 229, 334B  
 America Laura Nathans 229, 334B  
 Columbus 229, 334B  
 David Herman (d. 1923) 229, 334B  
 David Russell 229  
 Deborah Lyon (b. 1951) 229  
 Dorothy Olivia (b. 1909) 229  
 Edmund P. (b. 1910) 229, 334B  
 Elinor (b. 1907) 229, 334B  
 Elizabeth (b. 1947) 229, 334B  
 Elizabeth Kate 229  
 Florence Dubrow 229  
 Frida Neufeld 229, 334B  
 Herman David (1881-1954) 229, 334B  
 Irene Koenig 229, 334B  
 Janet Kahn 229, 334B  
 Joan Krechmer 229  
 Joanne Coleman 229  
 Judith Ann (b. 1948) 229, 334B  
 Laura Berman 229, 334B  
 Philip G. (b. 1918) 229  
 Philip Goldsmith 229, 334B  
 Philip N., Jr. (b. 1934) 229, 334B  
 Philip Nathans (1906-1964) 229, 334B  
 Richard (b. 1941) 229, 334B  
 Richard Bruce (b. 1954) 229  
 Roger Kahn (b. 1937) 229, 334B  
 Roger, Jr. (b. 1963) 229  
 Ruth Beizer 229  
 Vivian Singley 229, 334B  
**STEELE**  
 Henry Milford 97  
 Jessamy Hart 97  
 Valerie 122  
**STEENBEKE**  
 Frances Mary 238  
**STEFFENS**  
 John M. 241  
 Nina Mapleson Peixotto Stewart 241  
**STEGG**  
 Joseph 139  
**STEIFEL**  
 Babette, (1921-) 327B  
 Leopold 327B  
 Rose Meyers 327B  
**STEIN**  
 See also Von Stein  
 Alan David 107  
 Anna Levy (see Stein, Nanine (Anna)

Levy)  
 Arthur 254  
 Bernard (see Davies, Bernard)  
 Birdye Jacobs 107  
 Blanche Estelle Emanuel 65  
 Brenda Clark 107  
 Carrie 284  
 Cecilia 285  
 Diane Dushole Lewin (1946-) 323B  
 Dolene Guggenheimer 90  
 Dora Emily 65, 323B  
 Dorothy Hirschler 107, 108  
 Edith 215  
 Ellen (b. 1951) 15  
 Elva 282  
 Florette Rosenheim Rosenfeld 255  
 Hans (see Stone, Howard)  
 Helen Aufseser 15  
 Helen Grace Michaelson 65, 323B  
 Ignatz 65  
 John Carlisle 107  
 Jonathan Emanuel 65, 323B  
 Joseph 47  
 Joseph Arthur 107  
 Judith Emily 65, 323B  
 Katherine (b. 1920) 15  
 Leon Ignatius 65, 323B  
 Lottie E. Slater 47  
 Mary Obst 340B  
 Milford Alan 107, 108  
 Myra Kelley 107  
 Nancy Sue 65, 323B  
 Nanine (Anna) Levy 65  
 Nona Stern 15  
 Rebecca 48  
 Rita 107  
 Robert (b. 1917) 15  
 Robert (b. 1942) 15  
 Robert (son of Milford A.) 107  
 Robert Sol 65, 323B  
 Sally Ellen 65  
 Sarah 107  
 Sid J. (1890-1954) 15  
 Sidney, Jr. (b. 1923) 15  
 Simon 90  
 Solomon I. 65, 323B  
 Susan (b. 1946) 15  
 Suzanne Holstein 15  
 William H. (1947-1975) 340B  
**STEINBACH**  
 Ruth (Dolly) 83  
**STEINBERG**  
 Anita Hannah De Sola Williams 61  
 Charles (b. 1887) 248  
 Charles (1850-1922) 248  
 David (b. 1857) 248  
 Deliah Phillips 248  
 Ellen (b. 1918) 286  
 Estelle Sheftall 268  
 Esther (b. 1842) 248  
 Esther (1857-1931) 248  
 Erta Alice Eiseman 286  
 Fanny 268  
 Florence Louise (b. 1914) 286  
 Gitlah (b. 1848) 248  
 Harmon (b. 1843) 248  
 Henry (1844-1930) 248  
 Isaac (b. 1877) 248  
 Isaac (1801-1864) 248  
 Isaac (1880-1891) 248  
 Leo Charles 268  
 Leon 61  
 Letheria 268  
 Louise (b. 1916) 286  
 Mark Charles 286  
 Max 268  
 Minnie 248  
 Paula 61  
 Rachel (b. 1846) 248  
 Samuel 61  
 Sarah 248  
 Stephen Randall 61  
 Susan 61



Sylvia Deich 61  
**STEINER**  
 Albert (m. Ruth Heller) 186  
 Albert F. 13  
 Amelia Isaacs 277  
 Carl 285  
 Charles 178  
 Dorothy Lowman Pritz 286  
 Elsie 255  
 Frances Arnold 13  
 Joan Friedlander 285  
 John 339A  
 Joseph 339A  
 Joseph Henry (b. 1839) 277  
 Judith Lopez 178  
 Marjorie Selig 339A  
 Mary Ann Lopez 178  
 Robert 285  
 Ruth Heller Cohen 186  
 Suzanne 13  
 Therese 285  
**STEINERT**  
 Albert Morris 249  
 Alice Marie 249  
 Ellen Eisendrath 313B  
 Eric 313B  
 Ernestine 15  
 Kathryn Lillian 249  
 Marie 249  
 Marie A. Phillips 249  
 Sylvia C. 313B  
 Theodore 313B  
 William C. 313B  
**STEINFELD**  
 Amelia Isaacs 41  
 Irene 49  
**STEINHARDT**  
 Irma Mendes 191  
 Josephine Gans 83  
 Lewis 83  
 Louise 211  
 Samuel C. 191  
 Theresa 83  
**STEINHART**  
 Eleanora 89  
**STEINHAU**  
 Esther Jacobs 125  
**STEKEISE**  
 Marie 67  
**STENGEL**  
 Ivan 144  
 Marguerite Wittenberg 144  
**STEPHANI**  
 Alphonse 340B  
 Josephine Moehring 340B  
**STEPHENSON**  
 S. Caroline 304  
**STEPHACHER**  
 Brian 83  
 Cecile Louchheim 72, 83  
 Dolly Steinbach (see Steppacher, Ruth (Dolly) Steinbach)  
 Doris 83  
 Jill 83  
 Joanne Pendleton 83  
 John 83  
 Leah (Lillie) Gans 83, 324A  
 Lee 83  
 Lester (b. 1892) 83, 324A  
 Lester, Jr. 83  
 Lynn 83  
 Marjorie Dolvig 83  
 Maurice 72  
 Mildred 83  
 Ruth (Dolly) Steinbach 83  
 Ruth 83  
 Walter M. III (b. 1920) 83  
 Walter M. IV (b. 1955) 83  
 Walter Maurice (1859-1919) 83, 324A  
 Walter Maurice, Jr. (1890-1936) 72, 83  
**STERLING**  
 Mabel 251  
 Rebecca 52

**STERN**  
 Aaron 284  
 Abraham 282, 283  
 Adam 321A  
 Adelheid Marx (1822-1916) 282, 283  
 Adeline Myers Cohen 32, 281  
 Albert 108  
 Andrew 282  
 Ann Eliza Bushnell 15  
 Anne (b. 1918) 285  
 Arthur Kaufman (b. 1885) 282  
 Augusta Myers (b. 1877) 281  
 Babette Feilheimer (d. 1969) 282  
 Babette Wessner 284  
 Barbara E. Rodrigues 15  
 Beatrice (b. 1903) 274  
 Beatrice (dau. of 'Dutch' Mose) 283  
 Benjamin (b. 1864) 283  
 Benjamin (1857-1933) 295  
 Bernhard (1820-1873) 219  
 Bertha Lowenberg 108  
 Bertha S. Levy 283  
 Bessie (b. 1883) 282  
 Betsy 282, 283  
 Betty Marx 282  
 Beverly 294  
 Blanche Gold 108  
 Bobby Jane 282  
 Bobette Sylvia (b. 1915) 282, 339B  
 Bonnie, see Stern, Esther Barnett (Bonnie)  
 Buck, see Stern, Morton "Buck"  
 Carl Samuel 285  
 Carl, Jr. (b. 1921) 285  
 Carrie Levy 311A  
 Carrie Kaufman 282  
 Carrie Straus 282, 283  
 Catherine 284  
 Charles (m. Esther Barnett) 16  
 Charles (son of Jacob) 282, 283  
 Charles III (b. 1943) 16, 321A  
 Charles J., Jr. (Jerry) 282  
 Charles Jerome (1886-1957) 282  
 Charles, Jr. (1915-1941) 16  
 Charlotte Daniel 285  
 Christopher 288  
 Claire 284  
 Daniel Merz 71  
 David 325B  
 David (b. 1956) 15  
 David (m. Edith Katzenberg) 282, 339B  
 David (1842-1896) 32, 281  
 David III 284  
 David Richard 71  
 David Thomas (son of J. David) 284  
 Denah (1859-1934) 282  
 Dene (m. S. F. Loucheim) 72  
 Dene (m. 1955) 282, 339B  
 Dinah Hunt 325B  
 Dorothy 284  
 Dorothy Alice Fleisher 71  
 'Dutch Mose' (see Stern, Moses ('Dutch Mose'))  
 Edith Katzenberg 282, 339B  
 Edith Mendel 284  
 Edna 283  
 Edna Phillips 249  
 Edward (1849-1923) 284  
 Edward Leon (b. 1917) 282  
 Eleanor Mahlike 282  
 Elizabeth Vera "Evelo" 339A  
 Elsie Weston Lazarus 150, 325B  
 Emanuel (b. 1829) 285  
 Emanuel (d. 1828) 285  
 Emilie (1846-1907) 284  
 Esther Barnett (b. 1879) 16, 321A  
 Esther Barnett (Bonnie) (b. 1945) 16, 321A  
 Etta Barnett 15  
 Etta Berkowitz (see Stern, (Henri) Etta Berkowitz)  
 Evelo, see Stern, Elizabeth Vera

"Evelo"  
 Frank (see Stern, Franklin (Frank))  
 Frank, Jr. (b. 1918) 282  
 Franklin (Frank) 281  
 Frederick 283  
 G. Marjorie Phillips 249  
 Gates (b. 1915) 15  
 Greta 284  
 Hannah Doll 283  
 Hannah Marx 282  
 Harold Cohen (b. 1888) 242  
 Harry (m. Sarah Long) 284  
 Harry (son of Charles) 283, 339B  
 Harry (son of Julius (Jim)) 284  
 Harry, Jr. 339B  
 Helen Burgher 16, 321A  
 Helene 229, 334B  
 (Henri) Etta Berkowitz 281  
 Henrietta (Hettie) Pfaelzer 296  
 Henrietta Adler 284, 313B, 339B  
 Henrietta Mary ('Mme. Majeska') 284, 339B  
 Henry Root 150, 325B  
 Henry, R. Jr. 325B  
 Herman O. 242  
 Hettie Pfaelzer (see Stern, Henrietta (Hettie) Pfaelzer)  
 Horace 296  
 Isaac (son Emanuel) 285  
 Isaac (1857-1868) 282  
 J. David III 284  
 J. David, Jr. 284, 339B  
 Jacob (m. Jeanette Kaufman) 281  
 Jacob (1823-1912) 282  
 Jacob Edgar (b. 1872) 281  
 Jane H. Wolf 282  
 Jeanette 282  
 Jeanette Huat 285  
 Jeanette Kaufman 281  
 Jennifer 288  
 Jerry, (see Stern, Charles J., Jr. "Jerry")  
 Jill 284  
 Jim (see Stern, Julius Long (Jim))  
 Joan B. (b. 1942) 16, 321A  
 Joan Mayer 16  
 Joe 311A  
 Joel (b. 1921) 15  
 Jonathan 284  
 Joseph 321A  
 Josephine 284  
 Josephine May 305  
 Judith (b. 1859) 219  
 Julia 284  
 Julie Ebstein Berman 282  
 Juliet Lit 284, 339B  
 Julius (b. 1913) 15  
 Julius (1804-1870) 284, 313B, 339B  
 Julius David (1841-1907) 284, 339B  
 Julius Long (Jim) 284  
 June 108  
 Kate Arnstahl 70  
 Katherine Goldstone 116  
 Laura Weill 91  
 Lee 15  
 Lee George 15  
 Leo 237  
 Leon J. 170  
 Lewis Julius 284  
 Lilabell Damon 281  
 Linda Mac Pike 321A  
 Linda Sauer 71  
 Louise Beggs 284  
 Louise Mayer 16, 321A  
 Louise S. Bergman 282  
 Lucile 222  
 Mabel 107, 108  
 Madeline Schafer 295  
 Madeline Wolf 284  
 Malcolm Henry (b. 1915) 282  
 Marcus (1828-1904) 282, 283  
 Margaret (b. 1916) 285  
 Margaret (Peg) 288  
 Margaret (Peggy) Blumenthal 71

Margaret Hamburger 284  
 Margaret Robertson 15  
 Mary Hamburger 284  
 Matilda (1845-1910) 32, 281  
 Maud Elise (b. 1880) 281  
 May 283  
 May Mumford 15  
 Melba Jackson 15  
 Meredith 284  
 Michael 284  
 Minnie A. Sands 170  
 Minnie L. 236  
 Monica Mary Began 284  
 Morton "Buck" (1889-1981) 283, 339B  
 Moses ('Dutch Mose') 283  
 Moses (m. Josephine May) 305  
 Moses (of Schwetzingen) 282, 283  
 Moses (son of Marcus) 283  
 Moses (1863-1927) 108  
 Moses Harry (1853-1908) 282  
 Myer (1824-1899) 325B  
 Myer 116  
 Myer M. (1859-1926) 283  
 Nancy 325B  
 Nancy (dau. of Emanuel) 285  
 Nancy (m. Lewis David Hirschler) 10  
 Natalie (b. 1920) 282  
 Nina Henrietta Weiss 285  
 Noah 321A  
 Nona 15  
 Patricia 282  
 Paulina Oppenheimer 237  
 Peg (see Stern, Margaret (Peggy) Blumenthal)  
 Peter 282  
 Philip Alfred (1874-1898) 281  
 Rachel Myers 219  
 Rebecca (b. 1861) 219  
 Regina Straus 282, 283  
 Richard M. (b. 1946) 16, 321A  
 Richard (Rabbi) 339A  
 Richard (son of Moses) 283  
 Richard Fleisher (b. 1940) 71  
 Robert (1912) 16, 321A  
 Robert Jacob 321A  
 Rosa (1843-) 339B  
 Rosalind 283  
 Rose (b. 1858) 219  
 Ruth 283  
 Sadie (b. 1890) 282, 339B  
 Samuel 282, 283  
 Sara 325B  
 Sara Helen (1980-) 321A  
 Sara Stern 325B  
 Sarah (dau. of Marcus) 283  
 Sarah (dau. of Samuel) 283  
 Sarah Long 284  
 Sarah Van Nierop 242  
 Selma 284  
 Simon (1847-) 325B  
 Simon 284  
 Simon Adler (1838-1904) 284  
 Sophia 283, 339B  
 Sophie 296  
 Sophie Muhr 284  
 Stephen 282  
 Stimes 284  
 Sue Frank 282  
 Susan B. (b. 1942) 16, 321A  
 Theresa Mulqueenie 321A  
 Tillie 283  
 Tommy (?) 284  
 Virginia Peixotto 242  
 Walter D. 325B  
 William (b. 1910) 16, 321A  
 William A., Jr. 284  
 William Adler 284, 339B  
 William Daniel (b. 1945) 71  
**STERNBERG**  
 Helen 107  
 Herbert 107  
 Joseph 107

**STERNBERGER**  
 Amelia 255  
 Barbara 91  
 Clarence 183  
 Gertrude Selig 283  
 Tillie 255  
**STERNE**  
 Adolphus 285  
 Alicia Hortense Friedman 41  
 Carl 285  
 Eugene 285  
 Eva Catherine Rosine Ruff 285  
 Hortense Friedman 41  
 John 285  
 Leo (or Lee) 41  
 Mary 42  
**STERNE (STERN)**  
 Adolphus 285  
**STERNES**  
 Alice Cohen 39  
 Mary 39  
 Wellbarn S. 39  
**STETTHEIMER**  
 Carrie 13  
**STEVENS**  
 Adele Horwitz 118  
 Constance 237  
 Fannie 221  
 Frances Barnes 118  
 Michael Marion (b. 1980) 330A  
 Nancy Judith Levy Elias 330A  
 Nancy Stern 285  
**STEVENSON**  
 Elizabeth Augusta Goodwin (1815-1891) 157  
 Elizabeth Goodwin 155, 157  
 Esther Smith (1813-1863) 157  
 George Pitt (1818-1853) 157  
 George Pitt, Jr. (d. 1819) 155, 157  
 Maria Louise (1817-1905) 157  
**STEWART**  
 Alexander Hart (1918-1931) 101  
 Amy Coleman Hart 101  
 Barbara Kambholz 271  
 Beatrice 204  
 Bertha 289  
 Catherine Leslie 95  
 Ella Hoke Levy 164  
 George Anne 164  
 Georgia Euphan 164  
 Gloria 285  
 James 271  
 John Hatch 241  
 Katherine Ann Hogan 164  
 Margie Hoke 164  
 Myles C., Jr. 164  
 Myles Collier 164  
 Nina Mapleson Peixotto 241  
 Olivia Elizabeth Johnson 81  
 Oaeola Olar 101  
 Pamela Ann De Sola 60  
 Richard A. F. 81  
 Roy 60  
 Shelby Katherine 164  
**STEYN**  
 Marion 158  
**STICE**  
 Joshua 201  
 Louise Mordecai 201  
**STIEGLITZ**  
 Louise 288  
**STIFEL**  
 Edward 295  
 Jean Schaffer 295  
 John Edwin 295  
 Peter Leonard 295  
**STIFF**  
 Henrietta (1865-1920) 311B  
**STILES**  
 Lizzie A. 324B  
**STIMAN**  
 Loris 26  
**STINER**

Esther 227  
**STINES**  
 Esther Tavares 152  
 Florence (b. 1850) 152  
 Joseph Cohen 152  
 Minnie Esther (b. 1855) 152  
**STINSON**  
 Lillian 39  
 Mary Jane Mayer 247  
 R. Andrew 247  
 Raiford 247  
**STIRLING**  
 Anna 74  
**STIVER**  
 Anita 322A  
 Judith 322A  
 Laura 322A  
 Mariadina Cohen 322A  
 Richard 322A  
 Theodore 322A  
**STIX**  
 Aaron (1831-1868) 285, 286  
 Aaron (1876-1879) 287  
 Aaron Louis (b. 1862) 285  
 Addie Beeber (b. 1878) 285  
 Adele (b. 1872) 286  
 Adele Longini 286  
 Adele Meyer 286  
 Adine A. Haviland 288  
 Agnes (1871-1875) 287  
 Alan 285  
 Albert I., Jr. (b. 1906) 286  
 Albert Iglauer (b. 1872) 286  
 Alice (b. 1870) 286  
 Allen Howard 285  
 Alma (b. 1877) 287  
 Alma Adler 286  
 Ann (b. 1916) 286  
 Aurelia (b. 1854) 286  
 Aurelia (1824-1825) 285  
 Aurelia (1862-1918) 286  
 Babette Oppenheimer 285  
 Barbara 285  
 Belle Straus 285  
 Bertha (b. 1871) 286  
 Betsy Meyer (b. 1912) 286  
 Beverly R. McDonnell 288  
 Carl 340A  
 Carl Hans (b. 1890) 285  
 Carol Hoffman 285  
 Caroline (b. 1829) 285, 292  
 Caroline (Carrie) 288  
 Carrie (b. 1860) 286  
 Carrie (b. 1866) 285  
 Carrie (see also Stix, Caroline (Carrie))  
 Caryl Corey 288  
 Charles (see also Stix, Karl (Charles))  
 Charles (1816-1844) 285  
 Charles Aaron (1861-1916) 286  
 Charles Henry (b. 1880) 286  
 Charles Henry (1856-1878) 286  
 Charles Louis (1854-1912) 285  
 Charles Nathan (b. 1868) 286  
 Charlotte Lyon (b. 1899) 285  
 Christopher Terry 285  
 Claire Netter 286  
 Clara Friedlander 286  
 Cora (b. 1873) 287  
 Cynthia Ruth 288  
 Daniel Louis 288  
 David (b. 1960) 285  
 David 287  
 David Field 288  
 Deborah (Dorothea) Cohen 285, 286, 287  
 Diane Elizabeth 285  
 Dinah (dau. of William II) 287  
 Dinah Rice (1842-1927) 285, 287  
 Dorothea Cohen (see Stix, Deborah (Dorothea) Cohen)  
 Dorothy Kerstein 285, 340A  
 Edgar Robert (b. 1891) 285

Edgar Robert (b. 1920) 285  
Edith (b. 1874) 287, 340A  
Edith Fechheimer 286  
Elizabeth (b. 1894) 286  
Elizabeth (b. 1909) 287  
Elizabeth Antoinette 288  
Elizabeth Thompson 287  
Erma Kingsbacher 287  
Ernest W., Jr. (b. 1916) 287  
Ernest William (1878-1955) 287, 340A  
Fannie Troy 286  
Florence Deitch 285  
Frances (Frankie) 288  
Frances Troy (b. 1906) 286  
Frankie (b. 1867) 285  
Frederica Beeber 285  
Frederick S. (b. 1897) 286  
Gail Virginia 285  
Gary Castle 285  
Gloria Stewart 285  
Grace Amelia (b. 1904) 286  
Grace Freiberg 286  
Hannah Rice 285, 286  
Harry (1863-1872) 286  
Harry Friedlander (b. 1882) 286  
Hazel Rose Sherwin 287  
Helen (b. 1875) 187, 286  
Helen (b. 1892) 286  
Helen Dorothy 286  
Helen Fechheimer 286  
Henry (1826-1908) 285, 286  
Henry Sachs (b. 1850) 286  
Henry Walter (b. 1906) 286  
Herman (1818-1825) 285  
Hugh 285  
Hugh Sylvan 288  
James Louis 288  
Jennifer Ann 285  
Jill Rainer 285  
John 285  
John Louis 285  
John Morris (b. 1920) 287  
Joseph Louis (b. 1852) 285  
Julie 285  
Karl (Charles) 285  
Katherine Victoria 285  
Lawrence C., Jr. (b. 1915) 285  
Lawrence Cullman (b. 1887) 285  
Lena Cullman 285  
Lena Thurnauer (see Stix, Pauline  
(Lena) Thurnauer)  
Louis (b. 1902) 285  
Louis (1821-1902) 285  
Louis Charles (1883-1806) 285  
Louis Nathan (b. 1864) 286  
Louis Nicholas 288  
Louis Sylvan 288  
Louise Arnold 285  
Lucile Meyer 286  
Margaret Prudence 288  
Marguerite Gompertz 288  
Marian 285  
Mary Eleanor 285  
Mary F. (b. 1909) 286  
May Beeber (b. 1882) 249, 285  
Michael Sherwin 287  
Muriel Marka 285  
Nancy (b. 1920) 285  
Nancy Jane 285  
Nathan (b. 1899) 286  
Nathan (1835-1908) 285, 286  
Otto Louis (b. 1864) 285  
Patricia Castle 285  
Patricia Lynn 288  
Pauline (b. 1866) 287  
Pauline (Lena) Thurnauer 285, 286  
Pauline Fischel 285  
Rachel (b. 1866) 286  
Rachel (b. 1869) 287  
Regine J. Kronacher 285  
Richard S. (b. 1896) 286  
Ricka Iglaier 285, 286  
Robert Daniel 288

Robert Louis (b. 1916) 285  
Robert Louis (1857-1915) 285  
Roger Bruce 285  
Rosa (1856-1914) 285  
Rosalie Ann Simpkins 288  
Ruth (b. 1898) 286  
Ruth Virginia Fink 285  
Sadie Fraley 286  
Sarah (1833-1844) 285  
Solomon (1788-1865) 285, 286, 287  
Solomon (1867-1868) 287  
Solomon Henry (b. 1870) 286  
Solomon Nathan (1866-1917) 286  
Stephen Louis 285  
Susan 285  
Susan Hilda 288  
Susan Hurd 288  
Susan Sherwin 287, 340A  
Sylvan Louis (b. 1871) 285  
Thomas (b. 1896) 285  
Thomas Callahan (b. 1916) 285  
Thomas Howard 287, 340A  
Thomas L. 285  
Thomas L., Jr. 285, 340A  
Walter Henry (b. 1876) 286  
Wayne Phillip 285  
William (1838-1914) 285, 287  
William II (b. 1911) 287  
William III 287  
Winifred (b. 1897) 286  
Yetta Hackes 285  
Zillah (b. 1859) 285  
**STOCK**  
Sarah 116  
**STOCKARD**  
Atkinson, Jr. 333A  
Jackie (see Stockard, Mary Johnson  
(Jackie))  
Margaret Mordecai Ashe 200, 333A  
Mary Johnson (Jackie) 329A  
Meta 333A  
Samuel 200, 333A  
**STOCKER**  
Joel 3  
Kate Abraham 3  
**STOCKTON**  
Anna Louisa Smith 218  
**STOKES**  
Adrien 115  
Barbara Hoyt 158  
Durham 115  
Ethel Leon 115  
Isaac Newton Phelps 158  
Janet R. C. 158  
Mitchell P. 158  
Olivia P. 158  
Philip Geoffrey 115  
Samuel N. 158  
Thomas H. 158  
**STONE**  
Allan Barry 285  
Allison Marguerite 285  
Anna Pearl 237  
Arthur 160  
Barbara Bernsteina 282  
Carol Ann Roth 237  
Charles P. 338A  
Claudia Barry 285  
Constance Blockley 122  
Corla 122  
Dwight H. 237  
Edward A. 160  
Gene Nathan 321A  
Harry D. 237  
Howard 122  
Jeremy Patricia 285  
Margery 122  
Marguerite Patricia ("Peggy") Cullman  
285  
Maria Louise Clary 338A  
Mary (1850-1928) 312A  
Michael 282  
Peggy Cullman (see Stone, Marguerite

Patricia ("Peggy") Cullman)  
Peter 321A  
Robert L. 160  
Rose Newman 160  
Zelda Barnbaum 237  
**STOPPELBEIN**  
Edwin Eleanor Moise 196  
Warren 196  
**STORK**  
Aaron (1764-1843) 99  
Billah 99  
Hart (d. 1845) 99  
Jeanette (ca. 1760-1834) 99  
Sarah (1791-1863) 99  
**STORY**  
Anne (b. 1906) 251  
Austin P., Jr. (b. 1924) 251  
Austin Putnam (b. 1890) 251  
Carrie Pinto Denning 251  
Clifford Blake 76  
Cordelia Wallace 251  
Duncan A. 76  
Elfrida Muriel Oakes 76  
Herbert Winterbourne 76  
Hilda Manon 76  
Isabelle Emma Oakes 76  
Minnie Ethel Naus 76  
Sibyl Edna 76  
Walter Sprague (b. 1868) 251  
William Wallace (b. 1929) 251  
**STOUT**  
Catherine (1782-1811) 188  
Nancy Ann Brasch 297, 314A  
Richard A. 314A  
**STRAHL**  
Louise (1865-) 327B  
Merton P. 11  
Sarah (Sally) Ann Price 11  
**STRAIT**  
Mayme Ruth Arrington 239  
**STRANGE**  
Carolyn 208  
**STRASBURGER**  
Alvin 84, 164  
Alvin, Jr. 84  
August Kohn 84  
Caroline Moog 41  
Corinna Friedman 41  
David Lafayette 84  
Florian 41  
Helene Cahn 313A  
Irma 108  
Julien (d. 1918) 41  
Leo (b. 1861) 41  
Mary Alice Kohn McElveen 84, 164  
Richard 313A  
**STRASMAN**  
Wolfgang 235  
**STRAUS**  
Adah V. 162, 329B  
Adah Virginia Levy 162, 329B  
Adam 162, 329B  
Aubrey Hamilton (d. 1947) 162, 329B  
Audrey H. 162, 329B  
Augusta Wilma 108, 162, 325A  
Bernard 219  
Bertha Raynor 48  
Carrie 282, 283  
Charles Emanuel 162, 329B  
Charlotte Fingerhut 162  
Clifford Allan (1912-1987) 162, 329B  
Diane E. 314A  
Edna 21  
Ellen Louise Sulzberger 314A  
Eric 314A  
Fanny 143  
Gerald 219  
Hannah 162, 329B  
Harry 219  
Henry 219  
Jeanne 314A  
Judith Stern 219  
Katherine 314A

Lee 219  
Malcolm Lee 162  
Marjory 285  
Matthew (1958-) 329B  
Michael (see Straus, Matthew)  
Mildred 191  
Phyllis Lindsay 162, 329B  
R. Peter 314A  
Rachel 219  
Sara M. 222  
Viola 119  
Vivien 144  
Wilma Marx 162  
Yetta 172  
**STRAUSS**  
Adele 10  
Babette 14  
Barnett 160  
Belle 285  
Bertha (1864-1940) 330B  
Carolotta Levy (see Straus, Lotta  
(Carolotta) Levy)  
Charles Q. 290  
Elizabeth 3  
Elsa Lovitt 3  
Hannah (1841-1901) 241  
Harry (m. Rachael Alexander) 290  
Harry (son Barnett) 160  
Harry Abraham 3  
Linda Leopold 3  
Lotta (Carolotta) Levy 160  
Margaret 3  
Marie 278  
Nancy Therese 3  
Rachael Alexander 290  
Rachel (b. 1837) 160  
Rachel (m. 1860) 160  
Regina 282, 283  
Therese Abraham 3  
William Victor 3  
William Victor, Jr. 3  
**STRAWN**  
Madria (1919-) 330A  
**STREUSAND**  
Eather H. 42  
**STRIBLING**  
Carole Faye 42  
**STRICKER**  
Helen Kroha 306  
Ludwig 306  
**STRICKLAND**  
I. (1848-) 335B  
Margaret (1815-1898) 324A  
Mary 90  
**STRIDE**  
Dorothy 226  
**STRIKER**  
Cecil 306  
Cecil Lee 306  
Delia Workum 306  
Theodore 306  
**STROEBEL**  
Meriam Sheftall 270  
Philip 270  
**STROMAN**  
Jean Harvey 208  
**STROMBERG**  
Lena 145  
**STRONG**  
Charles M. (d. 1935) 256, 313A  
Earl 38  
Florence Cohen 38  
Georgianna Hays 105  
Janie Russell Gustin McCauley 256,  
313A  
Susan 309A  
Thomas W., Jr. 105  
**STRONGIN**  
Gladys 124  
**STROOCK**  
Alan M. 285  
Daniel W. 285  
Katherine 285

Marianna 285  
Robert A. 285  
**STROUD**  
Marion 254  
Marion S. Rosengarten 254  
Morris W. III 254  
**STROUSE**  
Abe 215  
Alice Fensterwald 107  
Leona Ransoboff Alvarez 215  
William 107  
**STRUDWICK**  
Jane Daves 217  
**STRUM**  
Samuel 292  
**STRUTT**  
Alexander Ronald George 79  
Algernon Henry 79  
Eva Isabel Marian Bruce 79  
Lavinia Mary 79  
Michael 79  
**STRYKER**  
Kate 225  
**STUARD**  
Rubie 146  
**STUART**  
George Mackenzie 82  
Grace 227  
Josephine I. 70  
Mary 82  
Mary Babington 82  
**STUBBLEFIELD**  
Elizabeth 217  
**STUDD**  
Mary De Vere 79  
**STULMAN**  
Anita 327A  
Norman 327A  
Sylvia L. Goldman 327A  
**STURDEVANT**  
Irene Phillips 159  
Richard Matthew 159  
**STURGIS**  
J. W. 146  
Maud Kokernot 146  
**STURHAHN**  
Carl F. 30  
Edward M., Jr. 30  
Edward Marshall 30  
Herbert Carl 30  
Joan 30  
Leigh Rollinson 30  
Louise Dailey 30  
Maie Nunes Carvalho 30  
**STURM**  
Alice Wyler 292  
Fanny 135  
Gabriel 189  
Helen (b. 1905) 292  
Louis Wyler (b. 1911) 282  
Marjorie Katzenberg 282  
Regina Marx Jacobs 189  
Sophie W. (b. 1904) 292  
**STUTTGART**  
Clara Souza 280  
Isaac (d. 1830) 280  
**STUTZ**  
Arthur 201  
Arthur, Jr. 201  
Ethel Lenoir Mordecai 201  
**STYLE**  
Gerald Rodney 79  
Melloney Scobell 79  
**SUARES**  
Aaron 289  
Caroline (1819-1904) 289  
David 289  
David de Isaac 240  
Ester 289  
Henry Edgar (d. 1914?) 289  
Isaac (father of Rachel) 240  
Isaac (1854-1898) 289  
Isabelle Nathan 228, 289

Jacob (1755-1818) 289  
Jacob Edgar (1818-1894) 228, 289  
Judith (1769-1853) 289  
Mary Ann (1806-1897) 228, 289  
Rachel (1809-1873) 289  
Rachel de David de Isaac 240  
Sarah (1808-1865) 289  
**SUAREZ**  
Amado 310A  
Josephine 310A  
Madeline Hart 97, 310A  
Manuel J. 97, 310A  
**SUASSO**  
Leonora (Rachel) 258  
3rd Baron (see Lopes, Antonio, 3d  
Baron Suasso)  
Sarah 258  
**SUCKLE**  
Kathy 71  
Margaret James Fleisher 71  
William Victor 71  
**SUCRE**  
Josefina 336A  
**SUDE**  
Kay Eve Barenkopf 229, 334B  
Laurie Jean 229  
Leslie Ellen 229, 334B  
Paul J. 229, 334B  
**SUGARMAN**  
Clara 187  
**SULLIVAN**  
Betty (b. 1913) 166  
Caroline Anne 299  
Catherine A. (d. 1940) 309B  
Mary Louise 123  
**SULSBACHER**  
Madeline 285  
**SULTAN**  
Andrea Judith (b. 1944) 245  
Arthur Leigh 245, 338A  
Arthur Phillips 245, 338A  
Erna 275  
Evelyn Graham Miller 245  
Evelyn Phillips Milkman 245  
Graham Phillips 245  
James Phillips 245  
Katherine Gray (1978-) 338A  
Kimberly Brooke 245  
Margaret McKinnon (1977-1977) 338A  
**SULZBERGER**  
Abraham (1810-1880) 290  
Abraham Moses (d. 1758) 290  
Ann (b. 1930) 291, 314A  
Ann (dau. of Frank L.) 291  
Anna 291  
Arthur Hays (b. 1891) 291  
Arthur O., Jr. 291  
Arthur Ochs ("Punch") 291  
Babetta Odenheimer 290  
Barbara Grant 291  
Beatrice 291, 313B  
Beatrice Josephi 291  
Carol Fox Fuhrman 291  
Carrie 290  
Cathy Jean 291, 314A  
Chaia 290  
Clara Frank 291  
Cynthia Fox 291  
Cyrus 291  
Cyrus L. (b. 1912) 291  
Cyrus L. (1858-1932) 104, 291  
Cyrus Leopold (1858-1932) 104, 291  
David (1838-1910) 291  
David Alexis 291  
David Hays 291  
Edward 291  
Elhanan 290  
Eliezer Sussmann 290  
Ellen Louise 291, 314A  
Ester Emden 290  
Fanny (Zipporah) Wasserman 290  
Fanny 290  
Flora 291

Frádel 290  
 Frank L. (b. 1887) 291  
 Frieda 290, 340A  
 Gail Gregg 291  
 Gellah 290  
 Hannah 290  
 Helen Becker 291  
 Iphigene Bertha Ochs 291  
 Jacob (d. 1897) 290  
 Jean (dau. of David Hays) 291  
 Jean (dau. of Frank L.) 291  
 Joseph (1841-1931) 290  
 Joseph E. 290  
 Judith Peixotto 291  
 Karen Alden 291  
 Kate 291  
 Katherine Thomas 291  
 Lena Einstein (see Sulzberger, Zirlah (Lena) Einstein)  
 Leo (1885-1926) 291  
 Leopold (1805-1881) 290, 291  
 Lillie Bernhardt 290  
 Louise Blumenthal 291  
 Low Ezra Judah 290  
 Luba Malina 290  
 Maier (b. 1625) 290  
 Maier (1721-1789) 290  
 Marian Beatrice 291  
 Marian Effie 291  
 Marie Einstein 291  
 Marina Tatiana Lada 291  
 Mayer (son of Solomon) 290  
 Mayer (1843-1923) 290  
 Meir 290  
 Moses 290  
 Myron (b. 1878) 290  
 Myron, Jr. (b. 1904) 290  
 Naphtali Hirsch 290  
 Punch (see Sulzberger, Arthur Ochs ('Punch'))  
 Rachel Peixotto Hays 104  
 Rebecca 290  
 Rena Fuld 290  
 Rosalie 291  
 Ruth Rachel 291  
 Sarah (1839-1928) 291  
 Solomon (b. 1839) 290  
 Solomon (1761-1838) 290  
 Solomon (1838-1918) 290  
 Solomon L. (b. 1857) 291  
 Sophia Einstein 290  
 Sophia Lindauer 290  
 Susan Warma 314A  
 Susmann Elieser (b. 1665) 290  
 Zirlah (Lena) Einstein 290, 291

**SULZER**  
 Helen Rose 220

**SUMMERALL**  
 Charles P., Jr. 200  
 Charles Pelot 200  
 Laura Mordecai 200

**SUNBY**  
 Nina 334A

**SUNDBERG**  
 Greta 72

**SUNDHEIM**  
 Florence Selig 283  
 Hermine 283  
 Leon 283

**SUNSTEIN**  
 Leon 72  
 Selma Gerstley Fleisher 72

**SUPERA**  
 Mary 11

**SUSSMAN**  
 Beryl Martin 18  
 Leo 18  
 Peggy 18  
 Ray Grace Benjamin 18  
 Richard 18

**SUTHERLAND**  
 Jennie 207

**SUTRO**

Dorothy Helena (1896-1936) 331B  
 Leopold 331B

**SUTTON**  
 Ann Demaris 265  
 Cleve Simpson 265  
 David Aubrey 265  
 Diane Faye (1957-) 325A  
 Edith Louise 265  
 Gail Joan (1952-) 325A  
 Helen Cecilia Hecht 325A  
 John William 265  
 Joseph Aubrey 265  
 Josephine 93  
 Leonard 325A  
 Marla Carol (1955-) 325A  
 Victoria Fauth 265  
 Victoria Seimas Fauth Searl 265

**SWARTZ**  
 Amanda Rose 292  
 Aurelia (b. 1850) 292  
 Caroline Stix 285, 292  
 Charles Louis (b. 1859) 292  
 Elizabeth Lash 292  
 Elsa (b. 1886) 292  
 Emanuel (b. 1852) 292  
 Emma Weil 292  
 Eugene W. (b. 1893) 292  
 Florence Eiseman 292  
 Frederick B. (b. 1903) 292  
 Harry Louis (b. 1863) 292  
 John (b. 1912) 292  
 Joseph Louis (b. 1818) 285, 292  
 Louis Charles (1885-1918) 292  
 Louis Friedman (b. 1892) 292  
 Louis Joseph (b. 1881) 292  
 Louise Friedman (dau. of Isaac) 187  
 Margaret Drey 292  
 Millie (b. 1861) 292  
 Settie (b. 1860) 292  
 Solomon Louis (b. 1866) 292  
 Sophie (1854-1903) 292

**SWAYTHLING**  
 Lord 332A

**SWENEY**  
 Linda Lilly 215

**SWINNEY**  
 Lyda 307  
 Nevin 215  
 Shamus 215  
 Shannon Margaret 215  
 Susan 215

**SWIFT**  
 Eliphalet (d. 1815) 140  
 Esther Judah Jessup 140  
 Harriett C. 140  
 Josephine R. 156  
 Katherine F. 105

**SWITCH**  
 Bertha 52, 53

**SWITZER**  
 Alice 156  
 Dana Niles 29  
 Douglas 29  
 Emily Cone Pollitz 91  
 Emily Guggenheimer Pollitz 91  
 Frances Anna Demoux 29  
 Kathleen 29  
 Louis 91  
 Michael Douglas 29

**SWOPE**  
 Horace 187  
 Jennie Marks 187  
 Mier 187

**SYCLE**  
 Junius (m. Virginia Levy) 162  
 Junius (son of Junius) 162  
 Virginia Levy 162

**SYKES**  
 Edward 101  
 Miriam Hart 101

**SYLVERA**  
 Rachel 114

**SYLVESTRE**  
 Alexander 276

Angelique 276  
 Henry 276  
 J. Baptiste 276  
 Louis 276  
 Mary 276  
 Rose 276  
 Rosette Solomons 276  
 Sophia 276

**SYMINGTON**  
 Jack 158

**SYMMEERS**  
 Marina Baruch 17

**SYMMONS**  
 Catherine 127  
 Jacob 127  
 Jane 127, 326A  
 Rosa 303

**SYMONS**  
 See also Simmonds  
 Mathilda 249

**SZAKACS**  
 Carla Lynn Rhodes 237  
 Christine Marie 237  
 John Fitzgerald 237  
 John Theodore 237

**SZOLD**  
 Betty 5  
 Joan 5  
 Miriam 5  
 Robert 5  
 Ruth 5  
 Zipporah Falk 5

**TABAR**  
 Esperanca 13

**TABOADA**  
 Hannah Lopez (Da Fonseca) 178  
 Moses 178

**TAFT**  
 Harriet 205  
 Mary Moses Bower 205  
 William 205  
 William Nelson 205

**TAGGERT**  
 Eliza 128

**TAKAHISA**  
 Hideko 208

**TAKEUCHI**  
 Saeichi 2  
 Shoji 2  
 Tsungi 2  
 Yoshi 2

**TALBERT**  
 Fred 253  
 Natalie Guggenbeim 253

**TALLEY**  
 Anne Hays Myers 217  
 Audrey (1920-) 330A  
 Daniel 217  
 Daniel D., Jr. 217  
 Daniel Doak III 217  
 Edmund Myers 217  
 Kate Harris 29  
 Lilburn Trigg 217

**TALON (FRATTALONE)**  
 Jane Prentice 238  
 Mark 238

**TANNENWALD**  
 Alan (1983-) 320B  
 Carol Baum 320B  
 David (1985-) 320B  
 Jonathan (1983-) 320B  
 Leslie K. 320B  
 Myra Barnet 15  
 Peter (b. 1943) 15, 320B  
 Robert (1947-) 320B  
 Selma Ruth Peterfreund 15, 320B  
 Theodore 15  
 Theodore, Jr. (b. 1916) 15, 320B

**TANNER**  
 Deborah Ethel (1942-) 330A

**TANOPSKY**  
 Barbara L. Kayton 255, 310B  
 Joan (b. 1963) 255, 310B

Marian (b. 1965) 255, 310B  
 Robert (b. 1930) 255, 310B  
 Susan (b. 1966) 255, 310B

**TANSEY**  
 Jeanette Marie Stern 339B  
 John Llewellyn 339B

**TARAZA**  
 Irene 253

**TARSHISH**  
 Alan 299  
 Rowena Wilson Tobias 299

**TASCH**  
 Adeline Schiffer 215  
 William 215

**TASSUE**  
 Fanny Wolf 303

**TATE**  
 Ellen 261

**TATHEM**  
 Emily 118

**TAUBER**  
 June 291

**TAUSON**  
 Mascha 228

**TAVARES**  
 Esther 152

**TAVERIN**  
 Barbara Elsie Jacobs 285  
 John 285

**TAYLOR**  
 Ada Moss Ransohoff 215  
 Alice Marshall 133  
 Archibald (b. 1801) 68  
 Catherine (1795-1798) 68  
 Charles 133  
 Clarence 133  
 Dorothy 215  
 Edward (son of Emil) 215  
 Edward 81  
 Eliza 133  
 Elizabeth Anne (d. 1882) 155  
 Emma 215  
 Esther (m. David Judah) 140  
 Esther (1797-1798) 68  
 Ethel 35  
 Erting (b. 1803) 68  
 Fannie 133  
 Fanny Etting (1766-1828) 68  
 Fanny Yates Cohen 35  
 Frank (m. Georgina E. B. Hart) 97  
 Frank (son of William) 133  
 Georges 2  
 Georgina E. B. Hart 97  
 Helen Hart 52  
 Henry 35  
 Hetty 133  
 Ionic (b. 1793) 68  
 Isabel 133  
 Isabel De Leon Jacobs 133  
 Isabel De Leon Williams 133  
 Isabella F. 269  
 James Marshall 133  
 John 2  
 John C. (m. 1895) 218  
 Josephine D. 158  
 Laura H. 201  
 Lincoln 215  
 Louisa Myers 218  
 Margaret Clark (b. 1908) 198  
 Marie Abraham 2  
 Marjorie 11  
 Mary (1893-1958) 335B  
 Mary Frances 4  
 Maud 81  
 Miriam Nones Jacobs 133  
 Muriel Charlotte Johnson 81  
 Octavus 35  
 Peter 2  
 Robert (1767-1803) 68  
 Robert B. (b. 1799) 68  
 William Jacquelin 133  
 William Wallace 87  
 Wirt 133

**TEIM**  
 See Tim

**TEISER**  
 Dora 174  
 Gustav 174  
 Hannah Lichtenstein 174  
 Mary (Mamie) Morris 174  
 William 174

**TELLER**  
 Adeline Hackenburg (1865-1932) 92  
 Alice Hannah (1854-1934) 71, 92  
 David (1824-1905) 92  
 Estelle Elaine Simon 92  
 Fanny Espen (1896-1941) 92  
 Frank (1856-1924) 92  
 Frank Long (b. 1896) 92  
 Frieda Mary 311A  
 Getta Long 92  
 Helen 116  
 Helen Rowe 92  
 Ida (b. 1898) 92  
 Ida Marie (1853-1897) 71, 92  
 Jean Long (b. 1927) 92  
 Jerome Long (b. 1890) 92  
 Julia Espen 92  
 Julius Lazarus (1863-1929) 92  
 Laura Spielberger 92  
 Louis Allen (1858-1921) 92  
 Nancy Moody 71  
 Oscar Bower (b. 1916) 92  
 Oscar Bower (1860-1919) 92  
 Rebecca Allen Hackenburg 92  
 Regina Adelaide Weinburgh 92  
 Solomon (1870-1912) 92  
 William Hackenburg (1867-1895) 92

**TELTON**  
 E. S. 140  
 Florence Judah 140

**TEMPLETON**  
 Isabel Sturgiss 87

**TENNER**  
 Alma J. 266

**TERRY**  
 Elizabeth 144

**TESCHNER**  
 Rosebud L. (b. 1903) 275

**TESSLER**  
 Marcia 208

**TEVIS**  
 Blanche Florance 74  
 Carol 74  
 Flora 74

**TEWELES**  
 Martha 182

**TEXEIRA**  
 Myer Hart (see Hart, Myer)

**TEXEIRA DE MATTOS**  
 Samuel 255, 338B  
 Susannah Salvador 258, 338B

**THACKERAY**  
 Rowland 12

**THALER**  
 Shirley 240, 337B

**THALHEIMER**  
 Albert 283  
 Beatrice 283  
 Byron 283  
 Carol Conner 283  
 Clarence 283  
 Eleanor J. Cohen 283  
 Florence Weiss 283  
 Jack A. 283  
 Judy 283  
 Susy 283  
 Tillie Stern 283

**THALL**  
 Janet 257

**THALMAN**  
 Cora 230  
 Ella Cornelia Nathans 230  
 Simon 230

**THARLES**  
 Lillian Forrester 269, 270

Lilly 269

**THARP**  
 Linda Leigh 163  
 Louise Carey 163  
 Page Hale (b. 1911) 163  
 Page Hale (b. 1947) 163

**THATCHER**  
 Mary Elizabeth 36

**THAYER**  
 Anna A. 336A  
 Shelby 118

**THAYLER**  
 (see Thaler)

**THEBAULT**  
 C. H., Jr. 257  
 Freda Dorfer 257

**THESS**  
 Jane L. 267

**THEOBALD**  
 Marguerite 156

**THEODORA**  
 Rosalie 102

**THEXTON**  
 Elspeth 253

**THIBAUT**  
 Fanny 276

**THIBODOUX**  
 Julie 199

**THOENI**  
 Herman B. III, (1932-) 322B  
 Herman Bruce Jr. (1905-1959) 322B  
 Janice Marie (1935-) 322B  
 Nadine Cecilia Davega 322B  
 Shirley Ann Egerer 322B

**THOM**  
 Frances Maria Myers 216  
 Marjorie Adele 60  
 Sarah Polack 60  
 William 60  
 William Alexander III (1893-1911) 216  
 William Alexander, Jr. (1853-1894) 216

**THOMAE**  
 Charles W. 157  
 Mary A. Craven 157

**THOMAS**  
 Cruger 88  
 Edward S. 75  
 Emily O'Beirne 79  
 Francis Henry 79  
 Georgie Ruth 70  
 Hanson 88  
 Hermine Cary Johnstone 88  
 John Hanson 88  
 Judith Cary 88  
 Katherine 291  
 Mary 39  
 Pat 270  
 Rosina 248  
 Susan Oliver Brooks 75  
 Virginia Sheftall 270

**THOMPSON**  
 Caroline Matilda 119  
 Drury 151  
 E. J. 94  
 Elizabeth 287  
 Elizabeth Ridgely Hunt 155  
 George Washington 155  
 Hope Palmer 158  
 James Steel 154  
 John Ireland 158  
 Lucie J. Hart 96  
 Margaret Mary 154  
 Marion 88  
 Martha Lampley 154  
 Mary 103  
 Mary Catherine Lazarus 151  
 May Margaret 217  
 S. Allen 96

**THOMSON**  
 Adeline Hyneman Hirsch 123  
 William G. 123

**THORMAN**

Abraham 293  
 Bertine (Birdie) 293  
 Clara Aron 293  
 Dudley 293  
 Elizabeth (Lizzie) 293, 294  
 Fanny (b. 1846) 293  
 Frank 293  
 Hanna Marx 293  
 Harold (b. 1893) 293  
 Helen 293  
 Henry 160  
 Jesse 293  
 Judy 293  
 Laura 293  
 Lizzie (see Thorman, Elizabeth (Lizzie))  
 Lloyd 293  
 Lydia 293  
 Mary Amico 293  
 Myer 293  
 Philip, Jr. 293  
 Rebecca 293  
 Regina Klein 293  
 Rose 293  
 Rose Ellison 160  
 Samuel 293  
 Selma Einrich 293  
 Simon 293  
 Simpson 293  
 Sophia S. Schuster 293  
 Stanley 293  
 Yalah 293

**THORN**  
 Betty Lou Vogel 295  
 Gretchen 295  
 Karen Lee 295  
 Lyle Andrea 295  
 Robert 295  
 Robert, Jr. 295

**THORNDIKE**  
 Isabel 295

**THORNE**  
 Elizabeth Hardwick 208

**THORNWALL**  
 Carleton D. 71  
 Joan Bernstein Glickman 71

**THRELKELD**  
 Nancy Ann 311B

**THROCKMORTON**  
 Catherine 93  
 Clement 93  
 Emma Wilmore 93  
 George 67

**THURNAUER**  
 Pauline (Lena) (1826-1865) 285, 286

**TIBBETT**  
 Elianor 230

**TICE**  
 Edith Eugenia 309B

**TIPPANY**  
 Beatrice 156

**TILLEY**  
 Aline Hart Dowd 310A  
 Stephen 310A

**TILLMAN**  
 Cassius L. 119  
 Ericka 119  
 Mamie Hyams 119  
 Mordecai Hyams 119

**TILMAN**  
 Charles E. 36

**TIM**  
 Adeline 295  
 Agnes Gordon 295  
 Albert (1872-1880) 296  
 Alfred 295  
 Bernard 296  
 Bernard Louis (1869-1935) 296  
 Bernhardt Louis (1813-1872) 295  
 Bertha Kohn 295  
 Caroline 295  
 Carolyn 295  
 Carrie 295

Clarence 296  
 David 295  
 Edna Rice 295  
 Esther (Hester) 295, 340A  
 Esther (1835-1887) 295  
 Evelyn Wildenstein 295  
 Fannie 296  
 Fannie Markstein 295  
 Fanny Kiam (b. 1878) 296  
 Florence 296  
 Henrietta 295  
 Henry 295  
 Hester (see Tim, Esther (Hester))  
 Jennie (Jane) 295  
 Jesse Gertrude Levy 295  
 Julia 295  
 Louis (son of Bernhardt) 295, 296  
 Louis Bernard 295  
 Louis De Jonge 296  
 Martin 295  
 Mary 295  
 Mildred 295  
 Rachel 295  
 Sarah 295  
 Solomon 295  
 Stella De Jonge Hestlein 296  
 Sylvia 296  
 Teenie Cutler 296

**TIPPEIT**  
 Janet Seansongood 306  
 Jon 306  
 Martha 306  
 Stanley T. 306

**TISCHLER**  
 Esther 174

**TISHMAN**  
 Lola 124

**TOBIAS**  
 Abraham (1793-1856) 176, 298  
 Abraham (1857-1860) 298  
 Abraham (1862-1931) 299  
 Adelaide Justina Hendricks 111, 298  
 Alfred (b. 1877) 297  
 Alice Da Costa 297  
 Amelia Bamed (1825-1906) 150, 297  
 Arthur Stanley (1897-1951) 299  
 Arthur Washington (b. 1852) 298  
 Ashley Cowen (1855-1919) 298, 299  
 Ashley Cowen III (b. 1915) 299  
 Ashley Cowen, Jr. (b. 1886) 299  
 Augusta (dau. of Henry Ashbur) 297, 314A  
 Augusta (dau. of Meyer) 297  
 Augustus Tobias 297  
 Augustus Levy (1825-1879) 298  
 Augustus S. (1815-1884) 297  
 Blume 295  
 Catherine A. T. 297, 314A  
 Charles (son of Meyer) 297  
 Charles (1810-1855) 297  
 Charles (1860-1913) 298  
 Charles Reynolds (b. 1859) 298  
 Colleton Harby (1831-1862) 298  
 David De Oliveira (1804-1874) 256, 298  
 David Henry (1860-1907) 299  
 David Henry, Jr. (b. 1895) 299  
 David Lopez (b. 1938) 299  
 Edith Rosalie (1848-1932) 171, 297  
 Edith Winona (b. 1893) 299  
 Edwin Creighton (b. 1932) 299  
 Edwin James 299  
 Eleanor (b. 1857) 299  
 Eleanor (1859-1941) 298  
 Eleanor Elizabeth (b. 1919) 299  
 Eleanor Lopez 176, 298  
 Elise (1885-1962) 297, 314A  
 Eliza (d. 1847) 297  
 Eliza (dau. of Meyer) 297  
 Eliza Hart 297  
 Elizabeth (m. Arthur Stanley) 299  
 Elizabeth (1867-1894) 298  
 Ella Theresa (1889-1919) 299

Ella Theresa O'Neill 299  
 Ellen (b. 1844) 297  
 Emilie Agens Commins 299  
 Emily (1828-1914) 194, 198  
 Emily (1839-1870) 297  
 Emily (1863-1947) 298  
 Eric Wilkes 299  
 Esther 229, 298  
 Ethel 297, 314A  
 Ethel G. Mimnaugh 299  
 Eva 69  
 Eve Marie 299  
 Fanny (see also Tobias, Frances (Fanny))  
 Fanny (1856-1922) 298  
 Fanny Hermann 295  
 Florence (1873-1960) 297, 314A  
 Florian (1858-1927) 297, 314A  
 Frances (Fanny) (1809-1881) 110, 111, 297, 314A  
 Francis H., Jr. (b. 1890) 297  
 Francis Hendricks (1856-1922) 171, 297, 314A  
 Frederick 297  
 George 297  
 Harriet (1812-1874) 110, 297  
 Harriette Hart 297  
 Henrietta (1841-1860) 297  
 Henry (d. inf.) 314A  
 Henry (1814-1846) 110, 297  
 Henry Ashur 297, 305, 314A  
 Henry Harmon (1849-1910) 297, 314A  
 Hermoine Hendricks 110, 297, 314A  
 Hortense 295  
 Hortense Alexander (b. 1903) 299  
 Hortense Alexander (m. 1900) 9, 299  
 Hortensia (1858-1860) 299  
 Howard (b. 1883) 297  
 Ida Urania (b. 1854) 298  
 Isaac (b. 1818) 297  
 Isaac (1771-1803) 298  
 Isaac (1796-1860) 298  
 (Isaac) Alfred (1823-1873) 110, 297, 314A  
 Isabel (b. 1903) 299  
 Isabel (1855-1925) 299  
 Isabel Rogers 298  
 Isabel Webb 299  
 Isabel (la) Cowen 298  
 Isabella (1857-1938) 298  
 Jacob (1749-1775) 298  
 Jacob (1786-1811) 298  
 Jacob Frederick (b. 1820) 297  
 James 299  
 James Cantwell 299  
 James May (b. 1933) 299  
 Jane Rogers 299  
 Janie E. 299  
 Jean (b. 1927) 297  
 Jeanne Teresa (b. 1901) 299  
 Jessie Morningstar 299  
 Jessie Randolph (b. 1922) 299  
 John L. Mimnaugh (b. 1921) 299  
 John Randolph (1871-1949) 299  
 Joseph (1684-1761) 298  
 Joseph Franklin (1826-1902) 298  
 Joseph II (1745-1786) 298  
 Joseph III (1764-1810) 1, 298  
 Joseph IV 298  
 Joseph Lopez (1825-1893) 203, 298, 299  
 Josephine 298  
 Josephine Luna Lewis 171, 297, 314A  
 Josephine Pope 298  
 Judith (b. 1798) 298  
 Judith (b. 1937) 299, 314A  
 Judith (d. 1816) 298  
 Judith (dau. of Joseph) 298  
 Kathleen (1853-1921) 298  
 Leah (b. 1809) 93, 298  
 Leah (1771-1799) 163, 298  
 Leah Amanda 298  
 Leah D'Oliveira 298

Leila (b. 1861) 298  
 Louis Cohen (1848-1871) 297  
 Louisa (1842-1910) 297  
 Louisa Ellerbe 299  
 Margaret (b. 1927) 299  
 Margaret Ellis 299  
 Margaret McManus 298  
 Marion J. (1835-1836) 298  
 Marjorie Smith 297  
 Mary (b. 1845) 297  
 Mary (see also Tobias, Miriam (Mary))  
 Mary Anna Seniff 298  
 Mary Emilie (b. 1927) 299  
 Mary McCullough 298  
 Masoad (b. 1801) 298  
 Masoad (1740-1798) 298  
 Meyer (or Michael) (d. 1838) 297  
 Meyer (1845-1847) 297  
 Minnie Doubleday (1867-1953) 297, 314  
 Miriam (Mary) (b. 1832) 297  
 Miriam 297  
 Morris (London) 297  
 Moses Cohen Mordecai (1866-1919) 299  
 Neomi Newsome 299  
 Opal S. Wilkes 299  
 Orlando Joseph 298  
 Priscilla Lopez (1823-1902) 216, 298  
 Rachel Aarons 1, 298  
 Rachel Da Costa 298  
 Rachel H. (1837-1881) 298  
 Rachel Russell 256, 298  
 Rachel Wolff 297, 305, 314A  
 Rebecca (b. 1744/5) 69  
 Rebecca 297  
 Rebecca Levy (1785-1878) 297  
 Rinaa (b. 1788) 298  
 Rinaah (b. 1741) 57, 298  
 Rosa Hays (b. 1914) 8, 299  
 Rosa Hays Mordecai 203, 298, 299  
 Rose Weber 298  
 Roselane Hendricks 110, 297  
 Rowena Wilson 299  
 Sallie Alexander (b. 1901) 299  
 Samuel I. (d. 1832) 297  
 Samuel I. (London) 297  
 Samuel I. (1811-1887) 297  
 Sarah Anne (b. 1833) 298  
 Sarah Applegate 297, 314A  
 Seniff (1853-1871) 298  
 Simpson Isaac (1837-1862) 297  
 Solomon (b. 1791) 298  
 Solomon (b. 1824) 297  
 Solomon Mortimer (1829-1833) 297  
 Sophia (dau. of Meyer) 297  
 Sophia (1816-1892) 297  
 Sophia (1825-1884) 297  
 Sophia Louisa (1834-1919) 297  
 Sophia Solomons 297  
 Sophia St. Amand 298  
 Sophie 298  
 Teresa Fisher 299  
 Thaddeus (1824-1853) 298  
 Thomas Jefferson (b. 1899) 299  
 Thomas Jefferson (1830-1878) 111, 298  
 Thomas Jefferson (1868-1937) 9, 299  
 Thomas Jefferson, Jr. (b. 1906) 299  
 Tobias (1785/6-1861) 297  
 Toby Ann 295  
 Ursula Cantwell 299  
 Vernon Wulbern (b. 1896) 299  
 Virginia Judith Nathans 298  
 Virginia Jenkins (1827-1895) 298  
 Washington (1851-1914) 297  
 William E., Jr. (b. 1904) 297  
 William Eldridge (1881-1942) 297, 314A  
 William Randolph (1905-1926) 299

**TOBIASON**  
 Abigail Adolphus (b. 1859) 300  
 Amelia Levine (b. 1858) 300  
 Amelia Levine (m. Isaac Tobiason)

153, 300  
 Anna Cecile (b. 1861) 300  
 Emilie 300  
 Esther (1835-1903) 300  
 Fanny Rowland 254, 300  
 Israel (1797-1865) 153, 300  
 Louis (1829-1904) 254, 300  
 Priscilla Louise (d. 1888) 300  
 Rosita (1825-1871) 300  
 Theodore (1834-1892) 300

**TODD**  
 Dorothy 199  
 Mary 119  
 Robert S. 119

**TODROS**  
 Emanuel 246  
 Lionel 246  
 Madeline Phillips 246  
 Maria 246

**TOLEDANO**  
 Simha 180, 331B  
 Welcome (Bienvenida) Valentine 180, 331B

**TOLSON**  
 Sallie Ardath 238

**TOMKINS**  
 Harriet Frances Hart (b. 1842) 96  
 Mary Cornelia Hays 105  
 Minthorne 105  
 Minthorne L. 96

**TONEY**  
 Edmonia 190

**TOOMER**  
 Marjorie Content 40

**TOPILOW**  
 Helen 239

**TOPKIS**  
 Bernard (-1977) 324A  
 Bertha Ezekiel Kohner 70, 324A

**TORGENSON**  
 Eunice Elvira 266

**TORONTA**  
 'Mme.' (see Brimson, Florence)

**TORRANCE**  
 Isabella Chisholm 65

**TORRAS**  
 Lula 168

**TOR (R) ES**  
 Rebecca 305

**TORRES**  
 See also De Torres  
 Isaac Namias 60  
 Ribca (Rebecca) 58  
 Sarrah de Isaac Namias 60

**TOURNE**  
 Esther Jackson 119  
 James Binaighi 119  
 Joseph Etienne 119

**TOURO**  
 Abraham (Holland) 300  
 Abraham (1777/8-1822) 300  
 Isaac (1738-1783) 104, 300  
 Jeosuah de Samuel 178  
 Jochebet Lopez Da Fonseca 178  
 Judah (1775-1854) 300, 340B  
 Leah de Jeosuah 178  
 Nathan (b. 1781) 300  
 Rebecca Hays (1779-1833) 175, 300  
 Reyna (Malcha) Hays 104, 300

**TOUSSAINT**  
 Gerard (1941-) 326A  
 Jane Louis Isaacs Doyle 326A

**TOWNSEND**  
 Anne Bullitt 118  
 Beatrice Francis May Nicholas 157  
 Caspar 118  
 Edward N. 157  
 Edward Nicholl, Jr. 157  
 Eleanore T. Victor 157  
 Elizabeth Benziger 157  
 Kilian Van Renssalaer 157  
 Robert Carter Nicholas 157

**TOWNSHEND**

Sarah Lopez Rivera 331B  
 William Lumsden Smith 331B

**TRAGER**  
 Eva Jacobs 134  
 Louis 134

**TRAHAN**  
 Marie Celeste 16

**TRANUM**  
 Carol King 173  
 Honor Spingarn 173  
 Joel Arthur 173  
 Mark Spingarn 173

**TRASK**  
 Harriet Judah 140  
 James 140

**TREAT**  
 Edith A. 80

**TREISMAN**  
 Dorothy C. Cullman 285  
 Jeffrey 285  
 Joel Harold 285  
 Norman 285

**TREMAINE**  
 Lyman F. 39  
 Nell Ford Russell 39  
 Russell F. 39

**TRENCHARD**  
 Audrey Marie Moise 196  
 Thomas L., Jr. 196  
 Thomas Lee 196

**TREPAGNIER**  
 Catherine Harris 94  
 Dalton 94  
 Edgar 94  
 Eva 94

**TREZVANT**  
 Lucy 205

**TRICOU**  
 Eugenie De Buys 116

**TRIST**  
 Fanny 84

**TRIGG**  
 Frances (Fannie) Colquhoun 217

**TRILLING**  
 Beatrice Sulzberger 291, 313B  
 Beth 313B  
 Fay Goldberger 313B  
 John L. 313B  
 Leonard 291, 313B  
 Michael L. 313B  
 Richard J. 313B

**TRIMBLE**  
 Almada Clark 25  
 David 156  
 Frances H. Smith 156  
 I. Ridgeway 156  
 Isaac Ridgeway (b. 1860) 156  
 Margaret E. Jones 156  
 Miriam (1839-1882) 244  
 Sally Scott Lloyd 156

**TRUPIER**  
 Marie Dominique 79

**TROCOONS**  
 Ana T. 336A

**TRONDALE**  
 Irene (b. 1889) 257

**TROPPE**  
 Caroline Lorie 215  
 Frederick 215  
 Kathryn Moss Jacoby 215  
 Peter 215

**TROTTER**  
 Doris M. 141

**TROUNSTINE**  
 Amy May Josephs 21  
 Henry 21  
 Jean (b. 1947) 21  
 John 47  
 Peggy 21  
 Philip (b. 1949) 21

**TROUSDALE**  
 Burdette 180  
 Gordon 180

Henry 180  
James Monroe 180  
Jim Gray 180  
Mamie 180  
Rebecca Isabel Willis 180  
Thornton 180  
**TROWBRIDGE**  
Marjorie A. 157  
**TROWEL**  
Elizabeth 206  
**TROY**  
Fannie (b. 8142) 286  
**TRUSLOVE**  
Marion 81  
**TRUSSEL**  
Howard 328A  
James Alan (1945-) 328A  
Joan Patricia (1948-) 328A  
Marjorie Livingston 328A  
Stephen Edward (1942-) 328A  
**TSCHUMY**  
Bertha Virginia Seixas 266  
L. P. 266  
**TUBBERSING**  
John Henry 313A  
Mary Selina Russell 313A  
**TUCHNER**  
Hannah (1810-1903) 71  
**TUCKER**  
Angelina (Lena) 191  
Carl 314A  
Diane E. Straus 314A  
Elise 191  
Elizabeth Braxton Williams 28  
George Holbert 28  
Hallie Lucille Nordhaus 119  
Harriet Maria Johnson 81  
Henry Tod 81  
Henry Tudor (b. 1866) 81  
James 295  
L. O. 119  
Lena (see Tucker, Angelina (Lena))  
Mary Tim 295  
Olivia 81  
Rebecca 4  
Robert 191  
Sarah Ann 75  
Stella Mendes 191  
**TUCKNER**  
Yetta 296  
**TUDOR**  
Alexander Ethan 96  
Eleanor 96  
Elizabeth 96  
Helena Beatrix 96  
**TUDOR-HART**  
Anne Hallowell Richards (Nancy) 96  
Catherine Rhodes 96  
Ernest Percival 96  
Julie Aimee Delia Eleanor Kleykowska  
(Nellie) 96  
Nancy Richards (see Tudor-Hart, Anne  
Hallowell Richards (Nancy))  
Nellie (see Tudor-Hart, Julie Aimee  
Delia Eleanore Kleykowska (Nellie))  
**TUFTON**  
Charles Henry 246  
Stella Josephine Faudel Phillips 246  
**TUHOLSKIE**  
Edward J. 8  
Joan Magnus 8  
**TUNIS**  
Arthur 265  
Camilla Seixas 265  
William E. 265  
**TUNSTALL**  
Lenora 25  
Sarah 25  
**TUNZE**  
Justine Anna 195  
**TUPPER**  
Marie Moses 209  
Paul 209

**TURETSKY**  
John 335A  
Laurel Blossom Sonneborn (1986-)  
335A  
Wendy Golda Sonneborn 335A  
**TURK**  
Diana Umstadter 301, 340B  
Emily 301, 340B  
Margaret Lane 200  
Mary Willis Mordecai 200  
Morris 301, 340B  
Rudolph 200  
William 200  
**TURNER**  
Abbie St. Anne 206  
Abbie St. Anne Bryan 206  
Eliza 76  
Frances 23, 309A  
Harold 81  
Lucius P. 206  
Lucius P., Jr. 206  
Margaret Louise Johnson Shaw 81  
Mary Ella 270  
Minnie Noah 232  
Richard 232  
**TUTEUR**  
John 307  
John, Jr. 307  
Marion Holman Kahn 307  
Mary 307  
**TUTHILL**  
Anna 201  
**TUTTLE**  
Mildred Hammond Hays 105  
Sidney 105  
**TWIGGS**  
Marion 216  
**TWILLEY**  
Melissa Lynne 53  
Robert Julian 53  
Teresa Lynne De Cordova 53  
**TWYFORD**  
Helen 115  
**TYLER**  
Irene 128  
**TYO**  
Ceceilia Marie Russell Meyer 313A  
Gordon Edward 313A  
**TYRE**  
Margaret Joy Cayton 327B  
Norman 327B  
Susan (1940-) 327B  
**UDELL**  
Charles 222  
Helen Edel 222  
James 222  
Louis 222  
**UPFENHEIMER**  
Cornelia Isaacs Bach 125  
Sigmund 125  
**ULLMAN**  
Caroline Spatz 185  
Clarence I. (b. 1875) 185  
Eleanora 189  
Emma Mayer 189  
Henry G. 189  
Jacob (1838-1903) 185  
Ruth Weizenkorn 236  
Samuel 189  
Stella 301  
**ULMAN**  
Alice M. Morrison 204  
Barbara 90  
Barry 90  
Clarissa 13  
Eleanor 90  
Ella Guggenheimer 90  
Ellen 149  
Joseph N. 90  
Joseph N., Jr. 90  
Katherine Van Rensselaer 304  
Marjorie Weil 90  
Morris Solomon 204

Morrison 204  
**ULRICH**  
James 313A  
James, Jr. 313A  
Scott 313A  
Sharon Connelly Hanff 313A  
Trey 313A  
**UMSTADTER**  
Bertha 301  
Betty 301  
Diana 301, 340B  
Esther Cohen (m. 1872) 34, 301  
Fanny (Frumet) Sarlouis 301, 340B  
Henrietta 301  
Jacob (b. 1805) 301, 340B  
Jacob (b. 1874, Norfolk) 301  
Michael (b. 1863) 301  
Michael (1843-1922) 34, 301, 340B  
Miriam (b. 1873) 301  
**UNGER**  
Anna Maria Kessler 324B  
Anne Caroline, (1843-1905) 324B  
Clara Agusta (1854-1936) 324B  
Edmund (1841-) 324B  
Eva Bamberger 14  
Frank 253  
Hettie Hart 103, 324B  
Isaac 14  
Isadore Emilie 103, 324B  
Leopold Paul 103, 324B  
Lewis Raphael (1845-1917) 324B  
Marron Bertha Price Guggenheim 253  
**UNTERBERG**  
Mabel 226  
**UNTERMEYER**  
Sophie Guggenheimer 89  
**UPSHUR**  
Gertrude 155  
**UROUHART**  
Elizabeth 79  
**URSCHER**  
Mary Elizabeth 199  
**URY**  
Hortense 138  
**USHER**  
Francis Carolyn Woods 313A  
**UTZ**  
Marlene 310A  
**VAIL**  
Helen 97  
**VAILL**  
Heth 102  
**VALE**  
Violet 22  
**VALENCIA**  
Abigail 263  
**VALENTINE**  
Benvenida de Isaac Henriques (d.  
1815) 273, 274  
Daniel Henriques 180, 331B  
David Henriques (1758-1837) 300  
Deborah Luria 180, 331B  
Elias 300  
Elizabeth Jewel (or Jubel) 300  
Emanuel (1826-1880) 184  
Esther 180, 331B  
Fanny Mairs 184  
George 184  
Harry Stewart 324B  
Isaac 300  
Isaac D. (1787-1842) 106, 300  
Isaac D. (1833-1862) 184  
Isaac Henriques 273, 274  
Isaac M. 184  
Isadore C., Kline 324B  
Israel (1824-1850) 184  
Jacob (1829-1891) 184  
James Alden 128  
Joshua de Isaac Henriques 273  
Kitty (1788-1849) 300  
Louise 184  
Miriam 184  
N. Hertz (1833-1873) 184

N. Levin (b. 1872) 184  
Phoebe Hays 106, 300  
Rachel Solis 273  
Rebecca (d. 1821) 300  
Rebecca (1653-1740) 170  
Samuel (1794-1868) 184  
Semira (1807-1849) 16, 300  
Simon 170  
Welcome (Bienvenida) 180, 331B  
**VALERY**  
Floretta Henry 115  
Julius J. 115  
**VALGUARNERA**  
Margaret Hirsch 172  
**VALQUETE**  
Mary 147  
**VALLENTINE**  
Adele 228  
Julia Rose 228  
Rosa Nathan 228  
**VALVERDE**  
Aaron 302  
Abraham (b. 1699) 302  
Abraham (Barbados, 1654) 302  
Abraham (son of David) 302  
Abraham (son of Jacob) 302  
Abraham Israel Hisquiau 302  
Abraham, Jr. 302  
David Israel (Jr.) 302  
David (son of Abraham) 302  
David (son of Jacob) 302  
Elias (son of David) 302  
Elias (1691-1739) 302  
Elias Raphael 302  
Esther (b. 1703) 302  
Esther (b. 1711) 302  
Esther (1703-1729) 302  
Esther (dau. of Isaac Haim) 302  
Isaac 302  
Isaac Haim 302  
Jacob (Recife, 1649) 302  
Jacob (son of David) 302  
Jacob (son of Isaac) 302  
Jacob (1685-1729) 302  
Jacob Jeosua (Jr.) 302  
Jael (dau. of Elias) 302  
Jael (dau. of Jacob) 302  
Jael (1665-1721) 302  
Jael Hana (1716-1742) 302  
Leah (dau. of Elias) 302  
Leah (dau. of Jacob) 302  
Leah (m. 1736) 302  
Lunah (b. 1707) 302  
Lunah (dau. of Abraham Israel  
Hisquiau) 302  
Moses (son of Abraham) 302  
Moses (son of Jacob) 302  
Rachel (b. 1717) 302  
Rachel (d. age 16) 302  
Rachel (dau. of Abraham Israel  
Hisquiau) 302  
Rachel (dau. of Elias) 302  
Rachel Franco Nunes 302  
Rebecca (d. 1687) 302  
Rebecca (dau. of Elias) 302  
Rebecca (dau. of Jacob) 302  
Rebecca (m. Elias) 302  
Rebecca Navarro 302  
Ribca de Isaac Israel Pereira 302  
Sarah 302  
Simcha de Jacob Franco Nunes 302  
Simha 302  
Simha Franco Nunes 302  
Simha Sarah (1714-1743) 302  
**VAN AMERINGEN**  
Patricia 282  
**VAN ANTWERP**  
Carrie Noah 232  
**VAN BEIL**  
Rebecca Hyneman 123, 325B  
Solomon C. 123, 325B  
**VAN BERGH**  
Amelia Ezekiel 70, 323B

Dinah Sloman 323B  
Harriet 70  
Morris 70, 323B  
Tobias 70  
**VAN BIEL**  
See Van Beil  
**VAN BLITZ**  
See Arons Van Blitz  
**VAN BRUNT**  
Aaron Isaacs (see Isaacs (Van Brunt),  
Aaron)  
Carl 124  
Gatzel Isaac (see Pront, Gatzel Isaac)  
Gladys Strongin 124  
Laurie 124  
Marion Rydholm 124  
Peter 124  
Vincent 124  
**VAN BUREN**  
Ida 232  
Martin E. 88  
Peggy Cole 88  
**VANDERBECK**  
James Wilson 141  
Mary Benedicta Judah 141  
**VANDERBERGH**  
Enid 261  
**VAN DER BEUGEL**  
Betsy 95, 146  
**VAN DER DOES**  
Rachel Hyneman 123  
William 123  
**VAN DER KAMP**  
John Jacob 325B  
Pauline E. 325B  
**VAN DER WILDEN**  
Valentijn Valck (Jerachmeel Falk) 170  
**VAN DEVENTER**  
Dorothy Rebecca Henriques Oxholm  
310A  
Harry R. 206  
Mary Louisa Moses 206  
Philip 310A  
**VANDEVER**  
Caroline 87  
**VAN DORN**  
Frances 128  
**VAN DRUFF**  
Emily Lea 238  
**VAN DUZER**  
Eugenia 124  
**VAN DYK**  
Loek 326A  
**VAN FENE**  
Geetla (Catherine) Waterman 303  
**VAN GIESEN**  
Caroline Ancker 11  
Frank S. 11  
Virginia 11  
**VANHAM**  
Mary Elizabeth 146  
**VAN KLEEF**  
Frances G. Goldstone 116  
Noah 116  
**VAN MEEDEN**  
Anna Maria Coben Leland Hall 32  
Claus 32  
**VAN MINDIN**  
Jean 6  
Myriam 6  
Roger 6  
**VAN NESS**  
Christopher (1954-) 330A  
David Jon 330A  
Erik Pratt (1976-) 330A  
James Haggood (1976-) 330A  
**VAN NIEROP**  
Sarah 242  
**VAN OS**  
Alison 108  
Betty 108  
Ellen 108  
Eloise Lowenberg 108

Helen Wasserman 108  
Henry 108  
Henry III 108  
Henry Schloss 108  
Henry, Jr. 108  
Irvin 108  
Joseph 108  
Joseph Dreyfous 108  
Julie 108  
Julie Hansel 108  
Nancy Duncan 108  
Nellyn 108  
Rosa Schloss 108  
**VAN OSTERN**  
Nancy 146  
**VAN PELT**  
Fleur De Marie Clarke 247  
Howard 247  
Merton 247  
Peter 247  
William 247  
**VAN RAALTE**  
Alex 60  
Catherine 5  
Cecilia (Cissie) Oppenheimer 60  
Kenneth 60  
Peter 60  
**VAN RENSSLAER**  
Eliza Rogers 126  
Katherine 204  
Sarah Rogers 126  
W. P. 126  
**VAN SANT**  
Doris Ruth 125  
**VAN SCHOONHAVEN**  
Mrs. - 304  
**VAN SHARK**  
Anne Valeu Morel 201  
Antony Gerard 201  
**VAN STRATTEN**  
Adelaide 122  
**VAN VECHTEN**  
Estelle Marks 264  
**VAN VEEN**  
Levi (1745-1820) 303  
Yetta (d. 1837) 303  
**VAN WEL**  
Kean 122  
Susan Bletchley 122  
**VAN WYCK**  
Jessica Davis Nahl 49  
Lucy Mitchell Browne 155  
Sydney McMechen 155  
William 49  
**VARNNEY**  
(Elma) Dora 200  
**VASEN**  
Benjamin (1870-1920) 166  
Charlotte Deutsch 166  
**VAUGHAN**  
Matilda 195  
Patricia Stuart Goldsmid 82  
Robert 82  
Sallie 88  
**VAUGHN**  
Matilda Jane 199  
**VAZ**  
Emma Nunez 178  
**VECHTEN**  
See Van Vechten  
**VEILL**  
Isaac 280  
Judith Julia 102, 204, 280  
Judith Soria (d. 1826) 280  
**VELHA**  
Judica (Judith) 298  
**VENDIG**  
Alma 83  
Helen Francis 215  
**VERDEREAU**  
A. 97  
Eudora Jane Hart 97  
**VERNEUILLE**

Angelique Charlotte Jacinthe 135

**VERNON**

Catherine Rose 198

**VERPLANCE**

Jeanette 67

**VEZINA**

Clarisse 141

**VIBBERT**

Eliza D. Fisher 168

Horace R. 168

**VICTOR**

Abraham 320B

Albert 320B

Alice 101

Amelia Arnold 320B

Belle 320B

Carrie 229, 334B

Eleanore T. 157

Hannah Bodenheimer 320B

Isadore 320B

Isadore Arnold 320B

Jeannette 167

Minnie 320B

**VICTORY**

Blanche Florance Cohen 31

**VIEYRA**

Esther 241

**VIGNEAU**

Marie Genevieve (Polty) Jacobs 135

Stanislaus 135

**VILLASMIL**

Angela Nones 336A

Raul 336A

**VINEBERG**

Eva 95

**VINNE**

See De Vinne

**VINTON**

Mary Linn Cooper 157

William Howard 157

**VISIGLIO**

Amy Nathan 13

George R., Jr. 13

Jennifer Anne 13

Linda Ellen 13

**VLIERDEN**

See Von Vlierden

**VOGEL**

Anita Stiver 322A

Ann Virginia 295

Arthur 295

Betty Lou 295

Ellen Fleisher 72

Margaret 322A

Mary Rice 295

Mildred Tim 295

Robert 72

Rudolph 322A

**VOGG**

(Shina) Jane 2

**VOLCANI**

Bea 276

Eleanor Susan ("Toi") Solomons

Jackson 276

Yannon 276

**VOLK**

Isabel E. Elbert 23

Israel E. 23

**VOLPO**

Gail 23

Isabel E. Elbert 23

Israel E. 23

**VON BRIESEN**

Alice Ellen Henry 325B

Arthur 192

Carol 192

Eric 192

Gretchen 192

Laura 192

**VON DER DOES**

Maria 273

**VON GELDREN**

Abigail (1854-1889) 104

**VON HONIG**

Aaron Cappé (d. 1834) 305

Charlotte (d. 1820) 305

Miriam Levy De Fonseca 305

Rachel Cappé (1792-1879) 305

Simion (d. 1829) 305

**VON LUBENSTEIN**

Gebhardt 129

Geppy Jacoby 129

**VON RONKEL**

Betsy 189

**VON STADE**

Frederick W. 139

Frederick, Jr. (1855-1934) 139

Philippine Eudora Richard 139

**VON STEIN**

Joshua 243

Phila 243

**VON STERNBERG**

Jean Jackson 130

John 130

**VON THINGLESTADT**

Carl 148

Clara Levy 148

Florine Levy 148

**VON VLIERDEN**

Miriam Wolff 305

P. 305

**VON WALSLIEBEN**

Edward James 310B

James (b. 1957) 310B

Jessica (b. 1962) 310B

Justin (b. 1959) 310B

Mae Kursheedt 310B

Nancy (b. 1965) 310B

William (b. 1955) 310B

**VORSCHER**

Gustave A. 46

Gwendoline Lillian David 46, 244

Mildred 46

**VOSS**

Arthur 129

Jessica Jackson 129

**WAAG**

See also Waag (E)

Abraham (1719-1803) 85, 302

Amelia (see Waag, Minky (Amelia))

Benedict (see Waag, Moses (Benedict))

David 302

Elkan 302

Ephraim (see Waag, Gumprecht

(Ephraim))

Ether Benjamin 18

Gumprecht (Ephraim) 302

Hart (Herman) 302

Herman (see Waag, Hart (Herman))

Judith (b. 1786) 302

Margoles (1788-1789) 302

Matthias (b. 1788) 302

Meir 92, 302

Minky (Amelia) 302

Mordecai Gomez (b. 1776) 302

Moses (Benedict) 302

Moses (son of P. U. B. Zur Waage)

302

Moses (son of Phaibush) 302

Myer (b. & d. 1773) 302

Myer (b. 1783) 302

Naphtali Hart (b. 1778) 302

Phaibush 302

Philip 18

Rachel Gomez 85, 302

Zipporah (b. 1771) 302

**WAAG (E)**

Zipporah Hart 92, 302

**WAAGE**

Abraham 340B

Brendel 340B

David 340B

Esther (-1609) 340B

Isaak (-1585) 340B

**WACHTEL**

Josephine (1907-) 327A

**WACKER**

Anne 320A

**WADE**

Martha Dee 52

**WADLOW**

Bonnie 269

Carol Annette 269

Dorothy Claire Sheftall Baldwin 269

J. L. 269

**WAGER**

Mary 155

**WAGNER**

Hattie 160

Marguerite 285

**WAHL**

Abigail (b. 1973) 311A

Anthony G. III 311A

Anthony George II 311A

Blume 235

David 235

Heather (b. 1966) 311A

Jane Carol Roddy 159, 311A

Megan (b. 1968) 311A

Saul (1541-1617) 261

**WAHLERT**

Betty Reade 255

William 255

**WAINHOUSE**

David W. 115

Katherine Cohen 115

**WATSMAN**

Diane Faye Sutton 325A

Mark Harris 325A

**WATZFELDER**

Minnie Lewis (1852-1932) 171, 312A

Solomon L. (1844-1914) 171, 312A

**WALCOTT**

Blanche Sophia Finzi Daniels 51

Ernest 51

**WALDMAN**

Elizabeth 107

Elizabeth Lee 107, 325A

Elsie Lee Margolius 107

Margot Lee 107

Marie 47

Ronald B. 107

Sarah 130

**WALDO**

Adelaide Schiffer Price Ehrich 253

Richard Harold 253

**WALDORF**

Bessie Hoffman Palmbaum 339B

Marian Hoffman 283

Milton (-1954) 339B

**WALKER**

Ethel Mary 138

**WALKER**

Aline Mordecai 202

Bess 86

Charles 46

Eliza Lock 46

John Moseley 202

Julia 211

Suzanne 30

**WALL**

See also La Wall

Lizzie 216

Mary Jacob Franks 75

**WALLACE**

Ann Loucheim 72

Annie Lea 268

Bessie Vivian De Cordova 53

Cordelia (b. 1897) 251

Kenneth Franklin 53

Ruth Irene Helton 53

William D. 72

William Earl 53

William Stuart 72

**WALLACK**

Carole (m. 1964) 108

**WALLER**

Allen 108

Caroline 200, 201

Gladys Mae Oberdorfer 108

Richard 108

Robert 108

**WALLERSTEIN**

Eve 149

Irwin (b. 1880) 15

Molly (b. 1913) 15

Rena Aufesser 15

Theresa (d. 1894) 274

**WALLMAN**

Jerald 216

Jonathan Moss (b. 1942) 216

Sybil Moss 216

**WALSH**

Marie Charlotte Evans 41

Mary (d. 1855) 156

Matilda Sarah Hohenfels 118

Robert 118

Rosalie 118

Walter 118

Walter, Jr. 118

**WALTER**

Ethel Andrews 12

John Charles 12

Mildred Julia 199

**WALTERS**

Bessie 101

Catherine Delicia 81

Charles 180

Ellen 180

Ellen Cohen 180

Ethel Andrews 12

Harry 180

Henriette 89

Jennie Picken 180

John 12

Joseph 89

Miriam 89

Percy 180

Rebecca 180

Rose Guggenheimer 89

Sidney Louis 180

Will 180

**WALTON**

Anita De Ribas 265

Anna 11

Colby 322A

Dora Morris 322A

Elizabeth Steel 334B

Holmes Crane 265

John 334B

Kalen 334B

Rachel 81

303  
 Gertrude Wile Nathan 303  
 Herbert 303  
 Ichel 303  
 Isadore Max 303  
 Leiser 303  
 Leon Laizer 293, 294, 303  
 Lucille Miller 255  
 Rebecca Steeg 303  
 Rosa Symmons 303  
 Seward 303  
 William 255  
 William Graupe 303

**WAITTS**  
 Elizabeth 337A  
 Mattie Josephine Kokernot 146

**WAXELBAUM**  
 Charles 83  
 Helene Marks 83  
 Wolf 320A

**WAY**  
 E. A. 120

**WAYBRANDT**  
 Margaret May 176

**WEATHERS**  
 Coral 208

**WEATHERSTON**  
 Judith Ann 332A

**WEAVER**  
 Hannah Jean 32  
 Jesse 117

**WEBB**  
 Caroline 227  
 Isabel 299  
 Jane Elias 95  
 Katherine 146  
 Leonard 95

**WEBBER**  
 Maud Elise Stern 281  
 William 281

**WEBER**  
 Cecilia 325B  
 Ethel 91  
 Evelyn (b. 1949) 111, 325B  
 Florence 49  
 Jonathan (b. 1954) 111, 325B  
 Robert 111, 325B  
 Robin (b. 1950) 111, 325B  
 Rose 298  
 Sally Solis Hendricks 111, 325B

**WEBSTER**  
 Joan 138  
 Winifred 61

**WECHSLER**  
 Clara 22

**WEEDEN**  
 George J., Jr. 65  
 George Judson 65  
 Laura Mittie 65  
 Margaret Emily Emanuel 65

**WEEKS**  
 Edwin J. 215  
 Jowes Edwin (b. 1913) 215  
 Lewis Eugene (b. 1915) 215  
 Margaret R. Moss 215  
 Margaret Roxana (b. 1911) 215

**WECHSELBAUM**  
 Alice (1905-) 327B  
 Carrie Kayton 143, 327B  
 Mildred Wolf 327B  
 William 143, 327B  
 William Jr. (1908-) 327B  
 Wolf (see Wazelbaum, Wolf)

**WEIDENFELD**  
 Gerald 45

**WEIDENFELD (WIDEN)**  
 Morton M. 45  
 Roslyn Louise Davega 45

**WEIDNER**  
 Mabel (1899-) 336B

**WEIGEL**  
 Selma 249

**WEIGERT**

Rebecca Jackson 130

**WEIL**  
 Amy 292  
 Arthur Edward 103  
 Barbara 166  
 Benjamin 43  
 Carol Ann 9  
 Caroline 294  
 Carrie Stix 286  
 Cecile Rich 42  
 Celeste Dorothy (b. 1890) 286  
 Charlotte Alexander 9  
 Clara Esther (d. 1872) 103  
 Dorothy 172  
 Edward Henry (b. 1836) 103, 183  
 Elizabeth Arnold 42  
 Elizabeth H. 134  
 Ella Leyens 43  
 Emma 292  
 Ethel 103  
 Eugene S. (b. 1847) 286  
 Eugene S. (b. 1897) 286  
 Gertrude 103  
 Hannah Elise (b. 1884) 286, 292  
 Helen 90  
 Helene (1878-) 327B  
 Henry Aaron (b. 1887) 286  
 Henry Isaac (1793-1853) 103  
 Herbert 339A  
 Herman (1851-1899) 327B  
 Hermione 9  
 Ina Mae 167  
 Isaac Henry (1823-1890) 103  
 Isabel R. Lyons 103, 183  
 Isabel Rebecca 103  
 Jane 296  
 Josephine Kayton 327B  
 Judith Alexander 9  
 Kate 339A  
 Kenneth Cecil 9  
 Laura Krohn 306  
 Leonel 42  
 Lilly Leyens 43  
 Marcus 43  
 Margaret Lee 42  
 Marjorie 90  
 Mary Lynne 42  
 Matilda 103  
 Matilda Marks 103  
 Max 306  
 Maya 42  
 Patricia 296  
 Peggy Ann Neumark 21  
 Roman Lee 9  
 Roman Lee, Jr. 9  
 Rosa 230  
 Sarah Cecilia 103  
 Stanley L. III 21  
 Stanley Lee, Jr. 21  
 Susie Solomon 273  
 Sylvia Irma Loeb 339A  
 Zoe Boyer 286

**WEILER**  
 Ellen Ulman 149  
 Esther Liebenstein Laib 149  
 Herman 149  
 Julia 149  
 Simon 149

**WEILL**  
 Elsie F. 107

**WEILLER**  
 Beverly Brown 27  
 Bruce 27  
 Claire Carvalho 30  
 Douglas 27  
 Edwin A. 27  
 Edwin A. III 27  
 Edwin A., Jr. 27  
 Herbert A. 30  
 Jeffrey 27  
 Kathryn Brickner 27  
 Peter J. 27  
 Priscilla Pringle 27

Wendy 27

**WEIMAN**  
 Leslie 118  
 Miriam Hohenfels 118  
 Samuel 118  
 Selma 118

**WEINBERG**  
 Agnes Doris Moses 208  
 Albert 208  
 Anita 208  
 Anita Lazaron Ryttenberg 61  
 Avrom Michael 125  
 Barbara (dau. of J. Albert) 208  
 Barbara (m. Charles Jonathan) 307  
 Carolyn 208  
 Carroll 208  
 Doris Guhring 208  
 Dudley 125  
 Flora Moses 208  
 Harold Phelps 208  
 Jack Albert 208  
 Jack Albert, Jr. 208  
 Jean Beason 208  
 Jonathan David 125  
 Joyce Thais Johnson 108  
 Marian June Myers 125  
 Mary Jane Westheimer 208  
 Mary Miles Bloodworth 208  
 Mortimer M. III 208  
 Mortimer M. Jr. 208  
 Mortimer Meyer 208  
 Myra Ruth 125  
 Nancy 21  
 Perry M., Jr. 208  
 Perry Moses 208  
 Rosalie 208  
 Stevan George 208  
 Susan 208  
 Wendy Lou 208

**WEINBERGER**  
 Dorothy 282, 339B

**WEINBERLY**  
 Peggy 15

**WEINBURGH**  
 Regina Adelaide 92

**WEINER**  
 Allan 185  
 Barbara 311B  
 Charles 260  
 Ellen Elise Friedman 71  
 Gertrude Spatz 185  
 Hilda Beatrice Samuel 260  
 Isabel 12  
 Jack 71  
 Michael Samuel 71  
 Miriam (1876-1902) 185  
 Ruth (1942-) 327B  
 Sarah Jones 137  
 Sina 137  
 Solomon 137  
 Thomas 71  
 William Thomas 71

**WEINGES**  
 Conrad Mathew 196  
 Sarah Elizabeth Moise 196

**WEINREICH**  
 Bertha (1853-1890) 40

**WEINSTEIN**  
 Gussie 238

**WEINSTOCK**  
 Irma 130  
 Linda Frank 22

**WEIS**  
 Carrie (Caroline) Mayer 189  
 Julius 189

**WEISBAUM**  
 Joyce Ann Saffer 40  
 Laurence Reid 40  
 Robert S. 40

**WEISBEIN**  
 David 117  
 Rebecca C. Hertz 36, 117

**WEISBERG**

Barbara M. (b. 1946) 252  
 Joan P. (b. 1942) 252  
 Miriam Polock Rosenbach 252  
 Solomon 252

**WEISBERGER**  
 Carolyn 71  
 Patricia Bernstein 71  
 Richard William 71

**WEISEN**  
 See Wiesen

**WEISER**  
 George 270  
 Ruth Helene Muriel Sheftall 270

**WEISKOPF**  
 Anna 181

**WEISMAN**  
 Bertha 237  
 D. Donald 288  
 Donald Stix 288  
 James Stix 288  
 Susan Hilda Stix 288

**WEISS**  
 Aline Pollitzer 285  
 Amy 288  
 Barbara 285  
 Carol Therese (b. 1895) 285  
 Caroline (b. 1920) 285  
 Caroline (Carrie) Stix 288  
 Catherine 285  
 Daisy (see Weiss, Dorothy (Daisy))  
 Daniel 288  
 David 288  
 Deirdre 288  
 Dorothy (Daisy) 237  
 Elizabeth (b. 1920) 285  
 Ellen 288  
 Evangeline Black 288  
 Florence 283  
 Geoffrey 288  
 Hope 45, 322B  
 Jennifer 288  
 Joan 288  
 Joan Earle Flowers 86  
 John 86  
 John K., Jr. (Kim) 288  
 John Kimball 288  
 Karen 288  
 Katherine 288  
 Kathryn B. 21  
 Kim (see Weiss, John K., Jr. (Kim))  
 Louis 285  
 Louis Stix (b. 1894) 285  
 Louise Stieglitz 288  
 Martin 83  
 Mary Ellen 288  
 Nina Henrietta (b. 1889) 285  
 Peter 288  
 Phyllis Warner 288  
 Ray Levi 285  
 Robin 288  
 Samuel 288  
 Samuel W. 285  
 Samuel William (b. 1918) 285  
 Theresa Steinhardt 83  
 Vita Ortman 288  
 William 288  
 William Politzer 288  
 William Stix (b. 1888) 285

**WEISSMAN**  
 Berta 237  
 Hugh Stix 288

**WEITZFELDER**  
 Minnie Lewis 171  
 Solomon 171

**WELLFORD**  
 Alexander 217  
 Beverley Randolph 217  
 Edmund (b. 1914) 217  
 Frances Colquhoun Myers 217  
 James McDonald 217  
 Margaret Carter 217  
 May Margaret Thompson 217

McDonald (b. 1913) 217  
 McDonald, Jr. 217

**WELLING**  
 Ruth 307

**WELLINGTON**  
 Colette Audrey Gratz 88  
 William Stanwood 88

**WELLS**  
 Anne Elizabeth Jonas 136  
 Edna 119  
 Eric 61  
 H. P. 266  
 Hilda Pinto 61  
 Ida 336B  
 J. B. II 148  
 Juanita Lillian Seixas 266  
 Lulu 95  
 Miriam Labatt 148  
 T. B. 136

**WELSCH**  
 Barbara Shoyer 271  
 Gottfried 271  
 Louise 271

**WELT**  
 Blanche 166  
 Eleanor 166  
 Eleanor Levy 166  
 Harry E. 166  
 Isaac 166  
 Josephine 101

**WELTE**  
 Alan 310A  
 Carlota Henriques 310A

**WELTMAN**  
 Chapman (1871-1932) 273  
 Hyams (1867-1905) 273  
 James (1825-1875) 273  
 Leah Solomon 273  
 Louis (b. 1875) 273  
 Nellie (b. 1865) 273  
 Phoebe (b. 1873) 273  
 Sallie (b. 1869) 273

**WENER**  
 Jean 191

**WENMAN**  
 Esther Sarah Emanuel 66  
 J. C. 66  
 Jack 66

**WENBER**  
 Andrena 206  
 Catherine Esther Moses 206  
 Gustav 206

**WERDER**  
 Desirée Heydenfeldt 58  
 William 58

**WERNER**  
 A. 311B  
 Anna Springer Moses 311B  
 Caroline Bloomingdale 24  
 Cecilia C. Levy 311B  
 Charlotte K. 114  
 Delia (b. 1863) 311B  
 Dora 228  
 George 24  
 Jacob (b. 1865) 311B  
 Lynn 24  
 Morris H. (b. 1900) 311B  
 Pauline (b. 1858) 311B  
 William (b. 1861) 311B

**WERTHEIM**  
 Julie 48  
 Sophia (d. 1970) 116, 310

**WERTHEIMER**  
 Alfred J. (b. 1887) 292  
 Amy Weil 292  
 Charles (b. 1915) 292  
 Charles (1883-1914) 292  
 David 50  
 Dora (b. 1885) 292  
 Dora Davis (see Wertheimer, Dorothy (Dora) Davis)  
 Doris Ann 293  
 Dorothy (Dora) Davis 50

Edel 235  
 Edward 70  
 Gladys Bowman 70  
 Grendl Oppenheim 235  
 Hannah Elise Weil 286, 292  
 Henriette Meyer 292  
 Hirsch Oppenheim 235  
 Isaac 235  
 Jacob J. 292  
 Jane Carolyn (b. 1912) 292  
 Jeanne (b. 1895) 292  
 Jeanne (b. 1918) 292  
 Joseph (b. 1881) 292  
 Julia 228  
 Lea Oppenheimer 337B  
 Lenore 293  
 Leon 293  
 Lobb 235  
 Louis (b. 1880) 286, 292  
 Louis, Jr. (b. 1908) 292  
 Millie Swartz 292  
 Miriam Nathan 228  
 Nancy (b. 1915) 292  
 Ruth Schloss 293  
 Samson 235  
 Sophie 187  
 Telze 235  
 Wolf 235, 337B

**WESER**  
 Harriett Elizabeth Sheftall 269  
 Nicholas William 269

**WESSLER**  
 Ellen Freed 321A  
 Fredi Hurwitz 321A  
 James 321A  
 John 321A  
 Margaret Muhlfelder 321A  
 Stanford (1917-) 321A  
 Stanford 16  
 Stephen 321A

**WESSNER**  
 Babette 284

**WEST**  
 Charles F. 101, 169  
 Elizabeth Ann Bateman 37  
 Gertrude Hart Levy 101  
 Jane Isaacs 126  
 Jones 207  
 Julie Anne 37  
 Nancy 126  
 Nathaniel H. 126  
 Ray Blesi 37

**WESTERMAYER**  
 Caroline Louisa 203

**WESTFELDT**  
 Clara 201  
 Susan Alice Mordecai 201

**WESTHEIMER**  
 Ann Duffie 307  
 Charles I. 307  
 Duffie C. 307  
 Duffie Heinsheimer 307  
 Helen 107  
 Ida Hecht 107  
 Irvin 307  
 Irvin F. 307  
 Irving 107  
 John R. 307  
 Louis 107  
 Mary H. 307  
 Mary Jane 208  
 May Orton 307  
 Myra 107  
 Richard E. 307  
 Robert I. 307  
 Ruth Welling 307  
 Sally E. 307  
 Thomas O. 307  
 William C. 307

**WETMORE**  
 Rebecca Cornelia Schott Schott 155  
 William Henry 155

**WEITZLER**



Charles Noé Benjamin 124  
Emma 10  
Eugene Noé (b. 1868) 124  
Frances Zelmira Isaacs 124  
Jessie Leonore (1866-1918) 124

**WEXELBAUM**  
Jennie 215

**WEXLER**

Abigail Jean (1980-) 337B  
Barry 337B  
Janet Sue Oppenheim 337B  
Jill Sable (1985-) 337B

**WEYER**

Margaret Phillips 249

**WEYL**

Bertha Nevin Poole 284  
Carrie Stein (m. 1894) 284  
Charles (1896-1920) 284  
Charles Frederick (son of Charles) 284  
David 284  
David Richard 284  
Donald Maurice 284  
Doris Ann 284  
Edward Stern 284  
Eleanor Gittleson 284  
Elinor Jean 284  
Elizabeth 134  
Emilie Saller 284, 340A  
Emilie Stern 284  
Helen C. Roberts 284  
James (1908-1935) 284  
Jane Lavin 284  
Josephine Stern 284  
Julius (1871-1935) 284  
Louise 284  
Mary Caroline 284  
Maurice Nathan 284  
Miriam Saller 284  
Nathan 284  
Nathaniel 284  
Oscar 284  
Stephen Edward 284  
Sylvia (dau. of David) 284  
Sylvia (dau. of Nathan) 284  
Sylvia (m. Nathaniel) 284  
Walter Edward 284

**WEYLAND**

Beatrix 296

**WEYLE**

Emma Arnold 320B  
Emmanuel 320B

**WHALEY**

Elizabeth 112

**WHARTON**

Edward Clifton 94  
Louisiana Goodman 94

**WHATLY**

Sarah Ansell 180

**WHEATLEY**

Bobbie (see Wheatley, Esther  
(“Bobbie”))  
Esther (“Bobbie”) 125

**WHEATLY**

Amelia Goldsmith 125  
Barbara Ann 90  
Charles 180  
David 125  
Hortense Amy Lindheim 90  
John 90  
Margaret Jean 90  
S. Hartley 125  
Sarah Ansell 180

**WHEDDE**

Charles Maurice 157  
Mary Patterson Nicholas 157  
Thomas M. 157

**WHEELER**

Carol Jane Allen 295  
Helen Janet 233  
James Hamilton 295  
James Phelps 295  
Mina Margaret 189  
Patricia 295

**WHELAN**

Gabrielle Prentice 238  
Gail Prentice Andrews 238  
John Degnan 238  
John-Paul Prentice 238

**WHELEN**

Laura Baker 80

**WHEELER**

Dorothy 226

**WHICHCOTE**

Thomas 79

**WHITAKER**

Audrey Ellen 239  
Sharon 238

**WHITE**

Bertha 21  
Charles Joseph (1835-1906) 312B  
Clara 145  
Cornelia 39  
Cornelia C. Coben 39  
Cynthia 150  
Eliza (1795-1887) 181  
Elizabeth Elvira Russell 312B  
Frances Munnerlyn 198  
Hilda Manon Story 76  
Kay 268  
Leo G. 21  
Lorraine 122  
Mary 123  
Rose Goldsmith Heyman 21  
Sarah Georgina 246  
Sidney Crawford 76  
W. B. 39

**WHITEHEAD**

Charles P. 249  
Donald 249  
Edith 222  
Ethel Stix Phillips 178  
Florence F. (b. 1913) 84  
Hildegard (b. 1915) 84  
Hildegard Goldschmidt 84  
Linda 249  
Mary Laub 249  
Michael 249  
Paul 249  
Russel F. 84

**WHITESIDE**

Clara Corinna Nathans Shuster 230

**WHITNEY**

Harry 230  
Augustus 82  
Jessie Heron Goldsmid 82

**WHITHAM**

Ruby 140

**WHITLOCK**

Elizabeth (Esther) (1744-1804) 32, 200  
Esther (see Whitlock, Elizabeth  
(Esther))

**WHITNEY**

Barbara 325B  
Harry Payne 325B  
Howard 265  
Jenny Seixas 265  
Mary C. 157

**WHITTEMORE**

Ida 111

**WHITTESEY**

Lois Tibbets 157

**WHYTE**

Barbara Henrietta 77  
Betty 95  
Catherine (b. 1883) 212  
James 77  
James A. 212  
Louisa Lucy Honeywood 77  
Marie Luria Moses 212

**WICKHAM**

Lucretia 126

**WIDEN**

Andrew 45  
Morton M. (see Weidenfeld (Widen),  
Morton M.)  
Roslyn Louise Davega (see Weidenfeld

(Widen), Roslyn Louise Davega)

**WIEL**

Faith 301  
Joseph 11  
Maud 11

**WIENER**

Amy Garson 293  
Ann 293  
Arthur 89  
Beatrice Bernstein 293  
Charles 260  
Clarice Herman 293  
Dorothy Dorman 293  
Elmer 293  
Esther (Ester) Hays Budwig 293  
Ethel 293  
Hattie Guggenheimer 89  
Henry 293  
Jacob 293  
Laura Hoale 293  
Laura Samuel 260  
Linda 293  
Lois 293  
Michael 293  
Milton 293  
Milton J. 293  
Rebecca Thorman 293  
Robert 293  
Sanford 293  
Sarah 293  
Summer 293

**WIESEN**

Dorothy (1900-1974) 334B

**WIETERS**

Paula Sue 125

**WIGLEY**

Myrtle 528

**WILCOX**

Ann 215  
Carol Alice 309B  
Isabel Poindexter 133  
Sherrard 133

**WILDE**

David 264  
Henrietta 264  
Joan Geisenberger 8  
John 264  
Roger 8  
Virginia Seixas 264

**WILDES**

John 337A  
Sarah Jane Nunez 337A

**WILEY**

Ida Nones 336B  
Joseph M. Jr. (1868-1908) 336B

**WILGUS**

Emma 52, 53

**WILKENS**

Rosalie Amanda 267

**WILKERSON**

Elizabeth (1785-1886) 324A  
Nancy 184

**WILKES**

Opal S. 299

**WILKINS**

Armonis 22  
Charles (b. 1941) 214  
Esther Harby Elsbree 312A  
Evelyn Lawrence Moss 214  
Ross IV (b. 1937) 214  
Ross, Jr. 214  
Susan 312A  
Suzie C. (1864-1943) 336B  
Winona 10

**WILKINSON**

Annie 260  
Belle 293  
Claude S. 309A  
Edward Perry 309A  
Elisabeth Bryan 42  
James Harris (1862-1936) 309A  
Mary Eliza Cardoza 29, 309A  
Nellie McCurdy Smith 309A  
William G. (1805-1869) 29, 309A

**WILKOFF**

Faith 301

**WILKS**

Elizabeth 75

**WILLETT**

Bertha Lee Mordecai 201  
Howard Clark 201  
John Clark 201

**WILLIAMS**

Alice 133  
Alice Marshall Taylor 133  
Amelia Solomon Glazer 61  
Angelina L. Fisher 168  
Anita Hannah De Sola 61, 323A  
Ann Hughes Preston 217  
Annie Mordecai 202  
Anselmy Davis 37  
Betty Elizabeth McCutcheon 37  
C. A. 203  
Carrington 133  
Charles J. 202  
Douglas Leifert 61  
Eda Carter 133  
Edgar Whitfield 28  
Edward De Castro 61  
Eleanor Marshall 133, 188  
Elise 208  
Elise McFadden 208  
Eliza 28  
Elizabeth Alexia Murta 28  
Elizabeth Bomeister 26  
Elizabeth Braxton 28  
Elizabeth Kennon 217  
Ellen Esther (see Esther Ellen De  
Castro)  
Ellen Jean 312B, 334B  
Esther Ellen De Castro 61, 323A  
Ethel 266  
Fannie Miller 133  
Goldie 148  
Harriet Leifert 61  
Henry De Castro 61  
Henry J. (1866-1941) 61, 323A  
Henry Julian (b. 1929) 61  
Henry, Jr. 61  
Isabel De Leon 133  
J. Morton, Jr. 61  
Jacob Morton (see Williams, Morton  
Jacob)  
James G. B. 74  
Jean 208  
John R. 168  
John W., Jr. 37  
John Watson 37  
Lavinia Florance 74  
Lucile Cohen 37  
Lucile Phelps 208  
Lucy Phelps 208  
Mary Helen 197  
Mary Warren 133  
Miriam 174  
Morton Jacob 61, 323A  
Peter James 61  
Phyllis Marie Louise (1917-) 330A  
R. C. 208  
Richard Kennon 217  
Robert Charles McFadden 208  
Robert Lynn 235  
Robert Lynn, Jr. (b. 1945) 235  
Sarah Ann Oppenheim 235  
Sarah Solomon Neal Cramer 273  
Thomas Roger 61  
Virginia 208  
Walter A., Jr. 133  
Walter Armistead 133

**WINBURN**

James Randall 11  
Virginia Van Gieson 11

**WINDER**

Alice Lloyd (b. 1832) 156  
Alice Lloyd (b. 1886) 156  
Charles Sidney (b. 1856) 156  
Charles Sidney (m. 1855) 156  
Corinae H. Pope 156  
Edward Lloyd (b. 1858) 156  
Elizabeth Lloyd (1862-1862) 156  
Mary Dorsey Parker 156

**WINDSOR**

Louisa Hays 105

**WINBERG**

Doris Moses 208  
Mortimer 208  
Mortimer, Jr. 208  
Perry 208

**WINEMAN**

Cordelia M. 132  
Laura Louise Jacobs 132  
Philip (d. 1895) 132  
Philip, Jr. 132

**WINFREE**

Elizabeth Christopher Hinsdale 200  
John M. 200

**WINKLEMAN**

Ann Kirshbaum 284  
John 284  
Nathaniel William, Jr. 284  
Norah 284  
William 284

**WINKLER**

Clementia De Ribas 265  
Esther 265  
George Howe 265  
Virginia Dorothy Binswanger 23, 309A  
Walter 309A

**WINN**

John 122  
Virginia Leland 122

**WINNEMORE**

Anna Bella Phillips 245  
Augustine Edward 245  
Phillips (b. 1910) 245

**WINSLOW**

Arthur 200  
Nettie Davis Menken McMahon 192  
Rebecca Isabel 180  
Sallie Janette 180  
William Francis 180  
Willie H. 180

**WILLOWBY**

Mildred 257

**WILMANS**

Christopher Nahl 49  
Margery Nahl 49  
Stephen C. III 49  
Stephen Caleb 49  
Stephen Caleb, Jr. 49

**WILMORE**

Emma 93  
Wilbel 93

**WILMOT**

Ellen Honor 159

**WILSON**

A. N. 8  
Anna M. (Sarah) 230  
Caroline 295  
Charlotte 199  
Frederick N. 105  
Georgiana 230  
Kate Mosler 8  
Lawrence Naylor Hodgson 77  
Maud Naylor 77  
Muriel 95  
Nancy (dau. of A. N.) 8  
Nancy (m. Robert G. Nathan) 227  
Robin E. 305  
Rowena 299  
Steven 8  
Zaidee Violet Honeywood 77

**WINSTEN**

Alfred 116  
Marion (b. 1927) 116  
Marjorie K. Levy 116

**WINSTOCK**

Irene 21

**WINTER**

Annie (b. 1894) 10  
Elly (b. 1890) 10  
Gabrielle (b. 1924) 10  
Grace Amelia Allen 10  
Hannie Schwabe 10  
Jacob 10  
Leo (b. 1897) 10  
Lottie 145, 328A  
Rosetta Friedlander 181

**WINTERS**

April Joy (1972-) 330A  
Jane Eileen Levy 330A  
Kimberly Jane (1974-) 330A  
Warren Dale 330A

**WINTERSTEEN**

James McIlbenny 118  
Marian Newhall Horwitz Coates 118

**WINTHROP**

Francis B. 126  
Julia Anne Rogers 126

**WINTZ**

Allison Margaret 52  
Cary De Cordova 52  
David Gibson 52  
Elizabeth De Cordova 52  
Elmir Cary 52  
Elmir D. 52  
Fannie 52  
Henry D. 52  
Jessie Gibson 52  
John R. 52  
Lorena A. 52  
Margaret Sturgis Mackey 52

**WISDOM**

Adelaide Labatt 148, 328B  
Mortimer M. 18, 148, 328B  
Rebecca De Mendes Kruschnitt 18  
William 148

**WISE**

Anna (Hannah) Samson 259  
Annie 88  
Arabella D. 106  
Barton 39  
Carrie Cohen 39  
Della Morris 174  
Edith Fidele 191  
Ellen 188  
Ellen Wright 39  
Hannah Samson (see Wise, Anna  
(Hannah) Samson)



Henry 188  
 Leopold 259  
 Margaret Lynn Lewis 211  
 Mary 188  
 Oren 211  
 Rudolph L. 174  
 Sarah (dau. of Henry) 188  
 Virginia A. (b. 1905) 174  
 Wirt Oren 211

**WISEMAN**  
 Charles 251  
 Mame Pinto 251

**WISSLER**  
 Elizabeth Brooke Mordecai 201

**WITMER**  
 Emma Repplier 169, 330B  
 Lightner 169, 330B

**WITTENBERG**  
 Agnes Sbeftel 144  
 Charles 144  
 Helene 144  
 Marguerite 144

**WITTGENSTEIN**  
 Esther Phillips Ellis 245  
 Joseph 245

**WITTKOWSKY**  
 Adolph (1832-1904) 120  
 Cecil (see Wittson, Cecil)  
 George Heyman 120  
 Hamilton H. (1871-1893) 120  
 Jacob A. (1866-1887) 120  
 Legriel Adolph 120  
 M. J. (1874-1899) 120  
 Pauline Heyman 120  
 Susan Hyams 120

**WITTON**  
 Cecil 120

**WOCK**  
 Clara Lavine 67

**WOERNER**  
 Karl S. 12  
 Leonora Louise 12

**WOLBACH**  
 Alberta Falck 48  
 Robert 48  
 Robert Albert 48

**WOLCOFF**  
 Blanche Sophia Finzi Daniels 51  
 Ernest 51

**WOLF**  
 See also Wolfe, Wolff, Woolf  
 Aaron 314A  
 Abigail 23  
 Abraham Simon (1809-1880) 252, 303  
 Alan Mitchell 8  
 Alan Mitchell, Jr. 8  
 Anthony Edwin 16  
 Arthur 303  
 Bessie Katzenberg Kind 282  
 Betty Hart Nathan 227  
 Catherine (1775-1850) 303  
 Claire J. Heller 186  
 Daniel Brandeis 125  
 Edwin David (b. 1938) 23  
 Edwin II (b. 1911) 23  
 Elaine 91  
 Elinor Kemper 23  
 Elizabeth 182  
 Ellen Louise 8  
 Ellen Rose 23  
 Fanny (dau. of William Leo) 303  
 Fanny (1806-1872) 13, 303  
 Flora Barth 23  
 George (b. 1809) 303  
 George (son of Victor) 310A  
 George Leo 303  
 Gussie 239  
 Hanchen (see Wolf, Jane (Hanchen))  
 Ida Johanna (b. 1850) 303  
 Isabella Loney Goldsmith 284  
 Isabella (b. 1805) 303  
 Isabella (d. 1841) 303  
 Jane (Hanchen) 303

Jane H. 282  
 Jo Ann 186  
 Joan 327A  
 Joan Lowenthal 297, 314A  
 Johanna Leo Warburg 303  
 Joseph, M. D. 303  
 Judith Ann 125  
 Lewis (see Wolf, Ludwig (Lewis))  
 Louis Leo 303  
 Louise 91  
 Ludwig (Lewis) 303  
 Madeline 284  
 Malka Menachem Mendel 324B  
 Marcia Frances Bortin 125  
 Margaret Anna 23  
 Margaret Dannebaum 23  
 Mark Alexander 125  
 Mary 23  
 Mary Alice 23  
 Mary Elizabeth Cahn 236  
 Mary M. Payson 23  
 Matthew Stephen 236  
 Michael 186  
 Mildred (1914-) 327B  
 Milton (son of Victor) 310A  
 Miriam H. Polock 252, 303  
 Moritz (Morris) Leo (b. 1803) 257, 303  
 Morris 23, 172, 282, 284  
 Morris Leo (see Wolf, Moritz (Morris) Leo)  
 Nicholas Edwin 23  
 Pauline Sara Binswanger 23  
 Rachel Franks Salomon 257, 303  
 Rebecca Ann 322B  
 Rebecca Seixas Hart 97, 310A  
 Robert (b. 1914) 23  
 Rose (Jim) Hirsh 172  
 Rose (m. David Drucker) 307  
 Sarah (b. 1803) 303  
 Simon 303  
 Simon Zev (Rabbi) (-1646) 324B  
 Sophia (dau. of William Leo Wolf) 303, 340B  
 Sophie 313A  
 Stanford J. 186  
 Stephen 186  
 Stephen Louis 236  
 Steven Jacob 125  
 Susan 186  
 Susan Claire 8  
 Susannah 23  
 Sydel 290  
 Theodore William 303  
 Victor B. (b. 1861) 97, 310A  
 Virginia (b. 1942) 24  
 William Leo (d. ca. 1851) 303  
 Zev 87

**WOLFE**  
 See also Wolf, Wolff, Woolf  
 Adele B. 304  
 Arabella (d. 1889) 26  
 Belle (see Wolfe, (Isa) Belle)  
 Benjamin (1767-1817/8) 304  
 Benjamin Franklin (1848-1863) 304  
 Clarissa 132, 304  
 David C. B. (b. 1868) 304  
 Deborah (b. 1856) 304  
 Ellen (1836-1853) 304  
 Esther 304  
 Gertrude Amelia (b. 1873) 304  
 Hartwig Cohen (b. 1867) 304  
 Henrietta (1787-1864) 304  
 Henrietta L. (b. 1862) 304  
 Hudson Garland 304  
 (Isa) Belle (1850-1921) 17, 304  
 Isaac Saling (b. 1858) 304  
 Isaac Saling (1787-1856) 304  
 Jacob (1839-1895) 304  
 James M. (b. ca. 1802) 304  
 Joel (b. 1796/8) 304  
 Joseph G. 304  
 Leah Yatter 304

Lucile 304  
 Marion (1846-1856) 304  
 Michael B. 304  
 Nathaniel 304  
 Rachel (1836-1870) 304  
 Rachel Marx 304  
 Rebecca Cecilia (b. 1860) 304  
 Rose Eva (b. 1852) 64, 304  
 S. Caroline Stephenson 304  
 Saling (1817-1893) 34, 304  
 Saling Isaac 304  
 Samuel L. (d. 1866) 304  
 Sarah (b. 1865) 304  
 Sarah C. (dau. of Udolpho) 304  
 Sarah Cohen 34, 304  
 Simon 304, 340B  
 Solomon (b. 1854) 304  
 Sophia (d. 1821) 304  
 Udolpho 304  
 Virginia 304

**WOLFF**  
 See also Wolf, Wolfe, Woolf  
 Aaron (1795-1872) 305, 341A  
 Aaron (1843-1920) 110, 305  
 Aaron (1858-1859) 305  
 Aaron (1860-1918) 305  
 Adele 8  
 Adeline Carol 278  
 Adeline Henrietta 211  
 Adeline Winthrop Moses 211  
 Agnes Hendricks (m. 1867) 110, 305  
 Agnes Hendricks (1870-1901) 305  
 Alexander R. 233, 305, 341A  
 Alfred 260  
 Aline 310A  
 Allen 107  
 Alma (1874-1878) 305  
 Amelia 320B  
 Amy Samuel 260  
 Ann Sutzberger 291  
 Anna (see Wolff, Hannah)  
 Anna Nones 233, 305  
 Annette Ruth 138  
 Arnold 107  
 Arthur Moses (b. 1881) 305  
 Augusta 305  
 Babette 238  
 Bee Gay 305  
 Belinda 127  
 Caroline 305  
 Carrie 238  
 Catherine 102  
 Leopold 8  
 Cecile 278  
 Cecilia 260  
 Charles Geller (1848-1898) 305  
 Charlotte (b. 1817) 305  
 Christina Louise 238  
 Corinne 320B  
 Daniel 305  
 Daniel N. (1820-1899) 305  
 David 305, 341A  
 Doris Selma Friedman 211  
 Dorothy Grace Fidiem 238  
 Dorothy Phillips 249  
 E. Fox 305  
 Edmund 107  
 Edward 305  
 Edwin Lynn 211  
 Edwin (1864-) 331A  
 Elias (1822-1869) 113, 305, 341A  
 Elizabeth 183  
 Elizabeth Levy 127  
 Elkah 305  
 Emily Rebecca (1878-1912) 29, 305  
 Emila (b. 1851) 305  
 Emila (dau. of Charles G.) 305  
 Erna 320B  
 Estah 305  
 Esther 305  
 Esther Barak 238  
 Esther Irene 138  
 Etta Riser 8  
 Eugene Joseph Maginnis 238

Fannie Borren 138  
 Fanny Andrade 138  
 Fanny Levy 305  
 Florence Fuller 305  
 Frances Louisa Nathan 226, 305  
 Frances Nathan 285, 305  
 Frank Joseph (1876-1878) 305  
 Fred 107  
 Frederick 172, 173, 331A  
 Grace (1862-1935) 305  
 Gussie Weinstein 238  
 Gwendolyn Macleod 305  
 Hannah (b. 1829) 305, 341A  
 Hannah (d. 1850) 305  
 Harold Israel 238  
 Harriet Hart 102  
 Hattie 238  
 Hattie Wolff 238  
 Helen (Nellie) (1866-) 331A  
 Helen Adler 102  
 Helen Louise Eiseman 286  
 Helen Sternberg 107  
 Henrietta (Tony) Jacobs 107  
 Henry (see Wylie, Harry Hilliard)  
 Herman Henry 238  
 Howard 127  
 Irene Rachel Joseph 138  
 Isaac (1857-1934) 305  
 Jack (see Wolff, Sol (Jack))  
 Jacob 320B  
 Jacob Benjamin (d. 1822) 305  
 Jacob Benjamin (1815-1850) 305, 341A  
 Jean Fitter 305  
 Jean S. 305  
 Jeanne Touro 211  
 John 102  
 John B. III 305  
 John B. IV 305  
 John Benjamin 305  
 John Benjamin, Jr. 305, 341A  
 Jonathan 102  
 Joseph (b. 1830) 305  
 Josephine Luna Henriques 113, 305  
 Judith Pucto 305  
 Julius Ruben (1849-1886) 226, 305, 341A  
 Kathryn Antoinette Peirano O'Brien 238  
 Kauman Borren 238  
 Kenneth 127  
 Leah (d. 1866) 305  
 Leah Rosenblatt Heskes Frankel 238  
 Leopold 8  
 Lillian Hendricks (1868-1953) 159, 305, 314A  
 Lionell 238  
 Lottie Fox 305  
 Lucy 305, 341A  
 Margaret Lyon Scheuer Pearl 305, 312A, 332A, 341A  
 Martia (1881-1948) 138  
 Mary 305  
 Mary Fuller Hollister 305  
 Max (m. 1884) 278  
 Melville L. 310A  
 Minnie Victor 320B  
 Miriam (b. 1821) 305, 341A  
 Miriam (d. 1839) 305  
 Miriam Cappé (m. Moses) 305  
 Miriam Cappé (1823-1887) 305  
 Miriam Solomons 278  
 Moses (1756-1815) 305, 340A  
 Moses (1816-1855) 305, 341A  
 Moses (1855-1923) 305  
 Moses Percy (b. 1875) 305  
 Moses (1833-) 341A  
 Mozes (see Wolff, Moses)  
 Neil Solomons (b. 1889) 278  
 Norma Aline Down 310A  
 Patricia 127  
 Paula Dale 238  
 Perla 305  
 Rachel (b. 1863) 305

Rachel (b. 1890) 305  
 Rachel (dau. of Moses) 297, 305, 314A, 341A  
 Rachel (1768-1843) 305  
 Rachel Alexander 138  
 Rachel Cappé Von Honig 305, 341A  
 Rachel Levy 305  
 Rachel Lewis 172, 173, 331A  
 Rachel Miriam (b. 1890) 305  
 Rachel Miriam Levy 305  
 Ralph (son of John B.) 305, 341A  
 Ralph (Raphael) (1799-1850) 305, 341A  
 Ralph Fuller 305, 312A, 332A  
 Ralph G. 286  
 Ralph G., Jr. (b. 1915) 286  
 Ralph, Jr. 305  
 Raphael, (see Wolff, Ralph (Raphael))  
 Rebecca (1823-1916) 305  
 Rebecca Josephine Levy 341A  
 Rebecca Levy 305  
 Rebecca Robles 305  
 Reuben Julius (1837-1911) 305, 341A  
 Robin E. Wilson 305  
 Rosetta Maud 138  
 Ruth (b. 1825) 305  
 Samuel Edwin 211  
 Sarah 159  
 Sarah Florence 138  
 Sarah Moses 213, 305  
 Sarah (1835-) 341A  
 Sidney (1872-) 331A  
 Sol (Jack) 238  
 Solomon (1818-1825) 305, 341A  
 Stanley 107  
 Stanley, Jr. 107  
 Sue 107  
 Tony Jacobs (see Wolff, Henrietta (Tony) Jacobs)  
 Vera 305  
 Walter 320B  
 Wendy (dau. of John B., Jr.) 305  
 Wendy (dau. of John) 102  
 William (b. 1874) 238  
 William (m. Harriet Hart) 102  
 William (1860-1864) 331A  
 William (1868-) 331A

**WOLFFE**  
 (see Wolff)

**WOLFINSOHN**  
 Judith 291  
 Sarah Adler 291  
 Wolfe 291

**WOLFSOHN**  
 Adele (b. 1855) 265

**WOLLENBERG**  
 Leonore Bitterman 309A  
 Robert 309A

**WOOD**  
 Caroline C. Peizotto 240  
 Edward 97  
 Emma 106  
 Ginevra Belle 180  
 Helen Nathans 230  
 Henry Malcolm 240  
 Lauretta 241  
 Marguerite Hart 97  
 Peggy 240  
 Rachel Gomez Judah 85  
 Richard Warren 240  
 Sol Sidney 240

**WOODALL**  
 Mae 101

**WOODEN**  
 Katherine May Lilienthal 276  
 Marilyn Joan 276  
 Wayne Stanley 276  
 Wesley 276

**WOODFIN**  
 Augustus 4  
 Ida 4  
 Mary Isabella Abrahams 4

**WOODRUFF**

Lucy Maria 168  
 Maria Pinto 251

**WOODS**  
 Frank 193  
 Grace 255  
 Jean (see Henry, Freda Joseph ('Jean Woods'))  
 Jeffrey Thomas 189  
 Margaret Eleanor Jacobs 189  
 Marion Elizabeth Houghton 193

**WOODWARD**  
 Clara (1880-1936) 214  
 Joseph Asson 214  
 Stella Moss 214

**WOODWORTH**  
 Beulah Osborn 50

**WOODY**  
 Mary Helen 141

**WOODYARD**  
 Bridessa Block 321B  
 Henry 321B

**WOOLEY**  
 Addison 264  
 Addison, Jr. 264  
 Ann Elvidge Rice 42  
 Daniel M. 264  
 Debra Anne 42  
 Henrietta Wilde 264  
 Mannie Cecil, Jr. 42  
 Richard 264

**WOLFF**  
 See also Wolf, Wolfe, Wolff  
 Anna Nones 233  
 Belinda 127  
 Benjamin 331B  
 Benjamin (1867-1937) 331B  
 Caroline A. (1824-1904) 30, 305  
 Cecile Mordecai 202  
 Cecilia 196, 199, 205  
 Charlotte A. (1817-1883) 109, 219  
 Clarence Reuben (1838-1867) 305  
 Cordelia Harris 16, 94, 305  
 Eliza T. (1815-1867) 153, 305  
 Elizabeth Ann Levy 127  
 Emma C. 305  
 Ethel 122  
 Henry M. 202  
 Howard 127  
 Isaac (1782-1870) 213, 305  
 Jacob 305  
 Kenneth H. 127  
 Levi (b. 1810) 305  
 Miriam R. (d. 1857) 305  
 Patricia Isabel 127  
 R. (son of Isaac) 94, 305  
 Rachel (1768-1843) 51, 305  
 Rachel Andrews Moses 12, 205  
 Ralph 94, 305  
 Sarah 305  
 Sarah Moses 213, 305  
 Solomon 12, 205  
 Solomon Jackson (1829-1830) 305  
 Sophia 331B  
 Theodosia (1820-1824) 305  
 Theodosia Rudolph (1833-1838) 305  
 Winfred Claire Marsden 331B

**WOLFORD**  
 Arabella Johnson 230

**WOOLSEY**  
 Benjamin (1720-1771) 126  
 Esther Isaacs 126  
 Mary (1754-1845) 126  
 Sarah (m. 1780) 126  
 William Walter 126

**WOOTEN**  
 Ida Felicia 325A

**WORD**  
 Esther Phillips 244

**WORK**  
 Frances Polk Petzelt 74  
 Frederick 74

**WORKUM**  
 Aimee Bettman 306

Claire (see Workum, Clara (Claire))  
Clara (b. 1826) 306  
Clara (Claire) 307  
Clara (dau. of Levi Jacob) 306  
Coralie Buchsbaum 307  
David (1831-1885) 101, 306, 307  
David J. (1863-1924) 306  
Delia 306  
Duffie 306, 307  
Elizabeth Hart 101, 306, 307  
Ezekiel (b. 1861) 306  
Gertrude 306  
Grace 306  
Hannah 306  
Hannah Ezekiel 69, 306  
Henry 306  
Jacob (see also Workum, Jephtha (Jacob))  
Jacob Clarence 307  
Jacob L. (1792-1870) 306  
Jephtha (Jacob) 306  
Juliet 307  
Julius 306  
Katie 306  
Laura Senior 307  
Lee J. (b. 1897) 306  
Lee J., Jr. (b. 1930) 306  
Levi Jacob (1822-1883) 69, 306  
Mary (b. 1933) 306  
Pauline 306  
Rachel 306  
Rachel Florence 307  
Ruth Iglauer 306  
Sally 306  
Sarah Levy 306  
Theodore 306  
Theresa 306  
Theresa Mayer (1867-1930) 306  
**WORMS**  
Amelia (1842-1915) 228  
Hannah Adolphus 7  
Henry (ca. 1807-1878) 228  
Rachel Lamert 228  
Rebecca Nathan 228  
**WORMSER**  
Heloise Jelinek 327B  
Herbert (1896-) 327B  
Joseph (1857-1915) 327B  
Rose Block 327B  
Ruth (1917-) 327B  
Sallie Kayton 327B  
Sidney (1893-1943) 327B  
**WORSHAM**  
Annie Gambatti 117  
**WORTH**  
Eva 244  
John 244  
Pearl 215  
Sarah Phillips Lucas 244  
**WORTHAM**  
Anne 91  
**WORTHINGTON**  
Abigail Levy Goodwin 154, 155  
John 154, 155  
Sarah Ristean 155  
William 155  
**WRAY**  
Dorothea Rosalie Bultman 208  
Dorothy Barnett 208  
Jane 253  
Joseph S. III 208  
Joseph Suttle, Jr. 208  
**WRIGHT**  
Anne Maria 106  
Carolyn Ruben 42  
Elise Hofheimer 301  
Elise Parker 301  
Ellen G. 309  
Estelle K. 272  
Mary Small Einstein 287  
May Florence 74  
Russell 287  
Susan E. 254

Wesley IV 301  
**WUCHER**  
Lillian 336A  
**WURMS**  
Rose Greenfield 174  
**WURZBURGER**  
Helen Isaacs 127, 326A  
Peter 127, 326A  
Walter S. (see Wurzbürger, Peter)  
**WUSTHOFF**  
Gayle 196  
**WYCKOFF**  
Alexander 115  
Evelyn Cohen 115  
Melba 30  
**WYLE**  
Elizabeth 144  
Irene S. Sheftel 144  
John Sheftel 144  
Julius 144  
**WYLER**  
Alice (b. 1875) 292  
Carl Iglauer (b. 1913) 285  
Effie (b. 1878) 292  
Elliot (b. 1882) 292  
Florence Iglauer 285  
Jesse 285  
Joan Godfried 285  
John (b. 1938) 285  
Katherine (b. 1909) 285  
Lillian (b. 1876) 292  
Louis 292  
Marjory Straus 285  
Sophie Swarts 292  
William 285  
**WYLIE**  
Alta Lenore (Elenor) Culp 173  
Benjamin G. 166  
Billy (see Wylie, William Francis (Billy))  
Elenor Culp (see Wylie, Alta Lenore (Elenor) Culp)  
Florence Jones 166  
Harry Hilliard (1870-) 331A  
James Kevin (Jamie) 173  
Lucilla 157  
Phillipa Henrietta Charlotte (Phyllis) 173  
Robert Earl (Robbie) 173  
William Francis (Billy) 173  
**WYMAN**  
B. H. 97  
Henrietta Block 24  
Margaret Hart 97  
**WYNN**  
Doreen Clare (b. 1952) 257  
Ivor James (b. 1928) 257  
Mary Lorraine Karstendiek 257  
Sharon Ann (b. 1951) 257  
**YABI**  
Amiko 2  
Miyako 2  
Shoji Takeuchi 2  
Yayeko 2  
**YARROW**  
Andrew Bernard 296  
Bernard 296  
Olivia 296  
Sandra Ann 296  
Sylvia Tim Hammerschlag 296  
**YATES**  
Ada Friedlander 308  
Alexander 308  
Amy (b. 1865) 308  
Benjamin (d. 1798) 308  
Benjamin (Elijah) (b. 1800) 308  
Catherine (dau. of Benj.) 308  
Catherine (see also Yates, Katy (Catherine))  
Clara (b. 1837) 308  
Daniel (b. 1848) 308  
Dora Esther (b. 1879) 308  
Edith (b. 1874) 308

Edward Wilson (b. 1839) 308  
Elijah (see Yates, Benjamin (Elijah))  
Ellis Keyser (b. 1867) 308  
Ellis S. (1854-1884) 260  
Ellis (Samuel) (1805-1849) 260, 308  
Fanny (b. 1797) 169, 308  
Fanny Levy 308  
Flora (dau. of Benj.) 308  
Flora (1781-1851) 260, 308  
Frances 308  
George (b. 1908) 308  
George Alfred 308  
George Samuel (1834-1887) 308  
Hanah (dau. of Samuel) 308  
Hannah 308  
Hannah Keyser 308  
Jochabed (1787-1870) 260, 308  
Julia (m. 1848) 308  
Julia Moseley 308  
Juliette 261  
Kate (b. 1910) 308  
Kate Margaret 308  
Kate Samuel 260, 308  
Katie (b. 1875) 308  
Katy (Catherine) (1785-1858) 260, 308  
Lewis 308  
Lucy (b. 1869) 308  
Mabel (b. 1877) 308  
Marion Isabel (b. 1873) 308  
Martha Abrahams 308  
Montague Solomon (b. 1880) 308  
Phoebe (1794-1870) 151, 308  
Polly 308  
Rachel (1790-1853) 308  
Richard (1835-1840) 308  
Rose 48  
Samuel (1757-1825) 308  
Samuel (1829-1900) 308  
Sarah (m. 1818) 260, 308  
Sarah (17917-1855) 308  
Saul 308  
Walter George (b. 1870) 308  
**YATTER**  
Leah (b. 1873) 304  
**YEAKLE**  
Mary Emma (1870-1948) 336B  
**YEANDLE**  
Sarah Abigail Haas 88, 304  
Wilbur 88  
**YEATS**  
Priscella Bene 53  
**YERGER**  
Alma 313A  
**YORIEU**  
Elizabeth 184  
**YORKE**  
Cherry Clare 79  
Nora Beatrice Maitland 79  
Peter 79  
**YOST**  
Dorothy 199  
Mildred 199  
**YOUNG**  
See also De Young  
Anne Rachel Schulson 325B  
David 337A  
Elizabeth 144  
Elizabeth Wyle 144  
John Brooke 200  
Marie 36  
Mary Caroline Nunez 337A  
Rosina Ursula 200, 201  
Sloan 144  
Stephen Bruce 325B  
Thomas 144  
**YOUNGHEART**  
Sylbe 15  
**YOUNGS**  
Jean 306  
John Curtis 306  
Laura Iglauer 306  
Paul 306  
Susan 306

**YULEE**  
C. Wickliffe 171  
David 171  
Florida 171  
Mary 171  
**ZABIN**  
Ann 313A  
Barbara 313A  
Dorothy Hanff 313A  
James 313A  
**ZACHARIAH**  
Kitty 280  
**ZACHARY**  
Rose 2  
**ZAGAT**  
Ruth 222  
**ZALMAN**  
Shelomo (see Gratz, Solomon (Shelomo Zalman))  
**ZANDER**  
Hannah 174  
**ZANGER**  
Martha (1885-) 327B  
**ZEIDEL**  
Adam 334B  
Bruce 334B  
Judith Ann Steel 334B  
**ZEKIND**  
Theresa 331A  
**ZELLERBACH**  
Charles 294  
Doris Joseph 294  
Gary 294  
Harold J. 294  
Harold, Jr. 294  
John W. 294  
Margery Haber 294  
Merla Burstein 294  
Nancy 294  
Rolinde 294  
Stephen 294  
Susan 294  
Thomas H. 294  
William J. 294  
**ZELLNER**  
Mabel 12  
Rebecca 137  
**ZEMAN**  
Saide 237  
**ZEMANSKY**  
Anne (1854-1936) 104  
**ZERKIN**  
Allen Jay 71  
Rebecca 71  
Sally Kohn 71  
**ZHEUTLIN**  
Joan Szold 5  
Morton 5  
**ZIELINSKY**  
Sophie Brush 27  
Zette Brush 27  
**ZIMMERMAN**  
Daniel (1979-) 333A  
Ethel Jackson 129  
J. Fred 129  
Jonathan (1976-) 333A  
Martin 333A  
Nancy Reiner 333A  
**ZOLL**  
Allison (1985-) 325A  
David (1947-) 325A  
Lynn Augusta Goodman Rouse 325A  
**ZONDERVAN**  
Rhea 329B  
**ZUCKER**  
Barbara Ann Fleisher 72  
Beatrice Fannie Oppenheimer 237  
Jeffrey David 72  
Lawrence Julian 237  
Stanley 72  
**ZUCKERMAN**  
Margaret Brickner 27  
Robert B. 27

Robert S. 27  
**ZUGENT**  
Ben 320B  
Emma Arnold 320B  
**ZUKAV**  
Josephine Kohner 324A  
**ZUKOR**  
David 326B  
Esther Phoebe Johnson 326B  
Simon 326B  
**ZUM DRACHEN**  
Edel 337A  
Samuel 337A  
**ZUNTZ**  
Abraham (d. 1813) 308  
Abraham S. 308  
Alexander (1742-1819) 4, 308  
Ellen (1781-1866) 308  
Gertrude 308  
Grace Augusta 308  
Judah (father of Alexander) 308  
Judah (1783-1829) 308  
Moses (ca. 1790-1810) 308  
Rachel Abrahams 4, 308  
Uriah 308

