



# HANDBOOK



No. 04-24

Oct 04

## USSOCOM Combat Convoy



*Tactics, Techniques, and Procedures*

Center for Army Lessons Learned (CALL)  
Fort Leavenworth, KS 66027-1350

FOR OFFICIAL USE ONLY



## **FOREWORD**

Lessons learned during Operation Enduring Freedom and Operation Iraqi Freedom (OIF) revealed that special operations forces face an increased threat posed by asymmetric forces operating throughout the depth of the battlespace. The United States Special Operations Command (USSOCOM) established and dispatched Joint Counter-Ambush Advisory Teams to both war zones and in coordination with the Director, Operational Testing and Evaluation (DOT&E), Joint Survivability (JSURV) Quick Reaction Test (QRT), and the Center for Army Lessons Learned (CALL) collected convoy operations lessons learned and tactics, techniques, and procedures (TTP). The result of this effort is the USSOCOM Combat Convoy Handbook. The aim of this handbook is to describe those actions best suited to counter the threats to convoys in the hope of reducing the USSOCOM casualty rate during combat operations. This handbook provides a quick-reference TTP guide for convoy commanders and their subordinates on how to train for and conduct tactical convoy operations on the asymmetric battlefield.

The lessons learned collection team consisted of subject matter experts from the following United States Special Operations Command (USSOCOM) units:

United States Army Special Operations Command (USASOC)  
Naval Special Warfare Command  
Air Force Special Operations Command  
Special Operations Command Central  
Combined Joint Special Operations Task Force - Arabian Peninsula (CJSOTF-AP)  
Navy Explosive Ordnance Disposal Group TWO  
Joint Readiness Training Center, Special Operations Training Detachment (SOTD)



**UNITED STATES SPECIAL OPERATIONS COMMAND  
(USSOCOM)  
COMBAT CONVOY HANDBOOK**

<b>TABLE OF CONTENTS</b>	
<b>INTRODUCTION</b>	<b>vii</b>
<b>CHAPTER 1: SPECIAL OPERATIONS FORCES (SOF) COMBAT CONVOY OPERATIONS</b>	<b>1</b>
<b>Section I: Special Operations Forces (SOF) Mobility</b>	<b>1</b>
<b>Section II: Operation Iraqi Freedom (OIF)/Operation Enduring Freedom (OEF) Theater Threats</b>	<b>1</b>
<b>Section III: Improvised Explosive Devices (IEDs)</b>	<b>4</b>
<b>Section IV: Situational Awareness (SA)</b>	<b>8</b>
<b>Section V: Rules of Engagement (ROE)</b>	<b>9</b>
<b>Section VI: Combat Convoy Planning</b>	<b>11</b>
<b>Section VII: Mission, Enemy, Terrain and Weather, Troops and Support Available, Time Available, Civil Considerations (METT-TC)</b>	<b>12</b>
<b>Section VIII: Task Organization</b>	<b>14</b>
<b>Section IX: Vehicle Considerations</b>	<b>15</b>
<b>Section X: Duties and Responsibilities</b>	<b>17</b>
<b>Section XI: Vehicle Positions</b>	<b>19</b>
<b>Section XII: Vehicle Preparation Techniques</b>	<b>19</b>
<b>CHAPTER 2: MOUNTED TACTICS</b>	<b>27</b>
<b>Section I: Formations and Movement Techniques</b>	<b>27</b>
<b>Section II: Blocking and Bumping Techniques</b>	<b>31</b>
<b>Section III: Dismount and Remount Procedures</b>	<b>39</b>
<b>Section IV: Precious Cargo Movement</b>	<b>42</b>
<b>Section V: Large Convoys</b>	<b>43</b>
<b>CHAPTER 3: BATTLE DRILLS</b>	<b>45</b>
<b>Section I: Individual Driver Skills</b>	<b>45</b>
<b>Section II: Collective Battle Drills</b>	<b>50</b>

<b>CHAPTER 4: CONVOY CHECKLISTS AND BRIEFINGS</b>	<b>69</b>
<b>Section I: Vehicle Convoy Pre-Operations Checklist</b>	<b>69</b>
<b>Section II. Convoy Commander Brief</b>	<b>72</b>
<b>Section III: Vehicle Convoy Post-Operations Checklist</b>	<b>81</b>
<b>Section IV: Medical Evacuation (MEDEVAC) Procedures</b>	<b>83</b>
<b>CHAPTER 5: GLOSSARY</b>	<b>87</b>
<b>CHAPTER 6: REFERENCES</b>	<b>91</b>

<b>List of Figures</b>	
<b>Figure 1-III-1. Various Types of Improvised Explosive Devices</b>	<b>4</b>
<b>Figure 1-III-2. Typical Improvised Explosive Device Configurations</b>	<b>5</b>
<b>Figure 1-III-3. The Basic Attack</b>	<b>6</b>
<b>Figure 1-III-4. Channeling Traffic to Pass Improvised Explosive Device</b>	<b>6</b>
<b>Figure 1-III-5. The Multiple Improvised Explosive Device Attack</b>	<b>7</b>
<b>Figure 1-VII-1. Civil Considerations</b>	<b>14</b>
<b>Figure 1-IX-1. Vehicle Characteristics</b>	<b>16</b>
<b>Figure 1-XI-1. Vehicle Position Designations</b>	<b>19</b>
<b>Figure 1-XII-1. Extra Crew-Served Weapon (CSW) Ammo Storage</b>	<b>22</b>
<b>Figure 1-XII-2. PEQ-2 on Fabricated Mount</b>	<b>23</b>
<b>Figure 1-XII-3. Setting Up Vehicle</b>	<b>24</b>
<b>Figure 1-XII-4. Setting Up Vehicle – Side/Front View</b>	<b>25</b>
<b>Figure 1-XII-5. Setting Up Vehicle – Rear View</b>	<b>26</b>
<b>Figure 2-I-1. Vehicle Transit Formations (File)</b>	<b>27</b>
<b>Figure 2-I-2. Vehicle Transit Formations (Staggered)</b>	<b>28</b>
<b>Figure 2-I-3. Vehicles Fields of Fire</b>	<b>28</b>
<b>Figure 2-I-4. Vehicles Fields of Fire</b>	<b>29</b>
<b>Figure 2-I-5. Overpasses</b>	<b>30</b>
<b>Figure 2-I-6. Overpasses</b>	<b>30</b>
<b>Figure 2-II-1. Blocking From Rear</b>	<b>31</b>

<b>Figure 2-II-2. Bump/Block Call Made From Front; Vehicles 2 and 4 Prepare to Move</b>	<b>31</b>
<b>Figure 2-II-3. Vehicles 2 and 4 Break Out and Bump to Block Intersection</b>	<b>32</b>
<b>Figure 2-II-4. Blocking on Ramps</b>	<b>32</b>
<b>Figure 2-II-5. Intersection Blocking</b>	<b>33</b>
<b>Figure 2-II-6. Vehicle in Heavy Traffic</b>	<b>33</b>
<b>Figure 2-II-7. Blocking on U-Turns</b>	<b>34</b>
<b>Figure 2-II-8. Blocking on Traffic Circles</b>	<b>34</b>
<b>Figure 2-II-9. Dead End Break Out</b>	<b>35</b>
<b>Figure 2-II-10. Dead End Break Out</b>	<b>35</b>
<b>Figure 2-II-11. Dead End Break Out</b>	<b>36</b>
<b>Figure 2-II-12. Dead End Break Out</b>	<b>36</b>
<b>Figure 2-II-13. Dead End Break Out</b>	<b>37</b>
<b>Figure 2-II-14. Oncoming Traffic</b>	<b>38</b>
<b>Figure 2-II-15. Oncoming Traffic</b>	<b>38</b>
<b>Figure 2-III-1. Dismount/Quickstop Points of Domination</b>	<b>39</b>
<b>Figure 2-III-2. Dismount/Quickstop Points of Domination</b>	<b>40</b>
<b>Figure 2-III-3. Dismount./Mount Drills</b>	<b>41</b>
<b>Figure 2-III-4. Vehicle Dismount in Heavy Traffic</b>	<b>42</b>
<b>Figure 2-IV-1. Precious Cargo Standing Operating Procedures</b>	<b>43</b>
<b>Figure 2-V-1. Vehicle Transit Formations</b>	<b>44</b>
<b>Figure 2-V-2. Fields of Fire (Larger Formation)</b>	<b>44</b>
<b>Figure 3-I-1. Ramming Vehicle</b>	<b>45</b>
<b>Figure 3-I-2. Recovery Technique</b>	<b>46</b>
<b>Figure 3-I-3. Recovery Technique</b>	<b>47</b>
<b>Figure 3-I-4. Recovery Technique</b>	<b>48</b>
<b>Figure 3-I-5. Recovery Technique</b>	<b>49</b>
<b>Figure 3-I-6. Recovery Technique Dismount Option</b>	<b>49</b>
<b>Figure 3-I-7. Recovery Technique</b>	<b>50</b>
<b>Figure 3-II-1. Bail Out Rear</b>	<b>51</b>

<b>Figure 3-II-2. Bail Out Left</b>	<b>52</b>
<b>Figure 3-II-3. Bail Out Right</b>	<b>52</b>
<b>Figure 3-II-4. React to Ambush "Blow Through"</b>	<b>53</b>
<b>Figure 3-II-5. React to Ambush "Blow Through"</b>	<b>54</b>
<b>Figure 3-II-6. React to Ambush "Blocked Lead"</b>	<b>54</b>
<b>Figure 3-II-7. React to Ambush "Blocked Lead"</b>	<b>55</b>
<b>Figure 3-II-8. React to Ambush "Blocked Lead"</b>	<b>55</b>
<b>Figure 3-II-9. React to Ambush "Isolated Follow"</b>	<b>56</b>
<b>Figure 3-II-10. React to Ambush "Isolated Follow"</b>	<b>56</b>
<b>Figure 3-II-11. React to Ambush "Isolated Follow"</b>	<b>57</b>
<b>Figure 3-II-12. React to Ambush "Assault Through"</b>	<b>57</b>
<b>Figure 3-II-13. React to Ambush "Assault Through"</b>	<b>58</b>
<b>Figure 3-II-14. React to Ambush "Assault Through"</b>	<b>58</b>
<b>Figure 3-II-15. React to Ambush "Assault Through"</b>	<b>59</b>
<b>Figure 3-II-16. React to Ambush "Assault Through"</b>	<b>59</b>
<b>Figure 3-II-17. React to Suspected IED "Blow Through"</b>	<b>60</b>
<b>Figure 3-II-18. React to Suspected IED "Short"</b>	<b>61</b>
<b>Figure 3-II-19. React to Suspected IED "Split"</b>	<b>61</b>
<b>Figure 3-II-20. React to IED: "Blow Through and Recover"</b>	<b>62</b>
<b>Figure 3-II-21. React to IED: "Blow Through and Recover"</b>	<b>63</b>
<b>Figure 3-II-22. React to IED: "Security By Width"</b>	<b>63</b>
<b>Figure 3-II-23. React to IED: "Security By Width"</b>	<b>64</b>
<b>Figure 4-II-1. Two-Vehicle Convoy Seating Configuration</b>	<b>73</b>
<b>Figure 4-II-2. Four-Vehicle Convoy Seating Configuration</b>	<b>74</b>



**CENTER FOR ARMY LESSONS LEARNED**

<b>Director</b>	<b>Colonel Lawrence H. Saul</b>
<b>Project Manager</b>	<b>Commander Steven R. Schreiber (USSOCOM)</b>
<b>Project Analysts</b>	<b>Rick Boyer (JSURV) Arvel Masters (CALL)</b>
<b>Contributing Editors</b>	<b>Major Robert Blanton (USSOCOM) Lee Ann Jones (JSURV) Major William Gambino (JRTC SOTD)</b>
<b>Editor, layout, and design</b>	<b>Valerie Tystad</b>
<b>Cover design and graphics</b>	<b>Catherine Elliott</b>
<b>Contributors</b>	<b>Joint Survivability Test and Evaluation  USSOCOM Joint Counter-Ambush Advisory Team</b>

**This information was deemed of immediate value to forces engaged in the Global War on Terrorism and should not be necessarily construed as approved Army policy or doctrine.**

**This information is furnished with the understanding that it is to be used for defense purposes only, that it is to be afforded essentially the same degree of security protection as such information is afforded by the United States, that it is not to be revealed to another country or international organization without the written consent of the Center for Army Lessons Learned.**

If your unit has identified lessons learned or tactics, techniques, and procedures, please share them with the rest of the Army by contacting CALL:

Telephone: DSN 552-3035 or 2255; Commercial (913) 684-3035 or 2255  
 Fax: DSN 552-4387; Commercial (913) 684-4387  
 E-mail Address: callrfi@leavenworth.army.mil  
 Web Site: <http://call.army.mil>

When contacting us, please include your phone number and complete address.



## INTRODUCTION



One of the key issues shaping the Global War on Terrorism and, in particular, the on-going fighting in Iraq and Afghanistan is the ability of United States (U.S.) Special Operations Forces (SOF) to adapt to a combination of classic maneuver and asymmetric warfare. The purpose of this publication is to identify and consolidate Operation Iraqi Freedom (OIF) and Operation Enduring Freedom (OEF) lessons learned and provide the most effective tactics, techniques, and procedures to the United States Armed Forces either currently serving in or preparing for future deployment to Iraq or Afghanistan.

The Iraqi insurgency has evolved by introducing diversified threats that range from vehicle-borne improvised explosive devices (VBIEDs) to complex ambushes employing improvised explosive devices (IEDs), rocket-propelled grenades (RPGs), and small arms. This new operational environment tests U.S. combat capabilities and tactics in ways we have not encountered or confronted in recent history. OIF and OEF challenge our Soldiers and Leaders to adjust tactically to meet the threat and explore new protective measures to counter evolving threat tactics. The validated tactics, techniques, and procedures (TTP) contained and illustrated in this handbook, though not doctrine, are applicable to a variety of circumstances or locations.

This handbook provides a quick-reference guide for special operations forces (SOF) training and conducting tactical convoy operations within Iraq and Afghanistan.

Unless noted, the graphic images (vehicle, interval, etc.) depicted in the diagrams contained in this text are not to scale. The following terms are used throughout the

handbook and are offered hereto to facilitate reader comprehension of the material presented.

### SOF Combat Convoy Terms and Definitions

The following simple command and control terms are used by SOF operators over the radio and/or verbally within vehicles.

**Alert: "Walker"/"Bicycle"/"Truck":** This signal can indicate any potential threat and is given by the individual observer. Ensure that all vehicles are aware of the same. Often the signal is followed by "left," "right," "front," etc.

**Alert: "Overpass"/"Checkpoint":** A signal from an observer inside a vehicle and/or from a forward vehicle commander to trailing vehicles that there is something ahead that could possibly change the route or require actions on the part of the truck crew. When this signal is given, it is repeated throughout the truck and is often followed with a distance in meters.

**"Assault Through":** A command given by the convoy commander or senior vehicle commander for designated elements to dismount and/or maneuver vehicles offensively against threat forces, often preceded by "Contact L/R," or "Bailout L/R." Emphasis is conducting rapid swarm-like assault, taking the fight to the enemy.

**"Bail Out":** A command given by either the vehicle commander or driver for all occupants to egress from vehicle. The command should be followed with a "left" or "right" indicating the safest or "clean" side for personnel to consolidate. There may also be a requirement for personnel to move far from the vehicle to hard cover. This must also be indicated. For example: "Break contact, 9 o'clock, inside peel, 300 meters...."

**"Block":** The command to block is given when feeder roads, etc. need to be temporarily barricaded by designated vehicles in the convoy. Sometimes "left" or "right" follow the block command indicating a particular side of the road.

**"Blocking from the Rear":** Sometimes called the "Offset" formation, blocking from the rear is used to block third party traffic from the rear, enabling a collective uninterrupted lane change. The convoy commander can choose the time/location to allow third-party vehicles to pass on the convoy's right side (more fire power and no drivers).

**"Blow Through":** Command given by lead vehicle commander or convoy commander requiring entire element or vehicle to move through threat or area regardless of circumstances. Usually applies to intersections, improvised explosive device (IED) detonations, or small arms fire (SAF).

**"Brakes":** A signal from the driver to the vehicle occupants that he is applying the brakes, as well as from a forward vehicle commander warning other vehicles of the reduction in speed. The driver will state, "Brakes, Brakes, Brakes," with an urgency relative to how quickly he is applying them. **Note:** This signal is very important and can prevent unnecessary accidents/injuries.

**"Bump (up)":** Command given by designated vehicle commander or convoy commander indicating requirement for designated vehicles to bump up to a location to block.

**"Clear":** A statement indicating that a particular lane is clear. Often preceded by "left lane" or "right lane."

**"Contact":** A statement indicating that the element or portions of the friendly element are receiving hostile fire (SAF, IED, etc.). This statement is usually followed by a "left," "right," etc. specification.

**"Dismount":** A command given by the convoy commander indicating that all designated dismounts take up their assigned security positions outside the vehicles. Implies a longer duration halt and the requirement to seek cover, as well as search out "blind spots."

**"Man Down":** A statement given when a team member is injured and cannot continue the mission.

**"Quickstop":** A signal given by the vehicle commander to quickly dismount for a short period of time. Implies a shorter duration halt or "walk along" than the "Dismount" command.

**"(Re) Mount" (or "Recover"):** A command given by the convoy commander for all dismounts to return to their assigned vehicles. Implies headcount and accountability procedures. Sometimes preceded with preparatory command of "Prepare to Mount."

**"Reverse Out":** Command or signal for vehicles to back out of present location. Another version of this command is "Turn Out" indicating that designated vehicles perform three-point turn alternatively as opposed to reversing out.

**"Status":** A request from the vehicle commander/team leader requiring all team members to report.

**"Support":** A request for additional personnel to assist in security or target engagement.

**"Up":** A reply from each team member to the other team members that they are present, have their assigned equipment, and are uninjured.

**"Vehicle Down":** A statement indicating that a vehicle is inoperable and unable to move.



## CHAPTER 1

### SPECIAL OPERATIONS FORCES (SOF) COMBAT CONVOY OPERATIONS

#### Section I

##### Special Operations Forces (SOF) Mobility

Special operations forces (SOF) combat convoys: “A deliberately planned combat operation to move personnel and/or cargo via groups of tactical and/or unconventional ground transportation assets in a secure manner to/from a target destination under the control of a single commander in a permissive, uncertain, or non-permissive environment.”

(United States Special Operations Command (USSOCOM) Joint Counter-Ambush Advisory Team, Baghdad, Iraq and Afghanistan 2003-2004)

SOF mobility includes the following:

- Insertion method for direct action (DA) missions and special reconnaissance (SR) missions
- Low-profile movement and/or escort of precious cargo (high-value targets [HVTs]/prisoners, contacts, host nation [HN] personnel, or very important persons [VIPs])
- Resupply operations
- Quick reaction force (QRF) operations
- Civil-military operations (CMO)
- Humanitarian assistance (HA)
- Psychological operations (PSYOP)

#### Section II

##### Operation Iraqi Freedom (OIF)/Operation Enduring Freedom (OEF) Theater Threats

###### 1. General Theater Threats:

- Vehicle-borne improvised explosive devices (VBIEDs)
- Suicide bombers
- Rocket-propelled grenades (RPGs)
- Sniper fire

- Direct fire ambushes
- Grenade attacks
- Mortar attacks
- Hostile crowds
- Terrorist/hostile surveillance

### **2. Potential Specific Threats:**

- Locations/vehicles threat areas: (**Note:** Requires verbal call out to entire patrol)
  - Entrances to alleys
  - Rooftops and balconies (near and far)
  - Overpasses
  - Vans with sliding doors and motorcycles
  - Ambulances
  - Bicycles with baskets
  - Trucks with cargo
- Personnel threat areas:
  - Any crowd or gathering (markets, busy intersections, etc.)
  - Any person who appears not to fit in with the crowd or avoids eye contact

### **3. Principles of Patrolling:**

- Planning: Who, what, when, where, why, and how
- Reconnaissance: Use all available means to know routes; use advances
- Security: Everyone's responsibility; consider the three-dimensional (3-D) environment (depth, width, and elevation)
- Control: Rehearsals, briefings, and effective communications
- Common sense

### **4. Characteristics of SOF Combat Convoys:**

- Aggressiveness:



- Use aggressive, not "home town," driving skills
- A menacing "porcupine" muzzles outward posture (everyone except the driver faces outward)
- Predatory presence; "Go ahead...make my day" attitude
- Demonstrate a positive readiness and willingness to engage threats
- Potential use of vehicles as lethal force
- Dominate your environment
- Situational awareness (SA):
  - 360-degree security
  - Advance parties/reconnaissance
  - Know your route(s)
  - Collective mission knowledge
  - Well-rehearsed internal communication
  - Communication to higher (Blue Force Tracker [BFT])
  - Scanning in 3-D (depth, width, elevation)
  - Watching people, their hands, and their behavior
- Unpredictability:
  - Adapting to an already elusive and adaptive enemy
  - Vary routes, departure times, vehicle intervals, and vehicle speeds
  - Think like the enemy; "How would I attack me?"
  - Convoys should not be easily timed, observed, or approached
  - Do not appear lost
- Agility:
  - Driving as fast as appropriate
  - Maneuvering through or around motorists, pedestrians, etc.
  - Compressing or expanding vehicle intervals

- Be prepared to rapidly change course of action with well-rehearsed standing operating procedures (SOPs) and battle drills

### 5. Threats to Large Convoy Operations:

- SOF may participate in or conduct large convoys (more than four vehicles)
  - Consider the use of gun trucks as an escort force
  - Adapt techniques presented in this handbook such as convoy task organization, blocking, and dismounting.
- Large convoys are more challenging to control and many combat service support (CSS) vehicles (tractor trailers, FMTVs, buses) are virtually incapable of anything more than immediate self-defense.
- When working with indigenous drivers or passengers, do not allow them to use cell phones or to direct when the convoy will halt.
- Enforce operational security (OPSEC), cell phone use, and light discipline.

### Section III

#### Improvised Explosive Devices (IEDs)

IEDs are the greatest threats to convoys! Extremist groups continue to use IEDs to attack coalition forces in an attempt to discredit security efforts.



Figure 1-III-1: Various types of IEDs

- Why use an IED?
  - Low cost and components are readily available (“more bang for the buck”)
  - Easily disguised and exposes the terrorist to a low risk of exposure when attacking
  - Provides anonymity
  - Psychological warfare at its most vicious level
- When can you expect an IED attack?
  - Because of reduced exposure time compared to a traditional ambush, anytime is a good time for an IED strike
  - Morning is especially dangerous because many IEDs are placed under cover of darkness
  - Periods of reduced visibility
- IEDs can be disguised as anything or hidden anywhere.



**Figure 1-III-2: Typical IED configurations**

- Types of IED attacks:

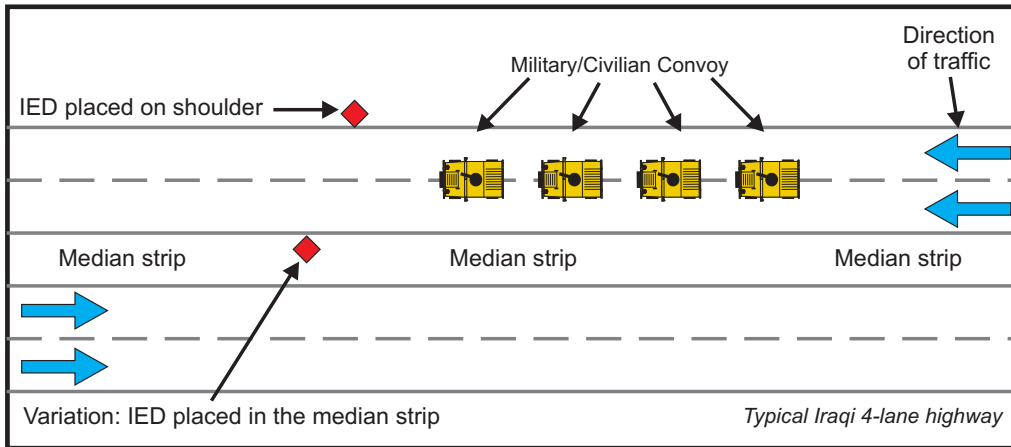

Figure 1-III-3: The basic attack

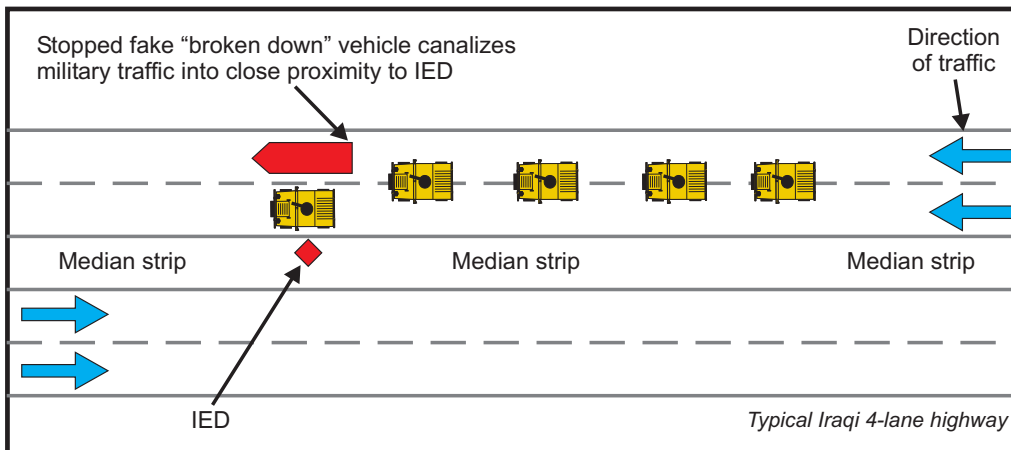

Figure 1-III-4: Channeling traffic to pass an IED



Figure 1-III-5: The multiple IED attack

(Note: IED can also be hidden in trash or debris rather than in vehicles.)

- Categories for suspected IEDs: The commander on the ground must decide what actions to take in the event of suspected IEDs. Some options are better than others and METT-TC factors will dictate whether to blow through, observe and/or report, inform explosive ordnance disposal (EOD), or destroy the device unilaterally.
  - Category 1, potential IED: An area or condition that has a high potential for IED use, such as roadside trash, many small rocks, etc. This may be a location where IEDs have been used before.
  - Category 2, suspected IED: Signs of on-going emplacement but no visible devices. This situation should be reported immediately and action is required if the enemy is present.
  - Category 3, possible IED: Objects, activities, or conditions requiring treatment as though an IED is present due to context and conditions (rucksacks, mailbags, dead animals, MRE packages, roadside mounds, rock piles, etc.). There may be no obvious IED indicators; however, this situation requires reporting and EOD verification.
  - Category 4, probable IED: Device identified by, but not limited to, clear indicators of imminent IED activity including protruding wires or an individual with command device or other similar devices used in proximity of the activity and/or location. These situations are verifiable and easily identified and require EOD "render safe procedures" (RSP).

- How to protect yourself:
  - Stay alert; make yourself a “hard target.”
  - Be prepared for IED attack followed by ambush.
  - Be and appear vigilant; personnel who look ready to fight back make bad targets.
  - Maintain maximum safe speeds.
  - Maintain vehicle dispersion.
  - Be extra cautious at choke points: Iraqi vehicle breakdowns, bridges, one-way roads, traffic jams, and sharp turns.
  - Overpasses have been used to attack friendly forces by IED, direct fire, and horizontal wires.
    - \* Unit must have a number of options they can execute randomly at every overpass.
    - \* When possible send a vehicle forward to scout the danger area.
  - If something causes the convoy to stop, watch the flanks for IEDs; dismount with weapons at the ready.
  - Vests and helmets save lives, wear them!
  - Ballistic eye protection saves eyesight.
  - Rehearse actions on contact for an IED.
  - Get out of the “kill zone” fast.
  - Do not approach the IED; IEDs are often command-detonated.
  - Brief all convoy personnel on latest IED threat; what types of IEDs are being used and where have they previously been emplaced on your route?

### **Section IV**

#### **Situational Awareness (SA)**

A key element to survival is your ability to assess your operational environment or SA. The following are possible indicators of an ambush:

- Absence of women and children when normally present
- Dramatic changes in population from one block to the next

- Intelligence reports that a “blue X” on rocks indicates an IED site
- Signals with flares/city lights (turned off/on) as convoy approaches
- Vehicle following convoy for long distances and then pulling off the side of the road prior to an ambush
- Broken down vehicles along the roadways
- Dead animals along the roadways
- Freshly dug hole along the roadway indicates possible future IED site (report it)
- Obstacles in roadway used to channel the convoy
- Personnel on overpasses
- Personnel inside traffic circles

## **Section V**

### **Rules of Engagement (ROE)**

**ROE is dynamic and changing. Refer to your unit for the most current available information.**

Combined Forces Land Component Command (CFLCC) ROE:

- On order, enemy military and paramilitary forces are declared hostile and may be attacked subject to the following instructions:
  - Positive identification (PID) is required prior to engagement. PID is a reasonable certainty that the proposed target is a legitimate military target. If no PID, contact your next higher commander for a decision.
  - Do not engage anyone who has surrendered or is out of the battle due to sickness or wounds.
  - Do not target or strike any of the following except in self-defense to protect yourself, your unit, friendly forces, and designated persons or property under your control:
    - \* Civilians
    - \* Hospitals, mosques, churches, shrines, schools, museums, national monuments, and any other historical or cultural sites

- Do not fire into civilian populated areas or buildings unless the enemy is using them for military purposes or if necessary for your self-defense; minimize collateral damage.
- Do not target enemy infrastructure (public works, commercial communication facilities, or dams), lines of communication (roads, highways, tunnels, bridges, or railways), and economic objects (commercial storage facilities or pipelines) unless necessary for self-defense or if ordered by your commander. If you must fire on these objects to engage a hostile force, disable and disrupt, but avoid destruction of these objects, if possible.
- The use of force, including deadly force, is authorized to protect the following:
  - Yourself, your unit, and friendly forces
  - Enemy prisoners of war
  - Civilians from crimes that are likely to cause death or serious bodily harm, such as murder or rape
  - Designated civilians and/or property, such as personnel of the Red Cross/Crescent, United Nations (UN), and U.S./UN supported organizations
- Treat all civilians and their property with respect and dignity. Do not seize civilian property, including vehicles, unless you have the permission of a company-level commander, and you give a receipt to the property's owner.
  - Detain civilians if they interfere with mission accomplishment or if required for self-defense.
  - United States Central Command (USCENTCOM) General Order No. 1A remains in effect. Looting or taking war trophies is prohibited.
- Remember the following:
  - Attack enemy forces and military targets.
  - Spare civilians and civilian property, if possible.
  - Conduct yourself with dignity and honor.
  - Comply with the Law of War. If you see a violation, report it.
- ROE will remain in effect until your commander orders you to transition to post-hostilities ROE.



## Section VI

### Combat Convoy Planning

Convoy Sequence of Events:

- Initiate troop leading procedures (TLP):
  - Receive the mission.
  - Issue the warning order.
  - Make a tentative plan.
  - Initiate movement.
  - Conduct reconnaissance.
  - Complete the plan.
  - Issue the operations order.
  - Supervise execution.
- Conduct initial coordination.
- Gather route intelligence and reconnaissance data.
- Delegate preparatory tasks.
- Conduct thorough convoy briefing.
- Conduct convoy operation.
- Conduct after action review (AAR):
  - Introduction and rules
  - Commander's mission and intent (what was supposed to happen)
  - Relevant doctrine and tactics, techniques, and procedures (TTP)
  - Summary of recent events (what happened)
  - Discussion of key issues (why it happened and how to improve)
  - Discussion of optional issues
  - Discussion of force protection issues (discussed throughout)

- Closing comments (summary)
- Document and disseminate
- Recover and prepare for follow-on mission.

## **Section VII**

### **Mission, Enemy, Terrain and Weather, Troops and Support Available, Time Available, and Civil Considerations (METT-TC)**

#### **1. Mission:**

- Clarity of task and purpose for both convoy and actions at the target destination
- Remember OPSEC and deception
- ROE and weapons status considerations
- Standing risk assessment
- Contingency planning: (GOTWA)
  - **G**oing (where)
  - **O**thers I am taking
  - **T**ime of my/our return
  - **W**hat to do if I/we do not return at that time
  - **A**ctions to take if I come in contact/if you are in contact
- Rehearsals

#### **2. Enemy:**

- Known and suspected ambush/IED locations along route
- Get updates on latest enemy TTP for the area of operations
- Gather latest lessons learned (combined explosive exploitation cell [CEXC], CALL, etc.)

#### **3. Terrain and Weather:**

- Use most recent imagery, maps, and Falcon View
- Request daylight route overflight (unmanned aerial vehicles [UAVs] or fixed/rotary-wing air reconnaissance)
- Urban, rural, or open highway travel

- Plan both primary and alternate outgoing and return routes
- Use recognizable checkpoints

#### **4. Troops and Support Available:**

- Deconflict with friendly elements along routes
- Coordinate with support assets: emergency close air support (ECAS), rotary-wing, QRF, armor support, and casualty evacuation (CASEVAC)
- Assign personnel to duties early, and ensure that they are capable of performing those duties
- Set up, line up, and inspect vehicles
- Have subordinates backbrief key portions of plan
- Consider fatigue, night driving, boredom, personal relief, “cocoon” mentality (armored vehicles)

#### **5. Time Available:**

- Post and adhere to a realistic timeline
- Missions can be time sensitive
- Use template plans (“off-the-shelf”)
- Utilize simple concept of operations (CONOPS) and field fragmentary orders (FRAGOs)
- With more time, use PowerPoint® briefs showing the route on photo imagery

#### **6. Civil Considerations:**

- Consider effects of recent coalition offensive operations in area where route passes
- Cultural knowledge of hand signals and tribes
- Interpreters
- Curfew times
- Driver behavior
- Curiosity



**Figure 1-VII-1: Civil considerations**

## **Section VIII**

### **Task Organization**

The SOF convoy commander designates primary and alternate tactical responsibilities (advance, lead, follow, counter assault) to each ground mobility vehicle (GMV) or non-tactical vehicle (NTV) with respect to the enemy situation. Though a SOF unit may have fewer than three or four vehicles for a given operation, the convoy commander must consider and assign the responsibilities to the vehicles best suited to the task. The following task organization is a model.

#### **1. Advance Vehicle**

- Moves well ahead of the main formation (kilometers, city blocks, or period of time)
- Verifies the planned route, provides early warning, establishes checkpoints, and prepares for the main body arrival at target destination
- Non-tactical or local-looking vehicle is recommended as an advance vehicle
- Rotary wing aircraft (AH-6, MH-60, or MH-53) also used as advance vehicle

#### **2. Lead Vehicle**

- At times lead vehicle serves as the advance by bumping out ahead of the main body

- First vehicle in the main body
- Provides tactical decision making and immediate warning of potential threats
- Convoy commander normally rides in the lead vehicle

### **3. Follow Vehicle**

- Last vehicle in the main body
- Responsible for rear security, blocking traffic, accountability, medical support, and tactical recovery or evacuation on contact
- The assistant convoy commander, often the NCOIC, usually rides in the follow vehicle

### **4. Counter Assault**

- Counter assault is a force or vehicle responsible for taking the fight to the enemy with direct offensive ground maneuver
- Has capability to breach structures and perform vehicle recovery
- Ideally located, as a reserve, in a vehicle that remains well behind the main body
- Counter assault force is located in the trail vehicle or is a QRF

## **Section IX**

### **Vehicle Considerations**

#### **1. Vehicle Selection for Special Operations:**

- Up-armored tactical
- Light-skinned tactical: GMV
- NTV: armored
- NTV: light skinned

#### **2. Vehicle Considerations:**

- Armor versus no armor
- Turrets
- Tire selection
- Suspension

- Road-worthiness
- Manual or automatic transmission
- Seating
- 2 x 4 versus 4 x 4
- Communications equipment

**3. Vehicle Characteristics:**

- Fire power
- Ballistic protection
- Ability to accelerate
- Maneuverability
- High or low profile
- Reliability



**Figure 1-IX-1: Vehicle characteristics**

## Section X

### Duties and Responsibilities

#### 1. Convoy Commander/Officer-in-Charge (OIC):

- Vehicle commander for lead or second vehicle
- Overall responsibility for conduct of convoy
- Ultimate on-ground decision maker
- Task organizes vehicle responsibilities
- Conducts convoy brief and after action review (AAR)
- Generally travels in lead or second vehicle
- Monitors, supervises, and controls convoy
- Maintains communications with higher authority

#### 2. Vehicle Commander (VC): (Note: VC cannot be the CSW operator or the driver.)

- Responsible for equipping, organizing, and supervising required tactical activities of assigned vehicle
- Task organizes a fire team minimum per vehicle
- Maintains communications with convoy commander and other vehicle commanders
- Provides direction to driver
- Serves as alternate navigator
- Designates alternate driver
- Designates crew-served weapon (CSW) sectors of fire

#### 3. Vehicle Driver (DR):

- Operates vehicle (drivers will not shoot while driving)
- Takes direction from the VC
- Responsible for fueling and maintaining vehicle
- Can be rotated
- Must be a skilled driver
- Does not dismount unless mission is complete or is bailing out

### **4. Navigator (NAV):**

- Responsible for primary and alternate route selection
- Maintains awareness of location (map, Global Positioning System [GPS], etc.)
- Communicates checkpoints, turns, danger areas, etc. to VC
- Records changes to route post-operation to S-2
- Responsible for covering assigned sector with direct fire

### **5. Crew-Served Weapon (CSW) Operator:**

- Responsible for primary and alternate sectors of fire
- Targets greatest threat
- Can be rotated out

### **6. Security Personnel (SEC):**

- Observe for potential close threats
- Signal and direct civilian traffic as required by vehicle commander
- Can rotate as necessary into other positions (except for NAV or VC)
- Dismount on order
- Under duress, can serve as alternate VD, NAV, CSW operator, or VC.

### **7. Convoy Tracker:**

- Responsible for tracking the location and disposition of the convoy at the point of origin
- Participates in convoy planning, briefings, and rehearsals
- Maintains and terminates communications with convoy



**Section XI**  
**Vehicle Positions**

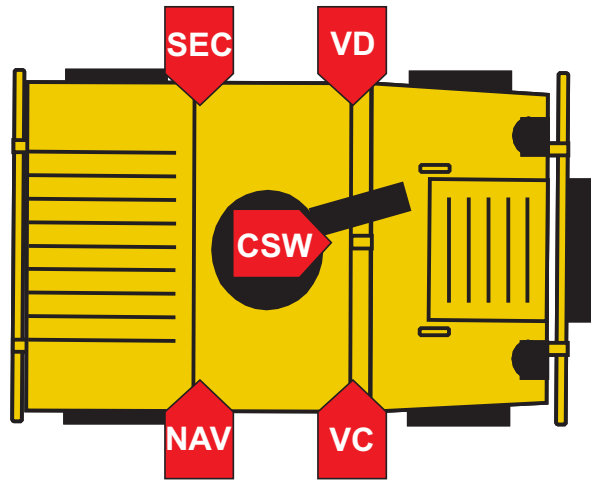

Figure 1-XI-1: Vehicle position designations

**Section XII**  
**Vehicle Preparation Techniques**

**1. Shoot:**

- Ammo for CSW behind the turret to balance weight on the turret bearings
- Ammo can in front of vehicle can be used to store flash bangs, fragmentation grenades, smoke grenades, and baseball-sized stones.
- Use of spot lights and marking lasers for deterrence
- Smoke launchers
- Rehearse dismounted/mounted live-fire shooting drills

**2. Move:**

- Place tire on brush guard, in the absence of a bumper, for pushing objects or ramming.
- Tow lines are attached to the frame tow point, then lightly attached to hood lift point, and the running end with a 10,000 pound carabiner is attached at the corner of the driver's windshield. (Refer to technique in Figure 3-I-2)
- Tow line in rear comes up to right rear door.

- Attach running boards/foot rests.
- Carry enough extra fuel to complete all missions.
- Consider using run-flat tires designed to maintain mobility after being punctured.

### 3. Communicate:

- Ensure everyone knows how to zero all radios.
- Intra-squad/inter-vehicle radios.
- During daytime rural missions, have computer with imagery/Falcon View in the primary navigation vehicle for contingency situations and positive target identification.
- Omni-directional antennas (X-wing) are recommended for satellite communications. (**Note:** Ensure antenna is not placed in CSW swing-arc or field of fire. The higher and more centered on the vehicle roof, the better the satellite reception.)
- Consider thermite grenades for emergency destruction (should only be wired by a qualified special forces [SF] 18C, sea-air-land [SEAL] team demolitions specialist or [EOD]) using emergency destruction procedures according to SOP.
- Consider placing radios in rucksacks for faster egress, increased ability to maintain communications, faster recovery, and to preclude the need to destroy the radio when bailing out.

### 4. Communications Equipment:

- AN/PRC 119D Single Channel Ground and Airborne Radio System (SINCGARS) for command and control (C2) vehicle
- External speaker
- AN/PSC 5C/D (multiband interface tactical radio [MBITR]) for ground/air communications
- Bail out backpack for evasion and recovery (E&R)
- Each man will have intra-squad radio (MBITR or Motorola)
- Crypto equipment for all radios
- Blue Force Trackers in accordance with unit SOP
- Primary, alternate, contingency, emergency (PACE)
- Iridium and Thuraya (satellite phones) for back-up

### 5. Survive:

- Load-outs for similar vehicles should be nearly identical in order to reduce confusion at night and under stress.
- Tailgate is clean, allowing access to bed for HVTs or wounded and alternate sector of fire for rear/flank security
- Ballistic blankets must be used with 6-mm/1/4 inch steel plate and strapped/secured to areas requiring additional protection
- Sandbags should be used with discretion; consider added weight, space needed, and secondary missile effects
- Fire extinguishers (large enough to extinguish a person on fire)
- M-5 medical bags and stretchers
- Ballistic helmet, ballistic eye protection, gloves, and Level IV body armor
- All doors removed from light skinned tactical vehicles (situation dependent)
- When an informant is attached, they will remain in an armored vehicle
- Use flash bangs, hand and arm signals, or point weapon systems to disperse crowds
- Drive your rifle muzzle into the chest of non-compliant personnel to create interpersonal distance
- Use combative striking skills (palm strikes, elbows) to protect weapon



**Figure 1-XII-1: CSW operator has immediate access (from left to right) to flashbangs, fragmentary grenades, HC smoke, and small rocks. (Note: MK 19 can be used for storing a greater amount of ammunition)**



**Figure 1-XII-2: PEQ-2 on fabricated mount (note tracer starter belt)**

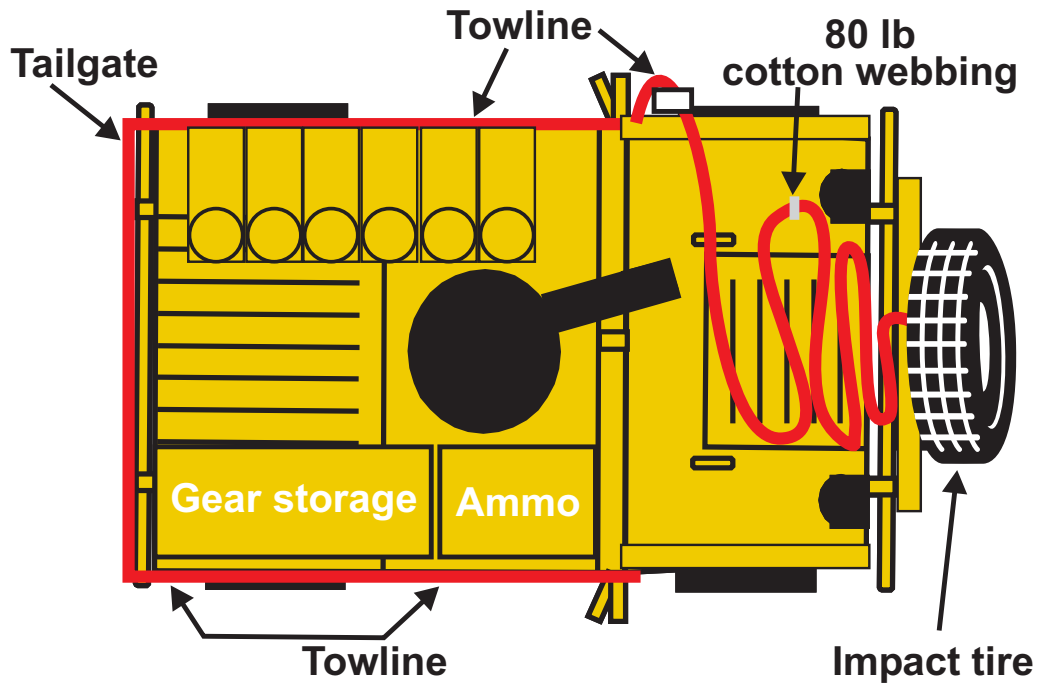

Figure 1-XII-3: Setting up vehicle



Figure 1-XII-4: Setting up vehicle, side/front view



Figure 1-XII-5: Setting up vehicle, rear view



CHAPTER 2

MOUNTED TACTICS

Section I

Formations and Movement Techniques

1. Vehicle Transit Formations:

- Drive as fast as appropriate.
- Control convoy speeds to prevent spreading out or rear vehicle from falling behind.
- Convoy speed is determined by the slowest vehicle or the rear vehicle's ability to catch up.
- Infrared lights during night convoys will help with communications in traffic areas and at stops.
- Rear security is necessary to prevent vehicles from approaching from any direction.
- Maintain an aggressive posture in order to keep vehicles from approaching too close.
- Vehicles 1 and 3 are the foundation of the formation and need to maintain position and speed.
- Vehicles 2 and 4 block and cover security on the move.

(Note: Convoy commander ultimately decides upon responsibilities within larger convoy formations.)

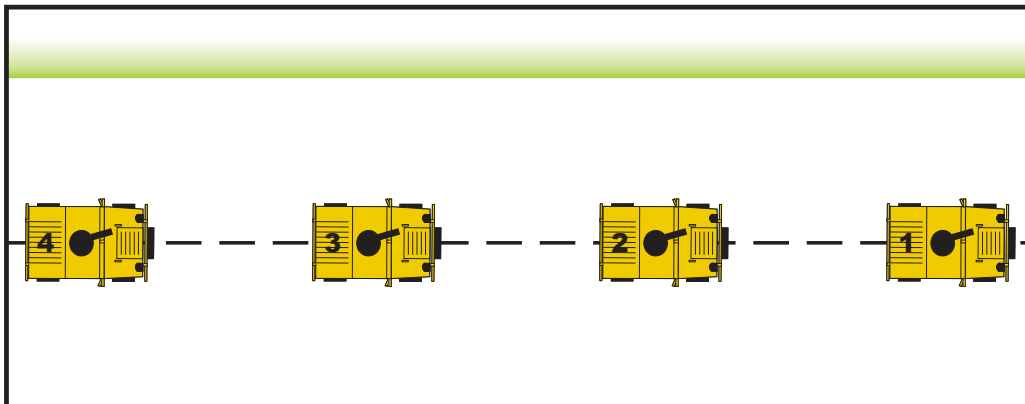

Figure 2-I-1: Vehicle transit formations (file)

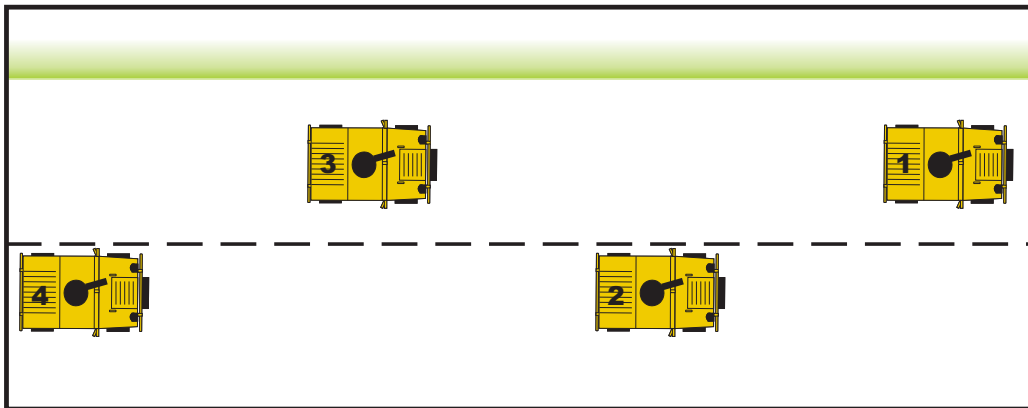

Figure 2-I-2: Vehicle transit formations (staggered)

**2. Fields of Fire:**

- CSW operators cover their assigned sector, but must be prepared for contact from any direction.
- Coverage is a rotating 360-degree field.
- Right side of convoy generally has the greatest firepower because of driver's inability to shoot.
- Assume an aggressive posture.
- Using overt lights at night to scan is perceived as aggressive.



Figure 2-I-3: Vehicle fields of fire

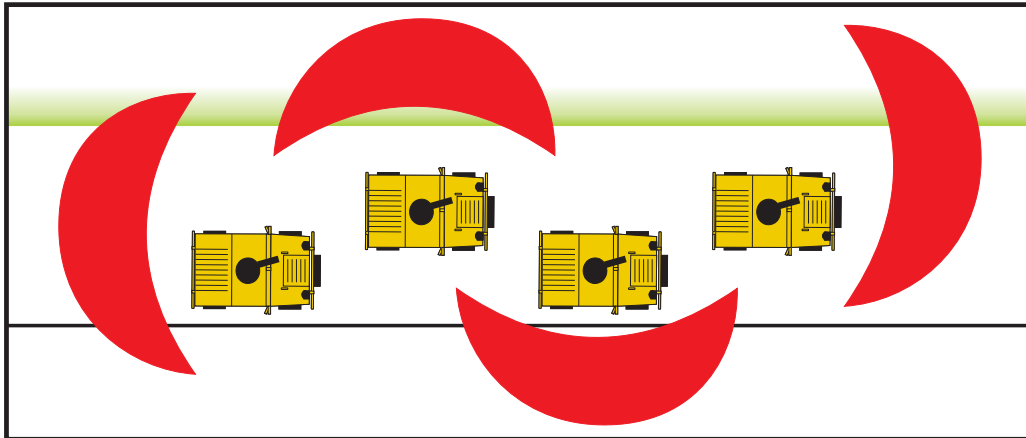

Figure 2-I-4: Vehicle fields of fire

**3. File Formation:**

- The base formation for all movement
- Easy to control

**4. Stagger Formation:**

- Enables more "outs" at terminal positions during contact
- Used for protection of softer vehicles
- Enables greater headlight coverage at night
- Blocks the road
- Interlocks fields of fire

**5. React to Overpass:**

- Accelerate
- Adjust interval
- Change lanes completely or randomly weave between lanes
- Observe the entire danger area, both under and immediately beyond the overpass
- Use traveling or bounding overwatch techniques to approach overpasses

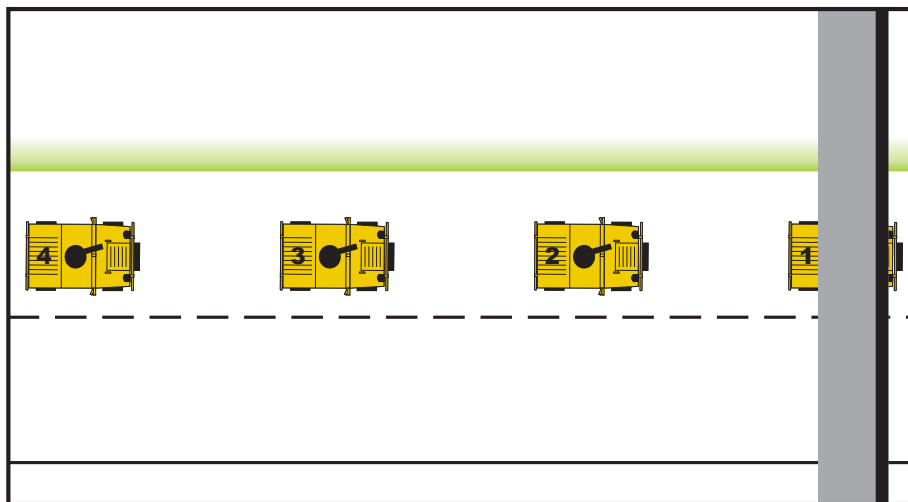

Figure 2-I-5: Overpasses

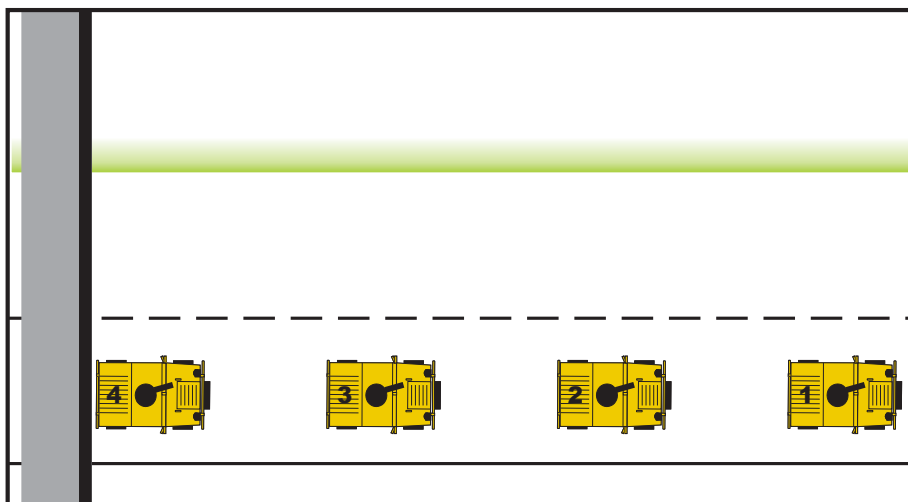

Figure 2-I-6: Overpasses

Section II

Blocking and Bumping Techniques

1. Blocking From Rear:

- Vehicle 2 is used to block intersections and traffic coming into the convoy. Vehicle 2 is bumped forward by rear security
- “Block right” call comes from vehicle commander (VC) in vehicle 1
- Used mainly in large intersections and are primarily planned in advanced

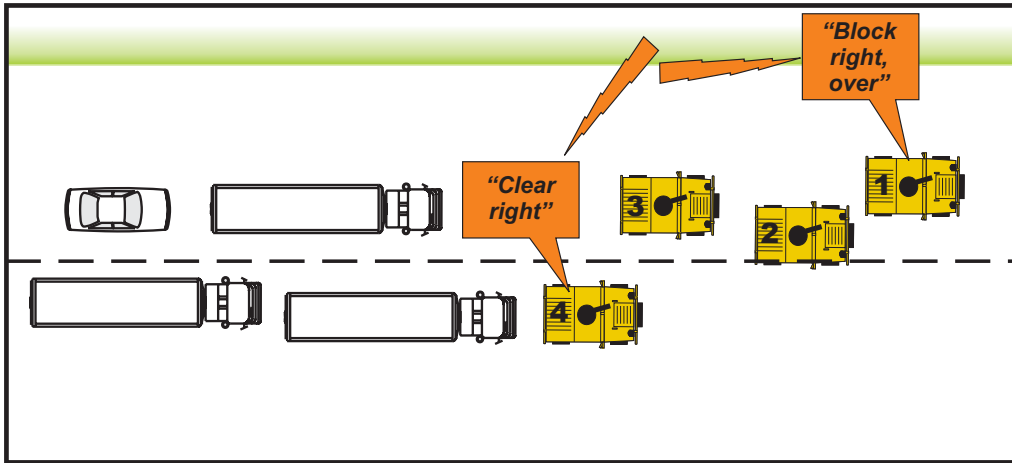

Figure 2-II-1: Blocking from rear

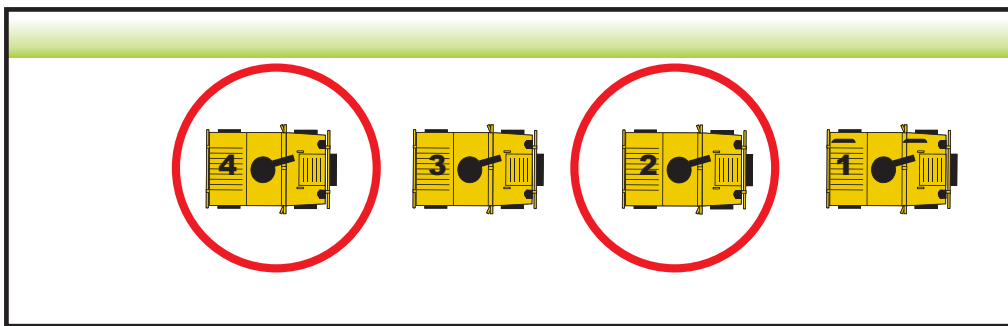

Figure 2-II-2: Bump/block call made from front; vehicles 2 and 4 prepare to move

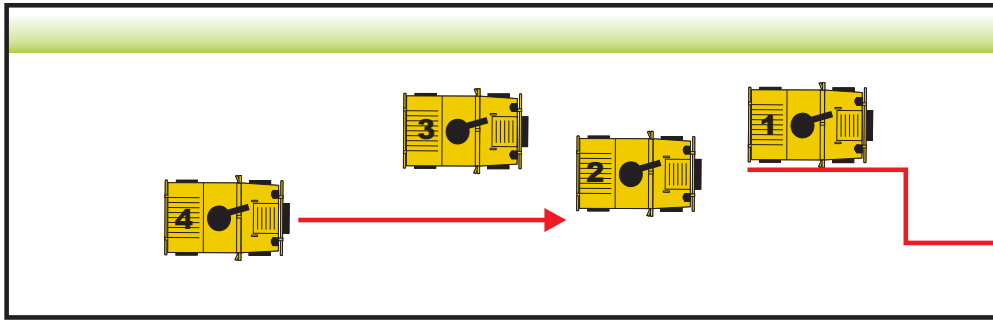

Figure 2-II-3: Vehicles 2 and 4 break out and bump up to block intersection

**2. Blocking on Ramps:**

Vehicle 2 runs initial block, vehicle 4 bumps 2 out and takes up the blocking position, and vehicle 2 falls back into formation. When all vehicles pass, vehicle 4 reconstitutes.

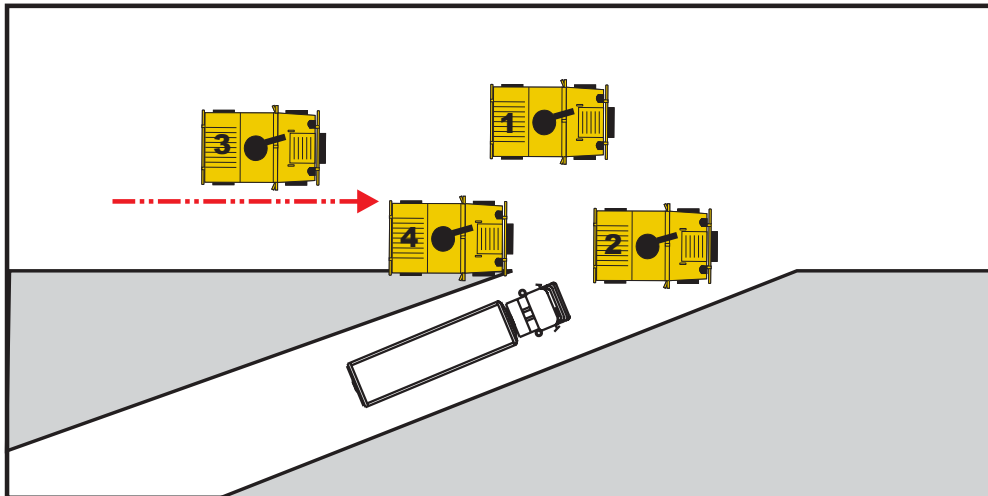

Figure 2-II-4: Blocking on ramps

**3. Intersection Blocking :**

Vehicle 2 initially blocks, vehicle 4 bumps up then assumes blocking position, and vehicle 2 falls back into formation. When all vehicles pass, vehicle 4 reconstitutes.

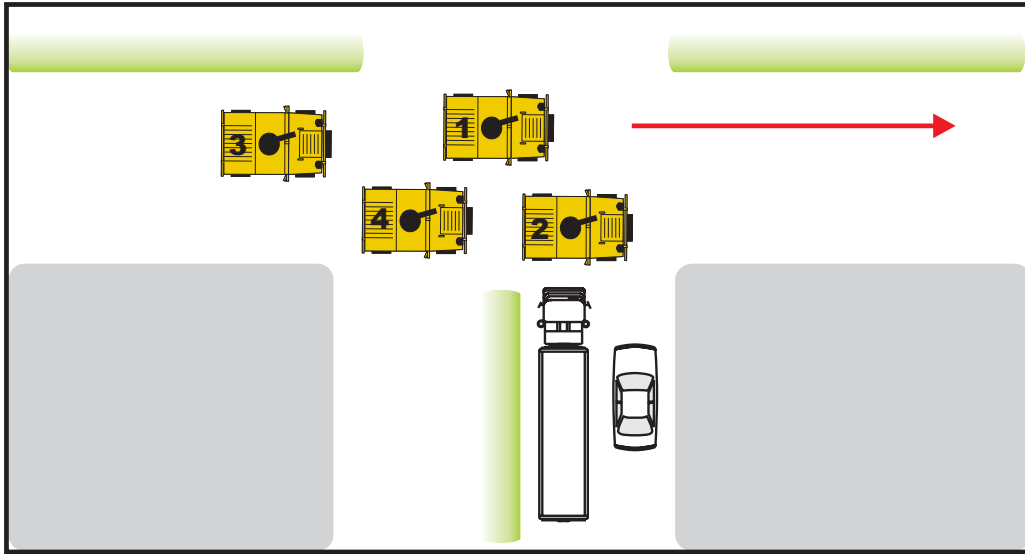

Figure 2-II-5: Intersection blocking

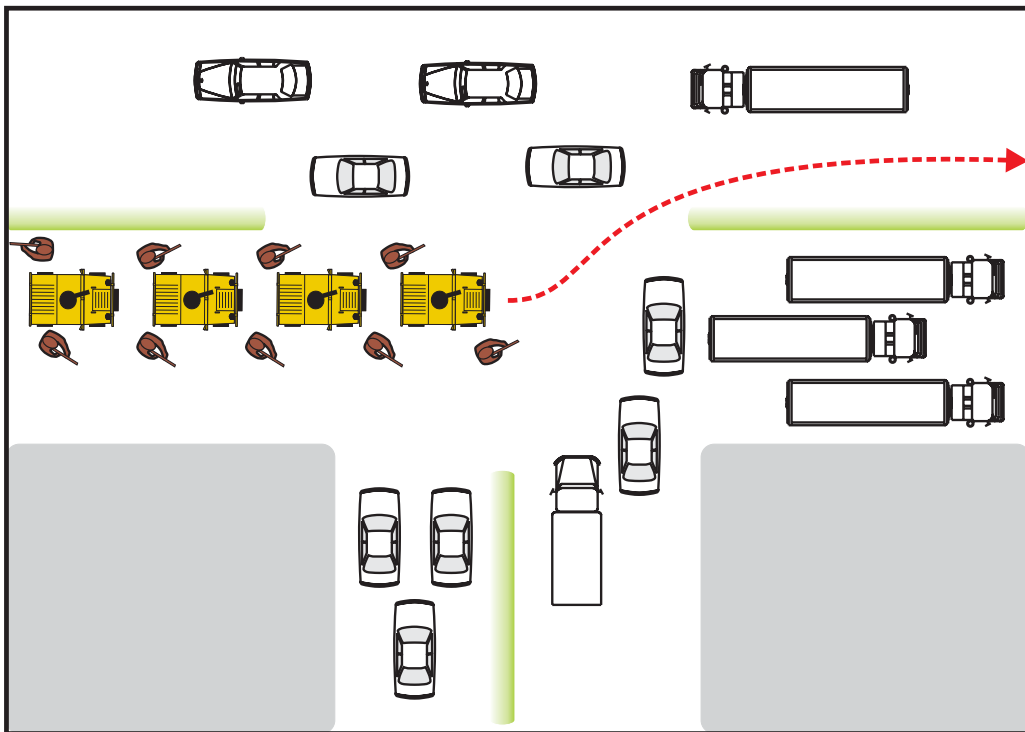

Figure 2-II-6: Vehicles in heavy traffic

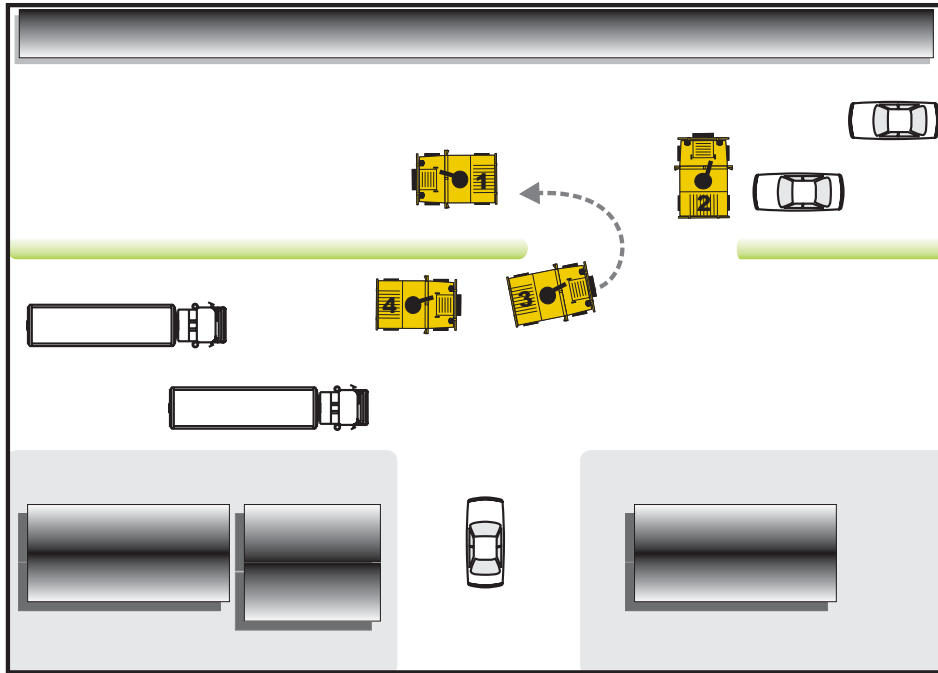

Figure 2-II-7: Blocking on U-turns

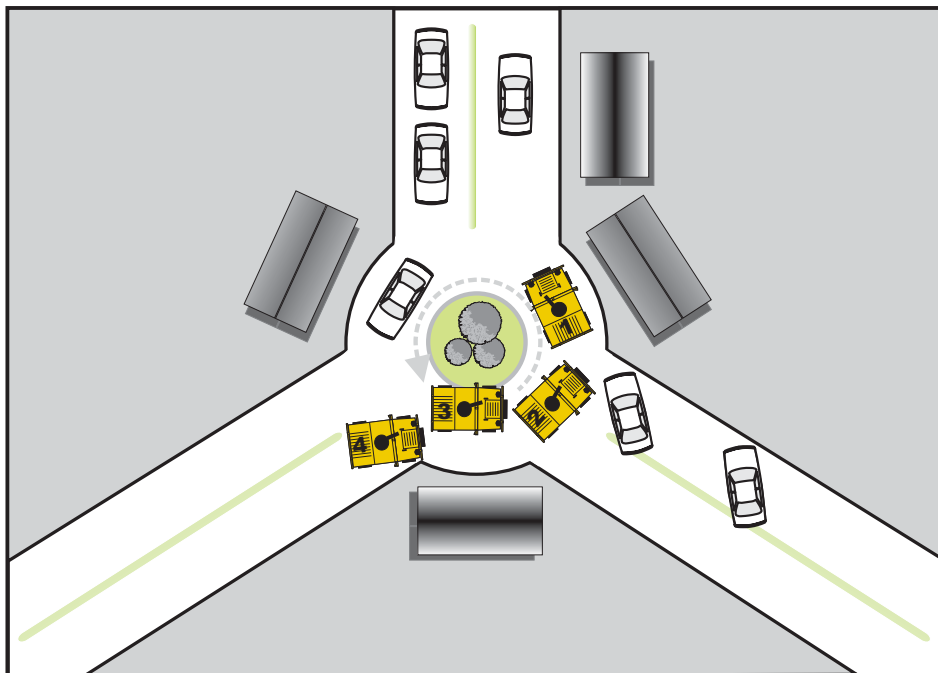
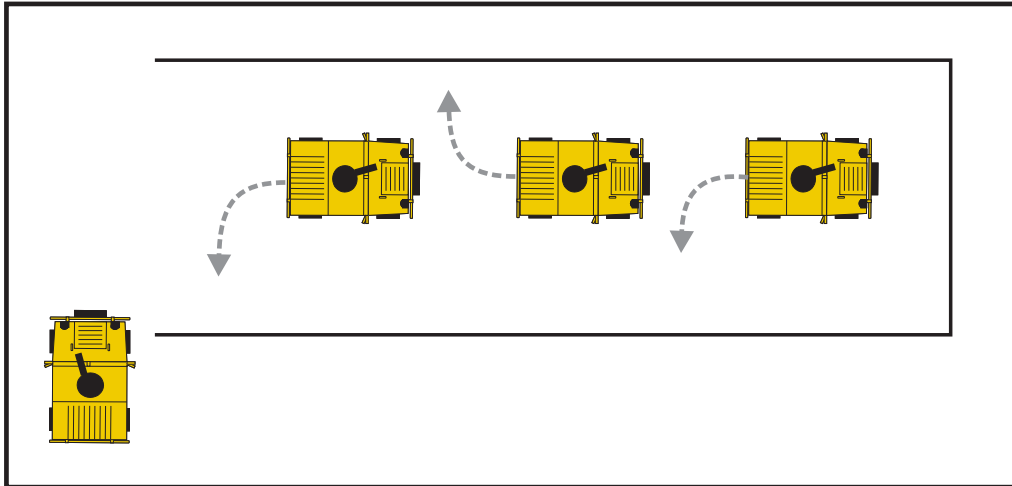

Figure 2-II-8: Blocking on traffic circles



**4. Dead End Breakout:**

- Last vehicle in immediately backs to "out" that provides hard cover
- Dismount as necessary to provide 360 degrees mutually supporting security
- Remaining vehicles initiate alternating 3-point turns in order to maintain observation of one another, as well as potential threats



**Figure 2-II-9: Dead end breakout**

- Dismounts provide overwatch
- Vehicles continue 3-point turns or backing in bounds if area is too narrow

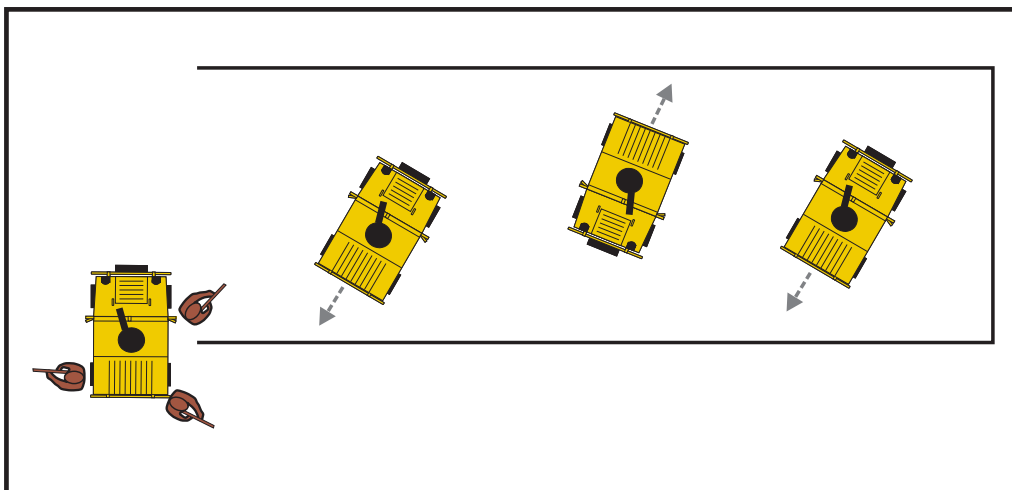

**Figure 2-II-10: Dead end breakout**

(**Note:** If vehicles opt to back out, they will still require space for 3-point turns once out. Cover vehicle designates that point.)

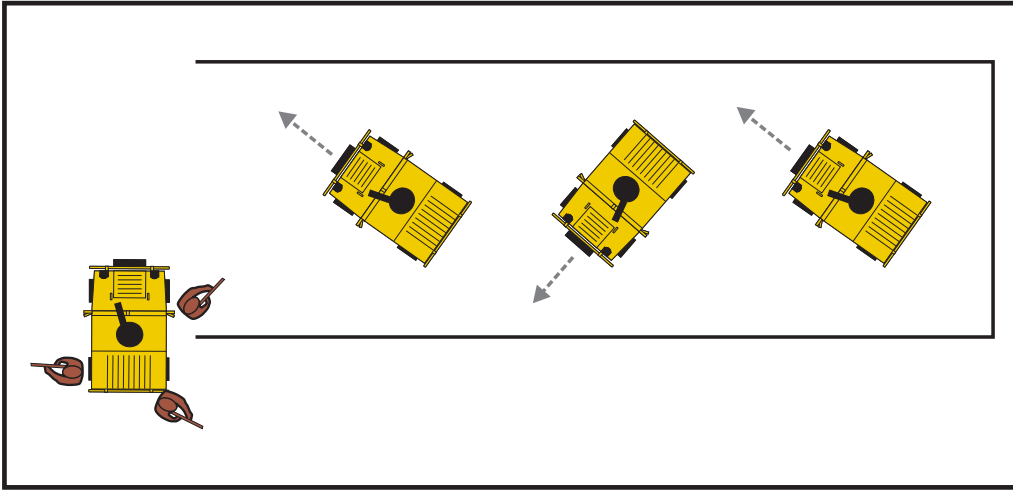

**Figure 2-II-11: Dead end breakout**

- Vehicles reconstitute and orient for a new direction of travel

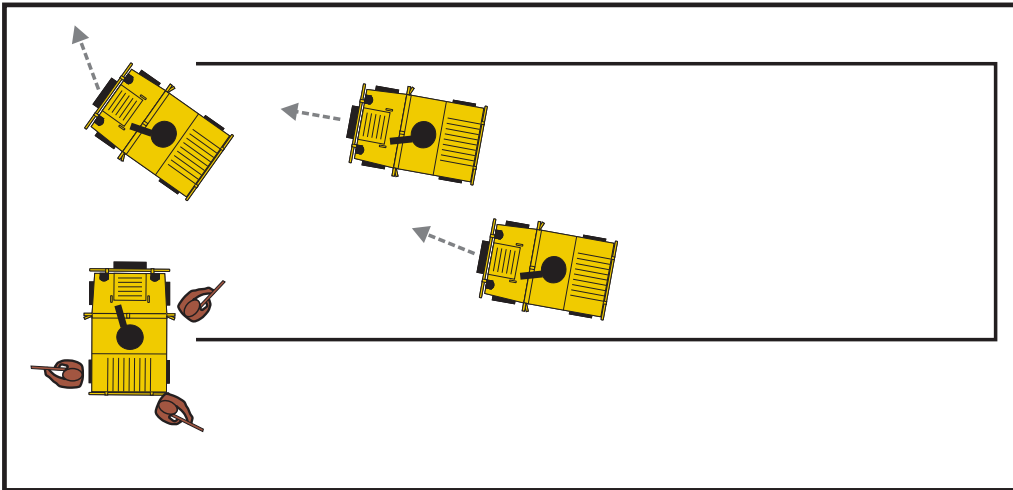

**Figure 2-II-12: Dead end breakout**

- Dismounts re-mount and last vehicle begins to move in its original position

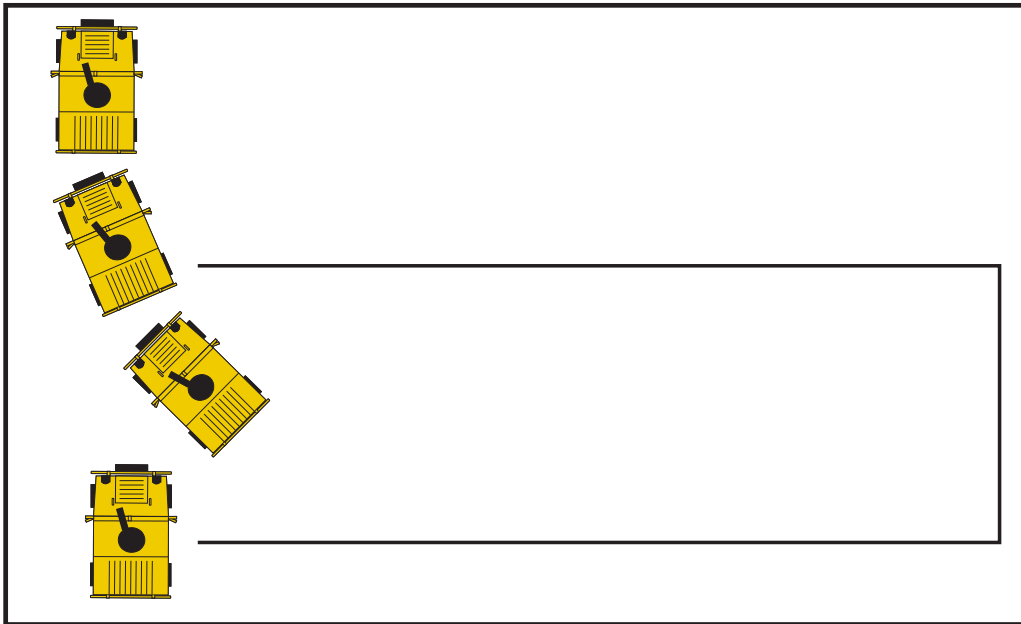

Figure 2-II-13: Dead end breakout

**5. Oncoming Traffic:**

- Driving through oncoming traffic is used when there is a traffic jam or to correct direction, or it may be the only route for an upcoming turn.
- When driving the wrong way, unmask heavy weapons and favor one side of the road.
- Use arm and hand signals to push vehicles to the opposite side of the road. If that does not work, draw down on them and they should move or stop.
- Keep tight and find your out or turn fast.

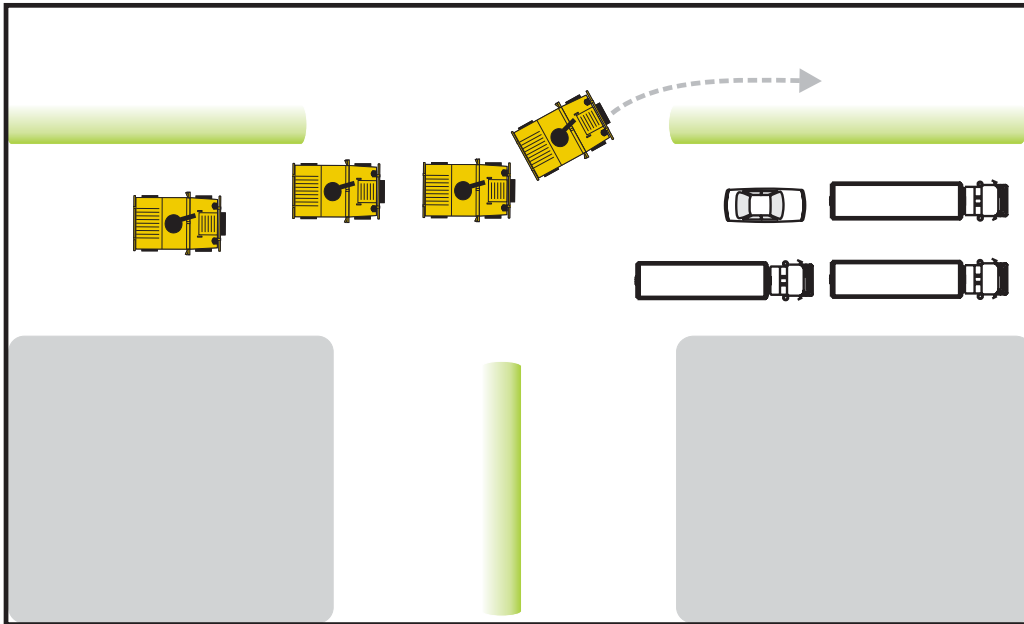

Figure 2-II-14: Oncoming traffic

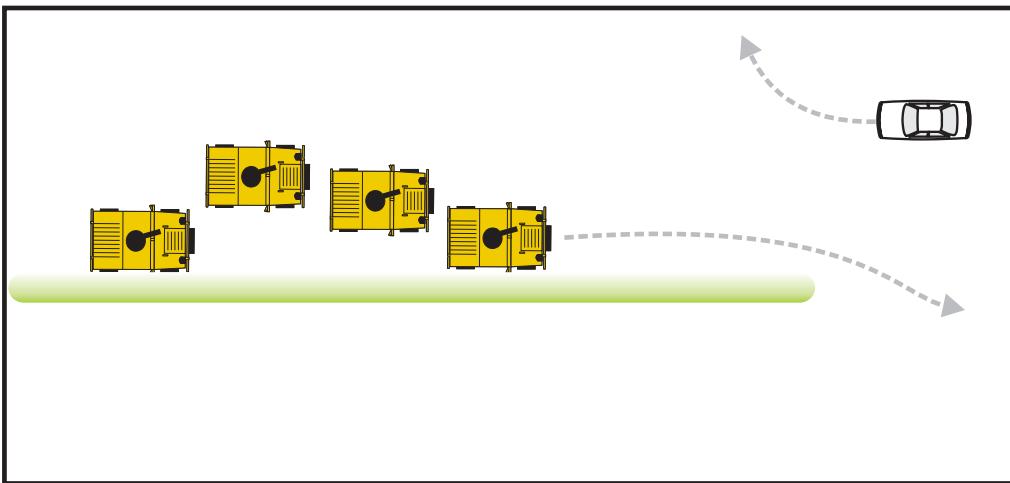

Figure 2-II-15: Oncoming traffic

Section III

Dismount and Remount Procedures

1. Dismount/Quickstop Procedures:

- Dismount or quickstop call is made by CC through VC.
  - Quickstop: for short duration halts or moving alongside vehicles in heavy traffic, markets, etc.
  - Dismount: Longer duration stops that involves greater use of individual head cover and clearance of "blind spots."
- Moving forward can also signal the mounting call.
- Protect space between vehicles.
- Rear security is the only one behind a vehicle, but should stay off to the side, extra security only if severely short of personnel.
- Use your weapon to motion people back.
- As a last resort, a muzzle or palm strike will get their attention.
- If contacted, move to a hard point, suppress fire, or mount and extract (situation dependent).

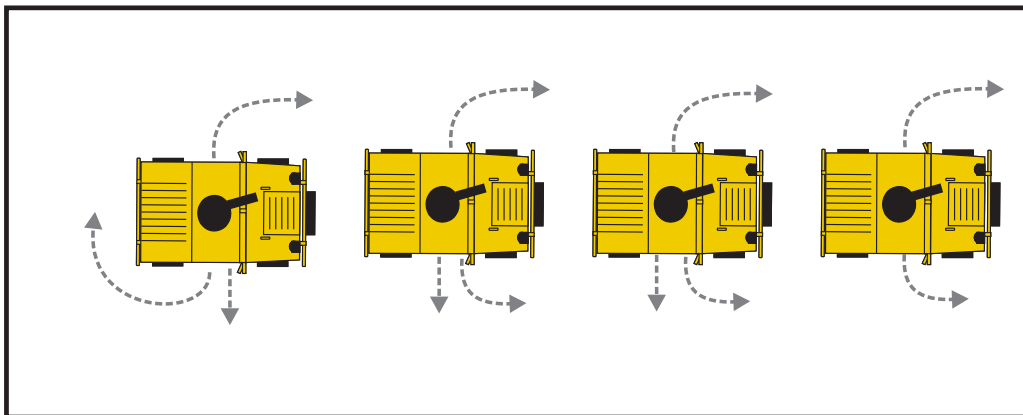

Figure 2-III-1: Dismount/Quickstop points of domination

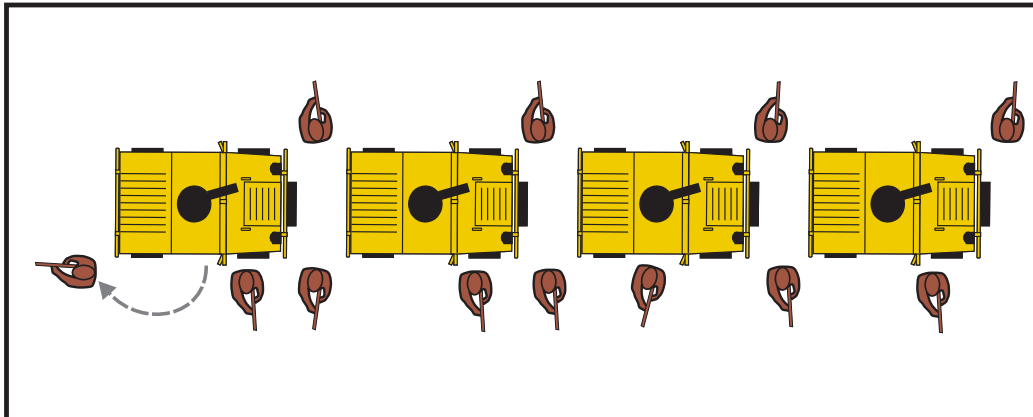

Figure 2-III-2: Dismount/Quickstop points of domination

## 2. Dismount/Mount Drills:

- Protect your back side with a wall or building.
- Have two ways out, if necessary. Drive through pedestrians to save friendly lives.
- Man heavy guns.
- Drivers can stand next to driver's seat and provide extra security only if severely short of personnel.
- Push security out to a comfortable distance.
- No indigenous personnel/vehicles allowed between vehicles.
- Seek cover and achieve interlocking sectors of fire

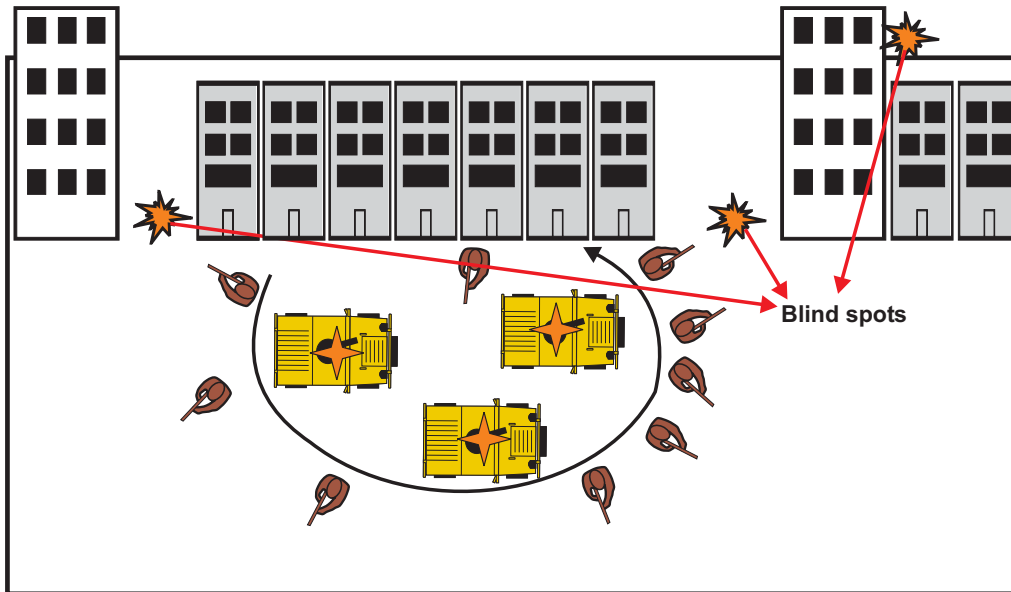

Figure 2-III-3: Dismount/mount drills

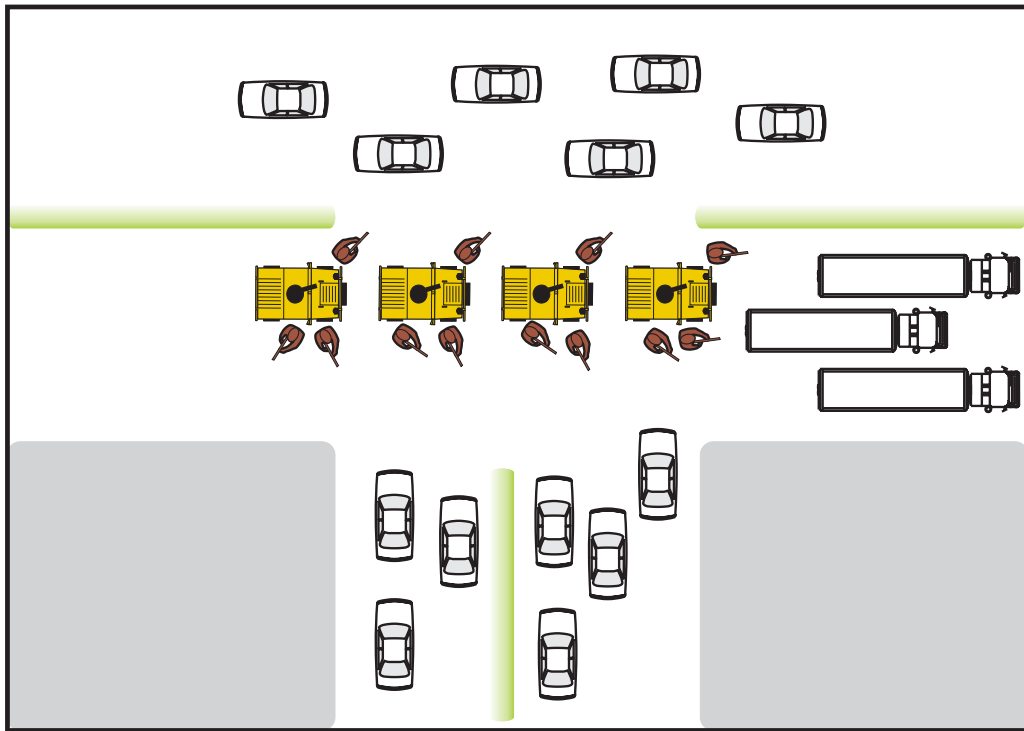

Figure 2-III-4: Vehicles dismount in heavy traffic

#### Section IV

#### Precious Cargo Movement

**1. Precious cargo (PC) is considered any vehicle that is not a transport vehicle with onboard high-value target (HVT):**

- Resupply
- Personnel security detachment

**2. Placement and protection of PC:**

- PC is placed in the second slot in convoy.
- Vehicle 2 is its protection and can move behind or in front to block any approaching vehicle.
- Vehicle 4 protects the rear and right side, if needed.
- PC is placed in the center of convoy:
  - Vehicles 3 and 4 are the blocking force.



- Speed is controlled by the PC vehicle unless other vehicles are slower.
- Vehicles 2 and 3 are used to roll up and block planned intersection on route.
- Vehicle 4 will move up and protect precious cargo.
- Same standing operating procedures (SOPs) for HVT transport.

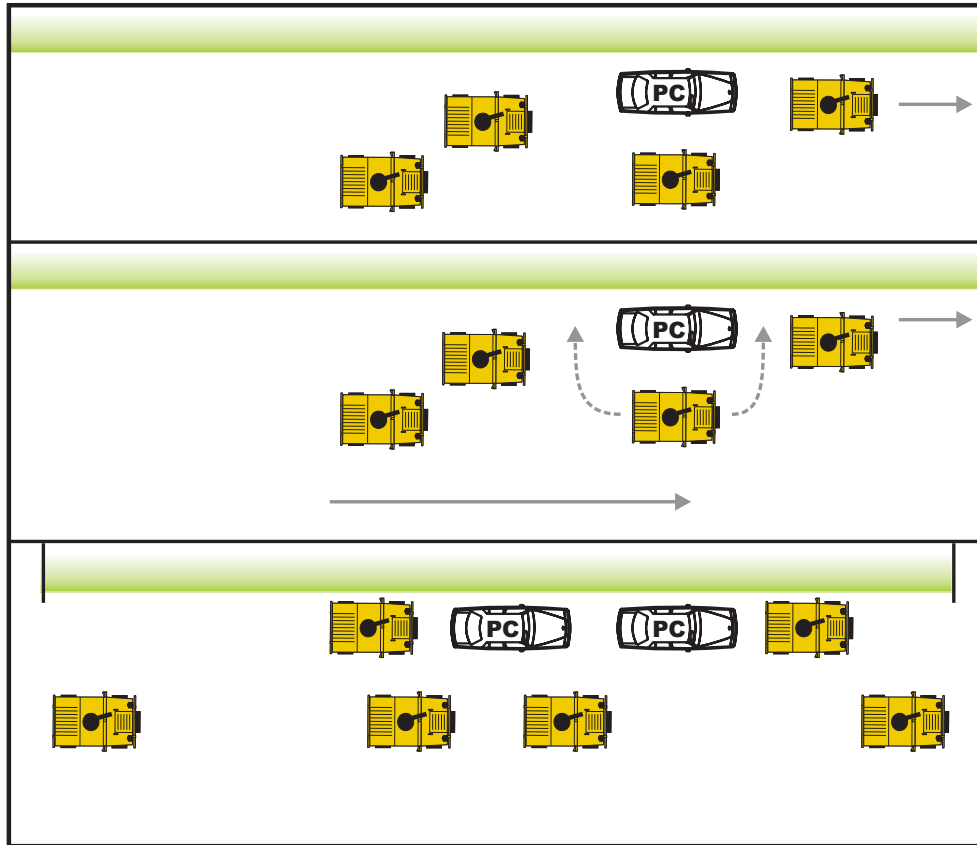

Figure 2-IV-1: Precious cargo SOP

## Section V

### Large Convoys

#### Larger Vehicle Formation:

- Vehicles fall in the same as a foot patrol formation.
- Speeds need to be controlled in larger formations.
- Spacing is also important due to day and night threat levels.

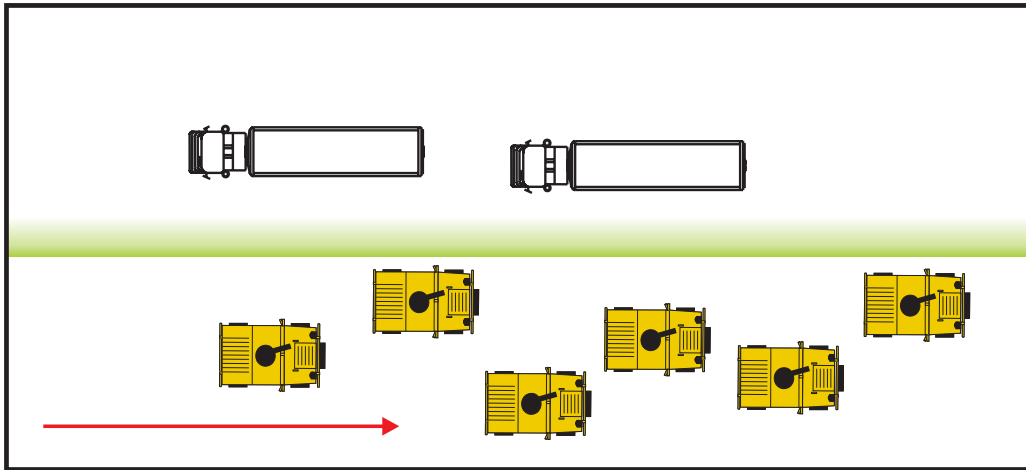

Figure 2-V-1: Vehicle transit formations

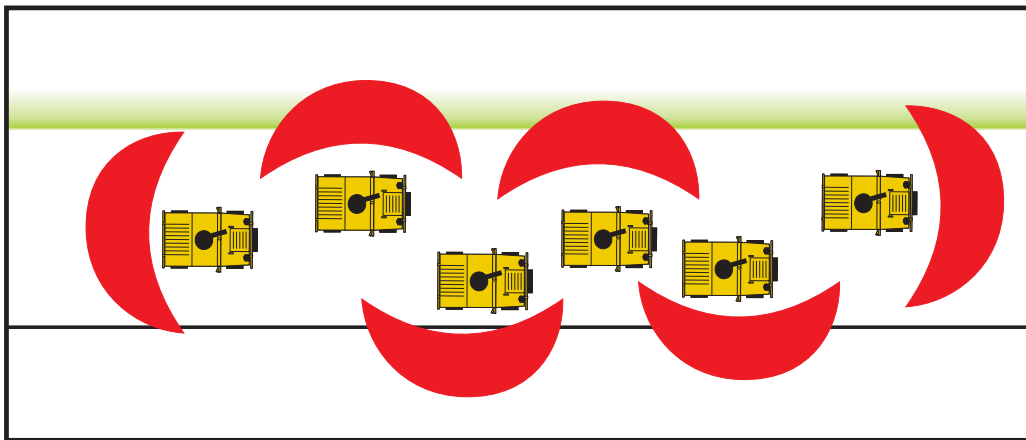

Figure 2-V-2: Fields of fire (larger formation)

**CHAPTER 3**  
**BATTLE DRILLS**

**Section I**

**Individual Driver Skills**

**1. Ramming Techniques:**

- Ramming vehicle approaches vehicle at a slow rate of speed as though stopping (10-15 mph).
- Shift to lower gear, if necessary.
- Use "hard point" of team vehicle against the target vehicle's rear quarter panel.
- Make contact with the wheel at the lighter end of the vehicle (rear is preferable).
- At close contact, increase speed (do not let off the gas).
- Maintain speed, push through, and clear vehicle
- Either push through or ram and pin overwatching target vehicle occupants.

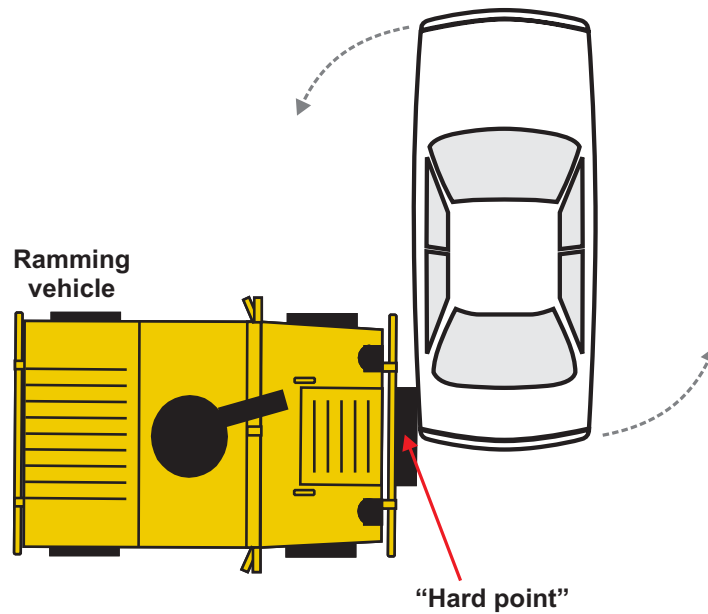

Figure 3-I-1: Ramming vehicle

## 2. Down Driver Drill:

- Stationary vehicle:
  - All vehicles in convoy provide suppressive fire.
  - Shooter in left rear seat steps out of vehicle, removes driver, and transfers the driver to the back cargo area.
  - Shooter then assumes driving position.
- Moving vehicle: Closest shooter takes control of vehicle the best way possible (vehicle dependent)

## 3. Ground Mobility Vehicle (GMV) Tow-Strap Recovery Technique:

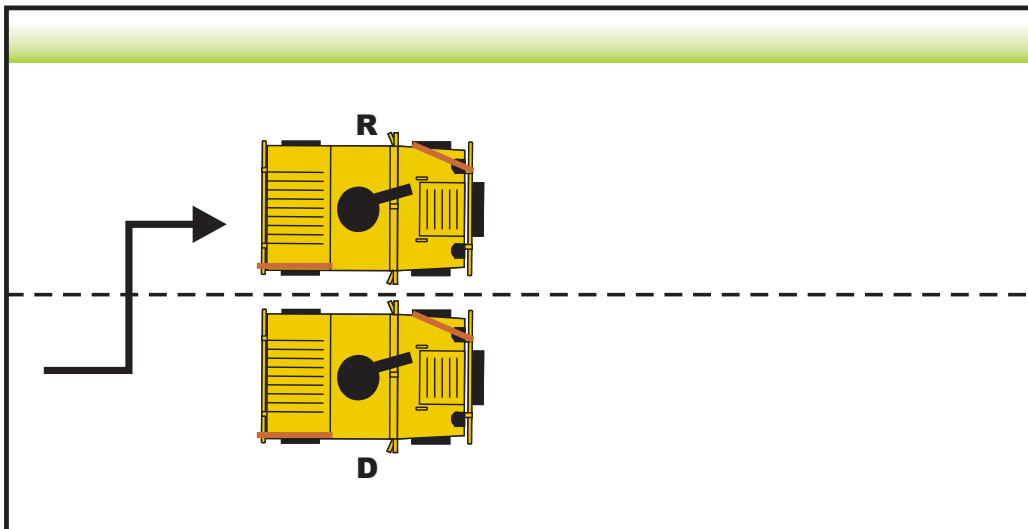

Figure 3-I-2: Recovery technique

- Recovery gun truck ("R") approaches driver's side of downed gun truck ("D")
- Can be accomplished from the rear (as depicted) or by backing from a forward position
- Tow lines are depicted by orange lines on the front driver's side and rear right side.

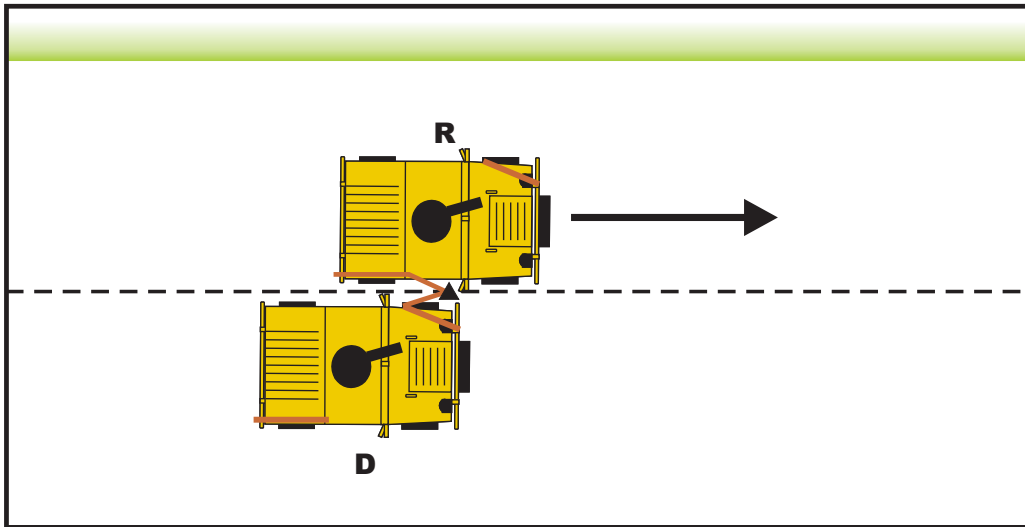
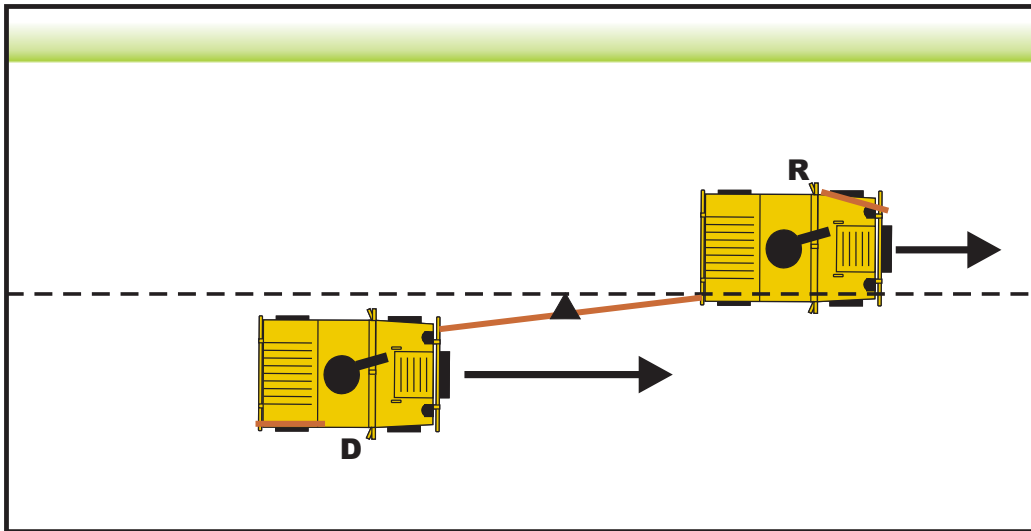

Figure 3-I-3: Recovery technique

- Shooter in near passenger position of "R" and driver of "D" both ready their strap hooks (depicted by black triangle) and maintain eye contact.
- Both positively engage hooks and observe tow line to ensure it does not snare on a portion of either vehicle.
- Driver of "D" ensures that his vehicle is in neutral and prepares to brace the steering wheel.



**Figure 3-I-4: Recovery technique**

- Can be accomplished without stopping the recovery vehicle (if approach is from the rear)
- Can be accomplished in a reverse towing fashion by placing the recovery vehicle to the right side of the downed vehicle; reverse "R" and "D" in the diagram
- Ensure that the weight of the recovery vehicle is equal to or greater than the weight of downed vehicle
- The "herringbone" technique, often used for halts, is not recommended because of the possibility of power steering lock-up and roadside mine/IED threats

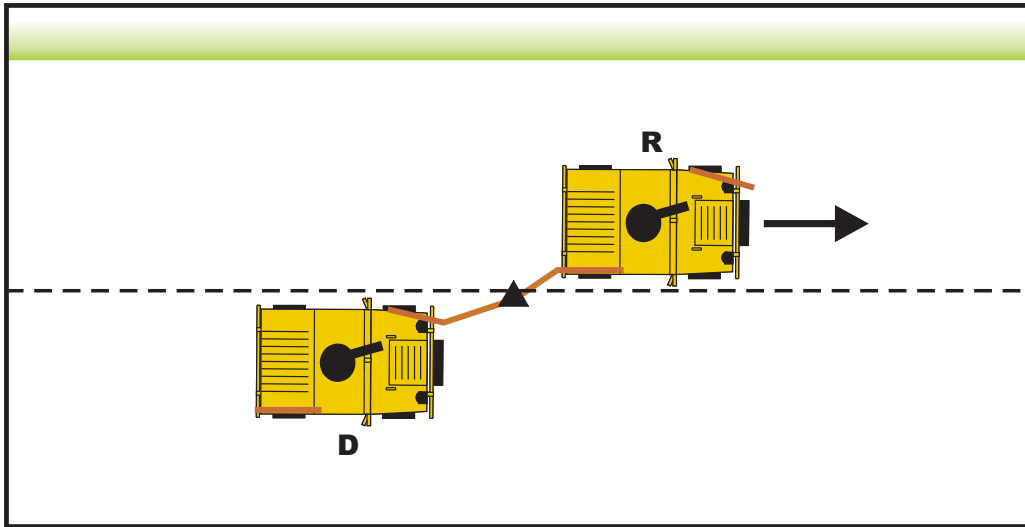

Figure 3-I-5: Recovery technique

- Driver of "D" observes 80 lb. cotton webbing/"100 mph" tape breaking.
- Driver of "R" increases speed only after lines are tight.

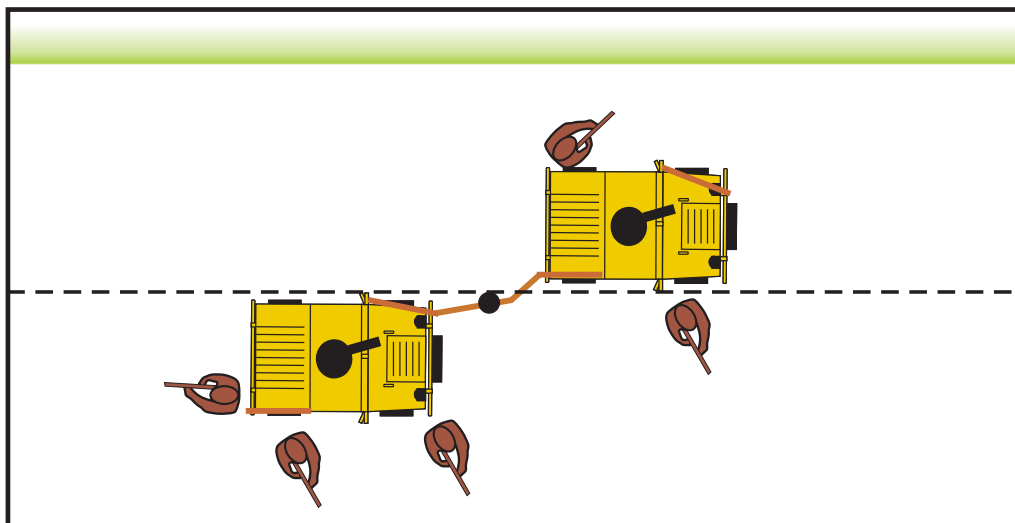

Figure 3-I-6: Recovery technique dismount option



**Figure 3-I-7: Recovery Technique**

## **Section II**

### **Collective Battle Drills**

#### **1. React to Contact Near Ambush:**

- Enemy is distinguishable and accessible: Faces, sights do not cover silhouette, hand grenade/rock throwing range
- Identify source of contact by calling out, “left/right/front/rear”
- Return fire on the move (drive through kill zone)
- Elements obscure with smoke and throw fragmentation grenades
- Establish fire superiority if blocked (“talking machine guns”)
- Assault through/withdraw as applicable:
  - Elements can assault through or withdraw to an out by bounds or peel
  - Maintain support by fire (SBF)/overwatch throughout maneuver
  - Move dismounted to evacuate vehicles if vehicles are rendered unrecoverable



**2. Bail out procedures:**

- Call made by VC/DR when vehicle is inoperable or occupants need to use the vehicle as rolling cover (partial bail out).
- All occupants return fire and move to the "clean" side for cover.
- Order of movement must be well-rehearsed.
- Implement destruction plan.
- Return fire and break contact or await recovery vehicle (vehicles are bullet/rocket propelled grenade [RPG] magnets).

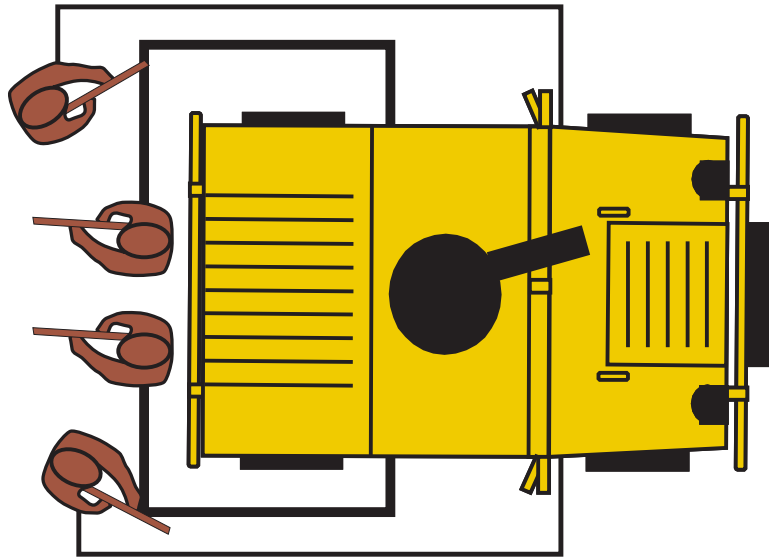

**Figure 3-II-1: Bail out rear: Rear-most occupants move to rear first under cover-fire (if required) of more forward occupants to prevent masking fires.**

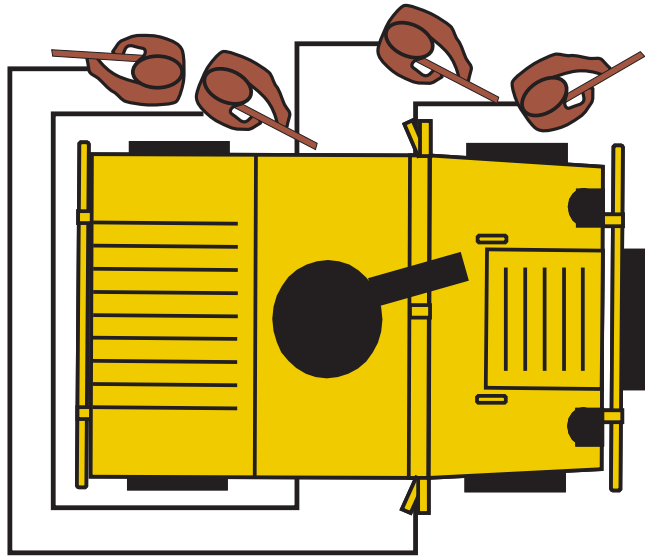

Figure 3-II-2: Bail out left

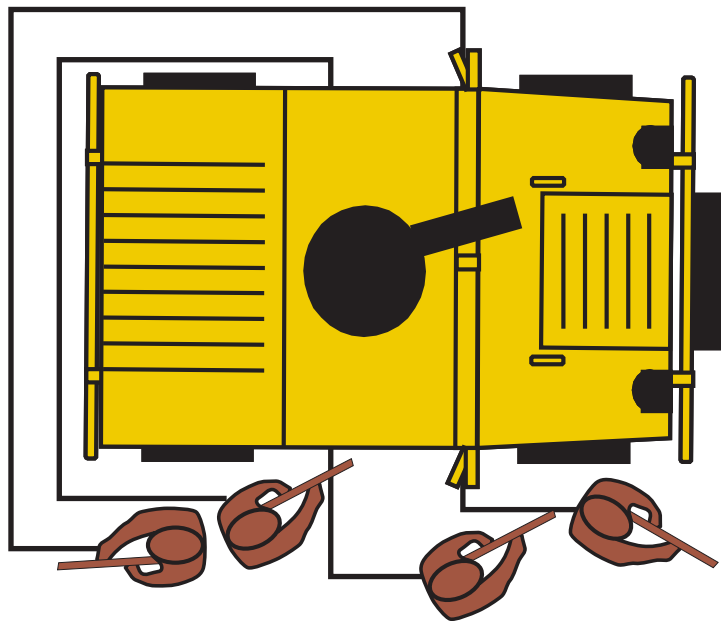

Figure 3-II-3: Bail out right

**2. React to Contact - Far Ambush:**

- Enemy is well beyond hand grenade range, inaccessible, or terrain precludes maneuver
- Rolling fire
- Establish SBF for blocked elements
- Recover blocked elements upon suppression of enemy fire
- Report

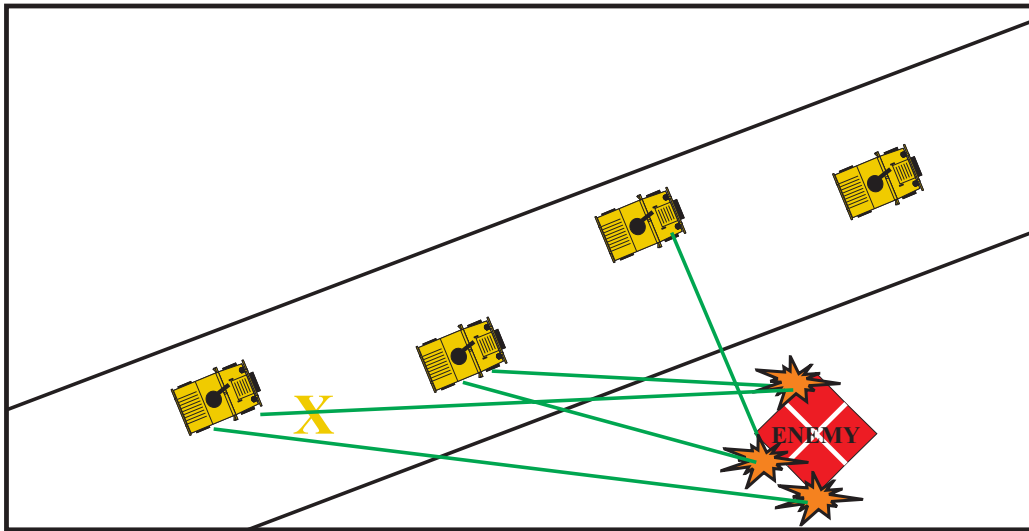

Figure 3-II-4: React to ambush, "Blow Through"

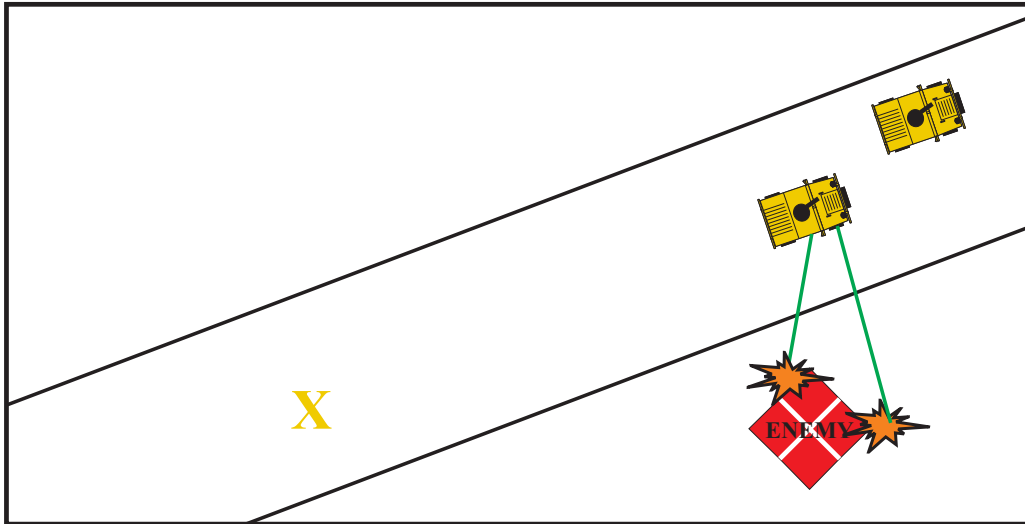

Figure 3-II-5: React to ambush, "Blow Through"

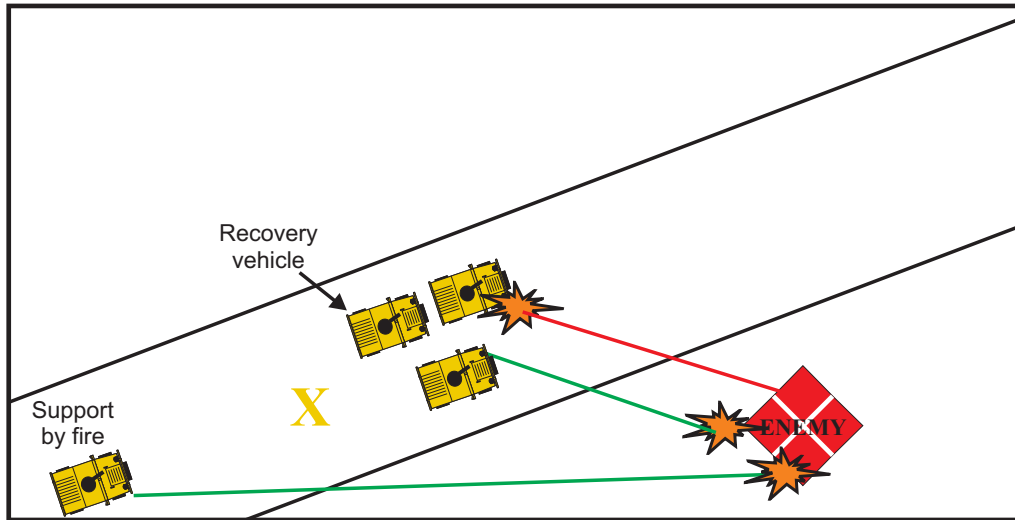

Figure 3-II-6: React to ambush, "Blocked Lead"

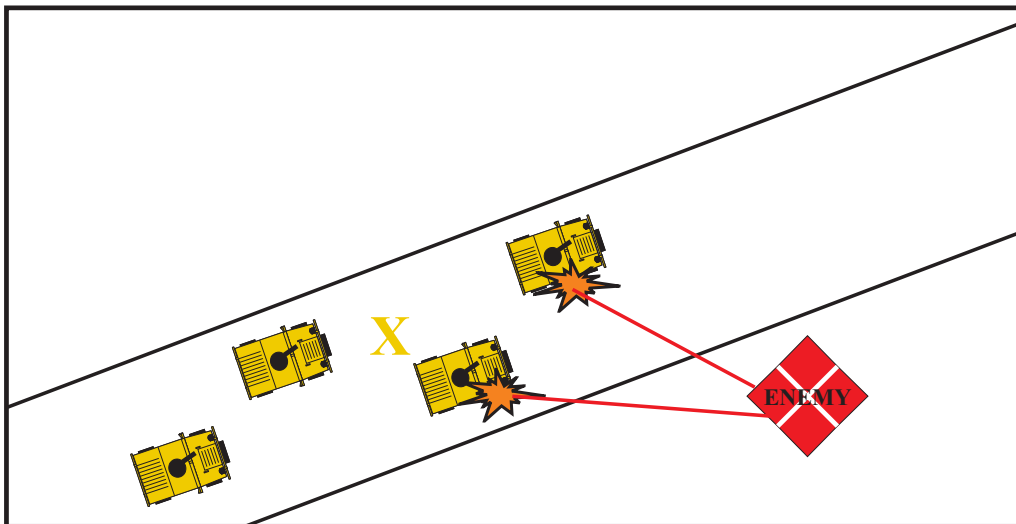

Figure 3-II-7: React to ambush, "Blocked Lead"

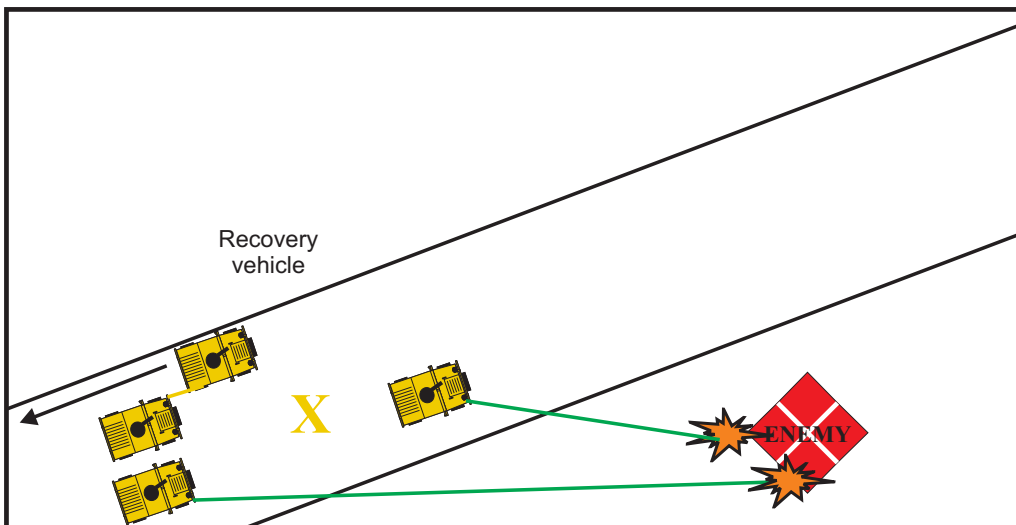

Figure 3-II-8: React to ambush, "Blocked Lead"

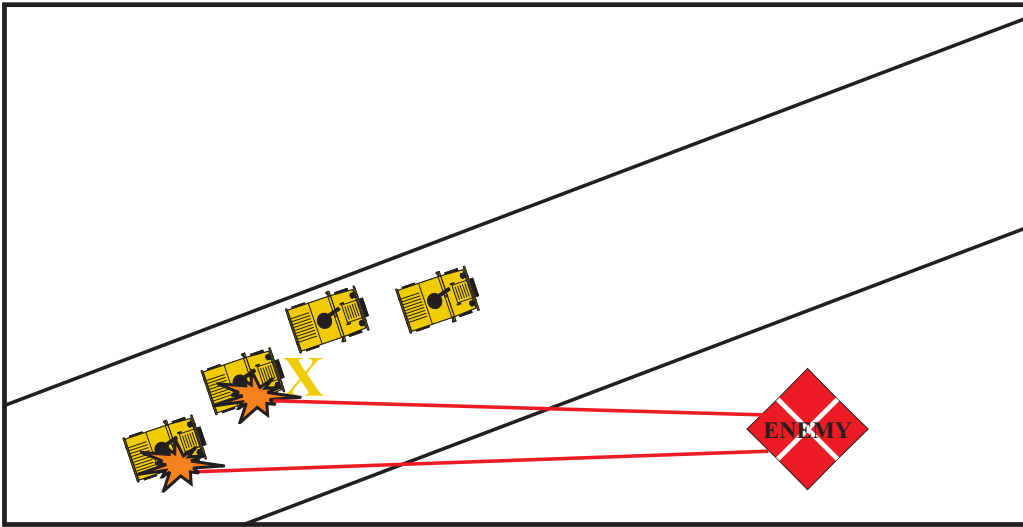

Figure 3-II-9: React to ambush, "Isolated Follow"

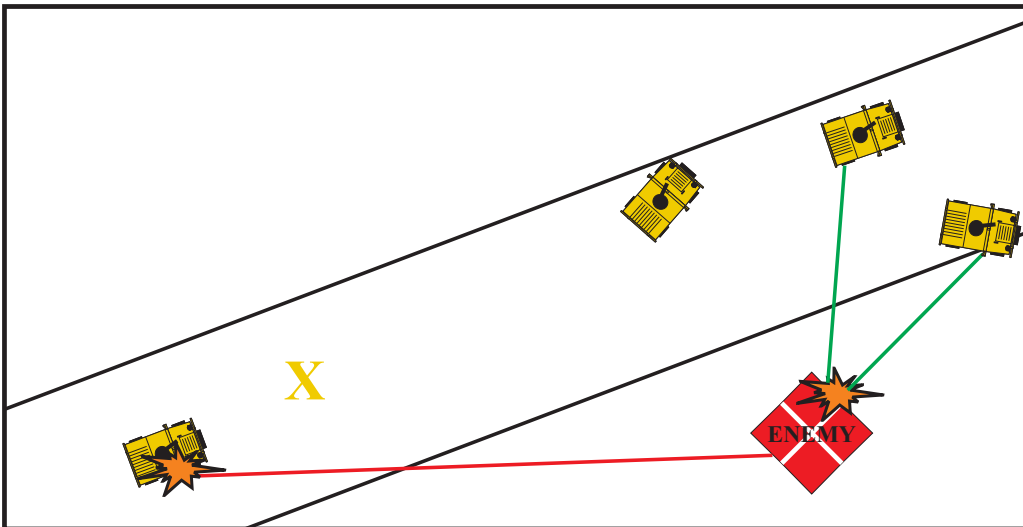

Figure 3-II-10: React to ambush, "Isolated Follow"

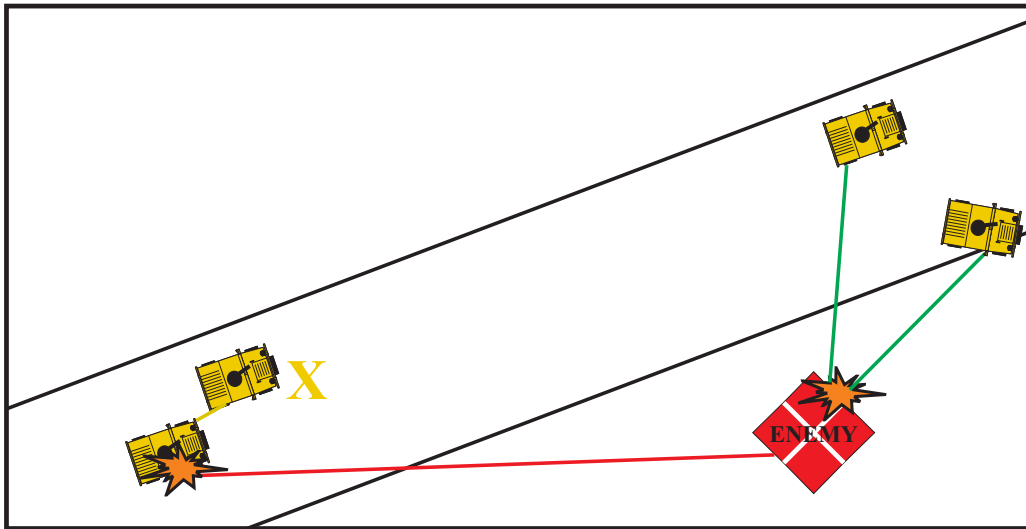

Figure 3-II-11: React to ambush, "Isolated Follow"

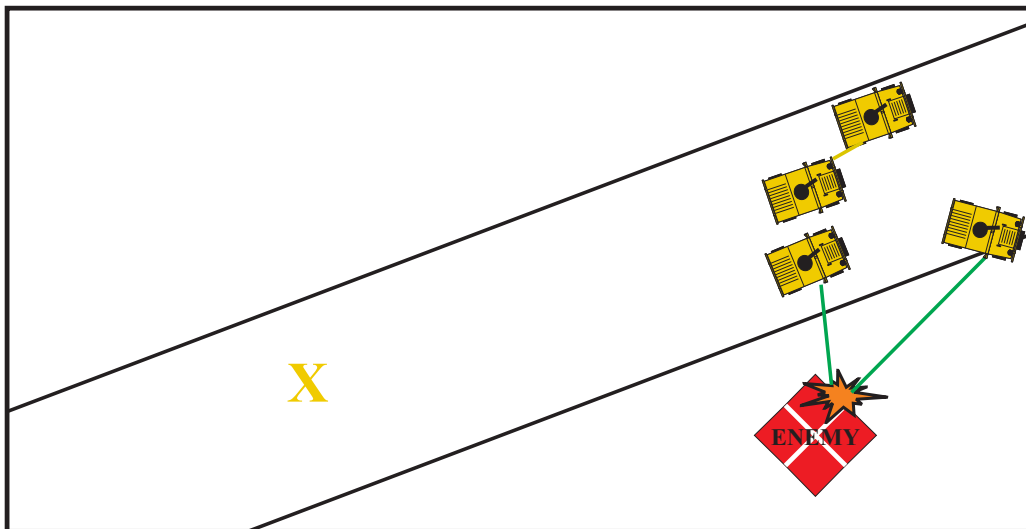

Figure 3-II-12: React to ambush, "Assault Through"

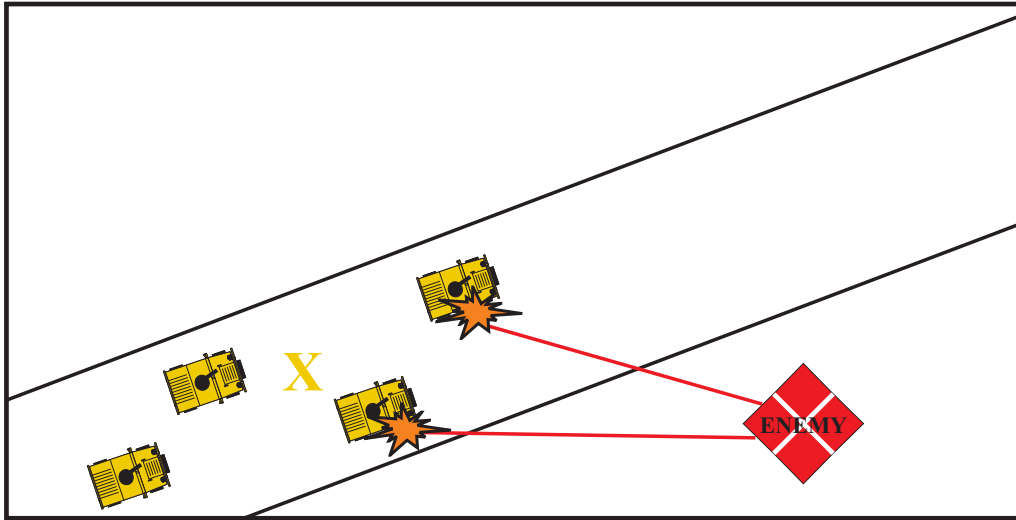

Figure 3-II-13: React to ambush, "Assault Through"

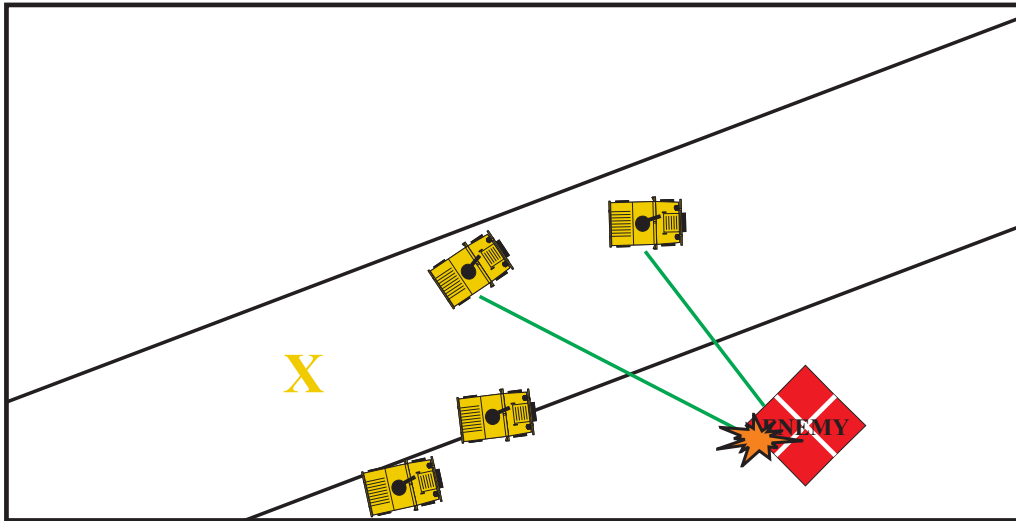

Figure 3-II-14: React to ambush, "Assault Through"



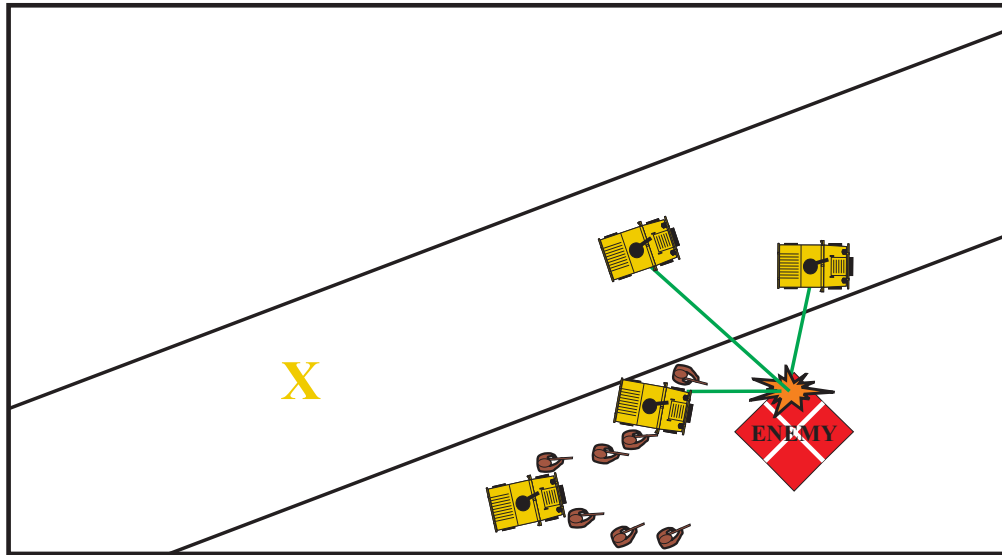

Figure 3-II-15: React to ambush, "Assault Through"

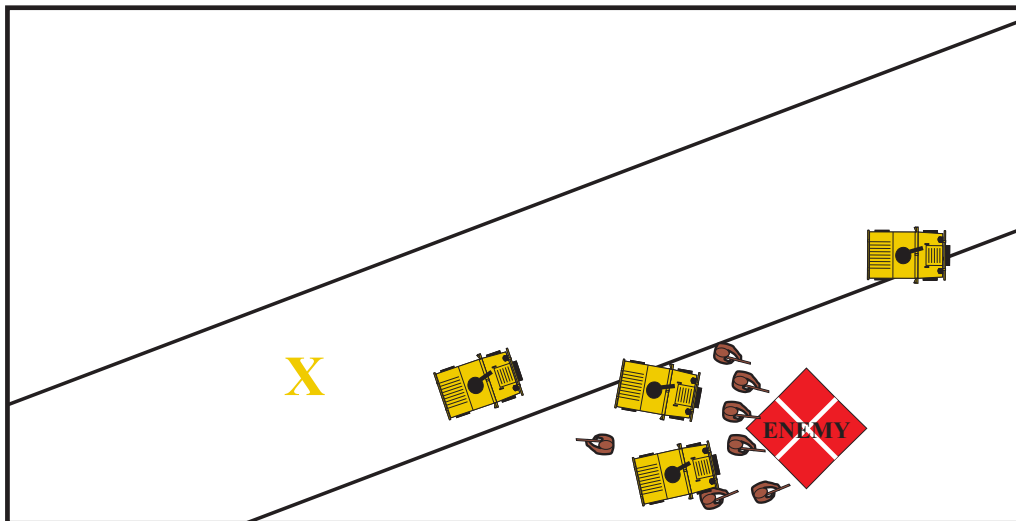

Figure 3-II-16: React to ambush, "Assault Through"

### 3. React to Sniper Fire:

- Single shooter with noticeable effect
- Move and employ smoke to obscure position
- Increase speed if possible

- Move out of kill zone
- Suppress if firing point is identifiable
- Continue/abort mission

**4. React to Suspected IED:**

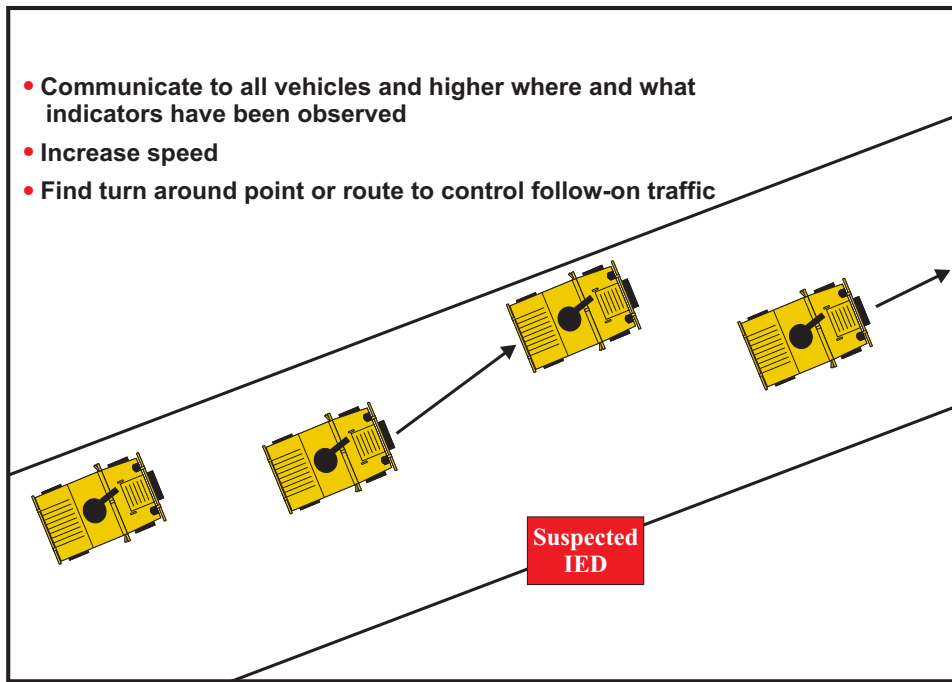

**Figure 3-II-17: React to suspected IED, "Blow Through"**

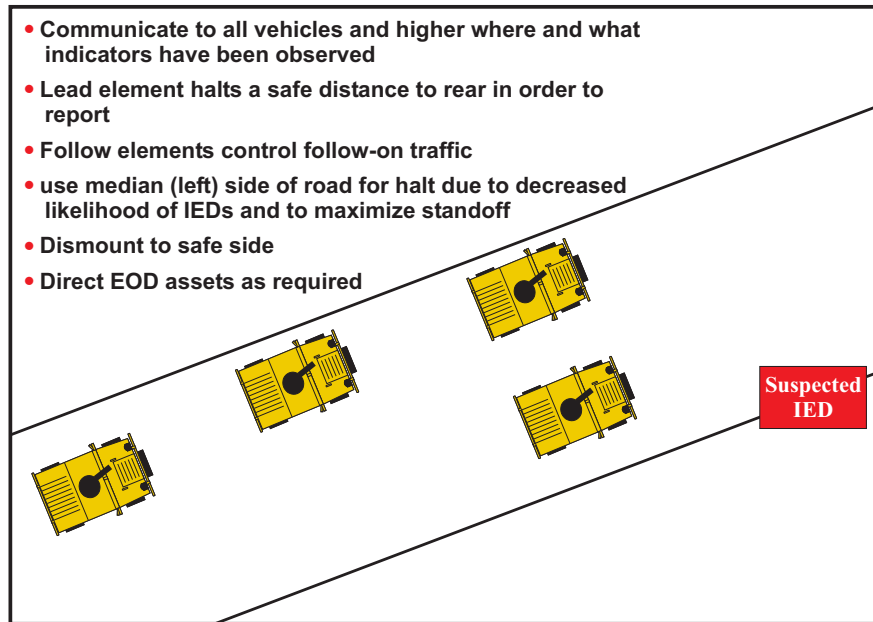

Figure 3-II-18: React to suspected IED, "Short"

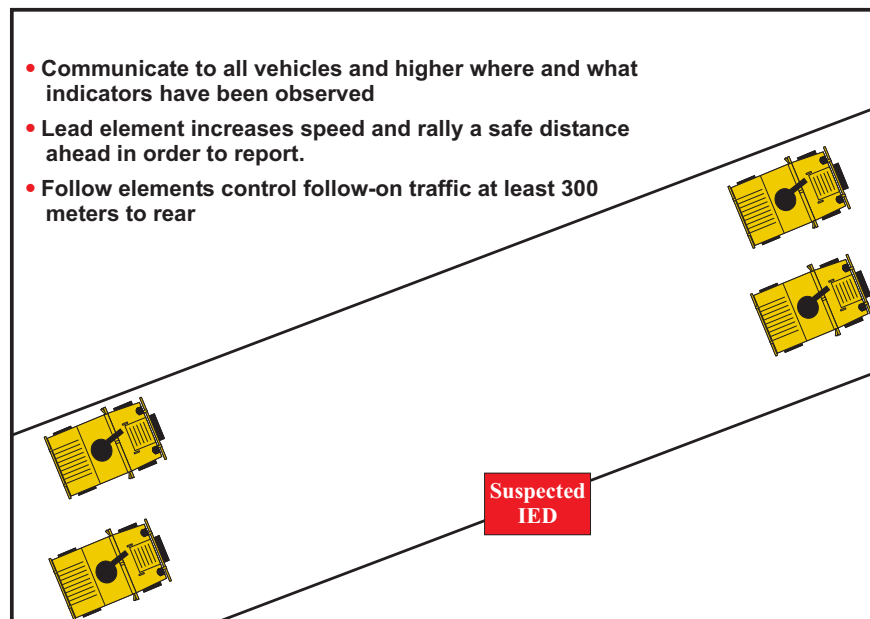

Figure 3-II-19: React to suspected IED, "Split"

- Drive by at a safe distance, mark position, and report to higher immediately.

- Stop and move back 300 m/minimum (time/distance permitting).
- Hand off to nearest friendly unit to block traffic.
- Change to oncoming lanes and continue/abort mission.
- Beware of obvious IEDs that can channel the convoy into a “daisy-chained” IED ambush.

### 5. React to IED Detonation:

- Drive through kill zone if possible.
- Push or tow damaged vehicle.
- Observe for additional devices.
- Mark position; report to higher.
- Assault enemy firing point in order to prevent future attacks.

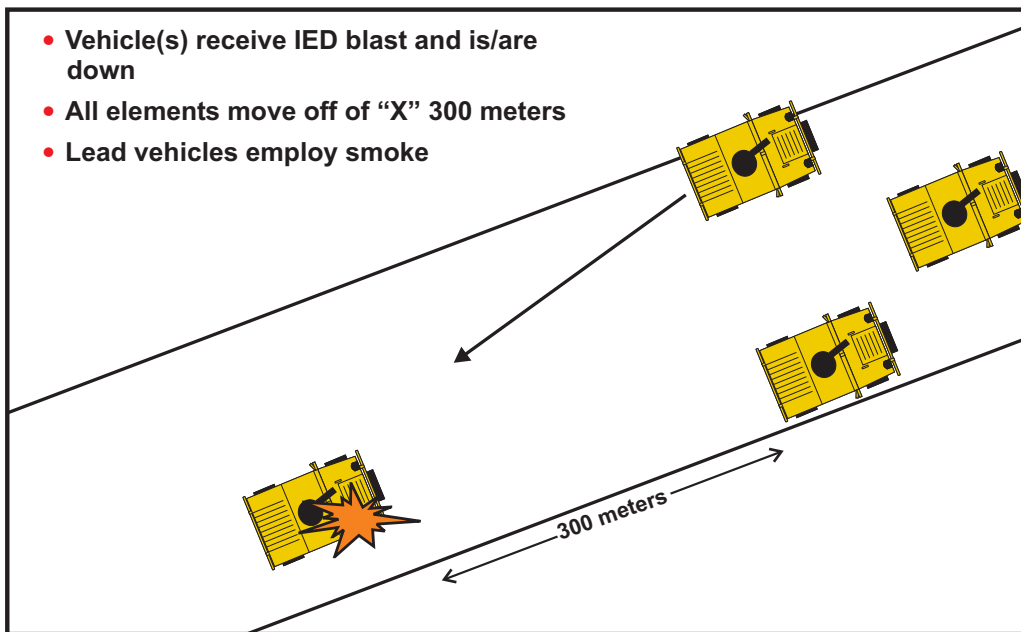

Figure 3-II-20: React to IED detonation, "Blow Through and Recover"

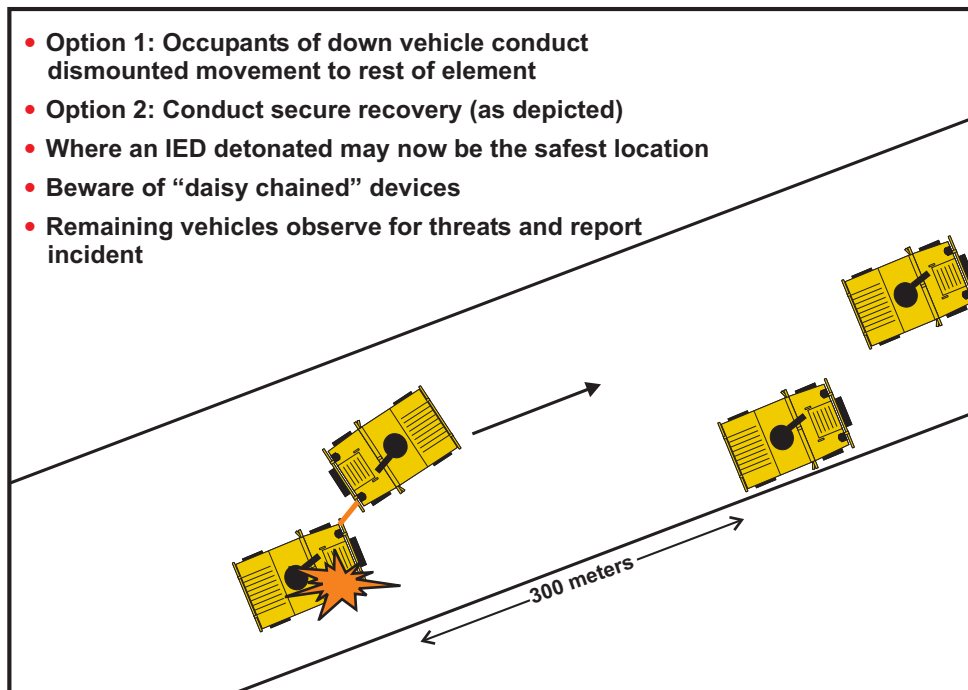

Figure 3-II-21: React to IED, "Blow Through and Recover"

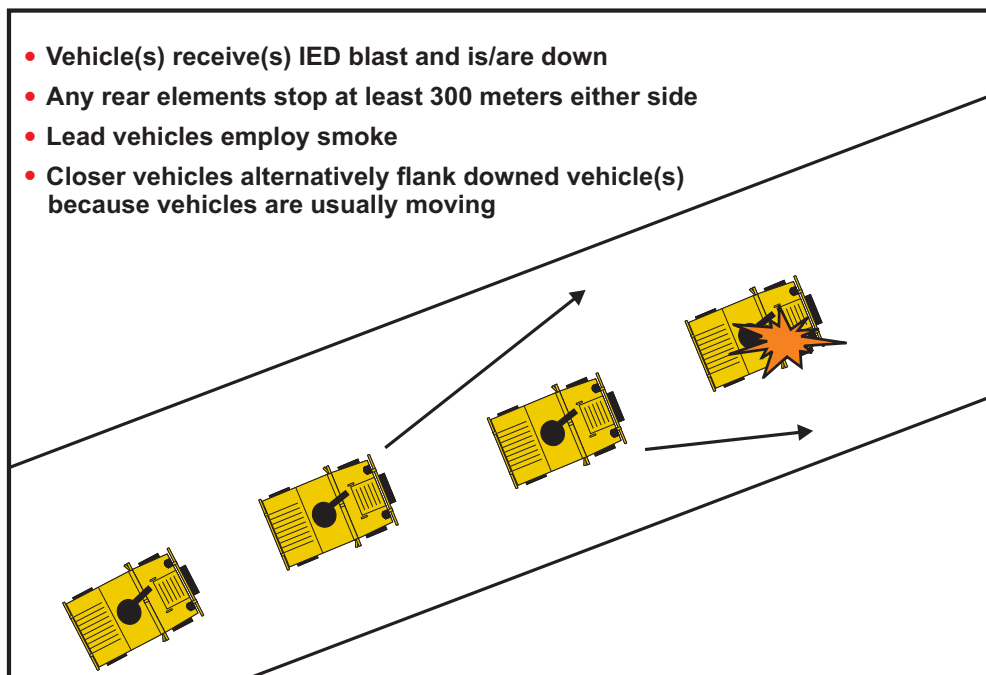

Figure 3-II-22: React to IED, "Security By Width"

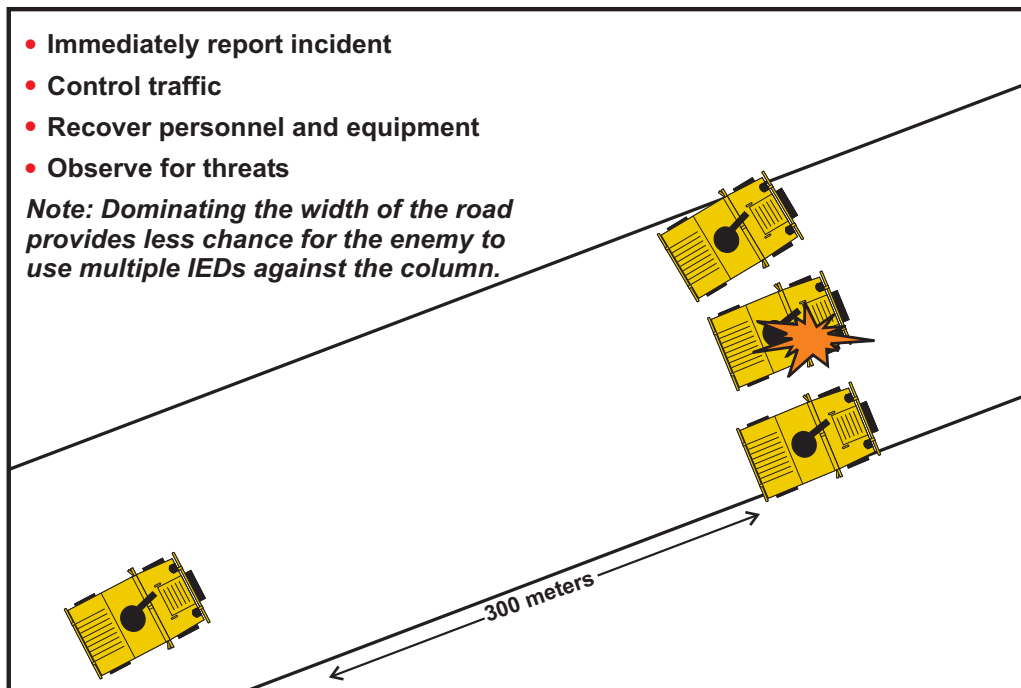

Figure 3-II-23: React to IED, "Security By Width"

**6. React to Road Block:**

- Overwatch and change direction if possible.
- Establish SBF and ram to clear obstacle.
- Evaluate; continue mission/return to base (RTB).

**7. React to Vehicle-Born Improvised Explosive Device (VBIED):**

Mobile/stationary:

- Avoid
- Gain distance
- Ascertain intent (attack convoy or moving to predetermined target location)
- Mark position and report to higher authority (**Note:** Use the SALUTE [size, activity, location, unit, time, and equipment] reporting format. Specify direction of travel, make/model of car, description of driver/passengers, and VBIED indicator[s])
- Eliminate threats as necessary; shoot the driver rather than trying to shoot tires out

**8. React to Large Crowd:**

- Dismount.
- Use vehicles as barricade.
- Employ pyrotechnics and/or non-lethals.
- Utilize combative strikes.
- Maintain 360-degree security.
- Move to an out and withdraw.

**9. Vehicle Recovery:**

- Once convoy commander determines that area in vicinity of disabled vehicles is secure and positions the gun truck in a good overwatch position (remaining at a standoff distance if possible), recovery/CASEVAC operations can begin.
- CASEVAC operations:
  - Aid and litter team will position on safe side of vehicle and extract casualties and personnel.
  - Treatment of casualties, except for emergency treatment to prevent loss of life, will occur once casualties are safely removed from kill zone.
- Vehicle recovery procedures:
  - Recovery team will position on safe side of disabled vehicle.
  - VC will dismount and assess disabled vehicle.
  - If determined vehicle can be safely recovered, VC will guide recovery vehicle into position and conduct a hasty hookup. VC will operate disabled vehicle, if necessary.
  - Upon exiting contact area, complete and correct hookup procedures will occur.
  - If assessment results in outside support necessary for recovery, leader will contact higher authority for guidance.
- Once recovery operations are complete, team will displace and conduct link-up with convoy at rally point.

**10. Consolidation and Reorganization:**

- Upon breaking contact, all vehicles, to include gun trucks, will proceed to rally point and conduct consolidation and reorganization actions.

- Once in position and stopped, personnel will dismount their vehicle on safe side (inside) of the box and establish security.
- Consolidation and reorganization begin when rally point is secured. This includes repositioning of weapon systems, if necessary.
- Ammunition status/redistribution:
  - Personnel will report their ammunition status to VC, who will report the status to the convoy commander.
  - Redistribute ammunition as necessary.
- Casualty treatment/evacuation:
  - Casualty treatment will begin upon pulling into rally point. VC/driver will begin buddy-aid until relieved by combat lifesaver (CLS) or patient is stabilized.
  - CLSs will immediately dismount and scan vehicles in search of casualties (four-way flashers). Upon encountering a casualty, the CLS will evaluate buddy-aid and, if adequate, continue search. It is important not to delay the CLS reaching a more serious casualty.
  - Aid and litter teams will transport casualties (using litters/cots and body bags/improvised litters) to the casualty collection point.
  - CLSs should focus on treatment of casualties and not be a part of the aid and litter team.
  - Medical evacuation (MEDEVAC) requests. (Refer to Chapter 4.)
  - Secure sensitive items/documents/weapons.
  - Aid and litter team will continue to assist with evacuation of casualties.
  - Landing zone (LZ) team:
    - \* Select and secure LZ (always downwind of unit box formation).
    - \* Clear objects from LZ site.
    - \* Prepare to display appropriate LZ signals/markings.
    - \* Assist with loading of casualties.
- Equipment inspections:
  - Drivers will inspect vehicles/cargo and report status.



- Recovery teams will ensure proper hook-up procedures are conducted.
- Convoy commander will request recovery support or guidance if unable to conduct unit recovery.
- Leaders will conduct weapon, communication, and sensitive item inspections and update VCs.
- Convoy commander will also conduct the following, if required:
  - Direct priority of cross leveling of cargo/loads.
  - Establish new chain of command.
  - Submit final situation report (SITREP).
- Continue mission.



## CHAPTER 4

### CONVOY CHECKLISTS AND BRIEFINGS

#### Section I

##### Vehicle Convoy Pre-Operations Checklist

\_\_ Submit concept of operations (CONOPS) to approving authority (per standing operating procedure [SOP]).

\_\_ Submit vehicle request. Ensure the following equipment is present (per SOP):

- Radio mounting hardware
- Weapons mounts
- Spare tire with jack
- Fuel (full tank)
- Fuel cans (2 extra, full)
- Water
- Meals, ready to eat (MREs)
- Extra ammo cans for spare ammo
- Stretchers
- VS-17 panel
- Tow straps

\_\_ Submit vehicle equipment request as follows (per SOP):

- Communications gear
  - Long range
  - Inter-vehicle
  - Squad/Internal (PRC-148s)
  - Blue Force Trackers (BFTs) (**Note:** Draw and turn on at least 45 minutes prior to allow for acquisition/registration of unit)
  - Antennas (as required)
  - Cell phone (local, iridium)

- Communications plan (including special instructions [SPINS])
- Weapons
  - Crew-served weapons (CSW)
  - Stand-off (M-24, M-82A1, SR-25, and SPR)
  - Extra magazines
- Ammunition
  - CSW (.50 cal link, 7.62-mm link, 5.56-mm link, 40-mm link)
  - Personal weapons (as per unit SOP)
  - Pyrotechnics (white HC smoke, red star cluster)
  - Grenades (fragmentation)
  - Flash bangs (as per unit SOP)

(**Note:** Ensure standby ammunition is drawn to stage in vehicles.)

\_\_\_ Submit supporting personnel request (per SOP).

\_\_\_ Rules of engagement (ROE). See Judge Advocate General (JAG) for current area of responsibility (AOR) ROE.

\_\_\_ Submit intelligence support request for the following (per SOP):

- Identification of friendly/enemy/ambush occurrence locations
- Maps/evacuation and recovery plan

\_\_\_ Submit medical equipment request (per SOP).

- Obtain casualty evacuation (CASEVAC) plan

\_\_\_ Submit supporting arms request.

\_\_\_ Contact joint operations center (JOC) for contact phone listing.

\_\_\_ Isolated personnel report (ISOPREP) updated/on file

\_\_\_ Assemble supporting personnel to brief timeline and ensure they have the following minimum equipment:

- Standard/non-standard uniform
- Body armor

- Ballistic helmet
- Ballistic eye protection
- Gloves
- Load-bearing equipment (LBE)
- Primary/secondary weapons
- PEQ-2/CVL (optional)
- Ammunition load (as per unit SOP)
- Night observation device (NOD) (night operations)
- Global Positioning System (GPS) with extra batteries (at least for the vehicle assistant commanders (CDRs)/navigators)
- Strobe (covered)
- Squad radio with headset and boom microphone (i.e., PRC-148)
- Map
- Compass (GPS with compass feature will suffice)
- Overt light
- Knife
- Falcon View up-load
- Binoculars
- Blow-out kit (comms/medical/ammo)

\_\_ Develop vehicle convoy operations brief (Refer to Chapter 4, Section II).

\_\_ Conduct route planning and develop map with marked choke points, danger areas, enemy/friendly positions, rally points, and medical facilities (primary/secondary).

\_\_ Conduct advance route reconnaissance (if applicable).

\_\_ Conduct weapons test fires/function checks (if applicable).

\_\_ Conduct communications checks (all radios).

\_\_ Conduct vehicle convoy operations brief.

\_\_ Conduct rehearsals.

\_\_ Conduct mission.

## **Section II**

### **Convoy Commander Brief**

(**Note:** This format provides the SOF operator with a quick, efficient briefing. By filling in the blanks the commander can build his convoy. The convoy should not roll until the entire briefing has been read. The key portions of this briefing are seating, routes, battle drills, command/signal, and non-tactical vehicle (NTV) fratricide reduction measures. This briefing can be printed and laminated in either pocket-size for individual use or poster-size for use in the briefing room.)

### **ADMINISTRATIVE**

#### **1. Force List (Roll Call)**

#### **2. Personnel**

- Responsibilities
  - Convoy CDR/navigator \_\_\_\_\_
  - Asst. convoy CDR \_\_\_\_\_
  - Vehicle commanders (VCs) \_\_\_\_\_
  - Officer-in-charge \_\_\_\_\_
  - Drivers (primary/alternate) \_\_\_\_\_
  - CSW operator \_\_\_\_\_
  - Shooters \_\_\_\_\_
  - Medics \_\_\_\_\_
  - Guide/interpreter \_\_\_\_\_
  - Convoy tracker \_\_\_\_\_
- Seating arrangement (See Figures 4-II-1 and 4-II-2)
- Sectors of fire
  - Friendly force in sector
  - General enemy situation in sector (See "Routes.")
  - Weather conditions

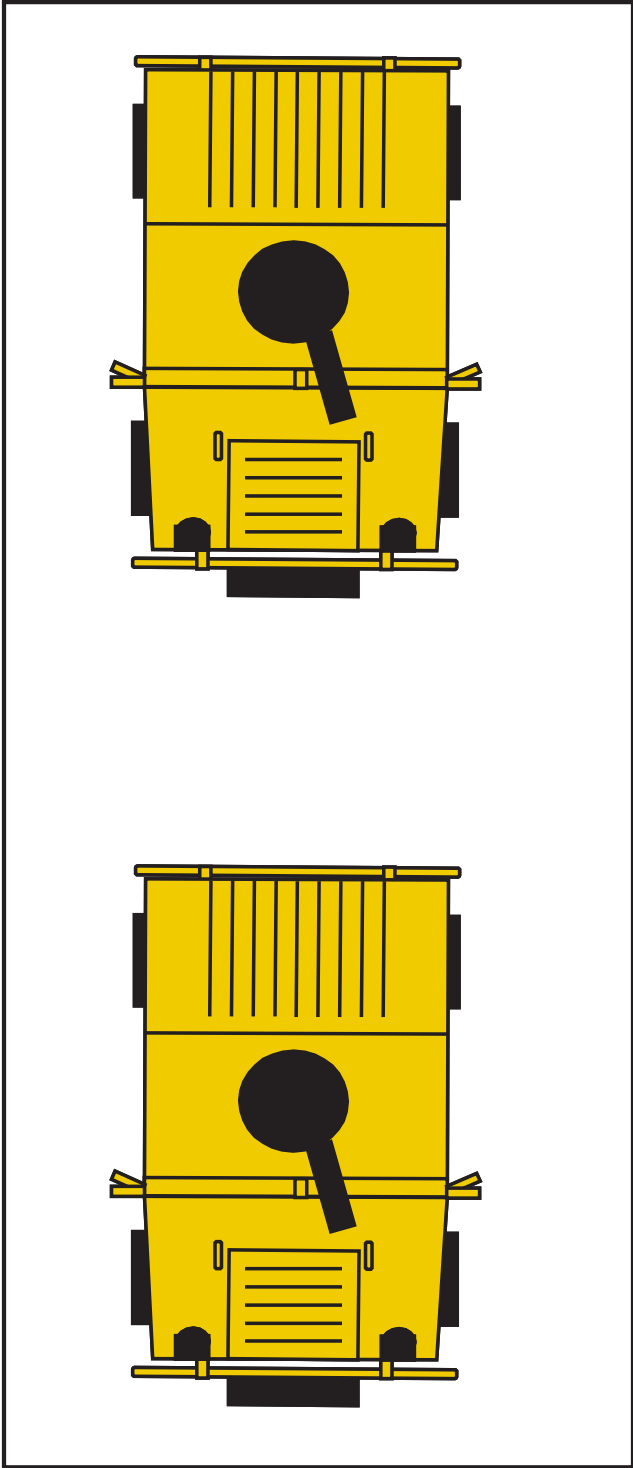
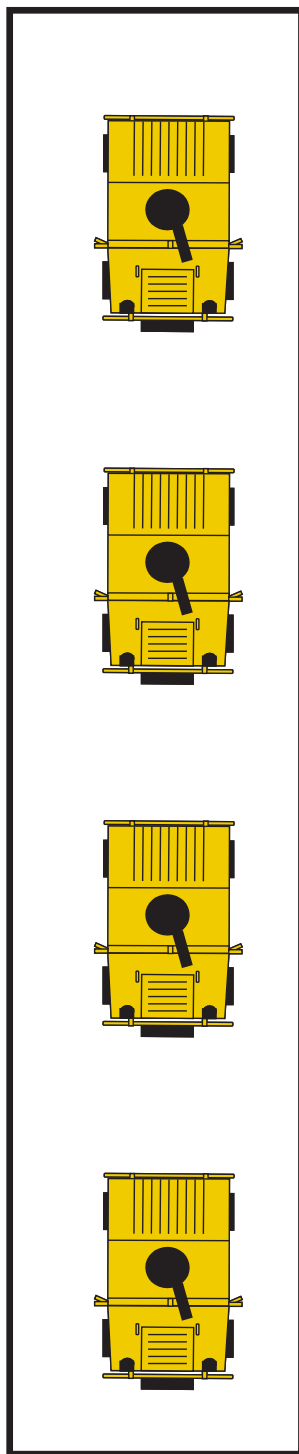

Figure 4-II-1: Two vehicle convoy seating configuration  
(Note: Positions filled in during convoy briefing)



**Figure 4-II-2: Four vehicle convoy seating configuration**  
(Note: Positions filled in during convoy briefing)



## MISSION

State the objectives of the mission: who, what, when, where, and why (task and purpose are keys.)

---

---

---

---

---

---

**Example:** SFOD-A XXX conducts tactical convoy to prison #1 from and returning to FOB XX NLT 231000ZDEC03 in order to (IOT) safely transport enemy prisoners of war (EPW) to coalition detention facility.

## EXECUTION

---

### 1. Concept of Operations:

Convoy execution and task(s) of elements, teams, and individuals at the objective(s). (Broad general description from beginning to end.)

---

---

---

---

---

---

---

---

---

---

### 2. Convoy Execution:

- Timeline
  - Vehicle/Personal gear preparation, preventive maintenance checks and services (PMCS) completed
  - Briefing
  - “Jock-up”/don equipment
  - Load vehicles
  - Rehearsals/test fires
  - Start point (SP)/departure
  - Arrive/depart objective:

#1: \_\_\_ / \_\_\_

#2: \_\_\_ / \_\_\_

#3: \_\_\_ / \_\_\_

#4: \_\_\_ / \_\_\_

#5: \_\_\_ / \_\_\_

#6: \_\_\_ / \_\_\_

- Return to base (RTB)
- Debrief/after action review (AAR)
- Recovery: Post-op vehicles/personal gear
- Route(s) (primary/alternate):
  - Brief using prepared map. Note choke/check/rally points, enemy/friendly locations, known danger areas, locations of medical facilities, communications and reporting, and weapons readiness status.
  - Brief enemy situation affecting route
- Coordinating instructions
  - Planned danger areas:
    - \* Known danger areas include bridges/overpasses (local police, past ambush sites, wires)
    - \* Open interval and maneuver to different lane while under bridge.
  - Security
    - \* Fields-of-fire: Cover assigned sectors while mounted/dismounted; cover up/down bridges, rooftops, balconies, storefronts, multi-story structures, and cross streets.
    - \* Scan crowds, vehicles, and roadsides for attack indicators. (**Note:** Communicate indicators throughout the convoy)
    - \* Beware of motorcycles, vans with side doors, and dump trucks.)
    - \* Beware of objects in the road (cars, potholes, objects, fresh asphalt, and trash.)

- Convoy speed
  - \* Highways/open roads: Example: 50+ mph
  - \* Urban/channeled areas: As fast as traffic will allow (**Note:** Be prepared for evasive maneuvers, bumping, and blocking to allow for continuous movement.)
- Vehicle interval
  - \* Highways/open roads/clover leafs/bridges/ramps: Open spacing, but do not allow vehicles to enter convoy.
  - \* Urban/channeled areas: Close interval, but must have visual of tires on vehicle in front of your vehicle. Drive on wrong side as necessary.
  - \* Speed is dictated by either the rear vehicle's ability to keep up or having slower vehicles in the lead.
- Headlight status (on/off, blackout, use of night observation devices [NODs])
- ROE (as dictated by theater commander): Consider when to use vehicle as a weapon.
- Battle drills: Rapid decision making, fire superiority/suppression, and movement out of kill zone are the keys to successful disengagement or counter attack. In all situations, contact higher with size, activity, location, unit, time, equipment (SALUTE)/spot report and, as deemed necessary, call for quick-reaction force [QRF] and/or medical evacuation [MEDEVAC].) (**Note:** The following battle drills are offered as examples. Battle drills should be rehearsed, and at a minimum, read out loud.)
  - Improvised explosive device (IED) detonation: *Blow through/tow out of kill zone. Be prepared to respond to secondary device or contact.*
  - Suspected IED: *Drive past and report, or pull back and put host nation (HN) in charge of stopping traffic.*
  - Small arms fire (direct/indirect): *Return fire/evade, continue mission.*
  - Road block: *Push through, suppress as necessary, call for quick reaction force (QRF).*
  - Stand-off weapons fire: *Return fire if origin is known, evade.*
  - Disabled vehicle: *Push through/tow out of kill zone.*

- Down driver: *Moving: nearest shooter controls steering; stationary: closest shooter moves and replaces driver.*
- Loss of guide: *Move to secure location, assess location.*
- Dead end situations: *Last in backs "out" and dismounts shooters for cover; remaining drivers execute alternating outward 3 point turns or back out if too narrow; mount and continue.*
- Break in contact: *Lead element(s) halts no further than subsequent checkpoint once break is known.*
- Actions upon convoy halts:
  - Dismount/mount: Convoy commander will call "quickstop" for short halts and "dismount" for longer duration halts that require pushing out a perimeter. All personnel with the exception of drivers and CSW operators will dismount and provide 360-degree security until convoy is ready to move out.
  - Upon dismounting, immediately clear field-of-fire and area directly in front of position. (**Note:** An IED may be at your feet.)
  - **Do not position yourself between vehicles or between vehicle and hard/fixed objects.**

## LOGISTICS/EQUIPMENT

---

### 1. Individual Equipment (+ pre-combat inspections [PCI])

- Standard/non-standard uniform/civilian attire ("roughs," etc.)
- Body armor (tactical Level IV or concealable)
- Ballistic helmet
- Ballistic eye protection
- Gloves
- Load-bearing equipment (LBE)
- Primary/secondary weapons systems
- PEQ-2/CVL
- Ammunition load (as per unit SOP)
- NODs
- Global Positioning System (GPS)

- Maps
- Compass
- Handheld/weapon-mounted white light(s)
- Knife
- Non-lethal weapons (baton, etc.)
- Smoke, fragmentation, flashbang, grenades
- "Blow-out" kit
- Chemical protective over garment (CPOG)/military operational protective posture (MOPP) equipment (if required and what level)

### 2. Vehicles

- Description (by vehicle number, BFT SN#, and/or call sign)
- Vehicle equipment (**Note:** Ensure all vehicle equipment is set up the same.)
  - CSW with mount(s)
  - Offensive/defensive munitions (CSW/pyro/M4 magazines/stand-off weapon systems)
  - Communications (long range, inter-vehicle, squad/internal)
  - Medical treatment bag (M-5)
  - Stretchers/litters
  - Cell phone(s)/Iridium satellite phones
  - Blue Force Trackers (BFTs) by serial number (SN#)
  - Map(s)
  - VS-17 panel
  - Water
  - MREs
  - Sandbags (as needed)
  - Tow strap
  - Ballistic blankets (as needed)

- Evasion and recovery (E&R) equipment ("overnight kit")
- Sensitive item destruction devices

---

**COMMUNICATIONS**

---

**1. Chain of Command**

**2. Convoy Call Sign(s):** \_\_\_\_\_

**3. AOR Communications/MEDEVAC Plan**

**4. Convoy Primary/Alternate/Contingency/Emergency (PACE) Communications (extra batteries):**

- Long Range (Back to: \_\_\_\_\_)
  - Radio: \_\_\_\_\_ primary/alternate \_\_\_\_\_ / \_\_\_\_\_
  - Radio: \_\_\_\_\_ primary/alternate \_\_\_\_\_ / \_\_\_\_\_
- Squad (on objective)
  - Radio: \_\_\_\_\_ primary/alternate \_\_\_\_\_ / \_\_\_\_\_
  - Radio: \_\_\_\_\_ primary/alternate \_\_\_\_\_ / \_\_\_\_\_
- Inter-vehicle
  - Radio: \_\_\_\_\_ primary/alternate \_\_\_\_\_ / \_\_\_\_\_
  - Radio: \_\_\_\_\_ primary/alternate \_\_\_\_\_ / \_\_\_\_\_
- Hand and arm/visual signals (as per unit SOPs)
- Command and control terms: "Quickstop," "Dismount," "Remount," "Clear," Block(ing)," "Bumping," "Status," "Up," "Blow through (potential threat) XXX meters," "Brakes, brakes," "Rolling," "Contact, L/R/F/R," "Reverse out," "Bailout," "Man down," "Support."
- BFTs SN #s
- Pyrotechnics
- Special instructions (SPINS)
- Supporting arms: freq: \_\_\_\_\_ call sign: \_\_\_\_\_
- QRF: freq: \_\_\_\_\_ call sign: \_\_\_\_\_ (**Note:** HOPSETS changes with AORs)

- CASEVAC: freq:\_\_\_\_\_ call sign:\_\_\_\_\_

---

## SAFETY

---

### 1. Overall Risk to Force:

- Low
- Medium
- High

### 2. Overall Risk to Mission Accomplishment:

- Low
- Medium
- High

### 3. Fratricide Reduction Measures:

- NTV friendly signaling/recognition techniques (FONE)
  - Far
  - Overhead
  - Near
  - Emergency (day/night)
- Actions at friendly checkpoints
- Action while passing/approaching "green"/coalition convoys

## Section III

### Vehicle Convoy Post-Operations Checklist

\_\_\_ Report vehicle convoy operation completion to the JOC.

\_\_\_ Conduct debrief/AAR (**Note:** Cover entire operation, sustains and improvements).

\_\_\_ Vehicles:

- Refuel, clean (trash, windows, interior, exterior)
- Inventory following equipment (as applicable):

- Radio mounting hardware
- Weapons mounts
- Spare tire with jack
- Fuel (full tank), fuel cans (2 extra, full)
- Water
- MREs
- Extra ammo cans for spare ammo
- Stretchers
- VS-17 panel
- Tow straps
- Clean/turn in communications gear
  - Long range
  - Inter-vehicle
  - Squad/Internal (i.e., PRC-148s)
  - BFT (**Note:** Draw and turn on at least 45 minutes prior to allow for acquisition/registration of unit.)
  - Antennas (as required)
  - Cell phone (local, iridium)
  - Communications plan (including SPINS)
- Clean/turn in weapons/ammunition
  - CSW
  - Stand-off
  - Extra magazines
  - CSW (.50 cal. link, 7.62-mm link, 5.56-mm link, 40-mm link)
  - Personal weapons (as per unit SOP)
  - Pyrotechnics (white HC smoke, red star cluster)
  - Grenades (fragmentation)



- Flash bangs (as per unit SOP)

**(Note:** Ensure standby ammunition is drawn to stage in vehicles.)

- \_\_ Submit intelligence reports (if applicable).
- \_\_ Inventory/return medical equipment.
- \_\_ Recover supporting personal equipment.
- \_\_ Conduct planning for follow-on operation.
- \_\_ Submit contingency operations (CONOPS).

## **Section IV**

### **Medical Evacuation (MEDEVAC) Procedures**

#### **1. Location of Pickup Site:**

Encrypt the grid coordinates of the pickup site. When using the DRYAD Numeral Cipher, the same “SET” line will be used to encrypt the grid zone letters and the coordinates. To preclude misunderstanding, a statement is made to indicate that grid zone letters are included in the message (unless unit SOP specifies its use at all times).

#### **2. Radio Frequency, Call Sign, and Suffix:**

Encrypt the frequency of the radio at the pickup site. (It is not a relay frequency.) The call sign (and suffix, if used) or person to be contacted at the pickup site may be transmitted in the clear.

#### **3. Number of Patients (PNTs) by Precedence:**

- Report only applicable information and encrypt the brevity codes:
  - A - URGENT
  - B - URGENT-SURGICAL
  - C - PRIORITY
  - D - ROUTINE
  - E - CONVENIENCE
- If two or more categories must be reported in the same request, insert the word “BREAK” between each category.

**4. Special Equipment Required:**

Encrypt the applicable brevity codes:

- A - None
- B - Hoist
- C - Extraction equipment
- D - Ventilator

**5. Number of Patients by Type:**

Report only applicable information and encrypt the brevity codes. If requesting MEDEVAC for both, insert the word “BREAK” between the litter entry and ambulatory entry.

- L + # of PNT – Litter
- A + # of PNT – Ambulatory (sitting).

**6. Security of Pickup Site:**

- N - No enemy troops in area
- P - Possible enemy troops in area (approach with caution)
- E - Enemy troops in area (approach with caution)
- X - Enemy troops in area (armed escort required)

**7. Number and Type of Wound, Injury, or Illness:**

Specific information regarding patient wounds by type (gunshot or shrapnel); report serious bleeding, along with patient blood type, if known.

**8. Method of Marking Pickup Site:**

Encrypt the brevity codes:

- A - Panels
- B - Pyrotechnic signal
- C - Smoke signal
- D - None
- E - Other

**9. Patient Nationality and Status:**

The number of patients in each category need not be transmitted. Encrypt only the applicable brevity codes.

- A - United States (U.S.) military
- B - U.S. civilian
- C - Non-U.S. military
- D - Non-U.S. civilian
- E - EPW

**10. Nuclear, Biological, and Chemical (NBC) Contamination:**

Include this line only when applicable. Encrypt the applicable brevity codes.

- N - Nuclear
- B - Biological
- C - Chemical

**11. Terrain Description:**

Includes details of terrain features in and around proposed landing site. If possible, describe relationship of site to prominent terrain feature (lake, mountain, tower, etc.).



**CHAPTER 5**

**GLOSSARY**

<b>3-D</b>	<b>three dimensional</b>
<b>AAR</b>	<b>after action review</b>
<b>AOR</b>	<b>area of responsibility</b>
<b>Asst.</b>	<b>assistant</b>
<b>BFT</b>	<b>Blue Force Tracker</b>
<b>C2</b>	<b>command and control</b>
<b>Cal</b>	<b>caliber</b>
<b>CASEVAC</b>	<b>casualty evacuation</b>
<b>CC</b>	<b>convoy commander</b>
<b>CCB</b>	<b>convoy commander's brief</b>
<b>CDR</b>	<b>commander</b>
<b>CEXC</b>	<b>combined explosive exploitation cell</b>
<b>CFLCC</b>	<b>Combined Forces Land Component Command</b>
<b>CJSOTF-AP</b>	<b>Combined Joint Special Operations Task Force - Arabian Peninsula</b>
<b>CLS</b>	<b>combat lifesaver</b>
<b>CMO</b>	<b>civil-military operation</b>
<b>CONOPS</b>	<b>concept of operations</b>
<b>CPOG</b>	<b>chemical protective over garment</b>
<b>CSW</b>	<b>crew-served weapon</b>
<b>DA</b>	<b>direct action</b>
<b>DoS</b>	<b>Department of State</b>
<b>DR</b>	<b>driver</b>
<b>E&amp;R</b>	<b>evasion and recovery</b>
<b>ECAS</b>	<b>emergency close air support</b>
<b>EOD</b>	<b>explosive ordnance disposal</b>
<b>EPW</b>	<b>enemy prisoner of war</b>

## USSOCOM COMBAT CONVOY HANDBOOK

---

<b>FBI</b>	<b>Federal Bureau of Investigation</b>
<b>FRAGO</b>	<b>fragmentary order</b>
<b>GMV</b>	<b>Ground mobility vehicle</b>
<b>GOTWA</b>	<b>(G) Going, (O) Others, (T) Time, (W) What to do, (A) Actions to take, (5-point contingency plan)</b>
<b>GPS</b>	<b>Global Positioning System</b>
<b>HA</b>	<b>humanitarian assistance</b>
<b>HN</b>	<b>host nation</b>
<b>HRT</b>	<b>hostage rescue team</b>
<b>HVT</b>	<b>high-value target</b>
<b>IED</b>	<b>improvised explosive device</b>
<b>IOT</b>	<b>in order to</b>
<b>JOC</b>	<b>joint operations center</b>
<b>LBE</b>	<b>load-bearing equipment</b>
<b>LZ</b>	<b>loading zone</b>
<b>MEDEVAC</b>	<b>medical evacuation</b>
<b>METT-TC</b>	<b>mission, enemy, terrain and weather, troops and support available, time available, civil considerations</b>
<b>MOPP</b>	<b>mission-oriented protective posture</b>
<b>MRE</b>	<b>meals, ready to eat</b>
<b>NBC</b>	<b>nuclear, biological, and chemical</b>
<b>NOD</b>	<b>night observation device</b>
<b>NTV</b>	<b>non-tactical vehicle</b>
<b>OEF</b>	<b>Operation Enduring Freedom</b>
<b>OIC</b>	<b>officer-in-charge</b>
<b>OIF</b>	<b>Operation Iraqi Freedom</b>
<b>OPSEC</b>	<b>operational security</b>
<b>PACE</b>	<b>primary, alternate, contingency, emergency</b>
<b>PC</b>	<b>precious cargo</b>
<b>PCI</b>	<b>pre-combat inspections</b>

<b>PID</b>	<b>positive identification</b>
<b>QRF</b>	<b>quick reaction force</b>
<b>ROE</b>	<b>rules of engagement</b>
<b>RPG</b>	<b>rocket-propelled grenade</b>
<b>RTB</b>	<b>return to base</b>
<b>SA</b>	<b>situational awareness</b>
<b>SALUTE</b>	<b>size, activity, location, unit, time, and equipment</b>
<b>SBF</b>	<b>support by fire</b>
<b>SEAL</b>	<b>sea-air-land</b>
<b>SFAUC</b>	<b>special forces advanced urban combat</b>
<b>SITREP</b>	<b>situation report</b>
<b>SOF</b>	<b>special operations forces</b>
<b>SOP</b>	<b>standing operating procedures</b>
<b>SP</b>	<b>start point</b>
<b>SPINS</b>	<b>special instructions</b>
<b>SR</b>	<b>special reconnaissance</b>
<b>TLP</b>	<b>troop-leading procedures</b>
<b>TTP</b>	<b>tactics, techniques, and procedures</b>
<b>UAV</b>	<b>unmanned aerial vehicle</b>
<b>ULEO</b>	<b>unconventional law enforcement operations</b>
<b>UN</b>	<b>United Nations</b>
<b>U.S.</b>	<b>United States</b>
<b>USCENTCOM</b>	<b>United States Central Command</b>
<b>USSOCOM</b>	<b>United States Special Operations Command</b>
<b>VBIED</b>	<b>vehicle-born improvised explosive device</b>
<b>VC</b>	<b>vehicle commander</b>
<b>VIP</b>	<b>very important person</b>





## CHAPTER 6

### REFERENCES

#### AARs

Center for Army Lessons Learned (CALL), *Convoy Leader Training Handbook*, Nov 03.

CJTF-7 OIF Smart Card 4, Version 1.A, 2 Jan 04.

Coalition Provisional Authority Force Protection Working Group Briefing, 16 January 2004.

USSOCOM Joint Counter-Ambush Advisory Team, AAR, Jan 04

Sea-Air-Land (SEAL) Team 5 "F" Platoon AAR and PowerPoint®, 30 Aug 03.

#### FMs

FM 7-7J, *Mounted Battle Drills*, Chapter 3.

FM 7-8, *Infantry Rifle Platoon and Squad*.

FM 7-98, *Operations in a Low-Intensity Conflict*.

FM 8-10-6, *Evacuation Request Procedures*.

FM 31-28, *Special Forces Advanced Urban Combat (SFAUC)*.

FM 55-30, *Army Motor Transport Units and Operations*.

#### Non DoD

Federal Bureau of Investigation (FBI) Hostage Rescue Team (HRT),  
Unconventional Law Enforcement Operations (ULEO).

United States Department of State (DoS) Bureau of Diplomatic Security (DS)  
Protective Security Operations Training Manual.



**CALL PRODUCTS INFORMATION PAGE**

In an effort to make access to our information easier and faster, we have put all of our publications, along with numerous other useful elements, on our World Wide Web site. The URL is <http://call.army.mil>.

If you have any comments, suggestions, or requests for information, you may contact us via e-mail at [call@leavenworth.army.mil](mailto:call@leavenworth.army.mil).

We also encourage you, the soldier in the field, to send in any tactics, techniques, and procedures (TTPs) that have been effective for you or your unit. You may send them to us in draft form or fully formatted and ready to print. Our publications receive wide distribution throughout the U.S. Army and we would like to include your ideas. We will even put your name on the byline.

**Contact us by:**

**PHONE:** DSN 552-3035/2255; Commercial (913)684-3035/2255  
**FAX:** Commercial (913) 684-9564  
**MESSAGE:** CDRUSACAC FT LEAVENWORTH, KS // ATZL-CTL//  
**MAIL:** Center for Army Lessons Learned  
ATTN: ATZL-CTL  
10 Meade Ave  
Fort Leavenworth, KS 66027-1350

Additionally, we have developed a repository, the CALL Database (CALLDB), that contains a collection of operational records (OPORDS and FRAGOS) from recent military operations. Much of the information in the CALL DB is password-protected. You may obtain your own password by visiting our web site and going to the CALL database page. Click on "Restricted Access" and "CALL DB Access Request." After you have filled in the information and submitted the request form, we will mail you a password. You may also request a password via STU III telephone or a SIPRNET E-mail account.

CALL's products are produced at Fort Leavenworth, KS and are not distributed through publication channels. Due to limited resources, CALL selectively provides its products for distribution to the following major organizations, agencies, and individuals and relies on them to disseminate initial distribution of each publication to their subordinates. Contact your appropriate higher element if your unit or office is not receiving initial distribution of CALL publications.

<b>Installation Distribution Centers</b>	<b>TRADOC LOs</b>
<b>Corps, Divisions, and Brigades</b>	<b>ROTC Headquarters</b>
<b>Special Forces Groups and Battalions</b>	<b>Combat Training Centers</b>
<b>Ranger Battalions</b>	<b>Regional Support Commands, Division, Brigades, Battalions</b>
<b>TRADOC Schools</b>	<b>Staff Adjutant Generals</b>

### CALL PRODUCTS "On-Line"

There are two ways to access information from CALL on-line: E-mail and the World Wide Web (www). CALL offers Web-based access to the CALL data base (CALLDB). The CALL Home Page address is

**<http://call.army.mil>**

CALL produces the following publications:

**CTC Bulletins, CTC Observations, and Trends Products:** These products are periodic publications that provide current lessons learned/TTP and information from the training centers.

**Special Editions:** Special Editions are newsletters related to a specific operation or exercise. Special Editions are normally available prior to a deployment and targeted for only those units deploying to a particular theater or preparing to deploy to the theater.

**News From the Front:** This product contains information and lessons on exercises, real-world events, and subjects that inform and educate soldiers and leaders. It provides an opportunity for units and soldiers to learn from each other by sharing information and lessons. *News From The Front* can be accessed from the CALL Homepage.

**Training Techniques:** Accessed from the CALL Homepage, the Army's first on-line publication focuses on TTP for brigade and below.

**Handbooks:** Handbooks are "how to" manuals on specific subjects (i.e., rehearsals, inactivation).

**Initial Impressions Products:** Initial impression products are developed during and immediately after a real-world operation and disseminated in the shortest time possible for the follow-on units to use in educating personnel and supporting training prior to deployment to a theater. Products that focus on training activities may also be provided to support the follow-on unit.

Many customers are sending in their requests for information to CALL by E-mail. By sending an E-mail message to CALL, you can register for future electronic publications, make requests for information or publications, or send in your own observations; tactics, techniques, and procedures; and articles. CALL's current E-mail address is:

**[call@leavenworth.army.mil](mailto:call@leavenworth.army.mil)**

***Support CALL in the exchange of information by telling us about your successes so they may be shared and become Army successes.***



# Center for Army Lessons Learned

**FOR OFFICIAL USE ONLY**