

MOON



THEISM



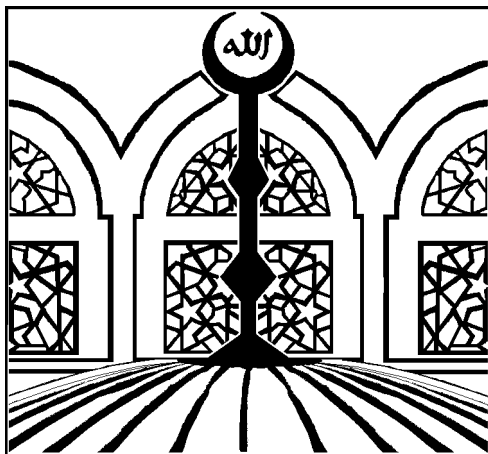
YOEL NATAN

# Moon-o-theism

## Religion of a War and Moon God Prophet

### Volume I of II

By Yoel Natan



*Allah* (Arabic: *aUl*) in the crescent of a finial in front of windows with a star-field motif. *Al-Aksa Mosque*, Temple Mount, Jerusalem.<sup>1</sup>

Yoel Natan is the author of:  
The Jewish Trinity,  
The Jewish Trinity Sourcebook,  
Baptism &  
Lutheran Eschatology  
Web site: [www.Yoel.Info](http://www.Yoel.Info)

Edition 1.0  
Copyright © 2006 by Yoel Natan.  
All Rights Reserved.

Without limiting the rights under copyright reserved above, no part of this publication may be reproduced, stored in or introduced into a retrieval system, or transmitted, in any form or by any means (electronic, mechanical, photocopying, recording, or otherwise), without the prior written permission of both the copyright owner and the publisher of this book.

---

<sup>1</sup> Figure 00-01 (doubles as Figure 12-18). *Allah* (Arabic: *aUl*) in crescent in front of *Mosque* windows with a star field motif. Caption for the source picture is: “The ‘*alam* (finial [*sic*]) of the small dome above the entrance to the *Aqsa Mosque* [at the temple mount]” (Nuseibeh & Grabar. *Dome*, pp. 175-176). For more information on the association of the name *Allah* with crescent finials, see the *Lahut* and *Turkish Blessing* entries in the Index.

Table of Contents (ToC)

Volume I of II

**MAPS OF MIDEAST WORSHIP CENTERS .....5**

**MIDEAST MILEAGE .....7**

**TABLE OF ANCIENT PLANETARY DEITIES FOUND IN THE MIDEAST ..8**

**CHRONOLOGY OF THE *KORAN'S SURAS* (CHAPTERS) AND WAR VERSES .....9**

**THE *MAKKAN* AND *MADINAN SURAS* SORTED BY *SURA* NUMBER .....9**

**THE ORDER IN WHICH *SURAS* WERE WRITTEN, SORTED BY *SURA* NUMBER...10**

**THE ORDER THE *SURAS* WERE WRITTEN, SORTED FIRST TO LAST.....11**

**CHRONOLOGICAL LIST OF *SURAS* INTERSPERSED WITH NOTES ON *JIHAD* .....12**

**THE *KORAN'S* 164 WAR VERSES IN CHRONOLOGICAL ORDER (SUMMARY).....14**

**SUMMARY OF EACH CHAPTER.....16**

**PREFACE .....20**

**GOAL OF THIS *MOON-O-THEISM* BOOK .....20**

**TWO BASIC QUESTIONS THIS *MOON-O-THEISM* BOOK ANSWERS .....24**

**CHAPTER 01: MOON-O-THEISTIC WAR-GOD RELIGION.....26**

***ALLAH* AS A *WAR-GOD* .....26**

**THE CONSEQUENCE OF *ISLAM* BEING A BIBLICIZED WAR-AND-MOON-GOD RELIGION .....33**

***ISLAM* WAS A RELIGION OF A WAR-GOD FROM ITS VERY INCEPTION .....35**

**THE CHRONOLOGY OF VIOLENCE IN *ISLAM* .....39**

**THE *JIHAD* MEANS INNER STRUGGLE SHAM .....41**

**THE LESSER VERSUS GREATER *JIHAD* SHAM.....44**

**KHIDR-SECOND LAMECH LOGIC: A PRESCRIPTION FOR ANTEDILUVIAN VIOLENCE .....52**

**THE HIGH CRIME AND INCARCERATION RATES OF *MUSLIMS*.....283**

***ISLAMISTS* STILL DREAM OF MAKING INFIDELS INTO *DHIMMIS* AND SEX-SLAVES .....287**

***JIHAD* CONTAINMENT AROUND THE WORLD.....289**

***ISLAMIST* AUTONOMOUS REGIONS .....299**

**LET'S YOU AND HIM FIGHT: DECEPTIVE TRIANGULATION .....302**

**THE COVENANT OF SECURITY .....320**

**CHAPTER 02: MOON-O-THEISTIC MIDEAST.....323**

***ALLAH* AS A MOON-GOD .....329**

**SOUTHERN ARABIAN AND *ABYSSINIAN* MOON-GODS THAT DOUBLED AS WAR-GODS .....333**

**CRITIQUE OF THE REVISIONIST VIEW ON THE SUN- AND MOON-GODS IN SOUTHERN ARABIA.....338**

**CHAPTER 03: MOON-O-THEISTIC PROSELYTIZING .....360**

**IMPORTANT *SOLA SCRIPTURA ISLAMIST* SCHOLARS .....361**

<i>ALLAH'S IDENTITY THEFT AGAINST YAHVEH</i> .....	364
SOME WORDSMITHS THAT <i>MUHAMMAD</i> HAD.....	370
ASSASSINATED OR LATER APPROVED OF THEIR ASSASSINATION .....	370
THE PSYCHOLOGY OF <i>DHIMMITUDE</i> AND THE VIOLENCE-INDUCED CONVERSION SYNDROME (VCS).....	396
WHAT GIVES <i>ISLAM</i> ITS ALLURE AND SEEMING SUCCESS .....	400
<b>CHAPTER 04: MOON-O-THEISTIC SCRIPTURE.....</b>	<b>429</b>
SOME <i>MAKKAN</i> ASTRAL AND PAGAN <i>SURAS</i> .....	429
MARRYING ONE'S OWN RELATIVES .....	438
<i>SABEAN</i> AND <i>SABIAN</i> USED AS SYNONYMS IN <i>KORAN</i> .....	451
THE <i>KORAN'S</i> TWENTY-NINE MENTIONS OF THE MOON .....	485
THE LUNAR MONTH CYCLE FOR READING THE <i>KORAN</i> .....	488
<i>KORANIC</i> MYSTICAL LETTERS THAT MAY STAND FOR TITLES OF <i>ALLAH</i> .....	491
THE <i>KORAN'S</i> SEEMINGLY NONSENSICAL LETTERS (SUMMARY).....	492
<i>KORAN</i> CHAPTERS DEDICATED TO <i>SIN</i> THE MOON-GOD .....	492
<b>CHAPTER 05: MOON-O-THEISTIC <i>HARAN</i> CONNECTION .....</b>	<b>501</b>
<b>CHAPTER 06: MOON-O-THEISTIC CHRISTIAN CONNECTION.....</b>	<b>531</b>
<b>Volume II of II</b>	
<b>CHAPTER 07: MOON-O-THEISTIC JEWISH CONNECTION.....</b>	<b>609</b>
SUMMARY OF <i>MUHAMMAD'S</i> GENEALOGY AND JEWISH EXTRACTION .....	613
<b>CHAPTER 08: MOON-O-THEISTIC TEN COMMANDMENTS .....</b>	<b>629</b>
THE MOON-GOD RELIGION BEGETS DOUBLE PREDESTINATIONISM .....	646
THE MEANINGS OF THE <i>ISLAMIC</i> MONTHS' NAMES .....	667
THE IDEAL ALIGNMENT OF THE JEWISH ZODIAC & <i>ISLAMIC</i> MONTHS .....	674
HUMAN SACRIFICE AT THE <i>KAABA</i> IN THE PRE- <i>ISLAMIC</i> ERA .....	676
<i>MUSLIMS</i> VIEW THE SLAUGHTER OF INFIDELS AS HUMAN SACRIFICES.....	679
HUMAN SACRIFICE AT THE <i>KAABA</i> DURING THE <i>ISLAMIC</i> ERA .....	689
<b>CHAPTER 09: MOON-O-THEISTIC <i>KAABA</i> .....</b>	<b>746</b>
THE VULVIFORM BLACK STONE WITH ITS SILVER CASING.....	752
THE SECOND AUSPICIOUS STONE AT THE <i>KAABA</i> DEDICATED TO <i>ALLAT'S</i> NIPPLES .....	761
A THIRD AUSPICIOUS STONE AT THE <i>KAABA</i> DEDICATED TO <i>MANAT</i> .....	762
<i>HUBAL AS BAAL</i> .....	768
<b>CHAPTER 10: MOON-O-THEISTIC VENUS ALTARS.....</b>	<b>776</b>
<i>THE RAKAH CRESCENT-ORB ORANT POSITION (THE RAISING OF THE HANDS)</i> .....	799
WHETHER THE ORANT POSITION IS BIBLICAL OR NOT .....	801
<b>CHAPTER 11: MOON-O-THEISTIC <i>MOSQUES</i> .....</b>	<b>852</b>
<b>CHAPTER 12: MOON-O-THEISTIC TEMPLES.....</b>	<b>863</b>
<b>CHAPTER 13: MOON-O-THEISTIC PILGRIMAGES.....</b>	<b>915</b>
<b>CHAPTER 14: MOON-O-THEISTIC PROPHET .....</b>	<b>931</b>



<b>CHAPTER 15: MOON-O-THEISTIC DRUG .....</b>	<b>950</b>
<b>CHAPTER 16: MOON-O-THEISTIC RELIGIOUS CULTURE .....</b>	<b>991</b>
<b>THE KORAN'S SEEMINGLY NONSENSICAL LETTERS (DETAILED).....</b>	<b>998</b>
<b>HALAL FOOD IS FOOD SACRIFICED TO DEMONS.....</b>	<b>1020</b>
<b>APPENDIX: MOON-O-THEISTIC COINS .....</b>	<b>1038</b>
<b>NUMISMATIC METAL ABBREVIATIONS .....</b>	<b>1063</b>
<b>SELECTED ISLAMIC COIN REFERENCES .....</b>	<b>1064</b>
<b>BACK MATTER.....</b>	<b>1065</b>
<b>18 ETHNIC-CLEANSING VERSES IN THE KORAN .....</b>	<b>1065</b>
<b>THE KORAN'S 164 WAR VERSES (DETAILED).....</b>	<b>1067</b>
<b>ABBREVIATIONS.....</b>	<b>1094</b>
<i>Bible Book Name Abbreviations .....</i>	<i>1094</i>
<i>Other References (Also see the Selective Bibliography) .....</i>	<i>1095</i>
<b>GLOSSARY .....</b>	<b>1098</b>
<i>English-Arabic Who's Who.....</i>	<i>1098</i>
<i>English-Arabic Glossary Index.....</i>	<i>1099</i>
<i>English-Arabic Glossary.....</i>	<i>1099</i>
<i>The Five Stages of the Dreaded PC-AIDS and PC-ASS Diseases .....</i>	<i>1121</i>
<b>SELECTIVE BIBLIOGRAPHY.....</b>	<b>1144</b>
<b>THUMBNAIL GALLERY .....</b>	<b>1157</b>
<b>ABOUT THE BOOK COVER.....</b>	<b>1162</b>
<b>INDEX.....</b>	<b>1163</b>

Maps of Mideast Worship Centers

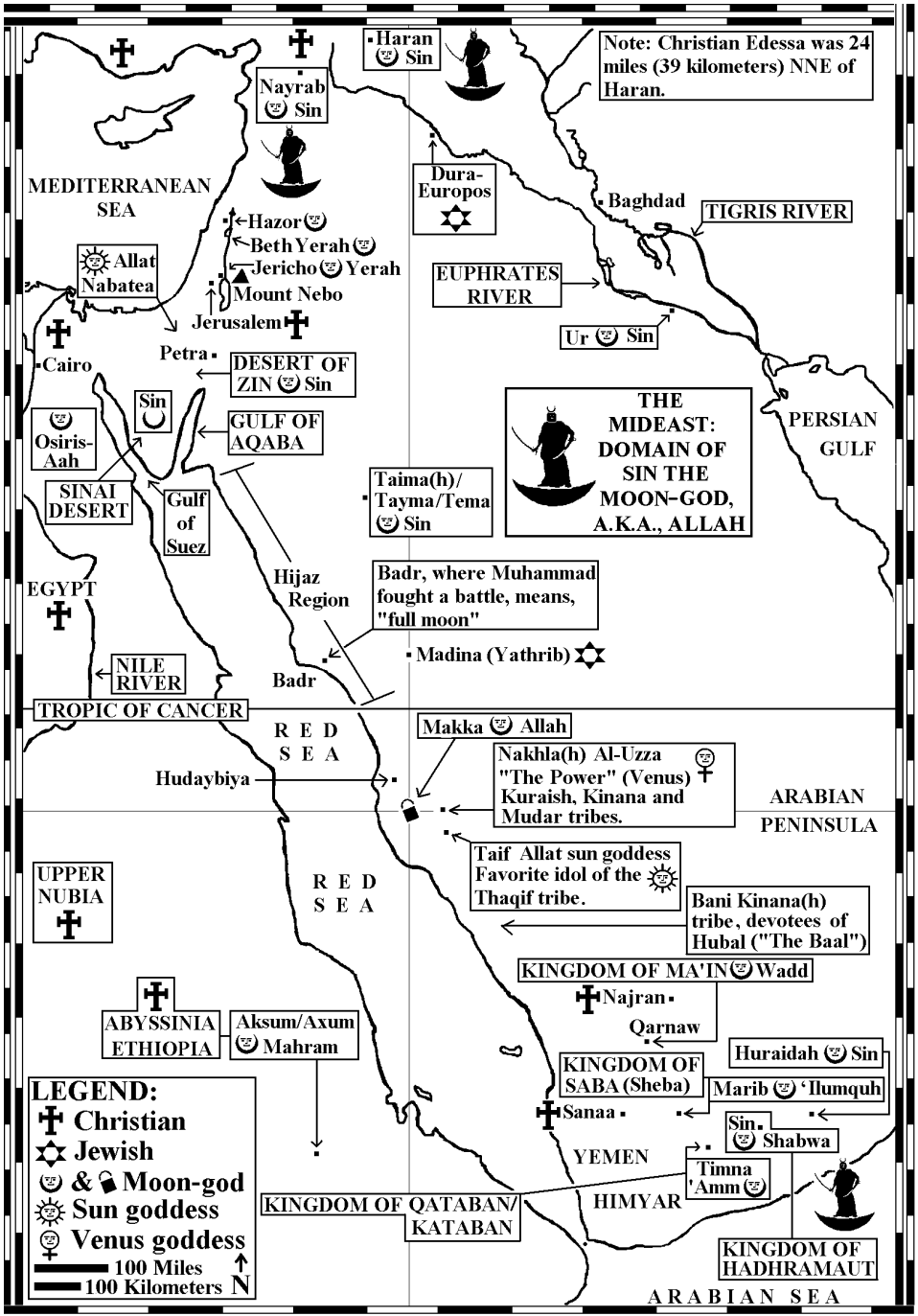


Figure 00-02. Notable moon-god worship centers in the Mideast (less detailed map).<sup>2</sup>

<sup>2</sup> A sampling of ancient and modern cities is provided for bearings.



## Mideast Mileage

**Table of Straight-line Distance Between Various Cities in the Fertile Crescent**

<i>Dura-Europos</i>	328 M 527 KM				
<i>Haran, Turkey</i>	347 M 559 KM	176 M 283 KM			
<i>Hazor</i>	31 M 49 KM	329 M 529 KM	333 M 536 KM		
<i>Jericho</i>	84 M 135 KM	387 M 623 KM	427 M 688 KM	110 M 176 KM	
<i>Ur</i>	632 M 1,016 KM	409 M 658 KM	578 M 930 KM	649 M 1,045 KM	644 M 1,036 KM
<b>Miles/ KM</b>	<i>Beth Yerah</i>	<i>Dura-Europos</i>	<i>Haran</i>	<i>Hazor</i>	<i>Jericho</i>

**Note:** *Ur* and *Dura-Europos* are in Mesopotamia, *Hazar*, *Jericho* and *Beth Yerah* are in Palestine and *Haran* is in Southeast Turkey. These can be located on the maps, above.

**Table of Straight-line Distance Between Jerusalem and Various Cities in Arabia and Abyssinia**

<i>Aksum, Ethiopia</i>	929 M 1,495 KM				
<i>Huraydah, Yemen</i>	1,047 M 1,685 KM	635 M 1,021 KM			
<i>Jerusalem, Palestine</i>	345 M 556 KM	1,233 M 1,985 KM	1391 M 2,239 KM		
<i>Marib, Yemen</i>	959 M 1,544 KM	450 M 725 KM	185 M 298 KM	1304 M 2,098 KM	
<i>Makka, Arabia</i>	434 M 698 KM	508 M 818 KM	687 M 1,106 KM	765 M 1,231 KM	560 M 901 KM
<b>Miles/ KM</b>	<i>Tema, North Arabia</i>	<i>Aksum, Ethiopia</i>	<i>Huraydah Yemen</i>	<i>Jerusalem, Palestine</i>	<i>Marib, Yemen</i>

### Abbreviations:

KM = kilometers

M = miles

### Conversion Factor:

1 KM = 0.62 M

1 M = 1.6 KM

Table of Ancient Planetary Deities Found in the Mideast<sup>4</sup>

English	Sun	Moon	Mercury	Venus
Roman	<i>Sol</i>	<i>Diana/Luna</i>	<i>Mercurius</i>	<i>Venus</i>
Greek	<i>Helios/Apollo</i>	<i>Selena/Artemis</i>	<i>Hermes</i>	<i>Aphrodite</i>
Arabian	<i>Allat Shams</i> , meaning “The goddess sun.” <sup>5</sup>	<i>Allah Taala, Sin</i> , meaning “The most high god <i>Sin</i> .” <sup>6 7</sup>	<i>Almustari</i> <i>Asad/</i> <i>Atarid/</i> <i>Utarid</i> <sup>8</sup>	<i>Uzza/</i> <i>Zuhra/</i> <i>Zuhara</i>
Hebrew	<i>Shemesh</i>	<i>Yareah/Yareach</i>	<i>Nebo</i>	<i>Helil</i>
Canaanite	<i>Shapash</i>	<i>Yarah</i>	<i>Astarte</i>	<i>Resheph</i>
Babylonian	<i>Shamash</i>	<i>Sin</i>	<i>Nabu</i>	<i>Ishtar</i>
Akkadian	<i>Shamash</i>	<i>Sin</i>	<i>Nabu</i>	<i>Ishtar</i>
Sumerian	<i>Utu</i>	<i>Suen/Nanna</i>	<i>Nabu</i>	<i>Inana</i>

English	Mars	Jupiter	Saturn
Roman	<i>Mars</i>	<i>Iupiter</i>	<i>Saturnus</i>
Greek	<i>Ares</i>	<i>Zeus</i>	<i>Kronos/Rephan</i> ( <i>LXX</i> Amo 05:26; Act 07:43)
Arabian	<i>Merrikh</i> <sup>9</sup>	<i>Hubal, or</i> <i>Hubal Al</i> <i>Mushtari</i> . <sup>10</sup> <i>Hubal’s</i> personal name was <i>Ghanm</i> . <sup>11</sup>	<i>Zuhal/Kaiwan</i> <sup>12</sup>
Hebrew	<i>Nergal</i>	<i>Baal</i> <sup>13</sup>	<i>Kiyyun</i> ( <i>MT</i> Amo 05:26)
Canaanite	<i>Baal</i>	<i>El</i>	<i>Ashtaroth</i>
Babylonian	<i>Nergal</i>	<i>Marduk/Bel/Baal</i> <sup>14</sup>	<i>Ninib/Ninurta</i>
Akkadian	<i>Nergal</i>	<i>Marduk</i>	<i>Ea/Bel</i>
Sumerian	<i>Nergal</i>	<i>Enki</i>	<i>Nanna</i>

<sup>4</sup> Sources include: 1) Wherry. *Commentary*, vol. i, section i, p. 38, 2) *Institute for Biblical & Scientific Studies*, “Genesis 1:14-19 Day 4 Wandering Stars,” bibleandscience.com, accessed 20 Dec 2003 and 3) Stobbart, J.W.H. *Islam and its Founder*, p. 32, as quoted by Siddiqui. *Life*, Ch. 1: *Arabia before Islam: Religion of the pre-Islamic Arabs*.

<sup>5</sup> The *Nabateans* in northern Arabia worshipped *Nasr*, meaning “Eagle” or “Vulture,” both of which were considered solar-god animals.

<sup>6</sup> Wherry. *Commentary*, vol. i, section i, p. 36.

<sup>7</sup> *Muhammad’s* titles were *YaSin* (O *Sin*) (*K* 036 title) or *IYYaSin* (meaning “My God is *Sin*”) (*K* 006:085; 037:123, 130). See the “*Koran* Chapters Dedicated to *Sin* the Moon-god” section.

<sup>8</sup> *Almustari* is Arabic for “running god,” and refers to Mercury’s quick pace. The *Nabateans* in northern *Arabia* worshiped Mercury as *Aktab-Kutbay*.

<sup>9</sup> Mars (Arabic: *Merrikh*) is not mentioned much in Arabian pagan sources since his “war” function had been assigned to the Arab national moon-gods instead.

<sup>10</sup> *Habaal, or Hubal Al Mushtari*, literally meaning “The lord Jupiter.”

<sup>11</sup> Guillaume wrote: “[*Hubal*] is the reading of *Al-Kalbi* [*Book of Idols*], but all [*Sirat Rasul Allah*] manuscripts have *Ghanm*, a deity unknown. Confer also *Yaq. iii. 665.8*” (*Ishaq. Sirat*, p. 100 & fn).

<sup>12</sup> *Kaiwan* is Arabic for “steady,” and refers to the planet Saturn’s slow pace along the ecliptic.

<sup>13</sup> The Romans equated *Baal* with Jupiter, and the Greeks equated *Baal* with *Zeus* (*ISBE*, “Jupiter,” entry 5183, authored by Burton Scott Easton).

<sup>14</sup> In Babylon, “*Marduk’s* [*Bel* or *Baal’s*] star was Jupiter” (*EB*, accessed 20 Aug 2004, *Marduk* entry). *Baal* (or *Bel*) at *Palmyra*, Syria, and at *Baalbek-Heliopolis*, Lebanon, was Jupiter in the Classical and Late Antique eras (*Ness. Astrology*, Ch. 3).

Chronology of the *Koran's Suras* (Chapters) and War Verses

<b>The <i>Makkan</i> and <i>Madinan Suras</i> Sorted by <i>Sura</i> Number</b>				
<b><i>Sura(s)</i></b>	<b>Consensus</b>	<b>Nöldeke<sup>15</sup></b>	<b>Yusuf Ali<sup>16</sup></b>	<b>Maududi<sup>17</sup></b>
1	<i>Makkan</i>	<b>BH</b>	<b>No mention</b>	<b>BH</b>
2-5	<i>Madinan</i>	AH	AH	AH
6-7	<i>Makkan</i>	BH	BH	BH
8-9	<i>Madinan</i>	AH	AH	AH
10-17	<i>Makkan</i>	BH	BH	BH
18	<i>Makkan</i>	<b>BH</b>	<b>No mention</b>	<b>BH</b>
19	<i>Makkan</i>	BH	BH	BH
20	<i>Makkan</i>	<b>BH</b>	<b>AH</b>	<b>BH</b>
21	<i>Makkan</i>	BH	BH	BH
22	<i>Madinan</i>	<b>AH</b>	<b>BH/AH</b>	<b>BH/AH</b>
23	<i>Makkan</i>	BH	BH	BH
24	<i>Madinan</i>	AH	AH	AH
25-32	<i>Makkan</i>	BH	BH	BH
33	<i>Madinan</i>	AH	AH	AH
34-46	<i>Makkan</i>	BH	BH	BH
47-49	<i>Madinan</i>	AH	AH	AH
50-56	<i>Makkan</i>	BH	BH	BH
57-66	<i>Madinan</i>	AH	AH	AH
67-97	<i>Makkan</i>	BH	BH	BH
98	<i>Madinan</i>	<b>AH</b>	<b>AH</b>	<b>BH or AH</b>
99	<i>Makkan</i>	<b>BH</b>	<b>BH or AH</b>	<b>BH</b>
100-106	<i>Makkan</i>	BH	BH	BH
107	<i>Makkan</i>	<b>BH</b>	<b>BH</b>	<b>AH</b>
108-109	<i>Makkan</i>	BH	BH	BH
110	<i>Madinan</i>	AH	AH	AH
111-114	<i>Makkan</i>	BH	BH	BH

**Summary:** The consensus view of Noeldeke, Yusuf Ali and Maududi is that the twenty-four *Madinan Suras* are: 002-005, 008-009, 022, 024, 033, 047-049, 057-066, 098 and 110. The other ninety *Suras* are all *Makkan*.

**Legend:**

- ☉ The bolded AH/BH means there is no consensus on the date of the *Sura*,
- ☉ AH, or often just H, is the abbreviation for *Anno Hijri*, indicating a *Madinan Sura*,
- ☉ BH, or often BAH, is the abbreviation for “Before (*Anno*) *Hijri*,” indicating a *Makkan Sura* in the above list,
- ☉ *Anno* is Latin for “year.”
- ☉ The *Hijri*, Arabic for “migration,” occurred when *Muhammad* and his *Muslim* followers migrated from *Makka* to *Madina* in 622 AD/1 AH. There is no zero-year.

<sup>15</sup> Nöldeke, Theodor. *Geschichte des Qorans* (see Sell, *Quran*, pp. vii-viii).

<sup>16</sup> *Yusuf Ali*. *Meanings*, compiled from Yusuf Ali's 114 *Sura* Introductions.

<sup>17</sup> Maududi. *Meaning*, compiled from “Chapter Introductions to the *Quran*.”

The following two tables follow Theodor Nöldeke's chronology from *Geschichte des Qorans*.<sup>18</sup> The twenty-four *Madinan Suras* are bolded.

The Order in Which <i>Suras</i> Were Written, Sorted by <i>Sura</i> Number											
<i>K</i>	#	<i>K</i>	#	<i>K</i>	#	<i>K</i>	#	<i>K</i>	#	<i>K</i>	#
1	48 <sup>th</sup>	21	65 <sup>th</sup>	41	71 <sup>st</sup>	<b>61</b>	<b>98<sup>th</sup></b>	81	27 <sup>th</sup>	101	24 <sup>th</sup>
<b>2</b>	<b>91<sup>st</sup></b>	<b>22</b>	<b>107<sup>th</sup></b>	42	83 <sup>rd</sup>	<b>62</b>	<b>94<sup>th</sup></b>	82	26 <sup>th</sup>	102	8 <sup>th</sup>
<b>3</b>	<b>97<sup>th</sup></b>	23	64 <sup>th</sup>	43	61 <sup>st</sup>	<b>63</b>	<b>104<sup>th</sup></b>	83	37 <sup>th</sup>	103	21 <sup>st</sup>
<b>4</b>	<b>100<sup>th</sup></b>	<b>24</b>	<b>105<sup>th</sup></b>	44	53 <sup>rd</sup>	<b>64</b>	<b>93<sup>rd</sup></b>	84	29 <sup>th</sup>	104	6 <sup>th</sup>
<b>5</b>	<b>114<sup>th</sup></b>	25	66 <sup>th</sup>	45	72 <sup>nd</sup>	<b>65</b>	<b>101<sup>st</sup></b>	85	22 <sup>nd</sup>	105	9 <sup>th</sup>
6	89 <sup>th</sup>	26	56 <sup>th</sup>	46	88 <sup>th</sup>	<b>66</b>	<b>109<sup>th</sup></b>	86	15 <sup>th</sup>	106	4 <sup>th</sup>
7	87 <sup>th</sup>	27	68 <sup>th</sup>	<b>47</b>	<b>96<sup>th</sup></b>	67	63 <sup>rd</sup>	87	19 <sup>th</sup>	107	7 <sup>th</sup>
<b>8</b>	<b>95<sup>th</sup></b>	28	79 <sup>th</sup>	<b>48</b>	<b>108<sup>th</sup></b>	68	18 <sup>th</sup>	88	34 <sup>th</sup>	108	5 <sup>th</sup>
<b>9</b>	<b>113<sup>th</sup></b>	29	81 <sup>st</sup>	<b>49</b>	<b>112<sup>th</sup></b>	69	38 <sup>th</sup>	89	35 <sup>th</sup>	109	45 <sup>th</sup>
10	84 <sup>th</sup>	30	74 <sup>th</sup>	50	54 <sup>th</sup>	70	42 <sup>nd</sup>	90	11 <sup>th</sup>	<b>110</b>	<b>111<sup>th</sup></b>
11	75 <sup>th</sup>	31	82 <sup>nd</sup>	51	39 <sup>th</sup>	71	51 <sup>st</sup>	91	16 <sup>th</sup>	111	3 <sup>rd</sup>
12	77 <sup>th</sup>	32	70 <sup>th</sup>	52	40 <sup>th</sup>	72	62 <sup>nd</sup>	92	10 <sup>th</sup>	112	44 <sup>th</sup>
13	90 <sup>th</sup>	<b>33</b>	<b>103<sup>rd</sup></b>	53	28 <sup>th</sup>	73	23 <sup>rd</sup>	93	13 <sup>th</sup>	113	46 <sup>th</sup>
14	76 <sup>th</sup>	34	85 <sup>th</sup>	54	49 <sup>th</sup>	74	2 <sup>nd</sup>	94	12 <sup>th</sup>	114	47 <sup>th</sup>
15	57 <sup>th</sup>	35	86 <sup>th</sup>	55	43 <sup>rd</sup>	75	36 <sup>th</sup>	95	20 <sup>th</sup>		
16	73 <sup>rd</sup>	36	60 <sup>th</sup>	56	41 <sup>st</sup>	76	52 <sup>nd</sup>	96	1 <sup>st</sup>		
17	67 <sup>th</sup>	37	50 <sup>th</sup>	<b>57</b>	<b>99<sup>th</sup></b>	77	32 <sup>nd</sup>	97	14 <sup>th</sup>		
18	69 <sup>th</sup>	38	59 <sup>th</sup>	<b>58</b>	<b>106<sup>th</sup></b>	78	33 <sup>rd</sup>	<b>98</b>	<b>92<sup>nd</sup></b>		
19	58 <sup>th</sup>	39	80 <sup>th</sup>	<b>59</b>	<b>102<sup>nd</sup></b>	79	31 <sup>st</sup>	99	25 <sup>th</sup>		
20	55 <sup>th</sup>	40	78 <sup>th</sup>	<b>60</b>	<b>110<sup>th</sup></b>	80	17 <sup>th</sup>	100	30 <sup>th</sup>		

<sup>18</sup> Chronologies by Jalalu'd-*Din* as-Syut, Noeldecke and Muir can be found in Sell, *Quran*, pp. 203-204. However, of the three chronologies, only Theodor Noeldecke's chronology agrees with Maududi and Yusuf Ali's reckoning of which *Suras* are *Makkan* and which *Suras* are *Madinan*. Sell writes that Noeldecke's chronology is "the best and most authoritative" (Sell, *Quran*, p. vii).

The following table and previous table follow Theodor Nöldeke's chronology from *Geschichte des Qorans*.<sup>19</sup>

<b>The Order the Suras Were Written, Sorted First to Last</b>											
#	K	#	K	#	K	#	K	#	K	#	K
1 <sup>st</sup>	96	21 <sup>st</sup>	103	41 <sup>st</sup>	56	61 <sup>st</sup>	43	81 <sup>st</sup>	29	101 <sup>st</sup>	65
2 <sup>nd</sup>	74	22 <sup>nd</sup>	85	42 <sup>nd</sup>	70	62 <sup>nd</sup>	72	82 <sup>nd</sup>	31	102 <sup>nd</sup>	59
3 <sup>rd</sup>	111	23 <sup>rd</sup>	73	43 <sup>rd</sup>	55	63 <sup>rd</sup>	67	83 <sup>rd</sup>	42	103 <sup>rd</sup>	33
4 <sup>th</sup>	106	24 <sup>th</sup>	101	44 <sup>th</sup>	112	64 <sup>th</sup>	23	84 <sup>th</sup>	10	104 <sup>th</sup>	63
5 <sup>th</sup>	108	25 <sup>th</sup>	99	45 <sup>th</sup>	109	65 <sup>th</sup>	21	85 <sup>th</sup>	34	105 <sup>th</sup>	24
6 <sup>th</sup>	104	26 <sup>th</sup>	82	46 <sup>th</sup>	113	66 <sup>th</sup>	25	86 <sup>th</sup>	35	106 <sup>th</sup>	58
7 <sup>th</sup>	107	27 <sup>th</sup>	81	47 <sup>th</sup>	114	67 <sup>th</sup>	17	87 <sup>th</sup>	7	107 <sup>th</sup>	22
8 <sup>th</sup>	102	28 <sup>th</sup>	53	48 <sup>th</sup>	1	68 <sup>th</sup>	27	88 <sup>th</sup>	46	108 <sup>th</sup>	48
9 <sup>th</sup>	105	29 <sup>th</sup>	84	49 <sup>th</sup>	54	69 <sup>th</sup>	18	89 <sup>th</sup>	6	109 <sup>th</sup>	66
10 <sup>th</sup>	92	30 <sup>th</sup>	100	50 <sup>th</sup>	37	70 <sup>th</sup>	32	90 <sup>th</sup>	13	110 <sup>th</sup>	60
11 <sup>th</sup>	90	31 <sup>st</sup>	79	51 <sup>st</sup>	71	71 <sup>st</sup>	41	91 <sup>st</sup>	2	111 <sup>th</sup>	110
12 <sup>th</sup>	94	32 <sup>nd</sup>	77	52 <sup>nd</sup>	76	72 <sup>nd</sup>	45	92 <sup>nd</sup>	98	112 <sup>th</sup>	49
13 <sup>th</sup>	93	33 <sup>rd</sup>	78	53 <sup>rd</sup>	44	73 <sup>rd</sup>	16	93 <sup>rd</sup>	64	113 <sup>th</sup>	9
14 <sup>th</sup>	97	34 <sup>th</sup>	88	54 <sup>th</sup>	50	74 <sup>th</sup>	30	94 <sup>th</sup>	62	114 <sup>th</sup>	5
15 <sup>th</sup>	86	35 <sup>th</sup>	89	55 <sup>th</sup>	20	75 <sup>th</sup>	11	95 <sup>th</sup>	8		
16 <sup>th</sup>	91	36 <sup>th</sup>	75	56 <sup>th</sup>	26	76 <sup>th</sup>	14	96 <sup>th</sup>	47		
17 <sup>th</sup>	80	37 <sup>th</sup>	83	57 <sup>th</sup>	15	77 <sup>th</sup>	12	97 <sup>th</sup>	3		
18 <sup>th</sup>	68	38 <sup>th</sup>	69	58 <sup>th</sup>	19	78 <sup>th</sup>	40	98 <sup>th</sup>	61		
19 <sup>th</sup>	87	39 <sup>th</sup>	51	59 <sup>th</sup>	38	79 <sup>th</sup>	28	99 <sup>th</sup>	57		
20 <sup>th</sup>	95	40 <sup>th</sup>	52	60 <sup>th</sup>	36	80 <sup>th</sup>	39	100 <sup>th</sup>	4		

<sup>19</sup> Chronologies by Jalalu'd-Din as-Syut, Noeldecke and Muir can be found in Sell, *Quran*, pp. 203-204. However, of the three chronologies, only Theodor Noeldecke's chronology agrees with Maududi and Yusuf Ali's reckoning of which *Suras* are *Makkan* and which *Suras* are *Madinan*. Sell writes that Noeldecke's chronology is "the best and most authoritative" (Sell, *Quran*, p. vii).



<b>Chronological List of Suras Interspersed With Notes on Jihad</b> Subdivided by period of prophethood according to Noeldeck's reckoning <sup>20</sup>
<b>1<sup>st</sup> Makkan Period (612-617 AD)</b> 1 <sup>st</sup> to 5 <sup>th</sup> year of writing the <i>Koran</i>
<b>[610 AD received call to prophethood at cave in Mount Hira</b> (Ishaq. <i>Sirat</i> , p. 111)] <i>Koran</i> 096 (order: 1 <sup>st</sup> ) ["Read!...Read!" (K 096:001, 003)] 074 [Ishaq. <i>Sirat</i> , p. 122, note 1] [Muhammad tells the Mekkans "I will bring you slaughter" (Ishaq. <i>Sirat</i> , p. 133)] 111, 106, 108, 104, 107, 102, 105, 092, 090, 094
<b>[612 AD received Sura 093 after 3-year hiatus in receiving revelation</b> (Ishaq. <i>Sirat</i> , p. 111-112)] 093 (order: 13 <sup>th</sup> Sura) ["Your lord has not forsaken or hated you" (K 093:003)] 097, 086, 091, 080, 068, 087, 095, 103, 085, 073 [War Verses Count=1], 101, 099, 082, 081, 053, 084, 100, 079, 077, 078, 088, 089, 075, 083, 069, 051, 052, 056, 070, 055, 112, 109, 113, 114, 001
<b>2<sup>nd</sup> Makkan Period (617-619 AD)</b> 5th to 6th year of writing the <i>Koran</i>
<b>[Social boycott at Mekka begins in 617 AD</b> (Ishaq. <i>Sirat</i> , p. 159)] <i>Koran</i> 054 (order: 49 <sup>th</sup> Sura), 037, 071, 076 [War-verse Count=2], 044, 050, 020, 026, 015, 019, 038, 036, 043, 072, 067, 023, 021, 025 [War-verse Count=3] 017, 027, 018 [K 018 is "The Cave" Sura (Ishaq. <i>Sirat</i> , pp. 133, 137)]
<b>[Social boycott at Mekka ends in 619 AD</b> (Ishaq. <i>Sirat</i> , p. 172)]
<b>3<sup>rd</sup> Makkan Period (619-622 AD)</b> 7th to 13th year of writing the <i>Koran</i>
<i>Koran</i> 032 (order: 70 <sup>th</sup> Sura), 041, 045, 016 [War-verse Count=4] 030, 011, 014, 012, 040, 028, 039, 029 [War-verse Count=6], 031, 042 [War-verse Count=7], 010, 034, 035, 007, 046, 006, 013
<b>Madinan Period (622-632 AD)</b> 13th to 23rd year of writing the <i>Koran</i>
<b>[Migration to Madina in 622 AD]</b> <i>Koran</i> 002 (order: 91 <sup>st</sup> Sura) [War-verse Count=17] ["Fighting is prescribed for you and though you may hate it, it is best for you" (K 002:216)] 098, 064 [War-verse Count=18], 062, 008 [War-verse Count=52], 47 [War-verse Count=55] ["When a Sura mentioning Jihad is revealed, the hypocrites (who have a spiritual disease) swoon as in death" (K 047:020).]
<b>[Battle of Badr in 624 AD]</b> <i>Koran</i> 003 (order: 97 <sup>th</sup> Sura) [War-verse Count=80], 061 [War-verse Count=83], 057, 004 [War-verse Count=101] ["As soon as fighting is prescribed, those who fear men more than they fear God say 'O Lord, why hast thou prescribed fighting for us?'" (K 004:077)], 065 <b>[Battle of Uhud in 625 AD]</b> [Muhammad swore at the Battle of Uhud that every martyr "would like to return and fight for god and be killed a second time" (Ishaq. <i>Sirat</i> , p. 400).] <i>Koran</i> 059 (order: 102 <sup>nd</sup> Sura) [War-verse Count=107]
<b>[Battle of the Trench in 626 AD]</b> <i>Koran</i> 033 (order: 103 <sup>rd</sup> Sura) [War-verse Count=115] ["The hypocrites (who have a spiritual disease) say Allah and his messenger promised us only a delusion" (K 033:012)], 063 [War-verse Count=116], 024 [War-verse Count=118], 058, 022 [War-verse Count=121]
<b>[Treaty of Hdaybiya of 628 AD]</b> <i>Koran</i> 048 (order: 108 <sup>th</sup> Sura) [War-verse Count=131], 066 [War-verse Count=132], 060 [War-verse Count=133]
<b>[Conquest of Mekka in 630 AD]</b> [During Mekka's conquest, Muhammad said

<sup>20</sup> Sources: W. M. Watt's *Bell's Introduction to the Quran*, and *The 1911 Edition Encyclopedia*, "Mahommedan Religion," 48.1911encyclopedia.org.

“Stop this killing!...Refrain from killing...for there has been too much killing even if there were profit in it.<sup>21</sup>]

[**Muhammad gave his Farewell Sermon at Hajj in 631 AD**] *Koran* 110 (order: 111<sup>th</sup> *Sura*), 049 [War-verse Count=134], 009 [War-verse Count=161] [“When a *Sura* involving *Jihad* is revealed, the rich ask to be exempted from *Jihad*” (*K* 009:086), 005 [War-verse Count=164] (order: 114<sup>th</sup> *Sura*)

[**Muhammad died in ~632 AD**]

---

<sup>21</sup> Ishaq. *Sirat*, pp. 554-555.

The <i>Koran's</i> 164 War Verses in Chronological Order (Summary)					
Period of Sura	Order of Sura	Ch.	The <i>Koran's</i> 164 War Verses (7 <i>Makkan</i> Verses Bolded) <sup>22</sup>	# Per Sura	Running Count
1 <sup>st</sup> <i>Makkan</i> 612-617 AD	23 <sup>rd</sup>	73	<b>020</b> <i>Shakir</i> : “fight in <i>Allah's</i> way”	1	1
2 <sup>nd</sup> <i>Makkan</i> 617-619 AD	52 <sup>nd</sup>	76	<b>008</b> <i>Shakir</i> : <i>Muslims</i> feed captives	1	2
2 <sup>nd</sup> <i>Makkan</i> 617-619 AD	66 <sup>th</sup>	25	<b>052</b> <i>Palmer</i> : “fight strenuously with” unbelievers “in many a strenuous fight”	1	3
3 <sup>rd</sup> <i>Makkan</i> 619-622 AD	73 <sup>rd</sup>	16	<b>110</b> <i>Yusuf Ali</i> : “who thereafter strive [ <i>jahadoo</i> ] and fight for the faith”	1	4
3 <sup>rd</sup> <i>Makkan</i> 619-622 AD	81 <sup>st</sup>	29	<b>006</b> “whoever strives [Arabic: <i>jahada</i> ], he strives [Arabic: <i>yujahidu</i> ] <b>069</b> “(as for) those who strive hard [Arabic: <i>jahadoo</i> ] for Us”	2	6
3 <sup>rd</sup> <i>Makkan</i> 619-622 AD	83 <sup>rd</sup>	42	<b>039</b> “...who, when an injury is done them, avenge themselves...”	1	7
Early <i>Madinan</i>	91 <sup>st</sup>	2	178-179, 190-191, 193-194, 216-218, 244	10	17
<i>Madinan</i>	93 <sup>rd</sup>	64	014	1	18
<i>Madinan</i>	95 <sup>th</sup>	8	001, 005, 007, 009-010, 012, 015-017, 039-048, 057-060, 065-075	34	52
<i>Madinan</i>	96 <sup>th</sup>	47	004, 020, 035	3	55
<i>Madinan</i>	97 <sup>th</sup>	3	121-126, 140-143, 146, 152-158, 165-167, 169, 172-173, 195	25	80
<i>Madinan</i>	98 <sup>th</sup>	61	004, 011, 013	3	83
<i>Madinan</i>	100 <sup>th</sup>	4	071-072, 074-077, 084, 089-091, 094-095, 100-104, 144	18	101
<i>Madinan</i>	102 <sup>nd</sup>	59	002, 005-008, 014	6	107
<i>Madinan</i>	103 <sup>rd</sup>	33	015, 018, 020, 023, 025-027, 050	8	115
<i>Madinan</i>	104 <sup>th</sup>	63	004	1	116
<i>Madinan</i>	105 <sup>th</sup>	24	053, 055	2	118
<i>Madinan</i>	107 <sup>th</sup>	22	039, 058, 078	3	121
<i>Madinan</i>	108 <sup>th</sup>	48	015-024	10	131

(Table header and data continued on next page)

<sup>22</sup> Compare this table with the “164 War Verses” and “18 Ethnic-cleansing Verses” tables.

(Table continued from previous page)

The <i>Koran's</i> 164 War Verses in Chronological Order (Summary)					
Period of <i>Sura</i>	Order of <i>Sura</i>	Ch.	The <i>Koran's</i> 164 War Verses (7 <i>Makkan</i> Verses Bolded) <sup>23</sup>	# Per <i>Sura</i>	Running Count

...

<i>Madinan</i>	109 <sup>th</sup>	66	009	1	132
<i>Madinan</i>	110 <sup>th</sup>	60	009	1	133
<i>Madinan</i>	112 <sup>th</sup>	49	015	1	134
<i>Madinan</i>	113 <sup>th</sup>	9	005, 012-014, 016, 019-020, 024-026, 029, 036, 038-039, 041, 044, 052, 073, 081, 083, 086, 088, 092, 111, 120, 122-123	27	161
<i>Madinan</i>	114 <sup>th</sup>	5	033, 035, 082	3	164

<sup>23</sup> Compare this table with the "164 War Verses" and "18 Ethnic-cleansingVerses" tables.

## Summary of Each Chapter

### Summary of Chapter 01: Moon-o-theistic War-god Religion

This chapter addresses the “So What?” question as to why non-*Muslims* ought to care whether *Islam* is a glorified pagan war-god religion before delving into the proofs going back to nascent *Islam*. The also chapter takes on *Islamic* and non-*Islamic* apologists for *Islam* who say that *Islam* is a Religion of Peace.<sup>TM</sup>

The chapter concludes with several tables summarizing how *Islam* still is a war-god religion, the lengthy one being the Khidr-Second Lamech Logic table.

### Summary of Chapter 02: Moon-o-theistic Mideast

Some may find that the idea of *Allah* being a moon-god sounds farfetched, until one studies the religious context of the Mideast. This chapter includes brief descriptions of moon-god worship centers in the Mideast. These can be located on the accompanying map and in the Index:

☉ **Moon-gods:** *Allah*, ‘*Amm*, *Ilumquh*, *Mahram*, *Osiris* (or *Osiris-Aah*), *Sin/Syn*, *Wadd*, *Yerah*

☉ **Moon worship centers:** *Aksum*, *Beth Yerah*, *Haran*, *Hazor*, *Huraydah*, *Jericho*, *Marib*, *Makka*, *Nayrab*, *Qarnaw*, *Shabwa*, the *Sinai Desert*, *Tema*, *Timna*, *Ur* and the *Desert of Zin*.

The vicious god that the *Koran* depicts is consistent, not with the God of the Bible, but with a South Arabian war-and-moon-god. Hans Kraus wrote:

...the main god, the national god of war...this is in all South Arabian, yes, nearly in all Semitic monuments, a sure identifying mark of the moon-god.<sup>24</sup>

This chapter ends by examining and ultimately rejecting the minority view that is now challenging traditional archeological assumptions made about *Yemen* in the last century.

### Summary of Chapter 03: Moon-o-theistic Proselytizing

*Islam*'s apologetics are forceful and usually bulldoze the truth into one corner to make way for *Islam*. *Islam*'s proselytizing results in many forced conversions around the world, and often relies on violence and *Jihad* terrorism to “shock and awe” people into believing in *Allah* and his prophet, *Muhammad*. The chapter concludes with an analysis of what it is about *Islam* that appeals to certain people.

### Summary of Chapter 04: Moon-o-theistic Scripture

*Muhammad* was not able to start *Islam* from a clean slate free of astral religion elements. *Muhammad* mistakenly thought that *Allah* the moon-god was *Yahveh* of the Bible all along. So in the end *Muhammad* just mixed a few Judaistic concepts into the moon-god religion that he grew up with and knew well.

*Muhammad* was forty before he posed as a prophet of *Allah*. So nearly two-thirds of his life, *Muhammad* was an astral worshipper. *Muhammad* always remained a moon-god worshipper at heart and this affected and defined *Islam*'s development.

<sup>24</sup> Nielsen, 1912, pp. 593-594, as translated in Krause, “*Haram–Harimat*.”

### Summary of Chapter 05: Moon-o-theistic *Haran* Connection

*Haran* was a major moon-god center of worship. *Haran* also had a thriving Ibrahimic pilgrimage business. *Muhammad* went on camel caravans and may have toured *Haran* at some point. *Muhammad* may have also heard of *Haran* indirectly through the “Religion of *Ibrahim*” pilgrims who toured *Haran*.

These *Hanifs* would have passed along the claim of the *Haranians* that *Ibrahim* was a polytheist moon-god worshipper. The *Hanifs* of course would deny that *Ibrahim* was a polytheist but accepted the claim that *Ibrahim* was a moon-god monotheist.

### Summary of Chapter 06: Moon-o-theistic Christian Connection

*Muhammad* wrongly believed that the Jewish and Christian belief systems imitated the polytheism of ancient pagan religions. He said: “They imitate what the unbelievers of old used to say” (K 009:029). This chapter will document how *Muhammad*:

1) Came to think that the Christian Trinity was comprised of *Allah* the moon-god, Mary was *Allah*’s cohort and wife (K 072:003), and Jesus the sun-god (K 005:116). Incidentally, *Muhammad* thought Jews worshipped *Allah* the moon-god, along with Ezra as a sun-god (K 002:259-260; 009:030).

2) By making Jesus and Ezra out to be sun-gods, was able to cast the *Muslim* dispute against Jews and Christians as being pro-lunar and anti-solar in nature, as well as being just pro-monotheistic and anti-polytheistic. This was a devious move by *Muhammad* since priests and followers of different gods often clashed in the Mideast and brought down at least one empire.

How *Muhammad* came to believe that Jews and Christians were polytheistic was based on Jewish and Christian artwork that included sun and moon symbols. Jews incorporated mosaic zodiac circles with sun and moon imagery in their synagogues well into Byzantine times. Astral imagery could be found on Jewish coins and in the temple until 70 AD.

*Muhammad* knew that Jews continued to practice astrology and even sorcery to his day. Christians recycled Egyptian *Isis* and *Horus* statues and even used Egyptian *Ankh* symbols as crosses.

Besides the artwork with the moon and sun symbols, Jews followed a solilunar calendar and the Christians used a solar calendar. This led *Muhammad* to believe that Christians and Jews worshipped sun-gods in addition to the moon-god *Allah*.

Jews and Christians intercalated days and months to account for the sun’s movement and the seasons, a practice *Muhammad* banned (K 009:036-037). *Muhammad* thought that Jews worshipped Ezra as a sun-god and *Muhammad* believed that Christians worshipped Jesus as a sun-god.

The pagan *Makkan* intercalators adjusted a solilunar calendar out of deference to the moon and sun-gods, and even the Four Seasons deities, all at the expense of *Allah* the moon-god. So based on the Christian solar and Jewish solilunar calendars and other artwork, *Muhammad* automatically figured that Jews and Christians were giving undue deference to the sun and Four Seasons, all at the expense of *Allah* the moon-god.

**Summary of Chapter 07: Moon-o-theistic Jewish Connection**

Besides investigating the connection between Jewish synagogue zodiac circles and the doctrine and practice of *Islam*, this chapter investigates how *Muhammad's* family was intermarried with *Madinan* Jewry.

**Summary of Chapter 08: Moon-o-theistic Ten Commandments**

This chapter reveals that the zodiac circle served as *Muhammad's* own set of Ten Commandments tablets, so to speak, and thus zodiac circles affected *Islamic* doctrine and practice.

**Summary of Chapter 09: Moon-o-theistic Kaaba**

This chapter details the moon's connection to the *Kaaba* and the moon's influence on pre-*Islamic* pagan rites, as well as later *Islamic* doctrine and practice.

**Summary of Chapter 10: Moon-o-theistic Venus Altars**

*Mosque Mihrabs* are Venus altars. The Black Stone at the *Kaaba* was a *Mihrab* Venus altar.

**Summary of Chapter 11: Moon-o-theistic Mosques**

Venus-altar *Mihrabs* were incorporated into *Mosques*. *Mosques* are places of astral worship.

**Summary of Chapter 12: Moon-o-theistic Temples**

Besides the many moon-o-theistic *Mosques*, there were at least three moon-o-theistic temples: the *Kaaba*, the Dome of the Rock and a moon-god temple built at *Haran*. The *Haran* temple lasted from the seventh through the twelfth centuries. The *Muslim* conqueror of *Haran* built the moon temple that *Saladin* later tore down.

**Summary of Chapter 13: Moon-o-theistic Pilgrimages**

Many previous treatments on *Islam* comment in passing on the obviously pagan aspects of the *Hajj*. This chapter however examines the specifics, and highlights the pro-lunar, anti-solar rites of the *Hajj*, showing beyond a doubt that *Islam* is a Judeo-pagan religion.

**Summary of Chapter 14: Moon-o-theistic Prophet**

The *Koran* reveals that *Muhammad's* initial revelations and his first "miracle" involved sightings of the moon and various Moon illusions.

**Summary of Chapter 15: Moon-o-theistic Drug**

Pagan temples often doubled as pharmacies since people looked to the gods for healing and a "spiritual experience." Such healing today would be considered holistic healing or quackery, depending on whether the potion worked. Such drug-induced spirituality today would be dubbed a mere psychedelic experience that is almost certainly more detrimental than beneficial.

The ancient priest and priestess revelators relied on drugs as well. An unvarnished reading of *Muslim* tradition reveals that in nascent *Islam*, *Muhammad* and *Muslims* relied on drugs, but were prohibitionists when it came to alcohol use.

**Summary of Chapter 16: Moon-o-theistic Religion and Culture**

Some have said that *Allah* may have been a pre-*Islamic* moon-god, but *Muhammad* so thoroughly reformed the system that only vestiges of the lunar religion remain. This book however shows that *Islam* was, and remains to this very day, a moon-god religion at its core, despite the constant denials on the part of *Muslims*. The doctrines and practices imported into *Islam* from Judaism and other sources are merely cosmetic and not integral to *Islamic* doctrine or practice.

**Summary of the Appendix: Moon-o-theistic Coinage**

Many *Islamic* coins dating from the beginning of *Islam* to the present sport crescents. These constitute additional evidence that early *Muslims* knew *Allah* as a moon-god.



## Preface

### Goal of This *Moon-o-theism* Book

Some people may not like this unflinching book because they believe that it is best to not debate touchy subjects like religion and politics. People who advance this notion mostly come in two flavors:

- The **aggressive** types believe so strongly in universalism, ecumenicalism or cultural relativism that they would not mind reversing the Enlightenment and bringing back the Inquisitions for people who dare to question another faith. These people would make good *Islamists* since they agree with *Muhammad* who said, “Sacred things demand retaliation” (*K* 002:194).
- The **passive** types do not want anyone to be impolite or cause offense. These are the sort of people that totalitarian dictators, heretic burners and *Islamists* love to have around since they do not give them any troubles. The passive types would make good *Muslims* since they do not ask hard questions—an activity *Muhammad* said leads to hell (*K* 005:101-102).

Those who counsel silence in the face of *Islam* for whatever reason ought to answer this question: What are the alternatives to criticizing *Islam*? More centuries of *Jihad* and eternal vigilance by counter-terrorism forces? Yet more expensive and deadly wars on terrorism every few years when terrorism rears its ugly head?

Criticism is necessary now since every day that goes by the freedom to criticize *Islam* is diminished. Besides, the lack of assertive criticism is what allows totalitarian systems to grow the monstrosities in the first place, but criticism eventually proves to be their downfall, too.

Some will say that criticism of *Islam* is valid since *Islam* is not monolithic. This is just a stealth variant of the tired old relativist’s argument that no criticism is valid since nothing is absolute—a self-contradicting statement by the way. Other variants of the relativist’s argument use words like “stereotype,” “over-generalization,” “sweeping generalization,” “tar them all with the same brush” and “pot calling the kettle ‘black.’” Stealth relativists can be summarily dismissed out of hand since no book critical of *Islam* would ever make them happy.

The observations in this book hold true for most *Muslims* since the observations are mostly about the *Koran* and *Hadith* that most *Muslims* believe in. Besides, there is no major school of moderate *Islamic* thought. Poll after poll show that a substantial number of *Muslims* agree with *Islamic* terrorists—enough to make terrorism unstoppable in the foreseeable future especially given the fact that bombs can be made in the kitchen from household ingredients. Moreover, considerable number of *Muslims* want *Sharia* law implemented—enough to make it happen in a lot of places.

Some people may allege this book is “too negative” to do any good and some may even allege that it is hate-speech. This book is not hate-speech, but it is **about** the hate-speech contained in the *Koran*, *Hadiths* and *Sira*, as well as derivative literature that has been judged to “pose a grave threat to non-*Muslims* and to the *Muslim* community itself.”<sup>25</sup>

When one wants to free *Muslims* from their war-and-moon-god religion, one must investigate the hateful war propaganda “as is” and not just the vaunted beautiful side of *Islam*, a side of *Islam* that came at the expense of non-*Muslims* anyway.

<sup>25</sup> Pipes, Daniel. “Saudi Venom in U.S. Mosques,” *DP*, 1 Feb 2005.

This approach to *Islam* is similar to how one must talk about the evils of drug addiction to counsel drug addicts, and not just discuss the euphoric effects of drugs and the camaraderie among drug users who share needles. When one wants to free Communists who have been brainwashed by propaganda, one must talk about the mental hospitals and gulags and not just the glorious art in the Hermitage museum.

This book is in line with biblical polemics ever since the days of Jonah (Jon 03:04) and John the Baptist (Mat 03:07; Luk 03:07). This book is in the genre of Christian polemics on the market that are described by Daniel Pipes:

As a summary puts it: ‘*Islam* is a caustic blend of regurgitated paganism and twisted Bible stories. *Muhammad*, its lone prophet, conceived his religion solely to satiate his lust for power, sex and money. He was a terrorist.’ Strong stuff, to be sure, but also part of a Christian polemical legacy going back to the very origins of *Islam*.<sup>26</sup>

This book is about plowing the soil so seed will grow (Mat 13:08, 23; Mar 04:08, 20; Luk 08:08, 15). Some Christians however only like evangelistic books that sow, plant, water and harvest seedbeds (1Co 03:08; 2Co 09:10). Without the plow though, these feel-good books would only serve to water weed beds.

Unlike many other books on *Islam* that are outside the Christian tradition, this book goes to the root of the problem which is *Islam*. *Muhammad* found a way to combine the power of the pen with the power of the sword in *Islam*. The text of the *Koran* incites its readers to *Jihad* Holy War in order to spread the faith.

I believe that this book is the type of approach that Daniel Pipes calls for. He wrote:

Ending terrorism requires more than targeting terrorists, their leaders or their organizations. It requires recognizing and defeating the body of ideas known as militant *Islam* or *Islamism*. The war cannot be won until politicians and others focus on this ideology rather than on terrorism, which is merely its manifestation.<sup>27</sup>

Daniel Pipes, quoting from the 9/11 Commission report issued on 22 July 2004, wrote that the committee determined...

...*Islamist* terrorism is ‘the catastrophic threat facing the US’...[the] US strategy, therefore, must be to...prevail over ‘the ideology that gives rise to *Islamist* terrorism.’ In other words, ‘the US has to help defeat an ideology, not just a group of people’...[*Islamists*]...have ‘hostility toward us and our values [that] is limitless...’<sup>28</sup>

The root of the problem is the *Koran*, because the natural reading of the *Koran* promotes violence. In fact mental gymnastics and verbal contortionism are required to make the *Koran*’s 164 War verses read as anything other than incitement to kill.

The *Koran* serves as the ultimate recruiting manual for terrorists since over a billion *Muslims* have been taught that God inspired the *Koran*. *Imams* can easily use the *Koran* to show that their violent brand of *Islam* is the pure and pristine form of *Islam* exactly because, as history shows, the violent brand of *Islam* IS the original and authentic form of *Islam*. Robert Spencer wrote on the subject:

The *BBC* has a story about how young *Muslims* in Britain are turning...toward what is described as ‘pure *Islam*’: i.e. that of fanaticism and

<sup>26</sup> Pipes, Daniel. “Weblog: Censure Anti-Islamic Books?” *DP*, 22 Nov 2004.

<sup>27</sup> Pipes, Daniel. “Capturing *Osama*,” *jewishworldreview.com*, 9 Mar 2004.

<sup>28</sup> Pipes, Daniel. “The 9/11 Report’s Straight Shooting on *Islamist* Terror,” *FPM*, 27 Jul 2004.

violence. It is precisely because *Imams* like *Abu Hamza*, whom I profile in *Onward Muslim Soldiers*, are able successfully to characterize their version of the religion as ‘pure *Islam*’ that they are able to win recruits. And they will continue to do so...<sup>29</sup>

The purpose of this *Moon-o-theism* book is to explain and thereby dampen the warmongering and persecuting power of the *Koran*.

This *Moon-o-theism* book is the first full-length book on the subject of *Allah* being a war-god and a moon-god. Some Christian ministries might object to this book on the grounds that this *Moon-o-theism* book is not an apologetics book, nor a lovey-dovey missionary outreach manual. This author makes no apologies for this critical study and polemical treatment on *Islam*. The polemical genre has a long and storied history in Christianity going back to the Church Fathers. Besides, no one is making touchy-feely people buy this book.

Christians have a right not only to evangelize but also to protect themselves and others. Perhaps not initially but in the long term, a critical analysis of *Islam* will increase the overall safety of “Jews, women, gays, civil libertarians, *Hindus*, Evangelical Christians, atheists and scholars of *Islam*, among others...”<sup>30</sup>

Evangelism books that soft-pedal the Gospel have their time and purpose, but a hard-hitting, critical treatment of *Islam* is what is needed at the moment. Here my thinking parallels Ali Dashti’s, who said about his critical study of *Islam*:

Had the *Shah* [the ruling dynasty of *Iran*] allowed books like this to be published and read by the people, we would never have had an *Islamic* revolution.<sup>31</sup>

The *Shah* was risk-averse and riot-averse when it came to critical scholarship (called “blasphemy” on “the Arab street”). Censorship did not bring peace and prosperity nor any appreciation of the *Shah*’s regime, but merely empowered uncritical thinkers who then fomented the *Islamic* revolution of 1979.

Now, these same *Iranian* revolutionaries are threatening *Israel* with nuclear annihilation. Because they have never read a critique on the *Koran* like *Moon-o-theism*, at least one *Mullah* is willing to sacrifice 100 million *Muslims* in order to rid the Mideast of the nation of *Israel*.<sup>32</sup>

With *Islam*, an ounce of information is worth a pound of retaliation and a stitch in time saves nine. Unfortunately, both the “ounce” and “stitch” never came, so now a pound of retaliation and nine stitches are in order. Military intervention is inevitable because books critical of *Islam* are rarely published in any *Muslim* country. For instance, the crown prince of *Saudi* Arabia announced on *Saudi* national television:

This country will never accept anybody, whoever he may be, to hurt the *Islamic* faith, in the name of freedom of opinion or any other name.<sup>33</sup>

Even more alarming is the fact that it is getting harder and harder even for Westerners to say or write anything critical of *Islam*. *Islamists* have many “useful idiots” and fellow-traveler *Dhimmi* sympathizers living in the West who accuse critics of *Islam* of racism and bigotry.

<sup>29</sup> Spencer. “Britain: why young *Muslims* turn radical, *JW*, 7 Mar 2004.

<sup>30</sup> Pipes, Daniel. “A French lesson for Tom Harkin,” *WND, DP*, 5 Jan 2004.

<sup>31</sup> Warraq. *Why*, p. 5.

<sup>32</sup> Amir, Taheri. “Recipe for Disaster: Asking the right *Iran* questions,” *NRO*, 14 Nov 2003.

<sup>33</sup> Ghafour, P.K. Abdul. “Freedom of Expression Not at Cost of *Islam: Abdullah*,” arabnews.com, 15 Jan 2004.

Most Western *Dhimmis* have never read or even heard about the many kill commands in the *Koran* and in *Islamic* texts. They are blithely unaware that *Islamists* hope to impose *Sharia* law in the West, if not in this generation, then the next.

Western *Dhimmis* are in denial over the fact that if *Islamists* win out, Western *Dhimmis* will live (or die) as unequals, women will be subjugated, and anyone doing anything remotely un-*Islamic* will suffer draconian punishments.

Once the West is conquered for *Islam*, non-*Muslims* in the West will be worse off than *Dhimmis* in the Mideast are now since there will be no one left who will look out for the interests of *Dhimmis* under *Muslim* rule.

As it is now, publishers and authors need to ignore death threats coming from *Islamists* and legal challenges lodged by Western *Dhimmis* and *Islamists* alike. In fact an octogenarian French Catholic priest cannot even send out a newsletter to parishioners with criticisms of *Islam* without being fined. As *Al-Jazeera* (*JihadTV*) reported, the priest...

...was fined 800 *Euros*...and was found guilty of ‘provoking discrimination, hatred or violence’ for comments he made in a letter to his parishioners in the northern town of *Domqueur* at the end of 2002. ‘The Asiatics proliferate and invade our land, bringing with them an ideology that threatens the whole world,’ he wrote. ‘Indeed I would add there is no such thing as ‘moderate’ *Islam*. All the populations infected by the *Muslim* religion are indoctrinated by the *Quran*—a holy book which is the manual for the extension of the kingdom of the devil at the expense of the kingdom of Christ,’ he said. [The priest] was also ordered to give a symbolic one *Euro* in damages to the League of Human Rights, which brought the case, and to pay for the judgment to be published in two local newspapers.<sup>34</sup>

So the priest cannot warn his flock against a people who seek to make *Sharia* law the “Law of the Land,” not even in words that are innocuous when compared to the 164 ethnocidal and genocidal war verses found in the *Koran*.

Thus *Muslim* advocacy groups have managed to impose censorship and self-censorship on the West, as *Ibrahim* Nawar from *Arab Press Freedom Watch* laments:

...censorship is now taking place in liberal, Western countries like the UK. These countries should instead be setting an example to the oppressive Arab regimes that violate freedom of expression on a daily basis.<sup>35</sup>

To complicate the situation, in the West the threshold for what constitutes incitement to violence gets lower every day. Alexis Amory wrote about how the head of the *Commission for Racial Equality* reported Kilroy-Silk to the police:

He [Trevor Phillips] said that although there was no incitement of any kind to violence in Kilroy-Silk’s article, ‘some people may read it that way.’ So now we have a new definition of ‘incitement to racial violence’: How some dimwits might interpret a newspaper article.<sup>36</sup>

So now a UK critic of *Islam* must defend himself against a baseless charge that could land him in prison for seven years. Government censorship’s worst effect is that it leads to more and more self-censorship.

<sup>34</sup> “French priest fined for anti-*Muslim* comments,” *aljazeera.net*, 19 Jan 2004 (*DW*, 19 Jan 2004).

<sup>35</sup> Nawar, *Ibrahim*. “Kilroy-Silk is right about the Middle East, say Arabs,” *telegraph.co.uk*, 1 Nov 2004 (*LGF*, 11 Jan 2004).

<sup>36</sup> Amory, Alexis. “The PRAVDA BBC,” *FPM*, 16 Jan 2004.

## Two Basic Questions This *Moon-o-theism* Book Answers

This book answers two basic questions:

- ☉ Was *Allah* always the God of the Bible, or was *Allah* a pre-*Islamic* Arabian war- and moon-god? and
- ☉ If *Allah* was a pre-*Islamic* war- and moon-god, should *Islam* still be considered a moon-god religion despite *Muhammad*'s Bublicizing reforms?

Concerning the question of whether *Allah* was a moon-god, this book analyzes the available evidence. Most currently known moon-god evidence fits these categories:

- ☉ **Geography:** The region around *Makka* was heavily into moon-god worship.
- ☉ **Apologetics:** *Muslim* arguments against *Allah* being a moon-god are diversionary or beg the question, while arguments for *Allah* being a moon-god become stronger the more the subject is studied.
- ☉ **Traditions:** The *Hadiths* evidence moon-god worship, rites, thinking and doctrine.
- ☉ **Scripture:** The *Koran* is basically a moon-god scripture with a biblical stories repetitiously added in as filler material. A close reading peels back the bublicized, pious interpretation of the *Koran* and reveals its **anti-solar, pro-moon-god** religion origin. The *Koran* complements the *Hajj*, which is an **anti-solar, pro-moon-god** rite that became popular due to the oppressive heat of the sun in Arabia. Here are a few illustrative examples:

- ★ *Zulqarnain* was a good *Muslim*. *Zulqarnain* means “two-horned one” and refers to a king with a crescent crown who worships the Moon-god. *Zulqarnain* watches the sun set in a mud puddle (K 018:083). Gibb and Kramers say about *Zulqarnain*: “The two horns go back to an old mythological idea. *Naram-Sin* was for example represented as *Adad* with two horns (on the stele of *Susa*; cf. *Fouilles a Suse*, i., pl. x).<sup>37</sup>
- ★ *Allah* guided *Muhammad* and *Ibrahim* by the sky (K 002:144; 006:075, 077), and on another occasion *Allah* used the sun to guide those who took refuge in a cave (K 018:017). *Ibrahim* indicated his preference for northerly stars that spin around the north celestial pole but do not set below the horizon (K 006:076). *Ibrahim* then called the moon “my lord” (K 006:077). Finally, *Ibrahim* saw the sun and said that of the sun, moon and stars, the moon was greatest of the three (K 006:078).
- ★ After calling the moon “my lord” (K 006:077), *Ibrahim* said the moon-god created the sky and earth (K 006:079, see also 007:054, etc.) This is similar to other Mideast and Mediterranean astral creation myths that say a high god created the stars and planets, then assigned the deities to each and finally chose an astral body for his perch and symbol. In astral creation myths, no astral body is eternal, nor is any astral body the deity itself, but the astral bodies serve as thrones and symbols of the deity.
- ☉ **Rites:** The *Hajj* especially, and other moon-god rites, suggest moon-god worship. The *Koran* and *Hajj* were anti-solar, not because of any incipient monotheism, but because the sun's heat was so oppressive in Arabia. Karen Armstrong wrote:

<sup>37</sup> Gibb & Kramers. *Encyclopedia*, p. 76, *Dhu'l-Karnain* entry.

The *Hajj* itself was originally an Autumn[al] rite apparently persecuting the dying sun to bring on the winter rains.<sup>38</sup>

- ☉ **Architecture:** The *Hatim* Wall by the *Kaaba*, the Dome of the Rock, historic and modern *Mosques* and other buildings suggest moon-god worship.
- ☉ **Interior Worship Fixtures:** The *Mihrab* Venus altars and other architectural aspects of *Mosques* suggest the astral origin of *Islam*.
- ☉ **Religion and Culture:** The shape of the Arabic alphabet, word usage, artwork, symbols on coinage and the like, all suggest that *Islam* still is a modified version of an ancient moon-god religion.
- ☉ **The Ensuing Set of Evils:** Certain evils are characteristic only of certain sets of religious beliefs. Slight nuances in doctrine can have dramatic effects on society and history. The evils of *Islam* are characteristic of a war-and-moon-god religion.

Concerning the question of whether *Allah* **still** ought to be considered a moon-god, the evidence overwhelmingly indicates that *Islam* is a moon-god religion that unconvincingly masquerades as being the unadulterated form of Judaism and Christianity.

*Muslims* themselves would agree that *Allah* is not the God of the Bible as it now reads, but only as it once supposedly read in its uncorrupted form. *Muslims* themselves also agree that *Allah* is not the Christian Trinity. In the final analysis, one can safely conclude that the crescent finial found above *Mosques* is an accurate indicator of the nature of the religion practiced within.

---

<sup>38</sup> Armstrong. *Biography*, p. 62.

## Chapter 01: Moon-o-theistic War-god Religion

### *Allah as a War-god*

*Allah* of the *Koran* is consistent with a South Arabian war-and-moon-god. *Merriam-Webster's Encyclopedia of World Religions* (2000) states:

Most of the gods of the Arab tribes were sky gods, often associated with the heavenly bodies (chiefly the sun and moon), and to them were ascribed powers of fecundity, protection, or revenge against enemies (p. 70).

Ditlef Nielsen wrote:

...the main god, the national god of **war**...this is in all South Arabian, yes, nearly in all Semitic monuments, a sure identifying mark of the **moon-god**.<sup>39</sup>

Incidentally, that South Arabian and Abyssinian high-gods were moon-gods is taken up in the chapter on Mideast Moon-gods.

Egerton Sykes wrote that *Allah* "seems to have been preceded by *Ilmaqah* [aka *Almaqah*] the [*Sabean*] moon-god,"<sup>40</sup> who ultimately was modeled on the Mesopotamian *Sin*. The *Sabean* kingdom was a theocracy much like an *Islamic* caliphate. Simpson wrote:

The *Sabeans* were principally defined by their allegiance to the god 'Almaqah. They were 'the progeny [wld] of 'Almaqah, bound together by common sanctuaries, rituals, festivities and ruler.<sup>41</sup>

Similar to *Islam*, the alliances *Sabeans* entered into always had a religious component, and the wars the *Sabeans* fought were religious wars, as Breton explains:

As the influence of *Saba* spread throughout South Arabia, the cult of *Almaqah* was imposed upon tribal groups who already had pantheons of their own....As the *Sabean* state expanded, the cult of *Almaqah* spread to the conquered and even the allied territories. A king of *Kamna* who built the towers of the high-wall of *Nashq* dedicated these structures to *Almaqah*, the kings of *Maryab* (*Mar'rib*) and *Saba*. When the *Sabeans* seized the city of *Nashshan*, they forced its inhabitants to build a temple to *Almaqah* within the city walls as a sign of their subjection to *Sabaeen* power. When the Highland tribes became allied with *Saba*, they either built their own sanctuary to *Almaqah* or made a pilgrimage to the shrine of this divinity. A number of such sanctuaries were built throughout the lands of the *Bakil* tribe near *Amran* and *Rayda*, northwest of *Sana*....The integration of various tribes into a single political body was underpinned by their common recognition of *Almaqah* as a patron god...the sovereign would offer a ritual feast to the entire tribal assembly...to pronounce measures of collective security and other decrees...<sup>42</sup>

This forced syncretism reminds one of how *Muhammad* told *Muslims* to fight until "all religion is for *Allah*" (*K* 002:193; 008:039). So when *Muslims* conquered a territory, they imposed *Allah* worship on pagans on pain of death, but they did not kill or forcibly convert Christians and Jews who supposedly already worshiped *Allah*.

The fact that the main god of each of the several South Arabian kingdoms was a moon- and war-god rather than a lesser god meant there was constant warfare between the kingdoms. This is similar to the prevailing condition of *Islamdom* the

<sup>39</sup> Nielsen, 1912, pp. 593-594, as translated in Krause, "Haram-Harimat."

<sup>40</sup> Sykes. *Mythology*, p. 7, *Allah* entry.

<sup>41</sup> Simpson. *Sheba*, p. 68.

<sup>42</sup> Breton, *Felix*, p. 117....120....131.

last 1,400 years, as Samuel Huntington said: “*Islam’s* borders are bloody and so are its innards.”<sup>43</sup> Since *Allah* is a moon- and war-god, *Muslims* cannot turn to another god to trump *Allah* or appease *Allah*. The only thing *Muslims* can do is ask “*Allah*, why have you ordained fighting for us?” (K 004:077; also see K 002:216; 009:086; 033:010-012; 047:020). Of course the Christian God is not a war-god, so his scriptures do not demand that his followers fight like the *Koran* does. Simpson wrote about the constant warfare between South Arabian kingdoms occasioned by their all having war-gods for high-gods:

Most Middle *Sabaeen* [110 BC-300 AD] dedicatory inscriptions are motivated by the hope that the deity will help with some problem or they offer thanks for favor shown. There are two topics mentioned very often, victory in war and childbirth. Since the Middle *Sabaeen* period was a time of **constant war** between the South Arabian states, it was quite natural that people expressed their gratitude for their return from the battlefield or for obtaining booty...All major deities were asked for oracular decisions in almost all circumstances of human life, such as when people **started a war** or when they hoped for children.<sup>44</sup>

Reading about the *Sabeen* moon- and war-god *Almaqah’s* religion from temple inscriptions is enlightening about *Almaqah’s* successor, *Allah*, and about *Islam*:

- ☉ A 250 AD inscription excerpt reads: As for their servant Kawkab, he has thanked the power and glory of ‘*Almaqah Thahwan* [i.e. the bull] because He has granted him to remain safe and unscathed in all those campaigns and battles, and because He has granted him to return with honour, with spoils of [thirty-two] slaughtered enemies and with booty which has delighted his heart.<sup>45</sup>
- ☉ A 1<sup>st</sup> C BC inscription excerpt reads: Rabib Ya’zam of the tribe *Akhraf of Hirran* has dedicated this inscription to ‘*Almaqah of Hirran* because...’*Almaqah* has granted him trophies, spoils and captives...and because He saved his servant Rabib in the battle in which he faced the Arabs in the region of *Manhat*...<sup>46</sup>
- ☉ Karib’il Watar, son of Dhamar’ali (~ 8<sup>th</sup> C. BC) inscribed on a massive stone in *Almaqah’s* temple at *Sirah* his exploits that included winning “control of the incense route [and] crushing the kingdoms of *Awsan* and *Nashan*.”<sup>47</sup>

Statues are also informative not only about *Alumqah*, but ultimately about *Allah*:

The famous bronze statue of the dedicant *Ma’dikarib* from *Almaqah’s* temple of *Awwam* has an inscription that shows it is dedicated to *Alumqah*. The man is a warrior as indicated by the lion skin cape with four paws showing, he has a curved dagger like a *Jambiya* fastened to his belt,<sup>48</sup> and his right closed fist is held out and has a hole that probably once held a sword. The curved dagger suggests that *Alumqah* is a war- and moon-god.

Plaques are nearly as informative about *Allah* as they are about his predecessor *Alumqah*:

- ☉ The *Bar’an* temple is two kilometers south of *Almaqah’s* main temple at *Marib* which is anciently called *Awwam* but now is called *Mahrem Bilqis*.

<sup>43</sup> Huntington. *Clash*, p. 258.

<sup>44</sup> Simpson. *Sheba*, p. 164 + figure 59.

<sup>45</sup> Simpson. *Sheba*, pp. 62-63 + figure 30.

<sup>46</sup> Simpson. *Sheba*, p. 63 + figure 31.

<sup>47</sup> Simpson. *Sheba*, p. 69.

<sup>48</sup> Phillips. *Sheba*, p. 287.



“An inscription on one of the six monolithic pillars mentions “*Almaqah* of *Bar’an*.” A 5<sup>th</sup> C BC bronze plaque fragment from the *Baran* temple shows two ibexes, an *Assyrian*-styled tree of life between two winged bulls and six warriors in procession, each carrying bows and a trophy—the severed hand of the defeated enemy.<sup>49</sup> The ibexes and bulls are moon-god symbols and the warriors with severed hands show that *Almaqah* was a war- and moon-god. The severed hands reminds one of punishments set forth in the *Koran* (*K* 005:033) and the *Koran* says to cut off finger-tips and heads (*K* 008:012).

- C There are plaques dedicated to a moon- and war-god—judging from the bucranium—that show devotees raising their right hand and holding swords in their left—one with a crescent-shaped pommel.<sup>50</sup> There are also bronze statues dedicated to the moon- and war-god *Alumqah*, and many of them seem to have been holding swords or spears judging from the holes in their closed fists. An inscription on one bronze statue says it is the fourth bronze warrior dedicated to *Alumqah* from a certain devotee.<sup>51</sup> Since *Allah* was a war- and moon-god, the feature of holding swords was carried on in *Islam*, as Zwemer wrote:

There seems to be no question that the staff or sword was a necessary adjunct of the preacher from the earliest times. Jahiz [776-868 AD] is quoted as saying ‘As far as I am concerned, the preacher can mount the pulpit naked but he must have a turban and a staff.’<sup>52</sup>

There are many indications that *Muhammad* was a war-god prophet. For instance, his only prophecy recorded in the *Koran* involved predicting who would win a war—the *Byzantines* or the *Sassanian* Persians (*K* 030:002-004).

The religion that *Muhammad* founded did not revolve around the deity of the messiah and doctrinal matters, but instead formulated manuals of war that included *Dhimmitude* for the vanquished and *Sharia* law with draconian punishments for all.

The fact that *Allah* was a war-god can be seen from the fact that *Allah* is seen as the protector of believers (*K* 002:107, 120, 257, 286; 003:068, 122, 123), while idols protect unbelievers (*K* 002:257). Thus in *Muslim* thinking the entire world is zoned into two perpetually warring camps, the *Dar al-Islam* and *Dar al-Harb* (the Territory of War).

*Dhimmis*, meaning “protected ones,” are Christians and Jews who must pay a *Jizya* poll tax, acknowledge the superiority of *Islam* and are to be in a state of subjection to *Muslims* (*K* 009:029). Thus everyone allowed to remain alive in the *Dar al-Islam* must either be protected by *Allah* himself, or by *Allah*’s followers.

The vicious, vindictive god that the *Koran* depicts is not consistent with the God of the Bible. The *Koran* is full of references to a fire and brimstone hell, yet the Bible does not dwell on hell and only gives it infrequent mention.

The Bible also does not tell Christians to fight, yet *Muhammad* said that *Muslims* should fight until “all religion is for *Allah*” (*K* 002:193; 008:039). *Islam* also is a supersedionist faith (*K* 003:067) and a supremacist belief system (*K* 003:139; 005:056; 008:030; 009:029, 033; 048:028; 061:009).

<sup>49</sup> Simpson. *Sheba*, pp. 60-61 + catalog 26 (5<sup>th</sup> C BC bronze plaque).

<sup>50</sup> Simpson. *Sheba*, catalog 124 (1<sup>st</sup> C BC-1<sup>st</sup> C AD alabaster plaque showing devotee with raised right hand and crescent-shaped pommel in left), catalog 125, (1<sup>st</sup> C BC-1<sup>st</sup> C AD plaque), p. 117.

<sup>51</sup> Simpson. *Sheba*, catalog 24 (6<sup>th</sup> C BC 4<sup>th</sup> of 4 bronze warriors), catalog 25 (7<sup>th</sup>-6<sup>th</sup> C BC bronze statue), pp. 59-60.

<sup>52</sup> Zwemer. *Heirs*, ch. 4, p. 37.

By contrast to warlike *Allah*, *Yahveh* did command some fighting when the Hebrews were taking over and defending the Promised Land. Certainly there is no Biblical command for believers to fight until the very Last Day, or until all religion is for *Yahveh*. Instead, *Yahveh* said he would make it so no other nation would covet *Israel's* land and attack *Israel* (Exo 34:24; 2Ch 17:10). *Yahveh's* ideal is national peace and rest—not warfare (1Ch 22:09; Isa 66:12).

Male moon-gods in the Mideast often are pictured with scimitars due to the scimitar-shape of the crescent moon. Thus moon-gods were natural warrior gods. This fact seems to have been recognized by *Gilgamesh*. *Gilgamesh* seems to credit *Sin* for his ability to take an ax and a sword to kill and scatter a pride of lions on the prowl at night.<sup>53</sup>

Among the many ways to know that *Allah* was a war-god in pre-Islamic times is the fact that when the *Makkans* were about to have a civil war, war oaths were taken inside the *Mosque* next to the *Kaaba*. The oath takers then dipped their hands in scent and “rubbed their hands on the *Kaaba* strengthening the solemnity of the oath.”<sup>54</sup> Moreover, the one who controlled access to the *Kaaba* and *Mosque* also was the caretaker for the standards of war, as Ibn Ishaq wrote:

...access to the *Kaaba*, the standard of war, and the assembly house should belong to the ‘*Abdu'l-Dar* as before.<sup>55</sup>

The *Kaaba* was known as the House of *Allah*, so these war activities connected with the *Kaaba* suggest that *Allah* was the war-god. Similarly, the martial side of *Mosques* was seen in medieval Spain where the army standards were kept in the *Cordoba Mosque* until the troops went out to battle.<sup>56</sup>

The *Islamic* traditions and the continual warlike history of *Islam* show that *Allah* was a pre-Islamic war god. The *Koran* has many instructions about treaties (*K* 002:177; 004:090, 092; 008:056, 058; 008:072; 009:001, 003-004; 009:007-008, 012).

The 164 War verses in the *Koran* are a dead giveaway that *Allah* is a war-god. *Allah* repeatedly said that he “loves” his followers who “fight,” for instance:

Surely, *Allah* loves those who **fight** in His way in [battle] ranks as if they were a firm and compact wall (*Shakir K* 061:004; also see *K* 003:146; 005:054; 049:009; 061:004).

Leading *Islamist* Sheikh Yousef Al-Qaradhawi said:

When the *Muslims*, the Arabs and the Palestinians enter a war, they do it to worship *Allah*. They enter it as *Muslims*.<sup>57</sup>

Usama bin Laden said in a video making the rounds of Canadian *Muslims* in 2006:

Therefore each individual from amongst the *Muslims* should come forth to kill the Jews and Americans, for killing them is foremost of obligations and the greatest form of worship.<sup>58</sup>

The chest-thumping *Allah* was so interested in war all the time that his followers complained about it, saying “Our Lord! Why hast Thou ordained fighting for us?” (*K* 004:077; also see *K* 002:216; 009:086; 033:010-012; 047:020). The fact that *Islam* is

<sup>53</sup> *The Epic Of Gilgamesh*, 16:4 “The Search for Everlasting Life.”

<sup>54</sup> Ishaq. *Sirat*, p. 56.

<sup>55</sup> Ishaq. *Sirat*, p. 57.

<sup>56</sup> Nicolle. *Moors*, p. 10.

<sup>57</sup> “Leading *Islamist* Sheikh Yousef Al-Qaradhawi...” memri.org, 28 Feb 2006, no. 1102, *JW*.

<sup>58</sup> “*Jihadist* video aimed at *Muslim* youth,” *CBC News*, cbc.ca, 20 Jun 2006.

a *Jihad* fighting machine explains why the punishment for apostasy is death. Apostasy is akin to deserting the army during a battle.

Another way to know that *Allah* was a war god is the fact that *Harb* means “war” and is related to the Arabic root meaning “fight” (*hrb*), “spear” (*Harba*) and *Mihrab*. The *Mihrab* altar is always on the *Kiblah* line at a *Mosque* and points to the *Kaaba* at *Makka*. So every *Muslim* at a *Mosque* prays through a war-oriented *Mihrab* altar to the war-god and moon-god *Allah*. Also, an *Umayyad*-era coin dated 695-698 AD has a *Mihrab* and spear.<sup>59</sup> The *Ayatollah* Khomeini spoke on the purpose of *Mihrabs* in a 1981 speech celebrating *Muhammad*'s birthday:

*Mihrab* means the place of war, the place of fighting. Out of the *Mihrabs* wars should proceed. Just as all the wars of *Islam* used to proceeded out of the *Mihrabs*. The prophet has [had a] sword to kill people. Our [Holy] *Imams* were quite military men. All of them were warriors. They used to wield swords; they used to kill people. We need a *Khalifa* who would chop hands, cut throat, stone people. In the same way that the messenger of God used to chop hands, cut throats, and stone people. In the same way that he massacred the Jews of *Bani Qurayza* because they were a bunch of discontent people. If the Prophet used to order to burn a house or exterminate a tribe that was justice.<sup>60</sup>

Yet another way to know that *Allah* was a war god is by looking at the many *Mosques* built like impregnable fortresses. The four *Minarets* remind one of watchtowers. The four tall, thick stone or brick walls surrounding many *Mosques* are so tall that anyone standing outside the compound can only see the dome of the *Mosque*.

In these high-walled *Mosques*, clerics write *Fatwas* making the blood of heretics and apostates licit, and plan the violent *Islamization* of the inhabitants outside the windowless walls. There is where *Imams* incite ranks of *Muslims* with fiery sermons and imprecatory prayers. There is where *Muslims* are primed to form vigilante mobs whenever they hear of an infraction of *Sharia* law, such as a *Koran* being desecrated.

These heavily-built *Mosques* remind one of the *Ribat* castles that *Jihadist* volunteers used to man on the frontiers of *Islam*, and from whence *Jihad* campaigns were organized and commenced. This association comes to mind especially when one reads say, how *Muslims* are constantly killing Christians and burning churches in *Nigeria*. Thirty *Nigerian* churches were burned in the 2006 Cartoon riots alone!<sup>61</sup>

While the churches burn, *Muslim* clerics may be sitting comfortable in their unassailable and nearly unburnable brick fortresses, such as the main *Mosque* in *Abuja*, the capital of *Nigeria*. Perhaps they even climb the *Minarets* to view the smoke rising from dozens of churches off in the distance.

That *Islam* is a war-god religion can be seen from the fact that **some** consider the sixth pillar of *Islam* to be *Jihad*, and a corollary is that the entire world is split between the *Dar Al-Islam* (Territory of *Islam*) and the *Dar Al-Harb* (Territory of War). Notice the *Harb* root which common between *Dar Al-Harb* and *Mihrab*, discussed just above.

<sup>59</sup> *Mihrab* coins are discussed and illustrated in the Venus Altar chapter.

<sup>60</sup> “Khomeini’s speech on the day of celebration of the birth of *Muhammad*: 1981,” faithfreedom.org, accessed 24 May 2006.

<sup>61</sup> “Nigeria: *Muhammad* cartoon protests spark attacks on Christians,” alertnet.org, 20 Feb 2006.

The reason that the *Mihrab* is named after a spear is that the outdoor version of a *Mihrab* is a spear stuck in the ground—what the traditions call a *Sutra*. *Muhammad*'s use of a *Sutra* is discussed elsewhere in this book.

One cannot pass off the *Mihrab*-equals-“spear” equation as a meaningless quirk of etymology when one considers the fact that for most of *Islam*'s history, the *Imam* held a sword during sermons which he gave in the *Minbar* pulpit that usually stood a few feet to the right of the *Mihrab*. Riccodo *da Montecroce* wrote in 1300 AD:

...when they [*Muslims*] come together to be taught the *Koran* by their religious leaders, the one in charge draws a sword, holding it in his hand while teaching or placing it in full view in order to terrorize the hearers.<sup>62</sup>

In 1917 John Buchan wrote in Chapter One of his novel *Greenmantle*:

*Islam* is a fighting creed and the *Mullah* still stands in the pulpit with the *Koran* in one hand and a drawn sword in the other.

Zwemer wrote in 1946 that *Imam*'s held swords during sermons everywhere:

It is not generally known that in every *Mosque*, according to orthodox tradition, from West Africa to Western China, a sword or staff is kept near or in *Minbar*, and it is required that the *Khatib* hold it when preaching the Friday sermon. In some cases it is made of wood—but the symbol is always present.<sup>63</sup>

Another way to know that *Islam* is a war-god religion is the fact that riots tend to occur right after Friday Prayers everywhere in *Islamdom*, especially in *Israel*. Goel reports on the experience of India in this matter:

In the history of *Islam* in India, Friday ‘sermons result in working up the feelings of the *Namazis* [observant *Muslims*], and saber-rattling and street riots generally take place on Friday after the afternoon prayers.’<sup>64</sup>

The reason Friday Prayers get *Muslims* all riled up is the *Imam* reads and preaches out of the *Koran* with its 164 War verses at Friday Prayers. This shows that *Allah* is much different from *Yahveh* since his weekly day is a Day of Rest—not war (Exo 16:23; Lev 23:24, 39). Incidentally, *Muhammad* burned down the houses of those who failed to show up for Friday prayers.<sup>65</sup>

Not only does the *Koran* make *Islam* warlike but so does *Sharia* law, as Goel wrote:

It [*Islam*] looks too much like a military machine to pass as a peaceful society. The rules laid down by the *Shariat* [*Sharia* law] read like a manual compiled for use in military barracks—waking up every morning to the call of a bugle, rolling up the bed...One is amazed as well as amused when this mechanical conformity to a set pattern of external exercises is presented by the spokesmen of *Islam* as the very essence of universal spirituality and morality.<sup>66</sup>

Count Keyserling wrote about how *Islam* is a big war machine and how *Allah* is a “warlord”:

This militarization of everyday *Muslim* life was noticed with keen interest by Count Keyserling (1880-1946 CE) during his travels in *Islamic* countries. He summed up his overall impression in his *The Travel Diary of a Philosopher*. ‘*Islam* is a religion,’ he wrote ‘of absolute surrender and submissiveness to

<sup>62</sup> Montecroce. *Crucible*, p. 79.

<sup>63</sup> Zwemer. *Heirs*, ch. 4, pp. 42-43.

<sup>64</sup> Lal, K. S. *Theory and Practice of Muslim State in India*. Aditya Prakashan, New Delhi, 1999, as quoted by Goel. *Calcutta*, ch. 8.

<sup>65</sup> *Sahih Bukhari*, vol. 1, bk. 11, nos. 617, 626; vol. 9, bk. 89, no 330; *Muslim* 4:1370.

<sup>66</sup> Goel. *Calcutta*, ch. 8.

God—but to a God of a certain character—a **warlord** who is entitled to do with us as he will and who bids us stand ever in line of battle against the foe...The ritual of this belief embodies the idea of discipline. When the true believers every day at fixed hours perform their prayers in serried [squeezed in] ranks in the *Mosque*, all going through the same gestures at the same moment, this is not, as in *Hinduism*, done as a method of self-realization, but in the spirit in which the Prussian soldier defiled [i.e. lined up in formation] before his Kaiser. This military basis of *Islam* explains all the essential virtues of the *Mussulman*. It also explains his fundamental defects—his unprogressiveness, his incapacity to adapt himself, his lack of invention. The soldier has simply to obey orders. All the rest is the affair of *Allah*.<sup>67</sup>

While *Muhammad* figured that his moon- and war-god was the God of the Bible, Christians know that *Allah* is a malevolent entity (Deu 32:17; Psa 106:37). The “*Allah*” demon diabolically tried to masquerade both as the God of the Bible (2Co 11:13-15) and as a war-and-moon-god consistent with the *Koran*.

After many people realized that the Bible and *Koran* are irreconcilable, *Muhammad* claimed that Christians and Jews suppressed (*K* 002:140, 174; 005:014-015, 061) and ignored (*K* 005:044) those parts of the Bible that have not been corrupted beyond recognition (*K* 004:046). Moreover, *Muhammad* said that Jews and Christians added their own verses and sold the Bible as though it were a commodity (*K* 002:079). *Muhammad* said Jews and Christians do this because they are cursed (*K* 002:088-089, 159; 004:047; 005:064, 078).

Someone might ask “How can *Muslims* profess to have a great respect for the Bible, including the New Testament, yet still be not be pacific?” *Muslims* treat the Bible like they do the *Koran*. *Muslims* believe all the peaceful verses in the *Koran* were abrogated by the Sword Verse (*K* 009:005). The contrivance called *Tahrif* and *Tabdill*, i.e. the *Muslim* belief that the Bible has been altered,<sup>68</sup> serves to abrogate all the peaceful verses in the Bible along with any other passage that cannot be construed to be *Islamic*.

One might ask “How can *Muslims* profess to have a great respect for Bible personages, including Jesus, and still not be irenic?” The answer?

☛ *Muslims* only respect the *Muslim* version of Bible characters. For instance, *Muslims* say...

...if David and Solomon were to return to life, these [Zionist] criminals would fight them and they would fight back. David and Solomon were among our ranks. If Solomon had a temple, we would be worshipping *Allah* in it. We would not be worshipping idols and polytheism in it, like they do.<sup>69</sup>

☛ *Muslims* do not ask WWJD? (What **W**ould **J**esus **D**o?) but rather WWMJD? (What **W**ould the *Muslim* **J**esus **D**o?) The Saved Sect in London published a Web site in 2006 with a WWMJD message:

We can envisage that, if alive in the UK today, Jesus would undoubtedly have supported *Jihad* in Afghanistan and *Iraq*, as opposed to the capitalist-driven US-led alliance...and would also have been no

<sup>67</sup> Goel. *Calcutta*, ch. 8.

<sup>68</sup> Gibb & Kramers. *Encyclopedia*, pp. 560-561, *Tahrif* entry.

<sup>69</sup> “Jordanian Professor/Terrorist on *Saudi Al-Majd* TV,” *MEMRI*, 22 Nov 2005, #1030 *DW*.

doubt interned [jailed] under the Home Secretary Mr. Clarke's new terrorism laws, thereby languishing in Belmarsh Prison.<sup>70</sup>

- C *Muslims* believe what *Muhammad* said about Jesus' return at the end of the world...

Jesus...He will descend (to the earth)...[and] He will fight the people for the cause of *Islam*. He will break the cross [i.e. end Christianity], kill swine [i.e. Jews (*K* 002:065-066; 005:060; 007:166)]...<sup>71</sup>

So, using the same ruse that *Muslims* use about Jesus, infidels could say that they respect *Muhammad* if infidels believed that *Muhammad* was going to rise from the dead, shake off 1350-years' worth of dustballs and cobwebs, and then come clean by admitting that he had conspired with a demon to create *Islam*.

### The Consequence of *Islam* Being a Biblicized War-and-moon-god Religion

*Allah* gained a few redeeming qualities when he was biblicized but he retained most of the damnable character traits he had as an ancient war-and-moon-god. Not surprisingly, *Islam* tends to be a cruel religion that proves lethal for many *Muslims* and non-*Muslims* alike. A comparison of the *Koran* and the Bible bears these points out. For instance:

- C *Yahveh* says "love your enemies" (Mat 05:44) but *Allah* says be merciful to *Muslims* but harsh toward non-*Muslims* (*K* 009:073, 123; 048:029; 066:009).
- C *Yahveh* sent his only Son to die for sinners (Rom 05:08) but *Allah* would have his followers use the sword to convert others to *Islam* and kill or subdue those who refuse to convert (*K* 009:029; *Sahih Muslim* bk. 19, no. 4294).

Only the New Testament has the example of the Good Samaritan. This helps to explain why Christian charity dwarfs *Islamic* charity. For instance, the *Saudis* were able to raise 150 million USD for the families of Palestinian suicide-bombers but only a fraction of that amount for the Boxing Day 2004 Tsunami relief fund.<sup>72</sup>

Westerners raised much more money even though most of the Tsunami victims and survivors were *Muslims* and the remainder was nearly all non-Christians.<sup>73</sup> The Tsunami shows everyone's priorities quite well, as Paul Wolfowitz said:

There's very little generosity so far from parts of the *Muslim* world that are big on talking about *Jihad* and other things, but when 200,000 people—all of them *Muslim* in the case of Indonesia—died in this catastrophe, there's not much help forthcoming...I hope those people might think a little bit about what they've done and what they haven't done,' Mr. Wolfowitz said.<sup>74</sup>

Reuters reported the lack of philanthropy in *Islamdom*:

<sup>70</sup> Woolcock, Nicola & Sean O'Neill. "Once a friendly Christian, he now backs the bombers," [timesonline.co.uk](http://timesonline.co.uk), 24 Apr 2006, *JW*.

<sup>71</sup> *Sunan Abu-Dawud*, "Bk. 37: Battles (*Kitab Al Malahim*)," no. 4310. See also *Sahih Bukhari*, vol. 3, bk. 34, no. 425; vol. 3, bk. 43, no. 656; vol. 4, bk. 55, no. 657; *Sahih Muslim*, bk. 001, nos. 287+289.

<sup>72</sup> Hanson, Victor Davis. "The Disenchanted American: Are we growing world-weary?" *NRO*, [victorhanson.com](http://victorhanson.com), 7 Jan 2005.

<sup>73</sup> Siemon-Netto, Uwe. "Are there *Muslim* Samaritans?" [washtimes.com](http://washtimes.com), 4 Jan 2005, *DW*.

<sup>74</sup> "US criticises *Muslim* aid," *Sydney Morning Herald*, [smh.com.au](http://smh.com.au), 12 Feb 2005.

Despite their oil wealth, the Gulf states have had little tradition of donating overseas aid.<sup>75</sup>

The West, through private individuals, charities and non-governmental agencies such as UNICEF and the World Health Organization (WHO), has provided nearly all the funds to fight polio.<sup>76</sup> Meanwhile, oil revenues fund *Jihad* rather than health initiatives, even though most cases of polio originate in, ravage and emanate from, *Islamdom*, as AP reported:

The WHO campaign to fight polio has cost \$4 billion so far, but states of the Organization of the *Islamic* Conference have contributed just \$3 million [USD], even though recent outbreaks of polio have occurred mostly in *Islamic* countries, said spokeswoman Linda Muller.<sup>77</sup>

Sometimes, conspiracy theories are to blame for the epidemics, as AP reported:

The *Yemen* cases all stem from an outbreak in Nigeria two years ago, which occurred after *Islamic* clerics urged parents to boycott the vaccine for fear it was part of an American anti-*Muslim* plot. The polio that then erupted in Nigeria spread first to *Chad*, then to nearby *Sudan*—and then across the Red Sea into *Saudi* Arabia and *Yemen*. In some cases, the virus was carried by job-seekers and in others by *Muslim* pilgrims. ‘The *Islamic* world took a real beating because of what the clerics did in northern *Nigeria*.’ said Bruce Aylward...of WHO.<sup>78</sup>

The West even supports the Palestinians with humanitarian and developmental aid while the Arab League remains delinquent except for providing cash to charities that are front groups for terrorists, such as *Hamas*, as *The New York Times* reported:

Gulf governments have reaped tens of billions in extra oil profit over the past two years but have failed to meet even the minimal commitment of \$55 million a month in aid to the PA. (World Bank officials say only \$9 million a month has arrived.) In total, Arab League...owe[s] the PA \$891.8 million.<sup>79</sup>

Because *Allah* has no Son, *Muslims* have no Savior (1Jo 04:14). Even if *Allah* were *Yahveh* and not a war-and-moon-god, *Yahveh* the Father still would not accept *Muslims* into heaven for many reasons. They include:

☉ *Muslims* think of *Allah* as being a slave master and to call *Allah* their spiritual father would be blasphemous.

✠ Whoever does not believe that Jesus is *Yahveh* the Son is not accepted by *Yahveh* the Father (1Jo 02:23; 2Jo 01:09).

✠ *Muslims* believe that the Spirit is actually the demon who masqueraded as the angel Gabriel. This is tantamount to saying that the Spirit is a demon, which is a sin against the Holy Spirit (Mat 12:31; Mar 03:29). It is known that the *Muslim* Gabriel was a demon since the *Muslim* Gabriel taught doctrines of demons (1Ti 04:01). Also, *Muhammad* said that among the angels, Gabriel was the foremost enemy of Jews.<sup>80</sup> Saint Paul loved Jews and prophesied that the Jewish elect would be saved before the Last Day (Rom 09:03-05, 25-26; 11:01-02, 14-15). Only demons are enemies of the elect.

<sup>75</sup> “Britain to ask Arab world to help Africa-paper,” reuters.com, 4 Jun 2005, *DW*.

<sup>76</sup> “Poor, Young Battle Polio in *Yemen*,” news.yahoo.com, 4 Oct 2005, *DW*.

<sup>77</sup> “WHO Asks *Islamic* Nations for Polio Funds,” asia.news.yahoo.com, 9 May 2005, C&R; also see Pipes, D. “A Conspiracy Theory Spreads Polio,” *DP*, 24 May 2005.

<sup>78</sup> “Poor, Young Battle Polio in *Yemen*,” news.yahoo.com, 4 Oct 2005, *DW*.

<sup>79</sup> Makovsky, David. “Gaza: Moving Forward by Pulling Back,” nytimes.com, 12 May 2005.

<sup>80</sup> *Sahih Bukhari*, vol. 5, bk. 55, no. 546; vol. 5, bk. 58, no. 275; vol. 6, bk. 60, no. 7.

### **Islam Was a Religion of a War-god From Its Very Inception**

The pagan Roman Empire was so warlike partly because the Romans believed their empire's mythical founders, *Romulus* and *Remus*, were the twin sons of Mars, the Roman god of war. All over the former Roman Empire there were statues of two naked babies, *Romulus* and *Remus*, looking up to drink the milk of the she-wolf.

Similarly, the politico-religious entity that is *Islam* never was at any time “a Religion of Peace”™—even at its very inception since *Allah* was a centuries-old South Arabian war-and-moon-god. War-god prophets only create warlike religions.

*Muhammad*'s so-called peace only came after everyone surrendered to *Muslims* and there were no longer any religions with a god other than *Allah*, as *Muhammad* said:

Fight with them until there is no persecution and religion should be only for *Allah*, but if they desist, then there should be no hostility except against the oppressors (*Shakir K 002:193*).

This is how the peace of *K 002:193* was understood by *Islamic* scholars, as *Shaykh Al-Islam Ibn Taymiya* wrote:

Everyone who hears the call of the Messenger of *Allah*...to the religion of *Allah* with which he was sent and does not respond to it must be fought so that there will be no *Fitnah* [i.e. civil strife, war, riots] and so that submission will all be for *Allah*.<sup>81</sup>

*Muhammad* believe that *Allah* the moon-god was the God of the Bible, and said:

God hath purchased of the believers their persons and their goods; for theirs (in return) is the garden (of Paradise): they fight in His cause, and slay and are slain: a promise binding on Him in truth, through the Law, the Gospel, and the *Koran*: and who is more faithful to his covenant than God? then rejoice in the bargain which ye have concluded: that is the achievement supreme (*K 009:111*).

Since *Muhammad* apparently thought that even the New Testament promised heaven in exchange for martyrdom during battle, he believed that *Jihad* fighting was the will of *Allah* from the very start at *Mekka* in 610 AD.

Scholars try to say that *Islam* is a Religion of Peace™ nowadays, or at least initially until *Muhammad* came to *Madina*. This assertion goes against *Muhammad*'s assertion that *Allah*'s methods of dealing with humans does not change (*Rodwell K 048:023*; see also *K 033:062*). The real reason the Religion of Peace™ claims are pressed are so *Muslims* can say that:

- ☉ Non-*Muslims* are the culprits who turned *Islam* into a war machine and thus they deserve *Jihad*-inflicted violence.
- ☉ *Muhammad* was a man of peace and was not a brigand-at-heart who liked to engage in crimes due to his moral turpitude and criminal mentality.

Even before *Muhammad* was kicked out of *Makka*, he told the *Makkans*:

Will you listen to me, O *Quraysh*? By him [*Allah*] who holds my life in His hand I bring you [*Makkans*] slaughter.<sup>82</sup>

*Muhammad* made this alarming threat, as recorded in the traditions, when the as yet incomplete *Koran* only contained about seven War verses in six *Makkan Suras*.<sup>83</sup> About 157 verses dealing with War were later added at *Madina*.

<sup>81</sup> *Majmu' al-Fatawa* 28/249; see O'brien, Patrick D. “What is *Jihad*?” C&R, 15 Oct 2004.

<sup>82</sup> Ishaq. *Sirat*, p. 131.



Alarming, *Muslim* clerics in all four *Sunni* schools of thought say that the *Koran* and the traditions' War verses apply to *Muslims* today.<sup>84</sup> The 164 War verses transform the *Koran* into something more than mere incitement to commit mass murder or "slaughter," as *Muhammad* phrased it. They transform the *Koran* into incitement to commit genocide.

*Muhammad* added to the kill commands the troubling elevation of the Arabic language and culture in the *Koran* (K 012:002; 013:037; 016:103; 020:113; 026:195; 039:028; 041:003; 042:007; 043:003; 046:012). The War verses combined with Arabization of other cultures makes *Islam* both a genocidal and ethnocidal culture-killing machine, and drags every country that it dominates back to the seventh century, undoing all progress that has been made since then.

The murderous *Koran* has ensured that paganism is dead in the Mideast, unless of course one is referring to the paganism inherent in and inextricable from *Islam* itself. Judaism has been greatly diminished. Christianity is an endangered species in the Mideast—even in the Holy Land. After suffering a terrible genocide in the twentieth century at the hands of *Muslims*, Armenians were still taunted in the street by *Muslim* children jeering "Armeni, Armeni-dog, sweeper of hell are you!"<sup>85</sup>

Every form of religion besides *Islam* is all but extinct in Arabia. *Hindus* are a despised minority along their namesake river, the *Indus*, which flows through *Muslim Pakistan* and *Muslim-Sufi Kashmir*. *Buddhism* is extinct in India, the land of its birth. *Buddhism* is extinct in central *Afghanistan* where in 2001 the *Taliban* destroyed two 35-meter tall, fifth- or six-century AD *Buddha* statues at *Bamiyan*.

One can read why there are about 20,000 Zoroastrians left in the world:

In *Sharifabad* the dogs distinguished clearly between *Muslim* and Zoroastrian and...would flee as before Satan from a group of *Muslim* boys...*Muslims* found a double satisfaction in tormenting dogs since they were thereby both afflicting an unclean creature and causing distress to the infidel [Zoroastrianism] who cherished him. There are grim...stories from the time (i.e. into the latter half of the 19th century) when the annual poll-tax (*Jizya*) was exacted, of the tax gatherer tying a Zoroastrian and a dog together, and flogging both alternately until the money was somehow forthcoming, or death released them.<sup>86</sup>

The 164 War verses and the elevation of Arabic culture and language, together constitute incitement to commit ethnocide against non-*Muslim* cultures and religions. The *Koran* is a manual for war and propaganda to commit genocide.

*Islam* has wiped out hundreds of cultures and what has the world received in return? Not much when compared to what the world has lost in terms of spirituality, technology, freedom, personal and national security, kindness, love, charity, tolerance and peace.

I do not know any civilized person who does not agree that war is the worst man-made curse ever visited on our unhappy planet, and *Islam* has given us thirteen

<sup>83</sup> Seven War verses in six *Makkan Suras* (K 016:110; 025:052; 029:006, 069; 042:039; 073:020; 076:008). See the tables that list the *Koran's* 164 War verses in *Sura* and chronological orders.

<sup>84</sup> Spencer. *Onward*.

<sup>85</sup> Soroudi, Sorour. "The Concept of Jewish Impurity and its Reflection in Persian and Judeo-Persian Traditions" *Irano-Judaica* 1994, Vol. III, p. 155 (footnote 33), as quoted by Bostom, Andrew G. "The Real Roots of *Muslim* Hatred," *FPM*, 3 Jun 2004.

<sup>86</sup> Boyce, M. A Persian Stronghold, pp. 141-142, as quoted by Bostom, Andrew G. "The Real Roots of *Muslim* Hatred," *FPM*, 3 Jun 2004.

centuries of it. Incessant, uninterrupted, aggressive war, with unprovoked murder, mayhem, mutilation, torture, famine and slavery.

*Muhammad's* biographer, *Ibn Ishaq*, states that *Muhammad* received permission to fight (not an order to fight) just before emigrating to *Madina*.<sup>87</sup> However, as the table provided earlier in this book shows, Noeldeke, Maududi and Yusuf Ali all agree that *K* 016, 029 and 073 are *Makkan Suras*. This suggests that *Muhammad* already wrote a “fight” verse during his earliest “ministry” at *Makka* (*K* 073:020).

In Maududi's introduction to *K* 073, he states that commentators are unanimous about *K* 073:001-019 being *Makkan*. However, in keeping with the theory that *Islam* only turned violent at *Madina*, Maududi assigns the very last verse of *K* 073—verse 20, to the *Madinan* period. Maududi wrote:

About the second section (v. 20), although many of the commentators have expressed the opinion that this too was sent down at *Makkah*, yet some other commentators regard it as a *Madani* [*Madinan*] Revelation, and this same opinion is confirmed by the subject matter of this section. For it mentions fighting in the way of *Allah* and **obviously, there could be no question of it at *Makkah***; it also contains the Command to pay the obligatory [charity poll tax] *Zakat*, and it is fully confirmed that the *Zakat* at a specific rate and with an exemption limit (*Nisab*) was enjoined at *Madina*.<sup>88</sup>

Just as *Muhammad* surely enjoined charity both in *Makka* and *Madina*, he must have also encouraged *Jihad* fighting at *Makka*. Why would the *Koran* be peaceful and tolerant during the *Makkan* period while the traditions have *Muhammad* telling the *Makkans* under oath that he would slaughter them?<sup>89</sup> If *Islam* were peaceful from the start, why would the *Makkans* meet *Muhammad* and tell him:

Our conscience is clear. By God, we will not leave you and our treatment of you until either we destroy you or you destroy us.<sup>90</sup>

*Ibn Ishaq* relates that *Muhammad's* threat of slaughter occurred right before Hamza accepted *Islam* in 616 AD.<sup>91</sup> The meeting where the *Makkans* acknowledge *Muhammad's* threat and tell him they are willing to fight to the death occurred in the same year. Six years later *Muhammad* traveled to *Madina* in 622 AD.

*Islam* was a fighting religion from the start and that is why there are six *Makkan Suras* contain seven War verses (*K* 016:110; 025:052; 029:006, 069; 042:039; 073:020; 076:008; see the chart on the chronology of the *Suras*).

The first blood to be shed between the *Makkans* and *Muslims* was, not surprisingly, drawn by a *Muslim* in 613 AD, almost immediately after *Muhammad* began his public ministry. In Guillaume's translation of *Ishaq's* biography of *Muhammad*, *Muhammad's* public ministry begins on page 117 and a *Muslim* draws first blood on page 118, the very next page! *Ibn Ishaq* wrote:

...Sa'd [a *Muslim*] smote a polytheist with the jawbone of a camel and wounded him. This was the first blood to be shed in *Islam*.<sup>92</sup>

Sita Ram Goel wrote about the *Makkan* period of *Islam*:

<sup>87</sup> *Ishaq. Sirat*, p. 212.

<sup>88</sup> Maududi, Syed *Abu-Ala'*. *Chapter Introductions to the Quran* (online).

<sup>89</sup> *Ishaq. Sirat*, p. 131.

<sup>90</sup> *Ishaq. Sirat*, p. 134.

<sup>91</sup> *Ishaq. Sirat*, p. 131.

<sup>92</sup> *Ishaq. Sirat*, p. 118.

The curses were soon backed by street brawls which his boisterous *Muslims* managed to provoke. He had a real tough lot on his side, apart from his ideology which animated the lowest passions in human nature.<sup>93</sup>

Margoliouth wrote about early *Islam*:

The hands of all alike were tied by fear of bloodshed; but in the case of humble converts they were ready to come very near that limit [i.e. bloodshed]. The persons whose accession to *Islam* was most welcomed were men of physical strength, and much actual fighting must have taken place at *Makkah* before the Flight; else the readiness with which the *Muslims* after the Flight could produce from their number tried champions would be inexplicable. A tried champion must have been tried somewhere: and no external fights are recorded or are even the subject of an allusion for this period. The Prophet himself is said on one occasion after reciting *Sura xxxvi (K 036 Ya Sin [meaning "Oh [moon-god] Sin"])* to have flung dust on the heads of his opponents.<sup>94</sup> And the wise principle of hitting back when hit appears to have characterized the new religion from its start and to have been the cause of its speedy success.<sup>95</sup>

It is hard to believe that the fight verses in *Makkan Suras* were all of *Madinan* origin. Maududi's late dating of *K 073:020* is just another worn-out ruse whereby *Muslim* commentators try to make it seem as though *Islam* was "a Religion of Peace"<sup>TM</sup> at its inception, but only turned violent in self-defense. Maududi even states that he did not even consider the possibility that a "fight" verse in the *Koran* could have come from the *Makkan* period. Maududi states:

...obviously, there could be no question of it at *Makkah*.

Many *acaDhimmis* have based their historical timeline for the development of *Islam* on the pious fictions that *Muslims* have about *Islam*—that *Islam* was peaceful at first. The pious fiction goes that the *Makkans*, and then later the Crusaders, are at fault for *Islam*'s turning into a slave-catching war machine.

Based on this pious fiction, commentators argue that many *Makkan Suras* are peppered with *Madinan* verses, merely because these verses speak of fighting and charity. The fact however that *Allah* was a war-and-moon-god suggests that *Islam* was violent from the very start.<sup>96</sup>

The only reason *Muhammad* held back at *Makka* is that *Muslims* were the weaker party in the conflict, so they had to build their strength and confidence (*K 003:149; 086:017*). *Sura 086* incidentally is a *Makkan Sura* and it says ominously:

So give a respite to the disbelievers. Deal thou gently with them for a while (*K 0086:017*).

So when dating the chapters and verses of the *Koran*, one must avoid artificial distinctions based on historical contrivances. One must not let pious fictions and propaganda rewrite history and determine chronology. Just as *K 073:001-019* are *Makkan*, so the last verse (*K 073:020*) is *Makkan*, even though it mentions *Jihad* and the *Zakat*.

Noeldeke, and also Maududi in his *Sura* introductions, figure that *K 016* and *029* were written during *Muhammad*'s early "ministry" at *Makka*. Thus four "fight"

<sup>93</sup> Goel. *Calcutta*, ch. 3.

<sup>94</sup> Wakidi (W.), 51, as reference by Margoliouth. *Rise*, p. 154 & fn. 3; also see Ishaq. *Sirat*, p. 222, where Ishaq says *Muhammad* said "*Ya Sin*," and sprinkled dust.

<sup>95</sup> Margoliouth. *Rise*, pp. 154-155.

<sup>96</sup> Nielsen, 1912, pp. 593-594, as translated in Krause, "*Haram-Harimat*."

verses were written early in *Muhammad's* career as a prophet (K 016:110 and 029:006, 069; 073:020).<sup>97</sup> The rest of the ethnocide and genocide verses were written at *Madina*.

So the “peace and tolerance” verses of the *Koran* were not *Allah's* final word for very long. Not long after their inclusion in the *Koran*, the “peace and tolerance” verses were abrogated and nullified by “fight” verses even BEFORE *Muslims* were chased out of *Makka* to *Madina*.

This shows that *Muhammad* considered *Allah* to be a typical south Arabian war-and-moon-god who never lacks a *casus belli* (cause for war). The demon *Allah* would have his followers fight at the slightest provocation and flimsy pretext, even against overwhelming odds (K 002:249; 033:015) and even if it meant expulsion, exile or certain death (K 003:143; 004:074; 033:023).

This table lists briefly what was discussed above.

The Chronology of Violence in Islam	
610 AD	<i>Muhammad</i> receives his call. Is choked by the angel Gabriel three times. <i>Muhammad</i> keeps his ministry private for three years.
610-614 AD	In his 23 <sup>rd</sup> <i>Sura</i> (K 073:020) <i>Muhammad</i> wrote: “...fight in <i>Allah's</i> way.”
610-614 AD	In his 52 <sup>nd</sup> <i>Sura</i> (K 076:008) <i>Muhammad</i> wrote that <i>Muslims</i> feed the captives.
610-614 AD	In his 66 <sup>th</sup> <i>Sura</i> (K 025:052) <i>Muhammad</i> wrote that <i>Muslims</i> ought to “fight strenuously with” unbelievers “in many a strenuous fight.”
613 AD	<i>Muhammad</i> began his public ministry. Almost immediately a <i>Muslim</i> attacked a pagan <i>Makkan</i> with the jawbone of a camel.
615 AD	Some <i>Muslims</i> emigrated to Abyssinia to avoid the pagan <i>Makkans</i> .
616 AD	<i>Muhammad</i> told the <i>Makkans</i> that he was going to bring them slaughter. Shortly thereafter, the <i>Makkans</i> tell <i>Muhammad</i> that either the <i>Makkans</i> would destroy him, or he would destroy the <i>Makkans</i> .
616-622 AD	In his 73 <sup>rd</sup> <i>Sura</i> (K 016:110) <i>Muhammad</i> wrote that <i>Muslims</i> “thereafter strive and fight for the faith and patiently persevere.”
616-622 AD	In his 81 <sup>st</sup> <i>Sura</i> (K 029:006, 069) <i>Muhammad</i> wrote “strives hard [in <i>Jihad</i> ], he strives only for his own soul” and “(as for) those who strive hard [in <i>Jihad</i> ] for Us.”
616-622 AD	In his 83 <sup>rd</sup> <i>Sura</i> (K 042:039) <i>Muhammad</i> wrote “...who, when an injury is done them, avenge themselves...”
622-632 AD	<i>Muhammad</i> fled to <i>Madina</i> where he wrote 157 more War verses. The seven War verses written at <i>Makka</i> plus these <i>Madinan</i> War verses equal 164 War verses.

### How *Muhammad* Was Able to Implement His “Religion of Peace”™ Propaganda Coup d'état

*Muslim* historians like to say that *Islam* started out as a Religion of Peace,™ but then was forced to be warlike in order to survive the persecution of the *Makkans*.

<sup>97</sup> Nehls & Eric. *Islam*, “The Books of *Islam*: The *Quran*.”

*Muslims* say that the early *Muslims* were trying to be good neighbors but were forced to liquidate their persecutors. The persecutors brought on their own demise by being shortsighted and spiritually stubborn.

This makes for great reading—almost like a Greek tragedy. Just how fictional this version of events is can be seen by how the same excuse has been used by *Muslims* down to the present day.

Somehow, *Muslims* always deem themselves to be persecuted in some way, form or fashion, even in democracies that allow for freedom of religion. Then they say that since democracies do not allow for funding terrorism, that this is religious persecution. Then *Muslims* say that it is persecution, rather than the vicious *Koran* and *Hadiths*, that bring out the martial nature of *Muslims* and *Islam*.

*Muhammad* was able keep the violent nature of *Islam* under wraps for a long time at *Makka* by employing the unethical *Islamic* un-principle called “sanctified lying” (*Takiya*-speak).

Early *Muslims* used the *Takiya* un-principle to keep the *Koran* from all pagans, unless it was felt that the pagan was about to convert, as *Ibn Ishaq* reported. Umar came to a house where he overheard *Khabbab* reading the *Ta Ha* chapter (*K* 020) out loud, though when Umar came in, they hid the sheet. When Umar asked to see the sheet, *Fatima* replied:

My brother, you are unclean in your polytheism and only the clean may touch it.<sup>98</sup>

This was how *Muhammad* was able to keep the seven *Makkan* War verses a secret from the *Makkans* (see previous section or the chart for citations).

Not only did *Muhammad* hide the violent nature of *Islam* for years at *Makka* but he used *Takiya*-speak to hide his prophetic mission, as an encyclopedia notes:

*Muhammad* himself was known to have used *Takiya* when he kept his prophetic mission hidden for three years from the *Quraish* during their prolonged hostility toward *Muslims*. As a result, the *Islamic* religion prospered in *Makkah* and many lives were spared, making emigration to *Madina* possible during that time.<sup>99</sup>

Incidentally, *Muslims* take *Muhammad*'s example to heart and try to hide their *Jihad* mission as long as possible. Otherwise, they would be put under law enforcement surveillance and it would be harder to support or engage in *Jihad*. For instance, an *Imam* producing the radio show “Radio *Islam*,” in Chicago, USA, said:

*Islam* does not condone terrorism; *Islam* is not at war with the West; and your *Muslim* neighbor is your friend.<sup>100</sup>

The problem with statement is that it contradicts the *Koran* and the traditions of *Islam*, and the producer's assumed name is “*Imam Abdul Malik Mujahid*,” which means “Leader, Slave, King, Holy Warrior.” If *Muhammad*'s example and the example of countless other *Muslims* means anything, it is only a matter of time before this *Muslim* leaves *Makka*, makes his personal *Hegira* to *Madina* and then wages *Jihad*.

---

<sup>98</sup> *Ishaq. Sirat*, p. 157.

<sup>99</sup> *Wikipedia*, fact-index.com, *Taqiyya*, 22 Jun 2004.

<sup>100</sup> Johnson, Charles. “Radio *Islam*: A SoundVision Production,” *LGF*, 5 Oct 2004.

### The *Jihad* Means Inner Struggle Sham

Often when there is a discussion of *Jihad*, an apologist for *Islam* will bring up the tired cliché about how *Jihad* means “struggle,” as in “inner spiritual struggle.” The idea is to say that *Islam* and *Jihad* are not about killing but self-improvement.

Unfortunately, *Muhammad*’s sanctification and self-help advice for *Muslims* involves predation on non-*Muslims*. Informed non-*Muslims* know what they see and read and that is: *Jihad* = Legalized Killing + Loot + (Sex)Slaves + *Houris* + Paradise.

From reading history and about current events, one can gather that when all the hate and War verses of the *Koran* and *Hadith* are turned inward, a *Muslim*’s vaunted “inner spiritual struggle” is mainly about the inner *Jihadist* killing the inner honest nice guy. The “inner spiritual struggle” is about killing the fear of dying on the battlefield!

Once the “inner nice guy” is killed, the inner *Jihadist* becomes THE *Muslim* self. The inner *Jihadist* has no regrets and pangs of conscience over killing the inner honest nice guy, much as Cain did not fret over Abel. The bottom line is that whenever the *Koran* is internalized, the resultant inner spiritual struggle leads to more hatred of non-*Muslims*, and more *Jihadist* sympathy, support and activity.

The confusion about *Jihad* is similar to how many Westerners think *Fatwa* is the same as a death sentence or a bounty reward. *Muslims* will state that a *Fatwa* is in fact a legal opinion or ruling issued by an *Islamic* scholar. Technically, this is correct but a *Fatwa* may also condemn an apostate or blasphemer to death. Thus the clarification about the meaning of *Fatwa* is an attempt to obfuscate how *Fatwas* are sometimes used to incite murder.

The reason that apologists for *Islam* have been able to tell many non-*Muslim* English speakers that *Jihad* means only “struggle” is none of the major English translations of the *Koran* use the word *Jihad* to translate the Arabic word *Jihad* and its various forms. If they had, people would have seen from the context exactly what was meant by the Arabic word *Jihad*.

The “*Jihad* means “struggle”” argument backfires when one discusses the Arabic *Koran* or a transliteration of the Arabic of the *Koran*. Why? Because ““strive hard” in Arabic is *Jahidi*, a verbal form of the noun *Jihad*.”<sup>101</sup>

Some words translated as “struggle” are: *Wajahadoo* (K 002:218), *Jahadoo* (K 016:110; 029:069), *Jahada*, *Yujahidu* (K 029:006) and *Almujahideena*, *Waalumjahidoona* (K 004:095). So it is apparent that many of the words translated as “struggle” in fact mean *Jihad* and *Mujahideen*—a common word meaning *Jihadists*.

Worse still is the fact that when *Jihad* warfare is meant or implied, some *Koran* translations use the word “struggle” rather than “fight,” much less “*Jihad*.” The fact that “struggle” often refers to *Jihad* can be seen from its use in the *Koran* where the context suggests Holy War (e.g. K 002:218; 004:095; 009:019-020, 081, 086, 088; 016:110). Here are a few examples where one translation will use a form of “fight” while another uses a form of “struggle”:

- ☉ K 002:218 [Arabic: *Wajahadoo*]
  - ★ *Yusuf Ali*: suffered exile and **fought** (and strove and struggled)
  - ★ *Shakir*: fled (their home) and **strove** hard in the way of *Allah*
- ☉ K 003:142 [Arabic: *Jahadoo*]
  - ★ *Yusuf Ali*: **fought hard** (in His Cause)
  - ★ *Pickthall*: **really strive**

<sup>101</sup> Spencer, Robert. “*Jihadism* and the *Qur’an*,” *FPM*, 8 Dec 2005.

- ☉ K 004:095 [Arabic: *Waal mujahidoona...Almujahideena...Almujahideena*]
  - ★ *Yusuf Ali*: **strive** and **fight** in the cause of God...strive and fight...strive and fight...
  - ★ *Sher Ali*: **strive** in the cause of *Allah*...strive...strive...
- ☉ K 005:035 [Arabic: *Wajahidoo*]
  - ★ *Khalifa*: **strive** in His cause
  - ★ *Sale*: **fight** for his religion
- ☉ K 005:054 [Arabic: *yujahidoona*]
  - ★ *Yusuf Ali*: **fighting** in the way of God
  - ★ *Arberry*: **struggle** in the path of God

A preliminary examination suggests that Sale (1734 AD) and Yusuf Ali (1934 AD) are more true to the spirit of the *Koran* in that they **tend** to use a form of the word “fight” where other English translations use a form of the word “struggle” in the attempt to make the *Koran* seem less threatening to non-*Muslims*.

The *Hadith* quote the *Koran* and often mention the circumstances during which the *Koran* verse was “revealed.” Comparison of these *Hadith* and *Koran* translations show that where *Koran* translations say “struggle,” the correlating *Hadith* specifically mentions *Jihad*. Here are two examples:

- ☉ *Sahih Muslim*, bk. 20, no. 4638, relates the circumstances when K 009:020 (*Sura ix.20*) was revealed and specifically mentions *Jihad* (“*Jihad* in the way of *Allah* is better...”). By contrast, all the major *Koran* translations of the verse have “struggle” or “strove.”
- ☉ *Sahih Muslim*, bk. 20, no. 4676 relates the circumstances when K 004:095 (*Sura iv.95*) was revealed and specifically mentions *Jihad* (“those who go out for *Jihad* in the way of *Allah* are not equal”). *Pickthall*, *Shakir*, *Sher Ali*, *Khalifa*, *Arberry*, *Palmer*, *Rodwell* and *Sale* only have “struggle” or “strive” and such, while *Yusuf Ali* has “strive and fight in the cause of God.”

Some *Muslims* may actually think of *Jihad* as being a mere “struggle” and *Fatwas* as being mere “religious rulings,” but they are not concerned about the fact that *Jihad* and *Fatwas* have proven lethal to non-*Muslims*. On the other hand, *Muslims* may be engaging in *Takiya*-speak (sanctified lying) in order to put infidels at ease so they do not work to defend themselves from *Jihad* and *Fatwas* until it is too late.

The difference in perspective on *Jihad* and *Fatwas* may result from whether a person is on the giving or receiving end of *Jihad* or *Fatwas*. The baseball is going to think about a bat differently than the batter will, and the farmer is going to think about breakfast differently than farm animals. *Jihad* and *Fatwas* are statistically more deadly for non-*Sunnis* than for *Muslims* who engage in *Jihad* and issue the *Fatwas*.

Non-*Muslims* need to know that the innocuous sounding “struggle” definition of *Jihad* is every bit as threatening as the “Holy War” definition. For instance, Hitler’s *Mein Kampf* is often translated into English as “My Struggle.” That book resulted in millions of murders meant to speed up the survival of the fittest evolution to the nth degree. Similarly, *Muhammad*’s “*Mein Koran*” and *Muhammad*’s “struggle” has resulted in many millions of murders in the cause of *Allah* over fourteen centuries in order to speed along *Dawa* proselytizing and the forced conversion of the human race.

The reason that knowledgeable apologists for *Islam* bring up the *Jihad*-struggle distinction is they either want to spiritualize or hide all the many fight commands in the *Koran*. Apparently, translators of the *Koran* want to do this too since some major

English translations do not even mention the words “*Jihad*” or “Holy War,” even when the word *Jihad* is found in the Arabic. Instead, they mention “strive,” “struggle” or, at most “fight.”

Even when War verses are considered in isolation, often the fact that “struggle” refers to a military expedition becomes obvious, for instance:

Whenever a chapter is revealed, saying: Believe in *Allah* and strive hard along with His Apostle, those having amplexness of means ask permission of you and say: Leave us (behind) that we may be with those who sit [and not go on *Jihad*] (*Shakir K 009:086*).

The history that goes along with the *Koran* shows that *Jihad* means “terrorism” and “military expeditions” rather than an “inner struggle.” When did *Muhammad* ever engage in an “inner struggle” to say, curb his sexual appetites or curb his lust for blood in battle?

*Muhammad*’s history is a clue as to what *Jihad* in the *Koran* means. Sita Ram Goel wrote:

Biographers of *Muhammad* have listed as many as eighty-two expeditions which he mounted against various tribes of Arabia and the neighboring lands, in a brief span of ten years between his migration to *Madina* in 622 CE and his death in 632 CE. The average comes to two expeditions every three months. Twenty-six of these, we are told, were led by him in person. After he had reduced *Makka* and the rest of Arabia, he started planning expeditions against the Byzantine and the Persian Empires. It was only his death which stopped him from waging more wars.<sup>102</sup>

It is ironic that *Muslims* claim that the “Greater” *Jihad* (*Jahada Nafsah*) is about controlling oneself, and the lesser *Jihad* is about controlling non-*Muslims* through Holy War. What does *Islam* have to do with self-control—especially controlling one’s lust? As Professor Jadunath Sarkar stated:

It is not necessary that he should tame his own passions or mortify his flesh; it is not necessary for him to grow a rich growth of spirituality. He has only to slay a certain class of his fellow beings or plunder their lands and wealth, and this act in itself would raise his soul to heaven.<sup>103</sup>

*Islam* is all about indulging one’s lust with four wives who can be replaced at will, and sating one’s sexual appetites with an unlimited number of concubines and sex-slaves (*K 004:003, 023-024; 023:005; 033:050; 070:030*). Even in the afterlife *Muslims* will have no restriction on their sex drive. *Muslims* think that even now the countless *Jihadists* who died in *Islam*’s Holy Wars are copulating non-stop with up to seventy-two *Houris*. Little do they suspect that this would be hell, not heaven.

*Muslims* talk about the Greater *Jihad* as being an inner spiritual battle to become a more pious *Muslim*, and to memorize more and more of the *Koran*. *Muslims* and *Muslim* apologists think that this is laudatory and admirable but in fact it is abominable and horrendous.

A *Muslim* who memorizes the 164 War verses in the *Koran* is making himself into an *Islamic* terrorist. Even if *Muslims* only memorize the first nine chapters, they’ve memorized 117 of the 164 War verses.<sup>104</sup> Most terrorists in the world are

<sup>102</sup> Goel. *Calcutta*, ch. 3.

<sup>103</sup> Goel. *Calcutta*, ch. 8.

<sup>104</sup> See the Contents section to locate the table on the *Koran*’s 164 War verses.



*Islamists*, so there is a statistically significant correlation between reading the *Koran* and becoming a terrorist.

It is well known that many *Islamists* and *Jihadists* have memorized part or all of the *Koran*. In fact while in jail many *Jihadists* try day and night to memorize the *Koran*. The “American *Taliban*” John Walker Lindh memorized a large part of the *Koran* before going on *Jihad*, and “Abdulaziz *Al-Muqrin*, *Al Qaeda*’s chief of operations for the Arabian Peninsula,” was released from jail in 1997 as a reward for having memorizing the *Koran* while in jail.<sup>105</sup>

The Greater *Jihad*, therefore, is rather like a *Ninja* assassin training his body and mind to make the kill. In fact the *Sufi Al-Junayd* imagines that if he can just master his own personal demons, this will facilitate his mastery of Christians and other non-*Muslims* in battle:

Those who have striven against their desires and repented for our sake, we shall guide them to the ways of sincerity, and one cannot struggle against his enemy outwardly (i.e. with the sword) except he who struggles against these enemies inwardly. Then whomever is given victory over them will be victorious over his enemy, and whomever is defeated by them, his enemy defeats him.<sup>106</sup>

So one can see that the fact that *Jihad* means “struggle” in addition to “Holy War” does not help the *Muslim* cause much, except in the minds of those who are easily beguiled.

That *Jihad* is mostly about an inner spiritual struggle is about as laughable as the idea that *Islam* is a Religion of Peace™ because *Islam* comes from the root word, *Salaam*, which means “peace.” The fact that the word *Muslim* means “he who has submitted” indicates that, at best, *Islam* is an imposed and enforced peace.

Yet another related sham is that *Jihad* is a “mercy,” as one *Muslim* put it:

*Jihad* is actually considered a *Rahma* (mercy) in *Islam*. If there is an oppressor and there is *Jihad* to stop his oppression, it is a mercy on him (the oppressor).<sup>107</sup>

### The Lesser Versus Greater *Jihad* Sham

*Muslims* talk about the Greater *Jihad* of an inner personal struggle versus the Lesser *Jihad* of battling with infidels. Non-*Muslims* get the false impression that the militaristic side of *Islam* pales in comparison to the deeply spiritual side of the religion. In fact:

☉ Going on a *Jihad* adventure is the highest form of spirituality in *Islam*—greater than going on a *Hajj* pilgrimage by far.

☉ In the *Reliance of the Traveler* manual of *Sharia* law, there are only two sentences dedicated to *Jihad* as an inner spiritual struggle (Greater *Jihad*), and eight pages dedicated to *Jihad* as holy war (Lesser *Jihad*).<sup>108</sup>

☉ Yashiko Sagamori states his assessment of *Islam*:

*Islam*...without *Jihad*...is nothing but a set of meaningless rituals.<sup>109</sup>

<sup>105</sup> Stakelbeck, Erick. “Rattling Riyadh,” nypost.com, 15 Jun 2004, *JW*, 18 Jun 2004.

<sup>106</sup> *Ibn Qayyim Al-Jawziyya, Al-Fawa'id*, ed. *Muhammad Ali Qutb*, Alexandria: *Dar Al-da'wa*, 1412 AH/1992 AD, p. 50.

<sup>107</sup> Mirza, Zaigham Ali. “*Muslim* society ‘has lost ability to strategise,’” khaleejtimes.com, 3 Nov 2004, *JW*.

<sup>108</sup> O’Brien, Patrick D. “*Jihad*: The Misunderstood Infidel Murder & Conquest Word,” C&R, 29 Aug 2005.

One verse that is used to talk about how the Greater *Jihad* is non-violent is: "...kill not your own people" (K 004:029). This verse does not apply to *Jihad* however because *Jihad* is not against *Muslims*. The *Islamists* do not consider any *Muslims* they target to be true *Muslims*.

And here is yet another verse, excerpts of which are quoted to talk about how the Greater *Jihad* is non-violent:

...whosoever kills a human being...it shall be as if he had killed all mankind, and whoso saves the life of one, it shall be as if he had saved the life of all mankind (K 005:032).<sup>110</sup>

This verse is often said to mean that *Islam* is a non-violent religion. This interpretation is contradicted by the 164 War verses, two of which immediately follow K 005:032 (K 005:033, 035). Another reason that K 005:032 does not preach non-violence is K 005:032 is highly conditional, as the full-text shows (see bolded excerpt):

We [*Allah*] ordained for the Children of *Israel* that if any one slew a person—**unless it be for murder or for spreading mischief in the land**—it would be as if he slew the whole people; and if any one saved a life, it would be as if he saved the life of the whole people (Yusuf Ali K 005:032).

This rather ambiguous phrase "spreading mischief in the land," basically allows *Muslims* to kill anyone they please, whenever they please. It seems *Muhammad's* definition of "mischief-making" was quite loose. He taught that at least six animals ought to be killed on sight because they were "mischief-makers":

the mouse, the scorpion, the kite [a hawk], the crow, the dog and the salamander (*Sahih Bukhari*, vol. 3, bk. 29, nos. 55, 57; vol. 4, bk. 54, nos. 525-527, 532; vol. 4, bk. 55, no. 579).

One could surmise that most non-*Muslims* would be considered mischief-makers worthy of death, at least by *Islamists* and terrorists.

The *Koran* says that all pagans, Christians and Jews are considered worthy of death even if they are not mischief-makers. The only thing that keeps the Jewish and Christian *Dhimmis* alive is the *Jizya* tax they pay. If however anarchy prevails and there is no *Muslim* leader to collect the tax, the *Jihad* against non-*Muslims* is resumed by a *Muslim* populace or army driven on by outrage or by a quest for loot.

Furthermore, K 005:032 does not even apply to *Muslims* because the context indicates that *Muhammad* was talking about the *Israelites* under Moses. The passage that *Muhammad* quotes comes not from the *Pentateuch* but from the Babylonian *Talmud*, *Tractate Sanhedrin*, 37a.

*Muslims* of course do not follow the Mosaic law code, nor Mosaic *Kosher* laws (K 003:050, 093; 004:160; 006:146), or the Jewish *Sabbath* (K 002:065; 004:047, 154; 007:163; 016:124). *Muslims* surely will not follow this "do not kill" verse (K 005:032) instead of the 164 War verses which command much killing and conquering, especially since two War verses (K 005:033, 035) follow K 005:032!

Study of *Islamic* terrorism shows that generally only the most devout *Muslims* are recruited to be *Jihadists* and terrorists, especially for martyrdom operations involving suicide attacks. Often converts are recruited, because in any movement, it is often the converts, a.k.a. "new blood," who are the most fervent. This shows that

<sup>109</sup> Sagamori, Yashiko. "Peacemongers and *Jihadeers*, Part II," middleeastfacts.com, 10 Jan 2005.

<sup>110</sup> Standing, Peter. "*Koran* a Book of Peace, Not War, Scholars Say," *National Geographic Today*, nationalgeographic.com, 25 Sep 2001.

*Jihad* is actually the highest form of spirituality in *Islam*, as one who is not fooled by feel-good propaganda might suspect!

*Muhammad* admitted that Holy War was the ultimate expression of spirituality when he said “that the Lord gave the *Muslims* the *Hajj* and Holy War in exchange for [instead of] monasticism.”<sup>111</sup> Only the most outwardly spiritual persons of any religious persuasion would become monks and nuns. This shows that *Muhammad* thought *Jihad* and *Hajj* were activities for the most devout and spiritual *Muslims*.

*Muslims* also talk about Lesser and Greater *Jihads* as though they had equal authority and footing in the *Koran* and the traditions. As it turns out, the concept of the Greater *Jihad* is NOT spelled out in the *Koran*, and the Greater *Jihad*'s basis in the traditions is tenuous to the extreme and has no credence among most *Muslims*.

Apparently, the whole idea of Greater and Lesser *Jihad* came from the mention of “the Greatest *Jihad*” in K 025:052. Here *Muhammad* was saying that instead of just mustering enough forces for a **battle**, *Muslims* ought to rouse themselves and mobilize for full-blown **war** against infidels.

Despite the obvious reading of K 025:052, some *Muslims* have read into the verse that there are two types of *Jihad*, a Greater spiritual type and a Lesser warrior type. How this is done: *Muslims* interpret and even translate K 025:052 as though “the *Koran*” is in the original Arabic text, as though *Muslims* are supposed to fight with words alone.

The reader can check the original Arabic for K 025:052, or a transliteration of the Arabic, and he or she will find that there is no word for *Quran* (*Alqur-anu*, *Alqur-ana* or *Waalqur-ani*) in the verse. Even so, translators have translated as though *Quran* is in the Arabic, for instance:

- ☉ Yusuf Ali translated: “...strive against them with the utmost strenuousness, with the (*Quran*),”
- ☉ Sher Ali translated: “...strive against them by means of the *Quran* with a mighty striving.”
- ☉ Rodwell translated: “...but by means of this *Koran* strive against them with a mighty strife.”

Thus if one scratches the surface of the arguments, one find he cannot substantiate that: 1) there are two types of *Jihad* from the *Koran*, or 2) the warrior-type of *Jihad* is of lesser importance than spiritual *Jihad*.

The traditions are not much more helpful than the *Koran* in establishing that there are two types of *Jihad*. *Jihad* theorists such as Hassan *Al-Banna* and *Abdullah Azzam* consider all the traditions that mention the Lesser-Greater *Jihad* distinction to be “weak” *Hadiths*.<sup>112</sup> The strong traditions are those found in the respected *Hadith* collections: *Sahih Bukhari*, *Sahih Muslim*, *Sunnan Abu-Dawud*, or *Malik's Muwatta*.

Incidentally, *Muslims* often pull quotes from weak traditions to make *Islam* look tolerant even though these weak traditions mean nothing to *Islamists*. The fact that *Muslims* must resort to weak traditions or *Hadith* to show that *Islam* is tolerant shows the true nature of *Islam*. Examples *Muslims* offer, most often without any citation to hide the fact that they are not from the respected *Hadith*, are that *Muhammad* said:

- ☉ “Whoever harms a *Dhimmi* has harmed me.”

<sup>111</sup> Grunebaum. *Festivals*, p. 44, as quoted in Stortroen. *Makka*, p. 20.

<sup>112</sup> Spencer. *Onward*. “Singapore: Book aims to...,” *JW*, 25 Sep 2004.

- ☉ “The one who kills a *Mu'ahid* (people with whom the state has treaties) without right he will not smell the fragrance of *Jannah* (heaven) even if its smell was forty years traveling distance” (*Hadith* book Ahmed).

Even more damning is the fact that the Lesser-Greater *Jihads* traditions were promulgated, if not invented, by the *Sufis*, a heretical sect that *Sunnis* and other *Muslims* tended to persecute and slaughter. Patrick Hughes wrote:

*Sufi* writers say that there are two *Jihads*: *Jihad Akbar*, or ‘the greater warfare,’ which is against one’s own lusts; and *Jihad Asghar*, or ‘the lesser warfare,’ against infidels. **The duty of religious war (which all commentators agree is a duty extending to all time).**<sup>113</sup>

It would seem *Sufis* wanted to de-emphasize *Jihad* among *Muslims* in order to save themselves from the sword of traditional *Muslims*. What the *Sufis* did is similar to how some non-*Muslims* today spread the “*Islam* is peace” message in the attempt to pacify *Muslims*. The problem with doing this is the *Jihadists* and *Islamists* are not convinced, but too many non-*Muslims* start believing the propaganda that *Islam* is peaceful when *Islam* is decidedly not.

Someone might ask why *Muslims* talk of Greater and Lesser *Jihad* today. Knowledgeable *Muslims* do not believe in the distinction between Lesser and Greater *Jihad*, and they know that this is merely *Takiya*-speak in order to calm the apprehensions of non-*Muslims*. Basically, by bringing up meaningless distinctions between lesser and greater *Jihad*, *Muslims* try to sell the idea that the 164 War verses in the *Koran* do not constitute one big credible death threat against non-*Muslims*, but merely 164 trivial death threats that non-*Muslims* can brush aside.

A similar *Islamic* ruse is—in order to dodge the misogynist label—*Muslims* use *Takiya*-speak to claim that *Muhammad* said not to beat wives with anything bigger than a toothbrush (*Miswak*). Unfortunately, this is a late, weak tradition at best that is not found in the main *Hadith* collections (*Sahih Sittah*).

Like the Greater-lesser *Jihad* distinction, the toothbrush gloss on *K* 004:034, where *Muhammad* commanded the beating of wives, is a sham meant only for Western consumption.<sup>114</sup>

The so-called “Lesser *Jihad*” is often called “The *Jihad* of the Sword” (*Jihad Bi Al-Saif*), and the “Greater *Jihad*” is often called “The *Jihad* Against One’s Baser Instincts” (*Jihad Al Nafs*).

*Sunni Muslims* consider the whole Lesser-Greater *Jihad* dichotomy to be a *Sufi* heresy, and *Sunnis* officially believe only in the *Jihad* of the Sword. *Sunnis* might engage in *Takiya*-speak and say that *Jihad* is an inner spiritual struggle though.

*Sunnis* and others believe that the *Jihad* of the Sword can be offensive, defensive or pre-emptive, as *Sheikh* Dr. Abdul-Qādir Ibn ‘Abdul-‘Azīz wrote:

‘*Jihad At-Talab*’ is when you seek the enemy and battle them within their state. And ‘*Jihad Ad-Dafa*’ is the fighting against the enemy, which initiated the fighting with the *Muslims*.<sup>115</sup>

<sup>113</sup> Hughes, *Dictionary*, p. 243, *Jihad* entry.

<sup>114</sup> Glazov, Jamie. “Symposium: Gender Apartheid and *Islam*,” *FPM*, 31Dec 2004; see also bible.ca/*Islam/Islam-wife-beating-toothbrush.htm*, accessed 31 Dec 2004.

<sup>115</sup> ‘Abdul-‘Azīz, *Sheikh* Dr. Abdul-Qādir Ibn. *Fundamental Concepts Regarding Al Jihaad*. *Muslimcreed.com*, *JW*, 20 Sep 2004.

Some say that the *Sufis* were peaceful and tolerant but just as *Sufis* were indefatigable proselytizers for *Islam*. *Sufis* also promoted both draconian *Sharia* law and “Holy War with Sword (*Jihad bi Al-Sayf*) all over *Islamdom*.<sup>116</sup>

In modern times, *Sufis* still uphold *Sharia* law. For instance, Sultanhussein Tabandeh was a *Sufi* leader who in 1966 wrote *A Muslim Commentary on the Universal Declaration of Human Rights*.<sup>117</sup> Tabandeh’s draconian prescriptions for dealing with non-*Muslims* became public policy in the *Islamic Republic of Iran*.<sup>118</sup>

The imposition of *Sharia* law is not trivial since it is a slow-motion *Jihad* against non-*Muslims* that after a short while manages to take far more land and lives than the original *Jihad* conquest did. For instance, Bat Yeor wrote:

In 1662, the vizier Fazil Ahmed Koprulu Pasha (1661-1676 [AD]) was persuaded by a *Sufi* that his indulgence toward Christians was causing a plague and fires and had halted Ottoman victories. He therefore ordered the churches to be demolished and the head carpenter and mason to be strangled, accusing them of having engaged the workers for these constructions.<sup>119</sup>

The *Sufi* involvement in the repression of *Dhimmis* and in *Jihad* could fill volumes but here is a sampling:

- ☉ The *Chechens*, well known for *Jihad*, are mostly *Naqshbandi Sufis*.
- ☉ *Sufi* scholar *Abu-Hamed Muhammad Al-Ghazali* (1058-1127 AD). Ghazali wrote that *Muslims* ought to go on *Jihad* at least once per year. Ghazali wrote that *Muslims* may use catapults against, or set fire to, a fortress filled with non-*Muslim* women and children.<sup>120</sup>
- ☉ David Nicolle wrote about *Sufis* during the Second *Taifa* period (1145-1147 AD) in *Andalus*:
 

*Sufi* ‘mystical’ *Islamic* religious brotherhoods were another feature of this troubled time, providing militias in several parts of *Andalus*.<sup>121</sup>
- ☉ *Sufis* orders helped conquer *Byzantium* in 1453 and then stayed and built a presence there. *Jelveti Sufi Sheikh Aziz Mahmud Hudayi* gave the first Friday sermon, or *Khutba*, in the *Blue Mosque* (i.e. *Sultan Ahmed Mosque*) that was built from 1609 to 1616 not far from *Hagia Sophia*.<sup>122</sup>
- ☉ *Goel* wrote about the *Sufis* who operated in *India* until the British colonization:

A study of this literature leaves little doubt that *Sufis* were the most fanatic and fundamentalist elements in the *Islamic* establishment in medieval times. *Hindus* should go to this literature rather than fall for latter-day *Islamic* propaganda. The ruin of *Hindus* and *Hinduism* in *Kashmir* in particular, can be safely credited to *Sufis* who functioned there from the early thirteenth century onwards.<sup>123</sup>

- ☉ Timur, a.k.a. Tamerlane (~1336–1405 AD), was a *Sufi* who slaughtered hundreds of thousands of infidels and many lukewarm *Muslims*. Rene

<sup>116</sup> Bostom & Spencer. “*Sufism* w/o Camouflage (Beyond Stephen Schwartz),” *JW*, 6 Feb 2005.

<sup>117</sup> Spencer, Robert. “Australian *Muslim* lawyer: hey, *Sharia* isn’t so bad,” *DW*, 1 Mar 2006.

<sup>118</sup> Bostom, Andrew G. “Confused *Islamic* Apologetics,” *FPM*, 10 Aug 2004.

<sup>119</sup> Yeor. *Dhimmitude*, p. 85.

<sup>120</sup> Bostom, Andrew G. “*Sufi Jihad?*” *americanthinker.com*, 15 May 2005.

<sup>121</sup> Nicolle. *Moors*, p. 24 & chronology on p. 5.

<sup>122</sup> wikipedia.org, *Istanbul* entry, accessed 4 July 2005.

<sup>123</sup> Goel. *Calcutta*, ch. 7.

Grousset wrote: “It is the *Koran* to which he continually appeals, the *Imams* and [*Sufi*] dervishes who prophesy his success.”<sup>124</sup>

- C *Sufis* also had a *Talibanizing* streak, for instance: *Al-Maqrizi* records in his chronicle, *Khitat*, that a *Sufi* iconoclast named Sa’id *Al-Su’ada* damaged the nose, face and ears of the *Sphinx* in 1378 AD (780 AH).<sup>125</sup> The *Sphinx* was built by Pharaoh *Khafre* (ruled ~2575-2465 BC). Tellingly, the *Sphinx* remained largely intact for 3,843 years, but could not outlast a few hundred years’ worth of *Sufis*.

Another point is that the Greater *Jihad* would seem to call for patient, non-violent struggle with oneself and with the world. All such verses have been abrogated in favor of the Lesser *Jihad*-type of verses that advocate violence. Thus if there ever was a Greater *Jihad*, it may have been entirely abrogated by the war verses. This would explain why, of all the sects in *Islam*, only the *Sufis* emphasize ethics and morals, but non-*Muslims* find even *Sufi* ethics and morality scary.

When one looks at how the sermons in *Mosques* were presented, one could tell that the *Jihad* of the Sword was the Greater *Jihad*, despite what weak traditions say. One reason is the *Imam* held a sword during sermons, as *Riccolodo da Montecroce* wrote in 1300 AD (as was quoted several pages back in reference to the *Mihrab*):

...when they [*Muslims*] come together to be taught the *Koran* by their religious leaders, the one in charge draws a sword, holding it in his hand while teaching or placing it in full view in order to terrorize the hearers.<sup>126</sup>

In 1917 *John Buchan* wrote in Chapter One of his novel *Greenmantle*:

*Islam* is a fighting creed, and the *Mullah* still stands in the pulpit with the *Koran* in one hand and a drawn sword in the other.

*Zwemer* wrote in 1946 that the Friday Sermon situation was the same everywhere:

It is not generally known that in every *Mosque*, according to orthodox tradition, from West Africa to Western China, a sword or staff is kept near or in *Minbar*, and it is required that the *Khatib* hold it when preaching the Friday sermon. In some cases it is made of wood—but the symbol is always present.<sup>127</sup>

Another reason one can tell that the *Jihad* of the sword was the Greater *Jihad* despite what any weak traditions say, was by the content of the sermons. The preacher had to work hard to convince *Muslims* to go off to war, which must mean it was the greatest work. For instance, here is a tenth-century (fourth-century AH) sermon by a preacher named *Ibn Nubata*:

How long, you men, will you hear warning and heed not? And how long will you abide the whipping and stir not? Your ears shake off the Preacher’s words. Or are your hearts too haughty to hear? The Fiend has roused up those others to fight for his lies, and they rise up and follow, while the Omnipotent summons you to His Truth, and you ignore His call. Beasts fight for mate and cub; birds will die for their nests; yet Prophet and Revelation have they none [the implication is that *Muhammad* and the *Koran* incite violence]. But you who

<sup>124</sup> Grousset, Rene. *The Empire of the Steppes*, translated by Naomi Walford, Rutgers University Press, New Jersey, 1970, pp. 416-417, as quoted in Bostom, Andrew G. “Killing from *Koranic* Piety: Tamerlane’s Living Legacy,” [americanthinker.com](http://americanthinker.com), 1 Oct 2005.

<sup>125</sup> Haarmann, Ulrich. “Regional Sentiment in Medieval *Islamic* Egypt,” *Bulletin of the School of Oriental and African Studies*, 1980, 43:64, citing *ibn ‘Abd Al-Salam*, *Fayd*, folio 52a-b, [myopticchurch.com](http://myopticchurch.com), 2002.

<sup>126</sup> Montecroce. *Crucible*, p. 79.

<sup>127</sup> *Zwemer*. *Heirs*, ch. 4, pp. 42-43.

understand and have the [*Sharia*] law and wisdom, scatter away like startled camels before their foes. God claims your faith and steadfastness; God promises His Help and Victory again. Do you really trust Him? Do you doubt His Justice or His Goodness? Give your soul, man, wholly up to Him unto Whom it doth belong. Put no trust in prudence; your prudence will not put off your appointed term to die [K 003:154; 004:078]. War! War! Ye men of heart! Victory! Sure Victory! Ye resolute! Paradise! Paradise for you who march on! And hell! hell for you who fly! [flee]. Victory's reward in this world and the martyr's in the Next; and of these two how much the sweeter is the last! Then stand by God; for 'Him who helpeth [helps] God, will God most surely help' ([K 0]22:40).<sup>128</sup>

When one looks at the prayers that *Muslims* school children had to recite every day, one can see that the Greater *Jihad* dealt with warfare and not morality and ethics. Here is a nineteenth-century *Jihad* prayer recited by school children in Cairo, Egypt:

I seek refuge with God from Satan the accursed. In the name of God, the Compassionate, the Merciful. O God, aid *El-Islam* and exalt the word of truth and the faith, by the preservation of thy servant and the son of thy servant, the *Sultan* of the two continents (Europe and Asia), and the *Khakan* (Emperor or monarch) of the two seas [the Mediterranean and Black Seas], the *Sultan*, son of the *Sultan* (Mahmood) Khan (the reigning *Sultan* when this prayer was composed). O God, assist him and assist his armies and all the forces of the *Muslims*: O Lord of the beings of the whole world. O God, destroy the infidels and polytheists, thine enemies, the enemies of the religion. O God, make their children orphans and defile their abodes, and cause their feet to slip, and give them and their families and their households and their women and their children and their relations by marriage and their brothers and their friends and their possessions and their race and their wealth and their lands as booty [loot] to the *Muslims*: O Lord of the beings of the whole world.<sup>129</sup>

### Whether *Islam* Is Still a Moon-god Religion

The evidence presented in this *Moon-o-theism* book clearly shows that *Islam* is a moon-god religion. Moon-gods were not the moon itself but were associated with the moon. The evidence shows that *Allah's* main symbol in *Islam* is the moon.

Someone who dismisses the idea of *Islam* being a modified pagan moon-god religion undoubtedly holds misconceptions about the nature and beliefs of pagan moon-god religions.

One common misunderstanding about astral religions is that pagans thought the sun, moon and stars were gods and goddesses. The pagans believed the bright objects in the sky were in fact inanimate objects that were created and controlled by intelligent beings.

In astral religions, the heavenly objects serve as symbols and lofty perches for the astral deity who is rather like a divinized person. For instance:

- ☉ The astral religion worshippers from *Tyre* and *Sidon* called King Herod a god (Act 12:22).

<sup>128</sup> Glassé. *Encyclopedia*, p. 210.

<sup>129</sup> Lane, E.W. *Modern Egyptians*, p. 575, as quoted by Bostom, Andrew G. "The Real Roots of Muslim Hatred," *FPM*, 3 Jun 2004.

- ☉ Though sun worshippers bowed toward the sun, they still figured the sun was a human charioteer (2Ki 23:11; Eze 08:16).
- ☉ The Old Testament astral worshippers (Deu 04:19; 17:03; Jer 19:13) made images of their gods and often placed them in temples (2Ki 17:16; Amo 05:26; Act 07:43).
- ☉ At *Lystra* in Asia Minor, the crowd thought that Paul and Barnabas were planetary deities come down to earth in human form (*Acts* 14:12-13). The Lycaonians thought that:
  - ★ Barnabas was *Zeus*-Jupiter.
  - ★ Paul was *Hermes*-Mercury.

It might now be taught that *Allah* is located in heaven, or above the heavens, or everywhere and nowhere. Nonetheless, *Allah*'s symbol is the moon and the religion of *Islam* is a modified moon-religion. Thus *Allah* is a moon-god and is not *Yahveh*, the God of the Bible.

### **Muslim Polemics Regarding the Identity of Allah**

Some *Muslims* admit that pre-*Islamic* Arabs thought of *Allah* as being a moon-god, but assume that *Muhammad* stripped away these pagan notions. This book will show that *Allah* retains the symbols of a moon-god but also his character is still that of a pre-*Islamic* moon-god. *Allah* is not the God of the Bible since he has no son.

Other *Muslims* would like to disabuse anyone of the correct idea that *Allah* was ever known to be a moon-god. The Institute of *Islamic* Information states:

In chapter four he [Robert Morey] claims that *Allah* is the name of 'a moon-god', which renders *Muslims* moon worshippers and pagans, the worst lie anyone has ever created against *Islam* in the last fourteen centuries. The lie that *Allah* is 'a moon-god' has been picked up by several other anti-*Islam* organizations that are publishing tracts, flyers and brochures by the tens of millions and distributing them in the entire English-speaking world.<sup>130</sup>

This book also deals with *Muslim* polemics concerning the identity of *Allah*. For instance, *Muhammad* assures the *Koran* reader that *Allah* and the God of the Bible are the same (*K* 002:062; 003:064; 005:059; 006:107; 016:035; 021:108; 029:046, 061-063; 039:003).

The idea that *Allah* is *Yahveh* is quite absurd since *Allah* is not even a triad, much less the Trinity of the Bible. Also, the deity's character and actions in the *Koran* are totally different from the character and actions of the God of the Bible.

Besides, *Muhammad* did not know what he was talking about. *Muhammad* taught that:

- ✧ Jews worshipped Ezra as the Son of *Allah* (*K* 002:259-260; 009:030).
- ✧ The persons of the Christian triad were *Allah the Father*, Jesus the Son and Mary the mother (*K* 004:169; 005:077, 116).

Moreover, *Muhammad* said that these other religions worshipped *Allah* too:

- ☉ Arabian astral paganism (*Sabianism*, also spelled *Sabeanism* and *Sabianism*)
- ☉ Zoroastrianism (Magianism)
- ☉ Religion of *Ibrahim* (*Hanifism*) (*K* 002:062, 135; 005:069; 022:017).

<sup>130</sup> "An Anti-*Islam* Book Review," The Institute of *Islamic* Information & Education (III&E), [iiiie.net/Articles/AntiIslamBookReview.html](http://iiiie.net/Articles/AntiIslamBookReview.html), accessed 1 Jan 2004.



So in order to accept the idea that *Islam's Allah* is the God of the Bible, one would need to be a near-Universalist who believed that the deity of the Christians, Jews, *Islam*, astral paganism, Zoroastrianism and the *Hanifs* were the same person.

### Khidr-Second Lamech Logic: A Prescription for Antediluvian Violence

**Table of Contents:** I. 31 Active Ingredients (Contents) (page 52); II. Medicinal Use (p. 52); III. Medicinal Effectiveness (p. 57); IV. Inert Ingredients (p. 76); V. Intake Directions (p. 78); VI. Overdose Warning (p. 78); VII. Overdose Remedy (p. 81); VIII. Dark Side-effects (p. 81); IX. Labeling (p. 82); X. Cocktail Copyright (p. 82); and XI. 31 Active Ingredients (Discussion) (p. 83).

#### I. 31 Active Ingredients of the Khidr-Second Lamech Logic (Contents)

##### A. Psychological Conditioning to Kill:

Ingredient: 1. Apocalyptic Thinking (p. 83), 2. Born to be *Muslim* (p. 85), 3. Present Life Not Meaningful or Fun (p. 86), 4. Death-wish (p. 87), 5. An Abusive Religion (p. 88).

##### B. War-god Religion Mindset:

Ingredient: 6. The Right to Seethe With Outrage (p. 90), 7. Code-of-Silence (p. 95), 8. Externalizing Blame (p. 104), 9. Khidr-Second Lamech-style *Lex Talionis* (p. 129), 10. License-to-Deceive (p. 196), 11. Gangland Uniforms (p. 202).

##### C. Weaponized War-god Religion:

Ingredient: 12. 164 War Verses (p. 208), 13. Command to Ethnic Cleanse (p. 212), 14. Irredentist Turf Wars (p. 212), 15. Warrior Hall of Fame (p. 250), 16. Sworn to Die Fighting (p. 254).

##### D. Incentives for Going on *Jihad*:

Ingredient: 17. Seductive Afterlife (p. 255), 18. Riches in the Afterlife (p. 257), 19. Looting on a Commission-basis (p. 258), 20. Polygamy and *Harem* (p. 259), 21. Rewards for the Homeless and Travelers (p. 259), 22. Plenary Absolution of Sins (i.e. skip purgatory) (p. 259).

##### E. Disincentives Against the Live-and-Let-Live Attitude:

Ingredient: 23. *Jihad* Shirkers are Damned (p. 265), 24. Death-to-Deserters (p. 266).

##### F. Dehumanization and Demonization of Non-*Muslims*:

Ingredient: 25. Dehumanization of Infidels (p. 266), 26. Infidels Are of the Devil's Party (p. 276).

##### G. War-god Gives *Muslims* a License-to-Kill

Ingredient: 27. *Jihadists* are *Allah's* Grim Reapers (p. 276), 28. Infidel Blood is *Halal* (p. 278), 29. Blasphemers and Mischief-Makers' Blood is *Halal* (p. 279), 30. Heretics, Apostates and Collaborators' Blood is *Halal* (p. 281) and 31. Excommunicated *Muslims'* Blood is *Halal* (p. 283).

**II. Medicinal Use:** The *Koran* is a manual for (Plan A) *Dawa* proselytizing and (Plan B) *Jihad* war, forced conversion of pagans upon pain of death, and the utter subjugation of conquered Christians and Jewish *Dhimmis* who suffer from confiscatory taxation, and alternately from state terror and *Islamist* mobs.

A *Koran*-reading public usually spawns terrorist-supporting states, states propped up by terrorists, or states who turn a blind eye to terrorists with a list of foreign targets since—as Plato said—a people usually get the government they deserve.

The *Koran* gives all the reasons why *Muslims* ought to be *Jihadists* and then

asks the rhetorical question of each of its readers:

Why then should **you** not fight in the cause of God and in the cause of those who, being weak, are ill-treated (and oppressed)?—Men, women and children whose cry is: ‘Our Lord! Rescue us from this town, whose people are oppressors; and raise for us from thee one who will protect; and raise for us from thee one who will help!’ (K 004:074-075).

US President George Bush has repeatedly said in the past that “*Islam* is a Religion of Peace.”™ While Bush touted *Islam* as being peaceful, a poll showed that 45 percent of Bush’s beloved *Iraqis* “believe attacks on US and British troops are justified,” 82 percent object to the presence of foreign troops, and only one percent of *Iraqis* believe foreign troops enhance security there.<sup>131</sup>

These statistics explains why *Iraqis* in *Fallujah* on the *Tigris* River killed, burned and mutilated four contractors in 2004, and why in *Duluiya* on the *Tigris* in 2005 a contractor was shot and another contractor was doused with petrol and set alight while “barefoot children, yelping in delight, piled straw on to the screaming man’s body to stoke the flames.”<sup>132</sup>

In an online poll at a *Jihadist* site, 546 *Muslims* were asked “What [first] acquainted you with *Jihad*?”<sup>133</sup> The response was:

- o Reading the *Koran* and Authentic *Hadith*: (125 votes) 22.9 percent
- o Resistance in *Chechnya*: (114) 20.9 percent
- o *Kafir* [infidel] torture of *Muslims* in their lands: (49) 9 percent
- o My environment: (49) 9 percent
- o TV and Internet *Jihad* Videos: (47) 8.6 percent
- o The 9/11 Attack (blessed Usama and Azzam): (46 votes) 8.4 percent
- o My choice isn’t listed: (39) 7.1 percent
- o Resistance in Palestine: (24 votes) 4.4 percent
- o I’m not yet acquainted with it: (23) 4.2 percent
- o Learned people, *Sheikhs*: (14) 2.6 percent
- o I can’t remember: (12) 2.2 percent
- o School religion and morality textbooks: (4) .07 percent

Some say that the *Koran* is the basis for a Religion of Peace.™ A rejoinder to this notion is that if it is insane to keep doing the same thing while expecting different results, then it is insane to think that a book that commands, and has inspired, *Jihad* against pagans, Jews and Christians for fourteen hundred years will ever produce anything but a non-stop global *Jihad* against non-*Muslims*.

Some *Muslims* argue that the phrase “holy war” (*Qital* or *Harb Muqaddasah*) is not found in the *Koran*, so *Muslims* who engage in Holy War are hijacking *Islam* for their own ends.<sup>134</sup> This is an argument based on the technicality that *Jihad* literally means “struggle” and only “holy war” in certain contexts. This argument is as silly as saying that:

- ☛ Since the word “behead” is not in the *Koran*, the *Koran* does not encourage beheading, even though it has the command: “strike the neck” (K 008:012; 047:004).
- ☛ Since the word “Trinity” is not found in the Bible, most Christians do not

<sup>131</sup> “Poll shows *Iraqis* back attacks on UK, US forces,” heraldnewsdaily.com, 22 Oct 2005, *JW*.

<sup>132</sup> Blomfield. “US troops fighting losing battle for *Sunni* triangle,” telegraph.co.uk, 22 Oct 2005.

<sup>133</sup> “Another Poll—*Qur’an* Teaches to Kill,” onlinejihad.blogspot.com, 5 Sep 2005, *JW*.

<sup>134</sup> Spencer, Robert. “I am not rich,” *JW*, 22 Mar 2005.

believe in the Trinity!

*Islamists* are indeed hijacked and radicalized by *Islam*—not the other way around. This explains why, of the 42 terrorist groups notorious enough to make the US State Department list of terrorist groups, 29 (or 69 percent) are based in *Islamdom*.<sup>135</sup> Since only a fifth of the world is *Muslim*, that means *Islamdom* has 3.45 times as many terrorists per capita.

One cannot say *Islamic* terrorism is just a manifestation of socio-economic or a region's political problems because:

- ☉ Wherever *Islam* sets down roots, terrorist sympathizing and terrorism spring forth.
- ☉ Regardless of a revert's (*Muslims* prefer the term "revert" over "convert to *Islam*") upbringing, culture and socio-economic status, "conversion to *Islam* substantially increases the probability of a person's involvement in terrorism," as Daniel Pipes noted.<sup>136</sup>

<sup>135</sup> 29 notable terrorist groups in *Islamdom*: Algeria: GIA, GSPC; Egypt: Gama'a *Al-Islamiyya*, *Islamic Jihad* Group, *Al-Jihad*; Indonesia: JI; Iran: Hizballah, MEK; Iraq: *Al-Qaida in Iraq*; Kurdistan: KKG; Lebanon: Asbat *Al-Ansar*; Libya: LIFG; Pakistan: HUM, JEM, LT, Lashkar i Jhangvi; Morocco: GICM; Palestine: ANO, *Al-Aqsa* Martyrs Brigade, HAMAS, PLF, PIJ, PFLP, PFLP-GC; Philippines: *Abu Ssayaf* Group; Saudi Arabia: *Al-Qa'ida*; Turkey: DHKP/C; Uzbekistan: IMU (Foreign Terrorist Organizations (FTOs), state.gov, 11 Oct 2005), *C&R*.

<sup>136</sup> Pipes, Daniel. "Converts to Terrorism," *DP*, 6 Dec 2005.

<sup>137</sup> Spencer, Robert. "Bush...Says *Muslim* Leaders Must Denounce Terrorism," *JW*, 20 Oct 2005.

<sup>138</sup> *Jihad* will last until the Day of Resurrection (*Bukhari*, vol. 4, bk. 52, no. 104).

<sup>139</sup> Fight Jews down to the Last Day: *Sahih Muslim*, bk. 041, nos. 6981-6985; also see *Sahih Muslim*, bk. 041, nos. 6981-6985, as well as *Sahih Bukhari*, vol. 4, bk. 52, nos. 176-177, and *Sahih Bukhari*, vol. 4, bk. 56, no. 791.

<sup>140</sup> Hughes, *Dictionary*, p. 243, *Jihad* entry.

<sup>141</sup> Nasr, Octavia. "*Al Qaeda* in Iraq issues virulent manifesto: Group calls for violence, destruction of 'American empire,'" *cnn.com*, 26 Aug 2005, *C&R*.

<sup>142</sup> Moore, Charles. "Where is the Gandhi of *Islam*?" *telegraph.co.uk*, 9 Jul 2005.

<sup>143</sup> *Jihad*=path of *Allah*: K 002:190, 218, 244, 246, 003:146, 167; 004:074-076, 084, 089, 094-095; 008:074; 009:081, 111; 047:004; 049:015; 057:010; 061:004, 011.

<sup>144</sup> *Muslim Brotherhood* Movement, *ummah.org.uk/ikhwan*, accessed 27 Mar 2005.

<sup>145</sup> Director of London's *Al-Maqreze* Centre for Historical Studies Hani Sibai: There are No 'Civilians' in *Islamic* Law; *Memri.org*, Dispatch No. 932, 12 Jul 2005, *JW*.

<sup>146</sup> Bostom, Andrew G. "*Sufi Jihad*?" *americanthinker.com*, 15 May 2005.

<sup>147</sup> Five "holy war(s)" mentions: *Bukhari*, vol. 4, bk. 56, no. 792; vol. 5, bk. 57, no. 1; vol. 6, bk. 60, no. 139; and *Sahih Muslim*, bk. 19, nos. 4294, 4327.

<sup>148</sup> One "holy military expeditions" mention: *Bukhari*, vol. 4, bk. 53, no. 353.

<sup>149</sup> 26 "holy battle(s)" mentions: *Bukhari*, vol. 1, bk. 2, no. 35; vol. 1, bk. 6, no. 321; vol. 1, bk. 12, no. 812; vol. 2, bk. 14, no. 64; vol. 2, bk. 21, nos. 279, 281; vol. 2, bk. 22, no. 302; vol. 2, bk. 24, no. 559; vol. 3, bk. 29, no. 84; vol. 3, bk. 40, no. 559; vol. 3, bk. 42, no. 616; vol. 3, bk. 44, no. 666; vol. 3, bk. 46, no. 724; vol. 4, bk. 52, nos. 58, 134, 170, 210; vol. 4, bk. 53, nos. 358, 382, 412; vol. 7, bk. 62, nos. 9, 13a, 16; vol. 8, bk. 77, no. 607; vol. 8, bk. 78, no. 681; and vol. 9, bk. 90, no. 332.

<sup>150</sup> *Sahih Muslim*, bk. 37, no. 6670; Spencer, R. "I am not rich," *JW*, 22 Mar 2005

<sup>151</sup> Goel. *Calcutta*, ch. 3.

<sup>152</sup> Pipes, Daniel. "The Ugly History of *Jihad*," *FPM*, 31 May 2005.

<sup>153</sup> Windhoek. "Arab Slavery of Africans," *New Era*, *newera.com.na*, 26 Sep 2005, *allafrica.com*.

<sup>154</sup> Fregosi. *Jihad*, p. 329.

<sup>155</sup> Ecott, Tim. "A side order of couscous: Giles Milton's remarkable tale of 18th-century slavery, White Gold," *books.guardian.co.uk*, 21 Aug 2004.

<sup>156</sup> Elst, Koenraad. "Was There an *Islamic* 'Genocide' of *Hindus*?" *sarvadharm.org*, accessed 23 Jun 2004.

Holy War is a major part of the essence of *Islam* that *Muhammad* says will never fizzle out. *Muhammad* said that:

- ☉ *Muslims* should fight until “all religion is for *Allah*” (*K* 002:193; 008:039). *Tafasir-i-Husaini* explains *K* 008:039 as “Fight them till all strife be at an end,” that is, until “no polytheists remain of the pagans or Jews or Christians” (vol. i, p. 239).<sup>137</sup>
- ☉ *Jihad* would last until the Day of Resurrection.<sup>138</sup>
- ☉ *Muslims* would chase and kill Jews in a genocidal fashion down to the Last Day.<sup>139</sup>
- ☉ Unbelievers “will not cease fighting with you until they turn you back from your religion, if they can” (*K* 002:217; also see *K* 002:120).

The *Jihad* entry in Hughes’ *Dictionary of Islam* notes:

The duty of religious war...all commentators agree is a duty extending to all time.<sup>140</sup>

The *Koran* and the traditions are why *Al-Qaeda* states:

The call for *Jihad* goes on until doomsday, whether there is an *Imam* calling for it or not.<sup>141</sup>

Thus it is as Charles Moore wrote:

From time to time, perhaps, he [an *Islamist*] will kill for a specific reason—to take power in one country, to drive foreign troops out of another—but, in principle, there is no end to his killing until everyone who does not share his particular version of truth is exterminated.<sup>142</sup>

The fact that *Jihad* warfare extends to the last day (discussed above) puts to rest the notion that all the War verses in the *Koran*:

- ☉ Are not prescriptive for today but are merely descriptive of events that occurred 1350 years ago when *Muhammad* was building a *Caliphate*.
- ☉ Apply only during a time of war. This idea is disingenuous in that *Islam* is in a permanent state of war with infidels, and non-*Muslims* states are considered to be in the *Dar al-Harb* (the Territory of War).

Some “all religions are alike” skeptics say that commands like the War verses can be found in the Old Testament:

- ☉ Sometimes this assertion is part of a *Tu Quoque* argument, i.e. the critic alleges that Christianity is as violent as *Islam*.
- ☉ Other times apologists for *Islam* try to say that—like the war verses in the Bible—the War verses are merely descriptive of events long ago but are not prescriptive for today.

The skeptics and apologists for *Islam* are wrong in that there are no verses in the Bible like the War verses in the *Koran*. It is a stretch too far to say that Bible verses such as “Choose some of our men and go out to fight the Amalekites” (Exo 17:09) could incite Christians to fight non-Christians. By contrast, it is immediately apparent how the many open-ended *Jihad* commands such as:

- ☉ “Fight the pagans wherever you find them” (*K* 009:005).
- ☉ “Fight Christians and Jews until they pay the *Jizya* tax in submission” (*K* 009:029).
- ☉ Fight those of the unbelievers who are near to you and let them find in you hardness (*K* 009:123).

could till the end of time incite *Muslims* to fight pagans, Christians and Jews.

*Muhammad* asserted that the *Torah*, the Gospels and the *Koran* each promise heaven in exchange for dying in battle (*K* 009:111). Neither the Old Testament or

New Testament contain any such promise, nor do they contain any verses urging the reader to fight non-believers. The New Testament has no fighting language whatsoever that is not obviously metaphorical and spiritual.

Some of the differences between the Old Testament war commands and the *Koran's* War verses are:

- 1) The OT does not promise heaven and fleshly rewards in the afterlife for the fallen as does the *Koran*.
- 2) The OT war commands had a limited land objective (the Holy Land) and a limited timeframe, and after a brief war *Yahveh* was to give *Israel* peace with its neighbors (Exo 34:24; 2Ch 17:10). By contrast, the *Koran* says *Muslims* should fight until “all religion is for *Allah*” (K 002:193; 008:039), and *Muhammad* said *Jihad* would last to the Last Day (see citations above in this section).
- 3) The *Koran's* open-ended fight commands target all non-*Muslims* until the end of the world, namely pagans (e.g. K 009:005), Jews and Christians (e.g. K 009:029-030). The Old Testament targets only extinct Bronze Age tribes that no longer exist: the *Canaanites*, *Hittites*, *Amorites*, *Perizzites*, *Hivites*, *Jebusites*, *Midianites* and *Amalekites* (Exo 23:23, 32-33; Deu 20:17; 25:19; Num 25:16-18; 31:13-18; 1Sa 15:03).
- 4) Incidentally, someone might argue “the Old Testament prescribes capital punishment for “breaking the *Sabbath*” and adultery, yet Jews and Christians interpret these passages differently, so also *Muslims* can dull the sharp edges off the *Koran*.” This argument actually tends to prove that *Islam* can never moderate itself for very long when left to its own devices. Just as *Islam* has not reformed itself—absent Western pressure—in regard to the *Koran's* or *Sharia* law's capital punishments for adultery, homosexuality, habitually skipping *Salat* and Friday Prayers and such, it remains unreformed—absent Western pressure—when it comes to the *Koran's* *Jihad*, ethnic cleansing and Khidr-Second Lamech Logic passages.

Holy War is sacrosanct in *Islam* as set forth in the *Koran* and *Hadith*:

- ☉ *Muhammad* said that *Allah* loves followers who fight battles as “if they were a firm and compact wall” (*Shakir* K 061:004; also see K 003:146; 005:054; 049:009; 061:004).
- ☉ *Muhammad* said that those who go on *Jihad* fight in the cause (or way or path) of *Allah* (or God).<sup>143</sup> These passages are the basis for the *Muslim* Brotherhood's slogan:

*Allah* is our objective. The Messenger is our leader. *Quran* is our law. *Jihad* is our way. Dying in the **way** of *Allah* is our highest hope.<sup>144</sup>

- ☉ *Muslims* are told that:
    - ★ *Allah* “hates” non-*Muslims* (K 002:190, 205, 276; 003:032, 057, 140; 004:036, 107, 148; 005:064; 035:039; 061:003).
    - ★ *Allah* considers non-*Muslims* to be “enemies” (K 002:098; 008:060; 009:114; 041:019, 028).
    - ★ *Allah* will engender hatred and enmity in non-*Muslims* until the Last Day, especially on account of *Islam* (K 005:014, 064; 048:029).
    - ★ There are no “civilians” in the *Koran* or *Sharia* law, meaning that *Muslims* are free to kill non-combatant men, women and children.<sup>145</sup>
- The *Sufi* scholar *Abu-Hamed Muhammad Al-Ghazali* (1058-1127

AD) wrote that *Muslims* may use catapults against, or set fire to, a fortress filled with non-*Muslim* women and children.<sup>146</sup>

- ☉ *Muslims* are told to hate non-*Muslims* for the sake of *Allah*, for instance:

  - ★ The best of the actions is to love for the sake of *Allah* and to hate for the sake of *Allah* (*Sahih Muslim*, bk. 40, no. 4582).
  - ★ Hatred exists between *Muslims* and all non-*Muslims* forever until non-*Muslims* revert to *Islam* (*K* 060:004).
- ☉ The opponents of *Islam* are consistently described as being servants of Satan (*K* 004:076), as unbelievers (*K* 002:191; 008:012; 009:005; 047:004), and as being cursed by *Allah* (*K* 009:030). *Muslims* are supposed to fight Christians and Jews until they pay the *Jizya* tax since everyone must either willingly submit to *Allah* (i.e. become a *Muslim*), or unwillingly submit to *Muslims* (*K* 009:029).
- ☉ The *Hadiths* mentions *Jihad* often. Bukhari mentions “holy war(s)” three times, and *Muslim* mentions “holy war(s)” twice,<sup>147</sup> Bukhari mentions “holy military expeditions” once<sup>148</sup> and Bukhari mentions “holy battle(s)” twenty-six times.<sup>149</sup> Some of these “holy war” references are in passages where *Muhammad* spoke of battles in the indefinite future, but mostly raids during the last decade of *Muhammad*’s life (622-632 AD). *Muslims* only engaged in one defensive battle (the Trench), and even that was a police action brought on by *Muhammad*’s *Makkan* caravan-raiding habit. *Muhammad* led twenty-six raids, and sent his men out on fifty-six more raids including the purely offensive raid against the Byzantines at *Tabuk*, Syria,<sup>150</sup> for a total of eighty-two offensive raids.<sup>151</sup> This averages out to about nine *Jihad* raids per year, or one *Jihad* campaign every five or six weeks for nine years.<sup>152</sup>

*Muhammad* said that those who subscribe to Khidr-Second Lamech Logic would become homicidal maniacs who would kill pagans wherever they found them (*K* 009:005). Each wild-eyed *Muslim* scarecrow would chase ten non-*Muslims* crows who have no knowledge of Khidr-Second Lamech Logic and thus are mystified as to why exactly *Muslims* are chasing after, killing and enslaving infidels (*K* 008:065).

All this explains why *Muslims* have been continuously involved in slavery and *Jihad* from 622 AD down to the present, and have:

- ☉ Enslaved more people than anyone else (e.g. 17 million Africans by Arabs in last 1350 years,<sup>153</sup> 3 million Hungarian Catholics between 1574 and 1681 AD by *Ottomans*,<sup>154</sup> 1 million Europeans by *Moroccans* between the 16<sup>th</sup> and 17<sup>th</sup> centuries,<sup>155</sup>).
- ☉ Killed more people than anyone else except the Communists (e.g. millions of Christians and pagans, upwards of 50 million *Hindus*, etc.).<sup>156</sup>

**III. Medicinal Effectiveness:** A Mr. Khidr-Second Lamech persona is created in nearly every *Muslim* just by reading or hearing the *Koran*.<sup>157</sup> One Egyptian *Muslim* said:

In the head of almost every one of us [*Muslims*] is something of Dr. Jekyll and something of Mr. Hyde: a mind simultaneously demented and wretched.<sup>158</sup>

<sup>157</sup> Bukay, David. *Muhammed’s Monsters*, Bookworld Services, 2004.

<sup>158</sup> “Reform in the Arab and Muslim World,” *MEMRI*, no. 576, 21 Sep 2003.

Many *Muslims* have “a darker outlook on the wider world.” In 2006 a Beeston, Leeds, UK, *Muslim* described how he considered his life to be short and worth nothing compared to that of the afterlife, and how he contemplated suicide-bombing like the 7/7 (2005) London bombers:

The western mind and the *Muslim* mind are two different psychologies. The *Muslim* mind will see that this life means nothing unless I sacrifice myself for *Allah*...My life means nothing, you know...I would give up this evil, two-seconds of a life.<sup>159</sup>

Nabil Abdel Fatah of the *Al Ahram* centre for Political and Strategic studies in *Cairo* spoke about the creeping *Islamization* in Egypt:

We are seeing an increase of conservative, *Islamist feeling*. The *Islamization* of Egyptian society is happening from the bottom up, and now it has reached the middle classes—the doctors, the lawyers. Over the next few years political *Islam* will grow and grow. The duality between secular and religious is very dangerous and will lead to a very serious conflict in Egyptian society. We are already seeing terror attacks. And we will see new radical groups who will want to change the state in the most basic way—by suicide bombs and assassination.<sup>160</sup>

A moderate *Muslim* is a social drinker of Khidr-Second Lamech logic and will not report fellow heavy drinkers to authorities, but will scoff at people who make the connection between *Islam* and terrorism as though they were party-poopers.

There is no telling when a moderate *Muslim* might gulp down Khidr-Second Lamech logic to the dregs and become a terrorist—as authorities are now finding out. The *Financial Times* reported in 2006 that a UK parliamentary committee stated:

The police and security services were startled by the speed with which citizens turned to violent extremism that was manifested in the July 7 attacks in London.<sup>161</sup>

They were startled because, as British Home Secretary John Reid said, “there was little in their background that marked ‘them out as particularly vulnerable to radicalization.’”<sup>162</sup> The parliamentary report stated that “the consequence of the finding that people could turn rapidly to violent extremism ‘means the window of opportunity for identifying and disrupting threats could be very small.’”<sup>163</sup>

The commission found that “Their motivation appears to have been a mixture of anger at perceived injustices by the West against *Muslims* and a desire for martyrdom.”<sup>164</sup> Of course, Christians and others religionists value martyrdom and are angry over persecutions, but yet they did not suicide-bomb the Communists or *Muslims*. Because Khidr-Second Lamech Logic is known only to *Islamists* who closely read and cross-reference *Koranic* verses, *The Financial Times* report that:

The [UK parliamentary] report called for a better understanding of the process of radicalisation though there was no simple *Islamist* extremist profile. It quoted Andy Hayman, assistant commissioner of the Metropolitan

<sup>159</sup> “Focus: Undercover on planet Beeston,” *The Sunday Times*, timesonline.co.uk, 2 Jul 2006, *JW*.

<sup>160</sup> de Quetteville, Harry. “Statue attack fuels fears of an *Islamist* Egypt,” telegraph.co.uk, 18 Jun 2006.

<sup>161</sup> Fidler, Stephen. “Agencies ‘startled by speed of conversion from citizen to killer,’” *Financial Times*, ft.com, 12 May 2006, DW.

<sup>162</sup> Conger, George. “Report: UK bombers wanted martyrdom,” jpost.com, 12 May 2006.

<sup>163</sup> Fidler, Stephen. “Agencies ‘startled by speed of conversion from citizen to killer,’” *Ibid*.

<sup>164</sup> Conger, George. “Report: UK bombers wanted martyrdom,” jpost.com, 12 May 2006.

police, as saying: ‘We were working off a script which has actually been completely discounted from what we know as reality.’<sup>165</sup>

*Islam* has historically unleashed a beast inside *Muslims*, as Andrew Bostom wrote:

The 13th century chronicler, *Bar Hebraeus* (died 1286 AD), provided this contemporary assessment of how the adoption of *Islam* radically altered *Mongol* attitudes toward their Christian subjects:

And having seen very much modesty and other habits of this kind among Christian people, certainly the *Mongols* loved them greatly at the beginning of their kingdom, a time ago somewhat short. But their love hath turned to such intense hatred that they cannot even see them with their eyes approvingly, because they have all alike become *Muslims*, myriads of people and peoples.<sup>166</sup>

*The Wall Street Journal* editorial page noted that Khomeini unleashed a monster:

Something horrible was unleashed in *Iran* by Khomeini—a divinely sanctioned fanaticism that made decent people into monsters. The aftershocks of that event still torment and inspire *Muslims* worldwide.<sup>167</sup>

Militant leader Aminu Tashen-Ilimi was a moderate *Muslim* until it dawned on him what the *Koran* and *Islam* are really all about. He described his experience:

When I repented and discovered the true faith, understood the true words of *Allah*, I left everything behind: my family, my job, and migrated...*Allah*, the almighty Lord, has authorised every *Muslim* to fight and establish an *Islamic* government over the world. One day it will happen in *Nigeria* and everywhere...I’m ready to take up arms...Those who fought in *Kanama* and *Gwoza* are only *Muslims* who performed their holy duty.<sup>168</sup>

The Moderate-*Muslim-to-Islamist* transmogrification has happened quickly:

J. Stephen Tidwell, assistant director in charge of the Los Angeles field office, said the homegrown threat has increased as terrorist groups have spread their ideology overseas through propaganda. He said one of the suicide bombers in the July attacks on London’s public transit system was a citizen who had been radicalized **in a year**. ‘Now, it’s an idea,’ he said. ‘That’s why you’ve got radicalized homegrown entities picking up the sword ... that gives us pause.’<sup>169</sup>

In modern times, many people have seen the scary effects of conversion to *Islam* or *PrIslam* (Prison *Islam*). Olivier Guitta wrote:

The usual scenario goes like this: either the rioters end up in jail and are easily converted right there to Radical *Islam* or an *Imam* from the *Banlieue* [French housing projects in the exurbs] convinces them to join the *Jihad*. At first, family, friends and cops find the transformation almost miraculous. From a drug trafficker, alcohol-drinking, girl-chasing individual, the thug becomes religious, even reserved, adopts a quieter lifestyle and no longer gets in trouble with the police. But this is a transfer of violence: instead of burning cars, the youngster focuses his hatred on the West and becomes a *Jihadi*. It is no

<sup>165</sup> Fidler, Stephen. “Agencies ‘started by speed of conversion from citizen to killer,’” *Ibid*.

<sup>166</sup> *The Chronography of Bar Hebraeus*. Translated from Syriac by Ernest A. Wallis Budge, Oxford University Press, Vol. 1, 1932, p. 354, as quoted in Bostom, Andrew G. “Killing from *Qur’anic* Piety: Tamerlane’s Living Legacy,” americanthinker.com, 1 Oct 2005.

<sup>167</sup> Gerecht, Reuel Marc. “Radical *Islam*’s Eruption,” opinionjournal.com, 3 May 2006.

<sup>168</sup> “*Nigerian Taliban* plots comeback,” news24.com, 11 Jan 2006, C&R.

<sup>169</sup> Marquez, Jeremiah. “Interview: FBI’s LA boss says homegrown terrorists top concern,” *The Modesto Bee*, modbee.com, 19 Jan 2006, *JW*.



coincidence that scores of French citizens are in *Iraq* fighting coalition troops (at least half a dozen Frenchmen have died in this fashion).<sup>170</sup>

Walid Phares wrote about Lebanese Assem Hammoud who was caught plotting a bombing in an internet chat room in 2006. Hammoud's mother has pictures of him "with quasi naked women" from Europe and tells about her prodigal son's lavish lifestyle. This is more proof of the theory that most *Jihadists* are low-budget versions of play-boys who want sex-slaves or *Houris* without having to pay for diamonds, drinks and furs. Hammoud's family history of being *emirs* [rulers] in *Andalusia* [*Muslim Spain*] may have enticed him, too, since a door attendant reported...

...a sudden change in his personality occurred lately...he started to wear the white *dashdasha*...on Fridays, started to go to prayers, and wears it when he comes back from work. He stopped bringing women when he visited the area.<sup>171</sup>

The transition from wayward drug-addled *Muslim* to observant sober *Muslim* can turn out to be chilling since, instead of following a 12-step program to healthy living, recovering *Muslims* often follow a 13-step program—the 13<sup>th</sup>-step being *Jihadism*, as Gareth Harding reported:

...most European *Jihadis* are well-educated *Muslims* who have experienced a personal psychological trauma—such as drug or alcohol addiction—before becoming born-again *Islamists*.<sup>172</sup>

Mohammed Reza Taheri-azar is typical of the from the frying pan (addiction) into the fire (*Jihadism*) phenomenon. Daniel Pipes says Taheri-azar is an example of the Sudden *Jihad Syndrome* (SJS) where, without any warning, normal everyday *Muslims* become mass-murders or would-be mass murderers.<sup>173</sup>

While attending college in North Carolina, Taheri-azar's *Sig Ep* fraternity brothers noted he was "a frequent marijuana smoker and 'most always high' and that he drank heavily as well."<sup>174</sup> Then, not long before March 2006, he "gave up his heavy marijuana and alcohol use and became more religiously observant."<sup>175</sup> Taheri-azar's parents "married in *Iran* in 1972 and were divorced in 2003,"<sup>176</sup> and in the same year as the divorce, Taheri-azar took up reading the *Koran*. He wrote:

I live with the holy *Koran* as my constitution for right and wrong and definition of injustice....I've read all 114 chapters about 20 times since June of 2003 when I started reading the *Koran*.<sup>177</sup>

By reading the *Koran*, Taheri-azar learned of his supposed "right of violent retaliation" and that

...*Allah* gives permission in the *Koran* for the followers of *Allah* to attack those who have raged [*sic*; waged] war against them, with the expectation of eternal paradise in case of martyrdom.<sup>178</sup>

<sup>170</sup> Guitta, Olivier. "France's lost territories," counterterror.typepad.com, 9 Nov 2005.

<sup>171</sup> Phares, Walid. "Amir *Andalousi*: Casanova or a *Jihadi* on a mission?" counterterrorismblog.org, 8 Jul 2006, hotair.com.

<sup>172</sup> Harding, Gareth. "Analysis: EU, U.S. at odds on threat," upi.com, 6 Mar 2006.

<sup>173</sup> Pipes, Daniel. "Sudden *Jihad Syndrome* (in North Carolina)," *DP*, 14 Mar 2006.

<sup>174</sup> "Background on Mohammed Reza Taheri-azar," terrorismunveiled.com, 6 Mar 2006.

<sup>175</sup> Spencer, Robert. "Tarheel *Jihad*," *FPM*, 8 Aug 2006, terrorismunveiled.com.

<sup>176</sup> "Family: Alleged UNC campus crasher a 'kind, gentle soul,'" *Picayune Item*, picayuneitem.com, 25 Mar 2006.

<sup>177</sup> Pipes, Daniel. "More on the North Carolina *Jihadi*, Mohammed Taheri-azar," *DP*, 14 Mar 2006.

<sup>178</sup> Spencer, Robert. "Killing for *Allah*," *FPM*, 29 Mar 2006.

Taheri-azar's 13<sup>th</sup>-Step involved trying to run over nine people with a sport-utility vehicle (SUV) "to spread the will of *Allah*."<sup>179</sup>

The transition from moderate *Muslim* to observant *Muslim* can be scary even without any prior abuse of illegal drugs. Extremists report feeling all-consuming seething anger and hatred as though they had an Intermittant Explosive Disorder (IED) like "road rage." They feel they can attack anyone because the *Koran* and derivative literature have primed them to act on *Jihad* commands and their exaggerated feelings of victimization. *CBC News* reported from Toronto:

Heft says a lot of young *Muslims* are angry and extremism is prevalent in the Toronto area. They get upset when they hear of alleged atrocities overseas in places like *Iraq*. 'People get emotional. Imagine if somebody came into your house and raped your family, or by mistake just blew up your family, you'd get a little angry.' Heft knows personally about the road to religious extremism. He says when he was in the thick of it, **he would have killed his own parents** had they come between him and his newly chosen religion [*Islam*].<sup>180</sup>

*Newhouse News* reported similarly about extremists' anger. A student, Tawfik Hamid, attended a *Mosque* at the University of *Cairo* and heard *Koran* verses like:

Truly, *Allah* loves those who fight in his cause...as if they were a solid cemented structure (*K* 061:004).

Slay the idolaters wherever you find them. Arrest them, besiege them and lie in ambush everywhere for them (*K* 009:005).

The ex-*Islamist* Tawfik Hamid later recounted:

'You feel you belong to a powerful group [*Islamists*]...and the verses we read and the talks, they were very powerful in stimulating the feelings of **anger**—that others are your enemy and you must join with other *Muslims* to **fight** the infidels...I felt **evil**—thinking of killing non-*Muslims*, of raping their wives—because all of it was justified in the books I was reading. Hatred developed gradually. I became very extremist. I became fanatical...In just a few months, I became like a beast...Every time I went to lectures or to prayers at the *Mosque*, I felt the burning of wanting to be a martyr, to kill infidels.<sup>181</sup>

What saved Tawfik Hamid from becoming a suicide-bomber is...

...he remembered reading the Bible on his own in high school, and the words that had so moved him. 'Blessed are the merciful, for they will be shown mercy. Blessed are the pure in heart, for they will see God. Blessed are the peacemakers, for they will be called sons of God [Mat 05:07-09].'<sup>182</sup>

Though Tawfik still considers himself a *Muslim* in 2005, he joined the ranks of other ex-terrorists influenced by the Bible such as Walid Shoebat, Zak Anani, Ibrahim Abadallah<sup>183</sup> and Taysir (Tass) *Abu-Saada*.<sup>184</sup> Tawfik said...

...When my conscience started to come back, I had contradictory feelings...They [e.g. "his abiding belief in the sanctity of life"] were very faint,

<sup>179</sup> "Driver at UNC Cites Vengeance for *Muslims*," *washingtonpost.com*, 7 Mar 2006, *mypetjawa*.

<sup>180</sup> "Man who knew some plot suspects says *Islamic* 'anger' prevalent," *CBC News*, *cbc.ca*, 16 Jun 2006, *LGF*.

<sup>181</sup> Nutt, Amy Ellis. "What Makes a Terrorist?" *newshousenews.com*, 23 Dec 2005, *C&R*.

<sup>182</sup> Nutt, Amy Ellis. "What Makes a Terrorist?" *newshousenews.com*, 23 Dec 2005, *C&R*.

<sup>183</sup> "Princeton U. Says Campus Event Against Terrorism is 'too inflammatory,'" *DW*, 5 Dec 2005.

<sup>184</sup> *Abu-Saada*, Taysir (Tass). "Ex-*Fatah* fighter for Yasser Arafat asks forgiveness," *Maoz Israel Ministries*, *maozisrael.com*, 1 Feb 2006.

very deep in me, and after a period of time they grew and I had to reject those other [*Jihadist*] beliefs.<sup>185</sup>

After *Jihadists* retire, they often consider coming out of retirement, as one said:

‘It’s difficult to forget the time I was a combatant,’ says Abang Syamsuri, a former *Mujahideen* who fought during both the conflicts in *Sulawesi* and *Maluku*. ‘I stopped fighting in 2001, but had a discussion with myself until 2005. I would think, ‘Should I be a combatant or live a normal life in *Poso*?’<sup>186</sup>

Another retired *Jihadist*, Khalid, said that even though his father was against his going on *Jihad* from the start, and even though the *Yemeni* authorities offered him money not to go on *Jihad*, the draw of *Jihad* might prove to be irresistible.

But Khalid can see no way to escape from his past. Like many veterans, he looks back on his years of fighting with nostalgia—the thrill of battle, the feeling of brotherhood, the steadfast devotion to a cause. But on some days, it feels as if he has no place in the world. He lives in *Sanaa*, but it no longer seems like home....if he stays in *Yemen*, the brothers will keep trying to draw him back into the struggle...they come over to his house and try to rally him for a mission to *Iraq* or *Sudan*...Even his fiancée’s younger brother tried to enlist his aid to join the insurgency in *Iraq*.<sup>187</sup>

The director of the Brussels-based European Strategic Intelligence and Security Centre said that *Jihadists* often come out of retirement after less than a decade:

Twenty years ago, following Russia’s retreat from *Afghanistan*, a lot of people returned to their home countries, and behaved relatively calmly. But 10 years later they were the ones found, more or less systematically, to be involved in the networks that were dismantled between 2001 and 2005.<sup>188</sup>

Often, it is hard to tell when *Jihadists* have come to town—or come out of retirement. The only indications may be an increase in mysterious fatal accidents, unsolved stabbings, random shootings, pipe bombings, mortar and rocket attacks, stone throwing, lobbing rocks at moving vehicles, and train derailments.

If the *Jihadists* have big ambitions but no financial supporters, they might rob guns from gun stores and even police stations, rob banks, run drugs, sell black market cigarettes, re-label and sell food that is beyond its expiration date and such. The spike in the crime rate could easily be mistaken for a crime spree. For instance, in 2006 on the island of *Poso*, there are...

...continuing incidents of ‘mysterious’ attacks [such as] the beheading of three girls walking to a Christian school in October’ [2005,] ‘and an ineffectual bomb blast near a church Monday. Most of the attacks since the accord have appeared to target Christians.<sup>189</sup>

A *Muslim* described the attitudes of many of his *Muslim* friends in the UK who would probably call themselves “moderate” simply because they are amateurs who deign to leave the killing of infidels to the professionals, i.e. the *Jihadists*:

Most worryingly, my research opened up my eyes to the fact that people whom I know very well—friends, family and colleagues—possess opinions that are enough to send shivers down the spines of most people. These are ordinary

<sup>185</sup> Nutt, Amy Ellis. “What Makes a Terrorist?” newhousenews.com, 23 Dec 2005, *C&R*.

<sup>186</sup> Unmacht, Eric. “A religious conflict tamed,” *Christian Science*, csmonitor.com, 11 Jan 2006.

<sup>187</sup> My bloody career, *The Guardian*, observer.guardian.co.uk, 23 Apr 2006.

<sup>188</sup> Moutot, Michel. “Europe faces threat from *Iraq jihadists*,” kuwaittimes.net, 15 May 2006.

<sup>189</sup> Unmacht, Eric. “A religious conflict tamed,” *Christian Science*, csmonitor.com, 11 Jan 2006.

people who have well-paid jobs, are educated and seem very pleasant in conversation....[Their attitude was]....whether it be through a bomb on a train or a natural disaster...*Muslims* are always happy to see the enemies of *Allah* being killed...<sup>190</sup>

*Compass Direct* reported on the general mindset of *Pakistani Muslims*:

Editor Najam Sethi decried vandalism as a national ‘reflex action’ whenever anyone was accused of committing blasphemy. Sethi fingered semi-literate clerics for issuing ‘mini-*Fatwas*’ over TV channels or the Internet, holding them responsible for ‘brainwashing the nation into a colossal vandalizing mob.’ One such ‘on-line *Fatwa* factory’ is actually run by a federal state minister, Sethi noted.<sup>191</sup>

Mamoun Fandy, a senior fellow of Middle East and *Islamic* politics at Baker Institute at Rice University, stated:

I have talked with many *Muslims*, especially in the West, who in public condemn violent acts but in private conversations say ‘The West deserves this.’ In public, they will say it is a revenge for Palestine and *Iraq*, but in private I hear blind hatred, a virus that is taking over too many *Muslim* minds.<sup>192</sup>

*Muslim* Khaled Kishtainy describes the attitude of most moderate *Muslims*:

Most of the people we contacted were of the opinion that the Westerners are sons of dogs who understand only force, and that the *Muslims* have no choice but to strap on their weapon and fight.<sup>193</sup>

Just having a *Koran* collect dust around hotels, hospitals or houses is unsafe since, as a UK intelligence report noted in 2005:

*Islamist* terrorists include ‘a significant number’ who come from ‘liberal, non-religious *Muslim* backgrounds’ or who converted to *Islam* in adulthood.<sup>194</sup>

*Muslims* constantly warn that their, or other *Muslims*’, emotions may boil over and with the result that they cannot help but commit monstrous deeds against those who have only themselves to blame for provoking *Muslims* to violence. For instance, *Ynet* reported from *Hebron*:

One resident told *Ynet* local residents were ‘boiling’ over the perceived slight, and said signs reading ‘*Muhammad* is a pig’ were driving people to the point of insanity.<sup>195</sup>

When a Christian newspaper reprinted caricatures of *Muhammad*, *Islam Online* said:

Editors should not take free speech as an excuse to insult a certain religion; otherwise they risk an extremist response from the offended, which carries grave consequences.<sup>196</sup>

<sup>190</sup> Hoque, Aminul. “*Islamic* pride and prejudice,” independent.co.uk, 12 Apr 2004, *AllahPundit.com*, 16 Apr 2004.

<sup>191</sup> “*Pakistan: Muslim* Mob Attacks Christian Homes: Police do nothing as homes are ransacked,” compassdirect.org, 13 Sep 2005, *C&R*.

<sup>192</sup> Fandy, Mamoun. “For *Muslims*, a role in the war on terror,” usatoday.com, 11 Aug 2005, *JW*.

<sup>193</sup> “Arab Liberal [Khaled Kishtainy]: Most *Islamic* Ideologues, Organization Leaders Advocate Violence,” *MEMRI*, no. 696, 16 Apr 2004.

<sup>194</sup> Pipes, Daniel. “The Next London Bombing,” *DP*, 11 Jul 2005.

<sup>195</sup> Waked, Ali. “Anti-*Muslim* graffiti in *Hebron*,” ynetnews.com, 1 Jun 2005, *C&R*.

<sup>196</sup> Maher, Ahmad. “Norwegian *Muslims* Blast Magazine Over Prophet Cartoons,” *Islam-online.net*, 11 Jan 2006.

Every true *Muslim* will act out his or her Mr. Khidr-Second Lamech persona in one way or another because *Jihad* is a communal obligation (*K* 009:122). It takes a village to create a terrorist, after all. Alyssa Lappen wrote:

...when one group of *Muslims* assumes responsibility for *Jihad* warfare—the only righteous kind of war, in the *Islamic* view—the rest of the *Umma* (*Muslim* community) is relieved of this *Fard*, or religious duty. Thus if radical *Muslims* believe they act on behalf of all *Islamdom*, *Islamic* traditions also confirm that they do.<sup>197</sup>

As soon as one terrorist dies or retires, another *Muslim* must take his or her place (*Reliance of the Traveler, Jihad* o9.1, def. c3.2). It is incumbent on every *Muslim* to either go on *Jihad* or support *Jihad*:

Those who believe in God and the Last Day ask thee for no exemption from fighting with their goods and persons. And God knoweth well those who do their duty (*Yusuf Ali K* 009:044).

The *Muslim* historian, Tabari (839–923 AD), does not deny that *Islam* is a killing machine, for he records this incident without any comment:

Among them were many Christians who had accepted *Islam* but when dissension [a conflict] had developed in *Islam* had said ‘By God, our religion from which we have departed is better and more correct than that [*Islam*] which these people follow. Their religion [*Islam*] does not stop them from shedding blood, terrifying the roads and seizing properties.’<sup>198</sup>

The famous Jewish philosopher Maimonides wrote ~1200 AD about *Muslims*:

No matter how we suffer and elect to remain at peace with them, they stir up strife and sedition...<sup>199</sup>

The transformation from an easygoing Dr. Jekyll who merely ascribes to a murderous, totalitarian ideology, i.e. *Islam*, to a Mr. Hyde who actually acts out what the *Koran* prescribes, can happen quickly without any change in a person’s overall temperament. Daniel Pipes wrote:

Taking up the *Islamist* cause, even to the point of sacrificing one’s life for it, usually happens in a discreet manner, quite unobservable even to a person’s closest relatives.<sup>200</sup>

An example of what Pipes refers just above is Mohammed Taheri-Azar. He read the *Koran* 20 times between June 2003 and March 2006—the month he tried to run over nine people with an SUV.<sup>201</sup> He became enthralled by numerology and wrote:

I know that the *Koran* is a legitimate and authoritative holy scripture since it is completely validated by modern science and also mathematically encoded with the number 19 beyond human ability.<sup>202</sup>

Of course what Taheri-Azar here sees as proof of the *Koran*’s divine origin, others would see as proving the *Koran*’s demonic origin if it were not for the fact that the scholarship behind the number 19 numerology is fatally flawed.<sup>203</sup> Anyway, even as

<sup>197</sup> Lappen, Alyssa A. “The Legacy of *Jihad*,” *FPM*, 9 Sep 2005.

<sup>198</sup> *Al-Tabari, The History of Al-Tabari (Ta'rikh Al-rusul wa'l-muluk)*. State University of New York Press, New York, 1993, pp. 187-188, 191-192.

<sup>199</sup> *Yeor. Dhimmi*, pp. 351-352.

<sup>200</sup> Pipes, Daniel. “The California Suicide Bomber,” *FPM*, 4 Apr 2005.

<sup>201</sup> Pipes, Daniel. “More on the North Carolina *Jihadi*, Mohammed Taheri-azar,” *DP*, 14 Mar 2006.

<sup>202</sup> “Mohammed Taheri-Azar’s letter to police,” *The Herald-Sun*, heraldsun.com, 24 Mar 2006.

<sup>203</sup> Nehls & Eric. *Christians Answer Muslims*, “The Mysterious 19 in the *Quran*” chapter.

Taheri-Azar contemplated a terrorist attack, he continued to act normally for two years and only planned the specifics of the attack in the last two months.<sup>204</sup>

How effective is the *Koran* in changing *Muslims* into viewpoint *Islamists*?

- ☉ There are 200,000 terror-related suspects listed in the US National Counterterrorism Center (NCTC) database, most of whom are *Muslim*. This suggests that 1.5 percent of 1.3 billion (1 out of 65) *Muslims* are documented terrorism suspects, and the list of suspected terrorists “continues to grow.”<sup>205</sup>
- ☉ A University of Amsterdam “study found 40 percent of the Moroccan youth in the Netherlands reject western values and democracy. Six to seven percent are prepared to use force to defend *Islam*. The majority are opposed to [the practice, if not the theory of] freedom of speech for offensive statements, particularly criticism of *Islam*.”<sup>206</sup>
- ☉ According to Daniel Pipes, between one out of eight or ten *Muslims* (i.e. ten to fifteen percent) hold an *Islamist* viewpoint.<sup>207</sup> Pipes also notes that even after 9/11, half of the world’s *Muslims* “sympathize more with Osama bin Laden and the *Taliban* than with the United States, and 65 percent of Palestinians would support an *Al-Qaeda* attack in the US and EU.”<sup>208</sup>
- ☉ In 2006, a Pew poll revealed 23 percent of Turks, 30 percent of Indonesians, 44 percent of Egyptians, 45 percent of Jordanians, and 52 percent of Pakistanis favor *Iran* developing nuclear weapons. “At the same time...more than six-in-ten in Jordan (65 percent) and Egypt (61 percent) say that if *Iran* develops nuclear weapons, it would be likely to attack Israel; about half of Turks (51 percent) and Indonesians (49 percent) agree.” The same poll showed that 87 percent of Pakistanis, 76 percent of Egyptians, 68 percent of Jordanians, and 61 percent of Indonesians feel that the hard-line *Islamist* party, *Hamas*, coming to power would benefit the Palestinians.<sup>209</sup>
- ☉ Sympathy for terrorists is widespread in *Islamdom*: In 2006, a poll revealed that 56.2 percent of Palestinians supported suicide bombings against Israel.<sup>210</sup> Rediff.com reported in 2006: “Most polls indicate that 45% to 60% of *Pakistani* adults support *Jihadi* terror, Osama bin Laden, [and] open hatred for other religions.”<sup>211</sup> Daniel Pipes noted that when UK *Muslims* were asked about the 7/7 (2005) subway bombers, “A whopping 56 percent can see ‘why some people behave in that way.’”<sup>212</sup>
- ☉ In 2006, a poll of Indonesians, one of the most moderate *Islamic* nations, revealed that “11.2 percent believed suicide bombings were justifiable on occasion while 0.5 percent said the method could always be justified to defend *Islam* from its enemies....8 percent support masterminds of past suicide bombings....almost half the respondents back stoning as a

<sup>204</sup> “Disappointed With Outcome,” wral.com, 7 Mar 2006, michellemalkin.com.

<sup>205</sup> Pincus, Walter & Dan Eggen. “325,000 Names on Terrorism List,” washingtonpost.com, 15 Feb 2006, A01, The Jawa Report, mypetjawa.mu.nu.

<sup>206</sup> “Centre for extremist studies established,” expatica.com, 14 June 2006, LGF, C&R.

<sup>207</sup> Pipes, Daniel. “Protecting *Muslims* while Rooting out *Islamists*,” DP, 14 Sep 2001.

<sup>208</sup> Pipes, D. “Are the Palestinians the World’s Most Radicalized Population?” DP, 22 Dec 2005.

<sup>209</sup> “Allies Share U.S. Concerns Over *Iran*, *Hamas*,” pewglobal.org, 13 Jun 2006, tigerhawk.

<sup>210</sup> “JMCC Poll of Palestinians: 56.2% support suicide bombing operations against Israeli civilians,” Independent Media Review Analysis, imra.org.il, 20 Feb 2006, C&R.

<sup>211</sup> “The threat in the North East,” in.rediff.com, 27 Apr 2004.

<sup>212</sup> Pipes, Daniel. “Trouble in Londonistan,” DP, 11 Jul 2006.

punishment for adulterers while support for other extreme elements of *Islamic Sharia* was also significant....11 percent agreed with causes advocated by the Indonesian *Mujahidin* Council (MMI) of *Abu Bakar Bashir*...the leader of *Jemaah Islamiah*.<sup>213</sup>

Thus Khidr-Second Lamech Logic is as effective at creating passive view-point *Islamists* as marijuana is at creating a psychological dependency in those who sample it (sample/addiction rate: 15 percent). Khidr-Second Lamech Logic is even more effective at creating passive view-point *Islamists* than are meth (5 percent), heroin (3 percent), crack (8 percent), painkillers (10 percent)<sup>214</sup> and illegal stimulants (10 percent)<sup>215</sup> at creating addicts.

It is impossible to create a profile for *Islamic* terrorists since they have different temperaments and skills and come from all walks of life.<sup>216</sup> For every *Muslim* who gives himself wholly over to Khidr-Second Lamech logic and becomes a career terrorists or *Jihadist*, there are nice, law-abiding *Muslims* who are abstainers, experimenters and casual abusers of Khidr-Second Lamech logic—just as is the case with every ideology or drug.

The only factor that all *Islamists*, *Jihadists* and terrorists have in common is the *Koran* with its Khidr-Second Lamech logic, but unfortunately, most *Muslims* hold to Khidr-Second Lamech too. Thus *Muslims* are like popcorn in that each kernel looks similar to the next until the batch is popped. *Muslims* may seem well adjusted until they have a personal, spiritual or existential crisis and then they either sing or pop. Many have notice this *Muslim* popcorn phenomenon:

C *Muslims* themselves constantly express disbelief their sons, daughters, siblings, relatives, friends and colleagues have turned to *Islamic* terrorism even when the evidence is overwhelming and incriminating. The refrain is often heard, “He’s innocent. He’s [a] very humble, peaceful brother.”<sup>217</sup>

C Daniel Pipes wrote about *Muslim* popcorn:

Individual *Islamists* may appear law-abiding and reasonable but they are part of a totalitarian movement, and as such, all must be considered potential killers.<sup>218</sup>

C In the London police arrested 520 *Muslims* between 9/11/2001 and mid-2004, which is one out of every 1,346 *Muslims* in London.<sup>219</sup> By June 2006 police across the UK made “about 1,000 wrongful anti-terrorist arrests since 9/11,”<sup>220</sup> yet they were unable to identify in time the four 7/7/2005 “Tube” subway and bus bombers and the four 7/21/2006 would-be subway bombers.

C German federal prosecutor Kay Nehm said about *Muslim* popcorn:

I have the impression we’re sitting on a powder keg. The attacks on Madrid and London showed that dissatisfied migrants living in a

<sup>213</sup> “One in 10 Indonesians back suicide bombings,” alertnet.org, reuters, 16 Mar 2006, C&R.

<sup>214</sup> Tierney, John. “Debunking the Drug War,” nytimes.com, 9 August 2005.

<sup>215</sup> Aldhous, Peter. “Prescribing of hyperactivity drugs is out of control,” newscientist.com, 31 Mar 2006, windsofchange.net, 11 Apr 2006.

<sup>216</sup> Reynolds, Paul. “Seeking out the suicide bombers,” news.bbc.co.uk, 29 Apr 2006, DW.

<sup>217</sup> Campion-Smith, Bruce & Michelle Shepherd. “Plan to ‘behead’ PM,” Toronto Star, thestar.com, 7 Jun 2006, JW.

<sup>218</sup> Pipes, Daniel. “Sudden *Jihad* Syndrome,” DP, 14 Mar 2006.

<sup>219</sup> “Cops foil terrorists,” Online Sun, thesun.co.uk, 25 Jul 2004.

<sup>220</sup> Laville, Sandra & Hugh Muir. “Secret report brands *Muslim* police corrupt,” guardian.co.uk, 10 Jun 2006, JW.

country can become radicalised without the threat they pose being recognised in time.<sup>221</sup>

- C The Canadian Security Intelligence Service comments on *Muslim* popcorn:
 

They'd been born in country...They had all of the slang and comfort with the culture that you and I have, and yet, boom, here they are committing terrorist acts...It's a huge challenge to the police and the security forces to find them, to have a broad enough net to catch them. And so far I haven't heard anyone give us a good handle on how they can deal with it.<sup>222</sup>
- C Europeans are finding out about *Muslim* popcorn too:
 

Senior security officials across Europe warned in interviews with The Associated Press that the relative ease and low cost of an attack, combined with the anger and isolation felt by *Muslim* populations, mean more bloodshed is almost inevitable. The officials painted a picture of a diverse group of militants with competing agendas, vastly different social and educational backgrounds and a litany of gripes that makes it difficult to predict their next move...‘There is no profile; they come from everywhere,’ said Manfred Murck, deputy director of the German Office for the Protection of the Constitution...‘You can't concentrate on certain targets, you can't concentrate on certain persons...Everything is possible, anything goes, and you just have to try and be as close as you can to the whole group.’<sup>223</sup>

Newt Gingrich estimates that one out of 25 or 33 *Muslims* are *Islamists*—probably meaning *active Islamists* rather than just *Muslims* with an *Islamist* outlook.<sup>224</sup> *Islamists* either are *Jihadists*, or aid and abet *Jihadists* by giving them moral, financial and rhetorical support.

Estimates of the percent of *Islamists* among *Muslims* are derived from:

- C Surveys of *Muslims* that ask about their beliefs and opinions, and whether they would elect *Islamists* candidates to political office if given the chance.
- C The fact that elections must be manipulated in *Islamic* countries so *Islamist* candidates for parliament are largely excluded. Otherwise, *Islamists* would win on a plurality or better as has occurred in: Algeria (National Liberation Front: 1991), *Iraq* (2006), *Kuwait* (2002), *Morocco* (Justice and Development Party: 2002) and the West Bank/*Gaza* (*Hamas*: 2006).<sup>225 226</sup>
- C Facts gleaned from investigations, arrest, conviction and deportation records. For instance, from 9/11 to May 2005 (a little over 3.5 years), one out of 258 *Muslims* were involved in terror-related activities in the US, and that does not include those *Muslims* whose terrorist activities went undetected.<sup>227</sup>
- C The desecration of *Korans* in prisons, the publications of cartoons of *Muhammad* in newspapers, and terrorist acts against *Muslims*, all have occasioned mass protests around *Islamdom*, and even among the *Muslim*

<sup>221</sup> Hall, Allan & Michael Lynch. “On the defensive,” theage.com.au, 19 May 2006.

<sup>222</sup> “Domestic terrorists exist in Canada: CSIS,” *CTV.ca News*, 29 May 2006, *C&R*.

<sup>223</sup> Haven, Paul. “Europe tries to prevent the next attack,” news.yahoo.com, 29 May 2006, *Hot Air*.

<sup>224</sup> “With *Islamists* in mind, Gingrich mulls 2008 presidential run,” news.yahoo.com, 9 Jan 2005 (quote from Gingrich’s *Winning The Future*, 2005) *JW*.

<sup>225</sup> Pipes, Daniel. “The *Hamas* electoral victory: Democracy’s bitter fruit,” *DP*, 27 Jan 2006.

<sup>226</sup> Spencer, Robert. “Boston on the *Islamic* concept of freedom,” *DW*, 2 Mar 2006.

<sup>227</sup> Seper, Jerry. “Terrorists will fail,” washtimes.com, 5 May 2005, *DW*, 12+21 May 2005.



diaspora. Yet tellingly, no terrorist act done in the name of *Islam* **against non-Muslims** has ever outraged “the Arab Street” enough to spark anything more than a tiny protest to denounce the perpetrators and to get the word out that these acts are un-*Islamic*. The same could be said for the issues of slavery, FGM, endemic wife-beating, mysogony and other troublesome aspects of *Islam*.

- C How “the Arab street” is readily given over to rioting and violent protests since the start of *Islam*. Throwing and sling-shotting stones and Molotov Cocktails shows a criminal disregard for human life.<sup>228</sup> “The Arab Street” gives frequent expression to the callous and murderous spirit inculcated in *Muslims* by *Islamic* scripture and teachings.

An *Islamist* is one who, by reading and hearing the *Koran* (i.e. the Khidr-Second Lamech Logic) becomes willing to kill, or at least to support killers, in order to set up an *Islamic* society, state or *Caliphate*. The *Muslim* Brotherhood was established to avenge the fallen *Caliphate* and re-establish it. *The Washington Post* reported:

When Osama bin Laden called the Sept. 11 attacks on the World Trade Center and the Pentagon ‘a very small thing compared to this humiliation and contempt for more than 80 years,’ the reference was to the aftermath of World War I, when the last *Caliphate* was suspended as European powers divided up the Middle East.<sup>229</sup>

The triggering event that sends a person down the path toward becoming a *Jihadist* is often a personal, family or career setback, calls for *Jihad* read in pamphlets or heard in the *Mosque* or on television, a desire for deeper spirituality, or being convinced beyond a doubt that the *Koran* is from *Allah*, and then acting on the *Koran*’s commands—like Mohammed Taheri-Azar (discussed above). Often *Muslims* interviewed after a terrorist act will say the perpetrator recently became “very religious” and “prayed five times per day.”<sup>230</sup>

The rest of *Muslims* who subscribe to Khidr-Second Lamech Logic turn into moderates who try to shirk the duty of *Jihad* the *Koran* imposes on them (*K* 002:216), and say “*Allah*, why have you ordained fighting for us?” (*K* 004:077; also see *K* 002:216; 009:086; 033:010-012; 047:020).

Moderate *Muslims*:

- C Present themselves as Second *Muhammads* who seek to re-interpret *Islam* for the masses though most *Muslims* will only accept the First *Muhammad*.
- C With varying degrees of sincerity, engage in historical negationism while presenting decoy *Islams* that fool non-*Muslims* into complacency about the threat that *Islam* poses to Westerners and Western civilization.
- C Are silent about *Jihad*, see no evil in *Jihad*, and attack anyone as a racist or an ignorant bigot if he or she sees *Jihad* for what it is—an evil.<sup>231</sup> At other times, moderates engage in doublespeak in order to sound as though they are condemning terrorism while in fact they only condemn counter-terrorism efforts—what moderates often refer to as “state-terrorism.”

<sup>228</sup> Weiss, Efrat & Roe Nahmias. “Border policeman dies of wounds,” ynetnews.com, 3 Jul 2005.

<sup>229</sup> Vick, Karl. “Restoration of *Caliphate* resonates with mainstream *Muslims*,” washingtonpost.com, 14 Jan 2006, *DW*.

<sup>230</sup> Grossbongardt, Annette. “Turkey: Fear Prevails after Priest’s Murder,” spiegel.de, 12 Apr 2006.

<sup>231</sup> Mowbray, Joel. “*Islamic* Hall of Shame,” *FPM*, 30 May 2005.

- ⊕ Pretend that *Jihadists* are misguided folk in their midst, but among themselves moderates often think of *Jihadists* as being heroes of the faith whose address their concerns (K 004:075). Saying that the extremists are a “tiny minority” implies that alarmists exaggerate the dangers of *Jihad* and *Islamization*.
- ⊕ Play down reports about *Imams* in America who advocate for *Jihad* against *Israel* and America in their sermons by saying that particular *Imam* is more of “a political figure than a religious figure” and “the congregation itself might not hold the same beliefs” but just attend Friday Prayers there since it happens to be the nearest *Mosque*.<sup>232</sup> All the while there is no admission that without these type of fiery sermons, there would be fewer *Jihadist* terrorists.
- ⊕ Attack non-*Muslim* experts on *Islamic* terrorism who are well informed about the awful, ugly truth about *Islam* by saying that they are ignorant of *Islam*, and calling them *Islamophobes*. Moderates then lay down a rhetorical smokescreen by presenting a whitewashed and bowdlerized form of *Islam*.

Moderate *Muslims* from *Muhammad*'s day down to our day only present arguments easily overcome by those who recruit for *Jihad* such as “The weather is too hot to go on *Jihad*” (K 009:081).

Moderate *Muslims* have never mounted any serious *Koranic* or theological challenge to *Islamists* and in fact moderate *Muslims* are often transformed into *Jihadists* by Khidr-Second Lamech Logic. It is just as a *Muslim* who regretted converting from Christianity said (whose words the historian Tabari (839–923 AD) recorded):

Their religion [*Islam*] does not stop them from shedding blood, terrifying the roads and seizing properties.<sup>233</sup>

Some say that “most *Muslims* have allowed the extremists to take control of the religion, more or less without a fight.”<sup>234</sup> *Muslims* have not offered any meaningful arguments against *Islamism* beyond mere slogans such as “No to terrorism.”

Many *Muslims* actually **agree with** and **support** *Islamists*.<sup>235</sup> Just how strong support for *Islamists* is can be ascertained from the fact that many *Muslims* believe apostates deserve death, in keeping with *Sharia* law, as the *BBC* reported in 2006:

...an overwhelming number of ordinary *Afghans* appear to believe Mr. Rahman [an *Afghan* Christian convert from *Islam*] has erred and deserves to be executed.<sup>236</sup>

One 2006 study showed that...

...each increase of 1 percent in the percentage of *Muslims* in the population the level of freedom goes down by 0.031 points on a scale of 7.<sup>237</sup>

A February 2005 poll conducted in the Mideast found:

Asked whether *Shari'a* should be the only source of legislation, one of the sources of legislation, or not be a source of legislation, most *Muslims* believed it

<sup>232</sup> Barakat, M. “Activist *Imam* puts politics into sermons,” *washingtontimes.com*, 6 Jul 2005.

<sup>233</sup> *Al-Tabari, The History of Al-Tabari (Ta'rikh Al-rusul wa'l-muluk)*. State University of New York Press, New York, 1993, pp. 187-188, 191-192.

<sup>234</sup> Mowbray, Joel. “Moderate *Muslims* blaze new path,” *washingtontimes.com*, 24 May 2005, Jawa Report, *mypetjawa.mu.nu*.

<sup>235</sup> Pipes, Daniel. “British Opinion Surveys from an *Islamist* Hell,” *DP*, 25 Jul 2005.

<sup>236</sup> Majumder, Sanjoy. “Mood hardens against *Afghan* convert,” *news.bbc.co.uk*, 24 Mar 2006, *JW*.

<sup>237</sup> “Statistics Show Strong Correlation Between *Islam* and Authoritarianism,” *The Jawa Report*, *mypetjawa.mu.nu*, 7 Feb 2006.

should at least be a source of legislation. Support was particularly strong in Jordan, Palestine and Egypt, where approximately two-thirds of *Muslim* respondents stated that the *Shari'a* must be the only source of legislation; while the remaining third believed that it must be 'one of the sources of legislation.' By comparison, in Lebanon and Syria, a majority (nearly two thirds in Lebanon and just over half in Syria) favored the view that *Shari'a* must be one of the sources of legislation.<sup>238</sup>

In the UK in 2005 and 2006 support for *Sharia* and *Jihad* was strong. Polls found:

*Muslims* widely state that *Sharia* should reign in Britain. 40 percent approve of *Sharia* being applied in predominantly *Muslim* areas, and 61% want *Sharia* courts to settle civil cases among *Muslims*. All of 58% want those who criticize or insult *Islam* to face criminal prosecution. Schools should be prohibited from banning female pupils from wearing the *Hijab*, say 55%, while 88% insist that schools and work places should accommodate *Muslim* prayer times....Some 37% consider Jews in Britain 'legitimate targets as part of the ongoing struggle for justice in the Middle East,' and 16% state that suicide bombings can be justified in Israel. (Among 18- to 24-year-olds, that number rises to 21%.)<sup>239</sup>

A March 2004 poll by *The Guardian* of *Muslims* in the UK revealed:

13 per cent of British *Muslims* believed that *Al-Qaeda* attacks on the US were justified.<sup>240</sup>

The *Muslim* diaspora supports *Islamists*—and to a frightening extent. A *YouGov* poll sampled British *Muslim* and found that in July 2005:

- Ⓒ 32 percent think that “Western society is decadent and immoral and *Muslims* should **seek to bring it to an end**,”
- Ⓒ 27 percent would **not** “inform the police if they believed that someone they knew or knew of might be planning a terrorist attack.”
- Ⓒ 30 percent feel **no** “duty to go to the police if they ‘see something in the community that makes them feel suspicious.’”
- Ⓒ 53 percent would **not** “go to the police if they believed an *Imam* or other religious person was trying to radicalize young *Muslims* by preaching hatred against the West.”<sup>241</sup>

A July 2005 poll of *Muslims* for UK's *Sky News* found:

- Ⓒ 46 percent agreed that “*Muslim* clerics who preach violence against the West are...[in] touch with mainstream *Muslim* opinion.”<sup>242</sup>

A July 2005 poll of *Muslims* for UK's *The Guardian* found:

- Ⓒ 8 percent say “ordinary *Muslims* should **not** do more work with the police to root out extremists from the *Muslim* community.”
- Ⓒ 36 percent say the 7/7 London bombings had nothing to do with “the *Muslim* community for not doing more to root out extremists.”

<sup>238</sup> “Revisiting the Arab Street: Research From Within,” Center for Strategic Studies, U. of Jordan, Amman, Feb 2005, p. 52 + figure 1V2; also Kramer, Martin. “Poll That Hid *Hamas*,” [sandbox.blog-city.com](http://sandbox.blog-city.com), 26 Jan 2006; “Strong support for *Sharia* in Jordan, PA...,” *JW*, 9 Feb 2006.

<sup>239</sup> Pipes, Daniel. “Trouble in Londonistan,” *DP*, 11 Jul 2006.

<sup>240</sup> Masood, Ehsan. “A *Muslim* Journey,” [prospectmagazine.co.uk](http://prospectmagazine.co.uk), Aug 2005, Rogier van Bakel (*Nobody's Business* blog).

<sup>241</sup> King, Anthony. “One in four *Muslims* sympathises with motives of terrorists,” [telegraph.co.uk](http://telegraph.co.uk), 23 Jul 2005, *JW*.

<sup>242</sup> Survey Reveals Beliefs,” *Sky News*, [sky.com](http://sky.com), 22 Jul 2005, C&R.

- ☉ 38 percent say “foreign *Muslims* who incite hatred should be ... allowed to live in the UK.”<sup>243</sup>

A December 2005 *Populus* poll in the UK found that:

- ☉ Only 52 per cent think that the state of Israel has the right to exist, with 30 per cent disagreeing, a big minority.<sup>244</sup>

A 2006 *Populus* survey of UK *Muslims* just before the anniversary of the 7/7 (2005) London Tube subway attacks found that:

- ☉ 13 percent of British *Muslims* think that the 7/7 bombers are “martyrs.”
- ☉ 7 percent agree that suicide attacks on civilians in the UK can be justified in some circumstances, rising to 16 percent for a military target.
- ☉ 16 percent would be “indifferent” if a family member decided to join *Al-Qaeda* and two per cent would be proud.<sup>245</sup>

Concerning the above 2006 *Populus* poll results, Trevor Phillips, the chairman of the UK Commission for Racial Equality, said:

These results show that there are people within the *Muslim* communities who...think that they are at war with the rest of the community.<sup>246</sup>

In the above polls, 7 percent of UK *Muslims* believe attacks on civilians in the UK can be justified, and 37 percent of UK *Muslims* believe that UK Jews are legitimate targets. This explains how, as Daniel Pipes commented, an “extremely large”<sup>247</sup> number of UK *Muslims* (i.e. one percent or 16,000 persons) are engaged in terrorist activities even while the government conducts seventy terrorism investigations simultaneously and police say ever more are in the offing.<sup>248</sup>

Many moderate *Muslims* would agree with radical *Muslims* in that “‘a lot of killing’ is unavoidable if the world is to come under the banner of *Islam*” and that terrorist attacks “wouldn’t necessarily be the wisest thing to do but it wouldn’t be un-*Islamic*.”<sup>249</sup>

In the *Koran* and *Islamic* jurisprudence, *Jihad* is a communal obligation except in a defensive war (*K* 009:122). Thus most *Muslims* feel that *Jihad* is the duty of some other *Muslims* who may feel that higher calling just as they feel someone else, and not them, ought to be an *Imam*. *Muhammad* described this sentiment thus:

He [*Muhammad*] proclaimed that the Lord gave the *Muslims* the *Hajj* and Holy War in exchange for monasticism.<sup>250</sup>

For everyone to be a *Jihadist* would be logistically impossible, anyway. Still, many *Muslims* are in the recruitment pool for *Jihad* or pocketbook *Jihad*.

Moderate *Muslims* may try to disassociate themselves from terrorists but this is mainly out of self-interest and does not indicate they necessarily want the terrorists

<sup>243</sup> Dodd, Vikram. “Two-thirds of *Muslims* consider leaving UK,” guardian.co.uk, 26 Jul 2005; “*Muslim* Poll,” icmresearch.co.uk, Jul 2005; and Pipes, Daniel. “More Survey Research on British *Muslim* Attitudes,” *DP*, 26 Jul 2005.

<sup>244</sup> Riddell, Peter. “Poll shows voters believe press is right not to publish cartoons,” timesonline.co.uk, 7 Feb 2006, *JW*.

<sup>245</sup> Frean, Alexandra & Rajeev Syal. “*Muslim* Britain split over ‘martyrs’ of 7/7,” *The Times*, timesonline.co.uk, 4 Jul 2006.

<sup>246</sup> Frean, Alexandra & Rajeev Syal. “*Muslim* Britain split over ‘martyrs’ of 7/7,” *The Times*, timesonline.co.uk, 4 Jul 2006.

<sup>247</sup> Pipes, Daniel. “The Next London Bombing,” *DP*, 11 Jul 2005.

<sup>248</sup> Phillips, Melanie. “State of denial,” melaniephillips.com, *Daily Mail*, 5 Jul 2006.

<sup>249</sup> Millward, David. “Radical *Muslim* questions tactics of bombers,” telegraph.co.uk, 30 Jul 2005.

<sup>250</sup> Grunebaum. *Festivals*, p. 44, as quoted in Stortroen. *Makka*, p. 20.

apprehended. Experience has shown that *Muslim* terrorists can move and operate unimpeded among *Muslims* without much fear of being turned in.

Another reason that moderate *Muslims* are not desirable citizens is they are missing a whole range of behaviors and attitudes instilled in Christians by the Bible, which values, such as the sanctity of human life, have been absorbed by osmosis by Westerners as a whole. The *Koran* however counters these Christian values with Khidr-Second Lamech Logic values where only *Muslim* life is sacred, and Mideasterners absorb these terrible values by osmosis.

Many naïve secularists want critics of *Islam* to say that *Islam* and moderate *Muslims* are not dangerous but only *Islamism* and *Islamists* are dangerous. This distinction without a meaningful difference is as misleading as saying gasoline is not dangerous until it happens to catch on fire.

Many moderate *Muslims* are merely one repetition of Khidr-Second Lamech Logic away from being terrorists. The newspapers are littered with stories of moderate-*Muslims*-turned-terrorists, as Dexter Filkins of *The New York Times* lamented:

In a two-hour interview in his home, Mr. Banna [a rich *Muslim*] described a son unlikely to harbor extreme religious or political views, or to even pick up a gun. In a way, Mr. Banna's tale contained echoes of those told by many Middle Eastern parents, of sons who had once looked on the West with great hope and enthusiasm, endured some alienating experience, then turned to violence against the very place they had coveted for so long.<sup>251</sup>

Mr. Banna's son killed himself and 179 *Iraqis* in 2005 using a car-bomb in *Iraq*. After a suicide-bombing in *Qatar*, the newspapers were full of statements such as:

He was a decent man and a moderate pious *Muslim* who never talked about politics or even thought about having a beard...This is unbelievable. He was an ordinary person and never sounded like an extremist or someone who has a different religious or political ideology...He had everything he wished for: A nice Palestinian wife born in *Qatar*, three cute kids and a job with a very good salary...He was also very happy when he got a baby last month...My son sounded very normal in the [last] phone call and was giving me details of his next trip... he was planning to visit Egypt this summer so that I will be able to see the baby...If he had any intentions of carrying out the attack I would have noticed something and he would have tried to say goodbye indirectly. But it was just a normal call like all the calls he made during the past 18 years...I am shocked...It is impossible that he could have done that because he had no motivations and his history is as clean as snow...<sup>252</sup>

Moderate *Muslims* can still be terrorist sympathizers, supporters and apologists. They can also be wife-beaters (K 004:034), serial divorcees via temporary marriages and quick-and-easy divorce, polygynists with up to four wives, and slavers who have an unlimited number of sex-slaves (K 004:003, 023-024; 023:005; 033:050; 070:030). *Muslims* can even be pimps who are assured of *Allah's* forgiveness if they force their unwilling slaves into prostitution (K 024:033).

<sup>251</sup> Filkins, Dexter. "Tortuous Trail: From a Bombing in *Iraq* to Fury at a Family in Jordan," nytimes.com, 15 Mar 2005, natashatynes.org.

<sup>252</sup> Said, Summer. "Qatar Bomber's Action Baffles Family, Friends," *Arab News*, arabnews.com, 25 Mar 2005.

Moderate *Muslims* are experts in *Kitman* and *Takiya*-speak, *Tu Quoque* (You do it too!) and Turnspeak arguments—all forms of lying sanctioned by the *Koran* (see *Kitman* in the Glossary).

The reasons that moderate *Muslims* are experts in these forms of lies is, first of all, the lies work the same for moderate *Muslims* as they do for *Islamists*, as Michael Ledeen wrote:

The terror masters have the same contemptuous vision of us. And if you look at the way they deal with our governments, you will see a mixture of contempt and bemusement, as they repeatedly get us to go for the same tricks and deceptions.<sup>253</sup>

Secondly, moderate *Muslims* lie because they feel that they:

- ☉ Must offer excuses as to why they do not reject such a vile and violent religion as *Islam* even though they are not willing to kill to impose *Islam* on others by force.
- ☉ Need to explain away why they do not condemn *Islamic* terrorists without adding on copious qualifications to their condemnation.
- ☉ Need to explain somehow that *Jihad* is mostly about an internal spiritual struggle or else Infidels might take counter-terrorism measures against both *Muslims* and *Islam*.<sup>254</sup>

Beth Goodtree wrote that according to William P. Welty, “*Al-Takiya*...is...falsehoods told to prevent denigration of *Islam*...”<sup>255</sup> *Takiya* lies that are told so *Islam* is not denigrated include:

*Islamic* tradition does not have a notion of holy war. *Jihad* simply means to strive hard or struggle in pursuit of a just cause.<sup>256</sup>

...the actions of Osama bin Laden and *Al-Qaeda* do not follow the teachings of *Islam*’s holy book.<sup>257</sup>

Other examples include: “*Islam* is a Religion of Peace,”<sup>TM</sup> “*Islam* did not spread by the sword,” “*Islam* is not inherently violent,” “Violence in *Islam* is a recent phenomenon,” Violence is sporadic and does not ebb and flow throughout *Islam*’s history from the days of *Muhammad* on down,” “Terrorists misunderstand *Islam*,” “*Islam* does not sanction beheading, ethnic cleansing and genocide.”

Moderate *Muslims* do not necessarily stay moderate their entire lives. Where else do *Islamic* terrorists come from other than the pool of all *Muslims*—especially *Muslims* named *Muhammad*. Recall that the...

...the leader of the 9/11 plotters? Mohammed Atta. The British *Muslim* who self-detonated in a *Tel Aviv* bar? Asif Mohammed Hanif. The gunman who shot up the *El Al* counter at LAX? Heshamed Mohamed Hedayet. The former US Army sergeant who masterminded the slaughter at the embassy bombings in *Kenya* and *Tanzania*? Ali Mohamed. The murderer of Dutch filmmaker Theo van Gogh? Mohammed Bouyeri. The notorious *Sydney* gang rapist? Mohammed Skaf. The Washington [D.C.] sniper? John Allen Muhammed.<sup>258</sup>

<sup>253</sup> Ledeen, Michael. “Very Different Playbooks: Them vs. us,” *NRO*, 19 Apr 2004.

<sup>254</sup> “Spanish *Muslims* issue *Fatwa* against *Al-Qaeda*’s Osama Bin Laden [& say the U.S. response to 9/11 was disproportionate],” uk.biz.yahoo.com, 10 Mar 2005, *LGF*.

<sup>255</sup> Goodtree, Beth. “Deceit, Thy Name Is *Islamism*,” *Isralert.com*, Mar 2005.

<sup>256</sup> “What ever happened to Khaled *Abou El Fadl*’s reputation?” *DW*, 2 Jun 2005.

<sup>257</sup> Bowman, Quinn. “Religion in Our Community: *Islamic* Center proud of its ethnic, national diversity,” athensnews.com, 2 Jun 2005, *JW*: “What is important is how the *Quran* is judged...”

<sup>258</sup> Steyn, Mark. “Toon-deaf Europe is taking the wrong stand,” *suntimes.com*, 12 Feb 2006.

Moderate *Muslims* are not willing to use violence to impose *Sharia* law or rush a *Caliphate* into existence when these objectives can be met through democratic means, e.g. protest marches and the vote. Nevertheless, Khidr-Second Lamech Logic affects moderate *Muslims* since the *Koran* tends to instill in all its serious readers a moral turpitude, if not a criminal mentality. The evidence for this is:

- ☉ A normal person who read the *Koran* would flee *Islamdom* and warn others against *Islam* and the *Koran*, but moderate *Muslims* were mostly born into *Islam*, and so they try to defend the indefensible against critics of *Islam*. It is mainly apostates from *Islam* who risk telling others about the true nature of *Islam*, while moderate *Muslims* sit back and take no risks.
- ☉ Some say moderate *Muslims* are afraid of the extremists but even in America and other comparatively safe places, moderate *Muslims* do not rise to the occasion to confront and face down the extremists, but they never miss an opportunity to: 1) obfuscate about the true nature of *Islam* and 2) apply the *Islamophobe* label to those who tell the truth about the nature of *Islam*.
- ☉ Many moderate *Muslims* do not uphold the idea of religious and political pluralism, nor do they agree with the principle of equality under the law for all, nor the Voltairian principle: “I disapprove of what you say but I will defend to the death your right to say it.”<sup>259</sup> For instance:

★ During the Cartoon Riots of 2006, *Pakistani* President Musharraf said:

The **most** moderate *Muslim* will go to the street and talk against it because this hurts the sentiments of every *Muslim*...Whether an extremist or a moderate or an ultra-moderate, we will condemn it.<sup>260</sup>

★ Walid el-Sallab, 23, the student-union president of the relatively liberal American University in *Cairo* led a rally against the cartoons and said:

The word *Islam* is derived from peace. You cannot just go and attack people...But honestly, I feel that if I were to see the Danish Prime Minister, I might kill him myself without thinking.<sup>261</sup>

★ Adel Hamouda, 55, the editor of *al-Fagr*, a liberal *Cairo*-based weekly that ran the cartoons early on said:

We attacked the cartoons and said that this deepens the culture clash and does not resolve it.<sup>262</sup>

What use are moderate *Muslims* to the West in battling *Islamists* when even the moderate *Muslims* wish to suppress free speech rights and enforce a *de facto Sharia* law on the West?

*Muslims* often say they are “terrorized” by threat-profiling and counter-terrorism measures, *Globe & Mail* reported one *Muslim* involved with drafting statements condemning terrorism for a *Muslim* organization said:

You have no idea how **terrified** the *Muslim* community feels—following 9/11 when we found our *Mosques* under surveillance by police and CSIS and Bill C-36 [Canadian anti-terrorism legislation] was passed.<sup>263</sup>

*Globe & Mail* also reported a...

<sup>259</sup> This sentence is not by Voltaire, but by a biographer of Voltaire who coined it in 1906.

<sup>260</sup> “Tear gas fired at 7,000 protesting cartoons,” msnbc.msn.com, 13 Feb 2006.

<sup>261</sup> Ratnesar, Romesh. “Fanning the Flames,” time.com, 12 Feb 2006, Big Pharaoh blog.

<sup>262</sup> Ratnesar, Romesh. “Fanning the Flames,” time.com, 12 Feb 2006, Big Pharaoh blog.

<sup>263</sup> Jimenez, Marina & Michael Valpy. “Groups wrestle with reacting to acts of terror committed by those claiming to represent *Islam*,” theglobeandmail.com, 16 Jul 2005.

...Toronto *Imam* [Aly Hindy] warned Public Safety Minister Anne McLellan at a closed-door meeting to stop ‘**terrorizing**’ Canadian *Muslims*. ‘If you try to cross the line I cannot guarantee what is going to happen. Our young people, we can’t control,’ [said] Aly Hindy, the head of Scarborough’s *Salaheddin* [*Saladin*] *Islamic Centre*....The *Imam* said six or seven young men have approached him to discuss ‘fighting overseas’ in places such as *Iraq* and *Afghanistan*.<sup>264</sup>

The same *Imam*, Aly Hindy, also sent out a flyer to various *Mosques* that read:

We believe CSIS [Canadian Security Intelligence Service] should stop **terrorizing** us...<sup>265</sup>

The Canadian legal system is known for its liberality and Canada has no death penalty, so saying that Canadians terrorize *Muslims* does pass the laugh test.

This mischaracterization of Canadian law enforcement purposely makes *Muslims* angry and justifies future terror attacks via a moral equivalency argument, i.e. they terrorize *Muslims*, so *Muslims* should terrorize them back. In fact after the 7/7 London bombings, a poll commissioned by *The Guardian* revealed that “nearly two-thirds of *Muslims* identify racist and *Islamophobic* behavior as a cause” of the suicide-bombing attacks on London’s “Tube” subways and a double-decker bus.<sup>266</sup>

In the West, moderate *Muslims* and *Islamists* work hand-in-glove to defeat non-*Muslims* by whitewashing the evils of the *Koran* and *Islam*. Moderate *Muslims* repeat the eyewash mantra that *Islam* is a Religion of Peace,<sup>TM</sup> and that any talk otherwise is hate-speech.

Moderate *Muslims* try to lull, distract, embarrass, cow, browbeat and shame non-*Muslims* into dropping their guard so *Jihadists* and *Islamic* terrorists can blindside and sucker-punch their victims. After a terrorist attack, moderate *Muslims* have been known to cheer and defend the *Jihadists*, and jeer the victims by blaming them for their own destruction.

There are some non-*Muslim* narco-terrorists and terrorists with nationalistic motives (e.g. IRA, ETA), but there are hardly any non-*Muslims* who fight for their faith and are willing to kill in order to set up a theocratic empire.

Comparing *Muslim* to non-*Muslim* terrorists is like comparing apples and oranges. For instance, the entire IRA vs. Loyalist conflict in Ireland killed 3,600 over several decades but *Al-Qaeda* almost matched that number in one morning.<sup>267</sup>

There is no scripture of any major religion besides that of *Islam* that tells its readers to kill people who exist today. The *Koran*’s 164 War verses calls for 1.2 billion *Muslims* to wage *Jihad* on five billion people (Christians, Jews and pagans) until there is no more persecution and “until all religion is for *Allah*” (*K* 002:193; 008:039).

The *Koran* is the only Scripture that creates theo-terrorists who kill over creedal differences, and bomb more often during religious holidays (e.g. *Ramadan*, Christmas, New Year’s, Valentine’s Day, Easter, Passover, *Yom Kippur*, *Hanukka*).

Theo-terrorists kill more people on a per bomb and per year basis, commensurate to their global and eternal objectives. By contrast, political-minded terrorists limit their bombings commensurate to their limited political and material objectives.<sup>268</sup>

<sup>264</sup> Freeze, C. “*Imam* warns *Ottawa* to back off *Muslims*,” theglobeandmail.com, 25 Jul 2005, C&R.

<sup>265</sup> Freeze, C. “*Imam* warns *Ottawa* to back off *Muslims*,” theglobeandmail.com, 25 Jul 2005, C&R.

<sup>266</sup> Dodd, Vikram. “Two-thirds of *Muslims* consider leaving UK,” guardian.co.uk, 26 Jul 2005.

<sup>267</sup> “Irish nationalists clash with police at rally,” news.yahoo.com, 25 Feb 2006.

<sup>268</sup> Miller, Rory. “The Difference Between *Islamic* Terrorists and Others,” techcentralstation.com, 16 Feb 2005.



If the 4.7 billion non-*Muslims* became terrorists, or had a terrorist mindset, at the same rate *Muslims* become *Islamists* (10-15 percent), there would be 470 to 705 million non-*Muslim* terrorism supporters and terrorists. Daniel Pipes wrote:

With the exception of the Oklahoma City bombing of 1995, notes *Al-Qaeda* authority Rohan Gunaratna, all major terrorist attacks of the past decade in the West have been carried out by...[*Muslims*]...Of the 212 suspected and convicted terrorist perpetrators during 1993-2003, 86 percent were *Muslim* immigrants and the remainder mainly converts to *Islam*.<sup>269</sup>

Since *Muslims* form only one percent or so of the West's population, this shows that *Muslims* are 212 times as likely to commit terrorist acts—and not for any other reason than *Muslims* subscribe to the *Koran* and Khidr-Second Lamech Logic.

A study of UK universities tallied 23 *Islamist* groups, 10 ultra-nationalist groups (BNP) and 1 animal rights extremist group. Police say these groups may engage in subversive activities and may “pose a serious threat to national security.” *Muslims* are only 2.7 percent (1.6 million) of the UK's population (60.4 million), so if one assumes that these groups have about the same number of members on average, a *Muslim* in the UK is 77 times as likely as a non-*Muslim* in the UK to belong to a subversive group that potentially endangers national security.<sup>270</sup>

*Muslims* are also much far more likely to commit crime and go to jail than non-*Muslims* wherever a draconian system of law is not enforced like *Sharia* law that includes amputations for minor to mid-level crimes such as shoplifting, adultery and selling drugs (see “The High Crime and Incarceration Rates Among *Muslims*” table).

So anecdotal data and statistics show that Khidr-Second Lamech Logic is highly effective in transforming *Muslims* into criminals and would-be or real theo-terrorists, though the exact dosage necessary for the transformation varies by the individual's temperament and circumstances.

**IV. Inert Ingredients:** Between the one percent of “good” verses in the *Koran* that have mostly been abrogated the Sword Verse, and the twenty-one percent of verses that are of objectionable character, 78 percent of the *Koran* is inert filler material—like fizz in a carbonated drink.<sup>271</sup>

The reason the filler material was necessary at all was *Muhammad* discovered that if he put the 1280 evil verses to rhyme and included some tales, he could say dreadful things without losing his all-too-receptive audience. H.A.R. Gibbs wrote:

Mohammed's utterances were delivered in a sinewy oracular style cast into short rhymed phrases...a loose rhyme or assonance marking the end of each verse.<sup>272</sup>

Some have said the rhyme at the end of many *Koran* verses makes the verse ring like a bell. Thus the *Koran*'s insinuating itself into the culture of the Mideast is similar to how horrendous political ditties became nursery rhymes in the last several centuries in the West.<sup>273</sup>

<sup>269</sup> Pipes, Daniel. “No American *Muslim* Terrorists?,” *DP*, 12 Dec 2005.

<sup>270</sup> Taylor, Matthew & Rebecca Smithers. “Extremist groups active inside UK universities, report claims,” *The Guardian*, education.guardian.co.uk, 16 Sep 2005.

<sup>271</sup> *The Skeptic's Annotated Quran*, skepticsannotatedbible.com/quran/index.html, “Ibn Warraq on How to Debate a *Muslim*, Part III” plus comment, *DW*, 11 Dec 2004, updated 28 Nov 2005.

<sup>272</sup> Gibb. *Survey*, p. 36.

<sup>273</sup> For instance, “Mary, Mary, quite contrary” is about Queen Bloody Mary's graveyard, and torturing and beheading Protestants, “Jack and Jill” is about a king and queen being beheaded, and

The singsong quality of the *Koran* embeds its message in the brain, so that *Muslims* are constantly thinking or dreaming violent thoughts. The *Sira* histories reveal that *Muhammad* and his fighters dreamt about *Jihad*. *Muhammad*

- ☉ Received a dream before the Battle of *Uhud* that showed the outcome of the battle. *Muhammad* saw himself wearing a coat of mail while riding a ram. He also held a bent sword and saw some of his cattle sacrificed.<sup>274</sup>
- ☉ Interpreted the dreams of two of his fighters who dreamt before the Battle of *Uhud* that they would be martyrs. The two dreamers were *Khaythamah* of the *Aws* tribe and '*Abd Allah Ibn 'Amr* of the *Bani Salimah*, a clan of the *Khazraj* tribe.<sup>275</sup>

Modern *Muslims* also dream about fighting and killing. For instance, *Asia News* reported:

A Christian convert from *Islam* was killed for his faith. *Ziwar Muhammad* Isma'il, who worked as a taxi driver in *Zakho* in the autonomous *Kurdish* region of northern *Iraq*, was shot dead by *Abd al-Karim Abd al-Salam* at a taxi station early on the morning of February 17. *Abd al-Salam* approached *Ziwar* and told him to return to *Islam*. When *Ziwar* refused he opened fire with an automatic rifle. *Abd al-Salam* fled but was chased by other taxi drivers who, after apprehending him, turned him over to the police. *Abd al-Salam* claims that **the prophet *Muhammad* appeared to him in a dream and told him to kill the Christian.**<sup>276</sup>

*Erik Schechter* of *World Press* wrote about the dreams of Palestinian children:

Like their older siblings, children are exposed to the same religious slogans in the *Mosques*; they see the same pro-martyrdom posters in the streets...Even pre-teens have been found to fantasize about *Shahada*, or Martyrdom. 'I have studied the dreams of 300 Palestinian children from ages 10-12 and I would say that **15 percent of them dream of being suicide-bombers,**' notes *Shafiq Masalha*, a clinical psychologist who teaches at *Tel Aviv University's* education program.<sup>277</sup>

*Robert Fisk* wrote about the dreams of miniskirt-chasing suicide-bombers:

You know, I [*Abu Ali*] was told by the survivor of another bombing that he saw the suicider with the bomb in his shirt actually dancing in the street and singing a silly song, a verse about beautiful angel women. Think of it, he was dancing. He was in a trance, thinking of the women who would reward him in a few seconds' time in paradise. I think about the word 'trance' and remember the inspiration of dreams among the *Sunni Wahhabis*, how *Mullah Omar* of the *Taliban* announced he had led his militia into battle after a dream that he must end corruption in *Afghanistan*, how *Al-Qa'ida* men told me they discussed their dreams. Did not the Prophet Mohammed receive his message from God in dreams? **'It [i.e. dreaming] is an obsession with the**

a "Ring around the Rosies...A tissue!... We all fall down" is about a bubonic plague welt, sneezing and dying ("Nursery Rhymes—lyrics and origins!" famousquotes.me.uk, accessed 20 Feb 2005).

<sup>274</sup> Lings. *Sources*, pp. 173, 181.

<sup>275</sup> Lings. *Sources*, pp. 174-175.

<sup>276</sup> "Iraq: Christian convert killed in Iraq," asianews.it, 19 Feb 2005, *DW*.

<sup>277</sup> Schechter, E. "Child Suicide-bombers: The Children's Crusade," *Worldpress.org*, 29 Sep 2004.

<sup>278</sup> Fisk, Robert. "Baghdad, the city that dreams of death," *independent.co.uk*, 3 Feb 2005.

<sup>279</sup> My bloody career, *The Guardian*, *observer.guardian.co.uk*, 23 Apr 2006.

<sup>280</sup> Pipes, Daniel. "Gitmo Recidivists," *DP*, 30 Sep 2004.

**bombers.**<sup>278</sup>

The *Koran's* Khidr-Second Lamech Logic is quite powerful by itself as is evidenced by the fact that *Islam* was a killing machine for two centuries before the *Hadith*, *Sira* and *Sharia* law were canonized and popularized.

The *Koran's* Khidr-Second Lamech Logic works in derivative works such as the *Hadith*, *Sira* and *Sharia* law manuals, and in distillations such as *Jihadist* manuals, tracts and sermons. *Jihadist* literature gets its convincing power entirely from the *Koran* since *Jihadists* often have “only a well-thumbed copy of the *Koran*”<sup>279</sup> to read for extended periods such as during combat or while in prison, yet:

- ☉ Their *Jihadist* inclinations in no sense wanes in the absence of *Jihadist* literature, and many inmates go right back to *Jihad* upon release.<sup>280</sup>
- ☉ Even after reading the *Koran* by itself for a long while, *Jihadists* never come to the startling conclusion that they have been “had” and that the *Jihadist* literature is at variance with the spirit and letter of the *Koran*.

**V. Intake Directions:** The *Koran* is only about the size of the New Testament, so the *Koran's* evil brew is concentrated and potent. Its compact size allows *Muslims* to readily hear, memorize and internalize the cocktail. Even if a *Muslim* has only memorized the first nine chapters of the *Koran*, he has memorized 117 of the 164 War verses.

Once the *Koran* reaches medicinal strength in a *Muslim*, no further optic or aural intake is required. A *Muslim* can then simply recall the cocktail from memory to transform himself or herself from a moderate *Muslim* into, as the occasion requires, a wife-beater, serial divorcer, polygamist, fascist *Islamist*, terrorist sympathizer, terrorist supporter or terrorist.

**VI. Overdose Warning:** *Muslims* who adhere to Khidr-Second Lamech Logic too much, or are more sensitive to Khidr-Second Lamech Logic than average *Muslims*, will engage in behavior that is counter-productive as far as *Islam* is concerned, such as: 1) Beating one's wife black and blue or to death (*K* 004:034), 2) Carrying out terrorist attacks while *Muslims* are trying to enforce a cease-fire (*Hudna*) or lull (*Tahdiya*), and are even paying terrorists not to attack,<sup>281</sup> or 3) Suicidal *Jihadist* activity (e.g. suicide-bombings). In other words, they no longer just try to kill non-*Muslims* but they purposely kill themselves in order to kill and maim others.

The *Koran* is a loaded gun and naturally is even more dangerous when unstable madmen are acting on its precepts, or when read by *Jihadists* who are emotionally immature and impressionable teenagers. The thought that marrying one's own cousins has been very common in *Islamdom* for fourteen centuries gives no comfort in this regard either (see the ToC for the Marrying One's Own Relatives section).

When the *Koran* had only 110 of its 114 chapters, and only 133 of its 164 War verses, it already prompted so much indiscriminate killing during the conquest of *Mekka* that *Muhammad* remarked:

Stop this killing!....If anyone should say ‘The apostle killed men in *Makka*,’ say ‘God permitted his apostle to do so but he does not permit you.’

<sup>281</sup> O'Sullivan, Arieh. “IDF nabs *Hizbullah*-funded terrorist,” jpost.com, 12 Dec 2005.

Refrain from killing...for there has been too much killing even if there were profit in it.<sup>282</sup>

What is especially shocking about this massacre is that many *Mekkan* pagans were acquaintances and relatives of the *Muslims* from childhood.

After the conquest of *Mekka*, *Muhammad* added another four chapters and 31 War verses. With its full complement of 164 War verses, the *Koran* inspired enough *Jihad* to kill, as some have estimated, 50 million people in fourteen hundred years, and the *Jihad* continues at a frightening rate.

Another example of how the *Koran* makes *Muslims* hyper and overreactive is reported by *The Times Online*. When a moderate *Muslim*...

...struck up an argument [and] threw a leaflet to the ground he was punched in the face. Up to seven members of the [Savior] sect jumped on the man and began kicking him as he lay on the floor...[until] his face [was] swollen and bleeding. Unabashed, one of group...shouted out to onlookers: 'You should not feel sorry for him. He is a *Kuffar* and deserves it.' One of the sect told the [undercover] reporter that 'the brothers' needed to calm down and stop attracting attention to themselves in public. 'They should have taken him round the corner and beaten him there,' he said.<sup>283</sup>

Overdosing on the *Koran* has been described as demon possession. "*Sheikh Abdul-Aziz Al Sheik*...the [Saudi] kingdom's grand *Mufti* said the greatest test to the nation of *Islam* came from its sons who were 'lured by the devil' to carry out acts of violence."<sup>284</sup>

*Jihadists* may or may not be demon-possessed as Judas was (Luk 22:03; Joh 13:27) but the Bible's descriptions of what demons **want** humans to do is exactly what the *Koran* **commands!** The demons want *Muslims* to:

- ☉ Commit honor-killings and wage *Jihad* (Jdg 09:23-24).
- ☉ Carry out terror attacks on the unsuspecting (1Sa 19:09-10).
- ☉ Commit suicide, especially in water and fire (Mar 09:22):
  - ★ Demons want *Muslims* to suicide-bomb (i.e. bombs are fiery) especially when Christians and Jews are the targets (Luk 22:03; Joh 13:02; Act 05:03).
  - ★ *Muhammad* says those who die in battle are martyrs (e.g. K 004:074). What is less well-known is that *Muhammad* said there are seven types of martyrs who die in different ways, e.g. certain diseases, drowning and

<sup>282</sup> Ishaq. *Sirat*, pp. 554-555.

<sup>283</sup> "Focus: Undercover in the academy of hatred," [timesonline.co.uk](http://timesonline.co.uk), 7 Aug 2005, *DP*.

<sup>284</sup> "*Islam* 'does not mean killing,' says cleric," [guardian.co.uk](http://guardian.co.uk), 20 Jan 2005.

<sup>285</sup> "Body of suspected British suicide bomber found," [telegraph.co.uk](http://telegraph.co.uk), 19 May 2003.

<sup>286</sup> Bernstein, Richard. "A death in Berlin reignites *Muslim* anger," *The New York Times*, [iht.com](http://iht.com), 11 May 2006.

<sup>287</sup> Jacobs, Stevenson. "Official: Gitmo Prisoners Waging '*Jihad*,'" [forbes.com](http://forbes.com), 27 Jun 2006, *JW*.

<sup>288</sup> Selsky, Andrew. "89 *Gitmo* detainees on hunger strike," [news.yahoo.com](http://news.yahoo.com), 1 Jun 2006.

<sup>289</sup> McGreal, Chris. "Prisoners protest at Israeli 'security,'" [guardian.co.uk](http://guardian.co.uk), 2 Aug 2003.

<sup>290</sup> Rubinstein, Danny. "The hunger strike's resonance," [haaretz.com](http://haaretz.com), 23 Aug 2004.

<sup>291</sup> Zaman, Amberin. "*Muslims* are accused of killing 'unclean' dogs," [telegraph.co.uk](http://telegraph.co.uk), 27 Mar 2006, *DW*.

<sup>292</sup> Alush, Zvi. "Israeli goat fights terror," [ynetnews.com](http://ynetnews.com), 9 Jan 2006.

<sup>293</sup> Geisler & Saleeb. *Answering*, p. 36.

<sup>294</sup> Dickey, Christopher. "The Suicide Solution," [msnbc.com](http://msnbc.com), 6 Sep 2005.

<sup>295</sup> Dickey, Christopher. "The Suicide Solution," *Newsweek*, [msnbc.com](http://msnbc.com), 6 Sep 2005.

burning (*Sahih Muslim*, bk. 20, nos. 4705-4709; *Sunan Abu-Dawud*, bk. 20, no. 3105; *Malik's Muwatta*, no. 16.12.36).

- \* Because *Islamic* doctrine makes it easy to become a martyr (when compared to Christianity), and because of demons' promptings, *Jihadists* sometimes commit suicide soon after a suicide-attack has failed, or after they are jailed. Suicide by hanging or by hunger striking is a propaganda stunt that sometimes is more persuasive than suicide bombing. For instance: 1) In 2003 when a failed suicide-bomber turned up drowned on a *Tel Aviv* beach, *Muslims* said "To die through drowning is still an act of martyrdom, we believe."<sup>285</sup> 2) In 2006 a *Muslim* who wanted to stab the editor-in-chief of *Die Welt* newspaper for reprinting *Muhammad* cartoons committed suicide in his jail cell.<sup>286</sup> 3) In 2006 three *Jihadists* in jail at *Guantanamo Bay* staged their own hanging as part of their resistance,<sup>287</sup> 4) *Jihadists* in prison go on mass hunger strikes and often are force-fed liquid food via nasotracheal intubation: a) 131 hunger strikers out of 460 *Jihadists* jailed at *Guantanamo Bay* in 2005—and 89 strikers in 2006,<sup>288</sup> b) 500 strikers out of 6,000 *Jihadists* in Israel in 2003<sup>289</sup>—and 4,000 in 2004.<sup>290</sup>

C Kill pigs just as the demons did (Luk 08:32-34)—so now the Mideast is nearly pig-free.

C St. Paul warned that people would come preaching that certain foods were unclean as well as other doctrines learned from demons (1Ti 04:01-03).

C Kill most dogs. In Turkey in 2006 it was reported:

Pro-*Islamic* municipalities in Turkey are killing stray dogs, animal rights groups claim. Municipal workers are hunting, torturing and killing the animals by the hundreds... There is a myth among pious *Muslims* that dogs are unclean.<sup>291</sup>

Dogs' "original sin" is that they devoured the demon's favorite earthly monarch, Queen Jezebel (1Ki 21:23-24; 2Ki 09:10, 36). Tellingly, the symbol both of *satyr* demons and unbelievers, namely the goat "is a very friendly animal and it is accepted in the *Muslim* world."<sup>292</sup>

C Collect the *Jizya* poll tax from Jews and Christians on pain of death, or on pain of *Jihad* warfare (*K* 009:029). The *Jizya* tax was paid to the *Umma* in the form of *Dinar* coins that sported crescents and *Islamic* doctrinal statements. This reminds one of how the spirits were said to play trick-or-treat and demanded food and offerings in the shape of a crescent or with a stamped image of Venus (*Astarte*), or else the sword and famine would follow close on (*Jer* 07:18; 44:17-19, 25).

*Muslims* believe exactly what the demons want them to believe concerning just about everything, which is not surprising since the *Koran* was composed by a demon masquerading as Gabriel (1Ti 04:01). The demons want to harden hearts and make *Muslims* unreceptive to the Gospel. For instance:

C *Muslims* are confident that they will enter heaven as long as they believe in one God and in *Muhammad* as their prophet, but demons (*Jinn*) are said to believe in *Muhammad* (*K* 046:029-032; 072:001-019),<sup>293</sup> and demons believe in one God—same as *Muslims* do, yet Saint James says that the demons tremble (*Jam* 2:19).

C *Muslims* accuse Christians of polytheism similar to how Satan is accusing and slandering Christians (*Job* 01:09; 02:05; *Zec* 03:01; *Luk* 22:31; *Rev*

12:10).

- ⊕ *Muslims* accuse Christians of changing the Bible similar to how Satan tempted Eve saying “Did God really say...?” (Gen 03:01-05).
- ⊕ *Yahveh* offers peace in every way (2Th 03:16), yet *Muslims* want *Jihad* warfare in order to become martyrs to gain heaven and seventy-two *Houris*.
- ⊕ *Yahveh* offers healing if you hear his word (Isa 06:09-10; Mat 13:14-15; Joh 12:39-40; Act 28:26-28) but *Muhammad* said that anyone who dies from disease is a martyr, thereby countering *Yahveh*’s offer. There are seven types of martyrs (*Sahih Muslim*, bk. 20, nos. 4705-4709; *Sunan Abu-Dawud*, bk. 20, no. 3105; *Malik’s Muwatta*, no. 16.12.36).
- ⊕ Jesus said that those who had a tower fall on them were no more sinful than anyone else, so all ought to repent (Luk 13:01-05), but *Muhammad* nullifies Jesus’ appeal by saying any *Muslim* who is crushed by a wall is a martyr (see the *Hadith* listed above for the seven types of martyrs).
- ⊕ *Muhammad* said:

He who is killed while protecting his property is a martyr, and he who is killed while defending his family or his blood or his religion, is a martyr (*Sunan Abu Dawud*, bk. 40, no. 4753; also see no. 4754; *Sahih Bukhari*, vol. 3, bk. 43, no. 660; and *Sahih Muslim*, bk. 1, nos. 259+260). What *Muhammad* taught here encourages suicide-bombings because as long as a *Muslim* can convince himself that he is defending his nation (i.e. blood) or *Islam* (i.e. his religion), he feels assured his obituary will say “martyr” rather than “suicidal maniac.” Moreover, psychologists say that people are more readily inclined to commit suicide attacks against those they perceive to be occupiers of their homelands. Handlers convince *Muslims* that the *Umma* is their homeland, so if any part of *Islamdom* is under attack, *Jihadists* feel their homeland is occupied and their religion is being attacked. This makes suicide-bombings called for—in their mind. C. Dickey wrote:

*Al Qaeda* propaganda tells them that the *Umma*, the global nation of all *Muslims*, is under attack. ‘I am directly responsible for protecting and avenging my *Muslim* brothers and sisters,’ said Mohammad Sidique Khan in his video testament....<sup>294</sup>

‘We know that what we call ‘suicide contagion’ is particularly prevalent in the late teens and early adult age. There is a search for identity and for heroism.’ These are exactly the themes the suicide organizers exploit. They say suicide is no longer suicide, it is martyrdom. Among people who see themselves fighting a hopeless battle against occupation, ‘within their own in-group there’s a kind of veneration that contributes to the contagion effect,’ says Diekstra....And Pape goes further: ‘Once social disapproval for suicide weakens...then you see suicide contagions occur. What happens in suicide terrorism is that not only disapproval wanes but approval grows. The underlying factor that supplies it is the political goal: to expel the foreign occupation forces.’<sup>295</sup>

**VII. Overdose Remedy:** Implore Christians for an exorcism without delay!

**VIII. Dark Side-effects:** Many *Muslims* however for various psychological reasons, cannot handle the *Koran*’s mix of Khidr-Second Lamech Logic and hatred, incitement to violence, and commands to beat wives (*K* 004:034), pimp sex-slaves (*K* 024:033) and rape captives (*K* 004:023-024; 023:005; 033:050; 070:030).

While much *Jihad*-related killing baffles Westerners unfamiliar with the *Koran*-based sermons that *Muslims* hear on tape and in *Mosques*, some *Muslims* engage in erratic behavior that baffles even their coreligionists. For instance:

- ☉ In 2005 a British man was shot by *Muslim* proselytizers after they failed to convert him to *Islam*, though his sister and her friend converted.<sup>296</sup>
- ☉ A *Muslim* in Germany roped up four schoolgirls on a bus and held them hostage at knifepoint.<sup>297</sup>
- ☉ A *Muslim* telephoned threats in to the same synagogue ninety-two times in three days. Instead of blaming this behavior on *Koran* reading, it was said he had a “mental state may have been affected by cannabis or alcohol abuse” or “some kind of paranoid psychotic illness.”<sup>298</sup>
- ☉ An Egyptian stabbed a Hungarian man and woman because they were kissing near *Cairo*’s *Al-Hussein Mosque* even though they were in the main tourist bazaar, *Khan el-Khalili*, and even though *Mosques* are ubiquitous in *Cairo*. Rather than blame this Jack-the-Ripper episode on the *Koran*, the *Cairo* police blamed it on the perpetrators’ unemployment and depression.<sup>299</sup>
- ☉ A man killed his wife and four children as a sacrifice on *Muhammad*’s birthday. The police, struggling to make sense of the crime, said he suspected her of unfaithfulness.<sup>300</sup>
- ☉ An Arizona newspaper reported: “Ali Warrayat was deeply religious and had a *Koran* hanging from his rearview mirror...He said a swastika was once painted on the *Mosque* where he prays, so he had the mark tattooed in red and black on the bottom of his foot. In his religion, stepping on things is considered disrespectful. He also described trying to put the dog in his trunk to show it the *Koran*. He said dogs are ‘filthy’ and that was why the dog didn’t want to be in the trunk with the holy book.”<sup>301</sup>

**IX. Labeling:** The *Koran* contains Khidr-Second Lamech Logic. Just as Lamech Logic made the world so violent that a Flood was called for, Khidr-Second Lamech Logic will hasten the end of the world. So the *Koran* should have a skull-and-crossbones poison symbol on its cover and a childproof lock.

**X. Prescription Copyright Muhammad © 632 AD:**

There is no error in the cocktail ingredients (*K* 004:082). The cocktail’s ingredients cannot be changed (*K* 006:034; 010:064) but the *Koran* can be concentrated or crystallized just as one can make brine or rock-salt out of the ocean saltwater.

The following *Sola Scriptura* pharmacists are famous for their *Reductio ad Jihad et Sharia et Dawa* (Reduction of the *Koran* to *Jihad*, *Sharia* law and Proselytizing) approach to the *Koran*: Mawardi, Ghazali, Maturidi, Taymiya, Wahhabi, Ilyas, Qutb and Maududi (see the ToC for the *Islamist Sola Scriptura* scholars table).

<sup>296</sup> “Man ‘killed by Islamic zealots,’” news.bbc.co.uk, 7 Sep 2005, *JW*.

<sup>297</sup> “Man releases German schoolgirls,” cnn.com, 12 Apr 2005.

<sup>298</sup> “Insulted by a Jew,” sky.com, 25 Feb 2005, *DW*.

<sup>299</sup> Egyptian stabs two Hungarian tourists who kissed outside *Cairo Mosque*,” news.yahoo.com, 29 Mar 2005.

<sup>300</sup> “*Pakistani* says he sacrificed wife, four children for *Muslim* festival,” yahoo.com, 22 Apr 2005.

<sup>301</sup> Davis, Kristina & Katie McDevitt. “Crash into store was a personal statement,” eastvalleytribune.com, 29 Dec 2005, *JW*.

These scholar's distillations of Khidr-Second Lamech Logic mean *Muslims* reach medicinal levels quickly, making their *Jihad* more ruthless and instant, and their ethnic cleansing and *Dawa* proselytizing activities much more intimidating.

### XI. 31 Active Ingredients of Khidr-Second Lamech Logic (Discussion)

**Ingredient 1 (Apocalyptic Thinking):** *Sunnis* believe that if they fight to set up a *Caliphate*, this will precipitate the coming of the *Dajjal* Antichrist who in turn would trigger the return of *Isa* (Jesus). Jesus would then kill the Antichrist, and end Christianity and Judaism. *Hadiths* have *Muhammad* saying that Jesus...

...will descend (to the earth)...[and] He will fight the people for the cause of *Islam*. He will break the cross [i.e. end Christianity], kill swine [i.e. Jews (*K* 002:065-066; 005:060; 007:166)]...<sup>302</sup>

Many *Muslims* have claimed to be a *Caliph* and have demanded the allegiance of all *Muslims*, and then went on the warpath with enthusiastic followers bent on hastening the coming of endtime events. These movements have nearly always led to disastrous consequences for all involved.

There has been speculation that *Usama bin Laden* or *Mullah Omar* of *Al-Qaeda* might anoint himself *Caliph*, especially because a *Caliph* can declare an offensive *Jihad* whereas ordinary *Muslims* can only call for defensive *Jihad*. This explains why terrorists usually couch their *Jihad* talk in terms of *Muslims* being victims defending themselves against aggressors, no matter how absurd it sometimes sounds.

*Muslim* eschatology mentions battles in Rome, Constantinople (*Istanbul*), *Mekka*, *Madina* and Jerusalem. Thus *Muslims* focus on taking or keeping these locales though *Jihad* or demographic warfare, and they feel assured that they will win these battles and eventually take over the entire world.<sup>303</sup>

*Muslim* eschatology gets a bit more involved when one discusses the *Mahdi*, the Guided One. The coming of the *Mahdi* is an official *Shiite* dogma, and is not found in *Sunni* systematic theology. The *Mahdi* is **not** mentioned in the two most authoritative *Hadith* collections: *Sahih Muslim* and *Sahih Bukhari*. Popular belief among some *Sunnis* has it that the last *Caliph* will be the *Mahdi*, but other *Sunnis* say Jesus will be the *Mahdi* when he returns.<sup>304</sup>

The *Mahdi* ushers in a short Millennial-type kingdom before the end of the world where *Muslims* are united in force of arms, in doctrine and in the application of *Sharia* law. After the *Mahdi* appears, comes the Antichrist and then Jesus' return.

The idea of the immanent return of the *Mahdi* inspires violence just as the idea of the revival of the *Caliphate* inspires violence, as does the expectation of reformers who come at the head of each century, for *Muhammad* said:

God will send to this community, at the head of every hundred years, one who will renew for it its religion.<sup>305</sup>

Gibb and Kramers wrote:

<sup>302</sup> *Sunan Abu-Dawud*, "Bk. 37: Battles (*Kitab Al Malahim*)," no. 4310. See also *Sahih Bukhari*, vol. 3, bk. 34, no. 425; vol. 3, bk. 43, no. 656; vol. 4, bk. 55, no. 657; *Sahih Muslim*, bk. 001, nos. 0287, 0289.

<sup>303</sup> "Allah promise to us that we will win this holy war," *JW*, 26 Jun 2006.

<sup>304</sup> Gibb & Kramers. *Concise, Al-Mahdi* entry, p. 311.

<sup>305</sup> *Ahmad ibn Muhammad ibn Hanbal*, v. 34:1, as quoted in Lings. *Sources*, p. 330.



The more...the *Muslims* have felt themselves oppressed and humiliated, either by their own rulers or by non-*Muslims*, the more fervent has been their longing for this ultimate restorer of the true *Islam* and conqueror of the whole world for *Islam*. And as the need for a *Mahdi* has been felt, the [would-be] *Mahdis* have always appeared and *Islam* has risen, sword in hand, under their banner. It is impossible here to give the history of these risings. See for details upon them the article *Mahdi* by Margoliouth in Hasting's *Encyclopedia of Religion and Ethics*, viii, 336-340 and Goldziher, *Vorlesungen*, pp. 231, 268, 291.<sup>306</sup>

Cyril Glassé wrote similarly:

A number of political leaders have exploited these expectations for their own ends and claimed to be the *Mahdi*. Ibn Tumart (470-525/1077-1130) of the *Almohads*, and the *Mahdi* of the *Sudan*, Muhammad Ahmad ibn 'Abd Allah (1259-1303/1843-1885), are historical examples, but contemporary ones are not lacking.<sup>307</sup>

Thomas Patrick Hughes names another would-be *Mahdi*: "Saiyid Ahmad, who fought against the *Sikhs* on the northwest frontier of the *Panjab*, AD 1826..."<sup>308</sup>

In 2006 Saudi Cleric Nasser bin Suleiman Al-'Omar said that many *Muslims* are involved in *Jihad* and terrorism because they want to hurry the prophesied endtime battles where *Muslims* conquer the entire earth. He said:

The *Islamic* nation now faces a great phase of *Jihad*, unlike anything we knew fifty years ago. Fifty years ago, *Jihad* was attributed only to a few individuals in Palestine, and in some other *Muslim* areas. Following the events of *Afghanistan*, the nation has embraced *Jihad*. Young and old, men and women—everyone is talking about *Jihad*.

Whoever is familiar with the *Sunna* and the *Hadith* knows that a battle against the enemies of *Allah* awaits on the horizon, in which the *Muslims* will be victorious. This is confirmed by the reliable *Hadiths*, as well as by reality.

But some young people wish to expedite this, and because of their love for *Jihad*, get involved in things that are not *Jihad*. As I've said, all these minor battles, which took place in certain *Muslim* countries, only delay the victory. This diverts the strife and calamity into the lands of the *Muslims*, instead of aiming them directly at the enemies.

Yes, there are places where *Jihad* is proper—in *Afghanistan*, Palestine, *Iraq*, *Chechnya*, *Kashmir* and the Philippines. There are many places where *Jihad* is undoubtedly proper.<sup>309</sup>

<sup>306</sup> Gibb & Kramers. *Concise, Al-Mahdi* entry, p. 313.

<sup>307</sup> Glassé. *Concise, Al-Mahdi* entry, p. 247.

<sup>308</sup> Hughes. *Dictionary, Al-Mahdi* entry, p. 305.

<sup>309</sup> "Saudi Cleric Nasser bin Suleiman Al-Omar," memritv.org, Clip No. 1122, 19 Apr 2006.

<sup>310</sup> See the Glossary for information on *Islam*'s version of Purgatory.

<sup>311</sup> See the Glossary for information on *Islam*'s version of Purgatory.

<sup>312</sup> *Mishkat Al Masabih* (also spelled *Messabih*), vol. 2, no. 5552, as quoted by Robert Spencer in Glazov, Jamie. "Symposium: *Islamic* anti-Semitism," *FPM*, 31 Oct 2003.

<sup>313</sup> *Sahih Muslim*, bk. 041, nos. 6981-6985; also see *Sahih Muslim*, bk. 041, nos. 6981-6985, as well as *Sahih Bukhari*, vol. 4, bk. 52, nos. 176-177, and *Sahih Bukhari*, vol. 4, bk. 56, no. 791.

<sup>314</sup> Reiss, Rabbi Moshe. "Jihad knocks on House of Saud's door," *Asia Times*, atimes.com, 7 Jul 2005, *JW*.

<sup>315</sup> Thomas, G. "Radical *Islam* Finds Fertile Ground on African Island," *cbn.com*, 24 Feb 2006.

Mideast popular culture complements and enhances apocalyptic thinking since it is all about blood and gore. *Al-Jazeera* plays *Jihadist* footage of firefights, bombings and videotaped beheadings and executions. Mideast TV also broadcast *Jihad* incitement and recruitment pitches, often in the guise of sermons and prayers said in *Mosques*.

Besides teachings about the *Mahdi*, the *Caliphate* and reformers, the *Muslim* mind is constantly being focused on judgment day and purgatory. One way to avoid purgatory fire, which is as hot as hellfire, is by going on *Jihad*. *Jihadists* are promised that they will not enter *Muslim* purgatory if they died during *Jihad*,<sup>310</sup> but they would instead go straight to the heavenly garden (*Janna*) (*K* 002:154; 003:169-170; 009:111).

Anyone who skips purgatory also gets to skip the “eye for an eye” retaliation period between purgatory and heaven where, evidently, *Muslims* will literally poke each others’ eyes out, knock out each others’ teeth, bite each other and such (read about Purgatory in the Plenary Absolution ingredient of this table).

An entry in the popular collection of traditions called the *Mishkat Al Masabih* has *Muhammad* saying that *Muslims* would be able to skip purgatory<sup>311</sup> and gain immediate entrance into heaven if they only killed a Jew or Christian:

When judgment day arrives, *Allah* will give every *Muslim* a Jew or Christian to kill so that the *Muslim* will not enter into hellfire.<sup>312</sup>

*Muhammad* said that even nature would help *Muslims* commit genocides when the last day was near:

The last hour would not come unless the *Muslims* will fight against the Jews and the *Muslims* would kill them until the Jews would hide themselves behind a stone or a tree, and that stone or a tree would say: *Muslim*, or the servant of *Allah*, there is a Jew behind me; come and kill him; but the tree *Gharqad* [box-thorn or salt-bush] would not say [it], for it is the tree of the Jews.<sup>313</sup>

All this **apocalyptic thinking** has led to many murders, sometimes by *Muslims* with unstable personalities. *Rabbi* Moshe Reiss gives an example:

Recently, some have defined this ‘**apocalyptic thinking**’ to mean that every *Muslim* must **kill a Jew or Christian** to substitute for him in hell. This has (as noted by Richard Landes) been interpreted to mean that every *Muslim* has to kill a Jew or a Christian in order to be saved. A French-Arab youngster slaughtered and mutilated a Jew, his neighbor since childhood. He triumphantly announced to his parents, his hands still bloodied, ‘I’ve killed my Jew, I can go to paradise.’<sup>314</sup>

Similarly, in *Zanzibar* a convert from *Islam* to Christianity related to a reporter:

The *Muslims* are teaching people to hate Christians, that if you behead a Christian you will go to heaven.<sup>315</sup>

**Ingredient 2 (Born to be Muslim):** *Muhammad* mentally disarmed and duped his hearers by saying that everyone was born a *Muslim* (*K* 030:030), but non-*Muslim* parents raised their *Muslim* infants to become pagans, Jews and Christians.<sup>316</sup>

<sup>316</sup> *K* 030:030; *Sahih Bukhari*, vol. 2, bk. 23, nos. 440, 441 & 467; vol. 8, bk. 77, no. 597; *Sahih Muslim*, vol. 4, ch. 1107, nos. 6423 & 6426.

Naturally, under *Sharia* law, non-*Muslims* are not allowed to adopt *Muslim* children, even if they are abandoned orphans.<sup>317</sup>

From the *Muslim* perspective, converting to *Islam* is all about unlearning Christianity, Judaism or paganism, and just finding one's natal self and the natural religion of *Islam*. This is a main reason why *Islamic* terrorists see themselves as evangelists for *Islam*—they reason that they do not really have to teach *Islam*, but must just break the infidels' idols and scare infidels away from error, and then the infidels will naturally embrace *Islam* (see the ToC for the Violence-induced Conversion Syndrome (VCS) section).

In order to lose their individual identity and virtually become anonymous, *Muslims*, especially *Jihadists* and converts to *Islam*, take on aliases such as the name *Muhammad* and “the names of the prophet *Muhammad*'s companions.”<sup>318</sup>

*Muhammad* used what was a lie before it became a cliché—that all religions are the same—a canard that overcame criticism of the most objectionable parts of his new religion, for instance:

- ☉ To those who claimed that the *Koran*'s *Allah* was not the same as *Yahveh* of the Bible, *Muhammad* instructed *Muslims* just to insist (with the sword of course) that *Allah* was *Yahveh* (*K* 002:135; 003:064), and that *Muslims* believe what Abraham believed while Jews and Christians corrupted their scriptures and became polytheists (*K* 003:065).
- ☉ To those who objected along the lines of “Their religion [*Islam*] does not stop them from shedding blood, terrifying the roads, and seizing properties,”<sup>319</sup> *Muhammad* said that the *Koran* was no different from: 1) the *Torah* in that Moses authorized killing over spreading corruption in the land” (*K* 005:032) and 2) the *Torah* and the Gospels in that both promised heaven in exchange for dying during *Jihad*, and besides, *Allah*'s mode of dealing with humans does not change (*Rodwell K* 048:023; see also *K* 033:062). Of course these are all lies in that Moses did not authorize individuals to commit terrorism, and the Old Testament does not promise heaven for dying in battle, and the New Testament does not speak of Christians fighting at all, much less promising heaven for dying in battle.

**Ingredient 3 (Present Life Not Meaningful or Fun):** *Muhammad* taught that this mortal life is not a meaningful gift from above but a mere “sport” and “play” provided by *Allah* (*K* 006:032; 029:064; 047:036; 057:020). Those who truly live life are the martyrs. *Muhammad* instructed *Muslims* to “Think not of those who are slain in *Allah*'s way as dead. Nay, they live” (*K* 003:169).

*Muhammad* said that *Muslims* should feel as though they are in jail, for “The world is a prison-house for a believer and Paradise for a non-believer” (*Sahih Muslim*, bk. 42, no. 7058). *Muhammad* said *Muslim* ought to be happy when killing heretics. *Muhammad* said:

Soon there will appear disagreement and dissension in my people; there will be people who will be good in speech and bad in work. They recite the

<sup>317</sup> Duin, Julia. “Christian orphans stuck in limbo in *Iraq*,” *washingtontimes.com*, 22 Dec 2004.

<sup>318</sup> “Focus: Undercover in the academy of hatred,” *timesonline.co.uk*, 7 Aug 2005, *DP*.

<sup>319</sup> *Al-Tabari, The History of Al-Tabari (Ta'rikh Al-rusul wa'l-muluk)*. State University of New York Press, New York, 1993, pp. 187-188, 191-192.

*Koran* but it does not pass their collar-bones. They will swerve from the religion... They are worst of the people and animals. **Happy is the one who kills them and they kill him.** They call to the book of *Allah* but they have nothing to do with it. He who fights against them will be nearer to *Allah* than them (the rest of the people).<sup>320</sup>

One can see from the above texts why the killjoy *Ayatollah* Khomeini said:

*Allah* did not create man so that he could have fun. The aim of creation was for mankind to be put to the test through hardship and prayer. An *Islamic* regime must be serious in every field. There are no jokes in *Islam*. There is no humor in *Islam*. There is no fun in *Islam*. There can be no fun and joy in whatever is serious.<sup>321</sup>

**Ingredient 4 (Death-wish):** The *Koran* repeatedly states that *Muslims* should not love this life (*K* 003:152; 014:003; 016:107; 028:077; 075:020; 076:027), and *Muslims* ought to wish for death during *Jihad* in order to sell or exchange this life for the Hereafter (*K* 004:074; see also *K* 002:094-096; 003:142-143; 033:023; 062:006). The *Hadiths* record the same sentiment found in the *Koran*. *Muhammad* said:

☉ “O *Allah*! There is no life except the life of the Hereafter.”<sup>322</sup>

☉ “O *Allah*! The real life is the life of the Hereafter.”<sup>323</sup>

☉ “O *Allah*! There is no life worth living except the life of the Hereafter.”<sup>324</sup>

☉ “O *Allah*, there is no good except the good of the Hereafter.”<sup>325</sup>

The death wish has been, and is, a major motivator for *Jihadists*. For instance:

☉ Khalid *Al-Walid* (died 642), said in 634 AD when he called on the enemy to surrender:

If you refuse the *Jizya*, I will bring against you tribes of people who are more eager for death than you are for life. We will fight you until God decides between us and you.<sup>326</sup>

☉ *Al-Qaeda* and other *Jihadists* are fond of using the motto: “We love death while you love life.”<sup>327</sup>

☉ In 2006 *Hizbullah* Secretary-General *Sheikh* Nasrallah stated:

Another weakness is that both as individuals and as a collective, they [Israeli Jews] are described by *Allah* as ‘the people who guard their lives most’ [*K* 002:096]. Their strong adherence to this world, with all its vanities and pleasures, constitutes a weakness. In contrast, our people and our nation’s willingness to sacrifice their blood, souls,

<sup>320</sup> *Sunan Abu-Dawud*, bk. 40, no. 4747.

<sup>321</sup> Spencer. *Unveiled*, p. 118.

<sup>322</sup> “No life except Hereafter” (*Bukhari* vol. 4, bk. 52, no. 208; vol. 5, bk. 58, nos. 139-141; vol. 5, bk. 59, no. 424; *Muslim*, bk. 019, nos. 4444 - 4446).

<sup>323</sup> “Real life is Hereafter” (*Bukhari* vol. 5, bk. 59, no. 425).

<sup>324</sup> “No life worth living except hereafter” (*Bukhari* vol. 8, bk. 76, nos. 422+423).

<sup>325</sup> “No good except in hereafter” (*Bukhari*, vol. 4, bk. 52, no. 88; vol. 5, bk. 59, no. 426; *Muslim*, bk. 019, nos. 4447+4448).

<sup>326</sup> Tabari. *The Challenge to the Empires*. Translated by Khalid Yahya Blankinship, SUNY, New York, 1993, vol. 11, p. 4.

<sup>327</sup> Pipes, Daniel. “Islamophobia?” *FPM*, 25 Oct 2005, *DW*.

children, fathers, and families for the sake of the nation's honor, life, and happiness has always been one of our nation's strengths.<sup>328</sup>

**Ingredient 5 (An Abusive Religion):** Overall the *Koran* has 529 verses of injustice, 386 of intolerance, 327 of cruelty and violence, 46 insults to women, and 9 of wicked family values—totaling 1,297 evil verses.

There are only 62 verses that espouse morally acceptable principles<sup>329</sup> and no doubt some of these good verses have been abrogated and rendered obsolete by the Sword Verse. Abrogation and the awful *Hadith* are two topics never discussed when *Muslims* try to show that *Islam* is peaceful and tolerant!

Since there are 6,151 verses in the *Koran*, for each verse in the *Koran* that espouses good, there are twenty-one verses of pure evil, and seventy-eight neutral filler verses. So the *Koran* is 21 percent pure evil, one percent passable and 78 percent filler material.<sup>330</sup>

Moderate *Muslims* ascribe to the 79 percent of the *Koran* that is morally passable or filler material, but *Islamists* ascribe to the entire *Koran*, including the 21 percent of verses that espouse pure evil.

The *Koran* commands *Muslim* men to beat their wives (*K* 004:034), likens them to a field to be ploughed (*K* 002:223), says a woman's testimony is worth half that of a man's (*K* 002:282), allows men to marry four wives, allows men a quick divorce, allows men to have sex with his slaves (*K* 004:003), says a daughter's portion of the inheritance is half that of her brothers' (*K* 004:011) and such.

The *Hadith* are just as misogynistic as the *Koran*. *Muhammad* said that compared to men, women tend to lack common sense, fail at religion and rob others of wisdom (*Sahih Muslim*, bk. 1, no. 142). *Muhammad* even placed women in general on the same low category he placed Jews, pagans and pigs. *Muhammad* said that a woman, Jew, Magian (Zoroastrian), dog, donkey or a pig passing in front a praying *Muslim* closer than a stone's throw away annuls the *Muslim's* prayer.<sup>331</sup>

All the misogynistic features of *Islam* have led to the rampant and systemic abuse of women in *Islamdom* starting already in *Muhammad's* time, as *Muhammad's* favorite wife Aisha said:

I have not seen any woman suffering as much as the believing women.

Look! Her skin is greener than her clothes! [i.e. from a beating her husband meted out] (*Sahih Bukhari*, vol. 7, bk. 72, no. 715).

The *Koran's* effect on *Islamic* society is grim. *The New York Times* reported that in Syria...

...nearly one married woman in four surveyed had been beaten...Many Syrians...do not believe that violence in the home 'counts' as violence....It all depends very much on education and income level, but many people see a

<sup>328</sup> “*Hizbullah* Secretary-General *Sheikh* Nasrallah Speech on *Al-Manar* TV,” memri.org, 26 May 2006, Special Dispatch No. 1176, solomonias.com.

<sup>329</sup> *The Skeptic's Annotated Quran*, skepticsannotatedbible.com/quran/index.html, “Ibn Warraq on How to Debate a *Muslim*, Part III” plus comment, *DW*, 11 Dec 2004, updated 28 Nov 2005.

<sup>330</sup> Rodwell's English *Koran* translation has 6,151 verses (Robertson. *Secrets*, p. 92).

<sup>331</sup> Women passing by annuls prayer: *Sahih Bukhari*, v. 1, bk. 9, nos. 490, 493; *Sahih Muslim*, bk. 4, nos. 1032, 1034, 1038; and *Sunan Abu-Dawud*, bk. 2, nos. 703-704.

woman who is beaten as being in a bad relationship; they don't see her as a victim of violence.<sup>332</sup>

The *Koran's* influence is not quarantined to *Islamdom*, though. When *Muslim* immigrants come to the West, sometimes they combine the worst of both worlds concerning the treatment of women, as Mark Steyn wrote...

...the *tournante* or 'take your turn'—the gang rape that's become an adolescent rite of passage in the *Muslim* quarters of French cities—and similar phenomena throughout the West: 'Multiculturalism means that the worst attributes of *Muslim* culture—the subjugation of women—combine with the worst attributes of Western culture—license and self-gratification.'<sup>333</sup>

The *Koran* says that fornicators are to receive 100 lashes (*K* 024:002), and adulterers are to receive house arrest until death "or God **ordain** for them some (other) way" (*K* 004:015). The way later "**ordained**" for adulterers was stoning, which still happens in parts of *Islamdom* not influenced by the West (*Sahih Muslim*, bk. 17, ch. 3, no. 4206; bk. 17, ch. 4, no. 4194; *Sharia* law manual *Reliance of the Traveler*, o12.0-o12.6).

*Sharia* punishments are carried out by *Sharia* courts, and extra-judicially by *Islamist* vice squads and by family members who carry out "honor-killings" on other family members.

The *Koran* commands, for various offenses, the amputation of hands (*K* 005:038; 012:031, 050) and the amputation of a hand and foot on opposite sides (*K* 005:033, 038; 007:124; 020:071; 026:049).

An amputation must occur even if the stolen object is an egg or rope (*Bukhari* 8:6799; *Muslim* 3:4185), or is worth the paltry sum of a quarter of a *Dinar* coin (*Bukhari* 8:6789; *Muslim* 3:4175-79). The amputation must occur even if the thief repents first (*Ibn Kathir*, 3:175-76; *Bukhari* 8:6800-6801; *Muslim* 3:4187 and 4188).<sup>334</sup>

In case *Sharia* courts are not empowered to exact draconian punishments, individual *Muslims* are permitted to take the initiative and kill anyone who spreads corruption in the land or fights against *Islam*, to include entire nations (*K* 005:033). For instance, *Imam Abu Hamza al-Masri*...

...called upon the faithful to murder female tourists in his native Egypt, saying: 'If a woman, even a *Muslim* woman, is naked and you have no way of covering her up, it is legitimate to kill her.'<sup>335</sup>

Of course "naked" to Hamza means a woman not wearing a *Hijab*. Hamza also said:

The first phase [of *Jihad*] is called the *Shawkat al-Nekaya*, it is called the needle of bleeding the enemy. Like you imagine you have one small knife and you have a big animal in front of you...You have to stab him here and there until he bleeds to death...This is the first stage of *Jihad*, destruction of the enemies of *Allah*. We ask *Muslims* to...bleed the enemies of *Allah*

<sup>332</sup> Zoepf, Katherine. "U.N. Finds That 25% of Married Syrian Women Have Been Beaten," *nytimes.com*, 11 Apr 2006, *DW*.

<sup>333</sup> Steyn, Mark. "Early skirmish in the Eurabian civil war," *telegraph.co.uk*, 8 Nov 2005.

<sup>334</sup> Arlandson, J. "Thieves, give *Muhammad* a hand!" *americanthinker.com*, 12 Apr 2005, *DW*.

<sup>335</sup> "The Voices of *Islam*: What *Muslims* Hear at Friday Prayers," *spiegel.de*, 19 Apr 2006.

<sup>336</sup> O'Neill, Sean. "*Abu Hamza's* video 'call to arms,'" *timesonline.co.uk*, 13 Jan 2006.

<sup>337</sup> "Hamza 'had terrorism manual,'" *thisislondon.co.uk*, 12 Jan 2006, *JW*.

<sup>338</sup> "Hamza attacks 'enemies of *Islam*,'" *news.bbc.co.uk*, 12 Jan 2006, *JW*.

anywhere by any means. You can't do it by nuclear weapon, you have to do it by kitchen knife, no other solution. You can't do it by chemical weapons, you have to do it by mice poison.<sup>336</sup>

Hamza said targets included...“skyscrapers, ports, airports, nuclear plants and football stadiums and large congregations of people at Christmas,”<sup>337</sup> and...

...every place of iniquity, every brothel, every video shop which is selling naked, for the victorious party is a target...Every court is a target and every brothel is a target and everybody who's endorsing that is a target and anybody who goes into these places to protect them, to invite people for them, is a target...Churches have become places of dancing, iniquity, business and black magic. You name it. Child prostitution—and every day there is evidence of that.<sup>338</sup>

**Ingredient 6 (The Right to Seethe With Outrage):** The *Koran* and *Hadith* teach *Muslims* to be outraged and grievously offended against any slight criticism of *Muslim* culture and religion. This behavior all too often climaxes in violence against those allegedly giving the offense, especially because *Muhammad* said that those who “spread corruption in the land,” i.e. undermine in any way *Islamic* culture and religion, ought to be killed (*K* 005:032; see the *Lex Talionis* section of this Khidr-Second Lamech table).

An example of the *Hadith* teaching intolerance, and how and when to seethe, includes *Muhammad's* teaching on daily prayers. While *Muslims* could forego some of the five daily prayers if they feared unbelievers (*K* 004:101), he also said:

He who misses the afternoon prayer, it is as though he has been deprived of his family and his property (*Sahih Muslim*, bk. 4, no 1306).

They diverted us from saying the middle prayer, i.e. the ‘*Asr*’ prayer. May *Allah* fill their houses and graves with fire (*Sahih Muslim*, bk. 4, no 1314).

*Muhammad* set the example for just how incensed *Muslims* ought to become when they are kept from prayers, or when other *Muslims* neglect organized prayer. He burned down the houses of those who failed to show up for Friday prayers at the *Mosque*.<sup>339</sup> He attacked towns if he did not hear a *Muezzin* give the *Adhan* Call to Prayer in the morning.<sup>340</sup> Regarding *Muslim* prayers, Samuel Zwemer wrote: his readers:

A curious tradition is given by *Abu Dawud* [bk. 2, no. 0704], on the authority of *Ibn Abbas*, who said ‘I think the Apostle of God said ‘If one of you prays without a *Sutra* (a thing set up by a praying person) before him, his prayer is apt to be annulled by a dog or an ass or a pig or a Jew or a *Magi* or a menstruating woman; if they pass before him [a *Muslim* praying] they ought to be punished on that account; with the pelting of stones.’<sup>341</sup>

Another *Hadith* says someone who passes in front a praying *Muslim* ought to be forcefully resisted since there is “a devil in him.”<sup>342</sup>

The fact that *Muhammad* taught *Muslims* to be incensed whenever prayer is

<sup>339</sup> *Sahih Bukhari*, vol. 1, bk. 11, nos. 617, 626; vol. 9, bk. 89, no 330; *Muslim* 4:1370.

<sup>340</sup> *Sahih Bukhari*, vol. 1, bk. 011, no. 584, vol. 4, bk. 52, no. 193; *Sahih Muslim*, bk 4, no. 745.

<sup>341</sup> Zwemer. *Animism*, ch. 3 + fn 15: “Ad-Damiri’s *Hayat Al-Hayawan*, 3, v. i, p. 708”; a woman passing by annuls prayer: *Sahih Bukhari*, v. 1, bk. 9, nos. 490, 493; *Sahih Muslim*, bk. 4, nos. 1032, 1034, 1038; and *Sunan Abu-Dawud*, bk. 2, nos. 703-704.

<sup>342</sup> *Sahih Muslim*, bk. 4, no 1025, see also nos. 1023-1024 and *Sunan Abu Dawud*, bk. 2, no. 718.

interrupted is a reason that *Muslims* tack this charge on to their other complaints, for instance:

- ⊕ Arresting police officers are often accused of disrupting prayer times at home or in a *Mosque*, as the news outlet, the *Philippine Daily Inquirer*, reported in 2005:

They said some of the arrested men were in mid-afternoon prayers when the raiders barged in.<sup>343</sup>

- ⊕ In 2005, 16 *Jihadist* inmates awaiting trial said that before the assistant superintendent of a *Pakistani* military jail, Tipu Sultan threw a *Koran* on the ground, he “forced them to stop their prayers.”<sup>344</sup>

*Islamists* do not believe in accommodating infidel sensibilities regarding dress,

<sup>343</sup> Esguerra, Christian. “Bombs, guns in raid ‘planted,’ says group,” *Philippine Daily Inquirer*, p. A1, 11 Jan 2005, cross-posted at news.inq7.net, hinduvoice.net, and *JW* on 12 Jan 2005.

<sup>344</sup> Shahzad, Saleem Syed. “Pakistan: Jihadis Allege Desecration of *Koran* in Jail,” adnki.com, 27 Dec 2005, *JW*.

<sup>345</sup> Rosenthal, John. “What a Relief!: Relatively ‘Few’ *Islamic* Radicals Employed at French Airports,” Transatlantic Intelligencer, trans-int.com, 26 Apr 2006, solomonias.com.

<sup>346</sup> “With war on terror, Blair losing battle for hearts of British *Muslims*: poll Monday,” uk.news.yahoo.com, 29 Nov 2005.

<sup>347</sup> Pipes, Daniel. “Weblog: *Islamists* Infiltrate Law Enforcement,” *DP*, 24 Jan 2005.

<sup>348</sup> Bennet, J. “Palestinians’ Big Plans for *Gaza*, With a Bit of Doubt,” nytimes.com, 27 Aug 2005.

<sup>349</sup> Vidino, Lorenzo. “The *Muslim* Brotherhood and *Islamic* law in Europe,”

counterterrorismblog.org, 30 Apr 2006.

<sup>350</sup> Raab, David. “The Beleaguered Christians of the Palestinian-controlled Areas,” IMRA, imra.org.il, 10 Oct 2002.

<sup>351</sup> Yeor. *Dhimmitude*, pp. 179, 335.

<sup>352</sup> Hares, Walid. “New Targets for Suicide-bombers,” *FPM*, 7 Oct 2003.

<sup>353</sup> “Iraqis protest Saturdays off,” jpost.com, 27 Feb 2005, *DW*.

<sup>354</sup> “Iraqis protest Saturdays off,” jpost.com, 27 Feb 2005, *DW*.

<sup>355</sup> “*Islamic* militants tell *Thais* to stop all work on Fridays,” gulf-times.com, 26 July 2005.

<sup>356</sup> “*Thai Muslim* militants expand no-work order,” alertnet.org, 10 Aug 2005, *C&R*.

<sup>357</sup> Moore, Charles. “Is it only Mr Bean who resists this new religious intolerance?” telegraph.co.uk, 11 Dec 2004, *LGF*, 12 Dec 2004.

<sup>358</sup> Campbell, Lynn & Shirley Ragsdale. “*Muslims* condemn cartoon-sparked violence,” desmoinesregister.com, 7 Feb 2006, mychristianblood.blogspot.com

<sup>359</sup> Campbell, Lynn & Shirley Ragsdale. “*Muslims* condemn cartoon-sparked violence,” *Idem*.

<sup>360</sup> Fleming, John V. “First Amendment Riots, er, Rights,” dailyprincetonian.com, 6 Feb 2006.

<sup>361</sup> “Mushrooming cartoon clash provokes world debate,” monstersandcritics.com, 4 Feb 2006.

<sup>362</sup> “Palestinians die on ‘day of rage,’” news.bbc.co.uk, 6 Oct 2000.

<sup>363</sup> “*Muslims* Plan Mass Prayers to Protest At Cartoons Slur,” *The Nation (Nairobi)*, allafrika.com, 6 Feb 2006.

<sup>364</sup> Moore, Charles. “Is it only Mr Bean who resists this new religious intolerance?” telegraph.co.uk, 11 Dec 2004, *LGF*, 12 Dec 2004.

<sup>365</sup> Warraq. *Why*, p. 353.

<sup>366</sup> Glazov, Jamie. “We Are All Souad,” *FPM*, 9 Jun 2004.

<sup>367</sup> Dalrymple, Theodore. “The Suicide Bombers Among Us,” city-journal.org, Autumn 2005.

<sup>368</sup> von Rohr, Mathieu. “Zacarias Moussaoui’s Mother Talks: ‘He Was Such a Nice Boy,’” *Spiegel Online*, spiegel.de, 27 Apr 2006, *JW*.

<sup>369</sup> Khadim, Farhad. “Analogy of Zidane and the *Muslim Ummah*,” Article Ref: IV0607-3039, 13 Jul 2006, *JW*.

<sup>370</sup> Waked, Ali. “Anti-*Muslim* graffiti in *Hebron*,” ynetnews.com, 1 Jun 2005, *C&R*.

<sup>371</sup> Waked, Ali. “Anti-*Muslim* graffiti in *Hebron*,” ynetnews.com, 1 Jun 2005, *C&R*.

<sup>372</sup> Weiss, Efrat. “*J’lem* stabbing—to ‘avenge pig in *Mosque*,’” ynetnews.com, 11 Oct 2005.

<sup>373</sup> “Are *Muslims* the Jews of Today?” fjordman.blogspot.com, 28 Nov 2005, *DW*.



work activities and religious rites. For instance:

- ☉ At two Paris airports at *Orly* and *Roissy*, there are forty known *Islamists* (*Salafists*) and 122 *Muslims* are under suspicion of being *Islamists*. Some refuse “to have any contact with female personnel,” grow their beards, wear a *Djellaba*, or demand that their schedules be adjusted “to accommodate their prayers.” “In *Lyon*, employees of the company *Servair* wrote pro *Bin Laden* slogans on the doors of a plane.”<sup>345</sup>
- ☉ A 2004 poll of UK *Muslims* revealed that:
  - ★ “Fifty-five percent said schools should not be allowed to ban pupils from wearing the *Hijab*, or *Islamic* headscarf, on the premises.”
  - ★ “Eighty-eight percent say schools and workplaces should accommodate *Muslim* prayer times as part of their normal day. Some 51 percent say they pray five times every day, 46 percent of men and 68 percent of women.”<sup>346</sup>
- ☉ *Muslims* in the US do not hesitate to sue their employers if they must work through any of the five daily prayers even if this means shutting down assembly lines and wasting the time of infidel workers.<sup>347</sup>

The five daily prayers occur at changing times during the day since they are astronomically determined (e.g. sunrise, sun just after zenith, sunset). Depending on the time zone and daylight savings time, the noon *Zuhr* prayer can occur at 11:34 AM or 12:57 PM. Variable start times means everyone working with observant *Muslims* must constantly refer to a prayer time chart and watch the clock, and provide prayer rooms.

*Muslims* also tend to want all work and business decision-making to cease during prayer times. In other words, *Muslims* are not happy unless everyone is praying. For example, *The New York Times* reported:

Yet grumbling over the Authority’s management has already begun. As part of a new outreach effort, Palestinian officials briefed municipal leaders on Sunday night about the receiving teams. **Late in the presentation**, the mayor of the central *Gaza* town of *Deir el Balah*, a *Hamis* member named Ahmed *al-Kord* **excused himself to pray** [for the *Maghrib* sunset or *Isha* night prayer time]. When he returned a few minutes later, he found that the meeting was breaking up. ‘I thought there would be a discussion group,’ he said to *Muhammad* Kafarna, another *Hamis* member, who is the mayor of the northern town of *Beit Hanun*. ‘They showed us the plan and left,’ Mr. Kafarna said. He added to a reporter, ‘To the media they’re talking about participation. But in practice it doesn’t exist.’<sup>348</sup>

In other words, *Salat* prayer times are perpetual grievance-producing machine that often ends up in litigation, if not *Jihad*-inspired terrorism.

While *Muhammad* could have chosen Saturday or Sunday for his day of prayer, he chose Friday so that *Muslims* would be working and selling while Christians and Jews were worshipping and resting, and *Muslims* would be in the *Mosque* on Friday and not buying anything from Christians and Jews. In effect, it was a two-day per week boycott of Christian and Jewish businesses.

*Muhammad* also sought to disrupt the Judeo-Christian workday by interposing five daily prayers at odd hours, which is more intrusive than three prayers at morning, noon and night (Psa 055:017; Dan 06:10, 13).

*Muhammad*’s boycott of the Judeo-Christain workweek and calendar is continued today whenever *Muslims* **demand** time off on Friday for prayer at the

*Mosque*, and time off for *Muslim* holidays. Sweden's largest *Muslim* organization, the Brotherhood-linked *Sveriges Muslimska Förbund* (SMF) sent a list of "demands" to all Swedish political parties. Two of the demands were:

Swedish *Muslims* should be given time off work for Friday prayers and *Islamic* holidays...<sup>349</sup>

What *Islamists* eventually will demand is that no one work on Friday, the *Muslim* Day of Prayer. Also, if there is to be a two-day weekend, *Islamists* will eventually demand that the weekend be on Thursday and Friday so as not to make any concessions to Jews or Christians regarding Saturday or Sunday.

Trying to change the weekend to Thursday-Friday is an attack on the Judeo-Christian weekend, and is alluded to in the *Jihadist* slogan:

First the Saturday people (Jews), then the Sunday people (the Christians) (Arabic: *Al Yom Al Sabt Wa Ghadan Al Ahad*).<sup>350 351 352</sup>

When the *Iraqi* interim government proposed a Friday-Saturday weekend to replace the Thursday-Friday weekend, *Islamists* said that observing "the Zionism holiday" would be "depriving *Iraqis* of their identity" because "Thursday and Friday...were blessed in *Islam* and by *Sharia*."<sup>353</sup> Notice that having Sunday off was not seriously considered though there are Christians in *Iraq*.

*Muslims* can be deadly serious about the Thursday-Friday weekend too:

In predominantly *Sunni Samarra* [in *Iraq*], the *Mutawakal* high school opened after insurgents threatened to kill its teachers if they took the day [Saturday] off.<sup>354</sup>

In southern *Thailand*, *Islamists* killed dozens of rubber plantation owners and workers. Then in July 2005 a leaflet was sent out demanding that *Thais* not work on Friday—the *Muslim* day of prayer. *Gulf Times* reported:

‘I have no idea who did this, but it was like magic. Everybody seems to be obeying,’ said 51-year-old Yarn Rattananiyom, another rubber farmer. ‘Definitely, I will not go out tapping on Fridays no matter how good rubber prices are,’ he said.<sup>355</sup>

*Muslims* then demanded that *Thais* not work on Thursday too so as to *Islamize* the area as well as undermine the *Thai* government which "marks Saturday and Sunday as the weekend," as *Reuters* reported:

*Muslim* militants, having scared many people in three southern *Thai* provinces into not working on Fridays, the *Islamic* holy day, have distributed a leaflet ordering a work-free Thursday as well.<sup>356</sup>

Charles Moore wrote of the theological reason why *Muslims* are so touchy:

In a religion [*Islam*] which, unlike Christianity, has no idea of a God who himself suffers humiliation, all insult must be avenged if the honour of God is to be upheld.<sup>357</sup>

*Muhammad* said that *Muslims* are to start a fight over any slight about *Islam* or *Muhammad* (*K* 009:012). All 1.2 billion *Muslims* are each supposed to treat a real or imagined insult against *Islam* as though the critic insulted his or her own mother or sister (*K* 033:006).

In 2006, when a Danish newspaper printed twelve caricatures of *Muhammad*, *Imam Ibrahim Dremali* from Des Moines *Islamic* Center in Iowa, USA stated in keeping with the spirit of *K* 033:006:

*Muhammad* and *Allah* are more valuable to us than our own lives, the lives of our children, mothers and fathers...So when someone comes along and publishes those pictures, they must know what they are doing. They are

testing *Muslims*, trying to see what we will do, how we will react. It is an insult to the prophet, God, *Muslims*, *Islam*, the *Quran* and all humanity.<sup>358</sup>

Mohamad Khan, an *Imam* at the *Muslim* Community Center of Des Moines, said:

When it first came out, some of the European press were making a lot of fun out of it...I knew it would cause great anger and that if there wasn't an apology, the people would show their outrage.<sup>359</sup>

*Muslims* even called for "an international day of rage" over the cartoons<sup>360</sup> similar to other days of rage *Palestinians* have observed in the recent past during *Intifada* II.<sup>362</sup> They also called for group prayer to "express our love of the Prophet *Muhammad*."<sup>363</sup>

In 2004, Iqbal Sacranie of the mainstream *Muslim* Council of Britain said "any defamation of the character of the prophet Mohammed..." is a 'direct insult and abuse of the *Muslim* community.'<sup>364</sup> Taking this perspective tends to magnify any slight, whether intentional or not, into a monstrous outrage deserving of jail-time or capital punishment. This goes a long way in explaining a tendency among *Muslims*, as Warraq noted:

We notice the double standards inherent in all such *Muslim* demands. While *Muslims* feel free to insult Christianity [with impunity], they themselves go into paroxysms [i.e. tantrums] of rage and violence at the slightest hint of criticism of *Islam*, which must be 'accepted uncritically as divine revelation by non-*Muslims* as well as by *Muslims*, and this must be reflected in the structure and conduct of the state and of society.'<sup>365</sup>

Jamie Glazov described the rage that *Islamists* often exhibit as being comparable to the scene that possessed persons make during demon exorcism.<sup>366</sup>

Theodore Dalrymple wrote on the subject on how *Muslims* handle insults:

The French-*Iranian* researcher Farhad Khosrokhavar, who interviewed 15 French *Muslim* prisoners convicted of planning terrorist acts, relates in his book, *Suicide Bombers: Allah's New Martyrs*, how some of his interviewees had been converted to the terrorist outlook by a single insulting remark—for example, when one of their sisters was called a 'dirty Arab' when she explained how she could not leave home on her own as other girls could...[Thus] an insult is understood not as an inevitable human annoyance, but as a wound that outweighs all the rest of one's experience.<sup>367</sup>

The rage that *Muslims* feel upon being called a name sometimes leads to *Jihad* and terrorism. For instance, the mother of Zacarias Moussaoui, the alleged "20th hijacker" in the 9/11 plot, said that her son started down the road to fundamentalism and terrorism because:

He couldn't stand being called a 'dirty Arab' on the street...That's how it started.<sup>368</sup>

Farhad Khadim described what sets some *Muslims* off on the path of terrorism:

And like the *Ummah* today, the provocation was too much for him. He snapped and did something uncharacteristic because he felt victimized. Perhaps he was called a 'dirty terrorist' as some report, or his sister or mother were called by some degrading name as others report. Whatever it was, he lost all sense of where he was, his legacy, his future and the difference he could have made to the game, and fell victim to the deliberate provocative assaults on his person.<sup>369</sup>

The rage that *Muslims* feel when *Muhammad* is insulted leads to violence. For instance, in 2005, when an unknown person scrawled the graffiti "*Muhammad* is

a pig,” on a *Hebron Mosque* wall, *Muslims* were “boiling over [at] the perceived slight.” This graffiti was “driving people to the point of insanity” and seven people had to be arrested.<sup>370</sup>

The *Hebron* mayor Arif *Al-Jabari* responded to the graffiti using the well-worn verbiage about how the victims will be responsible for any heinous act that *Muslims* may commit—in other words, mere graffiti disrespecting *Muhammad* excuses and justifies murder or mass-murder:

If the Israelis do not put an end to these extremists’ actions, we will consider them responsible for the escalation that will follow, given their acceptance and excusing of the extremists’ actions.’ *Jabari* also said the graffiti was not just an insult to Palestinian *Muslims*, but to *Muslims* everywhere. ‘We respect everyone, and only one side is responsible for this. *Israel* must act quickly to prevent a further escalation,’ *Jabari* said.<sup>371</sup>

Later in 2005, as though on cue, a *Muslim* stabbed three Israelis in Jerusalem, killing one. The reasons he gave was someone tossed a pig’s head into a walled *Mosque* compound in *Tel Aviv*, and someone else drew a pig on a *Mosque* wall in *Hebron*.<sup>372</sup>

Some people afflicted with PC-AIDS and PC-ASS notice that *Muslims* often behave worse when criticized, so they suggest that *Muslims* and *Islam* not be criticized at all. Some PC critics compare critics of *Islam*, whom they call *Islamophobes*, to racists whose damaging criticisms contributed to societal woes.

The situation of today’s *Muslims* however hardly compares to that of any of yesterday’s downtrodden peoples, but compares rather well to that of yesteryear’s fascists!<sup>373</sup> Not criticizing *Islam* neither helps *Muslims* nor non-*Muslims* since:

- ☉ *Islam* did not moderate itself at all over 1350 years in the near absence of serious criticism, so even if all the critics of *Islam* are silenced, the *Koran* and *Islamic* literature will continue to speak with deleterious effect.
- ☉ *Muslims*’ bad reactions to exposure to criticism are not a natural reflex response but are a result of learning and conditioning that can only be undone by steady doses of—or even a diet of—criticism.
- ☉ America was repeatedly attacked by *Islamists* even though nearly all Americans were blissfully unaware of *Islam* until after 9/11, and Jews in Europe have been attacked by *Islamists* regardless of whether they are critical of *Israel* and sympathetic to *Islam*’s cause in the Holy Land.
- ☉ Critics of *Islam* note that their criticisms are factually-based and are laced with direct quotes of canonical *Islamic* literature, while racist propaganda is based on an alloy of murky conspiracy theories, pseudo-science and forged documents, e.g. the Protocols of the Elders of Zion.

**Ingredient 7 (Code-of-Silence):** *Islamists* only believe in *Sharia* law<sup>374</sup> and generally do not accept the validity of non-*Muslim* governments.<sup>375</sup> Usman Badar, president of the University of NSW *Muslim* Students Association in Australia said:

Western values are not worthy of human subscription...Democracy sounds nice enough, (but) not to a *Muslim*...Sovereignty is for none but *Allah*...*Allah*

<sup>374</sup> Do not obey any lawcode besides *Sharia* law: K 004:059-061, 065, 115; 005:044-45, 47, 50; 024:047-051; 028:050; 042:02; 058:020.

<sup>375</sup> Do not obey any non-*Muslim* ruler: K 003:149; 025:052; 026:151; 033:001, 048; 068:008; 076:024; 096:019.

did not say...whatever the people want, we'll have this. [Secular society] relegates *Allah* to the margins of public life and places human beings above him. This, to put it blatantly, is as blasphemous as it gets.<sup>376</sup>

By contrast, Christians believe in paying taxes and rendering obedience both to Caesar and to *Yahveh* (Mat 22:21). Christians have nothing comparable to the draconian *Sharia* law code.

The *Koran* (e.g. K 004:092) and *Sharia* law were the driving force behind the expanding *Madinan* state that later became the *Islamic* empire, which explains why *Muslims* wish to implement *Sharia* law in autonomous neighborhoods, and why *Muslims* seek ever-expanding zone of influence within infidel lands. In fact,

...the European Council for *Fatwa* and Research, a *Muslim* Brotherhood front group led by Tariq Ramadan and *Sheikh* Yusuf *al-Qaradawi*, is working on a special constitution for European *Muslims*—that will be ‘above national legislation.’<sup>377</sup>

While many *Muslims* are reticent to contact or cooperate with infidel police even in matters where *Sharia* law and civil law overlap, they are absolutely averse to contacting the infidel police whenever acts legal under *Sharia* law are criminalized under secular law. The UK’s *The Globe and Mail* reported:

Thousands of young—mostly *Muslim*—women are thought to be subjected to forced marriages each year, although the true scale of the problem is hidden behind a code-of-silence.<sup>378</sup>

*Islamists* have a love-hate relationship with the civil courts, meaning they want it to serve their interests but not that of others:

☉ *MSNBC* reported that a top *Al-Qaeda* leader “rejected the authority of secular institutions,” but “he once filed a libel lawsuit in a British court against the Arabic-language newspaper *Al-Hayat*.”<sup>379</sup>

☉ *CAIR* sued the website Anti-*CAIR* but the suit was “dismissed with prejudice.” *CAIR* wanted to avoid the discovery process so their organizational chart, funders and dodgy contacts could be kept secret.<sup>380</sup>

*Islamists* have the same love-hate relationship with law enforcement and the criminal legal system. *Islamists* sympathize with or support *Jihadism*, i.e. terrorism, and believe that infidels are unclean (*Najis*), so if they call 9-1-1 at all, it is definitely not because they are looking out for the safety and welfare of infidels, but rather only themselves and other *Muslims*. In deciding whether to call 9-1-1 for the police, *Islamists* run the scenario through their Us-Versus-Them filter first which has been summarized as:

Me and my brother against my cousin, me and my cousin against the world.<sup>381</sup>

<sup>376</sup> Bolt, Andrew. “*Muslims* here who say democracy is a no, no,” *Herald Sun*, [heraldsun.news.com.au](http://heraldsun.news.com.au), 14 Apr 2006.

<sup>377</sup> Johnson, Charles. “A *Muslim* Constitution in Europe,” *LGF*, 26 Jun 2006, “*Islamistisk forfatning i Europa*,” [dr.dk](http://dr.dk), 21 Jun 2006.

<sup>378</sup> Hickley, Matthew. “Plans to outlaw forced marriages shelved,” [dailymail.co.uk](http://dailymail.co.uk), 7 Jun 2006.

<sup>379</sup> Whitlock, Craig. “The architect of the new war on the West,” [washingtonpost.com](http://washingtonpost.com), 22 May 2006.

<sup>380</sup> Pipes, Daniel. “*CAIR* Backs Down from Anti-*CAIR*,” *DP*, 21 Apr 2006.

<sup>381</sup> “*Iraq* and *al Qaeda*: Who’s campaigning to deny the links?” *WSJ*, 25 Oct 2002; “Kid gloves syndrome,” [theaustralian.news.com.au](http://theaustralian.news.com.au), 28 Jan 2006.

*Islamists* have the same love-hate relationship with the emergency medical services, as Ynet reported in 2006:

...at the *Al-Ghurabaa* website, a reader sent in a question, asking: ‘If a *Kaffir* (infidel) is about to die on the road, can we help him?’ He was told that a dying ‘infidel’ could only be helped on the condition that he was called to *Islam*. ‘If someone had Covenant of Security with the people he is living with, and the person was not at war with *Islam* and *Muslims*, it is allowed to help the person as part of his *Da’wah* (*Islamic* spiritual awakening) to show his good character. But he must call him to *Islam* by it, and not do it out of love, [i.e., *Muslims* are to hate infidels]’ the site’s web team answered.<sup>382</sup>

Because of their love-hate relationship with the police, *Islamists* accuse the police of racism if they profile based on culture, religion or race in the attempt to catch terrorists or crack down on *Muslim* gangs. Police are then afraid they will be fired (sacked) or made to “undergo courses in racism awareness and valuing cultural diversity.”<sup>383</sup> This allows *Islamists* to create autonomous zones where the *Koran* is the law of the land, for instance:

- ☉ “The reluctance of police to tackle ethnic criminals has allowed gangs to operate with impunity in areas of Scotland, the north of England and parts of London” and UK Member of Parliament Mohammad Sarwar admitted that “some communities are being terrorized” by these gangs.<sup>384</sup>
- ☉ Due to Arab recrimination, there is an “increasing police reluctance to operate in Arab communities” in *Israel* and a “lack of adequate police response” whenever Arabs are involved.<sup>385</sup>

Incidentally, *Islamists* often form autonomous zones where the police fear to tread, but this is covered in the Irredentist Turf section of this table.

*Islamic* leaders often refuse government requests to ask their people to report radicals, extremists and potential terrorists to police, something that they consider “spying.”<sup>386</sup> Sham reasons given for the refusal to cooperate include:

- ☉ Syed Reza of Young *Muslims* of Canada “was offended by the assumption he would even have a close proximity to potential terrorists,” as though the police must assume that there are no fewer degrees of separation (*a la* Kevin Bacon) between *Muslims* and *Islamic* terrorists than between the average Canadian and *Islamic* terrorists.
- ☉ Karl Nickner, Executive Director of CAIR-Canada, said, “The community shouldn’t have to apologize for 17 people who may have had extremist ideas...Do we ask the Italian community to apologize for the *Mafia*? No, we don’t, and we shouldn’t.” Of course, this comparison is absurd because while Italians dread the *Mafia* and the *Mafia* relies on protection-money rackets to survive, *Muslims* willingly collect *Zakat* charitable money for *Islamic* terrorists, harbor terrorists, and elect *Islamists* as their leaders.<sup>387</sup>

Meanwhile, *Muslim* leaders encourage *Muslims* to report non-*Muslims* to the police:

<sup>382</sup> Lappin, Yaakov. “Lappin UK site: Can we help dying infidel?” ynetnews.com, 5 Jun 2006, *JW*.

<sup>383</sup> Macaskill, Mark & Jim McBeth. “Sarwar: police too scared of Asian gangs,” timesonline.co.uk, 8 Jan 2006, *DW*.

<sup>384</sup> Macaskill, Mark & Jim McBeth. “Sarwar: police too scared of Asian gangs,” *Idem*.

<sup>385</sup> “Rioting in *Sakhnin*,” jpost.com, 10 Jan 2006.

<sup>386</sup> “Australian *Islamic* leader rejects call to ‘spy’ on *Muslims*,” news.yahoo.com, 13 Nov 2005.

<sup>387</sup> Clarkson, Brett. “Know your rights, *Muslims* urged,” torontosun.com, 16 Jul 2006, *LGF*.

- ⊕ *Muslims* agree to monitor the alleged hate speech of Christian pastors who warn against *Islamists*. In 2005, two Christian pastors in Australia stand to be fined and jailed under religious vilification laws.<sup>388</sup> Tariq Ramadan advises *Muslims* to quickly sue over alleged hate speech:

We as *Muslims* in Europe should stand proud. If any one acts against *Islam* and *Muslims*, sue them immediately.<sup>389</sup>

- ⊕ *Muslims* monitor around their *Mosques* so pranksters, vandals and trespassers are arrested outside *Mosques* while inside the very same *Mosques* sermons and prayers of incitement goes unreported.<sup>390</sup>
- ⊕ *Islamist* groups advise *Muslims* to avoid the police if possible, and to not cooperate with, nor volunteer information to, the police.<sup>391</sup> If however *Muslims* are slighted or assaulted somehow by non-*Muslims*, they are to immediately seek out the police for legal recourse.<sup>392</sup>
- ⊕ *Muslims* use civil libel and slander lawsuits to keep reporters at bay. The Sun reported on one such case:

That lawsuit, according to journalists and terrorism investigators, is part of a larger trend of litigation by *Muslim* groups that, they say, is having a ‘chilling effect’ on the ability to report domestic ties to terrorism.<sup>393</sup>

- ⊕ In 2006<sup>394</sup> a prominent *Muslim* filed a complaint that led to Alberta Canada’s Human Rights Commission suing the *Western Standard* magazine over publishing the silly Danish *Muhammad* cartoons.
- ⊕ In 1998 a *Muslim* FBI agent refused to tape-record conversations with a *Muslim* who was eventually put on trial for sending money to *Islamic Jihad* in Palestine, saying “A *Muslim* does not record another *Muslim*.” He also tipped *Muslims* off that they were under FBI surveillance.<sup>395</sup>
- ⊕ U.N. nuclear watchdog agency chief Mohamed *El-Baradei*, a devout *Muslim* from Egypt who was supposed to ensure that *Iran* does not create nuclear weapons (as *Pakistan* secretly did), warned *Israel*, which is fighting for its very existence in the face of *Iranian* leaders threats to “wipe *Israel* off the map,” not to bomb *Iranian* atomic facilities saying:

‘You cannot use force to prevent a country from obtaining nuclear weapons. By bombing them half to death, you can only delay the plans,’ *El-Baradei* was quoted as saying by the respected *Oslo* newspaper *Aftenposten*. ‘But they will come back and they will demand revenge.’<sup>396</sup>

Notice how *El-Baradei*’s boosterism is pro-*Iran*, the very country he is supposed to inspect. *El-Baradei* also engaged in moral equivocation by

<sup>388</sup> Sheehan, Paul. “Spreading the word of intolerance,” smh.com.au, 4 Oct 2004; also Bolt, Andrew. “Let us all pray,” *Herald Sun*, jimball.com.au, 14 Nov 2003.

<sup>389</sup> Kucuk, Bahtiyar. “Media Responsible for *Islamophobia*,” zaman.com, 2 Jul 2006, *DW*.

<sup>390</sup> Munro, Ian. “Jews offer safety tips to *Muslims*,” theage.com.au, 28 Nov 2005, israellycool.com.

<sup>391</sup> “Call to *Muslims* over police help,” news.bbc.co.uk, 7 Jun 2006, *JW*.

<sup>392</sup> “CAIR’s inconsistent Advice on Law Enforcement,” *DP*, 4 Jul 2004.

<sup>393</sup> Clyne, Meghan. “Treasury Department Tars Alamoudi, Founder of the *Islamic Society of Boston*,” nysun.com, 9 Dec 2005, *JW*.

<sup>394</sup> “W. S. sued for publishing cartoons,” westernstandard.blogs.com, 29 Mar 2006, *LGF*.

<sup>395</sup> Sperry, Paul. “Sami’s Guardian Angel,” *FPM*, 9 Dec 2005, *JW*.

<sup>396</sup> “*Iranian* Ayatollah supports his president,” jpost.com, 10 Dec 2005.

implying that the real problem is not that *Iran* might get nuclear weapons but that anyone has them:

...I believe nuclear weapons should have no place in our collective conscience...How do we create an environment in which all of us would look at nuclear weapons the way we look at slavery or genocide, as a taboo and a historical anomaly?<sup>397</sup>

El-Baradei even suggested that the US give *Iran* a guarantee that it would not attack *Iran*, even though *Iran* is an international terrorism-supporting state.<sup>398</sup>

*Islamists* are loath to ever contact the government about an *Islamic* terrorist. *Imam* Omar Bakri Mohammed, who wanted “to replace Britain’s democratic government with a regime based on *Sharia*, *Islamic* religious law,” stated:

I have said publicly, on the record, if I knew somebody was going to attack here...I would never tell the police. I am not working for the police. I would never, ever, tell the police about any *Muslim*. It is God-forbidden.<sup>399</sup>

Another reason that Bakri would not tip off the police is in many countries, a terrorist plotter could be jailed for a long while or receive the death sentence. *Muhammad* however said “No *Muslim* should be killed [suffer the death penalty] for killing a *Kafir* [an infidel] (*Hadith Sahih Al Bukhari*, vol. 9, bk. 83, no. 50; also vol. 1, bk. 3, no. 111). Also, *Al-Ghazali* (1058-1111 AD) wrote:

Speaking is a means to achieve objectives...when one conceals the whereabouts of a *Muslim* from an oppressor who asks where he is, it is obligatory to lie about him his hiding. Or when a person entrusts an article with one for safekeeping and an oppressor, wanting to appropriate it, inquires about it, it is obligatory to lie about its concealment. If one informs the oppressor about the article and he seizes it, then one is financially liable to the owner to cover the article’s cost.<sup>400</sup>

Even if a *Muslim* found the criminal conduct of another *Muslim* objectionable, he might stay quiet if informing on the *Muslim* might lead to undesirable results under the *Islamic* principle “that stipulates ‘silence about a despicable thing, if the result of its uprooting is liable to cause something even more despicable.’”<sup>401</sup>

The above reasons explain why:

C Terrorists generally can work unhindered among *Muslims*, and why *Islamist* groups can establish a foothold among any *Muslim* population. For instance, Imran Khan of the *BBC* reported:

We asked Osman Abdullah, last years head of *Islamic* Society, why he did not inform the Union or the University about the activities of *Hizb Ut Tahrir* (*HuT*). He said ‘What could we have done, tell me? You’re telling us to go to the *Kaffir* against a *Muslim*, is that what you are saying we should have done?’ *Kaffir* is Arabic for Infidel. This reluctance to sell out your brother or your sister is allowing groups like *HuT* to get in a real place in Britain.<sup>402</sup>

<sup>397</sup> Krieger, Hilary L. “ElBaradei: Don’t bomb *Iran*’s nuclear facilities,” jpost.com, 11 Dec 2005.

<sup>398</sup> “Bush administration rules out security guarantee for *Iran*,” kvoa.com, 13 Dec 2005.

<sup>399</sup> Isikoff, Michael & Mark Hosenball. “Transplanted *Jihadi*,” msnbc.com, 17 Aug 2005, *JW*.

<sup>400</sup> Misri. *Reliance*, section r8.2, page 745.

<sup>401</sup> Bar’el. Zvi. “When Danny Yatom meets Khaled Meshal,” haaretz.com, 5 Feb 2006.

<sup>402</sup> “*Hizb ut Tahrir* (on Newsnight),” news.bbc.co.uk, 27 Aug 2003, hotair.com, 9 May 2006.



☉ Whenever a terrorist is arrested, *Muslims inevitably* will tell reporters what a wonderful, law-abiding person the detained person is, and how the arrest was wrongful due to mistaken identity, bigotry, profiling or whatnot.

What *Al-Ghazali* wrote (see quotation above) explains why from 2003 to 2005, Coalition soldiers received limited cooperation from *Iraqis* in fighting terrorists, as when soldiers asked residents who fired a rocket-propelled anti-tank missile from their houses, “They heard nothing, they saw nothing, same as...usual.” The *Telegraph* reported that “the mutual distrust between the Americans and the local community deepened just a little bit more.”<sup>403</sup>

*Muslims* protect *Muslims* who take infidels hostage, and usually do not allow infidels to attack *Muslim* countries from *Muslim* lands. For instance, before Gulf War II the US asked to pass through Turkey to attack *Iraq* from the north, but Turkey made outrageous demands thereby blocking the move. *Muhammad* said:

The Last Hour would not come until the Romans would land at *Al-A'maq* or in *Dabiq*. An army consisting of the best (soldiers) of the people of the earth at that time will come from *Madina* (to counteract them). When they will arrange themselves in ranks, the Romans would say: ‘Do not stand between us and those (*Muslims*) who took prisoners from amongst us. Let us fight with them;’ and the *Muslims* would say: ‘Nay, by *Allah*, we would never get aside from you and from our brethren that you may fight them.’ They will then fight...(*Sahih Muslim*, bk. 041, no. 6924).

Of course the White House did not know about this *Hadith* before Gulf War II in 2003 because, as George Bush said on 17 Oct 2005, “for the first time in our nation’s history, we have added a *Koran* to the White House Library,”<sup>404</sup> so there probably was no *Hadith* collection in the White House library stacks either.

*Muslims* will hide and protect *Jihadist* terrorists since *Muhammad* said that *Muslims* have a “duty to” harbor *Jihadists* and give “asylum and aid in religion,” e.g. safe-houses, and that those who do so “are the believers in truth, [and] for them is forgiveness and *Rizqun Karim* (a generous provision i.e. Paradise)” (*Hilali-Khan K* 008:072-074). Also, in the early Madinan Covenant between *Muslims* and Jews, *Muhammad* said:

A believer shall not slay a believer for the sake of an unbeliever, nor shall he aid an unbeliever against a believer.<sup>405</sup>

Due to the above-mentioned passages from the *Koran* and *Hadiths*, *Muslims* will generally not tip off the police before or even after a terrorist attack, nor assist infidel armies in attacks on rogue *Muslim* nations.

*Islamists* consider any government run by infidels to be based on man-made rules rather than on the divinely instituted *Sharia* law. *Islamists* think that following such a government is tantamount to polytheism (*Shirk*) since unbelievers fight for Satan and idols (*K* 004: 076, 119; 016:098-100; 034:020; 058:019).

*Shirk* is not the only reason *Islamists* would shun and avoid a government run by unbelievers, though. *Muhammad* made *Islamists* safe from government interference by instituting a *Muslim* code-of-silence backed up by eternal disincentives for would-be informers and whistle-blowers:

<sup>403</sup> Blomfield. “US troops fighting losing battle for *Sunni* triangle,” telegraph.co.uk, 22 Oct 2005.

<sup>404</sup> “President Bush Hosts *Iftar* Dinner at White House,” usinfo.state.gov, 17 Oct 2005.

<sup>405</sup> Ishaq. *Sirat*, p. 232.

‘The asylum granted by any *Muslim* is to be secured by all the *Muslims* even if it is granted by one of the lowest social status among them. And whoever **betrays** a *Muslim* in this respect will incur the Curse of *Allah*, the angels and all the people, and his compulsory and optional good deeds of worship will not be accepted.’<sup>406</sup>

‘Every **betray**er will have a flag which will be fixed on the Day of Resurrection, and the flag’s prominence will be made in order to show the betrayal he committed.’<sup>407</sup>

For pious *Muslims*, there is no way around *Muhammad*’s injunctions against whistle-blowers and informers while remaining true to *Islam*. One cannot, say, excommunicate (*Takfir*) a *Muslim* and then report his terrorist activities to authorities as though he were a non-*Muslim*. First, if a *Muslim* objects to terrorism at all, it is on grounds that it is politically counter-productive or it is merely *Haram* (impermissible) and not a damnable sin. Second, *Muhammad* forbade excommunication over deeds; one may only be excommunicated for holding to false doctrine. This is why most *Muslims* do not regard terrorism, suicide-bombing or inciting to violence as being damnable sins that makes the perpetrator an apostate or liable to be excommunicated from *Islam*:

⊕ On 6 July 2005 “a major conference of 170 *Muslim* scholars from 40 countries meeting in *Amman*, Jordan gave an opinion” that “it is **not** possible to declare” that “those who issue *Fatwas* to kill innocent people in the name of *Islam*” are “apostates” and “not real *Muslims*.”

⊕ In 2005, “high-ranking *Muslim* clerics” confirmed “that those who carry out suicide bombings **cannot** be treated as apostates and remain *Muslims*.”<sup>408</sup>

⊕ In 2006 a high-ranking scholar, Dr. Mohammad Rafat Othman, of *Al-Azhar* seminary in Egypt stated: “Those using suicide bombing against the enemy, the land robbers, and the occupier of nations, are martyrs.”<sup>409</sup>

Even after *Abu* Musab *Al-Zarqawi* had three hotels bombed in *Amman*, Jordan, killing 59 and injuring a hundred, most of whom were Palestinians at a wedding party, *Zarqawi*’s tribe in Jordan could not excommunicate (*Takfir*) him. They merely came up with the ambiguous slogan, “If my son was a terrorist, I wouldn’t hesitate to kill him”<sup>410</sup> that left in doubt whether they considered him a terrorist.

*Zarqawi*’s tribe also “disown[ed] him until the Day of Judgment,”<sup>411</sup> by which they meant only that all would be forgiven him in the afterlife. This is confirmed by the fact that after *Zarqawi* was killed in 2006, a sign was hung in his hometown saying “the wedding of the hero martyr *Abu* Mousab *Al* *Zarqawi*,” and at the public “wedding party” that was videotaped via cell phones.<sup>412</sup>

<sup>406</sup> *Sahih Bukhari*, vol. 4, bk. 53, no. 404; vol. 3, bk. 30, no. 94; vol. 4, bk. 53, nos. 397 & 404; vol. 8, bk. 80, no. 747; vol. 9, bk. 92, no. 403.

<sup>407</sup> *Sahih Bukhari*, vol. 4, bk. 53, no. 411; also see vol. 4, bk. 53, no. 410.

<sup>408</sup> “Criticism of suicide bombers censored at the UN,” International Humanist and Ethical Union, iheu.org, 26 July, 2005, *DW*.

<sup>409</sup> Nahmias, Roe. “*Islamic* leaders: Suicide bombers go to hell,” ynetnews.com, 30 Jun 2006, *JW*.

<sup>410</sup> “*Al-Khalayleh* tribe disowns *al-Zarqawi*,” jpost.com, 20 Nov 2005.

<sup>411</sup> “*Zarqawi*’s family in Jordan disowns him,” upi.com, 20 Nov 2005, natashatynes.com.

<sup>412</sup> “A Video of *Abu* Musab *al-Zarqawi*’s Wedding Celebration in the City of *Zara’a*, in Jordan, on the Occasion of His Martyrdom,” SITE Institute, siteinstitute.org, 20 Jun 2006.

Veiled women weeping near the house were admonished by *al-Khalayilah* who said ‘Don’t cry, but ululate, for he is a hero and a martyr.’<sup>413</sup>

No repentance or forgiveness over deeds (even terrorism) is ever required to continue being a *Muslim*, as *Muhammad* said:

**Three things are the roots of faith:** to refrain from (killing) a person who utters, ‘There is no god but *Allah*,’ and not to declare him unbeliever whatever sin he commits, and not to excommunicate him from *Islam* for his any action (*Sunan Abu-Dawud*, bk. 14, no. 2526).

The three roots of faith that *Muhammad* numerates above are interrelated since:

- ⊕ Excommunicating a *Muslim* is tantamount to robbing and killing him. In the *Koran Muhammad* said not to declare a *Muslim* a non-*Muslim* in order to make his possessions *Halal* (permissible) for *Muslims* to loot (*K* 004:094).
- ⊕ Excommunication would mean a *Muslim* is an apostate, and *Muhammad* said that apostates and heretics (religious innovators) must be killed (*Sahih Al Bukhari* vol. 4, bk. 52, no. 260; vol. 9, bk. 84, no. 57).

Thus the situation regarding excommunication is as Alfred Guillaume described:

Provided that a man accepts the two fundamental assertions of *Islam*, the unity of God and the apostleship of *Muhammad*, any deviation from the right path is tolerated; though, it is only right to add, not approved. In any event the mortal sinner is guaranteed the prophet’s intercession on the Day of Judgment.<sup>414</sup>

Another major reason *Muslims* are reticent to excommunicate a *Muslim* is that if a *Muslim* declares another *Muslim* a non-*Muslim*, i.e. excommunicates him, all those *Muslims* who disagree with the excommunication believe the excommunicator has made himself into a non-*Muslim*. The vast majority of *Muslims* would consider whoever tried to excommunicate a terrorist to have instead just excommunicated himself.

Wrongful excommunication is taken as grounds for excommunication of the wrongful excommunicator. After all, *Muhammad* did say that not excommunicating *Muslims* over deeds is a “root of faith” (see quote above). Moreover, *Muhammad* explicitly stated that whoever wrongfully excommunicates another *Muslim* actually excommunicates himself (*Sahih Muslim*, bk. 1, no. 117).

That *Muslims* cannot excommunicate over deeds is why *Fatwas* or condemnations of terrorism generally do not mention any terrorist by name, nor by group affiliation (e.g. *Al-Qaeda*), nor by an attack (e.g. *Madrid 3/11*). Sometimes they slyly mean by “terrorist” so-called “state terrorists” like the US President or Israel or Russia, so such *Fatwas* do not condemn *Jihadists* at all!

The 2005 Spanish *Fatwa* against Usama Bin Laden is exceptional in that it does mention his name and group.<sup>415</sup> This *Fatwa* issues a conditional excommunication of *Bin Laden*—not over his deeds of terrorism, but rather because he justified terrorism as *Jihad* rather than as *Lex Talionis*. The text reads:

**As long as** Usama bin Laden and his organization defend the legality of terrorism and try to base it on the Sacred *Koran* and the *Sunna*, they are committing the crime of *Istihlal* and they have become *ipso facto* apostates (*Kafir Murtadd*), who should not be considered *Muslim* nor be treated as such.<sup>416</sup>

<sup>413</sup> Karon, Tony. “How They Got Zarqawi,” time.com, 8 Jun 2006.

<sup>414</sup> Guillaume. *Islam*, p. 115.

<sup>415</sup> Phares, Walid. “The Washington *Fatwa*,” washingtontimes.com, 8 Aug 2005.

<sup>416</sup> “Spanish *Fatwa* Against Terrorism – 17 March 2005,” theamericanMuslim.org, 19 Apr 2005.

This Spanish *Fatwa* seems to imply that if *Bin Laden* just changed his justification of terrorism from the rubric of *Jihad* to *Lex Talionis*, Spanish *Muslims* would embrace *Bin Laden* with open arms. The Spanish *Fatwa* and *Lex Talionis* are discussed further in the *Lex Talionis* section of this Khidr-Second Lamech table.

Because *Muslims* cannot and will not excommunicate terrorists, at least in any meaningful and practical sense, no *Muslim* can truly dissociate *Islam* or himself from terrorism. Therefore, every *Muslim* inextricably shares in the monstrous acts of his coreligionists, as radio talk-show host Michael Graham stated:

If the Boy Scouts of America [BSA] had 1,000 scout troops, and ten of them practiced suicide bombings, then the BSA would be considered a terrorist organization. If the BSA refused to kick out those ten troops, that would make the case even stronger. If people defending terror repeatedly turned to the *Boy Scout Handbook* and found language that justified and defended murder—and the scoutmasters in charge simply said ‘Could be’—the Boy Scouts would have been driven out of America long ago.<sup>417</sup>

The *Muslim* Code-of-Silence is a main reason why *Usama Bin Laden* and other *Jihadists* have not be captured yet, as *WND* reported:

...*bin Laden* is protected by *Milmastia*—the *Islamic* code of hospitality that demands protection for fellow *Muslims* who seek shelter in their country—even if such protection means risking their lives. Believing *Muslims* know that the \$25 million reward comes with the price tag of apostasy and eternal damnation. Mercs point out that *Pakistani* soldiers and ISI officials are even unwilling to collar *Osama* and his cohorts when they appear in *Peshawar*. They do not want to go to hell for money or [president] *Musharraf*.<sup>418</sup>

Another factor why *Muslims* do not turn in *Jihadists* is their misplaced loyalties...

...*Muslim* radicals routinely preach that *Muslims* should have no loyalty to non-*Muslim* states but only to fellow *Muslims*.<sup>419</sup>

Thus an American-born *Muslim* said:

‘I did grow up there [America]. But that doesn’t mean my loyalty is with the Americans,’ said *Babar* in a November 2001 interview [just after 9/11 Incidentally]. ‘My loyalty will, has always been, is, and forever will be with the *Muslims*.’<sup>420</sup>

British secret agents describe the dual-loyalties of many *Muslims*...

...our *Muslims* cannot be trusted...Their first loyalty is to *Islam*, not to Britain. It is the same in the US...*Islam* poses such a powerful bond over its fellow believers that the problem of recruiting *Muslim* undercover agents is acute. Walk into a *Muslim* neighborhood and begin making inquiries about terrorists and you will hit a wall of silence...We’ve never had a security problem like this in England before. And it is getting bigger all the time...<sup>421</sup>

Just because a *Muslim* is not a *Jihadist* or an *Islamist* does not mean the *Muslim* is a model citizen. If a *Muslim* believes what *Muhammad* said about the code-of-

<sup>417</sup> Bowden, James Atticus. “Moslems Censor American Speech,” MichNews.com, 31 Aug 2005.

<sup>418</sup> Williams, Paul L. “Where *bin Laden* is, why he’s still alive,” *WND*, 6 Aug 2005, *JW*.

<sup>419</sup> Spencer, Robert. “British policeman jailed for...,” *JW*, 5 Oct 2004.

<sup>420</sup> “Unraveling the threads of terrorism: American-born *Al-Qaida* suspect in custody helps investigators,” msnbc.com, 11 Aug 2004, *JW*, 12 & 13 Aug 2004.

<sup>421</sup> Avner, Yehuda (former Israeli ambassador to St. James Court). “An athenaeum encounter,” jpost.com, 17 Mar 2005.

silence and that *Muslim* feels that *Jihad* is a supererogatory deed, naturally he or she will be disinclined to condemn *Islamic* terrorists, much less inform on *Jihadists* to the authorities despite any incentives or disincentives not to (i.e. carrots and sticks). A *Muslim* informing on a terrorist would be like a Christian turning in a priest or pastor or monk for giving charity to the poor.

The head of community policing in London described the situation there after the 7/7 bombing in 2005. He states that the many *Muslims* there were not helpful at all in identifying the “preachers of hate,” those “distributing the hate material” and those “who are radicalized.”<sup>422</sup>

The head of community policing in London, Tarique Ghaffur, who is a *Muslim*, stated that among the reasons for *Muslim* not helping police was the *Muslim* community was “in retreat from the ‘hysterical and hostile’ public reaction to the bombings,” even though the public mood in London did not even hint of any riot or mayhem.<sup>423</sup> In fact, in places like Nottinghamshire northwest of London, 4,000 police officers are wearing green ribbons, the traditional color of *Islam*. Anyway, the head of London community policing, Ghaffur, also said...

...*Muslim* communities were unable to identify ‘the tipping point between right and wrong, where hate becomes a criminal offence.’<sup>424</sup>

In other words, *Imams* have always peddled hate, but *Muslims* never considered it wrong or illegal because the hatred is thoroughly *Islamic* in character.

**Ingredient 8 (Externalizing Blame):** When *Muslims* speak in public about issues such as paganism inherent in *Islam*, *Islamic* terrorism, torture, widespread poverty, endemic wife abuse, ubiquitous female genital mutilation (FGM) or *Islam*’s lengthy history of *Jihad*, they often opine that the root cause of these problems is never:

- ☉ *Muslims* themselves but always a pre-*Islamic* culture, Christians or Jews.
- ☉ *Islam* itself but a distortion of *Islam* brought about by *Islamophobia*, racism, discrimination, provocation, colonialism, capitalism, globalization, counter-terrorism profiling and such.

Examples of *Muslims* blaming anything that is wrong in *Islam* on non-*Muslims* include:

- ☉ *Ibn Warraq* quoted the *Muslim* myth about the origin of *Islam*’s crescent:

The crescent, the emblem of *Islam*, was originally the symbol of sovereignty in the city of *Byzantium*.<sup>425</sup>

This is anachronistic since *Muslims* only conquered *Byzantium* in 1453 AD, but already in the eleventh century AD or before, *Muslims* put a crescent over a cross whenever they conquered a church, or replaced the cross with a crescent.<sup>426</sup> The crescent came from *Allah*’s having been a moon-god.

- ☉ *Ibn Warraq* quoted the *Muslim* myth about how “...the veil was adopted by the Arabs from the Persians.”<sup>427</sup> However, the veil was in use for millennia

<sup>422</sup> Blitz, Roger. “*Muslims* accused of failing to help police,” *Financial Times*, news.ft.com, 10 Aug 2005.

<sup>423</sup> Blitz, Roger. “*Muslims* accused of failing to help police,” *Financial Times*, news.ft.com, *Idem*.

<sup>424</sup> Blitz, Roger. “*Muslims* accused of failing to help police,” *Financial Times*, news.ft.com, *Ibid*.

<sup>425</sup> Warraq. *Why*, p. 194.

<sup>426</sup> Newby. *Encyclopedia*, p. 81, *Hilal* entry.

<sup>427</sup> Warraq. *Why*, p. 315; also see Brockelmann. *Peoples*, p. 27; and El Guindi, F. & J. Espisito (editors). *The Oxford Encyclopedia of the Modern Islamic World*, Vol 2, pp. 108-111, *Hijab* entry.

in the Mideast by *Muhammad*'s day. The 3,000-line, 2,000 BC *Babylonian* legend, *The Epic of Gilgamesh*, mentions a woman wearing a veil:

The tavern-keeper *Siduri*, who lives by the seashore, she lives...the pot stand was made for her, the golden fermenting vat was made for her. She is covered with a veil...*Gilgamesh* was roving about...wearing a skin...<sup>428</sup>

The veil is mentioned in the Bible often<sup>429</sup> and the *Koran* mentions both the veil<sup>430</sup> and *Purdah* seclusion curtains (*Shakir K* 024:031; 033:059). The *Hadith* say a woman ought to cover all but the face and hands (*Sunan Abu Dawud*, bk. 32, no. 4092).

C Amir Taheri wrote about *Islamic* iconoclasm in *The Wall Street Journal*:

There is no *Quranic* injunction against images, whether of *Muhammad* or anyone else. When it spread into the *Levant*, *Islam* came into contact with a version of Christianity that was militantly iconoclastic.<sup>431</sup>

Taheri said “*Quranic*” because the *Hadiths* record how *Muhammad* “the perfect exemplar” was an iconoclast who prohibited images and smashed crosses and idols. Two of many such *Hadiths*<sup>432</sup> have *Muhammad* saying:

- ★ Angels (of Mercy) do not enter a house wherein there is a dog or a picture of a living creature (a human being or an animal) (*Sahih Bukhari*, v. 4, bk. 54, no. 448).
- ★ (Do not leave) a picture without obliterating it (*Sahih Muslim*, bk. 4, no. 2115).

Taheri's argument about images might fool non-*Muslims* but not *Muslims*, just as arguments about *Islam* being peaceful might fool non-*Muslims* but not *Muslims*. For instance:

- ★ In Minneapolis, USA, parents of *Muslim* children in Kindergarten prefer their children not draw humans or animals.<sup>433</sup>
- ★ Arrested *Al-Qaeda* Louai Sakka's jail cell in *Turkey* has magazines with all the pictures covered with tabs of paper because, as he explained:  
Angels don't come where faces are pictured.<sup>434</sup>

C *Muslims* explain that the *Koran* teaches that the Christian Trinity is Jesus, Mary and *Allah*, and that the Jews worship Ezra as the Son of God, only because there were sects in Arabia that taught this at the time. So, some heretical sect is blamed for the discrepancy rather than *Muhammad*.

<sup>428</sup> Acad. for Ancient Texts, Reno, Nevada, ancienttexts.org, *Gilgamesh*, Tablet X.

<sup>429</sup> Veils in the Bible: *Gen* 24:65; 38:14, 19; *Exo* 34:33-35; *Joh* 22:14; *Soi* 01:07; 04:01, 03; 06:07; *Isa* 03:19; 47:02; *Lam* 03:65; *Eze* 13:18, 21; *2Co* 03:13-16; 04:03.

<sup>430</sup> Veils in the *Koran*: *K* 002:007; 006:025; 007:046, 054; 012:107; 013:003; 017:045-46; 018:011, 057, 101; 019:017; 024:030-031, 060; 033:032-033, 053, 059; 038:032; 039:006; 041:005, 022; 042:051; 050:022; 091:004; 092:001.

<sup>431</sup> Taheri, Amir. “Bonfire of the Pieties,” *Wall Street Journal*, opinionjournal.com, 8 Feb 2006.

<sup>432</sup> *Muhammad*'s Iconoclasm: *Sahih Bukhari*, v. 3, bk. 34, no. 428; v. 4, bk. 54, nos. 447-449, 539; v. 4, bk. 55, no. 570; v. 5, bk. 59, no. 338; v. 9, bk. 87, no. 165; v. 7, bk. 72, nos. 834, 836, 843, 846; *Sahih Muslim*, bk. 24, nos. 5246-5254, 5266, 5272; *Sunan Abu Dawud*, bk. 1, no 227; bk. 4, no. 2115; bk 32, no. 4140.

<sup>433</sup> Belden, Doug. “The Art of Compromise,” *Pioneer Press*, twincities.com, 17 Feb 2006, michellemalkin.com.

<sup>434</sup> Vick, Karl. “A Bomb-Builder ‘Out of the Shadows,’” *washingtonpost.com*, 20 Feb 2006.

Another example of externalizing blame is one *Muslim* said after the 7/7 London bombing that terrorism would cease if only President George Bush and Prime Minister Tony Blair would apologize for mistreating *Muslims* after 9/11.<sup>435</sup> This *Muslim* obviously does not see terrorism as being a natural extension of *Islam*'s 1350 years of violence.

Some *Muslims* blame objectionable cultural practices in *Islamdom* on pre-*Islamic* cultures, such as veil wearing, FGM and honor-killing. Even if this were the case, one must ask:

- ☉ Why are *Muslim* cultures so susceptible to absorbing and acculturating objectionable practices rather than resisting and reforming them?
- ☉ Why do other cultures evolve from century to century while *Islamic* cultures remain largely medieval at least in mindset, if not in behavior too?
- ☉ Why do evils that pass in the rest of the world find their fullest expression in *Islamdom*?

*Islamists* and apologists for *Islam* should ask themselves "How is it that *Islam* is better than the West just because..."

- ☉ Non-*Muslims* developed guns, cannons and car bombs when terrorism and warfare are constantly churning in *Islamdom*?
- ☉ There are small, isolated non-*Muslim* terrorist groups when everyone lives and dies by the sword in the Mideast?
- ☉ Non-*Muslim* armies operating in the Mideast occasional commit war crimes when *Muslim* travelers and immigrants are constantly plotting and carrying out terrorist attacks in the West on both people and infrastructure? For instance, in 2006 a *Muslim* planned to blow up Sydney's power grid.<sup>436</sup>
- ☉ Acid-splashing was invented in Southeast Asia when *Muslims* throwing bulbs and bottles of acid are commonplace in India, and when every women in the Mideast must wear a veil for fear of an acid attack?
- ☉ The *Hindu Tamil* Tigers of *Sri Lanka* adopted the suicide-bomb belt or vest, when other cultures never adopted it, and among those few that did, the bomb-belt proved to be a short-lived fad except among *Muslims*?
- ☉ Arsonists burned 260 cars and motor scooters in Rome during the summer of 2005,<sup>437</sup> when *Muslims* in France burned 17,500+ trash bins and 28,000+ cars, and pelted 9,000+ police cars in 2005 alone?<sup>438</sup>
- ☉ Israeli settlers chop down some Arab olive orchards when *Islamists* do the same to Israeli trees, and when *Islamists* start one-third of forest fires in *Israel*?<sup>439</sup> so that "two national forests have been laid to waste."<sup>440</sup>
- ☉ Israel occasionally assassinates terrorists when *Islamic* terrorists are shooting at cars, blowing up in buses and cafes, and even trying to poison the Israeli water supply?<sup>441</sup>
- ☉ Westerners lampoon *Muhammad* when anti-semitic and anti-Christian cartoons are everywhere in the Mideast?

<sup>435</sup> "London bomber's uncle defends nephew's 'sacrifice,'" zeenews.com, 17 Jul 2005, *JW*.

<sup>436</sup> "Lodhi 'planned power grid bombings,'" news.com.au, 19 Apr 2006, *JW*.

<sup>437</sup> Wingfield, Brian. "An Inferno of Vehicles Expands a City's Circle of Suffering," 5 Sep 2005; Pipes, Daniel. "Further Thoughts on the French *Intifada*," *DP*, 8 Nov 2005.

<sup>438</sup> Guitta, Olivier. "The *intifada* comes to France," weeklstandard.com, 14 Nov 2005.

<sup>439</sup> "Al-Qaida planned U.S. forest fires," WND.net, 27 Oct 2003.

<sup>440</sup> Glick, Caroline. "Column One: Ilan Halimi and Israel," jpost.com, 24 Feb 2006.

<sup>441</sup> " Hamas leader: Jews control U.S. Christianity," ynetnews.com, 6 Apr 2006, israellycool.com.

- ⊕ Non-*Muslims* disrespect women when *Muslims* in the West rape at a great rate than the average in the West,<sup>442</sup> and many *Muslim* women in the Mideast are treated as second-class citizens and even as virtual slaves?

While other cultures experience stints of anti-Semitism, virulent racism and fascism, these are enduring or reoccurring features of *Islam*. Anti-Semitic rhetoric and attitudes are rife everywhere in *Islamdom*, even amongst the *Muslim* diaspora. The Pan-Arab movement is racism to the extent that it goes beyond celebrating diversity, and Arab culture and language is forced on the unwilling such as the Maronites, Copts and Arameans. Arab racism is behind the ethnic cleansing of black *Muslims* in *Darfur, Sudan*, that started in 2003.

Even in the heart of the West, *Islam* retains its medieval laws and practices. *Muslims* in the West create autonomous zones where the *Koran* and *Sharia* law are the law of the land. These zones grow in size from a street corner, to a neighborhood, to suburb, to a city, until finally the country is partitioned along demographic lines.

Despite objections to the contrary, most objectionable practices in *Islam* can easily be traced back to *Muhammad*, the *Koran* and *Hadiths*. The reason the unpleasant practices are stubbornly persistent in *Islam* is *Muslims* follow *Muhammad's* example since:

- ⊕ He is allegedly God's gift to *Muslims*—their “excellent exemplar” (Arabic: *Uswa Hasana*), whom *Muslims* are supposed to emulate (*K* 033:021; see also *K* 004:059, 115; 053:002). *Muhammad's* favorite wife Aisha said: “The character of the Apostle of *Allah* was the *Koran*” (*Sahih Muslim*, bk. 4, no. 1623). *Muhammad* is “the perfect role model in all situations.”<sup>443</sup>
- ⊕ *Muslims* are to obey *Muhammad* since *Muhammad* said so (*K* 003:032, 132; 004:013, 059, 069; 005:092; 008:001, 020, 046; 009:071; 024:047, 051-052; 024:054, 056; 033:033; 047:033; 049:014; 058:013; 064:012).
- ⊕ *Muhammad* had *Allah* say:

Oh you who believe, make not unlawful the **good things** that *Allah* has made lawful for you (*K* 005:087; see also *K* 006:146; 010:059; 016:116).

Unfortunately, the “**good things**” include anything the prophet practiced, approved of or endorsed, to include: 1) preteen marriage (i.e. Aisha), 2) polygyny, 3) concubinage, 4) FGM (see FGM in the Glossary), 5) ethnocide of pagans, Jews and Christians in the Arabian peninsula and beyond, 6) slavery and slave-trading, 7) instituting laws that give women a second-class citizenship, 8) instituting laws that make non-*Muslims* into despised, abused and overtaxed *Dhimmis*, 9) *Jihad* warfare and the occupation of conquered territory, 10) taking loot, 11) instituting the *Fay* tribute, 12) breaking treaties on a whim (*ad libitum*) and a pretext (*a la Hudaybiya*), 13) assassination of singers, poets, critics and political opponents (see the assassinated wordsmiths table), 14) torture with fire (e.g. *Kinana*<sup>444</sup>) and so on.

In the spirit of externalizing blame, *Muslims* advance conspiracy theories and false narratives where *Muslims* are the “true” victims and non-*Muslims* are the instigators of senseless Mideast wars, and are the perpetrators behind terrorist attacks such as 9/11, 3/11 and 7/7. In 2006 a *Pew* poll showed that in all ten countries polled,

<sup>442</sup> See the high crime and incarceration rate table.

<sup>443</sup> Salahi, Adil. “The Prophet as a Man—29: Perfect Role Model in All Situations,” ArabNews.com, 25 Mar 2005, *JW*, 31 Mar 2005.

<sup>444</sup> Ishaq. *Sirat*, p. 515.



including France, Germany, Britain and Spain, “a majority [of *Muslims*] views September 11 as a hoax perpetrated by the American government, Israel, or some other agency.”<sup>445</sup>

Hardly any *Muslims* object loudly and works hard to overturn the old falsities, and new lies are disseminated at a furious rate.<sup>446</sup> It is as Daniel Pipes wrote:

This pattern of avoiding unpleasant facts offers an insight into the problems of *Muslim* society. Turning defeat into victory, evidence into forgery, and terrorism into an ‘inside job’ creates an alternate and more hospitable world. But this denial avoids problems rather than dealing with them. Not acknowledging who carried out the 9/11 atrocities, for example, means ignoring its many causes, from a radicalized school curriculum to the use of *Islamic* ‘charities’ for money-laundering.<sup>447</sup>

Alain Finkielkraut commented similarly on the French *Muslim* riots of 2005:

Why have parts of the *Muslim*-Arab world declared war on the West?... We are witness to an *Islamic* radicalization that must be explained in its entirety... to a culture that, instead of dealing with its problems, searches for an external guilty party. It’s easier to find an external guilty party.... The riots will subside but what does this mean?... There won’t be a return to quiet but a return to routine violence.<sup>448</sup>

A main reason that *Muslims* indulge in conspiracy theories is *Muslims* view the world to be divided between *Dar-al-Islam* and *Dar-al-Harb*, the Territory of War that is ruled by *Muslims*. *Muhammad* said that “war is deceit.”<sup>449</sup> Thus any lie or conspiracy theory that advances the cause of *Islam* in its war on infidels is excusable, acceptable and even desirable.

Another main reason *Muslims* lie (or cast aspersions by formulating myriad conspiracy theories) is *Sharia* law allows *Muslims* to lie to avoid the consequences of their behavior, and especially in order to avoid retaliation. Thus many *Muslims* will blame *Mossad* or the CIA for acts of terrorism when there is no doubt in their mind that the perpetrators were *Islamic* terrorists. *The Reliance of the Traveler* manual on *Sharia* law states:

It is not unlawful to lie when the aim can only be attained through lying in times of war, settling a disagreement or gaining the sympathy of a victim that is legally entitled to retaliate so that he foregoes retaliation (definition 8.6.5).

The reasons *Muslims* do not speak up against terrorism, unless prodded and pressured to, are several. For instance, if one believes in, and was raised in, a religion headed up by a vengeful war- and moon-god, then when terror or a disaster strikes:

☉ Non-*Muslims*, this strengthens a *Muslim*’s faith in *Islam* or converts a non-*Muslim* to *Islam*.

☉ *Muslims*, one thinks the disaster calls for more fervent worship and prayer. For instance, an Indonesian cleric, Bashir, said to relatives of *Muslim* blown up by *Muslim* suicide-bombers: “...accept this fate from *Allah*... approach

<sup>445</sup> Pipes, Daniel. “[Pew Poll on] How *Muslims* Think,” *DP*, 27 Jun 2006.

<sup>446</sup> Edwards, Michael. “*Sheikh* criticised for terrorism comments,” *Lateline, Australian Broadcasting Corporation*, abc.net 12 Jul 2005, *JW*.

<sup>447</sup> Pipes, Daniel & Jonathan Schanzer. “Denial: A River in Egypt,” *DP*, 14 Jan 2002.

<sup>448</sup> Mishani, Dror & A. Smotriez. “What sort of Frenchmen are they?” *haaretz.com*, 17 Nov 2005.

<sup>449</sup> *Sahih Bukhari*, vol. 4, bk. 52, nos. 267-270; also see *Sahih Muslim*, bk. 32, no. 6303.

closer to *Allah*...These saddening incidents, in essence, are warnings, scolding from *Allah* to us all who are not respecting his *Sharia*.<sup>450</sup>

Another reason *Muslims* do not speak up against terrorism is the *Koran* forbids *Muslims* to speak about evil except to engage in victimology:

God loveth [loves] not that **evil** should be noised abroad in public speech, except where **injustice** hath been done [i.e. to *Muslims*] (*Yusuf Ali K 004:148*).

So as long as terrorism does not affect *Muslims* adversely, *Muslims* are not supposed to talk about it, according to this passage.

Another reason *Muslims* do not speak up against terrorism is that many *Muslims* do not see terrorism against non-*Muslims* as being evil but as being a divinely-inspired *Jihad*.

Yet another reason they do not speak up against terrorism is if a non-*Muslim* kills a *Muslim*, a great injustice has been done—as though the non-*Muslim* murdered all of humanity according to *K 005:032-033*. But if a *Muslim* kills a non-*Muslim*, this is of no consequence whatsoever since that non-*Muslim* was fighting against *Islam* or was spreading corruption in the land, or was doing something deserving of death under *Sharia* law (*K 005:032-033*), or was just being a non-*Muslim* which is bad in itself (see the *Lex Talionis* ingredient of this Khidr-Second Lamech table). For instance, when *Muhammad* had an infidel poetess, Asma, daughter of Marwan, assassinated, *Muhammad* said nonchalantly:

Two goats won't butt their heads about her.<sup>451</sup>

Likewise today *Muslims* do not root out terrorists or protest much, if at all, whenever infidels are killed by *Islamic* terrorists<sup>452</sup>—surely not as though they actually believe that the killing of an infidel was as bad as though “all of humanity had just been murdered”—no matter how often they might bandy that verse about (*K 005:032*).

According to the concept of *Kisas*, “all believers must be against the murderer and can only takes sides against him.”<sup>453</sup> *Kisas* is why *Muslims* make a big clamor and protest whenever a non-*Muslim* kills a *Muslim* but are mostly apathetic whenever a *Muslim* kills a non-*Muslim*. (*Kisas* and *K 005:032-033* are discussed further in the *Lex Talionis* section of this Khidr-Second Lamech Logic table).

Since many *Muslims* believe infidels deserve death for having killed *Muslims*, not many *Muslims* will shed a tear when *Islamic* terrorists kill infidels, as Mamoun Fandy, a senior fellow of Middle East and *Islamic* politics at Baker Institute at Rice University, stated (as was quoted earlier in this Khidr-Second Lamech table):

I have talked with many *Muslims*, especially in the West, who in public condemn violent acts but in private conversations say ‘The West deserves this.’

In public, they will say it is a revenge for Palestine and *Iraq*, but in private I hear blind hatred, a virus that is taking over too many *Muslim* minds.<sup>454</sup>

*Koran 004:148* is responsible for much denial of responsibility and scapegoating of non-*Muslims* for terrorism and everything that is wrong in *Islamdom*. The mindset that *Koran 004:148* produces would be considered pathological if it were not for the fact that this way of thinking is part of the culture of *Islamdom*.

<sup>450</sup> “Bashir condemns *Bali* bombings,” theaustralian.news.com.au, 4 Oct 2005.

<sup>451</sup> Ishaq. *Sirat*, p. 676.

<sup>452</sup> Scheherezade, Faramarzi. “*Muslims* address silence on Europe attacks,” news.yahoo.com, 24 Jun 2006, *LGF*.

<sup>453</sup> Gibb & Kramer. *Encyclopedia*, *Kisas* entry, p. 262, right column, middle.

<sup>454</sup> Fandy, Mamoun. “For *Muslims*, a role in the war on terror,” usatoday.com, 11 Aug 2005, *JW*.

Weaving false narratives and spinning conspiracy theories exculpatory for *Muslims*, but inculpatory for non-*Muslims*, is seen as extremely helpful to the cause of *Islam*. The end justifies the means in *Islamist* jurisprudence, as Ilana Mercer wrote:

...the concept of truth in Arab culture is extremely elastic. *Al-Ghazzali*, ‘the famous 11th-century *Muslim* theologian, claimed that the lie is not wrong in itself. If the lie is the way to achieve good results, then it is permissible. It is necessary to lie when the truth might lead to unpleasant or undesired results,’ writes Dr. David Bukay. More recently, Arab sociologist Sania Hamady (Katz, 2002) has documented the low value attached to truth in Arab culture. Feelings, flights of fancy and fabrications are integral to Arab discourse. Lies are also potent political weapons, having successfully achieved the delegitimization of *Israel*...Clearly, *Muslim* leaders have learned that Westerners demand nothing more than a denunciation of terrorism. So they denounce—and get on with the business of *Jihad* (which is, like *Shari’a*, an essential tenet of true *Islam*).<sup>455</sup>

*Koran* 004:148 explains why no *Muslim* can admit that counter-terrorism measures against *Muslims* are ever warranted since this would be tantamount to admitting that *Muslims* engage in terrorism and not holy war or righteous retaliation. A case in point is no matter how aggressive *Muslims* are after unilaterally declaring a lull (*Tahdiya*) or truce (*Hudna*), “Only the non-*Muslim* party to a truce can break it,” as Robert Spencer points out.<sup>456</sup> For instance, *Hamas* declared in June 2006 that it “would no longer honor a truce with *Israel*”<sup>457</sup> due to an Israeli counter-terrorism attack, even though the truce was fictional and *Muslims* never honored to start with. This latest of many truces began on 22 January 2005 and by year’s end 45 Israelis were killed—23 from suicide-bomb attacks. Also, 406 Israelis were wounded. During the same period there were 377 *Kassam* rockets fired at *Israel*, 848 mortar shells launched, and there were 1,133 shooting attacks.<sup>458</sup> These figures do not include 2006.

*Muslims* also talk about Westerners killing *Muslims* in the Mideast without providing any context—as though Westerners are bloodthirsty and are not retaliating or defending the West, but are actually eager to come to the godforsaken Mideast to kill *Muslims* senselessly. For instance, an Op-Ed piece in *Arab News* claims that millions of Arabs are victims of the West through no fault of their own:

Attacks against *Muslim* minorities and their *Mosques* and schools whenever there is a terrorist attack in the West illustrate the dangerous level of hatred and racism that exists in the US, UK, Australia, New Zealand, Canada, Germany, Italy and elsewhere...but never did we [*Muslims*] hear of Christian and Jewish minorities in Arab and *Muslim* countries being attacked, nor their churches, synagogues and schools being torched and vandalized by the local populations...<sup>459</sup>

How a *Muslim* could write the above blatantly false statement (that *Muslims* have not killed Christians and destroyed churches) is by holding to a double standard:

<sup>455</sup> Mercer, Ilana. “‘Islamikazes’ in our midst,” *WND*, 19 Jul 2005, *DW*.

<sup>456</sup> “*Hamas* military wing calls off truce with *Israel*,” *JW*, 9 Jun 2006.

<sup>457</sup> “*Hamas* military wing calls off truce with *Israel*,” *jpost.com*, 9 Jun 2006, *JW*.

<sup>458</sup> Dudkevitch, Margot. “2,990 terror attacks during 2005 ‘truce,’” *jpost.com*, 2 Jan 2006.

<sup>459</sup> Kazak, Ali. “Fighting Terror: We Need to Deal With Underlying Causes, Factors,” *arabnews.com*, 17 Jul 2005.

- ⊙ When a *Muslim* reads of non-*Muslims* killing *Muslims*, it is assumed that this was not just a matter of retaliation, because retaliation assumes the *Muslim* did something evil to deserve retaliatory measures, and the *Koran* forbids talk about *Muslims* ever doing evil (K 004:148).
- ⊙ When a *Muslim* reads about a *Muslim* killing an infidel, the *Muslim* is not faulted since the killing is assumed to be a justifiable response to some evil that the infidel did. However, if the act was clearly unjustified, then the *Muslim* is automatically said to be a non-*Muslim*, thereby exonerating *Muslims* and *Islam* of any guilt and disgrace.

One can see that no matter who is at fault, evil is always ascribed to infidels and not *Muslims* or *Islam*.

Pious *Muslims* are known to go to great lengths to show that *Muslims* are victims, and that non-*Muslims* are the usual suspects, all despite commonsense and appearances to the contrary. This is in keeping with K 004:148, for instance:

- ⊙ After the Netherlander Theo van Gogh was killed over his thought-provoking movie on the connection between the *Koran* and the abuse of women, a Danish author could find no artists willing to illustrate his children's book on *Muhammad* for fear of *Islamists*. So a Danish newspaper, *Jyllands-Posten*, published twelve tame cartoons of the Prophet *Muhammad* to "test Denmark's free speech norms." Though the newspaper and artists received death threats and had to receive police protection, and though *Islamists* have put Westerners in fear and have taken away their free speech rights, an *Imam*, speaking for *Muslims* in general, proclaimed that *Muslims* were in fact the victims, saying "We are being mentally tortured."<sup>460</sup> A protest sign in *Kenya* read "Freedom of expression is Western terrorism."<sup>461</sup>
- ⊙ Many *Muslims* claim that *Al-Qaeda* is an invention of the West and an excuse for taking over Mideast countries with oil. Other *Muslims* admit *Al-Qaeda* exists, but is not behind any terrorist attacks on the West, as *The Washington Post* reported:

Baasyir, who proclaims himself an admirer of Osama *Bin Laden* but still denies that he [Usama] is a terrorist leader, said that he is just a victim of 'the infidel Bush's America.' Then he quoted a verse from the *Koran*: 'The infidels will never stop fighting us until we follow their way' [K 002:217].<sup>462</sup>

- ⊙ Another example of how *Muslims* say they are always the victims is after *Muslims* carried out the 7/7 London bombing, a *Kashmiri* legislator said:

...*Kashmiris* considered Britain their second home and could never think of carrying out terror activities there...No *Muslim* is involved in the London terror bombings because *Islam* does not allow its followers to kill innocent people.<sup>463</sup>

Obviously, if *Muslims* did not carry out the terrorism, then the perpetrators must have been non-*Muslims*. So in other words, habitually denying that

<sup>460</sup> Bilefsky, Dan. "Denmark Is Unlikely Front in *Islam-West* Culture War," nytimes.com, 8 Jan 2006, *DW*.

<sup>461</sup> "Muslims Offended by Danish Cartoons," news.yahoo.com, 10 Feb 2006, *JW*.

<sup>462</sup> Ismail, Noor Huda. "Schooled For *Jihad*, They Turned to Terrorism: I wanted to know why," washingtonpost.com, 26 Jun 2005, p. B01, *JW*.

<sup>463</sup> "No *Muslim* was involved in London blasts," dailylimes.com.pk, 19 Jul 2005.

*Muslims* were the perpetrators is another case of *Muslims* thinking that only non-*Muslims* are ever at fault.

- C Another example of how *Muslims* say they are always the victims is how an *Imam* said after the 7/7 and 7/21 London bombings...

...that the eight suspects in the two bombing attacks on London 'could have been innocent passengers.' *Mohammad* Naseem, the chairman of the city's central *Mosque*, called Tony Blair a 'liar' and 'unreliable witness' and questioned whether CCTV [Closed-circuit TV] footage issued of the suspected bombers was of the perpetrators.<sup>464</sup>

Since the *Koran* inculcates into the mind victimology, *Jihad* and conspiracy, the few *Muslim* condemnations of terrorism are forced, as Charles Moore wrote:

When did you last hear criticisms of named extremist groups and organizations by *Muslim* leaders, or support for their expulsion, imprisonment or extradition? How often do you see *Fatwas* issued against suicide bombers and other terrorists, or statements by learned men declaring that people who commit such deeds will go to hell? When do *Muslim* leaders and congregations insist that a[n]...*Imam* leave his *Mosque* because of the poison that he disseminates every Friday? When did a British *Muslim* last go after a *Muslim* who advocates or practices violence with anything like the zeal with which so many went after Salman Rushdie? Why is not more stigma attached to the *Muslims* who are murdering other *Muslims* every day in *Iraq* and the Middle East?<sup>465</sup>

Someone might say that *Muslims* **do** speak about evil that *Muslims* do when they issue statements or *Fatwas* condemning terrorism. Most *Muslims* deny that *Muslims* ever commit terrorism using various loopholes, for example:

- C Conspiracy theories exonerate *Muslims* and blame the West for framing *Muslims* for terrorist acts.
- C Declaring that *Islamic* terrorists only **think** they are *Muslims* and they distort the teachings of the *Koran*.

Thus *Muslim* statements of condemnation of terrorism do not even come close to associating evil with *Muslims*, but just continue to pile more blame on infidels, or infidels who happen to **think** they are *Muslim*. Fiamma Nirenstein wrote about the conspiracy theories that pass for serious political analysis in *Islamdom*:

*Bin Laden*? The *Muslim* Brotherhood? Certainly the terrorist attacks are not their work, no! This is a lie. A *Muslim* could never do this. And if they say they do it in the name of *Islam*, they are not *Islamic*; or, most likely, this shows, like the television says, that someone uses the name of *Islam* just to hide the real perpetrators...*Al-Jazeera* [TV] and even *Al-Arabia* [TV] interviewed 'experts' to confirm this point of view...It cannot be a *Muslim*, it's certainly the Israelis and the Americans...the television broadcasts an 'analysis' that charges the *Mossad* and the CIA with mass murders...the television said that only the Israelis and the Americans have a real interest in seeing Egypt on its knees...<sup>466</sup>

*Muslims* go to great lengths to disassociate *Muslims* and *Islam* from terrorism. For instance, *Pakistani* President...

<sup>464</sup> Britten, Nick. "Leading cleric rails at injustice of 'Muslim bashing,'" telegraph.co.uk, 28 Jul 2005, C&R.

<sup>465</sup> Moore, Charles. "Where is the Gandhi of *Islam*?" telegraph.co.uk, 9 Jul 2005.

<sup>466</sup> Nirenstein, Fiamma. "*Muslim* 'Moderates' And Terrorism," *The New York Sun*, 28 Jul 2005.

...Musharraf said suggestions that *Islam* rejected tolerance and promoted terrorism amounted to a ‘hate campaign’ against the faith.<sup>467</sup>

Similarly, Iqbal Sacranie, the head of the *Muslim* Council of Britain, was a backer of a proposed incitement to religious hatred law because he hoped that people would be prosecuted for: 1) pairing up the words “*Islamist*” and “terrorist” and 2) making security estimates of the number of *Muslims* in Britain who were terrorists or terrorism supporters. Sacranie said:

There is no such thing as an *Islamic* terrorist. This is deeply offensive. Saying *Muslims* are terrorists would be covered by this provision.<sup>468</sup>

There are other examples of *Muslims* trying to disassociate *Muslims* and *Islam* from terrorism and criminalize the forming of certain opinions based on the facts. Turkish Prime Minister Erdoğan said that terrorism has no...

...religion, language, race or country...no religion permits terrorism...therefore, it is very ugly to put the word ‘*Islam*’ before ‘terrorism.’<sup>469</sup>

Later in 2005, Erdoğan added that “associating *Islam* and *Muslims* with terrorism” was a misconception and constituted *Islamophobia*, and that “*Islamic-phobia*” and “anti-*Islamism* must [both] be treated as a crime against humanity just like anti-Semitism.”<sup>470</sup> There is however no such thing as *Islamophobia*, because a phobia is an irrational fear. What is called *Islamophobia* is “actually a normal impulse for self-defense,” as Robert Spencer notes.<sup>471</sup> Daniel Pipes responded to Erdoğan’s 2004 assertion against pairing “*Islam*” and “terrorism”:

Martin Kramer dismisses Erdoğan’s comment about *Islamic* terrorism as ‘utter nonsense,’ which it is. And it is nonsense with a purpose; what Erdoğan said represents the standard verbal deception that *Islamists* routinely engage in, hiding their radical utopianism behind the integrity of the *Islamic* religion. (For a Western analogy, think of communists who hid behind the label of socialist.)<sup>472</sup>

The mistaken belief that many *Muslims* hold—that non-*Muslims* perpetrate terrorism—though they might call themselves *Muslim* as part of their cover—constitutes more incitement to hatred and terrorism against non-*Muslims* in general.

The statements of condemnation of terrorism that *Muslim* groups issue do not, in accordance with *Koran* 004:148, place the blame for terrorists on *Muslims* but are mainly meant to **deflect blame** onto non-*Muslims*. For instance, Shukri Abed, from the Middle East Institute think tank in Washington DC, said about one such *Fatwa*:

Abed said it was most likely that the *Fikh* Council [of North America] wants to **deflect** any **blame** for terrorist attacks from North American *Muslims* as a whole...their motive is obviously to possibly impact their relations with the governments of the US and Canada.<sup>473</sup>

Nihad Awad, US CAIR’s executive director, said about a *Fatwa* issued by the *Fikh* Council of North America after the 7/7 London bombings in 2005:

<sup>467</sup> “Pakistan Leader Urges U.S. Jews to Help Make Peace,” nytimes.com, 18 Sep 2005.

<sup>468</sup> Pipes, Daniel. “Downing Street’s Favorite—The *Muslim* Council of Britain,” *DP*, 7 Jul 2005.

<sup>469</sup> Pipes. “Erdoğan: ‘Turkey Is Not a Country Where Moderate *Islam* Prevails,’” *DP*, 14 Jun 2004.

<sup>470</sup> “Anti-*Islamism*”: Albayrak, Mukremin & Nuri Imre. “Erdoğan Asks *Islamic* Leaders to Explain *Islam* in the Best Way,” zaman.com, 6 Sep 2005, *Islamonline.net, DW*; “*Islamic-phobia*”: Ser, Sam. “Turkey’s chief rabbi attends ‘Meeting of Civilizations,’” jpost.com, 30 Sep 2005.

<sup>471</sup> Spencer, Robert. “MSU prof’s e-mail outrages *Muslims*,” *JW*, 25 Apr 2006.

<sup>472</sup> Pipes, Daniel. “Erdoğan: ‘Turkey Is Not a Country Where Moderate *Islam* ...’” *Idem*.

<sup>473</sup> Tully, Andrew. “U.S.: Can Antiterror *Fatwa* Have Impact On Militants?” *Radio Free Europe/Radio Liberty*, frerl.org, 29 Jul 2005.

...there is nothing new to this *Fatwa* and the one issued in Britain. He said *Muslims* in the United States have been trying for more than a decade to demonstrate to their fellow Americans that they should not condemn all *Muslims* because of the actions of the very few.<sup>474</sup>

*Ibrahim* Hooper, a spokesman for CAIR, advanced CAIR's all-too-successful campaign to hoodwink Americans into dissociating terrorism from *Islam* despite all the evidence to the contrary. He said:

This brutal attack on innocent civilians [by a Jewish terrorist] once again demonstrates that terrorism and extremism can rise out of any faith. We call on American religious and political leaders to condemn the attack and to repudiate the extremist views that apparently motivated the perpetrator. Terror is terror, no matter what faith the terrorist espouses.<sup>475</sup>

Another *Muslim* deflection of blame over terrorism comes from *Pakistan*:

*Pakistan's* top *Muslim* clerics have said it is becoming increasingly difficult for them to preach the real concept of *Jihad*, or holy war, to young *Muslims*. 'The situation in *Iraq*, *Afghanistan* and Palestine is radicalizing young people,' says *Mufti* Rafi Usmani, one of *Pakistan's* highest-ranking clerics. 'And an angry young man is in no-one's control,' he said....These *Ulema* are convinced that the solution to terrorism no longer lies in the hands of the *Muslim* world or the clerics....The West, they say, must seek a resolution of all the conflicts involving the *Muslim* world and hit at the root causes that have spawned terrorism all over the world. Other high-ranking *Islamic* scholars have also endorsed these views.<sup>476</sup>

Cynical or deceived *Muslims* mis-ascribe *Jihad*-terrorism to non-*Muslims* in order to deflect blame, and thus blame the victims of terror for *Islamic* terrorism. Because the statements of condemnation make it seem as though non-*Muslims* terrorized *Muslims*, they constitute incitement to terrorism.

Not only are *Muslims* upset that they keep on being blamed for terrorism that *Muslims* did not commit (they claim), but some *Muslim* will want to take revenge on non-*Muslims* for committing acts of terror on *Muslims* if any *Muslims* happened to have died. One can see that *K* 004:148 creates a sort of perpetual-motion cycle-of-violence machine.

Another ploy that *Muslims* use to deflect blame is to say that their *Imams* do not preach the War verses "literally" and *Islam* is a Religion of Peace.<sup>TM</sup> The idea is to get non-*Muslims* to admit that they cannot read minds, and that they cannot easily prove that a *Muslim* means Holy War rather than something benign. Reading minds however is not necessary since opinion polls of *Muslims* reveal that a substantial minority believes in the rightness of Holy War and even terrorism.

As discussed earlier, throughout *Islamic* history and even nowadays, *Jihad* has meant Holy War first and foremost, and then sometimes as an inner struggle. The *Sufis*, who are some of the more amiable *Muslims*, have long believed that the Greater *Jihad* was an inner spiritual struggle, yet *Sufis* were very active in preaching the Lesser *Jihad* too.

<sup>474</sup> Tully, Andrew. "U.S.: Can Antiterror *Fatwa* Have Impact On Militants?" Radio Free Europe/Radio Liberty, rferl.org, 29 Jul 2005.

<sup>475</sup> "CAIR Condemns Bus Attack by Israeli Terrorist," releases.usnewswire.com, 4 Aug 2005.

<sup>476</sup> Khan, Aamer Ahmed. "Pakistan clerics explain *Jihad*," news.bbc.co.uk, 23 Jul 2005, *JW*.

From reading history and about current events, one can gather that when all the hate and War verses of the *Koran* and *Hadith* are turned inward, a *Muslim*'s inner spiritual struggle is mainly about the toils of the inner *Jihadist* killing the inner honest nice guy. Thus the inner “war is deceit” *Jihadist* becomes THE self, and has no regrets and pangs of conscience over killing the inner honest nice guy, much as Cain did not fret over killing Abel. The bottom line is that whenever the *Koran* is internalized, the resultant inner spiritual struggle leads to more outward hatred and *Jihadist* activity, support and sympathy.

The declarative War verses do not lend themselves well to a metaphorical or nuanced interpretation, as *Imams* and most everyone else well know. What *Muslim* teachers mean when they say they do not teach *Jihad* literally is that the *Koran* should be read as a general, not immediate, call for *Jihad*.

*Imams* indeed believe there is a time and place for *Jihad* in the modern world but not necessarily at the very moment they happen to be preaching about *Jihad*. In other words, the *Imam*'s message is that would-be *Jihadists* in Eurabia and America should either:

- ☉ Travel to where there is a call for *Jihad*, places such as *Chechnya*, *Iraq* or *Palestine*, or
- ☉ Wait for the day when the call for *Jihad* goes out where the sermon on *Jihad* was taught. In the UK. and America and elsewhere, that time would be when demographics favor a *Muslim* takeover by vote or by force. This is why *Muslims* speak of the Black Flag of *Jihad* one day flying over No. 10 Downing Street and even the White House.<sup>477 478</sup>

It does not really matter much what spin *Muslims* put on the *Koran*. Repeating the 164 War verses *ad nauseum* such as “kill the pagans wherever you find them” (*K* 009:005) and “fight Christians and Jews until they pay the *Jizya* poll tax” (*K* 009:029), is playing with a loaded gun. It only takes one listener or reader to take a War verse seriously and literally for pagans, Christians and Jews to die.<sup>479</sup>

It is not ideal by any stretch of the imagination that *Muslims* living outside of *Islamdom* ought to live *en masse* amongst infidels. Historically, infidels are the main victims of *Jihad* and *Sharia* law, and the main victims of today's *Islamic* terrorism.

Infidels ought not bide their time just hoping that fewer *Muslims* take up terrorism. Infidels must take preventative security measures to protect infidels—measures that include encouraging emigration back to *Islamdom* to deportation to *Islamdom*. Politicians are becoming enlightened on this subject, for instance:

- ☉ UK “Shadow Home Secretary David Davis” said: “The concept of multiculturalism” is “outdated.”<sup>480</sup>
- ☉ “Mainstream UK politician” and UK defense minister stated:

‘If they don’t like our way of life, there is a simple remedy: go to another country, get out,’ Mr. Howarth said. Asked what if these people were born in Britain, he replied: ‘Tough. If you don’t give allegiance to this country, then leave.’ He added: ‘There are plenty of other countries

<sup>477</sup> Golan, Ori. “One Day the Black Flag of *Islam* Will Be Flying Over Downing Street,” jpost.com, 2 Jul 2003, *FPM*.

<sup>478</sup> Elders, Larry. “Would a *Muslim* flag above the White House solve America’s problems?” jewishworldreview, 18 Sep 2003.

<sup>479</sup> Pipes, Daniel. “Television in Time of War,” *DP*, 2 Aug 2005.

<sup>480</sup> “London religious hate-crime soars,” cnn.com, 3 Aug 2005.



whose way of life would appear to be more conducive to what they aspire to. They would be happy and we would be happy.<sup>481</sup>

Idealistic, ivory-tower multiculturalists say that *Muslims* have the right to live in the midst of pagans, Christians and Jews—the very people *Islamists* intend to one day convert or kill—or conquer, tax and *Dhimmify*. These multiculturalists ought to go live in *Islamdom* as a *Dhimmi* now so they can taste the fate they would allot to later generations in the West—namely to live under *Sharia* law.

A look at *Muslim* condemnations of terrorism is revealing, such as the July 28, 2005 *Fatwa* endorsed by 145 (and counting) North American *Muslim* organizations, *Mosques* and *Imams*. The *Fiqh* (or *Fikh*) Council of North America ruled that:

In the light of the teachings of the *Qur'an* and *Sunnah* we clearly and strongly state:

1. All acts of terrorism targeting civilians are *Haram* (forbidden) in *Islam*,
2. It is *Haram* for a *Muslim* to cooperate with any individual or group that is involved in any act of terrorism or violence.
3. It is the civic and religious duty of *Muslims* to cooperate with law enforcement authorities to protect the lives of all civilians.<sup>482</sup>

Let us see why Shukri Abed (quoted above) said this *Fatwa* was an attempt to “deflect any blame” and influence the US and Canadian governments.<sup>483</sup> Note that:

- C The *Fatwa* mentions the word “terrorism” rather than *Jihad* though many *Muslims* deny that *Jihad* or Khidr-Second Lamech Logic terrorism is terrorism at all.
- C The *Fatwa* distances *Muslims* from terrorism by not mentioning any method such as suicide-bombings, though in 2005 *Muslims* have a near-monopoly on suicide-bombings.
- C The *Fatwa* seeks to condemn all terrorism rather than just *Islamic* terrorism because what *Muslims* find worrying is not so much *Islamic* terrorism (since the targets are deemed non-*Muslims*), but rather the potential backlash against *Muslims* after an episode of *Islamic* terrorism (since that targets *Muslims*). *Muslims* sometimes refer to counter-terrorism efforts and investigations as terrorizing the *Muslim* community, and *Muslims* say that the Western media sensationalizes terrorism.<sup>484</sup> If it were not for the backlash, everything would be business as normal for *Muslims* after every terror attack, that is, after the celebrations were over like those that occurred on 9/11 and after.
- C The *Fatwa* uses non-*Islamic* terms such as “civilian” even though *Jihadists* do not recognize any law code but *Sharia* law.<sup>485</sup> “*Al-Qaeda* in *Iraq*” (an *Al-Qaeda* franchisee) head terrorist, *Abu* Musab *Al-Zarqawi*, said “*Islam* does not differentiate between civilians and military (targets) but rather distinguishes between *Muslims* and infidels..*Muslim* blood must be spared...but it is permissible to spill infidel blood.”<sup>486</sup> Furthermore, “The

<sup>481</sup> Peev, Gerri. “*Muslims* who hate us can get out, says Tory,” news.scotsman.com, 3 Aug 2005.

<sup>482</sup> “U.S. *Muslim* Religious Council Issues *Fatwa* Against Terrorism,” cair-net.org, 28 Jun 2005.

<sup>483</sup> Tully, Andrew. “U.S.: Can Antiterror *Fatwa* Have Impact On Militants?” *Radio Free Europe/Radio Liberty*, frerl.org, 29 Jul 2005.

<sup>484</sup> Akhtar, Rajnaara C. “The backlash has begun, and I fear for the innocent,” independent.co.uk, 16 Jul 2005, Rogier van Bakel (*Nobody's Business* blog).

<sup>485</sup> “There Are No Such Things as Civilians,” memritv.org, Clip no. 748, 8 Jul 2005.

<sup>486</sup> “Zarqawi backs killing civilian ‘infidels,’” news.yahoo.com, 7 Oct 2005, *JW*.

[U.N.] document [defining “terrorism”] condemns terrorism ‘in all its forms’ but at the insistence of *Islamic* countries, negotiators deleted wording describing the targeting of civilians as ‘unjustified.’<sup>487</sup> So the facts indicate that the *Fatwa* was meant only for Western consumption, much as Arab leaders say “peace” in English to put non-*Muslims* at ease while saying *Jihad* in Arabic (like Arafat used to do), in keeping with the *Hudaybiya* precedent set down by *Muhammad*.<sup>488</sup>

All these cryptic *Fatwas* condemning terrorism are next-to-useless not only because they are so conditional and build a weak case, but because *Muhammad* himself said that terrorism was heinous under certain circumstances (i.e. the timing), but nevertheless said terrorism was justified as the lesser of two evils—the greater evil being persecution (*K* 002:191, 193, 217).

*Muhammad* undeniably commanded his men to “terrorize the enemy” (*K* 008:060) while blaming non-*Muslims* if *Muslims* ever had to resort to *Jihad* and *Lex Talionis* (*K* 022:039). *Muhammad* even said that mutilating the enemy was wrong, but *Muslims* were justified in mutilating the enemy in accord with *Lex Talionis* (*K* 016:126).

Based on the *Islamic* principle that whatever is not *Haram* (forbidden) is *Halal* (permissible)<sup>489</sup> and “the firmly established principle [that] ‘Necessity makes prohibited things permissible,’”<sup>490</sup> the *Fatwa* actually puts its blessing on terrorism against non-civilians.

These principles are in keeping with the *Koran* which says to wage *Jihad* until there is no persecution and all religion is for *Allah* (*K* 002:193; 008:039). The *Koran* also says not to obey any non-*Muslim* authority<sup>491</sup> and not to obey any lawcode besides *Sharia* law.<sup>492</sup>

The *Fatwas* against terrorism generally do not mention any terrorist or terrorist groups, but the 2005 Spanish *Fatwa* against Usama Bin Laden is an exception. The Spanish *Fatwa* declares *Bin Laden* to be a “*Kafir Murtadd Mustahlil*, that is to say an apostate.”<sup>493</sup> Thus the *Fatwa* is in keeping with *K* 004:148 because if Usama is considered an apostate and not a *Muslim*, one can then speak of his evils.

When asked why the North American *Fikh* Council’s (NAFC) *Fatwa* of 2005, issued after the 7 July 2005 terror attack in London, did not name any *Islamist* terrorist group, *Ibrahim Hooper* of CAIR said the terrorist groups’ names were left off the because otherwise the *Fatwa* “would have been a laundry list.”<sup>494</sup> This last statement seems to be an inadvertent admission that terrorists are more than just a tiny minority of *Muslims*, especially when one considers that there was room to list all 145 *Muslim* organizations, *Mosques* and *Imams* who endorsed the *Fatwa*.

<sup>487</sup> Leopold, Evelyn & Paul Taylor. “UN Assembly approves weakened summit blueprint,” news.yahoo.com, 13 Sep 2005, C&R.

<sup>488</sup> Pipes, Daniel. “Back in the News: The Treaty of *Hudaybiya*,” *DP*, 16 Oct 2003.

<sup>489</sup> Gibb & Kramers. *Encyclopedia, Haram* entry, p. 133.

<sup>490</sup> Glasse. *Encyclopedia, Wudu* entry, p. 422, right column.

<sup>491</sup> Do not obey any non-*Muslim* ruler: *K* 003:149; 025:052; 026:151; 033:001, 048; 068:008; 076:024; 096:019.

<sup>492</sup> Do not obey any lawcode besides *Sharia* law: *K* 004:059-061, 065, 115; 005:044-45, 47, 50; 024:047-051; 028:050; 042:02; 058:020.

<sup>493</sup> “Spanish *Fatwa* Against Terrorism – 17 March 2005,” theamericanMuslim.org, 19 Apr 2005.

<sup>494</sup> Zoll, Rachel. “*Fatwa* stirs debate among U.S. *Muslims*,” gazetttimes.com, 6 Aug 2005.

CAIR endorsed the NAFC's *Fatwa*. CAIR and NAFC have murky connections<sup>495</sup> and Fawaz Damra was deported for endorsing terrorism just months after signing the NAFC *Fatwa* purported to be against terrorism!<sup>496</sup>

The real reason the terrorists were not named has nothing to do with lack of space or readability, but *Islamic* jurisprudence, as the *Shaykh* Burhan-ud-din Ali (flourished 12th century AD) stated:

Slaying of the women or infant children of infidels is also prohibited in principle. But if a *Muslim* slays them, he invites no censure.<sup>497</sup>

The *Sunni Hanafi* school ruled likewise, according to *Hugh's Dictionary*:

If a *Muslim* attack infidels **without** previously calling them to the faith, he is an offender, because this is forbidden; but yet if he does attack them before thus inviting them and slay them, and take their property, neither fine, expiation, nor atonement are due [from the offending *Muslim*], because that which protects (namely, *Islam*) does not exist in them, nor are they under protection by place [meaning they are not 'protected' *Dhimmi*s because they are not in *Muslim* lands].<sup>498</sup>

Due to *Islamic* jurisprudence, *Islamic* leaders usually do not criticize terrorists by name, either, as *The New York Times* reported:

Mr. Abbas himself criticized the bombing on practical, not moral grounds, saying that it 'harms the Palestinian interests and could widen the cycle of violence, chaos, extremism and bloodshed...But in a speech to the Palestinian parliament...he refrained from condemning *Islamic Jihad*. Even when the group has taken credit for terrorist attacks, Mr. Abbas has not criticized it by name.<sup>499</sup>

Most *Fatwas* against terrorism never call terrorism a capital offense but merely call it *Haram*, i.e. forbidden. This puts the act in the same broad category as say, urinating while facing *Mekka*, which goes against *Muhammad's* example:

*Abdullah b. Umar*...said: I went up to the roof of the house and saw the Messenger of *Allah*...squatting on two bricks for relieving himself with his face towards *Bait-Al-Maqdis* [i.e. the temple mount] (*Sahih Muslim*, Bk. 2, No. 0509; also see *Malik's Muwatta*, Bk. 14, No. 14.2.3).

The fact that most *Muslim* statements of condemnation mention only generic perpetrators and generic victims of terrorism is outrageous given the fact that:

- ☉ Nearly all terrorism in the world today is carried out by *Muslims* in the name of *Islam*.
- ☉ Terrorist statements are peppered with *Koran* and *Hadith* quotations.
- ☉ The vast majority of victims of *Islamic* terror are non-*Muslims*.

However, this is in keeping with *K* 004:148 which says not to speak publicly of evil unless *Muslims* have been wronged.

*Muslim* statements of condemnation of terrorism contrast greatly with Christian and Jewish condemnations of terrorism which do not try to hide the fact that there are

<sup>495</sup> Emerson, Steven. "The American *Islamic* Leaders' *Fatwa* is Bogus," The Counterterrorism Blog, counterterror.typepad.com, 28 Jul 2005, *JW*.

<sup>496</sup> Milicia, Joe. "Ohio Cleric to Be Deported for Terror Ties," *breitbart.com*, 25 Nov 2005, *JW*.

<sup>497</sup> Goel. *Calcutta*, ch. 4, as quoted from ch. 2 of the *Hidayah* treatise compiled by *Shaykh* Burhan-ud-din Ali (flourished 12th century AD).

<sup>498</sup> Hughes. *Dictionary*, p. 245, right column, *Jihad* entry.

<sup>499</sup> Erlanger, Steven. "Israel Intensifies Crackdown on Palestinians," *nytimes.com*, 27 Oct 2005, *backspin.typepad.com*.

always going to be a bad apple in the bushel. For instance, when a Jewish terrorist killed four Arabs in 2005, *Israeli* Prime Minister Ariel Sharon stated:

This was a reprehensible act by a bloodthirsty **Jewish** terrorist who sought to attack innocent *Israeli* citizens...<sup>500</sup>

Often the main thrust of *Muslim* statement of condemnation of terrorism is actually a directive telling non-*Muslims* to: 1) Not associate terrorism with *Islam*,<sup>501</sup> 2) Believe that terrorism is really the fault of non-*Muslims*, and to 3) Change foreign policy or counter-terrorism laws, or 4) vote some politician out of office whom *Muslims* despise. Why *Muslims* want Western foreign policy changed is they believe that...

...whenever and wherever *Muslims* have moved toward establishing an *Islamic* state, the ‘treacherous hands of the secular West are always there...to bring about [their] defeat.’ Nor are *Muslim* rulers of any help [to *Islamists*], for they are ‘all in the pockets of the Western powers.’<sup>502</sup>

*Muslim* condemnations of Khidr-Second Lamech Logic terrorism are insincere cynical works of *Takiya* that are excuses and near-justifications for terrorism.<sup>503</sup> The statements are get-out-of-jail-free cards that allow *Muslims* to maintain the Religion of Peace™ masquerade to evade police scrutiny, deportation and retaliation.

Statements of condemnation of terrorism often turn around action and reaction, for instance: counter-terrorism measures cause terrorism. Here a *Muslim* says in an Op-Ed piece that: 1) the media reporting on terrorism and 2) terrorism experts’ opinions about *Islamists* incite *Muslims* to commit terrorism (basically because terrorism experts do not buy into the fantasy that *Islam* is a Religion of Peace,™ and that some moderate *Muslims* are not all that moderate, even though world leaders might be fooled):

The immediate media response on numerous fronts has been to demonize *Islam* and bring out of the closet so-called experts...Opinions from some media commentators are being conceded as legitimate interpretations of *Islam*, although many of them have no scholarly background on *Islam* and unanimously offend almost the entire *Muslim* world...the universally respected scholars such as Tariq *Ramadan* are being targeted as extremists...creating a villain out of the voices of reason and reconciliation...The mainstream media needs to take responsibility for its actions and seriously consider the **incitement** that misrepresentation of *Islam* and *Muslims* in Britain can set in motion. By **sensationalizing** this tragedy, our communities are being **torn apart**.<sup>504</sup>

Notice how the op-ed writer (quoted above) says media attention on fifty-plus victims who were torn limb-from-limb is “**sensationalizing**,” while the real victim of the terrorists is the *Muslim* community which is metaphorically being “**torn apart**.”

Here is the boilerplate that many *Muslim* condemnations of terrorism follow:

<sup>500</sup> “PM Sharon’s Statement Following the Terrorist Attack in *Shfaram*,” Prime Ministers Office, pm.gov.il, 4 Aug 2005.

<sup>501</sup> Enchin, Harvey. “A Religion of Peace vs. apologists for terrorism,” *The Vancouver Sun*, canada.com, 15 Jul 2005.

<sup>502</sup> Pipes, Daniel. “The Danger Within: Militant *Islam* in America,” *Commentary*, Nov 2001.

<sup>503</sup> Keath, Lee. “*Islamic* leaders criticized for adding ‘but’ to condemnations,” *suntimes.com*, 10 Jul 2005.

<sup>504</sup> Akhtar, Rajnaara C. “The backlash has begun, and I fear for the innocent,” independent.co.uk, 16 Jul 2005, Rogier van Bakel (*Nobody’s Business* blog).

1) Faults infidels for being too quick to suppose the latest terror attack was by *Muslims*, which reflexive response *Muslims* characterize as being *Islamophobic*.

2) Says *Islamic* terrorists are not *Muslim* but are a “minority who claim falsely to represent us” and says their latest act of terrorism was “absolutely un-*Islamic*...completely contrary to our teaching and practice...”<sup>505</sup> Says *Islamic* terrorists must not be *Muslim* because their terror act hurt the cause of *Islam* more than help it (in other words they admit backhandedly that terrorism helpful to *Islam* is *Islamic*).<sup>506</sup>

3) Declares that non-*Muslims* incite *Muslims* to terrorism by: a) the media misrepresenting *Islam* and *Muslims*, b) counter-terrorism measures, or by c) *Muslims*’ unresolved grievances (e.g. Western or American hegemony, *Israel*’s racist-apartheid colony, *Islamophobia*, discrimination, humiliating or violent counter-terrorism measures, i.e. “state-terrorism”).

4) Says *Muslims* are victims twice-over because not only do they now fear the terrorists that Westerners created in the midst of *Muslims*, but *Muslims* must fear a backlash against *Muslims* in the form of “hate” crimes or unfair counter-terrorism legislation (i.e. the law smartly makes use of threat-profiling).

In short, *Muslim* statements of condemnation against terrorism actually feed hatred and are victimology statements that will make the next terrorist attack more likely—because they say: 1) infidels are biased when they quickly assume that *Muslims* “did it,” 2) infidels are wrong to associate terrorism with *Islam*, 3) infidel wrongs against *Muslims* are the root cause of terrorism and 4) infidels will lash out at innocent *Muslims* following the latest terrorist incident, beginning the whole cycle anew.

Someone might ask “How can any *Muslim* denounce terrorism when he has not renounced terrorism?” And “How can *Muslims* say *Islamic* terrorists are non-*Muslims*?” The answer is the statements of condemnation of terrorism are pure deceit allowed under the *Takiya* principle discussed in this table in the License-to-Deceive section. Gibb and Kramers wrote that *Muhammad* allowed...

...in case of need the denial of the faith (*K* 016:106 [which, incidentally, is a damnable sin (*K* 002:217)]), friendship with unbelievers (*K* 003:028) and the eating of forbidden foods (*K* 005:003b; 006:119; [006:145]). This point of view is general in *Islam*.<sup>507</sup>

If a *Muslim* can outwardly deny the faith without jeopardizing his soul surely he can publicly deny the sixth pillar of *Islam*: *Jihad*. Only when the doctrine of *Jihad* is hypocritically deemed un-*Islamic* do *Islamic* terrorists become heretics.

Clear examples of *Takiya* are sometimes found when comparing *Muslims*’ statements to the media, often in English, with later statements made to *Muslims*, often in Arabic:

- ☉ Daniel Pipes wrote that Arafat had a habit of “saying one thing in English and another in Arabic”<sup>508</sup>—talking peace and renouncing terrorism in English but enjoining *Jihad* in Arabic.
- ☉ During the 2006 Danish Cartoon Riots, Danish *Imam Abu Laban* “told Danish television that he denounced the boycott of Danish products and

<sup>505</sup> Pipes, Daniel. “Sir *Ibrahim* Hooper and Lord Salam *Al-Marayati*?” *DP*, 12 Jun 2005 + updates.

<sup>506</sup> “UAE Scholar Says London Bombers Infidel,” arabnews.com, 16 Jul 2005, *JW*.

<sup>507</sup> Gibb & Kramers. *Encyclopedia, Takkiya* entry, pp. 561-562.

<sup>508</sup> Pipes, Daniel. “Why *Hamas*[’s Electoral Victory] Leaves Me Neutral,” *DP*, 31 Jan 2006.

called for its cancelation. One hour later however in an interview with *Al-Arabiya*, he said he was ‘pleased’ with the boycott.”<sup>509</sup>

- ⊕ After the 7/7 bombing in London, UK *Imam* Omar Bakri “condemned the killing of all innocent civilians,” deceptively meaning only *Sharia*-compliant *Muslims*.<sup>510</sup> Then Bakri told his followers “Killing a *Kufar* [unbeliever] for any reason you can say it is OK even if there is no reason for it.”<sup>511</sup>
- ⊕ After the 7/7 bombing in London, Hamid Ali, *Imam* at a *Mosque* in West Yorkshire, UK, “told newspapers that the perpetrators ought to be punished. But in a secretly taped conversation, he said: “What they [*Times*’ editor: the bombers] did was good.”<sup>512</sup>

Any informed *Muslim*, including terrorists, know the *Pro Forma* statements of condemnation are works of *Takiya* because the *Takiya* principle is invoked in the very same statements of condemnation. For instance, the statements mention:

- ⊕ How *Muslims* have been harmed in the past and how this led to *Islamic* terrorism.
- ⊕ How terrorism incidents or suicide-bombings are counter-productive since their net effect is to harm *Muslims* more than non-*Muslims* due to the backlash, i.e. mob violence and counter-terrorism laws.

For instance, a *Kashmiri* legislator said that “No *Muslim* is involved in the London terror bombings” of 7/7. He then went on to invoke the *Takiya* principle by saying “that tension was increasing between Britons and *Kashmiris* living in Britain following the London blasts.”<sup>513</sup>

Terrorists and their kin know the statements of condemnation and disassociation are a ruse since terrorists and their families make similar wily statements as part of their “moderate” *Muslim* cover to ward off suspicion from the police.<sup>514 515</sup>

Every *Muslim* knows the statements of condemnation are a *Takiya* in line with *Muhammad*’s dictum that *Muslims* could befriend infidels until such time as *Muslims* can gain the upper hand (*K* 003:028).

The *Muslim* statements of condemnation of terrorism never forward any cogent and compelling arguments disabusing *Muslims* of the *Umma*’s cherished beliefs about Khidr-Second Lamech Logic terrorism:

- ⊕ When *Koran* verses are given, they follow a non-traditional interpretation that sounds good only to non-*Muslims* but *Islamists* cite *Koran* verses using the traditional interpretations.
- ⊕ If traditions are cited, they are considered weak, unreliable and heretical, while the *Hadith* and jurisprudence that *Islamists* cite for killing and raping during *Jihad* are strong, for instance:
  - ★ It is not permissible to kill women or children unless they are fighting against the *Muslims*...or if killing them will help defeat the enemy

<sup>509</sup> Uni, Assaf. “Danish *Muslim* unrepentant for sparking cartoon riots,” *haaretz.com*, 14 Feb 2006.

<sup>510</sup> “Inside the sect that loves terror,” *timesonline.co.uk*, 7 Aug 2005.

<sup>511</sup> “*Abu* Hamza said killing non-*Muslims* ‘OK’ in any circumstance,” *news.yahoo.com*, 13 Jan 2006, *JW*.

<sup>512</sup> “British imam praises London Tube bombers,” *The Sunday Times*, *timesonline.co.uk*, 12 Feb 2006, *JW*.

<sup>513</sup> “No *Muslim* was involved in London blasts,” *dailytimes.com.pk*, 19 Jul 2005.

<sup>514</sup> Pipes, Daniel. “How *Islamist* Killers Dissemble,” *DP*, 14 Jul 2005.

<sup>515</sup> Pipes, Daniel. “But he was good to his mother: Murdering for militant *Islam*,” *Middle East Forum*, *meforum.org*, 3 Dec 2003.

(‘*Umdat al-Salik (Reliance of the Traveler), Jihad, The Rules of Warfare*, o9.10).

- ★ According to *Muhammad*, the *Imams* and *Caliph* captors were still within their rights to rape captives, and they need not even practice *Coitus Interruptus*.<sup>516</sup>

Poll after poll indicated that the vast majority of *Muslims* support terrorism—at least in principle or in theory, but a newly common form, suicide-bombings, still remains controversial. In 2005 only 11 percent of Jordanians said that suicide bombings **against civilian targets** was never justified. In Lebanon 11 percent said never, in *Pakistan* 46 percent, and in both Indonesia and Turkey 66 percent said never.<sup>517</sup> Sina Ali, a former *Muslim*, wrote:

Up to this day *Muslims* feel that it is perfectly justifiable to kill the non-*Muslims*, through terrorist activities to advance their religion and make *Islam* dominant but if their victims rise to retaliate they claim to be victimized for their faith.<sup>518</sup>

As one *Muslim* said of one of the suicide bombers who struck on 7/7 in London:

This lad has made a name for himself in the world. *Muslims* call it a sacrifice, the Europeans call him a terrorist.<sup>519</sup>

That the *Koran’s* command to frame every evil with infidels as the perpetrators and *Muslims* as the victim (*K* 004:148) necessitates outrageous conspiracy theories,<sup>520</sup> double standards and other tribalisms cloaked in religiosity. All this is in line with *Muhammad’s* teachings that:

- ☉ “The best of the actions is to love for the sake of *Allah* and to hate for the sake of *Allah*” (*Sahih Muslim*, bk. 40, no. 4582).
- ☉ *Koran* 060:004 says *Muslims* are to hate non-*Muslims* unless they revert to *Islam*.
- ☉ The *Islamic* doctrine *Al-Wala’u Wa Al-Bara*, meaning “Love for *Allah’s* sake and hatred for *Allah’s* sake.”

False narratives, double standards, tribalisms and blaming “the other” tend to crowd out any concern *Muslims* might have for *Islam’s* many victims, as *The Guardian* reported:

The problem is that the frustration—and its close relative, defensiveness—threaten to drown out all other discussions. It leaves little room these days for the outrage and horror one might have still expected in comments on the atrocities of 7/7. That’s troubling. In one exchange, participants pondered the respective responsibilities of Tony Blair and the bombers for the July attacks: 50/50, said one; 80/20 Blair, said another; while the last concluded that the attacks were

<sup>516</sup> *Sahih Bukhari* vol. 003, bk. 034, no. 432; vol. 005, bk. 059, no. 459; vol. 007, bk. 062, nos. 135, 136; vol. 009, bk. 093, no. 506; *Sahih Muslim*, bk. 8, nos. 22, 29 & 3371; *K* 004:024; Spencer.

*Disturbing*, pp. 50-51, 53; Trifkovic. *Sword*, p. 43.

<sup>517</sup> “*Islamic Extremism: Common Concern for Muslim and Western Publics*,” Publicspewglobal.org, 14 Jul 2005.

<sup>518</sup> Sina, Ali. “The Game of Deception,” *JW*, 9 Jan 2005.

<sup>519</sup> “London bomber’s uncle defends nephew’s ‘sacrifice,’” zeenews.com, 17 Jul 2005, *JW*.

<sup>520</sup> Pipes, Daniel. *Conspiracy: How the Paranoid Style Flourishes and Where It Comes from*,” Simon and Schuster, 1999.

Blair's fault alone. The impulse to apportion blame very simply on *Iraq* and Blair has overwhelmed...soul searching...<sup>521</sup>

Soul-searching is a forgotten pastime among *Muslims*, especially when other aspects of *Islam* are factored in such as supersessionism (*K* 003:067) and supremacism (*K* 003:139; 005:056; 008:030; 009:029, 033; 048:028; 061:009), for...

...individualism is, at best, negligible. The *Umma*—the community of believers or the 'Nation of *Islam*'—is pre-eminent. Infinitely less eminent is the infidel, whose inherent inferiority, codified in elaborate *Dhimmi* jurisprudence, makes him fair game. Responsibility is always externalized. *Muslim* savagery toward innocents has been felt from *Beslan* to *Bali*, from *Kashmir* to *Casablanca*. Yet, they'll invariably shift the blame (successfully, I might add) to *Israel*, America, Russia and other 'occupations.'<sup>522</sup>

*Muslims* sometimes believe in contradictory conspiracy theories and their own assertions contradict their conspiracy theories, as Barry Rubin wrote:

Among the notions that the bulk of the governments, media and public opinion of the Arab world plus *Iran* hold are that America itself or *Israel* staged the September 11 attacks and that the US deserved them; that Saddam Hussein was a good ruler of *Iraq*; that *Israel* is going to be destroyed if the Arabs continue the conflict; and that democracy is something they already have and a Western subversive plot.<sup>523</sup>

On Monday a *Muslim* might say the CIA attacked America on 9/11 but on Tuesday the same *Muslim* will say that *Israel's Mossad* carried out 9/11. What is important is not the truth of the matter but to criminalize non-*Muslims* and exonerate *Muslims* in keeping with *Koran* 004:148 and other *Koran* verses.

*Muslims* sometimes cherish conspiracy theories that contradict favorite false narratives, for instance:

☉ *Muslim* Holocaust Deniers will say the Holocaust proves *Islam's* supersessionist views (*K* 003:067) and *Allah's* rejection of Jews mentioned frequently in the *Koran*.

☉ *Muslims* will deny that *Muslims* carried out 9/11, 3/11, 7/7 and other terrorist attacks, yet they will defend and sympathize with the *Islamic* terrorists who carried out those attacks.

The main reason the Holocaust is denied is that accepting the Holocaust as historical would entail speaking evil of *Muslims* which is forbidden (*K* 004:148). The *Mufti* of Jerusalem, Amin *Al-Husseini*, was funded by Nazis during the 1930's, and a million *Muslim* conscripts manned *Nazi* armies—including the *SS*. These *Muslims* participated in ethnic cleansings in the Balkans and in rounding up Jews for the Holocaust such as at the ghetto in Warsaw, Poland.<sup>524</sup>

Recent examples of conspiracy theories held dear include: 1) 9/11 was perpetrated by Jews in order to jumpstart the War on Terror, which is really just a cover for a holy war by modern Crusaders against *Islamdom*, 2) Polio and AIDS and sterility came from the West by way of purposely contaminated vaccines,<sup>525 526</sup> and

<sup>521</sup> Bunting, Madeleine. "Why *Muslims* must guard against the satisfactions of complaint," *The Guardian*, guardian.co.uk, 21 Nov 2005, *DW*.

<sup>522</sup> Mercer, Ilana. "'Islamikazes' in our midst," *WND*, 19 Jul 2005, *DW*.

<sup>523</sup> Rubin, Barry. "The Region: A small outbreak of reason," jpost.com, 5 Sep 2005.

<sup>524</sup> Glick, Caroline. "Column One: The beginning of the reckoning," jpost.com, 14 Jul 2005.

<sup>525</sup> "NBC: *Islamic* Biological Warfare," strategypage.com, 10 May 2005, *JW*, 12 May 2005.

<sup>526</sup> Pipes, Daniel. "A Conspiracy Theory Spreads Polio," *DP*, 24 May 2005.



3) US and Israel bombed a large-domed *Shiite* shrine, the *Askariya Mosque* in *Samarra* in *Iraq*, because:

- ☉ As the influential cleric *Sheikh* Youssef Qaradawi said: “We cannot imagine that the *Iraqi Sunnis* did this...No one benefits from such acts other than the US occupation and the lurking Zionist enemy.”<sup>527</sup>
- ☉ As *Iranian* President Ahmadinejad, said: “They invade the shrine and bomb there because they oppose God and justice.”<sup>528</sup>

Conspiracy theories arise in *Islamdom* because of the *Koranic* injunction to not talk about the evils that *Muslims* do, but only evils done to *Muslims*—especially by non-*Muslims* (*K* 004:148).

Non-*Muslims* are not well represented in *Islamdom* and few *Muslims* are interested in defending the non-*Muslim* past or present. Many refuse to defend the actions of past or present Westerners out of fear of bodily harm, or out of the concern that *Muslims* will raise the price of oil. So, one false narrative dovetails with another and there is nothing that will slow down or stop cascading conspiracy theories. These false narratives are dangerous since they serve as incitement for, or at least justification for, ethnic cleansings, genocides and Khidr-Second Lamech Logic terrorism and warfare.

A true *Muslim* never feels the need to say to non-*Muslims* “I’m sorry,” or feel guilt or remorse—even over suicide bombings that kill children.<sup>529</sup> To the extent that a *Muslim* believes in *Islam*, he or she never feels any need to talk about wrongs that *Muslims* have done, much less feel any pangs of conscience, as Alvin Schmidt wrote:

Marcus Mabry recently stated, when *Muslim* leaders from various countries gather at international forums, they never discuss slavery. He further adds: ‘They feel no remorse for the past and no responsibility for the present.’ This lack of remorse is especially regrettable in light of the fact that *Muslims* have enslaved countless individuals for centuries, since the very earliest days of *Islam*...In the eighth century, the so-called tolerant Moors enslaved about one-fifth of the Spaniards, forcing them to be ‘menial domestics, concubines, eunuchs, musicians and dancers, stewards or agents, soldiers and guards.’<sup>530</sup>

Liberal Tunisian Researcher Dr. Iqbal *Al-Gharbi* wrote about what many *Muslims* do:

We still insist that we are always the victims and that we are always innocent. Our history is angelic, our imperialism was a welcome conquest [*Futuhat*], our invaders [*Ghuzah*] were liberators, our violence was a holy *Jihad*, our murderers were *Shahids*, and our defective understanding of the *Koran* and the daily violation of the rights of women, children and minorities were a tolerant *Shari'a*.<sup>531</sup>

*Muslims* score propaganda points discussing Western guilt over slavery, but while the *Koran* actually condones slavery and having sex-slaves, Saint Paul says:

We also know that law is made not for the righteous but for lawbreakers and...for slave traders...and for whatever else is contrary to the sound doctrine

<sup>527</sup> Karimi, Nasser. “Iran: U.S., Israel Destroyed *Iraqi* Shrine,” news.yahoo.com, 23 Feb 2006, bigPharaoh.blogspot.com.

<sup>528</sup> Karimi, Nasser. “Iran: U.S., Israel Destroyed *Iraqi* Shrine,” news.yahoo.com, *Idem*.

<sup>529</sup> Rapoport, Meron. “In the name of truth,” haaretz.com, 28 Apr 2005.

<sup>530</sup> Segals. *Islam’s Black Slaves*, p. 98, as quoted by Schmidt. *Divide*, p. 120.

<sup>531</sup> “Liberal Tunisian Researcher Dr. Iqbal *Al-Gharbi*: *Muslims* Must Take Responsibility for Past Mistakes,” memri.org, 4 Nov 2005, No.1019, *DW*.

that conforms to the glorious gospel of the blessed God, which he entrusted to me (NIV 1Ti 01:09-10).

Jesus said, “Do to others as you would have them do to you” (Luk 06:31) and “Love your neighbor as yourself” (Mar 12:31), which directives militate against slavery and any other abuse one can name. By contrast, *Muhammad* commanded *Muslims* to be harsh with non-*Muslims* (K 009:073, 123; 048:029; 066:009), which command complements the *Koranic* commands that *Muslims* enslave others.

Ironically, Black *Muslims* often demand reparations from the West even though *Muslims*, including Black *Muslims* themselves, were the worst slavers in history, and some *Muslims* still hold slaves today! Western slavery lasted several centuries and came to be viewed as being un-Christian; slavery in *Islam* lasted 1400 years and slavery is still seen as being *Islamic* by virtue of the slaver *Muhammad*'s example.

Slavery continues in parts of *Islamdom* to this day. Officially slavery was banned in *Saudi Arabia* in 1962, but the royals and rich still practice it there in all but name, and *Saudis* even bring slaves to the US<sup>532</sup> If the West were ever to fall to *Islam*, slavery would be re-instituted globally (see the table “*Islamists* Still Dream of Making Non-*Muslims* into *Dhimmis* and Sex-slaves”).

Just a few hundred years of slavery led to large black populations in the New World, so it is especially troubling that large Black population in the Mideast do not exist even after fourteen hundred years of slavery. The reason is Black men were castrated and Arab men impregnated the black women, not unlike the Arab-*Muslim*-on-Black-*Muslim* ethnic cleansing ongoing in Sudan in 2004-2005. Evidence of Arab slavers impregnating black women include how “*Mauritania* alone is reported to have some one million *Haratin*.”<sup>533</sup>

That *Muslims* do not speak of their war crimes down through history (in keeping with K 004:148) is why in 2005 *Al-Azhar* Seminary in *Cairo* had the audacity to ask Pope John Paul II to apologize over the Crusades even though *Muslims* have killed and enslaved millions of Christians over the last 1400 years.<sup>534</sup>

Christians should not apologize for the Crusades and the West ought not apologize over colonialism since these acts put an end to much *Jihad* and *Dhimmitude* on land and to *Jihadist* piracy on the Mediterranean and the high seas. Besides, the apologies are not reciprocated but are fed into the *Muslim* propaganda machine, all in accordance with K 004:148 which says that *Muslim* should not talk about the evils they do but only about how *Muslims* have some grievance, real or imagined. The Catholic Church has seen how their apologies to *Muslims* have backfired, as the Egyptian Jesuit Samir Khalil Samir wrote:

...he [Benedict XVI, Pope (2005-)] has never fallen into the behavior found in certain Christian circles in the West marked by ‘do-goodism’ and by guilt complexes. Recently, some *Muslims* have asked that the Pope ask forgiveness for the Crusades, colonialism, missionaries, cartoons, etc. He is not falling in this trap, because he knows that his words could be used not for building dialogue, but for destroying it. This is the experience that we have of the *Muslim* world: all such gestures, which are very generous and profoundly spiritual, to ask for forgiveness for historical events of the past, are exploited and are presented by

<sup>532</sup> Pipes, Daniel. “Saudis Import Slaves to America,” *FPM*, 14 Jun 2005.

<sup>533</sup> Richardson. *Secrets*, p. 210.

<sup>534</sup> Sina, Ali. “The Golden Rule and *Islam*,” *JW*, 1 May 2005.

*Muslims* as a settling of accounts: here they say ‘You recognize it even yourself: You’re guilty.’ Such gestures never spark any kind of reciprocity.<sup>535</sup>

*Muslims* wax eloquent and sensationalize the supposed abuses committed by Western militaries even though these same militaries ended Saddam Hussein’s murderous regime. Saddam was a *Sunni Muslim* who murdered nearly 300,000 *Muslims* (not counting the millions of *Iraqis* and *Iranians* who died during the *Iran-Iraq* war).<sup>536</sup> Saddam’s victims were *Kurds* (182,000) and the rest were mostly *Shias*, neither of who are Arabs who are “the best of peoples” (*K* 003:110). Besides, *Muslims* are not supposed to talk about the evils of *Muslims* (*K* 004:148).

*Imams* are fluent in victimhood-talk and *Jihadists* are instructed to complain of torture if they are ever caught. Just as *Muslims* memorize the *Koran*, they memorize a script about discrimination and how their free speech rights have been infringed.<sup>537</sup> Robert Spencer wrote that whenever a *Jihadist* is charged...

...you can be sure that we will hear how quiet, pious and devout he is, and how inconceivable it is that he could have been involved with anything remotely resembling terrorism—and that it is only the racism and hysteria of the American authorities that is causing all his troubles.<sup>538</sup>

The cult of victimology, in keeping with *Koran* 004:148, drives individual and group acts of terrorism, as Robert Spencer wrote:

This is a pattern that repeats itself in virtually every case: *Jihadists* point to the enormities of their opponents and claim: ‘You drove us to it.’ We see it happening in *Iraq* and elsewhere. But they never address the expansionist and violent aspects of *Islamic* theology, or the fact that while their pretexts keep changing, their own actions remain the same: they never seem to be satisfied that their grievances have been redressed, and make peace. They just find another grievance.<sup>539</sup>

*Muslims*, in keeping with *Koran* 004:148, never discuss how terrorism might be the *Muslim*’s fault since this would be a discussion of evil done by *Muslims*. This is how they excuse even Usama *Bin* Laden:

Baasyir, who proclaims himself an admirer of Osama *Bin* Laden but still denies that he [Usama] is a terrorist leader, said that he is just a victim of ‘the infidel Bush’s America.’ Then he quoted a verse from the *Koran*: ‘The infidels will never stop fighting us until we follow their way’ [*K* 002:217].<sup>540</sup>

Also not discussed is how counter-terrorism measures arise because of prior *Islamic* terrorism. In some convoluted way terrorism is always the non-*Muslims*’ fault, and *Muslims* never initiate any “cycle of violence.” In recent decades, America has been blamed for *Islamic* terrorism even though *Jihadism* existed well over a thousand years before the United States became a nation.

The *Koran*, especially the War verses, engenders great hatred against non-*Muslims*. *Koran* 004:148 focuses blame on all non-*Muslims*. *Muslims* will blame the targets of their hatred for causing the hatred *Muslims* feel for them.

<sup>535</sup> Samir, S.J., Samir Khalil. “When Civilizations Meet: How Joseph Ratzinger Sees *Islam*,” *chiesa.espressonline.it*, 4 May 2006, *DW*.

<sup>536</sup> “Babies found in *Iraqi* mass grave,” *news.bbc.co.uk*, 13 Oct 2006.

<sup>537</sup> Dwyer, Timothy. “Prosecution Called ‘Overzealous,’” *washingtonpost.com*, 26 Apr 2005, *JW*.

<sup>538</sup> Spencer, Robert. “*Jihad* in Brooklyn,” *JW*, 27 Apr 2005.

<sup>539</sup> Spencer, Robert. “*Jihadist* group growing in Asia,” *JW*, 2 May 2005.

<sup>540</sup> Ismail, Noor Huda. “Schooled For *Jihad*, They Turned to Terrorism: I wanted to know why,” *washingtonpost.com*, 26 Jun 2005, p. B01, *JW*.

*Muslims* will also blame a third-party for ethnic cleansing they themselves started, as the *Serbs* were blamed for the *Balkan* conflict even though the *Muslims* started it, and the Israelis were blamed for Christians leaving Palestine in droves although Palestinian *Muslims* perpetrated the ethnic cleansing.<sup>541</sup>

*Muslims* are seemingly oblivious to the fact that if it were not for the *Koran*, they would hold no grudges against, nor harbor any hatred for, any people, much less engage in terrorism or in *Jihad* empire-building the last 1400 years.

*Koran* 004:148 explains why *Muslims* make mind-boggling, reality-inverting, hypocritical statements of blame against adherents to other religions who are relatively righteous by comparison to *Muslims* in general, for instance:

- ☉ The official policy of the Turkish government is to deny the Armenian genocide, and Turkey has fined and jailed scholars who fail to ignore or deny the genocide. Some Turks now claim that Armenians are just fraudulently seeking reparations for a genocide that did not occur.<sup>542</sup>
- ☉ Despite all the trillions of dollars spent on oil and many billions given in foreign and humanitarian aid to the Palestinians and Egyptians, and to the Indonesians after the 2004 Boxing Day *Tsunami*, no dent has been made in anti-Americanism in *Islamdom*. This is to be expected because money is fungible, so sending money to *Islamdom* just means more *Mosques* where the *Koran* and its hatred of the infidel is preached constantly.<sup>543</sup>
- ☉ In 2005, the *Saudi* government, like *Muslims* around the world expressed “deep indignation” at a retracted *Newsweek* report that a killing manual, the *Koran*, had been flushed down a toilet.<sup>544</sup> The *Saudis* have however as a matter of state policy, shredded and incinerated Bibles and crosses, and jailed, whipped and beheaded Christians who distributed Bibles.<sup>545</sup>
- ☉ After the Christian Concern organization reported that *Saudi* Arabia had arrested 46 Christians and the US State Department accused *Saudi* Arabia of “‘particularly severe violations’ of religious freedom,” a *Saudi* official denied the reports saying “the allegations ‘don’t go with the principals and values of the kingdom and above all our tolerant *Islamic* belief which guarantees the rights of *Muslims* and residents of different religions and ethnicities alike.”<sup>546</sup>
- ☉ Even while *Muslims* engage in terrorism and seek to extend the rule of *Sharia* law, *Muslims* categorically dismiss legitimate fears and concerns of non-*Muslims* and label them *Islamophobes*, bigots and racist scaremongers. Yet, non-*Muslims* are supposed to take the fears of *Muslims* seriously even though *Muslim* rights groups constantly issue: 1) warnings about impending backlashes after *Islamic* terrorist attacks—outbreaks of *Islamophobia* that rarely occur, and 2) issue hate-crimes reports with incidents that are unsubstantiated, exaggerated or are hoaxes.<sup>547</sup>

<sup>541</sup> Farah, Joseph. “Christian persecution by Arafat,” WorldNetDaily.com, 3 Jan 2003.

<sup>542</sup> Laciner, Sedat (member of TEIMK: Turkish-Armenian Relations National Committee). “The Armenian Issue: Inventing a Past,” turkishweekly.net; “Armenians Dreamt It,” *DW*, 22 May 2005.

<sup>543</sup> Malkin, M. “We hate you! Now give us more money,” michellemalkin.com, 23 May 2005.

<sup>544</sup> “*Saudi* ire at *Koran* ‘desecration,’” news.bbc.co.uk, 13 May 2005.

<sup>545</sup> Goodenough, Patrick. “*Saudis* Do Destroy Bibles, Think Tank Affirms,” CNSNews.com, 23 May 2005, *DW*.

<sup>546</sup> El Deeb, Sarah. “*Saudis* Deny Persecuting Christians,” news.yahoo.com, 7 Jun 2005, *DW*.

<sup>547</sup> Pipes, Daniel & Sharon Chadha. “CAIR’s Hate-crimes Nonsense,” *DP*, 18 May 2005.

- C *Muslims* dismiss non-*Muslim* concerns about the commands in the *Koran* about killing and subduing Christians, Jews and pagans, and claim that the *Koran* compares well to the Bible even though the Bible has no commands to kill *Muslims* or any race of people in existence. So while non-*Muslims* are expected to ignore the fact that the *Koran* wants them dead or subdued, non-*Muslims* are supposed to be empathetic to a *Muslim*'s reaction when he or she stumble upon an extra kill command in the *Koran* she was not expecting. Azza Basarudin said after finding the statement "Death to all *Muslims*" scribbled in a second-hand *Koran*:

I dropped the book because I did not know what to do. I was paralyzed after 9/11—I could not leave my house for a couple of weeks—and I realized that fear was coming back. I could not even go near this book for a couple of days. I feel like I am being violated all over again because I am a *Muslim*.<sup>548</sup>

Notice how Basarudin's ascribing to the *Koran*'s kill commands while at the same time feeling revulsion for the "Death to all *Muslims*" statement is consistent with her view of 9/11. Daniel Pipes noted how Basarudin "presents 9/11 not as an occasion when *Muslims* violated Americans but when Americans violated *Muslims*."<sup>549</sup>

- C Even as *Sunni Muslims*: 1) bomb and destroy churches, synagogues and *Shiite Mosques*, 2) use *Sunni Mosques* as armories and *Sunni Minarets* as sniper nests and 3) burn American and *Israeli* flags, *Muslims* say things such as "American soldiers are known for disrespect to other religions. They do not take care of the sanctity of other religions."<sup>550</sup> A *rabbi*, whose son died trying to defend Joseph's tomb from *Muslim* mobs, said about the "Great *Koran*-flushing Riots of 2005, "They [*Muslims*] lost the right to protest about disrespect for religion and holy objects a long time ago,"<sup>551</sup> a statement with which *Muslims* would disagree, no doubt.
- C Sudanese officials and their spokesmen angrily denied accusations of genocide and ethnic cleansing that went on for decades against Christians and pagans in the south and now against *Muslims* in the *Darfur* region.
- C *Muslim* angrily deny that unemployment, AIDS, FGM, marriage to children, polygamy, spousal abuse, terrorism and in short, anything bad, are widespread in the *Muslim* world; or they deny that say, FGM, is bad at all. The issue of problems endemic to *Islamdom* are hardly ever discussed in *Muslim* circles except to blame them on non-*Muslims*.<sup>552</sup>
- C *Muslims* use the latest retaliatory strike against them to justify the next strike on infidels, seemingly oblivious to the fact that they start most conflicts. *Muslims* believe that the only proper response to an attack is to submit to *Islam*, so any retaliation by infidels is just further justification to attack. To think otherwise would violate *Koran* 004:148.
- C *Muslims* blame non-*Muslims* for the rise of *Islamic* terrorism, even though it is inconceivable that, say: 1) The fact that a tiny percentage of *Muslims* live

<sup>548</sup> Pipes, Daniel. "Amazon.com's *Koran* Desecration Problem," *DP*, 20 May 2005.

<sup>549</sup> Pipes, Daniel. "Amazon.com's *Koran* Desecration Problem," *DP*, 20 May 2005.

<sup>550</sup> Graham, Stephen. "Newsweek Apologizes; *Afghans* Want Action," *excite.com*, 15 May 2005.

<sup>551</sup> Klein, Aaron. "Muslim double standard on religious desecration?" *WND.com*, 17 May 2005.

<sup>552</sup> Dreyfus, Marion D. S. "Female Genital Mutilation and African AIDS," *FPM*, 8 Jun 2005.

in “occupied” territory makes it right or excusable for 1.2 billion *Muslims* to engage in terrorism, or that 2) Security checks that inconvenience *Muslims* could cause or justify mass-murder, for instance:

Shaikh Omar Bakri Mohammad told *Gulf News* [that] Prime Minister Tony Blair’s policies were creating extremists and possible terrorists throughout the country.<sup>553</sup>

After all, to think that *Muslims* are actually responsible for terrorism would violate *Koran* 004:148, a verse that says *Muslims* should not speak about any evil unless a *Muslim* happens to be the victim.

- C When *Muslim* terrorist infiltrators, onlookers serving as human shields for terrorists, stone-throwing youths serving as decoys, and arms smugglers trying to penetrate secured borders, are killed, *Muslims* claim they were merely playing soccer or whatever.<sup>554 555</sup>

<b>Ingredient 9</b> (Khidr-Second Lamech-style <i>Lex Talionis</i> ):
---

**I. Introduction to *Muslim*-style *Lex Talionis* (K 005:032)**

**II. Khidr Kills Extra-Judiciously Over Mere Unbelief, and Muhammad Kills Extra-Judiciously Over Persecution**

**III. Muhammad, The Second Lamech, Who Avenges Multiple Times Over Magnifying a Religious Offense Into a Capital Offense Committed Against All Muslims**

*Magnifying the Killing of a Muslim Into a Genocide of All Muslims*

**IV. Whether *Muslim* Killing Is Really Based on K 005:032**

**I. Introduction to *Muslim*-style *Lex Talionis* (K 005:032)**

Normal *Lex Talionis* requires a balanced reciprocity between the offense and the retaliation, hence an eye for an eye or a life for a life. *Islam*’s Khidr-Second Lamech-style *Lex Talionis* involves supposedly divinely-sanctioned unbalanced retaliation, meaning: A life or lives (plural) are taken over:

- C A life of a *Muslim* taken for any reason (as per *Muhammad*, the Second Lamech).
- C The mere persecution of a *Muslim* (as per the Second Lamech, *Muhammad*).
- C The mere vexation of a *Muslim* (as per Khidr).

By contrast, whenever the situation is reversed, the *Islamic* ideal is that no *Muslim* is ever killed over the vexation, persecution or murder of an infidel or infidels (as per the Second Lamech).

*Muhammad*, the Second Lamech, said that it was acceptable to slaughter infidels whenever they “persecute” *Muslims* (K 002:191, 193, 217), “spread corruption in the land” (K 005:032) and whenever “holy things demand retaliation” (K 002:194).

The “persecution” that was “worse than slaughter” that *Muhammad* referred to (K 002:191, 193, 217) was the pagan *Mekkans* keeping *Muslims* from the *Kaaba* temple. The *Mekkans* felt compelled to do so because they knew *Muhammad* would end their cherished pagan worship at the *Kaaba* once and for all (K 002:217).

When *Muhammad* gained control of the *Kaaba*, far from promoting co-existence and diversity, he banned pagans from worshipping there (K 009:028). He also told

<sup>553</sup> Sands, Chris. “Cleric: Blair’s policies creating militants,” *gulfnnews.com*, 30 Apr 2005, *LGF*.

<sup>554</sup> Waked, Ali & Efrat Weiss. “Did guards kill stone-thrower?” *ynetnews.com*, 8 Jul 2005.

<sup>555</sup> Waked, Ali & Hanan Greenberg. “IDF kills 3 boys in *Gaza*,” *ynetnews.com*, 9 Apr 2005.

*Muslims* to kill pagans “wherever you find them” unless they convert first (*K* 009:005).

The reader might ask “What is corruption?” and “Who does *Muhammad* think spreads corruption and mischief?” (*K* 005:032). The issue is hardly academic but is a life or death matter since organized or freelance *Islamists* may kill depending on their varying definitions of “corruption in the land,” for instance:

- Ⓒ Some *Muslims* feel that drawing caricatures of *Muhammad* constitutes “corruption in the land” worthy of threats of assassination,<sup>556</sup> while other *Muslims* think that only a novel like Rushdie’s *Satanic Verses* is worthy of death.<sup>557</sup>
- Ⓒ In Egypt, more than a hundred years ago, *Mufti* Mohammed Abdu issued a *Fatwa* permitting the private display of statues. In 2006, Egypt’s Grand *Mufti* Ali Gomaa issued a *Fatwa* saying that based on the *Hadith* where *Muhammad* said “Sculptors would be tormented most on Judgment Day,” statues for decorating homes were “sinful” and forbidden. Gamal *al-Ghitani*, editor of the literary *Akhbar al-Adab* magazine, said:

We don’t rule out that someone will enter the *Karnak* temple in *Luxor* or any other pharaonic temple and blow it up on the basis of the *Fatwa*.<sup>558</sup>

Just two months after Gomaa’s *Fatwa* was issued, “a black-clad and veiled woman screaming, ‘Infidels, infidels!’” wrecked three sculptures in a *Cairo* museum. “She had been listening to the *Mufti*, and was following his orders.”<sup>559</sup>

- Ⓒ “Conservative” *Hamas* does not object to elections, but the “puritanical” *Islamic Army of Gaza* says elections “cause strife among *Muslims* in the name of democracy, freedom and women’s rights.” To the *Islamic Army*, an election office is a “center of corruption, in which immoral acts that contradict our religion have been practiced.”<sup>560</sup> This language implies that the *Islamic Army* may firebomb the election office and kill election workers in accordance with *K* 005:032.

Spreading corruption includes: 1) proselytizing to a religion other than *Islam*, 2) *Muslims* spreading heretical doctrines, 3) advocating for democracy and secular law rather than for *Sharia* law and 4) vice, to include tourists wearing skimpy clothing at a beach. Draconian vice-suppression measures that *Muslims* implement include:

- Ⓒ Serge Trifkovic wrote that in *K* 005:032, mischief-makers deserving of crucifixion (*sic!*) include...

...those who resist the establishment of the *Muslim* rule or who disobey the *Sharia* [law] once it is established.<sup>561</sup>

- Ⓒ In *Saudi Arabia* obesity is a major problem. Women do not exercise because full-body outfits are mandatory even in the oppressive heat. Clerics warn

<sup>556</sup> “*Muslim* scholars scold newspaper for cartoons,” *Copenhagen Post*, cphpost.dk, 11 Nov 2005, freerepublic.com.

<sup>557</sup> Rushdie, Salman. “The Right Time for An *Islamic* Reformation,” washingtonpost.com, 7 Aug 2005, B07.

<sup>558</sup> “*Fatwa* against statues triggers uproar in Egypt,” khaleejtimes.com, 3 Apr 2006, *DW*.

<sup>559</sup> de Quetteville, Harry. “Statue attack fuels fears of an *Islamist* Egypt,” telegraph.co.uk, 18 Jun 2006.

<sup>560</sup> “*Islamist* gunmen order closure of *Gaza* Strip election office,” haaretz.com, 15 Nov 2005.

<sup>561</sup> “President Bush’s Speech on Terrorism,” chroniclesmagazine.org, 7 Oct 2005.

that disrobing in locker-rooms would cause girls to “lose their shyness that is the hallmark of good morals” and “become attracted to each other,” i.e., become lesbians. “*Muslim* woman should realize that she is a target for corruption... There is no faster way to corrupt nations than the emancipation of women—that is getting her out on the street to entice men and ruin their morals.”<sup>562</sup>

- C Many millions of *Muslim* women have their clitoris preemptively removed during female circumcision just so they will not “spread corruption in the land” (K 005:032). Lecturer Dr. *Muhammad* Wahdan of Cairo’s *Al-Azhar* seminary stated on *Kuwaiti Al-Rai* TV on 28 Mar 2006:

In Egypt, we have four and a half million spinsters. The definition of a spinster is a woman who has reached 30, without ever receiving a marriage proposal. We have a spinster problem in the Arab world and the last thing we want is for them to be sexually aroused. Circumcision of the girls who need it makes them chaste, dignified and pure.<sup>563</sup>

Hamdun Dagher’s book *The Position of Women in Islam* (1997) states:

All this applies to men. But what is the reason underlying the circumcision of girls, which is applied in some *Islamic* countries? The first reason is the statement of *Muhammad*: ‘Circumcision is a law for men and a preservation of honour for women.’ The second reason lies in the supposition that circumcision makes a woman more enjoyable, provided that it is practised moderately. *Umm ‘Atiyya* the *Ansarite* narrated that a woman used to circumcise in *Madina*, and the Prophet said to her, ‘Do not overdo it, because this makes woman more favourable and it is more agreeable for the husband.’ As to the third reason why a female should be circumcised, it is to ‘diminish her lust,’ and to ‘tone down the sexual desire of the woman.’<sup>564</sup>

- C In 2001 the head *Mufti* of Egypt, Nasr Farid Wasel, issued *Fatwas* against beauty pageants, bullfights, watching solar eclipses and against the TV “Arab version of ‘Who wants to be a millionaire?’” saying it was a form of betting.” Tellingly, Wasel “refused to support rights activists in their campaign to outlaw female genital mutilation.”<sup>565</sup>

*Muhammad* said that many workers of corruption are actually unaware they are working corruption (K 002:012). *Muhammad* said that people who cheat at trade work corruption (K 011:085). *Muhammad* said that **most** People of the Book are ungodly (K 003:110; 005:059, 061) and **most** are insolent unbelievers (K 005:068) who do evil (K 005:066). *Muhammad* said Jews do evil by eating non-*Kosher* foods (K 005:062-063, 066). *Muhammad* says Jews are workers of corruption and “they make haste about the earth to do corruption there” (K 005:064).

*Muhammad* has *Allah* saying “Our messengers went to them with clear proofs and revelations, but **most** of them, after all this, are still transgressing (*Khalifa* K 005:033). Later he said that Jews spread mischief (or corruption) in the land (K 005:064). Thus *Muhammad* thought that “**most**” Jews and for that matter, Christians

<sup>562</sup> *Abu-Nasr*, Donna. “Exercise a Challenge for Saudi Women,” washingtonpost.com, 18 May 2006, bakelblog.com, *Nobody’s Business*.

<sup>563</sup> “Egyptian Experts on *Islamic* Religious Law Debate Female Circumcision,” memritv.org, 28 Mar 2006, Clip No. 1090.

<sup>564</sup> Dagher, Hamdun. “The Position of Women in *Islam*,” light-of-life.com, 1997, ch. 21.

<sup>565</sup> “*Fatwa* against statues triggers uproar in Egypt,” khaleejtimes.com, 3 Apr 2006, *DW*.



and pagans, could be killed for spreading corruption without there being any retaliation in accord with *K* 005:032. *Islamist* preaching usually follows this line, as *The New York Sun* reported about one *Islamist*:

In the articles, Mr. Walid Ahmad Fitaihi said Jews ‘perpetrated the worst of evils,’ ‘brought the worst corruption to the earth’ and ‘killed prophets...’<sup>566</sup>

*Iranian* Supreme Leader Ayatollah Ali Khamenei said non-*Muslims* “cannot be called human beings but are animals who roam the earth and engage in corruption.”<sup>567</sup> This description makes all non-*Muslims* liable to be killed under *K* 005:032. This pronouncement is sobering knowing that *Iran* has embarked on developing nuclear weapons and has already threatened to wipe *Israel* off the map.

Jesus said “turn the other cheek” (Luk 06:29) but as one UK *Islamist* put it:

*Islam* is not like Christianity, where they turn the other cheek.<sup>568</sup>

Jesus said that those who live by the sword, die by the sword (Mat 26:52). By contrast, *Muhammad* prescribed retaliation, including during the four sacred months (*K* 002:178-179, 194; 005:032; 006:151; 017:033; 022:039; 025:068; 042:040). *Muhammad* said “In retaliation there is **life** for you [i.e. *Muslims*]” (*K* 002:179). A verse that may explain what is meant by “**life**” in *K* 002:179 is:

Fight them, and God will punish them by your hands, cover them with shame, help you (to victory) over them, and **heal the breasts of believers** (*K* 009:014).

*Muslim* militants constantly allude to the “in retaliation there is **life** for you” verse quoted above (*K* 002:179), as one militant said:

The resistance is a historic phenomenon created during these years, and it is created from the fact that there is no **life** with the occupation. If *Abu Mazen* does not succeed in the diplomatic path, the only option remaining is the resistance, the *Intifada*.<sup>569</sup>

*Jihadists* allude to the “**healing**” verse (*K* 009:014) concerning retaliation as when:

C *Alert News* quoted a *Jihadist* video in 2006: “This is the video for carrying out God’s ruling against the [four] Russian diplomats [to *Iraq*] which we present to **heal** the hearts of believers and in revenge for our brothers and sisters for the torture and killing they receive at the hands of the infidel Russian government.”<sup>570</sup>

C *The Courier Mail* quoted another *Jihadist* website in 2006: “Here is a film of the remains of the bodies of the two American soldiers kidnapped near *Yussufiyah* (south of *Baghdad*). We are showing it to avenge our sister who was raped by a soldier belonging to the same division as these two soldiers...they [the *Jihadists*] repressed their sighs to avoid news of the affair spreading but they swore to avenge their sister...Praise God, they captured two soldiers from the same division as this vile crusader. Here are the remains...**to rejoice the hearts** of the faithful [allusion to *K* 009:014].”<sup>571</sup>

<sup>566</sup> Clyne, Meghan. “Treasury Department Tars Alamoudi, Founder of the *Islamic Society of Boston*,” nysun.com, 9 Dec 2005, *JW*.

<sup>567</sup> “*Iran’s* *Mejlis* parliament in *Tehran*,” *Adnkronos International*, adnki.com, 28 Nov 2005, *DW*.

<sup>568</sup> Cohen, David. “Terror on the dole,” *Evening Standard*, 20 Apr 2004, thisislondon.co.uk, 21 Apr 2004, *LGF*, *DW*, freerepublic.com.

<sup>569</sup> Waked, Ali. “Third *Intifada* almost here,” ynetnews.com, 28 Sep 2005.

<sup>570</sup> “*Iraqi Qaeda*-led group says Russian hostages killed,” alertnet.org, 25 Jun 2006, *JW*.

<sup>571</sup> “Internet video shows mutilated US soldiers,” couriermail.news.com.au, 11 Jul 2006, mypetjawa.mu.nu.

The murderous mindset that is inculcated by the *Koran's* saying that people ought to be killed over spreading corruption in the land (K 005:032) and over persecution (K 002:191, 193, 217) is expressed and acted out by *Muslims* often. For instance:

- ⊙ *Al-Qaeada's* Number Two man “*Al-Zawahiri* decries globalization, including tourism, as cultural domination that degrades *Muslims*.” *Islamists* have declared a “Global War on Tourism” and so far have attacked resorts on the Island of *Bali, Kashmir*,<sup>572</sup> on the Red Sea beaches of the *Sinai*, and at archaeological sites in Egypt. *Islamists* hate tourism because it tempts *Muslims* with “hedonism” and “sexual freedoms” and “the tourist industry puts money in the coffers of the governments that terrorists hate.”<sup>573</sup>
- ⊙ A 16-year-old observant Jewish teenager from Florida flew with his father to *Tel Aviv* for the Passover holiday and died from injuries from a bombing at a *Shwarma* stand.<sup>574</sup> *Abu Nasser* a senior leader of the *Al Aqsa* Brigades said, “This is a gift from *Allah*. We wish this young dog will go directly with no transit to hell...I imagine him as one of these *Nazis* who live here [*WND*: in the settlements.] There is no difference between him and them...Our hero believed in *Allah* and died while fighting for *Allah* but your pig was killed in a restaurant in an area full of prostitution.”<sup>575</sup>
- ⊙ At Bethlehem University, which was rumored to be on deceased *Abu Musab Al-Zarqawi's* [hit] list, some students have stopped attending classes for fear of being killed or wounded. Sources at the university said that the reason why it was being mentioned as a potential target was because the administration had suspended the activities of the *Hamas*-affiliated *Islamic* List. *Hamas* supporters on campus recently won 10 seats during elections for the student council. Since then, *Hamas* activists in the West Bank have been waging a campaign of incitement against Bethlehem University, accusing its administration of **discrimination** against *Muslim* students. A leaflet issued by *Hamas* supporters in *Hebron* last week threatened to launch *Kassam* rockets at the university. Other sources however claimed that the university was being targeted for screening a film depicting a *Muslim* man kissing his wife on the cheek.<sup>576</sup>
- ⊙ Mr. Golayev, 36, said the *Islam* he observes is opposed to violence, but he warned that **the mistreatment of believers was driving men like him to desperation**. ‘They will pressure me enough,’ he said ‘and then I will blow somebody’s head off’...On the morning of Oct. 13, scores of men took up arms in *Nalchik*, the capital of the neighboring republic, *Kabardino-Balkariya* [between the Black and Caspian Seas]. **They were mostly driven, relatives said, by harassment against men with beards and women with headscarves** and by the closing of six *mosques* in the city. In two days at least 138 people were killed...Larisa Dorogova, a lawyer in *Nalchik* whose nephew Musa was among those killed in the fighting, said *Muslims* had appealed to the authorities, both religious and secular, to end the abuse of

<sup>572</sup> “30 injured as militants attack tourist buses in *Kashmir*,” *monstersandcritics*, 31 May 2006, *JW*.

<sup>573</sup> Dickey, Christopher. “The Global War on Tourists,” *msnbc.com*, 5 May 2006.

<sup>574</sup> Traubmann, Tamara. “U.S. teen killed in *Tel Aviv* suicide bombing buried in Florida,” *haaretz.com*, 17 May 2006.

<sup>575</sup> Klein, Aaron. “Florida teen’s massacre called ‘gift from *Allah*,’” *WND.net*, 15 May 2006, *JW*.

<sup>576</sup> *Abu Toameh, Khaled*. “Christmas in Bethlehem: *Al-Zarqawi* or Santa,” *jpost.com*, 10 Dec 2005.

believers, only to be ignored. ‘If they had listened to the letters we wrote—from 400 people, from 1,000—maybe this would not have happened,’ she said....‘They were all good guys,’ Ms. Dorogova said of *Nalchik*’s fighters. The paradox of *Islam* in today’s Russia is that *Muslims* have never been freer...[For instance,] Mustafa Batdiyev, the president of *Karachayevo-Cherkessia*, said his region openly supported *Islam*...The republic pays for people to make pilgrimages to *Mekka*. The last day of *Ramadan* is a holiday in the republic.<sup>577</sup>

- C One of the 7/7 bombers said on his Last Testament video that he was going to blow up the London Underground because “this is a country that is **oppressing** people of my religion.”<sup>578</sup> *The Guardian* reported that UK *Muslims* tended to more-or-less agree with this 7/7 bomber (just quoted):

In one exchange, participants pondered the respective responsibilities of Tony Blair and the bombers for the July attacks: 50/50, said one; 80/20 Blair, said another; while the last concluded that the attacks were Blair’s fault alone. The impulse to apportion blame very simply on *Iraq* and Blair has overwhelmed...soul searching...<sup>579</sup>

*Muhammad* taught that if any *Muslim* dies while lifting a finger for *Islam* or *Muslims*, he dies a martyr (*Sunan Abu Dawud*, bk. 40, no. 4754; also see no. 4754; *Sahih Bukhari*, vol. 3, bk. 43, no. 660; and *Sahih Muslim*, bk. 1, nos. 259+260). Therefore, the motivation exists for *Muslims* to try to kill anyone they deem to be persecuting *Muslims*, or deem to be “spreading corruption in the land,” even at the risk of their own lives, for they think this is a legitimate *Jihad*:

- C *Ayatollah Khomeini* said in February 1989 in *Teheran*:

I inform all zealous *Muslims* of the world that the author of the book entitled *The Satanic Verses*—which has been compiled, printed and published in opposition to *Islam*, the Prophet and the *Koran*—and all those involved in its publication who were aware of its content are sentenced to death. I call on all zealous *Muslims* to execute them quickly, wherever they may be found, so that no one else will dare to insult the *Muslim* sanctities...  
[W]hoever is killed on this path is a martyr.<sup>580</sup>

- C In 2006, during the Cartoon Riots, an unnamed senior *Iranian* cleric stated:  
*Muslims* must take the most ferocious stance against insults to *Islamic* sanctities...If setting fire to embassies of countries that insult the Prophet aims to show that these countries no longer have any place in *Islamic* countries then this act is permissible...**Anyone who dies in this path** [*Iran Focus* news editors: of protests against the insults] **is a martyr**.<sup>581</sup>
- C In 2006, during the Cartoon Riots, Javed *ul-Hassan*, *Imam* of the *Jamaat-ud-Dawa* in *Kashmir*, said that “**it’s too late for apologies**...the only possible response to the blasphemous cartoons is ‘*Jihad*, holy war!’”<sup>582</sup>

<sup>577</sup> Myers, S. L. “Growth of *Islam* in Russia Brings Soviet Response,” *nytimes.com*, 22 Nov 2005.

<sup>578</sup> “Bomber’s case ‘rubbish’—Blair,” *news.bbc.co.uk*, 22 Nov 2005, *DW*.

<sup>579</sup> Bunting, Madeleine. “Why *Muslims* must guard against the satisfactions of complaint,” *The Guardian*, *guardian.co.uk*, 21 Nov 2005, *DW*.

<sup>580</sup> Trifkovich, Serge. “The Racial and Religious Hatred Bill,” *chroniclesmagazine.org*, 27 Oct 2005, *DW*.

<sup>581</sup> “*Iran Focus*, *iranfocus.com*, 28 Feb 2006, *JW*.

<sup>582</sup> Koelbl, Susanne. “*Muhammad*’s Silent Army: *Islamist* Extremists...,” *spiegel.de*, 25 Feb 2006.

**Organized terrorists** would rather view their deeds first under the rubric of *Jihad* and second, under *Lex Talionis* since there are many more war verses in the *Koran* than there are verses calling for retaliation. Moreover, the promises of the *Houris* and other rewards for *Jihad* help terrorists “gain support among *Muslims*...[and] recruit new followers,”<sup>583</sup> but the *Koran* associates no rewards for mere acts of *Lex Talionis*.

**Freelance terrorists** are usually not as keen as organized terrorists to explain the theological roots of their *Jihad* since they often die in the attack and are not as interested in recruiting other for *Jihad*. Freelancers usually say their motivation for killing infidels is *Lex Talionis* retaliation. The lone wolves follow the *a la* the Khidr model—people who think they are enlightened lone wolves authorized by *Allah* to kill.

One example of a freelance terrorist is Mohammed Reza Taheri-azar. He thought about committing a terrorist attack for two years and planned the specifics for two months.<sup>584</sup> Police found what motivated him and justified his act: “A paperback copy of the *Koran*.”<sup>585</sup> Then in 2006, he rented an SUV, hit nine pedestrians but surprisingly killed none of them. Taheri-azar wrote that...

...in the *Koran*, *Allah* states that the believing men and women have permission to murder anyone responsible for the killing of other believing men and women [K 005:032]...After extensive contemplation and reflection, I have made the decision to exercise the right of violent retaliation that *Allah* has given me to the fullest extent to which I am capable at present...*Allah* gives permission in the *Koran* for the followers of *Allah* to attack those who have raged [*sic*; waged] war against them, with the expectation of eternal paradise in case of martyrdom.<sup>586</sup>

Notice that Taheri-azar did not mention *Jihad* but merely retaliation.

Terrorists think that the *Koran*'s verses on retaliation justify their self-declared *Jihad*, as James Arlandson wrote:

*Muslim* polemicists like *Sayyid* Qutb assert that *Islam*'s mission is to correct the injustices of the world [i.e. “retaliate”]. What he has in mind is that if *Islam* does not control a society, then injustice dominates it, *ipso facto*. But if *Islam* dominates it, then justice rules it (*In the Shade of the Qur'an*, vol. 7, pp. 8-15). *Islam* is expansionist and must conquer the whole world to express *Allah*'s perfect will on this planet, so Qutb and other *Muslims* believe.<sup>587</sup>

In any case, the concept of retaliation is integral in the formation of an *Islamic* terrorist or *Islamist* rioter's mindset, as the case may be:

C Alain Finkelkraut commented on the French riots of 2005:

Why have parts of the *Muslim*-Arab world declared war on the West?...We are witness to an *Islamic* radicalization that must be explained in its entirety...to a culture that, instead of dealing with its problems, searches for an external guilty party. It's easier to find an external guilty

<sup>583</sup> “Spanish *Fatwa* Against Terrorism – 17 March 2005,” [theamericanMuslim.org](http://theamericanMuslim.org), 19 Apr 2005.

<sup>584</sup> “Disappointed With Outcome,” [wral.com](http://wral.com), 7 Mar 2006, [michellemalkin.com](http://michellemalkin.com).

<sup>585</sup> Kaufman, Joe. “North Carolina Tar Heel Terror,” *JW*, 7 Mar 2006.

<sup>586</sup> Spencer, Robert. “Killing for *Allah*,” *FPM*, 29 Mar 2006.

<sup>587</sup> Arlandson, James. “The Truth about *Islamic* Crusades and Imperialism,” [americanthinker.com](http://americanthinker.com), 27 Nov 2005.

party....The riots will subside but what does this mean?...There won't be a return to quiet but a return to routine violence.<sup>588</sup>

- ⊕ Canadian security researchers wrote of their homegrown *Jihadists*:

A small number of *Muslims* in Canada have adopted the path of violence and *Jihad* in the pursuit of political and/or religious aims,' the CSIS report says. 'The reasons for this are varied and include parental influence, the efforts of charismatic spiritual leaders with extremist views and a general sense of anger at what is seen as *Muslim* oppression....Sympathy for the global *Muslim* community, which is perceived as suffering at the hands of the West, Russia and *Israel*, is another factor,' CSIS writes. Extremists believe they must take action to help their 'spiritual brethren.'<sup>589</sup>

*Jihad* is getting a bad name in the West since the "internal struggle" definition of *Jihad* does not fly anymore. So *Muslims* have been trying to reframe *Jihad* as being merely retaliation or, in secular parlance, resistance. *Muslims* try to portray *Muslim* terrorists as victims who only react to injustices done to them by the West.

Another reason *Muslims* like to frame *Jihad* as being retaliation is that acts that are otherwise outlawed (*Haram*) in *Islam* are allowed (*Halal*) if they are done out of retaliation:

- ⊕ The *Islamic* principle that "Whatever is not explicitly said to be *Haram* (forbidden) is *Halal* (permissible)."<sup>590</sup>

- ⊕ The *Islamic* principle that "The firmly established principle [that] 'Necessity makes prohibited things permissible.'"<sup>591</sup>

- ⊕ *Muhammad* condemned fighting during the holy months but said it must be done anyway because "persecution is more heinous than slaughter" (*K* 002:191, 193, 217).

- ⊕ Mutilation is outlawed in *Islam* except to retaliate against an enemy that mutilates dead soldiers (*K* 016:126).

- ⊕ Torturing need not be done only out of retaliation since *Muhammad* tortured a Jew, Kinana, with fire, though the Jews had tortured no *Muslim*.<sup>592</sup>

- ⊕ *Muhammad* said "And one who attacks you, attack him in like manner as he attacked you" (*K* 002:094). Terrorists quote this verse often, for instance:

★ In 2005, *Umm Nidal*, mother of three *Hamas* "martyrs," said on PA TV:

They are the ones who think that this man [a Palestinian terrorist] has come to kill innocent people [in restaurants and malls]. This is what they [non-*Muslims*] think. But we, as *Muslims*, think differently. We are familiar with the *Koranic* verse: 'One who attacks you, attack him in like manner' [*K* 002:094].<sup>593</sup>

★ In 2006 the Mujahideen Shura Council quoted *K* 002:094 before killing four Russians.<sup>594</sup>

Thus it is not surprising that *Muslim* terrorists are known for torturing, beheading and mutilating corpses, for instance:

<sup>588</sup> Mishani, Dror & A. Smotriez. "What sort of Frenchmen are they?" *haaretz.com*, 17 Nov 2005.

<sup>589</sup> Bell, Stewart. "*Jihadists* born here pose new threat, hard to detect, CSIS says," *National Post*, *canada.com*, 19 Nov 2005.

<sup>590</sup> Gibb & Kramers. *Encyclopedia*, *Haram* entry, p. 133.

<sup>591</sup> Glasse. *Encyclopedia*, *Wudu* entry, p. 422, right column.

<sup>592</sup> Ishaq. *Sirat*, p. 515.

<sup>593</sup> "Palestinian Legislative Council..." Special Dispatch 1063, MEMRI.org, 4 Jan 2006, *JW*.

<sup>594</sup> "Iraqi *Qaeda*-led group says Russian hostages killed," *alrtntnet.org*, 25 Jun 2006, *JW*.

- ⊕ “In 1948, *Muslims* murdered several *Israeli* men at *Gush Etzion*, cut off their testicles and placed testicles in the dead men’s mouths.”<sup>595</sup>
- ⊕ Yasser Arafat’s PLO massacred 582 people who were mostly Christians, in January 1976, in *Damour*, Lebanon. The “Bodies were raped and featured dismembered genitals in their mouths.”<sup>596</sup>
- ⊕ At *Najaf, Iraq*, in 2004 *Sheik Al-Sadr*’s militia cut off the genitals of 200 men and stuffed them in their mouths.<sup>597</sup>
- ⊕ In 2004 in *Iraq*, *Al-Qaeda* terrorist “Zarqawi himself... callously cut the throats of the struggling Americans. Then he roughly decapitated them, holding the heads up for the cameras—and, with a nonchalant twist of the knife, gouged out one of the victim’s eyes.”<sup>598</sup>

Terrorists like to claim that infidels are raping and torturing *Muslims*, regardless of whether the claim is true or exaggerated, because this claim helps recruit *Jihadists*. Not only are *Muslims* riled up by the accusations but many recruits look forward to raping infidel men and women under the *Lex Talionis* rubric.

Given such incitement, it is not surprising that terrorists are known for raping hostages—men, women and even children. For instance, grade school girls were raped at *Beslan*, Russia, in 2004, and “men, women and children” were raped at *Najaf, Iraq*, in 2004, by *Sheik Al-Sadr*’s militia.<sup>599</sup>

The Spanish *Fatwa* against *Bin Laden* in 2005 is an example of how *Muslims* in the West try to reframe *Jihad* terrorism as *Lex Talionis* terrorism. First, the Spanish *Fatwa* of 2005 condemns any terrorist who justifies terrorism under the *Jihad* rubric rather than the *Lex Talionis* rubric:

- ⊕ Argues that terrorism is *Halal* (allowed) rather than *Haram* (disallowed).
- ⊕ “Defend the legality of terrorism and try to base it on the Sacred *Koran* and the *Sunna*.”<sup>600</sup>

Then, the Spanish *Fatwa* of 2005 affirms the legitimacy of terrorism under the retaliation rubric when it says:

There is no doubt *Muslims* have the legitimate right to react against any aggression or any situation of oppression.<sup>601</sup>

Another example of how *Muslims* in the West try to reframe *Jihad* terrorism as *Lex Talionis* terrorism comes from *Hizb ut Tahrir (HuT)*. When the *BBC* confronted a former senior member of *HuT*, Yamin Zakaria, with a tract against Israel, he said...

...it is not encouraging violence, it is encouraging retaliation, there’s a difference. Violence is unprovoked, without reason. That is not what the party is encouraging. What they are saying is that we have the right to retaliate.<sup>602</sup>

*Muslims* in the West, in order to fool infidels about how *Islam* actually initiates violence through offensive *Jihad*, would rather have terrorism described as being *Lex Talionis*, a mere reaction against Western policies and colonialism. Terrorists by

<sup>595</sup> Schlüssel, D. “Sex & The *Islamic* Terrorist,” debbieschlussel.com, 31 Jan 2005.

<sup>596</sup> Schlüssel, D. “Sex & The *Islamic* Terrorist,” debbieschlussel.com, 31 Jan 2005; confer Kahl, M. “Yasir Arafat’s Planned Christian Genocide,” chretiens-et-juifs.org, accessed 12 Apr 2005.

<sup>597</sup> Scarborough, Rowan. “*Al-Sadr*’s Killing Fields,” *The Washington...*” *Idem*.

<sup>598</sup> McGeough, Paul. “Zarqawi: the new *bin Laden*,” *Sydney Morning Herald*, smh.com.au, 17 Oct 2004.

<sup>599</sup> Scarborough, Rowan. “*Al-Sadr*’s Killing Fields,” *The Washington Times*, *FPM*, 1 Sep 2004.

<sup>600</sup> “Spanish *Fatwa* Against Terrorism – 17 March 2005,” theamericanMuslim.org, 19 Apr 2005.

<sup>601</sup> “Spanish *Fatwa* Against Terrorism – 17 March 2005,” theamericanMuslim.org, 19 Apr 2005.

<sup>602</sup> “*Hizb ut Tahrir* (on Newsnight),” news.bbc.co.uk, 27 Aug 2003, hotair.com, 9 May 2006.

contrast justify terrorism under **both** *Jihad* and *Lex Talionis*. For instance, terrorists freely quote *K* 008:060 about preparing war horses to terrorize the enemy, and they talk of how they must fight fire with fire, i.e. state terrorism with terrorism. For instance, the Chechnyan terrorist Basayev “admitted that he was ‘a bad guy, a bandit...Ok, so I’m a terrorist but what would you call them (the Russians)?”<sup>603</sup> Likewise, *Bin Laden & Company* justify terrorism under **both** *Jihad* and *Lex Talionis*. They believe they can even go so far as to bomb the US with nuclear weapons based on *Lex Talionis*, for we read:

[*Bin Laden*] secured from a *Saudi Sheik*...a rather long treatise on the possibility of using nuclear weapons against the Americans. [The treatise] found that he was perfectly within his rights to use them. *Muslims* argue that the US is responsible for millions of dead *Muslims* around the world, so reciprocity would mean you could kill millions of Americans.<sup>604</sup>

Of course for terrorism to be in accord with *Lex Talionis* requires that terrorism target infidels and just anyone. The Spanish *Fatwa* came in response to *Muslims* leaving time-bombs in about dozen rucksacks and gym bags on commuter trains in Madrid, and undoubtedly *Muslims* died on these conveyances alongside infidels. Thus the Spanish *Fatwa* of 2005 reads:

There can be no doubt that the *Muslims* have a legitimate right to react against aggression or a situation of oppression [i.e. terrorism is okay]. However, any such reaction must not lead to **blind** or **irrational hatred** [i.e. must be targeted not to include *Muslims*]:

Let not hatred of those [i.e. infidels] who prevent access to the House of Inviolable Adoration (that is to say, the fulfillment of your religious obligations) incite you to exceed the limits [by killing *Muslims*, but killing infidels is okay (*K* 009:005)], but on the contrary help one another [i.e. *Muslims*] in promoting goodness and piety, and do not help one another in promoting evil and enmity [i.e. against fellow *Muslims*] (*K* 005:002).<sup>605</sup>

Similarly, in 2005 during the French *Muslim* riots, the Union of French *Islamic* Organizations (UOIF) issued a *Fatwa* using the word “**blind**.” One is right to suspect the *Fatwa* is really a riddle meant to fool non-*Muslims* since “most French leaders have kept a critical distance from the group [the UOIF] because of its links with the *Muslim* Brotherhood.”<sup>606</sup>

The UOIF is not unlike nearly all *Fatwa*-issuing organizations in that *Fatwa*-issuing organizations often have ties to terrorists. Some are only two degrees removed from very terrorists that the *Fatwas* purport to condemn (i.e. their friend’s acquaintance is a member of the terrorist organization named in the *Fatwa*). Some of these same organizations are staffed, or were formerly staffed, by people who have issued death threats or death-sentence *Fatwas*.<sup>607</sup>

The UOIF *Fatwa* on the French riots in 2005 read:

It is formally forbidden to any *Muslim* seeking divine grace and satisfaction to participate in any action that **blindly hits** private or public property or could

<sup>603</sup> “Basayev broadcast enrages Russia,” news.bbc.co.uk, 29 Jul 2005.

<sup>604</sup> “CIA Agent Details Terror Threat,” cbsnews.com, 14 Nov 2004, *JW*.

<sup>605</sup> “Spanish *Fatwa* Against Terrorism – 17 March 2005,” theamericanMuslim.org, 19 Apr 2005.

<sup>606</sup> “French *Muslim* group issues *Fatwa* against rioting,” alertnet.org, 6 Nov 2005.

<sup>607</sup> “Group [UAC] Officially Denounces *Fatwa* Against *Islamic* Terrorism,” *JW*, 9 Aug 2005.

constitute an attack on someone's life. Contributing to such exactions is an illicit act.<sup>608</sup>

The weasel words “**blindly hits**” (as opposed to, say “directed attack”) are similar to other words used in similar *Fatwas* such as “senseless,” “irrational hatred,” “innocent” and “civilian” that give wiggle room for terrorism. For instance, CAIR's 2004 “Not in the Name of *Islam*” petition concerning terrorism uses the terms “innocent lives” and “innocent people.”<sup>609</sup> In 2006, 150 *Mosques* in Birmingham, UK, signed a statement that only forbids the killing of “innocent civilians.”<sup>610</sup>

The 2005 UOIF *Fatwa*'s issuers are saying that terrorism is okay by them as long as the terrorists: 1) kill premeditatively with a purpose—like Khidr did, 2) act only on “rational hatred”—like Khidr did, 3) extra-judiciously kill only the “guilty” infidels like the stranger Khidr did and 4) do not kill “civilians”—though this last condition is thrown in for Western consumption only since *Islamic* jurisprudence makes no such distinction between persons, as *Imam* Omar Bakri Mohammed phrased it:

We don't make a distinction between civilians and non-civilians, innocents and non-innocents. Only between *Muslims* and unbelievers. And the life of an unbeliever has no value. It has no sanctity.<sup>611</sup>

Here is an example of how the weasel words are used. In 2005 the *Muslim* Council of Britain (MCB) condemned the 7/7 and 7/21 attacks by issuing a *Fatwa*. In discussing this *Fatwa*, Iqbal Sacranie said...

...in terms of any **innocents** wherever they are in any part of the world—there can never, ever be justification of killing **civilians**.<sup>612</sup>

One is wrong to assume that Sacranie believes “civilians” are synonymous with “innocents” since Salman Rushdie is a civilian, yet Sacranie “in 1989 said that ‘Death is perhaps too easy’ for the author of *The Satanic Verses*.”<sup>613</sup>

As it is, Sacranie's statement implies that anyone not a **civilian** is fair game for *Islamic* terrorism, because in *Islam*—whatever is not *Haram* (forbidden) is *Halal* (permissible).<sup>614</sup> In fact, Sacranie admitted as much, as *The Independent* reported:

Sir Iqbal insists that British *Muslim* scholars have taken a lead in condemning suicide attacks. But he reveals that in the behind-the-scenes discussions before the statement was issued on Friday a distinction was drawn by some between military targets and civilian targets in the Middle East. ‘I will tell you where the confusion gets into it. Where there is a war. Where there are soldiers, they try to kill the soldiers.’<sup>615</sup>

*Islamists* do not consider infidels to be civilians since—as one 7/7 suicide bombers stated:

...Your democratically elected governments continuously perpetuate atrocities against my people and your support of them makes you directly

<sup>608</sup> “French *Muslim* group issues *Fatwa* against rioting,” alertnet.org, 6 Nov 2005.

<sup>609</sup> “Not in the Name of *Islam*,” 13 May 2004, islam.about.com, cair-net.org.

<sup>610</sup> “*Muslim* leaders condemn terrorism,” bbc.co.uk, 23 Jun 2006, *JW*.

<sup>611</sup> “Militant Cleric Says Attack on London ‘Inevitable,’” *Yahoo News!*, 18 Apr 2004, *LGF*.

<sup>612</sup> Woolf, Marie. “Sir Iqbal Sacranie: ‘There can never be justification for killing civilians,’” news.independent.co.uk, 18 Jul 2005, *JW*.

<sup>613</sup> Rushdie, Salman. “The Right Time for An *Islamic* Reformation,” washingtonpost.com, 7 Aug 2005, B07.

<sup>614</sup> Gibb & Kramers. *Encyclopedia, Haram* entry, p. 133.

<sup>615</sup> Woolf, Marie. “Sir Iqbal Sacranie: ‘There can never be justification for killing...,’” *Ibid*.



responsible just as I am directly responsible for protecting and avenging my *Muslim* brothers and sisters. Until we feel security, you will be our target.<sup>616</sup>

The use of the words “**blindly hits**” in the Union of French *Islamic* Organizations (UOIF) *Fatwa* of 2005 merely means that *Muslims* do not believe in equal-opportunity bombing. They believe that *Jihadists* ought to discriminate in their selection of targets just as Khidr had. (Khidr is discussed later in this section.) This contention is confirmed by:

C The fact that the words “**violence**,” “**criminal**,” “**blind(ly)**” “**civilians**” and “**innocents**” are used subtly and discriminately. For instance, when suicide-bombers targeted non-*Muslims*, these acts are celebrated in the streets and receive “wide support from a [*Muslim*] public”<sup>617</sup> as a legitimate response to occupation or a justified retaliation over the enemy’s criminal acts. By contrast, in 2005 *Muslims* noticeably changed their tune when three *Islamic* suicide-bombers in *Amman*, Jordan, killed more *Muslims* than non-*Muslims*. Silet *Al-Thaher* reported what then was said and written in the West Bank:

‘Oh my God, oh my God. Is it possible that Arabs are killing Arabs, *Muslims* killing *Muslims*?’....Similar thoughts were heard over and over in the West Bank and *Gaza Strip* on Thursday, as Palestinians expressed outrage over suicide attacks aimed at **civilians**....‘Palestinians have tasted the **blind violence** that does not differentiate between people—children, women, wedding parties, ordinary people,’ said Palestinian newspaper commentator Hani *al-Masri*. The Palestinian Authority ordered flags lowered to half-staff for one day and declared a three-day period of mourning....[A relative of the victims said] ‘It was devastation. Children were crying. No religion, no *Islam*, no *Muslim* people allow this to happen’....[The reporter noted] many Palestinians seemed most upset that the victims in *Amman* were *Muslim*. Some hinted that attacks against Israeli or American targets could still be acceptable. At a small *Mosque* in *Gaza City*, worshippers asked God to send the souls of the *Amman* victims to heaven and to prevent the attackers from harming the image of *Islam*...‘They could go and fight American soldiers. They could come to Palestine to fight Israeli soldiers in the West Bank. But to kill **innocents**, there is nothing to describe them but **criminals** and the **enemy** of God.’<sup>618</sup>

Erik Schechter wrote about the Palestinians’ discriminating attitude toward suicide-bombings after the 2005 suicide-bombings in Jordan mentioned above:

...a poll conducted in December 2005 by the Palestinian Center for Policy and Survey Research found that 88 percent of Palestinians opposed *Al-Qaeda*’s triple bombing at hotels in *Amman*. Clearly, the respondents had a problem with the target [*Muslims*], not the tactic, as a different survey the same year found that 65 percent of Palestinians back *Al-Qaeda* operations in the United States and Europe.<sup>619</sup>

C The conspicuous absence of any mention of “French law” in the Union of French *Islamic* Organizations (UOIF) *Fatwa*.<sup>620</sup> This omission is entirely expected since

<sup>616</sup> Govan, Fiona & Paul Stokes. “In a measured Yorkshire accent, the July 7 suicide bomber delivers his message of hate,” telegraph.co.uk, 2 Sep 2005.

<sup>617</sup> *Al-Thaher*, Silet. “Jordan Attacks Claim 17 From One Family,” cbsnews.com, 10 Nov 2005, *JW*.

<sup>618</sup> *Al-Thaher*, Silet. “Jordan Attacks Claim 17 From One Family,” cbsnews.com, 10 Nov 2005, *JW*.

<sup>619</sup> Schechter, Erik. “Reaping a bloody harvest,” jpost.com, 11 May 2006.

<sup>620</sup> “RPT-Anti-riot *Fatwa* sparks feud among French *Muslims*,” alertnet.org, 7 Nov 2005, *JW*.

- Islamists* are trying to replace secular law with *Sharia* law.<sup>621</sup> The omission signals that *Muslims* may disregard French law in deference to *Sharia* law when determining how to act.
- C The discriminating nature of the French riots. Twelve churches<sup>622</sup> and two synagogues<sup>623</sup> were desecrated or burned but not any *Mosques*.<sup>624</sup> In fact, “When a [police] tear-gas canister exploded near a *Mosque* in *Clichy-sous-Bois* on the fourth violent evening, a new cry went up. ‘Now this is war,’ said one of the vandals. Others cried, ‘*Jihad*.’<sup>625</sup>
  - C *Islamists* are guiding youths in target selection when it comes to arson during the French *Muslim* riots of 2005, as UK’s *The Telegraph* reported:

But—and this is the crucial difference between the different generations of rioters [i.e. leftist labor unions and students]—most of those living in the French ghettos are *Muslims* and have **grown up during a period of Islamic radicalization. Many of the youths hurling petrol bombs on Parisian estates look up to a slightly older group of Mosque stalwarts.** These men are capable of being forces for both good and mischief; there have been examples from the past fortnight of situations calmed, but also of attackers acting under their direction, so that **Muslim-owned businesses, a Halal butcher’s shop and a Kebab joint, for example, are spared, while a bank branch and symbols of another France are targeted.** Intelligence officials have already spoken of the involvement of the more sinister of such figures in the recruitment of young French *Muslims* to fight the American-led coalition in *Iraq*. Several have been killed, others are missing. The gravest fear for French ministers is that the trouble of the past 10 days has been orchestrated by *Islamists* bent on exploiting the grievances of impressionable youths.<sup>626</sup>

*The New York Sun* reported similarly about the French *Muslim* riot of 2005:

...But the fact remains that only ethnic youths are rioting, that most of them explicitly pledge allegiance to *Islam* and such *Muslim* heroes as Osama bin Laden, that the *Islamic* motto—*Allahu Akbar*—is usually their war cry, and that they submit only to arch-conservative or radical imams. The fact also remains, according to many witnesses, that the rioters torch only ‘white’ cars, meaning white-owned cars, and spare ‘*Islamic*’ or ‘black’ ones [i.e. most *Muslims* in France are from North Africa]. One way to discriminate between them is to look for ethnic signs like a sticker with *Koranic* verses or a picture of the *Kaaba* in *Mekka* or a stylized map of Africa. Further evidence of the animating influence in the riots lies with the French rap music to which the perpetrators listen. Such music obsessively describes White France as a sexual prey.<sup>627</sup>

<sup>621</sup> Sookhdeo, Patrick. “Will London burn too [like France]?” spectator.co.uk, 11 Nov 2005, *JW*.

<sup>622</sup> Charlton, Emma. “France plans curfews to curb riots,” heraldsun.news.com.au, 8 Nov 2005.

<sup>623</sup> Sitbon, Shirli. “Riots spark fear among French Jews,” ynetnews.com, 7 Nov 2005.

<sup>624</sup> Bostom, Andrew G. “Eurabia’s Morass Elicits Mythical ‘Solutions,’” americanthinker.com, 24 Nov 2005, *DW*.

<sup>625</sup> Dickey, Christopher. “Rage on *Rue Picasso*: Will the riots swell the ranks of *Jihadists* in Europe?” msnbc.msn.com, 14 Nov 2005.

<sup>626</sup> Randall, Colin. “France divided as the flames creep ever closer to central Paris,” telegraph.co.uk, 7 Nov 2005, *JW*.

<sup>627</sup> Gurfinkiel, Michel. “France Facing ‘Horrendous’ Balance Sheet,” nysun.com, 8 Nov 2005, *DP*.

- C Controlled rioting and pogroms are a favorite tactic of *Islamists* that are used everywhere against non-*Muslims* since the start of *Islam*. Goel wrote about the situation in India:

That part of the ‘*Muslim* minority’ which had voted for *Pakistan* but had chosen to stay in India, restarted the old game when India was proclaimed a secular state pledged to freedom of propagation for all religions [1948 AD]. It revived its tried and tested trick of masquerading as a ‘poor and persecuted minority.’ It cooked up any number of *Pirpur* Reports. The wail went up that the ‘lives, liberties and honour of the *Muslims* were not safe’ in India, in spite of India’s ‘secular pretensions.’ At the same time, street riots were staged on every possible pretext. The ‘communal situation’ started becoming critical once again.<sup>628</sup>

With statements of condemnation and *Fatwas* like the Union of French *Islamic* Organizations (UOIF)’s *Fatwa*, *Islamic* scholars can redefine terrorism as being acts of retaliation rather than say, acts purifying *Islam* of apostates and collaborators. This turns the focus of *Jihad* solely on infidels and away from *Muslims*. For instance, the *Hizb ut-Tahrir (HuT)* *Islamist* group stated it was “against explosions in cities,” but then wonders why the West condemns bombs in Western cities when the West has bombed *Muslim* cities.<sup>629</sup> So what *HuT* is saying is the West has no right to condemn tit-for-tat *Lex Talionis* terrorism and *HuT* hopes that *Jihadists* will refrain from untargeted attacks that could inadvertently kill *Muslims*.

Statements issued by *Muslim* organizations seem to help terrorists fine-tune their methods and public relations rhetoric. Otherwise, terrorists cannot recruit or raise funds among *Muslims*, nor get the reaction from the infidel public and politicians they are looking for, as Daniel Pipes explains:

Indigenous *Muslims* of northwestern Europe have in the past year deployed three distinct forms of *Jihad*: the crude variety deployed in the United Kingdom, killing random passengers moving around London; the targeted variety in the Netherlands, where individual political and cultural leaders are singled out, threatened and in some cases attacked; and now the more diffuse violence in France, less specifically murderous but also politically less dismissible...the British variant is clearly counterproductive, so the Dutch and French strategies probably will recur.<sup>630</sup>

## II. Khidr Kills Extra-Judiciously Over Mere Unbelief, and Muhammad Kills Extra-Judiciously Over Persecution

*Muhammad* told the story of a *Muslim* sage Khidr, literally “the green man” (*K* 018:065-082 and *Hadiths*). *Muhammad* said that Khidr was wiser than the *Muslim* Moses and even mentored the *Muslim* Moses (*Sahih Bukhari*, vol. 6, bk. 60, no. 251).

*Muhammad* said that the stranger Khidr, without any warning and without the parents’ knowledge or permission, extra-judiciously slew a “young boy” (*Sher Ali, Kalifa K* 018:074). The *Muslim* Moses was shocked and objected, saying:

<sup>628</sup> Goel. *Calcutta*, ch. 9.

<sup>629</sup> Gardham, Duncan. “Radical websites defy deportation threat by urging *Islamic* war on West,” telegraph.co.uk, 29 Aug 2005.

<sup>630</sup> Pipes, Daniel. “Reflections on the Revolution in France,” *DP*, 8 Nov 2005.

What! Have you slain an **innocent** soul **not out of retaliation**? Truly you have acted heinously! (*K* 018:074).

If the boy had been an infidel, the *Muslim* Moses may not have given the boy's murder a second thought since *Muhammad* said *Muslims* ought to kill infidels if they do not convert (*K* 009:005)—but the boy's parents were *Muslim* so the *Muslim* Moses had to object. One can tell the parents of the slain boy in the Khidr story were *Muslim* since *K* 018:081 says *Allah* was “their lord.”

Khidr told the *Muslim* Moses:

As for the boy, his parents were believers and we [Khidr's use of the Majestic Plural that *Muhammad* copied from the Jews] feared lest he should make disobedience and ingratitude to come upon them [the boy's parents]. So we [another majestic plural] desired that their Lord [his parents' god, *Allah*] should give them in exchange one better than he [the lad] in purity and closer in filial affection (*K* 018:080-081).

Khidr's response to Moses implies that the boy was not an “**innocent**” as Moses assumed, in that the boy was an unbeliever who might have otherwise grown up to vex his *Muslim* parents with his disbelief (*K* 018:080-081).

The boy may not have exhibited any signs of being an unbeliever yet, but *Muhammad* said it was admirable to kill a hypocritical *Muslim*. *Muhammad* considered hypocritical *Muslims* to be mere firewood for Hell that just happened to be clad with garments—even when they were alive (*K* 063:004). The *Hadith* record *Muhammad* inciting would-be Khidrs to violence:

Soon there will appear disagreement and dissension in my people; there will be people who will be good in speech and bad in work. They recite the *Koran* but it does not pass their collar-bones. They will swerve from the religion... They are worst of the people and animals. **Happy is the one who kills them and they kill him.** They call to the book of *Allah* but they have nothing to do with it. He who fights against them will be nearer to *Allah* than them (the rest of the people).<sup>631</sup>

*Muslims* often cite verses in the *Koran* and *Hadith* entries besides the Khidr story when justifying *Islamic* terrorism. Why? Because there are many more *Jihad* verses, and quoting *Jihad* verses is easier than bringing up the Khidr story and saying, “The moral of the story is...” Nevertheless, *Muslims* do seem to allude to the Khidr story to justify terrorism, and *Islamist* terrorists live by the Khidr story in terms of killing whomever they deem to be guilty, killing taxpayers and destroying infrastructure useful to infidels, and doing acts of charity for *Muslims*. For instance:

☛ Just as Khidr preemptively sabotaged boats so that an infidel king could not later commandeer them for war (*K* 018:071, 079), terrorists say they seek to ruin the infrastructure that is useful to infidels whether *Muslim*-owned or not—everything from government (e.g. Pentagon, White House) and financial buildings (e.g. World Trade Center twin towers) to oil fields and oil refineries in *Saudi* Arabia and forests in Israel.

☛ In 2006 Mohammed Reza Taheri-azar boasted that he had “injured several people both physically and psychologically, who were also American taxpayers...and am proud to have carried it out in service of and in obedience of *Allah*.”<sup>632</sup>

<sup>631</sup> *Sunan Abu-Dawud*, bk. 40, no. 4747.

<sup>632</sup> Spencer, Robert. “Freelance *Jihadists*,” *FPM*, 28 Jun 2006.

- C In 2006 convert Michael Julius Ford, whose *Imam* was Gerald Muhammed, killed two of his coworkers and shot others before a SWAT Team killed Ford. Ford's police record showed he was arrested on 19 October 2002 for "allowing the well-being of a minor to be endangered" which sounds like something a would-be Khidr would do given that Khidr killed a lad for mere unbelief. After the terrorist act, Ford's younger sister, Khali, said:

He told me that *Allah* was going to make a choice and it was going to be good and told me people at his job was making fun of his religion and he didn't respect that.<sup>633</sup>

Ford sounds like Khidr who said that he killed a lad because he was an unbeliever who was going to vex his *Muslim* parents (K 018:080). Taheri-azar and Ford both sound like Khidr who said repeatedly that he was just doing *Allah's* will. Khidr claimed to have a "higher truth" straight from *Allah's* "presence" (K 018:065-066). Khidr killed a lad in the hopes that *Allah* would bring a blessing out of it (K 018:081), and he said that when he killed, sabotaged and was charitable, "I did it not of my own accord" (K 018:081).

*Muslims* will **allude** to the Khidr story to justify the severity of the punishment under *Sharia* law. For instance, *Muslims* alluded to the Khidr story (K 018:080-081) when the *Afghan* Abdul Rahman faced the death penalty for converting from *Islam* to Christianity. Rahman tried to retrieve his children from his wife's father—"wanting the custody of the children, which is always given to *Muslims* against apostates."<sup>634</sup> *Muslims* then cited how Rahman had vexed his parents and family and brought trouble on them—just as Khidr told Moses the unbelieving lad would have done if Khidr had not killed him first:

Mr. Rahman converted [to Christianity] while in *Pakistan* where he worked for a Christian aid agency. He was arrested after he returned to his birthplace and tried to regain custody of his daughters, who had been living with his **parents**. His **family** turned him in and he was arrested with a Bible in his possession. 'It is a crime to convert to Christianity from *Islam*. **He is teasing and insulting his family** by converting,' Judge Zada said. 'The Attorney-General is emphasizing he should be hung.'<sup>635</sup>

Abdul Rahman told his **family** he was a Christian. He told the neighbors, bringing shame upon his **home**....Prosecutors say he should die. So do his **family**, his jailers, even the judge....'We will cut him into little pieces,' said Hosnia Wafayosofi, who works at the jail. 'There's no need to see him.' '**We are Muslim**, our **fathers** were *Muslim*, our **grandfathers** were *Muslim*,' said Abdul Manan, Rahman's **father**, who is 75. 'This is an *Islamic* country. Imagine if your son told a police commander, also a *Muslim*, that he is a Christian. How would this affect you? It's very difficult for **us**'....'He is my **son**,' said Manan, crying. 'But if a son does not care about the dignity of his **family**, the dignity of his

<sup>633</sup> Cardona, Felisa & JP Eichmiller. "Shooting spree baffles those close to 22-year-old Ford, 27 Jun 2006, *LGF*."

<sup>634</sup> Moore, Charles. "Jack is a man of straw when *Muslims* talk of killing converts," telegraph.co.uk, 25 Mar 2006, *DW*."

<sup>635</sup> Albone, Tim. "Afghan man faces death for turning to Christianity" theglobeandmail.com, 21 Mar 2006, michelemalkin.com.

**father**, God can take him away. You cannot make anything out of such a son. He is useless' [a likely allusion to the Khidr story].<sup>636</sup>

When it became likely that Rahman might be released due to international pressure, moderate *Imam Abdul* Raouf of the *Afghan Ulama* Council, who was jailed three times for criticizing the *Taliban*,<sup>637</sup> said:

We will not allow God to be humiliated. This man must die...Cut off his head! We will call on the people to pull him into pieces so there's nothing left.<sup>638</sup>

Besides justifying: 1) capital punishment for apostasy under *Sharia* law, 2) extra-judicial assassinations by strangers who feel they are authorized by *Allah* to act as judge, jury and executioner and 3) terrorism acts, one can see how the story of Khidr could be used to justify the frequent honor-killings in *Islamdom*. Khidr actually made the murder an act of faith—faith that *Allah* would smile upon a *Muslim* murdering a non-*Muslim* lad and would bless the act by giving the *Muslim* parents a better replacement son. Thus honor-killings and extra-judicial killings can be an act of faith in *Islam* just as *Jihad*-related murders are an act of faith in *Islam*.

Honor-killings will be further discussed later this section, and FGM is discussed elsewhere, but it should be noted here that the stranger Khidr's extra-judicious killing of a healthy lad in the hopes that *Allah* would give the couple a better son (*K* 018:080-081) seems to have occasioned and justified other gross abuses against children in *Islamdom*, for instance:

☪ If Khidr's killing of a lad because that lad would later vex his *Muslim* parents in the future, then "taxing" Christian nations by abducting tens of thousands of their sons and inducting them into the *Sultan's* palace or *Janissary* army was justified since *Devshirme* made the sons obedient to *Allah* and did not involve killing.<sup>639</sup>

☪ If Khidr could kill a lad thereby sending him to hell for eternity so he would not vex his *Muslim* parents in the future, surely *Islamists* can encourage youths to engage in "martyrdom" operations thereby sending the boy to heaven and allowing the boy to free his parents and others from purgatory. Thus *Muslims* use children's books and school textbooks, kid's television and youth camps to encourage *Muslim* children to: 1) go on *Jihad*, 2) risk life and limb to star in phony *Jihadist* propagandist movies like the one about *Muhammad Al-Dura* in 2004 at "Martyr's Square in *Gaza*, 3) transport arms and bombs through checkpoints and during street fighting,<sup>640</sup> 4) throw rocks at jeeps and tanks or bunkers while armed militants attack, 5) test the defenders' reaction time by approaching fences (i.e. "pinging the system") thereby inducing "threat fatigue," and 6) act as human shields for *Jihadists* who are: a) setting mines, b) street fighting or sniping, c) attending parades, funerals, pep rallies or strategy meetings, or d) are in disabled vehicles. Aerial videos show children and other bystanders swarming around terrorists' cars and pick-ups immediately after being hit by Israeli missiles to act as human shields against further missile

<sup>636</sup> Barker, Kim. "Afghan's openness about his Christianity went too far," *Houston Chronicle*, chron.com, 20 Mar 2006, michelemalkin.com.

<sup>637</sup> "Clerics want Christian convert's death," jpost.com, 23 Mar 2006, *JW, C&R*.

<sup>638</sup> Steyn, Mark. "Facing down a culture where they talk like crazies," *Chicago Sun Times*, suntimes.com, 26 Mar 2006.

<sup>639</sup> "The Encyclopedia of the Orient," lexicorient.com, *Devsirme* entry, accessed 16 Jun 2006.

<sup>640</sup> Wilson, Scott. "Preparing for Battle and its Victims in a Palestinian City," washingtonpost.com, 7 Jul 2006, backspin.typepad.com.

strikes, and they wish to become a martyr in the process. Another reason for the swarms is so they can quickly strip the dead or injured terrorist of weapons and claim *post facto* that he was an “innocent” civilian wearing civilian clothes. Reuters reported from a *Hamas* funeral in *Gaza* in 2006:

Asked if they would learn from the death of 19-year-old Mohammed Maher Shahine, killed while watching Thursday’s fighting as Israel stepped up an offensive in the strip, the boys answered almost with one voice. ‘No. We want to be martyrs too,’ they said, seemingly oblivious to the danger of following around bands of gunmen as they battle more powerful Israeli troops, who are backed by tanks and helicopters. ‘What is there to learn?’ asked Jamal Shahine, 42, a cousin of the deceased as dozens of relatives gathered under a mourning tent. ‘All these boys just want to fight.’<sup>641</sup>

The television and programs that inculcates the desire to fight and martyrdom include:

\* *Haaretz* reported in 2006:

In the clip, a child portraying *al-Dura* is peacefully playing in heaven, and calls to other children, ‘follow me.’ The popular singer Aida performs the song in the clip, which describes how the earth longs for the deaths of children, saying, ‘How pleasant is the smell of the earth whose thirst is quenched by blood pouring out of young bodies.’ Another clip that aired this week after a long absence depicts a young girl witnessing her mother’s murder and then singing about how she misses her mother. She sings, ‘If you can’t come to me, I can come to you.’ Palestinian Media Watch reported that the 2000-2003 Palestinian television campaign to recruit young children was so effective, that 70 to 80 percent of Palestinian children during that time wanted to die as *Shaheeds* [martyrs], according to three separate polls.<sup>642</sup>

\* “The World Assembly of *Muslim Youth* (WAMY), founded by the nephew of Osama *Bin Laden* in the US,” publishes children’s books that read:

Teach our children to love taking revenge on the Jews and the oppressors, and teach them that our youngsters will liberate Palestine and *Al-Quds* [Jerusalem] when they go back to *Islam* and make *Jihad* for the sake of *Allah*...The Jews are the enemies of the faithful, God and the angels...The Jews are humanity’s enemies; they foment immorality in this world; The Jews are deceitful, they say something but mean the exact opposite....Hail! Hail! O Sacrificing Soldiers! To Us! To Us! So we may defend the flag on this Day of *Jihad*, are you miserly with your blood?! And has life become dearer to you? And staying behind sweeter?<sup>643</sup>

\* WAMY summer camps remind one of Hitler Youth. Instead of roasting marshmallows and singing “*Kumbaya*, my Lord,” they engage in war chants:

We prefer death and refuse to be belittled for the Cause of *Allah*; O! how sweet a destiny! We have decided and sworn an oath to live or die as *Muslims*; Holding fast to the errors of the corrupt ones; Striving for *Muslims* to rule; *Muslims! Muslims! Muslims!*

<sup>641</sup> Baker, Luke. “Funerals don’t deter *Gaza* youth,” news.yahoo.com, 7 Jul 2006, *LGF*.

<sup>642</sup> Shragai, Nadav. “PA television airs clip encouraging children to become *shaheeds* [martyrs],” *haaretz.com*, 3 Jul 2006.

<sup>643</sup> “U.S. links Toronto Group to *bin Ladin*,” *nationalpost.com*, “WAMY Runs *Jihad* Camps in Ontario,” *LGF*, 19 Sep 2003.

We, with *Islam* were the best of nations; And with it conquered Kisraa [a Persian emperor] and Caesar; We have sown Justice in the world; So reap & spread amongst the people ‘*Allahu Akbar*’; Ask if you still don’t know who; *Muslims! Muslims! Muslims!...Raise the Qur’aan* as the constitution of our time; And fill the horizons with: We are *Muslims! Muslims! Muslims! Muslims!*

Another chant reads:

Hail! Hail! O sacrificing soldiers! To us! To us! So we may defend the flag; On this Day of *Jihad*, are you miserly with your blood?! And has life become dearer to you? And staying behind sweeter? Is staying in this world of torment more pleasing to us?<sup>644</sup>

C Across *Islamdom Madrasas* take in children who are made to beg in the street. They must meet their quota or else the teacher will upbraid or beat them. Reuters reports from *Daka*, the capital of *Senegal* on Africa’s Atlantic coast:

In a dirty white T-shirt hanging down to his knees, 4-year-old Harouna Balde begs for coins in bare feet among the traffic on the polluted streets of *Dakar*. Holding a rusty begging tin that is the trademark of the *Talibes*—students at *Senegal’s Koranic* schools—Balde says he must take back money or face a beating from his religious teacher, or marabout. ‘I must bring back 500 *Francs* (USD 0.90) every day to my master or face punishment,’ says the tiny boy. He travels from his squalid *Daara*, or religious school, in the distant suburb of *Thiaroye* to beg all day in the city center.<sup>645</sup>

C UK’s *Times Online* reported in 2006:

A senior member of an *Islamic* organisation linked to *Al-Qaeda* is funding his activities through the kidnapping of Christian children who are sold into slavery in *Pakistan*.<sup>646</sup>

C The unborn in *Islamdom* do not stand a chance unless they are the perfect picture of health. *Fatwas* are issued everywhere in *Islamdom* that...

...if doctors express founded fears that the future child may acquire serious or incurable diseases, pregnancy can be terminated.<sup>647</sup>

The *Muslim* Moses’ objection to the stranger *Khidr’s* extra-judicial killing of the son of believing parents (*K* 018:074) reminds one of the verse that *Muslims* cite most often (i.e. *K* 005:032) whenever they issue ineffectual statements or *Fatwas* against terrorism—statements meant for Western consumption only, of course. Moses told *Khidr*:

What! Have you slain an **innocent soul not out of retaliation**? Truly you have acted heinously! (*K* 018:074).  
and *K* 005:032 reads:

We prescribed for the Children of *Israel* that whoso slays a soul—**not to retaliate for a soul slain**, nor for corruption done in the land—shall be as if he had slain humanity altogether...

<sup>644</sup> Dreher, Rod. “Fun at *Jihad* summer camp,” beliefnet.com, 21 Jun 2006, *LGF*.

<sup>645</sup> “U.N.: *Koranic* schools in *Senegal* fuel child trafficking,” cnn.com, 16 Jun 2006, *JW*.

<sup>646</sup> Colvin, Marie. “Reunited: boys saved from slavers,” *The Sunday Times*, timesonline.co.uk, 21 May 2006, *DW*, C&R; also see Pipes, Daniel. “Pakistan’s Mock Devshirme,” *DP*, 21 May 2006.

<sup>647</sup> “On the usage of additional reproductive technologies in the treatment of barrenness,” *Islam Authentically*, umma.ws, accessed 9 Jan 2006.



In response to *Fatwas* condemning the killing of “innocents,” *Muslim* terrorists could:

- ☉ Profess to be as wise as the stranger Khidr and say what Khidr said to Moses:

Surely you cannot have patience with me, for how can you tolerate actions based on a higher knowledge than you have? (*K* 018:068-069).

- ☉ Respond just as Khidr did to the objections of the *Muslim* Moses about the extra-judicial killing of “innocents” (discussed above). In other words, anyone who vexes *Muslims* is not “innocent” and deserves to die just as the unbelieving son deserved to die at the hands of the stranger Khidr because he would have grown up to vex his parents.
- ☉ Say that the *Fatwas* condemning terrorism are illegitimate because they support democracy, and besides, modern laws of warfare regarding “innocents” and civilian non-combatants are not *Sunna* (sanctioned *Islamic* practice), but *Bida* (adding to *Islam* that which God has not ordained).
- ☉ Claim that they were in fact killing out of “retaliation” for *Muslim* killed, or were killing those who “spread corruption in the land”—two of the exemptions granted into *K* 005:032. In fact, terrorists quote *K* 005:032 all the time, so *Fatwas* and other pronouncements against terrorism that are based on *K* 005:032 are entirely ineffectual at countering terrorism against infidels, as Razi Azmi wrote in 2006 in *Pakistan’s Daily Times*:

Whenever a terrorist outrage occurs in any *Muslim* country and the victims are ordinary *Muslims*, we are told that *Muslims* must never kill *Muslims*. Even *Fatwas* are issued to that effect. The unspoken and unwritten subtext seems to suggest that it is acceptable for *Muslims* to kill non-*Muslims*, provided there is a pretext [e.g. infidels were killed out of retaliation or for “spreading corruption in the land” (*K* 005:032)]....The very people who openly or secretly admire [*Al-Qaeda* terrorist leader] Zaraqawi will, at the appropriate forums, cite the *Koranic* verse [*K* 005:032] to the effect that the killing of even one innocent person is tantamount to the killing of all mankind and to emphasize that *Islam* literally means peace.<sup>648</sup>

Terrorists think that only those who keep *Sharia* law are truly “**innocent**,” which means that infidels and even many lukewarm *Muslims* are not “innocent.”<sup>649</sup> For instance, Zachariah, a leader in radical Omar Bakri Mohammed’s Savior Sect in London, said after the 7/7 attack in 2005 that killed London commuters:

...the [52] victims were not ‘**innocent**’ people because they did not abide by strict *Islamic* laws.<sup>650</sup>

and as *The Times Online* reported:

In public interviews [Omar] Bakri condemned the killing of all **innocent** civilians. Later when he addressed his own followers he explained that he had in fact been referring only to *Muslims* as only they were **innocent**: ‘Yes I condemn killing any **innocent** people but not any *Kuffar* [non-*Muslims*].’<sup>651</sup>

<sup>648</sup> Azmi, Razi. “Thinking Aloud: ‘An archaic incongruity?’” *Daily Times*, [dailytimes.com.pk](http://dailytimes.com.pk), 15 Jun 2006, *JW*.

<sup>649</sup> Pipes, Daniel. “Can Infidels be Innocents?” *DP*, 7 Aug 2005.

<sup>650</sup> “Inside the sect that loves terror,” [timesonline.co.uk](http://timesonline.co.uk), 7 Aug 2005.

<sup>651</sup> “Inside the sect that loves terror,” [timesonline.co.uk](http://timesonline.co.uk), 7 Aug 2005.

Even if a non-*Muslim* were innocent, he would still not be exempt from *Jihad* attack since the *Koran* says that non-*Muslims* must be fought and killed unless they convert or pay the *Jizya* poll tax (*K* 009:005, 029-030).

*Islamists* often say no non-*Muslim* is innocent.<sup>652</sup> *Islamists* note that non-*Muslims* vote, pay taxes, serve in militaries, etc.,<sup>653</sup> in democracies that “follow ‘the laws of the devil.’”<sup>654</sup> These democracies “cause strife among *Muslims* in the name of democracy, freedom and women’s rights,” so an election office can be a “center of corruption, in which immoral acts that contradict our religion have been practiced,”<sup>655</sup> meaning that the election office is liable to be bombed in accordance with *K* 005:032. *Islamists* say that children, especially *Israeli* children, can be killed too since they will grow up to oppress *Muslims* the same as their parents, as a Palestinian *Hamis* leader...

...*Al-Zahar* once explained to the *BBC* that ‘all *Israelis* are militants...[there are] no civilian *Israelis*’ (3 Oct 2001).<sup>656</sup>

*Islamists* believe that *Muslims* who integrate with secular societies are not innocents and can be killed extra-judiciously either as collaborators, apostates, or as collateral targets. A ruler who does not rule according to *Sharia* law and the *Koran* is an unbeliever.<sup>657</sup> <sup>658</sup> *Muslims* who follow such a secular or infidel ruler are deemed to be without *Allah*’s protection and therefore can be killed as infidels (*K* 002:120; 013:037; 007:196).

*Islamists* believe that *Muslims* who denounce *Jihad* are infidels, as an *Al-Qaeda* manifesto states...

...doctrine and mission are clear and they can be summarized as our agreement to believe in and fight for the religion of God. We believe that those who follow these beliefs [i.e. *Jihad*] and the provisions of faith are true *Muslims* and anyone who denounces any of these beliefs and conditions is an **infidel** even if he still claims to be a *Muslim*.<sup>659</sup>

*Jihadists* can use even “true” *Muslims* as human shields. Ghazali used the term *Tattarrus* in his book *Al-Mustasfa* (*The Place of Purification*) to describe the practice of “using ordinary *Muslims* as human shields for *Islamic* combatants against infidel fighters.”<sup>660</sup>

According to *Jihadist* literature, the end justifies the means so “*Muslims* ‘must remove any obstacle in the way of implementing the *Islamic* ruling system,’”<sup>661</sup> even

<sup>652</sup> Pipes, Daniel. “Can Infidels be Innocents?” *DP*, 7 Aug 2005.

<sup>653</sup> “Focus: Undercover in the academy of hatred,” [timesonline.co.uk](http://timesonline.co.uk), 7 Aug 2005, *DP*.

<sup>654</sup> Sciolin, Oelaine. “From Tapes, a Chilling Voice of *Islamic* Radicalism in Europe,” [nytimes.com](http://nytimes.com), 18 Nov 2005.

<sup>655</sup> “*Islamist* gunmen order closure of *Gaza* Strip election office,” [haaretz.com](http://haaretz.com), 15 Nov 2005.

<sup>656</sup> Passner, Deborah. “*Hamis* Leaders,” [CAMERA.org](http://CAMERA.org), 25 Nov 2003, *JW*, 20 Apr 2004.

<sup>657</sup> Do not obey any lawcode besides *Sharia* law: *K* 004:059-061, 065, 115; 005:044-45, 47, 50; 024:047-051; 028:050; 042:02; 058:020.

<sup>658</sup> Do not obey any non-*Muslim* ruler: *K* 003:149; 025:052; 026:151; 033:001, 048; 068:008; 076:024; 096:019.

<sup>659</sup> Nasr, Octavia. “*Al Qaeda* in *Iraq* issues virulent manifesto: Group calls for violence, destruction of ‘American empire,’” [cnn.com](http://cnn.com), 26 Aug 2005, *C&R*.

<sup>660</sup> “*Sheikhs* debate whether killing *Muslim* non-combatants is permissible,” *JW*, 11 Jun 2005.

<sup>661</sup> Lindner, John M. “*Islamic* Radicals Agitate Judges in Indonesian Christianization Court Case,” [assistnews.net](http://assistnews.net), 18 Aug 2005, *WND*, *DW*.

if that means killing *Mutumarresoun*—Muslim civilians living under infidel rule.<sup>662</sup> In 2003, *Saudi Sheikh* Nasir bin Hamid al Fahd issued a *Fatwa* “justifying the use of WMDs against infidels” and the *Fatwa* “allowed Muslim collateral damage.”<sup>663</sup>

In *Iraq* in 2004 and 2005, suicide bombers killed many more *Iraqis* than coalition troops as the *Iraqis* applied for police and army jobs. Several suicide bombers even targeted coalition troops with car bombs as they handed out candy and toys to crowds of *Iraqi* children. It is as *Israeli* Terror analyst Tzvi Mazal said:

*Islam* allows attacks against *Muslims* who are seen by extremists as ‘collaborators,’ adds Mazal, explaining the ‘logic’ behind attacks against *Muslims* by terrorists. ‘Jews and Christians are seen as infidels—a category allowing for their murder.’<sup>664</sup>

Once collaborating *Muslims* are seen as infidels, this allows *Muslim* women and children to be killed as collateral targets—for *Muhammad* said that *Muslims* are not at fault if women and children are accidentally killed while targeting infidel men.<sup>665</sup>

Sadly, *Islamists* think that terrorists are “innocent.” For instance, when *Israel* killed a most-wanted terrorist in a fair firefight, a Palestinian authority referred to him as an “innocent victim.”<sup>666</sup>

*Islamists* living in non-*Muslim* lands maintain their “innocent” and “non-collaborator” credentials by: 1) considering themselves to be undercover agents of *Allah*, 2) keeping *Sharia* law, 3) living non-productive lives so as not to pay taxes to infidels, 4) not buying car insurance and 5) by living on the dole so infidels have less money.<sup>667 668</sup>

*Islamists* are not ashamed to be on the dole or to receive foreign aid while engaging in *Jihad* or terrorism, because they view these gifts as: 1) a *Jizya* tax that Jews and Christian pay *Muslims* so *Muslims* suspend *Jihad* (K 009:029) or 2) charity, since *Muhammad* said that *Jihadists* could receive *Zakat* alms along with the poor (K 009:060). For example:

- Ⓒ In the UK, Algerian Rachid Salama said “My brothers...were on benefits or living off charity so they could hang about discussing *Jihad* all day.”<sup>669</sup>
- Ⓒ A UK reporter noted: “Integration with British society is scorned, as is any form of democratic process. Followers are encouraged to exploit the benefits system. They avoid jobs which could bring them into contact with western women or might lead them to contribute to the economy of a nation they are taught to despise....It was important to be unemployed...as taking a job would contribute to the *Kuffar* system. He [Nassar] said he was receiving a job-seeker’s allowance and justified this by saying the prophet *Muhammad* also lived off the state and attacked it at the same time. ‘All money belongs

<sup>662</sup> Robinson, B.A. “When does *Islam* permit the killing of *Muslim* non-combatants? The principle of *Tattarrus*,” [religioustolerance.org](http://religioustolerance.org), 30 Jul 2005.

<sup>663</sup> Schechter, Erik. “Our own 9/11?” [jpost.com](http://jpost.com), 2 Mar 2006.

<sup>664</sup> Bahur-Nir, Diana. “Bibi: Red Sea attacks are a warning,” [ynetnews.com](http://ynetnews.com), 19 Aug 2005.

<sup>665</sup> *Sahih* Bukhari, vol. 4, bk. 52, no. 256; *Sahih Muslim*, bk. 19, no. 4321+2+3.

<sup>666</sup> PA’s Erekat: *Islamic Jihad* Leader Was ‘Innocent Victim,’” [ArutzSheva.com](http://ArutzSheva.com), 26 Oct 2005, *JW*.

<sup>667</sup> Cohen, David. “Terror on the dole,” *Evening Standard*, 20 Apr 2004, [thisislondon.co.uk](http://thisislondon.co.uk), 21 Apr 2004, *LGF*, *DW*, [freerepublic.com](http://freerepublic.com).

<sup>668</sup> Mick, Hayley. “A convert who wanted to spread the faith,” [theglobeandmail.com](http://theglobeandmail.com), 7 Jun 2006.

<sup>669</sup> Taher, Abul *et al.* “Focus: How liberal Britain let hate flourish,” *The Sunday Times*, [timesonline.co.uk](http://timesonline.co.uk), 12 Feb 2006.

to *Allah* anyway,' he said. There were other ways to opt out. 'All the brothers drive without insurance,' Nasser said proudly.<sup>670</sup>

- Ⓒ In Canada's largest mosque in *Calgary*, an *Imam* reportedly said in prayer in *Urdu*, "Oh, God, protect us from the infidels, who pollute us with their vile ways," even though he had been on the dole for most of thirty years. A *Muslim* man who confronted the *Imam* in public about his publicly expressed ungratefulness was subsequently shunned.<sup>671</sup>

*Islamists* are like *Muhayyisa b. Mas'd*, a follower of *Muhammad*, who was unapologetic about killing a random Jew at the command of *Muhammad* even though it turned out that the Jew was a valued customer that put bread on the table of *Muslims* and their extended families.<sup>672</sup>

The stranger *Khidr* told the *Muslim* *Moses* that the lad was not a believer even though his parents were believers. *Khidr* said that...

...the young boy's parents were believers and at some point the boy might have rebelled and been ungrateful, so I hope that *Allah* would give the parents another son who is better behaved and more affectionate (*K* 018:074, 080-081).

*Khidr's* saying that the boy was an unbeliever also answers *Moses's* other objection over the killing—that the lad was "innocent" (*K* 018:074). *Muhammad* says elsewhere that none are innocent except those on whom *Allah* has mercy (*K* 012:053).

So, one can see that once anyone does some cross-referencing of *Koran* verses and traditions (e.g. *K* 005:032 with the *Khidr* story), and once one finds out that the Sword Verse abrogates the earlier peaceful verses, there is not a single verse in *Islam* that keeps *Muslims* who are inclined to kill and rob from doing so if given the opportunity. Even the *Muslim* historian, *Tabari* (839–923 AD), does not deny that *Islam* is a killing machine, for he records this incident without comment:

Among them were many Christians who had accepted *Islam* but when dissension [a conflict] had developed in *Islam* had said 'By God, our religion from which we have departed is better and more correct than that [*Islam*] which these people follow. Their religion [*Islam*] does not stop them from shedding blood, terrifying the roads and seizing properties.'<sup>673</sup>

Thus one can see how modern *Imams* can say, as *Imam Abu Hamza* said:

Killing an adulterer, even if he is a *Muslim* is OK. Killing a *Kufar* (non-believer) who is fighting you is OK. Killing a *Kufar* for any reason you can say it is OK even if there is no reason for it.<sup>674</sup>

*Muslims* of course will continue to claim that *Islam* keeps them from indiscriminate killing of non-*Muslims*, but a little fact checking shows how hollow these assurances are. For instance, when rioters from the Jerusalem suburb of *Isawiya* (population 12,000) threw two firebombs at the Mt. Scopus *Hadassah* hospital entrance, an *Isawiya* town leader sought to reassure the hospital staff that it "was a one-time thing, not an *Intifada-Isawiya*." Why? *Israeli* security forces had long

<sup>670</sup> "Inside the sect that loves terror," [timesonline.co.uk](http://timesonline.co.uk), 7 Aug 2005.

<sup>671</sup> Corbella, Licia. "Divided loyalties," *Calgary Sun*, [calsun.canoe.ca](http://calsun.canoe.ca), 18 Jun 2006, *DW*.

<sup>672</sup> *Ishaq. Sirat*, p. 369. The account is also found in *El badiyah wa alnihay-Ibn Katheer*, vol. 4: the chapter on killing *Ka'ab Bin Al' Ashraf*.

<sup>673</sup> *Al-Tabari, The History of Al-Tabari (Ta'rikh Al-rusul wa'l-muluk)*. State University of New York Press, New York, 1993, pp. 187-188, 191-192.

<sup>674</sup> "Abu Hamza said killing non-*Muslims* 'OK' in any circumstance," [news.yahoo.com](http://news.yahoo.com), 13 Jan 2006, *JW*.

blocked *Isawiya* roads leading south and west, so the townsfolk probably did not want more road closures. The *Isawiya* council leader said:

The *Islamic* religion **specifically forbids** us to harm any hospital or clinic.<sup>675</sup>

This assurance, like most such assurances, comes without any specific citation besides the generic “*Islam* does not allow...” The few assurances that do come with a *Koran* citation conveniently forget to mention that the verse was abrogated by the Sword Verse (*K* 009:005). Often the nice phrases are cherry-picked out of a *Koran* verse that is otherwise terrible as is often done with *K* 005:032-033.

One wonders how “*Islam*” “**specifically forbids**” attacking hospitals when there were no hospitals in Arabia during *Muhammad*’s time. No hospitals are mentioned in biographies of *Muhammad*. Christians established the first hospital in 369 AD and *Caliph Al-Walid* is the first *Muslim* to found a hospital in 707 AD. Starting in *Islamic* times, “For a long period most physicians were Christian.”<sup>676</sup> Thus terrorists can say that any *Fatwas* supporting modern laws of warfare regarding hospitals are not *Sunna* (sanctioned *Islamic* practice), but *Bida* (adding to *Islam* that which God has not ordained).

*Muslim* leaders’ assurances that hospitals are not targeted is meaningless since no place is sacred when it comes to *Islamic* snipers, militants and suicide-bombers:

- ☉ From 2002 to 2003, “five Molotov bombs were thrown from this [Arab] village to the backyard of Mount Scopus *Hadassah* hospital.”<sup>677</sup>
- ☉ In November 2005, two firebombs were thrown at the *Hadassah* hospital.<sup>678</sup>
- ☉ In 2006 just a few months after the *Isawiya* council leader said *Islam* forbids bombing hospitals (above), two firebombs were thrown from the Arab village into the *Hadassah* hospital grounds.<sup>679</sup>
- ☉ On 7 December 2005, the headlines read that *Islamic* gunmen killed three people in a hospital in *Baghdad* trying to free an assassin!<sup>680</sup>
- ☉ Several examples of *Iraqi* hospitals being suicide-bombed just in 2005 can be culled from the news.<sup>681</sup>
- ☉ In 2005, a Palestinian burn patient tried to suicide-bomb the same *Israeli* hospital where she was receiving free therapy!<sup>682</sup>
- ☉ On 27 September 2005, an *Iraqi* sniper killed a US soldier from a fourth-floor window of a *Ramadi, Iraq*, hospital.<sup>683</sup>
- ☉ Hospital staff are not safe inside or outside of the hospital:
  - ★ In 2003 when Dr. David Applebaum of the *Sha’arei Tzedek* Medical Center died in the *Hillel* Café bombing in Jerusalem in 2003.<sup>684</sup>

<sup>675</sup> Svetlova, Ksenia. “Can trust be rebuilt?” jpost.com, 1 Dec 2005.

<sup>676</sup> Gibb & Kramer. *Encyclopedia*, pp. 326-327, *Maristan* (Arabic for “hospital”) entry.

<sup>677</sup> Eskenazi, Joe. “*Hadassah* hospitals strain to stay one jump ahead of terror,” *Jewish News Weekly of N. California*, jewishsf.com, 21 Nov 2003.

<sup>678</sup> Svetlova, Ksenia. “Can trust be rebuilt?” jpost.com, 1 Dec 2005.

<sup>679</sup> Lefkovits, Etgar. “*Hadassah* Mount Scopus Hospital firebombed,” jpost.com, 14 Mar 2006.

<sup>680</sup> Reid, Robert H. “Gunmen kill 3 freeing suspect from *Iraq* hospital,” thestar.com, 7 Dec 2005.

<sup>681</sup> “Suicide bomber kills 12 in *Mosul* hospital,” chinadaily.com.cn, 7 Feb 2005; 60KM south of *Baghdad*: “Suicide bomber kills three *Iraqis* in hospital,” english.people.com.cn, 28 Jun 2005; 30 killed outside *Baghdad* hospital: “More deadly blasts shatter *Iraqi*...,” msnbc.com, 24 Nov 2005; and “*Baghdad*: Car bomb explodes outside children’s hospital,” jpost.com, 19 Dec 2005.

<sup>682</sup> Fletcher, Martin. “Descent from patient to suicide bomber,” msnbc.com, 23 Jun 2005.

<sup>683</sup> Harnden, Toby. “Sniper shot that took out an insurgent killer from three quarters of a mile,” telegraph.co.uk, 1 Jan 2006, *C&R*.

<sup>684</sup> “Lifesaving group *Hatzolah* Jerusalem mourns e-room doctor,” hatzolah.org.il, 10 Sep 2003.

- ★ In 2003, Dr. Shlomo Mor-Yosef of the Mt. Scopus *Hadassah* Hospital had “been to at least 25 funerals of employees or their relatives.”<sup>685</sup>
- ★ *Al-Qaeda* tries to recruit AIDS, hepatitis and dengue fever sufferers as suicide-bombers to infect bystanders with blood-splattered bits of bone and shrapnel and to create bio-hazards for rescuers and health providers.<sup>686</sup>

*Muhammad* fully approved of Khidr’s actions in the story since he said that if the *Muslim* Moses had held his tongue and kept traveling with the stranger Khidr, Khidr would have shown the *Muslim* Moses “many [more] wonderful things” (*Sahih Muslim*, bk. 30, no. 5865). So here *Muhammad* refers to terrorism—the stranger Khidr’s murder of an unsuspecting lad—as being a “wonderful thing.” Incidentally, this reminds one of how an early convert to *Islam*, Huwayyisa, said *Islam* was “marvelous” because it made his own brother, Muhayyisa, murder a Jewish man in cold blood.<sup>687</sup>

Khidr is an archetypical *Muslim* terrorist, a man *Muhammad* and other terrorists model themselves after. For instance, Khidr ruined a man’s boat so a king could not commandeer it for war, he killed an unbelieving lad and he also fixed a wall in order to secure a buried treasure for two orphaned boys.

*Muslim* terrorists are known for their acts of sabotage, for killing the children of non-*Muslims* and for being do-gooders for *Muslims* in need. Similarly, many charities are just personification of Khidr that serve as front groups for terrorists. While they help *Muslim* orphans, they make infidels into orphans and bereaved parents. Incidentally, this is all in keeping with *Muhammad*’s dictum that *Zakat* alms can go to the poor, to *Jihadists* and others (*K* 009:060).

Like Khidr, *Muslim* jurists believe that unbelief is reason enough for a person to be killed as an apostate or pagan (*K* 009:005). Also, a Christian or Jew who refuses to pay the *Jizya* tax is to be killed (*K* 009:029). *Ibn* Taymiya wrote that infidel travelers could be slaughtered:

If a male unbeliever is taken captive during warfare or otherwise, e.g. as a result of a shipwreck, or because he has lost his way, or as a result of a ruse, then the *Imam* may do whatever he deems appropriate: killing him, enslaving him, releasing him or setting him free for a ransom consisting in either property or people. This is the view of most jurists and it is supported by the *Koran* and the *Sunna*.<sup>688</sup>

Similarly today, when aid workers came to help tens of thousands of *Pakistani Muslims* who were earthquake victims, clerics declared that they were “debauched foreigners” who were “spreading immorality.”<sup>689</sup> Since this equates to “spreading corruption in the land,” the clerics thereby declared the blood of the aid workers to be *Halal*. Thus it is not surprising to read that a *Pakistani* fired a rocket-propelled grenade at a large US helicopter that was dispatching aid to the earthquake victims.<sup>690</sup>

<sup>685</sup> Eskenazi, Joe. “*Hadassah* hospitals strain to stay one jump ahead of terror,” *Jewish News Weekly of N. California*, jewishsf.com, 21 Nov 2003.

<sup>686</sup> Hamer, Rupert. “HIV bombers: *Al-Qaeda*’s plot to infect troops with AIDS virus,” *sundaymirror.co.uk*, 8 Jan 2006, *JW*.

<sup>687</sup> Ishaq. *Surat*, p. 369.

<sup>688</sup> Peters. *Jihad*, p. 50.

<sup>689</sup> Rohde, D. “For Devout *Pakistani Muslims*, Aid Muddles Loyalties,” *nytimes.com*, 26 Oct 2005.

<sup>690</sup> News Release: HQ US Central Command, MacDill AFB, Florida, 1 Nov 2005, *C&R*.

Many *Islamists* consider European women especially to be “spreading corruption in the land,” so *Muslims* in Europe have raped and beaten nearly to death many infidel women and slashed others with knives.<sup>691</sup> Also see the high crime rate table.

To conclude this section, it particularly disturbing that *Islamic* civil rights organizations trumpet every abuse or killing of a *Muslim* that is perpetrated by infidels,<sup>692</sup> and issue: 1) warnings about impending backlashes after *Islamic* terrorist attacks—outbreaks of *Islamophobia* that rarely occur, and 2) inaccurate, exaggerated and uncorrected hate-crimes reports that present known hate-crime hoaxes as being real.<sup>693</sup> For every abuse of a *Muslim* is, in keeping with Khidr-Second Lamech Logic, worthy of an assassination or a massacre of the infidel perpetrators. Thus, broadcasting everyday news to *Muslims* is tantamount to encouraging would-be Khidrs to rise up from among *Muslims* to assassinate infidel perpetrators.

### III. Muhammad, The Second Lamech, Who Avenges Multiple Times Over Supposedly by Divine Warrant

#### *Magnifying a Religious Offense Into a Capital Offense Committed Against All Muslims*

*Muhammad* said that *Allah* prescribed that whenever an infidel killed a believer, i.e. a *Muslim*, the act was as heinous in *Allah*'s eyes as though all of humanity had just been murdered (*K* 005:032). By contrast, if a *Muslim* killed an infidel, no retaliation is called for since *Muhammad* commanded *Muslims* to kill pagans (*K* 009:005).

Just as *K* 005:032 magnifies any **murder** of a *Muslim* by a non-*Muslim* into a full-blown **genocide** of **all humanity**, so also a non-*Muslim* “spreading **corruption** in the land” is exaggerated, by reference to the same *Koranic* verse, into a **capital offense** and into a monstrosity against **all Muslims**, or at least into incitement to commit a capital offense and a monstrosity against **all Muslims**.

The foregoing interpretation of *K* 005:032 is also confirmed by the fact that *Muhammad* said: “Persecution is **more** heinous than slaughter” (*K* 002:191, 193, 217). The “more heinous” phrase means that *Muhammad* considered an infidel who persecuted *Muslims* to be worse criminals than those who committed mass murder.

Offenses that *Muhammad* magnified from a slight into an enormity include:

- ☛ All 1.2 billion *Muslims* are each supposed to treat a real or imagined insult against *Islam* as though the critic insulted his or her own mother or sister (*K* 033:006).
- ☛ Cursing a *Muslim* “is tantamount to killing him” (*Sahih Muslim*, bk. 1, no. 0202).

That *Muslims* consider “spreading corruption in the land” to be tantamount to warfare and genocide against *Muslims* or murder of all humanity—in keeping with the logic of *K* 005:032—is well known from *Dhimmi* history and current affairs:

- ☛ In Canada in May 2004 Cheryfa MacAulay Jamal wrote online that “the humiliation of *Iraqi* prisoners at the hands of American soldiers” made the U.S. military into “the filth of the earth, the uncivilized destroyer of

<sup>691</sup> Fjordman. “*Muslim* Rape Wave in Sweden,” *FPM*, 15 Dec 2005.

<sup>692</sup> “CAIR: ‘Marines’ Cheer Song About Killing *Iraqi* Civilians,” yahoo.com, 12 Jun 2006, *LGF*.

<sup>693</sup> Pipes, Daniel & Sharon Chadha. “CAIR’s Hate-crimes Nonsense,” *DP*, 18 May 2005.

humanity,” a likely allusion to *K* 005:032. Thus Jamal equates hazing and initiation rituals with genocide of all humanity. In 2006 Jamal’s husband was arrested for leading a plot to bomb government buildings in Canada. Ironically, in 2004 Jamal warned:

‘You don’t know that the *Muslims* in Canada will never be rounded up and put into internment camps like the Japanese were in WWII!’...This is a time when *Muslims* ‘are being systematically cleansed from the earth.’<sup>694</sup>

- C Public statements *Muslims* make nowadays such as:

*Mullah* Krekar in Norway...a *Kurdish* founder of *Ansar al Islam*...called...[the Danish 2006] publication of the [*Muhammad*] cartoons ‘a declaration of war against our [*Islamic*] religion, our faith and our civilization. Our way of thinking is penetrating [Western] society and is stronger than theirs. This causes hate in the Western way of thinking; as the losing side, they commit violence.’<sup>695</sup>

- C The fact that in 2006 *Muslim* protestors called for genocide over cartoons:

...the Danish cartoon [of *Muhammad*] affair was exploding across the Middle East. Gunmen raged in *Gaza*, and it was not long before protestors would hold up placards outside London’s Danish Embassy calling for genocide against nonbelievers.<sup>696</sup>

- C The mob action and draconian punishments meted out for any criticism of *Islam*, or deviation in *Muslim* ritual and doctrine, or evangelizing for a religion other than *Islam*—even in modern times. For instance:

- ★ In 2006 a bill proposed in *Indonesia* would censure the wearing of tight-fitting clothes and punish kissing in public with up to five years in prison. Exposing the midriff or bellybutton “could be punished by a 10-year sentence and a £30,000 [52,163 USD] fine.”<sup>697</sup>
- ★ In 2006, *Algeria* ratified a law that “anyone urging or forcing or tempting [in order] to convert a *Muslim* to another religion” could be jailed for 2 to 5 years and be fined 5 to 10 thousand *Euros*.<sup>698</sup>
- ★ In 2006, after people criticized a new law that “will help *Muslim* men to take multiple wives and claim property after divorce,” *Malaysia*’s law minister said he would use the Sedition Act “against anybody who **incites**.” Previously, the Sedition Act was only “used to curb speech detrimental to the government, inciting racial hatred, or questioning the [*Bumiputra* (Sons of the Soil)] rights of *Malaysia*’s ethnic *Muslim Malay* majority. Penalties include up to three years in jail or a fine of 5,000 *Ringgit* (1,880 USD) or both.”<sup>699</sup>
- ★ In East *Java* in 2006, a convert to *Islam*, Yusman Roy, led his small boarding schools in prayers in Bahasa Indonesia rather than exclusively in classical Arabic. He was imprisoned for “spreading hatred,”

<sup>694</sup> El Akkad, Omar & Greg McArthur. “Hateful chatter behind the veil,” theglobeandmail.com, 29 Jun 2006, *JW*.

<sup>695</sup> Rose, Flemming. “Why I Published the *Muhammad* Cartoons,” spiegel.de, 31 May 2006.

<sup>696</sup> Caldwell, Christopher. “After Londonistan,” nytimes.com, 25 Jun 2006.

<sup>697</sup> Sheridan, Michael. “*Bali* battles the *Muslims* who want an Indonesian cover-up,” timesonline.co.uk, 2 Apr 2006.

<sup>698</sup> “*Algeria* bans *Muslims* from learning about Christianity,” arabicnews.com, 21 Mar 2006.

<sup>699</sup> “Jail threatened over *Islam* insults,” Agence France-Presse, news.com.au, 21 Mar 2006.



seemingly an allusion to *K 005:032*.<sup>700</sup> “Animosity toward Roy ran so high that police posted guards to keep an angry mob from torching his house and school.”<sup>701</sup>

- ★ “Sumardi Tappaya, 60, a high school religious teacher on the island of *Sulawesi*, was locked up in January after a **relative** told police he had heard Sumardi whistling while he [Sumardi] prayed. The whistling was declared deviant by the local *Ulemas* and Sumardi is now in jail awaiting trial on charges of religious blasphemy. He faces five years in prison.”<sup>702</sup>
- ★ “Ardhi Husain, 50...ran an *Islamic* center in East Java that treated drug addiction and cancer with traditional medicine and prayer, was sentenced in September to five years in prison for writing a book that the *Ulemas* said contained 70 ‘errors,’ such as claiming that *Muhammad* was not the last prophet and that non-*Muslims* could go to heaven. Five editors of the book also received five-year terms. An employee who sold a copy to a neighbor received three years. After Husain’s arrest, a mob burned down his facility. No one has been arrested in the attack.”<sup>703</sup>
- ★ “Lia Aminuddin, 58...claims to be the Virgin Mary and leads the quasi-*Islamic* God’s Kingdom of Eden cult, was arrested in December [2005] on blasphemy charges after thousands of angry protesters surrounded her headquarters in *Jakarta*, the Indonesian capital.”<sup>704</sup>

When asked why the victims of *Islamist* mobs and arsonists were prosecuted while the *Islamist* perpetrators were not, the vice chairman of the Indonesian Council of *Ulemas* and *Fatwa* committee denied that the *Ulemas* were promoting intolerance, but claimed that “*Muslims* who engage in deviant practices are bringing violence upon themselves.” This would seem to be an allusion to *K 005:032*.<sup>705</sup>

Just as there is a double standard when it comes to murder (in that a *Muslim* may kill a non-*Muslim* with near impunity but the murder of a *Muslim* by a non-*Muslim* is considered a genocide), so there is a double standard when it comes to “spreading corruption in the land.” The *Koran*’s double standard is reflected in *Sharia* law, as Spencer wrote:

*Dhimmis* must not insult *Islam* or *Muhammad* (cf. *'Umdat al-Salik* o11.10(5)), but it nowhere forbids *Muslims* from insulting non-*Muslims*.<sup>706</sup>

For instance, *Muslims* protested the caricatures of *Muhammad* in Danish newspapers during the Cartoon Riots of 2006, though Arab newspapers reprinted the same cartoons. Also, Arab newspapers have printed anti-Semitic cartoons more vile than the Nazis’ cartoons for years, as *Spiegel* notes:

A boom in [*Muslim*] political cartooning took place in the late 1940s, immediately after the 1948 Arab Israeli War, Stav says. The first drawings tended to be crude imitations of cartoons from the *Nazi* propaganda—a Jewish

<sup>700</sup> Sheridan, Michael. “*Bali* battles the *Muslims* who want an Indonesian cover-up,” *timesonline.co.uk*, 2 Apr 2006.

<sup>701</sup> Paddock, Richard C. “Separation of *Mosque*, State Wanes in Indonesia,” *Los Angeles Times*, *latimes.com*, 20 Mar 2006, *DW*.

<sup>702</sup> Paddock, Richard C. “Separation of *Mosque*, State Wanes in Indonesia,” *Los Angeles...Idem*.

<sup>703</sup> Paddock, Richard C. “Separation of *Mosque*, State Wanes in Indonesia,” *Los Angeles...Ibid*.

<sup>704</sup> Paddock, Richard C. “Separation of *Mosque*, State Wanes in Indonesia,” *Los Angeles...Ibid*.

<sup>705</sup> Paddock, Richard C. “Separation of *Mosque*, State Wanes in Indonesia,” *Los Angeles...Ibid*.

<sup>706</sup> Spencer, Robert. “Middle Eastern Media Awash in Anti-Semitism,” *DW*, 13 Feb 2006.

octopus wrapping his tentacles around the globe, for example. But soon, they became more virulent. ‘In the German caricatures,’ Stav says referring to the [Nazi] *Der Stürmer* cartoons, ‘you never saw what they wanted to do to the Jews. But in the Arab caricatures, they show exactly how they want to kill them, murder them and annihilate Israel.’<sup>707</sup>

Many people do not notice or understand the double standard *Muslims* employ. David Ignatius wrote for Lebanon’s *Daily Star*:

I travel often to *Muslim* countries and I am sometimes astonished at how hundreds of years of history can seem condensed into the present, so that **every current injustice** is magnified by the weight of every past one. I don’t understand it but then, I have to remind myself, I’m not a *Muslim*. I haven’t lived it.<sup>708</sup>

Ignatius here unfortunately bought into the politically correct “the straw that broke the camel’s back” explanation used to excuse *Muslims* for their hair-trigger rage. However, what magnifies the offense is the Lamech’s Logic found in *K 005:032*, namely: every murder of a *Muslim* is a genocide of all humankind and every slight against a *Muslim* is an enormity against all 1.2 billion *Muslims*.

A closer analysis of the situation reveals that the Arab Street™ does not protest “**every current injustice**,” as David Ignatius wrote, but only those involving *Islam* in some way. Whenever an infidel hurts a *Muslims*, it automatically becomes a matter of religion, whereas *Sunni-on-Sunni* violence is not a matter of religion.

Because religion is involved whenever there is *Muslim*-infidel interaction, rumor or conspiracy theory is often enough to implicate infidels in the minds of *Muslim*. The chief editor of the Egyptian weekly *Al Fajr* said about the 2006 Cartoon Riots:

The feelings of the *Muslims* are being exploited for some purpose...**Religion** is the easiest thing to use in provoking the people. Egyptians will **never** go out on the street in protest about what happened in the case of the sinking ferry or against [purely political] corruption or this or that.<sup>709</sup>

Similarly in *Iran*, it is not the theocracy itself that riles the people but the corruption of the theocratic system, as Hugh Fitzgerald wrote:

It is the corruption of the *Muslim* clerics that has aroused opposition, but not, among the *Iranian* masses, the *Islamic* basis of the *Islamic Republic of Iran*.<sup>710</sup> *Muslims* feel that the cartoons of *Muhammad* are a religious crime since:

☉ “...*Islam* widely holds that representations of *Muhammad* are banned for fear they could lead to **idolatry**.”<sup>711</sup>

☉ Jordan’s King Abdullah II’s Royal Court judged that reprinting the caricatures of *Muhammad* was “‘**a corruption on earth**’ [K 005:032], which cannot be accepted or excused under any circumstances.”<sup>712</sup>

Only murder of *Muslims* by infidels and “spreading corruption in the land” are magnified a billion-fold by *K 005:032* and protested accordingly, but non-religious

<sup>707</sup> Hawley, Charles. “Middle Eastern Media Awash in Anti-Semitism,” *spiegel.de*, 10 Feb 2006.

<sup>708</sup> Ignatius, David. “Before reconciliation with *Muslims*, things will get worse,” *The Daily Star*, *dailystar.com.lb*, 11 Feb 2006.

<sup>709</sup> Slackman, Michael & Hassan M. Fattah. “Furor Over Cartoons Pits *Muslim* Against *Muslim*,” *nytimes.com*, 22 Feb 2006.

<sup>710</sup> Fitzgerald, Hugh. “Will political power lead to moderation,” *JW*, 27 Feb 2006.

<sup>711</sup> Harris, E. “Nigerian Christians Burn *Muslim* Corpses,” *washingtonpost.com*, 23 Feb 2006.

<sup>712</sup> Slackman, Michael & Hassan M. Fattah. “Furor Over Cartoons Pits *Muslim* Against...” *Ibid*.

crimes such as robbery and political corruption do not constitute a heresy or an assault on *Islam*, so they generally do not inflame the *Muslim* masses.

*Muslims* do not protest against *Muslim* abortions, nor against the genocide of *Muslim* against *Muslim*, such as the slaughter of black *Sunni Muslims* by Arab *Sunni Muslims* in *Sudan*. However, when infidels mistreat *Muslims*, then the magnifying effect of K 005:032 is brought to bear, and then *Muslims* then feel justified in killing infidels indiscriminately. For instance, in 2006, an observant *Iranian Muslim*, Mohammed Reza Taheri-azar, tried to run down nine pedestrians on the University of North Carolina-Chapel Hill campus with the biggest SUV he could rent because he was “**seeking retribution for the treatment of Muslims around the world.**”<sup>713</sup>

In keeping with K 005:032 where “spreading corruption in the land” is considered tantamount to inciting a genocide of humanity, *Muslims* regularly magnify a religious offense a **thousand-**, **million-** or **billion-fold**, and then they feel justified in taking action under *Sharia* law, making death threats, taking mob action, boycotting an entire nation’s products, or committing a terrorist act in order to gain back the honor of, and avenge, a billion+ *Muslims*, for instance:

☉ In 1784, Pierre-Augustin Caron de Beaumarchais complained in his stage comedy “Marriage of Figaro,” that when he penned verse about *Muslim Harems*, an envoy shows up saying he “offended the *Ottoman* empire, *Persia*, a large slice of the *Indian peninsula*, the whole of *Egypt* and the kingdoms of *Barca* [*Ethiopia*], *Tripoli*, *Tunisi*, *Algeria* and *Morocco.*”<sup>714</sup>

☉ In 2004, Iqbal Sacranie of the *Muslim Council of Britain* said that “any defamation of the character of the prophet *Muhammad* (Peace Be Upon Him)” is a “direct insult and abuse of the *Muslim community.*”<sup>715</sup>

☉ In 2005, after several *Korans* had been desecrated at the *Guantanamo* jail in *Cuba*, the Grand *Ayatollah* Fazel Lankarani of *Iran* wrote:

...the American soldiers have hurt the feelings of a **billion Muslims** and followers of **all** divine religions across the world.<sup>716</sup>

☉ In 2006, when a few Jewish settlers allegedly spray painted a *Mosque* in the town of *Qalqilyah* in the *West Bank* with graffiti that equated *Muhammad* with a pig, a riot erupted that hurt four people. *Israeli Arab Muslim Knesset* parliament member Ahmed Tibi said “the incident marked a **grave moral escalation** and an attempt by settlers to flare the ground [i.e. light a bonfire] by hurting the beliefs of **millions** of *Muslims.*”<sup>717</sup>

☉ The Cartoon Riots of 2006 occurred after an obscure right-wing Danish newspaper published twelve relatively tame caricatures of *Muhammad*. The paper likely had only a few *Muslim* subscribers, yet the offense was magnified as if all *Muslims* had been personally insulted:

★ In *Jiddah* (near *Mekka*) in 2006, Ekmeleddin Ihsanoglu, head of the Organization of the *Islamic Conference* (OIC), compared the publication

<sup>713</sup> Rupinta, Amber. “Sources: Possible link to terrorism, WTVD, abc11tv.com, 3 Mar 2006, *JW*.”

<sup>714</sup> From the famous “Freedom of Speech” monologue in Act V, Scene 3 (source: Warraq, Ibn. “Since they can’t stop a man thinking, they take it out on his hide instead,” *JW*, 3 Feb 2006).

<sup>715</sup> Moore, Charles. “Is it only Mr Bean who resists this new religious intolerance?”

telegraph.co.uk, 11 Dec 2004, *LGF*, 12 Dec 2004.

<sup>716</sup> “Grand *Ayatollah* Fazel Lankarani’s Statement on the Desecration of the Holy *Quran* by American Soldiers,” Lankarani.org, 16 May 2005.

<sup>717</sup> Harel, Amos. “Four hurt in West Bank clashes over graffiti slurring Mohammed,” haaretz.com, 12 Feb 2006.

of the twelve cartoons of *Muhammad* to a “September 11, 2001 attack on the United States” in which three **thousand** people died.<sup>718</sup>

- ★ In Denmark, *Imam Abu Laban* said “We want to internationalize this issue so that the Danish government will realize that the cartoons were insulting, not only to *Muslims* in Denmark but also to *Muslims* worldwide.”<sup>719</sup>
- ★ “*Muslim* ambassadors to Norway blasted Carl I. Hagen in a letter to the newspaper *Aftenposten*, claiming that he had offended 1.3 billion *Muslims* around the world.”<sup>720</sup>
- ★ In France, *Muslim* protesters carried signs saying “You have insulted **1.3 billion Muslims**” and “Our faith is stronger than your pen.”<sup>721</sup>
- ★ In *Bahrain*, the Chamber of Commerce and Industry said the cartoons were a “campaign aimed at defaming The Prophet...flagrantly hurt[ing] the feelings of a **billion** of *Muslims* all over the globe.”<sup>722</sup>
- ★ The *Afghan* Foreign Minister Abdullah said:  
As a *Muslim* country and as a *Muslim* man we consider the act an insult to **millions** of people in the world...<sup>723</sup>
- ★ When a California company printed T-shirts featuring the *Muhammad* cartoon, a typical email was: “What you are doing is offending more than a **billion** people in the world.”<sup>724</sup>
- ★ Tawakkul Karman, head of Women Journalists Without Constraints in *Sana, Yemen*, lamented that, during the Cartoon controversy, the extremists have “made it so that if you stand up in this tidal wave, you have to face **1.5 billion Muslims**.”<sup>725</sup>

When slights are magnified a billion-fold into an offense against all *Muslims*, or an attempted genocide against all *Muslims*, this tends to rile even many **moderate Muslims**, for instance:

- ★ During the Cartoon Riots of 2006, *Pakistani* President Musharraf, himself a moderate *Muslim*, said:

The **most moderate Muslim** will go to the street and talk against it because this hurts the sentiments of **every Muslim**...Whether an extremist or a moderate or an ultra-moderate, we will condemn it.<sup>726</sup>

- ★ In 2006, *Sheikh Yusuf Al-Qaradawi* called for “an international day of rage” to protest the *Muhammad* cartoons. Qaradawi is the head of the International Association of *Muslim* Scholars, the European Council for *Fatwa* & Research, and also a “telekoranist” for *Al-Jazeera*. The protests resulted in over a dozen deaths and much property damage. Ironically, London mayor

<sup>718</sup> “EU’s Solana tries to ease cartoons crisis on Mideast trip,” news.yahoo.com, 14 Feb 2006, *JW*.

<sup>719</sup> “When Danes Pay Danegeld: The End of the Scandinavian Model,” *DW*, 17 Mar 2006.

<sup>720</sup> “When Danes Pay Danegeld: The End of the Scandinavian Model,” *DW*, 17 Mar 2006.

<sup>721</sup> “Thousands march in France to protest Prophet cartoons, webindia123.com, 12 Feb 2006.

<sup>722</sup> *Al-Alaya’a*, Zaid. “*Yemen Joins Muslim World to Denounce Danish Abuse against the Prophet*,” *Yemen Observer*, yobserver.com, 2 Feb 2006, vol. ix, issue 04.

<sup>723</sup> “Afghanistan flays Danish publication about *Muslim* prophet,” xinhuanet.com, 2 Feb 2006, *DW*.

<sup>724</sup> “Hate Mail and Death Threats Target Seller of Mohammed Cartoon T-shirts,” news.yahoo.com, 21 Feb 2006.

<sup>725</sup> Slackman, Michael & Hassan M. Fattah. “Furor Over Cartoons Pits *Muslim* Against *Muslim*,” nytimes.com, 22 Feb 2006.

<sup>726</sup> “Tear gas fired at 7,000 protesting cartoons,” msnbc.msn.com, 13 Feb 2006.

Ken Livingstone had praised Qaradawi for being “a beacon of **‘moderation.’**”<sup>727</sup>

- Ⓒ In *Iraq*, Ayatollah Sistani, whom some US journalists wanted to nominate for a Nobel Peace Prize,<sup>728</sup> said that the Danes’ publishing caricatures of *Muhammad* in 2006 was a “**‘horrific action.’**”<sup>729</sup> For some context, note that Sistani says “sodomites should be killed in the worst manner possible,”<sup>730</sup> and in 2006 it was reported that *Badr* Corps death squads have been carrying out Sistani’s prescription in a “sexual cleansing of Iraq.”<sup>731</sup>
- Ⓒ Walid el-Sallab, 23, the student-union president of the comparatively **liberal American University in Cairo** led a rally against the cartoons in 2006 and said:

The word *Islam* is derived from peace. You cannot just go and attack people... But honestly, I feel that if I were to see the Danish Prime Minister, I might kill him myself without thinking.<sup>732</sup>

- Ⓒ Adel Hamouda, 55, the editor of *al-Fagr*, a **liberal Cairo**-based weekly that ran the cartoons in late 2005, said in early 2006:

We attacked the cartoons and said that this deepens the culture clash and does not resolve it.<sup>733</sup>

- Ⓒ Bernard Freamon, a *Muslim* professor at the Catholic Seton Hall University Law School in New Jersey, USA, and a writer on *Islamic* jurisprudence and *Islamic* legal history, wanted the Danish editors of the *Jyllands-Posten* newspaper prosecuted under EU. or Danish hate-speech laws. Seemingly under the influence of *K* 005:032, he magnified the twelve tame cartoons of *Muhammad* into the first indications of a coming genocide. Freamon wrote:

Danish prosecutors certainly must know Denmark is becoming a hotbed of skinheadism and anti-*Muslim* and anti-immigrant violence. Do they want their newspapers to fan these flames? They should not wait until they have a situation like that in *Rwanda* before they act.<sup>734</sup>

Many so-called **moderate Muslims** will criticize *Muslims* or *Islam* but then “cannot bear to allow it to be criticized” by infidels.<sup>735</sup> Some have speculated that this double standard is caused by filial piety felt for *Muslim* family and ancestors, or by loyalty for one’s cultural heritage, or embarrassment about what *Islam* teaches.<sup>736</sup>

This double standard is in fact consistent with *K* 005:032 where criticism by a *Muslim* of *Islam* may just be criticism, but criticism by infidels is magnified into “spreading corruption in the land,” “blocking the spread of *Islam*,” or even “aggression against *Islam*.”<sup>737</sup> That this is the case is why *Dhimmi* artists were not to

<sup>727</sup> Fleming, John V. “First Amendment Riots, er, Rights,” *dailyprincetonian.com*, 6 Feb 2006.

<sup>728</sup> “Sistani: ‘Sodomites should be killed in the worst manner possible,’” *DW*, 18 Mar 2006.

<sup>729</sup> “Window on the Week,” *nationalreview.com*, 10 Feb 2006, *DW*.

<sup>730</sup> “Iraqi cleric wants gays killed in ‘most severe way,’” *loogoonline.com*, 16 Mar 2006, *DW*.

<sup>731</sup> “Death squads targeting gays in *Iraq*,” *advocate.com*, 25-27 Mar 2006, *DW*, 6 Apr 2006.

<sup>732</sup> Ratnesar, Romesh. “Fanning the Flames,” *time.com*, 12 Feb 2006.

<sup>733</sup> Ratnesar, Romesh. “Fanning the Flames,” *time.com*, 12 Feb 2006.

<sup>734</sup> “A Danish Trojan Horse: Law and the *Muhammad* Cartoons,” *Jurist Legal New & Opinion*, *jurist.law.pitt.edu*, 19 Feb 2006, *JW*.

<sup>735</sup> Fitzgerald, Hugh. “Moderates still elusive,” *DW*, 25 Jan 2006.

<sup>736</sup> Fitzgerald, Hugh. “The five most dangerous words with regard to *Muslim* immigration to the West,” *DW*, 14 Dec 2005.

<sup>737</sup> Fitzgerald, Hugh. “A few suggestions for John Howard,” *DW*, 21 Feb 2006.

draw *Muhammad*, and “the *Dhimmi* is obliged not to [even] mention *Allah* or His Apostle...”<sup>738</sup>

Criticism of a *Muslim* or *Islam* by a non-*Muslim* is so grievous, according to *K* 005:032, that even many moderate *Muslims* cannot tolerate it. A moderate *Muslim* may criticize *Islam* himself but for a non-*Muslim* to subsequently criticize *Islam*—even in the same conversation—is another matter altogether!

An example of a moderate *Muslim* criticizing *Islam* but then going on a killing spree when an infidel criticizes *Islam* is Jordanian Raed Mansour *Al-Banna*. When he worked in the US on a visa for a few years, he was a “party animal” and a “bad boy” who womanized, drank, rode motorcycles, and was fond of “the grunge sound of Nirvana” rock band. *Al-Banna* “openly expressed his hatred for Osama bin Laden and *Al Qaeda*.” However, “one morning...an angry *Al-Banna* yelled at a co-worker he thought was defaming *Islam* and threatened to kill him.”<sup>739</sup> Eventually *Al-Banna* went back to the Mideast and killed 179 *Iraqis* in a suicide-bombing that failed to kill any Americans—no doubt his goal.

Because *Muslims* exaggerate a non-*Muslim*’s slight or crime against *Muslims* by saying that **all** *Muslims* or *Islam* or all humanity are victims instead of just one or two *Muslims*: 1) the slight because a capital offense and 2) other non-*Muslims* who had nothing to do with the slight or crime are implicated in the crime. Thus many *Muslims* feel that it is right that the West suffer terrorism over the deeds of individuals, and that the free speech and free press rights of billions are repressed over the speech of a few individuals, for instance:

- ☉ The *Sufi* leader Sultanhussein Tabandeh wrote in 1966 *A Muslim Commentary on the Universal Declaration of Human Rights*:

Since *Islam* regards non-*Muslims* as on a lower level of belief and conviction, if a *Muslim* kills a non-*Muslim*...then his punishment must not be the retaliatory death, since the faith and conviction he possesses is loftier than that of the man slain...Again, the penalties of a non-*Muslim* guilty of fornication with a *Muslim* woman are augmented because in addition to the crime against morality, social duty and religion, he has committed sacrilege in that he has disgraced a *Muslim* and thereby cast scorn upon the *Muslims* **in general**, and so must be executed.<sup>740</sup>

- ☉ In 2005, after several *Korans* had been desecrated at the *Guantanamo* jail in *Cuba*, the Grand *Ayatollah* Fazel Lankarani of *Iran* wrote:

The Holy *Koran* is the greatest of all books and the most perfect of them. In fact, desecration of the *Quran* is desecration of **all** divine books. Praise belongs to *Allah*; the zealous *Muslims* across the world have reacted strongly but it is necessary that they show their deep hatred and disgust at the criminal US government.<sup>741</sup>

Since the punishment must fit the magnitude of the crime against “all divine books,” note how the entire US government is implicated and targeted over the acts of a few prison guards.

<sup>738</sup> Bostom, Andrew G. “Confused *Islamic* Apologetics,” *FPM*, 10 Aug 2004.

<sup>739</sup> Reza, H.G. “Unlikely Candidate for Car Bomber,” *Los Angeles Times*, latimes.com, 15 Apr 2006, *JW*.

<sup>740</sup> Bostom, Andrew G. “Confused *Islamic* Apologetics,” *FPM*, 10 Aug 2004.

<sup>741</sup> “Grand *Ayatollah* Fazel Lankarani’s Statement on the Desecration of the Holy *Quran* by American Soldiers,” lankarani.org, 16 May 2005.

☉ In 2006, Abdelwahab El-Affendi, a senior research fellow at University of Westminster, London, said: “The very idea of giving Rushdie a literary prize after his book *Satanic Verses* was like offering Hitler the Nobel Peace Prize after *Auschwitz*.” El-Affendi also said the mild-mannered Danish editors and cartoonists who drew and published the cartoons had an “**active hate of the bitterest kind**.”<sup>742</sup>

☉ In 2006, when students at the University of California-Irvine campus displayed the tame *Muhammad* cartoons, the Associated Press reported that Osman Umarji, former president of the *Muslim* Student Union, said:

The agenda is to spread *Islamophobia* and create hysteria against *Muslims similar to what happened to the Jews in Nazi Germany*.<sup>743</sup>

☉ In 2006 when a Danish newspaper printed 12 caricatures of *Muhammad*:

★ *Iranian* President Ahmadinejad said the simple act of drawing *Muhammad* caricatures was “an affront to the worship of God and to the seeking of truth and justice, and an affront to **all** the prophets of God” and such. Upon hearing the exaggerated rhetoric the crowd responded with “Death to Denmark!” repeatedly.<sup>744</sup>

★ *Imam* Ibrahim Dremali from Des Moines *Islamic* Center in Iowa, USA stated:

It is an insult to the prophet, God, *Muslims*, *Islam*, the *Quran* and **all** humanity.<sup>745</sup>

Since the punishment naturally must fit the magnitude of the crime, all Danish citizens are now considered terrorist targets.

☉ In 2006, Ladi Mohammed, a Christian (*sic*) from the *Zuru* tribe attended a nursing school in *Sokoto*. “Due to misunderstanding between two female students,” Ladi was accused of making a “misguided and derogatory statement against *Islam*.” “The militants...threatened to cut off her head,” so Ladi was “whisked away from the school premises to save her from being lynched.” Since the punishment must fit the magnitude of the crime, the other Christian students are “living in fear of being attacked by the militant *Muslim* students,” the school closed temporarily and the state had to provide extra security for the school.<sup>746</sup>

☉ In 2006, journalists who criticized the clerical regime were jailed on the charge of “insulting *Islamic* values.”<sup>747</sup>

The fact that any offense of non-*Muslims* against a *Muslims* is magnified a billion+ times explains why:

☉ In the past, *Muslims* felt justified in exacting revenge on an entire *Dhimmi* community over a perceived slight or alleged crime of a single perpetrator. Andrew Bostom wrote that in *Muslim* Spain...

<sup>742</sup> El-Affendi, Abdelwahab. “Democratic solution for cartoons controversy,” aljazeera.net, 27 Feb 2006, The Jawa Report, mypetjawa.mu.nu.

<sup>743</sup> “Calif. Campus in Uproar Over *Muslim* Cartoons,” foxnews.com, 1 Mar 2006, *JW*.

<sup>744</sup> “*Iranian* President Mahmoud Ahmadinejad: The Real Holocaust Is in Palestine and *Iraq*,” memritv.org, Clip No. 1034, 11 Feb 2006, The Jawa Report, mypetjawa.mu.nu.

<sup>745</sup> Campbell, Lynn & Shirley Ragsdale. “*Muslims* condemn cartoon-sparked violence,” desmoinesregister.com, 7 Feb 2006, mychristianblood.blogspot.com

<sup>746</sup> “*Nigeria Muslim* Militants ‘Kidnap’ Christian Student,” bosnewslife.com, 15 Feb 2006, *JW*.

<sup>747</sup> “Two jailed *Iranian* reporters await press trial,” news.yahoo.com, 18 Feb 2006, *C&R*.

...harsh reprisals with mutilations and crucifixions would sanction the *Mozarab* (Christian *Dhimmi*) calls for help from the Christian kings. Moreover, if one *Dhimmi* harmed a *Muslim*, the whole community would lose its status of protection, leaving it open to pillage, enslavement and arbitrary killing.<sup>748</sup>

- ☉ Today, minorities in *Muslim* countries suffer similar to the way *Dhimmis* did in the past. For instance, on 21 Feb 2006, the President of the Christian Association of Nigeria wrote:

We have for a long time now watched helplessly the killing, maiming and destruction of Christians and their property by *Muslim* fanatics and fundamentalists at the slightest or no provocation at all.<sup>749</sup>

That same day, 21 Feb 2006, a rumor spread that a teacher desecrated a *Koran*. *Muslim* youth then took to the streets of *Bauchi* in northern *Nigeria*, burned down two churches and murdered thirteen with machetes.<sup>750</sup>

- ☉ In 2006, all Danish products were boycotted though only one Danish newspaper ran a dozen *Muhammad* cartoons.

Magnifying any offense by any non-*Muslim* constitutes propaganda that produces outrage in *Muslims*—outrage that fuels *Jihad*, terrorism and ethnic cleansing.

Magnifying an offense only on the part of an infidel, but never on the part of a *Muslim*, explains why *Muslims* practice a double standard when it comes to tolerating or not tolerating conduct such as critiquing *Islam*, as *Ibn Warraq* noted:

We notice the double standards inherent in all such *Muslim* demands. While *Muslims* feel free to insult Christianity [with impunity], they themselves go into paroxysms [i.e. tantrums] of rage and violence at the slightest hint of criticism of *Islam*, which must be ‘accepted uncritically as divine revelation by non-*Muslims* as well as by *Muslims*, and this must be reflected in the structure and conduct of the state and of society.’<sup>751</sup>

### *Magnifying the Killing of a Muslim Into a Genocide*

*Muhammad* said that *Allah* prescribed that whenever an infidel killed a believer, i.e. a *Muslim*, the act was as heinous in *Allah*’s eyes as though all of humanity had just been murdered (*K* 005:032). By contrast, if a *Muslim* killed an infidel, no retaliation is called for since *Muhammad* commanded *Muslims* to kill pagans (*K* 009:005).

In the *Madinan* Covenant between *Muslims* and Jews, *Muhammad* specified that a murderers’ whole household could be put to death—thereby magnifying the crime:

He who slays a man without warning slays himself and his household, unless it be one who has wronged him, for God will accept that.<sup>752</sup>

By default, it is usually presumed in *Islamdom* that when a *Muslim* kills an infidel, it is to avenge the death of a *Muslim*, or because the infidel was spreading corruption in the land (*K* 005:032) but whatever the case, *Muhammad* decreed that:

<sup>748</sup> Bostom, Andrew G. “Confused *Islamic* Apologetics,” *FPM*, 10 Aug 2004.

<sup>749</sup> “Reaction of the President of the Christian Association of Nigeria...on recent events in Nigeria,” [anglicancommunion.org](http://anglicancommunion.org), 21 Feb 2006, *History News Network*, [hnn.us](http://hnn.us).

<sup>750</sup> Curfew after third Nigerian riot,” [news.bbc.co.uk](http://news.bbc.co.uk), 21 Feb 2006, [gatewaypundit, blogspot.com](http://gatewaypundit.blogspot.com).

<sup>751</sup> Warraq. *Why*, p. 353.

<sup>752</sup> Ishaq. *Sirat*, p. 233.



No *Muslim* should be killed [suffer the death penalty] in *Kisas* (equality of judgment) for killing a *Kafir* [an infidel] (*Hadith Sahih Al Bukhari*, vol. 9, bk. 83, no. 50; also vol. 1, bk. 3, no. 111).

Furthermore, *Muslim* theologians ruled that even a *Muslim* who slays infidel women and infants “invites no censure,”<sup>753</sup> because “that which protects (namely, *Islam*) does not exist in them [i.e. infidels].”<sup>754</sup> Unless they pay the *Jizya* tax (*K* 009:029), there is no theological deterrent against *Muslims* killing Jews and Christians since they are not under *Allah*’s protection (*K* 002:120; 007:196; 013:037).

*Muhammad* and *Koran* commentators have always interpreted *K* 005:032 in favor of *Muslims* exclusively. Abul Kasem wrote that Kathir opined in his commentary on *K* 005:032 that “Saving life in this case occurs by not killing a soul that *Allah* has forbidden.” *Allah* only forbade the killing of *Muslims* but says to fight and kill non-*Muslims* (*K* 009:005, 029). Kathir then quotes other authorities who in turn cite traditions, and they are even more specific in interpreting *K* 005:032 as only applying to *Muslims*:

He who allows himself to shed the blood of a *Muslim*, is like he who allows shedding the blood of **all** people. He who forbids shedding the blood of one *Muslim*, is like he who forbids shedding the blood of all people...He who kills a **believing** soul intentionally...

Abul Kasem concluded:

This *Tafsir* [commentary] by Kathir says when a *Muslim* is killed it is as if the entire humanity is killed. When an infidel is killed, it has no relevance. Similarly, when a believer’s (i.e. a *Muslim*’s) life is saved it is as if the entire humanity is saved. You see, in *Koran* and in *Islam*, what matters most is the lives of *Muslims* and not the lives of infidels.<sup>755</sup>

The reason that *Muhammad* mentions that *Allah* “prescribed this law for the children of *Israel*” was to make clear that *Allah* saw only the murder of *Muslims* by non-*Muslims* as being so utterly heinous that it was as though they murdered all of humanity, but the reverse—where a *Muslim* kills a non-*Muslim*—is of no consequence.

One should not get the idea that the phrase “children of *Israel*” in *K* 005:032 means *Muhammad* thought this “prescription”: 1) had ended long ago, 2) been abrogated or 3) only applied to Jews, since the *Hadiths* disclose that *K* 005:032 was revealed and applied to the Arab *Uraynah* clan of eight. They were pagan until they converted to *Islam*, but then they killed a *Muslim* and apostatized back to paganism (all of which is discussed later in this section).

Since killing a *Muslim* was so heinous—like the killing of all humanity—*Muhammad* thought each *Muslim* ought to be avenged multiple times over, as will be discussed later in this section. This is how *Islamic* jurists and *Islamists* think, as when Omar Bakri alluded to *K* 005:032 when he said:

The toe of the *Muslim* brothers is better than all the *Kuffar* on the earth...*Islam* is superior, nothing supersedes it and the *Muslim* is superior.<sup>756</sup>

*Al-Qaeda* thinks the same way regarding *K* 005:032:

<sup>753</sup> Goel. *Calcutta*, ch. 4, as quoted from ch. 2 of the *Hidayah* treatise compiled by *Shaykh* Burhan-ud-din Ali (flourished 12th century AD).

<sup>754</sup> Hughes. *Dictionary*, p. 245, right column, *Jihad* entry.

<sup>755</sup> Kasem, Abul. “Deciphering an American *Fatwa*,” [faithfreedom.org](http://faithfreedom.org), 8 Aug 2005.

<sup>756</sup> “Focus: Undercover in the academy of hatred,” [timesonline.co.uk](http://timesonline.co.uk), 7 Aug 2005, *DP*.

The basics of our faith revolve around not harming true *Muslims* and not shedding one single drop of *Muslim* blood because one drop of true *Muslim* blood shed amounts to the demise of this whole world [an allusion to *K* 005:032].<sup>757</sup>

*Bin Laden* alluded to *K* 005:032 when he commented on *Pallywood's* video on *Muhammad al Durah*, where Palestinians faked a video that purportedly showed *Israeli* soldiers firing rifles and killing a Palestinian boy in a hail of bullets:

...in killing this boy the Israelis killed every child in the world.<sup>758</sup>

That *Al-Qaeda* values *Muslim* lives more than infidel lives, based on *K* 005:032, is why “the *Al-Qaeda* terrorist organization demanded the death of two Christians in retaliation for every *Muslim* killed in the US military strikes in Afghanistan.”<sup>759</sup> It also explains why *Al-Qaeda* is unapologetic about being so cold and ruthless, as No wonder Defense Secretary Donald H. Rumsfeld stated:

The *Al-Qaeda* terrorist network and affiliated *Islamic* extremists represent one of the most brutal enemies the United States has ever seen. They currently lack only the means—not the desire—to kill, murder millions of innocent people with weapons vastly more powerful than boarding passes and box cutters.<sup>760</sup>

*Islamists* in *Pakistan* believe as *Muhammad* did regarding *K* 005:032 (i.e. killing a lone *Muslim* is as bad as the murder of all of humanity) since during a “Cartoon” protest in 2006, politician Maulana Fazal-ur Rahman, said:

America is the killer of **humanity**, and we will keep raising our voice against it and its supporter (*Pakistani* President Musharraf).<sup>761</sup>

*Islamists* in Holland also believe as *Muhammad* did regarding *K* 005:032 since *Muhammad* Bouyeri, the killer of moviemaker Theo van Gogh, said during his trial:

‘Kill them, and *Allah* will help you and guide your hand [allusion to *K* 009:014],’ Bouyeri said. ‘There’s no room there for doubt or interpretation there.’ He said that killing one innocent *Muslim* is morally equivalent to killing all *Muslims* [i.e., *K* 005:032] and then remarked in English, ‘that’s for your administration, Uncle Bush,’ in an apparent reference to the US President.<sup>762</sup>

That *Muslims* generally believe as *Muhammad* did regarding *K* 005:032 (i.e. killing a lone *Muslim* is as bad as murdering all of humanity) can be seen by how after so many people have been killed by *Islamic* terrorists, yet:

☪ *Iraqi Islamic* Party said that *Islam* image was still “clear white”!<sup>763</sup>

☪ An Egyptian *Muslim* Brotherhood member of parliament, Ragab Hilal Hamida, said the *Koran* encourages terrorism, yet: “*Islam* does not need improvement of its image.”<sup>764</sup>

☪ In November 1995 American Adam Yahiyeh Gadahn said he converted to *Islam* because “I knew well that they were not the bloodthirsty, barbaric

<sup>757</sup> Nasr, Octavia. “*Al Qaeda* in *Iraq* issues virulent manifesto: Group calls for violence, destruction of ‘American empire,’” *cnn.com*, 26 Aug 2005, C&R.

<sup>758</sup> “Muhammed al Durah, a *Pallywood* Fake?,” *seconddraft.org*, 16 Dec 2005, *DW*.

<sup>759</sup> Baker, Barbara G. “Christmas Season Tense for *Pakistan's* Christians: Separate murders follow *Bahawalpur* massacre,” *christianitytoday.com*, 7 Dec 2001.

<sup>760</sup> Rumsfeld: *Al-Qaida* may be ‘most brutal’ enemy,” *msnbc.com*, 27 Mar 2006.

<sup>761</sup> Ahmad, Munir. “Cartoon protesters defy rally ban,” *seattlepi.nwsource.com*, 24 Feb 2006, *JW*.

<sup>762</sup> “Van Gogh killer begins presenting own defense in new terrorism case,” *Asharq Alawsat Newspaper*, *asharqalawsat.com*, 2 Feb 2006, *JW*.

<sup>763</sup> “Kidnap envoy meeting *Iraqi Sunnis*,” *news.bbc.co.uk*, 4 Dec 2005, *DW*.

<sup>764</sup> “Egyptian *Muslim* Brotherhood MPs,” *MEMRI*, 10 Mar 2006, Special Dispatch No. 1110, *JW*.

terrorists that the news media and the televangelists paint them to be,” yet in 1998 apparently went to join the *Taliban* in *Afghanistan*, and by 2004 he started solo-appearances in *Al-Qaeda* videos as Azzam the American.<sup>765</sup>

- C *Muslims* believe *Islam* really is a Religion of Peace™ despite appearances because all terrorism and *Jihad* are precipitated by infidels’ resistance to *Dawa* evangelism, as contemporary scholar Bassam Tibi wrote:

Unbelievers who stand in the way, creating obstacles for the *Da’wa*, are blamed for this state of war, for the *Da’wa* can be pursued peacefully if others submit to it. In other words, those who resist *Islam* cause wars and are responsible for them.<sup>766</sup>

*Muslims* in the Mideast generally believe as *Muhammad* did regarding *K 005:032* since, as *The Jerusalem Post* editors wrote:

It is hard to imagine a people for whom blowing oneself up in a crowd of innocents is not considered an act of barbarism. Yet it is hard to escape the impression that the Palestinians, even today, remain such a people....suicide bombings were officially and unofficially lionized by Palestinian society...the Palestinian refusal to break with terrorism is not just an assertion of a right to oppose *Israel* but an expression of the true objective of that struggle. Put simply, genocidal means are an inseparable sign of genocidal ends. The notion that Palestinians arrogate to themselves the right to impose and execute a death sentence on any and every *Israeli* man, woman and child says to us that, in Palestinian eyes, we have no right to exist. What the president of *Iran* and the leaders of *Hamas*, *Islamic Jihad* and *Hizbullah* say openly—that *Israel* should be ‘wiped off the map’—the terror attacks clearly attempt to put into practice. [Even moderate *Muslims*] cannot muster the slightest objection to terrorism in principle, not just in practice [and there is a] common moral Palestinian acceptance of terror against *Israel*.<sup>767</sup>

The *Iranian Mullahs* and *Iran’s* president Mahmoud Ahmadinejad believe as *Muhammad* did regarding *K 005:032* (i.e. killing a lone *Muslim* is as bad as murdering all of humanity) since the genocidal “Death to America” and “Death to Israel” chants are heard there all time. In 2006 president Ahmadinejad said:

If the Zionist regime commits another stupid move and attacks Syria, this will be considered **like attacking the whole Islamic world** and this regime will receive a very fierce response.<sup>768</sup>

Robert Spencer said his “remark appears as a more forthright use of *K 005:032*.”<sup>769</sup>

*Muslims* in Germany believe as *Muhammad* did regarding *K 005:032* since in 2006 *Muslims* in Berlin chanted “Death to Israel.”<sup>770</sup> Moreover, many Muslim Berliners are unsympathetic whenever American soldiers or even civilians are killed. After 9/11, *Muslims* in the *Neukölln* and *Kreuzberg* suburbs set off bottle rockets out of joy.<sup>771</sup> Seyran Ates, who grew up as a *Muslim* in Germany says:

<sup>765</sup> “Adam Yahiye Gadahn,” wikipedia.org; “*Al Qaeda* Terrorist’s Essay at USC,” *LGF*, 9 Jul 2006.

<sup>766</sup> Bostom, Andrew G. “Confused *Islamic* Apologetics,” *FPM*, 10 Aug 2004.

<sup>767</sup> “An absence of morality,” *jpost.com*, 5 Dec 2005.

<sup>768</sup> “*Iran* warns *Israel* not to attack Syria,” *uk.news.yahoo.com*, 13 Jul 2006, *JW*.

<sup>769</sup> “Israeli strike on Syria would be like attack on entire *Islamic* world,” *JW*, 13 Jul 2006.

<sup>770</sup> Ben, Yitzhak. “War in north: Support in New York, condemnation in Berlin,” *ynetnews.com*, 17 Jul 2006.

<sup>771</sup> Schneider, Peter. “The New Berlin Wall,” translated by Philip Boehm, *nytimes*, 4 Dec 2005.

The [7/7] attacks in London were in the eyes of many *Muslims* a successful slap in the face to the Western community. The next perpetrators will be children of the third and fourth immigrant generation, who—under the eyes of well-meaning politicians—will be brought up from birth to hate Western society. It's only a question of time before Berlin experiences attacks like those in London and *Madrid*.<sup>772</sup>

*Muslims* in Denmark and *Pakistan* believe as *Muhammad* did regarding K 005:032 (i.e. killing a lone *Muslim* is as bad as murdering all of humanity). Rogier van Bakel points out that when the novel *The Satanic Verses* was published, only the author Salman Rushdie and the translators were targeted. By contrast, when a Danish newspaper printed twelve tame caricatures of *Muhammad*, all Danes came under threat.<sup>773</sup> Denmark's foreign ministry in *Pakistan* warned...

...Danes not to visit the country, given that the *Jyllands-Posten* cartoons were 'seen by many *Muslims* as derogatory and blasphemous' [and terrorists] could make do with a scapegoat.<sup>774</sup>

The difference between the situations described above is Rushdie was a *Muslim* while the twelve cartoonists were infidels. Due to *Muhammad's* inflation of a *Muslim's* worth and his devaluation of an infidel's worth (K 005:032-033), blasphemy by infidels occasions genocidal impulses against many infidels, but blasphemy by a *Muslim* occasions only murderous threats against the one offender.

Jordanian *Muslims* think the same way regarding K 005:032. Seventy percent of Jordanian *Muslims* approved of suicide-bombings in 2004, but just 49 percent in mid-2005.<sup>775</sup> The decline is attributable to the fact that during this period, suicide bombings have mostly taken *Muslim* lives. The reason is that Israelis and Coalition forces in *Iraq* have taken measures to protect themselves, include security fences and walls, armored vehicles, body armor and other technology.

Anecdotal evidence says support for suicide-bombings in Jordan dropped further in late-2005 when three "*Al-Qaeda* in *Iraq*" (an *Al-Qaeda* franchisee) suicide bombers killed 58 *Sunnis* in Jordan. Only then did *Abu Musab Al-Zarqawi's* tribe in Jordan disown him and the tribe's new slogan became: "If my son was a terrorist, I wouldn't hesitate to kill him."<sup>776</sup> Thus *Muslims* sing a different tune when *Muslims* rather than infidels are killed.

The "progressive" Young Turk who wrote the following paragraph in 1912 obviously thinks the same way regarding K 005:032 in that the human worth of someone "who spreads corruption in the land" is degraded by that corruption, whether it be moral or doctrinal "corruption," as *Sheik Abd-ul-Hack* wrote:

The Mussulman religion is in open hostility to all your world of progress. Understand, you European observers, that a Christian, whatever his position may be, by the mere fact of his being a Christian is regarded by us as a blind man lost to all sense of human dignity. Our reasoning with regard to him is as simple as it is definitive. We say: the man whose judgment is so perverted as to deny the existence of a one and only God and to make up gods of different sorts, can only

<sup>772</sup> Schneider, Peter. "The New Berlin Wall," translated by Philip Boehm, nytimes, 4 Dec 2005.

<sup>773</sup> Van Bakel, Rogier. "Far Beyond Rushdie," *Nobody's Business*, bakelblog.com, 5 Dec 2005.

<sup>774</sup> "Demonstrations in *Pakistan* have escalated into death threats against Danish illustrators who drew pictures of the prophet Mohammed," *The Copenhagen Post*, cphpost.dk, 2 Dec 2005, C&R.

<sup>775</sup> "Islamic Extremism: Common Concern for *Muslim* and Western Publics: Support for Terror Wanes Among *Muslim* Publics," pewglobal.org, 14 Jul 2005.

<sup>776</sup> "*Al-Khalayleh* tribe disowns *al-Zarqawi*," jpost.com, 20 Nov 2005.

be the meanest expression of human degradation; to speak to him would be a humiliation for our intelligence and an insult to the grandeur of the Master of the Universe. The presence of such miscreants among us is the bane of our existence; their doctrine is a direct insult to the purity of our faith; contact with them is a defilement of our bodies; any relation with them a torture to our souls.<sup>777</sup>

Many Indonesian *Muslims* think the same way regarding K 005:032 in that the death of someone “who spreads corruption in the land” is of no concern to *Muslims*, as Simon Kearney reported:

Khozin does not believe that Westerners and *Muslims* can live side by side while Westerners continue to believe, for example, in allowing women to wear bikinis at the beach and to drink alcohol. It is a ‘morality war’ brought on by Australians and Westerners in general refusing to respect his culture....He considers the *Muslims* who died [suicide-bombers] as martyrs; he says the Westerners who died are **not his concern because they were unbelievers.**<sup>778</sup>

The *Islamic* teaching of the great worth of *Muslims* and the utter devaluation of non-*Muslims*, based on K 005:032, is integral in the conditioning of *Islamic* suicide-bombers. Researchers write:

These people do not do it out of hate: they do it more out of love for their own group. They are doing it because they believe they are doing good for their people. They are usually fully compassionate people. I never came across one that was a real nutcase...According to Philadelphia-based psychiatrist and former Central Intelligence Agency member Marc Sageman ‘the key is the group. What is outside the group does not really count, they do not really think about it. Whether it is soldiers or people drinking in a bar it is the same thing.’<sup>779</sup>

Due to K 005:032 and its hyper-valuation of *Muslims* and devaluation of infidels, whenever a *Muslim* is killed, *Muslims* automatically think that others are at fault. Not only does a worthless person killing a worthy person not make any sense in the *Islamic* economy of thought, but *Muhammad* said that no *Muslim* ought to die over the killing of an infidel. Thus non-*Muslims* have no right to retaliate in kind whenever *Muslims* kill non-*Muslims*. What this means in practice is in *Islamdom*, *Muslims* can kill non-*Muslims* with near-impunity. For instance, in the late-nineteenth century, a traveler wrote what life was like for Jews in *Tunis*, North Africa:

It was worse even in their intercourse with Mussulmans; if one of these fancied himself insulted by a Jew, he stabbed him at once and had only to pay a fine to the state by way of punishment... The Prime Minister down to the common soldier took every opportunity to oppress and rob Jews. They need only hear that this one or the other possessed great wealth to be after him at once for the purpose of confiscating his fortune for the paltriest of reasons, or to extort as many thousand *Piastres* as they thought he was worth.<sup>780</sup>

<sup>777</sup> Le Mecherouttiete, edited by Sherif Pasha, Paris, Aug 1912, p. 58, as quoted in Bostom, Andrew G. “Turkey: From Failed Reforms to a Modern *Jihad* Genocide,” americanthinker.com, 8 Oct 2005.

<sup>778</sup> Kearney, Simon. “School that nurtured the *Islamic* call to arms,” theaustralian.news.com.au, 10 Oct 2005.

<sup>779</sup> “Researchers probe motives of suicide bombers,” timesofoman.com, 4 Oct 2005.

<sup>780</sup> Hesse-Wartegg, Chevalier de. *Tunis: The Land and People*, London 1899, as quoted in Stillman, Norman A. *The Jews in Arab Lands*, Philadelphia, Jewish Publication Society, 1979, pgs. 416-417, 420, *JW*, 24 Nov 2005.

Similarly, whenever non-*Muslims* may have killed *Muslims*, as during police actions, counter-terrorism operations, or during a time of war, the infidels are automatically deemed war criminals and terrorists, for instance:

- C In 2006, an Egyptian *Muslim Brotherhood* member of parliament, Ragab Hilal Hamida, said:

From my point of view, *bin Laden*, *Al-Zawahiri* and *Al-Zarqawi* are not terrorists in the sense accepted by some. I support all their activities since they are a thorn in the side of the Americans and the Zionists...[On the other hand,] he who kills *Muslim* citizens is neither a *Jihad* fighter nor a terrorist but a criminal and a murderer. We must call things by their proper names!<sup>781</sup>

- C In 2005, two *Muslims* were electrocuted when they hid from police by jumping the fence of an electrical transformer station. Police deny that they had even chased anyone, yet this was the pretext for the massive French *Muslim* riots of 2005. After the riots...

...The outcome of an investigation is keenly awaited in the suburbs. If the police are exonerated, it could trigger new unrest.<sup>782</sup>

- C In 2005, *Thai* soldiers trying to suppress a *Muslim* insurgency were captured. During the stand-off, *Thai* forces were kept from rescuing the soldiers from a building near a *Mosque* by defiant *Muslim* women and children” who formed a human shield. As they held up a banner that said “You are in fact the terrorists,” the blindfolded *Thai* soldiers were beaten and macheted to death.<sup>783</sup>

- C In 2005, Malaysia’s former prime minister for 22 years, Mahathir Mohammad, did not consider 9/11 any reason at all for the US to invade Afghanistan or *Iraq*. Thus at a news conference he said:

Who are the terrorists? The people below who were bombed, or the bombers? Whose rights have been snatched away?...If you terrify people then you are a terrorist, and the people of *Iraq* are terrified of being bombed. They (the US and Britain) are state terrorists.<sup>784</sup>

- C *Muslims* do not consider self-defense enough of a reason for a non-*Muslim* to rebuke a *Muslim*, much less injure or kill a *Muslim*, for in *Islamic* thinking, non-*Muslims* ought to surrender and willingly be stabbed, raped, injured or slaughtered, for instance:

- ★ Historically, if a *Muslim* bullied a *Dhimmi*, the *Dhimmi* could not raise a hand or raise their voice to fend off the bully. Here is a contemporary description of life in Jerusalem in 1700 AD:

The latter [*Muslims*] are very hostile toward Jews and inflict upon them vexations in the streets of the city...the common folk persecute the Jews, for we are forbidden to defend ourselves against the Turks or the Arabs. If an Arab strikes a Jew, he [the Jew] must appease him but dare not rebuke him, for fear that he may be struck even harder, which they [*Muslims*] do without the slightest scruple. This is the way the Oriental Jews react, for they are accustomed to this treatment...Even the Christians are subjected to these vexations. If a Jew offends a *Muslim*,

<sup>781</sup> “Egyptian *Muslim Brotherhood* MPs,” *MEMRI*, 10 Mar 2006, Special Dispatch No. 1110, *JW*.

<sup>782</sup> Bennhold, Katrin. “In French suburbs, rage ‘is only asleep,’” *International Herald Tribune*, iht.com, 26 Dec 2005, *JW*.

<sup>783</sup> Ehrlich, Richard S. “*Muslim* women, children shield marine killers,” *Asia Times*, atimes.com, 24 Sep 2005.

<sup>784</sup> “Former Malaysian PM calls Britain ‘state terrorist,’” *guardian.co.uk*, 9 Sep 2005.

the latter strikes him a brutal blow with his shoe in order to demean him, without anyone's being able to prevent him from doing it.<sup>785</sup>

- ★ In 2005 Yaron London wrote about how *Israeli* police were investigated for killing Arab rioters:

But what would happen if this investigation also fails to find sufficient proof to charge police in the affair? Will the *Israeli* Arab community or its leaders accept these findings? Clearly not. Their suspicions of police wrongdoing will not be reduced in the slightest...The only acceptable conclusion for the Arab community would be a pre-ordained decision to hang several cops over the affair. *Knesset* Member Ahmad Tibi (Hadash-Ta'al) revealed much about the reigning feeling amongst this community by saying 'There's a victim, so there must be a killer.'<sup>786</sup>

- ★ 'In June 2001...some *Muslim* men from a nearby refugee camp attempted to pull a Christian girl into a car in order to rape her. A group of Christian men quickly stepped in to save the girl. When one of the *Muslim* perpetrators was injured in the process, the Christian rescuers were arrested. The sexual predators, on the other hand, were not even criminally charged.'<sup>787</sup>

If *Muhammad's* thinking that the killing a lone *Muslim* is as bad in *Allah's* eyes as murdering all of humanity (*K* 005:032) reminds the reader of Lamech, it should, since both *Muhammad* and Lamech drew similar conclusions due to their misunderstanding the Genesis account of Cain (*K* 005:027-034; Gen 04:15, 23-24).

Lamech thought he was especially favored and protected by *Yahveh* since he figured that his relative, Cain, was—judging from the fact that *Yahveh* said anyone who avenged Cain's cold-blooded murder of Abel would suffer punishment seven-times over (Gen 04:15). So when Lamech murdered a man who assaulted him, Lamech felt that *Yahveh* would avenge him seventy-times over because he had ten times more reason to murder the man than Cain had to murder Abel (Gen 04:23-24).

Lamech Logic may have spread among Cain's descendants who lived in the Mideast in Nod, which was east of Eden (Gen 04:16). The belief metastasized when men throughout the inhabited world took brides from Nod (Gen 06:01-07, 11-13). Lamech Logic led to so much violence that *Yahveh* had to destroy the entire Antediluvian world (Gen 06:11).

After the Flood, *Yahveh* repudiated Lamech Logic and set the record straight. *Yahveh* said:

Whoever sheds the blood of man, by man shall his blood be shed; for in the image of God has God made man (Gen 09:06).

In other words, each person is as valuable as the next, and a Lamechite's life is not seventy times as valuable as the life of a Sethite. None ought to be murdered with impunity regardless of their tribal affiliation or their belief system, and no one's murder ought to be avenged multiple times over.

Moses' words were no different from *Yahveh's*. Moses said an eye for an eye, and a life for a life, and the same lawcode that applied to Hebrews applied to aliens

<sup>785</sup> Ye'or. *Decline*, 378.

<sup>786</sup> London, Yaron. "Let's investigate everything," ynetnews.com, 2 Oct 2005.

<sup>787</sup> Weiner, Justus Reid. "Human Rights of Christians in Palestinian Society," Jerusalem Center for Public Affairs, jcpa.org, 2005.

(Lev 24:17, 22). Moses did say that children ought not be killed for the sins of their fathers, or fathers for the sins of the children (Deu 24:16).

*Muhammad* said that idolatry was dredged up from the Antediluvian world (K 071:023-025), but idolatry is not mentioned in the Bible regarding that period. Ironically, the only evil idea dredged up from Antediluvian times is Lamech's logic, and that idea was dredged up and given a deadlier twist by *Muhammad* himself.

Just as in Antediluvian times Lamech Logic was exported globally out of the Mideast, so today murderous *Islamism* is being exported out of *Islamdom*. This cannot be denied since *Muslims* themselves divide the world up between *Dar al-Islam* and *Dar al-Harb*—the Territory of War. One could say that today's world is divided up between the Postdiluvian West and the Antediluvian Land of the Second Lamech—*Islamdom* (Gen 06:11).

Petro-dollars sent to the Mideast are sent back to the West to build *Mosques* and *Madrasas* and to spread “pure” *Islam*. Moreover, *Muslims* immigrate to the West—often illegally:

Western Europe as a whole gets about half a million new *Muslims* a year. Most make their way from sub-*Sahara* Africa and North Africa, illegal immigrants smuggled by boat to Spain and Italy where they are free to travel with impunity to the rest of Europe. Thus Europe's *Muslim* population has doubled to 20 million in the last 10 years.<sup>788</sup>

*Muslim* immigrants swiftly augment their numbers by *Dawa* proselytizing, by having large families heavily dependant on dole and socialized medicine, and by taking advantage of “family reunification” immigration laws. “200,000 immigrants a year entering Germany, mostly family members of former Turkish immigrants.”<sup>789</sup>

Other means of augmenting numbers include importing child brides from *Islamdom*,<sup>790</sup> sometimes more than one bride per *Muslim* groom as polygamy and serial marriage flourish,<sup>791</sup> and by importing immigrant workers to work in immigrant-owned businesses.

“Pure” and aggressive forms of *Islam*, variously called *Islamism*, *Wahhabism*, *Talibanism*, *Deobandism*, *Salafism* and *Takfirism*, are spreading through immigration and proselytizing. Just as Lamech's Logic brought the demise of the Antediluvian world, so now *Islamism* may hasten the coming of the Last Day by spreading murder around the world (Mat 24:22; Mk. 13:20). Take for instance, the case of Ilan Halimi.

Ilan was a Sephardic Jew whose family came to France from North Africa either to escape anti-Semitism, or his family was kicked out.<sup>792</sup> Youssouf Fofana *Muslim* parents also immigrated to France, but from the Ivory Coast of West Africa.<sup>793</sup> Fofana grew up to become gang leader of the mostly-*Muslim* gang called “The Barbarians.”

“The Barbarians” used three “honey trap” seductresses to lure and kidnap unsuspecting males—most of whom were Jewish. In 2006, the gang recited *Koran* verses over the phone while Ilan could be heard screaming in the background.

<sup>788</sup> de Borchgrave, Arnaud. “Mini clash of civilizations,” *washtimes.com*, 15 Nov 2004.

<sup>789</sup> Elbaum, Rachel. “Integration questions stir passions in Germany,” *msnbc.com*, 24 May 2006.

<sup>790</sup> Stephens, Bret. “The Foreign Brides,” *The Wall Street Journal*, *wsj.com*, 2 May 2006, *DW*.

<sup>791</sup> “*Muslims* trawl web for wives,” *The Herald Sun*, *heraldsun.news.com.au*, 9 Apr 2006.

<sup>792</sup> Schlüssel, Debbie. “Ilan Halimi, Z'L: ‘Religion of Peace’s’ Latest Western Victim,” *debbieschlüssel.com*, 24 Feb 2006.

<sup>793</sup> Poller, Nidra. “The Murder of Ilan Halimi,” *nytimes.com*, 23 Feb 2006, *israpundit.com*.



“Police searches have now revealed the presence of *Islamist* literature in the home of at least one of the gang members.”<sup>794</sup>

Ilan was kept in an “apartment and later a utility room in the cellar in one of the project buildings.” “Many [*Muslims*] in the building knew what was going on, but did not act since it appears everyone knew the victim was Jewish.”<sup>795</sup>

Some “relatives and neighbors, beyond the immediate circle of the gang, who were told about the Jewish hostage and dropped in to participate in the torture.”<sup>796</sup> “They tortured Ilan with particular cruelty simply because he was Jewish.”<sup>797</sup>

Ilan was found dumped by a railroad track “handcuffed, naked, with four-fifths of his body covered with bruises, stab wounds and serious burns.”<sup>798</sup> Youssouf Fofana fled to “a *Muslim* neighborhood in Ivory Coast” where he was arrested.<sup>799</sup>

As was noted above, *Muhammad* thought that each *Muslim* ought to be avenged multiple times over based on the idea that *Allah* though killing a *Muslim* was as bad as murdering all of humanity (*K* 005:032). Naturally, *Muhammad* had a triple-standard concerning murder depending on who murdered whom. If a *Muslim* killed an **infidel**, the *Muslim* would **not** be killed in retaliation, would **not** go to hell, would **not** even be censured, and would **not** be required to pay the blood-money (*Diya*). Gibb and Kramers wrote in their *Kisas* encyclopedia entry:

On two occasions when *Muslims* had killed heathens who had...treaties with *Muhammad*, he did not allow *Kisas* to be made ‘because they were heathen,’ but paid the compensation himself...After the capture of *Mekka* the Prophet is said to have laid down the principle that any blood-guilt attaching to *Muslims* dating from the period of heathendom was to be disregarded.<sup>800</sup>

If a *Muslim* killed another *Muslim*, under the law of *Kisas*, the next-of-kin could either demand blood-money (*Diya*) or a life-for-a-life (*K* 017:033). Furthermore, *Muslim* assaulters and murderers do not go to hell forever as long as the *Muslim* regrets killing another *Muslim*, remains orthodox and does not indulge in any antinomian beliefs, as *Gardens of the Righteous* states:

We learn from this *Hadith* that in the course of struggling to protect one’s life and property, it is quite fair to kill a dacoit [a robber-gang member], robber or plunderer. Such a killing is not deemed a sin. In case he is a *Muslim*, he will go to *Janna* after suffering the punishment of his attacking a *Muslim*. But if he regards the act of attacking *Muslims* and encroaching upon their property lawful, he will be in hell forever.<sup>801</sup>

The *Hadiths* reveal that if a non-*Muslim* kills a *Muslim* however he automatically goes to hell forever unless he converts to *Islam* before his death (*K* 004:093; *Sahih Bukhari*, vol. 5, bk. 58, no. 194; vol. 6, bk. 60, no. 287).

No payment of blood-money (*Diya*) is to be accepted if a non-*Muslim* is known to have killed anyone besides an apostate from *Islam* (*Sahih Bukhari*, vol. 6, bk. 60,

<sup>794</sup> Poller, Nidra. “The Murder of Ilan Halimi,” nytimes.com, 23 Feb 2006, israpundit.com.

<sup>795</sup> Beyler, Clara. “All is not well in France,” ynetnews.com, 24 Feb 2006.

<sup>796</sup> Poller, Nidra. “The Murder of Ilan Halimi,” nytimes.com, 23 Feb 2006, israpundit.com.

<sup>797</sup> Beyler, Clara. “All is not well in France,” ynetnews.com, 24 Feb 2006.

<sup>798</sup> Poller, Nidra. “The Murder of Ilan Halimi,” nytimes.com, 23 Feb 2006, israpundit.com.

<sup>799</sup> Moore, Molly. “Killing in France Seen as ‘Wake-Up Call,’” washingtonpost.com, 25 Feb 2006.

<sup>800</sup> Gibb & Kramer. *Encyclopedia, Kisas* entry, p. 262, right column, middle.

<sup>801</sup> *Riyad-us-Saliheen (Gardens of the Righteous)*. Compiled by *Al-Imam Abu Zakariya Yahya bin Sharaf An-Nawawi Ad-Dimashqi*, *Book 11: The Book of Jihad*, chapter 235: Martyrdom without Fighting, topic 1357.

no. 25; see also vol. 9, bk. 83, no. 20). *Muslims* however will sometimes demand blood-money from infidels anyway, such as in 2004 when *Libya* tortured five *Bulgarian* nurses and a doctor into confessing they infected 400 children with AIDS. The death sentence would only be dismissed if *Bulgaria* gave *Libya* four billion dollars, a quarter of *Bulgaria's* Gross Domestic Product.<sup>802</sup>

Curiously, *Muslims* have a mark of Cain, so to speak. Pious *Muslims* and *Islamists* especially, develop a dark patch of skin—a callus—on their forehead by pressing their forehead to the ground during *Salat* prayers (*K* 048:029).<sup>803</sup> This prostration mark signifies a darkened and calloused mind and heart that leads to indifference to the suffering of *Islamic* terror victims.

*Muhammad* said that the fires of hell (i.e. purgatory) would burn *Muslims* to a crisp except for their prostration mark. The angels will then fish the *Muslims* out of purgatory by locating their prostration mark, and then reconstitute each *Muslim* from his or her prostration mark.<sup>804</sup> Thus *Muslims* are careful to create the prostration mark when praying. If their *Mosque* is carpeted and soft, they place on the carpet a rough unglazed fired tablets (Arabic: *Mohr*<sup>805</sup>) the size of a business card made from sand and clay from the Mideast.<sup>806</sup>

Another reason *Muslims* are careful to touch their forehead to the ground is during the time of *Muhammad*, an old *Mekkan* man was “killed as an infidel” because of instead of prostrating himself in prayer, he “took a handful of dust and touched his forehead with it saying ‘This is sufficient for me.’”<sup>807</sup>

Perhaps related to *Muhammad's* just-mentioned belief about purgatory and hell, but definitely related to how *Muhammad* valued the life of *Muslims* over non-*Muslims*, is: *Muhammad* said that *Muslims* ought not be punished by burning them with fire.<sup>808</sup> However, *Muhammad* himself had a Jew, Kinana, tortured with fire.<sup>809</sup> This suggests that *Muhammad* taught that burning infidels was okay, but burning *Muslims* was forbidden. Scarily, *Jihadists* have been secretly recorded arguing amongst themselves whether torturing an infidel with fire is a sin or not.<sup>810</sup>

The *Hadiths* that speak about when the Lamechian *K* 005:032 was revealed showed that *Muhammad* believed that a murdered *Muslim* ought to be avenged several times over—in keeping with the dictum that murdering a *Muslim* is as bad in *Allah's* eyes as murdering all of humanity. After all, the punishment must fit the crime:

Narrated *Abdullah Ibn Abbas*: The verse ‘The punishment of those who wage war against *Allah* and His Apostle and strive with might and main for mischief through the land, is execution or crucifixion or the cutting off of hands and feet from opposite side or exile from the land...most merciful’ [*K* 005:033]

<sup>802</sup> Schwappach, Eric. “The Condemned Six of *Benghazi*,” *DW*, 22 Nov 2005.

<sup>803</sup> Ngowi, R. “*Zanzibaris* Adopting Stricter Form of *Islam*,” news.yahoo.com, 4 Jul 2005, *JW*.

<sup>804</sup> *Sahih Bukhari*, vol. 8, bk. 76, no. 577; vol. 9, bk. 93, no. 532c: *Sahih Muslim*, bk. 1, no. 349.

<sup>805</sup> “*Islamic Laws of Ayatullah Khoei*,” islam.org, ch. 15 “Prayers,” para. 1069.

<sup>806</sup> “An American Faith: A mosque in Detroit stands as a testament to *Islam's* integration,” cleveland.com, 13 Aug 2005.

<sup>807</sup> *Sahih Bukhari*, v. 2, bk. 19, no. 173, 176; v. 5, bk. 58, no. 192; v. 5, bk. 59, no. 311; *Sahih Muslim* bk. 4, no. 1191.

<sup>808</sup> *Sahih Bukhari*, vol. 4, bk. 52, no. 259; *Sunan Abu-Dawud*, bk. 14, no. 2667.

<sup>809</sup> Ishaq. *Sirat*, p. 515.

<sup>810</sup> Sciolin, Oelaine. “From Tapes, a Chilling Voice of *Islamic* Radicalism in Europe,” nytimes.com, 18 Nov 2005.

**was revealed about polytheists.** If any of them repents before they are arrested, it does not prevent from inflicting on him the prescribed punishment which he deserves (*Sunan Abu-Dawud*, bk. 38, no. 4359).

Narrated *Abdullah Ibn Umar*: Some people [the Arab *Uraynah* clan numbering eight<sup>811</sup>] raided the camels of the Prophet...and apostatized [from *Islam* thereby becoming infidels]. They killed the herdsman of the Apostle of *Allah*...**who was a believer.** He (the Prophet) sent (people) in pursuit of them and they were caught. He had their hands and feet cut off and their eyes put out [by branding them with hot iron (*Sahih Bukhari*, vol. 2, no. 577)]. The verse regarding fighting against *Allah* and His Prophet...[K 005:032] was then revealed...(*Sunan Abu-Dawud*, bk. 38, no. 4356).

He then ordered to cut their hands and feet (and it was done) and their eyes were branded with heated pieces of iron. They were put in ‘*Al-Harra*’ and when they asked for water, no water was given to them. *Abu Qilaba* said ‘Those people committed theft and murder, became infidels after embracing *Islam* and fought against *Allah* and His Apostle’ (*Sahih Bukhari*, vol. 1, no. 234).

Notice that one *Muslim* was avenged eight times over—the entire Arab *Uraynah* clan of eight was dismembered, tortured and left to die of thirst though likely only one was guilty of murder.

*Muhammad*’s personal history showed that he believed multiple non-*Muslims* ought to be killed for every *Muslim* killed by a non-*Muslim*. Here are four examples of where *Muhammad* wanted to, or did, kill all the men of Jewish tribes because they killed a *Muslim* or they spread “corruption” in the land, in accordance with the Lamechian K 005:032 and *Muhammad*’s rendition of *Lex Talionis*:

- C When a *Muslim* was found killed by unknown persons, *Muslims* blamed a nearby Jewish settlement. Jews swore that they had nothing to do with the incident, but *Muslims* would not to accept their oaths since they were non-*Muslims*—as *Muhammad* taught them (*Sahih Bukhari*, bk. 73, vol. 8). Thus the accused Jews had to pay the blood-money (*Diya*), or else *Jihad* would ensue. So, *Muhammad* was about to kill many non-*Muslims* over a *Muslim* who died of unknown causes (*Malik’s Muwatta*, bk. 44, no. 44.1.1 & 2).
- C When an Arab woman sold the goldsmiths of the Jewish *Kaynuka* tribe some merchandise, they played a prank on her where her skirt was lifted. A *Muslim* man then killed the prankster, whereupon Jews killed the *Muslim*. Of course one would think that this would settle the matter, but the *Islamic* view is that the *Muslim* had the right to kill the Jew because he was spreading corruption in the land. Thus the Jew killing the *Muslim* was not retaliation for murder, but was outright murder. Moreover, even if the *Muslim* had committed murder, the Jews would still be in the wrong because *Muhammad* had decreed that no *Muslim* ought to be killed over murdering an infidel. *Abdullah b. Ubayy b. Salul* begged *Muhammad* not to “cut them down in one morning” because the *Kaynuka* tribe was not a strategic threat. *Salul* said the tribe had a mere 300 men with mail armor and 400 without mail. *Muhammad* only reluctantly agreed to have the *Kaynuka* leave the area if they left all their property behind.<sup>812</sup>

<sup>811</sup> “Eight persons from the tribe of ‘*UkP*’ (*Sahih Bukhari*, vol. 9, bk. 83, no. 37); also see Sa’d, *Ibn. Kitab Al-Tabaqat Al-Kabir (Book of the Major Classes)*, vol. 2, p. 114-115 (4), as quoted in Silas. “*Muhammad* and the *Muslims* from *Uraynah*,” [answering-Islam.org](http://answering-Islam.org), 16 Sep 2001.

<sup>812</sup> *Ibn Ishaq, Sirat*, p. 363, and *Ibn Hisham’s* note 568 on p. 751; *Lings. Sources*, pp. 161-162.

- ☉ *Muhammad* accused the *Nadir* Jewish tribe of plotting to kill him. It was finally agreed upon that *Muhammad* would only “spare their lives on condition that they could retain all their property” that a camel could carry besides armor and weapons.”<sup>813</sup>
- ☉ *Muhammad* sent Nu’aym to ensnare the *Kurayza* Jewish tribe and the *Mekkans* in a plot. Then the *Kurayza* insulted *Muhammad* from the walls of their fort.<sup>814</sup> *Muhammad* had all 600 to 900 *Kurayza* men beheaded and their women and children sold into slavery. *Muhammad* said this was “the judgment of *Allah* above the seven heavens.”<sup>815</sup>

So one can see that in the case of:

- ☉ The *Kaynuka* tribe, *Muhammad* wanted 700 Jewish men to die because one Jew had killed a *Muslim* because that *Muslim* had just murdered a Jew.
- ☉ The *Nadir* tribe, *Muhammad* wanted all the Jewish men killed just for plotting to kill one person, namely *Muhammad*, even though the plot came to nothing and the plot was probably just a figment of *Muhammad*’s fevered imagination.
- ☉ The *Kurayza* tribe, *Muhammad* killed 600 to 900 Jewish men for insulting *Muhammad* and plotting against the *Muslims* even though *Muhammad* had ensnared them in that plot!

Another example of *Muhammad* retaliating unfairly is when some *Makkan* women actually cut the nose and ears off *Muhammad*’s uncle Hamza, *Muhammad* vowed:

If God give me victory over [the] *Quraysh* in the future I will mutilate 30 of their men.

The *Muslims* vowed similarly:

By God, if God gives us victory over them in the future, we will mutilate them as no Arab has ever mutilated anyone.<sup>816</sup>

*Muslims* do follow *Muhammad*’s example of punishing or killing multiple infidels over the deeds of one infidel. For instance:

- ☉ Down through *Islamic* history, and in this case, in *Muslim* Spain...

...harsh reprisals with mutilations and crucifixions would sanction the *Mozarab* (i.e. Christian *Dhimmi*) calls for help from the Christian kings. Moreover, if one *Dhimmi* harmed a *Muslim*, the whole community would lose its status of protection, leaving it open to pillage, enslavement and arbitrary killing...from one day to the next, all the Christians in a city could lose their status as a protected people through the fault of just one of them. Everything could be called into question, including their personal liberty...Furthermore, non-payment of the legal tribute was not the only reason for abrogating the status of the ‘People of the Book’; another was ‘public outrage against the *Islamic* faith,’ for example, leaving exposed, for Moslems to see, a cross or wine or even pigs.<sup>817</sup>

- ☉ Innumerable times *Muslim* mobs have exacted revenge on entire communities over the offense of one or a few individuals, for instance:

<sup>813</sup> *Ibn Ishaq, Sirat*, p. 437.

<sup>814</sup> *Ibn Ishaq, Sirat*, p. 461.

<sup>815</sup> *Ibn Ishaq, Sirat*, p. 464.

<sup>816</sup> Guillaume. *Islam*, p. 387.

<sup>817</sup> Bostom, Andrew G. “Eurabia’s Morass Elicits Mythical ‘Solutions,’” *americanthinker.com*, 24 Nov 2005.

- ★ In 2006, much of *Islamdom* boycotted Danish products because one Danish newspaper printed caricatures of *Muhammad*,
- ★ In 2006, “hundreds of angry *Muslims* ransacked two churches in southern *Pakistan* [in *Sukkur*] before setting them on fire after allegations that a Christian had desecrated the *Koran*.<sup>818</sup>
- ★ More examples can be found under *Dhimmi* in the Glossary.
- ⊕ *Muslim* terrorists feel no regrets about killing multiple infidels over one infidel’s “spreading corruption in the land,” or over the jailing, injuring or death of one *Muslim* terrorist. For example:
  - ★ In 2005, *Muslims* carried out a suicide bombing in retaliation for one terrorist dying in a firefight.<sup>819</sup>
  - ★ In 2005 a *Muslim* stabbed three Israelis in Jerusalem, killing one, because someone tossed a pig’s head into a walled *Mosque* compound in *Tel Aviv*, and someone drew a pig on a *Mosque* wall in *Hebron*.<sup>820</sup>
- ⊕ *Muslims* assume there is a moral equivalency between *Muslims* killings thousands of people and an instance of infidels spreading so-called “corruption in the land” where infidels harm no one, as is revealed by their making all-too-facile comparisons. For instance, Yvonne Ridley, a British woman who converted to *Islam*, chastised the Danish in a 2006 conference on *Islamophobia* for:
  - ★ Making *Muslims* “feel like outsiders” even though *Muslims* make a point of not assimilating in Eurabia. Moreover, how can Ridley fault Europe for not being welcoming enough when the *Taliban* in *Afghanistan* held her hostage, and *Islamists* commit terrorism in the West and try to drive Westerners out of *Islamdom*.
  - ★ “...the fact that Denmark doesn’t have a single *Mosque* built as a *Mosque*—it doesn’t even have a *Muslim* cemetery,” meaning that the churches and synagogues converted into *Mosques* are not good enough, and *Muslims* are accustomed to the state paying for *Mosques* and cemeteries, therefore the *Jizya*-payers of Denmark should pay for these.
  - ★ Making the connection between *Islam* and terrorism. Ridley said, “I don’t demonize all Danes because of the Mohammed cartoons. And you shouldn’t demonize all *Muslims* on account of *Al-Qaeda*,” as though a Danish newspaper printing harmless cartoons is somehow remotely comparable to the murder of thousands of people.<sup>821</sup>

To conclude this section, it is disturbing that Western leaders parrot the *Takiya* they have been told about *Islam* being peaceful after their cities or nations have experienced *Islamic* terrorist plots or strikes, as when President Bush said in 2005:

Many *Muslim* scholars have already publicly condemned terrorism, often citing [the Lamechian] Chapter 5, Verse 32 of the *Koran*, which states that

<sup>818</sup> “*Muslims* ransack two churches in *Pakistan* over desecration of *Koran*,” news.yahoo.com, 19 Feb 2006.

<sup>819</sup> “Five people killed in *Hadera* suicide bombing,” haaretz.com, 26 Oct 2005.

<sup>820</sup> Weiss, Efrat. “*J’lem* stabbing—to ‘avenge pig in *Mosque*,’” ynetnews.com, 11 Oct 2005.

<sup>821</sup> “*Islam* Conference Fizzles,” *The Copenhagen Post Online*, cphpost.dk, 15 May 2006, *DW*.

killing an innocent human being is like killing all humanity, and saving the life of one person is like saving all of humanity.<sup>822</sup>

In 2006 Toronto, Canada, Mayor David Miller said in a *NPR* radio interview:

You know, in *Islam*, if you kill one person, you kill everybody. It's a very peaceful religion. And they're [*Muslims*] as shocked as Torontonians are.<sup>823</sup>

Not only does the Lamechian *K* 005:032 advocate the killing of non-*Muslims*, but the greater context—the overwhelmingly violent *Koran*—suggests that the verse has some darker meaning and that any cheery interpretation of any *Koranic* verse is just an artifice meant to fool and ensnare unsuspecting infidels less knowledgeable about the *Koran*.

The Lamechian *K* 005:032 is the theological unpinning for unbalanced retaliation and incites terrorism and genocide as surely as water runs downhill. If killing a single person is as bad as murdering all of humanity, then the killing of a single *Muslim* justifies the killing of all non-*Muslims*—not as an act of terrorism as *Islamists* would have it, but as retaliation and capital punishment for a “genocide.”

The magnification of the killing a *Muslim* into genocide in the Lamechian *K* 005:032 is the mirror image of the incitement to violence anti-Semites use when they charge that Jews are guilty of deicide and the ritual sacrifice of children. While the Lamechian *K* 005:032 makes a crime against one *Muslim* out to be a crime against all of humanity, anti-Semites indemnify many over the crime of a few.

The anti-Semitic allegations are magnified by attaching guilt to each member of a Jewish community or the entire Jewish nation, but the Bible keeps every sin in perspective: 1) only the murderer ought to die for a murder (Gen 09:06; Deu 24:16) and 2) no sin is unforgivable save that of terminal unbelief (Luk 12:10).

That the killing of a solitary *Muslim* is as bad as killing all of humanity (*K* 005:032) is a subtle incitement to genocide that came from the pits of hell twice—first in Antediluvian times to Lamech and later to the Second Lamech, *Muhammad*.

Another matter that is disturbing is how *Islamic* civil rights organizations trumpet every abuse or killing of a *Muslim* that is perpetrated by infidels, and issue: 1) warnings about impending backlashes after *Islamic* terrorist attacks—outbreaks of *Islamophobia* that rarely occur, and 2) inaccurate, exaggerated and uncorrected hate-crimes reports that present known hate-crime hoaxes as being real,<sup>824</sup> for every abuse of a *Muslim* is, in keeping with Khidr-Second Lamech Logic, worthy of an assassination or massacre of the infidel perpetrators. Likewise, the Lamechian *K* 005:032 magnifies every murder of a *Muslim* into an offense as awful as the genocide of the entire human race, while the same verse excuses, or makes a virtue out of, killing non-*Muslims* since they are by definition inimical to *Islamic* law and their very existence “spreads corruption in the land.” Thus, the *Koran* magnifies everyday news where inevitably a *Muslim* is killed by an infidel into hate-speech justifying and encouraging would-be Khidrs and Second Lamechs to rise up from among *Muslims* to commit acts of terrorism and even genocide.

<sup>822</sup> Spencer, Robert. “Bush’s New Terror Stance,” *JW, FPM*, 14 Oct 2005; also *DW*, 20 Oct 2005; confer “President Discusses War on Terror at National Endowment for Democracy,” [whitehouse.gov](http://whitehouse.gov), 6 Oct 2005.

<sup>823</sup> Steyn, Mark. “You can’t believe your lyin’ eyes,” [macleans.ca](http://macleans.ca), 13 Jun 2006.

<sup>824</sup> Pipes, Daniel & Sharon Chadha. “CAIR’s Hate-crimes Nonsense,” *DP*, 18 May 2005.

#### IV. Whether Muslim Killing Is Really Based on K 005:032

*Muslims* inevitably say that whatever behavior non-*Muslims* find objectionable has nothing to do with *Jihad* or *Islam* no matter how closely the behavior corresponds to the dictates of the *Islamic* religion. Examples include: terrorism, slavery beheading, mutilation, defacing artwork and statues, wife beating, killing homosexuals and blasphemers, female genital mutilation, and honor-killings.

*Muslims* will say the objectionable behavior mentioned above stems from: 1) Pre-*Islamic* local custom, 2) Expressions of human nature since after all, such crime is everywhere, 3) Desperation and hopelessness, 4) Retaliation against Western wrongs, 5) Resistance against occupation, globalization or the stealing of natural resources and such.

Here are a few examples of *Muslims* denying the *Islamic* basis for objectionable behavior and orchestrated violence, or non-*Muslims* parroting *Muslims*' denials and obfuscations. Further examples will be cited later in this section:

- ☉ During *Hajj* 2006, *Sheikh Abdulrahman Al-Sudeis* said at the Grand Mosque at *Mekka*, "*Islam* is **innocent** of this grave phenomenon (of terrorism)."<sup>825</sup>
- ☉ In 2005 "Nazir Ahmed, a member of Britain's House of Lords, rejected Khan's [last-testament video] comments, telling the program: 'The *Jihad* that you must do is become a good citizen and good member of the community. 'These people [7/7 suicide-bombers] **misinterpret** the *Koran* and take it **out of context**.'"<sup>826</sup>
- ☉ In 2005 the Minister of National Unity for *Malaysia*, Ongkili, said that government-funded International *Islamic* University's rule that non-*Muslim* women must wear veils was "**not religious in nature** but a matter of uniforms that must be followed."<sup>827</sup>
- ☉ "Shirin Ebadi fights for women's rights, and claims absurdly that their denial '**has nothing to do with Islam**.'"<sup>828</sup> Incidentally, the common phrase "nothing to do with *Islam*" brings up 63,000 hits in Google as of 5 November 2005.
- ☉ About *Devshirme*—the abduction of boys from Christian parents for induction into the *Sultan*'s army or palace—*The Encyclopedia of the Orient* states:
 

From the 15th until the 17th century, between 200,000 and 300,000 boys were taken out to *Devsirme*. The 'taxation' was performed in the Balkan countryside. At certain times, normally every 4th year, some of the young minor boys from each community were to be given to the *Sultan*. Their age was normally between 8 and 10, but it could at times be as high as 20. And the number of boys given to the sultan as part of *Devsirme* was between every 10th and 14th....**It was at all times clear that *Devsirme* was contradictory to Muslim law, Sharia. Sharia** had clear instructions to the *Muslim* ruler to protect and take care of all Christian subjects. **But the needs of the empire, as well as tribal traditions**, made the rulers instigate the practice.<sup>829</sup>
- ☉ In 2005 during the two weeks of *Muslim* riots in France, many suspected that *Islamists* were the "**hidden hand**" behind the riots, though the pretext was that the police were at fault when two *Muslim* youth were electrocuted as they hid

<sup>825</sup> "Saudi cleric says terrorism used to discredit *Islam*," news.yahoo.com, 10 Jan 2006, C&R.

<sup>826</sup> "UK bomber attacks *Muslim* leaders," *The Sydney Morning Herald*, smh.com.au 16 Nov 2005.

<sup>827</sup> "Non-*Muslims* 'must wear scarves,'" news24.com, 26 Oct 2005.

<sup>828</sup> Fitzgerald, Hugh. "As American As Apple Pie?" *DW*, 4 Nov 2005.

<sup>829</sup> "*The Encyclopedia of the Orient*," lexicorient.com, *Devsirme* entry, accessed 16 Jun 2006.

from racist police.<sup>830</sup> One commentator opined that “The *Muslim* thugs who make up the mobs...imbibed years of poison purveyed by radical *Imams*.”<sup>831</sup> France’s minister of employment said that polygyny led to “overly large families” that “led to anti-social behavior among youths who lacked a father figure” and consequently the youths are “unemployable.”<sup>832</sup> One could also add to this that the *Muslim* tendency to marry first cousins leads to more debilitating birth defects and poverty.<sup>833</sup> PC pundits, government officials and *Muslim* pressure groups said the riots occurred because the youths were “neglected” even though: 1) the rioters burned down government-built gyms, schools and health care clinics in their supposedly “deprived” neighborhoods and 2) the government spent \$40 billion on these neighborhoods between 2000 and 2005.<sup>834</sup> “When a [police] tear-gas canister exploded near a *Mosque* in *Clichy-sous-Bois* on the fourth violent evening, a new cry went up. ‘Now this is war,’ said one of the vandals. Others cried, ‘*Jihad*.’”<sup>835</sup> The arsonists often called out “*Allahu Akbar!*”<sup>836</sup> One *Muslim* who was planning for that night’s riot messaged other *Muslims* typing out:

It will continue, non-stop. We are not going to let up. The French won’t do anything and soon, we [*Muslims*] will be in the majority here.<sup>837</sup>

Some *Muslim* leaders said they wanted autonomous “extraterritorial status from the French government, meaning that they will set their own rules based, one can assume, on *Sharia* law.”<sup>838</sup> Reuters news service noted that the rioters are “angry teenagers who reject all other authority” than “*Imams* and local *Muslim* leaders in the suburbs.”<sup>839</sup> Nevertheless, *Muslims* denied the obvious and said “It’s not a...*Muslim* revolution...This has **nothing to do with religion**.”<sup>840</sup> A typical alternative explanation that *Muslims* gave for the riot was “**The problem is there’s** nothing for youths to do here.” A social worker explained the discrepancy, “Admitting there were radicals in the crowds would discredit their community. ‘They can’t say that, so they don’t say anything.’”<sup>841</sup>

*Muslims* continually claim that whenever they act out *Islam*, they are actually only respecting **local custom or tribal law**, or *Muslims* are merely retaliating in a time-honored way against present or historical wrongs done to *Muslims*. The

<sup>830</sup> “Paris Seeks ‘Hidden Hands’ in Riots,” *nytimes*, 5 Nov 2005.

<sup>831</sup> Pruden, Wesley. “No more lessons from French tutors,” *washingtontimes.com*, 8 Nov 2005.

<sup>832</sup> Arnold, Martin. “French minister says polygamy to blame for riots,” *Financial Times*, *news.ft.com*, 15 Nov 2005, *DW*.

<sup>833</sup> Giannangeli, M. “Ban Asian marriages of cousins, says MP,” *telegraph.co.uk*, 16 Nov 2005.

<sup>834</sup> Rotella, Sebastian. “Chirac to Fight Civil Unrest on Two Fronts,” *Los Angeles Times*, *latimes.com*, 15 Nov 2005, *DW*.

<sup>835</sup> Dickey, Christopher. “Rage on *Rue Picasso*: Will the riots swell the ranks of *Jihadists* in Europe?” *msnbc.msn.com*, 14 Nov 2005.

<sup>836</sup> “‘Marauding youths’ in France shout ‘*Allahu Akbar*,’” *JW*, 7 Nov 2005, *network.tv*, video 198614.

<sup>837</sup> Rahir, Kim. “Cyber-Rioting in France: ‘We Aren’t Going to Let Up! Are You Stupid?’” *Spiegel Online*, *spiegel.de*, 7 Nov 2005.

<sup>838</sup> Glick, Caroline. “Our World: The Paris fall,” *jpost.com*, 7 Nov 2005.

<sup>839</sup> “RPT-Anti-riot *Fatwa* sparks feud among French *Muslims*,” *alertnet.org*, 7 Nov 2005, *JW*.

<sup>840</sup> Moore, Molly. “Rage of French youth is a fight for recognition,” *Washpost.com*, *msnbc.msn.com*, 6 Nov 2005.

<sup>841</sup> “Paris Seeks ‘Hidden Hands’ in Riots,” *nytimes*, 5 Nov 2005.



assertions that “*Islam* has nothing to do with it” are effective in silencing infidels who have not studied the *Koran* and *Sharia* law.

Most people accept these assertions as fact since, after all, each *Muslim* has a degree in *Islamology*. However, after one becomes more familiar with *Islam*, these types of statements are seen for what they really are: pious platitudes, sheer evasiveness and naked propaganda. A case in point is author-journalist Steven Vincent read a book, *The Trouble With Islam* by a moderate *Muslim*, Irshad Manji. Vincent stated:

In her book, she argues that an Arab mindset, born of the desert and *Bedouin* traditions, **has hijacked *Islam***, transforming the religion into a creed fit more for the medieval **tribesman** of the *Hijaz*. That seems [or perhaps “seemed”] correct to me, but having traveled through Iran, I witnessed the same abuses of the religion, particularly against women. And of course the Iranians are not Arab [i.e. they are Persian] [emphasis Yoel Natan’s].<sup>842</sup>

So, it seems that Steve Vincent, who was murdered by *Muslims* in Iraq in 2005, came to the late realization that *Muslims* must be following something inherent in, rather than something incidental to, *Islam*.

Steve Vincent was correct in that *Muhammad* incorporated Arab tribal practice into *Islam* itself as one can see from reading the *Koran*, or one can take Gibb and Kramers’ word for it since they discuss *Kisas* in their encyclopedia on *Islam*:

The facts gathered from the records of the life of the Prophet are in agreement with this. In the so-called ordinance of the community<sup>843</sup> which belongs to the early *Madina* period it is laid down that if anyone slays a believer and is convicted, *Talion* takes place unless the avenger of the blood of the slain man desists; **all believers must be against the murderer and can only takes sides against him. Here the *Kisas* is brought from the sphere of tribal life into that of the religious-political community** ([the] *Umma*), but is still recognized as a personal vengeance...A limitation of *Kisas*, logical from the standpoint of the *Umma*, lies in the fact that the believer is forbidden to kill a *Muslim* on account of an unbeliever.<sup>844</sup>

Since the concept of *Kisas* is integrated into *Islam* itself, it means that whenever there is a perceived fault, a family automatically and mindlessly unites against an individual or another family, or clan against clan, town against town, tribe against tribe, nation against nation, sect against sect, or the *Umma* against the infidels. Arabs have an old saying that describes the phenomenon well:

Me and my brother against my cousin, me and my cousin against the world.<sup>845</sup>

Unfortunately, *Muslims* do not unite against an alleged offender for the sake of moral support and to see that the appropriate authorities do justice, but they feel they themselves must retaliate since *Muhammad* prescribed retaliation (*K* 002:178-179, 194; 005:032; 006:151; 017:033; 022:039; 025:068; 042:040). *Muhammad* said “In retaliation there is life for you [i.e. life for *Muslims*, not infidels]” (*K* 002:179). Thus any party offending *Muslims* can expect *Muslims* to unite and to exact vengeance one

<sup>842</sup> Glazov, Jamie. “In The Red Zone,” *FPM*, 9 Dec 2005.

<sup>843</sup> The *Madina* Covenant between Jews and *Muslims* (Ishaq. *Sirat*, pp. 231-233).

<sup>844</sup> Gibb & Kramer. *Encyclopedia*, *Kisas* entry, p. 262, right column, middle.

<sup>845</sup> “Iraq and al Qaeda: Who’s campaigning to deny the links?” *WSJ*, 25 Oct 2002; “Kid gloves syndrome,” [theaustralian.news.com.au](http://theaustralian.news.com.au), 28 Jan 2006.

way or another, whether the offending party happens to be a lone person, a clan, a nation or all infidels.

Incidents of retaliation over alleged faults are sometimes described purely in terms of a “Palestinian tradition,” “tribal justice” or “a family feud,”<sup>846</sup> but informed observers can see that *Islam* is clearly involved. *Muslims* forced non-*Islamic* societies to convert and conform to *Sharia* law on pain of death, but now *Muslims* learn the conformity from infancy, do not question it, and refer to it as their tradition.

Comparison of an *Islamic* society with a non-*Islamic* society is another proof that *Islam* is instrumental in creating a society based on personal and group vengeance. Outside of *Islamdom* crime is dealt with daily without the need to resort to honor-killing, blood vengeance, vigilante justice, clan warfare, sectarian violence and intramural killing.

One cannot blame the chronic violence and social disorder in *Islamdom* on the fact that *Islamdom* is comprised of innumerable clans and tribes, because the system of justice prescribed in the *Koran* is itself clannish and tribal in nature. This system of justice works to atomize *Islamdom* in clans and tribes who vie with each other. So the root cause of both the violence and the tribal nature in *Islamdom* is the *Koran*.

Even when several *Muslim* tribes are cobbled together to form a nation by the ballot box, or by a dictator’s calculated use of threats and incentives, the resulting government is just a thin veneer that barely conceals the Wild West raging below—where self-appointed individuals and large clans take the law into their own hands while the weak must fend for themselves because the government will not help them.

Not only does the *Koran* keep societies from developing into modern peaceful nation states free of vigilante violence, but the *Koran* in fact vitiates existing peaceful nation states whenever many *Muslims* immigrate. Law and order breaks down in *Muslim* autonomous zones<sup>847</sup> and is replaced with the law of the *Koran* with its honor-killings, blood vengeance and tribal justice. Two of many examples are:

- ☉ In certain suburbs of Berlin, “life follows two basic laws—the law of the neighborhood and the law of the *Koran*.”<sup>848</sup>
- ☉ In Denmark, doormen guards must be armed because gangs of “immigrants,” i.e. *Muslims*, often attack them.<sup>849</sup> In 2005, six or seven immigrants attacked a doorman when he refused them entry into a club. Two second-generation immigrants were shot and one died. Police said that “the practice of blood vengeance is still common among some immigrants” and a *Imam Abu Laben* (who later gained notoriety during the Danish *Muhammad* cartoon riots of 2006) suggested at the funeral that “the thirst for revenge could be cooled if 200,000 *Kroner* [33,000 USD] were paid...by the family of the doorman who fired the shots.”<sup>850</sup> 200 *Kroner* is the price of 100 camels, the blood-wit set by *Muhammad*.<sup>851</sup> Blood money is prescribed in *K*

<sup>846</sup> Williamson, Lucy. “A frightening family feud,” news.bbc.co.uk, 10 Sep 2005.

<sup>847</sup> Pipes, Daniel & Khalid Durán. “*Muslims* in the West: Can Conflict Be Averted?” U.S. Institute of Peace, Aug 1993, *DP*.

<sup>848</sup> Roebel, Sven. “The Murder of a Turkish Woman in Berlin: A German Court Goes Face to Face with Honor Killings,” *Spiegel Online*, spiegel.de, 12 Sep 2005.

<sup>849</sup> “Doormen arm themselves against immigrants,” *DR Nyheder*, dr.dk, 2 Jun 2005, *DW*.

<sup>850</sup> “Politicians reject *Imam*’s proposal of blood money,” *DR Nyheder*, dr.dk, 3 Jun 2005, *DW*.

<sup>851</sup> *Sahih Bukhari*, vol. 9, bk. 83, no. 36.

002:178.<sup>852</sup> The doorman and his wife and brother-in-law were spirited away under police protection.<sup>853</sup>

*Muslims* often say that abuse and violence in *Islamdom* have nothing to do with *Islam* even though the primary victims are singled out for abuse in the *Koran*: women in general and non-*Muslims* in particular. For instance, it is said that race or ethnicity is responsible for *Muslims* attacking Christians even though the minorities are of the same race and ethnicity as the *Muslims*.<sup>854</sup>

Another excuse enlisted to save *Islam* from criticism is “that the violence is mostly the result of ‘personally motivated’ disputes that are unrelated to religion.”<sup>855</sup> Most often the fact that non-*Muslims* are the principle victims is glossed over and news reports say “The victims of crime include both *Muslims* and Christians,”<sup>856</sup> totally ignoring the fact that non-*Muslim* are the victims so much more often than *Muslims* that the Mideast has nearly been emptied of minorities who reluctantly fled their ancestral homelands.

The excuse that minorities are targeted for bullying because they are powerless to fight back may be convincing if one has historically blinders on, but it does not explain why throughout most of *Islamic* history *Muslims* bullied, and thereby reduced, the subjugated majority down into a minority status. In fact, in many places in *Islamdom*, not one trace of the majority Christian populace is left.

The reason that the deeds of *Jihadists* can so easily be mistaken for street crime, or freedom fighting, or civil war, or tribal law, or a personal or marital dispute, or whatever, is *Muhammad* did not really codify law, but just packaged human nature “as is” into a belief system called *Islam*. Robert Spencer notes:

*Islam*’s only overarching moral principle is ‘if it is good for *Islam*, it’s right.’<sup>857</sup>

*Muslims* have no real law that curbs sin or crime because there is an escape clause built in assuring that every *Muslim* has complete immunity on judgment day. Riccoldo da Montecroce wrote:

The *Tartars* say the *Muslims* have no real law—just what comes naturally. It is certain that the *Islamic* law is deadly and raging, not from God, but from the Devil....Even though the *Koran* at times forbids robbery, perjury and other evil, such restriction is really license. He says evil should be avoided because God does not like it. But, if you do offend, God is compassionate and merciful and will forgive you...In all this it is sufficient for a *Muslim*, at the end of his life, to repeat, “There is no God but God and *Muhammad* is the apostle of God.”<sup>858</sup>

Riccoldo notes that expiation for perjury can be had for as little as a three-day fast (*K* 005:089). It seems no fasting is necessary to gain forgiveness for *Muslim* masters pimping their slaves into forced prostitution (*K* 024:033). Forgiveness can be had for manslaughter for a mere two-month fast (*K* 004:092). If one divorces a wife hastily and then wants her back, one can make amends with God by a two-month fast (*K* 058:003-004).

The *Koran*, which says that as long as a *Muslim* does not commit the great sins, *Allah* will forgive the small sins (*K* 004:031). *Muhammad* said it was enough to

<sup>852</sup> “Camel Economics,” fjordman.blogspot.com, 1 July 2005, *DW*.

<sup>853</sup> “Doorman placed under police protection,” *DR Nyheder*, dr.dk, 1 Jun 2005, C & R.

<sup>854</sup> Toameh, K. A. “Away from the manger—a Christian-Muslim divide,” jpost.com, 21 Oct 2005.

<sup>855</sup> Toameh, Khaled Abu. “Away from the manger—a Christian-Muslim divide,” *Idem*.

<sup>856</sup> Toameh, Khaled Abu. “Away from the manger—a Christian-Muslim divide,” *Ibid*.

<sup>857</sup> Kobrin, Nancy. “What You Can’t Say About *Islam*,” *FPM*, 23 Sep 2005.

<sup>858</sup> Montecroce. *Crucible*, pp. 80, 87.

forswear idolatry and believe in *Allah* and *Muhammad* to enter heaven. Saint James mocks this idea by saying even the demons believe in one God and yet they still shudder in anticipation of the coming judgment (Jam 02:19). *Muhammad* counters James' argument with a lie—saying that the *Jinn* (i.e. demons) converted to *Islam* by *Muhammad's* preaching (K 046:029-032; 072:001-019).<sup>859</sup>

*Muhammad* said that *Muslims* may do the deeds of the damned for as long as they live as long as their last act before dying is *Islamic*, as *Sahih Bukhari* related:

A man may do the deeds of the people of the Fire while in fact he is one of the people of Paradise... (the rewards of) the deeds are decided by the last actions (deeds) (*Sahih Bukhari*, vol. 8, bk. 77, no. 604; also see no. 593).

*Muhammad* said that any sin such as mutilating a body or mass-murder is excusable as long as it is done out of retaliation for persecution or murder (K 002:191, 193, 217; 016:126). By contrast, Saint Paul said that the sexually immoral, idolaters, adulterers, male prostitutes, homosexuals, thieves, greedy, drunkards, slanderers and swindlers will never inherit the kingdom of God (1Co 06:09-10). The reason is that those Christians who are saved are indwelt by the Spirit who controls their actions (Joh 14:17; Rom 08:09; Eph 02:10) but the Spirit would be repulsed from indwelling career sinners (Deu 23:14).

When *Muhammad* glorified crime and warfare into something sacred, he also aimed it away from *Muslims* toward non-*Muslims*. He knew that non-*Muslims* were more principled and practiced moral restraint and so could be bullied with less risk of *Muslims* getting their due comeuppance.

*Muhammad* knew that all religions besides *Islam* are peaceful and follow the Golden Rule or what C.S. Lewis termed The Law of General Beneficence.<sup>860</sup> *Muhammad* knew that other religions only approved of fighting fair despite any unprovoked attacks and war crimes occasioned on them.

Reza Aslan questions why people refer to “*Muslim*” pirates and slave masters, and “*Islam's*” slaves and slave trade, but not to “*Christian*” pirates, slavers and slave trade. Aslan then adds “After all, this is the only region in the whole of the *Muslim* world where such a phenomenon occurred.”<sup>861</sup> These statements show a gross ignorance of both the primary texts and histories of Christianity and *Islam* (see the table of contents for the table on *Islamists* and slavery).

As to the propriety of saying “*Muslim*” piracy, *Muhammad* happily dreamed of his followers becoming sea marauders (*Sahih Bukhari*, vol. 4, bk. 52, no. 56). As to the propriety of saying “*Islamic*” slavery, slavery of the worst kind is sanctioned in the *Koran*, in the traditions and in all four *Islamic* schools of jurisprudence, but not in the New Testament nor in any Christian school of thought. This explains why it was Christianity, not *Islam*, that taught that slavery should end everywhere.

A woman named Mukhtar is reportedly illiterate, yet she is a *Koran* teacher in her *Pakistani* village of *Meerwala*. She...

...was ordered gang-raped by a tribal council, or *Jirga*, after her 12-year-old brother was seen walking with a girl from a higher-ranking tribe. Mukhtar's brother also was beaten and sodomized for the

<sup>859</sup> Geisler & Saleeb. *Answering*, p. 36.

<sup>860</sup> Spencer, Robert. “*Iran's* Murderous Course,” *JW*, 2 Mar 2006.

<sup>861</sup> Aslan, Reza. “In the Service of the *Sultan*,” *washingtonpost.com*, 26 Jun 2005, p. BW08.

offense...[Mukhtar asked,] ‘Where does it say in *Islam* that you should violate women? Our *Islam* does not allow this, absolutely not.’<sup>862</sup>

Is Mukhtar’s answer to her rhetorical question correct? Not exactly. While the *Koran* and *Hadith* may not specify the exact punishment to meted out in this specific case, there is plenty of *Islamic* literature that an *Islamist* could use to justify rape and even sodomizing rape of men and women, for instance:

- ☉ *Muhammad* approved of raping captured women during *Jihad* and even advised against practicing *Coitus Interruptus* when doing so.<sup>863</sup>
- ☉ *Muhammad* allowed *Muslims* to have an unlimited number of sex-slaves (*K* 004:023-024, 092; 023:005; 033:050; 070:030).
- ☉ *Muhammad* allowed *Muslims* to pimp their slaves (*K* 024:033).
- ☉ Under the rubric of *Lex Talionis*, many *Islamists* believe they can commit rape just as they feel *Lex Talionis* allows for suicide-bombings (*K* 002:094),<sup>864</sup> mutilation (*K* 016:126) and torture (*Muhammad* tortured the Jew Kinana).<sup>865</sup>
- ☉ Stephen Murray and Will Roscoe wrote:

Some [*Muslims*] (such as [the poet] *Abu Nuwas* [died 195 AH/810 AD] and the [*Madinan*] jurists of the *Maliki* school) rationalized the practice of making non-believers [men and women] submit to penetration [sodomizing] by believers [*Muslims*] as a means of glorifying the superiority of *Islam*—a **duty** for *Muslims* rather than as a sin.<sup>866</sup>

Based on the above commands and precedents, a “rape” *Jihad* has been declared against infidel men and women, and against *Muslim* women who exhibit any infidel behavior such as not wearing a veil or headscarf. Nancy Kobrin stated:

At the ideological level...we encounter the classic practice of *Takiya*, lit. ‘guarding one’s self’ more commonly thought of dissimulation and its insidious behavior of orchestrating *Jihad* by every possible means in a clandestine manner. Rape is just one more weapon in the *Jihadi* arsenal for *Dar el-dawaa* [Territory of Evangelism] and *Dar ash-shahada* [Territory of Witnessing]....They are directly attacking not only the venerable Western female but also the rape should be thought of as a kind of ambush on the Western male.<sup>867</sup>

Peter Raddatz stated:

The current rape wave is the vital expression of an ongoing *Jihad* against women who under Western influence may drift slowly out of the grip of male *Muslim* hands.<sup>868</sup>

Gudrun Eussner stated:

On the one hand you have sexuality as a tool serving the expansion of *Islam*, and on the other hand there is sexuality as a weapon against disobedient and non-*Muslim* women, both categorized as ‘unbelievers.’ Against them *Jihad* is the

<sup>862</sup> Thomas, M. “Rape survivor brings fight here,” *Chicago Sun-Times*, [suntimes.com](http://suntimes.com), 30 Oct 2005.

<sup>863</sup> *Sahih Bukhari* vol. 003, bk. 034, no. 432; vol. 005, bk. 059, no. 459; vol. 007, bk. 062, nos. 135, 136; vol. 009, bk. 093, no. 506; *Sahih Muslim*, bk. 8, nos. 22, 29 & 3371; *K* 004:024; Spencer. *Disturbing*, pp. 50-51, 53; Trifkovic. *Sword*, p. 43.

<sup>864</sup> “Palestinian Legislative Council...” Special Dispatch 1063, MEMRI.org, 4 Jan 2006, *JW*.

<sup>865</sup> Ishaq. *Sirat*, p. 515.

<sup>866</sup> Murray. *Culture*, p. 304.

<sup>867</sup> Glazov, Jamie. “Symposium: To Rape an Unveiled Woman,” *FPM*, 7 Mar 2006.

<sup>868</sup> Glazov, Jamie. “Symposium: To Rape an Unveiled Woman,” *FPM*, 7 Mar 2006.

**duty**, and [concerning] what to do with women ‘conquered’ in *Jihad*, this may be read in the *Koran*: they become [sex-]slaves to be used by the victors.<sup>869</sup>

In keeping with the *Maliki* school’s dictum (see full quote above) that it is a “**duty**” for *Muslims* to make infidels submit to sodomy “as a means of glorifying the superiority of *Islam*,”<sup>870</sup> *Muslim* do just that to infidels and *Muslim* women who exhibit infidel behavior such as shaving or not wearing a veil or headscarf:

☉ *The Passion of Pelagius* records how a thirteen-year-old boy fended off an *Andalusian* king and became one of many martyrs of *Cordoba*.<sup>871</sup>

☉ Pseudo-*Dionysius* of *Tell-Mahre* wrote of his Mideast travels ~767-773. He discovered that just south of *Armenia* and in *Kurdistan*:

It was said that they [*Muslims*] seized **beardless** youths in the streets and defiled them. Scribes and ungodly money-changers, who were Christians, had young girls taken and led away and they defiled them, both daughters of the people and daughters of notables.<sup>872</sup>

☉ In the 19<sup>th</sup> century in colonized areas, some *Muslims* sodomized British Christian missionaries who were deemed too successful at evangelism, as Richard Burton wrote in his “Terminal Essay.”

☉ Just as *Muslim* men are allowed to be wife-beaters (*K* 004:034), they all-too-often sodomize their wives and children. Then in the case of incest or rape, the victim is expected to commit suicide:

★ Peter Raddatz stated:

The personal literary reports and the official UN analyses on *Islamic* family dynamics concur in a somewhat disquieting aspect. They confirm not only the tendency to incest but also an even stronger attitude towards anal sexuality, meaning an unusually high percentage of males preferring anal intercourse to vaginal, especially in the framework of ‘normal’ marital life....There is no ‘culture’ in the world where more married people practice anal intercourse than in *Islam*.<sup>873</sup>

★ Sharon Lapkin wrote:

And if that isn’t bad enough, the victims of these atrocities are then expected to commit suicide because rape victims bring irreparable shame upon their family.<sup>874</sup>

As to Mukhtar’s rhetorical question (quoted above), the *Koran* does specify the dowry system for marriage (*K* 060:010-011), so sidestepping the dowry system by dating un-chaperoned could be considered “spreading corruption in the land,” thus making those involved liable to be killed (*K* 005:032). So, given the *Koranic* system of so-called justice, many *Muslims* might say that Mukhtar received a light sentence when she was gang-raped rather than killed outright.

Many *Muslims* say unconvincingly that honor-killings have nothing to do with *Islam*, but Peter Schneider thinks that honor-killings and radical *Islamic* fundamentalism are linked, and that radical *Islamic* fundamentalism and *Islam* are linked just as Stalinism and Communism were linked.<sup>875</sup>

<sup>869</sup> Glazov, Jamie. “Symposium: To Rape an Unveiled Woman,” *FPM*, 7 Mar 2006.

<sup>870</sup> Murray. *Culture*, p. 304.

<sup>871</sup> Christys. *Andalus*, pp. 10, 88-89.

<sup>872</sup> Ye’or. *Decline*, p. 312.

<sup>873</sup> Glazov, Jamie. “Symposium: To Rape an Unveiled Woman,” *FPM*, 7 Mar 2006.

<sup>874</sup> Lapkin, Sharon. “*Muslim* Gang Rapes and the Aussie Riots,” *FPM*, 15 Dec 2005.

<sup>875</sup> Schneider, Peter. “The New Berlin Wall,” translated by Philip Boehm, *nytimes*, 4 Dec 2005.

Compiling country-by-country statistics on honor-killings has just begun because non-*Muslims* were mostly unaware of the hushed-up phenomenon. The statistics are divergent because the crime is under-reported in *Islamic* countries. In the West the crime went unsolved because police were not aware of such a motive for killing, namely cleansing the family name of dishonor by killing the unclean person.

Even now in 2006 police assume that honor killings involved adulterous wives or daughters thought to have lost their virginity, but are unaware that: 1) hitmen (sometimes erroneously called “bounty hunters”) are often hired rather than having a juvenile family member perpetrate the crime who will receive a lenient sentence,<sup>876</sup> 2) the boyfriends are also targets, 3) victims of incest might be killed by their own father or family for having been a source of temptation, 4) wives of failing or failed marriages, 5) girls and women who refuse to enter into or stay in forced marriages, and 6) girls and women who dress as Westerners and hold un-*Islamic* views about life and romance.

The more the subject is studied, the more prevalent honor-killings seems to be—and shockingly so:

- Ⓒ In Turkey in 2005 the punishment for honor-killings was changed to a slap-on-the-wrist to life imprisonment. Suddenly the number of female “suicides” jumped—36 in one region alone. Worldwide, men commit suicide three to four times as often as women, but in Turkey the ratio was reversed within a year. Now the typical honor-killing in Turkey goes:

‘Here’s a gun or here’s some poison, go and kill yourself so I don’t have to go to prison for it.’ If they don’t comply, they are killed anyway and declared to have committed suicide after a bout of depression.<sup>877</sup>

- Ⓒ In 2006 *The Wall Street Journal* reported: “There have been 55 honor killings in Germany in the past six years.”<sup>878</sup> In 2006, UK’s *Times* reported: There are 40 ‘honour killings’ a year in Germany and most of them result from the failure of an arranged marriage, which are illegal in the country.<sup>879</sup>

Though honor-killing occur more frequently in the *Muslim* suburbs of Berlin where “life follows two basic laws—the law of the neighborhood and the law of the *Koran*,”<sup>880</sup> “*Muslim* leaders in Berlin are at pains to stress that there is no basis for honour killings in the *Koran* but they have also been criticized for not making a clear condemnation of them.”<sup>881</sup> A representative of Germany’s largest association of *Mosques*, Huseyin Midik, stated:

We have preached twice in the last year on human rights, saying that it is forbidden to kill and so on.<sup>882</sup>

Notice that this condemnation is against “killing” and not specifically “honor-killing,” leaving “wiggle room” for honor-killing!

<sup>876</sup> Hickley, Matthew. “Plans to outlaw forced marriages shelved,” [dailymail.co.uk](http://dailymail.co.uk), 7 Jun 2006.

<sup>877</sup> Erdem, Suna. “Honour suicides: death by a bullet in the back,” *The Times*, [timesonline.co.uk](http://timesonline.co.uk), 25 May 2006.

<sup>878</sup> Stephens, Bret. “The Foreign Brides,” *The Wall Street Journal*, [wsj.com](http://wsj.com), 2 May 2006, *DW*.

<sup>879</sup> Boyes, Roger. “Teenager killed his sister for living a Western life,” [timesonline.co.uk](http://timesonline.co.uk), 14 Apr 2006, *DW*.

<sup>880</sup> Roebel, Sven. “The Murder of a Turkish Woman in Berlin: A German Court Goes Face to Face with Honor Killings,” *Spiegel Online*, [spiegel.de](http://spiegel.de), 12 Sep 2005.

<sup>881</sup> Furlong, Ray. “‘Honour killing’ shocks Germany,” [news.bbc.co.uk](http://news.bbc.co.uk), 14 Mar 2005.

<sup>882</sup> Furlong, Ray. “‘Honour killing’ shocks Germany,” [news.bbc.co.uk](http://news.bbc.co.uk), 14 Mar 2005.

In Peter Schneider's insightful article about honor crimes in Germany, he wrote:

Politicians and religious scholars of all faiths are right in pointing out that there are many varieties of *Islam*, that *Islamism* and *Islam* should not be confused, that there is no line in the *Koran* that would **justify murder**.<sup>883</sup>

Unfortunately, the "politicians" and journalists are willfully deceived by the self-deceived "religious scholars." The *Koran* is **not** like the Bible where Jesus saved a woman from being stoned for adultery (Joh 08:07-11). The *Koran* does in fact "**justify murder**" as well as *Jihad*, ethnic cleansing, honor-killing and such. Honor-killing **is** in fact in keeping with the *Koran*, *Hadith* and *Siras*:

☉ *K* 002:178 and *K* 017:033 give the next of kin the power to forgive or exact retaliation on a murderer. By contrast, the New Testament says the government, not the family, may pardon or exact retribution over any murder (Rom 13:04).

☉ *K* 005:032 says no retaliation is called for when someone kills anyone who "spreads corruption in the land."

☉ *Muhammad* said that "persecution is more heinous than slaughter" (*K* 002:191, 193, 217). Thus *Muhammad* taught that it is preferable to slaughter anyone who causes *Muslims* vexation than to suffer any further vexation.

☉ The Khidr story where Khidr kills a boy merely for being an unbeliever who **might** vex his parents in the future (*K* 018:065-082). A *Muslim* women is most likely to be beaten or killed if she becomes "Westernized" and her boyfriend or husband is a non-*Muslim*.<sup>884 885 886</sup> Often the non-*Muslim* boyfriend or husband is killed instead of the girl, or in addition to the girl.<sup>887</sup>

<sup>888</sup> In 2005 in Britain, an *Iranian* boyfriend was stabbed "46 times in the chest" and an Afghan boyfriend was hacked "to death with a scimitar."<sup>889</sup> In 2005 a stranger who was mistaken for the boyfriend was killed.<sup>890</sup> Lest one think that honor-killing and the Khidr story are unrelated since honor-killing involves lasses and not lads, honor-killings involve both, as Peter Schneider wrote:

...A groom who chooses his own wife faces threats...the groom as well as the bride must go underground to escape the families' revenge.<sup>891</sup>

☉ *Sharia* law as set forth in *Reliance of the Traveler* (o1.2):

The following are not subject to retaliation...(2) a *Muslim* for killing a non-*Muslim*...(4) **a father or mother (or their fathers or mothers) for killing their offspring, or offspring's offspring.**

<sup>883</sup> Schneider, Peter. "The New Berlin Wall," translated by Philip Boehm, nytimes, 4 Dec 2005.

<sup>884</sup> "Muslim slays daughter in 'honor killing': Kurdish refugee didn't approve of teen's relationship with Christian boy," *WND*, 29 Sep 2003.

<sup>885</sup> "Man suspected of honour killing of sister," expatica.com, 15 Apr 2005, *LGF*.

<sup>886</sup> Martindale, Mike. "Parents of son charged in beating... could lose daughter for delaying treatment for broken back," *The Detroit News*, detnews.com, C&R.

<sup>887</sup> "Man jailed for 'honour killing': A businessman was jailed for life yesterday for murdering his daughter's boyfriend," *The Guardian*, guardian.co.uk, 8 Oct 2003.

<sup>888</sup> Nelson, Fraser. "US reporter killed 'because he was to marry a Muslim,'" news.scotsman.com, 11 Aug 2005, *DW*.

<sup>889</sup> Long, Gideon. "Britain grapples with gruesome 'honor' crimes," news.yahoo.com, 6 Dec 2005.

<sup>890</sup> "Two guilty over religion killing Major Singh Gill," news.bbc.co.uk, 30 Jun 2005, *DW*.

<sup>891</sup> Schneider, Peter. "The New Berlin Wall," translated by Philip Boehm, nytimes, 4 Dec 2005.



*Islamists* often say and write that if there is no *Muslim* authority to enforce *Sharia* law, or a *Muslim* authority is unwilling to enforce *Sharia* law in its entirety, individual *Muslims* may take it upon themselves to enforce any of its provisions. Of course this is a main reason the *Muslim Brotherhood* was established in 1928, four years after the *Caliphate* was abolished, to encourage individual *Muslims* to take *Sharia* law into their own hands. So today, all *Islamists* would agree with *Al Ghurabaa* which states:

The insulting of...*Muhammad*...is something that the *Muslims* cannot and will not tolerate and the punishment in *Islam* for the one who does so is death. This is the *Sunnah* of the prophet and the verdict of *Islam* upon such people, one that any *Muslim* is able execute.<sup>892</sup>

- ☉ A *Sira* records *Muhammad*'s after-the-fact approval of a *Muslim* who murdered his own relative as he slept. 'Amr b. Umayya said he met a *Mekkan* one-eyed shepherd from the *B. al-Dil* clan and found they were both from the *Bakr* tribe (*Banu*). That evening in a cave the shepherd sang "I won't be a *Muslim* as long as I live, nor heed to their religion give." After the shepherd went to sleep, 'Amr b. Umayya stuck the end of his archery bow into the shepherd's brain through his good eye, for which deed *Muhammad* blessed his disciple.<sup>893</sup>
- ☉ The *Hadith* record how a blind master killed a concubine who had given him two sons. He claimed she had disparaged *Muhammad*. *Muhammad* approved of the murder and said that no retaliation was called for.<sup>894</sup>

One can see from the above how easy it is for honor-killers and murderers to get away with murder under the *Islamic* system of law and blame the victim too (as is discussed next). Incidentally, blaming the victim is easy to do whenever the victim is dead, or the victim is part of a less protected social class, for example, anyone deemed politically incorrect, slaves, aliens to a foreign country and the unborn.

In the West, the unborn child is in a sense blamed for his or her own abortion because that infant is unwanted or imperfect, or takes away the woman's control of her body or her lifestyle. So also is the case in the *Islamic* system:

- ☉ A murderer can easily bribe and threaten a family to forgive a murder and perhaps blame the victim too.
- ☉ A rape or incest victim is often jailed, stoned, honor-killed or is expected to commit suicide, as Sharon Lapkin wrote:

And if that isn't bad enough, the victims of these atrocities are then expected to commit suicide because rape victims bring irreparable shame upon their family.<sup>895</sup>

How *Sharia* law often fails to bring about justice for rape and incest victims is:

- ☉ A parent blames his rape or incest on the child or woman, who cannot prove rape or incest in a court of law because of the *Koranic* four-witness requirement to prove rape (*K* 024:013).
- ☉ Any unsuccessful attempt to prove rape or incest backfires on the victim because her testimony is taken as an admission either of perjury or of her

<sup>892</sup> "Kill those who insult the Prophet *Muhammad*," *alghurabaa.co.uk*, Jawa Report, 2 Feb 2006.

<sup>893</sup> Ishaq. *Sirat*, pp. 674-675.

<sup>894</sup> *Sunan of Abu Dawud*, vol. 6, bk. 38, no. 4348; see also Silas. "Murdering *Islam*'s Critics: The Female Slaves and Theo Van Gogh," *answering-Islam.org*, 23 Nov 2004.

<sup>895</sup> Lapkin, Sharon. "*Muslim* Gang Rapes and the Aussie Riots," *FPM*, 15 Dec 2005.

complicity in the rape or incest!<sup>896</sup> This occurs so often that *The New York Times* (17 May 2002) says that this is “a familiar pattern.”<sup>897</sup>

- ⊕ If the women are not jailed or stoned after failing to prove rape or incest, as many are,<sup>898</sup> they are liable to be honor-killed for:
  - ★ Allegedly tempting and luring the perpetrator to commit the rape or incest.
  - ★ Ruining the family’s honor.
- ⊕ No retaliation is due because the murderers are the heirs or next of kin whom are empowered by the *Koran* to either avenge a murder, or choose to forgive the murderer and call for no retaliation (*K* 017:033)!
- ⊕ If a *Muslim* is arrested for rape, often “the parents of the rapist children don’t understand why their children were arrested. This is showing their close attachment to *Islamic* law, the *Sharia*,” as Gudrun Eussner stated.<sup>899</sup>

The above explains to a great extent why honor-killings are rife in *Islamdom*. The US Congressional Human Rights Caucus (CHRC) reported:

While women are frequently the target of rape, incest or other forced illicit relationships, they are generally the only party held accountable under tribal traditions and customs. Divorce and refusal of arranged marriage have also led to honor killings. In each of these situations, whether the events actually occurred and whether the woman was victimized or gave consent are irrelevant, because even a mere suspicion is used as justification for an honor killing.<sup>900</sup>

James Emery wrote:

Among Palestinians, all sexual encounters, including rape and incest, are blamed on the woman. Men are presumed innocent; the woman must have tempted him into raping her or enticed him into having an affair. A woman is expected to protect her honor, even at the cost of her own life. If she survives a violent rape, she is condemned for her ‘mistake’ and may be killed by her family. ‘The issue of consent is irrelevant when it comes to honor killings,’ says Marsha Freeman, director of the International Women’s Rights Action Watch (IWRAW).<sup>901</sup>

If the *Imams* think honor-killing is *Harem* (forbidden), or at least ought not be prosecuted or punished, they naturally will not issue any strong condemnation of honor-killing because this would lead *Muslims* to cooperate with the police in solving the crime. That is why the German *Imam*’s condemnation is against “killing” and not specifically “honor-killing,” leaving “wiggle room” for honor-killing!

Honor-killings are not restricted to Germany and *Islamdom* but are everywhere *Muslims* are, even in the UK and the Netherlands, as Dutch MP Hirsi Ali stated:

If only people, including those in Britain, were aware of the sheer number of girls living in terror...Just going outside without your father or your brother’s permission can lead to your being taken to the home country of your parents and

<sup>896</sup> Glazov, Jamie. “*Islam* Symposium Part III: The Right to Dissent, Comedy and the *Burqa*,” *FPM*, 6 Mar 2003.

<sup>897</sup> Trifkovic. *Sword*, pp. 154-155.

<sup>898</sup> Glazov, Jamie. “*Islam* Symposium Part III,” *Idem*.

<sup>899</sup> Glazov, Jamie. “Symposium: To Rape an Unveiled Woman,” *FPM*, 7 Mar 2006.

<sup>900</sup> Congressional Human Rights Caucus (CHRC) Briefing Series on Gender-Based Violence: Violence Against Women: Honor Killings, [lantos.house.gov](http://lantos.house.gov), 9 Nov 2005.

<sup>901</sup> Emery, James. “Reputation Is Everything: Honor Killings Among the Palestinians,” *World&I*, [worldandi.com](http://worldandi.com), 2003.

being shot dead. You can be forced into marriage with someone who's going to rape you every night. You will conceive children year after year when you don't want to be pregnant.<sup>902</sup>

In 2006, a Turkish report said that in the last five years there were 1,091 honor-killings there.<sup>903</sup>

Honor-killers generally are not punished in *Islamdom* in keeping with *Sharia* law (quoted just above), though in a somewhat westernized country like Jordan, honor-killers get a maximum of six months in jail.<sup>904</sup> The typical *Muslim* Arab attitude in *Israel* toward honor-killings was reported by *Ynet News*:

The city counselor urges forgiveness and understanding for murder by trying to explain away the 'laws' [as being]...made up [i.e. man-made, not of the divinely revealed *Sharia* law]....Following the killing [of a 23-year-old *Druze* woman who dated a *Sunni* (*Druze* are a *Shiite* sect)], a member [Farej Hanifas] of the *Shfaram* City (NW of Nazareth in *Israel* proper) Council was thus quoted in the Arabic-language *el-Medina* newspaper: 'I think every mistake leads to certain results and the mistake this girl made was very, very serious. **This was an appropriate result for this action.**...Every community has its laws and this victim carried on with no consideration for the laws that govern this society; life has its own order and we cannot tolerate a situation of chaos.'<sup>905</sup>

Later, City Councilman Farej Hanifas said that his comment, "The result fit" the *Druze* woman's "mistake," was just the "prevailing public opinion, not his personal view." Indeed "there have been public calls for the release" of the honor-killers.<sup>906</sup>

A double honor-killing nearly occurred in the Arab village of *Tira* in central *Israel* in 2002 but the police rescued the couple. This attempted honor-killing was unique in that it occurred in public in daylight, the perpetrators were a mob and the offense was that Amal and Yusuf Kashua starred in the first Arab-*Israeli* pornography movie. Amal was disowned by her family. A local man from *Tira* said:

The whole town is satisfied and dissatisfied at once: Satisfied at what happened, because we tried to protect our **honor**, but on the other hand dissatisfied because she (Kashua) didn't die, nor her husband.<sup>907</sup>

*The Jerusalem Post* confirmed honor killings in *Israel* are all-too-common: there are about ten honor-killings per year in *Israel* and between two and three out of every ten Arab *Israeli* women who visit homeless shelters do so because they are under threat of being honor-killed.<sup>908</sup>

Sharon Lapkin wrote about honor-killing situation in the West Bank and *Gaza*:

*The Guardian* reported official figures from the Palestinian Women's Affairs Ministry in 2004, where it claimed 20 girls and women were honor-killed and a further 50 committed suicide. Another 15, it claimed, had survived murder

<sup>902</sup> Hickling, Susanah. "I'm lonely, but I have to go on," readersdigest.co.uk, 6 Jan 2006, *DW*.

<sup>903</sup> "Honor Killings: 1091 Murders Committed In Turkey In Past 5 Years," 26 Feb 2006, C&R, 1 Mar 2006.

<sup>904</sup> Lapkin, Sharon. "Palestinian 'Honor,'" *FPM*, 20 Jan 2006.

<sup>905</sup> Hlehel, Ala. "Tradition of killing: Why won't Israel prosecute 'family killing' murderers?" *ynews.com*, 15 Nov 2005.

<sup>906</sup> Khoury, Jack & Yoav Stern. "Arab women's groups: Men must speak out against honor killings," *haaretz.com*, 23 Dec 2005.

<sup>907</sup> "Israeli Arab Porn Video Inflames Community Passions," Reuters, 31 Dec 2002, *windsofchange.net*.

<sup>908</sup> "Woman murdered for 'family honor,'" *jpost.com*, 25 Jan 2006, *DW*.

attempts. And in 2005, the official figures reached 33. However, this official recognition of the sharp rise in reported honor killings is a limp excuse by a society that condones, camouflages and ignores most of its crimes against women.

According to Dr. Shalhoub-Kevorkian, a criminologist from Hebrew University, the real figures are much higher with almost all murders in the West Bank and *Gaza* most likely to be honor killings. In a two-year period between 1996 and 1998, Shalhoub-Kevorkian uncovered 234 suspicious deaths in the West Bank alone, which she believes were honor killings. Palestinian police do not record these deaths as murder but as deaths due to ‘fate and destiny.’ Shalhoub-Kevorkian believes the real number of honor killings may in fact be 15 times higher than the official figures....More often than not, the woman’s murder is reported as suicide or accident or is simply not reported at all. Anthropologist Emery claimed that many murdered women are buried in the desert: ‘The secret of their fate... entombed with them in the sand.’<sup>909</sup>

*Muslims* in *Deir Jarir* in the West Bank are suspected of honor-killing a pregnant woman who allegedly had a romantic affair with a man in *Taybeh*, Palestine’s only exclusively-Christian town (population 1,500).

Dozens or by some reports, hundreds of *Muslims* walked the half-mile from *Deir Jarir* to *Taybeh* to kill the Romeo but he eluded them. Instead, they looted and burned down fourteen houses owned by the man’s relatives as they chanted “Let’s get the Christians.”<sup>910</sup> Fourteen Palestinians were briefly detained and then released from custody but the Romeo was jailed and beaten.

So what was the reason for attack on *Taybeh*? A *Muslim* in *Deir Jarir* said that ‘In **Palestinian** tradition, when you make a mistake like this, you pay with your blood.’ A *BBC* reporter said the *Taybeh* incident was “tribal justice” and “a family feud,”<sup>911</sup> as though *Islam* had nothing to do with it.

How many millions of times over does this need to occur before reporters realize that the “illicit romance” excuse is just a pretext for a pogrom. After all, there has always got to be some pretext to justify ethnic cleansing. Reporters are still not on to the *Muslims*’ game of ethnic cleansing, even though “the game” has nearly emptied *Islamdom* of non-*Muslims*!

The *Taybeh* incident is actually all about *Islam*, though after fourteen centuries, *Islam* is so ingrained in the *Muslim* psyche that it seems like a **Palestinian** tradition and tribal justice. The behavior of killing both the daughter and her boyfriend is found all over *Islamdom* and among *Muslims* in the West.

The real reason for the honor-killing and the subsequent attack on *Taybeh* was because of: 1) *Islam*’s prohibition against *Muslim* women marrying or having sex with non-*Muslim* men (*K* 002:221; 060:010-011) and 2) for “spreading corruption in the land” (*K* 005:032). *Sharia* law also states:

...the penalties of a non-*Muslim* guilty of fornication with a *Muslim* woman are augmented because, in addition to the crime against morality, social duty and religion, he has committed sacrilege, in that he has disgraced a *Muslim* and thereby cast scorn upon the *Muslims* in general and so must be executed.<sup>912</sup>

<sup>909</sup> Sharon, Lapkin. “Palestinian ‘Honor,’” *FPM*, 20 Jan 2006.

<sup>910</sup> Feldinger, Lauren Gelfond. “Christians under cover,” *jpost.com*, 23 Feb 2006.

<sup>911</sup> Williamson, Lucy. “A frightening family feud,” *news.bbc.co.uk*, 10 Sep 2005.

<sup>912</sup> Bostom, Andrew G. “*Sufi Jihad?*” *americanthinker.com*, 15 May 2005.

The reason for the looting of *Taybeh* is not only is this is a part of *Jihad*, but *Muhammad* also asked for dowry payments whenever *Muslim* women went over to the infidel side (*K* 060:010). Looting is how *Muslims* retrieve the dowry that was lost after *Muslims* honor-killed their daughter.

*Muslims* often claim that honor-killings are an Arab cultural practice that stems from pre-*Islamic* pagan times. Pre-*Islamic* killings over honor probably involved assassinations and duels over accusations of cowardliness and such. Honor killings in the pre-*Islamic* world must have been rarer since it is hard to imagine many pagan men being overly concerned about what drives *Muslims* to kill their own daughters today.

The shame that commonly leads *Muslims* to kill their daughters or relatives is caused by the victim's infractions of *Sharia* law such as: a *Muslim* women is not to date or marry a non-*Muslim* man (*K* 002:221; 060:010-011). Most pagans would not mind if their daughter married outside the faith. *Muhammad* in fact never mentions pagans killing their daughters over honor, but he does mention their killing newborn daughters in order to avoid poverty (*K* 016:058-059).

Another reason that *Muslims* honor-kill is they think that otherwise, *Allah* will bring disaster upon the *Islamic* community, as repeatedly promised in the *Koran*. Pagans however generally were not concerned enough to kill over their children's chastity. Ibn Ishaq wrote that the first *Caliph*, *Abu Bakr* said:

Wickedness is never widespread in a people but God brings calamity upon them all.<sup>913</sup>

*Muslims* are taught to say reflexively that honor-killings occur among Christian Arabs and in other cultures. Juan Cole, the president of the Middle East Studies Association (MESA) tried to contextualize (or explain away) an honor-killing in *Basra, Iraq* by writing:

In Mediterranean culture, a man's honor tends to be wrought up with his ability to protect his womenfolk from seduction by strange men—August 8, 2005.<sup>914</sup>

While this assertion may or may not be true, what Cole failed to mention is that honor-killings are not endemic throughout the Mediterranean world—except in the *Islamic* regions. Besides, *Basra* is 800 miles away from the Mediterranean Sea and falls squarely in the Mideast and in *Islamdom*.

*Muslims* ignore the fact that non-*Muslims* within *Islamdom* may conduct honor-killings with the knowledge that conformity to *Islamic* norms means the unarmed minority will be somewhat safer from *Muslim* purists who are always ready to kill with impunity anyone or any community that “spreads corruption in the land” (*K* 005:032).

Just as *Muslims* ignore the fact that *Muslims* engage in terrorism at a **rate** far higher than non-*Muslims* due primarily to *Islam*'s deleterious influence, so they ignore the fact that honor-killings occur in *Islamdom* at a far high **rate** than outside *Islamdom* due to *Islam*'s deleterious influence. *The Jerusalem Post* states the truth of the matter:

Honor killings are unheard of among [Arab] Christians and that is why the murder of Faten Habash in *Ramallah* last week has shocked many Palestinians, including local [Arab] Christian families.<sup>915</sup>

<sup>913</sup> Ishaq. *Sirat*, p. 687.

<sup>914</sup> Joffe, A. H. “Juan Cole and the Decline of Middle Eastern Studies,” *FPM*, 15 Nov 2005, *MEQ*.

It would seem that the very few Christians who do honor kill do so only under the influence of *Islam*, and they are in the midst of a sea of *Muslims*—the only society where one can actually redeem his family's honor by killing a family member. In non-*Muslim* societies, honor killings make no sense since people would say “The issue whether ‘x’ rumor is true or not even worth mentioning now that he is a murderer.”

Any person breaking *Sharia* law is perceived as being an *Ipsa Facto* (Latin: by the very fact) apostate from *Islam* whose blood is *Halal*, meaning it is deemed permissible for anyone to kill that person.

While honor-killings may have occurred occasionally in pre-*Islamic* times, and even sometimes in modern non-*Muslim* cultures, the incidents were and still are extremely rare because there are fewer regulations and taboos outside of *Islam* to abide by, and breaking these regulations and taboos does not make one's blood instantly *Halal*. This is one reason why *Muslims* are rightly perceived as having a near monopoly on honor-killing crimes.

The other reason that *Muslims* are rightly perceived as having a near monopoly on honor-killing crimes is *Muslims*, and *Sharia* law, follow the traditions set down by *Muhammad*. *Sharia* law is designed to favor *Muslim* men and diminish the non-*Muslim* population. Naturally, it is very easy for *Muslims* to abuse the *Sharia* law system at the expense of a *Muslim* woman whose witness is worth half that of a *Muslim* man's (*K* 002:282), and a non-*Muslim*'s sworn testimony is not accepted at all in cases involving *Muslims* since *Muhammad* taught not to accept non-*Muslim* oaths (*Sahih Bukhari*, bk. 73, vol. 8).

How *Sharia* law is abused in honor-killing cases is not as well-known as how *Sharia* law is abused in rape and blasphemy cases. For instance, if a rape victim cannot produce four witnesses to prove rape (*K* 024:013), the rape victim is whipped for bringing false charges if the rapist denies the allegation. If the rapist says the sex was consensual, then the rape victim is convicted of fornication or adultery.

The *Koran* says that fornicators are to receive 100 lashes (*K* 024:002) and adulterers are to receive house arrest until death “or God **ordain** for them some (other) way” (*K* 004:015). Hence, most women never risk reporting a rape and just hope that they do not become pregnant. If they become pregnant, they may be tried for fornication or adultery. Needless to say, most rapists rape with near impunity in *Islamic* societies.

That *Sharia* law is an unequal justice system that favors *Muslims* men over *Muslim* women and infidels is a reason that *PrIslam* (*Prison Islam*) is so popular:

☛ As Gudrun Eussner said:

The *Muslim* male immigrants hate it in the USA because they are not totally free to live according to the *Sharia*. Women and children are entitled to call the police and sometimes do.<sup>915</sup>

☛ As Theodore Dalrymple wrote:

A man in prison who told me that he wanted to be a suicide bomber was more hate-filled than any man I have ever met...After a vicious rape for which he went to prison, he converted to a *Salafist* form of *Islam* and

<sup>915</sup> Abu Toameh, Khaled. “Bethlehem erupts in sectarian discord,” jpost.com, 9 May 2005.

<sup>916</sup> Glazov, Jamie. “Symposium: To Rape an Unveiled Woman,” *FPM*, 7 Mar 2006.

became convinced that any system of justice that could [ever] take the word of a mere woman over his own was irredeemably corrupt.<sup>917</sup>

It is well known that in *Muslim* countries such as *Pakistan*, non-*Muslims* are often falsely charged with blasphemy, defaming the Prophet, desecrating the *Koran* or saying something sacrilegious. Often the case does not make it to court or to appeal, because mobs and militias will exact vigilante justice. If the case does make it to court, the *Muslim* will automatically prevail since the sworn testimony of non-*Muslims* is devalued or not accepted in *Muslim* courts (*Sahih Bukhari*, bk. 73, vol. 8).

*Muslims* know they can nearly always prevail in court either as defendants or plaintiffs, so they feel free to abuse minorities who have no true recourse to the law. They also lodge false charges in order to counter-sue, bully, extort and settle personal scores and property disputes, and to rid their community of minorities. For instance:

- ☉ In late 2005 in *Pakistan*'s *Punjab* province in the town of *Kawanlit*, Iqbal bought property next to a twenty-year-old church. He started using church property for his animals and as a car park. When confronted, Iqbal's relatives, three men and twenty women, attacked the church by breaking windows, smashing the altar and burning Bibles. They also broke the legs of a seventy-year-old Christian woman and injured a fifty-year-old Christian woman. Then to compound the injustice, Iqbal opened a court case against eight Christians for starting the fight even though they were not present during the incident.<sup>918</sup>
- ☉ In 2006, reporters were covering a demonstration over the Danish Cartoons in the town of *Konya* in the *Anatolia* area of *Turkey*. Thirty men threw stones and shoes at a woman journalist that hit her on the head and shoulders. They called Aliye Cetinkaya a "slut" and a "blasphemer" because she was chewing gum, wearing jeans and had no head covering. The police did not intervene, so colleagues rescued her. Later, four men were identified from photos but only two were detained.<sup>919</sup> The *Islamist Association for Training, Research and Cooperation of the People*" (HEDA-DER) filed a police "complaint against Cetinkaya the same day, accusing her of disturbing the demonstration, an offence that carries a fine or between 18 months and three years imprisonment under a 1983 law on public demonstrations."<sup>920</sup>

In the same way that rapists and false accusers easily abuse *Sharia* law (as described above), so murderers also transform their acts of murder into an honor-killing thereby receiving a lesser sentence or, more often, no punishment at all. All the murderer need do is say that the victim blasphemed the Prophet or was "spreading corruption in the land" through heresy or prostitution or whatever and the *Sharia* courts will agree that the victim's blood was *Halal*, meaning it was permissible to kill the victim with impunity in accordance with *K* 005:032.

*Muhammad* approved of honor killings just like the honor killings we read about in today's newspapers. One *Hadith* reads:

<sup>917</sup> Dalrymple, Theodore. "The Suicide Bombers Among Us," city-journal.org, Autumn 2005.

<sup>918</sup> "Pakistan: Women Vandalize Catholic Church," compassdirect.org, 8 Feb 2006, *DW*.

<sup>919</sup> "Two detained over attack on journalist," ntvmsnbc.com, 13 Feb 2006, *C&R*.

<sup>920</sup> Police fail to stop attack on female journalist during anti-cartoons demonstration," Reporters Without Borders, rsf.org, 15 Feb 2006, gatewaypundit.

A blind man had a slave-mother who used to abuse the Prophet...and disparage him. He forbade her but she did not stop. He rebuked her but she did not give up her habit. One night she began to slander the Prophet...and abuse him. So he took a dagger, placed it on her belly, pressed it and killed her. A child who came between her legs was smeared with the blood that was there. When the morning came, the Prophet...was informed about it. Thereupon the Prophet...said: 'Oh be witness, no retaliation is payable for her blood' (*Sunan Abu Dawud* 38.4348).

Notice that the blind man was exonerated even though he probably made the whole story up about his wife blaspheming *Muhammad*. The ugly moral of this story is certainly not lost on honor-killers.

One can see both how today's *Islamic* honor-killings derive from the above *Hadith* and others like it, as well as from *K* 005:032 and cross-references; that is, by claiming that the victim of murder was a collaborator, prostitute, adulterer, fornicator, blasphemer or some such, a killer can completely exonerate himself in the eyes of *Muslims* and even become a folk hero, as *Ynet News* reports:

The men who know they will get off easy for murder... would not hesitate to give up several years of life for the guys in the neighborhood to think he's a 'real man,' a source of pride for the whole clan.<sup>921</sup>

*The Jerusalem Post* reported on one such killing where an excuse was given after the fact:

The same gunmen are also responsible for the...murder of two Christian teenage sisters from the Amr family [of Bethlehem]. The assailants then claimed that the sisters had been murdered because they were 'prostitutes' and had been 'collaborating' with *Israeli* security forces—a claim that has been strongly denied by the victims' relatives and many residents of the town... 'Some of the murderers were later killed by the *Israeli* army but others are now living in Europe after they had sought refuge in the Church of Nativity. It's absurd that *Muslim* men who...murder Christian girls are given political asylum in Christian countries like Ireland, Spain and Italy.'<sup>922</sup>

That the two women were not prostitutes is known from the autopsy, as *Cheisa* reported:

In 2002, two sisters of the Amre family, 17 and 19 years old, were executed by gunshot by a group of men close to the Palestinian Authority. The accusation was prostitution. But the autopsy revealed two things: first, they were virgins; and second, they had been tortured by having lit cigarettes applied to their genitals before they were executed.<sup>923</sup>

Honor-killings and *Sharia* law punishments that say a women with a "love child" must be killed after giving birth, or sometimes only after weaning the child, means that adoption agencies for orphans are a growth industry throughout *Islamdom*, as *Cheisa* reported:

In Bethlehem, there is a Christian institute called *La Crèche* (The Manger), which cares for newborns abandoned by their parents. 'They are the offspring of

<sup>921</sup> Hlehel, Ala. "Tradition of killing: Why won't Israel prosecute 'family killing' murderers?" *ynetnews.com*, 15 Nov 2005.

<sup>922</sup> *Abu* Toameh, K. "Away from the manger—a Christian-Muslim divide," *jpost.com*, 21 Oct 2005.

<sup>923</sup> Magister, Sandro. "The Custody Must Be Doubled in the Holy Land," *chiesa.espressonline.it*, 16 Nov 2005.



illegal relations cut off violently by the *Sharia*, the *Islamic* law that reigns supreme in the refugee camps,' the institute's directors explained to Elisa Pinna. 'Their number is growing. None of these children can be adopted by couples outside the country. It is prohibited; the Palestinian Authority doesn't want it. They must remain here, in Bethlehem. They must remain Palestinian and *Muslim*.'<sup>924</sup>

**Ingredient 10 (License-to-Deceive):** *Kitman*, *Takiya*, *Tu Quoque* (You do it too!) and Turnspeak (see the *Kitman* entry in the Glossary) are an integral part of an *Islamist's* Dr. Jekyll and Mr. Hyde personality. In fact, *Takiya* is acculturated even into moderate *Muslims* who seldom "come clean" about *Islam*, as Hugh Fitzgerald wrote:

We [Westerners] just cannot quite comprehend how deeply dyed by a culture of nonsense and lies and *Takiya* that comes with mother's milk, so that even those who seem to Westerners to be most full of rectitude are offering up some version (from mild to hot and spicy) of their refusal to come clean with the Infidels about *Islam* and what it inculcates, and how it shapes the attitudes, pervades the atmosphere, and is instinct in everything, that we find in *Muslim* societies such as *Pakistan*.<sup>925</sup>

*Muhammad* said that *Muslims* may do the deeds of the damned for as long as they live as long as their last act before dying is *Islamic*, as *Sahih Bukhari* related:

A man may do the deeds of the people of the Fire while in fact he is one of the people of Paradise... (the rewards of) the deeds are decided by the last actions (deeds) (*Sahih Bukhari*, vol. 8, bk. 77, no. 604; also see no. 593).

The biographies of *Muhammad's* life (*Sira*) relate that *Muhammad* gave permission to lie to at least two assassins:

☉ The assassin who lured Ka'b bin Ashraf to venture out of his home to his death (*Sahih Bukhari*, vol. 5, bk. 59, no. 369).

☉ Nu'aym, who then lied first to the *Makkan* pagans and then lied to the *Madinan* Jews during the Battle of the Trench.<sup>926</sup>

*Takiya* is in part based on *Muhammad's* statement that "war is deceit."<sup>927</sup> *Allah* also encourages *Muslims* to dissolve their oaths (e.g. treaties used to be confirmed by oaths) to non-*Muslims* (*K* 009:003; 066:002; *Bukhari* vol. 7, bk. 67, no. 427; vol. 9, bk. 89, no. 260).

*Muhammad* convinced himself that it would be foolish for *Muslims* to be honest since he believed that non-*Muslims* were open enemies of *Muslims* (*K* 004:101), and that non-*Muslims* are liars (*K* 016:039), evil (*K* 005:059), miscreants (*K* 024:055), perverts (*K* 063:004) and wicked (*K* 080:042).

*Muhammad* broke every treaty he ever entered into:

☉ The religious truce followed throughout Arabia from ancient times whereby there was supposed to be no fighting during four sacred months (*K* 009:005)—broken in 623 AD when *Muhammad* attacked a *Makkan* caravan during the sacred months.

<sup>924</sup> Magister, Sandro. "The Custody Must Be Doubled in the Holy Land," chiesa... *Idem*.

<sup>925</sup> Fitzgerald, Hugh. "The spoiled child of American diplomacy," *DW*, 3 Jan 2005.

<sup>926</sup> Lings. *Sources*, p. 225; see also Sina, Ali. "The Game of Deception," *JW*, 9 Jan 2005.

<sup>927</sup> *Sahih Bukhari*, vol. 4, bk. 52, nos. 267-270; also see *Sahih Muslim*, bk. 32, no. 6303.

- ☉ The mutual defense pact with Jews at *Madina* entered into on 622 or 623 AD—broken by 624 AD. *Muhammad* attacked three tribes of Jews, each on separate occasions (right after the Battles of *Badr*, *Uhud* and the Trench), even though Jews had not attacked *Muslims* in force.
- ☉ The ten-year *Al Hdaybiya* peace treaty with the *Makkans* (628 AD)—broken by 630, even though no *Makkan* had attacked a *Muslim* for three years—since the Battle of Trench in 627.
- ☉ The unspecified treaties that *Muhammad* had entered into with pagans. In 631 AD said he wanted *Muslims* to kill the pagans once the four sacred months were over (*K* 009:001, 005, 028-029).<sup>928</sup>
- ☉ Ryckmans wrote:

In 631 AD the Jewish and Christian communities in *Najran* [south of *Mekka*] formally accepted, in a convention with the Prophet *Muhammad*, the political domination of *Islam* in exchange for the right to continue to practice their religion.<sup>929</sup>

In 632 AD *Muhammad* said on his deathbed that all non-*Muslims* should be expelled from the Arabian Peninsula.<sup>930</sup> This broke the treaty with *Najran* contracted the year before and all other peace treaties not already broken.<sup>931</sup>

That *Muhammad* always intended to attack the places that he did, and that he was just waiting for a pretext to break a so-called “peace” treaty that he entered into out of convenience or necessity, is confirmed by tradition. *Muhammad*...

...waited for some act of aggression on the part of the Jews of *Khaybar*, whose fertile lands and villages he had destined for his followers...to furnish an excuse for an attack. But, no such opportunity offering, he resolved in the autumn of this year [i.e. 628] on a sudden and unprovoked invasion of their territory.<sup>932</sup>

Today, *Muslims* follow *Muhammad*'s example of citing pretexts before and after terrorist attacks, sometimes posthumously as when suicide-bomber leaves behind their last testaments on paper or video. If a pretext for inciting *Jihad* terror is weak or non-existent, *Islamists* will attack anyway as *Muhammad* did, or invent or embellish a pretext since after all, war is deceit:

- ☉ When twelve silly Danish *Muhammad* cartoons failed to rile *Islamdom* by 2006, a delegation of *Imams* from Denmark toured *Islamdom* and added three blasphemous cartoons sure to make *Muslims*' blood boil.<sup>933</sup>
- ☉ In 2006 *Muslim* youth “distributed pamphlets insulting *Muslims* in *Mutur*,” *Sri Lanka*, in order to agitate *Muslims* against the *Tamils*.<sup>934</sup>

*Muhammad*'s *Hdaybiya* example of limiting peace treaties to ten years may explain why Arab countries became belligerent with the Israelis in roughly ten-year intervals: 1948-1949 (War of Independence), 1956 (Suez Canal War), 1967 (Six-day

<sup>928</sup> Ishaq. *Sirat*, pp. 617-618, 620.

<sup>929</sup> Ryckmans. *Anchor*, v. 6, p. 175.

<sup>930</sup> *Muhammad*'s expulsion order that only *Muslims* be left on the Arabian Peninsula: Ishaq. *Sirat*, p. 689; Koelle. *Mohammedanism*, section ii:19, p. 231; *Sahih Bukhari*, vol. 4, bk. 52, no. 288; vol. 4, bk. 53, no. 393; vol. 5, bk. 59, no. 716; *Sahih Muslim*, bk. 019, no. 4366; and *Malik's Muwatta*, bk. 45, no. 5.18.

<sup>931</sup> *Sunan Abu-Dawud*, bk. 19, no. 3035.

<sup>932</sup> Bostom, Andrew. “Goebbels and the *Jihadist* Youth,” americanthinker.com, 11 Apr 2006.

<sup>933</sup> “Danish *Islamists* Fake Cartoons,” LGF, counterterror, 2 Feb 2006.

<sup>934</sup> “*Muslim* Youth Distributes Pamphlets Insulting *Muslims*,” SiberNews.com, 7 Jul 2006, *JW*.

War), 1973-1974 (*Yom Kippur/Ramadan War*), 1988-1992 (*Intifada I* uprising) and 2000-2004 (*Intifada II* uprising—ended by the security barrier).

The 1973 *Yom Kippur* or *Ramadan War* was a surprise offensive so naturally it occurred earlier than the ten-year mark, but then *Intifada I* put the schedule back on track. Incidentally, if there is no cease-fire, *Muslims* are supposed to go on *Jihad* annually according to *Sufi* scholar *Al-Ghazali* (1058-1127 AD).<sup>935</sup>

Arafat and his cronies started *Intifada I* and *II* at roughly ten-year intervals. Arafat even said he is using *Muhammad's Hudaybiya* ploy referring to the ten-year truce that *Muhammad* signed with the *Mekkans* but then, based on a flimsy pretext, broke within two years.<sup>936</sup>

Another way that *Muslims* follow *Muhammad's* “war is deceit” dictum is by calling for a ceasefire and talking peace right after *Muslims* ratchet up terror attacks, and right as non-*Muslims* gear up to retaliate. For instance:

☉ In May 2004, after fifteen *Israeli* soldiers were killed in one week, a spirited Arafat went on live Palestinian TV and told his people to “terrorize your enemy” (K 008:012, 057).<sup>937</sup> The next day Israel announced it was going to respond with force, and immediately Arafat called for a ceasefire.<sup>938</sup>

☉ In September 2004 *Israel* mobilized to invade *Gaza* to end incessant *Kassam* rocket attacks over the border. A *Hamas* leader promised that if *Israel* stopped the invasion, the *Kassam* attacks would stop.<sup>939</sup> *Israel* did not invade, but the *Kassams* never stopped falling on *Israel* even two years later.

☉ After waging an unprecedented terrorism campaign including bus-bombings,<sup>940</sup> *Hamas* unilaterally declared a cease-fire in January 2005. *Hamas* then entertained insincere peace proposals. The media bought into *Hamas'* feints at moderation and peace as though they were genuine:

★ In early 2005, the media said “a historic understanding” was reached even though nothing was ever signed and a *Hamas* leader said “*Hamas* reserves the right to return to its original demand [i.e. its claim on all of Palestine] in the future.”<sup>941</sup>

★ In 2006, the news headlines read “Haniyeh: Retreat to 1967 borders will bring peace.” *Hamas* leader Haniyeh did mention the word “peace” but left himself more than one out by referring to the *Hudaybiya* treaty and mentioning the “**government**.” He said:

If *Israel* withdraws to the 1967 borders, peace will prevail and we will implement a cease-fire [*Hudna*] for many years [i.e. ten years or whenever *Muslims* were strong enough to attack in accordance with the *Hudaybiya* treaty precedent discussed above]. Our **government** is prepared to maintain a long-term cease-fire with *Israel*.<sup>942</sup>

<sup>935</sup> Bostom, Andrew G. “*Sufi Jihad?*” americanthinker.com, 15 May 2005.

<sup>936</sup> Pipes, Daniel. “How Dare You Defame *Islam*,” *DP*, Nov 1999.

<sup>937</sup> “*Israel* Anniversary Marked by Bitterness,” foxnews.com, 15 May 2004, *JW*.

<sup>938</sup> “*Palestinians* call for ceasefire with *Israel*,” *Irish Examiner*, breakingnews.ie, 16 May 2004, *IsraPundit*.

<sup>939</sup> “*Hamas*: ‘stop offensive, we stop rockets,’” washingtontimes.com, 30 Sep 2004, C & R.

<sup>940</sup> “*Israel*: 2004 overview,” MIPT Terrorism Knowledge Base, tkb.org.

<sup>941</sup> Benhorin, Yitzhak. “Authority must carry out obligations,” ynetnews.com, 31 Mar 2005.

<sup>942</sup> Rubinstein, Danny. “Haniyeh: Retreat to 1967 borders will bring peace,” haaretz.com, 23 May 2006; “Haniyeh: Withdrawal will bring peace,” jpost.com, 23 May 2006.

Then later in that same interview Haniyeh hedged again and said he was only speaking as the leader of the Palestinian Authority (i.e. the “**government**”) and not as the leader of *Hamas*. When asked about changing the *Hamas* charter, Haniyeh said:

Leave *Hamas* aside now—I am speaking to you as the leader of the Palestinian government, the **government** of all the Palestinians, and not as the leader of a movement.<sup>943</sup>

So really Haniyeh was talking about changing nothing because the Palestinian Authority “government” has never officially been at war with Israel, but delegates terrorism to *Al-Aqsa* Martyrs Brigade, *Hamas*, etc.

The real reasons that *Hamas* claims to abide by a cease-fire are to:

- ★ Buy time to re-arm and recruit.
- ★ Cast Israeli retaliation (e.g. targeted killings) over the bus-bombing campaign and rash of terror attacks as violations of a ceasefire.
- ★ Portray Israel as a belligerent party that sabotages peace efforts.<sup>944</sup>
- ★ Demand that in exchange for extending the ceasefire, Israel release thousands of security prisoners in Israeli jails,<sup>945</sup> even those convicted of murder,<sup>946</sup> despite the fact that the Palestinians are unwilling to release an alleged collaborator in exchange.<sup>947</sup>

The *Tafsir* of *Ibn Kathir* (died 774 AH/1372 AD) commented on *K* 003:028 that a *Muslim* was “allowed to show friendship to the disbelievers outwardly, but never inwardly” if the *Muslim* feared for his safety. *Ibn Kathir* wrote:

*Al-Bukhari* recorded that [the early *Muslim*] *Abu Ad-Darda*’ said ‘We smile in the face of some people although our hearts curse them.’ *Al-Bukhari* said that *Al-Hasan* said ‘The *Tuqyah* [*Takiya*] is allowed until the Day of Resurrection’ (tafsir.com on *K* 003:028).

The *Takiya* doctrine has led some *Muslim* terrorists to boast of their prowess and self-control, such as in 2004 *Tarik Ibn Osman Shah* said:

I could be joking and smiling and then cutting their throats in the next second.<sup>948</sup>

There are many cases where *Islamists* use *Takiya* to trick or deceive people who have caused *Muslims* any sort of grief such as apostates from *Islam*, daughters and sons they consider wayward, blasphemers and detractors of *Islam*. The idea is to trick them into thinking that all is well and forgiven only to get the offending party to drop his guard so the *Islamists* have an opportunity to kill him or her. For instance, in *Pakistan* in 2005, *Nazir Ahmad*’s daughter “married the man of her choice against her father’s wishes.” *Ahmad* “contacted his daughter...saying he was ready to forgive her,” but when she visited, he slit her throat and her three younger sisters throats too so they would not have the chance to follow in her footsteps.<sup>949</sup>

<sup>943</sup> Rubinstein, Danny. “Haniyeh: Retreat to 1967 borders will bring peace,” *haaretz.com*, *Ibid*.

<sup>944</sup> Dudkevitch, Margot. “2,990 terror attacks during 2005 ‘truce,’” *jpost.com*, 2 Jan 2006.

<sup>945</sup> Benn, Aluf & Amos Harel. “PM: PA must end terror before peace talks can resume,” *haaretz.com*, 4 Feb 2005.

<sup>946</sup> Saadeh, Diala. “Palestinians Seek Wider Prisoner Release by Israel,” *news.yahoo.com*, 4 Feb 2005, *LGF*.

<sup>947</sup> Waked, Ali. “Death to traitors,” *ynetnews.com*, 11 Mar 2005.

<sup>948</sup> Chiarmonte, Perry & Lorena Mongelli & Andy Geller. “Bx [Bronxe] ‘*Qaeda*’ Man’s Chilling Boast,” *nypost.com*, 31 May 2005, *JW*, C&R, 1 Jun 2005.

<sup>949</sup> “*Pakistani* Man Kills Daughter for Marrying,” *news.yahoo.com*, 24 Dec 2005, *C&R*.

*Islamists* will also trick infidels into paying ransom money and trading hostages, as when Susan Osthoff was kidnapped. The German government paid five million USD and released a terrorist, Hamadi, who had killed a US soldier years earlier. “German authorities had in the past tried to use Hamadi as a bargaining chip to free German hostages held in Lebanon.”<sup>950</sup>

Osthoff turned out to be a *Muslim* convert, and it turns out the hostage-takers had told her “we do not harm women or children, and you are *Muslim*.”<sup>951</sup> Osthoff later defended her captors saying they were not “criminals” and she “cannot blame them for kidnapping her, as they cannot enter (*Baghdad*’s heavily fortified) Green Zone to kidnap Americans.”<sup>952</sup>

Upon release, Osthoff was found to have several thousand dollars that matched the serial numbers of the ransom notes. Osthoff did not cooperate with German intelligence during her debriefings, and she gave an interview on German TV wearing a *Burqa* that covered all but her eyes.<sup>953</sup> Osthoff announced on *Al-Jazeera* TV that she was immediately returning to *Iraq* to build a German cultural centre in *Arbil*—to the chagrin of the German government.<sup>954</sup>

*Islamists* use *Takiya* to pass themselves off as being tolerant, for instance:

☉ In 2005 German authorities banned the *Multi-Kultur-Haus* association and deported two *Imams* for their hate-sermons and literature, and because two *Jihadists* killed in *Chechnya* had attended their *Mosque*.<sup>955</sup>

☉ In 2005 US authorities had to deport a self-declared moderate *Imam*, Fawaz Damra, for supporting terrorism. He even signed the *Fikh* Council of North American’s *Fatwa* in 2005 that condemned terrorism.<sup>956</sup>

☉ In 2004 it was reported that a California police official said:

We’ll come back from a *Kumbayah* meeting with a local *Mosque* and realize that these guys who just agreed to help us are in our terror files! Then there’s the inevitable phone call from the imam three weeks later: ‘You need to check this guy out,’ and it turns out that the ‘suspect’ has been opposing the *Imam* in local power plays.<sup>957</sup>

☉ In 2006, Dahou Meskine and his son were arrested over money laundering to fund terrorism.<sup>958</sup> Meskine was the *Imam* of the *Clichy-Sous-Bois Mosque* and was Secretary General of the Council for *Imams*, a council backed by the French government to promote tolerant *Islam* and ventures that “counter the rising *Islamophobia* phenomenon.”<sup>959</sup>

<sup>950</sup> Goodenough, Patrick. “German Trade-off Suspected in Release of Terrorist Killer,” CNSNews.com, 22 Dec 2005.

<sup>951</sup> “Freed German hostage says *Iraq* captors not criminals,” news.yahoo.com, 26 Dec 2005.

<sup>952</sup> “Freed German hostage says *Iraq* captors not criminals,” news.yahoo.com, 26 Dec 2005.

<sup>953</sup> Diehl, Von Jörg, Lambeck, Martin S. & Schlichtmann, Klaus. “*Hat sie uns alle belogen? Osthoff mit Lösegeld erwischt*,” bild.t-online.de, 21 Jan 2006.

<sup>954</sup> Boyes, Roger. “Ex-hostage’s *Iraq* return angers her rescue team,” timesonline.co.uk, 28 Dec 2005, tigerhawk.blogspot.com, michellemalkin.com.

<sup>955</sup> Graham, Stephen. “German authorities ban *Islamic* group accused of extremism,” jpost.com, 28 Dec 2005.

<sup>956</sup> Spencer, Robert. “Radioactive *Mosques*?” *FPM*, 28 Dec 2005.

<sup>957</sup> MacDonald, Heather. “Homeland Security? Not Yet,” *City Journal*, *FPM*, 16 Nov 2004.

<sup>958</sup> Yahmid, Hadi. “French *Imam* Arrested on Money Laundering,” islam-online.net, 21 Jun 2006, *LGF*, counterterrorismblog.org.

<sup>959</sup> Yahmid, Hadi. “French *Islamic* Institute Fights *Islamophobia*,” islam-online.net, 15 Jun 2006, *LGF*, counterterrorismblog.org.

- More examples of *Taqiyya* are given in the Externalizing Blame section of this Khidr-Second Lamech table.

*Takiya* is also based on *K* 002:225; 003:028; 004:101; 005:003b, 089; 006:119, 145; 016:106 and 040:028 where *Muhammad* says that if *Muslims* feel compelled to do so, or fear the enemy, *Allah* allowed *Muslims* to feign friendship with infidels, hedge on the truth, suspend *Halal* dietary rules and *Salat* prayer and otherwise deceive infidels with impunity. Tad Trueblood wrote of how terrorists use *Takiya*:

*Takiya* is practicing the art of deception by adopting Western dress, lifestyle and habits in order to better blend in. Adherents are encouraged to essentially abandon traditional *Islamic* values, so that they can better fight the holy war in *Islam*'s name. This justifies all sorts of very un-*Islamic* behavior, including shaving beards, frequenting nightclubs and strip joints, engaging in fraud and petty crime, drug use and drug dealing and of course murdering innocent people.<sup>960</sup>

Based on the *Takiya* principle described above, *Muslims* may befriend and ally with non-*Muslims* who they do not particularly fear in order to strengthen their position against a mutual enemy. However, as soon as the mutual threat has faded or been defeated, *Muslims* are supposed to revert back to not befriending non-*Muslims*—breaking treaties, if necessary. The *Jihad* then ensues against the former ally based on some frivolous pretext. One counter-terrorism site said:

Like many *Islamic* concepts *Takiya* and *Kitman* were formed within the context of the Arab-*Islamic* matrix of tribalism, expansionary warfare and conflict. *Takiya* has been used by *Muslims* since the 7th century to confuse and split 'the enemy.' A favored tactic was 'deceptive triangulation'; to persuade the enemy that *Jihad* was not aimed at them but at another enemy. Another tactic was to deny that there was *Jihad* at all. The fate for such faulty assessments by the target was death.<sup>961</sup>

A textbook example of 'deceptive triangulation' comes from the Battle of the Trench. No one but the *Muslims* knew of Nu'aym's conversion to *Islam*, so *Muhammad* told him:

'To the utmost of your power...set them at odds with each other.' Nu'aym asked permission to lie and the Prophet said 'Say what you will to draw them off from us, for war is deception.'<sup>962</sup>

Nu'aym went to the *Kurayza* Jews secretly and told them that the *Makkan* pagans would leave them in the lurch unless they demanded hostages. Then Nu'aym went secretly to the *Makkans* and said that Jews were going to demand hostages who they would then turn over *Muhammad* to be beheaded.<sup>963</sup>

When the *Makkans* approached Jews to become allies, Jews demanded hostages as Nu'aym advised, while the *Makkans* figured this was a trap of which they had been apprised. So, lacking allies, the *Makkans* left *Madina*. The *Muslims* successfully triangulated the *Makkan* pagans against Jews, leaving Jews to be slaughtered and sold into slavery. The duped *Makkans* were later conquered.

<sup>960</sup> Trueblood, Tad. "Modern-day assassins form nucleus of *Islamic* terrorism," thespectrum.com, 18 May 2005.

<sup>961</sup> *Takkiya* and *Kitman*: The role of Deception in *Islamic* terrorism," Counter-Intelligence, Counter-Espionage and Counter-terrorism, ci-ce-ct.com, 2 Dec 2002.

<sup>962</sup> Lings. *Sources*, p. 225; see also Sina, Ali. "The Game of Deception," *JW*, 9 Jan 2005.

<sup>963</sup> Ishaq. *Sirat*, pp. 458-459.

See the Deceptive Triangulation table later in this chapter for modern examples of *Takiya*.

**Ingredient 11 (Gangland Uniforms):** Before the discussion of distinctively *Islamic* clothing and *Muslim* prostration marks begins in earnest, mention should be made of how many things are marked as being *Islamic*. Of course *Korans* and *Mosques* are distinctively marked but so are private cars. This fact is of consequence for those times when *Muslims* riot, for instance:

- ☉ During the French *Muslim* riot of 2005, “rioters torch only ‘white’ cars, meaning white-owned cars, and spare ‘*Islamic*’ or ‘black’ ones [i.e. most *Muslims* in France are from North Africa]. One way to discriminate between them is to look for ethnic signs like a sticker with *Koranic* verses or a picture of the *Kaaba* in *Mekka* or a stylized map of Africa.”<sup>964</sup>
- ☉ David Parsons wrote that in 1999, at the Basilica of the Annunciation at *Nazareth*, “*Muslim* gangs stoned worshippers, torched shops and smashed windshields of cars with crosses dangling from their mirrors...”<sup>965</sup>

Targeted riots leaving just non-*Muslims* carless and reliant upon walking or the public transportation system is reminiscent of how during *Islam*’s heyday, *Dhimmi*s were restricted to walking or riding donkeys with wooden saddles, while *Muslims* rode horses and camels.

It was noted in the “*Allah* as a Moon-god” section in the chapter on the Moon-o-theistic Mideast that *Muslims* wear *Sin*-the-moon-god approved beards and attire. *Islamists*’ favorite clothing is a loose-fitting smock with long sleeves (*Galabiyya*, *Dishdash*) similar to what *Sin* is pictured as wearing on steles. This moon-god attire and beard imitate the bearded billy-goat and ibex, both moon-god animals in South Arabia.

*Allah* commanded that *Muhammad* grow a long beard. *Muhammad* said:

My Lord [*Allah* the moon-god] hath [has] bidden [bid] me grow my beard and cut my moustache.<sup>966</sup>

*Muhammad* is the “perfect exemplar” that *Muslims* are to follow (*K* 033:021; see also *K* 004:059, 115; 053:002). Because *Muslims* imitate *Muhammad* and because *Allah* dictated the style of *Muhammad*’s beard, any criticism of a *Muslim*’s beard is considered blasphemy—a capital offense in *Islamdom*. Thus we read of people being arrested in *Islamdom* for criticizing a *Muslim*’s beard:

- ☉ In *Pakistan* in 2005. The Associated Press reported:

Masih had been arrested in July after a Christian convert to *Islam* allegedly reported to police that Masih insulted his ***Islamic beard***...[After his acquittal] Masih was in hiding and his life was in danger. ‘The people from the militant organization frequently visit his family and demand that he (Masih) be handed over to them,’ he said. Under *Pakistan*’s harsh blasphemy laws, insulting *Islam* or its prophet *Muhammad* is an offense and the offender can be punished by death.<sup>967</sup>

- ☉ In *Saudi Arabia* in 2005. *The Australian* reported:

<sup>964</sup> Gurfinkiel, Michel. “France Facing ‘Horrendous’ Balance Sheet,” nysun.com, 8 Nov 2005, *DP*.

<sup>965</sup> Parsons, David. “The Galilee Gauntlet,” *Middle East Digest*, May 1999, vol. 10, no. 5, christianactionforisrael.org (the Baptist man was Saleh Salami, a college student).

<sup>966</sup> Lings. *Sources*, p. 260.

<sup>967</sup> “Militants threaten Christian man in *Pakistan* after his acquittal in blasphemy case,” asia.news.yahoo.com, 27 Jan 2005, *DW*, 28 Jan 2005.

A *Saudi* academic has been sentenced to 200 lashes...four months in prison and banned from publishing...for insulting an *Islamist* colleague...[the] lecturer in linguistics at King *Saud* University was accused by...a [*Salafist*] lecturer of *Islamic* culture at the same university...of ‘mocking **long beards**’ and questioning his knowledge in an article published a few months ago...<sup>968</sup>

Not smirking when one sees an *Islamic* beard sometimes takes concentration because some *Muslims* copy *Muhammad* more closely than others do. For instance, *Sheikh Mohammad Abu Tir*, a *Hamas* member of parliament in 2006, dyes his beard carrot orange with *Henna*,<sup>969</sup> as do Belgian *Islamist* Jean-Francois Bastin, and *Somalian Islamist Sheik Hassan Dahir Aweys*.<sup>970</sup> Why? *Muhammad* sometimes dyed his beard yellow with saffron, but other times orange with *Henna*.<sup>971</sup> *Muhammad* also dyed his locks of hair that “reached his shoulders” orange with *Henna*.<sup>972</sup>

Two “Rightly-Guided” *Caliphs*, *Abu Bakr* and *Umar* also dyed their hair with *Henna* (*Sahih Muslim*, bk. 30, nos. 5779, 5782), but *Abu Bakr* added *Katam* to *Henna* so his hair turned out red (*Sahih Bukhari*, v. 5, bk. 58, no. 257). *Muhammad* said he liked hair that was dyed red, but preferred hair dyed orange like his own, or yellow with saffron (*Sunan Abu-Dawud*, bk. 33, no. 4199).

*Muhammad* wore green garments (*Sunan Abu-Dawud*, bk. 33, no. 4194), so when his hair was orange, he looked like a bearded Ronald McDonald™ clown wearing a pickle suit. When his hair was yellow, he would have looked like a designer green-and-yellow Q-tip™ (a cotton-tipped swab).

No wonder depictions of *Muhammad* are outlawed in *Islam* since his true appearance was beyond embarrassment. Moreover, this explains why he had to pick up the sword to get more followers—only so many *Mekkans* were colorblind!

Pious *Muslim* women wear headscarves and veils (*Hijabs*) and are called *Muhajaba*. Pious *Muslim* men are singled out by their “prostration mark” (*K* 048:029), a dark callus that develops from touching the forehead the head to the ground during the mandatory five prayers and supererogatory prayers.

That the purpose of the prostration mark is meant to separate and set *Muslims* above non-*Muslims* can be seen in the *Koran*:

- ☉ *K* 048:028, the verse just prior to the verse mentioning the prostration mark, says *Islam* prevails over all other religions,
- ☉ The verse mentioning the prostration mark (*K* 048:029) speaks of how:
  - ★ *Muslims* “are strong against unbelievers but are compassionate amongst each other,”
  - ★ Non-*Muslims* see *Dawa* evangelism efforts flourish and that “fills the unbelievers with rage at” *Muslims*.

In order to show they are committed *Islamists*, some *Muslims* speed along the creation of their callus. If their *Mosque* is carpeted and soft, they place on the carpet a rough unglazed fired tablets the size of a business card made from sand and clay

<sup>968</sup> “200 lashes for ‘mocking long beards,’” theaustralian.news.com.au, 21 Mar 2005, C & R.

<sup>969</sup> Wikipedia.org, *Muhammad Abu Tir* (a.k.a. Shei *Abu Mus’ab*) entry, accessed 18 Apr 2006.

<sup>970</sup> “Aussie” Dave. “Seeing more red,” israellycool.com, 25+26 Jun 2006; hotair.com.

<sup>971</sup> *Sunan Abu-Dawud*, bk. 33, nos. 4196 (beard with henna) + 4198 (beard with saffron).

<sup>972</sup> Margoliouth. *Rise*, pp. 88-89, 104-106, as quoted in Warraq. *Why*, p. 91.



from the Mideast.<sup>973</sup> The prostration marks, beards and clothing single out *Islamists* from regular *Muslims*, for instance:

*Zanzibar's Mosques* are fuller on Fridays, more women are wearing headscarves and more *Muslim* men are showing calluses created by frequently touching their foreheads to the ground in prayer.<sup>974</sup>

When the *Islamist* group *Hamas* took over *Gaza* and the West Bank in 2006, the new interior minister, *Said al-Siyam*, gave a directive that policemen should grow beards.<sup>975</sup> *The Guardian* reported that in *Saudi Arabia*, “Beards are seen as a sign of a committed *Muslim* in this religious society.”<sup>976</sup> In many neighborhoods in *Egypt*...

...headscarves are a must, even for women in jeans. The more religious wear the *Niqab*, a veil covering the entire face except for the eyes.<sup>977</sup>

The prostration marks, grooming and clothing make it easy for *Islamists* **not** to mingle with or greet lax *Muslims* or non-*Muslims* with the customary greeting: “*as-Salamu ‘alaykum* (“Peace be with you”).<sup>978</sup> *Muslims* are not supposed to initiate a greeting with non-*Muslims*, but if a non-*Muslim* greets them, they are to respond with “Peace be upon the rightly guided.”<sup>979</sup> This is not a genuine greeting at all since it means “Peace be only upon *Muslims*” and not infidels.<sup>980</sup> *Islamist* literature enlightens more on this point:

C The *Andalusian Maliki* jurist *Ibn Abdun* (died 1134 AD) ruled ~1100 AD that:

No...Jew or Christian may be allowed to wear the dress of an aristocrat, nor of a jurist, nor of a wealthy individual; on the contrary, they must be detested and avoided. It is forbidden to [greet] them with the [expression], ‘Peace be upon you’. In effect, ‘Satan has gained possession of them and caused them to forget God’s warning. They are the confederates of Satan’s party; Satan’s confederates will surely be the losers!’ [*Dawood K* 058:019]). A distinctive sign must be imposed upon them in order that they may be recognized and this will be for them a form of disgrace.<sup>981</sup>

C In 2005 the US Congress was informed about *Saudi* literature in *Mosques*:

...a booklet distributed by the *Saudi* Embassy in Washington offers instructions on how to ‘build a wall of resentment’ between *Muslims* and infidels, said Nina Shea, director of the Center for Religious Freedom. Among the book’s directives: ‘Never greet the Christian or Jew first. Never congratulate the infidel on his holiday. Never befriend

<sup>973</sup> “An American Faith: A mosque in Detroit stands as a testament to *Islam*’s integration,” cleveland.com, 13 Aug 2005.

<sup>974</sup> Ngowi, R. “*Zanzibaris* Adopting Stricter Form of *Islam*,” news.yahoo.com, 4 Jul 2005, *JW*.

<sup>975</sup> Colvin, Marie. “*Al-Qaeda* goes recruiting in festering *Gaza*,” *The Sunday Times*, timesonline.co.uk, 9 Apr 2006, *JW*.

<sup>976</sup> Nasrawi, Salah. “*Islamists* Dominate *Saudi Arabia* Elections,” guardian.co.uk, 24 Apr 2005.

<sup>977</sup> El Deeb, Sarah. “Cairo a Breeding Ground for Militants,” news.yahoo.com, 7 May 2005, *JW*.

<sup>978</sup> ‘*Umdat al-Salik*, o11.5 (3-4); Spencer, Robert. “This is a *Saudi* textbook,” *JW*, 22 May 2006.

<sup>979</sup> Also translated as “Peace only unto those who follow the true path.” The Arabic is variously transliterated as “*As-salaamu alaa manitaba al-Huda*” or “*Vasalam Ala Man Ataba ‘al hoda*.”

<sup>980</sup> Spencer, Robert. “Dear unclean infidel dog...,” *JW*, 8 May 2006.

<sup>981</sup> Bostom, Andrew G. “*Eurabia*’s Morass Elicits Mythical ‘Solutions,’” americanthinker.com, 24 Nov 2005.

an infidel unless it is to convert him. Never imitate the infidel. Never work for an infidel.<sup>982</sup>

*Islamists* really do follow this non-greeting prescription, for instance:

- ☉ In Canada in 2006, after an *Islamist* was arrested for terrorism, a neighbor recalled, “One thing I can tell you for sure—this guy was weird. There was one time I said ‘Hi,’ and he just looked at me. That was it.”<sup>983</sup>
- ☉ In Egypt in 2005, Refaat Abdel Hadi, a plumber in his 50s, said *Islamists* do not mingle with the rest of *Shubra el-Kheima*’s population. ‘A passing by *Sunni* will not salute me, only another *Sunni* like himself.’<sup>984</sup>
- ☉ The UK in 2004, *The Independent* reported about the transformation of one of the 7/7 suicide-bombers who bombed the London *Tube* subway:  
A series of setbacks in Hussain’s life may be behind a sudden change from a British Asian who dressed in Western clothes to a religious teenager who wore *Islamic* garb and only stopped to say ‘*Salaam*’ [“Peace”] to fellow *Muslims*.<sup>985</sup>
- ☉ The UK in 2004, a *Muslim* convert in the UK wrote that when she donned the veil, *Muslims* who never greeted her before started to greet her about town and she made friends with some of them.<sup>986</sup>
- ☉ In 2006, the *Iranian* president Ahmadinejad wrote a letter to US President George Bush that used the phrase “Peace only unto those who follow the true path” in the closing salutation.<sup>987</sup>

The *Islamic* behavior of not greeting, and not making friends with, unbelievers contrasts greatly with Christian behavior:

- ☉ Western civilization was inspired by Jesus’ Good Samaritan parable.
- ☉ Jesus said to love and pray for one’s enemies (Mat 05:43-44).
- ☉ *Muhammad* taught that the *Muslim* version of Jesus said “Go in peace,” to pigs.<sup>988</sup> The real Jesus did say that Christians should greet everyone and not just fellow Christians (Mat 05:47).

At first *Islamists* do not greet non-*Muslims*—as identified by their grooming and attire—with the traditional greeting of *as-Salamu ‘alaykum* (“Peace be with you”).<sup>989</sup> Over time the non-politeness ratchets up to the point where:

- ☉ Non-*Muslims*, including schoolchildren, are roughed up on the street.
- ☉ Non-*Muslim* women cannot walk outside un-veiled without suffering verbal harassment, e.g. being called “whore,” and without being: 1) assaulted and raped, 2) shot in drive-by shootings and 3) having acid splashed in the face.<sup>990</sup> Thus in *Iraq* in 2005, “women keep a black *Hijab* on the peg by the door to wear when venturing outside. Women who never wore the headscarf

<sup>982</sup> Matthews, William. “U.S. Lawmakers Told of Saudi-Funded Anti-West Rhetoric,” *defensenews.com*, 8 Nov 2005, *C&R*.

<sup>983</sup> McArthur, Greg. “*Mosque* was warned about suspect,” *theglobeandmail.com*, 5 Jun 2006.

<sup>984</sup> El Deeb, Sarah. “Cairo a Breeding Ground for Militants,” *news.yahoo.com*, 7 May 2005, *JW*.

<sup>985</sup> Akbar, Arifa & Ian Herbert “Hasib Hussain: The boy who grew up to bomb the No 30 bus,” *news.independent.co.uk*, 14 July 2005.

<sup>986</sup> “My Story: *Hijab* and Me,” *MCBDirect (Muslim Council of Britain’s Community Information Service)*, 15 Jun 2004.

<sup>987</sup> “Editorial: *Iran* Declares War,” *New York Sun*, *nysun.com*, 11 May 2006.

<sup>988</sup> *Malik’s Muwatta*, no. 56.1.4.

<sup>989</sup> ‘*Umdat al-Salik*, o11.5 (3-4); Spencer, Robert. “This is a *Saudi* textbook,” *JW*, 22 May 2006.

<sup>990</sup> Caldwell, Christopher. “A Swedish Dilemma,” *weeklystandard.com*, 28 Feb 2005, vol. 10, issue 22, *DW*, 19 Feb 2005.

turn to it for safety.”<sup>991</sup> In 2006 after *Hamas* won election, Christian women in the West Bank started wearing long sleeves and scarves to “play it safe and assimilate on the street.”<sup>992</sup>

- ☉ Ethnic-cleansing occurs when non-*Muslims* are convinced to leave or are forced out, unless non-*Muslims* sue for peace and become *Dhimmis*.

A cultural war based on clothing and grooming is all by *Muhammad*’s design. *Islamic* historians record that a Persian viceroy sent two envoys to *Muhammad* who noticed that the envoys shaved their face, but grew a long mustache—as was customary in the Persian court.<sup>993</sup> After the Persian envoys left, *Muhammad* commanded *Muslims* to weaponize their clothing and beards against the “fire-worshippers”—a term he used for *Sassanian Zoroastrians*. *Muhammad* said:

- ☉ Trim closely the moustache and grow a beard, and thus act against the fire-worshippers (*Sahih Muslim*, bk. 002, no. 0500).
- ☉ Act against the polytheists, trim closely the moustache and grow a beard (*Sahih Muslim*, bk. 002, no. 0501).

*Islamists* do not want to dress or groom like non-*Muslims* or have their women forego veiling in public because *Muhammad* said:

- ☉ He who copies any people [in matters of clothing] is one of them (*Sunan Abu-Dawud*, bk. 32 “Clothing” (*Kitab Al-Libas*), no. 4020).
- ☉ They would like you to be *Kafir* [unbelievers] as they are *Kafir*, so that you will all be the same (*K* 004:089a).

Not surprisingly, *Islamists* are the first to refuse to compromise on clothing:

- ☉ In 2005, *Shaykh* Dr. Abdalqadir *As-Sufi* issued an edict on the French headscarf ban in public institutions. He started out his *Fatwa* entitled “*Fatwa* on Women’s Headscarves” by quoting *K* 004:089a.<sup>994</sup>
- ☉ In 2005, Belgium outlawed *Niqabs* (face veils) and *Burkas* (all enveloping robes). A *Moroccan* woman was fined, but refused to pay the fine and comply with the new law. Not surprisingly...

...The woman’s husband was named in a *Brussels* court yesterday as one of 13 men accused of aiding and abetting terrorists linked to the *Madrid* [Spain 3/11] train bombings.<sup>995</sup>

- ☉ In 2004 in the UK, a schoolgirl refused to wear the school uniform, the *Shalwar Kameez*, which is a combination of trousers and a tunic, because, as the government side argued, she saw “it is a dress worn by non-believers and [so it was] not suitable for that reason.”<sup>996</sup>

Not surprisingly, it was the *Hizb ut-Tahrir* (*HuT*) *Islamists*, a radical group banned in several countries, who convinced the girl to lodge the lawsuit. The aim was to force the school to allow her to wear a *Jilbab* so *Muslims* would not need to dress the same as the *Hindu* and *Sikh* pupils.<sup>997</sup> A

<sup>991</sup> Piper, Elizabeth. “*Iraqi* women defy threats in fight for political clout,” news.yahoo.com, 21 Mar 2005.

<sup>992</sup> Feldinger, Lauren Gelfond. “Christians under cover,” jpost.com, 23 Feb 2006.

<sup>993</sup> Lings. *Sources*, p. 260.

<sup>994</sup> “*Fatwa* on Women’s Head-scarves,” issued by *Shaykh* Dr. Abdalqadir *As-Sufi*, 12 Mar 2005.

<sup>995</sup> Rennie, David. “Woman defies law banning the *Burqa*,” telegraph.co.uk, 30 Aug 2005.

<sup>996</sup> Rozenberg, Joshua. “Pupil refused to wear uniform of ‘non-believers,’” telegraph.co.uk, 8 Feb 2006, C&R.

<sup>997</sup> Hellen, Nicholas and Nina Goswami. “Revealed: radicals who backed girl in dress fight,” timesonline.co.uk, 20 Jun 2004, LGF.

*Jilbab* is an ankle-length gown that covers the entire body except for the face and hands.

Uniforms are known to affect the mindset and behavior of both the wearer and those who see the uniforms. Beards and veils help *Muslims* (i.e. *Allah's* caped and bearded crusaders) to tailor their thinking and personal and collective behavior to the code described in this Khidr-Second Lamech table. So whenever an *Islamic* terrorist is arrested, the usual refrains heard in the news are the:

- 1) Police are over-zealous bigots because “He’s innocent. He’s [a] very humble, peaceful brother.”<sup>998</sup>
- 2) Accused is being tortured in jail<sup>999</sup> (an accusation an *Al-Qaeda* manual says the brothers “must” lodge<sup>1000</sup>).
- 3) Accused recently grew a beard and started to wear *Islamic* garb recently. For instance:
  - ★ The AP reported in 2004 that *Muhammad* Bouyeri, the killer of moviemaker Theo van Gogh “grew radical...in Fall 2002. He began wearing traditional *Muslim* dress, grew a beard and attended a *Mosque* where key September 11 hijackers and plotters had reportedly met, including Mohamed Atta.”<sup>1001</sup>
  - ★ In 2006 Canadian police arrested twelve homegrown *Jihadists*. Though they dressed differently and came from “a broad ‘strata’ of society,” nevertheless they all “sport traditional *Muslim* male beards.”<sup>1002</sup>
  - ★ The 7/7/2005 London bombers came from Leeds and Beeston 200 miles north of London where the men attending the *Mosques* are “all dressed in traditional *Salwar Kameez* and the obligatory religious hat.”<sup>1003</sup>

The *Islamic* garb also conceals the identity of *Jihadists*, *Islamic* terrorists and their supporters from the police and military. For instance:

- C In 2005, when London police quickly identified the four 7/7 suicide bombers from surveillance footage, *Imam* Omar Bakri said...
  - ...they [the bombers and their handler] should have covered their faces to conceal their identity from prying CCTV cameras.<sup>1004</sup>
- C In 2006, during the worldwide Danish cartoon protests and riots, some London protesters held up signs with slogans such as “Butcher those who mock *Islam*,” “Be Prepared for the Real Holocaust,”<sup>1005</sup> and “UK you must pray. 7/7 on its way. UK you must pay. *Bin Laden* is on his way.”<sup>1006</sup> Because *Muslim* garb for women is so concealing, and because *Muslim* men

<sup>998</sup> Campion-Smith, Bruce & Michelle Shepherd. “Plan to ‘behead’ PM,” Toronto Star, thestar.com, 7 Jun 2006, *JW*.

<sup>999</sup> “Lawyers Allege Terror Suspects Being Tortured In Jail,” citynews.ca, 12 Jun 2006, *JW*.

<sup>1000</sup> “*Al Qaeda* 101: The *Jihad* manual,” globalnational.com, canada.com, 14 Jun 2006; “*Al-Qaeda* Manual UK/BM:176-180 Translation: Lesson 18: Prisons & Detention Centers,” disastercenter.com, accessed 12 Jun 2006, *JW*.

<sup>1001</sup> Spencer, Robert. “Turning students into terrorists,” *JW*, 9 Nov 2004.

<sup>1002</sup> Freeze, Colin. “Terror suspects appear in court,” theglobeandmail.com, 3 Jun 2006, michelemalkin.com, *JW*.

<sup>1003</sup> “Young, British and *Muslim*,” observer.guardian.co.uk, 18 Jun 2006, terrorismunveiled.com.

<sup>1004</sup> “Focus: Undercover in the academy of hatred,” timesonline.co.uk, 7 Aug 2005, *DP*.

<sup>1005</sup> Jordan, Mary. “Britons Urge Arrest of Protesters Advocating Violence,” washingtonpost.com, 7 Feb 2006, p. A18.

<sup>1006</sup> Bird, Steve. “Charges dropped over cartoon hate banner,” *The Times*, timesonline.co.uk, 13 Jun 2006, nordish.net.

often demonstrate wearing beards, sunglasses, *Kafiyyas*, hooded parkas and balaclava ski masks, only five *Muslims* were arrested after a month of investigation.<sup>1007 1008</sup> The London cartoon protesters' message should be taken seriously even though the cartoons are silly for the organizer, Anjem Choudary, leader of *Islamist* group *Al Ghurabaa* later said:

We are reaching a situation where the *Muslim* community is increasingly under siege. I'm afraid of a *Bosnia* or *Kosovo*-style reality here in Great Britain.<sup>1009</sup>

- C Beards, veils and headscarves are camouflage that help *Muslims* terrorists and their supporters blend into the *Muslim* population. The bulky clothing not only easily conceals weapons, but individual identities too. This is why *Islamists* are so adamant about the local populace dressing in beards, veils and other *Islamic* clothing. Furthermore, *Muslim* men carry out nefarious activities and terrorist attacks wearing all-concealing *Abayas* and *Burkas*: 1) sniping,<sup>1010</sup> 2) try to sneak through a checkpoint, then flee and fire weapons on pursuers,<sup>1011</sup> 3) approach checkpoint and fire concealed weapons,<sup>1012</sup> 4) sneak into *Mosque* and suicide-bomb,<sup>1013</sup> 5) perpetrate drive-by shooting,<sup>1014</sup> and make daring escapes from their hide-outs dressed as women.<sup>1015</sup> Even Michael Jackson wore an *Abaya* to go shopping *incognito* in a Gulf State.<sup>1016</sup>

**Ingredient 12 (164 War Verses):** Often counter-terrorism officials concentrate on *Jihadist* literature, as though the *Koran* by itself would not be enough to turn any *Muslim* into an *Islamist* or *Islamic* terrorist. *Jihadists* however put most stock in the *Koran* since *Muslims* believe it is the very words of *Allah*, while the *Hadith* and *Jihadist* literature is derived from the *Koran*, history and hearsay. One need only take the *Jihadists*' word for it:

- C Mohammed Taheri-Azar read the *Koran* 20 times between June 2003 and March 2006—the month he tried to run over nine people with an SUV.<sup>1017</sup> He became enthralled by numerology and wrote:

I know that the *Koran* is a legitimate and authoritative holy scripture since it is completely validated by modern science and also

<sup>1007</sup> "Five arrested over London cartoon protest," upi.com, Jawa Report, mypetjawa.mu.nu, C&R.

<sup>1008</sup> Bird, Steve. "Charges dropped over cartoon hate banner," *The Times*, timesonline.co.uk, 13 Jun 2006, nordish.net.

<sup>1009</sup> France, Anthony. "Fanatic's sick 7/7 rant," thesun.co.uk, 6 Jul 2006, LGF.

<sup>1010</sup> Snipers: "Palestinian snipers attack Gaza memorial service for murdered Hatuel family," IsraelInsider.com, 9 May 2004, LGF.

<sup>1011</sup> Terrorists dressed as *Muslim* women try to sneak through checkpoint five miles from the *Kaaba*, but are recognized as being men and then flee. They then engage their pursuers in a gun-battle (Nasrawi, Salah. "4 dead as militants, Saudi forces clash," fortwayne.com, 21 Apr 2005).

<sup>1012</sup> Terrorists dressed as *Muslim* women approach a checkpoint and fire concealed weapons: "Five killed in shootout in restive southern Thailand," news.yahoo.com, 6 Mar 2005, C & R.

<sup>1013</sup> Two suicide bombers dressed in *Abayas* blow up among worshippers at *Mosque* in *Baghdad*: "Two suicide bombers in Iraq kill dozens," jpost.com, 7 Apr 2006.

<sup>1014</sup> 3 men in car perpetrate drive-by shooting: "Men wearing *Burkas* shoot *Afghan* Civilians," centcom.mil, 16 Jul 2006, Release No.: 06-07-01PE, C&R.

<sup>1015</sup> Ahmaq, Mahmoud. "Terrorists Take to *Abayas* to Escape Dagnet," *Arab News*, 26 Apr 2004.

<sup>1016</sup> Pipes, Daniel. "If the King of Pop Converts to *Islam*," *DP*, 7 Mar 2006.

<sup>1017</sup> Pipes, D. "More on the North Carolina *Jhadi*, Mohammed Taheri-azar," *DP*, 14 Mar 2006.

mathematically encoded with the number 19 beyond human ability.<sup>1018</sup>

- C Time magazine reported from *Iraq* in 2005 that Marwan was a...  
...would-be suicide bomber who [said he] ‘was an average student but excelled in *Koranic* studies at the local *Mosque*.’ ‘The *Jihadis* are more religious people,’ he says. ‘You ask them anything—anything—and they can instantly quote a relevant section from the *Koran*.’ Like them, Marwan works *Koranic* allusions into his speech....

Marwan seems certain he is on a ‘pure’ path. Unlike many other insurgents, who reject the terrorist label and call themselves freedom fighters or holy warriors, Marwan embraces it. ‘Yes, I am a terrorist,’ he says. ‘Write that down: I admit I am a terrorist. [The *Koran*] says it is the duty of *Muslims* to bring terror to the enemy, so being a terrorist makes me a good *Muslim*.’ He quotes lines from the *Surah* known as *Al-Anfal*, or the Spoils of War: ‘Against them make ready your strength to the utmost of your power, including steeds of war, to strike terror into the enemy of *Allah* and your enemy’ [*K* 008:060]...<sup>1019</sup>

- C Mohamed Atta, one of the leaders of the 9/11 terrorists, wrote:  
Read *Al-Tawba* and *Anfal* [translator Imad Musa: traditional war chapters from the *Koran*] and reflect on their meanings and remember all of the things God has promised for the martyrs.... **It is enough for us that it** [Musa: the *Koran*] **are the words of the Creator** of the Earth and the plants, the One that you will meet [upon martyrdom or the Day of Judgment].<sup>1020</sup>  
*Al-Tawba* is *K* 009, a chapter with 27 War verses; *Anfal* is *K* 008, a chapter with 34 War verses.
- C Naturally, *Jihadists* will bless their bodies and possession with the *Koran* before an attack, not with *Jihadist* literature. Mohamed Atta wrote:

<sup>1018</sup> “Mohammed Taheri-Azar’s letter to police,” *The Herald-Sun*, heraldsun.com, 24 Mar 2006.

<sup>1019</sup> Ghosh, Aparisim. “Inside the Mind of an *Iraqi* Suicide Bomber,” time.com, 26 Jun 2005, JW; also see Spencer, Robert. “Yes, I am a Terrorist,” *FPM*, 29 Jun 2005, JW.

<sup>1020</sup> “Last words of a terrorist,” *The Observer*, guardian.co.uk, 30 Sep 2001.

<sup>1021</sup> “Last words of a terrorist,” *The Observer*, guardian.co.uk, 30 Sep 2001.

<sup>1022</sup> See the Contents section to locate the table on the *Koran*’s 164 War verses.

<sup>1023</sup> Nickel, Gordon. “*Islam*: A religion of peace?” *National Post*, canada.com, 13 Jun 2006.

<sup>1024</sup> Hughes, *Dictionary*, p. 243, *Jihad* entry.

<sup>1025</sup> Dashti. *23 Years*, p. 97.

<sup>1026</sup> Rubin, Michael. “Washington Must Plan Today For Democratic *Iran* of Tomorrow,” *Forward*, meforum.org, 8 Jul 2005.

<sup>1027</sup> Sciolin, Oelaine. “From Tapes, a Chilling Voice of *Islamic* Radicalism in Europe,” nytimes.com, 18 Nov 2005.

<sup>1028</sup> Ghosh, Aparisim. “Inside the Mind of an *Iraqi* Suicide Bomber,” time.com, 26 Jun 2005, JW; also see Spencer, Robert. “Yes, I am a Terrorist,” *FPM*, 29 Jun 2005, JW.

<sup>1029</sup> Durie, Mark. “Anti-dhimmitude...the theological roots of *Islamic* terror,” JW, 10 Nov 2005.

<sup>1030</sup> “Palestinian Legislative Council...” Special Dispatch 1063, MEMRI.org, 4 Jan 2006, JW.

<sup>1031</sup> “Egyptian *Muslim* Brotherhood MPs,” MEMRI, 10 Mar 2006, Special Dispatch No. 1110, JW.

<sup>1032</sup> Bostom, Andrew G. “The Legacy of *Jihad* in Historical Palestine (Part II),” *The American Thinker*, americanthinker.com, 20 Nov 2005.

<sup>1033</sup> “Women at war with the *mullahs*,” *The Sunday Times*, timesonline.co.uk, 19 Mar 2006.

Bless your body with some verses of the *Koran* [Musa: done by reading verses into one's hands and then rubbing the hands over whatever is to be blessed], the luggage, clothes, the knife, your personal effects, your ID, passport and all your papers.<sup>1021</sup>

There are at least 164 verses in the *Koran* encouraging warfare.<sup>1022</sup> Of those 164 verses that do not mention *Jihad* explicitly more or less imply *Jihad* Holy War along with draconian punishments of captives. Included in these 164 verses are twelve commands to kill, as Dr. Gordon Nickel wrote:

The *Koran* contains five commands to kill and twelve commands to fight (literally, 'try to kill'). Most are found in the second (*K* 002:190, 191, 193, 244), fourth (*K* 004:076, 084, 089, 091) and ninth (*K* 009:005, 012, 014, 029, 036, 123) *Suras*....The Arabic verb in all of these verses is **not** the verb related to *Jihad*. Rather, it is the verb *Qatala* in its first ('to kill') and third ('to fight, try to kill') forms. The *Koran* contains many other verses using forms of *Qatala* which—though not imperatives—appear to encourage fighting or killing. Among these is *K* 061:004: '*Allah* loves those who fight in his way.'<sup>1023</sup>

A search reveals that there are at least 114 entries in the major *Hadith* collections that mention *Jihad*: *Bukhari* (56), *Muslim* (36), *Malik* (7) and in the partial collection of *Abu Dawud* (15).

The *Jihad* entry in Hughes' *Dictionary of Islam* notes that *Islam* is in fact monolithic to the extent that:

The duty of religious war...**all commentators** agree is a duty extending to all time.<sup>1024</sup>

There is no strong *Hadith* that speaks of *Jihad* as being an "inner struggle," since this is just a late *Sufi* tradition, or more accurately, invention. *Muhammad*'s Great Commission to *Muslims* is to fight until there is no more persecution and "until all religion is for *Allah*" (*K* 002:193; 008:039). One can see why "**all commentators**" and all the mainstream schools of *Islamic* theology teach that violent *Jihad* must be waged until Judgment Day.

*Muhammad* said that he must spread fear of slaughter in the land (*K* 008:067)<sup>1025</sup> and he said "I have been helped by terror (in the hearts of enemies)" (*Sahih Muslim*, bk. 004, nos. 1062+1063+1066+1067). *Muslims*, like *Muhammad*, think that ultimately *Islam* will be helped by terrorism.

The *Koran* verse that terrorists like to quote the most lately is *K* 008:060 because it specifically connects *Jihad* with terrorizing the enemy, for instance:

☛ On 29 May 2005, hardline *Iranian* cleric Gholam Reza Hasani declared:

An atom bomb... must be produced as well. That is because the *Koran* has told *Muslims* to 'get strong and amass all the forces at your disposal to be strong' [*K* 008:060].<sup>1026</sup>

☛ In 2005 it was reported: "A song Mr. Ahmed listened to one weekend went: 'We are terrorists, we want to make it known to the world, from West to East that we are terrorists, because terrorism, as a verse of the *Koran* says, is a thing approved by God [allusion to *K* 008:060].'"<sup>1027</sup>

☛ *Time* magazine reported in 2005: "Unlike many other insurgents, who reject the terrorist label and call themselves freedom fighters or holy warriors, Marwan embraces it. 'Yes, I am a terrorist,' he says. 'Write that down: I admit I am a terrorist. [The *Koran*] says it is the duty of *Muslims* to bring terror to the enemy, so being a terrorist makes me a good *Muslim*.' He quotes

lines from the *Surah* known as *Al-Anfal*, or the Spoils of War: ‘Against them make ready your strength to the utmost of your power, including steeds of war, to strike terror into the enemy of *Allah* and your enemy’ [K 008:060]... ‘It doesn’t matter whether people know what I did,’ he says. ‘The only person who matters is *Allah*—and the only question he will ask me is ‘How many infidels did you kill?’”<sup>1028</sup>

- C “...*al-Qa’ida* leader Mahfouz Walad *al-Walid* has cited this very verse [K 008:060] as a justification for terrorism, in an interview for *Al Jazeera* on November 30, 2001: ‘This terrorism is a divine commandment. *Allah* has said...[here *al-Walid* quotes K 008:060]. Striking horror, panic and fear in the hearts of the enemies of *Allah* is a divine commandment, and the *Muslim* has in this matter two choices: Either he believes in these verses, which are clear, or he denies these verses, and [becomes] an infidel. The *Muslim* has no other option.”<sup>1029</sup>

- C In 2005, *Umm Nidal*, mother of three *Hamas* “martyrs,” said on PA TV:  
I am proud and honored to be a terrorist for the sake of *Allah*...[here she quoted K 008:060]. I am happy to implement this *Koranic* verse myself and to be a terrorist for the sake of *Allah*.<sup>1030</sup>

- C In 2006 an Egyptian *Muslim* Brotherhood member of parliament, Ragab Hilal Hamida, said the *Koran* encourages terrorism and quoted K 008:060 to prove it. He also said: “*Islam* does not need improvement of its image.”<sup>1031</sup>

The War verses in the *Koran* are invoked often to incite *Muslims* to warfare, ethnic cleansing, genocide and terrorism. For instance, Andrew Bostom wrote:

The *Mufti*’s [*Hajj Amin el-Husseini*] objectives for these recruits—and *Muslims* in general—were made explicit during his multiple [WWII] wartime radio broadcasts from Berlin, heard throughout the Arab world: an international campaign of genocide against the Jews. For example, during his March 1, 1944 broadcast he stated: ‘Kill the Jews wherever you find them [an allusion to K 009:005]. This pleases God, history and religion.’

Invoking the personal support of such prominent Nazis as Himmler and Eichmann, the *Mufti*’s relentless hectoring of German, Romanian and Hungarian government officials caused the cancellation of an estimated 480,000 exit visas which had been granted to Jews (80,000 from Rumania and 400,000 from Hungary). As a result, these hapless individuals were deported to Nazi concentration camps in Poland.<sup>1032</sup>

The Bible is unlike the *Koran* in that it is hard for a reader to misconstrue the Bible to say that Christians ought to attack non-Christians, but the *Koran* has passages such as K 009:005, 029 that are hard not to construe as commands that the reader attack non-*Muslims*. The result is as former *Muslim* Wafa Sultan stated:

...there are too many verses in the *Koran* which say you must kill those who are non-*Muslim*; you must kill those who don’t believe in *Allah* and his messenger. I started to ask: is this right? Is this human? All our problems in the *Islamic* world, I strongly believe, are the natural outcome of these teachings. Go open any book in any class in any school in any *Islamic* country and read it. You will see what kind of teachings we have: *Islam* tells its followers that every non-*Muslim* is your enemy.<sup>1033</sup>



**Ingredient 13 (Command to Ethnic Cleanse):** The eighteen ethnic-cleansing verses in the *Koran* (K 002:191; 004:089, 094, 104; 005:033; 007:004, 074; 009:005, 029, 123; 014:013-014; 021:044b; 033:026-027, 060; 059:002, 005; see the table on the eighteen ethnic-cleansing verses).

### Ingredient 14 (Irredentist Turf Wars)

*Muslims* have two irredentist reasons to conquer:

- Ⓒ The entire earth is *Allah's* and, by extension, *Muslims'*, so *Muslims* feel the imperative to get the earth back from infidels who stole it. The *Hadith* records *Allah's* claim on the entire world and how *Muhammad* felt this gave him the right to expel Jews from Arabia:

You should know that the earth belongs to *Allah* and His Apostle and I want to expel you from this land.<sup>1034</sup>

So it is not surprising that one *Muslim* terrorist said about Australia:

*Sharia* law is gonna [going to] prevail throughout the land...You tell [Prime Minister] Howard this, tell him *Islam* is gonna rule this land....The land, all the land is *Allah's* land, *Allah* created it and he's given it to *Muslims* and the *Muslims* are going to rule it.<sup>1035</sup>

- Ⓒ The principle “once *Muslim*, always *Muslim*,” whereby lands that *Muslims* no longer govern must be reconquered. This principle is derived from verses such as: “Drive them out of the places whence they drove you out” (K 002:191). Yousef *Al-Qaradhawi* says that *Islam* is monolithic in this regard:

All the school of *Islamic* jurisprudence—the *Sunni*, the *Shi'ite*, the *Ibadihiya* and all the ancient and modern schools of jurisprudence—agree that any invader who occupies even an inch of land of the *Muslims* must face resistance.<sup>1036</sup>

*Muslims* have a double claim on the following lands since not only are all lands *Allah's* and *Muslims'* but *Muslims* ruled in these countries before:

The Holy Land (1158 years: 638-1066, 1187-1917 AD), Spain (781 years: 711-1492 AD), Portugal (600 years), Greece (378 years: 1454-1832 AD), *Bulgaria* (500 years), *Rumania* (400 years), *Serbia* (400 years), Sicily (300 years), Hungary (150 years),<sup>1037</sup> India and *Kashmir*, the Philippines (briefly part of the *Sultanate of Malacca* (1403-1511 AD)), The *Sulu* Islands (capital: *Jolo*) and the southern half of *Mindanao* Island from the *Zamboanga* Bay to the Gulf of *Davao* (part of the *Maguindanaoan Sultan Qudarat* (~1619-1672 AD)).

*Islamic* scholars divide up the entire world into the Abode of *Islam* (*Dar Al Islam*) and the Abode of War (*Dar Al Harb*). This has led to *Muslims* fighting over:

France (Charles Martel drove the *Muslim* army out in 732–733 AD), Italy, Malta, Cyprus, Armenia, Poland, Georgia, Ukraine, southern Russia,<sup>1038</sup> Austria (the Turks were driven back from the gates of Vienna in 1683).

In keeping with *Islamic* teaching, *Islamists* have pretensions about taking over Britain. UK *Imam* Anjem Choudray told *BBC* TV news in 2006:

<sup>1034</sup> *Sahih Bukhari*, Vol. 4, bk. 53, no. 392; also see *Sahih Muslim*, bk. 019, no. 4363

<sup>1035</sup> “I’ll chop Bush up,” [dailytelegraph.news.com.au](http://dailytelegraph.news.com.au), 12 Apr 2006, C&R.

<sup>1036</sup> “Leading *Islamist* Sheikh Yousef *Al-Qaradhawi*...” [memri.org](http://memri.org), 28 Feb 2006, no. 1102, *JW*.

<sup>1037</sup> Schmidt. *Divide*, p. 148.

<sup>1038</sup> Schmidt. *Divide*, p. 148.

Who said that you own Britain anyway? You belong to *Allah*. Britain belongs to *Allah*; the whole world belongs to *Allah*. There isn't anywhere on the earth that I won't propagate God's law.<sup>1039</sup>

*Allah's* worldwide land claims drives the *Pakistani*-Indian conflict over *Kashmir* as are reflected in the poem entitled *Tarana e Malli*, which mentions the *Islamic* crescent. Here are four stanzas of *Tarana e Malli* translated into English:

Verse 1. **China and Arabia are ours, India is ours; we are Muslims and the whole world is our home.** Verse 2. In our breasts hides the legacy of the Oneness of God [*Tawhid*]; [therefore] it is not going to be easy for anyone to obliterate our name, our image [image = the crescent (see below)]. Verse 3. Amongst all the places where idols are worshipped, this is the only house of God [*Makkan Kaaba*, and by implication *Islam*], we are its protectors and it is our protector. Verse 4. We have been raised to our manhood under the shadows of swords; and **the sickle-dagger of Hilal** [Arabic/*Urdu* meaning "the crescent-moon"] **is our national symbol** (Source: *Kuliyat e Iqbal, Bange e Dara*).

The poem's *Islamic* sentiments also explain why the infidels have been largely driven out of *Allah's* land in *Pakistan* and East *Pakistan* (now *Bangladesh*). The poem was written by *Pakistan's* poet laureate, *Muhammad Allama Iqbal* (1873–1938 AD), who was the spiritual founder of *Muslim Pakistan*. In 1947, *Hindus* constituted about 30 percent in *Pakistan* and 38 percent in *Bangladesh*. Now, *Hindus* are less than one percent in *Pakistan* and only about 8 percent in *Bangladesh*.<sup>1040</sup>

The irredentism inherent in *Islam* in combination with *Islam's* offensive *Jihad*, creates a tug-o-war situation over land bordering *Islamdom* such as Spain (*Andalusia*), the southern quarters of eastern Europe, and India.

When *Islam* became an empire after its initial *Jihad* conquests, it imposed the Pact of Omar, *Sharia* law and *Dhimmitude* on the masses of non-*Muslims*. *Muslims* at first confiscated many churches, but starting destroying churches in wave after wave starting sometime before 688 AD, which was "less than fifty years after the conquest."<sup>1041</sup> (Jerusalem was conquered in 638). *Muslims* destroyed nearly all the churches in Spain upon the conquest there (711)<sup>1042</sup> and enslaved one-fifth of Spaniards.<sup>1043</sup>

North African *Jihadists* "...when campaigning against Christian states...liked to take church bells as war trophies, some of these then being made into *Mosque* lamps."<sup>1044</sup> The *Ottoman* historian Sukrullah wrote of the *Balkan* conquests:

Where there were bells, Suleiman broke them up and cast them into fires.

Where there were churches he destroyed them or converted them into *Mosques*.

Thus in place of bells there were now *Muezzins*.<sup>1045</sup>

*Muslims* today generally do not have large armies that can conquer infidel nations, but from *Trinidad & Tobago* Islands in the Americas to *Oceania*, from Eurabia to the Sub-*Sahara*, and especially where *Muslims* constitute more than ten

<sup>1039</sup> "Britain belongs to *Allah*, claims radical cleric!" newkerala.com, 9 Feb 2006, rantburg.com.

<sup>1040</sup> Muthuswamy, Moorthy. "Why *Pakistan* Owes India 1/3rd of Its Land," *Sword of Truth*, Issue #1999.49, 4 Dec 1999.

<sup>1041</sup> Yeor. *Dhimmitude*, p. 110.

<sup>1042</sup> Yeor. *Dhimmitude*, p. 436, endnote 10, which refers back to p. 85.

<sup>1043</sup> Segals. *Islam's Black Slaves*, p. 98, as quoted by Schmidt. *Divide*, p. 120.

<sup>1044</sup> Nicolle. *Moors*, pp. 22-23.

<sup>1045</sup> Bostom, Andrew G. "Eurabia's Morass Elicits Mythical 'Solutions,'" americanthinker.com, 24 Nov 2005.

percent of the population, *Muslims* are agitating for: 1) the stealth or overt imposition of *Sharia* law under say, the guise of prohibiting hate-speech, 2) pressing for special rights, privileges, exemptions and *Jizya*-payer-subsidized prayer rooms, “community” centers and *Mosques* in the name of say, diversity and multiculturalism and 3) engaging in terrorism funding, terrorism, rioting, pogroms and insurgencies in the name of say, political activism and freedom fighting.<sup>1046</sup> This is in accord with:

O Prophet, urge on the believers to fight. If there be twenty of you, patient men, they will overcome two hundred [20 is **ten percent** of 200]; if there be a hundred of you, they will overcome a thousand unbelievers [100 is **ten percent** of 1000], for they are a people who understand not (*K* 008:065; also see *K* 002:249 where it is said that by *Allah*’s will, a small army beats a large army).

Oriana Fallaci notes that:

Today’s *Islamic* expansionism, therefore, does not need the armies and fleets with which the Ottoman Empire once terrorized Europe. It only needs the immigrants, whom short-sighted politicians and befuddled multiculturalists continue to welcome.

Oriana Fallaci explains how the cultural and religious conquest occurs:

Yet all this immigration has not been accompanied by integration and assimilation—not because of European racism but by the *Muslims*’ own choice. Fallaci noted that many other groups have assimilated into European societies but *Muslims* have not. ‘They don’t even care to learn our language. They only obey the rules and laws of *Sharia*.’ They do not want to learn European ways; rather, ‘they want to impose on us their own habits and way of life. They have no intention of integrating with us. On the contrary, they demand that we integrate with them.’<sup>1047</sup>

Oriana Fallaci is not exaggerating when she says *Muslim* immigrants do not learn the languages of their host nations. For instance, only half of the one million Turks and *Moroccan* immigrants in the Netherlands speak Dutch.<sup>1048</sup> In the UK an estimated “90 per cent [of *Imams*]...preach in their mother tongue [i.e. not English].”<sup>1049</sup> Also in the UK, *Islamists* want *Urdu* rather than French or German taught as a second language in all schools from nursery school on up.<sup>1050</sup>

Apparently, the same language situation applies in Australia as in the EU, though statistics are hard to come by. After the Beach Riots of 2005 in *Sydney*, *The Australian* newspaper reporter had to converse in Arabic with a *Lebanese Muslim* mother of five children who had been in Australia 33 years and emigrated to Australia in 1972 when she was nine.<sup>1051</sup> No wonder “Austria’s interior minister, Liese Prokop” later “asserted publicly that 45 percent of her country’s *Muslim* immigrants ‘cannot be integrated’ and admonished them to ‘choose another country’ in which to live.”<sup>1052</sup>

<sup>1046</sup> Pipes, Daniel. “The Danger Within: Militant *Islam* in America,” *Commentary*, Nov 2001.

<sup>1047</sup> Spencer, Robert. “Fallaci: Warrior in the Cause of Human Freedom,” *JW, FPM*, 30 Nov 2005.

<sup>1048</sup> Brand, Constant. “EU officials implore new immigrants to learn ‘European values,’” *sfgate.com*, 19 Nov 2004.

<sup>1049</sup> McGrory, Daniel. “Newly-arrived hate *Imams* face early expulsion,” *timesonline.co.uk*, 20 Aug 2005, *JW*.

<sup>1050</sup> Pipes, D. “Transforming the West into an *Islamic* Society,” *DP*, 12 Dec 2005, *mediamonitors*.

<sup>1051</sup> Steyn, Mark. “Racism is bad—so is self-delusion,” *telegraph.co.uk*, 20 Dec 2005, *DW*.

<sup>1052</sup> Pipes, Daniel. “New Route to the West,” *DP*, 30 May 2006.

Oriana Fallaci anticipates that dwindling numbers of Europeans will end up in shrinking homelands and suffer the same fate as the *Dhimmi* nations in the Mideast:

Fallaci said that Europeans—French, Dutch, Germans, English, Italians—are about to reach the status of the *Comanches*, *Cherokees* and *Sioux*: ‘We will end up on their reservation.’ She noted that some *Muslim* spokesmen, confident of their imminent supremacy, already refer to non-*Muslim* Europeans as ‘indigenous people’ or ‘aboriginals.’<sup>1053</sup>

Some say that *Muslims* in the Mideast or in the West only became radicalized in the last few years. For example, some say it was only since *Ayatollah* Khomeini came to power in *Iran* in 1974, or since a radical missionary came to Australia at the end of 1994 living off the dole.<sup>1054</sup> Others say radical *Islam*’s penetration into the West was only made possible by missionaries living on state welfare in nanny states, often while in asylum status, or by missionaries preaching *PrIslam* (*Prison Islam*).

History books show that ever since the advent of *Islam*, *Muslims* have been fanatics. One can read old archival newspapers and find evidence of *Muslim* fanaticism. *PrIslam* is not new either. “Malcolm X, the Nation of *Islam* leader converted while serving time in prison in 1948.”<sup>1055</sup> Daniel Pipes notes that *Muslim* immigrants to America “in the 1920’s unblushingly declared, ‘Our plan is, we are going to conquer America.’” This did not go unnoticed at the time, as someone wrote in the 1920’s:

To the millions of American Christians...the plan to win this continent to the path of the ‘infidel Turk’ will seem a thing unbelievable. But there is no doubt about its being pressed with all the fanatical zeal for which the Mohammedans are noted.<sup>1056</sup>

*Islamists* take over first street corners, then neighborhoods, suburbs and cities, and then they partition the nation or take over an island. A few examples of the end results are:

☉ In *Pakistan* and *Bangladesh* many millions of non-*Muslims* have been forced out through violence and through the demographic hyper-growth of *Muslims*.

☉ In *Bosnia*, between 1971 and 1991, *Serbs* declined from 43 to 31 percent of the population while *Muslims* increased from 26 to 44 percent. Thus *Serbs* have been, by and large, forced out of their ancestral homeland.<sup>1057</sup>

The takeover is accomplished using pressure groups that use legal and quasi-legal means, mobsterism, dramatic demographic growth that pushes out non-*Muslims*, mob action, riots, pogroms, ethnic cleansings, insurgencies and civil war leading to a country’s partition. The overriding principles used to ethnic cleanse neighborhoods is to impose *Sharia* law as much as possible, and to “be kind to other *Muslims* while being harsh to infidels” in every conceivable way (*K* 009:073, 123; 048:029; 066:009). A few examples are:

☉ In certain suburbs of *Berlin* in 2005, *Muslims* seek to impose “two basic laws—the law of the neighborhood and the law of the *Koran*.”<sup>1058</sup>

<sup>1053</sup> Spencer, Robert. “Fallaci: Warrior in the Cause of Human Freedom,” *JW, FPM*, 30 Nov 2005.

<sup>1054</sup> Stewart, Cameron. “The day one man infected a community with hatred,” [theaustralian.news.com.au](http://theaustralian.news.com.au), 12 Nov 2005.

<sup>1055</sup> Pipes, Daniel. “If the King of Pop Converts to *Islam*,” *DP*, 7 Mar 2006.

<sup>1056</sup> Pipes, Daniel. “The Danger Within: Militant *Islam* in America,” *Commentary*, Nov 2001.

<sup>1057</sup> Steyn, Mark. “France’s *Muslim* future,” [jpost.com](http://jpost.com), 20 Nov 2005.

- ⊙ In 2006 the *Muslim* Public Affairs Council in the UK posts all *Muslim* businesses on their MPAC website that sell Israeli products and thus undermine the *Umma*-wide boycott on Israel. With so many *Jihadists* and would-be *Jihadists* online, this is tantamount to a death threat.<sup>1059</sup>
- ⊙ In Britain, *Al-Ghurabaa* (The Strangers), the successor group to *Al-Muhajiroun* (The Immigrants), has plastered “Islamic Values vs. British Values” stickers in various neighborhoods, staking out their claim.<sup>1060</sup>
- ⊙ Britain and Europe are in danger of “reverse colonization” because immigrants “stay connected to their homelands by the internet and cheap flights” and “The idea of assimilation was becoming redundant.”<sup>1061</sup>
- ⊙ In *Iraq* in 2006, *Al-Qaeda* in *Iraq* terrorist *Abu* Musab *Al-Zarqawi* sent out pamphlets stating that certain *Sunni* districts of *Baghdad* were his. *Zarqawi* even installed “emirs” over his “emirates” whose “men in black...see someone breaking the rules, they shoot them.”<sup>1062</sup> Some of the rules are:
  - ★ Women must wear veils, must not ride the bus without a male relative as escort, and must not wear western clothing.<sup>1063</sup>
  - ★ Vendors must not sell certain items on the pretext that they corrupt morals (alcohol, pop music, foreign films, athletic shorts, T-shirts with English writing), are supposedly Jewish (goatee beards), are products rumored to be made in Israel (mayonnaise), or are items not in existence in *Muhammad*’s day (*falafels*, bagged ice, cigarettes).<sup>1064</sup> After the ultimatum date stated on a flyer passes, a wave of killings follows. In May 2006 there were 1,398 targeted killings in *Baghdad* alone,<sup>1065</sup> not counting bombing victims which total often ranges from a few to scores.

*Muslim* militias and mobs and *Islamist* governments often work methodically together to take over a region and to consolidate their control over it, for instance:

- ⊙ While *Islamist* governments will legislate to discriminate against and *Dhimmify* non-*Muslims*, *Islamists* will arson or demolish temples, synagogues and churches while providing only token compensation, if any. Often the demolition occurs during worship services. *Islamists* give a pretext for the demolition—not mentioning the real reason—that they are going about methodically *Islamizing* a nation. Moreover, *Islamists* make it very hard or impossible for non-*Muslims* to construct replacement worship facilities. For instance:
  - ★ In the capital of *Dushanbe*—the last synagogue in all of *Tajikistan* was bulldozed. A distant plot of undeveloped land at the city’s edge was given in inadequate compensation. The lame excuse? The synagogue stood on government land that was being developed, yet the synagogue

<sup>1058</sup> Roebel, Sven. “The Murder of a Turkish Woman in Berlin: A German Court Goes Face to Face with Honor Killings,” *Spiegel Online*, [spiegel.de](http://spiegel.de), 12 Sep 2005.

<sup>1059</sup> “Muslim Shop Reported In Jewish Chronicle Treacherously Supporting Israel,” [mpacuk.org](http://mpacuk.org), 2 Jun 2006, [solomoniam.com](http://solomoniam.com).

<sup>1060</sup> Spencer, Robert. “Islamic values vs. British values,” *JW*, 6 Jun 2006, [terrorismunveiled.com](http://terrorismunveiled.com).

<sup>1061</sup> Almond, Peter. “Beware: the new goths are coming,” *The Sunday Times*, [timesonline.co.uk](http://timesonline.co.uk), 11 Jun 2006.

<sup>1062</sup> Colvin, M & W M. “Men in black terrorise Iraq’s women,” [timesonline.co.uk](http://timesonline.co.uk), 4 Jun 2006.

<sup>1063</sup> Hussein, Aqeel & C F. “Pack up or die, street vendors told,” [telegraph.co.uk](http://telegraph.co.uk), 4 Jun 2006.

<sup>1064</sup> Hussein, Aqeel & C F. “Pack up or die, street vendors told,” [telegraph.co.uk](http://telegraph.co.uk), 4 Jun 2006.

<sup>1065</sup> “Baghdad targeted civilian killings soar in May,” [cnn.com](http://cnn.com), Jun 2006.

was a hundred years old and was built in the old Jewish quarter. *The New York Times* reported:

While the congregants prayed, a bright orange bulldozer growled outside, continuing its work at the synagogue's edge. 'They could do this anytime,' whispered David Kiselkov, 56. 'But of course they choose to do it now.'<sup>1066</sup>

- ★ The *Malaimel Sri Selva Kaliyamman* century-old Hindu temple in Malaysia was reduced to rubble when Kuala Lumpur's city hall sent in bulldozers while 300 devotees were praying. The lame excuse? The temple was "on government land" that was being developed, and besides, a one day's notice of the demolition had been given.<sup>1067</sup>
- ⊕ In 1997, Palestinians under Arafat revived a Jordanian law that forbade Arabs from selling or leasing land to Jews anywhere in the Holy Land on pain of death.<sup>1068</sup> Also, "Palestinian Authority's (PA) Mufti in Jerusalem, Ikremah Sabri, has barred all Muslims accused of selling land to Jews from being buried in a Muslim cemetery."<sup>1069</sup> "Since 1994, dozens of Arab Israelis and PA residents have been murdered on suspicion of selling land to Jews."<sup>1070</sup> One need not even be an Arab or resident of the Holy Land to suffer consequences for selling or leasing land to Jews:
  - ★ In 2005, Irineos I, a Greek, was replaced as Greek Orthodox patriarch of Jerusalem by Theofilos III, another Greek, because Irineos leased a hotel by the Jaffa Gate in Jerusalem to Jews. The Greek Orthodox flock and clergy in the Holy Land is mostly Arab, and they demanded Irineos' ouster. Some Arab Christians hold anti-Zionist or nationalist sentiments but mainly they feel intense Muslim pressure not to sell land to Jews.<sup>1071</sup>
  - ★ In 2006, a legal resident of Jerusalem, Abu al-Hawa, allegedly sold Jews three buildings with 14 apartments on Mount of Olives, but he claimed the sale was to a third-party who then sold the land to Jews without his knowledge. Arab squatters promptly moved in the sold buildings and had to be evicted by Israeli police. The new Jewish residents had to hire a guard for the buildings.<sup>1072</sup> "A restaurant owned by Mr. Abu al-Hawa's family was torched and Mr. Abu al-Hawa was repeatedly summoned for questioning by the Palestinian Authority security forces."<sup>1073</sup> Abu Hawa was later found dead. His face was badly bruised, he was shot seven times and his body and car were partially burned.<sup>1074</sup> "He was buried in an outcast's grave near Jericho after residents of A-Tur barred his burial there."<sup>1075</sup>

<sup>1066</sup> Wilensky-Lanford, Ethan. "As Tajikistan's last synagogue goes, so does a culture," *The New York Times*, nytimes.com, 29 Mar 2006, iht.com, DW.

<sup>1067</sup> "Malaysia demolishes century-old Hindu temple," outlookindia.com, 21 Apr 2006, DW.

<sup>1068</sup> Walker, Christopher. "Arafat threatens to execute Arabs who sell land to Jews," *The Times* (London), 22 May 1997, afsi.org.

<sup>1069</sup> Glick, Caroline. "Why is Muhammad Abu Al-Hawa dead?" jpost.com, 18 Apr 2006.

<sup>1070</sup> Glick, Caroline. "Why is Muhammad Abu Al-Hawa dead?" jpost.com, 18 Apr 2006.

<sup>1071</sup> Klein, Aaron. "New patriarch: No land for Jews," WND.net, 26 Nov 2005.

<sup>1072</sup> Glick, Caroline. "Why is Muhammad Abu Al-Hawa dead?" jpost.com, 18 Apr 2006.

<sup>1073</sup> MacKinnon, Ian. "Arab is murdered for selling to Jews," timesonline.co.uk, 15 Apr 2006, JW.

<sup>1074</sup> Weiss, Efrat. "Israeli Arab murdered in Jericho," ynetnews.com, 13 Apr 2006, C&R.

<sup>1075</sup> MacKinnon, Ian. "Arab is murdered for selling to Jews," timesonline.co.uk, 15 Apr 2006, JW.

- ☉ In India, six *Harkat-ul-Jehad al Islami* (HUJI) terrorists marked on a map two *Hanuman* temples in the city of *Ramnavami*. They planned to blow them up “on Thursday as a large number of devotees pay obeisance there on this day” of the week.<sup>1076</sup>
- ☉ *Laskar Jihad* (*Jihad Warrior*) mapped all the towns on the Island of *Ambon*, Indonesia, west of *New Guinea*. The legend shows a crescent stands for “*Muslim* territory,” a cross indicated “*Republic of Mollucan* (RMC) Christians’ Territory” and a blue dot signified “disputed territory.” The data was said to be current as of...“Feb 2001—about nine months after the deployment of *Laskar Jihad* of *Ahlu Sunnah Wal Jamaah* in *Ambon, Maluku, Indonesia*.”<sup>1077</sup>
- ☉ In March 2005, *Laskar Jihad* was doing the same reconnaissance and mapping activity in nearby *West Papua*, as the *Herald Sun* reported:

Human rights activists in *West Papua*’s Central Highlands secretly filmed footage showing villages which had been ransacked and destroyed by the Indonesian military, leaving an estimated 6,000 people homeless...Mr. Yoman said Indonesian authorities had a policy to resettle large numbers of *Muslim* immigrants in the territory to dilute its Christian majority and inflame religious tensions. The program said that among the settlers were members of the terror group *Laskar Jihad*, which has been involved in attacking Christians on the island of *Ambon*. A member of the [*Laskar Jihad*] group told *Dateline* that *West Papua* had up to 500 dedicated followers and training camps. ‘The truth of *Islam* had to be realized so we had to wage *Jihad* against those who wanted to destroy *Islam*, whether that be people or places of worship,’ he said. ‘We were taught how to estimate the strength of the religious communities in *Sorong*, places of worship—Christian and others. We were also taught to observe where the Christian neighborhoods were in *Sorong* [a city on the western edge of the northwestern peninsula of *West Papua* not far from *Ambon Island*].’<sup>1078</sup>

*Muslims* today will take over or destroy churches wherever and whenever politically feasible, often after mobs and militias have chased out all but a few Christians from the surrounding neighborhoods. This has been the case in the recent history of Turkey, Lebanon, Indonesia, Sub-Saharan Africa, the *Balkans*.<sup>1079</sup> Somewhere in *Islamdom* or on its borders without fail more churches and entire Christian towns are destroyed every year, for instance:

- ☉ In 2004, a *Muslim* mob ethnically cleansed *Pristina, Kosovo*, of 40,000 *Serbians*. In *Pristina, Kosovo*, Christians had to abandon a church they were building, which was then turned into a public latrine.<sup>1080</sup> The *Muslim* mob shot up, looted and burned cars, homes and apartment complexes. Before

<sup>1076</sup> “HUJI terrorists planned to blow up *Hanuman* temples,” *Press Trust of India*, hindustantimes.com, 5 Apr 2006, *JW*.

<sup>1077</sup> *Jihadist* map of the Island of *Ambon* (malra.org/posko/ambon0102.jpg, accessed 21 Oct 2004). The map was originally posted at: [laskarJihad.or.id](http://laskarJihad.or.id)

<sup>1078</sup> Osborne, Paul. “*Papuan* militias ‘getting aid money,’” [heraldsun.news.com.au](http://heraldsun.news.com.au), 16 Mar 2005.

<sup>1079</sup> “The *Kosovo* Tragedy,” [interfax-religion.com/kosovo](http://interfax-religion.com/kosovo), 30 May 2005, C&R, 15 Nov 2005.

<sup>1080</sup> Spencer, Robert. “*Kosovo*: Church of Christ the Savior in *Pristina* turned into public toilet,” *DW*, 19 Apr 2004; also see [savekosovo.org](http://savekosovo.org).

burning some churches, they opened the tombs of *Serbs* and priests and scattered their bones around.<sup>1081</sup>

- ⊕ In 2004 in northern Nigeria, many Christians had been incessantly attacked and driven out. It was reported that:

A leader of minority Christian *Ibo*-speakers in *Kano*, Boniface Ibekwe, asked police in the presence of journalists to ‘stop this killing today or give us six months to leave *Kano* peacefully.’<sup>1082</sup>

...tensions mounted once again on January 3, 2004, after it emerged the *Muslim Emir* of Wase, deeply implicated in the violence of 2002, had brought more than 500 *Muslim* families to the area to settle in towns and villages abandoned by displaced Christians.<sup>1083</sup>

- ⊕ *The New York Times* reported from *Iraq* in 2004:

Yet most of Syria’s newest *Iraqi* Christian refugees say the decision to leave their homeland was anything but easy. They tell of Christian shopkeepers killed by *Islamist* gangs for daring to sell alcohol, of family businesses sold to ransom stolen children.<sup>1084</sup>

- ⊕ In 1993 Palestinian Christian Nadim Khoury returned from the US to *Taybeh*, an all-Christian town of 1,300 near *Ramallah*. His million-dollar brewery produced 2+ million pints per year until *Intifada* II began in 2000, but only 1.2 million pints after *Islamists* made the selling of alcohol in *Gaza* impossible. *Islamists* have chased all but 1,500 Christians out of *Gaza*<sup>1085</sup> and *Islamists* “torched the home of one of his distribution outlets.”<sup>1086</sup> In 2005, *Muslims* from the neighboring town, *Deir Jarir*, honor-killed a *Muslim* woman there for having a romantic relationship with a Christian in *Taybeh*. *Muslims* then torched thirteen homes in *Taybeh*, and the police took her alleged Christian lover in custody.<sup>1087</sup> The situation deteriorated in 2006 when *Hamas* won the Palestinian elections. Khoury is launching a non-alcoholic brand of beer in the hopes that *Hamas* “will think twice before they do anything to hurt our business.”<sup>1088</sup>

The remainder of non-*Muslims* are bullied and harassed constantly and have their businesses boycotted. They are also made to suffer through *Adhans* and sermons broadcast from *Minarets*. Why? Because listening to the *Adhan* is required of *Dhimmis* because the *Adhan*’s “Come to success” is a tool of *Dawa* evangelism.

Some say that the *Adhan* is just like ringing church bells, but there is no requirement in Christianity—as there is in *Islam*—that bells be heard at all. Moreover, *Islamists* say *Jihad* must resume if *Dawa* evangelism (e.g. via the *Adhan*) is restricted, because *Muslims* “must remove any obstacle in the way of

<sup>1081</sup> “Ethnic Cleansing of *Serbs* in *Pristina*, Mar 17-18, 2004 (*Kosovo*),” *Kosovo.com*, ERP KIM Info Service, Mar 2004, freerepublic.com, posted 28 Apr 2004; also see savekosovo.org.

<sup>1082</sup> Samuel, Oloche. “Nigerian *Muslims* rampage for 2nd day,” *cnews.canoe.ca*, 12 May 2004.

<sup>1083</sup> “Christians axed to death in church meeting by *Muslim* warriors,” Christian Solidarity Worldwide, *Australia Christian Channel*, *acctv.com.au*, 10 Mar 2004.

<sup>1084</sup> Zoepf, Katherine. “Many Christians Flee *Iraq*, With Syria the Haven of Choice,” *The New York Times*, 5 Aug 2004, *DW*.

<sup>1085</sup> Stahl, Julie. “Gaza’s Tiny Christian Community Threatened With Violence,” *CNSNews.com*, 22 Feb 2006, *israellycool.com*.

<sup>1086</sup> “Palestinian brewery to launch *Hamas* non-alcoholic beer,” *Yahoo! News*, 21 Feb 2006, *C&R*.

<sup>1087</sup> Williamson, Lucy. “A frightening family feud,” *news.bbc.co.uk*, 10 Sep 2005.

<sup>1088</sup> “Palestinian brewery to launch *Hamas* non-alcoholic beer,” *Yahoo! News*, 21 Feb 2006, *C&R*.



implementing the *Islamic* ruling system.”<sup>1089</sup> Furthermore, the *Hadith* record that *Muhammad* attacked towns where the *Adhan* was not heard:

Whenever the Prophet went out with us to fight (in *Allah*'s cause) against any nation, he never allowed us to attack till morning and he would wait and see: if he heard *Adhan* he would postpone the attack and if he did not hear *Adhan* he would attack them (*Sahih Bukhari*, vol. 1, bk. 11, no. 584).

Therefore, non-*Muslims* must hear the *Adhan* five times daily, drums at dawn during the month of *Ramadan* and frequent ambulance sirens too:

- ☉ During the Cartoon Riots and the *Muslim* boycotts of Danish foods in 2006, an *Imam* stated: “It was a grass-roots thing, though nobody is denying the role of the *Mosques*. They have loudspeakers and the people listen.”<sup>1090</sup>
- ☉ Around Bethlehem, “Everywhere the sound of the church bells is drowned out by the blaring loudspeakers of the *Muezzins*.” The local Christian population dropped from 35,000 to 6,500 in just a few years.<sup>1091</sup>
- ☉ Rediff.com reported that sermons from the Ahle-Hadis *Mosque* in the government bureaucracy enclave of *Pakistan* are audible for miles.<sup>1092</sup>
- ☉ Susan Goodman wrote about the situation in Jerusalem in 2005: “At about five in the morning, as night first lifts from the sky, the low resonance of a distant *Muezzin* can just be discerned. A poignant reminder of where I am and with whom I share the Jerusalem soundscape....An ambulance. We let it register without a conspicuous flicker of awareness. Conversations continue, a second siren and the tension is palpable. One ambulance is a woman in labor or a heart attack. Two ambulances a road accident. More than two... it's a suicide bombing. That's the Jerusalem adage I was taught soon after arriving.”<sup>1093</sup>
- ☉ In *Israel* during *Ramadan*, “This month-long *Muslim* holiday features daily fasts from sunrise to sunset. Early enough before sunrise to allow a substantial meal before the fast begins, drummers march through Arab communities to wake the faithful. Those in the nearby neighborhood are also liable to wake us, sometime around 4 AM. It is not a lively rhythm that they play, but a simple *dum, dum, de dum*, over and over.”<sup>1094</sup>

*Mosques* are the focal points where autonomous zones are created and expanded. Even the *Adhan* call to worship broadcast five times per day is really a subtle call to militantism. That is because *Muslims* are familiar with *Muhammad*'s life story, and they know that the first *Muezzin* Bilal was one of the early *Jihadists*.

Bilal got the *Muezzin* job by killing two unarmed infidel prisoners of war in cold blood with a sword. They were the “corpulent” Umayya and his son Ali, both *Mekkan* pagans of importance. The *Sufi* Martin Lings relates that right before Bilal butchered the two men...

<sup>1089</sup> Lindner, John M. “*Islamic* Radicals Agitate Judges in Indonesian Christianization Court Case,” assistnews.net, 18 Aug 2005, *WND*, *DW*.

<sup>1090</sup> Rennie, David. “How clerics spread hatred over cartoons,” telegraph.co.uk, 7 Feb 2006.

<sup>1091</sup> Magister, Sandro. “The Custody Must Be Doubled in the Holy Land,” chiesa.espressonline.it, 7 Sep 2005.

<sup>1092</sup> “The threat in the North East,” in.rediff.com, 27 Apr 2004.

<sup>1093</sup> Goodman, Susan. “Jerusalem Soundscape,” jpost.com, 30 Sep 2005.

<sup>1094</sup> Sharkansky, Ira. “Window on Israel: From a US visit,” jpost.com, 9 Oct 2005.

...Bilal shouted with all the power of the voice that had won him the function of *Muezzin*: ‘O Helpers of God, the head of disbelief, Umayya! May I not live if he survives!’<sup>1095</sup>

Alvarus Paulus (died 861 AD), a Spanish Christian, wrote in 854 AD about the evil influence of the *Adhan*:

Everyday they [*Muezzin*] cry out, in this rite of savages, with an enormous and monstrous roar, shouting like madmen from their smoky towers, their dissolute lips and jaws thrown open as if belching [the “Call to Prayer”]...this ritual of shouting and, through this superstitious effort, infect the souls of noble men with the evil spirit...<sup>1096</sup>

The loudspeakers of *Mosques* spread more than just the evil *Adhan*. In 2004, the loudspeakers of *Al-Aksa Mosque* at the temple mount in Jerusalem broadcast the message that Jews were “sons of monkeys and pigs” (*K* 002:065-066; 005:060; 007:166) and called for the Jews’ ‘total extinction.’<sup>1097</sup> Throughout *Islamdom*, it is common for *Imams* to publicly call for the annihilation of Jews and Christians over loudspeakers and on TV.<sup>1098 1099 1100</sup>

Loudspeakers in the *Gaza Strip* are used to mourn or praise known terrorists.<sup>1101</sup> When bus bombs went off killing sixteen and wounding over ninety, AP reported:

In the *Gaza Strip*, *Muslim* leaders praised the ‘heroic operation’—a phrase referring to suicide-bombings—over *Mosque* loudspeakers. ‘There will be no security for *Israel* as long as the occupation stands,’ said one of the leaders.<sup>1102</sup>

*Maariv* reported about events after *Hamas* chief *Sheikh YaSin* was killed:

*Gaza* city erupted in violent demonstrations against both *Israel* and the Palestinian Authority, with calls being sounded from [loudspeakers on] *Minarets* to take to the streets. Tires and cars were being burned and shots fired in the air.<sup>1103</sup>

In *Afghanistan* in 2006, a *Pakistani* named Saifullah says he had been enticed away from his blacksmith job to chase down loot or the seventy-two *Houris* [*K* 044:051]. His job was to “kill US troops and their ‘spies,’” and “set up roadblocks to interrogate clean-shaven men and confiscate cassettes, in line with the *Taliban*’s doctrine that shaving and listening to music are ‘un-Islamic.’” Saifullah said his *Taliban* commander “*Mullah* Samad had even been allowed to use a loudspeaker atop the *Loya Kariz Mosque* to call people to *Jihad*. He remembered the message as:

Join us in *Jihad*. If you don’t join us, God will punish you [*K* 009:081-082].<sup>1104</sup>

<sup>1095</sup> Lings. *Sources*, p. 150.

<sup>1096</sup> Wolf. *Antichrist*, found in Meyerson & English. *Spain*, pp. 12-13.

<sup>1097</sup> Headlines, *DebkaFile*, debka.com, 12 Mar 2004; cross-posted at *IsraPundit*.

<sup>1098</sup> “Saudi sermon: destroy the Zionist Jews,” “Syrian sermon: destroy the Zionist Jews and their supporters,” “PA sermon: take revenge against the U.S. and Israel,” imra.org.il, 20 Apr 2004.

<sup>1099</sup> “Leading Islamic Clerics Come Out For Reform in Arab-Islamic Society,” Memri.org, 5 Jun 2002, S.D. No. 386.

<sup>1100</sup> Spencer. “Twice in three days on PA TV: PA religious leaders call for genocide of Jews,” *JW*, 14 Sep 2004, Palestinian Media Watch, pmw.org.il.

<sup>1101</sup> “Israel Kills *Hamas* Leader, Two Others in *Gaza*,” foxnews.com, 30 May 2004.

<sup>1102</sup> Gutkin, Steve. “Two Bus Bombs in Southern Israel Kill 15,” news.yahoo.com, 31 Aug 2004.

<sup>1103</sup> “*Hamas* mentor *YaSin* killed in IDF attack,” *Maariv International*, 22 Mar 2004.

<sup>1104</sup> Ahmad, Sardar & Spin Boldak. “Recruits promised booty on Earth, virgins in the next,” *Mail and Guardian Online*, mg.co.za, 1 Feb 2006, *JW*, C&R.

In *Iraq* in 2004, “*Mosque* loudspeakers blared calls for *Jihad*, or Holy War, and women were seen carrying guns in the streets.”<sup>1105</sup> The *Associated Press* reported another incident of incitement from *Mosques* at *Fallujah, Iraq*.

During the fighting, a few *Mosques* blared messages calling gunmen to battle. ‘These people killed our children and made our women homeless and raped them. Fight them to the death and there is no doubt you will go to Heaven,’ went one message according to a Marine translator.<sup>1106</sup>

*NBC* reported the same thing a week later in the conflict:

Flames could be seen rising from buildings, and loudspeakers on *Mosques* in other parts of the city called for firefighters to mobilize.<sup>1107</sup>

*Muslims* in the *Gaza Strip* even use loudspeakers from the trip from the *Mosque* to the cemetery, as the *BBC News* reports:

When the bodies emerge from the *Mosque* and the march to the cemetery begins, it is led by a van loaded with loudspeakers that blast out demands for revenge.<sup>1108</sup>

In the Palestinian territory of *Israel*, there is another use of *Mosque* loudspeakers, as *The Jerusalem Post* reported:

The man killed in *Beit Rima* was identified as *Muhammad Husan*, 30. Villagers said he was forced to announce through the loudspeakers of a *Mosque* that he had been collaborating with *Israel* since 1997 and that he was responsible for the killing of wanted men. But less than 24 hours after he was executed in the village center, the *Aksa Martyrs Brigades* published a statement announcing that he had been killed by mistake and that he was innocent. The group also sent an apology to the victim’s family, saying a further investigation revealed that he was not a ‘traitor.’<sup>1109</sup>

*Imams* use the inside of *Mosques* to condition *Muslims* for war and even genocide. The *Koran* threatens *Muslims* who shirk on *Jihad* (see the *Jihad Shirkers Are Damned* section of this table), and these threats are mentioned in sermons today just as they were in *Muhammad*’s time, as *The Jerusalem Post* reported:

The *Sheikhs* in the local *Mosques* shout and scream into the loudspeakers during Friday sermons, scaring people with warnings about the evil deeds that will land them in Hell.<sup>1110</sup>

*Muhammad* used his *Mosque* as a military headquarters and as a place to rally his troops. In medieval Spain, the *Cordoba Mosque* stored the military standards with their *Koranic* inscriptions until the troops went out to battle.<sup>1111</sup> Today, many *Mosques* are used as *Jihadist* classrooms and libraries, as safehouses and even as ammunition dumps and bomb factories. A *Tunisian* progressive adds:

The *Mosque* (especially the Friday prayer sermon) is particularly used by *Islamists* to spread their message. [Egyptian progressive] Saadeddine *Ibrahim*

<sup>1105</sup> “U.S. Hits *Mosque* Compound in *Fallujah*,” foxnews.com, 7 Apr 2004, *LGF*.

<sup>1106</sup> Fayadh, Abbas. “School buses hit as 55 die in Basra blasts,” lam-online.com, 21 Apr 2004.

<sup>1107</sup> U.S. planes, artillery pound targets in *Fallujah*,” MSNBC.com, 27 Apr 2004.

<sup>1108</sup> Johnston, A. “Hero-worship in the ruins of *Rafah*,” *BBC News*, news.bbc.co.uk, 29 May 2004.

<sup>1109</sup> *Abu Toameh*, Khaled. “PA warns factions against killing ‘collaborators,’” jpost.com, 28 Apr 2004, *AllahPundit.com*, 29 Apr 2004.

<sup>1110</sup> Alvi-Aziz, Hayat. “Sinful Arab neglect,” jpost.com, 31 Mar 2005.

<sup>1111</sup> Nicolle. *Moors*, p. 10.

recently lamented how he would face a propaganda machine that uses a network of 150,000 mosques in Egypt.<sup>1112</sup>

Today, *Jihadists* often pray at a *Mosque* on their way to staging an attack or suicide-bombing. In modern times, groups of *Muslims* have gathered at *Mosques* for Friday Prayers before staging riots against the government and before attacking churches and Christian neighborhoods.

To truly appreciate the mindset of *Islamists*, one must know that *Muslims* battle each other uncivilly, not just over secular ground but over *Mosques* too. For instance:

- ☉ The placement of *Mosques* mark *Islamist* territory. *Mosques* are everywhere in *Islamdom* because they cannot be zoned out, for any place where the *Adhan* cannot be heard is unprotected from attack from *Islamists* who follow in *Muhammad's* footsteps (*Sahih Bukhari*, vol. 1, bk. 11, no. 584).
- ☉ *Muslims* are reticent to keep radical *Muslims* out of *Mosques* because *Muhammad* said that keeping other *Muslims* from a *Mosque* was a form of persecution worse than slaughter (*K* 002:191, 193, 217). Thus it is no surprise that:
  - ★ Within few decades after 1970, 80 percent of American *Mosques* became radicalized through the use of *Saudi-trained Imams* and petro-dollars,<sup>1113</sup> because there was no way to keep *Islamists* out.
  - ★ When US Secretary of State, Condoleezza Rice, wanted to visit a *Mosque* in Blackburn, England, the visit had to be cancelled because Ibrahim Master, a member of the *Mosque's* governing committee, said that even though a group threatened to protest in the *Mosque* during the diplomatic visit, “it would be impossible to prevent them from entering the *Mosque*...because the group were *Muslims*.”<sup>1114</sup>
  - ★ When Laura Bush, wife of President George Bush, entered the Dome of the Rock in 2005, hecklers (who could not, as a matter of religious policy, be screened out by security) called out:
 

‘How dare you come in here and why are you hassling our *Muslims*?’ ...one man seethed ‘None of you belongs in here.’<sup>1115</sup>
  - ★ When Ariel Sharon visited the temple mount in 2000, there were plenty of rioters ready even though the *Islamic Wakf* received advanced notice of his visit.<sup>1116</sup>
- ☉ In 2005 surfers in Sydney, Australia, had to “reclaim the beach” from Lebanese gangs that were beating up local lifeguards and intimidating beachgoers.<sup>1117</sup> A “solution” proposed that would have solidified *Muslim* control was to have...

<sup>1112</sup> “Tunisian Progressive: ‘*Islamism* is The Mother of All Big Lies,’” *MEMRI*, 25 Jan 2005, # 852.

<sup>1113</sup> Rettig, Haviv. “Expert: Saudis have radicalized 80% of US *Mosques*,” *jpost.com*, 5 Dec 2005; “The End of American Jewry’s Golden Era; An Interview with Daniel Pipes,” *DP*, 2 May 2004.

<sup>1114</sup> “Rice visit to English *Mosque* cancelled over security fears,” *breitbart.com*, 30 Mar 2006, *JW*.

<sup>1115</sup> Teibel, Amy. “Laura Bush Heckled at *Islamic Holy Shrine*,” *news.yahoo.com*, 22 May 2005.

<sup>1116</sup> Winston, Emanuel A. “*CNN* Slants The Story Of The Church Of The Nativity Siege or The Evil Empire Strikes Again,” *cnn.com*, 6 May 2002.

<sup>1117</sup> Corder, Mike. “Groups Try to Stem Violence in Australia,” *wtopnews.com*, 14 Dec 2005.

...*Muslim* and Lebanese ‘marshals’ and elders...sent from the western suburbs to patrol the area and sanction troublemaking young men visiting the beach.<sup>1118</sup>

This all sounds rather innocent until one considers all the “early battles in a continent-wide turf war”<sup>1119</sup> raging in Europe (discussed later in this section). Also, in Israel, “summer was a more typical time for clashes between Jews and Arabs...when gangs meet on the beach to fight.”<sup>1120</sup> Since Israel’s Arabs are ninety-nine percent *Muslim*, the Arab gangs are surely *Muslim*.

- C From December 2005 to March 2006, *Pakistan* closed down over forty “pirate” radio stations set up by *Imams* who preached *Jihad* and incited sectarian violence. The typical radio transmitter is small, runs off a car battery and costs 100 pounds (175 USD). An example of sectarian strife comes from *Bara, Khyber*, where an *Imam* of a more austere brand of *Islam* came to town. He and the local *Sufi Imam* “waged a turf war via their private channels.” A *Jirga* (tribal council) ruled that both “FM *Imams*” should be expelled from the area “after inciting their followers to bloody riots.”<sup>1121</sup> Three weeks later, the *BBC* reported:

Both clerics have been operating illegal FM stations to broadcast their religious beliefs and denounce the rival group as heretics. The two groups have also accused each one another of taking women and children hostage. Tension has risen sharply in the last few months after an earlier attempt to resolve the dispute through a *Jirga* (tribal assembly) failed. After an earlier armed clash between the two groups, the security forces intervened to force both the clerics out of the tribal areas. Although the two clerics have been in hiding since then, their followers continued to fight for control of the territory.<sup>1122</sup>

- C After 9/11, *Imams* tip off the police and FBI that *Muslim* detractors or would-be rivals in their *Mosques*, are terrorism suspects.<sup>1123</sup>
- C In 2006 in *Indonesia*, a moderate *Muslim* said how *Mosques* are radicalized:
 

...you get to be the top preacher by being the preacher with a sexy message. A sexy message can be very inflammatory: ‘Christians are the ones that created all these problems for you guys—kill them!’ Friday prayer is an obligation for men, so it has become a very effective medium to propagandize with preachings that are just very, very hateful toward non-*Muslims*.<sup>1124</sup>
- C In February 2006 in *Iraq*, *Sunni* militia destroyed the dome of the *Shiite Askariya Shrine*. The *Shiite Mahdi Army* stormed out of its stronghold of *Sadr City* and counter-attacked dozens of *Sunni Mosques*. *Sheik* Tamimi led hundreds of *Shias* to take the Saddam Hussein *Mosque*, No. 5-833 in Sector 3 of *Baghdad*, while “black-clad men pulled up in ten cars, blocking off the

<sup>1118</sup> Sexton, J. “Split beaches into sections, say leaders,” [theaustralian.news.com.au](http://theaustralian.news.com.au), 16 Dec 2005.

<sup>1119</sup> Bawer, Bruce. “Not all *Muslims* want to integrate,” *Christian Science Monitor*, [csmonitor.com](http://csmonitor.com), 17 Nov 2005.

<sup>1120</sup> Khoury, Jack & David Ratner. “We don’t speak Arabic here,” [haaretz.com](http://haaretz.com), 13 Mar 2006.

<sup>1121</sup> Wilkinson, Isambard. “FM *mullahs* fill the airwaves with hatred,” [telegraph.co.uk](http://telegraph.co.uk), 6 Mar 2006.

<sup>1122</sup> “Pakistan faction clash ‘kills 25,’” [news.bbc.co.uk](http://news.bbc.co.uk), *JW*.

<sup>1123</sup> MacDonald, Heather. “Homeland Security? Not Yet,” *City Journal*, *FPM*, 16 Nov 2004.

<sup>1124</sup> DeWolf, Smith Nancy. “Daughter of *Islam*,” [opinionjournal.com](http://opinionjournal.com), 25 Feb 2006, *JW*.

roads leading to the building.” The *Mosque* was renamed *Imam Ali Mosque*, a red flag was placed on the dome and a green one on the *Minaret*—both signs of *Shiite Islam*, and the *Adhan* was distinctively *Shiite* too.<sup>1125</sup>

- ⊕ In 2006 a cell phone rang in the *Iraqi* parliament with a *Shiite* chant as the ringtone. “Armed bodyguards of the *Sunni* speaker Mahmoud *al-Mashhadani* and” a veiled *Shia* politician, Ms. Gufran *Al-Saidi*, along with her bodyguards, scuffled in the lobby.<sup>1126</sup>
- ⊕ In October 2004 in *Gaza*, “armed *Islamic Jihad* men took over *Al Qassam Mosque*, a *Hamas* stronghold, by force, which takeover led to armed clashes between men from both groups. Thus [*Hamas* leader] Hamad complains in the tape, ‘the *Islamic Jihad* ignited our spirit of resistance when it took away our *Mosque*, and there is a danger they will try to take over others.’”<sup>1127</sup>
- ⊕ In 2006 thousands of *Fatah* supporters prayed outside *Mosques* at *Nusseirat* in central *Gaza Strip* and at *Beit Lahiya* in the northern *Gaza Strip* while *Hamas* supporters prayed inside. A *Fatah* spokesman explained that most *Mosques* in the Strip are *Hamas*-controlled, and:

They are preparing the stage for bloodshed. Some of them have even been calling for the elimination of their opponents, whom they describe as apostates and infidels...*Hamas* has turned the *Mosques* in the *Gaza Strip* into platforms for delivering political speeches. They have decorated the *Mosques* with political signs and banners and the preachers are saying awful things against Abbas and other *Fatah* leaders.<sup>1128</sup>

- ⊕ In 2005, Ehsan Masood, a *Muslim*, noted that the “overwhelming majority” of UK *Muslims* are *Sunni* and “Britain has about a thousand mosques,” yet “punch-ups [fist-fights] are all too common between different factions and the charity commission has a growing file of problem cases.”<sup>1129</sup>
- ⊕ In 2005, *The Times Online* reported on UK *Mosques*:
 

Small groups of extremists are known to target *Mosques* for takeover, driving out worshippers and replacing an *Imam* with their own choice of preacher, who is usually imported from countries such as *Pakistan* and does not speak English...there are no figures for how many *Imams* speak English but he estimates that 90 per cent probably preach in their mother tongue.<sup>1130</sup>
- ⊕ In 2006, *The Times Online* reported on how *Imam Abu Hamza* and his radical followers took over the *Finsbury Park Mosque* in north London:
  - ★ In 1997 there “were the bitter divisions between moderate *Muslim* factions,” so Hamza “just dropped anchor and moved in.”
  - ★ Hamza preached in Arabic and English rather than in *Pakistani* or Indian dialects.

<sup>1125</sup> Wong, E. “*Shiite* Militiamen Reclaim *Mosque* From the *Sunnis*,” nytimes.com, 3 Mar 2006.

<sup>1126</sup> Knight, S. “*Shia* ringtone sparks scuffle in *Iraqi* parliament, timesonline.co.uk, 10 May 2006.

<sup>1127</sup> Regular, Arnon. “Leading *Hamas* preacher warns of clash with *Islamic Jihad*,” haaretz.com, 15 Dec 2004, *Nobody’s Business*, bakelblog.com.

<sup>1128</sup> *Abu Toameh*, Khaled. “*Fatah* decries *Mosque* ‘incitement,’” jpost.com, 14 May 2006.

<sup>1129</sup> Masood, Ehsan. “A *Muslim* Journey,” *Prospect Magazine*, hvk.org, Aug 2005.

<sup>1130</sup> McGrory, Daniel. “Newly-arrived hate *Imams* face early expulsion,” timesonline.co.uk, 20 Aug 2005, *JW*.

- \* Hamza and his thugs scared off people with threats of violence. He was surrounded by bodyguards carrying knives. There were bouncers or “heavies” at “the door glaring and flashing their *Afghanistan* scars.”
  - \* Rachid Salama, an Algerian, said “My brothers...were on benefits or living off charity so they could hang about discussing *Jihad* all day. Whenever we were not praying, we were taken to watch TV. There were endless videos of *Mujaheddin* activity around the globe. *Jihadist Nasheeds* (songs) were played in the background, with medieval-style voice harmonies and deeply stirring lyrics about how brave *Mujhads* are suffering for *Allah* and dying in order to defend *Muslim* lands. They sometimes climaxed with a question—are you going to stand by and watch *Muslim* civilians killed?”<sup>1131</sup>
  - \* Rachid Salama said “The atmosphere was intense. Any slight dissent was stamped on so quickly and aggressively that I realised that the best thing to do was nod and say ‘*Inshallah*’ with the rest of my brothers.”<sup>1132</sup>
- C In 2006 *The Times Online* reported on how Abubaker Deghayes, whose brother Omar is a *Jihadist* detainee at *Guantanamo Bay*, took over *Al-Quds Mosque* run by Abduljalil Sajid in Brighton, a coastal town south of London:
- In May 1997 Brighton county court found Sajid had been assaulted four times by Deghayes in December 1996 and January 1997 and was also spat upon and threatened with a knife by one of his supporters. Injunctions were issued to prevent Deghayes and his supporters approaching Sajid but he was forced out of the *Mosque*, followed by the trustees of the *Sussex Muslim Society* charity, which operates it.<sup>1133</sup>
- C In 2005 it was reported that in Spain, Omar Checa Garcia is the leader of the *Jamal Islamiya Mosque* in *Granada* in the *Almeria* district. Garcia is a Spanish convert and considers himself a moderate however he has...
- ...several times blocked bids by North African *Muslims* to take over his *Mosque*, including one group that camped inside for three days before he threw them out...He [Garcia] sees the brand of *Islam* brought by most North African immigrants as ‘reactionary’ and foreign...This generation of immigrants is lost. It’s under the influence of these reactionary *Mosques*.<sup>1134</sup>
- Where do the takeover artists come from? In 2005 the Spanish newspaper *El Pais* reported that there were 600 *Islamist* worship centers in Spain, often in apartments, and also “six *Mosques* created by the extremist *Salafist Taqfir Wal Hijra* sect, which is believed to have masterminded the *Madrid* train attacks that killed 191 people in March last year,”<sup>1135</sup>
- C In 2005 in *Derband*, in southeast *Dagestan* on the west coast of the Caspian Sea, *Wahhabis* wanted to take over the 8<sup>th</sup> C. AD main Friday (*Juma*) *Mosque* called *Arafat*. Between 200 and 300 *Wahhabis* came from the *Bab-*

<sup>1131</sup> Taher, Abul et al. “Focus: How liberal Britain let hate flourish,” *The Sunday Times*, timesonline.co.uk, 12 Feb 2006.

<sup>1132</sup> Taher, Abul et al. “Focus: How liberal Britain let hate flourish,” *The Sunday Times*, *Ibid*.

<sup>1133</sup> Foggo, Daniel & Abul Taher. “*Imam* backs terror attack against Blair,” timesonline.co.uk, 18 Jun 2006.

<sup>1134</sup> Contenta, Sandro. “*Andalusia*’s connection,” thestar.com, 20 Mar 2005.

<sup>1135</sup> “Spain holds 15 suspected of recruiting for *Iraqi* insurgency,” news.yahoo.com, 19 Dec 2005.

*ul-Abwab Mosque* across town with “clubs, pieces of armature, knives and axes” either to oust the *Imam* and congregation that frequented the *Arafat Mosque* altogether, or at least have their *Wahhabi Imam* conduct the Friday midday prayers (*Namaz*):

After the fight on the floor of the *Mosque* there were pools of blood, the *Minbar* and an ancient mirror were broken as well as the benches, carpets covering the floor were torn.<sup>1136</sup>

The fight landed several *Muslims* in hospital beds. Another reporter wrote:

Everything had been turned upside down. The altar was on its side. Mirrors and sound equipment were smashed. Building materials—stone, wood and tiles—lay strewn across the floor, apparently used as weapons during the disturbances. *Streaks* of blood were visible everywhere. In one place, blood with a clump of hair stuck to it stained the wall. Lying broken on the floor was the flagpole from a green banner symbolizing *Islam*.<sup>1137</sup>

*Muslims* will sometimes gather at a *Mosque* and commit violence there, or march from the *Mosque* to commit violence elsewhere. This follows the example of *Muhammad* who told his followers in his *Madinan Mosque*, “Kill any Jew that falls into your power.”<sup>1138</sup> Thereupon, *Muslims* went out and killed 80 non-*Muslims*.<sup>1139</sup> For instance:

☉ *Muslims* are known for listening to sermons of incitement on Friday and rioting upon exiting the *Mosque*, such as at the *Al-Aqsa Mosque* on the temple mount.

☉ Rahul Gupta wrote this caption for a picture of a *Hindu* man being beaten inside a *Mosque*:

A *Hindu* being beaten by *Muslims* in a *Mosque* in *Bangladesh*. He was captured outside the *Mosque* while going home. After Friday prayers were over, the *Muslims* came out and grabbed the first *Hindu* they could. Mr. Vimal Patak, a *Bangladeshi* born *Hindu*, was beaten to death with sticks as the *Muslim Mullas* (priests) chanted “Kill the *Kafir!*” i.e. non-*Muslim*. With folded hands he begged for his life and died a brutal death.<sup>1140</sup>

*Muslims* are known to gather at *Mosques* or stadiums to hear incitement and then **protest march** or **bus** to another location to cause mayhem there, for instance:

☉ A British colonial administrator, Gertrude Bell, wrote:

[Writing on 16 August 1920]...the police gave warning that there was to be a **monster meeting in the big Mosque** next day, after which a procession through the town was to be organized. It would undoubtedly have led to disturbances and that was the object desired....[Later on 5 September 1920] We are now in the middle of a full-blown *Jihad*, that is to say we have against us the fiercest prejudices of a people in a primeval state of civilization...We’re near to a complete collapse of society—the end of the

<sup>1136</sup> “Fight in the oldest *Mosque* of Russia,” eng.*Islam.ru*, 12 Apr 2005, *JW*, 17 Apr 2005.

<sup>1137</sup> Turabov, Rinat. “*Dagestan: Muslim* Factions Clash,” iwpr.net, chechentimes.org, 15 Apr 2005.

<sup>1138</sup> Ishaq. *Sirat*, p. 369. The account is also found in *El badyah wa alnihay-Ibn Katheer*, vol. 4: the chapter on killing Ka’ab Bin Al’ Ashraf.

<sup>1139</sup> Warraq. *Quest*, p. 542, as quoted by Schmidt. *Divide*, p. 17.

<sup>1140</sup> Gupta, Rahul. “Ethnic Cleansing in *Bangladesh*,” mukto-mona.com/human\_rights/ethnic\_cleansing\_Bangladesh.html, accessed 2004.



Roman empire is a very close historical parallel. We've practically come to the collapse of society here and there's little on which you can depend for its reconstruction.<sup>1141</sup>

☉ The Turkish government claimed that a pogrom against the Greek community on 6-7 September 1955 was an unplanned riot by fanatics, but one author “questioned how riots could erupt so suddenly and violently as to destroy a whole community.”<sup>1142</sup> In fact, 100,000 *Islamists* were **transported** by the Turkish government and in nine hours they destroyed “4,500 Greek homes, 3,500 businesses, 90 religious institutions and 36 schools in 45 distinct communities.” The pogrom occurred in three waves:

★ The first wave was just intended to break down all the doors and barriers. *Muslims* brought “pickaxes, shovels, wooden timbers to serve as battering rams, acetylene torches, gasoline, dynamite and large trucks full of stones.”

★ The second wave came with trucks for pilfering and the pillaging and they proceeded to destroy “houses, the apartments, the church, the stores.”

★ The third wave was meant to finish where the others left off.<sup>1143</sup>

☉ *National Interest* reported on a *Muslim* massacre called the “March Pogrom” in *Kosovo* in 2004:

Members of the victimized community, in this case, [Christian] *Serbian* children, were accused of chasing four [Muslim] *Albanian* children into a river and causing the death of three of them. Hours later, what passes for authority in *Kosovo*, the U.N. Mission, issued a statement that the accusation against the *Serbs* was false, that the surviving *Albanian* child had told the U.N. that there had been no *Serbs*—yet the violence escalated and today it continues unabated.

**Busloads** of [Muslim] *Albanians* were transported to areas where *Serbs* are concentrated—in some cases, clashing with international peacekeepers. In some areas, entire *Serbian* villages have been burned to the ground. The U.N., ever courageous [an allusion to U.N. peace keepers fleeing the genocide of *Rwanda* in 1994], evacuated its missions from at least three cities in *Kosovo*. In two of them, *Serbian* Orthodox churches are in flames. And it has only gotten worse during the night.

Monasteries and churches dating back to the twelfth century are burning; some are already destroyed. Their cultural significance—not only for Christians but also for all humanity—is irreplaceable. Photographs and memories are all that remain of these objects of civilization. And the U.N. [peacekeepers] fled.

The wave of violence has been too well planned and coordinated to be a spontaneous reaction to rumors. ‘It was planned in advance,’ said Derek Chappell, the U.N.’s *Kosovo* mission spokesman. All that was needed was a pretext. It is clear that some in the *Kosovo Albanian* leadership believe that by cleansing all remaining *Serbs* from the entity

<sup>1141</sup> Gertrude Bell, Baghdad, *Iraq*, Baghdad, 1920, as quoted in Bostom, Andrew G. “*Iraq’s Jihad: Past as Prologue*,” *americanthinker.com*, 8 Jun 2005, *JW*.

<sup>1142</sup> Lappen, Alyssa A. “Turkey’s Forgotten *Islamist* Pogrom,” FPM, 24 May 2005.

<sup>1143</sup> Lappen, Alyssa A. “Turkey’s Forgotten *Islamist* Pogrom,” FPM, 24 May 2005.

(having already achieved the [ethnic]-cleansing of two-thirds of *Kosovo's Serbs* after 'liberation' in 1999) and destroying all *Serbian* [Christian] cultural sites, they can present the international community with a *fait accompli*. But [religio]-ethnic purity cannot be allowed to be the foundation for democracy and independence...<sup>1144</sup>

From June 1999 when KFOR took over *Kosovo* to 2004, eighty churches have been destroyed.<sup>1145</sup> From 1999 to 2006 "220,000 *Serbs* and non-*Albanians* have been driven out of the province; 40,000 *Serbian* houses have been destroyed and more than 1,000 *Serbian* civilians have been killed...[With the result that] almost 80 percent of *Kosovo's* territory is ethnically pure."<sup>1146</sup> During the March 2004 pogrom alone, 35 churches and monasteries were destroyed and nineteen *Serbs* were killed. Some believe that the "March Pogrom" was planned well in advance:

Strong suspicion exists among many in *Kosovo*, even those within NATO's *Kosovo Force* (KFOR) peacekeeping forces, that the March Pogrom was anything but a spontaneous event.<sup>1147</sup>

In 2006, the U.N. began setting up refugee camps for up to 40,000 *Serbs* in anticipation of the ethnic cleansing of *Kosovo* by *Albanian Jihadists* once *Kosovo* is declared an independent state later in the year.<sup>1148</sup>

- C In 2004, "*Kano's* [in Nigeria] main *Muslim* leader [cleric Umar Ibrahim Kabo] led a **demonstration** against the killings from the main *Mosque* on Tuesday, telling protesters that the *Yelwa* killings [a town a long ways away] were part of a supposed Western conspiracy against *Islam*. Two days of citywide mayhem and violence ensued."<sup>1149</sup> The violence came hours after thousands of *Muslim* protesters—some carrying daggers, sickles and clubs—marched from the main *Mosque* in the northern city of *Kano* [Nigeria], traditionally a hotbed of religious tensions.<sup>1150</sup>
- C In 2004 in *Bangladesh*, one thousand *Muslims* **marched** to the "small *Mosque*" carrying "maces, machete, clubs and axes" while "chanting anti-*Ahmadiyya* slogans." The *Sunnis* ransacked the twelve *Ahmadiyya* houses, beat and pelted worshippers with stones and tore down the *Mosque*.<sup>1151</sup>
- C In Norway in 2004, 20 *Muslim* gang members boarded a **bus** from *Kristiansand* and traveled north to attack a native Norwegian gang in *Vennesla*. That there was preplanning can be deduced from the mode of travel—the bus, their carrying axes, knives and bats, and "The two groups reportedly used the national newspaper *Dagbladet's* Internet chat service to arrange a meeting place."<sup>1152</sup>

<sup>1144</sup> Krnjjevic-Miskovic, Damjan de. "Pogrom in *Kosovo*," *National Interest, JW*, 18 Mar 2004.

<sup>1145</sup> "Serbian church sues over *Kosovo*," news.bbc.co.uk, 9 Dec 2004, *JW*; also see savekosovo.org.

<sup>1146</sup> "The Time for Demagogues has Returned: Interview with *Serbia's* Vuk Draskovic," service.spiegel.de, 13 Jul 2006.

<sup>1147</sup> Weyrich, Paul M. "Stability for Tragic *Kosovo*," CNSNews.com, 29 Oct 2004.

<sup>1148</sup> "Europe Prepares to Evacuate 40,000 *Kosovo Serbs*," *Focus i News*, focus-fen.net, 18 Apr 2006, *DW*, 20 Apr 2006; also see savekosovo.org.

<sup>1149</sup> Walsh, D. "Nigeria deploys soldiers to quell religious killings," lam-online.com, 14 May 2004.

<sup>1150</sup> Samuel, Oloche. "Muslims Hack Christians to Death in Nigeria," *FPM*, 13 May 2004.

<sup>1151</sup> "Ahmadiyya Mosque razed, 12 houses robbed in *B'Baria*: 11 including 6 women injured," thedailystar.net, 30 Oct 2004, *DW*.

<sup>1152</sup> "Juvenile bloodbath averted," afterposten.no, 13 Oct 2004, *JW*, 14 Oct 2004.

- ⊕ In China in 2004, “police stopped a **17-truck convoy** carrying *Hui* [*Muslim*] men” who were about to attack non-*Muslim Han* Chinese. 148 people died in ethnic clashes.<sup>1153</sup>
- ⊕ In 2005, at *Jotindryanagar* in the state of *Satkhira* in *Bangladesh*, fifteen thousand *IKNMB* members held a rally at 10 AM, and at 1 PM **marched** to an *Ahmadiyya Mosque*, which act sent the *Ahmadiyyas* into a panic. The *Sunnis* threw stones and injured fifty *Ahmadiyyas*. Immediately after hanging a sign on the *Ahmadiyya Mosque*, as if this were the cue, the *Sunnis* looted ten *Ahmadiyya* houses. As typical, the only person the police arrested during the melee was not a fanatic *Sunni* but an *Ahmadiyya*.<sup>1154</sup>
- ⊕ In 2005, a *Pakistani* Christian man won money gambling with *Muslims* who were sore losers. Rather than pay, they spread the rumor that the winner had burned a “*Koran Mahal*, a box for preserving torn pages of the *Koran*.” 2,000 *Muslims* then came on **buses** to *Sangla Hill* in the *Nankana* district of *Punjab* in *Pakistan* and ransacked and burned three churches, two schools and a convent, parsonages and Christian homes.<sup>1155</sup>
- ⊕ In 2005, after a beach riot in *Sydney*, Australia, *Muslims* to the south in *Melbourne* were organizing so “30 cars and a couple of **busloads**” of *Muslims* could join the fray but they were headed off by police.<sup>1156</sup>
- ⊕ In 2006, during the worldwide Cartoon Riots that killed dozens...

...some 400 people walked from a *Mosque* to the Danish Embassy in London. Some carried placards with slogans such as ‘Europe your 9/11 will come,’ ‘behead the one who insults the prophet,’ ‘be prepared for the real Holocaust’ and ‘massacre those who insult *Islam*.’ Later, one protester was charged with soliciting murder.<sup>1157</sup>

In Lebanon, the 2006 Danish Cartoon Riots were more violent.

...**heavily-laden coaches and minivans** began to arrive from *Beirut* and the rest of *Lebanon*. They were all full of young, often bearded men who wore headbands and carried identical flags with calligraphic inscriptions in Arabic such as: ‘There is no god but God and *Mohammad* is his Prophet’ and ‘O Nation of *Muhammad*, Wake Up.’ There were soon as many as 20,000 of them filling the streets. They walked up past the Christian quarter of *Gemmayze* and into the even more genteel Christian area of *Achrafieh*, [while smashing windows, burning cars and torching the Danish embassy and a church in *Ashrafiya*] gathering not far from the Danish embassy, the target of their protest. One man waved a placard in English that said: ‘Damn your beliefs and your liberty.’ Another carried a sign saying: ‘Whoever insults Prophet *Muhammad* is to be killed.’ And then in the early afternoon, as suddenly as it had all begun, it ended. The leaders of the mob turned to the angry young men beside them and told them it was time to leave. Obediently the crowd thinned out and began walking back to the **buses**, even

<sup>1153</sup> Kahn, Joseph. “Martial Law Declared as Nearly 150 Die in Clashes in Central China,” *nytimes.com*, 1 Nov 2004.

<sup>1154</sup> “50 hurt as bigots attack *Ahmadiyyas* in *Satkhira*: 10 houses looted,” *thedailystar.net*, 18 Apr 2005, *DW*.

<sup>1155</sup> “Anti-Christian rampage features 2,000 *Muslims*,” *WND*, 13 Nov 2005, *DW*.

<sup>1156</sup> Kerbaj, Richard & Cath Hart. “Melbourne youths prepare to head north,” *theaustralian.news.com.au*, 16 Dec 2005, *C&R*, *DW*.

<sup>1157</sup> “Brit. man remanded for *Muhammad* cartoons protests,” *jpost.com*, 6 May 2006.

as the Danish embassy continued to burn. By 3pm there wasn't a single protester left on the street.<sup>1158</sup>

When *Islamists* cannot drive non-*Muslims* out quickly due to strategic reasons (e.g. foreign policy considerations, or a Christian population that can protect itself), they seek to reduce their power and presence in various ways. One way is to build *Mosques* and *Minarets* next to churches. Another is to require that all churches be surrounded by tall walls as is common in the Gulf States and even in Palestine, as *Ynet* reported:

The Galilee Churches were established starting in the 16<sup>th</sup> century, when *Muslim* rulers, wanting to develop relations with European powers, permitted their representatives in the holy land to buy property and build places of worship. Passing by one of these churches, one may only see high walls, a metal gate and a bell tower. But these walls, however often hide beautiful churches...<sup>1159</sup>

The high walls means that the church is “out of sight, out of mind” for the populace. The walls also are needed for protection against “roving *Muslim* hooligans out to spoil Christian observances.”<sup>1160</sup> Bat Yeor wrote about the situation in the 1990's:

In *Hebron*, the Russian Orthodox church had to be protected by a high wall, immediately covered with *Islamist* graffiti, and in Bethlehem barbed wire encircled the Baptist church.<sup>1161</sup>

*Islamists* like to build *Minarets* and *Mosques* next to churches to: 1) check their expansion, 2) to harass worshippers as they walk in and out, 3) to disrupt church services by playing the *Adhan* five times per day and 4) to blast sermons from stadium-sized loudspeakers mounted on the *Minaret*(s). Examples include:

☉ The small Chapel of the Ascension on the Mount of Olives has a “flanking *Minaret*,” complete with a crescent finial and loudspeakers.<sup>1162</sup>

☉ *Muslims* destroyed the Church of the Sepulcher during the reign of *Fatimid Caliph Al-Hakim* (996-1021 AD). After driving out the Crusaders, *Saladin* (1138-1193 AD) built two *Mosques*, the *Omar* and *Al-Hanaqa Mosques*, that still loom over the Church of the Holy Sepulcher that had been reconstructed in 1048 AD. *Saladin* also reinstated the *Nuseibeh* family as key-holders at the Church of the Sepulcher. Today, the *Nuseibeh* family attends the *Omar Mosque* next to the Church of the Sepulcher.<sup>1163</sup> *Landay* wrote about attending a service at the Church of the Sepulcher in 1972 AD: “...from its graceful *Minaret*, the *Muezzin*'s call mingles with the chants of Christian clerics in the church below.”<sup>1164</sup> *Al-Hanaqa Mosque* abuts and overshadows the Church of the Sepulcher, which has allowed *Muslims* to:

★ In April 1997, “[knock] down the walls between a *Mosque* and the orthodox patriarchate, on the pretext that they were doing restoration work.”<sup>1165</sup> They “Seized two rooms of a Greek Orthodox monk and

<sup>1158</sup> McCarthy, Rory. “Rioting with well-planned spontaneity,” guardian.co.uk, 6 Feb 2006.

<sup>1159</sup> Zur, Yigal. “Waiting for Father Timothy,” ynetnews.com, 4 Jan 2006.

<sup>1160</sup> Parsons, David. “The True Star Of Bethlehem,” christianactionforisrael.org, 28 Dec 2001.

<sup>1161</sup> Yeor. *Dhimmitude*, p. 237.

<sup>1162</sup> Peters. *Jerusalem*, pp. 274-275, illustrations.

<sup>1163</sup> Kalman, Matthew. “*Muslim* family holds key to sacred sepulcher,” *The San Francisco Chronicle*, sfgate.com, 27 Mar 2005.

<sup>1164</sup> Landay. *Rock*, p. 18.

<sup>1165</sup> “Antenna Radio (antenna.gr): News in English (AM), 97-04-25,” Hellenic Resources Net, hri.org, 25 Apr 1997.

annexed them to a *Mosque* next to the Church of the Holy Sepulcher. The monk came back from abroad to find his access blocked and belongings thrown out.”<sup>1166</sup>

★ In 2002, *Muslims* tried to build a latrine servicing the *Al-Hanaqa Mosque* on the roof of the Church of the Sepulcher.<sup>1167</sup> Only the threat of legal action against the *Wakf* by *Israel* stopped the construction.<sup>1168</sup>

★ In 1997, *Muslims* dug a tunnel from the *Al-Hanaqa Mosque* that was discovered only after “two clerics discovered a hole in the floor of the crypt” inside the Church of the Sepulcher.<sup>1169</sup> Incidentally, in 2006 *Islamists* in *San’a, Yemen*, dug a 140-meter tunnel from a *Mosque* to a jail to break 23 inmates and terrorists out of jail.<sup>1170</sup>

C Jordanians captured and held part of the City of Jerusalem from 1949 to 1967, and in 1953 they “undertook to *Islamize* the Christian quarter of the Old City of Jerusalem by laws forbidding Christians to buy land and houses... and authorized *Mosques* to be built near churches, thus preventing any possibility of enlargement.”<sup>1171</sup>

C In the West Bank and *Gaza* in general, David Raab wrote the Palestinian *Muslims* have continued in the...

...tradition of Saladin—who constructed two *Mosques* contiguous to and taller than the Church of the Holy Sepulcher—*Mosques* have mushroomed adjacent to and usually taller than churches.<sup>1172</sup>

C In *Ramallah* in 2005, “Father Nazaih reported on the bitterness that still exists several years after *Muslim* fanatics stole Christian land next to the church. There they wanted to build a *Mosque*. ‘They came with tractors and burst into the place,’ he said. ‘They broke the walls of the houses. We did not realize what was happening. They took everything. Even the governor could do nothing. Of the thousands of families present in *Ramallah* in 1948, only a few hundred remain. Up to 40,000 Christians have gone to the United States,’ he added.”<sup>1173</sup>

C David Parsons wrote in 1999 about Nazareth, a city located in *Israel* proper: ...an 80 percent Christian majority before 1948 has dropped to under 33 percent.<sup>1174</sup>

In October 1999 “the Arab Christian mayor of *Nazareth*, Ramiz Jaraisy (Gerasi), was beaten by members of the opposing *Islamist* party.”<sup>1175</sup> Drew Christiansen wrote in 2000 about *Nazareth*:

<sup>1166</sup> Parsons, David. “The Galilee Gauntlet,” *Middle East Digest*, May 1999, vol. 10:5, christianactionforisrael.org.

<sup>1167</sup> Raab, David. “The Beleaguered Christians of the Palestinian-controlled Areas,” *IMRA*, imra.org.il, 10 Oct 2002.

<sup>1168</sup> Winston, Emanuel A. “*CNN* Slants The Story Of The Church Of The Nativity Siege or The Evil Empire Strikes Again,” *cnn.com*, 6 May 2002.

<sup>1169</sup> “Antenna Radio (antenna.gr): News in English (AM), 97-04-25,” Hellenic Resources Net, hri.org, 25 Apr 1997.

<sup>1170</sup> Ghobari, Mohamed. “13 *Al-Qaida* Convicts Escape *Yemeni* Prison,” *themoscowtimes.com*, 7 Feb 2006.

<sup>1171</sup> Yeor. *Dhimmitude*, p. 235.

<sup>1172</sup> Raab, David. “The Beleaguered Christians of the Palestinian-controlled Areas,” *IMRA*, imra.org.il, 10 Oct 2002, *USS Neverdock* blog.

<sup>1173</sup> “Christians in Holy Land in Crisis, Says Report,” *ZENIT*, 26 May 2005, *DW*, 25 Jun 2005.

<sup>1174</sup> Parsons, David. “The Galilee Gauntlet,” *Middle East Digest*, May 1999, vol. 10:5, *Ibid*.

Elsewhere in the Middle East however fundamentalists often seize or occupy land near churches in efforts to intimidate and harass local Christians. I remember, for example, being shown some years ago *Mosques* erected by fundamentalists near the entrances of Catholic churches in a neighboring Arab country. The occupation of the particular site in *Nazareth* [nearby the Basilica of the Annunciation] appears to have been intended as just such a provocation.<sup>1176</sup>

The Israeli government, under pressure from the Vatican, intervened and stopped the building of the *Shehab el-Din Mosque* meant to upgrade a shrine built in honor of a nephew of Saladin. The proposed *Mosque* would have meant *Muslims* could more easily: 1) bully Christian worshippers, 2) snarl traffic in the area, 3) take all the parking spaces and 4) postcards featuring vista views of Nazareth would show a huge *Mosque* next to the basilica.

David Parsons wrote about *Nazareth* in 1999:

The latest disturbances [in 1999] began when several thousand *Muslim* youths shouted insults at Christians leaving Easter services at the Basilica [of the Annunciation in *Nazareth*]. In a repeat of attacks at Christmas, the *Muslim* gangs stoned worshippers, torched shops and smashed windshields of cars with crosses dangling from their mirrors. Similar skirmishes occurred in the nearby *Galilee* village of *Turan* two years ago [in 1997], after *Muslims* interrupted a mass on Orthodox Good Friday. Christians were left fearful by days of firebombs and a fatal stabbing [of a Baptist man in *Turan*].<sup>1177</sup>

Besides the 1999 riot outside the basilica, *Muslims* erected a protest tent there to put pressure on Israeli politicians and Christians to let them build the *Shehab el-Din Mosque*. Of course just as they still do in 2006, they prayed prostrate *en masse* outside the *Shehab el-Din* shrine in full view of the basilica. When initial approval was granted in 1999 (later retracted in 2003), the *Islamists* had a victory parade. A *Cairo* newspaper reported:

Last week, as Israel's *Islamist* movement was transforming the cornerstone-laying ceremony for the *Mosque* of *Shihab Al-Din* in Nazareth into a virtual victory parade, one image lingered in the minds of Palestinian Christians, whether in Israel or the Occupied Territories. This was the sight of a solitary nun standing on the parapets of Nazareth's Basilica of the Annunciation while, beneath her, thousands of Palestinian *Muslims* chanted slogans of 'fire and blood' and pitched green-canister flares into the night. It was an icon of absolute vulnerability.<sup>1178</sup>

Then in February 2006 during the widespread Cartoon Riots that killed dozens, *Muslims* protested the Danish caricatures in *Nazareth* too. *Sheik* Raed Salah of the *Islamic* Movement led 500 chanting Israeli Arab *Muslims*

<sup>1175</sup> "Crisis in Nazareth: Background Information," nccbuscc.org, Oct 1999.

<sup>1176</sup> Christiansen, Drew. "Nazareth Journal," *America: The National Catholic Weekly*, americamagazine.org, 12 Feb 2000, vol. 182, no. 4.

<sup>1177</sup> Parsons, David. "The Galilee Gauntlet," *Middle East Digest*, May 1999, vol. 10, no. 5, christianactionforisrael.org (the Baptist man was Saleh Salami, a college student).

<sup>1178</sup> Usher, Graham. "Palestinian Christians after Nazareth," *Al-Ahram Weekly*, weekly.ahram.org.eg, 2-8 Dec 1999, Issue # 458.

from the nearby *As-Sala(a)m Mosque* toward the basilica.<sup>1179</sup> “Some carried signs in English reading, ‘Infidels, your day will come’ and ‘Don’t hurt our prophet’s feelings.’”<sup>1180</sup>

Then in March 2006, an emotionally disturbed Jewish man, his Christian wife and their daughter threw firecrackers from the balcony of the Nazareth basilica during a packed Lenten church service. While Christians inside the church protected the pranksters from a lynching, later that evening a mostly-*Muslims* crowd rioted outside the church, burning four cars—two of them police cruisers. Police used stun grenades and tear gas to break up the riot in which 13 police officers and 13 civilians were wounded.<sup>1181</sup> After this yet one more example of *Muslims* using the slightest pretext to engage in *Jihad* mayhem...

Ahmad Tibi, an Arab *Muslim Knesset* [parliament] member, said ‘I am proud that the *Muslims* defended the Church of Annunciation and I am sure Christian Arabs would not hesitate to defend *Mosques*.’<sup>1182</sup>

It should be noted that every day in *Nazareth* “the call of the *Muezzin* washes over the roof and the other roofs of the neighborhood.”<sup>1183</sup> David Raab wrote in 2002:

Loudly amplified *Muslim* sermons have been aired during Christian services, including the Pope’s April 2000 address in *Nazareth*, which had to be halted until the *Muslim* call to prayer was concluded.<sup>1184</sup>

As elsewhere, *Muslims* use their *Mosque* loudspeakers in *Nazareth* to incite riots and disturb Christian church services. In mid-2003, when bulldozers came to demolish the foundation of the *Shehab el-Din Mosque*...

...Loudspeakers immediately began calling on residents to come to the site and demonstrate in order to ‘save the *Mosque*.’ Seven of the Israeli Arabs protesting the move were arrested and two policemen were lightly injured, one of them suffering stabbing wounds, Israeli radio reported.<sup>1185</sup>

- C In *Bethlehem*, the Church of the Nativity looks drab today because *Muslims* stole the white marble for buildings on the temple mount and for *Mosques* in *Istanbul*.<sup>1186</sup> David Parsons wrote in 2000 about *Bethlehem*, located in the West Bank:

New *Mosques* have been built around *Bethlehem*’s Manger Square, and Christian visitors complain about the imposing *Muezzin* calls—not only five times a day for prayers but also reportedly whenever Christian tour groups are around.<sup>1187</sup>

<sup>1179</sup> “Cartoon row: Danish embassy ablaze,” *cnn.com*, 4 Feb 2006.

<sup>1180</sup> “Palestinians protest Danish cartoons,” *jpost.com*, 4 Feb 2006.

<sup>1181</sup> “Barakeh on church attack: Olmert’s head ‘sick with racism,’” *Haaretz.com*, 5 Mar 2006.

<sup>1182</sup> Klein, Aaron. “*Muslims* blame Israel for church attack...” *WND*, 5 Mar 2006.

<sup>1183</sup> Ben-Ami, Yuval. “Bohemia in *Nazareth*,” *haaretz.com*, 27 Dec 2005.

<sup>1184</sup> Raab, David. “The Beleaguered Christians of the Palestinian-controlled Areas,” *IMRA*, *imra.org.il*, 10 Oct 2002.

<sup>1185</sup> Shuman, Ellis. “Bulldozers raze controversial *Nazareth* mosque,” *Israelinsider.com*, 1 Jul 2003.

<sup>1186</sup> “*Bethlehem*, Part 2,” *ourfatherlutheran.net/biblehomelands/palestine*, accessed 29 Dec 2005.

<sup>1187</sup> Parsons, David. “The Galilee Gauntlet,” *Middle East Digest*, May 1999, vol. 10:5, *Ibid*.

Now there are fifteen *Mosques* and only ten churches left in Bethlehem.<sup>1188</sup>

Ever since Arafat and the Palestinian Authority took control of Bethlehem in 1995, Christian residents and tourists have dwindled to a fraction of what they were before. *Muslims* and *Muslim* apologists blame this on *Israel's* counter-terrorism measures, but the West Bank security fence was built starting in 2002 after the bulk of the Christians population had already left.<sup>1189</sup> In fact, the economy and tourist situation has improved in Bethlehem since 2002 since the tall concrete walls meant Palestinians could no longer infiltrate “Christian homes and churches in neighboring *Beit Jalla* to shoot at the Jerusalem suburb of *Gilo*.”<sup>1190</sup>

Christians have been subject to *Muslim* boycotts, and *Muslim* gangs and militias demanding protection money. Christian land and businesses have been confiscated by *Muslim* squatters who often came from *Hebron*.<sup>1191</sup> “The PA has been appropriating lands of the Greek Orthodox Church in Bethlehem and building *Mosques* on the formerly Christian land.”<sup>1192</sup> In April 2002, gunmen took over the Basilica of the Nativity and “other convents and Christian institutions in the city” for a month.<sup>1193</sup> Just before Christmas in 2005, gunmen demanding government jobs briefly occupied the mayor’s office, who happens to be Christian.<sup>1194</sup>

In 2001, Manger Square was “almost devoid of decorations,” yet the PA had enough money to hang: 1) “Stop the wall” signs,<sup>1195</sup> 2) a large banner that “read, ‘Sharon assassinates the joy of Christmas,’” 3) Palestinian flags and 5) posters of Arafat.<sup>1196</sup> In 2005, the City of Bethlehem had to take out loans to decorate Manger Square.<sup>1197</sup>

After *Hamas* won elections in Bethlehem in 2005, Masalmeh, a leader of the local *Hamas* contingent, said:

We in *Hamas* intend to implement this [*Jizya*] tax someday. We say it openly—we welcome everyone to Palestine but only if they agree to live under our rules.<sup>1198</sup>

C In Egypt, Johannes J.G. Jansen relates that a Coptic priest...

...pointed out that right next to every church in Egypt is a *Mosque*, its *Minaret* just a bit higher than the neighboring church spire...<sup>1199</sup>

<sup>1188</sup> Magister, Sandro. “The Mayor of Bethlehem is Christian, but It’s *Hamas* That’s in Charge,” [chiesa.espressonline.it](http://chiesa.espressonline.it), 29 Dec 2005, *DW*.

<sup>1189</sup> Klein, A. “World leaders, media blame Israel for fleeing Christians,” *WND*, 25 Dec 2005, *DW*.

<sup>1190</sup> Parsons, David. “The True Star Of Bethlehem,” [christianactionforisrael.org](http://christianactionforisrael.org), 28 Dec 2001.

<sup>1191</sup> Raab, David. “The Beleguered Christians of the Palestinian-controlled Areas,” *IMRA*, [imra.org.il](http://imra.org.il), 10 Oct 2002.

<sup>1192</sup> Klein, Aaron. “Palestinians blame *WND* for Bethlehem religious rift,” *WND*, 28 Dec 2005.

<sup>1193</sup> Magister, Sandro. “The Mayor of Bethlehem is Christian, but It’s *Hamas* That’s in Charge,” [chiesa.espressonline.it](http://chiesa.espressonline.it), 29 Dec 2005, *DW*.

<sup>1194</sup> Klein, A. “World leaders, media blame Israel for fleeing Christians,” *WND*, 25 Dec 2005, *DW*.

<sup>1195</sup> “Holiday Cheer Lacking In Bethlehem,” [cbsnews.com](http://cbsnews.com), 24 Dec 2003.

<sup>1196</sup> Hazboun, *Ibrahim*. “Israel bars Arafat from Bethlehem Mass,” [suburbanchicagonews.com](http://suburbanchicagonews.com), 25 Dec 2001.

<sup>1197</sup> Toameh, K. A. “Bethlehem mayor lacks Christmas celebration funds,” [jpost.com](http://jpost.com), 8 Dec 2005.

<sup>1198</sup> Masalmeh’s interview with Karby Legget, *Wall Street Journal*, [online.wsj.com](http://online.wsj.com), 23-26 Dec 2005, as quoted in Pipes, Daniel. “*Dhimmitude* in Practice,” *DP*, 29 Dec 2005.

<sup>1199</sup> “Hans Jansen ([arabistjansen.nl](http://arabistjansen.nl)) on *Dhimmitude* in Holland,” *DW*, 1 Apr 2005, translated by Rogier van Bakel (*Nobody’s Business* blog) from the Dutch broadsheet *Trouw*, 27 Nov 2004.



When US President Bush's aide "Hughes climbed a tower to gaze over the city skyline," she saw only "A thousand *Minarets*—and satellite dishes."<sup>1200</sup>

Karen Hughes was on a listening tour to find out why *Muslims* hated the US. She heard lies in the parlors and halls of power such as "We have no problems with Americans. But look at what Bush is doing..." and the *Muslim Brotherhood* told her "We are respectful of Egypt's laws."<sup>1201</sup> Ironically, the truth could be seen by all from the rooftops. The satellite dishes no doubt pulled in anti-American radical *Islamic* preaching, and the absence of church steeples showed how Egyptians *Muslims* felt they had to utterly prevail over the Copts in keeping with K 009:033.

Most often Copts are kept from building churches in Egypt, as is the case in many parts of *Islamdom*. Copts are not allowed to have house churches either, as *The Jerusalem Post* reported:

The Interior Ministry said in a statement that the violence started after a rumor spread through the village that two *Coptic* Christian brothers had turned their house into a church and urged *Copts* to pray inside. The statement said 200 *Muslim* villagers marched on the house, hurling stones at it before trying to storm the dwelling. Security guards employed by local authorities intervened and fired rifles into the air while trying to disperse the crowd, but mistakenly killed an 18-year-old *Muslim* student, Mohammed Mohsen Qassem, and injured three others, the statement said. Police also arrested 23 *Muslims* and Christians. Residents in the *Muslim*-majority village say local *Copts* have grown angry since authorities last year rejected their demand to build a church...Christian villagers must travel to a nearby village to attend church services.<sup>1202</sup>

C In Spain, *Muslims* are trying to drive the Catholic Church out of former *Muslim* strongholds. For example:

★ *Muslims* demanded that Catholics share the *Cordoba* Cathedral, a *Mosque* converted to a church sometime after 1492 AD, though the site originally been a church before *Muslims* invaded Spain.<sup>1203</sup>

★ Sandro Contenta wrote about *Granada*:

On a hilltop directly across from the *Alhambra* [700-year-old *Muslim* fortress], the first *Granada Mosque* to be built in 500 years opened its doors in 2003. Before construction, the choice of the highly symbolic site met with two decades of resistance from local authorities, not least because it is squeezed **between a Catholic church and a nun's convent**. 'The church hierarchy is very hostile to *Islam*,' says Abdulhasib Castineira, director of the Great *Mosque*, which was built largely with funds from *Morocco*, Malaysia and the United Arab Emirates.<sup>1204</sup>

*The Los Angeles Times* noted:

<sup>1200</sup> Kessler, Glenn. "Hughes Reaches Out Warily in Cairo," washingtonpost.com, 26 Sep 2005.

<sup>1201</sup> Kessler, Glenn. "Hughes Reaches Out Warily in Cairo," washingtonpost.com, 26 Sep 2005.

<sup>1202</sup> "Egypt: 1 dead, 23 detained in religious clashes," jpost.com, 30 Dec 2004.

<sup>1203</sup> Sills, Ben. "Cathedral may see return of *Muslims*," guardian.co.uk, 19 Apr 2004.

<sup>1204</sup> Contenta, Sandro. "*Andalusia's* connection," thestar.com, 20 Mar 2005.

Cloistered nuns on the other side of the *Mosque* added a few feet to the wall enclosing their convent, as if to say they wanted neither to be seen nor to see.<sup>1205</sup>

- ⊕ In the UK in 2006, in the Pollokshields area of Glasgow, Scotland, a *Muslim* leader called on the Catholic Church to change the main faith of a church school to *Islam* since 90 percent of its students were *Muslim*. The story makes no mention of the *Muslim* leader offering any compensation for the property, which reminds one of how most churches in *Islamdom* have been confiscated or destroyed the last 1400 years.<sup>1206</sup>

*Islamists* like to upstage non-*Muslims* by building huge *Mosques* funded by petro-dollars that tower over churches, or in the case of secular nations, next to international airports and sports venues. They are often in a rush to build these monumental-size *Mosques* in time for big televised events, for instance:

- ⊕ David Parsons wrote about the planned *Mosque* in honor of a relative of Saladin's that *Muslims* tried to build by the Basilica of the Annunciation:

The inescapable reality is that the flash point in *Nazareth* flared into violence when they [*Muslims*] became frustrated that the *Mosque* might not be finished in time for the mass of Millennium [2000 AD] travelers...including the pope...It seems some *Muslims* fancy that broadcasts of *Allah Akbar* just might seduce pilgrims on the Millennium's path. At the least, every visitor will be reminded *Nazareth* is *Muslim* now. For Christians, can any good thing come out of that?<sup>1207</sup>

- ⊕ Many Italians are incensed that there is a *Minaret* in Rome that is taller than St. Peter's *Basilica*.<sup>1208</sup> The Rome *Mosque* "was built to be the largest *Mosque* in Europe, in the very heart of Christianity."<sup>1209</sup> The *Mosque* was built near *Monte Antenne* in the *Parioli* district on the edge of *Villa Ada* Park a mere 2.5 miles northeast of Vatican City.
- ⊕ In Greece, the Orthodox Church nixed the idea of building a large *Mosque* in downtown Athens, so it is being built next to the airport. Greeks complain that this *Mosque* conveys the impression to visitors who fly in that Greece is an *Islamic* country since it is the first building they see upon arriving.<sup>1210</sup>
- ⊕ In *Beirut*, "the *Mufti* wanted a larger design" for the Mohammed *Al-Amin Mosque*.<sup>1211</sup> The *Mosque* was paid for by *Sunni* billionaire and Prime Minister Hariri, who was instrumental in gaining Lebanon's independence from Syria in 2004.<sup>1212</sup> The *Mosque* overlooks the central Martyrs' Square and statues both dedicated to Lebanese patriots from 1915-1916.<sup>1213</sup> Now however "the monster—some say monstrous—*Sunni Muslim Mosque*...

<sup>1205</sup> Wilkinson, Tracy. "Islam's claim on Spain," *Los Angeles Times*, latimes.com, 18 Jan 2005, *JW*.

<sup>1206</sup> Duncanson, Hilary. "Islamic group urges Catholic school to move to Muslim faith," news.scotsman.com, 16 Jan 2006, Jawa Report, mypetjawa.mu.nu, *DW*.

<sup>1207</sup> Parsons, David. "The Galilee Gauntlet," *Middle East Digest*, May 1999, *Ibid*.

<sup>1208</sup> Carter, Tom. "The Italian dilemma," washingtontimes.com, 21 Dec 2004, *DW*.

<sup>1209</sup> De Rosa, Giuseppe (S.I.) "Christians..."

<sup>1210</sup> Galpin, Richard. "Greek mosque plans cause friction," news.bbc.co.uk, 29 Jul 2003, *LGF*; also Jatrass, Stella L. "Dhimmitude in Greece," *JW*, 3 May 2005.

<sup>1211</sup> Noueihed, Lin. "Beirut Mosque Funded by Ex-PM Becomes His Mausoleum," reuters.com, 16 Feb 2005.

<sup>1212</sup> Noueihed, Lin. "Beirut Mosque Funded by Ex-PM Becomes His Mausoleum," *Idem*.

<sup>1213</sup> Noueihed, Lin. "Beirut Mosque Funded by Ex-PM Becomes His Mausoleum," *Ibid*.

dwarfs the surrounding Crusader churches and restored French mandate buildings.”<sup>1214</sup> Maronite Christian Georges said “‘You will see...When the people start praying in the church, next door they will start the call to prayer louder. It’s an expression of hate.’ Beshara Rai, the *Maronite* Bishop of *Byblos* said ‘We say that they have the right to build a *Mosque*...But why an enormous mosque next to a church? It’s a question of sensitivity and mutual respect. They shouldn’t have built this enormous thing.’”<sup>1215</sup>

- C In Holland an interesting situation arose because *Muslims* were not able to assert their presence by building next to a church since only eight to thirteen percent of the Dutch attend church on any given Sunday.<sup>1216</sup> So *Muslims* decided to instead assert their presumed dominance next to the main soccer stadium in *Rotterdam* since, after all, soccer is the new national religion of Holland. The *News Day* webzine reported:

To Ronald Sorensen, the *Minarets* rising above the historic *Feyenoord* soccer stadium in this port city symbolize everything that’s gone wrong with the Netherlands. ‘It’s an insult to put it here,’ snorts the 57-year-old leader of *Leefbaar Rotterdam* (Livable Rotterdam), now one of the largest parties in city government. ‘*Feyenoord* is like New York’s *Yankee Stadium*. It’s the temple to Dutch soccer. It’s the symbol of the Dutch working class.’ When completed, the *Mosque* will be one of the largest in Western Europe, with room for 1,500 worshipers and boasting *Minarets* that will soar 164 feet into the air—higher than the adjacent stadium’s light banners. In Sorensen’s mind, that proves two things: that the *Muslim* community could not care less about Dutch sensibilities, and that the former city officials who approved the *Mosque* deserved to be run out of office. After his party swept into power on a wave of anti-immigration sentiment two years ago, ‘we said we’ll find another spot for you[r *Mosque*],’ Sorensen said. ‘They [the *Muslims*] said no. We asked them to lower the height of the *Minarets*. They said no. It’s a symbol of their feelings toward us. They think we are inferior because we are not *Muslims*.’<sup>1217</sup>

- C *Muslims* are planning to build a huge *Mosque* and garden complex called *London Markaz* in time for the 2012 Olympics about 461 meters away from the Olympics site. Daniel Pipes wrote:

That the largest *Islamic* house of worship in Great Britain [*Baitul Futuh* in Morden, Surrey, 10,000 capacity] is already over three times larger than the largest Christian counterpart [Liverpool’s Anglican cathedral, capacity 3,000] speaks volumes about the spirit and ambition of British *Muslims*; that they are planning one [*London Markaz*, 70,000 capacity] almost 25 times bigger reinforces the point...<sup>1218</sup>

*Muslims* not only target those in the land of the living but also the dead. For instance, in France in 2002, there were “193 violent attacks on synagogues, Jewish

<sup>1214</sup> Fisk, Robert. “US recalls Damascus envoy as blame for *Beirut* assassination falls upon Syria,” robert-fisk.com, 16 Feb 2005.

<sup>1215</sup> Klaushofer, Alex. “Lebanon’s religious red lines,” news.bbc.co.uk, 23 Feb 2005.

<sup>1216</sup> Dreher, Rod. “Tiptoe Through the Tulips,” *NRO*, 3 Dec 2004.

<sup>1217</sup> Eisenberg, Carol. “*Muslims* in the Netherlands: Immigration becomes political,” newsday.com, 6 Dec 2004, *DW*.

<sup>1218</sup> Pipes, Daniel. “The *London Markaz*,” *DP*, 27 Nov 2005.

schools, *Kosher* shops, cemeteries and rabbis...the percentage attributable to the extreme right was only 9 per cent in 2002,<sup>1219</sup> meaning 91 percent or so of such attacks were by *Islamists*. The *Israeli* government reported in 1997 “Christian cemeteries have been destroyed, monasteries have had their telephone lines cut and there have been break-ins to convents.”<sup>1220</sup>

In attacking cemeteries, creepy *Islamists* follow in the footsteps of their creepier role model. *Muhammad*’s first land acquisition as a *Muslim* came when he dug up the graves of pagans and built his first *Mosque* over the former cemetery.<sup>1221</sup> There was of course plenty of vacant land around *Madina* that he could have built on instead.

The act of desecrating the graveyard is even creepier when one considers how *Muhammad* thought that the dead were conscious in their graves, and he even used to talk to the dead in their graves—as is discussed elsewhere. The *Hadith* record that:

☉ *Muhammad* said: “Do not leave an image without obliterating it, or a high grave without leveling it...(Do not leave) a picture without obliterating it” (*Sahih Muslim*, bk. 4, no. 2115).

☉ Jabir said: “*Allah*’s Messenger...forbade that the graves should be plastered or they be used as sitting places (for the people), or a building should be built over them” (*Sahih Muslim*, bk. 4, no. 2116).

*Muslims* have followed *Muhammad*’s pattern and teaching by desecrating infidels’ graveyards for over 1350 years now. Bat Yeor wrote:

*Dhimmi* religious ceremonies and burials had to take place discreetly. *Muslim* graves had to be distinguished from those of *Dhimmis*. As the infidel’s cemeteries warranted no respect, they were frequently razed to the ground and the graves desecrated, practices which still continue today in certain *Muslim* countries.<sup>1222</sup>

All the cemeteries by the many thousands of churches and synagogues that were destroyed or converted into *Mosques* the last 1350 years have been desecrated. For instance, when the Church of the Holy Sepulcher was destroyed by *Fatimid Caliph Hakim*’s reign in the eleventh century...

They even tried to dig up the graves and wipe out all traces of their existence. Indeed they broke and uprooted most of them.<sup>1223</sup>

After the Jordanian *Muslims* conquered part of Jerusalem during the 1967 war, they tore down all the synagogues and they used Jewish tombstones from the Mount of Olives as paving stones for a path to a latrine.<sup>1224</sup> *Muslims* still periodically vandalize the tombstones on the Mount of Olives.

In 2002, there were “193 violent attacks on synagogues, Jewish schools, *Kosher* shops, cemeteries and rabbis...the percentage attributable to the extreme right was only 9 per cent in 2002.”<sup>1225</sup>

<sup>1219</sup> Evans-Pritchard, Ambrose. “EU ‘covered up’ attacks on Jews,” theage.com.au, 2 Apr 2004.

<sup>1220</sup> Raab, David. “The Beleaguered Christians of the Palestinian-controlled Areas,” IMRA, imra.org.il, 10 Oct 2002, *USS Neverdock* blog.

<sup>1221</sup> *Bukhari*, vol. 1, bk. 8, no. 420; vol. 3, bk. 30, no. 92; vol. 5, bk. 58, no. 269; *Sahih Muslim*, bk. 4, no. 1068.

<sup>1222</sup> Yeor. *Christianity*, p. 88.

<sup>1223</sup> Gil. *A History of Palestine, 634-1099*, p. 373, as quoted in Bostom, Andrew G. “*Jihad* begot the Crusades, part 2,” americanthinker.com, 5 May 2005.

<sup>1224</sup> Grigg, Jenny. “In discussing Jerusalem, history matters,” jerusalemsummit.org, 9 May 2004.

<sup>1225</sup> Evans-Pritchard, Ambrose. “EU ‘covered up’ attacks on Jews,” theage.com.au, 2 Apr 2004.

In 2004, the grave of a Spanish policeman, who was killed trying to arrest seven *Muslim* terrorists involved in the 3/11 Madrid bombing, was desecrated.<sup>1226</sup>

In 2004, a *Muslim* mob ethnically cleansed *Pristina, Kosovo*, of 40,000 *Serbs* and turned one church into a public latrine.<sup>1227</sup> The *Muslim* mob shot up, looted and burned cars, homes and apartment complexes. Before burning some churches, they opened the tombs of *Serbs* and priests and scattered their bones around.<sup>1228</sup>

In 2005 *Somali* warlords, at the behest of *Sharia* courts, dug up 700 graves of WWI Italian soldiers and dumped their skeletons in a dump near the airport near *Mogadishu*.<sup>1229</sup> Now they are building a *Mosque* on the site of the cemetery just as *Muhammad* did shortly after 622 AD.<sup>1230</sup> After hearing about the *Somali* incident, and knowing that the *Mandaean* cemeteries at *Ahwaz, Iran*, and *Basra, Iraq*, were destroyed after Gulf War II, the *Sabian Mandaean* Association came to this conclusion:

It appears that desecration of ‘infidel’ cemeteries may be some sort of standard *Islamic* practice.<sup>1231</sup>

On the border of *Iran, Azerbaijani* and *Armenia*, in the *Nakhichevan* territory, “there were 27,000 monasteries, churches, *Khachkars*, tombstones and other *Armenian* monuments.” Between 1989 and 2002 alone, two thousand elaborately carved tombstones with crosses (*Khachkars*) were removed and destroyed from the ruins of *Julfa (Jugha)* on the north bank of the River *Araxes*. They date from before 1604 AD when “*Shah* Abbas of Persia forcibly resettled the inhabitants to *Isfahan*.”<sup>1232</sup>

*Muhammad* consolidated his control of a part of *Madina* and then he wrested control of *Madina* from Jews and pagan Arabs (both the quick and the dead). *Muhammad* even beheaded and buried 600 to 900 Jews in a trench right in the marketplace (*Shuk*) of *Madina* and that marketplace still exists today.<sup>1233</sup>

*Muhammad* robbed caravans because that weakened the enemy and enriched *Muslims*. Once *Muslims* were caught off-guard by a *Mekkan* army while waylaying a caravan. Despite being surprised, the *Muslims* won the Battle of *Badr*. *Muhammad* then had dozens of dead infidels thrown into a well near *Badr*.<sup>1234</sup>

*Muhammad* laid claim to the *Kaaba* by saying it was built by Abraham and Ishmael rather than ancient Arab pagans. *Muhammad* said that *Ibrahim* was neither Jewish or Christian but *Muslim* (K 003:067). Similarly, *Muslims* lay claim to many Jewish and Christian sites by claiming that most of the Biblical notables were *Muslims*. *Muslims* say...

...if David and Solomon were to return to life, these [Zionist] criminals would fight them and they would fight back. David and Solomon were among

<sup>1226</sup> “Spanish officer’s grave attacked,” *BBC News World Edition*, 19 Apr 2004, JW.

<sup>1227</sup> Spencer, Robert. “*Kosovo*: Church of Christ the Savior in *Pristina* turned into public toilet,” *DW*, 19 Apr 2004; also see [savekosovo.org](http://savekosovo.org).

<sup>1228</sup> “Ethnic Cleansing of *Serbs* in *Pristina*, Mar 17-18, 2004 (*Kosovo*),” *Kosovo.com*, ERP KIM Info Service, Mar 2004, [freerepublic.com](http://freerepublic.com), posted 28 Apr 2004; also see [savekosovo.org](http://savekosovo.org).

<sup>1229</sup> “*Somali* militias target cemetery,” [news.bbc.co.uk](http://news.bbc.co.uk), 19 Jan 2005, *DW*.

<sup>1230</sup> Ali Bile, Mohamed. “*Somali* militia building mosque over cemetery,” [iol.co.za](http://iol.co.za), 26 Jan 2005.

<sup>1231</sup> “Christian Cemetery Desecrations in *Iran* and *Iraq*,” *DW*, [mandaeenworld.com](http://mandaeenworld.com), 15 Apr 2005.

<sup>1232</sup> “*Azerbaijan*: Famous Medieval Cemetery Vanishes,” Institute for War & Peace Reporting, [iwpr.net](http://iwpr.net), 19 Apr 2006, *DW*.

<sup>1233</sup> Ishaq. *Sirat*, p. 464.

<sup>1234</sup> *Sahih Muslim*, bk. 40, no. 6869.

our ranks. If Solomon had a temple, we would be worshipping *Allah* in it. We would not be worshipping idols and polytheism in it, like they do.<sup>1235</sup>

*Muhammad* said that when Jesus returns near the end of the world...

Jesus...He will descend (to the earth)...[and] He will fight the people for the cause of *Islam*. He will break the cross [i.e. end Christianity], kill swine [i.e. Jews (*K* 002:065-066; 005:060; 007:166)]...<sup>1236</sup>

While *Muhammad* only misrepresented Jesus' religion, modern *Muslims* change Jesus' race. They say that Jesus was the "first Palestinian revolutionary" and that the ancient *Canaanites* were "Arab *Canaanites*" even though Arabs only invaded Palestine in 638 AD.<sup>1237</sup> The "Palestinian man-in-the-street" declares that "Jerusalem was Arab from the day of creation."<sup>1238</sup> Palestinians also change the Jews' nationality by replacing *Israel* on their maps with a state of Palestine that spans from the Mediterranean Sea to the Jordan River.<sup>1239</sup>

Arabizing or Turkicizing a race or culture is a tactic that some *Muslims* use to misappropriate others' lands. Besides the Arab *Canaanite* example (above), there is:

- ☉ *Muhammad's* example. He said *Muslims* could have an unlimited number of sex slaves and need not practice *Coitus Interruptus* with war captives who were then sold off as slaves.<sup>1240</sup> *Muslims* also castrated many black and Caucasian (e.g. *Mamluks*) slaves over the centuries. This all ensured that the dominant race of *Muslims* would become the dominant race wherever *Islam* set down roots, such as is the case in North Africa and the Mideast. It also ensured that virtually no trace of black slave populations remained in the Mideast despite the fact that black slavery there was relatively common.
- ☉ Myriad examples. *Muslims* try to diminish and Arabize all cultures that they come into contact with. Such has been the case with the Persians, Jews, Greeks, Armenians, Copts, Berbers, the Visigoths, Hindus, Malays and many others.
- ☉ The Turkish example. While the Turks only came to Turkey from Central Asia a thousand years ago, Kemalism taught that the Turks had come far earlier and that Armenians and Kurds came afterward, even though the Armenians and Kurds came to Turkey at least two or three thousand years before the Turks! Other lines of propaganda are: 1) the Kurds were really "Mountain Turks" who forgot their origin and language, even though Kurds are Indo-Aryan and Turks are Hun-Mongolian and 2) "all the great Babylonian, Sumerian, Egyptian and Hittite civilizations had been created by the Turks."<sup>1241</sup> Thus Turks have laid claim to Turkey and have dislodged others from their ancient sites, such as the Greeks from *Hagia Sophia*.

<sup>1235</sup> "Jordanian Professor/Terrorist on *Saudi Al-Majd* TV," MEMRI, 22 Nov 2005, #1030 DW.

<sup>1236</sup> *Sunan Abu-Dawud*, "Bk. 37: Battles (*Kitab Al Malahim*)," no. 4310. See also *Sahih Bukhari*, vol. 3, bk. 34, no. 425; vol. 3, bk. 43, no. 656; vol. 4, bk. 55, no. 657; *Sahih Muslim*, bk. 001, nos. 0287, 0289.

<sup>1237</sup> Parsons, David. "The Galilee Gauntlet," *Middle East Digest*, May 1999, vol. 10:5, christianactionforisrael.org.

<sup>1238</sup> Pipes, D. "The *Muslim* Claim to Jerusalem," *Middle East Quarterly*, meforum.org, Fall 2001.

<sup>1239</sup> "Be gone! Die anywhere you like, but don't die here," *Palestinian Media Watch*, pmw.org.il, 29 Dec 2005, C&R.

<sup>1240</sup> *Sahih Bukhari* vol. 003, bk. 034, no. 432; vol. 005, bk. 059, no. 459; vol. 007, bk. 062, nos.

135, 136; vol. 009, bk. 093, no. 506; *Sahih Muslim*, bk. 8, nos. 22, 29 & 3371; *K* 004:024; Spencer. *Disturbing*, pp. 50-51, 53; Trifkovic. *Sword*, p. 43.

<sup>1241</sup> Jensen, Eric. "History of Turkish Occupation of Northern Kurdistan," ondix.com, 27 Nov 1996.

- ☉ The *Iraqi* example. Saddam Hussein and the *Baath* Party tried to Arabize Kurds and Assyrians in *Iraq*, especially from cities in oil-rich areas such as *Mosul* and *Kirkuk*. If anyone refused a forced name-change (from say, Kurdish to Arabic-sounding), he was evicted from his property.
- ☉ The Lebanese example. While Lebanese says Lebanon is for them, Arabs say the Lebanese are Arabs, thus facilitating the rise of *Islam* there.
- ☉ The American example. *Muslims* have tried to pass off history books in US public schools with wily propaganda such as Columbus knew American Indian elites were *Muslims* who spoke Arabic since Columbus had a *Muslim* Arabic-speaking navigator.<sup>1242 1243</sup> The implied irredentist message is that *Muslims* have a legitimate claim to America, and American *Muslims* must free America from European invaders using all means at their disposal. Of course the skeptic would ask “If the New World had been discovered earlier than 1492, why is there no evidence of any exchanges of plants, animals, foods or diseases between the Old and New Worlds before Columbus’ day?”

*Muslims* twist history and claim that Biblical sites are actually *Islamic* sites, as when *Muslims* claim that some *Sheikh* is buried in Joseph’s tomb and not Joseph. On 11 Oct 2000, the Palestinian Authority forbade Jewish worshippers “at Joseph’s tomb [at *Nablus/Shechem*] until an international organization ‘determines’ whether the site is [really] holy to [the] Jews.”<sup>1244</sup> In 2000, *Muslim* burned tires in Joseph’s tomb before turning the old stone building into a *Mosque* and painting the dome green, the color of *Islam*. In 2003, *Muslim* vandals reduced to a pile of rubble the carved stone grave marker placed over Joseph’s tomb.<sup>1245</sup>

*Muslims* claim that the Jew’s Western “Wailing” Wall is part of *Al-Aqsa Mosque*, and they call it the *Buraq* Wall since the Night Journey legend has it that *Muhammad* tied his steed there.<sup>1246</sup> *Ynet News* reported about the temple mount:

*Sheikh Muhammad* Hussein, who runs the *Al-Aqsa Mosque* ... says the site is exclusively *Muslim*, telling *Ynet* that ‘the *Mosque* is *Muslim*, it belongs only to the *Muslims*. That is what *Allah* wanted, he who awarded the *Mosque* to the *Muslims*, and he who says that the *Mosque* is the *Muslims*’ only, and we don’t recognize any other way, we don’t recognize any compromise, like in the burial site of Abraham [at *Hebron*] or any other place.’<sup>1247</sup>

*Muslims* claim that “*Al Aqsa* was built since the time of Adam...40 years” after the *Kaaba* at *Mekka* was built. *Muslims* claim that the Jewish temples were built elsewhere since *Muslims* “don’t believe that a prophet like Solomon would have built the Temple at a place where a *Mosque* existed.”<sup>1248</sup> Instead, *Muslims* insist the Jewish temple was built

- ☉ Between Jerusalem and Jericho<sup>1249</sup> or in Bethlehem,<sup>1250</sup> or

<sup>1242</sup> Yeagley, David. “The Left Hijacks Indian History,” FPM, 28 Apr 2004, *DW*.

<sup>1243</sup> “Lebanese Cleric *Abd Al-Karim Fadhllallah*: When Columbus Reached America, He Encountered Arabic-Speaking Natives,” memritv.org, 20 Nov 2005, *DW*.

<sup>1244</sup> Dudkevitch. “Joseph’s Tomb: Holy, hotly contested,” jpost.com, 13 Dec 2003.

<sup>1245</sup> “Arab vandals desecrate Joseph’s Tomb,” WND.net, 25 Feb 2003.

<sup>1246</sup> Shiloh, Scott. “PA Claims Western Wall is *Moslem* Property,” arutzsheva, 12 Dec 2005, *DW*.

<sup>1247</sup> Waked, Ali. “Third *Intifada* almost here,” ynetnews.com, 28 Sep 2005.

<sup>1248</sup> Klein, Aaron. “*Al Aqsa* leader: Jews have no right to Mount,” WND, 22 Oct 2005.

<sup>1249</sup> Raab, David. “The Beleaguered Christians of the Palestinian-controlled Areas,” IMRA, imra.org.il, 10 Oct 2002.

<sup>1250</sup> Pipes, Daniel. “What Jewish Ties to Jerusalem?” *DP*, 20 Jun 2006.

- Ⓒ In *Nablus*. In July 2000, “during the Camp David summit meeting...Arafat tried to convince president Bill Clinton that the two Jewish Temples had been in *Nablus (Shechem)*” where Joseph’s tomb is.<sup>1251</sup>

*Muslims* make other claims to dispossess Israel of her inheritance, as D. Pipes wrote:

Palestinian Arabs now claim that Canaanites built Solomon’s Temple, that the ancient Hebrews were *Bedouin* tribesmen, the Bible came from Arabia, the Jewish Temple ‘was in *Nablus* or perhaps Bethlehem,’ the Jewish presence in Palestine ended in 70 C.E., and today’s Jews are descendants of the *Khazar* Turks. Yasser Arafat himself created a non-existent Canaanite king, Salem, out of thin air, speaking movingly about this fantasy Palestinian Arab ‘forefather.’ Palestinian Media Watch sums up this process: By turning Canaanites and Israelites into Arabs and the Judaism of ancient Israel into *Islam*, the Palestinian Authority ‘takes authentic Jewish history, documented by thousands of years of continuous literature, and crosses out the word ‘Jewish’ and replaces it with the word ‘Arab.’” The political implication is clear: Jews lack any rights to Jerusalem. As a street banner puts it: ‘Jerusalem is Arab.’ Jews are unwelcome.<sup>1252</sup>

Thus when Israelis conducted archaeological digs at the temple mount or display museum pieces, *Muslim* leaders call it a “‘confiscation’ of *Muslim* property.”<sup>1253</sup>

Because *Muslims* do not want anyone to find that *Aqsa Mosque* was built on top of the remains of the Jewish civilization, when *Muslims* converted Solomon’s Stables under *Aqsa Mosque* into an underground *Mosque* later named *Al-Marawani* after an early *caliph*. They used a bulldozer and dumped 68 truckloads—12,000 tons of fill, into the city dump of *Azzariyeh* village and on a slope of the *Kidron Valley*.<sup>1254</sup>

The Antiquities Authority called the dumping of the fill ‘an unprecedented archeological crime.’<sup>1255</sup> Jews later recovered the dirt and the initial sifting revealed artifacts from several archaeological periods such as First Temple Period *Bulla*.<sup>1256</sup>

The *Wakf* trustees and custodians of the temple mount are really just *Islamists* engaged in a turf war with Judaism. While on the one hand the *Wakf* tries to reclaim every *Mosque* and holy site for *Islam*,<sup>1257</sup> they would also like to erase all evidence supporting competing historical claims, as *MSNBC* reported:

Jews, who regard the site as their most sacred for having contained two biblical temples destroyed in ancient times, have long accused the *Wakf* of pursuing unbridled construction to erase evidence of pre-*Islamic* civilizations.<sup>1258</sup>

It has become clear to many that under the guises of doing renovations and repairs, the “overall *Wakf* plan [is] to turn the whole compound into one exclusive *Muslim* site.”<sup>1259</sup> The *Wakf* even got the King of Jordan to request permission to build a fifth *Minaret* to represent the five pillars of *Islam*!<sup>1260</sup> Some *Muslims* do not

<sup>1251</sup> Steinberg, Gerald M. “The temple mount—still in our hands?” jpost.com, 5 Jun 2005.

<sup>1252</sup> Pipes, Daniel. “What Jewish Ties to Jerusalem?” *DP*, 20 Jun 2006.

<sup>1253</sup> “New archaeological site unveiled near Western Wall,” haaretz.com, 27 Sep 2005.

<sup>1254</sup> Lefkovits, Etgar. “Temple mount relics saved from garbage,” jpost.com, 14 Apr 2005.

<sup>1255</sup> Lefkovits. “Plan to remove Mount artifacts criticized,” jpost.com, 19 Aug 2004.

<sup>1256</sup> Ilan, Shahr. “Gems in the dirt,” haaretz.com, 12 Oct 2005.

<sup>1257</sup> Khourie, J. “*Muslim* organization: *Kadima* opened branch in *Safed*,” haaretz.com, 1 Mar 2006.

<sup>1258</sup> “Israel says Jerusalem shrine could cave in,” *MSNBC.com*, 26 Sep 2004.

<sup>1259</sup> Lefkovits, Etgar. “Archaeologists decry *Wakf* ‘renovation,’” jpost.com, 9 Nov 2005.

<sup>1260</sup> Regular, Arnon. “Jordan to build 5th *Minaret* on temple mount,” haaretz.com, 25 Oct 2004.



want any non-*Muslim* to visit the temple mount at all, which was the policy during medieval times.<sup>1261</sup>

The Jerusalem temple mount *Wakf* follows the same archaeological policy that *Wahhabi* clerics follow in order to maintain their grip on *Saudi Arabia*. So that no competing *Islamic* school of thought can ever make any inroads on the power, *Saudi* architect Sami Angawi said:

They are removing any historical landmark that is not *Saudi-Wahhabi* and using the prime location to make money.

For instance, the *Wahhabis* have bulldozed most ancient structures in the Kingdom of *Saudi Arabia* so that the only older buildings that remain are *Mosques*.<sup>1262</sup> In fact, “In the early 1920s, the *Saudis* bulldozed and leveled a graveyard in *Medina* that housed the graves of the family and companions of *Muhammad*.”<sup>1263</sup> The *Saudi* regime also “demolish[ed] the building in which *Muhammad* married [his first wife] *Khadija*—a rare historic site [in *Mekka*]—in order to build a public lavatory in its place.”<sup>1264</sup> In *Jiddah* in 1975, where *Mekkan* pilgrims arrive by port or plane, the *Saudis* filled in the Tomb of Eve with concrete on the pretext that pilgrims were praying there.<sup>1265</sup>

In modern times, *Muslims* have been following *Muhammad*'s example of taking over turf as detailed above—even in the very heart of Europe. Wherever *Muslims* form a significant minority and have become militarized, infidels feel the need to arm themselves as they already do in *Israel*—and also in southern *Thailand* where...

...the military already has a network of volunteers who help security forces defend villages, as well as schools, temples and other public buildings.<sup>1266</sup>

*Muslims*—*Sunnis* and *Shias*—are following *Muhammad*'s example and are claiming and taking turf in *Iraq*:

A mostly *Sunni Arab* fringe is launching vicious attacks against civilians, often *Shiites* [*Shias*], while *Shiite* death squads are openly stalking *Sunnis* for revenge, and the *Shiite* [*Shia*]-dominated government makes regular arrests in *Sunni Arab* neighborhoods.<sup>1267</sup>

Recently, *Muslims* have started recruiting suicide-bomb armies in their turf wars, for instance:

☉ In 2005, *Iran* assembled 40,000 volunteers for suicide-bombing as a warning to the West not to meddle with *Iran*'s nuclear program.<sup>1268</sup>

☉ In 2005, 500 small bombs went off simultaneously across *Bangladesh*, killing two people and wounding 140.<sup>1269</sup> Then *Jamaat-ul-Mujahideen* formed a 2,000-volunteer suicide-bomb army and demanded that all women wear a *Burka* in public whether they were *Muslim* or not. Just to prove they are serious, in three weeks of suicide-bombing, they killed 28, “including

<sup>1261</sup> Klein, Aaron. “*Al Aqsa* leader: Jews have no right to Mount,” *WND*, 22 Oct 2005.

<sup>1262</sup> Howden, Daniel. “The Destruction Of *Mecca*: *Saudi* Hardliners Wiping Out Their Own Heritage,” *The Independent*, news.independent.co.uk, 5 Aug 2005, *DP*, 3 Apr 2006.

<sup>1263</sup> Fatah, Tarek. “*Saudi* royals destroying home of *Muhammad*,” *thestar.com*, 17 Aug 2005.

<sup>1264</sup> Ein-Gil, Ehud. “The roots of *Jihad*,” *haaretz.com*, 19 Mar 2006.

<sup>1265</sup> “*Jeddah*,” *wikipedia.org*, accessed 23 Mar 2006.

<sup>1266</sup> “Thailand to offer security training to 20,000 villagers in south,” *abc.net.au*, 14 Nov 2005.

<sup>1267</sup> Tavernise, Sabrina. “Violence alters *Iraq*, city by city,” *nytimes.com*, 20 Nov 2005, *JW*.

<sup>1268</sup> “*Iran* has 40,000 human ‘time bombs’: ‘Martyrdom’ movement...vs. U.S. *WND*, 7 Jul 2005.

<sup>1269</sup> “Over 500 Bombs Used in *Bangladesh* Attack,” *allheadlinenews.com*, 17 Aug 2005.

judges, lawyers and policemen.” Ultimately, the *Jamaat-ul-Mujahideen* say they want to impose *Sharia* law on the entire nation.<sup>1270</sup>

*Islamists* often use the threat of acid-attacks to force women to veil. *Hindu Kashmiri* women are targeted, especially when they vote. Assyrian Christian women in *Iraq* are targets, especially at the universities.<sup>1271 1272</sup> In *Pakistan*, there were 42 acid attacks in 2004 alone.<sup>1273</sup> In India, eleven people, mostly *Hindus*, were splashed with acid as they sat in a bus next to a *Muslim* woman who was the original target of the attack. Several *Hindus* may lose their sight permanently.<sup>1274</sup>

The situation of Europe with its growing *Muslim* population and shrinking infidel population is growing more dire by the day, as *Ynet News* reported:

...observers are increasingly concerned about some European states that are increasingly losing their ‘sovereign power’ in the face of millions of *Muslim* residents. In Sweden, we are talking about a *Muslim* near-autonomy comprising more than ten percent of the country’s population. This is the case in France, Germany and Spain too, but the process may in fact be global.<sup>1275</sup>

*Islamists* create neighborhoods and zones where infidels fear to tread in so as not to be robbed, kidnapped, bludgeoned and raped, and where *Muslim* women found wearing western attire are harassed, raped and even set on fire, as Fjordman wrote:

The number of rapes committed by *Muslim* immigrants in Western nations are so extremely high that it is difficult to view them only as random acts of individuals. It resembles warfare. *Muhammad* himself had forced sex (rape) with several of his slave girls/concubines. This is perfectly allowed, both in the *Sunna*<sup>1276</sup> and in the *Koran* [K 004:003, 023-024; 023:005; 033:050; 070:030]. If you postulate that many of the *Muslims* in Europe view themselves as a conquering army and that European women are simply war booty, it all makes perfect sense and is in full accordance with *Islamic* law. Western women are not so much regarded by most *Muslims* as individuals, but as ‘their women,’ the women who ‘belong’ to hostile Infidels. They are booty to be taken just as the land of the Infidels someday will drop, it is believed, into *Muslim* hands. This is not mere crime, but ideologically-justified crime or rather, in *Muslim* eyes, attacks on Infidels scarcely qualify as crime. Western women are cheap and offensive. We *Muslims* are here, here to stay, and we have a right to take advantage of this situation. It is our view of the matter that should prevail. Western goods, like the land on which we now live, belong to *Allah* and to the best of men—his Believers. Western women too essentially belong to us—our future booty.<sup>1277</sup>

<sup>1270</sup> “Non-veiled women issued death threats,” tvnz.co.nz, 9 Dec 2005, *DW*.

<sup>1271</sup> Shea, Nina. “Canary in a Coal Mine: *Iraq*’s future as a tolerant, democratic nation is at stake,” *NRO*, 14 Oct 2004.

<sup>1272</sup> “Women fleeing [*Baghdad*] college under *Islamist* threats [acid attacks on unveiled women],” washtimes.com, 17 Oct 2004, *DW*, 18 Oct 2004.

<sup>1273</sup> Felix, Qaiser. “Human rights in *Pakistan*: violence and misery for children and women,” asianews.it, 11 Feb 2005, *DW*, 13 Feb 2005.

<sup>1274</sup> “Mob sets fire to 2 *Mosques* after acid attack,” indianexpress.com, 28 May 2005, *DW*.

<sup>1275</sup> Asa, Haim. “A country getting lost,” ynetnews.com, 10 May 2005.

<sup>1276</sup> Trifkovic. *Sword*, p. 43; also see *Sahih Bukhari* vol. 003, bk. 034, no. 432; vol. 005, bk. 059, no. 459; vol. 007, bk. 062, nos. 135, 136; vol. 009, bk. 093, no. 506; *Sahih Muslim*, bk. 8, nos. 22, 29 & 3371; K 004:024; Spencer. *Disturbing*, pp. 50-51, 53.

<sup>1277</sup> Fjordman. “*Muslim* Rape Wave in Sweden,” *FPM*, 15 Dec 2005.

In France, as of early 2006, *Muslims* have not gone on bombing sprees, or formed suicide-bomber armies to press their demands yet, but that may not be far in the offing.<sup>1278</sup> French *Muslims* have been staking out their turf by pelting police and police cars with stones, by burning cars and buses, and through a high crime rate:

- ☉ In Paris in March 2005, a thousand black and Arab *Muslim* youths, “according to police estimates,” mass-mugged a student protest march,<sup>1279</sup> Poller wrote:

They threw kids to the ground, gratuitously beating and kicking them, snatching handbags, *iPods* [music players], wallets and cell phones. Riot police looking like robots with their thick leather padding stood by as the predators cut through the crowd wielding knives, clubs and tear gas bombs....The mentality of these French adolescents—whose parents come from Africa or the *Maghrib*—is a mixture of common ordinary delinquency, **Jihad against the infidels**, blind revolt...and stupid antics of spoiled kids.<sup>1280</sup>

- ☉ Bruce *Bawer* referred to the 18-day French riots of 2005 as “early battles in a continent-wide turf war” that only erupted after French politicians vowed to crack down on crime,<sup>1281</sup> which implied intruding on the police-free zone that *Islamists* had created in the suburbs of at least three hundred French cities. In 1991 there were 106 “hot spots” in France. In 1999 there were 818...

...no-go zones...where anything representing a Western institution (post office truck, firemen, even mail-order delivery firms and of course cops) is routinely ambushed with *Molotov* cocktails, and where war weapons imported from the *Muslim* part of *Yugoslavia* are routinely found.<sup>1282</sup>

In 2004 France must deal with 300 separatist movements in their infancy...

...a report this summer from a French government internal security agency telling of 300 areas in the country where separatist-like situations—grouping *Islamic* fundamentalist preachers, contempt for France and the West, and violence, held sway.<sup>1283</sup>

What constitutes a “hot spot,” a “no-go zone” or a “sensitive urban zone”? One can get a grasp of it from reading this: French Interior Minister Nicolas Sarkozy told the *Le Monde* newspaper that since the beginning of 2005...

...20 to 40 cars are set afire nightly in Paris’ restive *Muslim* suburbs.<sup>1284</sup>

Also, since the beginning of 2005, 28,000 cars and 17,500 trash bins have been torched and 9,000 police cars have been pelted.<sup>1285</sup> Needless to say, the native French, called *Gaulois* by *Muslims*, enter “no-go” zones only at their own risk.

<sup>1278</sup> Pipes, Daniel. “A Vision of the Terrible Future?” *DP*, 18 Aug 2005

<sup>1279</sup> Guitta, Olivier. *Mugged by la Réalité*, weeklystandard.com, 11 Apr 2005, *DW*.

<sup>1280</sup> Poller, Nidra. “The Death of France’s ‘Multiculturalism,’” *Op. Cit.*

<sup>1281</sup> Bawer, Bruce. “Not all *Muslims* want to integrate,” *csmonitor.com*, 17 Nov 2005.

<sup>1282</sup> “*Le Figaro* (daily),” 1Feb 2002, as quoted in Derbyshire, John. “September Diary,” *nationalreview.com*, 30 Sep 2004, *fjordman.blogspot.com*, *DW*, 30 Oct 2005.

<sup>1283</sup> Vinocur, John. “Politicus: Trying to put *Islam* on Europe’s agenda,” *International Herald Tribute*, *iht.com*, 21 Sep 2004.

<sup>1284</sup> Spencer, Robert. “Paris Burning,” *FPM, JW*, 4 Nov 2005.

<sup>1285</sup> Guitta, Olivier. “Paris When It Sizzles: The *Intifada* comes to France,” *weeklystandard.com*, 14 Nov 2005.

Just before the *Muslim* riots of 2005, there were “751 neighborhoods deemed ‘sensitive urban zones.’<sup>1286</sup> During about three weeks of rioting in up to 300 French cities starting on 27 October 2005, *Muslim* youths caused 210 million *Euros* (\$242m USD) in structural damage, and torched 10,000+ autos<sup>1287</sup> worth 20 million *Euros* (\$23m USD).<sup>1288</sup>

Despite the fact that France declared a State of Emergency with special police powers, it was reported on 8 December 2005 that between 46 and 79 vehicles are burned nightly. People warned that during “the end-of-year holidays,” French “regularly see outbursts of violence in suburbs of France’s major cities.”<sup>1289</sup>

*Muslims* openly declare their hatred of the West and their subversiveness:

*Al-Muhajiroun* has its headquarters in London, and its web site asserts that its goal is to form a ‘fifth column’ in Western countries for the purpose of penetrating ‘strongly in society and to become in position to overthrow the... *Kufr* (infidel) regime.’<sup>1290</sup>

The *Islamist* motto in the West is:

Thanks to your democratic laws, we will invade you [via immigration].

Thanks to our *Islamic* [*Sharia*] laws we will conquer [*Islamize*] you.<sup>1291</sup>

*Islamists* use death threats, assassinations and terrorist bombings to influence the foreign policy of European nations, and limit free speech critical of *Islam*. Some European and Australian politicians are glad to oblige *Muslims* and sue for peace by passing hate speech and religious vilification laws from which *Islamic* literature and speech is pre-exempted. *The Australian* reported on the situation in Holland:

Now, many politicians, writers and artists are considered to be in such danger that they have permanent armed guards and are driven around in bomb-proof armored cars. The Interior Ministry has set up a special unit assessing death threats from *Islamic* extremists and providing protection squads.<sup>1292</sup>

*Islamists* are active in Denmark as evidenced when *Jyllands-Posten* newspaper published twelve tame cartoons of *Muhammad* from twelve artists. *The Washington Times* reported:

Without recourse to *Sharia* censorship, Danish *Muslims* rioted over successive nights in *Arhus*, Denmark’s second largest city, even as their French co-religionists were burning France. Death threats sent several artists into hiding; bomb threats drove the paper to hire security guards. *Jyllands-Posten* however has refused to back down, which just might have something to do with the paper’s appearance, according to Brusselsjournal.com, on an *Al Qaeda* Web site listing potential targets.<sup>1293</sup>

<sup>1286</sup> Dickey, Christopher. “Rage on *Rue Picasso*: Will the riots swell the ranks of *Jihadists* in Europe?” msnbc.msn.com, 14 Nov 2005.

<sup>1287</sup> Klieger, Noach. “*Islam* is the problem in France,” ynet.com, 23 Nov 2005.

<sup>1288</sup> Doran, D’arcy. “France Set to Extend State of Emergency,” Breitbart.com, 14 Nov 2005.

<sup>1289</sup> “As many as 60 cars still burn nightly in France,” expatica.com, 8 Dec 2005, *JW*.

<sup>1290</sup> “*Al-Qaeda* Among Us,” arizonamonthly.com, Nov 2004, *JW*, 7 Nov 2004.

<sup>1291</sup> Allen, Jr., Ohn L. “Europe’s *Muslims* worry bishops,” National Catholic Reporter, nronline.org, 22 Oct 1999.

<sup>1292</sup> Browne, A. “*Muslim* fanatics terrorise a nation,” theaustralian.news.com.au, 21 Nov 2005.

<sup>1293</sup> West, Diana. “International caricatures,” washingtontimes.com, 18 Nov 2005.

When the *Jamaat-e-Islami* party of *Pakistan* offered a 50,000-Kroner (7,900 USD) bounty for killing any of the artists, Denmark's foreign ministry warned that all Danes ought not visit *Pakistan* since otherwise they might be killed.<sup>1294</sup>

Turf wars with *Muslims* go on in many places besides *Chechnya* and other places mentioned in the news, for instance:

- ☉ The *Muslim Hui* in northern China have often battled the neighboring non-*Muslim Han* people, who are of the same ethnicity.
- ☉ The *Uygurs* in the northwest *Xinjiang* region of China are *Turkic*-speaking *Muslims* who are not ethnic Chinese. Many *Uygurs* are involved in a separatist movement.
- ☉ In *Corsica*, a French island in the Mediterranean, “a large North African community is held in check [during the French *Muslim* riots of 2005] by a local nationalist movement that itself is prone to violence.”<sup>1295</sup>
- ☉ In Australia, beachgoers and lifeguards were harassed, beat-up, robbed and raped by *Muslim* gangs<sup>1296</sup> called “The Lebs.” “The Lebs” stay away from one *Sydney* beach called *Maroubra* because it was patrolled by the *Aussie* “**Bra** Boys” surfer club members.<sup>1297</sup> 5,000 Anglo Aussies rioted over two days in December 2005 and chased Mideastern-looking people from the beaches. While the media was busy demonizing the surfers for being racists, 40 to 50 carloads of *Muslims* smashed cars in *Cronulla*, a suburb near a beach in Sydney, after being incited to violence at a large *Mosque* at *Lakemba* by *Mufti Al-Hilaly*.<sup>1298</sup> Also, an Arab stabbed a Caucasian man at a golf course in Sydney<sup>1299</sup> and in western Sydney *Muslims* burned down a church hall, threw an incendiary device in another church, fired two shots at cars at a Lebanese Catholic school<sup>1300</sup> and broke all the windows of a Chinese church. The police had to set up a command post and “the situation was being treated as if it were a terror attack.”<sup>1301</sup>
- ☉ Near *Lisbon*, Portugal, in June 2005, five hundred *Muslim* youths mass-mugged (slang: “steamed”) beachgoers. The muggings went on for some time after police were first called to *Carcavelos* from the nearby town of *Cascais*, but when they proved to be insufficient, reinforcements were called in from elsewhere. The mega-gang refused to budge, so the police finally had to shoot their guns in the air to disperse the *Muslims*. Astonishingly, only a few *Muslims* were arrested.<sup>1302</sup>
- ☉ On New Years Day in 2006, up to 40 *Muslim* teenagers robbed, harassed and sexually assaulted some of the 600 holiday revelers on the train between

<sup>1294</sup> “Demonstrations in *Pakistan* have escalated into death threats against Danish illustrators who drew pictures of the prophet Mohammed,” *The Copenhagen Post*, cphpost.dk, 2 Dec 2005, C&R.

<sup>1295</sup> Gurfinkiel, Michel. “France Facing ‘Horrendous’ Balance Sheet,” nysun.com, 8 Nov 2005.

<sup>1296</sup> Corder, Mike. “Australians Try to Quell Racial Violence,” breitbart.com, 13 Dec 2005.

<sup>1297</sup> “Nasty reality surfs in as ugly tribes collide,” *Sydney Morning Herald*, smh.com.au, 12 Dec 2005.

<sup>1298</sup> McIlveen, Luke. “Young Arabs call for revenge attacks as hate groups gloat,” theadvertiser.news.com.au, 13 Dec 2005.

<sup>1299</sup> “Strike force for Sydney race riots,” cnn.com, 11 Dec 2005.

<sup>1300</sup> Rowbotham, Jill & Elizabeth Gosch. “Christmas is sacred, Pell warns,” theaustralian.news.com.au, 14 Dec 2005.

<sup>1301</sup> Leys, Nick & Dan Box. “Now churches are targeted,” theaustralian.news.com.au, 15 Dec 2005.

<sup>1302</sup> “Portugal youths in beach rampage,” news.bbc.co.uk, 11 Jun 2005.

Nice to Lyon in SE France. They also slashed seats, broke windows and pulled the emergency stop in order to escape along the tracks.<sup>1303</sup>

The situation in Europe in 2005 is as bad as it is after only fifty years of *Muslim* immigration, as Daniel Pipes and Khalid Durán wrote:

Before 1955 negligible numbers of *Muslims* lived in Western Europe and North America; just the odd student, merchant, sailor, worker, exile or convert. Their numbers began to swell in the 1960s...<sup>1304</sup>

The Euro-Neros such as the multiculturalist EU bureaucrats and PC royalty such as Prince Charles, who styles himself “the Defender of the Faiths [plural],” play their violins defending *Islam* from so-called negative stereotypes while *Muslims* burn Europe car-by-car.<sup>1305</sup>

Ironically, in 2005 as Prince Charles toured the US saying Americans were too critical of *Muslims* and that global warming was a worse threat than terrorism,<sup>1306</sup> an 18-day French *Muslim* riot was already on day six, and later the riot eventually spread to 300 French cities.<sup>1307</sup> Other leaders discount or dismiss the *Islamic* threat and say that global pandemics, asteroids or inter-galactic wars with UFOs (believe it or not!), are the most pressing threat to life as we know it.<sup>1308</sup>

The French *Muslim* riots of 2005 showed that Philip Jenkins was not an alarmist when he wrote:

It is quite conceivable that inter-religious violence could erupt in Europe itself; we might even imagine *Muslim* paramilitary groups waging religious war on French and German soil...by 2050.<sup>1309</sup>

Europe is finding out what Samuel Huntington said is true: “*Islam*’s borders are bloody and so are its innards.”<sup>1310</sup> Theodore Dalrymple wrote that “the suicide bombers among us,” the 7/7 London bombers, brought “the nightmare of permanent conflict.”<sup>1311</sup>

Indigenous Europeans are already moving out of many suburbs and towns due to the higher crime rate as *Muslims* move in.<sup>1312</sup> Some are moving out of the country, as in out of France<sup>1313</sup> and out of Holland.<sup>1314</sup> Mark Steyn wrote:

Europe could face a continent-wide version of the ‘white flight’ phenomenon seen in crime-ridden American cities during the 1970s, as Danes and Dutch scam to America, Australia or anywhere else that will have them.<sup>1315</sup>

<sup>1303</sup> Burleigh, Marc. “Gang terrorizes train in France,” *washingtontimes.com*, 5 Jan 2006, *JW*.

<sup>1304</sup> Pipes, Daniel & Khalid Durán. “*Muslims* in the West: Can Conflict Be Averted?” U.S. Institute of Peace, Aug 1993, *DP*.

<sup>1305</sup> Swank, J. Jr. “Prince Charles is fond of *Islam*, scolds Americans,” *MichNews.com*, 1 Nov 2005.

<sup>1306</sup> Ritchie, Kerri. “Prince Charles speaks out on climate change,” *abc.net.au*, 30 Oct 2005.

<sup>1307</sup> “Riots Plague Paris Suburbs for Sixth Night,” *foxnews.com*, 2 Nov 2005, *C&R*.

<sup>1308</sup> “Canadian Leader [Sher Zieve - Former Canadian Minister of Defence and Deputy PM] Says Bush Responsible for Coming Intergalactic War,” *theconservativevoice.com*, 25 Nov 2005, *DW*.

<sup>1309</sup> Jenkins. *Next*, p. 180.

<sup>1310</sup> Huntington. *Clash*, p. 258.

<sup>1311</sup> Dalrymple, Theodore. “The Suicide Bombers Among Us,” *city-journal.org*, Autumn 2005.

<sup>1312</sup> Marrin, Minette. “*Muslim* apartheid burns bright in France,” *The Sunday Times*, *timesonline.co.uk*, 13 Nov 2005.

<sup>1313</sup> Pipes, Daniel. “French Jews Escape to United States,” *DP*, 10 Oct 2004.

<sup>1314</sup> Brown, Stephen. “The Death of the Dutch?” *FPM*, 12 Nov 2004, *DW*.

<sup>1315</sup> Steyn, Mark. “Early skirmish in the Eurabian civil war,” *telegraph.co.uk*, 8 Nov 2005.

Daniel Pipes predicted “If non-*Muslims* flee the new *Islamic* order, as seems likely, the [European] continent could be majority-*Muslim* within decades.”<sup>1316</sup>

Many Europeans are stoic about the situation rather like King Hezekiah (2Ki 20:18-19). They say “Fortunately, I won’t live to see it.” Mark Steyn responded:

...that’s a false consolation. As France this past fortnight reminds us, the changes in Europe are happening far faster than most people thought. That’s the problem: unless you’re planning on croaking imminently, you will live to see it.<sup>1317</sup>

**Ingredient 15 (Warrior Hall of Fame):** *Muslim* are to emulate *Muhammad*, *Jihadists* and martyrs (i.e. *Jihadists* who died fighting) who populate *Islam*’s Hall of Fame.

Khidr-Second Lamech Logic and other frightful teachings in the *Koran* are meant to create billions of *Muhammads* since *Muhammad* is the “excellent exemplar” (*Uswa Hasana*) whom *Muslims* are supposed to emulate (*K* 033:021; see also *K* 004:059, 115; 053:002). He is “the perfect role model in all situations.”<sup>1318</sup> *Muhammad*’s favorite wife Aisha said: “The character of the Apostle of *Allah* was the *Koran*” (*Sahih Muslim*, bk. 4, no. 1623).

Scarily, *Muslims*’ “perfect role model” burned down the houses of those who failed to show up for Friday prayers at the *Mosque*.<sup>1319</sup> He also wanted the houses of those who kept *Muslims* from daily prayers burned down and their graves filled with fire.<sup>1320</sup> (Some context for this last statement: *Muhammad* was a necromancer who thought corpses were sentient and experienced torture and visions.<sup>1321</sup>)

*Muhammad* ordered assassination. He was a religious warrior who attacked towns from which he did not hear a *Muezzin* give the *Adhan* Call to Prayer in the morning.<sup>1322</sup> This means *Muslims* are to be warriors since *Muhammad* is the excellent exemplar (*K* 033:021). The terrorist leader, *Sheikh* Mukhlas, who in 2002 ordered the Bali bombing that killed 202 people, 88 of whom were Australians, wrote:

You who still have a shred of faith in your hearts, have you forgotten that to kill infidels and the enemies of *Islam* is a deed that has a reward above no other.... Aren’t you aware that the **model** for us all [*K* 033:021], the Prophet Mohammed and the Four Rightful *Caliphs*, undertook to murder infidels as one of their primary activities, and that the Prophet waged *Jihad* operations 77 times in the first 10 years as head of the *Muslim* community in *Madina*? What matters in this life is less important than what happens in the next. We should live to love *Jihad* and die as martyrs for *Allah*.<sup>1323</sup>

In *Islamdom* and in *Muslim* heaven (*Janna*), *Muslims* who do not go on *Jihad* are not equal to *Jihadists* (*K* 004:095) because *Allah* likes his followers to be

<sup>1316</sup> Pipes, Daniel. “*Muslim* Europe,” *DP*, 11 May 2004.

<sup>1317</sup> Steyn, Mark. “Early skirmish in the Eurabian civil war,” telegraph.co.uk, 8 Nov 2005.

<sup>1318</sup> Salahi, Adil. “The Prophet as a Man—29: Perfect Role Model in All Situations,”

ArabNews.com, 25 Mar 2005, *JW*, 31 Mar 2005.

<sup>1319</sup> *Sahih Bukhari*, vol. 1, bk. 11, nos. 617, 626; vol. 9, bk. 89, no 330; *Muslim* 4:1370.

<sup>1320</sup> *Sahih Muslim*, bk. 4, no 1314.

<sup>1321</sup> *Sahih Bukhari*, vol. 8, bk. 73, nos. 78+81; *Sahih Muslim*, Bk. 40, No. 6869; Blair & Bloom. *Paradise*, p. 15; Haykal. *Life*, pp. 231, 496, quoted in Geisler & Saleeb. *Answering*, pp. 155-156.

<sup>1322</sup> *Sahih Bukhari*, vol. 1, bk. 011, no. 584, vol. 4, bk. 52, no. 193; *Sahih Muslim*, bk 4, no. 745.

<sup>1323</sup> Powell, S. “Murder ‘infidels,’ Mukhlas urges,” theaustralian.news.com.au, 19 Dec 2005, *JW*.

fighters—or mothers of fighters—as *Newhouse News* reported:

Tawfik Hamid stood with 200 other students for afternoon prayers inside a *Mosque* at the University of *Cairo*. It was important for them to stand with their feet touching, as the *Koran* teaches, so that even in prayer they were prepared for war: ‘Truly *Allah* loves those who fight in his cause ... as if they were a solid cemented structure’ (K 061:004).<sup>1324</sup>

*Muhammad*’s Great Commission to *Muslims* is to fight until there is no more persecution and “until all religion is for *Allah*” (K 002:193; 008:039). He also said that the best deed one could do, besides of course just being a *Muslim*, is to engage in *Jihad*.<sup>1325</sup> *Muhammad* said no deed was equal in value to *Jihad*<sup>1326</sup>—not even serving water to pilgrims from the *Zamzam* well beside the *Kaaba* (K 009:019-020).

At the Battle of *Uhud* in 625 AD, the *Koran* was tamer and only had 101 War verses. Still, *Muhammad* swore at the Battle of *Uhud* that every martyr “would like to return and fight for god and be killed a second time.”<sup>1327</sup> At some point during his career, *Muhammad* said:

I would love to be martyred in *Allah*’s cause and then get resurrected, and then get martyred and then get resurrected again, and then get martyred and then get resurrected again, and then get martyred (*Sahih Bukhari*, vol. 1, bk. 2, no. 35; vol. 4, bk. 52, nos. 54+216).

*Jihadists* and their supporters are also in the *Muslim* hall of fame. The teaching that *Jihadists* are much better in the sight of *Allah* than even pious *Muslims* who do not go on *Jihad* (K 004:095-096), even better than those who guard the *Kaaba* or give out water to pilgrims at the *Kaaba* (K 009:019). So one can see that

<sup>1324</sup> Nutt, Amy Ellis. “What Makes a Terrorist?” newhousenews.com, 23 Dec 2005, C&R.

<sup>1325</sup> *Sahih Bukhari*, vol. 1, bk. 2, no. 25; vol. 2, bk. 26, no. 594.

<sup>1326</sup> *Sahih Bukhari*, vol. 4, bk. 52, no. 44; *Sahih Muslim*, bk. 020, nos. 4636 & 4638.

<sup>1327</sup> Ishaq. *Sirat*, p. 400.

<sup>1328</sup> Sciolino, Elaine. “From Tapes, a Chilling Voice of *Islamic* Radicalism in Europe,” nytimes.com, 18 Nov 2005.

<sup>1329</sup> “Last words of a terrorist,” *The Observer*, guardian.co.uk, 30 Sep 2001.

<sup>1330</sup> Hassan, Nasra. “Are you ready? Tomorrow you will be in Paradise...” timesonline.co.uk, 14 Jul 2005, *JW*.

<sup>1331</sup> “PA Approves Aid to Terrorists’ Families,” arutzsheva.com, 6 Dec 2005, *DW*.

<sup>1332</sup> Gross, Tom. “Yasser Abbas,” *Wall Street Journal*, wsj.com, 22 Dec 2005, *Media Backspin*.

<sup>1333</sup> O’Brien, Patrick. “Giving the Devil His Due: *Jihad Zakat*,” C&R, 23 Sep 2005.

<sup>1334</sup> Kerbaj, Richard. “*Muslims* give big to suspects’ families,” theaustralian.news.com.au, 21 Jun 2006, *LGF*.

<sup>1335</sup> Cohen, David. “Terror on the dole,” *Evening Standard*, 20 Apr 2004, thisislondon.co.uk, 21 Apr 2004, *LGF*, *DW*, freerepublic.com.

<sup>1336</sup> Harel, Amos. “Former PA official: PA spent millions, including foreign aid, on weapons acquisitions,” haaretz.com, 17 Apr 2006, *JW*.

<sup>1337</sup> Abu Toameh, Khaled. “*Fatah* decries *Mosque* ‘incitement,’” jpost.com, 14 May 2006.

<sup>1338</sup> Ehrenfeld, Rachel. “Saudi Dollars and *Jihad*,” *FPM*, 24 Oct 2005.

<sup>1339</sup> Freeze, Colin. “CSIS [Canadian Security Intelligence Service] probes man’s possible link to rebels,” theglobeandmail.com, 16 Oct 2004, p. A9.

<sup>1340</sup> “Police Identify French *Islamist* Killed in *Fallujah*,” *The Tocqueville Connection*, ttc.org, 22 Oct 2004, *JW*.

<sup>1341</sup> Walt, Vivienne. “Foreigners in *Iraq* say *Koran* requires fighting U.S.,” *San Francisco Chronicle*, sfgate.com, 28 Nov 2003.

<sup>1342</sup> Cohen, David. “Terror on the dole,” *Evening Standard*, 20 Apr 2004, thisislondon.co.uk, 21 Apr 2004, *LGF*, *DW*, freerepublic.com.



*Jihadists* do not need to die during *Jihad* to experience greater heavenly bliss since *Muhammad* said that *Jihadists* and their supporters are not rewarded equally (K 004:095). As one *Jihadist* put it “One day’s resistance for the holy war is worth 1,000 years of life.”<sup>1328</sup>

*Muhammad* taught that there were levels of heaven (K 017:021) and that *Jihadists* went to higher levels than non-*Jihadists*. *Muhammad* said:

...whoever cheerfully accepts *Allah* as his Lord, *Islam* as his religion and *Muhammad* as his Apostle, is necessarily entitled to enter Paradise... There is another act which elevates the position of a man in Paradise to a grade one hundred (higher), and the elevation between one grade and the other is equal to the height of the heaven from the earth... *Jihad* in the way of *Allah!* *Jihad* in the way of *Allah!* (*Sahih Muslim*, bk. 20, no. 4645).

The prospect of attaining a higher level of heaven does motivate *Jihadists*. Mohamed Atta, one of the leaders of the 9/11 terrorists, wrote:

Keep in mind that, if you fall into hardship... This test from Almighty God is to raise your level [translator Imad Musa: levels of heaven] and erase your sins. And be sure that it is a matter of moments, which will then pass, God willing, so blessed are those who win the great reward of God.<sup>1329</sup>

It is well-known that *Muslims* give money to the families of suicide-bombers.<sup>1330</sup> “The Palestinian Authority also retains jailed terrorists on its police payroll and pays them monthly salaries as well as pensions.”<sup>1331</sup> That this is the case and because cash is fungible, one could say that the West indirectly subsidizes terrorism since the West sends money to *Islamdom* in the form of oil- and drug-money, and economic, military and humanitarian aid. *The Wall Street Journal* reported in 2005 that the EU, especially, indirectly funds terrorism in the West Bank and *Gaza*:

The family of each ‘martyr’ will now receive a monthly stipend of at least \$250—a not inconsiderable amount for most Palestinians. Altogether, the families of these so-called martyrs and of those wounded in terrorist attempts or held in *Israeli* jails might receive \$100 million, according to *Al-Hayat Al-Jadida* [the official Palestinian newspaper]. **Around 30 percent of the Palestinian Authority budget comes from international donations, including a hefty amount from the European Union.**<sup>1332</sup>

A reason that so many *Muslims* give money to *Jihadists* and their (surviving) families—often through charities and front organizations—is, according to *Sharia* law, families must give their permission to *Jihadist* sons to fight, and thus families share in the honor and personal sacrifice of *Jihadists*:

The following may not fight in *Jihad*:... someone with at least one *Muslim* parent, until they give their permission (*Reliance of the Traveler* (‘*Umdat al-Salik*), o9.5).

*Muhammad* promised that everyone involved in equipping, feeding and housing *Jihadists* would have an eternal reward in heaven:

He who provides the equipment for a soldier in *Jihad* has himself performed *Jihad* (*Reliance of the Traveler* (‘*Umdat al-Salik*), o9.1).

The warrior gets his reward, and the one who equips him gets his own reward and that of the warrior (*Sunan Abu-Dawud*, bk. 14, no. 2520).

He who does not join the warlike expedition (*Jihad*), or equip, **or looks well after a warrior’s family when he is away**, will be smitten by *Allah* with a sudden calamity. Yazid *Ibn Abdu* Rabbihi said in his tradition: ‘before

the Day of Resurrection' (*Sunan Abu-Dawud*, bk. 14, no. 2497).

The Messenger of *Allah*...said: Anybody who equips a warrior (going to fight) in the way of *Allah* (is like one who actually) fights. And anybody who looks well after his family in his absence (is also like one who actually) fights (*Sahih Muslim*, bk. 20, no. 4668).

*Allah*'s Apostle said 'He who prepares a *Ghazi* [*Jihadist*] going in *Allah*'s cause is given a reward equal to that of a *Ghazi*; and he who looks after properly the dependents of a *Ghazi* going in *Allah*'s cause is (given a reward equal to that of) *Ghazi* (*Sahih Bukhari*, vol. 4, bk. 52, no. 96).

Khuraym Bin Fatik narrated that *Allah*'s Messenger...said 'If anyone makes a contribution towards *Allah*'s path, seven hundred times as much will be recorded to his credit' (*Tirmidhi* 3826, 1343 and *Nasa'i*).<sup>1333</sup>

*Muhammad* said that *Muslims* have a "duty to" harbor *Jihadists* and give "asylum and aid in religion," e.g. safe-houses, and that those who do so "are the believers in truth, [and] for them is forgiveness and *Rizqun Karim* (a generous provision i.e. Paradise)" (*Hilali-Khan K* 008:072-074).

The above explains why in 2006 300 *Muslims* gave USD 50,000 to the families of 22 accused *Jihadists* even though Australia spends a million USD per year in welfare and legal aid on these same 22 families.<sup>1334</sup>

The *Koran* states that *Zakat* alms can be spent on *Jihad*, i.e., "in *Allah*'s cause" (*K* 009:060)—and *Sharia* law reflect this point too. The *Reliance of the Traveler* ('*Umdat al-Salik*), states that *Jihadists* are the seventh category of people worthy of receiving alms (*Zakat*):

The seventh category is those fighting for *Allah*, meaning people engaged in *Islamic* military operations for whom no salary has been allotted in the army roster (O: but who are volunteers for *Jihad* without remuneration). They are given enough to suffice them for the operation, even if affluent; of weapons, mounts, clothing and expenses (O: for the duration of the journey, round trip and the time they spend there, even if prolonged...) (h8.17).

The above explains why *Islamists* are not ashamed to be on the dole,<sup>1335</sup> or to use Western foreign aid to support *Jihadist* insurgents or terrorists.<sup>1336</sup> They view these gifts as a form of the *Jizya* tax (*K* 009:029), or charity since *Muhammad* said that *Jihadists* could receive *Zakat* alms along with the poor (*K* 009:060). For instance, *The Jerusalem Post* reported in 2006 when the pro-*Jihadist* *Hamas* group was elected to power among Palestinian and Western aid was reduced:

In *Nablus*, thousands of *Hamas* followers gathered after prayers Friday to donate money and jewelry to the new government. 'These donations are our way of telling the world that we can live without them, and our children are paying what the Europeans **should** be paying,' said Bassam *al-Shakaa*, a former mayor of *Nablus*.<sup>1337</sup>

All the teachings noted earlier in this section are not lost on *Muslims*, as *FrontPage Magazine* noted:

On *Iqra* TV, on August 29, 2005, *Saudi* Arabia's secretary-general of the official *Muslim* World League *Koran* Memorization Commission, *Sheikh* Abdallah Basfar, urged *Muslims* everywhere to fund terrorism. He said: 'The Prophet said: 'He who equips a fighter—it is as if he himself fought.' You lie in your bed safe in your own home and donate money, and *Allah* credits you with the rewards of a fighter. What is this? A privilege,<sup>1338</sup>

In order to obtain their heavenly reward in accordance with *K* 008:072-074

and the *Hadiths* listed above, *Muslims* help out *Jihadists* by providing war materiel and safe-houses—as is evidenced by the ease in which native terrorists and foreign *Jihadists* such as the *Al-Qaeda* franchise can stealthily operate nearly anywhere there are a few *Muslims*. Captured foreign fighters in *Kashmir*, *Lebanon*, *Chechnya*, *Azerbaijan*, *Afghanistan* and *Iraq* have come from places such as the US, UK, Canada, EU, Australia, *Pakistan* and from the rest of *Islamdom*.<sup>1339 1340</sup> One Jordanian *Jihadist* in *Iraq* reported on the hospitality they received:

He said he wanted to dispute claims by US officials that foreign fighters were paid to attack American soldiers: ‘We are not paid money,’ he said. ‘We are guests of *Iraqis*, staying in their homes.’<sup>1341</sup>

Nowadays, equipping a fighter for *Jihad* often involves explosives and WMD (Weapons of Mass Destruction) ingredients rather than with swords, armor and horse, as was reported from *Londonistan* in 2004:

‘As far as I’m concerned, when they bomb London, the bigger the better,’ says *Abdul Haq*, the [*Islamist*] social worker. ‘I know it’s going to happen because *Sheikh Bin Laden* said so...I would like to see the *Mujahideen* coming into London and killing thousands, whether with **nuclear weapons or germ warfare**. And if they need a safehouse, they can stay in mine—and if they need some **fertilizer** [for a bomb], I will tell them where to get it...It will be a day of joy for me...’<sup>1342</sup>

**Ingredient 16 (Sworn to Die Fighting):** *Muhammad* approved of fighting in a suicidal fashion since many of his followers swore to *Allah* not to retreat in battle (*K* 033:015). *Muhammad* said his followers sold their life for the hereafter (*K* 004:074), used to wish for death (*K* 003:143) and vowed to die in battle (*K* 033:023). Thus terrorists commonly “have sworn an oath to die without turning a hair,” i.e. without flinching.<sup>1343</sup> “The idea of sacrificing oneself for the divinity” is called *Istishhad*.<sup>1344</sup>

Some *Muslims* claim that there is a command against suicide in the *Koran*: “do not kill yourselves” (*Rodwell K* 004:029). A comparison of *Koran* translations reveals that what the verse really deals with is murder—not suicide.

A later verse in the same chapter gives the context of *K* 004:029. *Muhammad* said *Muslims* are not to murder other *Muslims* (*K* 004:029) just as *Muslims* are supposed to be careful to loot only non-*Muslims* (*K* 004:094). In other words, when *Muhammad* says “Do not kill yourselves,” what he is really saying is: “Do not overdose on the *Koran*’s War verses and start killing other *Muslims*.”

A *Muslim* reporter from *Pakistan* was allowed to talk to suicide-bombers...

‘...so...you can explain **the Islamic context** of these operations,’ one man told me [the reporter]. ‘Even many in the *Islamic* world do not understand.’

One Palestinian would-be suicide-bomber told the reporter:

We made an oath on the *Koran*, in the presence of *Allah*—a pledge not to waver. This *Jihad* pledge is called *Bayt Al-Ridwan*, after the garden in Paradise [*Janna*] that is reserved for the prophets and the martyrs,

<sup>1343</sup> “Saudi Columnist: Terrorists Mistreat Their Wives and Children,” *MEMRI*, Dispatch Series No. 935, 15 Jul 2005, *DW*.

<sup>1344</sup> Melman, Yossi. “Didn’t we say it would be worthwhile paying attention to Zaraqawi?” *haaretz.com*, 27 Jul 2005.

*Muhammad* said in *Koran* 033:023 that some of his followers had sworn to die in battle and some of them already had fulfilled their vow. The reporter found that the same was true today among the Palestinians:

When a candidate is placed in a [martyrdom] cell, usually after months, if not years, of religious studies, he is assigned the lofty title of *Al-Shaheed Al-Hayy*, ‘the living martyr.’ He is also referred to as ‘he who is waiting for martyrdom.’<sup>1345</sup>

“**The Islamic context**” for suicide-bombings (mentioned above) explains why “...31 of 35 groups that have used suicide bombings are *Islamic*...,”<sup>1346</sup> and why *Muslims* will be using this technique until the Last Day unless some simpler and deadlier technique is invented.

By contrast with *Islamists*, only a few non-*Muslim* terror groups have ever used suicide-bombings, and they only planned to achieve limited purposes over a limited time, such as the *Sri Lankin Tamil* Tigers who abandoned the technique in 2003 and the Japanese *Kamikazes* who disbanded during WWII.

**Ingredient 17 (Seductive Afterlife):** The many promises of fleshly rewards in the afterlife if a *Muslim* dies while engaging in any *Jihad*-related activity, to include sumptuous banquets and plenty of sex with *Houris*.

*Houris* are nymph nymphomaniacs awaiting *Muslims* in heaven. *Houris* are described as “voluptuous women” (*K* 078:033) who will satisfy *Muslims* on couches in gardens (*K* 036:055-058). The *Houris* will be wives to *Muslims* (*K* 044:054; 052:020) who will be as beautiful as rubies and pearls (*K* 052:024; 055:058; 056:017; 076:019). Serge Trifkovic wrote:

According to some interpretations of the Tradition, and in the considered opinion of a contemporary *Islamic* commentator, ‘The men in Paradise have sexual relations not only with the women [who come from this world] and with ‘the black-eyed’ [*Houris*] but also with the serving boys...In Paradise, a believer’s penis [phallus] is eternally erect’ [Galal Al Kushk, as quoted in *Al Quds Al Arabi*, London, May 11, 2001].<sup>1347</sup>

The *Houris*’ virginity will be protected as though they were well-stored eggs (*K* 037:049) and will not be deflowered by men or *Jinn* (*K* 055:056, 074). *Houris* are perpetual virgins since their hymen is restored after each sex act (*K* 055:074; 056:034-036. Also see *K* 002:025; 036:056; 037:048-049; 038:049-053; 044:051-055; 045:070-074; 046:010-022; 052:019-020; 055:054-058; 056:022, 034-038 and 078:033).

While *Houris* are mentioned often in the *Koran*, there seems to be no mention in the **major** *Hadith* collections, or any mention in the *Koran*, about the **exact number** of *Houris* each man will receive. *Muhammad* only mentions that each *Muslim* man “will have two wives from the *Houris*,” but does not specify how many sex-slave *Houris* each man will have (*Sahih Bukhari*, vol. 4, bk. 54, no. 476).

Because *Muhammad* authorized a *Muslim* man to have up to four wives and

<sup>1345</sup> Hassan, Nasra. “Are you ready? Tomorrow you will be in Paradise...” timesonline.co.uk, 14 Jul 2005, *JW*.

<sup>1346</sup> Eggen, Dan & Scott Wilson. “Suicide bombs become potent tools for terror,” washingtonpost.com, 17 Jul 2005.

<sup>1347</sup> Trifkovic. *Sword*, pp. 63-64.

an unlimited number of sex-slaves on earth (*K* 004:023-024; 023:005; 033:050; 070:030), *Muslims* assume that they will receive many sex partners in heaven—and various teachings and traditions back up this assumption.

There is no hint in the *Koran* and the traditions that such delights are metaphorical, yet Westerners are often told that the *Houris* and other fleshy delights in *Muslim* heaven (*Janna*) are just metaphorical. Only some moderate *Muslim* academics believe this.

Rank-and-file *Muslims* are expecting literal *Houris* and serving boys as described in the *Koran* and the traditions. In fact, the *Muslims* that concern the West the most, the *Jihadists*, to a man believe that the *Houris* will be his personal *Harem* at his beck and call to meet his every need.

*Muslim* academics know all the above, yet choose to mislead non-*Muslims* by not mentioning that the widely held conception of *Muslim* heaven is indeed fleshy. Westerners, therefore, ought to read up on *Takiya* and *Kitman* which allow *Muslim* to deny the offensive tenets of *Islam*—and even *Islam* itself—if doing so helps the cause of *Islam*. Apparently, *Muslims* feel that misrepresenting to Westerners what most *Muslims* really think about *Janna* helps the cause of *Islam*.

*Muslim* women are sometimes told that there will be male *Houris* to service them. *Muslim* wives are sometimes told that they will continue being the wives of their husbands. They are also told that they will be made to look more gorgeous than the *Houris* so as to keep their husbands' interest despite the stiff *Houri* competition.

There are **minor** traditions and *Fatwas* that mentioned the figure “seventy” and “seventy-two” *Houris* and twenty-eight “serving boys.” Some *Muslims* teach that if a *Muslim* already married on earth, he will only receive twenty-three *Houris* in heaven. Caner and Caner wrote:

When another asked him how one man could have the strength to (be intimate with) seventy girls in one day he responded: ‘He would be given the strength of one hundred men!’<sup>1348</sup>

Stephen Murray and Will Roscoe wrote concerning the “serving boys”:

Pederasty has not been the only form of homosexuality in Arabic culture (and still less so in other *Islamic* cultures—especially in the eastern reaches of *Islam*) but it has long been the idealized form...within *Islamic* cosmology, male sexual pleasure is ‘good-in-itself’ not merely as a means to procreation, but as a prefiguring paradise, which according to the *Quran* is staffed with beautiful serving boys (*Al Fata*) as well as girls (the term *Houri* includes both) ([*K* 0]56.17ff; 52:17ff; 52:24; 76:19)...<sup>1349</sup>

Serge Trifkovic wrote concerning the “serving boys”:

The righteous [in heaven] will be served also by boys, ‘pure as pearls,’ dressed in green garments of fine silk and heavy brocade, adorned with bracelets of silver and used [accustomed] to drinking wine. The presence of intoxicating youths in such a luxurious environment must have some unusual purpose. They do not seem to be ordinary servants, who would not need to be

<sup>1348</sup> Serene, *Ibn. Kitab ul Isra'a wal Mu'raj*, quoted in Caner. *Unveiling*, p. 193.

<sup>1349</sup> Murray. *Culture*, pp. 302, 307 (also see p. 90).

<sup>1350</sup> Trifkovic. *Sword*, pp. 63-64.

<sup>1351</sup> Krause, Hans. *Hans Krause's Research Reports: Islam: Its Fight for World Domination 5*, kruse.de, “Ch. 3: *Islam* and the Gospel.”

ever young, breathtakingly beautiful and adorned in sumptuous dresses and jewelry. According to some interpretations of the Tradition, and in the considered opinion of a contemporary *Islamic* commentator, ‘The men in Paradise have sexual relations not only with the women [who come from this world] and with ‘the black-eyed’ [*Houris*], but also with the serving boys....In Paradise, a believer’s penis [phallus] is eternally erect’ [Galal Al Kushk, as quoted in *Al Quds Al Arabi*, London, May 11, 2001].<sup>1350</sup>

Hans Krause wrote concerning the “serving boys”:

*Muhammad* Djalal Kischk writes in his book *Khawatir Al-Muslim Fi Al-Mas'ala Al-Djinsiyya* that these paradisiacal boys are available to those, who have a desire for them [i.e. want to have anal intercourse with them].<sup>1351</sup>

To conclude this section, we can see that *Muslim* men will be given the sexual strength of a hundred men, meaning that they are cursed with a sexual addiction for eternity. *Islam* actually has two hells—a hot hell for unbelievers and a sexual-addiction hell for the faithful that *Muslims* refer to as heaven (*Janna*).

**Ingredient 18 (Riches in the Afterlife):** Just as *Muhammad* was once a merchant, so his religion is a merchants’ religion that uses merchants’ terminology. *Muhammad* said that those who apostatize from *Islam* or refuse to go on *Jihad*, sell out their religion (*Deen*) in exchange for paltry worldly goods (*K* 002:079, 090; 003:187; 005:044; 009:009; 016:095). Also, giving alms or going on *Jihad* constitute a loan to *Allah* that he will repay with interest in heaven (*K* 002:245; 005:012; 009:111; 057:011, 018; 064:017; 073:020). Thus a preacher can promise...

...that every coin they donate to overthrow Indonesia’s secular government will be repaid hundreds of times over in heaven. ‘The government no longer looks to *Allah*, but to America...Prepare your forces and banish the enemy.’<sup>1352</sup>

The repayment of the loan to *Allah* consists of, among other things, 72 virgins.

*Allah*’s promise of repayment with “interest” in heaven is enhanced by the fact that taking interest in this world is banned in *Islam* with the result that many *Muslims* are dirt-poor. The promise of 72 virgins is enhanced by the fact that:

- Wine, singing, gambling and collecting interest on loans are banned in *Islamdom* (*K* 002:275-278; 003:130; 004:161; 030:039).<sup>1353</sup>
- *Houris* do not wear veils as is required of *Muslim* women (*K* 033:032-033, 053, 059).
- *Muslims* can have seventy-two *Houris* but only four wives on earth (*K* 004:003).
- *Houris* are perpetual virgins who never tire of sex.
- *Houris* do not require that any unattainable dowry (brideprice) be paid (*K* 002:236 002:237 004:004 004:019 004:024 004:025 033:050 060:010).

So many *Muslims*, particularly young poor men, are made to feel they need to go to heaven to enjoy what they are denied on earth: wine, women and song.

The teaching about *Jihad* being a heavenly investment is not lost on *Jihadists* who fancy themselves as being *Allah*’s investment brokers. One *Jihadist* web site read “*Jihad* is a profitable investment that provides valuable dividends.”<sup>1354</sup>

<sup>1352</sup> Brummitt, C. “Accused Indonesian Cleric Preaches *Jihad*,” newsday.com, 11 May 2005, *LGF*.

<sup>1353</sup> Zwemer. *Essay*, Ch. 8: “The Completed Idea and Its Insufficiency,” pp. 110-112.

**Ingredient 19 (Looting on a Commission-basis):** In order to encourage *Muslim* leaders and men to go on *Jihad*, *Muhammad* systematized looting on a commission basis. The leader received a fifth, the *Jihadists* received the rest (*K* 003:161; 004:094; (*Sura* 008 is entitled “The Spoils”) 008:001, 041, 069; 033:019, 027, 050; 048:015, 019, 020, 021; 059:006-007).

The only warning *Muhammad* gave about *Jihad* was that *Muslims* should not call a *Muslim* a non-*Muslim* merely to make his possessions *Halal* (permissible) for *Muslims*—in other words, declaring that a *Muslim* is in fact a lootable non-*Muslim* (*K* 004:094).

Based on the *Koran* and *Hadith*, *Muslims* often say that the lives and property of non-*Muslims* (*Harbis*) in the Territory of War (*Dar al-Harb*) are licit (Arabic: *Muba'a*) for *Muslims* to destroy or to take by force.<sup>1355</sup> The ideas of gaining loot, *Houris* or sex-slaves and making *Dhimmis* out of infidels are by no means quaint ideas from a bygone medieval era, but are taken deadly seriously by *Jihadists*. For instance:

- ☉ The “*Andalusian* jurist, *Ibn Hazm* of *Cordoba* (died 1064 AD), wrote that *Allah* has established the infidels’ ownership of their property merely to provide booty for *Muslims*.”<sup>1356</sup>
- ☉ One early *Muslim* said: “*Muhammad* used to promise us that we should eat the treasures of *Chosroes* and *Caesar*.”<sup>1357</sup>
- ☉ The *Hadith* record *Muhammad* saying that *Muslims* would obtain “the treasures of the world.”<sup>1358</sup>
- ☉ *Imam Abu Hamza* told *Muslims* in his London sermons in 2006:  
...shoplifting and theft by *Muslims* from non-believers was permitted. Students were not required to repay loans and identity fraud by *Muslim* refugees [i.e. asylum seeking *Islamists* in the UK] was allowed...<sup>1359</sup>
- ☉ In 2006 *Usama bin Laden* said that “by defeating your enemy you would profiting from the world treasures.”<sup>1360</sup>
- ☉ See the table “*Islamists* Still Dream of Making Non-*Muslims* Into *Dhimmis* and Sex-Slaves” for other recent statements.

**Ingredient 20 (Polygamy and Harem Incentives):** *Muhammad* incentivized *Jihad*, specifically, the killing of infidel men and the capturing of infidel women, by saying that *Muslim* could have up to four wives and an unlimited number of sex-slaves (*K* 004:003, 023-024; 023:005; 033:050; 070:030). *Muhammad* very well knew that many *Muslims* could not afford the procurement of additional wives and sex-slaves unless they were gained through *Jihad*, and this is why

<sup>1354</sup> Purdy, Alison. “Terror Suspect ‘Tried to Buy 5,000 Tons of Sulphur,’” *PA News*, news.scotsman.com, 18 Nov 2004, *JW*.

<sup>1355</sup> Bostom, Andrew. “Meet Candidate ‘Martyr Mom,’” *FPM*, 5 Jan 2006, *JW*.

<sup>1356</sup> Arnaldez. “*La guerre sainte selon Ibn Hazm de Courdoue*,” vol. 2, 1962, pp. 445-459, as quoted in Bostom, Andrew. “*Jihad* begot the Crusades, part 1,” americanthinker.com, 5 May 2005.

<sup>1357</sup> Ishaq. *Sirat*, pp. 222, 454.

<sup>1358</sup> *Sahih Bukhari*, vol. 4, bk. 52, no. 220.

<sup>1359</sup> O’Neill, Sean. “Holocaust a punishment from God, said radical preacher,” timesonline.co.uk, 14 Jan 2006, *JW*.

<sup>1360</sup> Phares, Walid. “*Jihad*...then more *Jihad*: *Bin Laden*’s *Iraq* and *Somalia* orders,” counterterrorismblog.org, 1 Jul 2006.

slaves are referred to as being “those whom your right hand possesses,” since the sword used in *Jihad* was commonly held in the right hand (K 004:003; 016:071; 024:058; 030:028; 033:050, 052). *Muhammad* also said *Jihadists* could have sex with captured females even if they intended to ransom them back or sell them into slavery.<sup>1361</sup>

**Ingredient 21 (Rewards for the Homeless and Travelers):** *Muhammad* further incentivized war and ethnic cleansing by saying that *Muslim* who are “wronged” or persecuted and must flee their homes, will have their sins remitted and will have greater rewards in heaven (K 002:243; 003:195; 004:100; 008:074; 009:020; 016:041).

What this all means is *Muslims* can be obnoxious and hateful toward non-*Muslims* (in accord with the commands not to befriend non-*Muslims* and to be harsh to non-*Muslims*) and engage in as much *Jihad* and ethnic cleansing as possible (in accord with those *Koranic* commands), because even if it all backfires and *Muslims* are the ones who end up without house and home, they will gain a higher reward in heaven.

If *Muslims* then emigrate or seek asylum and then die in a foreign country, their reward in heaven is greater, especially if they died during a *Jihad* in a foreign country.<sup>1362</sup> Compounding this last belief is the common *Muslim* belief that “Those who, in their wills, accept burial away from home are conferred special celestial benefits.”<sup>1363</sup>

All these incentives to emigrate lead *Muslims* to inundate other countries with a human demographic tsunami. Then *Muslims*’ higher birthrate and Khidr-Second Lamech Logic terrorism continue to distress and marginalize the indigenous culture and eventually lead to full-blown *Dhimmi*fication, *Islamization* and Arabization of the indigenous culture.

**Ingredient 22 (The Plenary Absolution Incentive, i.e. Skip Purgatory):** The promise that all the sins of *Jihadists* would be blotted out and pardoned (K 003:157; *Sahih Muslim*, bk. 20, no. 4646), and “the gates of Paradise are under the shadows of the swords” (*Sahih Muslim*, bk. 20, no. 4681; see also bk. 19, no. 4314).

The *Koran* (K 019:070-071) and at least one *Hadith* (*Sahih Bukhari*, bk. 12, no. 770) teach that many *Muslims* will taste of hellfire. The *Dabistan*’s section on *Islam* also mentions *Muhammad* teaching Purgatory.<sup>1364</sup> Lately, a *Mufti* issued an edict that those who spread false rumors “will be plunged into hell for 70 Autumns.”<sup>1365</sup>

Tradition says that *Muslim* martyrs will be able to intercede for seventy relatives or friends to spring them out of Purgatory.<sup>1366</sup> This belief may be based partly on K 004:096 which some take to mean that *Jihadists* are given extra degrees of honor, forgiveness and mercy.

<sup>1361</sup> Spencer, Robert. “The Rape *Jihad*,” *FPM*, 24 & 26 Sep 2004, *JW*.

<sup>1362</sup> Filkins, Dexter. “Tortuous Trail: From a Bombing in *Iraq* to Fury at a Family in *Jordan*,” *nytimes.com*, 15 Mar 2005, *natashatynes.org*.

<sup>1363</sup> Blair & Bloom. *Paradise*, p. 28.

<sup>1364</sup> Fani. *Dabistan*, p. 321.

<sup>1365</sup> Ghalwash, Mae. “Squint hard, be creative in search for blasphemy in *Coca-Cola*™ logo,” *Associated Press*, *cjonline.com*, 21 May 2000.

<sup>1366</sup> Hassan, Nasra. “Are you ready? Tomorrow you will be in Paradise...” *timesonline.co.uk*, 14 Jul 2005, *JW*.



That *Jihadists* can forgive seventy people is a reason that *Jihadists* make out Last Testaments so their parents and friends can rest assured that the *Jihadist* intends to extract them from Purgatory—and not someone else instead.

The Last Testament is a sort-of thank-you note to the parents for their having put their blessing on the *Jihadist's* activities just as they would a wedding, since after all, the *Jihadist's* activities could end in a wedding to the *Houris*:

- ☉ A *Hamas* suicide-bomber referred to his impending death as “my wedding day with the Maidens of Paradise.”<sup>1367</sup>
- ☉ The *Al-Banna* family advertized a “wedding of the martyr” celebration after their son died in a suicide-bombing that killed 179 *Iraqis* and no Americans—his preferred target.<sup>1368</sup>
- ☉ The day after *Abu* Musab *Al-Zarqawi* was killed, a former preacher in Londonistan, *Sheikh* Omar Bakri, said “It is a good news *Alhamdulillah* (thank God), his wedding start as *Shaheed* (martyr)...”<sup>1369</sup>

This wedding-aspect probably explains why *Muhammad* said *Jihadists* ought to get their parents’ permission and blessing to go on *Jihad*,<sup>1370</sup> and why manly would-be *Jihadists* sometimes get their mother’s okay as when *Pakistani* Shahawar Matin Siraj said “I have to check with my mother.”<sup>1371</sup>

Anyone who skips Purgatory also gets to skip the “eye for an eye” retaliation period between Purgatory and heaven, as *Muhammad* said:

The believers, after being saved from the (hell)fire, will be stopped at a [*Sirat*] bridge between Paradise and hell and mutual retaliation will be established among them regarding wrongs they have committed in the world against one another. After they are cleansed and purified (through the retaliation), they will be admitted into Paradise (*Sahih Bukhari*, vol. 8, bk. 76, no. 542).

In *Saudi* Arabia in 2005, an Indian man was sentenced to having an eye gouged out after a fistfight with a *Saudi* resulted in the *Saudi* losing his eyesight.<sup>1372</sup> So it seems during this last period of *Lex Talionis* on the *Sirat* Bridge, *Muslims* will literally gouge out eyes (*Malik's Muwatta*, 43.8.6a), knock out teeth, bite and kill each other and such. After all, *Muhammad* said that a man who lost two teeth by biting someone on the hand ought to retaliate by having the man bite him back and then wrench out his teeth by hand (*Sahih Bukhari*, bk. 016, no. 4147).

*Jihadists* really are motivated to fight until martyrdom by thinking that they will get their parents, relatives and friends out of Purgatory and into heaven with them, as *The New York Times* reported:

Mr. Siddique has told interrogators that he misses his parents in Britain, according to the *Pakistani* security official. But he believes that the only way he can spend eternity with them is by becoming a martyr. ‘Do not waver or become

<sup>1367</sup> Marcus, Itamar & Barbara Crook. “*Hamas* Video: We will drink the blood of the Jews,” pmw.org.il, 14 Feb 2006, *JW*.

<sup>1368</sup> “Inflammatory and irresponsible journalism,” natashatynes.org, 11 Mar 2005.

<sup>1369</sup> Lappin, Yaakov. “*Zarqawi's* wedding with virgins has begun,” ynetnews.com, 8 Jun 2006.

<sup>1370</sup> *Sahih Muslim*, bk. 32, no. 6184; also see other *Hadith* and traditions quoted at *Al-Qaradawi*, *Sheikh* Yusuf. “The Lawful and The Prohibited in *Islam (Al-Halal Wal Haram Fil Islam)*,” pp. 234-235, as quoted by Fitzgerald, Hugh. “Family values,” *JW*, 28 Apr 2006.

<sup>1371</sup> Hays, Tom. “*Pakistan* Native Tried in NYC Subway Plot,” news.yahoo.com, 24 Apr 2006, *JW*.

<sup>1372</sup> Kollam. “*Kerala* man may lose eye under *Saudi*...law,” webindia123.com, 4 Dec 2005, *DW*.

weak,' he writes in one of his last diary entries. 'This is the only way I can be reunited with Mummy and Daddy.'<sup>1373</sup>

Similarly, the video of two *Hamas* suicide bombers who killed an Israeli soldier on 7 December 2005 states:

My dear mother, you who have cared for me, today I sacrifice my life to be your intercessor [on Judgment Day]. O my love and soul, wipe your tears, don't be saddened. In the name of *Allah*, I've achieve all that I've aspired. Don't let me see you sad on my wedding day with the Maidens of Paradise. So be happy and not sad, because in the name of *Allah*, after death is merciful *Allah's* paradise.<sup>1374</sup>

*The Guardian* reported about one would-be suicide-bomber:

One local man in his 40s told the *Guardian* he wanted to be a suicide bomber to atone for sins and secure a place in heaven. 'But the *Mujahideen* will not let me. They said I had eight children and it was my duty to look after them.'<sup>1375</sup>

Of course no *Muslim* can be absolutely sure *Allah* will accept his offering (of himself), so one *Jihadist* wrote in his Last Testament that he sent to his parents:

I am in *Iraq* seeking martyrdom. I hope we are all forgiven.<sup>1376</sup>

*Muslim* mothers tend to be happier than fathers when their sons die as so-called martyrs because, in *Islam*, women have much less assurance of salvation. *Muhammad* said that the majority of denizens of hell were women.<sup>1377</sup>

*Muhammad* offers mothers a way of escape. If their children die before they do, whether from disease or accidents or from *Jihad*, the children will shield their mothers from hellfire.<sup>1378</sup> So, it is no wonder that one mother said of her son:

Saber [a suicide-bomber] was loved by us in this world and, *Allah* be praised, he will get us into heaven in the world to come.<sup>1379</sup>

The hope of bypassing Purgatory is why many mothers are proud<sup>1380</sup> and:

C "At the funerals of their sons, the mothers ululate as though celebrating a wedding as the body of a boy, now defined as a martyr killed fighting Israel, is carried high into streets full of Palestinian flags. But Leila never cried in the weekly meetings for mothers of martyrs...Leila would respond stonily that, as they were *Islamic* martyrs, there was nothing to mourn."<sup>1381</sup>

C Palestinian *Umm Nidal* said:

At first I did not cry. I said '*Allah Akbar*' and bowed in gratitude. The truth is I was ashamed to say: '*Allah*, help me in my tragedy,' because I consider this a blessing, not a tragedy. I prepared boxes of *halva* and

<sup>1373</sup> Rohde, David & Mohammed Khan. "Ex-Londoner's Diary of *Jihad*: A Portrait Sprinkled With *Koran* Verses and Epithets," *nytimes.com*, 8 Aug 2005.

<sup>1374</sup> Marcus, Itamar & Barbara Crook. "Hamas Video: We will drink the blood of the Jews," *pmw.org.il*, 14 Feb 2006, *JW*.

<sup>1375</sup> Mahdi, Omer & Rory Carroll. "Under US noses, brutal insurgents rule *Sunni* citadel," *guardian.co.uk*, 22 Aug 2005.

<sup>1376</sup> Al-Haj, A. "Yemeni Youths Seeking Martyrdom in *Iraq*," *news.yahoo.com*, 20 Dec 2004, C&R.

<sup>1377</sup> *Sahih Bukhari*, vol. 1:28, 301; vol. 2:161; vol. 7:124-126. The *Hadith* is often repeated (see "The Majority in Hell are Women," *AnsweringIslam.org*).

<sup>1378</sup> *Sahih Bukhari*, bk. 3, vol. 1, no. 101; *Sahih Muslim*, bk. 32, nos. 6362, 6363, 6368, 6372.

<sup>1379</sup> "The Mother of a Palestinian '*Shahid*': I'm Sad but I Hope There Will Be Many More," clip no. 297, *memritv.org*, 14 Oct 2004, C&R, 22 Oct 2004.

<sup>1380</sup> "Palestinian mother proud of two sons killed on *Hamas* missions," *Jpost.com*, 19 Feb 2003.

<sup>1381</sup> Brittain, Victoria. "Bringing it home," *The Guardian*, *guardianunlimited.co.uk*, 12 Dec 2001.

chocolates and handed them out to his friends....*Allah* be praised, I am preparing myself. I will sacrifice them all [ten of her sons]. If my duty requires me to sacrifice them all, I will not refuse—even if it costs me a hundred sons.<sup>1382</sup>

☉ “In an unbelievably shocking scene [of a reality video], one mother boasted that she bore her son precisely for this purpose and the father proudly claimed credit for providing the training.”<sup>1383</sup>

☉ In 2006 Rediff.com reported that a *Pakistani* mother offered a son for *Jihad* saying:

I am the mother of four sons. What happens if I donate one son for *Jihad*, he embraces martyrdom and earns heaven for all of us! said she rationalising her decision.<sup>1384</sup>

☉ One Jordanian family, the *Al-Banna*'s, who are related to the founder of the *Muslim* Brotherhood in Egypt, advertized a “wedding of the martyr” invitation in the newspaper to celebrate their son's union with the *Houris* after he killed 179 *Iraqi* police recruits in a car suicide-bombing. Of course the family denies ever placing the invitation in the newspaper.<sup>1385</sup>

☉ In *Afghanistan*, a woman warlord who refers to herself and her followers as “we *Mujahidin*,” was glad when her sons but not her leader died. Why? Her sons would bail her out of purgatory, but her leader was only of benefit to her in this life:

‘Oh Masood!’ she [Bibi ‘The Pigeon’ Ayesha] sighs. ‘I smiled as I buried my sons, because they died in the way of God fighting a *Jihad* and I was proud of them. But [Ahmad Shah] Masood was my leader and was murdered [in September 2001 by a suicide-bomber]. It was the saddest day of my life.’<sup>1386</sup>

*Jihadists* can still gain plenary absolution for themselves and some relatives even if they do not become a martyr and are captured or go home after a while. How? They can memorize the *Koran* and become a *Hafiz* (plural: *Huffaz*) just as many students attempt to become *Huffaz* in the *Madrastas*:

Because the *Quran* is regarded as the actual words of *Allah*, memorizing it is regarded as a virtuous act that is divinely rewarded. *Islamic* tradition holds that the father of a *Hafiz* is awarded a gold crown in heaven and the *Hafiz* is granted the divine favor of being able to release 10 people or groups from the fires of hell...<sup>1387</sup>

*Jihadists* will often give themselves up to go to jail rather than fight to the death but not for the reasons one might suppose. On one hand they still could end up martyrs if they receive the death penalty. On the other hand, they may only feel the need to spring ten people out of purgatory by becoming a *Huffaz*, rather than spring

<sup>1382</sup> “Palestinian Legislative Council Candidate...” memritv.org, 21 Dec 2005, Clip No. 980, *JW*.

<sup>1383</sup> “Jerusalem cleric praises child ‘sacrifices,’” Israeli Minister of Foreign Affairs, mfa.gov.il, 10 Nov 2000; “Jerusalem cleric praises child ‘sacrifices’” WND.net, 10 Nov 2000.

<sup>1384</sup> “The threat in the North East,” in.rediff.com, 27 Apr 2004, *FPM, JW*.

<sup>1385</sup> “Inflammatory and irresponsible journalism,” natashatynes.org, 11 Mar 2005.

<sup>1386</sup> Loyd, Anthony. “*Kalashnikov* matriarch emerges to tell of her life as an *Afghan* warlord,” *The Times*, timesonline.co.uk, 21 Oct 2004, *DW*, 16 Mar 2006.

<sup>1387</sup> Vara, Richard. “*Muslim* youth diligent in *Quran* studies: Recitation of holy book is part of *Ramadan* services,” *Houston Chronicle*, chron.com, 16 Oct 2004.

seventy out of purgatory by becoming a martyr. For instance, *Time* magazine reported:

Others [suicide-bombers] compile lists of the 70 people *Islamic* tradition says a ‘martyr’ can guarantee a place in paradise. ‘I haven’t got my 70 names yet—I don’t think I know that many people,’ Marwan says, allowing himself a rare smile.<sup>1388</sup>

Prisons are fast becoming *Jizya*-payer-supported jailhouse *Madrasas*, *Dawa* proselytizing centers and *Islamist* recruitment centers with a captive audience.<sup>1389</sup> *Muslims* usually form a disproportionately large part of the prison population so they are able to exert peer-pressure and gangland-style pressure on incarcerated non-*Muslims*. One could say the *Muslim* expansion of the eighth century is being played out again starting in prisons everywhere.

Since prisoners no longer need worry about employment, they waste no time in growing their beards out. Clean-shaven terrorist *Muhammad* Taheri-azar sported a beard shortly after he was arrested in 2006. *Muslim* prisoners also tend to study the *Koran* and other *Islamic* texts much of the day. Taheri-azar rises at three o’clock in the morning to study the *Koran* and to write proselytizing letters.<sup>1390</sup> The “American” *Taliban* John Lindh, who goes by the name Hamza, has this daily regimen:

Like most of the other 70 *Muslim* prisoners—the majority of whom are black American converts to *Islam*...[and] nearly all of whom have converted in prison...Lindh eats the vegetarian diet out of concerns that even non-pork meats have not been prepared to *Halal* specifications. He shares a bunk-bedded cell on the prison’s ground floor with another white convert, and rises before dawn to pray for the first of five times each day. After breakfast, he goes to work in the prison library and education centre, then joins the other prisoners for lunch, before usually retiring to his cell for much of the afternoon to study the *Koran* and *Islamic* texts.<sup>1391</sup>

Prisoners also have more free time than ever to become a *Hafiz*—someone who has memorized the entire *Koran*. Taheri-azar even read the *Koran* during his court hearings.<sup>1392</sup>

In an *Islamic* country, a newly-minted *Hafiz* may be released, as *The New York Post* reported, the late “Abdulaziz *Al-Muqrin*, *Al Qaeda*’s chief of operations for the Arabian Peninsula,” was released from jail in 1997 as a reward for having memorizing the *Koran* while in jail.<sup>1393</sup> This makes sense in the *Islamic* economy of thought since, if memorizing the *Koran* gains absolution of sin for ten people surely a prisoner who has become a *Hafiz* can be pardoned and released!

Some prisoners are motivated to read the *Koran* since a *Muslim* superstition has it that...

<sup>1388</sup> Ghosh, Aparisim. “Inside the Mind of an *Iraqi* Suicide Bomber,” *time.com*, 26 Jun 2005, *JW*; also see Spencer, Robert. “Yes, I am a Terrorist,” *FPM*, 29 Jun 2005, *JW*.

<sup>1389</sup> Pipes, Daniel. “If the King of Pop Converts to *Islam*,” *DP*, 7 Mar 2006.

<sup>1390</sup> Spencer, Robert. “Letters from a *Mujahid*,” *JW*, 12 May 2006.

<sup>1391</sup> Sherwell, Philip. “The new Malcolm X?” *telegraph.co.uk*, 4 Sep 2006, *C&R*.

<sup>1392</sup> Schonberg, Jessica. “Pit driver reads *Quran* to self in latest appearance,” *The Daily Tarheel*, *dailytarheel.com*, 24 Mar 2006.

<sup>1393</sup> Stakelbeck, Erick. “Rattling Riyadh,” *nypost.com*, 15 Jun 2004, *JW*, 18 Jun 2004.

...reading of the *Sura Jinn* [K 072] is most important. If a prisoner reads it, he will soon, be set free.”<sup>1394</sup>

One can see why *Muslims* in jail are so sensitive about the treatment of their *Korans*!

Unfortunately, some prisons make the study of comparative religions hard for *Jihadists* by only providing them copies of the *Koran* but not the Bible. In one case, the government argued that providing even one Bible might “incite” prisoners.<sup>1395</sup> This is backwards since just the first nine chapters of the *Koran* alone have 117 war verses. By contrast, the Bible influences terrorists to become ex-terrorist—people such as Walid Shoebat, Zak Anani, Ibrahim Abadallah<sup>1396</sup> and Taysir (Tass) *Abu-Saada*.<sup>1397</sup> Another ex-terrorist, Tawfik Hamid, still considers himself a *Muslim* in 2005, but what changed him is recalling to memory Jesus’ words “Blessed are the peacemakers” (Mat 05:07-09).<sup>1398</sup>

That prisons are *Jizya*-payer-supported *Madrasas* is no exaggeration when one considers how terrorist leader *Sheikh* Mukhlas, who in 2002 ordered the *Bali* bombing that killed 202 people, 88 of whom were Australians, wrote “18 books in jail.”<sup>1399</sup> This eerily reminds one of how another fascist, Hitler, wrote the lengthy *Mein Kampf* while in jail.

*Muslims* can conduct *Dawa* proselytizing in prison and even recruit for *Jihad*. Mohammed Bouyeri, the killer of moviemaker Theo van Gogh, was observed giving *Koran* lessons to two people in a secluded spot in prison, and he loaned them violent books, leading psychologists to conclude “that he was still busy recruiting for *Jihad*.”<sup>1400</sup> *Muslim* gangs inside and outside of jail pressure people to convert, as the *BBC* reported:

...there was evidence the gangs were targeting vulnerable young men and threatening them with violence if they did not ‘convert’ and join them.<sup>1401</sup>

Prison converts to *Islam* have even engaged in organized terrorism upon their release.<sup>1402</sup> In *Israel*, terrorists in jail keep in touch with their handlers or subordinates via smuggled cell phones, and they even run for political office.<sup>1403</sup>

☉ In 2005 an inmate was elected mayor of a sizable West Bank town.<sup>1404</sup>

☉ In 2005 and 2006 Marwan Barghuti was a member of the Palestinian parliament and was considered a prime candidate for prime minister.<sup>1405</sup>

In 2006 31 jailed Palestinian terrorists ran for parliament and 14 were elected as members of that 132-seat body.<sup>1406</sup>

<sup>1394</sup> Donaldson, Bess Allen. “The *Koran* as Magic,” *The Muslim World* (1937 AD), vol. 27, pp. 254-266, answering-*Islam.org*.

<sup>1395</sup> Serrano, Richard A. “Guantanamo prisoner files suit in effort to get Bible,” *Salt Lake Tribune*, sltrib.com, 22 Nov 2005; Pipes, D. “Working out the Counterterrorist Kinks,” *DP*, 22 Nov 2005.

<sup>1396</sup> “Princeton U. Says Campus Event Against Terrorism is ‘too inflammatory,’” *DW*, 5 Dec 2005.

<sup>1397</sup> *Abu-Saada*, Taysir (Tass). “Ex-*Fatah* fighter for Yasser Arafat asks forgiveness,” Maoz Israel Ministries, maosisrael.com, 1 Feb 2006.

<sup>1398</sup> Nutt, Amy Ellis. “What Makes a Terrorist?” newshousenews.com, 23 Dec 2005, *C&R*.

<sup>1399</sup> Powell, S. “Murder ‘infidels,’ Mukhlas urges,” theaustralian.news.com.au, 19 Dec 2005, *JW*.

<sup>1400</sup> “*Mohammed bleef gesloten boek in observatiekliniek*,” volkskrant.nl, 11 Jul 2005, translated by Beila Rabinowitz, militantIslammonitor.org, 11 Jul 2005, *C&R*.

<sup>1401</sup> “*Muslim*’ gangs target vulnerable,” news.bbc.co.uk, 12 Aug 2005.

<sup>1402</sup> Pipes, Daniel. “L.A.’s Thwarted Terror Spree,” *DP*, 6 Sep 2005.

<sup>1403</sup> Waked, Ali. “Minister’s killer to run for office,” ynetnews.com, 1 May 2005, backspin.typepad.

<sup>1404</sup> Waked, Ali. “Mayor runs city from jail cell,” ynetnews.com, 8 May 2005.

<sup>1405</sup> “*Fatah* set to play Barghuti trump-card to counter *Hamas*,” news.scd.yahoo.com, 27 Nov 2005.

<sup>1406</sup> Grayeff, Yigal. “14 prisoners in Israeli jails elected,” jpost.com, 26 Jan 2006.

**Ingredient 23 (Jihad Shirkers Are Damned):** *Jihad* is a loyalty test (K 047:004). On one hand, only going on *Jihad* provides any certainty of salvation in *Islam* (K 004:074; 009:111). On the other hand, there are 783 incendiary threats of hellfire in the *Koran* and these are often quoted in fire-and-brimstone sermons, as *The Jerusalem Post* reported:

The *Sheikhs* in the local *Mosques* shout and scream into the loudspeakers during Friday sermons, scaring people with warnings about the evil deeds that will land them in Hell.<sup>1407</sup>

These threats of hellfire apply to able-bodied *Muslims* who neglect or refuse to go on *Jihad* (i.e. shirk their *Jihad* duties), because shirking *Jihad* is a symptom of a spiritual disease (K 033:012; 047:020) of those who fear men more than they fear God (K 004:077). Shirking *Jihad* constitutes damnable unbelief (K 009:039, 049, 081-082; 039:055-060).<sup>1408</sup> Thus when some followers said it was too hot to go on *Jihad*, *Muhammad* said “hell is even hotter” (K 009:081).

*Abu Maysara*, an *Al-Qaeda* franchise commander in *Iraq* stated in 2005:

God forbid that our *Jihad* should be [considered] civil strife [*Fitna*]. Rather the avoidance of *Jihad* is civil strife. That was the verdict of *Allah*, who said of those who shirked *Jihad*, ‘Surely they have already succumbed to temptation [*Fitna*], and hell engulfs the unbelievers [K 009:049].<sup>1409</sup>

In the *Islamic* system, asking hard questions such as “Why must one go on *Jihad*?” (K 004:077) leads to a loss of faith, which in turn leads to hell and forfeiting one’s share of the buxom *Houris* (K 005:101-102). That the fear of hell and the fear of asking hard questions leads to terrorism is affirmed by the terrorist Mohammed Taheri-Azar who wrote:

*Allah*’s commandments are never to be questioned and all of *Allah*’s commandments must be obeyed. Those who violate *Allah*’s commandments and purposefully follow human fabrication and falsehood as their religion will burn in fire for eternity in accordance with *Allah*’s will.<sup>1410</sup>

One cannot put off hell by shirking *Jihad* either since *Muhammad* said that there is no way one can put off one’s appointed date of dying (K 003:154; 004:078; 033:016).

*Muslims* believe that *Allah* punishes, or at least does not bless their community, when the community shirks *Jihad*. *Ibn Ishaq* wrote that the first *Caliph*, *Abu Bakr* said:

If a people refrain from fighting in the way of God, God will smite them with disgrace. Wickedness is never widespread in a people but God brings calamity upon them all.<sup>1411</sup>

This is why the *Islamists*’ panacea for *Islamdom*’s many problems always is: more *Jihad*, more *Sharia* and more *Islam*, or as they say “*Islam* is the solution.”

<sup>1407</sup> Alvi-Aziz, Hayat. “Sinful Arab neglect,” jpost.com, 31 Mar 2005.

<sup>1408</sup> There are 783 threats of eternal wrath in 6,151 verses of Rodwell’s English *Koran* (Richardson. *Secrets*, p. 92).

<sup>1409</sup> “The *Iraqi Al-Qa’ida* Organization: A Self-Portrait,” MEMRI, SDS No. 884, 24 Mar 2005.

<sup>1410</sup> “Mohammed Taheri-Azar’s letter to police,” *The Herald-Sun*, heraldsun.com, 24 Mar 2006.

<sup>1411</sup> *Ishaq*. *Sirat*, p. 687.

**Ingredient 24 (Death to Deserters):** The teaching that if *Muslims* desert and run from the battlefield, they would enjoy life very little and their life would be short since *Allah* would try to kill them (K 033:015-016). *Muhammad* also said:

He who does not join the warlike expedition (*Jihad*), or equip, or look well after a warrior's family when he is away, will be afflicted by *Allah* with a severe calamity before the Day of Resurrection (*Sunan Abu-Dawud*, bk.14, no. 2497),

One cannot put off death by deserting either since *Muhammad* said that there is no way one can put off one's appointed date of dying (K 003:154; 004:078; 033:016). Thus *Muslims* figure they might as well die in *Jihad* rather than stay at home, as "the Mother of Martyrs," Palestinian Legislative Council Member *Umm Nidal Farhat* said:

...if someone is destined to die, he will die, even if he hides in a crate—but why shouldn't we take the initiative and die as martyrs? There is an abyss between one form of dying and the other. So why shouldn't we choose martyrdom? *Allah* has chosen us, from among all people and has bestowed upon us the honor of *Jihad* in the front line of Palestine. So it is all the more fitting for us to initiate martyrdom, before death reaches us while we sit at home.<sup>1412</sup>

**Ingredient 25 (Dehumanization of Infidels):** The *Koran* dehumanizes non-*Muslims* since it teaches that *Allah* considers infidels "enemies" (K 002:098; 008:060; 009:114; 041:019, 028), "unclean" (K 009:028), "diseased in the heart" (K 002:010; 005:052; 008:049; 009:125; 010:057), "vile animals" (K 008:022, 055) and cattle (K 007:179).

By contrast with the *Koran*, God in the New Testament says that no one ought to call or consider any food or animal or human being ceremonially "unclean" (Act 10:28; 11:09). The Bible says that humans are made in the image of *Yahveh* (Gen 01:26-27; 09:06) but the *Koran* says no such thing.

When one group considers others to be animals, their conduct is more or less determined by the belief that they are dealing with animals. As far as *Islam* is concerned, non-*Muslims* can be harmed or killed with impunity for any reason or no reason, as long as it helps *Islam* in some way. And if it does not help *Islam*, it is easily excusable if the act somehow damaged another faith. Here are a few examples:

☛ In 2006, a Turkish *Muslim* entered a Catholic church and tried to stab the priest and some parishioners. As he charged at a priest with a 30-inch long butcher's knife, he said:

You are not a human being! I will violate your mother, your sisters, your children.<sup>1413</sup>

☛ In 2006, UK *Imam* Omar Brooks, aka *Abu Izzadeen*, "makes fun of non-*Muslims* as 'animals' and 'cowards,'" so naturally he said that the 7/7 (2005) London subway and bus bombers were "completely praiseworthy."<sup>1414</sup>

<sup>1412</sup> "Palestinian Legislative Council Member *Umm Nidal Farhat*: If Someone Is Destined to Die, He Will Die Even If He Hides in a Crate, But Why..." MEMRItv.org, Clip #1066, 19 Feb 2006.

<sup>1413</sup> "Intruder threatens catholic priests and youths," compassdirect.org, 16 Mar 2006, *DW*.

<sup>1414</sup> "Joking *Muslim* cleric mocks victims of London blasts," *The Sunday Times*, timesonline.co.uk, 9 Jul 2006, *JW*.

- ⊙ Delwar Hossain Sayeedi is a *Bangladeshi* parliamentarian who was invited to speak in the East London *Mosque* in 2006 despite the objections of many UK non-*Muslims*. Mockbul Ali, the UK Foreign Office's Islamic issues adviser, said that Sayeedi "has a very big following in the mainstream British *Bangladeshi Muslim* community and is viewed as a **mainstream Muslim** figure" even though Sayeedi compared *Bangladeshi Hindus* "to excrement" and defended attacks on the *Ahmadiya (Islamist)* community.<sup>1415</sup>
- ⊙ In 2006, *Iraqi Jihadists* "We announce the good news to our *Islamic* nation that we executed God's will and slaughtered the two crusader **animals** we had in captivity." Since the *Jihadists* did not view the soldiers as human, their dead bodies were not accorded any respect and they were desecrated so much that "visual identification was impossible."<sup>1416</sup>
- ⊙ Bat Yeor wrote that because non-*Muslims* are dehumanized, *Muslims* deem it "just" for millions of lives to be destroyed in the cause of *Jihad*:

*Dhimmitude* can be considered tolerant only through the **dehumanization** of millions of non-*Muslims*...Because such a system has been cloaked in 'justness,' today the lives of Jews, Christians, *Hindus* and others are held so cheap that they can be dispensed with by the thousands in *Israel*, America, Russia, *Sudan*, *Kashmir*, Indonesia and elsewhere; it is under the excuse of *Jihad* that such crimes against humanity are perpetrated with impunity.<sup>1417</sup>

- ⊙ Infidels are treated like some treat sheep and goats. Murray & Roscoe wrote: Some [*Muslims*] (such as [the poet] *Abu Nuwas* [died 195 AH/810 AD] and the [*Madinan*] jurists of the *Maliki* school) rationalized the practice of making non-believers [men and women] submit to penetration [sodomizing] by believers [*Muslims*] as a means of glorifying the superiority of *Islam*—a duty for *Muslims* rather than as a sin.<sup>1418</sup>

Because of *Muhammad's* low view of infidels, he threw dozens of dead infidels into a well after the Battle at *Badr* rather than give them a proper burial.<sup>1419</sup> He also built his first *Mosque* over a pagan cemetery in *Madina* even though there was plenty of open land around *Madina*.<sup>1420</sup>

Considering *Muhammad's* teachings about infidels, it is not surprising that...

...*Saudi* Arabia doesn't permit infidel funerals (*Saudis* have been known to dump unclaimed corpses into the sea).<sup>1421</sup>

Given *Koranic* teaching, it is not surprising that *Iranian* Supreme Leader Ayatollah Ali Khamenei said that non-*Muslims* "cannot be called human beings but are animals who roam the earth and engage in corruption."<sup>1422</sup> This description makes non-*Muslims* liable to be killed under *K* 005:032 where "spreading corruption in the land" is deemed a capital offense (see the *Lex Talionis* section of this *Khidr-*

<sup>1415</sup> Ford, Richard, Nicola Woolcock & Sean O'Neill. "Islamist hardliner heads for Britain," *The Times*, timesonline.co.uk, 14 Jul 2006, *DW*, dailyablution.blogs.com.

<sup>1416</sup> "U.S. soldiers' bodies mutilated, booby-trapped," *cnn.com*, 20 Jun 2006, hotair.com.

<sup>1417</sup> Yeor, Bat. "Eurabia: The road to Munich," *NRO*, 9 Oct 2002.

<sup>1418</sup> Murray. *Culture*, p. 304.

<sup>1419</sup> *Sahih Muslim*, bk. 40, no. 6869.

<sup>1420</sup> *Bukhari*, vol. 1, bk. 8, no. 420; vol. 3, bk. 30, no. 92; vol. 5, bk. 58, no. 269.

<sup>1421</sup> Chafets, Zev. "The only good infidel is a dead infidel," *jewishworldreview.com*, 10 Jun 2004.

<sup>1422</sup> "Iran's *Mejlis* parliament in *Tehran*," *Adnkronos International*, adnki.com, 28 Nov 2005, *DW*.



Second Lamech table). When a Zoroastrian member of parliament objected to the dehumanizing stereotyping, he was charged with slander by *Iran's* Revolutionary Tribunal.<sup>1423</sup> Similarly, the Web site of the *Imam Reza Mosque* in Berlin...

...praised the attacks of Sept. 11, designated women as second-class human beings and referred to gays and lesbians as animals.<sup>1424</sup>

Given *Koranic* teaching, it is not surprising that calls for extermination of Jews are broadcast from the temple mount and over the airwaves:

In [an] *Al-Aqsa* Friday sermon of unprecedented anti-Jewish virulence, *Muslim* preacher referred to Jews as ‘sons of monkeys and pigs’ [K 002:065-066; 005:060; 007:166] and ‘murderers of prophets.’ Loudspeakers [on *Minarets*] boomed across Jerusalem’s Old City with his message condemning the Jews to ‘total extinction.’ *DebkaFile*’s sources affirm [that] Arafat signs off on all temple mount sermons before delivery.<sup>1425</sup>

Calls for the extermination of Jews and subjugation of Christians go out on Palestinian Authority (PA) TV every so often.<sup>1426 1427</sup> One cannot say that this is just blustery rhetoric since one suicide-bomber who killed two policemen in 2004 was a beautiful hostess on a children’s PA TV show in *Shechem*.<sup>1428</sup>

In 2006 when Bird Flu came to Israel, an imam at the popular *Al-Tadwa Mosque* in *Beit Lahia* north of *Gaza City*, *Sheikh Abu Muhammad*, said that *Allah* “hit the Israelis with birds” because they were “the worst of humanity.” The *Imam* cited how *Allah* supposedly sent birds to attack Abrahah’s Christian army from *Yemen* when it tried to attack *Mekka* sometime before *Muhammad* was born (K 105:003). The *Imam* also asked his congregants to “pray for *Allah* to dry out the sexual organs of the Jews with a disease so they won’t be able to reproduce anymore.”<sup>1429</sup>

*Palestinian Media Watch* and other terror watching entities document how PA TV has all sorts of shows, even children’s with talking cartoon animals, and teenager shows with MTV-style song and dance, that promote massacres of non-*Muslims* even if they only chopped down a tree or two.<sup>1430</sup>

*Muhammad* said that no “unclean” person or thing ought to touch the *Koran* (*Yusuf Ali* K 056:079). Even devout *Muslims* must wash before prayers and before handling a *Koran* (K 004:043; 005:006). *Muslims* who refuse to go on *Jihad* are considered “unclean” hypocrites (Pickthall, Shakir, Rodwell K 009:095).

*Islamists* consider infidels to be “filthy” or “unclean” (*Najis*) (K 009:028).<sup>1431</sup>  
<sup>1432 1433</sup> Germans and *Muslims* who follow German customs are considered “unclean.”<sup>1434</sup> In accordance with K 056:079 which says the unclean ought not touch

<sup>1423</sup> “*Iran's* *Mejlis* parliament in *Tehran*,” *Adnkronos International*, adnki.com, 28 Nov 2005, *DW*.

<sup>1424</sup> Schneider, Peter. “The New Berlin Wall,” translated by Philip Boehm, nytimes, 4 Dec 2005.

<sup>1425</sup> Headlines, *DebkaFile*, debka.com, 12 Mar 2004; cross-posted at *IsraPundit*.

<sup>1426</sup> Spencer. “Twice in three days on PA TV: PA religious leaders call for genocide of Jews,” *JW*, 14 Sep 2004, Palestinian Media Watch, pmw.org.il.

<sup>1427</sup> Marcus, Itamar & Barbara Crook. “Palestinian Authority TV Sermon: Extermination of Jews and Subjugation of Christians—Inevitable Goal of History” pmw.org.il, 16 May 2005.

<sup>1428</sup> “Suicide-bomber Was Children’s TV Show Hostess,” ArutzSheva.com, 23 Sep 2004, *LGF*.

<sup>1429</sup> “Dry out sex organs of Jews, asks prayer...,” WND.net, 20 Mar 2006, israellycool.com, *DW*.

<sup>1430</sup> Marcus, Itamar & Barbara Crook. “Talking animal promotes massacre with AK-47 [rifle] on PA TV program for Palestinian children,” pmw.org.il, 25 Oct 2004, *JW*.

<sup>1431</sup> Sina, Ali. “The Fall of Europe,” faithfreedom.org, 25 May 2005, *DW*.

<sup>1432</sup> Bostom, Andrew. “The Yellow Badge of Denial,” americanthinker.com, 23 May 2006.

<sup>1433</sup> “*Iran* leader’s aide: Jews are filthy,” ynetnews.com, 8 Jun 2006, hotair.com.

<sup>1434</sup> Schneider, Peter. “The New Berlin Wall,” translated by Philip Boehm, nytimes, 4 Dec 2005.

a *Koran*, *Muslim* inmates sometimes become dangerously unruly when their *Korans* are handled by guards, unless they happen to be wearing clean white gloves.<sup>1435</sup>

According to orthodox *Islam*, the only thing that raises a non-*Muslim*'s worth beyond that of "despised and rejected apes" is a person's adherence to the creed of *Islam* (*K* 007:166). As one *Imam*, Syrian-born *Muslim* cleric Omar Bakri Mohammed, phrased it:

We don't make a distinction between civilians and non-civilians, innocents and non-innocents. Only between *Muslims* and unbelievers. And the life of an unbeliever has no value. It has no sanctity.<sup>1436</sup>

The *Koran*, *Hadith* and *Sira* condition *Muslims* to hate, ethnically cleanse and commit genocide by equating infidels with "unclean" animals that have historically been systematically tortured and exterminated throughout *Islamdom*:

In *Sharifabad* the dogs distinguished clearly between *Muslim* and Zoroastrian and...would flee as before Satan from a group of *Muslim* boys...*Muslims* found a double satisfaction in tormenting dogs, since they were thereby both afflicting an unclean creature and causing distress to the infidel [Zoroastrianism] who cherished him. There are grim...stories from the time (i.e. into the latter half of the 19<sup>th</sup> century) when the annual poll-tax (*Jizya*) was exacted, of the tax gatherer tying a Zoroastrian and a dog together and flogging both alternately until the money was somehow forthcoming or death released them.<sup>1437</sup>

A main reason that *Muhammad* and many *Muslims* are dog- and guide-dog-for-the-blind-o-phobes<sup>1438</sup> and pig- and cartoon-pig-o-phobes<sup>1439</sup> is: dogs bark and attack lurking terrorists and *Jihadists* who ambush or sneak up on infidels (*K* 009:005). Pigs are a convenient source of food for infidels, especially during the lean times of *Jihad* campaigns and sieges.<sup>1440</sup> Furthermore, *Muslims* are miffed that wild dogs are more welcome among infidels than *Islamists* are. A *Muslim* said about the *Israeli* separation wall:

Dogs can pass to Jerusalem but not us. How can we remember with anything but animosity and hatred?<sup>1441</sup>

Robert Spencer commented "Well, dogs don't tend to blow up as many civilians."

*Muslims* see that unclean dogs are "best friends" to infidels while *Muslims* tend to be infidel-o-phobes and Jew-o-phobes:

• A 2006 Pew survey showed that "publics in largely *Muslim* countries generally view Westerners as violent and immoral."<sup>1442</sup>

• The old anti-Semitic tract *The Protocols of the Elders of Zion* is a best-seller in *Islamdom*, and a 2006 Pew survey found that "In the *Muslim* world,

<sup>1435</sup> West, Diana. "Gonzo *Gitmo* charade," washingtontimes.com, 10 Jun 2005, *DW*.

<sup>1436</sup> "Militant Cleric Says Attack on London 'Inevitable,'" *Yahoo News!*, 18 Apr 2004, *LGF*.

<sup>1437</sup> Boyce, M. A Persian Stronghold, pp. 141-142, as quoted by Bostom, Andrew G. "The Real Roots of *Muslim* Hatred," *FPM*, 3 Jun 2004.

<sup>1438</sup> Pipes, Daniel. "*Muslims*, CAIR, and the Guide Dog Problem," *DP*, 14 Nov 2005.

<sup>1439</sup> "Piglet keeps Pooh off air," news.com.au, 17 Jun 2006, *LGF*, *DW*.

<sup>1440</sup> "*Gedud Haivri* K-9," defendisrael.net, *C&R*, 22 Oct 2005.

<sup>1441</sup> Quetteville, Harry De. "Ailing leader draws no sympathy from across the barrier," smh.com.au, 8 Jan 2006, *JW*.

<sup>1442</sup> "Great Divide: How Westerners and *Muslims* View Each Other," pewglobal.org, 22 Jun 2006.

attitudes toward Jews remain starkly negative, including virtually unanimous unfavorable ratings of 98 percent in Jordan and 97 percent in Egypt.”<sup>1443</sup>

*Muslims* often call Christians “(Sons of) dogs,” *Shias* “*Rafidite* dogs” and Jews “(Sons of) apes, pigs and swine.” *Muslim* Khaled Kishtainy describes the attitude of many *Muslims*:

Most of the people we contacted [in the UK] were of the opinion that the Westerners are sons of dogs who understand only force and that the *Muslims* have no choice but to strap on their weapon and fight.<sup>1444</sup>

The *Koran* says any person who disregards *Allah*’s revelations and is seduced by Satan is a dog (*K* 007:175-176). Ameer Ali wrote “Christian dog...was the designation usually given to the Byzantine emperors by the early *Muslims*.”<sup>1445</sup> *Muslims* attacked the Byzantine Empire constantly and beheaded the last Byzantine emperor.

Even today, *Muslims* call the persons they would attack “dogs.” For instance:

C *Muslims* continue to call Western leaders “dogs.”<sup>1446</sup> Terrorists call US President Bush a “dog” and “the dog who is the son of all dogs.”<sup>1447</sup> The *Imam* of Omar *Al Mukhtar Mosque* in Baghdad said “That dog Bush goes out with his dog. He pets the dog and says to the nation, the *Muslims* and the whole world: ‘My dog is better than the whole world.’ And they all applaud him...I say to the *Iraqis* whoever cannot slaughter (a sheep) on the Feast of Sacrifice, should take an American soldier and slaughter him.”<sup>1448</sup>

C “‘Go to hell, enemy of God!’ shouted the man, Rabei Osman Sayed Ahmed, as Mr. [Nick] Berg’s screams were broadcast [as he was beheaded]. ‘Kill him! Kill him! Yes, like that! Cut his throat properly. Cut his head off! If I had been there, I would have burned him to make him already feel what hell was like. Cut off his head! God is great! God is great!’...‘We hope that even their parents will come to the same end. **Dogs**, all of them, all of them. You simply need to be convinced when you make the decision.’”<sup>1449</sup>

C In 2005 a *Pakistani* Christian man won money gambling with *Muslims* who were sore losers. Rather than pay, they spread the rumor that the winner had burned a “*Koran Mahal*, a box for preserving torn pages of the *Koran*.” 2,000 *Muslims* then came on buses to *Sangla Hill* in the *Nankana* district of *Punjab* in *Pakistan* and ransacked and burned three churches, two schools and a convent, parsonages and Christian homes.<sup>1450</sup> A Catholic parish priest said:

I heard the *Mullahs* had been telling people over loudspeakers, ‘We are guardians of the *Koran* and it is our foremost duty to teach a lesson to those *Kafirs* [i.e. infidels],’ he said. ‘Then they came to my door’...They shouted

<sup>1443</sup> “Great Divide: How Westerners and *Muslims* View Each Other,” [pewglobal.org](http://pewglobal.org), 22 Jun 2006.

<sup>1444</sup> “Arab Liberal [Khaled Kishtainy]: Most *Islamic* Ideologues, Organization Leaders Advocate Violence,” *MEMRI*, no. 696, 16 Apr 2004.

<sup>1445</sup> Ali, Syed Ameer. *The Spirit of Islam: A History of the Evolution and Ideals of Islam with a Life of the Prophet*. Low Price Publications, Delhi, 1923, p. 279+fn. 1.

<sup>1446</sup> “Police find videotape with terror threats to Rome,” [smh.com.au](http://smh.com.au), 2 Apr 2004.

<sup>1447</sup> Sciolin, Oelaine. “From Tapes, a Chilling Voice of *Islamic* Radicalism in Europe,” [nytimes.com](http://nytimes.com), 18 Nov 2005.

<sup>1448</sup> “*Iraqi Sunni Imam* Tells of Tortures and Calls on *Iraqis* to Slaughter American Soldiers for the *Muslim* Holiday,” *MEMRI*, 22 Nov 2005, Clip No. 937, *JW*.

<sup>1449</sup> Sciolin, Oelaine. “From Tapes, a Chilling Voice of *Islamic* Radicalism in..” *Ibid*.

<sup>1450</sup> “Anti-Christian rampage features 2,000 *Muslims*,” *WND*, 13 Nov 2005, *DW*.

insults at the Christians, calling them *Kafirs* and ***Chucha*** [Spanish-origin word meaning “**dog**”], the abusive term for non-*Muslims* and untouchables, and ***Kuta*** which means ‘**dogs**’.<sup>1451</sup>

Weeks later during Friday prayers at the *Jamia Masjid Rizvia Mosque* in *Sangla Hill*, *Muslim* leaders called for the hanging of an accused *Koran* burner and also “They urged *Muslims* to unite for the honour and integrity of *Islam* and eliminate Christians.”<sup>1452</sup>

*Muhammad* commanded the killing of most dogs (*Sahih Bukhari*, vol. 4, bk. 54, no. 540; *Sahih Muslim*, bk. 10, nos. 3809-3814; *Sunan Abu Dawud*, bk.16, no. 2839), except those few dogs used for hunting and watching fields and flocks (*Sahih Muslim*, bk. 10, nos. 3815-3824, 3827-3828). Thus it is not surprising to read that in Turkey in 2006 it was reported:

Pro-*Islamic* municipalities in Turkey are killing stray dogs, animal rights groups claim. Municipal workers are hunting, torturing and killing the animals by the hundreds...There is a myth among pious *Muslims* that dogs are unclean.<sup>1453</sup>

*Muhammad* taught that at least six animals ought to be killed on sight because they were “mischief-makers”: the mouse, the scorpion, the kite [a hawk], the crow, the dog and the salamander (*Sahih Bukhari*, vol. 3, bk. 29, nos. 55, 57; vol. 4, bk. 54, nos. 525-527, 532; vol. 4, bk. 55, no. 579).

*Muhammad* said that toward the end of the world...

Jesus...He will descend (to the earth)...[and] He will fight the people for the cause of *Islam*. He will break the cross [i.e. end Christianity], kill swine [i.e. Jews (*K* 002:065-066; 005:060; 007:166)]...<sup>1454</sup>

Because Americans are seen as helping the Jews, *Islamists* consider Americans to be “pigs” too even though *Islamists* customarily reserve that term for Jews. Ertugul Orel is a *Muslim* in his eighties and he owns a sidewalk I outside Istanbul’s *Hagia Sophia*. He probably has heard many *Imams*’ sermons. Orel said after Gulf War II:

To tell you the truth, I do not see even see them as humans anymore. America is a pig.<sup>1455</sup>

An entry in the popular collection of traditions called the *Mishkat Al Masabih* has *Muhammad* saying that *Muslims* would be able to skip Purgatory<sup>1456</sup> and gain immediate entrance into heaven if they only killed a Jew or Christian:

When judgment day arrives, *Allah* will give every *Muslim* a Jew or Christian to kill so that the *Muslim* will not enter into hellfire.<sup>1457</sup>

<sup>1451</sup> Wilkinson, Isambard. “Christians under siege in *Pakistan* after riot,” telegraph.co.uk, 14 Nov 2005, *JW*.

<sup>1452</sup> Jacob, Peter. “*Pakistan*: *Muslim* extremists want to eliminate Christians from *Sangla Hill*,” asianews.it, 5 Dec 2005, *C&R*.

<sup>1453</sup> Zaman, Amberin. “*Muslims* are accused of killing ‘unclean’ dogs,” telegraph.co.uk, 27 Mar 2006, *DW*.

<sup>1454</sup> *Sunan Abu-Dawud*, “Bk. 37: Battles (*Kitab Al Malahim*),” no. 4310. See also *Sahih Bukhari*, vol. 3, bk. 34, no. 425; vol. 3, bk. 43, no. 656; vol. 4, bk. 55, no. 657; *Sahih Muslim*, bk. 001, nos. 0287, 0289.

<sup>1455</sup> Vick, Karl. “Restoration of Caliphate resonates with mainstream *Muslims*,” washingtonpost.com, 14 Jan 2006, *DW*.

<sup>1456</sup> See the Glossary for information on *Islam*’s version of Purgatory.

<sup>1457</sup> *Mishkat Al Masabih* (also spelled *Messabih*), vol. 2, no. 5552, as quoted by Robert Spencer in Glazov, Jamie. “Symposium: *Islamic* anti-Semitism,” *FPM*, 31 Oct 2003.

Most non-*Muslims* have no idea how revolting *Islamists* find pigs, nor do they know that *Islamists* think that people who eat pork and ham are in some sense dehumanized. The *Birmingham Mail* reported:

Disgusted *Muslim* prisoners at a Midland jail are boycotting meals after a rogue kitchen worker [a prisoner] was caught filling their *Halal* curries with unholy ham... Wasim Zafar ‘...was very depressed and had lost a lot of weight because he has not been eating much since he found out what had happened with the curries...He feels he can’t trust anyone again after finding out such a disgusting problem with the food.’ Wasim’s brother Anis said: ‘This is the ultimate insult to any *Muslim*. All the food we eat has to be blessed. This has really messed up the heads of anyone who ate the unholy meat. Religion is central to any *Muslims* life and this shows total disrespect to our religion.’ [Wasim’s brother Anis also said that] *Islam* decrees that followers cannot eat **meat from a pig as it creates ‘lowliness in character and destroys moral and spiritual faculties in a man.’**<sup>1458</sup>

Since *Muslims* are so virulently against dogs and pigs, and *Islamic* literature calls Christians and *Shias* dogs, and Jews pigs, and speaks of genocides of Jews and Christians, it is disturbing that many *Muslims* cannot even countenance the presence of piggy-banks, pig and dog knickknacks, novelty items and *kitsch*.<sup>1459 1460</sup>

What is disturbing is that many infidels accommodate *Muslim* “sensitivities” that ultimately are detrimental to the livelihood and well-being of infidels:

- Ⓒ Images, and pig and dog novelty items, have been removed from public view.<sup>1461</sup>
- Ⓒ *Islamic Mosques*, charities and schools that teach from texts that read for instance, that infidels are “filth,” are tax-exempt, receive grants and subsidies from the government and their donors receive credit (i.e., can take a deduction) on their income tax.<sup>1462</sup>
- Ⓒ If a soldier converts to *Islam*, at least on paper, he often receives a generous cash allowance (*per diem* separate rations) in lieu of cafeteria food. Not only does this make maintain a military more expensive but the military must assign more *Muslim* chaplains and build more *Mosques* for their “growing” *Muslim* population. These chaplains then evangelize and thereby further undermine the infidels’ military.<sup>1463</sup>
- Ⓒ Soup kitchens for the homeless are pressured into only serving costly *Halal* food to avoid accusations that they are insensitive to others’ cultural norms and discriminate based on race or religion.<sup>1464 1465</sup>
- Ⓒ Prisons offer *Muslims* more expensive, and often better-quality, *Halal* food compared to their regular food, thereby prompting prison “conversions” to

<sup>1458</sup> Smith, Adam. “*Muslim* fury over prison food,” *Birmingham Mail*, icbirmingham.icnetwork.co.uk , 2 Mar 2006, C&R.

<sup>1459</sup> “Piggy banks ‘offend UK *Muslims*,” 24 Oct 2005, theage.com.au, *DW*, *DP*, “*Islamist* Watch.”

<sup>1460</sup> Steyn, Mark. “Making a pig’s ear of defending democracy,” telegraph.co.uk, 4 Oct 2005.

<sup>1461</sup> Pipes, Daniel. “*Islam* Dispatches Santa, the Bible, and Winnie the Pooh [& Piglet],” *DP*, 3 Oct 2005; also Pipes, Daniel. “Away with Crucifixes, Crosses, and Christmas,” *DP*, 6 Dec 2005.

<sup>1462</sup> Pipes, Daniel. “Subsidizing the Enemy,” *DP*, 28 Apr 2006.

<sup>1463</sup> Sperry, Paul. “U.S. Marines Build Shrine To *Islam*,” *FPM*, 13 Jun 2006.

<sup>1464</sup> “French crackdown on ‘racist soup,’” news.bbc.co.uk, 25 Jan 2006, *DW*.

<sup>1465</sup> Smith, Craig. “Soup Kitchen Is Not for You,” nytimes.com, 28 Feb 2006.

*Islam*.<sup>1466</sup> Then the prison administration assigns more *Muslim* chaplains for their “growing” *Muslim* population, and these chaplains evangelize and spread *PrIslam*, thereby undermining the infidel society. Moreover, those who fraudulently “convert” to *Islam* may be considered apostates liable to be killed, a high price to pay for a couple months of better food. For instance:

- ★ Rock star Ian Brown served two months in a Manchester, England jail in 1999, and declared himself *Muslim* in order to get better food.<sup>1467</sup>
- ★ Reporter David Cohen interviewed a south London member of the infamous “*Muslim* Boys” gang who converted for better prison food:

When I ask Winston whether he believes in *Islam*, he prevaricates. ‘Sort of,’ he says. ‘I converted when I was in prison. I found it relaxing, **we got better food**. Now we all go to mosque together. If I refuse, they blow [shoot] me...I pray twice a day: before I do crime, and after. I ask *Allah* for a blessing when I’m out on the street. Afterwards, I apologize to *Allah* for what I done.’<sup>1468</sup>

Western culture is succumbing to the same forces of cultural vandalism that doomed much figural art in the Mideast. (*Muhammad’s* teachings and example of destroying figural art and crosses and idols are found in the *Hadith*<sup>1469</sup>). Make no mistake about it—just as:

- ☉ The *Iranians* discussed obliterating the spectacular *Persepolis* ruins in 2006.<sup>1470</sup>
- ☉ The *Taliban* destroyed the pair of Giant *Buddha* statues at *Bamiyan*, Afghanistan in 2000.
- ☉ A *Sufi* damaged the face of the *Sphinx* in Egypt during medieval times.<sup>1471</sup>
- ☉ The Turks built a *Minaret* at the *Parthenon*, and turned the largely intact *Parthenon* into a *Mosque*, and also used the building a gunpowder magazine which blew up in 1687 destroying most of the building and statues.

So no pictorial art, including cartoons, ought to be considered safe from the iconoclast’s hand.

While the small acts of accommodation may seem meritorious at the time, they do:

- ☉ Kill the infidel culture by a thousand paper cuts, thus smoothing the path for *Jihad* and the imposition of *Sharia* law.
- ☉ Aid and abet the ongoing psychological conditioning of *Muslims* to commit ethnocide and genocide against infidels since, after all, infidels are as unclean (*Najis*) as the pigs (*K* 009:028).<sup>1472 1473</sup>

<sup>1466</sup> “...fresh meat slaughtered according to *Islamic* traditions had been too expensive and difficult to source,” *National Nine News*, ninemsn.com.au, 13 Jun 2006, *DW*.

<sup>1467</sup> “Brown’s *Islamic* Conversion,” pr-inside.com, 8 May 2006, *DW*.

<sup>1468</sup> Cohen, David. “The rise of the *Muslim* Boys,” *Evening Standard*, *This is London*, 3 Feb 2005.

<sup>1469</sup> *Muhammad’s* Iconoclasm: *Sahih Bukhari*, v. 3, bk. 34, no. 428; v. 4, bk. 54, nos. 447-449, 539; v. 4, bk. 55, no. 570; v. 5, bk. 59, no. 338; v. 9, bk. 87, no. 165; v. 7, bk. 72, nos. 834, 836, 843, 846; *Sahih Muslim*, bk. 24, nos. 5246-5254, 5266, 5272; *Sunan Abu Dawud*, bk. 1, no 227; bk. 4, no. 2115; bk 32, no. 4140.

<sup>1470</sup> Pipes, Daniel. “Destroy Egypt’s Antiquities?,” *DP*, 3 Apr 2006.

<sup>1471</sup> Haarmann, Ulrich. “Regional Sentiment in Medieval *Islamic* Egypt,” *Bulletin of the School of Oriental and African Studies*, 1980, 43:64, citing ibn ‘*Abd Al-Salam*, Fayd, folio 52a-b, myopticchurch.com, 2002.

<sup>1472</sup> Sina, Ali. “The Fall of Europe,” faithfreedom.org, 25 May 2005, *DW*.

<sup>1473</sup> Schneider, Peter. “The New Berlin Wall,” translated by Philip Boehm, nytimes, 4 Dec 2005.

*Islamists* often call those they wish to kill “dogs” and “pigs.” For instance:

- ☉ In 2006 in the West Bank, a 76-year-old Greek Orthodox monk and two nuns were harassed for over a decade. One day as the monk tended his olive trees, they beat him up and tore his clothes. He said:

They were ready to kill me. Then they put wire fencing around me and they said we’ll put the **pig** [referring to the monk] inside and we’ll kill him because **pigs** are not wanted on this land... [Then in late 2005] graphic drawings depicting nuns being raped were daubed on monastery property.<sup>1474</sup>

- ☉ A chilling book, *Shara’I’ al-Islam*, by Muhaqqiq *Al-Hilli* (1240-1326 AD), likens “unbelievers to filth...pigs and dogs,” so just as water runs down a hill, it “includes a chapter on *Jihad*, setting down the conditions under which *Muslims* are supposed to fight Jews and Christians.” Here are more extracts:
  - ★ “The water left over in the container after any type of animal has drunk from it is considered clean and pure apart from the left over of a dog, a pig and a disbeliever.”
  - ★ “There are ten [*sic*] types of filth and impurities: urine, faeces, semen, carrion, blood of carrion, dogs, pigs, disbelievers.”
  - ★ “When a dog, a pig or a disbeliever touches or comes in contact with the clothes or body [of a *Muslim*] while he [the disbeliever] is wet, it becomes obligatory—compulsory upon him [the *Muslim*] to wash and clean that part which came in contact with the disbeliever.”<sup>1475</sup>

The *Koran’s* declaring non-*Muslims* unclean or impure affects *Muslim*-infidel relations in Europe, as *The Christian Science Monitor* reported:

A government report leaked last March depicted an increasingly two-track educational system: More and more *Muslim* students refuse to sing, dance, participate in sports, sketch a face or play an instrument. They won’t draw a right angle (it looks like part of the Christian cross). They won’t read Voltaire and Rousseau (too anti-religion), *Cyrano de Bergerac* (too racy), *Madame Bovary* (too pro-women) or *Chrétien de Troyes* (too *chrétien*). One school has separate toilets for ‘*Muslims*’ and ‘Frenchmen;’ another obeyed a *Muslim* leader’s call for separate locker rooms because ‘**the circumcised should not have to undress alongside the impure** [infidel Frenchmen].’<sup>1476</sup>

In one Berlin *Hauptschule* called Ruetli, a school for students 11 to 15 years old, “knife fights are common” and Arab immigrants (35 percent) rule the roost over Turks (26 percent) and Germans (17 percent). “The few German students—commonly called ‘pig-meat eaters’—try not to call on any attention to themselves, the teacher said.”<sup>1477</sup> A foreign student at the school said the German students were paying *Jizya*. *Expatica* reported:

The German (students) brown nose us, pay for things for us and stuff like that, so that we don’t smash in their faces.<sup>1478</sup>

<sup>1474</sup> Goldin, Megan. “Holy Land’s Christians caught in midst of conflict,” news.yahoo.com, 11 Apr 2006, *DW*.

<sup>1475</sup> O’Neill, Sean. “*Muslim* students ‘being taught to despise unbelievers as filth,’” timesonline.co.uk, 20 Apr 2006, *JW*, jawareport.

<sup>1476</sup> Bawer, Bruce. “Not all *Muslims* want to integrate,” *The Christian Science Monitor*, csmonitor.com, 17 Nov 2005, *DW*.

<sup>1477</sup> “German school ‘breeds terrorists,’” United Press International, upi.com, 30 Mar 2006.

<sup>1478</sup> “Police brought in as teachers lose control at Berlin school,” expatica.com, 31 Mar 2006, *JW*.

When reporters went to school on Thursday they were pelted with paving stones by masked youths from the schoolyard as the district's mayor stood helplessly at the entrance of the building.<sup>1479</sup>

The *BBC* reported similarly about the UK:

Sir Iqbal [head of the *Muslim Council of Britain (MCB)*] refused to disown a group known as *Al-e-Hadith*, which says the ways of Christians and Jews 'are based on sick or deviant views' and that 'imitating the *Kuffar* [non-Muslims] leads to a permanent abode in hellfire.'<sup>1480</sup>

The *Koran's* dehumanization of non-Muslims explains why graphic movies of infidels being beheaded or shot and quivering as they die, such as *Russian Hell 2000*, do not evoke revulsion or sympathy for *Jihad's* victims but "are used for recruitment and fund raising for terrorism."<sup>1481</sup>

The *Koran's* dehumanization of non-Muslims explains why *Jihadists* are motivated to continue their struggle by watching videos in the same genre as *Russian Hell 2000*, as *The New York Times* reported:

When his spirits flag, Mr. Siddique bolsters his morale by watching 'vids,' apparently videos or DVD's from the 'bros' [brothers (pr. Broze)] in *Iraq*.<sup>1482</sup>

In contrast to the moon-god *Allah*, *Yahveh* expects all humans to respect each other, regardless of differing belief systems, for the simple reason that all humans are made in the image of God (Gen 01:26-27; 05:01-02; 09:06; 1Co 11:07; Jam 03:09).

The fact that Jews are called "pigs" is an important factor in conditioning suicide-bombers for their mission, as Pierre Rehov reported:

From what I heard directly from many aspiring to *Shahada* (martyrdom) that I interviewed in prison and in the streets of some Palestinian towns and villages, you do not start thinking about becoming a suicide killer in reaction to an *Israeli* tank. The idea starts in the *Mosque*. Yes, where every Friday most *Imams* mix up religious and political sermons, where they say that the Jews are the descendants of Apes and Pigs, deserving no mercy after having betrayed God himself and killed most of the Prophets. And next, the idea is further advanced by Palestinian television where those sermons are mixed up with video clips showing *Israeli* soldiers raping Palestinian women and targeting children. And where numerous programs stage 'martyrs' talking from heaven about the delights of the afterlife and of the 72 virgins waiting for *Allah's* good servants. And then later in the streets, the kids who have been poisoned against the Jews in the mosques and on television, play 'martyrs and Jewish pigs' the same way western kids play cowboys and Indians.<sup>1483</sup>

While the foregoing spoke of how the *Koran* relegates unbelievers to the animal world, the *Koran* also says that hypocritical *Muslims* were mere firewood for Hell that happened to be clad with garments—even when they were alive (*K* 063:004). Apostates from *Islam* (*K* 003:010) and idolaters are also firewood for Hell (*K* 021:098; 072:015). Interestingly, *K* 008:037 says that *Allah* will stack the wicked

<sup>1479</sup> "Police brought in as teachers lose control at Berlin school," expatica.com, 31 Mar 2006, *JW*.

<sup>1480</sup> "Muslim leaders 'in denial' claim," news.bbc.co.uk, 21 Aug 2005, *DW*.

<sup>1481</sup> Russell, Betsy Z. "Al Qaeda recruits say images on Web sites part of allure," spokesmanreview.com, 21 May 2004.

<sup>1482</sup> Rohde, David & Mohammed Khan. "Ex-Londoner's Diary of Jihad: A Portrait Sprinkled With *Koran* Verses and Epithets," nytimes.com, 8 Aug 2005.

<sup>1483</sup> Rehov, Pierre. "What Paradise?," *FPM*, 16 Nov 2005, *DW*.



upon each other before throwing them into Hell. These dehumanizing verses may have inspired *Muslims* to stack dead infidels up like cordwood, as Goel wrote:

Babur [1519-1530 AD] shared a hobby with his ancestor, Timur [1398-1399 AD]. Both of them were mighty fond of raising towers of severed *Hindu* heads.<sup>1484</sup>

Similarly, as late as 1809 AD the Turks made a three-meter high tower called the Castle of Cegar (*Cele Kula*), or “Skull Tower,” using 952 *Serbian* heads.<sup>1485</sup>

**Ingredient 26 (Infidels Are of the Devil’s Party):** *Muhammad* taught that all people were born *Muslim* but their parents raise them as Jews or Christians.<sup>1486</sup> This is why all non-*Muslims* are called infidels, a word meaning “not faithful.” That all infants were once *Muslims* is why *Muslims* prefer the phrase “revert to *Islam*” rather than “convert to *Islam*.”

The *Koran* says unbelievers are of the devil’s party and infidels fight for idols (*K* 004:076, 119; 016:098-100; 034:020; 058:019), so it is not surprising that...

...In both 850 and 907/908 AD, the *Abbasid Caliphs Al-Mutawwakil* and *Al-Muqtadir*, respectively, decreed that Jews and Christians either attach wooden images (*Al-Mutawwakil*) or drawings (*Al-Muqtadir*) of devils to the doors of their homes to distinguish them from the homes of *Muslims*,<sup>1487</sup>

The *Andalusian Maliki* jurist *Ibn Abdun* (died 1134 AD) ruled ~1100 AD that:

In effect, ‘Satan has gained possession of them and caused them to forget God’s warning. They are the confederates of Satan’s party; Satan’s confederates will surely be the losers!’ [*Dawood K* 058:019]). A distinctive sign must be imposed upon them in order that they may be recognized and this will be for them a form of disgrace.<sup>1488</sup>

**Ingredient 27 (Jihadists are Allah’s Grim Reapers):** Non-*Muslims* are cursed (*K* 002:088-089, 159; 004:047; 005:064, 078). The *Koran* states in thirty-six verses that non-*Muslims* are losers.<sup>1489</sup>

Not only did *Muhammad* say that unbelievers do not succeed (*K* 040:056), he said they **never** succeed.<sup>1490</sup> *Muslims* by contrast are winners who succeed, according to the *Koran*.<sup>1491</sup> *Allah* will make *Muslims* master unbelievers in battle eventually (*K* 003:139-140) and will make *Islam* triumph over all other religions

<sup>1484</sup> Goel. *Calcutta*, ch. 6.

<sup>1485</sup> “*Islamic Conflict in the Balkans*,” [freesrpska.org/en/prevare/Islam.html](http://freesrpska.org/en/prevare/Islam.html); also Nationmaster.com Encyclopedia, “Skull Tower” entry, accessed 26 Jul 2004.

<sup>1486</sup> *K* 030:030; *Sahih Bukhari*, vol. 2, bk. 23, nos. 440, 441 & 467; *Sahih Muslim*, vol. 4, ch. 1107, nos. 6423 & 6426; Year. *Dhimmi*, p. 75, fn. 31.

<sup>1487</sup> Tabari (died 923 AD), cited in Ye’or, *Dhimmi*, p. 186; Ibn Al-Jawzi, cited in Gil, *A History of Palestine*, p. 159, note 32, as quoted in Bostom, Andrew G. “*Jihad* begot the Crusades,” [americanthinker.com](http://americanthinker.com), 5 May 2005.

<sup>1488</sup> Bostom, Andrew G. “*Eurabia’s Morass Elicits Mythical ‘Solutions’*,” [americanthinker.com](http://americanthinker.com), 24 Nov 2005.

<sup>1489</sup> 36 verses mentioning unbelievers as “losers”: *K* 002:027, 064, 121; 003:085, 149; 005:005, 021, 030, 053; 006:031; 007:023, 090, 092, 149, 178; 008:037; 009:069; 010:095; 011:022, 047; 012:014; 016:109; 018:103; 021:070; 023:034; 027:005; 029:052; 039:015, 063, 065; 041:025; 042:045; 046:018; 047:003; 058:019; 063:009.

<sup>1490</sup> Non-*Muslims* never succeed: *K* 006:021, 135; 010:017, 069; 012:023; 016:116; 018:020; 023:117; 028:037; 028:082.

<sup>1491</sup> *Muslims* succeed: *K* 002:189; 003:130, 200; 005:035, 090, 100; 007:069; 008:045; 022:077; 024:031; 062:010; 064:016.

though non-*Muslims* resist (K 003:139; 005:056; 008:030; 009:029, 033; 048:028; 061:009).

*Allah* gives power to the “true” believers (K 061:014), who are *Allah*’s agents of wrath against unbelievers who send infidels to their fated destiny in hell:

- ☉ “I will instill terror into the hearts of the unbelievers, smite above their necks and smite all their finger-tips off them This because they contended against God and His Apostle: If any contend against God and His Apostle, God is strict in punishment....**It is not you who slew them; it was Allah**” (K 008:012-013, 017).
- ☉ “Fight (kill) them (non-*Muslims*) and **Allah will punish (torment) them by your hands** and cover them with shame” (K 009:014).
- ☉ “**Allah will afflict you** [non-*Muslims*] **with a doom** from Him or **at our hands**” (K 009:052).
- ☉ “O you who believe! Fight those of the disbelievers who are close to you and let them find harshness in you, and **know that Allah is with those who are the pious**” (K 009:123).
- ☉ “Oh *Muslims*, whether you cut down the tender palm-trees or you left them standing on their roots, **it was by leave of God** and in order that He might cover with shame the rebellious transgressors” (K 059:005).

So, not only do *Muslims* “hate for the sake of *Allah*” (*Sahih Muslim*, bk. 40, no. 4582) but they think that *Allah* fights through *Muslims*.

Terrorists allude to or quote the above verses often, for instance:

- ☉ Ayman *Al-Zawahiri*, the No. 2 man in *Al-Qaeda*, said:

The Arabic language television network *Al-Jazeera* aired on Friday portions of the video by Ayman *Al-Zawahiri*, the No. 2 man in *Al-Qaeda*, ‘Reform and expulsion of the invaders out of the *Muslim* land will only be accomplished by fighting for the sake of God’...He then cited a *Koranic* verse: ‘God said fight them and God will torture them through your hands’ [K 009:014].<sup>1492</sup>

- ☉ Bouyeri, the killer of moviemaker Theo van Gogh, said during his trial: ‘Kill them. Through your hands, *Allah* will punish them’ [allusion to K 009:014]...‘There is no room for ambiguity here,’ Bouyeri noted with satisfaction. “It all very clear, yes, very clear.”<sup>1493</sup>

Since *Allah* is working through his believers (K 008:017; 009:014) to accomplish his will (K 009:123; 059:005), *Muslims* feel they are absolved of any responsibility for their actions even if it results in the death of millions. For instance, after listing the names of pagans that *Muslims*—led by *Muhammad* himself—killed at the Battle of *Uhud*, *Muhammad*’s biographer Ibn Ishaq wrote:

Thus **God killed** on the day of *Uhud* 22 polytheists.<sup>1494</sup>

The belief in fate is why the *Muslim Sultan* Tipu (1753-1799 AD) could make

<sup>1492</sup> “Bin Laden deputy...message cites *Al-Qaeda*’s three pillars for reform,” cnn.tv, 18 Jun 2005.

<sup>1493</sup> Vermaat, Emerson. “Mohammed Bouyeri’s Day in Court,” *FPM*, 9 Feb 2006.

<sup>1494</sup> Ishaq. *Sirat*, p. 403.

<sup>1495</sup> Ghosh, A. “*Islam* in Action, I,” chapter 9, hinduunity.org, accessed 18 Jan 2005.

<sup>1496</sup> Pipes, Daniel. “Nothing succeeds like failure,” *DP*, 28 Feb 2001.

<sup>1497</sup> Ishaq. *Sirat*, p. 386.

<sup>1498</sup> Ghosh, A. “*Islam* in Action, I,” chapter 9, hinduunity.org, accessed 18 Jan 2005.

<sup>1499</sup> “*Hamas* identifies with and supports *Chechen* and international *Islamic* terrorism on CDs...” Intelligence and Terrorism Information at C.S.S., intelligence.org.il, Sep 2004.

his guilt-free boast even though he committed many war crimes during *Jihad*-inspired conquest:

I am the chosen servant of prophet *Muhammad*, predestined in the eternal book of fate to root out the infidels from India and cast them into the bottomless pit of hell.<sup>1495</sup>

Today's *Muslim* rulers use similar fatalistic logic to explain their failures and defeats at the hands of infidels and the *Muslim* populace readily accepts this explanation since it would be un-*Islamic* not to, as Daniel Pipes wrote:

Fatalism offers *Muslim* rulers a way to avoid blame. It was all in the cards, what could we do? As'ad *Abu Khalil* of California State University finds that in times of defeat, Arab leaders typically adopt an attitude that 'people have no influence or effect whatever on their actions and deeds. It is only God who acts.' Invoking 'the inescapability of destiny' absolves Arab regimes and armies from responsibility. This pattern, he correctly notes, 'has become typical to the point of predictability.'<sup>1496</sup>

*Muhammad* said that there were a fixed number of unbelievers (*K* 074:031). *Muslims* have been so heartened by the West's pending population implosion because they figure this trend cannot be arrested or reversed since the population is graying beyond the childbearing years. Killing an unbeliever is never counterproductive in **this** cosmic number game.

The infidels are considered firewood that will fuel hell's fires (*K* 003:010; 008:037; 021:098; 063:004; 072:015). *Muhammad* said that *Allah* could have guided and saved everyone but chose instead to fill hell with humans and *Jinn* (*K* 007:018; 011:119; 032:013; 038:085). At the Battle of *Uhud* *Muhammad* said to a *Makkan* "We are not equal. Our dead are in paradise; your dead in hell."<sup>1497</sup> Similarly, *Jihadists* often mention sending non-*Muslims* to hell. The *Muslim* Turkish-Mongol leader Timur, a.k.a. Tamerlane (~1336–1405 AD), ordered...

...The *Muslims* should be separated and saved, but the infidels should all be dispatched to hell with the proselytizing sword.<sup>1498</sup>

Likewise today, a popular *Jihadist* recruitment video, *Russian Hell 2000*...

...contains...expressions of contempt for the Russian soldiers such as 'Fire is waiting for you in the next world...'<sup>1499</sup>

**Ingredient 28 (Infidels' Blood is *Halal*):** The teaching that no *Muslim* ought suffer the death penalty for killing a non-*Muslim* gives *Muslims* a license to kill with near impunity. *Muhammad* said:

No *Muslim* should [ever] be killed [suffer the death penalty] for killing a *Kafir* [an infidel] (*Sahih Bukhari*, vol. 9, bk. 83, no. 50; also vol. 1, bk. 3, no. 111).

Given this license to kill infidels, it is not surprising that this situation exists between *Sunnites* and *Shias* and *Kurds*, as *Iraqi* president Jalal Talabani said:

There is no real Arab empathy with the hundreds of women and children in *Iraq* killed on a daily basis at the hands of criminal terrorists who come from the Arab countries...These criminals and executioners [i.e. *Jihadists*], who consider the *Shias*—who constitute the majority in *Iraq*—to be infidels and consider the *Kurds*—the second-largest nationality in *Iraq*—to be traitors, are glorified by the Arab press.<sup>1500</sup>

<sup>1500</sup> Rubin, Barry. "The Region: A small outbreak of reason," jpost.com, 5 Sep 2005.

Wherever non-*Muslims* reside or travel without paying the *Jizya* poll tax to show their utter subjection, they are assumed to be spreading corruption in the land—something for which *Muhammad* said a person could be killed with impunity (K 005:032). Thus it is not surprising that *Islamic* clerics declared that earthquake relief aid workers were “spreading immorality,”<sup>1501</sup> thereby making their blood *Halal*, i.e. permissible for any *Muslim* to kill with impunity.

Some terrorists specialize in eliminating notable infidels just as *Muhammad* had poets and anyone else he perceived to be enemies assassinated (see the Wordsmith table). In *Somaliland* in 2005, four members of the terrorist cell *El Itihad* shouted *Allah Akbar* after a court sentenced them to death for killing three aid workers because...

They felt justified in murdering infidels who they believed were offending *Muslim* fundamentalism.<sup>1502</sup>

In the UK in 2005, a *Muslim* from South London was found guilty for plotting to assassinate a decorated British soldier. The same *Muslim* plotted to kill a Jew and a *Hindu* for nothing other than “their religious beliefs.”<sup>1503</sup>

**Ingredient 29 (Blasphemers and Mischief-Makers’ Blood is *Halal*):** The teaching that mischief-makers and blasphemers of *Allah* or *Muhammad* be killed (K 005:033; *Sahih Muslim*, bk. 19, ch. 41, no. 4436; *Sahih Bukhari*, vol. 3, ch. 45, no. 687; vol. 4, bk. 52, no. 270; vol. 5, bk. 59, no. 369).

*Sharia* law and the legal codes of nearly all *Muslim* countries have draconian punishments for blasphemy, and the threshold of proof necessary for conviction is usually extremely low. Not surprisingly, false accusations have been lodged against non-*Muslims* from the beginning of *Islam* until today. For instance, *The Boston Globe* reported that in *Pakistan*, desecration of a *Koran* carries a life sentence and an insult against *Muhammad* carries a mandatory death sentence:

The law, which can be invoked on the word of one witness, is frequently misused to settle scores, avoid debts or rouse violence against religious minorities. ‘It is used and misused to **spread fear and terror**,’ said Hina Jilani, a lawyer with the Human Rights Commission of *Pakistan*. ‘It’s a tool to be used against anyone you are in conflict with.’<sup>1504</sup>

The blasphemy laws super-empower and legally weaponize *Muslims* who then spread fear and terror just by their mere presence whether they are presumed to be naughty or nice. More than 100 *Pakistanis* were accused under blasphemy laws in 2004 alone.<sup>1505</sup>

Anyone is vulnerable to the blasphemy accusation, whether the accused is a high-ranking *Muslim* or not. No matter how absurd the charge, the *Muslim Street*<sup>™</sup> and *Muslim* pressure groups, which often have connections to terrorists, will back up the accuser and apply pressure on the police, the courts and the

<sup>1501</sup> Rohde, D. “For Devout *Pakistani Muslims*, Aid Muddles Loyalties,” nytimes.com, 26 Oct 2005.

<sup>1502</sup> “Cramb, Auslan. *Islamic* terrorists shot aid couple as they watched TV,” news.telegraph.co.uk, 23 Dec 2005, *DW*.

<sup>1503</sup> Gardham, Duncan. “*Muslim* planned revenge attack on hero soldier,” news.telegraph.co.uk, 23 Dec 2005, *JW*.

<sup>1504</sup> Walsh, Declan. “*Pakistan* Christians in a precarious position,” *The San Francisco Chronicle*, sfgate.com, 21 Nov 2005.

<sup>1505</sup> Walsh, Declan. “*Pakistan* Christians in a precarious position,” *The San Francisco...Idem*.

politicians. For instance:

- ⊕ In 2006, a senior Palestinian official of *Fatah*, *Muhammad* Dahlan, was accused by a *Hamas*-linked website of having “ridiculed *Islam* and the *Koran*.” Then the *al-Tawhid* [Monotheism] and *Jihad* group issued a leaflet saying Dahlan and four other *Fatah* leaders “would soon be ‘slaughtered’ as apostates.”<sup>1506</sup>
- ⊕ In 2005, 16 *Jihadist* inmates awaiting trial said the assistant superintendent of a *Pakistani* military jail, *Tipu Sultan*...

...forced them to stop their prayers and conducted a search during which a copy of the *Koran* was recovered. They say he threw it on the ground and yelled: ‘This is the book which teaches you terrorism. This is the book which has brought you here.’

The 16 accusers were backed up by *Khalid Khawaja*, “a close friend of *Osama bin Laden*.” *Khawaja* created “a human rights organization, *Defense of Human Rights*, primarily to fight for the human rights of *Jihadis* and their families.” *Khawaja* met with two radical politicians who promised to “take up the issue right from parliament to agitation on the streets.”<sup>1507</sup>

Another example of how *Muslims* usurp absolute life-or-death powers over others by the creative use of the blasphemy charge comes from northern *Nigeria*. In 2006, *Ladi Mohammed*, a Christian (sic) from the *Zuru* tribe attended a nursing school in *Sokoto*. “Due to misunderstanding between two female students,” *Ladi* was accused of making a “misguided and derogatory statement against *Islam*.” “The militants...threatened to cut off her head,” so *Ladi* was “whisked away from the school premises to save her from being lynched.” The other Christian students are “living in fear of being attacked by the militant *Muslim* students,” the school had to close until the state could provide extra security.<sup>1508</sup>

In the West, *Muslims* feel they have the right to accuse non-*Muslims* of blasphemy without proof as though they were still living in *Islamdom* under *Sharia* law. There is no death sentence in the West for blasphemy yet, but “the blasphemy accusation serves as the basis for a...corporate shakedown” and demands for contributions to *Muslims*’ favorite causes.<sup>1509</sup>

*Muhammad*’s definition of “**mischief-making**” was quite loose so one could surmise that most non-*Muslims* would be considered mischief-makers. *Muhammad* even taught that at least six animals ought to be killed on sight because they were “**mischief-makers**”: the mouse, the scorpion, the kite [a hawk], the crow, the dog and the salamander (*Sahih Bukhari*, vol. 3, bk. 29, nos. 55, 57; vol. 4, bk. 54, nos. 525-527, 532; vol. 4, bk. 55, no. 579).

All pagans, Christians and Jews are considered worthy of death even if they are not mischief-makers. The thing that keeps the Jewish and Christian *Dhimmis* alive is paying the *Jizya* tax. If however anarchy prevails and there is no *Muslim* leader to take the *Jizya* tax, the *Jihad* against non-*Muslims* is resumed by armed

<sup>1506</sup> *Abu Toameh*, *Khaled*. “*Al-Qaida* offshoot threatens Palestinian leaders,” jpost.com, 30 Apr 2006, C&R.

<sup>1507</sup> *Shahzad*, *Saleem Syed*. “*Pakistan: Jihadis* Allege Desecration of *Koran* in Jail,” adnki.com, 27 Dec 2005, *JW*.

<sup>1508</sup> “*Nigeria Muslim* Militants ‘Kidnap’ Christian Student,” bosnewsllife.com, 15 Feb 2006, *JW*.

<sup>1509</sup> *Pipes*, *Daniel*. “*Amazon.com*’s *Koran* Desecration Problem,” *DP*, 20 May 2005.

mobs, as has been repeated ever since *Islamdom* came to be.

Since *Islam* teaches that people ought to die for blasphemy in word or deed, e.g. desecrating a *Koran*, *Islam* is an anti-democratic religion. *Islam* militates against the democratic Voltairian principle: "I disapprove of what you say but I will defend to the death your right to say it." By contrast, Christianity has no such blasphemy provision, and even in the Old Testament *Yahveh* was usually long-suffering for centuries at a time when dealing with sin.

**Ingredient 30 (Heretics, Apostates and Collaborators' Blood is *Halal*):** *Muhammad* considered heretics (innovators) and apostates to be infidels (*Kufr*) who ought to be killed. Even if they are ought of reach and cannot be killed, their property and wives and children can be taken away from them, for the *Koran* says a *Muslim* woman cannot be married to an infidel (*K* 002:221; 060:010-011). *Islam Online* states in this regard...

...it is not lawful for a *Muslim* woman to be married to a disbeliever; and with regard to children, he is no longer trusted to take care of them.<sup>1510</sup>

*Muhammad* said:

**C Against Heretics:**

- ★ "Allah cursed him who accommodates an innovator (in religion)" (*Sahih Muslim*, bk. 022, nos. 4876+4877).
- ★ Innovators of religion will be damned (*Sahih Bukhari*, vol. 6, bk. 60, nos. 264+298; vol. 8, bk. 76, nos. 584+585; vol. 8, bk. 80, no. 747; vol. 9, bk. 88, no. 174; *Sahih Muslim*, bk. 030, no. 5682).

**C Against Apostates:**

- ★ "Whoever changed his *Islamic* religion, then kill him [i.e. kill any apostate or innovator, i.e. heretic]" (*Sahih Al Bukhari* vol. 4, bk. 52, no. 260; vol. 9, bk. 84, no. 57).
- ★ Both *Muslims* and non-*Muslims* can kill an apostate from *Islam* with impunity and no payment of blood-money (*Diya*) is required (*Sahih Bukhari*, vol. 6, bk. 60, no. 25; see also vol. 9, bk. 83, no. 20).
- ★ "If someone [a heretic] changes his *Deen* [literally "the faith," meaning "the religion of *Islam*"]—strike his neck!" (*Malik's Muwatta*, bk. 36, no. 18.15).

**C Against Collaborators:**

- ★ They but wish that you should reject the Faith as they do, and thus be on the same footing (as they)...take not friends from their ranks until they flee in the way of *Allah*...But if they turn renegades, seize them and slay them wherever you find them (*K* 004:089).

Concerning the interpretation of "strike his neck" (quoted just above), the *Hadiths* record that *Muhammad* sent *Abu Musa* and *Mu'adh* to rule *Yemen*. *Bukhari* wrote:

Once [in *Yemen*] *Mu'adh* paid a visit to *Abu Musa* and saw a chained man. *Muadh* asked, 'What is this?' *Abu Musa* said '(He was) a Jew who embraced *Islam* and has now turned apostate.' *Muadh* said 'I will surely chop off his neck!' (*Sahih Bukhari*, vol. 5, bk. 59, no. 632).

Apostasy worthy of death is described further by 'Umdat *al-Salik* in his book *Reliance of the Traveler, Justice*, Section 8: "Apostasy from *Islam* (*Ridda*)."

<sup>1510</sup> *Al-Qaradawi*, Dr. Yusuf. "Apostasy: Major and Minor," islamonline.net, 13 Apr 2006.

MEMRI reported that:

A three-volume treatise by Sa'id Ibn Nasser *Al-Ghamdi*, titled *Deviation from the Faith as Reflected in [Arab] Thought and Literature on Modernity*, has recently gained publicity in the Arab world. The book, published in December 2003 in Saudi Arabia...names more than 200 modern Arab intellectuals and authors whom he accuses of heresy—thus making it permissible to kill them.<sup>1511</sup>

In keeping with *Sharia* law on heretics, Iranian law has no penalty for killing a *Baha'i*.<sup>1512</sup> Also in keeping with the *Sharia* law, Muslims still do kill converts from *Islam* every year, often extra-judicially. Robert Spencer wrote:

...when the Egyptian secularist Faraj Foda was murdered in 1992, *Sheikh Muhammad Al-Ghazali*, whom some have hailed as a 'reformer,' declared:

'The killing of Faraj Foda was in fact the implementation of the punishment against an apostate which the *Imam* (the state) has failed to implement (undertake).' So *Al-Ghazali* was asserting that individual Muslims had the responsibility to implement *Sharia* when the state did not do so—and he was asserting this with specific reference to the killing of an apostate.<sup>1513</sup>

Apostates are dehumanized. Take for instance an *Afghan Muslim* who converted to Christianity. Several years later, he was put on trial for apostasy. It was said of him:

'He is known as a microbe in society and he should be cut off and removed from the rest of Muslim society and should be killed,' prosecutor Abdul Wasi told the court.... 'We will cut him into little pieces,' said Hosnia Wafayosofo, who works at the jail, as she made a cutting motion with her hands. 'There's no need to see him.'<sup>1514</sup>

*Muhammad* envisioned Muslims as a grand army in ranks (*K* 061:004), so apostates are not lost sheep or prodigal sons (*Luk* 15) but deserters deserving of death. Mark Steyn summed up the situation regarding apostasy in *Islamdom*:

We take it for granted that it is wrong to kill someone for his religious

<sup>1511</sup> "Saudi Doctorate Encourages the Murder of Arab Intellectuals," MEMRI, #1070, 12 Jan 2006, JW, C&R.

<sup>1512</sup> Marshall, Paul. "Apostates from *Islam*: The case of the Afghan convert is not unique," weeklystandard.com, 10 Apr 2006, vol. 11, issue 28.

<sup>1513</sup> Spencer, Robert. "Academic Lies About Killing Apostates," FPM, JW, 6 Apr 2006.

<sup>1514</sup> "Afghan man faces death for abandoning *Islam*," chicagotribune.com, 21 Mar 2006, michelemalkin, southchild.com.

<sup>1515</sup> Steyn, Mark. "Will we stick our necks out for his faith?" oregister.com, 25 Mar 2006.

<sup>1516</sup> Spengler. "The West in an *Afghan* mirror," *Asia Times*, atimes.com, 28 Mar 2006.

<sup>1517</sup> Lindner, John M. "Islamic Radicals Agitate Judges in Indonesian Christianization Court Case," assistnews.net, 18 Aug 2005, WND, DW.

<sup>1518</sup> Robinson, B.A. "When does *Islam* permit the killing of Muslim non-combatants? The principle of *Tattarrus*," religioustolerance.org, 30 Jul 2005.

<sup>1519</sup> Do not obey any lawcode besides *Sharia* law: *K* 004:059-061, 065, 115; 005:044-45, 47, 50; 024:047-051; 028:050; 042:02; 058:020.

<sup>1520</sup> Do not obey any non-Muslim ruler: *K* 003:149; 025:052; 026:151; 033:001, 048; 068:008; 076:024; 096:019.

<sup>1521</sup> Bahur-Nir, Diana. "Bibi: Red Sea attacks are a warning," ynetnews.com, 19 Aug 2005.

<sup>1522</sup> *Sahih* Bukhari, vol. 4, bk. 52, no. 256; *Sahih Muslim*, bk. 19, no.4321+2+3.

<sup>1523</sup> Goel. *Calcutta*, ch. 4, as quoted from ch. 2 of the *Hidayah* treatise compiled by *Shaykh* Burhan-din Ali (flourished 12th century AD).

beliefs. Whereas *Islam* holds it is wrong not to kill him.<sup>1515</sup>

The *Asia Times* columnist Spengler wrote that “Americans should remove the beam from their own eye” and “Philistine hypocrisy pervades Western denunciations of the Afghan courts” when they tried to impose death for apostasy.<sup>1516</sup> Spengler did not produce any N.T. verses that demanded death for apostasy, but there are plenty of *Islamic* texts to that effect, a sample of which were quoted above.

According to *Jihadist* literature, the end justifies the means so, *Muslims* “must remove any obstacle in the way of implementing the *Islamic* ruling system,”<sup>1517</sup> even if this means killing *Mutumarresoun*—*Muslim* civilians living under infidel rule—whether they are collaborators or not.<sup>1518</sup>

A ruler who does not rule according to *Sharia* law and the *Koran* is an unbeliever.<sup>1519</sup> <sup>1520</sup> *Muslims* who follow such a ruler are deemed to be without *Allah*’s protection and can be killed as infidels (*K* 013:037; 007:196).

In *Iraq* in 2004 and 2005, suicide bombers killed many more *Iraqis* than coalition troops as the *Iraqis* applied for police and army jobs. Several suicide bombers even targeted coalition troops with car bombs as they handed out candy and toys to crowds of *Iraqi* children. It is as *Israeli* Terror analyst Tzvi Mazal said:

*Islam* allows attacks against *Muslims* who are seen by extremists as ‘collaborators,’ adds Mazal, explaining the ‘**logic**’ behind attacks against *Muslims* by terrorists. ‘Jews and Christians are seen as infidels—a category allowing for their murder.’<sup>1521</sup>

Once collaborating *Muslims* are seen as infidels, this allows *Muslim* women and children to be killed as collateral targets—for *Muhammad* said that *Muslims* are not at fault if women and children are accidentally killed while targeting infidel men.<sup>1522</sup> Also, *Shaykh* Burhan-ud-din Ali (flourished 12<sup>th</sup> century AD) stated:

Slaying of the women or infant children of infidels is also prohibited in principle. But if a *Muslim* slays them, he invites no censure.<sup>1523</sup>

**Ingredient 31 (Excommunicated *Muslims*’ Blood is *Halal*):** The teaching of *Takfir*, the practice whereby dissenting or lukewarm *Muslims* who shirk on the responsibilities of prayer or *Jihad* are declared to be infidels or “hypocrites,” thereby making them liable to be killed. This can be deduced from the *Koran* since orthodoxy and orthopraxy are what differentiates a *Muslim* from a pagan, and pagans are to be killed on sight unless they convert to *Islam* (*K* 009:005).

### The High Crime and Incarceration Rates of *Muslims*

**Summary:** A *Muslim* is 3 times more likely to be jailed than the average Briton, 4 times more likely than the average Spaniard, 8 times more likely than the average Hollander, 9 times more likely than the average Frenchman, and 15 times more than the average American. In Copenhagen, Denmark, a *Muslim* is 15.3 times as likely to commit a crime like rape than the average Copenhagener. In *Oslo*, Norway, *Muslims* are 4.5 percent more likely to rape than non-*Muslims*. In France a *Muslim* is 15.2 more times likely to perpetrate an anti-Semitic crime than a non-*Muslim*.

During the Mandate Period of Palestine, the British noticed that Arab Christians



were not prone to violent crime as *Muslims* were, as Daphne Tsimhoni wrote:

Their [Christians] becoming town dwellers, with a higher proportion of educated middle class than the *Muslims*, made them a more peaceful element of the Arab population. This was demonstrated even during the mandate [period] by a low rate of heinous crimes in which they resembled Jews rather than *Muslims*. Furthermore, the Christians worried that *Muslim* religious emotions aroused against the Jews might subsequently be turned against them.<sup>1524</sup>

Twenty percent of immigrants (mostly *Muslim*) in Berlin have criminal histories even though having a criminal record often hinders or precludes gaining citizenship. Immigrants have raised the overall crime rate noticeably in Germany and “tended to engage in violent acts, which sometimes targeted policemen.” Immigrants are “posing a threat to the lives of Germans” and are “a drag on the country’s economy” and they create “parallel societies” that “breed more violence.”<sup>1525</sup>

Daniel Pipes noted that:

...76.5 percent of convicted rapists in Copenhagen [Denmark] belong to that 5 percent of the population [that are *Muslim*]...an especially combustible issue given that practically all the female victims are non-*Muslim*. Similar, if lesser, disproportions are found in other crimes.<sup>1526</sup>

This means *Muslim* are 15.3 times as likely to commit crime, including rape, than the average Copenhagener.

Norway’s *Aftenposten* newspaper reported:

While 65 percent of those charged with rape are classed as coming from a non-western background, this segment makes up only 14.3 percent of *Oslo*’s population. Norwegian women were the victims in 80 percent of the cases, with 20 percent being women of foreign background.<sup>1527</sup>

This suggests that immigrants, most of whom are *Muslim*, are about 4.5 percent more likely to rape. They also rape Norwegian natives more than twice as often as they rape immigrants and foreigners.

“France’s prisons hold nine times more young men with North African fathers than ones with French fathers,”<sup>1528</sup> though only six percent of the population in France is *Muslim*. In 2002, there were “193 violent attacks on synagogues, Jewish schools, *Kosher* shops, cemeteries and rabbis...the percentage attributable to the extreme right was only 9 per cent in 2002.”<sup>1529</sup> This means a *Muslim* was fifteen times more likely to perpetrate an anti-Semitic crime than the average non-*Muslim* in France.

Less than one out of forty Spaniards is *Muslim*, yet one out of ten prisoners is of

<sup>1524</sup> “Table of heinous crimes,” in the draft Report on Administration of Palestine 1924, enclosure in High Commissioner for Palestine Sir Herbert Samuel’s dispatch no. 645, June 5, 1925, PRO/CO 733-93, as noted in Tsimhoni, Daphne. “Israel and the Territories—Disappearance,” Middle East Forum, meforum.org, Winter 2001, vol. viii, no. 1.

<sup>1525</sup> *Al-Matboli*, Ahmed. “German Police Want Strict Integration Law,” *Islam-online.net*, 3 Apr 2005, *DW*, 5 Apr 2005.

<sup>1526</sup> Pipes, Daniel & Lars Hedegaard. “Something Rotten in Denmark?,” *Nypost.com*, 27 Aug 2002, and *National Post*, “Letters,” 10 Sep 2002, *DP*.

<sup>1527</sup> “*Oslo* rape statistics shock,” *aftenposten.no*, 5 Sep 2001, *fjordman.blogspot*, 24 Jul 2005, *DW*.

<sup>1528</sup> “The West and *Islam*: Tales from Eurabia,” *The Economist*, economist.com, 22 Jun 2006.

<sup>1529</sup> Evans-Pritchard, Ambrose. “EU ‘covered up’ attacks on Jews,” *theage.com.au*, 2 Apr 2004.

*Moroccan* or *Algerian* origin, i.e. *Muslim*. This does not even count the Spanish-*Muslims* who arrived from other parts of the globe! Thus a *Muslim* is at least four times as likely to be jailed than the average Spaniard.<sup>1530</sup>

In Holland *Muslims* make up eight percent of the population, but form fifty-five percent of the prison population and sixty-three percent of the convicted murderers.<sup>1531</sup> This means *Muslim* are seven times more likely to be imprisoned and eight times more likely to commit murder than the average Hollander.

In 2005 the UK was known for long having been lax on terrorists and for being a terrorist haven.<sup>1532</sup> Yet, in just three years after 9/11/2001, 520 of the 700,000 *Muslims* in *Londonistan* were arrested for terror activities, which is one out of every 1,346 *Muslims* in London.<sup>1533</sup>

So many *Muslims* land in London jails that pork has been taken off the menu entirely.<sup>1534</sup> Even though 8.46 percent of the *Londonistan* population is *Muslim*,<sup>1535</sup> “a quarter of prisoners at the Category B” HMP Brixton jail in south London is *Muslim*. At Brixton, the jail toilets had to be repositioned at *Jizya*-payer expense so that prisoners would no longer need to sit sideways in the WC so as not to face *Mekka*.<sup>1536</sup>

In the UK, 8 percent of the prison population is *Muslim*, even though only 2.7 percent are *Muslim* (1.6 million), meaning *Muslims* are more than three times as likely to go to jails as the average Briton.<sup>1537</sup> Also, “complaints of misconduct and corruption against Asian officers are 10 times higher than against their white colleagues.”<sup>1538</sup>

The number of *Muslims* in America is not known, but there probably are far fewer than two million *Muslims* in the US, which is 0.68 percent of the US population of 293 million people.<sup>1539</sup> The true number of *Muslims* in the US may only be a million—about 0.34 percent of the US population. While not all *Muslims* are Arabs and not all Arabs are *Muslim*, it is worth noting that only 850,000 respondents claimed exclusive Arab ancestry on the 2000 US census.<sup>1540</sup>

Experts such as Yehudit Barsky and *Muslim* leader *Muhammad* Hisham Kabbani say that over eighty percent of American *Mosques* have been radicalized<sup>1541</sup> due to *Saudi*-supplied foreign *Imams* teaching in *Mosques* built with petrodollars, free *Wahhabi* hate-literature, subsidized educational opportunities in *Saudi* Arabia and *Hajj* trips. Thus it is not surprising that

<sup>1530</sup> McLean, Renwick. “Spanish Prisons Provide Pool of Recruits for...” *Idem*.

<sup>1531</sup> Dreher, Rod. “Tiptoe Through the Tulips,” *NRO*, 3 Dec 2004.

<sup>1532</sup> Pipes, Daniel. “Weak Brits, Tough French,” *DP*, 12 Jul 2005.

<sup>1533</sup> “Cops foil terrorists,” *Online Sun*, thesun.co.uk, 25 Jul 2004.

<sup>1534</sup> Jailed *Muslims* angry over pork on menu,” BigNewsNetwork.com, 20 Aug 2004, *DW*.

<sup>1535</sup> O’Donnell, Lynne. “Militant *Muslims* find a haven in ‘*Londonistan*’: Some say Britain overdoing tolerance—attacks feared,” *San Fransisco Chronicle*, 24 Jul 2004.

<sup>1536</sup> Pyatt, Jamie. “Jail loos turned from East,” thesun.co.uk, 20 Apr 2006, bakelblog.com, *DW*.

<sup>1537</sup> Masood, Ehsan. “A *Muslim* Journey,” prospectmagazine.co.uk, Aug 2005, Bakel’s *Business*.

<sup>1538</sup> Laville, Sandra & Hugh Muir. “Secret report brands *Muslim* police corrupt,” guardian.co.uk, 10 Jun 2006, *JW*.

<sup>1539</sup> Pipes, Daniel. “How Many *Muslims* Live in the United States?” *DP*, 22 Apr 2003.

<sup>1540</sup> Pipes, Daniel. “Weblog: How Many Arab-Americans?” *DP*, 9 Mar 2005.

<sup>1541</sup> Rettig, Haviv. “Expert: Saudis have radicalized 80% of US *Mosques*,” jpost.com, 5 Dec 2005; “The End of American Jewry’s Golden Era; An Interview with Daniel Pipes,” *DP*, 2 May 2004.

American *Muslims* are much more likely to enter the US prison system than anyone else.<sup>1542</sup> For instance, *Muslims* are:

- ☉ "...one-sixth of all prisoners in New York state jails are *Muslim*."<sup>1543</sup>
- ☉ In 2006, "there are an estimated 250,000 *Muslim* inmates in the nation's prisons" and *Muslims* make "up 10 to 17 percent of the prison and jail population."<sup>1544</sup> This means *Muslims* are 29 to 50 times as likely to land in jail or convert to *Islam* in jail as the general American population (using the estimate that *Muslims* constitute 0.34 percent of Americans mentioned above).<sup>1545</sup>

*Muslims* cannot say that this American-*Muslim* incarceration rate is because many *Muslims* are immigrants because overall "foreigners are [only] 2.5 times more likely than natives to end up in a [US] federal jail."<sup>1546</sup> Since "64 percent of American *Muslims* are foreign born,"<sup>1547</sup> based on their immigrant status alone American-*Muslims* ought to be only 1.6 times more likely than native-born Americans to be jailed—not 22 to 50 times as is the case.

American-*Muslims* cannot blame poverty, illiteracy, religious or racial bias and discrimination, or lack of qualified lawyers for the incarceration rate since:

- ☉ There is no evidence of a spike in incarcerations for other than immigration matters after 9/11, the first time that the US public started scrutinizing *Muslims*.
- ☉ "59 percent of American *Muslims* have at least an undergraduate education, making them the most highly educated group in America. *Muslim* Americans are also the richest *Muslim* community in the world."<sup>1548</sup>

<sup>1542</sup> Alexiev, Alex. "Tablighi Jamaat: Jihad's Stealthy Legions," meforum.org, Jan 2005, xii:1.

<sup>1543</sup> Pipes, Daniel. "Muslim Immigrants in the United States," *DP*, 14 Aug 2002.

<sup>1544</sup> Silverberg, Mark. "The Silent War: *Wahhabism* and the American Penal System War on Terror," newmediajournal.us, 6 May 2006, *JW*.

<sup>1545</sup> Barrett, Paul. "Criminal Fifth Column," *The Wall Street Journal*, *FPM*, 5 Feb 2003.

<sup>1546</sup> Webster, Stephen. "Writing on the Wall," *American Renaissance*, Aug 2001.

<sup>1547</sup> "Muslim Americans: Model Citizens," newsmag.com, 5 Sep 2005, *JW*.

<sup>1548</sup> Spencer, Robert. "Does America Have a 'Muslim Problem'?" *JW*, 9 Sep 2005.

***Islamists Still Dream of Making Infidels Into Dhimmis and Sex-Slaves***

**Jizya Tax:** After *Hamas* won elections in Bethlehem in 2005, Masalmeh, a leader of the local *Hamas* contingent, said:

We in *Hamas* intend to implement this [*Jizya*] tax someday. We say it openly—we welcome everyone to Palestine but only if they agree to live under our rules.<sup>1549</sup>

In 2001, *Sheik Al-Madhi* said on PA TV in a Friday sermon from a *Gaza Mosque*:

We welcome as we did in the past any Jew who wants to live in this land as a *Dhimmi* just as the Jews have lived in our countries as *Dhimmis* and have earned appreciation, and some of them have even reached the positions of counselor or minister here and there. We welcome the Jews to live as *Dhimmis*, but the rule in this land and in all the *Muslim* countries must be the rule of *Allah*.<sup>1550</sup>

The *Islamic Liberation Party* announced in 2005...

...from London its political platform—to establish the *Islamic* caliphate over all corners of the earth—and declares that the party will suggest to the Queen of England that she convert to *Islam* and thus will not have to pay the *Islamic* poll tax on non-*Muslims* [i.e. the *Jizya*].<sup>1551</sup>

**Slavery:** The enslavement of non-*Muslims* continues in parts of *Islamdom* to this day, though many *Muslims* deny it. For instance, officially slavery was banned in *Saudi Arabia* in 1962, but the royals and the rich still practice it in all but name, and *Saudis* even bring virtual slaves to the US<sup>1552</sup> *Mauritanians* hold chattel slaves<sup>1553</sup> and in modern *Sudan* “taking [chattel] slaves goes hand in hand with the government’s concept of *Islamization*.”<sup>1554</sup> Robert Spencer wrote:

‘Each of us was raped by between three and six men....One woman refused to have sex with them, so they split her head into pieces with an axe in front of us.’ This happened in *Darfur*, from which Sudanese military personnel actually airlifted women to *Khartoum* to serve as sex-slaves.<sup>1555</sup>

UK’s *Times Online* reported in 2006:

A senior member of an *Islamic* organisation linked to *Al-Qaeda* is funding his activities through the kidnapping of Christian children who are sold into slavery in *Pakistan*. *The Sunday Times* has established that Gul Khan, a wealthy militant who uses the base of *Jamaat-ud Daawa* (JUD) near *Lahore*, is behind a cruel trade in boys aged six to 12. They are abducted from remote Christian villages in the *Punjab* and fetch nearly £1,000 each from buyers

<sup>1549</sup> Masalmeh’s interview with Karby Legget, *Wall Street Journal*, online.wsj.com, 23-26 Dec 2005, as quoted in Pipes, Daniel. “*Dhimmitude* in Practice,” *DP*, 29 Dec 2005.

<sup>1550</sup> Bostom, Andrew. “‘Democrats’ For *Jihad* and *Jizya*,” americanthinker.com, 30 Dec 2005.

<sup>1551</sup> “Arab Criticism of *Muslim* Extremist Activities in the West,” MEMRI.org, Dispatch Series No. 921, 10 Jun 2005, freerepublic.com.

<sup>1552</sup> Pipes, Daniel. “*Saudis* Import Slaves to America,” *FPM*, 14 Jun 2005.

<sup>1553</sup> Bryant, Elizabeth. “Faces of Globalization: *Mauritania* slavery,” washtimes.com, 26 Aug 2004.

<sup>1554</sup> Schmidt. *Divide*, p. 117.

<sup>1555</sup> Spencer, Robert. “The Rape *Jihad*,” *FPM*, 24 Sep 2004, *JW*.

who consign them to a life of misery in domestic servitude or in the sex trade.<sup>1556</sup>

If the West were ever to fall to *Islam*, slavery would be re-instituted globally because, based on the *Koran* and *Hadith*, *Muslims* think that the property, lives and bodies of non-*Muslims* are licit (*Halal*) for *Muslims* to take and fondle. *Muhammad* said it was fine for soldiers to rape captives and he said:

It does not matter if you do not do it [*Coitus Interruptus*], for every soul that is to be born up to the Day of Resurrection will be born.<sup>1557</sup>

*Sheikh* Saleh *Al-Fawzan*, a high-ranking *Saudi* religious official and the author of a widely-used textbook entitled *At-Tawhid*, i.e. *Monotheism*, said “Slavery is a part of *Islam*...Slavery is part of *Jihad* and *Jihad* will remain as long there is *Islam*...Whoever says such things [that slavery has been abolished] is an infidel...[and are] ignorant, not scholars.”<sup>1558</sup>

“*Sheikh* Mohammed Metwaly *El-Shaarawy* wrote in [the English language] *Al-Ahram* [*Cairo*] newspaper on 2 Sep 1992: ‘Having sex with female POW’s bestows honor on her since the master does to her what he does to his wife.’”<sup>1559</sup>

“The *Imam* of the *Mosque* of the Juristic Society in *Assiut* [in Middle Egypt on the west bank of the Nile] repeated publicly and for many years in his Friday sermons that: ‘Christian women are a loot for every *Muslim*.’”<sup>1560</sup>

Alvin Schmidt wrote:

As recent as 1999 it was reported that a prominent *Saudi Muslim* cleric, *Shaikh* Saad *Al-Buraik*, told Palestinians: ‘Their [Jewish] women are yours to take, legitimately. God made them yours. Why don’t you enslave them?’<sup>1561</sup>

In 2004 in *Al-Hawi Mosque* in central *Basra*, in southern *Iraq*:

A senior aide of radical *Shiite* cleric Muqtada *Al-Sadr* told worshippers during a Friday sermon in southern *Iraq* that anyone capturing a female British soldier can keep her as a slave.<sup>1562</sup>

***Dhimmitude***: Alyssa A. Lappen wrote:

Even in 1968, an Egyptian *Sheikh* explained at *Cairo*’s preeminent *Islamic* University of *Al-Azhar*, ‘we say to those who patronize the Jews that the latter are *Dhimmis*, people of obligation, who have betrayed the covenant in conformity with which they have been accorded protection.’ The late president Anwar *El-Sadat* [who later signed a peace treaty with Israel in 1979] declared in 1972, ‘They shall return and be as the *Koran* said of them: ‘condemned to humiliation and misery.’”<sup>1563</sup>

<sup>1556</sup> Colvin, Marie. “Reunited: boys saved from slavers,” *The Sunday Times*, timesonline.co.uk, 21 May 2006, *DW*, C&R; also see Pipes, Daniel. “Pakistan’s Mock Devshirme,” *DP*, 21 May 2006.

<sup>1557</sup> Trifkovic. *Sword*, p. 43; also see *Sahih Bukhari* vol. 003, bk. 034, no. 432; vol. 005, bk. 059, no. 459; vol. 007, bk. 062, nos. 135, 136; vol. 009, bk. 093, no. 506; *Sahih Muslim*, bk. 8, nos. 22, 29 & 3371; *K* 004:024; Spencer. *Disturbing*, pp. 50-51, 53.

<sup>1558</sup> Pipes, Daniel. “Saudi Religious Leader Calls for Slavery’s Legalization,” *DP*, 7 Nov 2003.

<sup>1559</sup> Khalil, Magdy. “Who is responsible for abducting Coptic girls?” *JW*, 26 Aug 2005.

<sup>1560</sup> Khalil, Magdy. “Who is responsible for abducting Coptic girls?” *JW*, 26 Aug 2005.

<sup>1561</sup> Mabry. “Price Tag?” p. 42, as quoted by Schmidt. *Divide*, p. 121.

<sup>1562</sup> “*Al-Sadr*’s *Basra* Aide Offers Rewards,” news.yahoo.com, 7 May 2004.

<sup>1563</sup> Lappen, Alyssa A. “And *Dhimmitude* For All,” *FPM*, 11 Apr 2005.

Adelman and Kuperman wrote:

In May 1999, *Sheikh* Yussef Salameh, the Palestinian Authority's undersecretary for religious endowment, praised the idea that Christians should become *Dhimmis* under *Muslim* rule.<sup>1564</sup>

Walid Fitaihi of the *Islamic* Society of Boston said in 2001 about Jews:

The words of the *Koran* [003:113] on this matter are true: they [Jews] will be humiliated wherever they are found, unless they are protected under a covenant with *Allah*.<sup>1565</sup>

*Israeli*-Palestinian peace-making was always premised on the exchange of “land for peace,” whereby the Israelis had a two-state solution in mind. However, what Palestinians had in mind is a one-state solution—an *Islamic* state from the Jordan to the Mediterranean wherein Jews live as *Dhimmis*. After all, *Dhimmis* are “protected ones” (i.e. have security), and *Muslims* are at peace with *Dhimmis* if the *Jizya* tax is paid and as long as it is convenient for *Muslims*.

When *Takiya* ruse becomes evident when past statements are examined, as when a Palestinian leader who praised the *Geneva* Peace Accord later praised Palestinian suicide-bombers. Qadura Faras, a Palestinian lawmaker said:

It is always asked, do you [Israelis] have a partner on the other side. I am telling you with full sincerity we are ready to reach an inclusive agreement with you which will promise us [*Muslims*] freedom and liberty and statehood [an *Islamic* state], and will promise you the thing we know you are sensitive to which is your full right to live in peace and security [as *Dhimmi* “protected ones” not exercising any “freedom and liberty and statehood”].<sup>1566</sup>

### ***Jihad* Containment Around the World**

*Islam* is a religion wrapped in a political ideology, so nations can be *Islamized* by losing the war with *Jihadists* and *Muslim* missionaries, or by losing the demographic war. Hence the need for fences, barriers and strictly-enforced immigration and visa travel laws to curb *Jihadists*. After all, the *Koran* was written to motivate *Muslims* to overcome walled forts and small armies while disregarding all other considerations such as Arabia's searing heat (*K* 009:081).

The guarded and fortified borders of nation states are still the first obstacle in the way of *Islamists* who want to form *Islamic* states and then string these states together into a *Caliphate*. Also, fences hamper efforts to transport WMD as when nuclear deterrence against such threats fail.<sup>1567</sup>

Guarded borders also pose an obstacle for *Islamists* who wish to threaten counter-terrorism experts and critics of *Islam* and curb the practice of freedom of speech globally. For instance, in 2005 when a Denmark newspaper published twelve caricatures of *Muhammad*, all twelve cartoonists were forced into hiding since more than one cleric offered rewards to their would-be assassin,<sup>1568</sup> ambassadors from eleven *Muslim* countries protested “the defaming of *Islam*” and there were widespread protests and riots in Europe as well as in *Islamdom*.<sup>1569</sup>

<sup>1564</sup> Adelman, J. & A. Kuperman. “The Christian Exodus from the Middle East,” copts.net, 2001.

<sup>1565</sup> “Terror in America *Muslim* American Leaders,” 16 Nov, *MEMRI*, No. 301.

<sup>1566</sup> Klein, Aaron. “‘Peaceful’ PA official praises suicide bombers,” *WND*, 12 Jan 2006, *JW*.

<sup>1567</sup> “France warns: Nukes in response to terror,” ynetnews.com, 19 Jan 2006.

<sup>1568</sup> “Cleric offers reward for killing Prophet cartoonist,” *Ireland Online*, iol.ie, 17 Feb 2006, *JW*.

<sup>1569</sup> Connolly, Kate. “*Muslims* march over cartoons of the Prophet,” telegraph.co.uk, 4 Nov 2005.

Cyprus-Cyprus	187-mile (301 KM) (some say 112 miles) barrier constructed of barbed wire, concrete walls, watchtowers, anti-tank trenches and minefields built by the U.N. after 1974. <sup>1570</sup> <i>Muslim</i> Turks captured 37 percent of NE Cyprus in 1974, including half the capital of <i>Nicosia</i> , and they imposed a 30-year travel ban that partially ended in 2003. In 1974, 200,000 Greeks fled to the Christian-controlled SW Cyprus, while 50,000 <i>Muslim</i> moved to NE Cyprus. The Christian side of Cyprus is at least five times as rich as the <i>Muslim</i> side where time has virtually stood still since 1974. After Cyprus gain European Union membership in 2004, it became an attractive destination for asylum seekers from <i>Bangladesh</i> , <i>Syria</i> , <i>Iran</i> , <i>Pakistan</i> , <i>Turkey</i> and <i>Iraq</i> , who mainly want to move on to Europe. <i>Cyprus Mail</i> reported: Theodorou told the conference that the biggest wave of illegal immigrants hailed from Turkey, which gave visas to third country nationals, mainly from <i>Muslim</i> countries, who used these visas to enter the north. These immigrants would cross over the Green Line with the help of smuggling rings controlled by Turks and Turkish Cypriots, he said....The crime rate is also on the rise, while foreign involvement in crime, either from immigrants or asylum seekers, has become a daily occurrence, he added. Foreigners are also implicated in human trafficking, noted Panayiotou...If this upwards trend [in bogus asylum seekers] continues, Cyprus will face economic and social problems given its small size. <sup>1571</sup>
Egypt-Egypt	After two separate vehicle-born bomb attacks, in 2005 a 12.5-mile (20 KM) 1.5-meter high fence was installed on the land side of the Red Sea resort town of <i>Sharm El-Sheikh</i> at the southern tip of the <i>Sinai</i> Peninsula. <sup>1572</sup> In 2006 the same resort was bombed again, but with planted bombs.
European Union-Belarus and Ukraine	The EU is building a fence between EU members Poland and Hungary and their neighbors to the east, <i>Belarus</i> and Ukraine, ostensibly to screen out economic immigrants. In 2004 Poland has refused entry to <i>Chechen Muslims</i> traveling through <i>Belarus</i> . <sup>1573</sup>
European Union-Morocco	“Since 2000, <i>Ceuta</i> —a seven square mile enclave that is home to 79,000 people—has been separated from <i>Morocco</i> by a £200 million razor wire border fence subsidized by the European

<sup>1570</sup> Thein, Ben. “Is Israel’s Security Barrier Unique?” *Middle East Quarterly*, vol. XI, no. 4, meforum.org, Fall 2004.

<sup>1571</sup> Evripidou, Stefanos. “Cyprus facing asylum onslaught through the north,” cyprus-mail.com, *DW*, 12 May 2005.

<sup>1572</sup> “Egyptian Resort Town Builds Fence to Prevent Attacks,” arabnews.com, 18 Oct 2005, terrorism.com.

<sup>1573</sup> Spencer, Robert. “Europe Will Be *Islamic* by the End of the Century,” humaneventsonline.com, 16 Sep 2004, *LGF*.

Union.<sup>1574</sup> Another Spanish city on the coast of *Morocco*, *Melilla*, had been secured by a “three-meter-tall double fence and watch towers.”<sup>1575</sup> By 2005 however this fence had been doubled in height to six meters (20 feet).<sup>1576</sup> These fences are meant to keep economic immigrants out of the EU, but Spain also knows there are many terrorist sleeper cells in *Morocco*.<sup>1577</sup> Thousands of *Muslims* have drowned trying to swim around the barriers, and many are cut by razor wire and barbs in mass human runs over the top of the fences.<sup>1578</sup> There are proposals for an EU coast guard and land force to ebb the tide of African immigration—just as Australia’s military monitors its coasts.<sup>1579</sup>

European  
Russia-Asia

In 2005 Russia spent USD \$2.3 billion to build 72 border posts between the Black and *Caspian* Seas and along its border

with *Kazakhstan* which runs from the north end of the *Caspian* Sea past the *Ural* Mountains to the *Altai* mountains near *Mongolia*. The posts will be manned by brigades with the latest equipment to thwart *Jihadist* penetration into Russia. Newer patrol boats will secure the *Caspian* and Black Seas.<sup>1580</sup>

The southern-most border posts are on the border between Christian *Georgia* and the *Muslim* Russian province *Chechnya* to the north, and between *Muslim Azerbaijan* and the *Muslim* Russian province of *Dagestan* to the north. The border posts roughly follow the Greater *Caucasus* mountain range.<sup>1581</sup> In 2005 Russia considered building *Israeli*-style anti-terror fences in parts of *Chechnya*.<sup>1582</sup>

<sup>1574</sup> Willsher, Kim. “Mustafa, the swimming fridge smuggler, and his macabre pact,” telegraph.co.uk, 19 Oct 2003.

<sup>1575</sup> WordIQ.com, accessed 10 Sep 2004, *Melilla* entry.

<sup>1576</sup> “Spain Starts Deporting Immigrants,” *Deutsche Welle*, dw-world.de, 7 Oct 2005.

<sup>1577</sup> Woolls, Daniel. “*Morocco* is Europe’s biggest terrorist threat, Spain’s judge Garzon says,” *The San Diego Union-Tribune*, signonsandiego.com, 15 Jul 2004.

<sup>1578</sup> Pipes, Daniel. “Europe Under Siege,” *FPM*, 18 Oct 2005, *DP*.

<sup>1579</sup> Pipes, Daniel. “Fortress Europe,” *DP*, 27 Nov 2005.

<sup>1580</sup> Medetsky, Anatoly. “Putin: Beef Up Southern Border,” moscowtimes.ru, 18 Jul 2005.

<sup>1581</sup> “Moscow to spend \$2.3b on border security project,” jpost.com, 16 Jul 2005.

<sup>1582</sup> Katz, Yaakov. “Exclusive: Israel may export security fence to Russia,” jpost.com, 8 Nov 2005.



India- <i>Bangladesh</i>	In 2004 the fence was partly built along sensitive areas making up 35 percent of border. Floodlights shine on river fords. The winding border is 2,545 miles (4,095 KM) long, but the fence is only 2,043-mile long. <sup>1583</sup> In 2006, only 40 percent of the border was fenced. <sup>1584</sup>
<p>India says there are ninety terrorist camps in <i>Bangladesh</i> used by militant groups, some of which attack India. Starting in 2004, India is repatriating three million <i>Bangladeshis</i> who are in India illegally.<sup>1585</sup> Since 1948 <i>Muslims</i> have driven many millions of <i>Hindus</i> out of <i>Bangladesh</i> into India via <i>Koranic</i> ethnic-cleansing practices. The CIA's <i>World Factbook</i> for 2005 says <i>Bangladesh</i> was 83 percent <i>Muslim</i>. <i>India News</i> reported:</p> <p style="padding-left: 2em;">A <i>Bangladeshi</i> human rights group today claimed that 31 <i>Islamic</i> militant outfits were operating in <i>Bangladesh</i> targeting non-<i>Muslims</i> and seeking to establish a 'greater <i>Islamic</i> nation' including parts of some adjacent Indian states...<i>Bangladesh</i>...[is] a 'cocoon of terrorism and violence'...a large number [i.e. amount] of ammunition, including grenades, had been smuggled into the country and 'freely' used against minorities.<sup>1586</sup></p> <p>In 2005, 500 small bombs went off simultaneously across <i>Bangladesh</i>, killing two people and wounding 140.<sup>1587</sup></p>	
India-Myanmar ( <i>Burma</i> )	Partly built along 909-mile (1,463 KM) long border. The CIA's <i>World Factbook</i> for 2004 says Myanmar is four percent <i>Muslim</i> and India is twelve percent <i>Muslim</i> .
India-Pakistan	1,800-mile (3,000 KM) border that is fenced wherever the

border is not rugged mountain. The fence was begun in the 1990's and was nearly complete as of 2004. The fence varies from eight to twelve feet in height. The fencing is double throughout its length and has land mines in between the fencing. It is electrified wherever electricity is available.<sup>1588</sup> Since 1948 *Muslims* have driven many millions of *Hindus* out of *Pakistan* into India via *Koranic* ethnic-cleansing practices. The CIA's *World Factbook* for 2004 says *Pakistan* is 97 percent *Muslim* (*Sunni* 77 percent, *Shia* 20 percent). Since *Pakistan* is now only one or two percent non-*Muslim*, the fence will not stop many *Hindus* fleeing *Pakistan*. This is similar to how *Israel* only built its separation fence after the Palestinian territories became ninety-nine percent *Muslim*, meaning that the fence would not trap many non-*Muslims* in Palestinian lands.

Even before the fence was complete in November 2004 India announced the security situation in *Kashmir* improved so much, troop cuts are planned.<sup>1589</sup> The reason given was "the number of terrorists inside *Jammu* and *Kashmir* plummeted almost 50 percent in the year after the barrier's construction. The fence stopped

<sup>1583</sup> Nelson, Dean. "India fences off *Bangladesh* to keep out *Muslim* terror," timesonline.co.uk, 13 Nov 2005, *DW*.

<sup>1584</sup> "India vows to fence its borders against *Bangladesh* aliens," news.yahoo.com, 2 Apr 2006.

<sup>1585</sup> "India finishes fence along 'sensitive' third of *Bangladesh* border," *Agence France-Presse* via clari.net, 11 Nov 2003.

<sup>1586</sup> "*Bangladesh* now has 31 *Islamic* militant groups," news.newkerala.com, 20 Jan 2005, *JW*.

<sup>1587</sup> "Over 500 Bombs Used in *Bangladesh* Attack; 2 Dead, 140 Wounded," allheadlinenews.com, 17 Aug 2005; also see Pipes, Daniel. "A Vision of the Terrible Future?" *DP*, 18 Aug 2005.

<sup>1588</sup> WordIQ.com, accessed 10 Sep 2004, "Indian-*Kashmir* barrier" entry.

<sup>1589</sup> "Relief, disbelief in *Kashmir* as India announces troop reduction," channelnewsasia.com, 12 Nov 2004.

almost 90 percent of infiltration attempts.”<sup>1590</sup> Occasionally, an interception is reported in the news.<sup>1591</sup>

Now that the fence has worked so well on the *Kashmir* and Indian borders, “*Pakistani* Foreign Minister Khurshid Kasuri says his country has proposed building a fence along the border with Afghanistan to curb the movements of militants and drug smugglers” into Afghanistan who fight the US-backed government there.<sup>1592</sup>

Fences would help keep terrorists and arms-smugglers out of *Iraq*, and also separate the *Kurds*, *Shias* and *Sunnis* from each other. These fences would be less expensive than stationing a permanent army in *Iraq*, and less involved than attacking *Syria*, *Iran* and other countries in order to stop the flow of *Jihadists* and arms.

Iraq	US troops are encircled in a complex in <i>Baghdad</i> behind a tall
blast wall. The wall means bombers must gain access by wearing uniforms or by using fake identity badges. The wall also occasions multi-vehicle attacks. The first vehicle is meant to take out the blast wall and the second or third is meant to blow up a building inside. Such was the case in 2005 with the Palestine Hotel where journalists are headquartered. <sup>1593</sup> Because insurgents who mine roads and stage rifle and RPG attacks often use nearby towns as hide-outs, US troops have encircled towns such as <i>Fallujah</i> with two- to three-meter-high sand-berms with watchtowers. <i>Samarra</i> has a berm 18-KM (11-miles) long. <i>Siniya</i> (population 50,000) is near the oil-refineries of <i>Baiji</i> and has a wall 10-KM (6-miles) long. <sup>1594</sup> In 2006, the town of <i>Rutbah</i> on the Syrian border was ringed with a 10.5-mile-long sand berm, seven feet high and 20 feet wide. <sup>1595</sup>	
<i>Israel-Gaza Strip</i>	There is a 35-mile (57 KM) chain-link fence constructed in 1994 along the east and north borders of <i>Gaza</i> . The western
border is the Mediterranean coastline. The southern border has a buffer zone that the Israelis named the <i>Philadelphia</i> (“City of Brotherly Love”) Route, but was renamed the “ <i>Saladin Corridor</i> ” by the Palestinians in 2004. These names shows the peace-orientation of the Israelis and <i>Jihad</i> -orientation of <i>Muslims</i> .	
In 2005 the Israelis lined the southern corridor with a 22-foot (7-meter) concrete wall in addition to the older steel wall. <i>Israel</i> had thought of building a trench or canal along the corridor to flood the dozens of Palestinian tunnels dig to Egypt built for smuggling in weapons and contraband. <sup>1596</sup> In 2005, <i>Israel</i> handed the corridor over to Egypt.	
The Mediterranean current flows by <i>Gaza</i> north toward <i>Tel Aviv</i> . In order to catch terrorists swimming, snorkeling or using dinghies, <i>Israel</i> has installed a 150-meter row of cement pilings going out from the shore on the <i>Gaza-Israel</i> north border. Extending out from the pilings is an 800-meter, 1.8-meter-high, partially submerged fence. <sup>1597</sup>	

<sup>1590</sup> Thein, Ben. “Is Israel’s Security Barrier Unique?” *Middle East Quarterly*, vol. XI, no. 4, meforum.org, Fall 2004.

<sup>1591</sup> “Indian troops kill six rebels in restive *Kashmir*,” news.yahoo.com, 2 Jul 2005, C&R.

<sup>1592</sup> “Karzai urges terror fight rethink,” news.bbc.co.uk, 13 Sep 2005.

<sup>1593</sup> “Journalists’ Hotel Attacked in *Iraq*,” foxnews.com, 25 Oct 2005.

<sup>1594</sup> Lenz, Ryan. “Military ‘berms’ village to control it,” *Arizona Daily Star*, azstarnet.com, 8 Jan 2006; *Al-Jibouri*, G. “U.S. troops build wall of sand around *Iraqi* town,” Reuters, 10 Jan 2006.

<sup>1595</sup> Castaneda, A. “U.S. Marines Wall in *Iraqi* City With Sand,” news.yahoo.com, 5 Mar 2006.

<sup>1596</sup> Dudkevitch, M. “Report: IDF plans canal in *Rafah*,” jpost.com, 15 May 2004.

<sup>1597</sup> O’Sullivan, Arie. “Navy builds anti-terror barrier off *Gaza* coast,” jpost.com, 17 Jun 2005.

*Israel* employs *Dvora* boats to patrol its coastal waters.<sup>1598</sup> After a Palestinian boat exploded and injured four IDF sailors in November 2002 in a nearby craft, *Israel* developed remote-control speedboats with cameras and machine guns that reportedly “already drawn blood” by 2005.<sup>1599</sup>

On the west and north of *Gaza*, Israelis are installing a triple fence complete with razor wire, motion sensors, video and night vision cameras, as well as watchtowers with remote-control machine guns every 1.2 miles. Remote control vehicles will patrol the perimeter on three patrol roads using a random pattern.<sup>1600</sup>

The *Gaza* barrier extends 10 KM to the southeast of *Gaza* into the *Negev* to stop smuggling and terrorist infiltration.<sup>1601</sup> In 2005, military sources say the *Negev* fence needs to be upgraded and lengthened to cover the entire 220-KM (138-mile) *Israeli*-Egyptian border at a cost of 1.5 billion.<sup>1602</sup>

IDF Chief-of-Staff Lt.-Gen. Dan Halutz said “Before we left *Gaza* there were some 30 civilians and soldiers killed a year,” but in the year since “two *Bedouin* kids [were] killed after picking up a mortar shell.”<sup>1603</sup> Between September 2000 and September 2005, “*Gazan* Palestinians killed 148 Israelis and 11 foreigners,” which is 31.8 civilians per year over those five years.<sup>1604</sup>

<i>Israel-Isreal</i>	“Caesarea and <i>Jisr e-Zarka</i> [cities], <i>Jouarish</i> and the <i>Geneh Dan</i> neighborhood in <i>Ramle</i> , and the <i>Pardes Shanir</i> neighborhood in <i>Lod</i> and <i>Nor Tzvi</i> ” have fences and walls to separate Jews and Arabs. The reasons include security from terrorists and robbers, noise control and property values. <sup>1605</sup>
----------------------	--

<i>Israel-Lebanon, etc.</i>	<i>Israel</i> patrols fences along the Lebanon, Syrian, Jordan and Egyptian borders. “Off the [Lebanese] coast of <i>Rosh Hanikra</i> , there are seven linked buoys reaching out 4,200 meters from the coast.” <sup>1606</sup>
-----------------------------	---

A former prime minister of *Israel*, Ehud Barak, that *Israel* was building a “villa in the jungle,” since, as liberal Labor Party op-ed writer, Larry Derfner wrote:

I too have basically given up on the hope of *Israel* and the Palestinians making friends and I too think the Arab-*Islamic* world, on the whole, is up to its neck in violence and fanaticism.<sup>1607</sup>

<i>Israel-West Bank</i>	215 KM (134 miles) out of the 764 KM (475 miles) planned fence was built in early 2005. The fence has high-tech sensors,
-------------------------	--

and is surrounded by a ditch, a road and a sand track that shows footprints.

Suicide-bombers still sneak into *Israel* because, as of 7 December 2005, only 35 percent of the West Bank security fence was complete.<sup>1608</sup> By March 2006, half will be complete and the rest may be complete by 2007.<sup>1609</sup>

<sup>1598</sup> “Lebanese boat enters Israeli waters,” ynetnews.com, 22 Oct 2005.

<sup>1599</sup> Leyden, Joel. “Israel Defense Forces Navy Unleashes ‘Death Shark’ Against Terrorism,” israelnewsagency.com, 20 Oct 2005.

<sup>1600</sup> Haas, D. “Israel Plans High-Tech Barrier Around *Gaza*,” washingtonpost.com, 28 Jul 2005.

<sup>1601</sup> O’Sullivan, Arie. “Army: New *Gaza* fence is formidable barrier,” jpost.com, 8 Sep 2005.

<sup>1602</sup> O’Sullivan, A. & Krieger. “PM to decide on Egyptian border fence,” jpost.com, 30 Nov 2005.

<sup>1603</sup> Katz, Yaakov & David Horovitz. “Halutz says *Islamists* are rising,” jpost.com, 1 Jun 2006.

<sup>1604</sup> Derfner, Larry. “Sharon’s way is still the right way,” jpost.com, 28 Jun 2006.

<sup>1605</sup> Nahmias, Roe. “Report: *Israel* building *Arab* ghettos,” ynetnews.com, 27 Dec 2005.

<sup>1606</sup> O’Sullivan, Arie. “Navy builds anti-terror barrier off *Gaza* coast,” jpost.com, 17 Jun 2005.

<sup>1607</sup> Derfner, Larry. “Rattling the Cage: *Israel* is their home too,” jpost.com, 10 Apr 2006.

<sup>1608</sup> “Deputy IDF Chief of Staff: Only 35% of . . .,” *Haaretz* News Flashes, 7 Dec 2005, 15:59.

<sup>1609</sup> Frankel, Rafael D. “Security fence won’t be done before ‘07,” jpost.com, 7 Feb 2006.

The incomplete fence explains why “half of the *Israeli* terror fatalities in 2004 came from attackers who entered Jerusalem from Bethlehem.”<sup>1610</sup> Also, settlers with yellow *Israeli*-license plates (or *Jihadists* with stolen plates) are waved through inspections points on their way into *Israel*.

Even though the fences are far from complete, they have reduced the number of Palestinian terrorist attacks on Israelis by a hundred per month.<sup>1611</sup> There are fewer rocket and mortar attacks emanating from *Gaza*, and fewer Israelis die now than during the *Gaza* occupation, and before the triple-fence was built around *Gaza*.<sup>1612</sup>

In some populated sections a 7- to 9-meter high concrete wall is necessary to stop sniper attacks, and the concrete wall is more resistant to vandalism and militants armed with wire-cutters.<sup>1613</sup> An 11-meter high wall has been proposed for Jerusalem (which borders on the West Bank) since some athletic Palestinians have been scaling the 8-meter walls with ease.<sup>1614</sup>

The Jerusalem fence-wall is well within city limits, follows demographic lines, and consequently leaves 60,000 city residents, mostly Arabs, in the West Bank.<sup>1615</sup> Many Arabs from the West Bank used to enter Jerusalem:

Prior to establishment of the security barrier, more than 40,000 visitors from towns and villages in the West Bank came into Jerusalem daily. On Fridays [for Friday Prayers], the figure reached as high as 300,000. But now, says Darwish, the wall keeps the visitors and their trade out of the capital.<sup>1616</sup>

*Israel* experienced an eighty-four percent decrease in deaths in the year after completing less than a fifth of the total length of the proposed security fence between the West Bank and *Israel* proper (134 KM/84 miles between *Salem* and *Elkana*).<sup>1617</sup>

The fence is often credited for ending *Intifada* II. From 29 Sep 2001 to 29 Sep 2005, 1,060 Israelis were killed and 6,089 were wounded in 26,159 terror attacks.<sup>1618</sup> In 2005, Palestinians declared a lull (*Tahdiya*) in fighting but this was merely meant to mask the effectiveness of the fence. Tellingly, the number of terror incidents on the *Israeli* side of the fence is way down but on the Palestinian side the rate has stayed the same, as *Haaretz* reported:

As of mid-September [2005], before the current escalation in *Gaza*, the total number of violent incidents this year stood at 2,800. More than 705 of the incidents were in *Gaza*, a figure similar to the previous two years. The number of attacks within the Green Line nearly stayed the same this year—197 attacks (as of September 10), compared to 215 the previous year.<sup>1619</sup>

Completion is slow on the West Bank fence because it dips into Palestinian territory behind the Green Line in places, and so faces legal and diplomatic hurdles. Also, the best route takes time to determine since it hinges on security, demographics, and that fact that it will be the future border of *Israel* with adjustments.

<sup>1610</sup> “IDF to ease restrictions on Bethlehem,” jpost.com, 19 Dec 2005.

<sup>1611</sup> Gorin, Julia. “Some of My Best Friends Are Anti-Semites!” *FPM*, 8 Jun 2005.

<sup>1612</sup> O’Sullivan, Arieh. “IDF figures show dramatic drop in terror,” jpost.com, 13 Dec 2005.

<sup>1613</sup> Greenberg, Hanan. “More wall, less fence,” ynetnews.com, 6 Apr 2005.

<sup>1614</sup> “Jerusalem envelope security fence may be too low,” jpost.com, 28 Sep 2004.

<sup>1615</sup> Izenberg, Dan. “Wall in capital could trigger war,” jpost.com, 23 May 2005.

<sup>1616</sup> Winer, Stuart. “Eastern promise,” jpost.com, 19 May 2005.

<sup>1617</sup> Dudkevitch, Margot. “*Shin Bet* publishes terror report,” jpost.com, 27 Sep 2004.

<sup>1618</sup> Pipes, Daniel. “Fourteen Terrorist Attacks a Day against Israel,” *DP*, 29 Sep 2005.

<sup>1619</sup> Or, Sagi. “Fewest deaths this year since intifada began,” haaretz.com, 28 Sep 2005.

*Israel* could justify the incursions beyond the Green Line on the grounds that *Muslims* launch rockets and volley mortar rounds over the fence, and that these should not land in *Israel* proper. Palestinians snipers are also a concern, as is the *Muslim* habit of shooting weapons into the air at parades and weddings and other celebrations. Moreover, the concrete walls are needed as a sound barrier to help keep the accursed *Adhan* broadcast from *Mosques* from the ears of Israelis who are light sleepers.

The walls and fence are necessary to keep the Religion of High Explosives™ at bay. During *Intifada* II (2000-2004), armed guards searched everyone at the entry to every café, restaurant, school, bus stand, train terminal, wedding hall, hospital, mall and wherever people congregate.<sup>1620</sup> “At every mall in *Israel*, a security guard at the parking lot’s entrance asks drivers to pop the trunk and open the glove compartment.”<sup>1621</sup> Security checkpoints are everywhere and many synagogues and religious schools in *Israel* must have “metal doors, metal detectors, ‘panic’ buttons and cameras for video observation.”<sup>1622</sup>

In 2005, two suicide-bombers tried to bomb *Soroka* Medical Center in *Be’er Sheva* in the *Negev*. The first was a burn patient being treated there. She was disarmed at a *Gaza* border checkpoint in a blast-proof room after a hi-tech scanner discovered a bomb vest under her robe. The second, from *Beit Omar* near *Hevron*, blew up after he aroused the suspicions of a bus driver because he was carrying a heavy bag and rucksack. He was pursued by two guards who were badly injured by the blast.<sup>1623</sup>

The only reason the first bomber did not get as far as the second bomber even though: 1) her bomb was concealed and his bombs were not and 2) she had an appointment at the hospital and he did not, was because the fence around *Gaza* was complete but the fence around *Hevron* was not, as one official said:

...the security fence in southern *Har Hebron* is completely porous. Palestinian vehicles freely travel the area and there are no police forces to stop this... The only complaint Palestinians have is the cost of the ride to *Beer Sheeva*, charged by *Bedouins* who live in the area.<sup>1624</sup>

In 2005, *Abu Musab Al-Zarqawi*’s “*Al-Qaeda* in *Iraq*” (an *Al-Qaeda* franchisee) declared “the separation wall...will feel the might of the *Mujahideen*.”<sup>1625</sup>

<p><i>Kuwait-Iraq</i></p>	<p>A 13-foot wide trench, sand berm and fence is meant to catch <i>Iraqi</i> tanks and vehicles over a 120-mile long area ever since the end of Gulf War II in 1991. As of 2004, <i>Kuwait</i> plans to install an additional 135-mile (217 KM) “iron” wall.</p>
<p><i>Morocco-Polisario</i></p>	<p>The Algerian-backed <i>Polisario</i> Front wants statehood for an area known as Western Sahara on the northwest coast of</p>

Africa. This proposed state’s name would be *Sahrawi* Arab Democratic Republic (SADR) and its largest city would be *Laayoune*. *Morocco* occupies three-quarters of area in dispute. Since 1983 *Morocco* has kept the *Polisario Front* contained to the sparsely populated eastern quarter by using a 1554-mile (2,500 KM) three-meter-

<sup>1620</sup> Spencer, Robert. “Israel, Front Line of the Global *Jihad*,” FPM, *JW*, 29 Nov 2005.

<sup>1621</sup> Barnea, Nahum. “Cat and mouse: Terrorists take advantage of...,” ynetnews.com, 29 Jul 2005.

<sup>1622</sup> “Russian Jews move to bolster security,” ynetnews.com, 18 Jan 2006.

<sup>1623</sup> Harel, Amos & Nir Hasson. “Suicide bomber critically injures guard in *Be’er Sheva* blast,” haaretz.com, 28 Aug 2005.

<sup>1624</sup> Waked, Ali. “*Islamic Jihad* behind *Beer Sheva* attack—sources,” ynetnews.com, 28 Aug 2005.

<sup>1625</sup> Gold, Dore. “*Jihad* coming: Israel had better start taking...,” ynetnews.com, 3 Jan 2006.

high sand and stone berm fortified with fences, bunkers and one million landmines. 120,000 Moroccan soldiers guard the barrier which has reduced *Polisario* terrorism to a minimum.<sup>1626</sup> In many places the barrier doubles and *Sahrawis* live a restricted life between the two barriers. The *Sahrawis* have dubbed the barrier “The Wall of Shame.” These same *Sahrawis* hold about 500 Moroccan POWs and some POWs are held for twenty years at a time!<sup>1627</sup>

Saudi Arabia-Iraq	Saudi Arabia <b>may</b> be planning to build a 900-KM (560-mile) fence along the <i>Saudi-Iraq</i> border. The intent is to nab <i>Jihadists</i>
as they enter or return from <i>Iraq</i> and also to separate the <i>Saudi's Shia</i> minority from <i>Shias</i> in <i>Iran</i> and <i>Iraq</i> in the hopes that they do not become radicalized. <sup>1628</sup>	
Saudi Arabia-Yemen	Saudi Arabia is building a ten-foot-high fence to separate the warlike <i>Wayilah</i> tribe in <i>Yemen</i> from the <i>Yam</i> tribe in <i>Saudi</i>
Arabia. <sup>1629</sup> The <i>Saudis</i> claim most of the explosives entering <i>Saudi</i> Arabia come from <i>Yemeni Islamists</i> . <sup>1630</sup> During Gulf War I (1990-1991), the <i>Saudis</i> expelled “several hundred thousand <i>Yemenis</i> ” when the <i>Yemeni</i> government announced support for Saddam Hussein’s invasion of <i>Kuwait</i> . <sup>1631</sup> This is similar to how <i>Saudi</i> Arabia expelled two-hundred thousand Palestinians to Jordan when Yasir Arafat announced support for Saddam Hussein.	
Singapore-Malaysia-Indonesia	Singapore is an island separated from <i>Malaysia</i> by the narrow <i>Johore</i> Strait, which is narrow enough to swim across. Singapore is separated from Indonesia by the Strait of
<i>Malacca</i> , which requires a boat to cross. The fence is being built on the coast facing <i>Malaysia</i> . <sup>1632</sup> Singapore is 18 percent <i>Muslim</i> , Indonesia is 83 percent <i>Muslims</i> and <i>Malaysia</i> is 60 percent <i>Muslim</i> .	
Thailand-Malaysia	“The <i>Thai-Malay</i> barrier is a proposed separation barrier covering 100 KM of the 650 KM border with <i>Malaysia</i> where

regular *Thai* patrols do not normally reach. To be constructed by *Thailand*, its stated purpose is to cut suspected escape routes used by militants in *Thailand's* largely *Muslim* south, where more than 500 people died just in the first ten months of 2004.<sup>1633</sup> Relations between the South East Asian neighbors have been strained since *Thai* officials said militants behind the violence had taken refuge in *Malaysia*. *Thai* security experts estimate that some 5,000 people hold dual *Thai-Malaysian* citizenship and they have been allowed to cross the border at will. Both nations have expressed concern over the dual-citizenship issue and *Thailand* aims to bring the practice to an end.”<sup>1634</sup> *The Jerusalem Post* reported that “*Thailand* was building a wall to cordon off almost two million *Muslims* in southern *Thailand*—a wall higher and longer than the controversial ‘security fence’ *Israel* is building.”<sup>1635</sup>

<sup>1626</sup> Thein, Ben. “Is Israel’s Security Barrier Unique?” *Op. Cit.*

<sup>1627</sup> WordIq.com, accessed 10 Sep 2004, *Polisario* entry.

<sup>1628</sup> Theodoulou, M. “Saudis plan to fence off border with chaos,” timesonline.co.uk, 10 Apr 2006.

<sup>1629</sup> WordIq.com, accessed 10 Sep 2004, “*Saudi-Yemen* barrier” entry.

<sup>1630</sup> Feldner, Yotam. “The Saudi Separation Fence,” *MEMRI*, no. 162, 13 Feb 2004.

<sup>1631</sup> “Background Note: Saudi Arabia,” state.gov/t/pa/ei/bgn/3584.htm, Sep 2004.

<sup>1632</sup> Singapore builds fence to halt illegal immigration from ocean, etaiwannews.com, 21 Aug 2004.

<sup>1633</sup> “*Buddhist* teacher killed in continuing violence in *Thailand's Muslim* south,” thestar.com, 10

Nov 2004, C&R.

<sup>1634</sup> WordIq.com, accessed 10 Sep 2004, “*Thai-Malay* barrier” entry.

<sup>1635</sup> Taheri, Amir. “Eye of the Storm: What if it’s not *Israel* they loathe?” jpost.com, 2 Dec 2004.

Turkey-Syria	Turkey built fences to keep both Syrian and Kurdish <i>Muslims</i> out. <sup>1636</sup> Turkey's nearly 500-mile-long fence bordering on Syria is mined. <sup>1637 1638</sup>
US-Mexico-Canada	It is known that <i>Muslims</i> have snuck over the northern and southern borders of the US An <i>Al-Qaeda</i> operative trying to bomb during the Millennial celebrations in 2000 was arrested on the US-Canadian border.
<p>Ironically, the US military protects borders around the world but not its own! The 14 miles of fence between San Diego, California and <i>Tijuana</i>, Mexico has cut down arrests there by 83 percent, leading many to believe that spending 8 billion to fence the 2,000 miles (3,200 KM) of US-Mexico border with hi-tech fencing would enhance security greatly.<sup>1639</sup> In 2005, Congress approved the fencing of the 700 most-trafficked miles of the US-Mexico border, and ordered a study of fencing along the US-Canada border.<sup>1640</sup> In 2006 some U.S. troops were sent to guard the border and subsequently Mexican guides and smugglers hiked their charges.<sup>1641</sup> Likely the price of street drugs will increase, too.</p>	
Uzbekistan-Kyrgyzstan	Uzbekistan is building a fence bordering <i>Kyrgyzstan</i> . The <i>-istan</i> suffix indicates these are <i>Muslim</i> -dominated countries. <sup>1642</sup>

<sup>1636</sup> Makovsky, David and Ben Thein. "Unilaterally Constructed Barriers in Contested Areas," washingtoninstitute.org, cross-posted at imra.org.il, 9 Jul 2004.

<sup>1637</sup> Rubin, Michael. "The problems of neo-Ottomanism," *NRO*, 10 Aug 2004, .meforum.org.

<sup>1638</sup> Stakelbeck, Erick. "Fence hypocrisy," washtimes.com, 31 Aug 2004.

<sup>1639</sup> Hall, Mimi. "Momentum builds for fence along U.S.-Mexican border," *USA Today*, usatoday.com, 17 Nov 2005, p. 1A.

<sup>1640</sup> Dinan, Stephen. "House passes bill on border security," washingtontimes.com, 17 Dec 2005.

<sup>1641</sup> "Mexico's Migrant-Smugglers Hike Rates," 14 Jun 2006, HotAir.

<sup>1642</sup> Stakelbeck, Erick. "Fence hypocrisy," washtimes.com, 31 Aug 2004.

### *Islamist Autonomous Regions*

Daniel Pipes and Khalid Durán wrote:

*Islamists* living in the West at a minimum seek to establish an autonomous zone in which to live their lives. More often, they seek to impose their views and ways of life on other *Muslims* and even on the non-*Muslim* majority. And in some cases, they hope to vanquish the West itself, purging its blemishes and making its strengths their own.<sup>1643</sup>

*Muslims* constitute the vast majority in *Morocco* and are becoming numerous in southern Spain. In 2005, a prison gang was casing the Strait of *Gibraltar* ferries that travel between *Ceuta, Morocco* and *Algeciras, Spain*, for bombing.<sup>1644</sup>

The southern Philippine Islands, where *Muslims* form the vast majority, is sometimes called the *Moro*. Not only are *Islamic* insurgents active everywhere in the south Philippines demanding autonomy, but shipping and ferries everywhere make for inviting targets. In 2004 *Superferry 14* was bombed by an *Abu Sayyaf* terrorist.<sup>1645</sup>

*Somalia* sits on a peninsula called the Horn of Africa. The Arabian Sea narrows between *Somalia* and *Yemen* at the south end of the Arabian peninsula. *Somalia* and *Yemen* are nearly 100 percent *Muslim*. Since 1991, *Somalia* has been controlled by warlords. In 2005 *Somali* terrorists took over a ship carrying 10 crewmen and 850 tons of rice provided by the U.N.<sup>1646</sup> In 2005, *Somali* pirates demanded 500,000 USD for “three Taiwanese captains and 45 crew members from Indonesia, China, the Philippines and Vietnam,” but settled for 50,000 USD.<sup>1647</sup> In 2005, a Ukrainian ship with 22 crewmen was hijacked while ferrying iron-ore from South Africa to Europe.<sup>1648</sup> “The London-based International Maritime Bureau said it knew of 30 pirate attacks off *Somalia* between March and November 2005.<sup>1649</sup> *Yemeni* pirates are also active but “the *Aden [Yemeni]* authorities...[are] largely indifferent” to piracy.<sup>1650</sup> After a warship in a *Yemen* port was attacked in 2000, the US Navy developed a sonic weapon, LRAD, for use against terrorists approaching with boat-bombs. A luxury cruise liner used evasive maneuvers and LRAD in 2005 to fend off pirates 100 miles off the *Somalian* coast.<sup>1651</sup>

*Zanzibar* is a semi-autonomous island off *Tanzania*,<sup>1652</sup> the country south of *Kenya*. While *Tanzanians* are a third Christian, a third *Muslim* and a third “other,” *Zanzibar* islanders are 99 percent *Muslim*. *Tanzanian Islamists* are agitating for implementation of *Sharia* law and the end to multi-party secular rule which has been the norm only since 1995.<sup>1653</sup>

<sup>1643</sup> Pipes, Daniel & Khalid Durán. “*Muslims* in the West: Can Conflict Be Averted?” U.S. Institute of Peace, Aug 1993, *DP*.

<sup>1644</sup> Goodman, *Al*. “Terrorist charges for jailed woman,” *cnn.com*, 9 Sep 2005.

<sup>1645</sup> Elegant, Simon. “The Return of *Abu Sayyaf*,” *time.com*, 23 Aug 2004.

<sup>1646</sup> Mayoyo, Patrick. “Fresh Bid to Set Hostages Free,” *The Nation* (Nairobi), 28 Aug 2005.

<sup>1647</sup> “*Somali* pirates slash hostage return prices,” *jpost.com*, 7 Sep 2005.

<sup>1648</sup> “Pirates hijack ship off *Somalia*,” *news.bbc.co.uk*, 21 Oct 2005.

<sup>1649</sup> “‘Mother ship’ behind pirate raids,” *news.bbc.co.uk*, 11 Nov 2005.

<sup>1650</sup> Frenkel, Sheera C. “US couple fights Red Sea pirates,” *jpost.com*, 6 Jun 2005, *JW*.

<sup>1651</sup> Pain, John. “Ship Blasted Pirates With Sonic Weapon,” *washingtonpost.com*, 7 Nov 2005.

<sup>1652</sup> *CIA Factbook 2004, Tanzania* entry.

<sup>1653</sup> Ngowi, R. “*Zanzibar* Adopting Stricter Form of *Islam*,” *news.yahoo.com*, 4 Jul 2005, *JW*.



In southern *Thailand*, there is an *Islamic* insurgency active where the land narrows to a long strip divided between three provinces where *Muslims* are concentrated. Only 3.8 percent of *Thais* are *Muslim*, according to the *CIA Factbook* for 2004. “*Islamic* insurgents were stepping up attacks [starting mid-2005] because they plan to declare an independent state” in 2006.<sup>1654</sup> In 2005 a retired general said: “The separatist movement has complete control of the people. Only the land belongs to us...”<sup>1655</sup>

In oil- and gas-rich *Aceh*, Indonesia, an *Islamic* insurgency called *Free Aceh* has operated since 1976. *Free Aceh* created an autonomous enclave where *Sharia* law was implemented on 1 January 2002. *Aceh* is at the pointy northwest edge of the island of *Sumatra*, a resource-rich island of Indonesia.<sup>1656</sup> *Aceh* is also a base for some of the *Muslim* pirates who plague the *Malaccan* Strait shipping channel. The area was hit hard by a Boxing Day tsunami in 2004.

*Rotterdam*, Netherlands, which is the busiest port in the world, also has the biggest *Mosque* in Europe. Nearly half of *Rotterdam*’s populace is *Muslim*. A quarter of the Netherlands is below sea-level and is protected by 1,500 dikes, which makes for an ideal terrorist target.<sup>1657</sup>

*Chechnya* and *Dagestan* are *Muslim* majority provinces of Russia on the land bridge between the *Caspian* and Black Seas. *Jihadists* there have sought independence for over two centuries, especially since 1991 when the USSR disbanded.

Ports everywhere are vulnerable. *Islamic* terrorists attacked and nearly sank a US Destroyer docked in *Yemen* in 2001, and in 2005 a terrorist fired three rockets at two US Navy ships docked in *Aqaba*, Jordan’s Red Sea port.<sup>1658</sup> Shipping lanes that are causes of concern among counter-terrorism experts include: 1) the canals of New York State, 2) the narrows of the Great Lakes in the US such as by Michigan, 3) the St. Lawrence River seaway between the US and Canada, 4) the Strait of *Hormuz* in the Persian Gulf, 5) the Strait of *Malacca* between Indonesia and Australia, 6) the Strait of Gibraltar, 7) *Bab el-Mandab* passage on the Arabian Sea, 8) the Suez canal and the narrow Red Sea,<sup>1659</sup> <sup>1660</sup> 9) the Bosphorus of the Black Sea, and 10) the Panama Canal.

In the Red Sea there are modern-day pirates, as the *Jerusalem Post* reported:

Over the past seven years, the Red Sea crossing has become dangerous for private boats. *Yemenite* pirates found they could loot and pillage the luxury yachts to their hearts content, due to a lax Coast Guard presence in the area, say *Israeli* authorities....The couple [two near-victims of pirates] found *Aden* [*Yemenis*] authorities to be largely indifferent [to the piracy] and watched as their complaint was added to a thick pile of similar reports on the local secretary’s desk.<sup>1661</sup>

<sup>1654</sup> “*Muslim* official shot dead in southern *Thailand*, teachers seek guns,” news.yahoo.com, 27 Jun 2005, C&R.

<sup>1655</sup> “*Muslim Thai* separatists strengthen in south,” jpost.com, 4 Jul 2005.

<sup>1656</sup> “*Aceh* introduces *Islamic* law,” cnn.com, 2 Jan 2002.

<sup>1657</sup> de Borchgrave, A. “Mini clash of civilizations,” washtimes.com, 15 Nov 2004.

<sup>1658</sup> “*Al Qaeda* claim for Red Sea attacks,” cnn.com, 19 Aug 2005.

<sup>1659</sup> Wood, David. “Terrorism Fears Divert Navy Supply Ships From *Suez* Canal,” newshousenews.com, 13 Jan 2005, *JW*.

<sup>1660</sup> O’Sullivan, Arieh. “[*Israeli*] Navy quits sending ships through *Suez*,” jpost.com, 9 Dec 2005.

<sup>1661</sup> Frenkel, Sheera C. “US couple fights Red Sea pirates,” jpost.com, 6 Jun 2005, *JW*.

In the Strait of *Malacca* by Indonesia, there were 28 pirate attacks in 2003 and 37 in 2004. The Associated Press also reported:

Most of the pirate attacks involved vessels being fired on and crew kidnapped for ransom. Thirty-six seafarers were abducted in the strait last year; four were killed and three injured. The pirates struck despite *Malaysia*, Indonesia and Singapore launching coordinated naval patrols in the 550-mile route, which is used by 50,000 ships each year.<sup>1662</sup>

---

<sup>1662</sup> “Malaysia Does Not Want Help Vs. Piracy,” news.yahoo.com, 25 Feb 2005.

**Let's You and Him Fight: Deceptive Triangulation  
Used to *Islamize* One Nation After Another**

**Discussion:** *Muslims* may pretend to be friends with infidel groups and states for the sake of *Muslim* security or to promote future *Islamic* expansionism, until such time as *Islam's* enemies are weakened by fighting among themselves and *Muslims* gain the upper hand (K 003:028). Hence, *Muslims* will play one enemy against another and will use ruses and propaganda to cultivate neutral but naïve nations into being enemies of *Muslims'* enemies. In the West, this game is referred to as “the enemy of my enemy is my friend.” In Arab cultures, the game is called: “Me and my brother against my cousin, me and my cousin against the world.”<sup>1663</sup>

**Pitting Christians vs. Jews:** The first *Muslim* conquerors stressed their doctrinal points of commonality when they met Christians and Jews separately. Christians could agree with *Muslims* on certain points against pagans and Jews, and Jews could agree with *Muslims* on certain points against pagans and Christians. This made the idea of *Muslims* conquering the Mideast and elsewhere seem more palatable than maintaining the *status quo* with Byzantine or *Sassanian* rulers in charge.

**Pitting *Dhimmis* vs. *Dhimmis*:** *Muhammad* and then later *Caliphs*, alternately triangulated one *Dhimmi* community against another to keep them in check and diminish them each in turn, as Bat Yeor has pointed out. Each community was interested in curbing the power and influence of the other *Dhimmi* communities, as well as edging out the other community as far as favors from the *Caliph* were concerned. Each side also was interested in seeing the other *Dhimmi* communities get their comeuppance so they could indulge themselves in *Schadenfreude*, i.e. pleasure derived from the misfortunes of others.

**Pitting U.N. vs. the West:** The bloc of 23 *Muslims* states has teamed up with dictators and many third-world countries in order to: 1) Render the U.N. useless in the fight for human rights and justice and religious freedom in *Islamdom*, 2) Block the U.N. from investigating any ethnic-cleansings and genocides that occur within *Islamdom* or on its fringes, 3) Block the U.N. from having anything but a narrow definition of terrorism, 4) Block the U.N. from condemning suicide-bombings in God's name as a “defamation of religion,”<sup>1664</sup> 5) Have the U.N. side with *Muslim* militias and terrorists against infidel nations such as in *Serbia* and 6) Turn the U.N. into weapon against *Israel*, *America* and other nations.<sup>1665</sup>

**Pitting the United States vs. Egypt's Enemies:** In 1974 the US brokered a peace agreement between *Israel* and *Egypt* where, in exchange for feigning friendship with *Israel*, *Egypt* got back the Sinai Peninsula it had lost to *Israel*, and *Egypt* received two billion USD per annum from the US in the form of cash and armaments—apparently *in perpetuum*.

*Egypt* has never shown much gratitude for the \$60 billion paid so far and the

<sup>1663</sup> “Iraq and al Qaeda: Who's campaigning to deny the links?” *WSJ*, 25 Oct 2002; “Kid gloves syndrome,” [theaustralian.news.com.au](http://theaustralian.news.com.au), 28 Jan 2006.

<sup>1664</sup> “Criticism of suicide bombers censored at the UN,” The International Humanist and Ethical Union (IHEU), [iheu.org](http://iheu.org), 26 Jul 2005, *DW*.

<sup>1665</sup> Fitzgerald, Hugh. “Stop taking the UN seriously,” *DW*, 9 Dec 2005; “The *Jihad* against Ethiopia,” *DW*, 14 Dec 2005.

Egyptian press is anti-American and anti-*Israeli* as ever. It seems the money is considered tribute, or a *Jizya* poll tax paid on the repressed Copts' behalf so they can continue to practice Christianity. There are only five million Copts in Egypt, so the US has paid \$12,000 USD in *Jizya* per Copt since 1974. Many American *Jizya*-payers have complained about this arrangement, but the military-industrial complex sees profit in it, so the mega-checks keep going out.

Unfortunately, the US has strengthened Egypt's hand against *Israel*, as well as against countries to Egypt's south that could better use the Nile's waters since they: 1) are always on the verge of starvation and 2) are semi-arid and need less water to grow food, while irrigating Egypt's hot and dry deserts is hugely wasteful of water.

The farther south one travels on the Nile, the more non-*Muslim* the countries become and the *Muslims* are less radicalized. Yet Egypt is able to flex its military muscle, thanks in part to the US, to veto all proposed irrigation projects to its south. This means the US helps the Egyptians to deprive Christians, pagans and less radical *Muslims* of needed food when the richer Egyptians could readily import food from elsewhere if the need arose.

**Pitting Jews vs. Anti-Jihadists:** In the West, *Muslims* fight for special protections for *Muslims* and *Islam* under anti-defamation and anti-hate-speech laws. In 2005 Erdoğan said that “associating *Islam* and *Muslims* with terrorism” was a misconception and constituted *Islamophobia*, and that “*Islamicphobia*” and “anti-*Islamism* must [both] be treated as a crime against humanity just like anti-Semitism.”<sup>1666</sup>

*Muslims* also argue that Europeans have blasphemy laws protecting Christianity, so they want new laws crafted specifically to protect *Islam*—even though blasphemy laws were repealed long ago or fell into disuse.<sup>1667</sup>

In 2006 *Muslims* sought to have the editors of a Danish newspaper tried for defamation and civil rights violations for having printed cartoons of *Muhammad*.<sup>1668</sup> *Islamic* countries banned the cartoons from their newspapers and censored the Web. They also asked the U.N. Commission on Human Rights to institute the same ban worldwide.<sup>1669</sup>

While *Muslims* and Jews seek to restrict the rights of non-*Muslims* whose sacred books generally are not filled with tribalisms, communalisms and a totalitarian religio-political ideology, they want advance exemption for their sacred books that would otherwise be proscribed under the laws they propose for others follow to the letter. Here is the exemption found in the Israeli penal code:

Publication of quotes from religious texts or prayer books, or protecting [protected] religious rituals will not be seen as offenses under Article 144-b, as long as the offense was not committed with intent to incite to racism.<sup>1670</sup>

<sup>1666</sup> “Anti-*Islamism*”: Albayrak, Mukremin & Nuri Imre. “Erdogan Asks *Islamic* Leaders to Explain *Islam* in the Best Way,” zaman.com, 6 Sep 2005, *Islamonline.net*, *DW*; “*Islamic-phobia*”: Ser, Sam. “Turkey’s chief rabbi attends ‘Meeting of Civilizations,’” jpost.com, 30 Sep 2005.

<sup>1667</sup> Rennie, David. “Turkey’s foreign minister asks the EU for blasphemy laws to protect *Islam*,” telegraph.co.uk, 13 Mar 2006.

<sup>1668</sup> Booth, Jenny. “Danish *Muslims* sue over *Muhammad* cartoons,” timesonline.co.uk, 17 Mar 2006, *DW*, *C&R*.

<sup>1669</sup> Kamran, Mohammad. “SC seeks legal avenues to ban blasphemous cartoons worldwide,” dailytimes.com.pk, 14 Mar 2006, *DW*, *C&R*.

<sup>1670</sup> Aloni, Shulamit. “Kahane won,” ynetnews.com, 21 Mar 2006.

Even while *Muslims* perpetrate most of the anti-Semitic crimes in the world and publish more anti-Semitic cartoons and diatribes than anyone else, some gentile politicians and Jewish leaders team up with *Muslims* in order pass laws that super-empower *Muslims* similar to how *Sharia* law super-empowers *Muslims*. For instance, Rome's chief rabbi Riccardo Di Segni visited the main *Mosque* in Rome to meet with two prominent *Muslims* in Italy. He said:

For us Jews it was evident...to react and protest the satirical [Danish] cartoons of what is sacred for *Islam*, and to show our solidarity...The fights against *Islamophobia* and anti-Semitism have to go hand-in-hand.<sup>1671</sup>

The only end results of such of meeting could be: 1) the rabbi received not one **sincere** assurance that *Muslims* would fight anti-Semitic cartoons anywhere, and 2) the potential victims of *Islamic* terrorism will no longer have the free-speech right to print cartoons to fight back against those who believe that incitement to terrorism is a free speech right and part of their free exercise of religion. This is confirmed by the fact that a 2006 international conference on racism, xenophobia, *Islamophobia* and anti-Semitism dropped the subject of anti-Semitism "following pressure from Arab countries." Then to add insult to injury, "Austria's ambassador to Israel, Kurt Hengel, told the *Post* that the Euro-Med framework was the only forum where Israel and Arab countries sat together, and that 'it wouldn't be wise for the Israeli side not to take part in this type of forum, where it can make its point.'<sup>1672</sup> What this means is when someone twists the Arabs' arm to sit at the same table as Israelis, Arabs still get to choose the subjects to be discussed.

Jews' backing of *Muslims* in their bid to gain special rights may backfire on Jews and other minorities. Just as *Islam* misappropriated elements of Christianity and Judaism as well as their lands, so nowadays *Islamists* are widely claiming to be the "New Jews"—the latest minority persecuted for no good reason.<sup>1673</sup> This will likely result in sympathy for, and special legal protections for, Jews being stripped away and given to *Muslims*. Also, it will lead infidels to believe that giving special protections to a persecuted minority:

☉ Always lead to abuse. Such was the case in Canada in 2005 when rabbinical family courts became de-recognized by the Canadian government because *Muslims* wanted *Sharia* family courts.<sup>1674</sup>

☉ Is a slippery slope whereby infidels plant the seeds for an *Islamic*

<sup>1671</sup> "Chief rabbi of Rome pays historic visit to Italian *Mosque*," haaretz.com, 13 Mar 2006.

<sup>1672</sup> Keinon, Herb. "Israel to boycott racism conference," jpost.com, 21 May 2006, *Media Backspin*.

<sup>1673</sup> "Are *Muslims* the Jews of Today," fjordman.blogspot.com, 28 Nov 2005, *DW*.

<sup>1674</sup> Houck, David Kennedy. "The *Islamist* Challenge to the U.S. Constitution," *Middle East Forum Quarterly*, meforum.org, Spring 2006.

<sup>1675</sup> "Jews, *Muslims* vow to fight for faith-based tribunals in Ontario," haaretz.com 14 Sep 2005;

also see Pipes, Daniel. "Enforce *Islamic* Law in Canada?" danielpipes.org, 27 Sep 2005.

<sup>1676</sup> Freedland, Jonathan. "The sickness bequeathed by the west to the *Muslim* world," guardian.co.uk, 14 Dec 2005, *DW*.

<sup>1677</sup> Trifkovich, S. "The Myth of an *Islamic* Golden Age," chroniclesmagazine.org, 7 Nov 2003.

<sup>1678</sup> Julius, Lyn. "Dilemmas of *Dhimmitude*," jewishquarterly.org, Spring 2005, no. 197.

<sup>1679</sup> Yeor. *Dhimmitude*, pp. 85, 109-110 & p. 436, endnote 10 (reference Spain).

<sup>1680</sup> Segals. *Islam's Black Slaves*, p. 98, as quoted by Schmidt. *Divide*, p. 120.

<sup>1681</sup> Pipes, Daniel. "Anti-Semitism Evolves," *DP*, 15 Feb 2005.

<sup>1682</sup> Elazar, Daniel J. "Can Sephardic Judaism be Reconstructed? After a Thousand Years, New Divisions?" Jerusalem Center for Public Affairs, jepa.org, accessed 2 Feb 2006, wikipedia.org.

theocratic state right in their own midst.

As a result, any laws against anti-Semitism and Holocaust-denial would be repealed or at least not enforced stringently.

*Muslims* and Jews have also fought for faith-based family and civil law arbitration and courts, as *Haaretz* reported in 2005:

Jews and *Muslims* in Canada's largest province pledged Wednesday to fight for faith-based tribunals to settle family disputes after Ontario's premier stunned their communities by announcing he would ban all religious arbitration in the province.<sup>1675</sup>

Having special courts tends to encourage the non-integration of *Muslims* into the West. This danger is appreciated more by billions of gentiles who cannot as easily skip the country and rejoin the Diaspora elsewhere, or make *Aliya* to *Israel* or *Yerida* out of *Israel*, if the multicultural experiment fails and anti-Semitism, anti-Americanism or anti-whatever blossoms and *Jihad* terrorism ensues apace.

A major reason why some Jews have a deep-seated, unshakable belief that Christianity is more of a threat to Jews than *Islam* is, though somehow the *Ashkenazi* in Europe came to greatly outnumber the *Sephardim* in *Islamdom* even after factoring in the Holocaust, is:

- ☉ Most people are unfamiliar with the anti-Semitism mandated in the *Koran* and *Hadith* and *Sira*, nor with the institution of *Dhimmitude*.
- ☉ The neo-pagan *Nazis*, who scoffed at Christianity and put their trust in eugenics and survival-of-the-fittest evolution, recycled popular Western anti-Semitism into *Nazi* propaganda.
- ☉ The Jews often see their Golden Age as having come and went during the *Convivencia* period in Spain, as Jonathan Freedland wrote:

In a period Jews still look back on as a golden age, *Muslims* were the people of scholarship, of science, of tolerance and coexistence—a contrast with the Crusader barbarians.<sup>1676</sup>

The *Convivencia* period is the Spanish version of England's *Camelot* myth. Serge Trifkovic wrote that the *Convivencia* period is...

...a fairy tale designed to create the illusion that multiculturalism has valid historical precedents that prove it can work.<sup>1677</sup>

Lyn Julius wrote about the *Convivencia* period:

One of leading writers on *Islamic* history, Bernard Lewis, believes the golden age in Spain is a myth—Jews were persecuted by both *Muslims* and Christians:

Belief in it was a result more than a cause of Jewish sympathy for *Islam*. The myth was invented by Jews in nineteenth-century Europe as a reproach to Christians—and taken up by *Muslims* in our own time as a reproach to Jews.<sup>1678</sup>

Anyway, how could the *Convivencia* period be a time of tolerance when *Muslims* had destroyed all the churches and kept them from being rebuilt, enforced the barbaric *Sharia* law<sup>1679</sup> and had enslaved a fifth of all Spaniards?<sup>1680</sup>

There are other ways that Christians have been compared badly to *Muslims*. Daniel Pipes noted:

Christians developed the abiding tropes of anti-Semitism (such as greediness and ambitions to world domination), and historically Christians killed most Jews. Therefore, Jews regularly fled Christendom for *Islamdom*.

In 1945, this pattern abruptly changed. Christians came to terms with Jews,

while *Muslims* adopted both the old Christian themes and murderousness. Today institutional anti-Semitism is overwhelmingly a *Muslim* affair. One result has been a steady reverse exodus, with Jews now fleeing *Islamdom* for Christendom.<sup>1681</sup>

As with all crime statistics, the number of persons affected must be tabulated in before comparisons can be made of the relative safety of a community. By 1931, the *Ashkenazi*, who lived in Christendom, were 92 percent of world Jewry.<sup>1682</sup> That means if Jews were victimized at the same rate in *Islamdom* and Christendom, 11.5 *Ashkenazis* would have been assaulted or murdered or fled for each *Sephardim* similarly affected. So saying that **more** Jews were killed in Christendom than in *Islamdom*, or **more** Jews fled Christendom for *Islamdom* than *vice versa*, by itself does not prove which religion was more tolerant of Jews.

**Pitting Mizrahi Jews vs. Ashkenazi Jews:** In *Israel*, *Muslims* argue that “the *Mizrahi* Jews (Jews of recent Middle Eastern descent) are Arabs and should forge a coalition with the Arabs against the *Ashkenazi* [European] Jews who are responsible for Zionism.”<sup>1683</sup>

The *Mizrahi* are a subset of the *Sephardic* Jews. *Sephardim* have not fared as well as *Ashkenazi* Jews in any sphere of life in *Israel*, on average, including in the academic sector where “only three to eight percent of our academics are *Sephardi* and only one percent Arab.”<sup>1684</sup> Lyn Julius wrote:

The very expression ‘Arab Jews’ is a misnomer to describe people who were living in the Middle East and North Africa 1,000 years before *Islam* and the seventh-century Arab invasion. From these communities sprang the Babylonian Talmud, Rabbi Hillel and the philosopher Philo.<sup>1685</sup>

In 1975, Qaddafi asked Jews to return to *Libya*, saying “Are you not Arabs like us, Arab Jews?” Albert Memmi, a *Tunisian*-born French writer wrote:

Yes, indeed we were Arab Jews—in our habits, in our culture, our music, our menu. But must one remain an Arab Jew if, in return, one has to tremble for one’s life and the future of one’s children and always be denied a normal existence? We would have liked to be Arab Jews. If we abandoned the idea, it is because over the centuries the *Muslim* Arabs systematically prevented its realization by their contempt and cruelty.<sup>1686</sup>

*Muslims* argue that both Jews and Arabs are victims of, and must ally against, Western hegemony, neo-colonialism and the colonialist enterprise called Zionism.<sup>1687</sup> *Muslims* argue this even though:

☉ It was *Muslims* who expelled 600,000 *Sephardic* Jews from Arab countries in 1948, and since then *Muslims* have made the lives of the remainder so miserable and insecure that most Jews have fled *Islamdom* altogether.

☉ The Jews had it better in *Islamdom* when the colonialists were in power there, as Lyn Julius wrote:

...As the European powers increased their influence and during the colonial era, Jews and Christians acquired near-equal status to *Muslims*.

<sup>1683</sup> Rapoport, Meron. “In the name of truth,” haaretz.com, 28 Apr 2005; see also Wurmser, Meyrav. “Post-Zionism and the Sephardi Question,” meforum.org, Spring 2005, Vol. II, No. 2.

<sup>1684</sup> Raved, A. & Nahmiass. “Disengagement will strengthen Galilee,” ynetnews.com, 16 Jun 2005.

<sup>1685</sup> Julius, Lyn. “Dilemmas of *Dhimmitude*,” jewishquarterly.org, Spring 2005, no. 197.

<sup>1686</sup> Julius, Lyn. “Dilemmas of *Dhimmitude*,” jewishquarterly.org, Spring 2005, no. 197.

<sup>1687</sup> Fitzgerald, Hugh. “Columbia Teaches Hate,” *DW, FPM*, campuswatch.org, 6 Jun 2005,

“Constructing ‘The Other,’” *DW*, 22 Dec 2005 (alludes to book of Prof. Gil Anidjar, Columbia U).

Crucially however conditions for the non-*Muslim* minorities deteriorated again when Arab nation states gained their independence...We [Jews] lived in the shadow of a beast [*Islam*] which for years had maintained a stony silence and suddenly his giant frame was wracked by a fever. We could feel him quaking and then he threw his full weight upon one victim or another.<sup>1688</sup>

*Muslims* have teamed up with some ultra-orthodox Jews from *Neturei Karta*. *Neturei Karta* leaders do not believe in the validity of the Jewish state and they have met with the likes of *Hezbollah*, *Hamas* and the Council on American-Islamic Relations (CAIR-USA).<sup>1689</sup>

A *Neturei Karta* leader, Moshe Hirsh, has met personally with Arafat, and in 2006 he met Iranian President Mahmoud Ahmadinejad who publically denies the Holocaust and calls for the elimination of Israel one way or another.<sup>1690</sup>

The delusional thinking that animates *Neturei Karta* is:

Before Zionists started pressing for a Jewish state in the early 1900s, Weiss said [that] Jews lived in harmony with *Muslims*. ‘Zionism brought about this terrible rift, this mistrust that we can’t live in *Muslim* lands,’ he said. ‘It’s a terrible tragedy. We can live together.’ ‘We pray everyday for the speedy dismantlement of this rule of the state of *Israel* so that it should be transformed into the rule of the Palestinian people, so Jews can live together with Arabs, *Muslims* in harmony....Nothing else will bring an ongoing long-lasting peace.’<sup>1691</sup>

**Pitting Conservatives vs. Free Speech:** *Muslims* like to speak of a common Abrahamic heritage and values in order insinuate *Islam* into the Western identity. This supposed confraternity between the West and *Muslims* is an illusion cast by *Muslims* in order to break down resistance to *Islamization*. The message is that are we like you—only better.

Another problem with this three-way “group hug” is that one party has totalitarian ideas, engages in *Takiya*-speak and double-crossing and wishes to ultimately overpower its allies. For instance, not only do *Muslims* criticize and protest against amoral Secularists and Hollywood, but *Islamists* go farther and kill free speech by:

- In 1977 *Muslims* took 149 hostages in a 39-hour stand-off in Washington D.C. on 9 March 1977 to protest a film about Hamza, *Muhammad*’s uncle, even though Hollywood took care not to show *Muhammad*’s face.<sup>1692 1693</sup>
- In 2005, Jordan and other *Muslim* countries banned Dan Brown’s *The Da Vinci Code* novel that said Jesus fathered a child by Mary Magdalene.<sup>1694</sup>
- In 2005 *Muslims* issued death-sentence *Fatwas* over Terrence McNally’s Broadway play *Corpus Christi* that portrayed Jesus as being gay.<sup>1695</sup>

<sup>1688</sup> Julius, Lyn. “Dilemmas of *Dhimmitude*,” jewishquarterly.org, Spring 2005, no. 197.

<sup>1689</sup> Pipes, Daniel. “A CAIR Miscellany,” & “Rabbi Moshe Hirsch, PLO Agent,” *DP*, 25 Mar + 25 Sep 2004.

<sup>1690</sup> Freund. “Anti-Zionist *Neturei Karta* sect pays solidarity visit to *Iran*,” jpost.com, 8 Mar 2006.

<sup>1691</sup> “U.S. *Muslim* leader embraces Orthodox *Rabbi* whose group opposes Israel,” haaretz.com, 23 Aug 2005, *DW*.

<sup>1692</sup> “25th Anniversary of Terror,” washpost.com, 9 Mar 2002.

<sup>1693</sup> Shaviv, Miriam. “Make ‘*Muslim*’ films at your own risk,” jpost.com, 1 Oct 2005.

<sup>1694</sup> Natasha. “Jordan Dispatch,” (*DaVinci Code* banned in Jordan) natashatynes.org, 1 May 2005.



G In 1993, *Muslims*, including Tariq Ramadan, managed to squash the performance of Voltaire's play "Fanaticism" written in 1741 with *Muhammad* as the star. Then in 2005 the play was presented at St. *Genis-Pouilly* in France near Switzerland with riot police stationed around the cultural center. "An hour into the performance, the mayor got called out of the hall because of street disturbances. The mayor says the mood was 'quasi-insurrectional,' but damage was minor. Police chased *Muslim* youths through the streets." *Muslim* youths ignited garbage cans and burned a car.<sup>1696</sup>

**Pitting Anti-Semites and Holocaust Deniers vs. Jews:** *Muslims* like the *Mufti* of Jerusalem plotted with *Nazis* against the Jews during WWII, and lately Holocaust Deniers and anti-Semites have conspired with their *Muslim* counterparts in an attempt to deprive Jews of their homeland and nation-state. In June 2006 Neo-*Nazis* plan to march and demonstrate two days during World Cup Soccer in Germany in support of *Iran* whose president Amadinejad denies the Holocaust and has threatened to blow up Israel with A-bombs.<sup>1697</sup> Western anti-Semitism is, among other things, self-defeating because once Israel is conquered, there will be one less buffer state between the West and *Islamdom*.

**Pitting Capitalists vs. Communists:** *Islamists* worked together with the US against the Cold War Communists in places such as *Afghanistan*. *Islam* became known as "a bulwark against Communism." Because the US allied with *Islamists*, including Usama bin Ladin, in the 1980s to drive the Soviets out of *Afghanistan*, and allied with *Islamists* to drive the *Serbians* out of *Bosnia* in 1999, many politicians were surprised that so many *Muslims* sympathize with *Bin Laden* who declared *Jihad* on the "Great Satan" (i.e. the US). This is similar to how the West allied with Stalin during WWII, but when Hitler was defeated, the thaw in relations was over and the Cold War began anew.

*Islamists* are strong-willed ideologists and were never really co-opted to do the Capitalists' bidding since *Islamists* are not interested in instant wealth. Democracy's one-man-one-vote cannot successfully compete for the hearts and minds of *Islamists* who are intent on 72 *Houris* in heaven, just as the Communism's Workers Paradise could not compete.

*Islamists* fought Communists to establish a caliphate and because *Muhammad* himself sneered at the idea of communism. It seems the idea of communism had floated around *Mekka* and *Madina* just as the idea has in many nascent religious communities and utopias before and since—even early Christianity (Act 02:44). *Muhammad* said:

*Allah* has provided for some of you more than *Allah* has provided for others. Those who are given plenty would never give their properties to their subordinates to the extent of making them partners. Would they give up *Allah's* blessings? (K 016:071).

That *Muhammad* was against communism did not make him a capitalist,

<sup>1695</sup> McRoy, Anthony. "There Can Be No End to *Jihad*: Interview with *Sheikh* Omar Bakri *Muhammad*," christianitytoday.com, 1 Feb 2005, *JW*.

<sup>1696</sup> Higgins, Andrew. "Muslims ask French to cancel 1741 play by Voltaire," *The Wall Street Journal*, post-gazette.com, 6 Mar 2006, bakelblog (Nobody's Business).

<sup>1697</sup> DPA. "World Cup 2006 News: Neo-*Nazis* plan pro-*Iran* parade at World Cup: report," monstersandcritics.com, 20 May 2006, counterterrorismblog.org.

though. *Muhammad* was dead set against the taking of interest—hence *Sharia*-compliant banks are the norm in *Islam*. The *Koran* is more about loot and imposing confiscatory taxes on Christian and Jews than it is about hard work, saving and investing. Besides, *Muslims* commonly believe in double predestination and think that whether one is wealthy or poor is just a matter of *Inshallah* fatalism—whatever *Allah* wills will be.

That *Islamists* have no special affinity for capitalism or communism, but are just interested in triangulating against their greatest (potential) opponent becomes obvious when one reviews the facts:

- ☉ Even as atheistic Communism threatened Iran's borders in the 1970's, it was the US halfway around the globe that Iran's Ayatollah Khomeini singled out as the Great Satan. Even more telling, he said the Little Satan was not Communism, but tiny Israel.
- ☉ Some *Muslim* terrorist groups still have communist leanings in 2006, e.g. the Popular Front for the Liberation of Palestine (PFLP) started by communists who were nominal Christians, but now *Jihadists* populate the PFLP.
- ☉ In 2006, the secretary general of Italy's largest *Muslim* organization (UCOII) called on Italian *Muslims* to vote for the Communists because when the Communist Party leader, Oliviero Diliberto, had been justice minister back in 1998-1999, he made "sure that dinner was served when [*Muslim* inmates] could interrupt their [*Ramadan*] fast."<sup>1698</sup>
- ☉ In the US in 2003, *Muslims* began switching their party affiliation from Republic to Democrat after the War on Terror began.<sup>1699</sup> Then in 2006 *Muslims* agreed to "make news" for Democratic-leaning NBC-TV by strolling around Republican-leaning NASCAR car racing events wearing *Islamic* clothing. This bit of race-baiting was to be done in the hopes of being insulted or assaulted while being filmed by hidden camera.<sup>1700</sup>

There are many microcosms of the triangulation described above, i.e. after Communism is defeated *Islamists* turn on their former partner. For instance, *Bangla Bhai Islamists* originally told *Bangladeshi* police and legislators that they were out to battle the *Purbo Banglar Communist Party*. This pleased the more moderate and secular police and legislators, but since the Communist threat subsided, they set out to *Talibanize* several *Bangladeshi* states with the goal of taking over *Bangladesh*.<sup>1701</sup>

**Pitting Multicultural Conciliorists (MCs) vs. Anti-Jihadists:** MCs try to find and fund Moderate *Muslims* whom they hope will reform *Islam*. Most so-called Moderate *Muslims* on the MCs' payroll are of two kinds: 1) They are not seen as being true *Muslims* by rank-and-file *Muslims* and have no following or influence, or 2) They hold to immoderate views showing that their moderate *Muslim* persona is only skin-deep. They may differ from *Jihadists* only in that they feel their spiritual path is *Dawa* and a slow *Jihad* rather than a *Blitzkrieg Jihad*.

MCs are easily exasperated by anti-*Jihadists* who probe into the background

<sup>1698</sup> "Italy: *Muslims* told to vote Communist," adnki.com, 5 Apr 2006, *JW*, C&R.

<sup>1699</sup> Pipes, D. "Arabs and Jews Sorting Themselves Out Politically in the US?" *DP*, 19 Oct 2003.

<sup>1700</sup> Spencer, Robert. "Dhimmis at NBC try to set up NASCAR for charges of 'Islamophobia,'" *DW*, 6 Apr 2006, C&R, michelemalkin.com.

<sup>1701</sup> Mulrine, Anna. "Europe's identity crisis," usnews.com, 10 Jan 2005, *LGF*.

of so-called moderate *Muslims*, and try to point out: 1) the futility of trying to reform *Islam*, and 2) that resisting *Jihadists* and *Islamists* is the only sensible course of action.

MCs want to co-opt *Islam* and spark a Reformation and Counter-Reformation in *Islam* as occurred during sixteenth-century with Protestantism and Catholicism. The analogy is flawed though because the Reformation was about Protestantism getting back to the Bible while the Counter-Reformation was about Catholics getting back into the spirit of Crusading and heretic-burning. It was **after** the Counter-Reformation that Catholics plunged Europe into the 30 Years' War.

Unfortunately, the *Islamists* are the agents both of a *Sola Scriptura* reformation and a counter-reformation all at the same time. Hence their interest in taking the *Koran* so seriously and literally, and why they want a *Caliphate* too.

The best that Westerners could hope for in changing *Islam* would be to create a moderate spin-off of *Islam*, but there already are spin-offs that have minimal impact on the vast majority of *Muslims*, such as the *Bahais* and *Ahmadiyyas*. Also, there is the danger of creating a militant spin-off. For instance, *Sikhism* is an amalgamation of *Islam* and *Hinduism*, and the *Sikhs*' religious symbols are a *Kirpan* dagger and a metal bracelet.<sup>1702</sup> History shows that *Sikhism* tends to be more aggressive than *Hinduism*. In 2004 the play *Behzti* by playwright Gurpreet Kaur Bhatti had to be canceled in Birmingham, UK, due to *Sikh* death threats. Thus as with Communism and Nazism, containment and attack are the only alternatives when dealing with *Islam* since co-option is not a good option.

**Pitting Western Collaborators vs. The West:** In order to infiltrate the government and insinuate themselves to gain power and privileges, *Muslims* will team up with leaders,<sup>1703</sup> commit to joint efforts with special interest groups, the army and police,<sup>1704</sup> and work with collaborators in government, churches and other organizations.<sup>1705</sup>

*Muslims* feigning solidarity with non-*Muslims* can tend toward the absurd, as when an *Imam* Muzammil Siddiqi led the national 9/11 prayer service at the National Cathedral on 15 September 2001.<sup>1706</sup> Siddiqi also gave President Bush a *Koran* on 26 September 2001 at a visit to the White House.<sup>1707</sup>

Non-*Muslim* collaborators may align themselves with *Muslims* in order to gain wealth (e.g. the U.N. Food for Oil scandal ending in 2003), or positions of power or influence immediately or later—as a quisling in the case of an anticipated coupe or *Muslim* invasion.

The causes that unite collaborators and *Muslims* have included anti-tax,<sup>1708</sup> anti-racism, anti-Communism, anti-terrorism, anti-war, anti-West, anti-Americanism and anti-globalism. It is a Devil's Bargain though, for when the

<sup>1702</sup> "Anger Over Crucifix Ban," sky.com, 6 Dec 2005, Nobody's Business, bakelblog.com.

<sup>1703</sup> Schlüssel, Debbie. "Bush's scary CAIR friends," WND.com, 16 Oct 2001.

<sup>1704</sup> Pipes, Daniel. "Weblog: *Islamists* Infiltrate Law Enforcement," *DP*, 24 Jan 2005.

<sup>1705</sup> Historians mention collaborators with *Muslims* often (Fregosi. *Jihad*, p. 90; Yeor. *Dhimmitude*, pp. 39, 109-110, 115-116; Yeor. *Christianity*, pp. 130, 258; Trifkovic. *Sword*, p. 116; and Jenkins. *Next*, p. 186).

<sup>1706</sup> Shribman, David M. "Somber nation unites in prayers of grief, for courage," *The Boston Globe*, boston.com, 15 Sep 2001.

<sup>1707</sup> Schlüssel, Debbie. "Extremist American *Imam*," *FPM*, DebbieSchlüssel.com 24 Jun 2004.

<sup>1708</sup> Gaffney, Jr., Frank J. "A Troubling Influence," *FPM*, 9 Dec 2003; Pipes. "Has Grover Norquist Dropped the *Islam* Portfolio?" *DP*, 17 Jan 2005.

common foe is vanquished, former collaborators are at the mercy of *Islamists*.

**Pitting Hindus vs. Colonialists:** *Muslims* convinced some *Hindus* and Christians to work with *Muslims* in the spirit of anti-colonialism, but as soon as the British left in 1947, *Muslims* divided India to create East and West Pakistan, later called Pakistan and *Bangladesh*. *Pakistan* eventually took northern *Kashmir* and wants the rest, too. N.S. Rajaram wrote how it happened:

Mahatma Gandhi made the restoration of the Turkish *Sultan* as *Caliph* the centerpiece of the disastrous *Khilafat* Movement in the support of which he launched the Non-Cooperation Movement in 1921. It resulted in a reign of terror in *Malabar (Kerala)* known as the *Moplah* Rebellion. It was the *Khilafat* that sowed the seeds of Partition [on India]. It also showed that terror could be used for political ends by invoking *Islam*.

Inspired by the terror that followed the *Khilafat*, *Mohammed Ali* Jinnah—a ‘liberal’ *Muslim*—resorted to terror to gain his political goal of partitioning India. In 1946, his call for ‘Direct Action’ in support of his demand for *Pakistan* led to street riots all across North India. The Congress capitulated and agreed to the Partition of India. So was *Pakistan* born.<sup>1709</sup>

Gandhi ignored the fact that *Muslims* were former conquerors of India, so when the British left, the *Muslim* domination of *Hindus* to the north of India proper resumed. Furthermore, after the colonialists left, *Muslims* in India proper re-triangulated against the *Hindus*, as Goel wrote:

The accomplices of *Islamic* imperialism in India—communists, socialists, *Nehruvian* secularists, *Gandhians*—were throwing all judicial proprieties and procedures to the winds in defense of *Islam* which they viewed as the most effective weapon against their common enemy—*Hindu* society and culture.<sup>1710</sup>

*Muslims* have ethnically cleansed many millions of *Hindus* from *Kashmir* and the surrounding *Muslim* states. In just a few decades, *Hindus* went from being 15 percent to 1.5 percent of the population of *Pakistan* and from 34 percent to 8 percent of the population of *Bangladesh*.<sup>1711</sup>

The Christian population in *Pakistan* has also declined due to the misuse of blasphemy laws in personal and property disputes, and churches and entire towns are sporadically burnt to the ground. Christians there still expect better treatment than they receive for their having helped *Pakistan* break away from India. Father James Chanan, the director of Pastoral Institute and United Religions Initiative Asia (URIA), said:

Minorities are not ‘*Zimmis*’ but are part of the mainstream because they took part in the *Pakistan* Movement.<sup>1712</sup>

**Pitting the West vs. Israel:** *Muslim* propaganda has been successful in enlisting many Westerners against Israel. Most assume *Muslims* are interested in a two-state solution, but a little probing reveals that many *Muslims* would be satisfied with nothing less than Jews ceding all their territory and becoming *Dhimmis* in a *Muslim* state.<sup>1713</sup>

<sup>1709</sup> Rajaram, N.S. “*Jihad*, Terrorism and *Dhimmitude*,” *DW*, 15 Jun 2005.

<sup>1710</sup> Goel. *Calcutta*, ch. 1.

<sup>1711</sup> Fitzgerald, Hugh. “Indian *Dhimmitude*—remedies and responses,” *DW*, 20 Mar 2006.

<sup>1712</sup> “Christians protest attack on churches,” *dailytimes.com.pk*, 3 Apr 2006, *C&R*, *DW*.

<sup>1713</sup> Pearl, Judea. “Dialogue of the deaf,” *jpost.com*, 16 Jun 2005.

**Pitting French Canadians vs. English Canadians:** French separatists in *Quebec*, Canada, have been trying to secede from Canada for decades, but have always fallen short of fifty percent in referenda. However, in 2005 the French separatists are seeking to enlist the votes of *Muslim* immigrants—this, only a few weeks after *Muslims* burned 10,000 cars in France. Furthermore, the French in *Quebec* are courting a *Moroccan* “suspected of involvement in terrorist activities whom the government is trying to deport.”<sup>1714</sup> In *Quebec*, the desire to have French-speaking immigrants led to mass immigration from the *Muslim* countries of *Algeria*, *Morocco*, and *Tunisia*. These immigrants now constitute a national security threat to *Quebec*, Canada and the US.<sup>1715</sup>

**Pitting the EU and Russia vs. the US:** *Iraq* and *Iran* both tried to partner with Russia and the EU against the US in power plays that were disguised as Internationalist versus Unilateralist conflicts. In 2003 the EU and Russia were against Gulf War II against *Iran*. Then after Gulf War II the EU and Russia were against taking steps to thwart *Iran*’s nuclear weapon development program. *Iraq* and *Iran* each betrayed their allies by continuing to support terrorism. *Iran* even trained *Chechen Jihadists* to fight Russians even as Russians built a nuclear plant in *Iran*.<sup>1716</sup>

**Pitting Assyrian Christians vs. Colonialists:** *Muslims* convinced Assyrian Christians to fight British colonialism, and Christians were co-founders of the *Baathist* Movement in *Iraq* and Syria. The founder of the *Baath* Party, Michel Aflaq, was a Greek Orthodox Christian who later converted to *Islam* and declared “*Islam* is to Arabism what bones are to the flesh.”<sup>1717</sup>

Even given this level of cooperation in the past, after Gulf War II the Assyrian Christians were “soon to be preyed upon [repeatedly], primarily by their traditional Kurdish *Muslim* enemies, joined by the other *Muslim* communities.”<sup>1718</sup> *Ekklesia* online magazine reported:

From 2003 to 2005, Christians have been “prevented from voting in the elections, in recent months many have had their land occupied and stolen, their churches firebombed and their families attacked...[and] wrongly portrayed by militant *Islamists* as American infiltrators...between 60,000 and 80,000 Chaldo-Assyrian Christians have fled the country since the fall of *Baghdad*...[There have been] mortar attacks, raids against Christian homes and forced conversions...Christian women are harassed, have acid thrown into their faces, are kidnapped and raped...[and] they seek some safety behind the *Muslim Hajib*.”<sup>1719</sup>

**Pitting Mideast Christians vs. Colonialists:** *Muslims* convinced Mideast Christians to ally themselves with *Muslims* against colonialists in the name of nationalism or Arab nationalism. The leaders could promise Christians whatever they wanted in the future since they knew that before the future arrived, the Christians would mostly be ethnically cleansed or otherwise squeezed out of the

<sup>1714</sup> Krauss, Clifford. “Separatists in *Quebec* Seek Immigrant Votes,” nytimes.com, 12 Dec 2005.

<sup>1715</sup> Fitzgerald, Hugh. “Quebec’s suicidal immigration policy,” *DW*, 3 Apr 2006.

<sup>1716</sup> Coughlin, Con. “Teheran ‘secretly trains’ *Chechens* to fight in Russia,” telegraph.co.uk, 27 Nov 2005, *JW*.

<sup>1717</sup> Bostom, Andrew G. & Hugh Fitzgerald. “Bostom *Iraq*’s *Jihad*: Past as Prologue,” americanthinker.com, 8 Jun 2005, *JW*.

<sup>1718</sup> Bostom, Andrew G. & Hugh Fitzgerald. “Bostom *Iraq*’s *Jihad*: Past as Prologue,” *Idem*.

<sup>1719</sup> Plea for Assyrian Christians and *Iraqi* minorities,” ekklesia.co.uk, 18 Aug 2005, *DW*.

Mideast. Moreover, Bat Yeor wrote:

Arab Christians...were duped by Arab nationalism which in reality was reconstructing the Arab *Muslim Umma*....Jews and Christians are only tolerated in terms of their economic or political profitability to the *Umma*. As the Lebanese tragedy showed, they can expect neither gratitude nor friendship from this service, which merely buys them the right to live in their own country once *Islamized*.<sup>1720</sup>

**Pitting Mideast Christians vs. Israel:** *Muslims* convinced Mideast Christians, especially Catholic Christians,<sup>1721</sup> to ally themselves with *Muslims* against *Israel* first in the spirit of pan-Arabism and anti-Zionism, but after 1948 in the spirit of anti-Zionism, post-colonialism and Palestinian nationalism.<sup>1722</sup>

In 1920, Christians constituted twenty percent of the population of the Holy Land, but in 2006 only one or two percent. Most Christians have emigrated due to the conflict, but mainly due to intense *Muslim* pressure and terrorism. Given these statistics and history, it is ironic to read that Christians and *Muslims* were a united front against Jewish immigrants in the Holy Land, as Dennis Ross wrote:

In *Jaffa* in May 1919, a Christian-*Muslim* assembly had convened and demanded a cessation of Jewish immigration, a prohibition on Jewish land purchases and a representative government of *Muslims*, Christians and Jews—something that would preserve a permanent Arab majority and Jewish minority.<sup>1723</sup>

The forced solidarity between Israeli *Muslims* and Christian Arabs was never so apparent than in March 2006 when an emotionally disturbed Jewish man, his Christian wife and their daughter threw fireworks from the balcony of the Nazareth basilica during a packed Lenten church service. No one was seriously hurt inside the church, but later that evening *Muslims* rioted right outside the basilica and burned four cars, including two police cars. Police used stun grenades and tear gas to break up the riots that left 13 police officers and 13 civilians wounded.<sup>1724</sup>

The next day a crowd of mostly *Muslims*, no doubt, “chanted anti-Israeli slogans”<sup>1725</sup> and carried signs such as “Israeli racism breeds hate.”<sup>1726</sup> After all this mayhem and after Christians have suffered so many *Muslim* riots...

Ahmad Tibi, an Arab *Muslim Knesset* [parliament] member, said ‘I am proud that the *Muslims* defended the Church of Annunciation and I am sure Christian Arabs would not hesitate to defend *Mosques*.’<sup>1727</sup>

Arab Israeli *Knesset* Member Taleb *El-Sana*, a *Muslim*, blamed Israel for the church attack, saying:

The act [of throwing firecrackers in a church] is the result of Zionism’s insane policy, which destroyed *Mosques*, desecrated churches and shows no

<sup>1720</sup> Yeor. *Dhimmitude*, pp. 238....358.

<sup>1721</sup> Yeor. *Dhimmitude*, pp. 280-281.

<sup>1722</sup> Elad, Moshe. “The Palestinianization of the church,” *haaretz.com*, 16 May 2005.

<sup>1723</sup> Ross, Dennis. *The Missing Peace*, Farrar, Straus & Giroux, New York, 2004, p. 33.

<sup>1724</sup> “Barakeh on church attack: Olmert’s head ‘sick with racism,’” *Haaretz.com*, 5 Mar 2006.

<sup>1725</sup> El Deeb, Sarah. “Thousands of Israeli Arabs Protest Attack,” *news.yahoo.com*, 4 Mar 2006.

<sup>1726</sup> “Olmert accuses *Muslims* of exploiting Nazareth church attack,” *Middle East Times*, *metimes.com*, 6 Mar 2006.

<sup>1727</sup> Klein, Aaron. “*Muslims* blame Israel for church attack...” *WND*, 5 Mar 2006.

tolerance toward other people's holy sites...*Islam* equally sanctifies the places holy for Christians and *Muslims*.<sup>1728</sup>

The Acting Prime Minister for Israel, Ehud Olmert, remarked:

It is almost absurd when the *Islamic* leadership, which is known for being intolerant toward Christianity, leads a demonstration caused by a spaced-out couple and uses it as political leverage during the election period.<sup>1729</sup>

Arab Israeli *Knesset* Member *Muhammad* Barakeh responded to Olmert saying:

These declarations are coming out of a head sick with racism and cruel condescension. The attempt to drive a wedge into the [Israeli] Arab population is a dirty game, which is well known on the Arab street.<sup>1730</sup>

Of course the only "dirty game" being played is not by the Israelis, but by *Muslims* who hijacked an unfortunate incident and used it to drive a wedge further between Christians and the only people in Israel capable of saving Christians from *Muslim* rioters and *Islamists*. Christians have long known this is the case and that why an aide to Latin Patriarch Michel Sabbah said:

It's outrageous that the *Muslims* are protesting intolerance and blaming Israel for disrespecting Christian sites...who asked that his name be withheld out of fear of retaliation by local *Muslims*. 'It is the *Muslims* who are leading a campaign against us to the point that most of the Christian population from Bethlehem and Nazareth had to run away.'<sup>1731</sup>

Daniel Pipes wrote about the same issue:

The French weekly *L'Express* quotes a Christian Palestinian to the effect that when the Palestinian state comes into existence, 'the sacred union against the Zionist enemy will die. It will be time to settle accounts. We will undergo the same as our Lebanese brothers or the *Copts* in Egypt. It saddens me to say so but *Israeli* laws protect us.'<sup>1732</sup>

Ray Hanania wrote similarly:

*Hamas* prefers the green banner with the inscription of the *Kaleema*, or *Muslim* Creed, to the Palestinian flag. When they do wave the Palestinian flag, they distort it by placing the *Kaleema* on the white banner as a religious warning to Christians and secular *Muslims*.<sup>1733</sup>

**Pitting Blacks vs. The West:** *Muslims* convinced Blacks to work with *Muslims* in the spirit of anti-racism, anti-colonialism and anti-slavery even though *Muslims* are the very worst offenders against Blacks in all three categories. *Islamic* oil money fuels many wars in Africa and has led to untold deaths by arms and starvation.<sup>1734</sup>

Jesus had no slaves and St. Paul condemns slave-traders (*NIV* 1Ti 01:09-10), but *Muhammad* had Black slaves and the *Koran* condones slavery and even sex-

<sup>1728</sup> Klein, Aaron. "Muslims blame Israel for church attack..." *WND*, 5 Mar 2006.

<sup>1729</sup> Klein, Aaron. "Muslims blame Israel for church attack..." *WND*, 5 Mar 2006.

<sup>1730</sup> "Barakeh on church attack: Olmert's head 'sick with racism,'" *haaretz.com*, 5 Mar 2006.

<sup>1731</sup> Klein, Aaron. "Muslims blame Israel for church attack..." *WND*, 5 Mar 2006.

<sup>1732</sup> Pipes, D. "The Hell of Israel Is Better than the Paradise of Arafat," *DP, MEQ*, Spring 2005.

<sup>1733</sup> "Barenboim needs a new tune: Celebrity activists should face truth of their 'friends,'" *yynetnews.com*, 19 Jul 2005.

<sup>1734</sup> "The Truth vs. Moammar Gaddafi: The Case for His Elimination," *theindividualist.blogspot.com/nouspoetikos*, 19 Dec 2003.

slavery (*K* 004:023-024; 023:005; 033:050; 070:030). *Muhammad* even refused to free some slaves that one of his disciples had freed.<sup>1735</sup>

The Mideast had more Black slaves than the West ever had but there is no large population of Blacks in the Mideast because slaves were not allowed to reproduce by law, custom or surgery.<sup>1736</sup> This is a form of genocide similar in spirit to the ongoing Arab-Muslim-on-Blacks (both *Muslim* and Christian Blacks) ethnic cleansing and genocide in southern *Sudan* and in *Darfur* in eastern *Sudan* ongoing since at least the 1950's.<sup>1737</sup>

Allying with *Muslims* has never brought any group any long-lasting good will from *Muslims*. Moreover, the lot of Christians, *Hindus* and Blacks who live near *Muslims* is worse now than it was during the colonial period due to *Sharia*-driven discrimination and *Jihad*-driven persecution, ethnic cleansing and terrorism, as well as by the growing WMD threat.<sup>1738 1739</sup>

**Pitting Hispanic-Americans vs. Anti-Jihadists:** *Muslims* joined up with Hispanic-American activists and called on Congressman Tom Tancredo to resign over advocating a tougher immigration policy and “suggesting that Americans bomb *Islamic* holy sites if terrorists launch a nuclear attack on the United States.” Tancredo’s spokesman said:

They are a lot more upset about what he [Tancredo] stands for, our nation’s security and border policy, than anything else.<sup>1740</sup>

**Pitting Immigrants From the Mideast vs. Their Host Nations:** *Muslim* immigrants in America try to use the same pan-Arab arguments to convince the very immigrants who were persecuted out of the Mideast (Christian-Arabs, Copts, Assyrians, Lebanese and such) that they **now** must stick together against anti-Arab racism.<sup>1741</sup>

*Muslims’* mis-identifying Copts as Arabs for fourteen centuries has been a wildly successful propaganda effort since ninety-five percent of Copts now identify themselves as Arab *Muslims*.

Arab-*Muslims* want to continue their supremacist, supersessionist, big-brother, cultural hegemony around the globe. In other words, *Dhimmis* may be lucky enough to check out of *Islamdom* but they can never really leave *Islamdom* behind altogether.

*Muslims* feigning solidarity with Copts can tend toward the absurd. For instance, four Copts were butchered in 2005 in New Jersey, USA. It was thought at the time that *Muslims* killed them because they had evangelized *Muslims*, but this turned out not to be true. Nevertheless, a *Sheik* and some other *Muslims* had the gall to attend the funeral at the Copt church! Naturally, altercations and a brawl ensued, necessitating police intervention during and after the funeral.<sup>1742</sup>

*Muslims* claim people of Mideastern origin are Arab yet Mideast Christians

<sup>1735</sup> Fregosi. *Jihad*, p. 290.

<sup>1736</sup> Richardson. *Secrets*, p. 207.

<sup>1737</sup> Glazov, Jamie. “Symposium: Darfur—*Islam’s* Killing Fields,” *FPM*, 10 Sep 2004.

<sup>1738</sup> Boles, Imad. “Egypt—Persecution,” Winter 2001, Vol. VIII, No.1, meforum.org.

<sup>1739</sup> Spencer, Robert. “Whistling in the dark: Syrian churches commemorate October 1973 war with Israel,” *DW*, 11 Oct 2004.

<sup>1740</sup> “Minority groups call on US congressman to resign,” jpost.com, 26 Jul 2005.

<sup>1741</sup> Fitzgerald, Hugh. “The cultural imperialism of the Arabs,” *DW*, 30 Oct 2005.

<sup>1742</sup> “Christians & *Muslims* Brawl,” natashatyne.org, 18 Jan 2005, Sarah’s comment, 20 Jan 2005.



hardly think of themselves as being Arabs, but rather just users of the Arabic language that *Muslim* conquerors forced on nearby ancient civilizations: 1) The Copts are not immigrants from the Arabian peninsula, but are related to the pyramid-building Egyptians, 2) The Lebanese *Maronites* are Phoenicians and Arameans and 3) The Assyrians are Arameans, not Arabs.

*Muslims* identifying themselves with Arab and Coptic Christians makes *Muslims* seem rather benign and friendly by association. It allows *Muslims* to more easily equate and blend in their terrorism-tainted fundraising activities with Christian charity, and equate their *Adhan* from loudspeakers with church bells.

If *Muslims* can make *Islam* seem just part of the Arab cultural milieu and mindset, they can make their charges of racism and anti-Semitism against so-called *Islamophobes* stick—or at least not seem risible.

Declaring solidarity with non-*Muslims* from the Mideast is just another way *Muslims* in America try to inflate their numbers and political influence. Only 24 percent of the 1.2 million Arabs in the US are *Muslim*.<sup>1743</sup> Not only do *Muslims* inflate their US numbers (often claiming six million *Muslims*),<sup>1744</sup> but they inflate the total number of US Arabs (e.g. by claiming 4.5 million Arabs).<sup>1745</sup>

Inflated numbers of *Muslims* are used to make the so-called “tiny minority of extremists” look even tinier by comparison. The inflated numbers are used to cast derision on the idea that a significant minority of *Muslims* are *Islamists* rather than just the purported “tiny minority.”

If *Muslims* can inflate their numbers, then politicians will court them rather than deport them, as one *Islamist* said:

[T]ake my word, if 6-8 million *Muslims* unite in America, the country will come to us.<sup>1746</sup>

When politicians think there are too many *Muslims* to monitor, whether based on accurate or exaggerated statistics, politicians are tempted to allow *Muslims* license to preach incitement to violence as long as the bombs go off somewhere else, as Daniel Pipes wrote:

To the extent the allowing of *Islamists* and terrorists safe haven on British soil is a conscious decision to keep the UK safe at the expense of others, this is an immoral and despicable policy that must be changed immediately.<sup>1747</sup>

Politicians may even allow *Muslims* to dictate foreign policy in exchange for domestic tranquility, as *Imam* Elmenyawi stated:

‘A Conservative victory would have been disastrous for *Muslims*. A minority government is a victory for us. We *Muslims* will wield greater power, especially with regards to foreign policy. There is no better shield

<sup>1743</sup> “*Muslim* Americans: Model Citizens,” newsmx.com, 5 Sep 2005, *JW*.

<sup>1744</sup> Pipes, Daniel. “How Many *Muslims* Live in the United States?” *DP*, 22 Apr 2003.

<sup>1745</sup> Pipes, Daniel. “How Many Arab-Americans?,” *DP*, 9 Mar 2005.

<sup>1746</sup> Pipes, Daniel. “The Danger Within: Militant *Islam* in America,” *DP*, Nov 2001.

<sup>1747</sup> Campbell, Jamie...and Pipes, Daniel. *Ibed*.

<sup>1748</sup> Ouellette, D. “*Muslim* Power in Canada,” *jpost.com*, 17 Aug 2004, *LGF*, *DW*.

<sup>1749</sup> “U.S. Fighting *Muslim* Faithful, Say Scholars,” *The Nation* (Nairobi), 6 Jun 2005, *DW*.

<sup>1750</sup> Barkat, Amiram. “For first time, Jews are no longer a majority between the Jordan, the sea,” *haaretz.com*, 11 Aug 2005.

<sup>1751</sup> Miller, David Ian. “Finding My Religion: *Muslim* teacher Abbas Kadhim on the role of *Islam* in shaping *Iraq*’s future,” *San Francisco Chronicle*, *sfgate.com*, *sfgate.com*, 13 Jun 2005.

<sup>1752</sup> “Russia’s turning *Muslim*, says *Mufti*,” *theaustralian.news.com.au*, 6 Aug 2005.

from terrorism than *Muslim* participation in Canadian political life.<sup>1748</sup>

Notice how statesmen surrender the country without a fight when they buy into inflated estimates of how many *Muslims* in are a country:

Several *Islamic* scholars at the 16th anniversary of the death of the spiritual leader Ayatollah Khomeini at the weekend accused the US of allegedly dividing the *Muslim* world in the name of democracy. But in a quick rejoinder, US spokesman Peter Claussen denied the allegation saying that there were many *Muslims* in the country. ‘We cannot possibly fight *Islam*. In the US, there are too many *Muslims* and we cannot just decide to fight the religion because doing so will mean fighting ourselves,’ he said.<sup>1749</sup>

Based on the inflated numbers of Palestinians, *Israel* relinquished the *Gaza* Strip in 2005 rather than at a later date. *Israeli* leaders wanted *Israel* to stay both Jewish and democratic but projections indicated that Palestinians already outnumber Jews—or would soon based on growth trends. Naturally, the Palestinian census bureau provided the high-end estimates.<sup>1750</sup>

Another example of inflated demographic statistics is how *Muslims* are sometimes said to be one of out every 3.5 persons on the globe rather than just one out of five:

Many Americans still think of *Islam* and terrorism as one and the same thing. This is a big problem. I mean, there are 1.7 billion *Muslims* in the world.<sup>1751</sup>

The 1.7 billion figure probably was chosen so *Islam* would appear to be surpassing Christian numbers within a decade or two. According to Adherents.com, in 2005 there are 2.1 billion Christians and 1.3 billion *Muslims*.

The inflated global estimates could be refuted by tallying *Muslims* country by country, so *Muslims* in every country overestimate their numbers and cast doubt on the official census figures. For instance, *The Weekend Australia* reported:

Russia’s leading *Muslim* cleric has alarmed Orthodox Church leaders and nationalists by claiming the country has...3 million more [*Muslims*] than previously believed. According to the last census, three years ago, about 14.5 million of Russia’s 144 million people were ethnic *Muslims*. Religious leaders have put the number at nearer 20 million. But the leader of the Council of *Muftis* of Russia, Ravil Gaynutdin, said this week the number of ethnic *Muslims* was 23 million and **rising**.<sup>1752</sup>

“Alarming” the Russian Orthodox with inflated census figures is in keeping with the *Koran* and is probably aimed at driving Russians out of the *Caucasus* area:

We will cast into the hearts of the unbelievers terror, for that they have associated with God [*Muhammad* alludes here to the Son and the Spirit (see K 005:073)] that for which He sent down never authority (K 003:151).

Notice how the Russian *Mufti* said the number is 23 million and **rising**, as though he is the *Islamic* version of the *Borg* (from *Star Trek*) telling Russians: “Resistance is futile. You will be *Islamized*!” Of course the Russians may be thinking more along the lines of how they might go the way of the mammoth.

**Pitting Non-Existent *Muslims* vs. Christians:** *Muslims* triangulate non-existent *Muslims* against non-*Muslims*. This is similar to armies using dummies and cardboard tanks to fool the enemy into thinking they are outmanned and outgunned. In the case of *Islam*, it is give the impression that non-*Muslims* have out-proselytized and out-reproduced the infidels, or soon will.

A Web search reveals that many *Muslims* continue in 2005 to refer to Africa as a “*Muslim continent*.”<sup>1753 1754</sup> In fact, *Muslims* even have *Voice of America (VoA)* radio repeating their propaganda which says that since *Islam* is growing, the West ought to give it money and a privileged status in the West. *VoA* reported:

With Africa on its way to becoming the first *Muslim* continent, most analysts agree that the West needs to do more to stem the tide of radicalism, by increasing assistance to moderate *Muslims*, enhancing cultural exchanges and encouraging the study and understanding of *Islam* in western universities.<sup>1755</sup>

The truth about demographics in Africa is reported by Philip Jenkins:

Somewhere in the 1960s, the number of Christians in Africa outpaced the number of *Muslims* in Africa.<sup>1756</sup>

Furthermore, the trend is for Africa to be more Christian since in the Sub-Sahara where *Islam* meets Christianity, places like Uganda are increasingly Christian.<sup>1757</sup>

**Pitting Rwandans vs. Christianity:** *Muslims* triangulate *Rwandans* against Christianity by saying that in the 1994 *Hutu-on-Tutsi* genocide, few *Muslims* died. *Muslims* say:

With killing all around, he said the safest place to be back then was in a *Muslim* neighborhood...nobody died in a *Mosque*.<sup>1758</sup>

So the horrid implication of this *Dawa* proselytizing appeal is that if you do not want to die in the next genocide, become a *Muslim*.

**Pitting Amoral People vs. Christianity:** *Muslims* promise non-*Muslims* they will rid or reform the immoral elements of Christian society by persuasion or force. *Muslims* tell moral-minded people they will have a decent family if they become *Muslim*. These are some of *Islam*'s big selling points, though when *Muslims* start to do take over a country, a whole new set of *Islamic*-related problems and immorality beset society, along with near-Antediluvian levels of violence and hatred (Gen 06:11-13).

**Pitting Nazis vs. Christianity:** *Muslims* groups such as CAIR appeal to ecumenical-minded Christians by saying that “We have more in common than we think” and then they cherry-pick some Christian-sounding verses out of the *Koran*. *Muhammad* inserted these verses to ensnare people into accepting his totalitarian gospel. Hitler did the same thing in his un-Christian *Mein Kampf*. Still today people are fooled into thinking that Hitler got his ideas from Christianity rather than from *Islam*'s genocide of Armenians. CAIR then hypocritically asks ecumenical-minded Christians to join them in league against “the forces of hate” who “try to pull *Muslims* and Christians apart,” evidently referring to knowledgeable people who resist *Islamization*.<sup>1759</sup>

<sup>1753</sup> Kallay, Alie Y. “Africa: The Only *Muslim* Continent,” [alineaam.org.za](http://alineaam.org.za), accessed 14 Aug 2005.

<sup>1754</sup> Latif, Abdul. “*Islam* in South Africa,” [themodernreligion.com](http://themodernreligion.com), accessed 14 Aug 2005.

<sup>1755</sup> AKL, Aida. “Radical *Islam* in Sub-Saharan Africa,” Washington, D.C., *Voice of America*, [voanews.com](http://voanews.com), 12 Aug 2005.

<sup>1756</sup> Bole, W. “Christianity outstripping *Islam* worldwide,” [baptiststandard.com](http://baptiststandard.com), 20 May 2002.

<sup>1757</sup> Bole, William. “Christianity outstripping *Islam* worldwide,” [baptiststandard.com](http://baptiststandard.com), *Idem*.

<sup>1758</sup> Lacey. “Rwanda’s growing faith: *Islam*,” *International Herald Tribune*, [iht.com](http://iht.com), 7 Apr 2004.

<sup>1759</sup> Spencer, Robert. “*Ibrahim* Hooper: *Muslims* and Christians: More in common than you think,” *DW*, 21 Dec 2004.

**Pitting Islam Critics vs. Islam Critics:** *Muslim* apologists sometimes try to set off one critic of *Islam* against another, such as by sending them impostor emails.<sup>1760</sup>

**Pitting Government vs. Islam Critics:** *Muslim* civil rights advocates meet with and ally themselves with government officials, and they file suits against their critics for slander, hate-speech and whatnot. This is an attempt to triangulate against their critics by making the government into a critic of critics of *Islam*. However, if *Islamists* ever gained power, all these alliances would be shunted and *Sharia* law would be imposed.

**Pitting Blacks vs. Jews:** *Muslims* try hard to split Jews and Christians, and Jews and Blacks. For instance, *Muslims* bankrolled one US Democrat's election campaign. *Arab News* and *Al-Jazeera*'s opined that:

Cynthia McKinney is running again, defying pro-*Israel* lobby's efforts to control Black agenda.<sup>1761</sup>

**Pitting Secularists vs. Christian Fundamentalists:** *Muslims* tell appreciative multiculturalists, Secularists and Laicists (militant Secularists, confer Laicite) that they will save the world from fundamentalist Christians in America, and from Jews in *Israel*.

*Muslims* helped multiculturalists to promote the idea that *Islamdom* historically has been a multicultural paradise—or can be—as evidenced by the *Convivencia* period in Spain that lasted from the mid-eighth century until the fall of the Umayyad dynasty in 1031 AD.

Multiculturalists constantly invoke the *Convivencia* period as proof that *Muslims* can integrate into a multiculturalist West peacefully even though during that same period Christians and Jews were *Dhimmi*s, *Muslims* engaged in constant *Jihad* and enforced the barbaric *Sharia* law. Prior to that time—during the Arab conquest of Spain (711 AD)—*Muslims* destroyed all the churches<sup>1762</sup> and enslaved a fifth of the Spaniards.<sup>1763</sup>

Serge Trifkovic explains that the *Convivencia* period is the Spanish version of England's Camelot myth...

...a fairy tale designed to create the illusion that multiculturalism has valid historical precedents that prove it can work.<sup>1764</sup>

The strategy is to strengthen multiculturalists who worked to facilitate both *Muslim* immigration and *Muslim* non-integration into the West. *Muslims* have a slogan for this strategy:

Thanks to your democratic laws, we will invade [via immigration] you.

Thanks to our *Islamic* [*Sharia*] laws we will conquer [*Islamize*] you.<sup>1765</sup>

This slogan betrays how *Islamists* confuse multiculturalism with democracy.

*Islamists* have adopted the language and rhetoric of charities, public relations firms and civil rights advocacy groups in order to fight counter-terrorism laws.

<sup>1760</sup> Sina, Ali. "The Game of Deception," *JW*, 9 Jan 2005 + comments.

<sup>1761</sup> Bloomfield, Douglas. "She's baaaack! The return of Cynthia McKinney," [jewishworldreview.com](http://jewishworldreview.com), 15 Jul 2004.

<sup>1762</sup> Yeor. *Dhimmitude*, pp. 85, 109-110 & p. 436, endnote 10 (reference Spain).

<sup>1763</sup> Segals. *Islam's Black Slaves*, p. 98, as quoted by Schmidt. *Divide*, p. 120.

<sup>1764</sup> Trifkovich, S. "The Myth of an *Islamic* Golden Age," [chroniclesmagazine.org](http://chroniclesmagazine.org), 7 Nov 2003.

<sup>1765</sup> Allen, Jr., Ohn L. "Europe's *Muslims* worry bishops," *National Catholic Reporter*, [nronline.org](http://nronline.org), 22 Oct 1999.

They also try to engender outrage in *Muslims* and multiculturalists about how authorities deal with *Islamofascists* and *Islam*-supremacists.<sup>1766</sup>

**Pitting Leftists vs. Capitalists:** *Muslims* appeal to Marxists and Socialists by adopting their rhetoric about oppression and exploitation, and they speak of their mutual hatreds, e.g. America, Israel, globalization, capitalism and imperialism.<sup>1767</sup>

Leftists then strive to protect *Islam* from stringent examination on campus, in the halls of government, and in the press, calling any critic of *Islam* or *Muslim* immigration a racist bigot and such. Of course, if *Islamists* did ever manage to take over a country, Marxists would be the first ones to be hung from lampposts as they were when the *Shia Ayatollah* Khomeini took over Iran in 1979.

**Pitting Democracy Advocates vs. Pro-West Regimes in the Mideast:** *Islamists* hate democracy but will participate in elections that the West pressures *Islamic* regimes to have, but only in order to take power and implement *Sharia* law, i.e., the classic one man, one vote, one time scenario.

### The Covenant of Security

The Covenant of Security seems to be based on *Muhammad*'s years of *Dawa* proselytizing among the *Mekkans* when there were some fist-fights but no open warfare like later on.

During a Covenant of Security, *Muslims* can pretend to be friends of non-*Muslims* and only later become openly hostile (K 003:028). The Covenant of Security is an informal treaty between *Muslims* and infidels, which is not a foreign concept since treaties are spoken of in the *Koran* (K 002:177; 004:090, 092; 008:056, 058; 008:072; 009:001, 003-004; 009:007-008, 012).

*Sheikh* Omar Bakri *Muhammad* explains the Covenant of Security in the UK and US, and how he thought the Covenant was failing in 2005 just a few months before the 7/7 bombings in London:

If the right of religious propagation [*Dawa* proselytizing] is forbidden, the USA becomes *Dar al-Fitnah* [Domain of Persecution]. There is also *Dar al-Amen* [Domain of Peace], where *Muslims* live in non-*Muslim* lands under a Covenant of Security. A Covenant of Security can be of two kinds: (1) a visa for study, asylum, etc., and (2) original *Shari'ah* rules whereby the norm that the lives and property of non-*Muslims* are lawful for *Muslims* to take unless they embrace *Islam* are removed because of a Covenant of Security. The *Mujahideen* today feel that they are like *Abu* Basir after the *Hudaybiya* Treaty. [Note: The treaty required *Muhammad* to return any man coming from *Makka*. *Abu* Basir, a new *Muslim* convert, went to *Makka*, but was pursued by two *Makkans* who successfully demanded that he be handed over. On the way back he slew one of them, but *Muhammad*, in loyalty to his promise, refused to receive him. Then he fled to live a brigand-like life with others in his situation, killing *Makkan* pagans and taking their property. Eventually the *Makkans* asked *Muhammad* to receive his group into *Madina* Lings (*Sources*, pp. 257-258)]. Thus the *Mujahideen*, knowing there is no Covenant of Security, believe all lives and property to be *Halal* for them. However, the norm is a treaty situation. The USA ceases to be *Dar al-Amen* for *Muslims* in America if: 1) America declares *Islam* to be the enemy; 2) it

<sup>1766</sup> Hussain, Ali. "Stealth' *Islamists* recruit students," timesonline.co.uk, 16 Oct 2005, *JW*.

<sup>1767</sup> Davis, Douglas. "The Unholy Alliance Revealed," *The Spectator*, *FPM*, 23 Aug 2005.

starts arresting or killing *Muslims*; 3) it bans *Islamic* preaching. *Muslims* are not allowed to fight America from within its borders when they normally live there—they must leave and then fight.<sup>1768</sup>

In 2006 when 250 policeman raided the East London home of two *Muslim* brothers and their parents looking for a bomb factory, a *Muslim* neighbor asserted that the police would find no evidence because “It is traditional that in this country you cannot have *Jihad*,” a reference to the recently defunct Covenant of Security.<sup>1769</sup>

Australian Pastor Danny Nalliah of “Catch The Fire” Ministries spoke about this Covenant of Security without actually naming it:

I have lived in *Saudi* Arabia and learned the real nature of *Islam*. It is to dominate other religions and other cultures. The *Koran* speaks of world domination. I have spoken to a lot of *Muslim* leaders who say it is easy to exploit the Western system. They say the key is to be patient, to learn the language, and to build up numbers. Then build up political power. Even Christians believe everyone should know about Christ and want people to follow Christ. But the worry is with *Islam*, it goes one step further. If peaceful methods fail, the *Koran* says you can use violence.<sup>1770</sup>

Daniel Pipes wrote that the 7/7 bombing and associate rhetoric signaled the definite end of the Covenant of Security for the UK, Pipes notes that one *Muslim* cleric had declared the Covenant of Security with the UK dead already in January 2005.<sup>1771</sup> In January 2004, Bakri told his online listeners exactly what unraveled the Covenant of Security in the UK in his mind:

‘I believe the whole of Britain has become *Dar ul Harb* (land of war) That *Dar ul Harb* has not started yet, but still really they [the infidels] start it. They arrest *Ulema* (religious men), they arrest scholars...they declare your job is to divide the *Muslims*, promote secularism. This is what makes it *Dar ul Harb*.’ Bakri urged listeners to join *Al-Qaeda* in order to carry out a *Jihad* in Britain.<sup>1772</sup>

*Sheikh* Omar Bakri *Muhammad* also said:

‘I believe the whole of Britain has become *Dar ul-Harb* (land of war). In such a state...the *Kuffar* (non-believer) has no sanctity for their own life or property.’<sup>1773</sup>

Another UK *Islamist* spoke about how the Covenant of Security was on its way to becoming null and void already in 2004:

<sup>1768</sup> McRoy, Anthony. “There Can Be No End to *Jihad*: Interview with *Sheikh* Omar Bakri *Muhammad*,” christianitytoday.com, 1 Feb 2005, *JW*.

<sup>1769</sup> Habberley, Stephen. “Accounts from the scene,” guardian.co.uk, 2 Jun 2006.

<sup>1770</sup> Sheehan, Paul. “Spreading the word of intolerance,” smh.com.au, 4 Oct 2004.

<sup>1771</sup> Pipes, Daniel. “British ‘Covenant of Security’ with *Islamists* Ends,” *DP*, 8 Jul 2005.

<sup>1772</sup> Lappin, Yaakov. “Analysis: War declared on Britain,” ynetnews.com, 7 Jul 2005.

<sup>1773</sup> O’Neil, Sean & Yaakov Lappin, “Britain’s online *Imam* declares war as he calls young to *Jihad*,” timesonline.co.uk, 17 Jan 2005, *JW*.

<sup>1774</sup> Cohen, David. “Terror on the dole,” *Evening Standard*, 20 Apr 2004, thisislondon.co.uk, 21 Apr 2004, *LGF*, *DW*, freerepublic.com.

<sup>1775</sup> Campbell, Jamie. “Why terrorists love Britain,” newstatesman.com, 9 Aug 2004; and Pipes, Daniel. “Weblog: The Rationale behind ‘*Londonistan*’?” *DP*, 9 Aug 2004 (Yoel Natan is mentioned as a source of info in this “*Londonistan*” Weblog entry).

<sup>1776</sup> Campbell, Jamie...and Pipes, Daniel. *Ibed*.

<sup>1777</sup> Campbell, Jamie. “Why terrorists love Britain,” newstatesman.com, 9 Aug 2004.

I want to warn that the police raids—if repeated—could create a bad situation. *Islam* is not like Christianity, where they turn the other cheek. If they raid our homes, it could lead to the ‘Covenant of Security’ being broken. *Islam* allows us to retaliate. That would include (he tugs his ‘*Jihad*’ [logo] coat tight against the night air) by violent means.<sup>1774</sup>

The *New Statesmen* reported in 2004 that the UK security apparatus knows about this Covenant of Security...

...According to [*Mohammed*] Sifaoui [an undercover investigative journalist], it has long been recognized by the British *Islamists*, by the British government and by UK intelligence agencies, that as long as Britain guarantees a degree of freedom to the likes of Hassan Butt [a loudmouth pro-terrorist *Islamist*], the terrorist strikes will continue to be planned within the borders of the UK but will not occur here. Ironically, then, the presence of vocal and active *Islamist* terrorist sympathizers in the UK actually makes British people safer, while the full brunt of British-based terrorist plotting is suffered by people in other countries.<sup>1775</sup>

Daniel Pipes responded to the *New Statesmen* article quoted above:

To the extent the allowing of *Islamists* and terrorists safe haven on British soil is a conscious decision to keep the UK safe at the expense of others, this is an immoral and despicable policy that must be changed immediately.<sup>1776</sup>

One big reason *Islamists* were hesitant to end the Covenant of Security in the UK was they knew they would lose their terrorism planning and fund-raising headquarters, as one UK *Islamist* opined:

Hassan suggests that there are *Islamists* who are prepared to break their covenant [of security] with the British. And he warns that ‘any attack will have to be massive [i.e. to be worth it for...]. After one operation everything will close down on us in Britain.’<sup>1777</sup>

## Chapter 02: Moon-o-theistic Mideast

### Introduction

That *Allah* was a moon-god may sound farfetched, until one studies the religious context of the Mideast. This chapter includes brief descriptions of moon-god worship centers in the Mideast. These cities can be located on the Mideast maps at the start of this volume, and these cities can be found in the Index:

*Aksum, Beth Yerah, Haran, Hazor, Huraydah, Jericho, Marib, Makka, Qarnaw, Shabwa, the Sinai Desert, Tema, Timna, Ur and the Desert of Zin.*

On the accompanying map, the notable temples may seem few and far between. The state of archeology is such that only large temples, such as those in the capitals of various kingdoms, receive any mention in books available to the public.

One can rest assured that “on every high hill and under every spreading tree,” there was a pagan shrine of some sort (1Ki 14:23; 2Ki 17:10; Isa 30:25; Jer 02:20; 03:06; Eze 06:13; 34:06). Many homes in the Mideast also had moon-god shrines in ancient times, and every *Bedouin*’s tent had at least one household god with a carved crescent. Moreover, the jewelry for camels (Jdg 08:21, 26) and people (Isa 03:18) was often crescent-shaped in honor of the moon-god.

Though the distances seem great between Arabia and the Fertile Crescent, there still was much contact between them. Arabia, after all, is a peninsula surrounded for the most part by great bodies of water, so all the land routes eventually led north.

That the race, culture, religion and language of Arabia were derived from the *Semites* in the Fertile Crescent facilitated extensive contact between the two. This explains why *Muhammad* believed that all Mideast sorcery had its source from two talkative angels named *Harut* and *Marut* (*K* 002:102). *Muhammad* said *Harut* and *Marut* lived in a well near Babylon where they hung upside down like bats.<sup>1778</sup>

If the Arabs knew that sorcery had its roots in Babylon, the Arabs probably suspected the same about their pagan religion. Tisdall wrote:

Early Arabian inscriptions prove this, containing as they do the names of such deities as *Sin* (the moon-god) and *Aththar* (*Ashtoreth, Ishtar* [Venus]), worshipped by the *Sumerians* in the first place and afterwards by the *Semites* of Babylonia, *Assyria*, Syria and of some parts of Arabia. Yet, though there was doubtless a *Hamitic* [Egyptian] element in the population, the great mass of the people from very early times has always been *Semitic* in origin and also in language, character and religion.<sup>1779</sup>

Much of Arabia is an empty desert, and many maps label as “The Empty Quarter” the triangle bounded by *Makka*, the Persian Gulf coast and *Yemen*. Life at the oases often involved mere subsistence living, so even regions dotted with settlements could be a cultural wasteland. The people who lived in these sparsely populated areas looked elsewhere for their culture and civilization.

Given these conditions, it is not surprising that, though Jerusalem was 765 miles (1,231 KM) from *Makka*, a *Makkan Sura* calls Palestine “the near land” (*K* 030:003). This particular verse alludes to how the Persian *Sassanians* had beaten the Byzantine Empire and sacked Jerusalem in 614 AD.

<sup>1778</sup> Jeffery, *Islam*, pp. 25-26, fn. 4.

<sup>1779</sup> St. Clair-Tisdall. *Sources*, p. 30.



One might ask “Why does the *Koran* not call *Yemen* ‘the near land?’” The reason Palestine was considered “the near land” is *Makka* is midway down the Arabian Peninsula on the western edge. So *Marib* in *Yemen* is not much closer (560 miles/901 KM) to *Makka* than Jerusalem (765 miles/1,231 KM).

North of *Makka* and *Madina* was “the near land” due to traveling conditions such as flatness of the terrain and climate that made for easier travel. Anywhere south of *Makka* was nearer to the earth’s hot equator and was more mountainous.

Hot and rugged conditions meant that a pilgrimage to *Makka* from *Sana, Yemen*, took forty-three days. A cooler trip along the Red Sea east coastal plain meant that Palestine was forty camel days from Palestine.<sup>1780</sup> Due to the flatness of the terrain, a pilgrimage all the way from *Kufa, Iraq*, to *Makka*, only took twenty-seven days.<sup>1781</sup>

Conditions meant that it took sixteen fewer days to travel from *Kufa, Iraq*, to *Makka*, than from *Sana, Yemen*, to *Makka*, though *Sana, Yemen*, is 271 miles (436 KM) closer to *Makka* than *Kufa, Iraq*, is. Similarly, a pilgrimage from Damascus to *Madina* took only 30 days.<sup>1782</sup>

Given these conditions and the relatively sparse population in Arabia, the *Makkans* considered moon-god centers anywhere in Arabia “near,” just as Palestine was “the near land” to *Makkans*.

So *Makka* would have undoubtedly been a moon-god worship center if *Makka* were representative of the pagan Mideast, as early *Muslim* traditions assure us it was.

## Mideast

Cuneiform tablets show that in the first and second millennia BC, there were myths that explained the rise of the astral gods. In these cosmogonic myths, the primal gods of the sky, earth and water gave birth to or created, the astral gods.

This higher tier of primal gods and their myths were undoubtedly forgotten long before *Muhammad*’s time. In fact, these primal gods may not have been worshipped at all but were just conjured up to explain the origin of the popular astral religion. Moderns mostly only know of these cosmogonic myths through clay tablets that had been buried for millennia.

Almost from the start of recorded history in the Mideast, the highest god generally was the moon-god. Tamara Green wrote:

...in Mesopotamian cosmology, the sun is clearly subordinated to the moon: in the *Enuma Elish* the moon is created before the sun, while in the Sumerian astral triad, the Evening Star and *Utū* the sun-god, are both the children of *Nanna* the moon.<sup>1783</sup>

Some Mesopotamian city-states and capitals of empires worshipped the sun-god or the Jupiter-god as the highest god. This however was an anomalous and short-lived exception to the rule since it was astrologer-priests who appreciated the sun and Jupiter. The people of the Mideast however saw the moon-god as the greatest god. The people always remained faithful to the moon-god but the priests and their power centers were ephemeral, and so was their sun and Jupiter worship.

One such city-state was *Babylon*. The priests of *Babylon* considered *Marduk*, the god of Jupiter, to be the high god. In the last few years of the *Babylonian* Empire, the

<sup>1780</sup> Lings. *Sources*, p. 2.

<sup>1781</sup> Peters. *Hajj*, p. xxv (also found in Peters. *Makka*, p. xxv), “The Pilgrim Routes of Arabia” map.

<sup>1782</sup> Peters. *Hajj*, p. xxv (the same map is found in Peters. *Makka*, p. xxv) . . . *Idem*.

<sup>1783</sup> Green. *Moon*, p. 24.

emperor *Nabonidus* favored the moon-god—to the chagrin of the *Babylonian* priests of *Marduk*. This dispute contributed to *Babylon*'s fall in 539 BC to Cyrus (died 529 BC), a subject discussed elsewhere in this book. The *Encyclopedia Britannica* states:

The last king of Babylon, *Nabonidus* (reigned ~556–539 BC), attempted to elevate *Sin* to a supreme position within the pantheon.<sup>1784</sup>

Jeremiah's prophecy about Babylon eventually was fulfilled. *Babylon* became a haunt for jackals where no one lived (Jer 51:37). Then, because fewer people worshiped the Jupiter god *Marduk*, Babylon reverted back to moon-god worship.

The dominance of the Mideast moon-god cult is shown by the fact that the moon-god worship center at *Ur* lasted until the third century BC, and the moon-god worship center at *Haran* lasted until the *Mongol* invasion in the eleventh century AD. *Ur* would have lasted longer had not the *Euphrates* River changed course.

### ***Aksum, Abyssinia (14:7:60 N 38:43:0 E)***

*Aksum* is a town in northern Ethiopia. From the first to the eighth century AD, *Aksum* was the capital of the *Abyssinian* Empire. The empire extended through Ethiopia and briefly included *Yemen*. *Muhammad* sent some of his followers as refugees to the *Negus*, the King of *Abyssinia* (Arabic: *Habash*).<sup>1785</sup>

In the fourth century AD, many *Abyssinians* converted to Christianity. Before this time, the moon-god was a high god. Pre-Christian *Abyssinian* pottery and coins often sported the crescent-and-orb symbol and...

...it appeared on the coins until the reign of Ezana [4<sup>th</sup> C AD], when the cross began to be used instead. The disc and crescent, however, presumably divested of its sacred character, continued to be used in Ethiopia as (apparently) a mint-mark on coins until the very end of the coinage (Munro-Hay 1984i: see Gersem, Armah).<sup>1786</sup>

*Abyssinian* monuments indicate the moon-god's high status. Creswell wrote:

They [monolithic pillars at *Aksum*] are of oblong cross-section [meaning the pillar is not geometrically square] and are carved to resemble houses of many stories, and the technique just described is counterfeited on the stone. The largest, now fallen and broken, measured 33.3 meters (109 feet) in height, tapered upward and ended in a crescent-shape, which was the symbol of *Mahram*, the *Abyssinian* god of war.<sup>1787</sup>

Because *Mahram* was male and a god of war, Greeks cataloguers of the antiquity era equated *Mahram* with *Ares*, whose astral symbol is Mars. Indo-European moon deities such as *Selene*, *Luna* and *Artemis* tended to be female, and were goddesses of wisdom, the hunt and the like.

Among the *Semites* the moon deity was usually male and was the high astral god. Often the moon-god had one or more female consorts. In Southern Arabia and in *Abyssinia*, the moon-god moonlighted and took on the job of god of war. This information, as well as the warlike *Koran* and the traditions, suggests that *Allah* was both a god of war and a moon-god.

<sup>1784</sup> *EB*. *Sin* entry, accessed 16 Aug 2004.

<sup>1785</sup> Ishaq. *Sirat*, pp. 146-153.

<sup>1786</sup> Munro-Hay, Dr. Stuart. *Aksum: An African Civilisation of Late Antiquity*, 1991, Ch. 8: "The Economy," online edition.

<sup>1787</sup> Creswell. *Architecture*, pp. 2-3.

Arabian settlers and traders transported the pagan religion of southern Arabia to *Abyssinia* at an early date. Here is Krause's German to English translation:

He [*Mahram*] is namely in all pagan *Aksumitic* inscriptions the main god, the national god of war, and the special protective god of the royal houses. This is in all South Arabian, yes, nearly in all *Semitic* monuments, a sure identifying mark of the moon-god. As the national god of war, he [*Mahram*] is identified in the Greek texts with the god of war *Ares* (Mars). And as the main god he [*Mahram*] is in *Adulitanum* 'the highest god.'<sup>1788</sup>

The Hans Krause provides evidence that shows a *Semitic* moon-god from Southern Arabia found his way to the northeast coast of Africa. Here is Krause's German to English translation:

The very old trading-traffic between South Arabia and the African coast has caused already in very early times South Arabians to come to Africa. Already in the first half of the first millennium BC, we do find *Sabean* settlements in Northeast Africa. In *Jeha* near present-day *Adua*, one has found a venerable old temple. According to the descriptions it is obviously a sister-temple of the famous moon-temple near *Mârib*. That is, an African *Haram Bilkîs* ([with] open windows and without a roof). The few inscriptions, that have been found, do prove that here once *Sabeans* have lived. The shape of the letters and the *boustrophedon* [where alternate lines of script run right-to-left and then left-to-right] type of writing do lead us into the time between the 5th and 8th century BC. We may assume that they are identical with the *Sirwah* and *Mârib* type. They also venerated the Venus-star, moon and sun just like their relatives in Arabia.<sup>1789</sup>

The *Eritrean News Wire* reported:

Whatever the direction, dating and details of such migration, there can be no denying that northern Ethiopia and *Yemen*, in the half millennium or so prior to the Christian era, shared a related civilization or civilizations. This is evident from the at least limited use in Ethiopia of the *Sabaeen* language and script, as found on ancient *Aksumite* inscriptions and coins, and an apparently identical religion. The latter centered on the worship of the sun and moon, and the local god *Almaqah*. The logo of the sun and moon, used at that time in *Yemen*, appears for example on an ancient *Aksumite* obelisk at *Matara*, as well as on virtually all pre-Christian *Aksum* coins which began to be struck in the first century A.D. Reference to *Almaqah* is likewise to be seen on many *Sabaeen* inscriptions on both sides of the Red Sea.<sup>1790</sup>

One can conclude from this data that the Abyssinian war-and-moon-god *Mahrem* was the same entity as the *Sabean* war-and-moon-god *Alumqah* (this chapter discusses how both *Alumqah* and *Allah* were South Arabian war-and-moon-gods).

<sup>1788</sup> Nielsen, 1912, pp. 593-594, as translated in Krause, "*Haram-Harimat*."

<sup>1789</sup> Nielsen, 1912, pp. 589-590, as translated in Krause, "*Haram-Harimat*."

<sup>1790</sup> Pankhurst, Richard. "Let's Look Across the Red Sea: Ethiopia's Historic Ties with Yemen," *Eritrean News Wire*, *Addis Tribune* (*Addis Ababa*), eri24.com, 17 Jan 2003.

**Beth Yerah, Palestine (approximately 32.7 N 35.5833 E)**

*Bet(h) Yerah* means “the House of *Yerah*.” *Yerah* was the moon-god. “*Beth Yerah* was settled in the Early Bronze Age (~3100–2300 BC).”<sup>1791</sup> *Beth Yerah* is located at the southern tip of the Sea of Galilee on a Jordan River ford.

**Egypt**

Egypt was “The Land of the Moon.” Jules Cashford wrote that *Set(h)* the sun-god...

...slew him [*Osiris*] again, this time dismembering his body into 14 pieces—the number of nights of the waning moon. Then he scattered the pieces all over Egypt, burying them each in a different place. So it was that Egypt became the ‘Land of the Moon’...each month *Osiris* is reborn through his son *Horus* as the new-moon, the new form of himself who takes his place and engages in the monthly battle of waxing and waning with *Seth*. The life, death and resurrection of *Osiris* follows the lunar pattern...the ritual emblem of *Osiris* was the shape of the new-moon [a crescent]...*Isis* and *Osiris*, as goddess and god of the moon, embodied the ever-renewing cycles of nature, both the waxing of growth—in the moon, the Nile, the plants, animal and human beings—and the waning of death—when the moon diminished, the Nile shrank, the plants shriveled and animals and people grew old and died.<sup>1792</sup>

**Haran, Turkey (36.88 N 39.00 E)**

*Haran* (Arabic: *Harran* Greek/Latin: *Charan*, *Charran*, *Carrhae*). “It was an important center on the trade route from *Nineveh* to *Carchemish* and the seat of the *Assyrian* moon-god.”<sup>1793</sup> *Haran* was a *Sin* moon-god worship center from ancient times until the *Mongol* invasions left the town depopulated in the twelfth century.

*Haran* is located in Southeast Asian Turkey, 24 miles (39 KM) southeast of *Urfa*, also called *Sanliurfa* (37.13 N; 38.77 E). *Sanliurfa* means “*Urfa* the Glorious.” *Sanliurfa* was predominately Christian in Byzantine times and was called *Edessa*. *Edessa* was the religious rival of the pagan stronghold at *Haran*.

There are five known *Sin* moon-god worship centers on caravan trails: *Ur*, *Harran* in southeast Turkey, *Nayrab* in modern Syria, *Tema* in Arabia and *Shabwa* in *Yemen*. These five differ from the many thousands of sites where *Sin* was either worshipped under a different name, or *Sin* worship was not especially notable.

*Nayrab* (36.17 N 37.22 E) is located in northern Syria not very far from the Mediterranean Sea, and is about 109 miles (175 KM) southeast of *Harran*. The *Encyclopedia Britannica* states:

Since the ancient trails seem to have been marked with sanctuaries, it is noteworthy that *Nayrab* near *Aleppo* [Syria] was like *Harran* and *Ur*—a center of the *Sin* cult.<sup>1794</sup>

The *Encyclopedia Britannica* relates that the eighteenth-century BC, *Mari* tablets indicate that the Hebrews (*Hapiru*) and Benjaminites (*Banu Yamina*) were involved in *Sin* moon-god worship. *Mari* is in northern Syria.

<sup>1791</sup> *EB*, “*Beth Yerah*” entry, accessed 11 Sep 2003.

<sup>1792</sup> Cashford. *Moon*, p. 24

<sup>1793</sup> *CEE*, *Haran* entry.

<sup>1794</sup> *EB*, accessed 16 Aug 2004, *Abraham* entry.

*Yamina* means “Sons of the South,” but literally, *Yamina* means “Sons of the Right[-hand],” referring to how the south is on the right hand side when one orients himself by the rising sun. The *Encyclopedia Britannica* states that the *Mari* texts indicate that the mass of Benjaminites...

...are always indicated as being north of *Mari* and in Harran, in the Temple of *Sin*...there were Benjaminites on the right bank of the river, in the lands of *Yamhad (Aleppo)*, *Qatanum (Qatna)* and *Amurru*...Since the ancient trails seem to have been marked with sanctuaries, it is noteworthy that *Nayrab*, near *Aleppo*, was like *Harran* and *Ur*—a center of the *Sin* cult, and that south of *Aleppo* on the road to *Hamah* there is still a village that bears the name of Benjamin.<sup>1795</sup>

### **Hazor, Palestine (33.1 N, 35.35 E)**

*Hazor* is located 5 miles (8 KM) southwest of Lake *Huleh* on the Upper Jordan River. *Hazor* is 10 miles (16 KM) north of the Sea of Galilee (*Kineret*), which lies between the upper and lower Jordan Rivers. *Hazor* was destroyed by the *Israelite* invasion after the *Exodus* from Egypt. The *Encyclopedia Britannica* states:

*Hazor*, in the Jordan Valley north of the Sea of Galilee, has yielded a 13th-century BC statue of a male deity on a bull-shaped base. In another temple a set of cultic objects, also from the 13th century, was found behind a stone slab: a seated male figure and a group of standing stones, the central one of which has engraved on it a vertical pair of arms with hands outstretched toward a disk and crescent.<sup>1796</sup>

### **Huraydah (or Hureidha), Southern Arabia (15.36 N 48.12 E)**

Brian Doe wrote:

The site consists of a temple and domestic buildings and tombs in the northern scree slopes [slopes with loose rock debris], in the Wadi *'Amd* a few miles northwest of the town of *Huraydah*. Under the direction of Dr. G. Caton Thompson in 1937,<sup>1797</sup> it was the first controlled archaeological excavation carried out in Southern Arabia...From inscriptions found on the site the temple was dedicated to the moon-god *Sin*, and the ancient name of this site is also given, it was *Madhabum*.<sup>1798</sup>

### **Jericho, Palestine (31.51N 35.27E)**

*Jericho* literally means “His moon.” The “his” likely refers to the moon-god *Yerah*. *Jericho* is about 18 miles east of Jerusalem at the north tip of the Dead Sea on the west bank of a ford of the Jordan.

*Beth Haran* (or *Bait Haram*, *Baitharan*, *Baitharra*) was near *Jericho* (Num 32:36). Its ruins are “*Tell er-Rameh* in *Wady [Wadi] Chesban*, about 6 miles East of Jordan.”<sup>1799</sup> *Beth Haran* was east “of the Jordan River, not far northeast of its mouth into the Dead Sea.”<sup>1800</sup>

The name *Beth-Haran* would seem to indicate that *Jericho* might have been influenced by the *Haran* in northern Syria, “the City of the Moon.” The

<sup>1795</sup> *EB*, accessed 16 Aug 2004, Abraham entry.

<sup>1796</sup> *EB*, “Syrian and Palestinian religion” entry, accessed 13 Sep 2003.

<sup>1797</sup> Thompson. *Moon*.

<sup>1798</sup> Doe. *Arabia*, pp. 237-238.

<sup>1799</sup> *ISBE*, *Beth-Haran* entry.

<sup>1800</sup> *CEE*, *Beth-Haran* entry.

Mesopotamian influence is further evidenced by the fact that not far from *Beth Haran* is Mount *Nebo*. *Nebo* is named after the *Babylonian* god of wisdom. *Nebo* is the divine scribe of the moon-god *Sin*.

Mount *Nebo* is located in Moab, east of the Jordan River, which today is in the Kingdom of Jordan. It rises more than 4,000 feet (1,200 meters) over the nearby Dead Sea. One can see a large swath of land west of the Jordan from *Nebo*'s peak.

The *Israelites* circumambulated *Jericho* thirteen times in seven days (Jos 06:03-04). This was done in mockery of the astral religion ritual of circumambulating seven times or in multiples of seven.

The ruins of *Jericho* still witness its fall to the *Israelites*—if one figures that the *Exodus* was early, and that the establishment's archeological dating is suspect due to extreme bias. The *Encyclopedia Britannica* wrote:

This [an archaeological layer of *Jericho*] may have been destroyed in the second half of the 14th century BC but evidence is too scanty for precision.<sup>1801</sup>

### ***Ma'in* (North of the Kingdom of *Saba*)**

*Ma'in* was the kingdom north of the kingdom of *Saba* that lasted from the 4<sup>th</sup> century B.C. to the 2<sup>nd</sup> century AD.<sup>1802</sup> Its capital was *Qarnaw* and its people were called the *Minaeans*. The *Minaeans* war- and moon-god was *Wadd*, which means "love." *Wadd* is mentioned as being an Antediluvian idol in the *Koran* (K 071:023-025). Hafiz Sarwar wrote of the idol "Wadd was shaped like a man."<sup>1803</sup> The *Merriam-Webster's Encyclopedia of World Religions* (2000) states:

In *Ma'in* the national god *Wadd* ("Love") originated from North Arabia and probably was a moon-god; the magic formula *Wd'b: Wadd* is (my?) father," written on amulets and buildings, is often accompanied by a crescent moon with a small disk of Venus (p. 70).

The fact that *Wadd* is associated with a crescent and is a father shows he is a male moon-god.

### ***Makka*, Arabia (21.45 N 39.82E)**

#### ***Allah* as a Moon-god**

There are many indications that *Muhammad* was a moon-god prophet. *Muhammad*'s only miracle recorded in the *Koran* involved the splitting of the moon (K 054:001). That the *Koran* is moon-god literature is suggested by the fact that *Muhammad* said if *Allah* caused the *Koran* to descend on a mountain, it would have split into two (K 059:021). This reminds one of the moon miracle (just mentioned) in that the moon split in two and each half set behind a separate mountain near *Mekka*.

Likewise, there are many indications that the *Kaaba* was a moon-god temple which will be explored later this *Moon-o-theism* book. One of the more obvious evidences sits next to the *Kaaba*, namely the crescent-shaped *Hatim* Wall that served as a moon-god altar.

The only god to complete with *Allah* the moon-god for the top slot of the pantheon was *Hubal*. *Hubal* was the god of Jupiter, as discussed later in this book.

<sup>1801</sup> *EB*, *Jericho* entry, accessed 13 Sep 2003.

<sup>1802</sup> *EB*, *Ma'in* entry, accessed 14 Sep 2003.

<sup>1803</sup> Sarwar. *Prophet*, pp. 18-19. Zwemer says the same in Zwemer. *Animism*, ch. 1.

The scholars Pocock and Dozy believed that *Hubal* was the equivalent of “the *Baal*” (*HaBaal*), meaning “the lord.”<sup>1804</sup> *Hubal* was just a title but traditions seem to preserve *Hubal*’s personal name: *Ghanm*.<sup>1805</sup>

*Allah*’s titles are many, including *Rabb* (lord) and *Rahman* (Merciful). *Allah*’s personal name seems to have been *Sin*, judging from how *Allah* is addressed as *Ya Sin*, meaning “Oh *Sin*” (*K* 036). These points are discussed elsewhere in the book.

*Allah*’s personal name *Sin*, was the same name as the moon-god *Sin*, who was known throughout the Mideast since ancient times. *Sin* was the name of the national war-and-moon-god of the nearby *Yemeni Hadramis* kingdom that existed from the fifth century BC to the fourth century AD.

Egerton Sykes wrote that *Muhammad*’s *Allah* “seems to have been preceded by *Ilmaqah* [also spelled *Ilumquh* and *Almaqah*] the moon-god.”<sup>1806</sup> Sykes’ surmise makes sense since:

- ☉ Ryckmans wrote that *Sabean* inscriptions mention the “Daughters of *Il*,” *Al-Ilat* (aka *Allat*) and *Al-Uzza*.<sup>1807</sup> Ryckmans wrote “...the so-called ‘Daughters of *Il*’...correspond to the ‘Daughters of *Allah*’ of pre-Islamic *Mekka*: the goddesses *al-Lat*, *al-Uzza* and *Manat* alluded to in the *Koran* [*K* 053:019–022 and the Satan Verses]. The first two appear also on South Arabian amulets.”<sup>1808</sup>
- ☉ *Il* means “god” and is short for *Ilah* (“god”), *Al-Ilah* (“The god”) and *Allah* (an abbreviation of *Al-Ilah*). Since the *Sabean Il* likely refers to *Almaqah*, it is no wonder Alfred Guillaume wrote: “Some scholars trace the name [*Allah*] to the South Arabian *Ilah*, a title of the moon-god...”<sup>1809</sup>
- ☉ *Muhammad* believed *Allah* was the god of the Queen of *Sheba* as well as King Solomon’s god (*K* 027:044).
- ☉ *Muhammad* believed that the king and traveler, *Zulqarnain*, was a good *Muslim* (*K* 018:083). *Muhammad*’s biographer, *Ibn Ishaq*, seemed to believe that the Queen of *Sheba*, *Zulqarnain* and King *Tubba* of *Yemen* were all good *Muslims* in a single dynastic line.<sup>1810</sup> According to the “south Arabian interpretation...King *Tubba Al-Akran* or *Dhu ‘l-Karnain*” is *Zulqarnain* in the *Koran*.<sup>1811</sup>
- ☉ *Zulqarnain* means “the two-horned one” and refers to a crown with a crescent. This indicates that *Zulqarnain*’s national high god was the moon-god. All the high gods and national gods in Southern Arabia were moon-gods and war-gods.

The Bible however never says that the Queen of *Sheba* was a believer in *Yahveh*. She came to Jerusalem to wine and dine her business associate, Solomon. She told Solomon that *Yahveh* was “your God” (1Ki 10:09).

Jesus said rhetorically that the Queen of *Sheba* would rise up and judge those who disbelieved Jesus (Mat 12:42; Luk 11:31). Jesus similarly said that the

<sup>1804</sup> Gibb & Kramers. *Encyclopedia*, p. 140, *Hubal* entry.

<sup>1805</sup> Guillaume wrote: “[*Hubal*] is the reading of *Al-Kalbi* [*Book of Idols*], but all [*Sirat Rasul Allah*] manuscripts have *Ghanm*, a deity unknown. Confer also *Yaq.* iii. 665.8” (*Ishaq. Sirat*, p. 100 & fn).

<sup>1806</sup> Sykes. *Mythology*, p. 7, *Allah* entry.

<sup>1807</sup> Ryckmans, Jacques. *EB*, “Arabian religions,” 2004.

<sup>1808</sup> Ryckmans. *Anchor*, v. 6, p. 173.

<sup>1809</sup> Guillaume. *Islam*, p. 7.

<sup>1810</sup> *Ishaq. Sirat*, p. 12.

<sup>1811</sup> Gibb & Kramers. *Encyclopedia*, p. 76, *Dhu ‘l-Karnain* entry.

Sodomites were more righteous than those who disbelieved him (Mat 11:23-24), even though they continually sinned against *Yahveh* (Gen 13:13).

Archaeology shows that the Queen of *Sheba* worshipped the national moon-god of the Kingdom of *Sheba* called '*Ilumquh*'.<sup>1812</sup> Recall that *Zulqarnain* means "The two-horned one," an allusion to the moon-god. This further suggests that the Queen of *Sheba* worshipped a moon-god—if *Zulqarnain* was in the same dynastic line as the Queen of *Sheba*.

*Muhammad* seems to think that '*Ilumquh* was just the local version of the moon-god *Sin* as is evidenced by the chapter title "*Ta Sin*," probably meaning "Oh [moon-god] *Sin*" (*K* 027:001). *Ta Sin* has the same meaning as *Ya Sin*, "Oh [moon-god] *Sin*," the chapter title of *K* 036. See the ToC for the discussion of the Mysterious Letters at the head of several *Suras*.

There are other indications that *Islam* came from *Sabean* '*Ilumquh* moon-god worship. Jacques Ryckmans wrote:

*Istisqa'*, a collective rogation [i.e. prayer] for rain with magical rites, in times of acute drought, is mentioned by the *Muslim* tradition and in two *Sabean* texts. The rite is still part of the *Islamic* ritual.<sup>1813</sup>

The *Hajj* ceremony of hiking into the valley and hills around *Mekka* and the subsequent ritual feast of *Eid Al Adha* reminds one of the pilgrimages and *Ibex* hunts performed in Southern Arabia to induce rain. Inscriptions show these *Ibex* hunts took in 10, 20, 50, 60, 150, 200, 460, 1000 and 4000 head at one time. The ruins of temples have banquet rooms with stone tables and benches where the victims of the hunt were eaten.<sup>1814</sup> Jacques Ryckmans wrote that the *Ibex* hunt rain rite is still being preformed today in the *Hadramawt* of Southern Arabia.<sup>1815</sup>

*Muhammad* said:

My Lord [*Allah* the moon-god] hath [has] bidden me grow my beard and cut my moustache.<sup>1816</sup>

Why would *Allah* order this? The fact that one of *Muhammad's* heroes, *Zulqarnain*, means "two-horned one" and refers to a king with a crescent crown (*K* 018:083), attests who how rulers and moon-god prophets like *Muhammad* chose to dress like their moon-gods.

*Islamists* follow *Muhammad's* example in dress and they grow a beard.<sup>1817</sup> *Muslim's* unshorn billy-goat or bearded *Ibex*-look (*Ibexes* are a kind of wild goat) along their loose-fitting smocks with long sleeves (*Galabiyya*, *Dishdash*), reminds one of how ancient Mideast moon-gods such as *Sin* looked, and how the *Sabean* moon-god *Almaqah's* favorite animal, the bearded *Ibex*, looks. Werner Daum wrote:

The traditional, wholly unrealistic figures of an *Ibex*, with the face of an old man, are made in the *Hadramut*. . . Whom do they represent? . . . There is only one explanation. . . the *Ibex*. . . is the imperial *Sabean* god '*Almaqah*—whose symbolic animal was the *Ibex*.<sup>1818</sup>

<sup>1812</sup> Doe. *Arabia*, p. 25.

<sup>1813</sup> Ryckmans, Jacques. *EB*, "Arabian religions," 2004.

<sup>1814</sup> Breton. *Felix*, p. 132.

<sup>1815</sup> Ryckmans, Jacques. *EB*, "Arabian religions," 2004.

<sup>1816</sup> Lings. *Sources*, p. 260.

<sup>1817</sup> Sturke, James. "Branson firm 'sacked Muslim in row over beard,'" *The Independent*, 11 Aug 2004, Home News, p. 17, headscarf.net.

<sup>1818</sup> Daum. *Ursemitische*, pp. 64-66.



That the *Sabeans* would give their *Ibexes* the face of a bearded man to symbolize their moon-god is similar to how, starting in ancient *Sumer*, one can see Fertile Crescent images of fully-bearded rams and bulls. Often the beards are formed using bluish *azure* or bluish *lapis-lazuli* stones.<sup>1819 1820</sup> Rams and bulls were moon-god animals, so they were made to look like *Sin* the moon-god.<sup>1821 1822</sup>

Inscriptions show that Christians in *Sirwah*, *Yemen*, where the Queen of *Sheba* was thought to have had a summer palace,<sup>1823</sup> called the Father *Allah*. *Sirwah* is an ancient settlement in the mountains to the west of *Marib*. Samuel Zwemer wrote:

On the Christian monuments found by Dr. Edward Glaser in *Yemen*, *Allah* is also mentioned. The *Sirwah* inscription (AD 542) opens with the words: ‘In the power of the All-merciful and His Messiah and the Holy Ghost,’ which shows that, at least in *Yemen*, Arabian Christians were not in error regarding the persons of the Trinity.<sup>1824</sup>

Undoubtedly the vestiges of the moon-god religion remained in *Sirwah* as they did elsewhere. For instance, the vestiges of the moon-god religion remained in the Christianized former Western Roman Empire until the ninth century, as MacMullen noted.<sup>1825</sup> One archaeologist wrote of *Marib*, *Yemen*:

Near the top of the delicate stone shaft was a beautifully carved circular sun with a crescent-moon...for some twenty-five hundred years this graceful pillar had stood guard above the sands near *Marib*...<sup>1826</sup>

Another example of the vestiges of the moon-god religion remaining even though Christianity has made inroads into the community is the monumental pillars topped by crescents in *Abyssinia* that still exist. The last such column may have been built in the fourth century even though the Ethiopian eunuch, the treasurer for Queen Candace, became a Christian in the first century (Act 08:27).

The Christian *Negus* ruled among pillars of monumental size topped with crescents in *Aksum*, *Abyssinia*. These crescent-topped pillars may have led *Muhammad* to believe both that *Allah* the moon-god was the god of Christians, and that the Christian *Negus* would be receptive to his *Allah* moon-god doctrine.

After the Abyssinian royalty converted to Christianity, they may not have rid themselves of the crescent symbols but merely added Christian and Byzantine symbols to their costumes. Thus the *Negus* may have actually worn a crescent and horn headdress. This was the case with Nubian royalty at least.

P. L. Shinnie wrote that in a medieval church at *Abd el Qadir* in *Nubia*, is a painting of the Eparch of Kingdom of *Dongola*—as identified by an inscription:

He is seen holding a representation of the church, of which he was presumably the founder, in his hand. On his head he wears the two-horned

<sup>1819</sup> *The New International Dictionary of the Bible* pp. 678-679, has an article and photographs of a wall painting of a harp, lute, double-pipe, and lyre. Also shown is a lyre found at *Ur*, circa 2500 with a gold head of a bearded bull with horns mounted on the back of the wooden soundbox.

<sup>1820</sup> Bull-headed lyre (restored) from tomb 789 (King’s Grave), Royal Cemetery, *Ur* (modern *Tell Muqayyar*), *Iraq*, circa 2600 B.C. Gold leaf and *lapis lazuli* over a wooden core, approx. 5’ 5” high. University Museum, University of Pennsylvania, Philadelphia.

<sup>1821</sup> *Larousse*, *Sin* entry, p. 56.

<sup>1822</sup> NationMaster.com, accessed 28 Mar 2004, “*Sin* (god)” entry.

<sup>1823</sup> Clapp. *Sheba*.

<sup>1824</sup> Zwemer. *Essay*, Ch. 2: “*Allah*, the Divine Essence,” p. 27.

<sup>1825</sup> MacMullen. *Eighth*, p. 70.

<sup>1826</sup> Phillips. *Sheba*, pp. 226-227.

headdress, which seems to have been an emblem of *Nubian* royalty. The double-headed eagles on his costume are again evidence of the persistence of *Byzantine* tradition.<sup>1827</sup>

So what this all means is that pagans would have seen the crescents at *Sirwah* and other Christian sites, and they would assume that Christians thought of the old moon-gods as being the God of the Bible. In the case of *Sirwah*, the pagans would have assumed that Christians referred to the moon-god *Almaqah* as *Allah*.

During the *Islamic* period, Christians felt they had to say *Allah* was the God of the Bible, even they knew this was false. If Christians did not give lip service to the idea that *Allah* was *Yahveh*, they would lose their *Dhimmi* “protected” status. Then they would then be considered pagans and would have been given the right only to choose between death and *Islam*.

The nearest kingdoms to *Makka*, not counting mere tribal confederations, were found in *Yemen*. There were other kingdoms in *Yemen* besides *Sheba*. They had different national moon-gods but those kingdoms and their moon-god religions did not last until nearly the time of *Muhammad*.

Other kingdoms besides *Sheba* either fell into ruin or were eventually Judaized or Christianized. The only near exception was the pagan Kingdom of *Sheba*, which lasted until the sixth century AD, the century that *Muhammad* was born (570 AD).<sup>1828</sup> What this all means is that the moon-god *Almaqah* probably was the *Allah* that *Muhammad* knew just as Egerton Sykes surmised (as quoted a bit earlier).

Southern Arabian and Abyssinian Moon-gods That Doubled as War-gods				
Yemeni Kingdom	Yemeni Nation	National Moon-god	Capital City	Duration of Existence
<i>Hadhramaut/Hadramawt</i>	<i>Hadramis</i>	<i>Sin, Syn</i> or <i>Sayin</i> (from <i>Su-en</i> )	<i>Shabwa</i>	5 <sup>th</sup> C. BC to 4 <sup>th</sup> C. AD
<i>Ma'in</i> (north of <i>Saba</i> )	<i>Minaeans</i>	<i>Wadd</i> (Love)	<i>Qarnaw</i>	4 <sup>th</sup> C. BC to 2 <sup>nd</sup> C. AD <sup>1829</sup>
<i>Qataban</i> , or <i>Kataban</i> (in southwest <i>Yemen</i> )	<i>Qatabanians</i> , or <i>Katabanians</i>	‘ <i>Amm</i> or ‘ <i>Anbay</i> (Paternal Uncle)	<i>Timna</i>	7 <sup>th</sup> C. BC to 1 <sup>st</sup> C. AD ( <i>Timna</i> was destroyed between 25 BC and 1 AD).
<i>Saba</i> , <i>Sabea</i> or <i>Sabia</i>	<i>Sabians</i> , <i>Sabeans</i> , or <i>Sabaeans</i>	<i>Almaqah</i> , <i>Ilmaqah</i> or ‘ <i>Ilumquh</i>	<i>Marib</i>	8 <sup>th</sup> C. BC to 6 <sup>th</sup> C. AD
<i>Abyssinia</i> , or <i>Ethiopia</i>	<i>Abyssinians</i> , or <i>Ethiopians</i>	<i>Mahram</i> (imported version of <i>Almaqah</i> )	<i>Aksum</i> or <i>Axum</i>	1 <sup>st</sup> C. AD to 4 <sup>th</sup> C. AD pagan; 4 <sup>th</sup> AD to 7 <sup>th</sup> C. AD Christian

*Marib* is located about 77 miles (123 KM) due east of *Sana(a)* (15.3547 N 44.2067 E). The moon temple at *Marib* is called *Mahram Bilqis*, meaning “The Temple of *Bilqis*.” In *Yemen* the Queen of *Sheba* was known as *Bilqis*.

<sup>1827</sup> Shinnie, P.L. “Medieval Nubia and Byzantium,” *Sudan Antiquities Service*, Khartoum, 1954, article + figure 5 (illustration), rumkatkilise.org/nubia.htm.

<sup>1828</sup> Doe. *Arabia*, kingdom list on insider cover map and p. 25.

<sup>1829</sup> *EB*, *Ma'in* entry, accessed 14 Sep 2003.

That the ruins of the moon temple at *Marib* are called the Temple of Queen *Sheba* reminds one of how the moon temple at *Makka* is associated with *Ibrahim*. These moon temples were just two out of thousands of pagan temples throughout the ancient world that were Biblicized by associating them with Biblical figures. The major difference however is that in *Makka*, the process of Biblicization did not lead to a conversion of the temple into a church or synagogue but it led to *Islam* instead.

*Muhammad* mentions the *Marib* dam break (K 034:016-019). Historians know this event meant the end of irrigation and agriculture at *Marib*, and spelled the end for civilization there. The *Mahram Bilqis* moon temple was left to the mercy of drifting sands around 550 AD, twenty years before *Muhammad* was born.<sup>1830</sup>

Other indications that *Makka* was a moon-god shrine include the fact that near *Makka* were related astral shrines. The tribe *Thaqif* had an *Allat* sun-goddess shrine at *Taif* (21:15N 40:21E), which is about 36 miles (58 KM) southeast of *Makka* (21:25:48N 39:49:12E).

Besides *Allah*, *Allat* was the *Thaqif*'s favorite idol, judging by how they tried to bargain with *Muhammad* over *Allat* while negotiating surrender terms. The *Thaqif* wanted three years during which they would wean themselves off *Allat*.<sup>1831</sup> *Allat* was either the consort or daughter of *Allah*, depending on the local myth. According to the Satanic Verses, the *Makkans* considered *Allat* to be a daughter of *Allah*.

*Makka* was also near the shrine of *Uzza* (Venus) at *Nakhla*. The *Nakhla* shrine was east of *Makka* and north of the *Taif* shrine mentioned above. *Nakhla* and *Taif* were sister shrines and daughters of the *Makkan* shrine.

*Nakhla*'s main deity was the Venus goddess, *Uzza*. *Taif*'s main god was *Hubal*, and *Taif*'s main goddess was the sun deity *Allat*. *Allat* and *Uzza* were considered Daughters of *Allah*, according to the Satanic Verses. Thus *Makka* was most important of the three shrines since the moon-god was nearly always the high god of the pagan Mideast triad.

Whenever anyone asks why *Makka* was such a holy spot, they ought to instead ask what made these three locations holy: *Makka*, *Taif* and *Nakhla*. Together these cities honored the typical Arabian triad of the moon, sun and Venus.

*Muhammad*'s tribe, the *Kuraish*, along with the *Kinana* and *Mudar* tribes, ran the *Nakhla* shrine.<sup>1832</sup> While the high god of the *Kuraish* was *Allah*, the *Kinana* tribe embraced *Hubal* (Jupiter) as their high god,<sup>1833</sup> even though *Hubal* had only recently come to the *Makkan Kaaba* from Syria.

One can extract the *Makkan* creation myth from the *Koran*. After *Ibrahim* called the moon "my lord" (K 006:077), he then said the moon-god created the heavens and the earth (K 006:079). *Allah* created the heavens and earth and made the sun and moon "subservient" (K 029:061-063). *Allah* then took the moon to be his main symbol and his perch.

That the moon was made "subservient" does not mean that *Allah* could not be a moon-god, for moon-god worshippers realized the moon itself was just a created object. Either it served as a crown or as a throne for the deity they worshipped. That the gods regulated the moon is even stated in creation myths such as when *Marduk* the god of Jupiter told *Sin* the moon-god:

<sup>1830</sup> Graveland. *Queen*.

<sup>1831</sup> Ishaq. *Sirat*, pp. 192, 615-616.

<sup>1832</sup> Ishaq. *Sirat*, p. 565.

<sup>1833</sup> Peters. *Hajj*, p. 25.

At the month's beginning to shine on earth, thou shalt show two horns to mark six days. On the seventh day divide the **crown** [the moon] in two [half-moon]. On the fourteenth day, turn thy full face [full-moon].<sup>1834</sup>

*Allah* also created or fathered the rest of the gods, probably by his consort *Allat* the sun-goddess and by his concubine Venus (*K* 043:086-087). At some point the sun, (*Allat*) Venus (*Uzza*), *Sirius* and Fate (*Manat*) were said to be *Allah*'s daughters (*K* 053:019-020, 049 and the Satanic Verses).

*Muhammad* believed that *Allah* and his daughter could assume human form, if that was not their form all the time. In fact, in *Muhammad*'s mind, the only way to tell divine persons from mere mortal humans was: deities did not eat food (*K* 005:075).

Worship at the *Kaaba* and in the *Makkan* environs during the *Hajj* is discussed elsewhere in this book. *Makkan* pagan worship in *Mosques* however involved a lot of clapping and whistling or “whistling through the fingers” (*Rodwell K* 008:035).

### **Marib, South Arabia (15.25 N 45:21 E)**

*Marib* was the ancient capital of the Kingdom of *Saba*, known to the Hebrews as *Sheba*, meaning “seven” or “oath.”<sup>1835</sup> *Marib* is located in foothills at an altitude of 3,900 feet (1,190 meters) and is 140 miles (225 KM) from the Arabian Sea coast.

*Marib* is located 77 miles (123 KM) due east of *Sana(a)*. *Sana* (15.3547 N 44.2067 E). The town *Awa* outside the city of *Sana* had a moon temple named after the moon temple at *Marib*.<sup>1836</sup> Ronald Lewcock wrote about the *Sabean* kingdom of which *Marib* was the capital:

It seems that in the last century B.C. and in the early centuries of the Christian era there existed a ‘greater *Sabean*’ state which owed its cohesion to, and expressed its identity through, the shared worship of the moon-god *Illumquh*.<sup>1837</sup>

The moon temple at *Marib* is known as the *Mahram Bilqis*, meaning “the Temple of *Bilqis*.” *Bilqis* is the Arabic name given to the Biblical Queen of *Sheba*. The temple probably was dedicated to *Almaqah* (aka *Ilmaqah*), the war-and-moon-god of the *Sabeans*.<sup>1838</sup>

The evidence for *Illumquh* being a war-and-moon-god is discussed in detail in the section that critiques the Revisionists’ view of gods in Southern Arabia below.

*Sirwah*, an ancient settlement the mountains to the west of *Marib*, is thought to have been the summer palace of the Queen of *Sheba*. *Sheba*'s winter palace possibly is at *Salhan* (15:25:23.8 N, 45:20:09.2 E), 12 miles (19 KM) to the north of *Marib*.<sup>1839</sup>

The Queen of *Sheba* traveled about 1,263 miles (2,033 KM) to Jerusalem (1Ki 10; 2Ch 9) to visit King Solomon—if she left from *Marib, Yemen*. In her day, at least, the Queen of *Sheba* was not known for her worship of *Yahveh*. The Queen of

<sup>1834</sup> *Larousse, Sin* entry, p. 56.

<sup>1835</sup> *Strong's* no. 07614: *Sheba* means “seven” or “oath.”

<sup>1836</sup> Lewcock. *San'a*, p. 20.

<sup>1837</sup> Lewcock. *San'a*, p. 21.

<sup>1838</sup> Donnet, Joel. “Quest for a Queen: A team of archaeologists excavates the site of an ancient temple in *Yemen* seeking to find any trail of the Queen of *Sheba*,” *Frontline*, “India’s national magazine” from the publishers of *The Hindu*, vol. 19, Issue 03, 02-15 Feb 2002.

<sup>1839</sup> Clapp. *Sheba*.

*Sheba* undoubtedly worshipped a moon-god, almost certainly *Illumquh*, the national god of *Sheba*.<sup>1840</sup>

That the Queen of *Sheba* had traveled to Jerusalem made it easier for *Muhammad* to believe that *Ibrahim* had come to *Makka*. The Queen of *Sheba*'s trip to Jerusalem would have been 560 miles (901 KM) longer than *Ibrahim*'s journey from Jerusalem to *Makka*. The Queen of *Sheba* may have sailed up the Red Sea to where the modern port and resort city of *Eilat, Israel*, is now. If the Queen of *Sheba* took the land route along side the Red Sea, she may have passed by *Makka*.

*Muhammad* realized that the Bible has Abraham traveling great distances, at least by ancient standards. *Ur* to *Haran* is 578 miles (930 KM), *Haran* to Jerusalem is 413 miles (665 KM) and Jerusalem to *Cairo* is 264 miles (425 KM). *Muhammad* did not know where the Biblical *Ur* was since by his day *Ur* had ceased to exist.

Jerusalem to *Makka*, at 765 miles (1,231 KM), is slightly longer than any of Abraham's trips. Nevertheless, given the Biblical travelogue, *Muhammad* did not doubt that *Ibrahim* could have visited *Makka*, even though the deserts of Arabia are extremely unforgiving. John of Damascus (~675 to ~749 AD) however derided *Muhammad*'s idea that Abraham nearly sacrificed his son at *Makka*:

Since the Scripture says that there was a grove-like mountain and wood [(Gen 22:08)], from which Abraham even cut for the holocaust on which he laid Isaac [not Ishmael], and also that he left the asses [donkeys] behind with the servants [(Gen 22:03, 05)], from where is, then, your little tale? For, in that place [*Makka*], there is neither wood from a forest, nor do asses travel through.<sup>1841</sup>

The *Koran* tells the story of how the Queen of *Sheba* (or *Saba* or *Sabea*) supposedly was chided by Solomon for worshipping the sun along with *Allah* the moon-god (*K* 027:024). Brian Doe wrote that the national moon-god of the Kingdom of *Sheba* was called '*Illumquh*'.<sup>1842</sup>

In contrast to the *Koran*, *Rabbinical* lore blames the Queen of *Sheba* for seducing Solomon into idolatry. This *Rabbinical* tale probably arose because Solomon's idolatry and the visit of the Queen of *Sheba* are mentioned in back-to-back chapters of the Bible (1Ki 10—11). Also, *Rabbinical* lore and the possibly *K* 027:024 misled the author of the medieval Ethiopian epic, the *Kebrā Nagast*, into thinking that the Queen of *Sheba* worshipped the sun-god as her main and only god.

The Bible says that Solomon's age-related feeble-mindedness and his foreign wives factored into his compromise with idolatry, and the Queen of *Sheba* had nothing to do with it. Since the Bible says Solomon made his compromises only after he was old, his compromise with idolatry probably occurred long after the Queen of *Sheba*'s visit (1Ki 11:04).

### ***Nayrab, Syria (36.17 N 37.22 E)***

See the *Harran* entry, above.

### ***Qarnaw and Shabwa, Yemen***

See the *Makka* entry, above.

<sup>1840</sup> Doe. *Arabia*, p. 25.

<sup>1841</sup> Sahas. *Heresy*, p. 137.

<sup>1842</sup> Doe. *Arabia*, p. 25.

**Sinai Desert and Mount Sinai**

The *Encyclopedia Britannica* states:

The name *Sinai* however seems to have been known much earlier and may have been derived from the original name of one of the most ancient religious cults of the Middle East, that of the moon-god *Sin*.<sup>1843</sup>

Perhaps the Desert of *Zin*, which in Hebrew means “flat,” was also named *Sin* in the past but the name morphed over time to *Zin*. This would not be beyond the realm of possibility given the fact that other land features in the area were named after *Babylonian* gods such as Mount *Nebo* and Mount *Sinai*.

Also of interest is the fact that the Arabic word for “desert” is *Sahara*, the same word after which the *Sahara* Desert is named. A Hebrew word for “moon” is *Saharon*. This suggests an etymological connection between the moon-god and deserts and further suggests that the Desert of *Zin* once was the Desert of *Sin*.

**Tema (or Taima(h), Tayma), Northern Arabia (27:37:60 N 38:28:60 E)**

*Nabonidus*, the last King of *Babylon* (555-539 BC), built *Tema* as a center of moon-god worship, specifically, to the moon-god *Sin*.

*Tema*, like many oases on the camel caravan routes, was dedicated to a moon-god. For instance, most of the capitals of kingdoms in Southern Arabia were on spice and pilgrim routes. In each capital the main temple was dedicated to the national war-and-moon-god.<sup>1844</sup>

Another example of oases dedicated to the moon-god is *Badr*. *Badr* in Arabic means “full-moon.” *Badr* was on the main north-south camel caravan route next to the Red Sea and *Badr* was to the southwest of *Madina*. *Badr* is where *Muhammad* fought one of his major battles as well as a subsequent raid.<sup>1845</sup>

**Timna, Arabia**

See the *Makka* entry, above.

**Ur, Mesopotamia (30:57:22 N 46:7:40 E)**

*Ur* was one of the earliest city-states in recorded history. The moon-god was known as *Sin* or *Nanna*. *Ur* is famous for its ziggurat.

Abraham and his family left *Ur* for *Haran* (Gen 11:28, 31; 15:07; Neh 09:07). *Haran* seems to have been a sister city, a caravansary and trading outpost for *Ur*. Both *Ur* and *Haran* were known throughout their ancient histories as being moon-god centers of worship.

*Ur* met its demise as the *Encyclopedia Britannica* states:

It was perhaps at this time [317 BC] that the *Euphrates* changed its course; and with the breakdown of the whole irrigation system, *Ur*, its fields reduced to desert, was finally abandoned.<sup>1846</sup>

**Zin, Desert of (See Sinai Desert, above)**

<sup>1843</sup> *EB*, accessed 2 Oct 2002, “*Sinai Peninsula*” entry. Also see ISBE, *Sinai* entry, Easton, M. G. *Easton Bible Dictionary*, 3<sup>rd</sup> Edition, 1897, and Mackenzie, Donald. *Egyptian Myth and Legend: With Historical Narrative, Notes on Race Problems, Comparative Beliefs, etc.* Gresham Publishing Co., London, sacred-texts.com, p. 259.

<sup>1844</sup> Phillips. Sheba, map inside cover.

<sup>1845</sup> Ishaq. *Sirat*, pp. 289, 447.

<sup>1846</sup> *EB*, accessed 15 Mar 2003, *Ur* entry.

**Critique of the Revisionist View on the Sun- and Moon-gods in Southern Arabia**

*The Revisionist View That Almaqah and Syn Were Sun-gods Rather Than War-and-moon-gods*

Nearly as long as South Arabia has been studied, scholars believed that the half dozen or so high-gods of southern Arabia were male war-and-moon-gods. Jacques Ryckmans wrote as recently as 2004 that some archeologists now believe that *Saba*'s *Almaqah* and *Hadramawt*'s *Syn* were both sun-gods instead of moon-gods.<sup>1847</sup> This section aims to accurately present and then convincingly refute this Revisionist view.

The following table is derived from J. Ryckmans' "Arabian Religions" article printed by *The Encyclopedia Britannica* (2004):

<b>Ryckmans' Revisionist View of Sun- and Moon-gods of South Arabia</b>		
<b>Kingdom</b>	<b>Sun-god or goddess</b>	<b>Moon-god</b>
<i>Hadhramaut</i>	<i>Syn</i> (or <i>Sayin</i> ) is a sun-god and national god	<i>Hawl</i>
<i>Ma'in</i>	Not mentioned	<i>Wadd</i> is the moon-god and national god
<i>Kataban</i>	Not mentioned	<i>'Amm</i> is the moon-god and national god
<i>Saba</i>	<i>Almaqah</i> is a sun-god and national god. <i>Shams</i> is a minor sun-goddess	Not mentioned
<i>Himyar</i>	<i>Shams</i> is the national sun-goddess	Not mentioned

Jean-Francois Breton also holds to the Revisionist view, but in 1999 thought that *'Amm* is Mercury. Breton's 1999 book *Arabia Felix* cites a 1989 article written by J. Ryckmans for a French journal that equated *'Amm* with *Nabu*, the scribal god whose planet is Mercury.<sup>1848</sup> In 1992 Ryckmans wrote about *'Amm*: "There is no good reason to consider him a moon god."<sup>1849</sup> J. Ryckmans then disavowed his earlier ideas when he wrote in 2004, "In *Kataban* the national god *'Amm*, 'paternal uncle,' may have been a moon god."<sup>1850</sup> One can see that J. Ryckmans' views have moved somewhat toward the traditional view over the years.

Here are some quotations that sum up the Revisionist view that *Almaqah* and *Syn* were sun-gods rather than moon-gods as traditionally thought. J. Ryckmans wrote:

Next to *'Athtar* [Venus], who was worshiped throughout South Arabia, each kingdom had its own national god, of whom the nation called itself the "progeny" (*wld*). In *Saba*' the national god was *Almaqah* (or *Ilumquh*), a protector of artificial irrigation, lord of the temple of the *Sabaeen* federation of tribes, near the capital *Ma'rib*. Until recently *Almaqah* was considered to be a moon-god, under the influence of a now generally rejected conception of a South Arabian pantheon consisting of an exclusive triad: Father Moon, Mother Sun (the word "sun" is feminine in Arabic), and Son Venus. Recent studies underline that the symbols of the bull's head and the vine motif that are associated with

<sup>1847</sup> Ryckmans, Jacques. *EB*, "Arabian Religions" entry, 2004; also see *Merriam-Webster's Encyclopedia of World Religions* (2000), pp. 70-71, "Arabian religions."

<sup>1848</sup> Breton. *Felix*, p. 122 + endnote 8 found on p. 192 which refers to bibliography p. 204. It is possible that Breton confuses *'Amm* with *Anbay* who Ryckmans elsewhere says is like *Nabu* (Mercury) (Ryckmans. *Anchor*, v. 6, p. 172), but one would need to look at his cited sourced.

<sup>1849</sup> Ryckmans. *Anchor*, v. 6, p. 172.

<sup>1850</sup> Ryckmans, Jacques. *EB*, "Arabian Religions" entry, 2004.

him are solar and *Dionysiac* attributes and are more consistent with a sun god, a male consort of the sun goddess....<sup>1851</sup>

Joël Donnet wrote:

...*Almaqah* was the main god of the *Sabeans*, to whom it was proper, even if he had equivalents in the neighboring tribes. Associated with fertility, agriculture and irrigation, it was first represented by a bull, and possibly by an ibex. It [*Almaqah*] was also often associated with a moon crescent, which led numerous archaeologists—including *Abdu Ghaleb* and Dr. Yusuf *Abdullah*, the president of the General Organization of Antiquities, Museums and Houses of Manuscripts—to call it the moon-god, and therefore to name *Mahram Bilqis* the Moon Temple. But Bill Glanzman disagrees with this vision, as he considers the moon as only one symbol of *Almaqah*, and certainly not the most important one, according to the numerous inscriptions from the site recovered during the 1950s and the last four years of the AFSM's fieldwork: 'So far, the moon isn't even mentioned in the texts, and we have found only a few examples of the *Almaqah*'s crescent moon in artwork. We very commonly find the bull (*Thawran*) associated with *Almaqah* in the inscriptions.'<sup>1852</sup>

J. Ryckmans wrote:

...the ancient [i.e. 1920s] claim of Ditlef Nielsen to reduce the whole pantheon to a basic triad Moon-father, Sun-mother (sun is feminine in Arabia), and Venus-son, has continued to exert negative influence, in spite of its having been widely contested...<sup>1853</sup>

A. F. L. Beeston wrote similarly to J. Ryckmans in *The Encyclopaedia Of Islam*:

For the period down to the early 4th century AD, few would now agree with the excessive reductionism of Ditlef Nielsen, who in the 1920s held that all the many deities in the pagan pantheon were nothing more than varying manifestations of an astral triad of sun, moon and Venus-star; yet it is certainly the case that three deities tend to receive more frequent mention than the rest...<sup>1854</sup>

Dr. Christian Ditlef Nielsen (1874-1949 AD) is credited with presenting the traditional triadic paradigm for South Arabian deities in the 1920s. The peculiar South Arabian astral triad (Father-moon, mother-sun and Venus-son) evidently was not known as late as 1885 when Richard F. Burton wrote:

The moon is masculine possibly by connection with the Assyrian Lune-god *Sin*; but I can find no cause for the Sun (*Shams*) being feminine.<sup>1855</sup>

### *Critique of the Revisionist View That Almaqah and Syn Were Sun-gods Rather Than Moon-gods*

The Revisionist view summarized above, even if it were true, would not significantly affect the argument that *Allah* was a moon-god. Why? The Revisionist view states that most of the main high gods in Southern Arabia were moon-gods, but

<sup>1851</sup> Ryckmans, Jacques. *EB*, "Arabian Religions" entry, 2004.

<sup>1852</sup> Donnet, Joël. "Looking for the Queen of *Sheba*," wanadoo.fr, May 2001.

<sup>1853</sup> Ryckmans, Jacques. "The Old South Arabian Religion," quoted in Daum, W. (editor). *Yemen: 3000 Years Of Art And Civilization In Arabia Felix*. Pinguin-Verlag (Innsbruck) und Umschau-Verlag, Frankfurt/Main, p. 107.

<sup>1854</sup> Beeston, A. F. L. "*Saba*" in Bosworth, C. E., E. van Donzel, W. P. Heinrichs & G. Lecomte, *The Encyclopaedia Of Islam*, 1995, v. viii, E. J. Brill, Leiden, pp. 664-665.

<sup>1855</sup> Burton. *Nights*, vol. 4, fn. 388.



two were sun-gods. Thus the odds are that *Allah* would be a moon-god, and there is plenty of evidence that says *Allah* really was a pre-Islamic moon-god.

Dr. Christian Ditlef Nielsen (1874-1949 AD) is often credited with noticing the triadic paradigm for South Arabian deities in the 1920s. Jacques Ryckmans and Jean-Francois Breton are two proponents of the Revisionist view of South Arabian deities who are currently active in this field of study. Jacques Ryckmans wrote:

...the ancient claim of Ditlef Nielsen to reduce the whole pantheon to a basic triad Moon-father, Sun-mother (sun is feminine in Arabia), and Venus-son, has continued to exert negative influence, in spite of its having been widely contested...<sup>1856</sup>

A. F. L. Beeston wrote similarly in the *Encyclopaedia Of Islam*:

For the period down to the early 4th century AD, few would now agree with the excessive reductionism of Ditlef Nielsen, who in the 1920s held that all the many deities in the pagan pantheon were nothing more than varying manifestations of an astral triad of sun, moon and Venus-star; yet it is certainly the case that three deities tend to receive more frequent mention than the rest...<sup>1857</sup>

Notice that in order to knock Nielsen's triadic theory, Ryckmans and Beeston understandably resort to *Argumentum ad Populum*, i.e. Nielsen's theory lost a popularity contest, and *Argumentum ad Verecundiam*, i.e. Nielsen is not an authority on the subject any longer since his scholarship is dated.

Ryckmans and Beeston unwittingly set up straw-man arguments when they suggest that there is no proof that *Almaqah* and *Syn* were a moon-god, and there is evidence that does not fit in Nielsen's theory in regard to *Almaqah* and *Syn*.

Nielsen, when formulating his theory, could hardly have missed the type of evidence that Ryckmans and other Revisionists cite. The vines would have been impossible to miss, and the fact that *Almaqah* was associated with the bull was known at least since 1955 when Wendell Phillips wrote:

In ancient *Sheba*, the bull always represented *Ilumquh*, who was known under other names, one of which was *Thor* (Bull).<sup>1858</sup>

The evidence that Ryckmans says shows that *Almaqah* is a sun-god could also be interpreted in keeping with Nielsen's contention that all the South Arabian moon-god were war-gods, too. A. F. L. Beeston admits as much in the *Encyclopaedia Of Islam*:

Garbini has produced cogent arguments to show that the attributes of 'Imkh [i.e. *Almaqah*] are rather those of a warrior-deity like Greek *Herakles* or a vegetation god like *Dionysus* [a sun-god].<sup>1859</sup>

So the evidence that Ryckmans says shows *Almaqah* is a sun-god could also be interpreted to show that *Almaqah* is a war-god (notice the "or" in the quote above). Evidently, Ditlef Nielsen interpreted the vines and bulls associated with *Almaqah* to be war-god and male attributes rather than as solar attributes. Nielsen wrote:

<sup>1856</sup> Ryckmans, Jacques. "The Old South Arabian Religion," quoted in Daum, W. (editor). *Yemen: 3000 Years Of Art And Civilization In Arabia Felix*. Pinguin-Verlag (Innsbruck) und Umschau-Verlag, Frankfurt/Main, p. 107.

<sup>1857</sup> Beeston, A. F. L. "Saba" in Bosworth, C. E., E. van Donzel, W. P. Heinrichs & G. Lecomte, *The Encyclopaedia Of Islam*, 1995, v. viii, E. J. Brill, Leiden, pp. 664-665.

<sup>1858</sup> Phillips. *Sheba*, p. 299.

<sup>1859</sup> Beeston, A. F. L. "Saba" in Bosworth, C. E., E. van Donzel, W. P. Heinrichs & G. Lecomte, *The Encyclopaedia Of Islam*, 1995, v. viii, E. J. Brill, Leiden, pp. 664-665.

...the main god, the **national** god of **war**...this is in all South Arabian, yes, nearly in all Semitic monuments, a sure identifying mark of the **moon-god**.<sup>1860</sup>

The same could be said of *Syn*'s eagle coin as was said of *Almaqah*'s bull and vines. Instead of the eagle being interpreted as being solar, Nielsen may have interpreted the eagle as being a moon- and war-god or male attribute. After all, the eagle was the main symbol found on the war standards of Roman legions. *Syn*'s eagle coin is discussed in detail below.

One can see that the Revisionist view of the South Arabian gods has a certain appeal to Westerners in that at least two of the main South Arabian deities, *Almaqah* and *Syn*, can be interpreted in the same manner as the preponderance of Mediterranean deities of Antiquity: instead of the high god being a moon-god, he's a sun-god, and instead of the vine and bull being war-god symbols, they are solar in nature.

Ditlef Nielsen's theory lets South Arabian mythology interpret itself first. This approach is especially appropriate in the case of *Almaqah* and *Syn* first because both their cults were thoroughly Mideastern and their origins pre-date the coming of Mediterranean influences to *Yemen*—probably by several centuries. Second, the use of vine, bull and eagle decorations is not a very strong indicator as to whether a god is solar or lunar, as is discussed in detail in this section.

The fact that the inscriptional evidence so far recovered at the *Bilqis* temple does not mention that *Almaqah* was a moon-god could be explained through statistics. Since most inscriptions have perished over time leaving only a few hundred intact, the chances are slim that any one of them would mention *Almaqah*'s astral association.

The nature of temple inscriptions is mainly votive and dedicatory, and the astral association of the god would be deemed too obvious to mention in inscriptions. Usually the astral nature of gods is determined from ancient myths, but there is no mythological literature that mentions *Almaqah* or the other South Arabian gods. It seems the oldest manuscript found in *Yemen* is from the *Islamic* era—the *Koran*.

From the fourth century AD to the time of *Islam*, Judaism and Christianity were on the ascendancy in South Arabia, so some of the temples like *Bilqis* fell into disuse already then. From the fourth century AD until the present, these temples have been covered and uncovered by blowing sand dunes, often leaving them to the mercy of iconoclasts and salvagers of metal and stone. One ought not expect to find many intact crescent artifacts and lunar inscriptions.

Aside from the crescents-and-orb symbols, the uncovered temple inscriptions currently are silent on whether *Almaqah* and *Syn* are moon- or sun-gods. This is other evidence, though, some of which is:

☉ Archaeologists found “a few examples of the *Almaqah*'s crescent moon in artwork” (see the Joël Donnet quote above) at the *Bilqis* temple. One archaeologist wrote of *Almaqah*'s temple, now called *Bilqis*:

Near the top of the delicate stone shaft was a beautifully carved circular sun with a crescent-moon...for some twenty-five hundred years this graceful pillar had stood guard above the sands near *Marib*...<sup>1861</sup>

☉ A *Hadramawt* temple altar had a crescent-and-orb symbol as well as a Venus altar symbol.<sup>1862</sup>

<sup>1860</sup> Nielsen, 1912, pp. 593-594, as translated in Krause, “*Haram–Harimat*.”

<sup>1861</sup> Phillips. *Sheba*, pp. 226-227.

☉ There are few, if any, solar disks and rays found in *Almaqah*'s and *Syn*'s temples.

All this suggests that *Almaqah* and *Syn* were moon-gods, not sun-gods.

In Ryckmans' view, *Almaqah* was a sun-god and *Shams* was a sun-goddess. In his "Arabian Religions" article for *The Encyclopedia Britannica*, Ryckmans does not mention who exactly in his view the moon-god at *Saba* was even though one would suspect the moon-deity would have been mentioned in inscriptions.

In Ryckmans' view, there are two sun deities of note at *Saba*. The traditional view seems to make better sense in that each slot of the South Arabian sun-moon-Venus triad was populated by a notable deity and no slot is doubly occupied: 1) *Almaqah* as moon-god 2) *Shams* as sun-goddess and 3) *Athtar* as Venus.

Both *Syn* and *Almaqah* fit best in their respective astral triads as moon-gods rather than sun-gods, and each for the same reason: the sun deity position is already taken by a major sun-goddess, and if *Syn* and *Almaqah* are sun-gods, that leaves no prominent deity for the moon-god position of the triad.

Breton wrote that *Sayin* was associated with and worshipped along side of '*Athtar* and *dhat-Himyam*'.<sup>1863</sup> '*Athtar* is Venus. Simpson wrote that the gender of *dhat-Himyam* is feminine indicating that she is a goddess. Simpson also wrote that...

...*Shamsum* was most certainly a solar goddess; as *Shamsum* in Middle *Sabaeen* times [110 BC-300 AD] often replaces the older deities *Dhat-Himyam* and *Dhat-Ba'danum*, these may also have been some sort of sun deities.<sup>1864</sup>

Ryckmans wrote about *Dhat-Ba'danum*:

Among other *Sabaeen* feminine denominations, that of *Dhat-Ba'danum*, a goddess who received dedications of votive statuettes of horses, was probably a sun goddess since the horse is associated with the solar cult in the Mediterranean culture.<sup>1865</sup>

Ryckmans said that *Hawl* was the *Hadramawt* moon deity, yet apparently nothing is known of *Hawl* beyond his name. Ryckmans wrote:

In *Hadramawt*, *Hawl* was probably a moon-god; his name apparently alludes to the lunar cycle.<sup>1866</sup>

Simpson, however, wrote that *hwl* (with a dot under the *h*) as a noun means "magical power," as a verb *hwl* means "to avert," and *hwl* was a word used on an amulet of the sun goddess *Shams*.<sup>1867</sup> So while *Hawl*'s etymology might be distantly related to a moon phase, that does not necessarily make *Hawl* a moon-god.

Since the moon-god would have been a major god, *Hawl* probably was not the moon-god. Thus the *Hadramawt* astral triad would be: 1) *Syn* was the moon-god, 2) *dhat-Himyam* was a sun-goddess who was later replaced by the sun-goddess *Shams*, and 3) *Athtar* was Venus.

Ryckmans says that a bull—the symbol of both *Almaqah* and *Syn*—is "more consistent with a sun god, a male consort of the sun goddess."<sup>1868</sup> Bowen and

<sup>1862</sup> Crescent-and-orb (Thompson, *Moon*, p. 55, plate Lxviii); and Venus altar carving (Thompson, *Moon*, pp. 50-51, plates xviii and xxi). The Venus-altar carving is illustrated in this Moon-o-theism book in relation to the Dome of the Rock (see the Thumbnail Gallery).

<sup>1863</sup> Breton. *Felix*, p. 122.

<sup>1864</sup> Simpson. *Sheba*, p. 162.

<sup>1865</sup> Ryckmans. *Anchor*, v. 6, p. 172.

<sup>1866</sup> Ryckmans, Jacques. *EB*, "Arabian Religions" entry, 2004.

<sup>1867</sup> Simpson. *Sheba*, p. 178, catalog item 236.

<sup>1868</sup> Ryckmans, Jacques. *EB*, "Arabian Religions" entry, 2004.

Albright say that “carved bulls heads” were “ubiquitous” in South Arabia,<sup>1869</sup> suggesting that the bull was primarily a lunar symbol in lune-loving South Arabia.

A bull and bull’s head (bucranium) were used as moon-god icons due to their curved horns. Whenever bulls are paired with ibexes as on many plaques,<sup>1870</sup> the pairing strongly suggests the bull is lunar rather than solar. The same could be said of bulls paired with crescent-and-orbs. A bull’s head artifact from 3<sup>rd</sup> C BC South Arabia has a crescent-and-orb on its forehead, and between the horns is a pair of ibexes flanking a tree of life that together form a crescent-and-orb motif.<sup>1871</sup> Ibex horns sometimes have crescent-and-orbs behind them, too.<sup>1872</sup>

Bulls as lunar icons probably far outnumber bulls used as solar icons among Semitic peoples, let alone in South Arabia. Moreover, the fierce bulls could be associated with the fact that the South Arabian moon-gods were also war-gods.

*Almaqah* was not only associated with bulls but also with ibexes and goats, which are moon-god animals owing to their curved horns. This suggests that the bulls associated with *Almaqah* were also considered lunar animals due to their curved horns. Joel Donnet wrote about *Almaqah*’s association to bulls and ibexes:

*Almaqah* however was the main god worshipped by the *Sabeans*. Symbolized first by a bull and then by an ibex, he was also associated with a crescent, which led certain archaeologists to call him the moon-god and therefore name *Mahram Bilqis* ‘the moon temple.’<sup>1873</sup>

Micha Lindemans wrote about *Almaqah*’s association to bulls and goats:

A moon-god and tutelary god of the South Arabian kingdom of *Saba*. The members of the tribe of *Saba* called themselves ‘the children of *Almaqah*.’ He is symbolized by a cluster of lightning flashes and a weapon which looks similar to the letter S. His symbolical animal is the bull. *Almaqah* is referred to in some texts as ‘Lord of the horned goats.’<sup>1874</sup>

Simpson wrote that a temple’s dedicatory inscription at *Sirwah* read “*Almaqah*, Master of the Ibex.”<sup>1875</sup>

Ryckmans says the vine motif was *Dionysian*. *Dionysus* was the widely worshipped night-sun. Ryckmans’ surmise reminds one of what the Roman historian Tacitus (~55 AD to ~120 AD) wrote about the Jewish temple:

From the fact that their priests used to chant to the music of flutes and cymbals and to wear garlands of ivy, and that a golden vine was found in the temple, some have thought that they worshipped Father *Liber* [*Dionysus*, i.e. the Night Sun], the conqueror of the East, though their institutions do not by any means harmonize with the theory; for *Liber* established a festive and cheerful worship, while the Jewish religion is tasteless and mean [i.e. by gaudy Roman standards].<sup>1876</sup>

<sup>1869</sup> Bowen & Albright. *Arabia*, p. 225, left column, top.

<sup>1870</sup> Simpson. *Sheba*, p. 54, catalog 17; pp. 60-61 + catalog 26; p. 117, catalog 125.

<sup>1871</sup> Simpson. *Sheba*, p. 132, catalog 160, Bronze bull’s head with ibex and tree of life motif.

<sup>1872</sup> Ibexes with crescent-and-orbs: Simpson. *Sheba*, p. 96, catalog 104; p. 139, catalog 180.

<sup>1873</sup> Donnet, Joel. “Quest for a Queen,” *Frontline*, [frontlineonnet.com](http://frontlineonnet.com), v.19, issue 3, 2-15 Feb 2002.

<sup>1874</sup> Lindemans, Micha F. [pantheon.org](http://pantheon.org), 9 Oct 2004, *Almaqah* entry.

<sup>1875</sup> Simpson. *Sheba*, p. 55.

<sup>1876</sup> Tacitus, *Histories*, 5.3ff, as excerpted from *Tacitus, Histories*, translated by A. J. Church & W. J. Brodribb, 1888, reprinted in Modern Library, New York, 1942, as quoted in MacMullen & Lane. *Sourcebook*, p. 162.

Just as Tacitus dismissed the vine motif as being *Dionysian* in the case of *Yahveh* based on the evidence, the same should apply in the case of *Almaqah*. The use of the vine motif in South Arabia probably differed from elsewhere because the gender, roles and astral association were different than in the Mediterranean world.

In Western cultures, the moon was usually a goddess, but in the Mideast the moon was the high god; in the West and Mideast Venus was a goddess, but in South Arabia Venus (*Athtar*) was generally male. In the West the sun was a high god, but in the Mideast the sun was most often a goddess.

With the genders of the sun, moon and Venus often being opposite that in the West, it is not surprising that the standard iconography in the Mideast was different. For instance, in the Mediterranean world vines might be associated with the sun god, not so much because of the astral aspect, but because of male fertility. Since the moon is male in the Mideast and Southern Arabia, vines then become a lunar symbol.

In the Mediterranean area and in the Mideast vines were most often carved in a scroll or undulating pattern. An artistic crescent-and-orb was created by curving the vines and using leaves or clusters of grapes for the orb—hence a moon-god symbol. That a scrolled vine is indeed intended as a crescent-and-orb pattern become obvious when a crescent-and-orb alternates between a vine scrolled as just described.<sup>1877</sup>

The crescent-and-orb vine motif is found throughout the moon-god-loving Mideast including *Marib* in South Arabia and *Petra* in northern Arabia.<sup>1878</sup> Vine art and the tall-short-tall *Allah* motifs are illustrated in this Moon-o-theism book, especially in regard to the Dome of the Rock (see the Thumbnail Gallery).

That vines were a lunar symbol in South Arabia can be assumed from the fact that vine friezes from *Husn al-'Urr* in the *Hadramawt*, had lunar “ibexes standing behind crossed tendrils.”<sup>1879</sup> Other plants besides vines were associated with the moon-god animals such as ibexes and bulls, for instance...

...a limestone capital with [an] acanthus leaf decoration beneath which is a crouching ibex flanked by bucrania [plural of bucranium, meaning “ceremonial bull’s head”] panels...was found in the *Wadi Harib* [but] it is thought to have been brought from *Marib*.<sup>1880</sup>

Ibexes and bulls were associated with the moon because of their curved horns. Ibexes were depicted in friezes with crescent-and-orb couplets formed from grape clusters and vines at *Marib*<sup>1881</sup> and at *Petra* in northwest Arabia.<sup>1882</sup>

At *Petra* even a lion is depicted in a scrolled vine.<sup>1883</sup> *Petra* was known for its many decorative crescent winged capitals atop columns and in building facades.<sup>1884</sup> This shows *Petra*’s love of the moon, and suggests that the lion may have been a moon-god symbol.

Nowadays people might associate the lion with the sun due to the orange-ish fur, and for the fact that people visit zoos, and wildlife shows are filmed, during daylight.

<sup>1877</sup> Simpson. *Sheba*, p. 97, catalog 109.

<sup>1878</sup> Nabatean crescent-and-orb grape vines at *Petra*: Glueck. *Dolphins*, plate 30 (p. 54), plates 176-177 (pp. 388-389).

<sup>1879</sup> Doe. *Southern*, p. 34, picture 4.

<sup>1880</sup> Doe. *Southern*, p. 34, picture 6.

<sup>1881</sup> Doe. *Southern*, p. 36, picture 9.

<sup>1882</sup> Ibex in scroll vine at *Petra*: Glueck. *Dolphins*, plate 169 (pp. 370-371), plate 170 (p. 372).

<sup>1883</sup> Lion in scroll vine at *Petra*: Glueck. *Dolphins*, plate 169 (pp. 370-371).

<sup>1884</sup> Nabatean crescent-and-orb capitals at *Petra*: Glueck. *Dolphins*, plate 173 (p. 385).

People in ancient times knew that lions are nocturnal hunters especially on moonlit nights, so naturally they associated the lion with the moon-god:

- ☉ In the *Gilgamesh Epic*, *Gilgamesh* prayed to *Sin* the moon-god for help in fending off lions at night.<sup>1885</sup>
- ☉ At *Hazor*'s moon-god temple, a lion orthostat guarded the entrance.<sup>1886</sup>
- ☉ At the moon-god temple in *Marib* a bronze statue dedicated to *Almaqah* wears a moon-god approved curved knife under his belt and a lion-skin cape as shown by the four paws.<sup>1887</sup>

Archaeologists discussing a cherub riding a lion statue found at *Timna*, capital of *Kataban* in southwest *Yemen*, note that this was a popular ancient statue motif that, at least in *Timna*, would have represented the moon-god controlling the sun. Berta Segall wrote that the cherub riding a lion motif...

...outside Arabia, indicates a supremacy of the divinity of the night-sky over that of the sky of the day, is possibly a sign that they meant to emphasize their special loyalty to the Arabian male god of the heavens. In Babylon the moon-god had from very ancient times 'renewed the royal seed to distant days' and was therefore the divinity of rulers and the ruling class and, in a wider sense, the 'life-index' the index to health and prosperity, of the ruled, as W.F. Albright suggested.<sup>1888</sup>

In the case of *Timna*, though, this statue may in fact represent a moon-god controlling a lunar animal, since the lion in the Mideast may have been a lunar animal more than a solar animal.

Revisionists cite classical Greek and Roman writers to support their theory in several points. For instance, a Greek historian Theophrastes of *Eresos* (372-287 BC) wrote that frankincense was collected in a *Sabean* temple of the sun even though he meant a *Hadramawt* temple hundreds of miles to the east.<sup>1889</sup> Breton says this suggests that the *Hadramawt Syn* was a sun-god, though Theophrastes' geography mistake suggests that Theophrastes was just hazarding a guess. Theophrastes made other mistakes such as he thought cinnamon was grown in South Arabia rather than in India.<sup>1890</sup> Lastly, Theophrastes could have had in mind the temple of the *Hadramawt* sun goddess *dhat-Himyam*.

Theophrastes' information implies that *Syn* would have been a sun-god if his temple was meant, except that Theophrastes probably just assumed that the *Hadramawts*' national god was a sun-god based on Mediterranean mythology. This mistake is similar to how Greek travelers thought the *Abyssinian* moon-god *Mahrem* was the god of Mars (*Ares*)<sup>1891</sup> on account of *Mahram*'s male gender and his preoccupation with war-making. After all, Greek moon-gods were female and were involved in hunting but not warfare.

<sup>1885</sup> Anonymous. *Gilgamesh*, "The Search for Everlasting Life." Also, Pritchard. *Ancient*, I:62, middle of Tablet IX.

<sup>1886</sup> Yadin, Yigael. *Hazor: The Rediscovery Of A Great Citadel Of The Bible*. Weidenfield and Nicolson, London & Jerusalem, 1975, pp. 44-47.

<sup>1887</sup> Phillips. *Sheba*, p. 287.

<sup>1888</sup> Segal, Berta. "The Lion-riders from *Timna*," Bowen & Albright. *Arabia*, pp. 163-164.

<sup>1889</sup> Breton. *Felix*, p. 122. Theophrastus' *Natural History*, 9.4.5.

<sup>1890</sup> Breton. *Felix*, pp. 54, 61.

<sup>1891</sup> Nielsen, 1912, pp. 593-594, as translated in Krause, "*Haram-Harimat*."

*Coins Show That Almaqah and Syn Were Moon-gods*

The topic of South Arabian antiquities, including coins, has been de-mythologized and de-astralized to a greater extent than warranted. This was not always the case. For instance, in 1937 John Walker discussed the moon-god in relation to South Arabian coins, and in 1952 he wrote an article “The Moon-god on Coins of the *Hadramawt*.”

Scholars de-emphasize the solar or lunar evidence by leaving a lot left unsaid in the literature, and it is sometimes said that an argument that so-and-so deity is lunar is speculative. Simpson wrote:

...the lunar nature of ‘*Almaqah* and *Ta’lab* is speculative...[*Sayin*’s] connection with the moon is merely speculative.<sup>1892</sup>

The evidence is also said to be ambiguous. For instance, Breton wrote about South Arabia in general:

There are bas-reliefs depicting ibexes (sitting or standing), bulls and gazelles, but it is unclear which gods these figures were meant to represent.<sup>1893</sup>

Inscriptions consecrated to the gods are often accompanied by a small circle which is generally interpreted as an image of planet Venus. These two symbols show up together in a variety of contexts such as engraved plaques, incense altars, and buildings. The image seems to have been essentially a form of talisman to bring good luck and ward off evil, rather than being exclusively related to a specific divinity. Scholars have been so far unable to establish a link between each symbol and a particular deity.<sup>1894</sup>

Just as bas-reliefs and Venus-and-moon couplets are often left uninterpreted, so also is the case with legends and images on coins. Nowadays, words such as *Shahr* (moon) and *Hilal* (crescent), and monograms (e.g. *Yanap*), are transliterated and generally not translated or interpreted, and there is no hint that such words or their etymology refer to moon-god worship. Untranslated words such as *Shahr* or *Sukr* (meaning “bright”) are merely said to be the names of kings, temples, palaces or mints.

Even if such words did refer to a king or mint, the fact that the name is etymologically connected to mythology and religion ought to be considered significant enough to mention just as scholars in similar discussions find it helpful to point out that, say, Nebuchadnezzar means “*Nabu* protects.”

Some words could be interpreted as applying to a moon-god or to a king or mint, so it is necessary to set out the case for each interpretation to see which is more plausible.

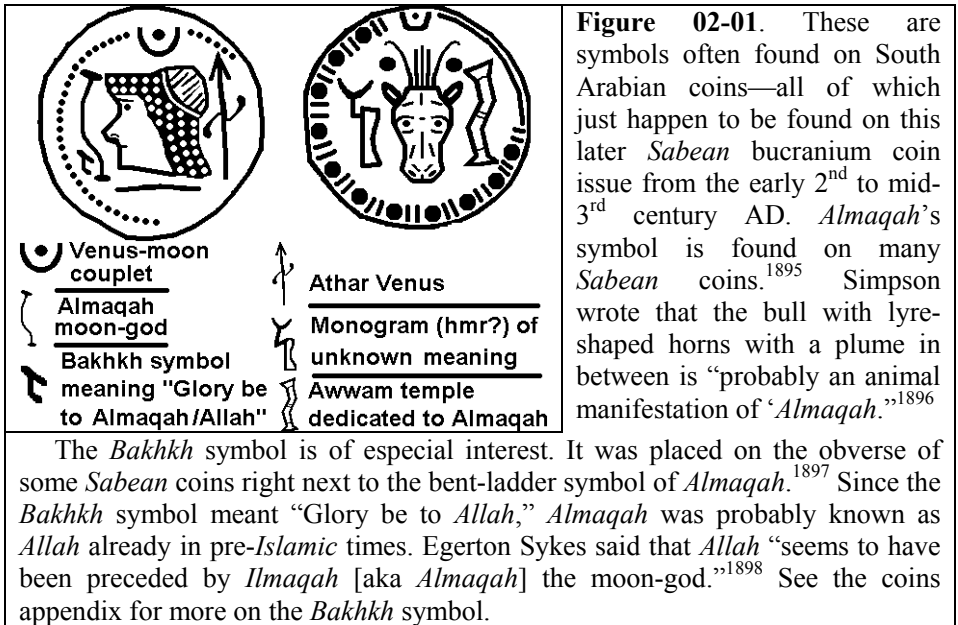
Many South Arabian coins have a crescent-and-orb symbol, or an owl or snake or bull or another moon-god symbol (see illustration below). Few if any have a sun-with-rays symbol as one would expect there to be if any of the high gods were sun-gods.

On a few *Katabanian* and *Sabean* coin issues, the obverse has a male bust and the reverse has an owl with an inscription next to the owl that reads: “*Shahar Hilal, Ynp!*” meaning “Moon Crescent, the Exulted.” Similarly, an issue of *Hadramawt* eagle coins has a tri-literal inscription *Y.Sh.H.* standing for “*Ynp, Shahar Hilal*” meaning “The exulted, Moon Crescent” (all illustrated and discussed below).

<sup>1892</sup> Simpson. *Sheba*, pp. 162...163.

<sup>1893</sup> Breton, *Felix*, p. 118.

<sup>1894</sup> Breton, *Felix*, p. 125.



Scholars have generally taken the view that the *Sahar Hilal* mentioned on *Sabean* coins above the owl refers to a certain *Katabanian* king (or kings) by that name, and that “the exulted” (*YNP*) is “the king’s title in *Sabaeen*.”<sup>1899</sup>

There are a few *Sahar Hilals* attested in inscriptions and coins: *Shahr Hilal* (~370 BC), *Shahr Hilal* Yuhan’im (~300 BC) and *Shahr Hilal* Yuhagbid (~100-120 BC), but there probably were other *Shahr Hilals* of which no record has been found.

The fact that “*Shahr Hilal* the exulted” surrounds the upper part of an animal manifestation of a moon-god (the owl) suggests that the phrase “Moon Crescent, the Exulted” refers to the moon-god, or alternatively, to the King *Shahr Hilal* and his high god. If the legend honored the king exclusively, one would think the legend would have been found not by the owl, but on the obverse by the man’s portrait. The man’s portrait may represent the moon-god *Almaqah* as suggested by the fact that some later issues of this coin have a crescent-and-orb touching the top of the head. However, there are some issues with the owl on both sides of the coin and the phrase “Moon Crescent, the Exulted,” which more strongly suggests the phrase refers to the moon-god.<sup>1900</sup>

That the *Sabeans* would call their moon-god “the exulted” is in keeping with the religious culture. After the *Mekkans* had fought the *Muslims* at the Battle of *Uhud* in

<sup>1895</sup> Coins with *Almaqah*'s symbols: Doe. *Southern*, pp. 121-122 and plate 44 (p. 85), 2<sup>nd</sup> row, *Qataban* coin 3 (1<sup>st</sup> C. BCE – 1<sup>st</sup> C. AD), 3<sup>rd</sup> row, *Sabean* coins 2 & 3 (1<sup>st</sup> C BCE) and 5<sup>th</sup> row, *Sabean* coins 1 & 2 (late 1<sup>st</sup> C AD), etc.

<sup>1896</sup> Simpson. *Felix*, p. 77, coins 69-70 Series with bucranium, early 2<sup>nd</sup>-mid-3<sup>rd</sup> centuries AD.

<sup>1897</sup> Bucraneum *Saba* coin series with *Bakhka* symbol: Simpson. *Sheba*, p. 77, catalog no. 69, *Saba* coin series with bucraneum, early 2<sup>nd</sup>-mid 3<sup>rd</sup> centuries AD; Doe. *Southern*, pp. 122 + plate 44, 5<sup>th</sup> row, *Saba* coin 1.

<sup>1898</sup> Sykes. *Mythology*, p. 7, *Allah* entry.

<sup>1899</sup> *Sylloge. Himyarite-Katabanian* coins 1462-1485 (end of 2<sup>nd</sup> C. BC to 1<sup>st</sup> C. BC).

<sup>1900</sup> *Sabean* coins with owl on both sides: Doe. *Southern*, pp. 121, plate 44, 2<sup>nd</sup> row, coin 1 (2<sup>nd</sup> C. BC); 3<sup>rd</sup> row, coin 2 (1<sup>st</sup> C. BC).



625 AD, *Abu Sufyan Ibn Harb* cried out to his god “*Hubal*, be thou exalted.” Then *Muhammad* replied “*Allah* is more exalted and more majestic.”<sup>1901</sup>

(◇ P NY) = ◇  
 Monogram YNP  
 Yanap!  
 The Exulted!

LLH      RHV  
 Hilal      Shahr  
 Crescent      Moon

SHR = HDR =  
 mint Hadhur,  
 town east of  
 San'a

**Figure 02-**  
02. A right-to-left phrase found on *Katabanian* and *Sabean* “old style” owl-on-amphora coins is: “*Shahar* [Moon]

= Barbarous Greek standing for AOE  
 "N" denomination mark  
 Symbols of *Alumqah*

*Hilal* [Crescent], *Ynp* [be exulted!].<sup>1902</sup> *Ynp* is written here as a tri-letter monogram.<sup>1903</sup>

In “new style” issues of this coin (not illustrated here), the inscription is replaced with a pair of monograms on either side of the owl, a bent-ladder symbol of *Alumqah* is added to the right of the owl’s talons, and some have a crescent-and-Venus couplet: 1) at the top margin of the obverse<sup>1904</sup> or reverse,<sup>1905</sup> or atop of the man’s portrait on the obverse.<sup>1906</sup>

Indications that the owl represents the *Sabean* moon-god and high-god are:

- C *Almaqah*’s bent-ladder symbol (depicted on the above two illustrations) is found on some later issues of the owl-on-amphora coin next to the owl.
- C The fact that the owl coins were the only coin the *Sabeans* minted from the mid-4<sup>th</sup> BC to late 1<sup>st</sup> C BC suggests that the moon-god was the high-god.
- C A later *Sabean* coin, the bucranium series (2<sup>nd</sup>-3<sup>rd</sup> C AD), has a crescent-and-orb, further suggesting the moon-god was the *Sabean* high-god.<sup>1907</sup>

The crescent by the owl’s back on *Sabean* coins is not the similar-looking South Arabian letter “r” since this coin is imitative of the Athena-owl Attic *tetradrachm* that has a crescent in nearly the same position. Also, the “r” is not a denomination mark since these series have an “n” and “g” to denote denomination.<sup>1908 1909</sup>

The fact that the “Moon Crescent, the Exulted” is on more than one kingdom’s coins suggests that it refers to the moon-god rather than any particular king or king. *Sahar Hilal* is mentioned on the *Katabanian* “series with two heads” coins (1<sup>st</sup> C BC-

<sup>1901</sup> *Al Kalbi. Idols*, p. 24.

<sup>1902</sup> *Sabean* coins with bust on obverse, owl on the reverse: Simpson. *Sheba*, p. 75, catalog no. 55, *Sabeao-Qatabanian* coin, late 2<sup>nd</sup>-1<sup>st</sup> C. BC; others like it are: Doe. *Southern*, pp. 121, plate 44, 1st row, coins 1 (5<sup>th</sup> C BC) & 2 (3<sup>rd</sup> C. BC); 3<sup>rd</sup> row, coin 1 (early 2<sup>nd</sup> C. BC).

<sup>1903</sup> The inscriptions and the fact that a symbol on the owl coins is *Almaqah*’s are found at: Doe. *Southern*, pp. 121-122 and plate 44 (p. 85), 2nd row, coin 2, *Saba* (2<sup>nd</sup> C. BCE); 3<sup>rd</sup> row, coin 3 (1<sup>st</sup> C. BCE); *Sylloge*, plates 50+51, *Sabean* coins 1460-1461 (end of 2<sup>nd</sup> C. BCE) and *Himyarite-Katabanian* coins 1462-1485 (end of 2<sup>nd</sup> C. BCE to 1<sup>st</sup> C. BCE).

<sup>1904</sup> Simpson. *Sheba*, p. 76, catalog nos. 64+68, *Saba* coins late 1<sup>st</sup> C. BC-early 1<sup>st</sup> C. AD.

<sup>1905</sup> Simpson. *Sheba*, p. 76, catalog no. 59, *Saba* coin Mid-2<sup>nd</sup>-late 1<sup>st</sup> C. BC.

<sup>1906</sup> Simpson. *Sheba*, p. 76, catalog nos. 61-63, *Saba* coin Mid-2<sup>nd</sup>-late 1<sup>st</sup> C. BC.

<sup>1907</sup> Simpson. *Sheba*, pp. 75-77.

<sup>1908</sup> Simpson. *Sheba*, pp. 75-76.

<sup>1909</sup> South Arabian alphabet charts are online, or see Phillips. *Sheba*, p. 42, or start of *Sylloge*.

1<sup>st</sup> C AD), on *Katabanian* owl-and-amphora coins (mid-2<sup>nd</sup> C BC), and on *Sabean* owl-and-amphora coins (late 2<sup>nd</sup>-1<sup>st</sup> C BC).<sup>1910</sup> John Walker wrote:

...both *Shahar* and *Hilal* have lunar significance in the South Semitic monuments. The former is a proper name meaning “moon” = Arabic *Shahr* (month); the latter is the same as the Arabic *Hilal* (new-moon [i.e. waxing crescent]).<sup>1911</sup>

Scholars have not considered the possibility that “Moon Crescent, the Exulted” refers to the moon-god, yet there is no other satisfactory solution, as Simpson wrote:

The reading and interpretation of the legend have raised many questions and prompted extensive study. Generally it is identified as the name of a *Katabanian* king, a certain *Shahr Hilal*, but **there is no understandable reason why** the *Katabanian* royal name was written on *Sabean* coins and in such a [“cursive” rather than formal, but ‘formerly identified as “Aramaic” or “Lihyanite”] script....In any case, we may suggest that the existence of both series—with *Sabaeen* typological features but with a portrait of a *Katabanian* ruler on the obverse, and with the name of a *Katabanian* king on the reverse of *Sabaeen* coins—reflects some form of political subordination or suzerainty of the South Arabian kingdoms when *Kataban* dominated a large part of southwest Arabia (Hill 1922, 53-55, plates VII, 27-28; VIII, 3-4).<sup>1912</sup>

Another indication that “Moon Crescent, the Exulted” (*Sh.H.Y.*) refers to the moon-god is this legend is found on *Hadramawt* coins, too, but transposed as *Y.Sh.H.* (The exulted Moon Crescent). Walker came close to the aforementioned solution in 1937 when he wrote about the *Syn*-eagle coin (as was partly quoted above):

If by any chance *Y.Sh.H.* should stand for *Yuhan'im Shahar Hilal* it is a noteworthy coincidence that both *Shahar* and *Hilal* have lunar significance in the South Semitic monuments.<sup>1913</sup>

Another solution scholars offer is that *Y.Sh.H.* stands for the first three consonants of a king's name: **Yashhur**'il Yuhar'ish, son of Abiyasa, *Mukarrib* (i.e. federation leader) of *Hadramawt* who lived around the time of Christ.<sup>1914</sup> Of course, this is conjectural based only on the congruence of three letters of the *Syn*-eagle coin and not inscriptional evidence where Yashhur' il says he minted new types of coins.

That Yashhur' il Yuhar'ish would use the first three letters of his first name on a coin seems unusual since South Arabian coins, including those of the *Hadramawt*, had the kings' names spelled out, or his initials or monogram. Note that the solution to *Sh.H.Y.* being “Moon Crescent, the Exulted” uses initials that are more in keeping with custom.

Another indication that *Y.Sh.H.* probably does not stand for King **Yashhur**'il Yuhar'ish is that the three series of *Hadramawt* coinage (eagle, square and bull) have enough similarities that Simpson says they were introduced by, or could be associated with, **Yashhur**'il.<sup>1915</sup> Yashhur' il, however, reigned in the early first

<sup>1910</sup> Simpson. *Sheba*, pp. 74-75, coins 50-55.

<sup>1911</sup> Walker. *New*, p. 270.

<sup>1912</sup> Simpson. *Sheba*, p. 75, coins 52-55 *Sabaeo-Qatabanian* series.

<sup>1913</sup> Walker. *New*, p. 270.

<sup>1914</sup> Simpson. *Sheba*, p. 78.

<sup>1915</sup> Simpson. *Sheba*, pp. 78-79, series with eagle, coins 75-79; square coinage, coin 80; and series with bull, coins 81-82.

century, but the Series with a Bull coins were not issued until starting in the late first century AD—well after Yuhar’ish’s time!<sup>1916</sup>

One wonders whether the *Syn*-eagle coin was re-dated to the early first century merely to tie it to King **Yashhur**’il Yuhar’ish, since in 1971—perhaps before the *Y.Sh.H.* equals **Yashhur**’il theory came into vogue—Doe dated the *Syn*-eagle coin to the “third or fourth century AD.”<sup>1917</sup>

Ryckmans and other Revisionist scholars have said that the eagle on *Syn*-eagle coins is a sun-god symbol just as *Nasr*, meaning eagle, was a male sun-god in north Arabia and Syria popular among the Arabs. *Nasr* is mentioned in *K* 071:023.

There was no consensus in the ancient world that the eagle was solar since, for example, the eagle was a symbol of Zeus, but his planet was Jupiter—not the sun. In 1937, Walker related that pre-*Islamic* amulets show the eagle was a South Arabian moon-god symbol:

☉ An amulet in the British Museum has *Himyarite* (pre-*Islamic* South Arabian) and *Pahlavi* (Persian Sassanian-era) scripts and shows an eagle standing on a crescent.

☉ Another amulet in the Berlin Museum has an eagle and the words “May ‘*Amm* make happy.”<sup>1918</sup> Ryckmans wrote “In *Kataban* the national god ‘*Amm*, ‘paternal uncle,’ may have been a moon god.”<sup>1919</sup>

Another indication that the *Syn*-eagle coin was a moon-god coin was that it was preceded by, and is similar to, three issues of *Hadramawt* lunar-oriented coins:

☉ From the mid-4<sup>th</sup> to 2<sup>nd</sup> C. BC, the *Hadramawt* kings issued an imitation Athena-owl and crescent and *AEO* legend coin.

☉ A variant of the above coin minted during the same period has a male head on the obverse and an owl and crescent with the word *SKR* rather than the pseudo-Greek *AOE* legend. What this indicates is the Athena-owl coin was updated to reflect the fact that in South Arabia the moon-gods were male.

☉ A third coin issued from ~1<sup>st</sup> C. BC-early 1<sup>st</sup> C. AD has a radiant male head on the obverse, and a caduceus snake on the reverse.<sup>1920</sup> Breton says the serpent was a symbol of the moon-god *Wadd* popular throughout South Arabia.<sup>1921</sup>

One can see that the *Syn*-eagle coin continued the centuries-long pattern (noted above) of coins more closely reflecting South Arabian male moon-god mythology. The *Syn*-eagle coin has a male head on the obverse with the name *Syn*. The male head probably represents the moon-god *Syn* and not a king since a later similar coin issue (illustrated later in this section) has a radiant head with an *S* standing for *Syn*.

The reverse of the *Syn*-eagle coin has the legend “Moon Crescent, the exulted” (*Sh.H.Y.*), as was discussed above.

The reverse of the *Syn*-eagle coin has an eagle standing on a crescent and the word *SKR* that means bull’s horn and moon crescent. Simpson wrote “*Shaqar* (*SKR*),

<sup>1916</sup> Simpson. *Sheba*, pp. 78, series with bull, coins 81-82.

<sup>1917</sup> Doe. *Southern*, p. 122.

<sup>1918</sup> Walker. *New*, pp. 271-272.

<sup>1919</sup> Ryckmans, Jacques. *EB*, “Arabian Religions” entry, 2004.

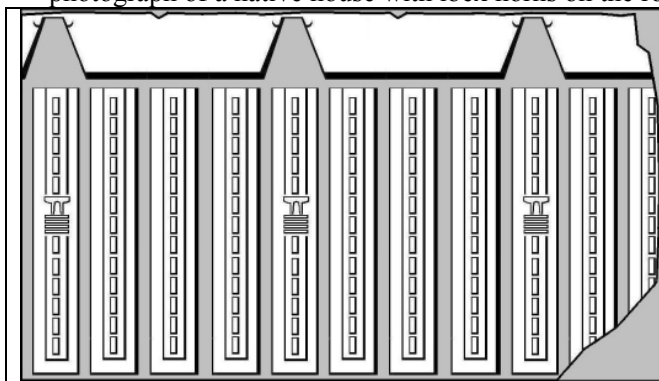
<sup>1920</sup> Simpson. *Sheba*, p. 77, *Athena*-owl coins 71-72; male head-owl coin 73; radiant head-caduceus coin 74.

<sup>1921</sup> Breton. *Felix*, p. 121.

the name of the royal residence in *Shabwa*, denoting, most probably, the royal mint as well.”<sup>1922</sup> Walker explained that *SKR* was an alternate name for *Syn*:

Mr. Beeston, in the above mentioned article [*Le Museon*, lxiv, 1951, p. 131]...regards it [*SKR*] as a quality or attribute of the moon-god, and suggests that it goes back to a root meaning ‘to be bright’ [Note: a crescent moon is bright]. This may be the correct derivation, but on the coins it would appear to be a proper name like *Sin*. In addition to the...coin evidence, there are other indications. The word *SKR* commonly denotes the roof or the upper part of the building. It [*SKR*] frequently occurs in the phrase...‘from its foundation to the roof’ [Walker footnote: See K. Conti Rossini, *Chrestomathia*, p. 252]...we know that the people of those days placed representations of the moon-god on the roofs of their temples and other buildings. A very good illustration of this is seen in fig. 6 [reproduced below] which shows an alabaster slab from the *Yemen*, now in the *Eski Sark* Museum, *Istanbul*, on which appears the outline of the elevation of a *Sabaeen* temple. On the roof of the temple can clearly be seen the bull’s horns of the moon-god projecting from each of the pinnacles.

Other pertinent illustrations showing gargoyles or rainwater heads in the shape of bulls’ heads are in C. Rathjens and H. v. Wissmann’s *Vorislamische Altertumer*, Hamburg, 1932, pp. 55-56. They are from the roof of a temple at *Hugga*...It is interesting to note that this practice still survives in the *Hadramawt* at the present day, although its original significance has been forgotten. Freya Stark (*Seen in the Hadhramaut*, London, 1938, p. 38) gives a photograph of a native house with ibex horns on the roof.<sup>1923</sup>



**Figure 02-03.** A *Sabaeen* moon-temple with pairs of “bull’s horns of the moon-god projecting from each of the pinnacles” in the form of a crescent.<sup>1924</sup> The temple is carved into an alabaster slab from *Yemen* now in

the *Eski Sark* Museum, *Istanbul*. Note the three arched-door Venus altars halfway up the wall, and the “tall narrow triple recesses which were a common feature on buildings facades during this period.”<sup>1925</sup> The slab is broken on the right side so one cannot tell how long the temple was, but judging from the size of the bull horns, the temple must have been about two stories high minus the pinnacles.

Breton wrote that in South Arabia:

The gutters of a great many civilian and religious buildings were also adorned with bull’s head motifs.<sup>1926</sup>

<sup>1922</sup> Simpson. *Sheba*, p. 77.

<sup>1923</sup> Walker. *Hadramaut*, pp. 625-626...fn. 1 on p. 626.

<sup>1924</sup> Walker. *Hadramaut*, pp. 625-626, figure 6 (see fuller quotation above).

<sup>1925</sup> Simpson. *Sheba*, p. 148.

<sup>1926</sup> Breton. *Felix*, p. 125.

Ryckmans wrote that “reliefs representing a bucranium and called *SHR* [accent on *S*, dot under *H*] ‘talismán’ were inserted into the façade of buildings.”<sup>1927</sup> The word *SHR* that Ryckmans writes of seems to be closely related to Walker’s word *SKR* in both meaning and spelling. Ryckmans says *SHR* also was one of the names of temple priests and administrators but their “functions are not clearly distinguished.”<sup>1928</sup> Note that *SKR* and *SHR* are fairly close in spelling to the word *Shhr* (*Shahr*) meaning crescent. This suggests they all mean crescent, and the priests called *SHR* would be moon-god priests.

The royal palace and mint of the *Hadramawt* region was a towerhouse complex called *SKR* (or *Shaqar*) though it is unclear whether this fact is assumed based on the mint name of coins, or whether there is an inscription to that effect.<sup>1929</sup> If it was named *SKR*, one can surmise that the building got this distinction due to the fact that its roof sported bull horns and was the tallest of the 250 tower-houses in the city of *Shabwa*.<sup>1930</sup>

That the *Hadramawt* mint would be named after a bull-horn crescent would be similar to how the *Katabanian* mint was, according to Doe, “probably” named *Harib*.<sup>1931</sup> *Harib* is related to the word *Harba*, to fight, and all the high gods of South Arabia were war-and-moon gods as Nielsen wrote:

...the main god, the **national** god of **war**...this is in all South Arabian, yes, nearly in all Semitic monuments, a sure identifying mark of the **moon-god**.<sup>1932</sup>

Each *Islamic Mosque* also has a “fighting” place called a *Mihrab* because *Allah* was, and still is, a war- and moon-god. Gibb and Kramers wrote:

*Mihrab* [dot under *h*] has been derived from [the word] *Harba* [with dot under *h*] “spear,” and from South Arabic *Mikrab*, Ethiopian, *Mekrab* “temple,” but the etymology is not certain...<sup>1933</sup>

Above it was discussed how *SKR* meant bull’s horn or crescent, but one can do a word-picture study of *Hadramawt* coins to find by the process of elimination the meaning of *SKR* (see the illustration below). The earliest three series of *SKR* coins are not illustrated here since they imitate coins from the Mediterranean and do not shed much light on the South Arabian word *SKR* other than the fact that *SKR* is lunar-related:

- ☉ The Athena-owl has a crescent but not the word *SKR*.
- ☉ The male head-owl coin has the word *SKR* and may or may not have a crescent, but the owl is a moon-god symbol nonetheless.
- ☉ The radiate head-winged caduceus coin has the word *SKR* and the snake is a South Arabian moon-god symbol.<sup>1934</sup>

If one looks at the coins below, the only element that is common to all the coins with the word *SKR* is not a bull or bull’s head, but a bull’s horn (under the eagle). Thus Walker’s word *SKR* means bull’s horn, and so might Ryckmans’ *SHR*.

<sup>1927</sup> Ryckmans. *Anchor*, v. 6, p. 174.

<sup>1928</sup> Ryckmans. *Anchor*, v. 6, p. 173.

<sup>1929</sup> Simpson. *Sheba*, p. 144.

<sup>1930</sup> Simpson. *Sheba*, p. 144.

<sup>1931</sup> Doe. *Southern*, p. 119.

<sup>1932</sup> Nielsen, 1912, pp. 593-594, as translated in Krause, “*Haram-Harimat*.”

<sup>1933</sup> Gibb & Kramers. *Encyclopedia*, p. 343, middle of the left column, *Masjid* entry.

<sup>1934</sup> Simpson. *Sheba*, p. 77, coins 71-74 are the two owl and radiant head coins of the early series.

The position of the bull's horn below the eagle suggests the horn represents a crescent. The position of the first letter (*S*) of *Syn*'s name between the bull's horns on the square coin suggest an orb-and-crescent.

**Figure 02-04.**  
*Hadramawt Syn* coins  
 (~1<sup>st</sup> half of 1<sup>st</sup> C AD to late 3<sup>rd</sup> C AD).

Note that by the process of elimination, *SKR* seems to mean “bull’s-horn crescent.”

The *Syn*-eagle coin is sketched from Doe. *Southern*, plate 44 (p. 85), and the rest are sketched from Walker. *Hadramawt* and Simpson. *Sheba*, p. 78.

Škr = = Bull's horn  
 Bull's horn = Crescent  
 Y. S. H. = The exulted Moon Crescent  
 Syn = Sin the moon-god

Scholars generally have not noticed the crescent on *Syn*-eagle coins only because those scholars drew their conclusions and seem to have not revisited all the evidence in a meaningful way since the first few *Syn*-eagle coins were found even though their condition was poor. Perhaps this is because coins end up in different museums and private collections and go unpublished for decades.

In 1937 Walker published five samples, two of which had the bull's-horn crescent worn off, two had the bull's horn mostly intact, and one had a bull's horn that dipped down on the left side which made Walker think it was an undulating line or perhaps *Almaqah*'s bent-ladder symbol.

The reason for the dip on the left side of the horn might have been artistic expression or a meaningless variation common on anything hand-made. Even in the industrial and information age, stamps and coins have unintended variations that make them unique and collectors' items.

Walker took the undulating bull's horn to be the norm though only one of his samples showed this feature and two show a bull's-horn crescent. Walker's 1937 reproduction showed the eagle standing straight up which correctly displays the half-crescent,<sup>1935</sup> but his 1952 composite drawing tilts the eagle rightward (see illustration below) because Walker thought the bull's horn was an artistic baseline or the bent-ladder symbol of *Almaqah*.<sup>1936</sup>

Walker understandably missed the crescent because of the paucity of samples available to him. Even in 1952, Walker did not have a complete, unworn *Syn*-eagle coin, but had to provide a composite drawing.<sup>1937</sup> Moreover, Walker expected a well-formed full-crescent like those on other South Arabian coins, not a primitive bull's-horn half-crescent. Walker wrote in 1937:

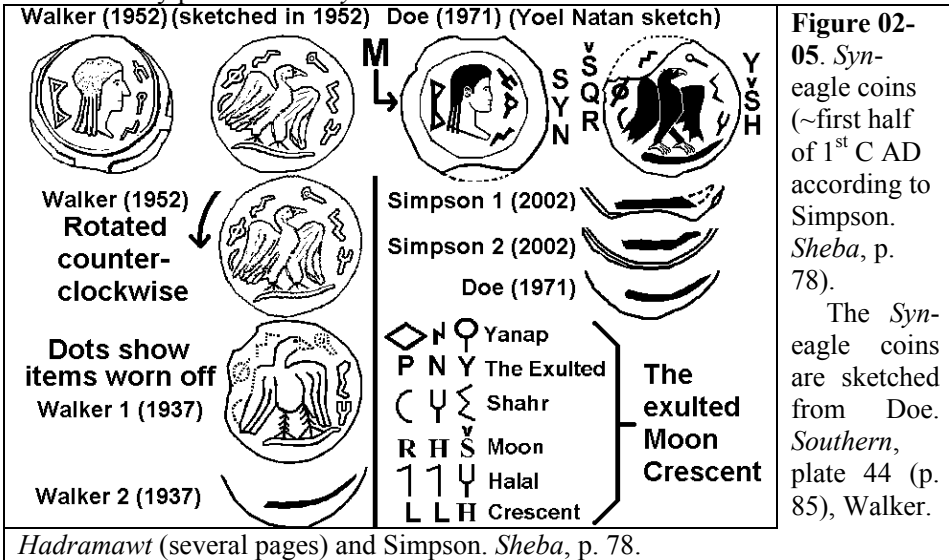
...his name *Sin* occurs on several inscriptions from the *Hadramawt*. But this is the first recorded instance of his name appearing on coins, although his

<sup>1935</sup> Walker. *New*, plate 33.

<sup>1936</sup> Walker. *Hadramaut*, pp. 625-626...fn. 1 on p. 626.

<sup>1937</sup> Walker. *Hadramaut*, p. 623, figure 1.

crescent-symbol is found frequently on *Himyarite* and other South Arabian epigraphic and numismatic remains. In view of this fact it is all the more remarkable that his crescent should be absent from the present coins though his name is written in full, unless, of course, we regard the curved line below the eagle on the reverse as being intended for that. But, as will appear below, this is doubtful...Below the eagle an undulating line will be observed...The question arises: Has this any special significance? Or is it simply a base line? The presence of a curved line, presumably a lunar crescent below the eagle on the British Museum gem mentioned above [discussed above in this Revisionist section], suggests that perhaps the present line may have a similar significance. There is, however, just another possibility which suggests itself, namely, that it may represent the well-known curved sign [*Almaqah's* bent-ladder symbol] on the already published *Himyarite* coins.<sup>1938</sup>



*Hadramawt* (several pages) and Simpson. *Sheba*, p. 78.

Factors that indicate the eagle on the *Syn*-eagle coin (illustrated above) is standing on a bull's-horn crescent include:

- ☉ The word *SKR* is to the left of the eagle. Walker argued that one of the meanings of *SKR* was a "bull's horn of the moon-god projecting from each of the pinnacles" of a *Sabean* moon-god temple.<sup>1939</sup> Birds of prey surely were seen perched on these horns just as is pictured on the *Syn*-eagle coin.
- ☉ The initials *Y.Sh.H.* standing for "*Ynp, Shahr Hilal*" meaning "The exulted, Moon Crescent" are to the right of the eagle (discussed above).
- ☉ The later *Hadramawt* coins all featured a bull or bull's head showing that the bull was the main symbol of the moon-god *Syn* (illustrated above).
- ☉ The earliest examples of the *Syn*-eagle coins were found between the cities *Shihr* and *Tarim*,<sup>1940</sup> and *Shihr* likely is related to "moon" (*Shahr*).
- ☉ The "r" letter in the word *SKR* forms a crescent next to the left side of the eagle in the *Syn*-eagle coin in the same position as the crescent in the coin

<sup>1938</sup> Walker. *New*, pp. 266...278-279.

<sup>1939</sup> Walker. *Hadramaut*, pp. 625-626, figure 6 (see fuller quotation above).

<sup>1940</sup> Walker. *New*, pp. 260; also Simpson. *Sheba*, p. 78.

that preceded it—the *Hadramawt* imitation of the *Athena-owl* on amphora coin. So one lunar coin begets another.

- ☉ The left side of the half-crescent horn does not dip down except on one sample (Walker 1937, coin 1), and that is not as pronounced as Walker's 1952 drawing would suggest. The left side of the Doe 1971 sample actually curves up to form three-fourths of a crescent.
- ☉ Other South Arabian coins (some are illustrated in this section) have baselines but they are relatively straight and in no way suggest they are a half-crescent, full-crescent or bull's horn.

*Artifacts and Dedicatory Plaques Show That Almaqah Was a War-and-moon god*  
(See the “Allah as a War-god” section earlier in this Moon-o-theism book.)

*Phonetics Suggest that Syn Really Was Sin, the Main Moon-god of the Mideast*

The Revisionist theory has it that the *Hadramawt Syn* was not the moon-god *Sin*, but the sun-god *Sayin*, a god whom we know little about.<sup>1941</sup> The conjectured pronunciation *Sayin* is based on the original three-letter root, and the vowels used in a transliteration (*Sabin*) by the Roman scholar Pliny the Elder (23–79 AD).<sup>1942</sup>

The likely reason that the Revisionists have started referring to the *Hadramawt Syn* (or *Sin*) as *Sabin* or *Sayin* is to deny the competing theory a proof that the *Hadramawt Syn* is the Mesopotamian *Sin*. Denying the opponent the use of language is known as the scorched-earth propaganda trick.

Semitic languages were written only with consonants and without any vowels or vowel pointing until the seventh or eighth centuries. This is why the scholars sometimes insert the vowels of Greek and Latin transliterations into Semitic words.

If one wanted to insert vowels into the name *Syn*, it might be better to borrow those used for the *Akkadian Su-en*. So instead of *Sayin*, it would be *Suyen*. One cannot put much stock in Greek and Roman historians' transliterations of South Arabian words since they are known to be unreliable. Examples from inaccurate Roman and Greek transliterations from Breton's book *Arabia Felix* (1999) include:

- ☉ Pliny: *Sabota* (*Shabwat/Shabwa*), p. 65; *Gebbanitae* (*Qatabanites*), p. 73.
- ☉ Stabo: *Sabata* (*Shabwat/Shabwa*), p. 80; *Marsiaba* (*Maryab/Ma'rib*), p. 167.
- ☉ Theophrastus: *Kitibaina* (*Qataban*); *Mamali* (*Qarnaw/Ma'in*), p. 54.<sup>1943</sup>

It is easy to imagine that immigrants, travelers or traders brought *Su-en* or *Sin* from the Mideast to the *Hadramawt*, since much of the Arabian language, culture and religion originally came from the Mideast. Moreover, some of the first major consumers of frankincense and myrrh were the moon-god priests of ancient Mesopotamian empires where *Sin* and other moon-gods loomed large. Breton wrote:

...around the eighth or seventh centuries...frankincense arriving in Assyria

was referred to by its South Arabian name of *Libnay*.<sup>1944</sup>

The fact that Assyrian priests were using the South Arabian name for frankincense already in the eighth century BC increases the likelihood that the *Hadramawt Syn* is really the Mesopotamian *Sin*.

<sup>1941</sup> Breton. *Felix*, p. 122.

<sup>1942</sup> *Natural History*, bk. 12, sec. 32, para. 63.

<sup>1943</sup> The first name is the ancient name and the second is the modern Arabic name as found in The *Jawf* and the *Arabia Felix* maps at Breton. *Felix*, pp. x-xi.

<sup>1944</sup> Breton. *Felix*, p. 115.



The Greeks and Romans only started using exotic fragrances centuries later when their empires spanned into the Mideast and Egypt. Pliny (23-79 AD) lamented that despite the recently introduced perfumes, the gods were more benevolent back in the days when worshippers “petitioned them with salted spelt.”<sup>1945</sup> Spelt was a wheat grown in Europe from the Bronze Age until the advent of modern bread wheat.

Some of the main caravansaries were moon-god worshipping centers: *Haran*, *Ur* and *Tema* in northern Arabia. *Tema* was a center of moon-god worship set up by Babylonian Emperor Nabonidus (556-539 BCE) whose mother was a *Sin* priestess.

Likely, it was only a matter of time before *Su-en* and *Sin* morphed into *Syn* or *Suyen* or *Sayin* in the *Hadramawt*. The pronunciation may not have reflected the spelling exactly if the spelling of *Syn* ossified. In fact, inscriptions from *Aden* in southeast *Yemen* and in *Abyssinia*—where there may have been immigrants from the *Hadramawt*—have the spelling *SN* and probably pronounced *Sin*.<sup>1946</sup>

Ryckmans however says that “phonetic objections” indicate that the *Hadramawt* *Syn* is not the widely worshipped moon-god *Sin*. Phonetics aside, one must ask “What are the chances of there being a sun-god named *Syn* in the *Hadramawt* and moon-god named *Sin* (or *Su-en*) known throughout the Mideast for millennia?”

It is recognized that other gods in South Arabia came from the Mesopotamian area despite the slightly different spelling and pronunciation, so why would *Syn* not be derived from *Sin* (or *Su-en*)? For instance:

- ☉ The *Makkan Hubal* likely was derived from *HaBaal* meaning “The *Baal*,” or “The Lord.”
- ☉ The South Arabian sun-god *Shams* corresponds to *Shemesh* of Mesopotamia.
- ☉ The South Arabian Venus god '*Athtar* corresponds to that of the Mesopotamian Venus goddess *Ishtar*.
- ☉ The Arabian cosmic god *Il* and *Ilah* was the Mesopotamian cosmic god *El*.
- ☉ The *Qataban* moon-god *Anbay* corresponds to the Babylonian god *Nabu* (note the “n” and “b” consonants in *Anbay* and *Nabu*). *Nabu* was the Mesopotamian god of writing and wisdom who wrote down the words and wisdom of the moon-god *Sin*. Thus the leap from being a wisdom and scribal god to moon-god was not great.

The Arabic culture, language, religion and religious iconography was largely derived from, and remained dependant on, Aramaic culture. For instance, artwork at *Marib* included the common Mideast cherubs, griffins, sphinxes, bulls, bucrania, crescent-and-orb couplets and trees of life.<sup>1947</sup>

*Sin* was first known as *Su-en* in Mesopotamia but within a few centuries became known as *Sin* within that same region. One can see the drift in the pronunciation of gods' names in place names and in compound names, for instance:

- ☉ *Sin*: Desert of *Sin*, Desert of *Zin*, *Sennacherib* (*Sin* multiplies brothers), *Sanballat* (*Sin* has given life)<sup>1948</sup>
- ☉ *Nabu*: Mt. *Nebo*, *Nebuchadnezzar* (May *Nabu* protect the crown)

<sup>1945</sup> Pliny the Elder. *Natural History*, 12.82; also at 12.93.

<sup>1946</sup> *Aden*: Walker. *New*, p. 265, fn. 8 (*Aden*); *Abyssinia*: Walker. *New*, p. 277.

<sup>1947</sup> Doe. *Southern*, pp. 36-37, pictures 9-13.

<sup>1948</sup> *NIV Study Bible* (2002) note on Neh 02:10: “*Sanballat*. A Babylonian name meaning ‘*Sin* (the moon-god) has given life.’”

So a change in the pronunciation and spelling from *Sin* (or *Su-en*) to *Syn*: 1) across the millennia, 2) across the 1,400 miles from Babylon to *Yemen* and 3) across the Aramaic-Arabic language barrier would be expected.

Some language purists like to say that Arabs are sticklers for pronunciation, and that the vowels and consonants would have remained constant over thousands of years. This is an exaggeration since even if there had been dictionaries and everyone was literate, such precision in pronunciation and spelling would have been a feat nothing short of miraculous. Even the spelling of the city *Marib* changed over time in inscriptions. Originally it was *Maryab* (*mryb*) but by the end of the second century BC, it had changed to *Ma'rib*.<sup>1949</sup> Another South Arabian word that seems to have changed spelling is bucranium (*SHR*),<sup>1950</sup> which in the *Hadramawt* became *SKR*.<sup>1951</sup>

The change in language occurs even when everything is written down and sacralized. For instance, the *Koran* standardized Arabic, but within 1350 years most Arabic speakers can no longer understand the *Koran* without training and familiarization. Students of the *Koran* even travel to *Makka* and *Yemen* to hear and learn an Arabic dialect that is closer to that of the *Koran*.

Richard Burton (1821–1890 AD) was not naïve about etymology. He said that a drift in the pronunciation of an Arabic word was an attempt to make it easier to pronounce. He relates that the first letter of the word *Sirat—Islam's* Sword Bridge—changed twice in less than thirteen hundred years: from *Sin* to *Sad* to *Za*. Burton wrote in 1885 AD:

The word [*Sirat*] was originally written with *Sin* [letter] but changed for easier articulation to *Sad* [letter], one of the four *Huruf al-Mutabbakat*, 'the flattened,' formed by the broadened tongue in contact with the palate. This *Sad* [letter] also by the figure *Ishmam* (=conversion) turns slightly to a *Za*, the intermediate [letter] between *Sin* and *Sad*.<sup>1952</sup>

Thus for *Sin* (or *Su-en*) to become *Syn* for ease of pronunciation, or as a peculiarity in a local dialect, is entirely conceivable.

There are other indications that the *Hadramawt* was directly affected by the Mideast, and thus by implication *Syn* was *Sin*. Caton Thompson wrote:

The southwest orientation, dissimilar to other recorded temples in southwest Arabia, conforms to the Babylonian ancestral practice of an axis diagonal to the cardinal points. The raised platform style of the building seems derived, probably indirectly, from the same area [i.e. Babylon].<sup>1953</sup>

A *Hadramawt* colony in *Yemen* called *Sumhuram* near *Khor Rory*, *Dhofar*, yielded an inscription using Babylonian letters, and another inscription to *Syn*, which all suggests that *Syn* was indeed *Sin*. Wendell Phillips wrote:

Dr. Jamme had deciphered a newly uncovered bronze inscription mentioning the name of the *Hadramaut* moon-god *Sin* and giving for the first time the name...*Sumhuram*, a long-lost city. Next came a strange inscription on a stone trough, running from left to right, and with peculiar forms of letters found previously only in inscriptions belonging to the Biblical *Chaldeans*.<sup>1954</sup>

<sup>1949</sup> Breton. *Felix*, p. 182.

<sup>1950</sup> Ryckmans. *Anchor*, v. 6, p. 174.

<sup>1951</sup> Ryckmans. *Anchor*, v. 6, p. 173.

<sup>1952</sup> Burton. *Nights*, vol. 4, fn. 318.

<sup>1953</sup> Thompson. *Moon*, p. 57.

<sup>1954</sup> Phillips. *Sheba*, pp. 337-338.

Also in *Saba, Yemen*, there are similar indications that the temple to *Almaqah* was a moon-temple with similarities to those built in Mesopotamia. Ryckmans wrote:

The temple of *Almaqah* in *Marib* had an unusual shape, that of an ellipse [meaning the main walled room was oval] with a major axis about 345 feet long, with a strong wall about 28 feet high, built of fine limestone ashlars.<sup>1955</sup>

The curved walls may be in honor of the curved crescent of the moon-god. The *ziggurat* at *Ur* was built in honor of the moon-god *Sin*. Many arches and curved walls are built using the principle of entasis, meaning the walls and columns are curved slightly so they look straight to the human eye. So...

...surprisingly, there is not a single straight line in the structure. Each wall, from base to top and horizontally from corner to corner, is a convex curve...<sup>1956</sup>

#### *A Sometimes Misconstrued Inscription Mentioning Syn and Athar*

The following *Hadramawt* inscription excerpt has been misconstrued by some to say that *Sin* the moon-god was not the high god in the *Hadramawt* region:

...to *Sin*, He of *Thum*, and to *Attar*, his father (Pritchard, *Ancient*, II:238).

Simpson seems to have fallen for the misinterpretation of the above inscription when he wrote:

In one *Hadramatic* inscription ‘*Athtar* is called ‘father’ of the *Hadramatic* deity *Sayin*.<sup>1957</sup>

Simpson takes the *Hadramawt* inscription to mean that *Attar*, a Venus-god in *Yemen*, fathered *Sin* even though Simpson wrote that *Syn* was “at the top of the *Hadramitic* pantheon.”<sup>1958</sup> It is unlikely that lowly *Attar* would father the top god in theogonic myths, especially when another goddess is called “mother of ‘*Attar*.”<sup>1959</sup>

Shabbir Ally of *Islamic Awareness* used the misinterpretation to attack the *Allah* was a moon-god theory. Ally wrote:

Quite revealing! This shows that the moon-god *Sin* had a father *Attar* who was also a god. So for these people the moon-god was not the high god. This again disproves [Robert] Morey.

Morey kept telling us that the moon-god was the high god among the pagans. Now we know that...he [*Sin*] also had a father. *Allāh* of course was never believed to have a father.<sup>1960</sup>

The reason that this inscription is misunderstood is twofold. South Arabian inscriptions are, as Ryckmans wrote: “...solemn texts drawn up in the third person...”<sup>1961</sup> Ryckmans also wrote:

In ancient times the ruler might call himself the ‘firstborn’ (*bikr*) of the god, while the nation was the ‘progeny’ (*wld*) of its national god.<sup>1962</sup>

Elsewhere Ryckmans wrote that “The protective formula...‘*Wadd* is father’ written on amulets or on the walls of buildings...”<sup>1963</sup> So “his father” (third person) in the

<sup>1955</sup> Ryckmans, Jacques. *EB*, “Arabian Religions” entry, 2004.

<sup>1956</sup> “Third dynasty of *Ur*, 22nd–21st century BC,” *EB*, 12 May 2002.

<sup>1957</sup> Simpson. *Felix*, p. 163 + fn. 4: “RES 2693” (RES = *Repertoire d’epigraphic semitique*, 8 vols., *Academie des Inscriptions et Belles-Lettres*, Paris, 1900-1968).

<sup>1958</sup> Simpson. *Felix*, p. 163.

<sup>1959</sup> Ryckmans. *Anchor*, v. 6, p. 172.

<sup>1960</sup> Ally, Shabbir. “Reply To Robert Morey’s Moon-god Myth & Other Deceptive Attacks On *Islam*,” *Islamic Awareness*, *Islamic-awareness.org*, accessed 1 Nov 2003.

<sup>1961</sup> Ryckmans. *Anchor*, v. 6, p. 171.

<sup>1962</sup> Ryckmans. *Anchor*, v. 6, p. 172.

above inscription likely should be understood as “my father” (first person), meaning that the royal person who commissioned the inscription was referring to *Attar* (Venus) as “my father” as was customary for royalty to do at the time in *Yemen*.

*Attar* (Venus) may have been considered the special protective god of the royal house in *Yemen* just as *Mahram* the war-and-moon-god was a “special protective god” of *Abyssinian* royals.<sup>1964</sup>

James B. Pritchard gave the correct interpretation of the inscription in question. He capitalized the pronouns referring to deities while leaving the pronouns that pertain to the devotee in lowercase. Note that the capital “He” in the inscription is a grammatical appositive and refers to the god *Sin*, and the small-letter “his” refers to a mortal king who is claiming divine parentage or ancestry:

Saduqdakar Barran, prefect of the property of the king of *Hadramawt*, son of ‘Ilsarah, dedicated to *Sin*, He [*Sin*] of [Pritchard: “the temple of”] ‘*Ilum*, an offering in bronze of which the weight is true, reddish-brown bronze—and he [the prefect] offered it—, which he [the prefect] promised to *Sin* as He [*Sin*] had him [the prefect] [promise] by His [*Sin*’s] oracle. And Saduqdakar consecrated in submission to ***Sin, He [Sin] of ‘Ilum, and to ‘Attar, his [the prefect’s] father,*** and to the goddess of His [*Sin*’s] temple ‘*Ilum*, and to the gods and goddesses of the city of *Sabwa*, his [the prefect’s] person and his understanding and his children and his possessions and the light of his eye and the thought of his heart as homage and submission which may be agreeable.<sup>1965</sup>

So the devotee happens to be a government prefect and is a member of royalty. The prefect is of royal lineage since ‘Ilsarah is the King of *Saba* and *Dhu-Raydan*, as Pritchard noted in his book a few pages earlier when he discussed another inscription.<sup>1966</sup> Perhaps this is the same Ilsarah Yahdub who fought off the Roman legion that, according to the Roman historian Strobe, tried to conquer *Marib* in 24 BC.<sup>1967</sup>

The inscription also seems to say that *Sin* is the moon-god ‘*Ilum*, or it equates the *Hadramawt Sin* with the *Sabean Ilumquh* (aka *Almaqah*). That *Sin* would be considered *Alumqah* is entirely possible because:

☉ In *Syn*’s *Hadramawt* temple at *Huraydah* one inscription addresses *Syn* and another inscription addresses *Almaqah*.<sup>1968</sup>

☉ Breton wrote:

As the influence of *Saba* spread throughout South Arabia, the cult of *Almaqah* was imposed upon tribal groups who already had pantheons of their own. The result was a hodge-podge of religious conceptions.<sup>1969</sup>

### Conclusion

The recent Revisionist view is wrong. *Almaqah* and *Syn* were not sun-gods, but were moon- and war-gods as the traditional view states.

<sup>1963</sup> Ryckmans. *Anchor*, v. 6, p. 172.

<sup>1964</sup> Nielsen, 1912, pp. 593-594, as translated in Krause, “*Haram–Harimat*.”

<sup>1965</sup> Pritchard. *Ancient*, II:238. Note: The inscription line numbers and some accent marks have been excluded, while bracketed comments have been added.

<sup>1966</sup> Pritchard. *Ancient*, II:231.

<sup>1967</sup> Elahi, Rahmat (the archaeologist). “A Glimpse of Archaeological Sites in Southern Part of the Republic of *Yemen*,” *Yementimes.com*, Issue 10, Culture Page, 6–12 Mar 2000, vol. x.

<sup>1968</sup> Thompson. *Moon*, p. 52 + plate LXII: *Syn* inscription, no 17a, *Almaqah* inscription no. 17b.

<sup>1969</sup> Breton. *Felix*, p. 117.

## Chapter 03: Moon-o-theistic Proselytizing

### Introduction

*Islam* has become the world's second largest religion, not by chance but through certain methods that when employed simultaneously multiply their effect. These methods cover a full spectrum that runs from persuasion and argumentation to economic and religious persecution.

The economic and religious persecution involves unfair taxation, discriminatory laws, persecution, enslavement, terrorism and even genocide. This chapter will discuss *Muslim* propaganda first, and then *Islam*'s physical acts of persuasion.

### Persuasion through Spurious Argumentation

*Muhammad* taught that everyone was born a *Muslim* (K 030:030) but non-*Muslim* parents raise their *Muslim* infants to become pagans, Jews and Christians.<sup>1970</sup> So *Muslims* prefer the term “revert” to “convert” when it comes to proselytizing. *Dawa* is the *Muslim* term for proselytizing.

*Muhammad* tells *Koran* readers that he created *Islam* by distilling and syncretizing complementary elements of Arabian paganism (*Sabeanism*, *Sabianism*), Judaism, Christianity, Zoroastrianism (*Magianism*) and the Religion of *Ibrahim* (*Hanifism*) (K 002:062, 135; 005:069; 022:017).

*Muslims* and aca*Dhimmis* have dwelt on the Jewish sources that *Muhammad* modified to create *Islam*, while glossing over the pagan sources of *Islam*. This gives *Islam* an unwarranted air of respectability—as though *Islam* really were the Religion of *Ibrahim* as *Muhammad* claimed (K 002:130, 135; 003:095).

*Muhammad*'s reliance on heretics to attack Christianity and Judaism means that scarcely any information in the *Koran* about Christianity is correct. Not even the names are correct. *Muhammad* thought that Moses' mother was also the mother of Jesus. Furthermore, *Muhammad* thought that Jesus was *Esau*, who was the son of Isaac and the brother of Jacob. C.C. Torrey wrote that the only likely explanation for *Muhammad*'s blunder is:

It is a patent fact that the prophet knew next to nothing about Jesus; also, that there are no distinctly and peculiarly Christian doctrines in the sacred book. All those who have studied the matter know and declare that the great bulk of the *Koranic* material is of Jewish origin; and we have certain knowledge that *Mohammed* resorted habitually to learned Jewish teachers....The form of the name [*Isa*] is remarkable, in comparison with *Yeshu*. The Christian Arabs of northern Arabia had the form *Yasu*, which is just what would be expected; '*Isa*' makes its first appearance in the *Koran*. It has been explained by Noldeke and others as a Jewish pleasantry of which *Mohammed* was the innocent victim, the name of *Esau*, the typical [Jewish] enemy, being in fact substituted for that of Jesus...There is another [farfetched] explanation...which neither simple nor free from difficulties, is not quite impossible...<sup>1971</sup>

<sup>1970</sup> K 030:030; *Sahih Bukhari*, vol. 2, bk. 23, nos. 440, 441 & 467; *Sahih Muslim*, vol. 4, ch. 1107, nos. 6423 & 6426.

<sup>1971</sup> Torrey. *Foundations*, pp. 72-73.

That rabbis referred to Jesus as Esau, the founder of *Edom*, is supported by the fact that later rabbis said they would “Rather [be living] beneath the yoke of *Edom* [Christendom] than that of Ishmael [*Islamdom*].”<sup>1972</sup>

*Islam*’s reliance on heretics to attack Christianity and Judaism continued throughout *Islamic* history. For instance, the early ninth century AD, *Shia* scholar *Abu Isa Muhammad b. Harun Al Warraq* wrote two treatises: *Against the Trinity* and *Against the Incarnation*. He borrowed his argumentation from Christians who held some heretical notions—the Nestorians, Melkites and Jacobites who lived around *Baghdad*.<sup>1973</sup>

Similarly, in modern times, it is not unheard of to find *Muslim* book outlets selling anti-Trinitarian books by Unitarians and *Jehovah*’s Witnesses. Thus Unitarians and *Jehovah*’s Witnesses facilitate the takeover of the West by *Islamists*.

### Is the Sword Mightier Than the Pen?

*Islamists* usually start with persuasion until they see that their efforts produce diminishing returns. *Islamic* apologetics has never had to stand on its own, but is mostly *ad hominem* attacks used to mark opponents as infidels deserving of death. Then all it takes is one *Muslim* reading the *Koran*’s 164 War verses one too many times, after which rage takes over from there.<sup>1974</sup> *Muslims* therefore rely ultimately on the sword rather than the pen to win arguments.

#### Important *Sola Scriptura* *Islamist* Scholars

*Hanafi* jurist *Abu Mansur Maturidi* (died 944 AD) is popular in Turkey and Central Asia. *Maturidi* is the main theologian for the *Deobandi* school that is popular in *Pakistan*, *India*, *Bangladesh*, *Malaysia* and *Indonesia*.

*Abu*’-*Hasan Al-Mawardi* (died 450 AH/1058 AD) in *Al-Akham as-Sultaniyyah* (4.2) allows for the killing of women and children who are perceived as aiding the war effort against the *Muslims* (confer *Reliance of Traveler*, ‘*Umdat Al-Salik* o9.10).<sup>1975</sup>

*Sufi* scholar *Abu-Hamed Muhammad Al-Ghazali* (1058-1127 AD). *Ghazali* wrote that *Muslims* ought to go on *Jihad* at least once per year. *Ghazali* wrote that *Muslims* may use catapults against, or set fire to, a fortress filled with non-*Muslim* women and children.<sup>1976</sup> *Ghazali*’s theology also made terrorism possible by justifying fighting the enemy from the midst of civilians. *Ghazali* used the term *Tattarrus* in his book *Al-Mustasfa (The Place of Purification)* to describe the practice of “using ordinary *Muslims* as human shields for *Islamic* combatants against infidel fighters.”<sup>1977</sup>

<sup>1972</sup> Ye’or, Bat. *Dhimmi*, pp. 352-354.

<sup>1973</sup> Thomas, David (editor and translator). *Anti-Christian Polemic in Early Islam: Abu Isa Al Warraq’s ‘Against the Trinity.’* Cambridge University Press, 1992, and Thomas, David (editor and translator). *Early Muslim Polemic against Christianity: Abu Isa Al Warraq’s ‘Against the Incarnation.’* Cambridge University Press, 2002.

<sup>1974</sup> See the Contents section to locate the table on the *Koran*’s 164 War verses.

<sup>1975</sup> *Islamic* law as set down in ‘*Umdat Al-Salik* o9.10, cf. *Al-Mawardi, Al-Akham as-Sultaniyyah*, 4.2, *JW*, 20 Apr 2004 & 11 Jun 2005.

<sup>1976</sup> Bostom, Andrew G. “*Sufi Jihad?*” *americanthinker.com*, 15 May 2005.

<sup>1977</sup> “*Sheikhs* debate whether killing *Muslim* non-combatants is permissible,” *JW*, 11 Jun 2005.

*Hanbali* jurist Taqi *Al-Din Ibn Taymiya* (1268-1328 AD). *Taymiya* is *Osama Bin Laden's* favorite theologian.<sup>1978</sup> *Taymiya* wrote that civilians can be killed even if they only bolstered the enemy's morale by their words.

The Arabian *Abdul Wahhab* (1703-1792 AD), founder of *Wahhabism*, is popular in Arabia but his popularity has spread globally thanks to *Saudi* oil money.

The Indian *Deobandi* scholar Maulana *Muhammad Ilyas Kandhalawi* (1885-1944 AD), who founded the *Tablighi Jamaat* missionary movement in 1927 near *Delhi*.

The *Pakistani* Maulana *Abul Ala Maududi* (1903-1979 AD) who founded *Jama'at-i-Islami* (Society of Islam) in 1941 AD.

The Egyptian *Sayyid Qutb* (1906-1966 AD) of the *Ikhwan* (*Muslim Brotherhood*). *Qutb* wrote the book *Malleem Fittareek* (*Milestones*) and was executed by *Nasser's* regime.<sup>1979</sup>

### **Muslim Obfuscation About Islam Being a Moon-god Religion**

Some *Muslims* defend *Islam* by pointing out that the *Koran* says to worship the creator of the moon, not the moon itself (*K* 022:018; 041:037). *Muslims* never seriously consider whether a demon might be playacting *Allah* and has inserted these verses into the *Koran* as part of his identity theft against *Yahveh*. *Muslims* dismiss this thought saying that this would too clever by half since the *Koran* says the schemes of the Devil are weak (*K* 004:076). Of course, *Muslims* never consider that the demon playacting *Allah* also inserted *K* 004:076 into the *Koran* simply because the Devil does not want *Muslims* to know he has them fooled, and that his schemes are so powerful that Paul said “the god of this age has blinded the minds of unbelievers” (2Co 04:04).

The verses forbidding worship of the moon and sun do not disassociate *Allah* from his moon-god past as some say they do (*K* 022:018; 041:037). These verses merely say that one ought not worship the orbs of the sun and moon, but they do not forbid worshipping a deity associated with these orbs. Crescents atop *Mosques* show the association of the moon with the god of *Islam*. Thus *Muslims* worship *Allah* the moon-god, but not the moon rock itself.

Mythology indicates that the ancients sometimes looked toward the moon to locate the moon-god, but thought of the god as being a person separate from the inanimate object itself. In a later chapter, one can find *Esarhaddon's* description of a *Sin* idol leaning on a cane. In the same chapter, *Nabonidus' mother*, *Adad-Guppi* describes *Sin* as a person who left *Haran* for the heavens.

The ancients believed in the moon-god, not the moon itself. The ancients did **not** pray “Oh moon, help me...” but rather “Oh *Sin*, save me,” or “Moon-god, save me...” Take for instance this excerpted prayer from the *Gilgamesh Epic*:

At night when he [*Gilgamesh*] came to the mountain passes *Gilgamesh* prayed: ‘In these mountain passes long ago I saw lions, I was afraid and I lifted my eyes to the moon; I prayed and my prayers went up to the gods, so now, O moon-god *Sin*, protect me.’<sup>1980</sup>

Some *Muslims* defend *Islam* by claiming that the crescent-moon atop their *Mosques*:

<sup>1978</sup> Pipes, Daniel. “The Ugly History of *Jihad*,” *FPM*, 31 May 2005.

<sup>1979</sup> De Borchgrave, Arnaud. “2002 Yearend: Whither radical *Islam*?” *upi.com*, 8 Dec 2002.

<sup>1980</sup> Anonymous. *Gilgamesh*, “The Search for Everlasting Life.” Also, Pritchard. *Ancient*, I:62, middle of Tablet IX.

- ☉ Reminds *Muslims* of how they follow the lunar religious calendar.
- ☉ Points the way to *Makka*.
- ☉ Is a handy symbol for differentiating *Mosques* from churches and other buildings.

*Muslims* like to point out that no one accuses the Christians of having a cross or fish god just because Christians use these symbols. Christians may rightly answer that all this is beside the point and is begging the question. The Christian god never was the Philistine fish god called *Dagon*, nor the *Babylonian* nature deity called *Tammuz* whose sign was a cross and circle (Eze 08:14).

The Christian use of the *IXTHUS* fish and cross symbols is clearly explainable without any reference to paganism. The Christian fish symbol came about not on account of *Yahveh* being a fish god but on account of the acronym *I.X.T.H.U.S.*, which also is the Greek word for “fish.”<sup>1981</sup>

Likewise, the Christian cross symbol is actually a crucifix and not just a cross or an X. The supposed pagan antecedents of the crucifix that critics refer to are not crucifixes but are in fact scepters, *Ankhs* (an Egyptian phallic-vulviform symbol), *Apollo*’s walking staff, shepherds’ crooks, and the letter *Tau*—the initial letter of *Tammuz*’ name and so forth.<sup>1982</sup>

*Muslims* sometimes go on the offensive and say the crescent is no more damaging to *Islam* than the Easter Bunny (Rabbit) and *Halloween* are to Christianity. These traditions however are clearly foreign to Christianity and every Christian knows that Easter-egg hunts and trick-or-treat are not found in the Bible. By contrast, according to both traditions and architecture, *Allah*’s *Kaaba* at *Makka* clearly was an astral temple where one could find a crescent or two.

Since *Allah* was a pre-*Islamic* moon-god, and since the crescent symbol has been used since the inception of *Islam*, the crescent shows that *Islam* is a moon-god religion. Besides, throughout *Islamic* history, the crescent often has been implicitly and explicitly associated with *Allah*.

Someone might say that perhaps *Allah* was a pre-*Islamic* moon-god but *Muhammad* gave *Allah* a promotion to the top job. This is analogous to the situation that Isaiah ridiculed: Venus (*Heyl*) tried to be like the *Assyrian* high god, who was the moon-god (*Hilal*) (Isa 14:12-14).

*Muhammad* did not rid pre-*Islamic* paganism of all its moon-god religion elements. In fact, to create his moon-god monotheism, *Muhammad* merely rejected solar worship and other non-lunar rites. *Islam* still has many of the rites, trappings and the look and feel of an ancient moon-god religion, and therefore is a moon-god religion still.

Some *Muslims* say that *Allah* was not a moon-god since he created the moon (*K* 006:096; 007:054; 010:005; 013:002; 021:033; 025:061; 029:061; 031:029; 039:005; 041:037; 071:016). In astral religions however the astral gods often were said to have created their own perches in the sky at the same time they created the heavens and the earth. So for *Allah* to have created the moon does clear him of the charge of being a moon-god.

<sup>1981</sup> *Ixthus* means “fish” in Greek, but also is an acrostic or acronym for the Greek: Jesus (*Jesus*) Christ (*Xristos*), God’s (*Theou*) Son (*Uios*), Savior (*Soter*). Hence the fish symbol which often has the acrostic: *IXTHYS* (*Y* = capital Greek “U”) or the anglicized versions: *IXTHUS* or *ICHTHUS*.

<sup>1982</sup> Hislop. *Babylons*, pp. 197-200.



Examples of how *Muhammad* did not start *Islam* with a slate clean of paganism include:

- ☉ *Muhammad* said in the *Koran* that pagan goddesses thought to be the astral Daughters of *Allah* were in fact male angels whom ancient apostates had given female names. In contrast, the Hebrews and Christians believed that pagan gods were demons.
- ☉ When *Muhammad* neared the end of his life, he reformed the *Makkan* pilgrimages somewhat but many astral and phallic elements were retained.

It is easy to overestimate the Biblical contribution to *Islam* for various reasons.

These include:

- ☉ What commonly passes for Biblical stories is in fact apocryphal folklore and *Muhammad's* imaginative historical fiction.
- ☉ The same Biblical-sounding information is repeated over and over.
- ☉ If one were to expurgate the needless repetitions, the *Koran* would shrink to the size of a pamphlet. If one deleted all Biblical-sounding information that was erroneous nonetheless, one would find that the *Koran* contains only a page or so of correct Biblical information.

### ***Allah's Identity Theft Against Yahveh***

The Devil's first temptation put to humans that caused their Fall into sin was to tempt them to be like *Yahveh* (Gen 03:16). This temptation is similar to the temptation that tripped up the Devil and led to his first sin, namely his ambition to be "like the Most High" (Isa 14:12-14; Eze 28:01-09).

The Devil has always tried to get humans to worship him, and has succeeded in getting humans to sacrifice to demons (Deu 32:17; Psa 106:037; Mat 04:08-10 (parallel: Luk 04:05-08); 1Co 08:05-06; 1Co 10:20-21; 2Th 02:04; Rev 09:20). Now the Devil acts as a counterfeit monotheistic god who propagates false doctrine through false teachers (1Ti 04:01-04).

Some false teachers use ontological arguments to say that the three monotheistic religions worship the same god, but only a person with a superficial understanding of these religions could say this. Judaism, Christianity and *Islam* are not abstract philosophers' religions with logical principles serving as deity, nor are they New Age religions with an impersonal force stepping in for deity. These are religions with followers ruled by supernatural personalities.

The *Koran* is just another of the Devil's clever attempts to get humans to worship him (or another demon) by committing identity theft against *Yahveh*. The *Koran* is *Allah's* fake passport. The *Koran* and *Islamic* traditions are *Allah's* false travelogue and false personal history whereby *Allah* the moon-god purports to be the God of the Bible.

Truly *Allah* is the greatest of all schemers, as *Muhammad* claimed (*K* 003:054; 008:030). Of course *Allah* finds scheming to be second nature since he is a demon (Deu 32:17; Psa 106:37; 1Co 10:20-21; 1Ti 04:01). When *Allah* tells lies, he is speaking in his native tongue. *Allah* finds telling the truth harder than speaking lies since speaking the truth is a foreign language to *Allah* (Joh 08:44).

*Muhammad* assures the *Koran* reader that *Allah* and the God of the Bible are the same God (*K* 002:062; 003:064; 006:107; 016:035; 021:108; 029:046, 061-063; 039:003). For instance, *Muhammad* said:

Say (unto mankind): Cry unto *Allah*, or cry unto the Beneficent, unto whichever ye cry (it is the same) (*Pickthall K* 017:110).

*Muhammad's* Universalism extends only so far since he rejects calling *Allah* “the Father” as Arabic Christians do (K 006:101; 072:003).

Modern *Muslims* and apologists for *Islam* are adamant about how non-*Muslims* and news reporters ought to use the capital-G “God” instead of the “transliterated” *Allah*. The fact that the small-g “god” would not suffice shows that this is a sneaky linguistic attempt to get non-*Muslims* to agree that *Allah* is *Yahveh*.

Tellingly, *Muslims* themselves continue to use the word *Allah* among themselves, even while instructing non-*Muslims* to refer to *Allah* as God. This shows that *Muslims* only respect the *Koran's* depiction of God and do not respect what the Bible has to say about *Yahveh* since *Muslims* think the Bible is corrupted.

The politically-correct campaign to have infidels use the word God rather than *Allah* also represent a scorched-earth policy—denying infidels the use of language in order to critique *Islam*, *Muhammad* and *Allah*. This is the same policy that was enforced in medieval times too since “the *Dhimmi* is obliged not to [even] mention *Allah* or His Apostle...”,<sup>1983</sup> much less draw pictures of them.

Modern *Muslims* think that Christians and Jews ought to be Universalist-minded enough to admit that the credo “there is no god but *Allah*” is true. Many *Muslims* say that “there is no god but *Allah*” is merely anti-polytheistic, but historically this short credo has been used in an anti-Trinitarian sense too.

The credo “there is no god but *Allah*” credo is found in the very anti-Trinitarian main inscription in the Dome of the Rock built in 792 AD.<sup>1984</sup> The *Koran* says of Christians that: 1) they will burn in fire (K 005:072), 2) *Allah* will taunt Christians on the day of their doom, saying: “Where are My partners whom you imagined?” (K 028:062-064; 040:073) and 3) *Allah* will tear Christians apart for ascribing partners to him (K 030:013-014).

Thus when *Muslims* and Ecumenicalists say Christians ought to accept as true the statement “there is no god but *Allah*,” they are merely trying to trick Christians into affirming an anti-Trinitarian statement, or at least be “good *Dhimmis*” and give lip-service to the idea. Worse still, *Muslims* might claim that Christians who say short *Muslim* credos like the *Shahada* have in fact converted and cannot revert back to Christianity upon pain of death!

Modern *Muslims* use similar Universalist arguments when they assert that pre-*Islamic* Christians and Jews called God *Allah*, meaning “The God,” even before *Muhammad's* time and afterwards too. Basically *Muslims* are saying that Christians ought to accept any god as being *Yahveh*, as long as that god has the title “The God.”

One fact that *Muslims* fail to mention is that the name *Allah* is not EXCLUSIVELY used by Jews, *Muslims* and Christians. Other Arabic-speaking religions of the past and present refer, or referred, to their god as *Allah*. As the *Nationmaster Encyclopedia* states in its *Allah* entry (note the “**and others**”):

It is used by *Muslims* worldwide, as well as Arabic-speaking Christians (notably Maronites (i.e. Roman Catholics)), Jews and **others**.<sup>1985</sup>

That *Allah* is *Yahveh* is absurd since *Allah* is not even a triad, much less the Trinity of the Bible. That *Yahveh* is the Trinity is why the New Testament says:

Anyone who does not honor the Son does not honor the Father, who sent him (Joh 05:23).

<sup>1983</sup> Bostom, Andrew G. “Confused *Islamic* Apologetics,” *FPM*, 10 Aug 2004.

<sup>1984</sup> Nuseibeh & Grabar. *Dome*, pp. 78-81.

<sup>1985</sup> *Nationmaster Encyclopedia*, *Allah* entry, accessed 6 Dec 2003.

Anyone who runs ahead and does not continue in the teaching of Christ does not have God; whoever continues in the teaching has both the Father and the Son (2Jo 01:09).

Jesus said Jews did not know or believe in the Father anymore than they knew or believed in him (Joh 07:28; 08:19, 55; 16:03). Satan had control over the synagogues and Judaism (Luk 04:33-33; Rev 02:09; 03:09) and the Temple at least since Intertestamental times (Jer 07:11; Mat 21:13; Mar 11:17; Luk 19:46; compare with Deu 32:17 & Psa 106:037). The logical conclusion is that the god of *Islam* is a demon in service to Satan.

The deity's character and actions depicted in the *Koran* are totally different from the character and actions of the God of the Bible. Besides, *Muhammad* did not know what he was talking about. *Muhammad* taught that:

☆ Jews worshipped Ezra as the Son of *Allah* (K 002:259-260; 009:030).

† The persons of the Christian Trinity were *Allah*, Jesus and Mary, rather than The Father, The Son and The Holy Spirit (K 004:169; 005:077, 116).

Moreover, *Muhammad* said that these other religions worshipped *Allah* too:

☉ Arabian astral paganism (i.e. *Sabeanism*, also spelled *Sabianism*),

☉ Zoroastrianism (i.e. *Magianism*).

☉ Religion of *Ibrahim* (i.e. *Hanifism*) (K 002:062, 135; 005:069; 022:017).

So in order to accept the idea that *Islam's Allah* is the God of the Bible, one would need to be a near-Universalist. To be consistent in one's beliefs, the near-Universalist would need to believe that the deity of the Christians, Jews, *Islam*, astral paganism, Zoroastrianism and the Religion of *Ibrahim* were all the same divine person.

Apparently, what happened was, when *Muhammad* got into the mode of syncretizing Arabian astralism with Christianity and Judaism, he found himself on a slippery slope and thus included Zoroastrianism too.

Evidently, the reason *Muhammad* thought that all the major religions in the Mideast worshipped *Allah* was he met an Arabic-speaking adherent of each major religion that called his god *Allah*.

So the name *Allah* was a superficial common denominator that led *Muhammad* to believe that these religions had the same god. In reality however the *Allah* of the:

☉ Christian and Jewish Arabic speakers was *Yahveh*, the God of the Bible.

☉ Zoroastrian Arabic speakers was *Ahura Mazda*.

☉ *Sabean* Arabic speakers was *Ilumquh*, a.k.a. *Sin* the moon-god.

☉ *Hanif* Arabic speakers was *Sin* the moon-god of the Mideast, the high god of *Haran* and *Ur*.

So if *Muslims* believe in the "*Allah*" of each one of these religions, they are polytheists who worship three deities: *Yahveh*, *Sin* the moon-god and *Ahura Mazda*. For these reasons and many more, Christians cannot and should not accept the *Muslim* and Papal claim that the god of the *Koran* is the God of the Bible.

One need not be obtuse or parochial to say that each religion has its own deity. In fact, most adherents of the other religions would readily agree that they are not worshipping the God of the Bible. Also, Jews will say that they do not worship the Trinity.

The fact that pagans knew all the *Baals* were not one god *Baal* can be ascertained by how they mentioned the god along with his location such as *Baal of Peor* (Num 25:03). They also hyphenated names like *Baal-Zebub*, the god of *Ekron*

(2K 01:02) and *Baal-Berith* (Jdg 08:33; 09:04). Moreover, the Hebrews spoke of the plural *Baals* and *Ashtorahs* (Jdg 10:06; 1Sa 07:04; 12:10).

Scholars have long noted that after a conquest, or as a result of cultural hegemony, local gods retained their original characters and roles but were worshipped under other names. Thus countless local gods gain well-known names such as Jupiter, Zeus, Apollo, *Baal*, Luna and such. For instance, in *Thyatira* in Asia Minor, the local god *Tyrimnos* was guardian of the city and patron of the guilds, and was later identified as the sun-god Apollo.<sup>1986</sup> Concerning the city Laodicea, Louis Brighton wrote:

...the ancient god of the region was *Men Carou*, a god of healing. In the Hellenized city of *Laodicea*, people continue to worship the ancient god but identified him with *Zeus*, the supreme Greek god.<sup>1987</sup>

Similarly, *Allah* was a local moon- and war-god who came to be worshipped under the same title *Allah* that Arab-speaking Christians and Jews used to call on *Yahveh*. *Allah* retained his moon- and war-god character, his demonic personality (Deu 32:17; Psa 106:037), his sacred location (*Mekka*) and temple (the *Kaaba*), of which *Allah* had long been the guardian and patron (K 002:125; 106:003).

Christians who have read both the *Koran* and the Bible tend to realize that the “take no prisoners” god of the *Koran* is not the God of love of the Bible (1Jo 04:08, 16). In fact, none of the Bible characters mentioned in the *Koran* are a true representation of that person. C. C. Torrey wrote:

His [*Muhammad*’s] characters are all alike and they utter the same platitudes....In *Sura* 11:27-51 is given a lengthy account of Noah’s experiences...It contains very little incident, but consists chiefly of the same religious harangues which are repeated scores of times throughout the *Koran* [i.e. tirades against partnering gods with *Allah*], uninspired and uniformly wearisome. We have the feeling that one of Noah’s contemporaries who was confronted with the prospect of forty days and forty nights in the ark would prefer to take his chances with the deluge.<sup>1988</sup>

Take the *Koranic* character *Isa*. *Isa* is supposed to be Jesus—but can any Christian imagine him having this conversation with the Father?!

*Allah* will say: ‘O *Isa* [Jesus] son of Mary, did you say to men, ‘Take me and my mother for two gods besides *Allah*?’ He [Jesus] will say: ‘Glory be to You! It did not befit me that I should say what I had no right to (say); if I had said it, You would have indeed known it; You know what is in my mind, but I do not know what is in Your mind; surely You are the great Knower of the unseen things’ (K 005:116).

Also, a *Muslim* tradition states that Jesus will return to destroy Judaism and Christianity and then be buried next to *Muhammad*. *Muhammad*’s description of Christ suggests that *Muhammad* may have seen a painting of Christ:

The Prophet [*Muhammad*]...said: ‘There is no prophet between me and him, that is, Jesus...He will descend (to the earth). When you see him, recognize him: a man of medium height, reddish fair, wearing two light yellow garments, **looking as if drops were falling down from his head though it will not be wet**. He will fight the people for the cause of *Islam*. He will break the cross [i.e.

<sup>1986</sup> Brighton. *Revelation*, p. 80.

<sup>1987</sup> Brighton. *Revelation*, pp. 96-97.

<sup>1988</sup> Torrey. *Foundations*, p. 108.

end Christianity], kill swine [i.e. Jews (*K* 002:065-066; 005:060; 007:166)] and abolish *Jizya* [i.e. everyone will be *Muslims*, so no one will be left to pay the poll tax on non-*Muslims*]. *Allah* will perish all religions except *Islam*. He will destroy the Antichrist [*Dajjal*] and will live on the earth for forty years and then he will die. The *Muslims* will pray over him.<sup>1989</sup>

Christians might think that the **drops** of water on Christ's head would refer to a picture *Muhammad* saw of the baptism in the Jordan, or sweating drops of blood in the Garden of *Gethsemane*. Another tradition however relates that *Muhammad* saw Christ's head dripping with water between "two men." Guillaume wrote that this "presumably refers to the two thieves on the cross."<sup>1990</sup>

Another instance of a phony character in the *Koran* is *Gabriel*. The Biblical *Gabriel* is comforting and when he appears to humans, he says "Fear not" (*Dan* 08:16-18; 09:21-23; *Luk* 01:11-20; 26-38).

The real *Gabriel* is nothing like the *Koranic Gabriel* who gave *Muhammad* several of his revelations. *Ibn Ishaq*, *Muhammad's* biographer, said that after *Gabriel's* first visit, *Muhammad* thought that he might be possessed by a demon.<sup>1991</sup> Norman L. Geisler wrote about *Muhammad's* initial call:

During his call he [*Muhammad*] was choked by an angel. *Muhammad* himself said of the angel, 'He choked me with the cloth until I believed I should die. Then he released me and said 'Recite!' (*Iqra*).' When he [*Muhammad*] hesitated, he received 'twice again the repeated harsh treatment.'<sup>1992</sup>

All of the *Koranic* characters are as phony as the Prophet *Muhammad* himself.

Sometimes Christians are asked where is the harm in accepting *Muhammad* as yet one more prophet. Knowledgeable Christians would rather think of *Muhammad* as a false prophet but *Muhammad* never produced one unambiguous prophecy. So, technically, *Muhammad* is better characterized first as a false teacher than as a false prophet.

Significantly, though early *Muslims* manufactured many traditions making *Muhammad* into a *Shaman* miracle worker, the cupboards are mostly bare when it comes to traditions making *Muhammad* into a prophet.

There is only one prophecy in the *Koran* of any note. *Muhammad* said that the Byzantines would defeat the Persians (*K* 030:003). Because the original *Koran* had no vowels, the Arabic word for "defeat" could have been rendered "be defeated."

The only difference between the Arabic for "defeat" (*Sayaghlibuna*) and "be defeated" (*Sayughlabuna*) is two vowels (a > u and i > a). So basically *Muhammad* left the scribes a "Fill in the Blanks" prophecy. Depending on how history turned out, the copyists would fill in "a" and "i" or "u and "a."<sup>1993</sup> Incidentally, the lack of vowels affects the *Hadiths* too—as we read in *Sahih Bukhari*:

*Allah* held back the killing from *Mekka*. (The sub-narrator is in doubt whether the Prophet said 'elephant or killing,' as the Arabic words standing for these words have great similarity in shape) (*Sahih Bukhari*, v. 1, bk. 3, no. 112).

<sup>1989</sup> *Sunan Abu-Dawud*, "Bk. 37: Battles (*Kitab Al Malahim*)," no. 4310. See also *Sahih Bukhari*, vol. 3, bk. 34, no. 425; vol. 3, bk. 43, no. 656; vol. 4, bk. 55, no. 657; *Sahih Muslim*, bk. 001, nos. 0287, 0289.

<sup>1990</sup> *Ishaq. Sirat*, p. xliii.

<sup>1991</sup> *Ishaq. Sirat*, p. 106.

<sup>1992</sup> Geisler & Saleeb. *Answering*, p. 154.

<sup>1993</sup> Shamoun, Sam. "Muhammad's False Prophecies," *Answeringislam*, accessed 24 Nov 2003.

In passing, *Muhammad's* prophecy about the duel between the Byzantine and Persian Empires was not any better than the oracle that the last king of *Lydia*, Croesus, received from *Delphi*. The oracle said that a great empire would fall during the coming battle.

Croesus assumed the oracle meant Persia but Croesus found out too late that the oracle meant *Lydia* instead. *Muhammad's* prophecy, when written out, could also have been read and interpreted either way. Of course, according to *Muslims*, *Muhammad* was sub-literate, so he did not know this was the case, and his amanuenses did not tell him either.

*Muhammad* was not a miracle-worker either. The miracles contained in the traditions read like mere folklore, and the only miracle of note mentioned in the *Koran* is the Splitting of the Moon (*K* 054:001—discussed elsewhere in this book).

The Splitting of the Moon may have occurred while *Muhammad* was at *Makka*, but some think the Splitting of the Moon is a prophecy of the End Times, which interpretation is convenient for *Islam* since it cannot then be verified for accuracy.

*Muhammad* did only one miracle—the Split Moon illusion—which can be enjoyed by anyone who drinks enough Jack Daniels whiskey to start seeing double. Since none of the many eager skywatchers of the sixth century reported seeing this phenomenon, we beg to doubt its validity.

So it would be better to say that *Muhammad* was a false teacher rather than a false prophet or false miracle worker (*Mat* 07:22). Because of fourteen centuries of usage however this book will sometimes refer to the Prophet *Muhammad* anyway.

Christians cannot accept *Muhammad* as a prophet. Doing so would mean rejecting the God-man Jesus of the Bible and accepting *Isa*, the fictitious personage described in the *Koran*. Moreover, accepting *Muhammad* as prophet would mean accepting the *Koran* as true scripture.

Accepting *Muhammad* as prophet would mean accepting all the other prophets mentioned in the *Koran*, prophets not mentioned in scripture. There are still more prophets mentioned in *Islamic* tradition, such as the “whole series of prophets, numbering hundreds [that] is said to have been buried round the *Kaaba*.”<sup>1994</sup>

Besides, why should Christians accept *Muhammad* as yet one more prophet of the Old Testament variety, when *Muhammad* did not accept other prophets on the Arabian Peninsula? *Muhammad* and his followers put to death all other moon-god prophets who dared to be *Muhammad's* equal—such as:

• *Al Aswad*.<sup>1995</sup>

• The prophetess *Sajah* of *Tamim*.<sup>1996</sup>

• *Maslama* (died 633 AD/12 AH). Not only did *Muslims* kill him but *Muslims* also gave *Maslama* the nickname *Musaylima*, meaning “The Liar.”

What is ironic is one of the proofs that *Muslims* fabricated to prove that *Muhammad* is a true prophet is that “No *Ismaili* has ever claimed prophethood falsely.”<sup>1997</sup> Evidently this saying was invented because the *Koran* contains no accounts of false prophets. I wonder why! Anyway, we are supposed to believe that for thousands of years no Arab ever claimed prophethood falsely, yet within *Muhammad's* lifetime he had to kill three impostor prophets! Hmm.

<sup>1994</sup> Gibb & Kramers. *Encyclopedia*, p. 197, *Kab'ah* entry.

<sup>1995</sup> Ishaq. *Sirat*, p. 648.

<sup>1996</sup> Lings. *Sources*, p. 336.

<sup>1997</sup> Ishaq. *Sirat*, p. 195.

*Muhammad* was an equal opportunity killer. He made no distinction between anyone who did not submit to him, including false prophets, wordsmiths, apostates and blasphemers.

*Muhammad* wanted anyone who fought against or proselytized *Muslims* to be: 1) killed or crucified, 2) have a hand and a foot on opposite sides amputated or 3) be banished (K 005:033). A few lines of poetry were enough to deserve the death sentence, according to *Muhammad*. *Muhammad* ordered these wordsmiths killed or later approved of their murders:

<b>Some Wordsmiths That <i>Muhammad</i> Had Assassinated or Later Approved of Their Assassination</b>
“Barbarism begins her reign by banishing the Muses”—Philip Dormer Stanhope, Earl of Chesterfield, 1749.
The <i>Koran</i> promises hellfire for those who mock <i>Muhammad</i> and <i>Islam</i> (K 003:186; 009:061-063; 033:057, 059-061). Based on <i>Koran</i> , <i>Hadith</i> and <i>Sira</i> , <i>Hanbali</i> jurist Taqi <i>Al-Din Ibn</i> Taymiya (1268-1328 AD) wrote that civilians can be killed even if they only bolstered the enemy’s morale by their words. <sup>1998</sup> Taymiya is Osama <i>Bin</i> Laden’s favorite theologian.
<i>Abdullah Ibn</i> Sa’d <i>Ibn</i> <i>Abi</i> Sarh, who was an amanuensis for <i>Muhammad</i> . Sarh used to suggest improvements in the wording of the <i>Koran</i> of which <i>Muhammad</i> approved. <i>Abi</i> Sarh apostatized after realizing that the <i>Koran</i> was a collaborative effort that was not divinely inspired since <i>Abi</i> Sarh knew that <i>Muhammad</i> was not inspired. He fled from <i>Madina</i> to <i>Makka</i> and was one of the ten people whom <i>Muhammad</i> ordered killed when he conquered <i>Makka</i> but the order was not carried out—to <i>Muhammad</i> ’s chagrin. <sup>1999 2000</sup>
The <i>Makkan</i> On-Nadr <i>b. ol-</i> Hareth, who told better tales than <i>Muhammad</i> did. <sup>2001</sup>
<i>Muhammad</i> said “Kill any Jew that falls into your power,” <sup>2002</sup> and “Who will deal with Ebn <i>ol-</i> Ashraf for me?” <sup>2003</sup> Thereupon, <i>Muslims</i> went out and killed eighty non- <i>Muslims</i> , included the <i>Madinan</i> half-Jewish poet, Kab <i>Ibn</i> <i>Al-</i> Ashraf. <sup>2004</sup> Kab wrote romantic poetry to <i>Muslim</i> women. <sup>2005</sup> In <i>Islam</i> , it is a big no-no for non- <i>Muslims</i> men to serenade <i>Muslim</i> women since non- <i>Muslim</i> men cannot marry <i>Muslim</i> women but <i>Muslim</i> men may marry infidel women (K 002:221; 060:010-011). Ka’b also wrote poetry urging the <i>Kuraish</i> to take revenge on <i>Muslims</i> over the Battle of <i>Badr</i> , as well as poems satirizing <i>Muhammad</i> and his Companions. <sup>2006</sup> The assassins brought the poet’s severed head to <i>Muhammad</i> . <sup>2007</sup> When Jews complained that one of their leaders had been lured and assassinated

<sup>1998</sup> Spencer, Robert (quotes provided by Andrew Bostom). “Two Bus Bombs in Southern Israel Kill 15,” *JW*, 31 Aug 2004.

<sup>1999</sup> Ishaq. *Sirat*, p. 550.

<sup>2000</sup> Thomas, G. “*Muhammad*, the *Quran*, and *Abdullah Ibn* Sa’d *Ibn* *Abi* Sarh,” AnsweringIslam.org, accessed 25 Nov 2003.

<sup>2001</sup> Dashti. *23 Years*, pp. 97-98.

<sup>2002</sup> Ishaq. *Sirat*, p. 369. The account is also found in *El badiyah wa alnihay-Ibn* *Katheer*, vol. 4: the chapter on killing Ka’ab *Bin* *Al’*Ashraf.

<sup>2003</sup> Dashti. *23 Years*, p. 99.

<sup>2004</sup> Warraq. *Quest*, p. 542, as quoted by Schmidt. *Divide*, p. 17.

<sup>2005</sup> Dashti. *23 Years*, p. 99.

<sup>2006</sup> Lings. *Sources*, p. 171.

<sup>2007</sup> Tabari VII:97; Ishaq. *Sirat*, p. 368.

by deceit, *Muhammad* said:

If he had remained as others of like opinion remain [i.e. silent]...he would not have been killed by guile. But he did us injury and wrote poetry against us; and none of you shall do this but he shall be put to the sword.<sup>2008</sup>

In 2006 Osama *bin* Ladin urged *Muslims* to kill all freethinkers who made light of *Islam* or *Muhammad* since he deemed them to be heretics and apostates. *Bin* Ladin said ““Take an example from *Muhammad ibn* Maslama and his companions’ who assassinated the poet Ka’b *ibn* Al-Ashraf.”<sup>2009</sup>

*Muhammad* said “Who will deal with this rascal for me?” regarding the *Madinan* lampooner *Abu* ‘Afak, who was said to be 120 years old.<sup>2010</sup>

*Muhammad* said “Who will rid me of Marwan’s daughter?”<sup>2011</sup> She was the *Madinan* poetess *Asma b.* Marwan, who was a mother of five sons,<sup>2012 2013</sup> who wrote verse criticizing the assassination of the 120-year-old lampooner. After she was killed, *Muhammad* told the assassin that nothing would come of it: “Two goats won’t butt their heads about her.”<sup>2014</sup>

The *Makkan* duo, *Fartana* and *Qariba*, who were lyric writers and singers from *Makka*.<sup>2015</sup>

A *Makkan* one-eyed shepherd who sang: “I won’t be a *Muslim* as long as I live, nor heed to their religion give.” ‘*Amr b.* *Umayya* stuck the end of his archery bow into the shepherd’s brain through his good eye, for which deed *Muhammad* blessed his disciple.<sup>2016</sup>

A blind master killed a concubine who had given him two sons. He claimed she had disparaged *Muhammad*. *Muhammad* approved of the murder and said that no retaliation was called for.<sup>2017</sup>

One can assume that moon-god prophets in South Arabia produced their own scripture just as *Muhammad* did. The moon-god prophets that *Muslims* killed were *Al* *Aswad*,<sup>2018</sup> the prophetess *Sajah* of *Tamim*, and *Maslama* (died 633 AD/12 AH) whom *Muslims* nicknamed *Musaylima*, meaning “The Liar.”<sup>2019</sup>

In keeping with *Muhammad*’s example, *Sunni Muslims* fight sects that spin-off from *Islam* that often have their own exalted personages, for instance:

- ☉ *Shias* with their hidden *Imam*, *Muhammad Al-Mahdi*, the Guided One.
- ☉ *Bahais* with their teacher *Baha’u’llah* (1817-1892 AD).
- ☉ *Ahmadiyah* sect with their prophet *Mirza Ghulam Ahmad* (1835-1908 AD).

Some modern *Muslims* try to excuse *Muhammad*’s purges and repression of free speech rights by saying that Arabs thought the poets were inspired by muses.

<sup>2008</sup> Lings. *Sources*, p. 171.

<sup>2009</sup> “Arab Reformists Under Threat by *Islamists*” memri.org, 3 May 2006, No. 1153, *JW*.

<sup>2010</sup> 120 years old: *Dashti. 23 Years*, p. 100; doesn’t mention age: *Ishaq. Sirat*, pp. 675-676.

<sup>2011</sup> *Ishaq. Sirat*, pp. 675-676.

<sup>2012</sup> *Dashti. 23 Years*, pp. 98, 100.

<sup>2013</sup> *Ishaq. Sirat*, pp. 675-676.

<sup>2014</sup> *Ishaq. Sirat*, p. 676.

<sup>2015</sup> *Dashti. 23 Years*, pp. 98, 100.

<sup>2016</sup> *Ishaq. Sirat*, pp. 674-675.

<sup>2017</sup> *Sunan of Abu Dawud*, vol. 6, bk. 38, no. 4348; see also Silas. “Murdering *Islam*’s Critics: The Female Slaves and Theo Van Gogh,” answering-*Islam.org*, 23 Nov 2004.

<sup>2018</sup> *Ishaq. Sirat*, p. 648.

<sup>2019</sup> Lings. *Sources*, p. 336.



*Muhammad* however only said that the poets were liars and it seems there is no record of his connecting them to the spirit world (K 026:223).

*Islamic* history shows that the poets *Muhammad* had killed made no pretense about being inspired. Their only “crime” was that they wrote a few lines of satire or doggerel about *Muhammad* when *Muhammad* very well deserved to be ridiculed. They seem not to have been killed for telling lies about *Muhammad* but for telling the truth. When the truth is so awful, why bother with lies?!

*Muhammad*’s example of killing poets and authors has been followed these last fourteen centuries and has had a powerful chilling effect on free speech, whether by *Muslims* or non-*Muslims*. Lately, this practice has been called “[Salman] *Rushdie* Rules...whereby anyone critical of *Islam* or *Islamism* is liable to be fined, jailed or perhaps threatened with death.”<sup>2020 2021</sup>

Though the traditions do not mention it, judging from the many mistakes in the *Koran*, *Muhammad* must have killed all would-be fact checkers too. For instance, *Muhammad* may have killed:

- ☉ Christians merely because they told him that Mary was not a member of the Trinity, as *Muhammad* claimed (K 004:169; 005:077, 116).
- ☉ Jews because they dared to tell *Muhammad* that they did not worship Ezra as a Son of God, as *Muhammad* claimed (K 009:030).

### Claims to Moral Superiority

*Muslims* are constantly referring to the West and Hollywood as very immoral. *Muslims* consider Christianity guilty by association, or fault Christianity for not having religious police on smut and vice patrol.

A look at crime and morality statistics does not paint such a rosy picture of the Mideast. Most of the crime and vice rampant in the West are also found in the Mideast in comparable or even greater measure—but perhaps out of sight.

Also, there are many behaviors that are legal or only frowned upon in much of *Islamdom* that are not known or are criminalized in much of the West. These include automatic weapon- (e.g. AK-47) and grenade-possession, drug abuse (e.g. marijuana, qat), honor-killings, polygyny, temporary marriage, FGM and child marriage. An example of weaponry and drug use comes from *Yemen* where...

...hand grenades are laid out alongside fresh produce at street-side markets and sources estimate that there are at least 10 million guns in circulation in a country with a population of 20 million. Social life revolves around qat, a leafy, reddish-green plant that contains amphetamine-like substances. Eighty per cent of adult men in *Yemen* chew regularly...The leaf combines the talkative affability of pot with the drive of speed. First comes euphoria and intense sociability—not ponderous, marijuana-induced ramblings, but a deep appreciation of the flow of conversation. In this stage, five hours can pass in what seems like 10 minutes...The final stage is depression and insomnia—it’s not uncommon to see solitary cloaked figures roaming the streets at night, waiting for the effects of the drug to pass. On average, *Yemeni* men spend about a third of their income on qat and commerce in the leaf accounts for a third of the nation’s GNP.<sup>2022</sup>

<sup>2020</sup> Elst, Koenraad. “The Rushdie Rules,” Jun 1998, vol. V, no. 2, meforum.org/article/395.

<sup>2021</sup> Pipes, Daniel. “An American Rushdie?” jpost.com, 4 Jul 2001.

<sup>2022</sup> My bloody career, *The Guardian*, observer.guardian.co.uk, 23 Apr 2006.

Child marriage, a.k.a. legalized molestation, is all-too-common in *Islamdom*, even between senior men and preadolescent girls as young as nine.<sup>2023 2024 2025</sup> Similar child abuse does occur outside of *Islamdom* but probably not on the same scale. Moreover, except for weird cults, none in the West say child marriage and temporary marriages have God's blessing or that God excuses such things.

*Islam* asserts that child marriage comes directly from God the Creator. But any God who had actually created womankind would know that girls should not risk pregnancy before they are 18 because their pelvises are too small. They are risking four-day labors—frequently ending in death agony—or fistulas that will cause them to leak and reek for the rest of their short and miserable lives.

No *Muslim* can condemn child marriages and polygyny because *Muhammad* engaged in these activities and sanctioned them in the *Koran* and *Hadiths*. This warped morality is exactly what one could expect would be spawned by a Judeo-pagan moon-god worshipping prophet.

While *Muslims* are very judgmental about sin and crime in the West to the point of rejoicing whenever the West suffers a terrorist attack, *Muslims* are non-judgmental about similar behavior in the Mideast.

One reason for the double standard is that war, temporary marriage (legalized prostitution), quick divorce, slavery, sex-slaves and such, are all found in the *Koran* and the traditions. Thus *Muslims* need not be concerned about their morality as long as everything is done in accordance with the *Koran*-based *Sharia* law.

According to the double standard however it is utterly inexcusable for the West to engage in a Holy War, plain-old war or in the slave trade. For the West to have a high divorce rate and legalized prostitution (Europe and Nevada) is morally reprehensible because the West does not follow the *Koran* and *Sharia* law.

In *Islamic* society, divorce is arguably the third most disruptive behavior after *Jihad* Holy War and terrorism. For the last fourteen hundred years, *Muslim* men have been able to divorce their wives merely by saying the word *Talaq* three times. So it is not surprising to read that in Singapore:

*Muslim* divorces are at an all-time high, with about 35 per cent, or more than three in ten marriages, breaking up within the first five years. ... Also, of *Muslims* who remarry after a first divorce, some 34 per cent go through a second divorce, compared with about 12 per cent of non-*Muslims*.<sup>2026</sup>

*Muhammad's* example in matters of marriage is, as in everything else, utterly contemptible. *Muhammad* had twenty-three sex partners and during one month he refused to have sex with any of them.<sup>2027</sup> He also threatened to divorce all his wives if they did not do his bidding (*K* 066:001-005). *Muhammad* also wanted to divorce one particular wife Sawda but struck a bargain where he would not divorce her as long as she did not complain about not having sex ever again.<sup>2028</sup>

Another big complaint that *Muslims* make in their finger-pointing *Islam*-screeds is that homosexuals in the West flaunt their gay lifestyle. In the Mideast however there is just as much same-sex copulation, but the homosexuals in the Mideast must merely claim to be bisexual to avoid the wrath of the religious authorities.

<sup>2023</sup> Pipes, Daniel. "Pasha Bordello Accepts Islamist Demands," *DP*, 25 Apr 2006.

<sup>2024</sup> Hughes, Donna M. "Sex Slave Jihad," *FPM*, 27 Jan 2004.

<sup>2025</sup> Pipes, Daniel. "Arabian Sex Tourism," *DP*, 7 Oct 2005. *FPM*.

<sup>2026</sup> Zainol, Vivi & Chai Hung Yin. "Muslim divorces," *Straits Times*, 2 Jul 2004.

<sup>2027</sup> Lings. *Sources*, p. 279.

<sup>2028</sup> Dashti. *Career*, p. 123.

Even President-for-life Arafat took advantage of this bisexual legal loophole. Arafat had a wife who converted to *Islam*, but she “had been estranged from him more or less since they were married.”<sup>2029</sup>

Arafat was known to be bisexual due to his bedroom romps with guards.<sup>2030</sup> Arafat died in 2004 of opportunistic infections that took over once AIDS ravaged his immune system. Arafat’s personal doctor said his blood was HIV positive, but hastened to add that the AIDS virus was introduced along with a lethal poison in order to camouflage the poison.<sup>2031</sup>

Arafat had a low blood platelet count, a weak immune system, extreme weight loss, blotches on face and hands and intermittent mental dysfunction—all common symptoms during the final stage of AIDS.<sup>2032 2033</sup>

The blotches on Arafat’s face and hands were probably Epidemic Kaposi Sarcoma (KS), which is caused by the interaction of the HIV virus, immune system suppression and human Herpes Virus-8.<sup>2034</sup>

Epidemic-KS is considered an “AIDS-defining condition” since Classic-KS, i.e. cases not related to AIDS, are rare. Classic-KS occurs in some elderly Italian and Jewish men and rarely afflicts more than their lower legs.<sup>2035</sup> Arafat was neither Italian nor Jewish and his KS probably afflicted his entire body.

In the final weeks of Arafat’s life, he complained of a fever and stomach flu and experienced noticeable weight loss. KS causes unexplained fever and weight loss<sup>2036</sup> and KS lesions affect the lymph nodes, gastrointestinal tract, lung, liver and spleen.

*Haaretz* reported about Arafat’s illness:

Prof. Gil Lugassi, president of the *Israel* Hematologists Association who read the French report, said that the symptoms described could be typical of AIDS. ‘An infection that begins in the digestive system and deteriorates so quickly into the collapse of the clotting system is typical of AIDS,’ he says.<sup>2037</sup>

Significantly, the permissive attitude toward bisexuality pertains even to the wives of *Saudi* princes, as Osama *Bin Laden*’s former sister-in-law wrote:

While *Saudi* princes rake off billions in business kickbacks, their neglected and depressed wives abuse drugs, drown their sorrows in extravagant shopping sprees and turn to lesbian affairs for comfort. Many of them have bone density problems because they never go outside or exercise. When their husbands divorce them, they may never see their children again. The *Bin Laden* women ‘did nothing, read nothing and were like pets kept by their husbands,’ she writes. They were fanatically religious.<sup>2038</sup>

The Christian West in general frowned on and even criminalized sodomy. When Victorian-era elite wanted to experiment sexually, they had to go to *Muslim* lands.

<sup>2029</sup> Glick, Caroline. “Column One: Plus a change?,” jpost.com, 12 Nov 2004.

<sup>2030</sup> Pipes, Daniel. “Arafat’s Bedroom Farce,” 10 Nov 2004; “The MSM (‘Mainstream Media’) on the Cause of Arafat’s Death,” danielpipes.com, 18 Nov 2004.

<sup>2031</sup> Harel, Amos & Yoav Stern. “FM Shalom denies any Israeli interference in Arafat’s death,” haaretz.com, 8 Sep 2005.

<sup>2032</sup> Isacharoff, Avi & Amos Harel. “The final days of Yasser Arafat,” haaretz.com, 8 Sep 2005.

<sup>2033</sup> “Homosexual Arafat said dying of AIDS,” *Jerusalem Newswire*, jnewswire.com, 7 Nov 2004.

<sup>2034</sup> “Kaposi’s sarcoma,” Library of Medicine & Institutes of Health, nlm.nih.gov, 12 Aug 2004.

<sup>2035</sup> What Is Kaposi Sarcoma? American Cancer Society, cancer.org, 16 Sep 2005.

<sup>2036</sup> What Is Kaposi Sarcoma? American Cancer Society, cancer.org, 16 Sep 2005.

<sup>2037</sup> Harel, Amos. “Medical experts: Arafat died of AIDS or poisoning,” haaretz.com, 8 Sep 2005.

<sup>2038</sup> Wente, Margaret. “Inside the House of *Bin Laden*,” theglobeandmail.com, 22 Jul 2004, p. A15, *DW*, 26 Jul 2004.

Richard Burton wrote in his terminal essay that the European elite especially, vacationed in *Islamic* lands specifically to experiment in the sexual perversions that were rampant.<sup>2039 2040 2041</sup> Stephen Murray, Will Roscoe and others confirm this.

To the shock and dismay of many Victorians, many amoral Europeans spent their vacations romping their way through North Africa and the Mideast. The escapaders felt that Victorian Europe and America were way too prudish about vice.<sup>2042 2043</sup> Even today homosexuality in the West remains at about one percent of the population, despite the pseudo-statistics offered by pro-homosexual groups.

One hard statistic about homosexuality in the West comes courtesy of 9/11. There were about 2,797 persons murdered by *Islam*-fascist terrorists at the New York World Trade Center. There were only twenty-four compensation claims by same-sex partners, though claimants stood the chance of receiving substantial awards.<sup>2044</sup> This means that less than one percent of the victims were homosexual. New York City is a large metropolitan area where one might expect a higher concentration of homosexuals, so the fact that there was only one percent means New York compares favorably to large cities in the *Islamic* world.

### Endless Moral Equivalency *Tu Quoque* (You do it too!) Claims

*Muslims* like to brush over historical and modern crimes of *Jihad*. After all, *Jihad* is a tenet of *Islam*, so how could *Jihad* be wrong or criminal? *Muslims* like to counter any criticisms about *Jihad* with accusations about the Crusades. They shrink the significance of the many millions of *Jihad*-related deaths and exaggerate the criminal follies of the Crusaders until they fit on two sides of the same coin.

The Crusades however were a relatively minor affair that lasted a few centuries, and were generally located in and around the Holy Land. *Jihad*, in contrast, has gone on for fourteen centuries, in an area from Spain to the Philippines. So comparing *Jihad* to the Crusades is like comparing watermelons to oranges.

The Crusades are discussed elsewhere in this book. Here however it is sufficient to point out that Christianity has a few pages of history that we are not entirely proud of. Those few pages are uncharacteristic of the Church and are not comparable to the volumes that are necessary to document *Islam*'s evil history. Besides, evil history is entirely characteristic of *Islam* and is in keeping with *Islam*'s dictates as found in the *Koran* and *Hadiths*.

The same could be said about the roll call of terrorists and suicide-bombers. The Christian list of terrorists is very short, but one thick tome could not contain the names of all the *Muslim* terrorists, much less their accomplices.

In fact, in a telling memo leaked to the press, US Defense Secretary Donald Rumsfeld wonders whether the Defense Department can actually counter all the many terrorists that *Imams* produce. That's saying a lot! Rumsfeld wrote:

Today, we lack metrics to know if we are winning or losing the global War on Terror. Are we capturing, killing or deterring and dissuading more terrorists every day than the *Madrasas* and the radical clerics are recruiting, training and

---

<sup>2039</sup> Burton. *Essay*.

<sup>2040</sup> Trifkovic, Serge. "Islam's Love-Hate Relationship with Homosexuality," *FPM*, 24 Jan 2003.

<sup>2041</sup> Murray. *Culture*,

<sup>2042</sup> Murray. *Culture*, pp. 204-221.

<sup>2043</sup> Burton. *Essay*.

<sup>2044</sup> Raab, Barbara, "Same-sex partners face discrimination: Unique legal, emotional troubles for gay survivors," *NBC News*, [msnbc.com/news/675127.asp](http://msnbc.com/news/675127.asp), 20 Dec 2001.

deploying against us?...The cost-benefit ratio is against us! Our cost is billions against the terrorists' costs of millions...How do we stop those who are financing the radical *Madrasa* schools? Is our current situation such that 'the harder we work, the behinder we get'?'<sup>2045</sup>

Rumsfeld is right. The US spent about 100 billion USD per year for three years policing and reconstructing *Iraq*, while the *Al-Qaeda* franchise claims its budget for the *Iraqi* insurgency is 11.45 million US per year—much of it coming from ransoms, donations by supporters, the black market and protection money paid by *Muslim* governments.<sup>2046</sup>

A reason the *Al-Qaeda* franchise spends only one dollar on *Iraq* for every 8,734 USD the US spends<sup>2047</sup> is that threats, bullets, matches and improvised explosive devices (IEDs) do not cost as much as building schools and roads, paying the salaries of officials and teachers, paying for the hospitalization of bombing victims. For instance, in 2005 and early 2006, fifteen schools were torched in one area of *Afghanistan* and another 200 were closed in a few provinces due to threats.<sup>2048 2049</sup> In mid-2006 a medical clinic was burned to the ground in southern *Afghanistan*.<sup>2050</sup>

Rumsfeld also took some flack from simpleton liberals for stating the obvious: "We are in a war of ideas as well as [in] a global War on Terror."<sup>2051</sup> Later in 2004 Rumsfeld admitted that it was "quite clear" that "we do not have a coherent approach to this [War on Terror]."<sup>2052</sup>

*Muslims* like to bring out their big moral cannons and say that the Christians murdered more people than *Islam* ever did. However, the World Wars and the Holocaust were not really about religion. Europe was already well into its post-Christian era by the time of the World Wars. Religion was passé and nationalism, Darwinian evolutionism, Nietzschean philosophy and other "isms" reigned supreme. Moreover, Hitler and other German leaders had been desensitized to suffering and death by the trenches of WWI, witnessing the Armenian massacre and various wars.

Hitler's goal behind the Holocaust was to speed up human evolution by weeding out whomever pseudo-scientists, e.g. eugenicists, said were inferior—leaving only blue-eye, blond-hair *Aryans*.

Hitler specifically criticized **Christians** for their charity efforts since it hindered the selection of the fittest. Paul Humber wrote:

In *Mein Kampf*, Hitler used the German word for evolution (*Entwicklung*) many times, citing 'lower human types.' He criticized the Jews for bringing 'Negroes into the Rhineland' with the aim of 'ruining the white race by the necessarily resulting -ization.' He spoke of 'Monstrosities halfway between man and ape' and lamented the fact of **Christians** going to 'Central Africa' to set up 'Negro missions,' resulting in the turning of 'healthy...human beings into a rotten brood...' In his chapter entitled "Nation and Race," he said "The stronger

<sup>2045</sup> Rumsfeld, D. "Memo: Subject: Global War on Terrorism," [globalsecurity.org](http://globalsecurity.org), 16 Oct 2003.

<sup>2046</sup> Mahnaimi, Uzi. "Qatar buys off *Al-Qaeda* attacks with oil millions," [timesonline.co.uk](http://timesonline.co.uk), 1 May 2005, *LGF*.

<sup>2047</sup> Henderson, Charles. "The 300 Billion Dollar Error," [about.com](http://about.com), accessed 30 Apr 2005.

<sup>2048</sup> "Afghanistan: Militants set fire to a school in...*Helmand*," [alertnet.org](http://alertnet.org), 21 Feb 2006, C&R.

<sup>2049</sup> "*Taliban* militants burn down three *Afghan* schools," [reuters.com](http://reuters.com), 28 Jan 2006, C&R.

<sup>2050</sup> "International Medical Corps clinic burned down in southern *Afghanistan*," International Medical Corps, [alertnet.org](http://alertnet.org), 30 Jun 2006, *JW*.

<sup>2051</sup> Spencer, Robert. "The Vatican's New Realism About *Islam*," *FPM*, 31 Oct 2003.

<sup>2052</sup> "Rumsfeld Fears Losing War On *Islamic* Extremism," [wtov9.com](http://wtov9.com), 5 Jun 2004.

must dominate and not blend with the weaker, thus sacrificing his own greatness. Only the born weakling can view this as cruel, but he, after all, is only a weak and limited man; for if this law did not prevail, any conceivable higher development (*Hoherentwicklung*) of organic living beings would be unthinkable.’ A few pages later, he said ‘Those who want to live, let them fight, and those who do not want to fight in this world of eternal struggle do not deserve to live.’<sup>2053</sup>

Dr. D. James Kennedy wrote:

Hitler exterminated over 273,000 people even before the Holocaust! ‘The first to be killed were the aged,’ the infirm, the senile, the mentally retarded and defective children [straight-talk note: including epileptics]. Then there were WW I veterans—amputees—still in hospitals. Their reward for giving an arm or leg for Germany was extermination as ‘undesirable.’ Even bed wetters and children with badly modeled ears were put to death—all part of the euthanasia project of Germany.<sup>2054</sup>

Darwin was the inspiration for Malthusian events such as the Holocaust. He wrote:

At some future period, not very distant as measured by centuries, the civilized races of man will almost certainly exterminate and replace the savage races throughout the world. At the same time the anthropomorphous apes...will no doubt be exterminated. The break between man and his nearest allies will then be wider, for it will intervene between man in a more civilized state, as we may hope, even than the Caucasian and some ape as low as a baboon, instead of as now between the Negro or Australian [Aborigine] and the gorilla.<sup>2055</sup>

Natural Selection as affecting civilized nations...With savages, the weak in body or mind are soon eliminated; and those that survive commonly exhibit a vigorous state of health. We civilized men, on the other hand, do our utmost to check the process of elimination; we build asylums for the imbecile, the maimed and the sick; we institute poor-laws; and our medical men exert their utmost skill to save the life of every one to the last moment. There is reason to believe that vaccination has preserved thousands, who from a weak constitution would formerly have succumbed to smallpox. Thus the weak members of civilized societies propagate their kind. No one who has attended to the breeding of domestic animals will doubt that this must be highly injurious to the race of man. It is surprising how soon a want of care, or care wrongly directed, leads to the degeneration of a domestic race; but excepting in the case of man himself, hardly any one is so ignorant as to allow his worst animals to breed.<sup>2056</sup>

Despite the commonly repeated canard, very few Bible-believing Christians were involved in the holocaust, or knew about the ongoing holocaust. If the general public had an inkling of what was happening, it is inconceivable that so many Jews would have naïvely boarded trains expecting to be “relocated” to some safe haven as some of them were led to believe.

<sup>2053</sup> Humber, Paul G. “The Ascent of Racism,” as quoted at “Hitler used Evolutionary Theory to Justify the Holocaust,” [straight-talk.net/evolution/hit.htm](http://straight-talk.net/evolution/hit.htm), accessed 18 Feb 2006.

<sup>2054</sup> Kennedy, Dr. D. James. “All They That Hate Me Love Death,” sermon transcript, Coral Ridge Ministries, Fort Lauderdale, Florida, as quoted at “Hitler used Evolutionary Theory to Justify the Holocaust,” [straight-talk.net/evolution/hit.htm](http://straight-talk.net/evolution/hit.htm), accessed 18 Feb 2006.

<sup>2055</sup> Darwin, Charles. *The Descent of Man*, 2nd ed. A.L. Burt, New York, 1874, p. 178.

<sup>2056</sup> Darwin, Charles. *The Descent of Man*, 2<sup>nd</sup> ed., 1874, pp. 138-139.

If there were rumors of the Holocaust, the public would not have believed them to be true because many erroneously thought of Hitler as being a Catholic. If they had known that Hitler rejected Christianity and was an ardent neo-pagan and evolutionist, then they would suspect the rumors to be true.

The same is the case with Stalin. He was a thoroughgoing evolutionist who ordered scientists to impregnate women with ape sperm to create ape-men warriors who would not complain of hardships. The experiment failed, needless to say.<sup>2057</sup> Once one knows this, one can easily conceive of Stalin having ordered the killing of many millions of people whom he obviously considered to be glorified apes.

One reason the *Nazis* did not want the public to know about the death camps is Christians were on the *Nazi*'s hit list—just not at the top. Ann Coulter wrote:

Hitler denounced Christianity as an ‘invention of the Jew’ and vowed that the ‘organized lie (of Christianity) must be smashed’ so that the state would ‘remain the absolute master.’<sup>2058</sup>

Hitler said ‘Christianity is an invention of sick brains: one could imagine nothing more senseless.’<sup>2059</sup> The *Nazi*'s attitude toward Christianity is reflected in this Hitler Youth song:

We are the joyous Hitler Youth. We need no Christian virtue, for our leader is Adolph Hitler. He is our deliverer and intercessor. No Cleric, no evildoer can hinder us, for we consider ourselves Hitler-Children. Not Christ we follow, but Horst Wessel.<sup>2060</sup>

Jews, the infirm, Gypsies and various non-Nordic races were further up the *Nazi*'s hit list than Christians. Many Christian pastors and priests who tried to resist the *Nazis* were quickly rounded up and the dissenters died at concentration camps such as *Dachau*. Ann Coulter wrote:

For decades, *The New York Times* had allowed loose associations between *Nazis* and Christians to be made in its pages. Statements like these were not uncommon: ‘Did the *Nazi* crimes draw on Christian tradition?’... ‘the church is ‘co-responsible’ for the Holocaust’... ‘Pope Pius XII, who maintained diplomatic ties with Hitler,...’ Then out of the blue one day in 2002, *The New York Times* ran a prominent article describing the *Nazis*' virulent crusade against Christianity. That very week, evidence from the Nuremberg trials [1945-1946 AD] detailing *Nazis*' crusade against Christianity had been posted on the Internet.<sup>2061</sup>

Why would *The New York Times* report only negative information about Christianity? Even though communism has killed a hundred million people during the twentieth century<sup>2062</sup> and continues to kill people in the twenty-first century, *The New York Times* has always been known for its socialist bias, and for being soft on and sympathetic toward communists.

<sup>2057</sup> Stephen, Chris & Allan Hall. “Stalin’s half-man, half-ape super-warriors,” news.scotsman.com, 20 Dec 2005.

<sup>2058</sup> Coulter, Ann. “WWJK: Who Would Jesus Kill?” *FPM*, 11 Mar 2004.

<sup>2059</sup> *Hitler’s Table Talk 1941–1944*, Oxford University Press, 1953, pp. 118, 119.

<sup>2060</sup> Blackburn, Gilmer W. *Education in the Third Reich: Race and History in Nazi Textbooks*. State University of New York Press: Albany 1985, p. 85.

<sup>2061</sup> Coulter, Ann. *Slander: Liberal Lies about the American Right*. Crown Publishers, New York, 2002, pp. 114-115.

<sup>2062</sup> *The Black Book of Communism: Crimes, Terror, Repression*, as quoted by Reedy, Jeremiah. “The Black Book of Red Blood,” *FPM*, 8 Oct 2003.

*The New York Times* would rather think that Christianity is largely to blame for the Holocaust rather than totalitarian socialism. Christians are to blame even though the Nazis denied Germany's churches any influence on the state—which badly needed it.<sup>2063</sup> Yet, in *The New York Times*' opinion, Christians have somehow ruined every major socialist experiment and caused every communistic utopia to fail.

Even today *The New York Times* is “pining away for those wonderful days when a Soviet Union existed,”<sup>2064</sup> and continues in its smug contempt for conservatives. No one is expecting an apology anytime soon since *The New York Times* still has never fully apologized to anyone over its cover-up of how millions of Ukrainians (mostly Christian) starved during Joseph Stalin's man-made famine. Roger Kimball wrote:

With peasants dropping like flies everywhere around him, [*The New York Times*' correspondent in Moscow] Duranty cheerfully cabled back to New York that, although there were some occasional food shortages, there was ‘no actual starvation.’<sup>2065</sup>

Even worse, a reporter for the *Manchester Guardian*, Malcolm Muggeridge, was wrongfully vilified, abused, discredited and fired for reporting the truth about the Ukrainian genocide because “Duranty led the denunciations” of Muggeridge.<sup>2066</sup>

It may be true that Pope Pius XII could have done more to save Hitler's victims, which included millions of Christians. For that matter, so could the British, the French and Roosevelt, but they turned their backs even on the Jews whom Hitler wished to expel. Besides, the church's main job is to save souls, while the state's main job is to save lives. The states failed in their stated mission more so than the church.

Anyway, the very people who split hairs to separate *Islam* and the *Koran* from the mindset and depravities of *Islamist* terrorists—these *de facto* apologists for *Islam* are somehow incapable of doing the same favor for Christianity and the New Testament when delving into the idiosyncrasies of Christian history.

Self-proclaimed “objective” critics of religion can see the sliver in the Christian eye, but miss the log in the *Islamic* eye. Nevertheless, the clichés that all religions are the same, that the Bible is as violent as the *Koran*, and that Christians are as dangerous as *Muslims* are becoming more shopworn every day. Thanks to the *Jihadists* themselves, we look forward to the day when these clichés are recognized for the half-baked lies they have always been.

### What Really Happened at Makka

In brief, what happened at *Makka* is as follows. The Arabian Jews and Christians used the appellation “*Allah*” because it is a common Arab contraction meaning “the God.” *Muhammad* was a pagan would-be prophet of the *Makkan* moon-god, one of whose many titles happened to be *Allah*.

At *Makka Muhammad* got wind of the teachings of heretical Judaism and Christianity. *Muhammad* further distorted these teachings and incorporated them into

<sup>2063</sup> Ponte, Lowell. “The Art of Religious War,” *FPM*, 5 Dec 2003.

<sup>2064</sup> Radosh, Ronald. “*The New York Times*' Continuing Love Affair With Communism,” *FPM*, 22 Aug 2001.

<sup>2065</sup> Kimball, Roger. “Was Walter Duranty a Victim?” *New Criterion's Blog*, reprinted in *FPM*, 25 Nov 2003.

<sup>2066</sup> Gossett, Sherrie. “Telling the Truth About Ukraine,” *Accuracy in Media*, aim.org 24 Dec 2004, MichelleMalkin.com.



his native paganism. *Muhammad* purged his native religion of its polytheistic notions but left the rest largely intact. For instance, the perception of *Allah* being a lunar war-god was not discarded. Hans Kraus wrote:

...the main god, the national god of war...this is in all South Arabian, yes, nearly in all *Semitic* monuments, a sure identifying mark of the moon-god.<sup>2067</sup>

A straight reading of the *Koran* constitutes a strong indicator that *Allah* was a pre-*Islamic* war-and-moon-god.<sup>2068</sup> Moreover, the fact that *Allah* regulated warfare using his crescent-moon is another strong indicator that *Allah* was a pre-*Islamic* war-and-moon-god. During the sacred lunar months, fighting was not allowed unless out of necessity (*K* 009:005).

The crescent-moon divided the lunar months, of which four were sacred truce months when war and murder were supposed to cease. *Muhammad* retained these four sacred truce months intact and commanded that *Muslims* fight the polytheists during the other eight months. *Muhammad* said:

So when the sacred months have passed away, then slay the idolaters wherever you find them and take them captive and besiege them and lie in wait for them in every ambush (*K* 009:005).

Surely the number of months with *Allah* is twelve months in *Allah's* ordinance since the day when He created the heavens and the earth, of these four being sacred; that is the right reckoning; therefore be not unjust to yourselves regarding them, and fight the polytheists all together as they fight you all together; and know that *Allah* is with those who guard (against evil) (*K* 009:036).

The tradition of using the calendar to regulate warfare on an annual basis continued in *Islam*. For instance, the mid-tenth-century “*Cordoba* Calendar” “stated that 28 February was the date when officials started touring the country [*Andalusia*] looking for volunteers for that summer’s [war] campaigns.”<sup>2069</sup> The same calendar “stated that June was when government officials toured the country collecting deer and wild goat horn to make composite bows.”<sup>2070</sup>

Of further interest is the fact that in *Muslim* theology, the world is divided up between the Abode of War and the Abode of *Islam*, which suggests that *Allah* was a war-god and a moon-god.

To this very day *Allah* the lunar war-god impersonates *Yahveh* using the poor caricature of *Yahveh* found in the pages of the *Koran*. *Muslims* conspire with *Allah* to keep the ruse going. For instance, recently *Muslims* say that since Christians used the appellation *Allah* in pre-*Islamic* times, Christians and *Muslims* must believe in the same God.

The Universalist argument based on common names does not prove that *Allah* is the god of the Bible. *Muhammad* used this same-name game to say that the Arabs calling on *Allah* in other religions believed in *Islam's Allah* too. These religions include:

- ☉ Arabian astral paganism (*Sabeanism*, *Sabianism*).
- ☉ Zoroastrianism (*Magianism*).
- ☉ Religion of *Ibrahim* (*Hanifism*) (*K* 002:062, 135; 005:069; 022:017).

<sup>2067</sup> Nielsen, 1912, pp. 593-594, as translated in Krause, “*Haram–Harimat*.”

<sup>2068</sup> See the Contents section to locate the table on the *Koran's* 164 War verses.

<sup>2069</sup> Nicolle. *Moors*, pp. 8-9.

<sup>2070</sup> Nicolle. *Moors*, p. 11.

Analysis shows that *Allah* had (and still has) many generic-sounding titles, *Allah* being just one of many. Arthur Jeffery wrote:

...Redhouse, in his article in the *Journal of the Royal Asiatic Society* for 1880, collected from various lists no less than 552 different names for *Allah*.<sup>2071</sup>

The reason that *Allah* had so many aliases is that as soon as Jews and Christians used a different title for *Yahveh*, such as *Rahman* (Merciful) or *Allah* (the God), the pagans immediately applied most of those titles to their gods, including the war-and-moon-god at *Makka*.

The fact that *Allah* the moon-god is not found in pagan inscriptions from pre-Islamic times shows that *Allah* was a minor appellation for the moon-god. The title only became elevated in importance among pagans when Christians and Jews spoke of *Yahveh* as *Allah*. Then the pagans followed suit and called their moon-gods *Allah* more often.

So this is how the *Makkan* war-and-moon-god came to have so many names, including the name *Allah*. Thus it is not statistically significant that *Allah* had a few names in common with the God of the Bible.

Zwemer wrote that *Muhammad* had “two hundred and one titles” and “a score” (twenty) matched twenty of *Allah*’s ninety-nine beautiful names.<sup>2072</sup> So if *Yahveh* must be *Allah* merely because they had a few Arabic titles in common, then it follows that *Muhammad* must be *Allah* because they share twenty titles.

Just as *Muhammad* is not *Allah*, *Allah* is not *Yahveh* merely because they share a common title in Arabic. *Yahveh* is the God of the Bible, while *Allah*, the god of *Islam*, is a demon.

### A Hypothetical Scenario Analogous to *Islam*

*Muhammad*’s creating *Islam* and *Muslim*’s believing in *Islam* is analogous to this hypothetical scenario. It is as though Paul went to the *Areopagus* (Act 17:19). *Areopagus* means “Mars Hill” and refers to the ancient Greek god of war.

Let’s say that on Mar’s Hill the astral-oriented philosophers dismissed Paul, but one sophist’s interest was piqued. His name was Imapagan, which means “I’m a pagan.” Imapagan went out and bought Jewish and Christian apocryphal literature, but no Hebrew or Greek canonical Scripture.<sup>2073</sup>

Imapagan happened to think along the same lines as Demetrius the Silversmith, who feared that Christianity would hurt the shrine business (Act 19:24-28). Imapagan feared that Christianity would dispense with paganism altogether unless Christianity was co-opted.

Imapagan purposely misread the Old Testament and then declared himself to be a strict monotheist and the Last Prophet of *Ho Theos*, Greek meaning “The god.” Imapagan’s main message was that pagans and Trinitarians are polytheists.

The Athenians did not welcome the sophist-turned-prophet at first. Instead of making a *Hijri* from *Makka* to *Madina*, Imapagan made a quick exit from *Athens* to *Delphi*. There, Imapagan built a following of thugs, not by robbing “the ships of the desert” (caravans) like *Muhammad*. Imapagan instead pirated sea commerce, as did the *Muslim Jihadist Barbary* Pirates from the tenth to nineteenth centuries AD.

<sup>2071</sup> Jeffery, *Islam*, p. 93.

<sup>2072</sup> Zwemer, *Essay*, Ch. 3: “The Ninety-Nine Beautiful Names of *Allah*,” p. 46.

<sup>2073</sup> By the time Paul visited Acts, the Gospel of Luke may have already been considered “Scripture.” See “the laborer is worthy of his hire” (Luk 10:07; 1Ti 05:18).

Imapagan's conception of "The god" (*Ho Theos*) was basically *Zeus*-Jupiter posing as *Yahveh*. Imapagan claimed that the religion of *Zeus* antedated Judaism and Christianity, but had been corrupted by those who wanted to be polytheists.

Imapagan wrote some scripture that said *Zeus*-Jupiter made the sun, moon and other planets, and that no one should worship any astral body including Jupiter. Imapagan's scripture also lists ninety-nine other names for *Zeus*-Jupiter such as "Most Pompous" and "Most Violent."

Imapagan hijacked selected portions of the apocryphal literature, some of which was modeled on the Old Testament. Imapagan also twisted a few passages of Scripture to support his claims. These texts serve as stolen and altered identification cards that help the demon named *Zeus*-Jupiter commit identity theft against *Yahveh*.

When this sophist-turned-prophet finally equipped his rag-tag army properly, he sailed into the port of *Athens* with his band of iconoclasts. There they smashed idols and declared that all the gods besides "*Ho Theos*" were actually male angels. The Athenians had given female names and divinized many angels, all of who were male, during the days of Homer.

Naturally his followers make their major pilgrimage, not to the three cities called Jerusalem, *Makka* and *Madina*, but to *Athens*, Mount Olympus and the Oracle at *Delphi*. Over the centuries the followers of Imapagan have tried to hijack Christianity and other religions, and have killed many people.

Imapagan died, but two millennia later, Imapagan's followers still nag Christians. Christians maintain that in times of antiquity, Imapagan's "The god" (*Ho Theos*) was *Zeus*. Christians point out that *Zeus* was believed to be the god of the planet Jupiter.

Imapagan's followers retort that only the Romans thought of *Zeus* as Jupiter, not the Greeks. This forced Christians to prove the obvious—the Greeks knew that *Zeus*-Jupiter was an astral god. First, Imapagan's scripture is analyzed to identify information consistent with *Zeus* being lord of Jupiter. Then the ancient Greek sources are mined for proofs that *Zeus* was lord of Jupiter.

Most people are skeptical that enough proof can be found to prove that *Zeus* was a Greek astral god, and that Imapagan's "The god" is none other than *Zeus*. The skeptics have bought into the arguments presented by Imapagan's followers.

The skeptics also do not know how detailed the extant ancient sources are. For instance, how many moderns know that Jupiter was renowned for zapping flies?! The TSK's note for Exo 08:24 states that Jupiter's appellations dealing with flies were: *Apomuios*, *Muiagros* and *Muiochoros*. Adam Clark wrote:

Among these we may reckon *Baalzebub*, the fly-god of *Ekron*; *Hercules*, *Muscarum Abactor* (*Hercules*, the expeller of flies), of the Romans; the *Muagrus* of the *Eleans*, whom they invoked against pestilential swarms of flies; and hence Jupiter, the supreme god of the heathens, had the epithets of ἀπομυιος [*apomuios*] and μωδης [*muwdes*], because he [Jupiter] was supposed to expel flies and defend his worshippers against them.<sup>2074</sup>

Imapagan's antagonistic followers constantly pester Christians by asserting that *Zeus* is the same deity as *Yahveh*. Imapagan's disciples say that Greek-speaking Christians in antiquity referred to *Yahveh* as "*Ho Theos*," meaning "the God." In fact, between Gen 01:01 and Rev 22:19, the LXX and New Testament use the phrase "*Ho Theos*" thousands of times to refer to *Yahveh*.

<sup>2074</sup> *The Adam Clarke Commentary's* note on Exo 08:24.

Since Imapagan also used the term “*Ho Theos*,” his followers claim that they must worship the same God as Jews and Christians. Of course no thought is given to the fact that the god of any syncretistic religion with ninety-nine names, or even 552 names,<sup>2075</sup> is bound to have a name or appellation in common with *Yahveh*.

Imapagan’s followers also badger Christians with the fact that Paul quoted pagan Greek poetry (*Acts* 17:27-29), and this supposedly proves that the Greeks had worshipped *Yahveh* all along under different names.<sup>2076</sup> Christians are supposed to ignore the fact that Paul said *Yahveh* was indeed “An Unknown God” to the Greeks (*Act* 17:23), meaning Greeks did not know Him under any name, much less *Yahveh*.

Imapagan’s followers also badger Christians with the fact that their scriptures say that “*Ho Theos*” made the sun, moon and planets. Imapagan’s followers say this proves *Zeus*-Jupiter cannot be a planetary deity even though the ancient astral deities, according to myth, created their dwellings and thrones in the sky. So saying that *Zeus*-Jupiter created Jupiter does not disprove the assertion that *Zeus*-Jupiter is an astral deity.

Christians are expected to be agreeably duped and are supposed to make believe that Imapagan’s god is *Yahveh* by:

- ☉ Forgetting the fact that Imapagan’s god is two persons short of the Trinity.
- ☉ Disregarding the fact that the character of Imapagan’s god seems more like that of *Zeus*-Jupiter than of the Biblical *Yahveh*.
- ☉ Accepting the idea that the ancient Greeks had known *Yahveh* all along even though Paul said that *Yahveh* was “An Unknown God” to the Greeks of antiquity (*Act* 17:23).
- ☉ Believing that *Zeus*-Jupiter had no consort, nor son nor daughter, as though *Zeus*-Jupiter had a real existence outside of myth.
- ☉ Dismissing the idea that Imapagan’s god had astral associations, though he and his family tree undeniably had astral associations:
  - ★ *Zeus* was known to the Romans as Jupiter.
  - ★ *Zeus*’ wife *Hera* was known to the Romans as *Juno* whose sign was the crescent-moon.
  - ★ *Zeus*’ son *Hermes* was known to the Romans as Mercury.
  - ★ The poet Homer wrote that *Aphrodite*, known to the Romans as Venus, was the daughter of *Zeus* and *Dione*.
  - ★ In mythology *Zeus* appeared as a white bull to seduce the Phoenician princess *Europa*. The horns of the crescent-moon probably inspired the white bull imagery. Later, a *Minotaur* (half-man, half-bull) was born into *Zeus*’ extended family.

The point of this section is summed up well in this quotation of Robert Spencer:

...there are serious differences between the Christian, Jewish, and *Muslim* views of God—serious enough to warrant keeping a distinction between them. This is especially true in light of the fact that the *Islamic* claim to be an Abrahamic faith is a supremacist claim which denies all legitimacy to Judaism and Christianity as they exist today.<sup>2077</sup>

<sup>2075</sup> Redhouse, in 1880 AD, collected 552 names for *Allah* (Jeffery. *Islam*, p. 93).

<sup>2076</sup> Paul quoted poems by Epimenedes the *Cretan* and Aratus the *Cicilian*.

<sup>2077</sup> Spencer, Robert. “Defense Department plays ‘Let’s pretend,’” *JW*, 23 Jun 2006.

### Who Is Fooled by *Islam* and Why

The only people who are fooled by the identity theft are those who want to be fooled (2Th 02:12). The account of how the Satanic Verses were stricken from the *Koran* shows the *Makkans* knew full well that *Allah* was a moon-god with a consort and daughters.

It was often necessary for *Muhammad* to deny that *Allah* had daughters (*K* 016:057; 017:040; 037:149, 153; 043:016; 052:039; 053:021). This is because *Allah*, a.k.a. *Sin*, was thought of as the Father of the astral gods and even of humans. A bilingual *Sumerian* and *Akkadian* text, *Hymn to Sin*, says: “O father, begetter of gods and men...”<sup>2078</sup>

*Hammurabi* (ruled 1792–1750 BC) thought he was “the royal scion [descendant] whom [the moon-god] *Sin* made; who enriched [the city] *Ur*...” *Hammurabi* also referred to the moon-god *Sin* as...

...the Lord of Heaven, the divine father, whose crescent gives light among the gods, take away the crown and regal throne from him; may he put upon him heavy guilt, great decay...<sup>2079</sup>

The differences between the *Koran* and the Bible, and *Allah* and *Yahveh*, are so clear and so irreconcilable that *Muslims* feel it necessary to claim that the Old Testament and New Testament have been corrupted nearly beyond recognition.

There are those who are willingly duped by *Muhammad*'s fraudulent *Koran*. These include *Muslims* and ecumenical-minded non-*Muslims* who like to think that the high god of each religion is the same god. For some ecumenists, the *Muslim* credo is a half-truth: “There is no god but *Allah* and *Mohammed* is his apostle.”

A cursory reading of the sacred literature of each religion reveals that *Yahveh*, *Allah*, *Brahma*, *Ahura Mazda* and other top gods have entirely different personalities and values. These gods and their scriptures are mutually irreconcilable.

Isaiah shows in a round-about way that the high god of the *Semitic* religions was a moon-god. Isaiah said that “the Morning Star, the Son of the Dawn” wanted to “ascend above the heights of the clouds” and “be like the most High” (Isa 14:12-14). Of course Venus is mostly visible near the horizon due to its relative proximity to the sun. The moon however transits the zenith often.

Isaiah called Venus by an unusual word *Helel*, because the crescent-moon was called similar words such as *Hilal*. This shows that by Isaiah's time, the mythical primal gods such as “sky” and “water” had faded from the scene. The astral gods ruled and the moon-god had become the *de facto* high god for most *Semites*.

We moderns might not have even learned of the *Semitic* primal gods if the many cuneiform tablets had not been found. These tablets were produced in the first and third millennia BC. By *Muhammad*'s time, *Allah* the moon-god was the high god and the primal gods had been long forgotten.

The situation of Western theology is similar to that of the Mideast. If the mythologies of Homer and Hesiod had not by chance been preserved, moderns would probably not know from the archaeological evidence about the primordial deities *Hyperion*, the *Titans*, *Gaia* (Earth) and *Uranus* (Sky). Based on inscriptions,

<sup>2078</sup> “The Hymn to *Sin*” composed during the reign of *Ashurbanipal* of *Assyria*, 668-633 BC, [piney.com/BabHymSin.html](http://piney.com/BabHymSin.html), or [ccat.sas.upenn.edu/humm/Resources/Ane/hymSin.html](http://ccat.sas.upenn.edu/humm/Resources/Ane/hymSin.html), accessed 28 Mar 2004.

<sup>2079</sup> “*Hammurabi*'s Code of Laws.” Translated by L. W. King. *Exploring Ancient World Cultures*, [eawc.evansville.edu/index.htm](http://eawc.evansville.edu/index.htm), accessed 26 Mar 2004.

we might assume that the Greek high gods were all astral—and that is probably what many ancient Greeks and Romans thought too.

### ***Muhammad's Partial Transmogrification of the Moon-god into Yahveh***

*Muhammad* did not do a very good job of transmogrifying the war-and-moon-god *Allah* into the peace-loving *Yahveh*. Having a personal relationship with *Allah* is out of the question since anyone who has read up on *Allah* knows that he is not a personable god.

The only relationship one can have with the higher power of *Islam* is not that of a Father and a child. *Allah* can only be a master (*Rabb*) and the *Muslim* (the submitter) a slave (*'abd*).<sup>2080</sup>

*Muhammad* claimed that *Allah* is closer to humans than their jugular vein (*K* 050:016). It is no wonder that *Muhammad* used this metaphor since he had many people beheaded and he probably saw a lot of jugular veins spurting blood. *Muhammad's* nearest approach to *Allah* he figured was about two bowshots away (*K* 053:009). These however are all just empty words since the *Allah* of the *Koran* remains a distant moon-god and might as well be the Man-in-the-Moon.

Early on, *Muhammad* realized that only the promise of reward and coercion, not volunteerism, could kick start his Judeo-pagan religion. Only the sword could make the majority of people accept that *Allah* the moon-god was indeed *Yahveh*, the God of the Bible.

From the founding of *Islam* to the present, unbiased scholars agree that neither the pre-*Islamic* nor the *Islamic Allah* is the same God as *Yahveh*. Cosmas, bishop of *Maiuma* near *Gaza* “became a martyr at the hands of *Muslims* in 743 AD because he repeatedly condemned ‘*Muhammad*, his mythography and all who believe in it.’”<sup>2081</sup> Cosmas was sentenced to death because he called *Muhammad* “a false prophet” and the “forerunner of the Antichrist.”<sup>2082</sup>

Alvarus Paulus, a Spanish Christian, wrote in 854 AD:

Everyday they [*Muezzin*] cry out, in this rite of savages, with an enormous and monstrous roar, shouting like madmen from their smoky towers, their dissolute lips and jaws thrown open as if belching [the ‘Call to Prayer’]...this ritual of shouting and, through this superstitious effort, infect the souls of noble men with the evil spirit....At this same time [each year], from long ago, this people [*Muslims*], placed among the nations, has hastened forth from all regions to the above-mentioned idol [at *Makka* during the *Hajj* pilgrimage] just as now the same lost multitudes rush to the same demon...<sup>2083</sup>

Alvarus Paulus’ observations of the *Minaret* and *Muezzin's* call are interesting. The “smoky towers” may refer to how *Muezzins* may have lit a fire to keep them warm while they watched for a crescent however Creswell wrote about *Minarets*:

*Manara* literally means ‘a place where fire (*Nar*) burns. For this reason it was applied to *Pharos*, at the top of which a fire burned at night, then to lighthouses generally and then by analogy to *Mosque* towers, our word *Minaret* being derived from it.<sup>2084</sup>

<sup>2080</sup> Trimmingham. *Arabs*, p. 316.

<sup>2081</sup> Sahas. *Heresy*, p. 54.

<sup>2082</sup> Sahas. *Heresy*, p. 68.

<sup>2083</sup> Wolf. *Antichrist*, found in Meyerson & English. *Spain*, pp. 12-13.

<sup>2084</sup> Creswell. *Architecture*, p. 14.

Alvarus was surely familiar with the square *Mosque-forts* called *Ribats*. *Cordova*, where Alvarus lived, is not very far from *Gibraltar*. When located by the sea, *Ribat* towers served as lighthouses and as places for calling out the *Adhan*.

Alvarus Paulus was not fooled into thinking that *Islam's Allah* was *Yahveh* the God of the Bible. First, *Allah* does not even claim to be a triad nor trinity (Rev 13:15), so *Islam's Allah* cannot be the Trinity of the Bible.

Second, Alvarus Paulus surely read in Isaiah that demons desire to pass themselves off as *Yahveh*. The Devil said "I will ascend above the tops of the clouds; I will make myself like the Most High" (Isa 14:14). So Alvarus Paulus knew that *Allah* was just trying to pass himself off as being *Yahveh*.

A Palestinian *Muslim* Anis Shorrosh, who converted to Christianity, wrote "the heaven and God of *Islam* are not the heaven and God of the Bible."<sup>2085</sup> Caesar Farah stated:

*Allah*, the paramount deity of pagan Arabia, was the target of worship in varying degrees of intensity from the southernmost tip of Arabia to the Mediterranean. To the *Babylonians* he was *Il* (god); to the *Canaanites* and later the *Israelites*, he was *El*; the South Arabians worshipped him as *Ilah*, and the *Bedouins* as *Al Ilah* (the deity). With *Muhammad* he becomes *Allah* [contraction of *Al Ilah*], God of the Worlds, of all believers, the one and only who admits of no associates or consorts in the worship of Him. Judaic and Christian concepts of God abetted the transformation of *Allah* from a pagan deity to the God of all monotheists. There is no reason, therefore, to accept the idea that *Allah* passed to the *Muslims* from Christians and Jews.<sup>2086</sup>

*Allah's* concocted history has only the slightest resemblance to *Yahveh's* history as recorded in the Bible. The *Koran* and *Hadiths* cannot be reconciled with the Bible because, as Samuel Zwemer put it:

Pagan practices are explained away by inventing *Muslim* legends attributed to Bible characters, and the whole is an incomprehensible jumble of fictitious lore.<sup>2087</sup>

Samuel Zwemer wrote about the *Hajj* at *Makka*:

The whole pilgrimage is, in the words of Kuenen, 'a fragment of incomprehensible heathenism taken up undigested into *Islam*.'<sup>2088</sup>

Rather than just admit *Islam* is recycled paganism, *Muslims* would rather say the *Koran* and *Hadiths* are irreconcilable with the Bible because Jews and Christians corrupted the Old Testament and New Testament. Without this escape, *Muslims* would be forced to admit that *Yahveh* and *Allah* the moon-god were two different gods, thus making *Muslims* into infidels.

Saying that the Bible is not an accurate record of *Yahveh* just shows *Islam's* hatred for who *Yahveh* is. Thus the punishments for disobeying the First Commandment apply to *Muslims*:

You shall have no other gods before me. You shall not make for yourself an idol in the form of anything in heaven above or on the earth beneath or in the waters below. You shall not bow down to them or worship them; for I, *Yahveh*, your God, am a jealous God, punishing the children for the sin of the fathers to

<sup>2085</sup> Shorrosh. *View*, p. 78.

<sup>2086</sup> Farah. *Islam*, pp. 27-28.

<sup>2087</sup> Zwemer. *Animism*, ch. 8.

<sup>2088</sup> Zwemer. *Animism*, ch. 8.

the third and fourth generation of those who hate me, but showing love to a thousand generations of those who love me and keep my commandments (Exo 20:03-06).

### The More Physical Methods of *Muslim* Proselytizing

*Muslims* gained most of their territory and population through conquest. Though one might not think it, this same method of proselytizing is going on today. Arnaud de Borchgrave wrote:

*Muslims* are a majority in 63 countries. Of the 30 conflicts now under way in the world, 28 concern *Muslim* governments and/or communities. Amir Taheri, an Iranian author and journalist, says two-thirds of the world's political prisoners are held in *Muslim* countries, which also carry out 80 percent of all executions each year.<sup>2089</sup>

First an area or nation is softened up by terrorism before it is conquered. Then come decades or even centuries of attrition by aggressive evangelism using the techniques mentioned in this book with the objective of converting every last inhabitant to *Islam*.

Roger Scruton wrote:

'*Islamism*'—*Islam* embraced as an all-encompassing ideology—is 'not an accidental product of the crisis that *Islam* is currently undergoing, and the fundamental tenets of the faith must be borne in mind by those who wish to understand the terrorist movements.' Wherever *Islamists* have gained power—*Iran, Sudan, Afghanistan*—the result is 'not the reign of peace and prosperity promised by the Prophet, but murder and persecution on a scale matched in our time only by the *Nazis* and the communists.'<sup>2090</sup>

Not surprisingly, as *Islamists* "tighten the screws," many flee. "70 percent of the world's refugees are *Muslims* fleeing from *Muslim* states."<sup>2091</sup>

*Muslims* commit most of the acts of terrorism every year, whether the terrorism occurs inside *Muslim* countries or not. *Muslims*, moreover, are the only group of people who both support and derive joy from terrorist acts.

Poll after poll consistently shows that nearly ninety percent of *Muslims* approve of suicide-bombings, and many ululate, dance and hand out candy whenever there is a sensational terrorist attack—not only on "the Arab Street," but in such places as Atlantic Avenue in Brooklyn, New York<sup>2092</sup> and in *Mosques* in Sydney and Melbourne, Australia.<sup>2093</sup> Many *Muslims* even named their newborns Usama.

The suicide-bombings and the fact that *Muslims* extol suicide-bombings show genocidal impulses, yet some *Muslims* claim that their suicide-bombers are like the Japanese *Kamikazes* of WWII. This is bad comparison since the *Kamikazes* only attacked military targets.<sup>2094</sup>

Some *Muslims* claim that their suicide-bombers are like Samson of the Old Testament (Jdg 16:27-31). Samson collapsed a temple, killing many people. The

<sup>2089</sup> De Borchgrave, Arnaud. "2002 Yearend: Whither radical *Islam*?" upi.com, 8 Dec 2002.

<sup>2090</sup> Kimball, Roger. "Why the West?," *The New Criterion*, newcriterion.com, Jan 2003.

<sup>2091</sup> Kimball, Roger. "Why the West?," *The New Criterion*, *Idem*.

<sup>2092</sup> Mason, Jackie & Raoul Felder. "*Islam* is a religion of WHAT?" *Jewish World Review*, jewishworldreview.com, 7 Jul 2004.

<sup>2093</sup> Akerman, Piers. "Emma in the middle, not..." dailytelegraph.news.com.au, 20 Dec 2005.

<sup>2094</sup> Wallace, B. "They've Outlived the Stigma," news.yahoo.com, 25 Sep 2004, *JW*, 4 Oct 2004.



director of the movie about Palestinian suicide-bombers, *Paradise Now* (2005), said that Palestinians who become suicide-bombers first felt humiliated by the Israelis...

...You feel like such a coward it kills you, he describes, saying this cowardice makes people start hating life and feel impotent. I realized, *Abu-Assad* explains, that when a man systematically goes through such humiliation, he chooses to kill his own impotency by carrying out an act of ‘let me die with the philistines [an allusion to Samson’s prayer].’<sup>2095</sup>

How can *Muslims* justify their actions by pointing to the Bible—the very book that *Muslims* say has been corrupted beyond recognition! Besides, there are few points of comparison between blowing up innocent civilians, including women and children eating in restaurants, and the Philistines in a pagan temple whom Samson killed.

If one reads about the Philistines who were killed, they were aggressors against an oppressed people, gloating over how they had poked Samson’s eyes out, and they were giving credit to their fish-god *Dagon* for Samson’s capture. Nowadays the situation is reversed and moon-god venerating maniacal *Muslims*, who think they are Samsons, are committing suicide-murder against a people beloved by *Yahveh* (Deu 32:10; Zec 02:08).

Besides, Samson was NOT primed to kill by a plethora of fight and kill commands in the Bible, and Samson’s strength came from the Spirit (Jdg 13:25; 14:06, 19; 15:14; 16:28). Thus we can be sure that Samson’s victims deserved death, or at least that *Yahveh* had determined their “time of grace” had expired.

In contrast, *Muslim* terrorists are primed for violence by the 164 War verses found in the *Koran*, the scripture of a war-and-moon-god who poses as *Yahveh*. The power of the terrorists comes not from the Spirit but from an explosive chemical reaction and shrapnel.

The explosive belts of *Islamic* suicide-bombers often contain cruel additives such as arsenic and vials of AIDS-infected blood. The killing and wounding inflicted by *Muslim* terrorists are demonic acts of grotesque evil. They are not senseless acts however since they further the purposes of Satan. Satan would like to build a satanic *Caliphate* in order to stamp out the Gospel of Jesus.

Many *Muslims* cheer even though civilians not party to the conflict are maimed for life or killed.<sup>2096</sup> In fact, many *Muslims* maintain their predator personas and do not wince when a terrorist act kills hundreds of children and adults, causes millions in property damages and depresses the economy for months or years.

*Muslims* have a near monopoly on suicide-bombing. Suicide-bombings have little to do with poverty or a psychological disorder, or else there would be countless suicide-bombers the world over.

A *Muslim* miniskirt-chasing suicide-bomber is comparable to a *Kamikaze* pilot in the sense that they both act out of honor and religious duty. *Muslims* even admit that suicide-bombing is just “a deafening religious ritual.”<sup>2097</sup> Michael Radu wrote:

But with the exception of the LTTE’s [*Sri Lanka*] acts, all other [suicidal] terrorist acts were committed by *Muslims*, and of those, all except those by the

<sup>2095</sup> Hofstein, Avner. “Oscar nominee: People hate Israelis for a reason,” ynetnews.com, 2 Mar 2006, *JW*.

<sup>2096</sup> “Majority of Palestinians Back Suicide-bombing,” *Reuters*, news.yahoo.com, 19 Oct 2003.

<sup>2097</sup> Bishara, Azmi, as quoted in *Al Ahrām Weekly* (*Cairo*), 22-28 May 2003, as cited in Susser, Asher. “The Decline of the Arabs,” *Middle East Quarterly*, meforum.org/article/564, Fall 2003.

PKK/Kadek in Turkey and Arafat's *Al Aksa [Aqsa]* Martyrs' Brigades [Palestine] were committed by members of openly *Islamist* groups.<sup>2098</sup>

*Kamikaze* means "divine wind" and the *Kamikazees* were followers of Japanese state religion—*Shintoism*. An *Islamikaze* is not comparable to a person who commits *Hara-Kiri* or "falls on his sword" out of shame of failure or humiliation.<sup>2099</sup>

One reason *Islam* has a near monopoly on suicide-bombing is many *Muslims* approve of the practice. In fact, many *Muslims* are in the "Amen! Corner" cheering in the streets whenever a terrorist strikes. The *Weekly Standard* reported:

There were incidents of wild rejoicing across Holland in the wake of the September 11 attacks, notably in the eastern city of *Ede*. The weekly magazine *Contrast* took a poll showing that just under half the *Muslims* in the Netherlands were in 'complete sympathy' with the September 11 attacks.<sup>2100</sup>

When US Ambassador Welch criticized the Egyptian press for supporting suicide-bombing, the press there was unapologetic. Adli Barssoum wrote in *Al Gumhuriya*:

*Al Gumhuriya* [newspaper] does not pretend to be the only paper describing the heroism of the Palestinian martyrs [i.e. double speak meaning "miniskirt-chasing suicide-bomber"]; this is the position of all the Egyptian papers because it accurately reflects the feeling of the Egyptian people.<sup>2101</sup>

Ken Sanes wrote similarly:

But a recent survey [2003] by the Pew Research Center for the People and the Press paints a very different picture. It found that a large number of *Muslim* respondents in many nations with significant *Muslim* populations 'believe that suicide-bombings can be justified in order to defend *Islam* from its enemies.' In *Pakistan*, which is America's nominal ally in the War on Terror, 33 percent said suicide-bombings are justifiable, while 43 percent said they aren't. In *Nigeria*, 47 percent said they are justifiable while 45 percent said they aren't. In *Bangladesh*, it was 44 to 37 percent. Even in *Indonesia*, while 70 percent said suicide-bombings aren't justifiable, a sizeable 27 percent said they are. These are all nations with large populations that make up a significant portion of the *Islamic* world. In two frontline states in the Arab-*Israeli* conflict, *Lebanon* and *Jordan*, the percentage saying suicide-bombings are justifiable was 73 percent (!) and 43 percent.<sup>2102</sup>

When reading such statistics, keep in mind that just one percent of a billion plus *Muslims* is one million plus persons who all read the *Koran's* 164 War verses that together constitute propaganda promoting ethnocide and genocide!<sup>2103</sup>

Suicide-bombing is taught from an early age in some *Muslim* countries. The author Michael Oren said:

...you saw these kids being instructed in the importance of dying as martyrs and transforming themselves into human bombs. One very pointed theme in southern *Lebanon* was kids getting their heads sliced with razors so that they can march around and reenact the massacre and then they had them drawing pictures

<sup>2098</sup> Radu, Michael. "Radical *Islam* and Suicide-bombers," *FPM*, 9 Oct 2003.

<sup>2099</sup> Israeli. *Islamikaze*, as cited in Bostom, Andrew G. "Caliphate Dreams," *FPM*, 12 Dec 2003.

<sup>2100</sup> Caldwell, Christopher. "Holland Under Siege," *Weekly Standard*, 20 Dec 2004.

<sup>2101</sup> *Al Gumhuriya* (Egypt), 26 Oct 2003, as translated in "The Egyptian Press Against Ambassador Welch: 'The Arrogant [U.S.] Ambassador Representing the Imbecile Bush,' SDS—Egypt/ U.S. and the Middle East, *MEMRI*, no. 602, 4 Nov 2003.

<sup>2102</sup> Sanes, Ken. "Clash of the super-systems," *Asian Times*, atimes.com, 7 Jan 2003.

<sup>2103</sup> See the Contents section to locate the table on the *Koran's* 164 War verses.

of dismembered martyrs. Little kids with red crayons filling in the blood and the viscera. I came away thinking that I don't really grasp what we're up against. And the question I'd ask you then is how are the American people going to ever really grasp what they're up against here?<sup>2104</sup>

*Jihad* warfare and giving pagans the choice of “the *Koran* or the sword” (*K* 009:029) are the more sensational techniques that *Muslims* use to spread *Islam*. There are however other equally terrible tools of proselytizing that *Muslims* employ that historians in the West have largely overlooked. The more dramatic of these methods include enslavement, terrorism and even genocide.

There are also silent ways that *Muslims* use to take over a non-*Muslim* nation and decimate hapless branches of Christianity. Like a python or a *Boa Constrictor* squeezing the life out of its victim, nations and religions are squeezed through economic disincentives, unfair taxation, discriminatory laws and low-level persecution punctuated by rampaging mobs and pogroms carried out by militants.

One can read web sites and books devoted to how *Muslims* “put the squeeze” on Buddhists, *Hindus*<sup>2105</sup> or Christians.<sup>2106</sup> Other victimized groups like the Zoroastrians were overwhelmed by the *Muslim* onslaught and either acquiesced or expired altogether.

*Muslim* persecution of Christianity is everywhere, as Walid Phares stated, “Roughly more than 120 million Christians live under various forms of oppression.”<sup>2107</sup> *Muslim* persecution of Christians in the Mideast is so bad that most have fled the region. Paul Marshall stated:

If persecution continues to drive out Christians from the Middle East (where they were a quarter of the population a century ago) then conflict will be largely *Israeli/Jew* versus *Arab/Muslim* with no intermediates.<sup>2108</sup>

Rather than dwell on history, it may be more useful for the Western reader if I mention how *Islam* currently is subtly ensnaring the West. Here, I will not even discuss the all too obvious facts about terrorists infiltrating the West and perpetrating acts of sabotage and terror.<sup>2109</sup>

In the last few centuries writers and composers romanticized *Islam* and *Muslim* lands. There was a love of all things Near East or Oriental, especially rugs, art, literature and architecture.

*Muslims* were romanticized in the Sir Walter Scott's book about the Crusades entitled *The Talisman* (1825). The book...

...depicts the *Muslims* as sophisticated and civilized and the Crusaders are all brutes and barbarians. It has nothing to do with reality.<sup>2110</sup>

The Russian composer Piotr Ilyich Tchaikovsky (1840–93 AD) wrote the enchanting symphony *Scheherazade*. Tchaikovsky's symphony inspires wonder for the Mideast, unlike any music actually produced in the region.

<sup>2104</sup> Stephens, Bret and Michael Oren. “Perle's horizons,” Jpost.com, 19 Oct 2003.

<sup>2105</sup> Hindus: web site: “Left Shoe News” links exposing *Islam*, hraic.org/links. Books: Ghosh. *Kafir* and Goel. *Hindu*.

<sup>2106</sup> Web site: Answeringislam.org. Book: Yeor. *Christianity*, and Yeor. *Dhimmitude*.

<sup>2107</sup> Glazov, Jamie. “Symposium: The *Muslim* Persecution of Christians,” *FPM*, 10 Oct 2003.

<sup>2108</sup> Glazov, Jamie. “Symposium: The *Muslim* Persecution ...” *Idem*.

<sup>2109</sup> Pipes. *America*, Pipes, Path, and Spencer. *Onward*.

<sup>2110</sup> Edwardes, Charlotte. “Ridley Scott's new Crusades film ‘panders to Osama Bin Laden,’” telegraph.co.uk, 18 Jan 2004.

The reason for the dearth of good music from the *Muslim* world is that *Muhammad's* negative attitude toward music arrested the development of music in the Mideast.<sup>2111</sup> Because of *Islamist* death threats, in 2005 the *Iraqi* symphony, one of the few in the *Muslim* world, performs only under tight security to an invitation-only audience.<sup>2112</sup>

Scheherazade was the storyteller character in the *Arabian Nights* tales. She told one-thousand-and-one tales to the *Caliph* just so he would not chop off her head! Scheherazade is more of a tragic figure than a romantic character. Some of the stories are horrifyingly awful—utterly and ashamedly racist, sexist, cruel and vicious.

The romanticism about *Islam* was about as true to the facts as Wagner's romanticism about the lofty Germanic past. Just as the *Nazis* used Wagner's flights of fancy to feed their propaganda machine, so *Muslims* take advantage of the West's deluded notions about *Islam*. The West's romanticization of *Islam* is analogous to a bee mistaking a Venus flytrap for a flower—the bee being the West and the Venus flytrap being *Islam*.

Ernest Renan described *Islam* as “the heaviest chains that ever shackled humanity.”<sup>2113</sup> *Islam* is beginning to shackle the West too—as Daniel Pipes warns:

It was not so long ago that Westerners could converse freely about *Muhammad*, *Islam*, *Muslims* and militant *Islam* just as they still can about parallel Christian subjects. No longer...violence and intimidation have shut down the frank discussion of...[*Islam*]. It has reached the strange point that, in a secular, Christian-majority country like the US, a biographer of Jesus has freedom to engage in outrageous blasphemies while his counterpart working on *Muhammad* feels constrained to accept the pious *Muslim* version of the Prophet's life. I present this silencing as something significant in itself and a potential first step toward the imposition of *Islamic* law [in the West].<sup>2114</sup>

The fact that there are critics or satirists of *Islam* still alive in the West is not on account of any tolerance inherent in *Islam* but rather is the result of police protection and the critic's having taken evasive measures. There have been thousands of attacks on critics of *Islam*—often at the behest of clerics who issue *Fatwas*.<sup>2115</sup>

The shackling of the West occurred after a lake of oil was found in the Mideast. Oil-revenue has revived the vassal-and-lord system that had gone by the wayside for a few centuries during the period of colonialism. Historically, *Islamic* evil empires ran on loot, the *Jizya* poll tax and other forms of tribute from non-*Muslims*.

Even when Europe was strong and *Islam* was weak, Europeans and the US paid protection money to the *Barbary* Pirate *Jihadists* so they would not engage in *Jihad* by attack sea shipping, and would not kidnap and slaughter innocents. Then however the US attacked the Barbary Pirates after they kidnapped and enslaved US citizens. Jackie Mason and Raoul Felder wrote:

John Adams and Thomas Jefferson asked of the envoy of Tripoli by what right did he make his claim for payment. As reported to Congress by Jefferson, “The Ambassador answered us that it was founded on the Laws of their Prophet,

<sup>2111</sup> *Muhammad* banned musical instruments (*Sahih Bukhari*, vol. 7, bk. 69, no. 494v); *Al-Misri*. *Reliance*, 140.1, as quoted in Spencer. *Disturbing*, p. 117.

<sup>2112</sup> Maceda, Jim. “Baghdad symphony strikes a hopeful note,” msnbc.msn.com, 10 Jun 2005, *DW*.

<sup>2113</sup> Spencer. *Disturbing*, p. xi.

<sup>2114</sup> Pipes, Daniel. *Militant Islam Reaches America*. W. W. Norton, New York, 2002, pp. xvii-xviii, as quoted in Richardson. *Secrets*, p. 218.

<sup>2115</sup> “Spencer on the murder of Theo van Gogh: Death of a ‘Blasphemer,’” *JW*, 3 Nov 2004.

that it was written in their *Koran*, that all nations who should not have acknowledged their authority were sinners, that it was their right and duty to make war upon them wherever they could be found and to make slaves of all they could take as Prisoners.<sup>2116</sup>

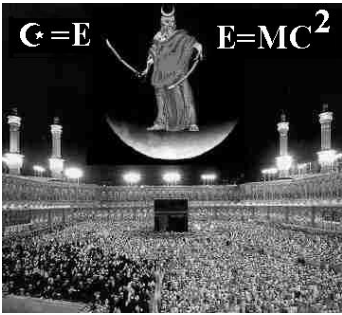
Today, the West pays for oil and gives *Muslims* foreign aid without strings attached, or with strings that are never pulled. The same nations to whom the US gives foreign aid resist any measures to reform the Mideast. Thus the oil and foreign aid money has greased and oiled *Islam's Jihad* war machine. This war machine has been low on fuel at certain points in history but has never been allowed to rust.

After the Mideast oil was found, the West and Western aca*Dhimmis* began to kowtow to *Muslim* sensitivities. The last honest looks at *Islam* (until lately) that were written by serious academics were those of Jeffery, Muir, Renan, St. Clair-Tisdall, Torrey, Wherry and Zwemer. Their academic formative years occurred well before the 1930's. Walid Phares spoke on the subject:

As of the 1970s a flow of funding coming from the oil producing regimes in the Arab and *Muslim* world—mostly authoritarian ones—sunk on Western campuses, paralyzing the process of information and education. These regimes blocked the circulation of knowledge as a way to avoid an international investigation of human rights and religious freedom in these *Muslim* countries. The direct result was that an army of scholars in the West participated directly in hiding the truth of persecutions, not only against Christians but also against enlightened *Muslim* intellectuals.<sup>2117</sup>

Thus nearly as soon as the period of scholarly critical examination of the *Koran* began, it ended. Michael B. Schub wrote “Academic research on the *Quran* lags centuries behind academic study of the Bible.”<sup>2118</sup>

South Korea provides a cautionary tale against any policy of suppressing criticism so as to befriend neighboring tyrannical regimes. North Korea tried to develop nuclear weapons while South Korea promoted its Sunshine policy from 2000 to 2005. This is similar to how several *Islamic* nations secretly strove for nuclear weapons while Westerners praised *Islam* for decades as being a Religion of Peace.<sup>TM</sup>



**Figure 03-01.** Here is the REAL reason that *Muslims* forbid non-*Muslims* to enter *Makka* on pain of death! An *Islamists'* “Guide for Preparing Nuclear Weapons” states: “...now the *Jihad* fighters have acquired technological skills that enable them, with *Allah's* help, to understand this [nuclear weapons] technology. Thus they are able to make a major leap forward in producing this kind of strategic weapon, even in the kitchens of their homes.”<sup>2119 2120</sup>

<sup>2116</sup> Mason, Jackie & R. Felder. *Islam* is a religion of WHAT? *Jewish World Review*, 7 Jul 2004.

<sup>2117</sup> Glazov, Jamie. “The *Muslim* Persecution of Christians,” *FPM*, 10 Oct 2003.

<sup>2118</sup> Schub, Michael B. “That Which Gets Lost in Translation,” *Middle East Quarterly*, meforum.org, Fall 2003.

<sup>2119</sup> “On *Islamic* Websites: A Guide for Preparing Nuclear Weapons,” Memri.org, No. 1004, 12 Oct 2005, *C&R, JW*.

<sup>2120</sup> Cartoon caption, continued:... This is a CIA USA Intelligence “photograph” of the war-and-moon-god *Allah* hovering over the *Kaaba* at *Makka*. The “photo” shows *Allah* instructing the *Hajjis* on the physics for making the *Islamic* atomic bomb. The sky serves as *Allah's* chalkboard,

During the Sunshine years videos of summary executions of North Koreans were not played on South Korean TV.<sup>2121</sup> One can see that dictators abuse periods of détente and dictatorial regimes fall only when pressured by an unrelenting enemy.



**Figure 03-02.** *Allah's* special formula ( $C = E$  and  $E=MC^2$ ) gives the *Islamic* mushroom cloud that special *Islamic* touch.

After OPEC unleashed its “oil weapon” in the Oil Embargo of 1974, the kowtowing became genuine genuflection and prostration. The West continues to pay homage and tribute to the Mideast and *Islam* by reading books by the aca*Dhimmis* such as Edward W. Said (1935-2003), John Esposito and Noam Chomsky.<sup>2122</sup>

Acad*Dhimmis* naively believe ahistorical accounts of how ecumenical-minded *Muslims* were tolerant toward non-*Muslims* within and without the borders of *Islam*. These stories were derived to give psychological comfort to Jews who just survived traumatic events such as the Holocaust. These hagiographic accounts really are saying nothing more than this: *Muslims* generally treated Jews better than Hitler did.

These mostly fictional accounts of *Muslim* generosity and benevolence are just psychological “crutches.” These nostalgic accounts of the “good old days” should not be presented by aca*Dhimmis* in history class as though they were true history.

Besides, even if *Muslims* once were non-discriminatory and treated *Dhimmis* the same as *Muslims*, this still would be nothing to brag about. It would just mean *Muslims* were equal opportunity abusers since *Muslims* themselves are *Islam*-victims of *Islam*, as Earnest Renan wrote:

*Muslims* are the first victims of *Islam*. Many times I have observed in my travels in the Orient, that fanaticism comes from a small number of dangerous men who maintain the others in the practice of religion by terror. To liberate the *Muslim* from his religion is the best service that one can render him.<sup>2123</sup>

Living in *Muslim* countries under *Sharia* law is no picnic and has nothing in common with the pursuit of “life, liberty and happiness.” *Sharia* law and the *Sunna* regulate everyday life and habits and the practice of religion and so are even more invasive, controlling and all-encompassing than secular totalitarian regimes and their ideologies.

and shows *Allah's* secret calculus for dominating the world: The  $C$  (i.e. *Islam's* star-and-crescent couplet) =  $E$  and  $E=MC^2$ .

The MI6 British Intelligence has learned that soon *Allah* will publish his sequel to the Manual for War, a.k.a. the *Koran*. The sequel however will be more organized than the original, which was the jumbled, stream-of-consciousness ravings of a madman bent on world conquest.

*Allah's* second Manual for War will follow the plainer format of the popular *Islam for Dummies* book by Malcolm Clark (Wiley, John & Sons Publishers, 2003). *Koran II* will be subtitled: *Hydrogen Bombs for Dummies*. *Koran II* will abrogate every verse in *Koran I* except of course the 164 War verses. These will appear in the Foreword of *Koran II*.

Indian Intelligence, RAW (Research and Analysis Wing), has learned that because a significant number of *Muslims* cannot read, Usama *Bin* Laden, Saddam Hussein, and Yasser Arafat (or impersonators, as necessary) will team up to deliver the content in the “Book on Tape” format, which will require 25 cassette tapes, or five CD-ROMs (USD 19.95). All profits will be laundered through charitable front groups before being siphoned off to needy terrorists.

<sup>2121</sup> Marquand, Robert. “S. Korea bars secret video of the North,” csmonitor.com, 29 Mar 2005.

<sup>2122</sup> Spencer, Robert. “Whitewashing Radical *Islam*,” *FPM*, 17 Sep 2003, *DW*, 17 Oct 2004.

<sup>2123</sup> Warraq. *Why*, p. ii.

**Figure 03-03.** Men throwing three totalitarian ideologies in the trash: the hammer and sickle of Communism, the Swastika of Nazism and the star and crescent couplet of Islam. The trash breeds flies eaten by a frog.<sup>2124</sup>



Distorted aca*Dhimmi* narratives of the way things were and still are in *Muslims* countries serve the *Islamist* agenda and do a great disservice to democracies everywhere. Robert Spencer wrote about aca*Dhimmis*:

If they [*Dhimmis*] complained about their inferior status, institutionalized humiliation, or poverty, their [*Muslim*] masters voided their [protection] contract and regarded them as enemies of *Islam*, fair game as objects of violence. For this, untold millions have died. Tens of millions have been uprooted from their homes. Tens of millions have been stripped of their cultural identity. And above all, millions have been cowed into silence and worse. For centuries *Dhimmi* communities in the *Islamic* world learned to live in peace with their *Muslim* overlords by acquiescing to their subservience. Like some slaves in the Old [antebellum American] South, some even actively identified with the dominant class and became strenuous advocates for it. It was almost unheard-of to find *Dhimmis* speaking out against their oppressors; to do so would have been suicide.

Spearheaded by *Dhimmi* academics such as [pro-terrorist, Marxist and anti-American] Edward Said, [as well as] John Esposito and Noam Chomsky, that same attitude of chastened subservience has entered into Western academic study of *Islam*, and from there into journalism, school textbooks and the popular discourse. One must not point out the depredations of *Jihad* and *Dhimmitude*; to do so would offend the multiculturalist ethos that prevails everywhere today. To do so would endanger chances for peace and rapprochement between civilizations all too ready to clash...

To continue to gloss over the destruction wrought by *Jihad* ideology and its attendant evil of *Dhimmitude*, is today to play into the hands of *Jihadists*, who have repeatedly vowed to *Dhimmitify* the West and destroy any recalcitrant elements. While *Jihadist* groups, even with their global diffusion, are not strong enough to realize this goal by themselves, they have a potent and destructive ally, a genuine fifth-column, in the *Dhimmi* academics and *Dhimmi* journalists they have recruited in the West. They have succeeded in confusing millions in the West into mistaking honesty and truthfulness for bigotry, and self-defense for oppression. Before it's too late for Western Europe and the US, which gave birth to the traditions of freedom and equality of rights for all that shine today as lights in the entire world, this must be stopped.<sup>2125</sup>

Besides the many aca*Dhimmis* and journalists, there are plenty of *Dhimmi* politicians and statesmen willing to self-censor their speeches, apology profusely and do anything to mollify and cover up for *Muslims*. For instance, the European Union's

<sup>2124</sup> This is Yoel Natan's rendition of a color animated gif found on the *Antipsykopatisk Senter* website ([antipsykopat.org](http://antipsykopat.org)). Credit goes to Gobi Web Design. The picture caption read:

"*Antipsykopaten i idealistisk og uselvsk aksjon.*" Reproduced under provisions of the Fair Use Act.

<sup>2125</sup> Spencer, Robert. "Dhimmi Watch: A Global Alliance For Justice," *Free Congress*, [freecongress.org](http://freecongress.org), 23 Sep 2003.

racism watchdog group published reports on anti-*Islamic* and anti-*Muslim* activity in Europe, but declined to publish a report detailing how *Muslims* were beating up Jews all over Europe. A European Union parliamentarian said:

We suspect that they are thinking in terms of not offending *Muslims* and *Islamists*, and that is not acceptable.<sup>2126</sup>

This generation of politicians has largely sold out the West to *Muslims* when it comes to immigration, foreign affairs and security. In order to appear nondiscriminatory, the US government enforces its security across the board rather than focusing on *Muslims*. So great-grandmothers must have their shoes X-rayed for bombs and submit to the occasional intrusive and humiliating body-search, so as to avoid cries of racism by the one demographic group that has produced all recent hijackers.

Western governments continue to hire and promote *Muslims* who have pro-*Islamist* attitudes and engage in pro-*Islamist* activities. Daniel Pipes wrote about the wolves guarding the henhouse:

It has been obvious for months that *Islamists* who despise America have penetrated US prisons, law enforcement and armed forces...The Defense Department responded last week to the chaplain's arrest by defending its hiring practices. Only under external pressure...did it agree to reassess them. Even then, the Pentagon insisted on reviewing the appointments of all 2,800 military chaplains—rather than the 12 *Muslims* among them. Political correctness run amok!...By pretending not to see that the enemy emerges from one source, the authorities dilute their focus, render their review nearly meaningless and endanger security. The US government needs to use commonsense and focus on militant *Islam*...Ironically, the Defense Department finds it easier to kill *Islamists* in *Afghanistan* than to exclude them from its own ranks. But only if the latter is carried out can Americans be confident their government is fully protecting them.<sup>2127</sup>

The next generation of politicians may turn into full-fledged collaborators and do the *Muslims*' bidding if the price is right. Then the West will go the route of the Byzantine Empire and other *Dhimmi* communities. Several writers have detailed how collaborators doomed the entire Byzantine Empire and East Europe to a *Muslim* conquest.<sup>2128</sup>

Bat Yeor points out that *Dhimmi* communities in the past have tried to strike separate bargains with *Muslims* while castigating other *Dhimmi* communities for bogus reasons.<sup>2129</sup> Now this type of cowardly behavior has reached the nation-state level, and states are betraying other states in the face of the *Islamic* threat, as the EU betrayed the US before Gulf War II. Reuven Koret summed up how the situation between the West and *Islam* stood in the year 2003:

On the diplomatic front, we [*Israel*] have reached a point where the US is our only true friend and with us, the only unwavering defenders against radical *Islam*. The rest of the world is either in league with the *Jihadists*, or [is] cowed

<sup>2126</sup> Lazaroff, Tovah. "Shelved report sparks EU furor," jpost.com, 4 Dec 2003.

<sup>2127</sup> Pipes, Daniel. "Pentagon *Jihadis*," *New York Post*, 29 Sep 2003.

<sup>2128</sup> Historians mention collaborators with *Muslims* often (Fregosi. *Jihad*, p. 90; Yeor. *Dhimmitude*, pp. 39, 109-110, 115-116; Yeor. *Christianity*, pp. 130, 258; Trifkovic. *Sword*, p. 116; and Jenkins. *Next*, p. 186).

<sup>2129</sup> Fitzgerald, Hugh. "Persecution of Christians in the *Muslim* world," *JW*, 1 Feb 2005.



by rising *Muslim* populations, [and is] mumbling pleading appeasements and pathetic rationalizations for not fighting back.<sup>2130</sup>

### ***Dhimmitude*: A Form of *Muslim* Proselytizing**

*Dhimmis* are non-*Muslim* residents of *Muslim* countries who at all times fear arrest and imprisonment and even fear for their lives. Raphael *Israeli*, drawing upon Bat Ye'or's works, wrote that *Dhimmitude* is...

...not only a subservient status...in political, social, economic and judicial terms, conferred on Jews and Christians...from which they could not disengage unless they converted to *Islam*, but it also became a state of mind...which dictated caution, surreptitious maneuvering in order to survive and a self-humiliating sycophancy towards the *Muslim* ruler in the hope of gaining his favor...[amounting] in the final analysis, after many centuries of oppression and contempt by the rule of *Islam*, to self-diminution of the *Dhimmis*...self-flagellation...and a total distortion of their self-image and the image of their oppressors. So much so that many Christians and Jews, years after being liberated from *Dhimmitude* continued to think and act as *Dhimmis*, namely to hold themselves grateful to their *Muslim* masters who beat, humiliated and mistreated them. What is more, the spirit of *Dhimmitude* has been adopted by, or has taken over, many Western societies today which for reasons hard to understand or explain, pretend not to hear or comprehend *Muslim* threats, smile and evince 'understanding' in the face of those threats, and seem to be marching foolishly towards spiritual and cultural capitulation and enslavement."<sup>2131</sup>

*Dhimmitude* has been the way of life for non-*Muslims* for fourteen centuries over three continents. *Dhimmitude* stems from the theocratic doctrine of *Jihad* warfare. *Islamists* have an adversarial, master-slave relationship with non-*Muslims* since they are perpetually at war with non-*Muslims*. Given the chance, many *Muslims* would either convert or enslave all non-*Muslims*.

Non-*Muslims* are viewed as potential crusaders and spies, or at least sympathizers who will aid and harbor the enemy. Non-*Muslims* are also viewed as potential polemicists and apologists who will seduce *Muslims* to leave *Islam*. Christians evangelizing *Muslims* and *Muslims* converting to another faith are both considered capital offenders. *Muslims* therefore treat Christians as though they were sirens propagating lethal ideas.

The degradations non-*Muslims* must suffer are codified into *Sharia* law, the law administered by *Islam* jurists, with additional extra-judicial humiliations. Even in modern times *Sharia* law is enforced in most *Muslim* countries through the legislatures and courts and by the mob.

In *Pakistan* for instance, Christians are routinely condemned to death for blasphemy. The charge is sometimes based on the testimony of one *Muslim* who holds a petty grudge, is a business rival, or just plain wants to persecute Christians.

### **The Psychology of *Dhimmitude* and the Violence-induced Conversion Syndrome (VCS)**

While Christians have relied (in the last two centuries) on Sunday school and Vacation Bible School (VBS) to produce converts, *Muslims* rely on the humiliating

<sup>2130</sup> Koret, Reuven. "A new year for an old people," *IsraelInsider.com*, 26 Sep 2003.

<sup>2131</sup> Israeli. *Islamikaze*, as cited in Bostom, Andrew G. "Caliphate Dreams," *FPM*, 12 Dec 2003.

conditions of *Dhimmitude* and the Violence-induced Conversion Syndrome (VCS) to produce converts—all in keeping with being a moon-and-war-god religion.

*Dhimmitude* has varying effects on different individuals—some choose to stay and some flee. For instance, most Zoroastrians have fled to India from Persia. The Byzantine Theophanes (758-818 AD) wrote in his chronicle that covers 284-813 AD, “Christians were emigrating to the safety of the Byzantine Empire, ‘fleeing the boundless evil of the Arabs.’”<sup>2132</sup>

People who do not flee *Dhimmitude* must wrestle with the psychology involved in occupier-occupied, captor-captive and master-slave relationships. Terms such as brainwashing, dissociative disorder and Stockholm syndrome apply, as N.S. Rajaram wrote:

*Dhimmitude* may be seen as the state of mind induced in the victims of *Islamic* terror, more particularly in the minds of the non-*Muslim* subjects in countries under *Islamic* rule. Like the famous ‘Stockholm Syndrome,’ which afflicts hostages by turning them into defenders of their kidnappers, *Dhimmitude* also has the effect of turning the victims of harsh *Islamic* rule into its defenders; there is an unconscious fear that criticizing them might make their condition worse.<sup>2133</sup>

Whether Christians like it or not, we are subject to *Islam*’s attempt to reorder the world according to his beliefs. The struggle is between whether *Koran* is right or the Bible is right, whether Christians are spiritually informed and good as the Bible says, or deceived and evil as the *Koran* says.

Christians may try to ignore the ongoing struggle but acts of terrorism are hard to ignore. They impinge on the private thought life, they have a powerful hold on the imagination, and they even create a mindset. The way terrorist acts monopolize attention, it is the mind-control and smelling salts of the masses.

Perhaps it is for the psychological reasons mentioned above that some people convert to *Islam* after reading the *Koran* and after hearing of a terrorist attack. The violent *Koranic* content, the images of hell and the gory terrorism scenes together grip their imagination and focus the mind so they can think of nothing else but the *Koran*.

It is not surprising, therefore, that terrorists are thought of as being proselytizers for *Islam*:

☉ In fact, Usama *Bin* Laden is thought of as being an proselytizer:

The writer [Usama *Bin* Laden’s top lieutenant, Ayman *Al* *Zawahiri*] referred to the attacks [9/11 and others] as ‘the blessed battle’ [*Jihad*] that exposed ‘America’s true face’ and said the number of youths who have joined the *Muslim* religion since the attacks has greatly increased. ‘Their numbers have increased by a degree that you can’t even imagine in such a short period,’ the message says.<sup>2134</sup>

☉ A *Muslim* *Imam* charged with terror-related crimes seems to connect terrorism with *Dawa* proselytizing. When a US Navy sailor emailed information that was useful for terrorists, the *Imam* who received the information...

<sup>2132</sup> Griffith. *Arabic Christianity*, VIII, p. 118, as quoted in Grabar. *Shape*, p. 167, left col., middle.

<sup>2133</sup> Rajaram, N.S. “*Jihad*, Terrorism and *Dhimmitude*,” *DW*, 15 Jun 2005.

<sup>2134</sup> “Top *Bin* Laden aide reportedly urges further attacks: No violence in Egypt, says alleged *Al* *Zawahiri* e-mail,” *CNN.com*, 6 Jan 2003.

...encouraged the enlistee to ‘keep up with the *Dawa* (an Arabic term for missionary work) and the psychological warfare...’<sup>2135</sup>

- ⊕ In 2006, Mohammed Reza Taheri-azar tried to run over at nine university students with an SUV. Besides citing retaliation as a motivation, he said he was “thankful for the opportunity to spread the will of *Allah*.”<sup>2136</sup>
- ⊕ Serge Trifkovic wrote about the terrorism-conversion phenomenon:

A surge in conversions to *Islam* in the Western world after September 11, especially among affluent, young Whites, attests that the strategy of reliance on the spiritual Death of the West is sound. It also fits a pattern set by recent history; similar surges followed the outbreak of the Gulf War, the *Bosnian* conflict and the *Fatwa* against Salman Rushdie. Perhaps there is, after all, no such thing as bad publicity.<sup>2137</sup>

In *Islamdom*, not much is written or said against the violence inherent in, and inextricable from, *Islam*. The fact that *Allah* the moon-god’s crescent symbol looks rather like a scimitar implies that violence is god pleasing (see “sickle-dagger” in the Index). Besides, many *Muslims* believe that violence is an proselytizing tool, a tool that is more effective than tracts or the *Koran*. This is what *Muhammad* thought:

When the help of God and victory comes, you will see people enter God’s religion [*Islam*] in droves (*K* 110:001-002).

*Muhammad* converted many more by the sword than he ever converted through preaching the *Koran*. *Muhammad* was not very evangelistic. He personally raided and pillaged dozens of towns during his career, but only attempted to preach in a mere three cities, those being *Makka*, *Nakhla* and *Madina*.

Roger Scruton notes that the *Koran* itself advances violent victories as proof of *Islam*’s truthfulness under the “might equals right” principle:

*Islam* originally spread through the world on the wings of military success. Conquest, victory and triumph over enemies are a continual refrain of the *Koran*, offered as proof that God is on the side of the believers.<sup>2138</sup>

*Ibn Ishaq* gives more than one example of conversion through violence, for instance:

The apostle [*Muhammad*] said ‘Kill any Jew that falls into your power’ [at this time *Muslims* went out of the *Mosque* and killed eighty non-*Muslims*<sup>2139</sup>]. Thereupon *Muhayyisa b. Mas’d* [a *Muslim*] leapt upon *Ibn Sunayna*,...a Jewish merchant with whom they had social and business relations, and killed him. *Huwayyisa* was not a *Muslim* at the time though he was the elder brother [of *Muhayyisa*, the murderer]. When *Muhayyisa* killed him [the Jew], *Huwayyisa* began to beat him [the murderer], saying ‘You enemy of God, did you kill him when much of the fat on your belly comes from his wealth?’ [i.e. “You killed our very best customer, you dolt!”] *Muhayyisa* answered, ‘Had the one [*Muhammad*] who ordered me to kill him [the Jew] ordered me to kill you [his own brother], I would have cut your head off.’ He said that this was the beginning of *Huwayyisa*’s acceptance of *Islam*. The other [the murderer’s

<sup>2135</sup> Crawley, James W. “Ex-S.D. sailor allegedly linked to terror suspect,” signonsandiego.com, 7 Aug 2004, *JW*, *LGF*.

<sup>2136</sup> “Driver at UNC Cites Vengeance for *Muslims*,” washingtonpost.com, 7 Mar 2006, mypetjawa.

<sup>2137</sup> Trifkovic. *Sword*, p. 298.

<sup>2138</sup> Scruton, Roger. “The Political Problem of *Islam*,” adapted from *The West and the Rest*, ISI Books, 2002, *The Intercollegiate Review*, Fall 2002, vol. 3.

<sup>2139</sup> Warraq. *Quest*, p. 542, as quoted by Schmidt. *Divide*, p. 17.

brother] replied, ‘By God, a religion which can bring you to this [to murder] is marvelous!’ and he became a *Muslim*.<sup>2140</sup>

Ergun and Emir Caner wrote about another case of the “violence leads to conversion” syndrome:

...Asma...satirized the prophet continually. One night Umayr *Ibn ‘Awf*, a military leader among the *Muslims*, attacked the poet while she was nursing one of her seven children. Although nearly blind, *Ibn ‘Awf* did not let this disability impede his zeal. Tearing the child from her hands, the militant slaughtered the mother joyfully. He then returned to camp and told *Muhammad* what he had done. *Muslim* scholars find solace in this event because the tribe in which she [the satirist] belonged, the *Banu Khutmah*, converted to *Islam*.<sup>2141</sup>

The *Hadith* collector, *Bukhari*, records that many Arab tribes took a wait-and-see approach to *Muhammad* and *Islam*:

...the Arabs (other than *Kuraish*) delayed their conversion to *Islam* till the Conquest (of *Makka*). They used to say: ‘Leave him (i.e. *Muhammad*) and his people *Kuraish*; if he overpowers them then he is a true Prophet.’ So, when *Makka* was conquered, then every tribe rushed to embrace *Islam* and my father hurried to embrace *Islam* before (the other members of) my tribe.<sup>2142</sup>

Finally, it should be noted that the wimp-to-body-builder, powerless-to-powerful, victim-to-perpetrator “if you can’t beat them, join them” transformative process is not unique to *Islam*. Gang members and Neo-Nazis are recruited the same way, as in 2005 after an *Ojibwa Chippewa* Amerindian read some Neo-Nazi material which glorifies death in keeping with the philosopher Nietzsche, he gunned down nine people and then killed himself. Mark Potok of the Southern Poverty Law Center in Alabama said:

‘Believe it or not, we run across this all the time,’ he told CNN. ‘We’ve found Jewish Nazis, gay Nazis, Blacks who wanted to be white supremacists. The reason it isn’t so unusual—these are powerless people to whom images of powerful people are appealing.’<sup>2143</sup>

Similarly, Nazi literature has found a readership among some Canadian Indians.<sup>2144</sup>

In 2005 an *Israeli* teenager spray-painted *Swastika* graffiti on a synagogue and other public buildings.<sup>2145</sup> Also in 2005, an *Israel* Defense Force (IDF) soldier was found to have a *Swastika* tattoo and admitted to being a Neo-Nazi.<sup>2146</sup> This led *Israeli* police to a ring of twenty Neo-Nazis right in *Israel*. One fascist cell group had even discussed the extermination of Jews in internet chat rooms.<sup>2147</sup>

<sup>2140</sup> Ishaq. *Sirat*, p. 369. The account is also found in *El badyah wa alnihay—Ibn Katheer*, vol. 4: the chapter on killing Ka’ab *Bin Al’ Ashraf*.

<sup>2141</sup> Caner & Caner. *Unveiling*, p. 50; also see *Ibn Ishaq. Sirat*, p. 676.

<sup>2142</sup> *Sahih Bukhari*, vol. 5, bk. 59, no. 595.

<sup>2143</sup> “School gunman stole police pistol, vest,” CNN.com, 23 Mar 2005.

<sup>2144</sup> Ser, Sam. “Two peoples, divided by one bigot,” jpost.com, 19 Apr 2005.

<sup>2145</sup> Sofer, Ronny. “*Beer Sheva* youth: Hitler was a genius,” ynetnews.com, 5 May 2005.

<sup>2146</sup> Weiss, Efrat. “Neo-Nazi IDF soldier?” ynetnews.com, 5 May 2005.

<sup>2147</sup> “Israeli police baffled by local neo-Nazi ring,” drudgereport.com, 31 May 2005.

## What Gives *Islam* Its Allure and Seeming Success

### *Introduction*

How *Dhimmitude* and the Violence-induced Conversion Syndrome (VCS) produce converts was discussed in the section above. *Islam* has other strategies that produce converts that are too numerous to list but the main time-honored ones are discussed here.

The Devil has been manufacturing religions for at least the last five thousand years. The Devil copied some of the means from the religion of *Yahveh* (*Yahvism*) but then prostituted them to achieve his own evil ends.

*Islam* makes doctrine of, and institutionalizes, the very worst features of pagan religions that made them successful, for instance: 1) Making a piety out of worldly behavior, 2) *Jihad*, 3) Ethnic cleansing during wartime and peacetime, 4) Fighting when strong while leaving the matter to the deity when weak, 5) *Lex Talionis*—Khidr-Second Lamech-style, 6) False messianism, 7) False signs, 8) False prophecy and 9) False promises of so-called success. These nine items are just some of the points discussed below, but the concept of *Lex Talionis* is discussed in the Khidr-Second Lamech Logic table.

### *Making a Piety Out of Worldly Behavior*

*Muhammad* said that *Muslims* must greet *Muslims* with blessings from God (*K* 004:086 024:061; also see the *Hadith*). *Sharia* law stipulates:

Such non-*Muslim* subjects are obliged to comply with *Islamic* rules...In addition, they...are not greeted with *as-Salamu 'alaykum*;...[and] must keep to the side of the street...<sup>2148</sup>

By contrast, Jesus said “If you greet only your brothers, what are you doing more than others? Do not even pagans do that?” (*Mat* 05:47).

*Muhammad* said “The best of the actions is to love [*Muslims*] for the sake of *Allah* and to hate [infidels] for the sake of *Allah* (*Sahih Muslim*, bk. 40, no. 4582). Jesus said “If you love those who love you, what reward will you get? Are not even the tax collectors doing that?” (*Mat* 05:46).

### *Controlling Others Rather Than Practicing Self-control*

Christianity is about practicing self-control rather than requiring everyone else to conform to rules whereby it makes it easy to practice Christianity and hard to be anything but a Christian (*Pro* 25:28; *Act* 24:25; *1Co* 07:05; *Gal* 05:23; *1Th* 05:06, 08; *1Ti* 03:02; *2Ti* 03:03; *Tit* 01:08; 02:02, 05, 12; *1Pe* 01:13; 04:07; 05:08; *2Pe* 01:06). *Islam* is about controlling society so that it becomes hard to be anything but a *Muslim*.

The *Koran* has so little content on self-control that centuries later the *Sufis* had to fabricate a tradition about the Greater *Jihad* being a struggle for self-control. The *Sufis* said that the Lesser *Jihad* was about conquering and controlling others, but one can see that *Muslims*' greatest efforts through the centuries has been expended on controlling society and infidels rather than self. As Professor Jadunath Sarkar stated:

It is not necessary that he should tame his own passions or mortify his flesh; it is not necessary for him to grow a rich growth of spirituality. He has only to

<sup>2148</sup> *Umdat al-Salik*, o11.5 (3-4); Spencer, Robert. “This is a *Saudi* textbook,” *JW*, 22 May 2006.

slay a certain class of his fellow beings or plunder their lands and wealth, and this act in itself would raise his soul to heaven.<sup>2149</sup>

Richardson wrote that *Islam* is all about “indulging the male sex drive as a ploy to entice pagan males into his fold.”<sup>2150</sup> There’s temporary marriages (*Muta, Misyar Urfi*), four wives who can be replaced at will, and sating one’s sexual appetites with an unlimited number of concubines and sex-slaves (*K* 004:003, 023-024; 023:005; 033:050; 070:030). Even in the afterlife *Muslims* will have no restriction on their sex drive and “There is no bachelor in paradise.”<sup>2151</sup> Thus *Muhammad* makes *Balaam* son of *Beor* look like an amateur when it comes to enticing men with sex in order to get what he wanted while luring people away from the truth (*Num* 25:01-03; 31:16; *Jud* 01:11; 2*Pe* 02:15; *Rev* 02:14).

*Islam is a Religion That Merchants, Especially Arms Merchants, Would Like to See Spread Around*

Carl Brockelmann wrote: “*Allah* was actually the guardian of contracts...”<sup>2152</sup> This goes a long way in explaining why *Allah* was *Muhammad*’s favorite god since *Muhammad* was a merchant, that is, before he found that being a highwayman and robber baron was more profitable.

*Islam* was spread far and wide by merchants as much as by *Jihad*. Why would merchants be interested in spreading *Islam*? One reason is *Islam* did not have a Day of Rest where commerce ceased like the Jewish *Sabbath* (*Exo* 20:11; 31:17; *Mar* 02:27) or the Christian Sunday.

*Muhammad* said that *Muslims* should interrupt commerce for Friday prayers and then resume commerce again once prayers were finished (*K* 062:009-010). Daniel Pipes notes that only recently have some *Muslims* copied Christianity and Judaism in that they now consider Friday to be a day of rest where they leave off work the whole day.<sup>2153</sup>

Conducting commerce, or “seeking *Allah*’s bounty” as the *Koran* phrases it (*K* 002:198; 016:014; 017:012, 066; 028:073), was a way of honoring *Allah*, the god of contracts, much as the Olympic sporting events honored *Apollo* in ancient Greece.

*Islam* shows itself to be a deranged merchants’ dream religion when it mandates that shoplifters and thieves have their hands cut off. Under Mosaic law a thief was not supposed to be harmed if caught in the act, except in self-defense, and he was to pay restitution—but not in the form of lopped-off body parts (*Exo* 22:01-03).

Under *Sharia* law, thieves are to lose a hand and they suffer other amputations for second and third offenses (*K* 005:038). The amputation can be over a stolen egg or rope (*Bukhari* 8:6799; *Muslim* 3:4185), or over anything worth the paltry sum of a quarter of a *Dinar* coin (*Bukhari* 8:6789; *Muslim* 3:4175-79). The amputation must occur even if the thief repents first (*Ibn Kathir*, 3:175-76; *Bukhari* 8:6800-6801; *Muslim* 3:4187 and 4188).<sup>2154</sup>

By contrast, under the strictest interpretation of Mosaic law, the accused might lose a hand only if he had deliberately cut off the hand of another (*Exo* 21:24; *Deu* 19:21).

<sup>2149</sup> Goel. *Calcutta*, ch. 8.

<sup>2150</sup> Richardson. *Secrets*, p. 166.

<sup>2151</sup> Serene, *Ibn. Kitab ul Isra’a wal Mu’raj*, as quoted in Caner. *Unveiling*, p. 193.

<sup>2152</sup> Brockelmann. *Peoples*, p. 9; also see *K* 009:006.

<sup>2153</sup> Pipes, Daniel. “The Western Mind of Radical *Islam*,” *First Things*, Dec 1995, *DP*.

<sup>2154</sup> Arlandson, J. “Thieves, give *Muhammad* a hand!” *americanthinker.com*, 12 Apr 2005, *DW*.

Another reason merchants spread *Islam* is *Islam* is hard on debtors. *Muhammad* said that while a martyr would give forgiven all his sins, up to and including mass-murder, except *Allah* would not forgive a martyr for leaving behind any unpaid debt! (*Sahih Muslim*, bk. 20, nos. 4649+4650).

So when someone is determined to be a suicide-bomber, they often go around paying off debts or ask that old debts be forgiven. For instance, *Al-banna* was a Jordanian suicide-bomber who killed 179 *Iraqis*. His parents recall:

...*Al-banna* asked his parents to send \$100 to a friend in the United States as payment for a nearly 3-year-old debt.<sup>2155</sup>

When *Time* magazine interviewed a would-be suicide-bomber, it reported:

Marwan says would-be ‘martyrs’ may use their waiting time to take care of business—paying off debts, resolving family matters, saying farewells.<sup>2156</sup>

Ironically, while being conscientious about paying off debts, suicide-bombers—like the 9/11 crews—are known to womanize, drink alcohol and commit other crime in support of their partying lifestyle or in support of terrorism, since martyrdom forgives all sins except debt. Terrorists are also known to have pornography collections.<sup>2157</sup>

*Islam* is the preferred religion of the wealthy, or those who would be wealthy, because there is no mention of tithing in the *Koran* as there is in the Old Testament. Tithing was the giving a tenth of one’s income (or some say “possessions”) to the priests to distribute as needed. Today, tithing, like other Old Covenant commands, is treated as a guideline by most New Covenant believers.

The *Koran* does speak of alms (*Zakat*) often, but *Zakat* for the average *Muslim* equals a paltry 2.5 percent of his bank account balance, investments and possessions owned for more than one year, but excluded from the *Zakat* levy are his dwelling, certain personal possessions, tools, riding and draft animals and the like. *Muhammad* was right, at least in regard to charity, when he said that *Allah* “has imposed no difficulties on you in religion” (*K* 022:078).

The many references to alms and the *Zakat* in the *Koran* assure *Muslims* who pay the *Zakat* of *Allah*’s pleasure and great reward in the hereafter.<sup>2158</sup> This is the case even though the miserly *Zakat* would hardly alleviate the sufferings of the poor even if the poor were to receive one hundred percent of *Zakat* contributions—which they do not. The poor only receive a fraction of the *Zakat* since others, including the state, compete for a share, for instance:

☉ Sometimes the *Zakat* on crops “became a purely secular tax,”<sup>2159</sup> meaning that instead of paying unto Caesar what is Caesar’s, and to God what is God’s, the *Caliph* received both Caesar’s and God’s share.

☉ *Caliph* “*Abu Bakr* made the *Zakat* in its fiscal form a permanent institution, which through the establishment of a state treasury contributed greatly to the

<sup>2155</sup> Reza, H.G. “Unlikely Candidate for Car Bomber,” *Los Angeles Times*, latimes.com, 15 Apr 2006, *JW*.

<sup>2156</sup> Ghosh, Aparisim. “Inside the Mind of an *Iraqi* Suicide Bomber,” time.com, 26 Jun 2005, *JW*; also see Spencer, Robert. “Yes, I am a Terrorist,” *FPM*, 29 Jun 2005, *JW*.

<sup>2157</sup> Harper, Tim & Michelle Shepherd. “Terror suspects plotted in Toronto, FBI charges,” thestar.com, 22 Apr 2006; “*Islamic* Extremists Love XXX Porn,” mypetjawa.mu.nu, 24 Apr 2006.

<sup>2158</sup> Paying the *Zakat* assures one of *Allah*’s approval and great rewards: *K* 002:277; 004:162; 005:012; 007:156; 009:071; 009:075; 027:003; 030:039; 031:004; 033:035; 057:018; 073:020.

<sup>2159</sup> Gibb & Kramer. *Encyclopedia*, *Zakat* entry, p. 656.

- expansion of *Muslim* power.”<sup>2160</sup> This reminds one of the *Corban* money during Jesus’ time when sons gave money to the temple that should have been used to support their needy parents (Mat 15:05; Mar 07:11).
- ☉ Gibb and Kramers wrote: “...according to Tradition, a *Zakat* given to the rich, thieves and prostitutes can also be meritorious, since it is the mere fact of giving which is the first consideration.”<sup>2161</sup>
  - ☉ *Muhammad* said that the *Zakat* should be given to the: 1) poor, 2) debtors, 3) travelers, 4) tax collectors for the service of collecting the *Zakat*, 5) *Dhimmis* who incline toward *Islam* but need an inducement to “revert” to *Islam*, 6) enemies to ransom *Muslim* prisoners and 7) *Jihadists* who fight in *Allah*’s cause (*K* 009:060).
  - ☉ *Sharia* law, as collated in *The Reliance of the Traveler* (*’Umdat al-Salik*), states that *Jihadists* are the seventh category of people worthy of receiving alms (*Zakat*) (h8.17).

So the rich in *Islamdom* can choose to give little *Zakat* money to the truly needy to live decent lives while giving lots of money to *Jihadist* so they can get themselves and others killed.

*Islamic* charities too often follow *Muhammad*’s prescription that the *Zakat* can fund *Jihad* (*K* 009:060), so infidels in the West unwittingly end up subsidizing *Jihad* by allowing *Muslims* to write off taxes on tax-deductible charitable contributions. Likewise, Western foreign aid to *Muslims* such as Arafat paid the salaries of Palestinian *Jihadists* scattered around the Mideast, and equipped them with weapons since that money was seen as *Zakat* and as *Jizya* (*K* 009:029, 060).<sup>2162</sup>

Even though the *Zakat* is manifestly inadequate to meet the needs of the poor even if other parties did not siphon a portion off, *Muhammad* condemned needy *Muslims* who complained that there was a lack of concern about their predicament (*K* 009:058-059). *Muhammad* also said:

*Allah* has provided for some of you more than *Allah* has provided for others.

Those who are given plenty would never give their properties to their subordinates to the extent of making them partners. Would they give up *Allah*’s blessings? (*K* 016:071).

*Muhammad*’s callousness toward the poor contrasts with *Yahveh* who said that the needy could pray to *Yahveh* who will then charge the stingy rich with sin (Exo 22:22-24; Deu 15:09).

*Algerian* Reformist Malek Chebel noted that in *Islamdom* “there is no redistribution of wealth, and when there is it only concerns the construction of *Mosques*.”<sup>2163</sup> Incidentally, *Mosques* are built less out of concern for helping the poor than with *Muhammad*’s saying that if anyone paid for a *Mosque*, his dwelling in heaven would be comparable in size to that *Mosque*.<sup>2164</sup>

The rich can feel good about fulfilling one of the five pillars of *Islam* by giving the *Zakat*, even though most *Zakat* dollars may not reach the poor. The stingy *Zakat*, especially after most of it has been siphoned off by the non-poor, helps to explain

<sup>2160</sup> Gibb & Kramer. *Encyclopedia, Zakat* entry, p. 655.

<sup>2161</sup> Gibb & Kramer. *Encyclopedia, Zakat* entry, p. 655.

<sup>2162</sup> Harel, Amos. “Former PA official: PA spent millions, including foreign aid, on weapons acquisitions,” *haaretz.com*, 17 Apr 2006, *JW*.

<sup>2163</sup> Szman, Nathalie. “Algerian Reformist Malek Chebel: 27 Propositions for Reforming *Islam*,” *memri.org*, 5 May 2006, No. 273.

<sup>2164</sup> *Sahih Muslim*, bk. 42, nos. 7109-7111.



why there are so many dirt-poor beggars in *Islamdom*, and why there is so much grinding poverty even in fabulously wealthy countries like *Saudi Arabia*.

### *Jihad*

*Muhammad* claimed that *Allah's* mode of dealing with humans does not change (*Rodwell K* 048:023; see also *K* 033:062). He wrongly claimed that both the Old and New Testaments were like the *Koran* in that they promised heaven in exchange for dying during *Jihad* (*K* 009:111). Thus *Muhammad* believed that the War verses in the *Koran* such as *K* 048:015-024 are like the Holy War commands in the *Pentateuch*.

*Islamic* history mentions that *Muhammad* actually fought with the *Makkan* pagans against the Tribe (*Banu*) *Hawazin* in the Sacrilegious (*Fijar*) Wars (~580 to ~590 AD).<sup>2165</sup> Thirty-two years after the Sacrilegious Wars in 622 AD, *Jihad* became a major characteristic of *Islam*.

The concept of perpetual *Jihad*, as heavily promoted in the *Koran*, did not come from Judaism. Most wars in ancient times were more or less Holy Wars. The ancients also looked for omens indicating whether they should fight. The participants listened to prophets and priests who supposedly received communications from high gods or war gods. *Mesha*, King of *Moab*, believed in holy war (*Jdg* 11:24). Lines 14-18 of the *Mesha Inscription* state “Now *Kemosh* said to me, ‘Go seize *Nebo* from *Israel*.”<sup>2166</sup>

While *Jihad* is taught in the *Koran* (see the 164 War Verses table), and indeed incited by the *Koran* (see the *Khidr-Second Lamech* Logic table), the concept of a Holy War is not supported by the NT. The Crusades can however be justified under the Just War principles worked out by *Augustine*—not as a Holy War but as a secular warfare of defense against an aggressive empire.

That *Jihad* has an allure is well-attested by the fact that *Jihad* videos, such as *Russian Hell 2000*, show beheadings, shooting and bombings mixed in with *Koran*-based *Jihad* messages. These videos “are used for recruitment and fund raising for terrorism.”<sup>2167</sup> *Sri Lanka*-born *Rohan Gunaratna*, the author of *Inside Al Qaeda, Global Network of Terror*, testified in court in 2004:

The material, when viewed by someone, they will be emotionally affected, they will want to go do this...and also they will want to give some contribution, some funds.<sup>2168</sup>

*Jihadists* are also motivated to continue their struggle by watching videos in the same genre as *Russian Hell 2000*, as *The New York Times* reported:

When his spirits flag, Mr. Siddique bolsters his morale by watching ‘vids,’ apparently videos or DVD’s from the ‘bros’ [brothers (pr. broze)] in *Iraq*.<sup>2169</sup>

The fighting aspect is not the only alluring aspect for young men, but the winning aspect, the earthly or heavenly spoils aspect, and the domination aspect are all alluring. Thus the closer a movement adheres to the fighting and dominating

<sup>2165</sup> Hughes. *Dictionary*, *Fijar* entry, with a source of *Muir. Life*, vol. 2, pp. 1-3.

<sup>2166</sup> Dearman, Andrew (Editor). *Studies in the Mesha Inscription and Moab*, Scholars Press, Atlanta, Georgia 1989, p. 98.

<sup>2167</sup> Russell, Betsy Z. “*Al Qaeda* recruits say images on Web sites part of allure,” spokesmanreview.com, 21 May 2004.

<sup>2168</sup> Russell, Betsy Z. “*Al Qaeda* recruits say images on Web sites part of allure...” *Idem*.

<sup>2169</sup> Rohde, David & Mohammed Khan. “Ex-Londoner’s Diary of *Jihad*: A Portrait Sprinkled With *Koran* Verses and Epithets,” nytimes.com, 8 Aug 2005.

ideals set forth in the *Koran*, the more popular it is. For instance, the ever-popular *Muslim Brotherhood* was founded in 1928 by Hassan *Al-Banna*, and...

...he called for *Muslims* to reject all Western influences and follow an aggressive dogma: 'It is the nature of *Islam* to dominate, not to be dominated, to impose its laws on all nations and to extend its power to the entire planet.'<sup>2170</sup>

Many young men would find what goes on in the *Mosque* more exciting than what occurs in church or synagogue services, as in *Cairo*...

Prayers were over. A protest began. In an instant, the *Mosque* was transformed: the gentle rhythms of worship replaced by the raw anger of dissent. 'We must fight our godless rulers! The only path is the law of the *Koran*,' shouted Magdy Hussein, an *Islamic* firebrand who has led widening street protests against Egypt's Western-backed government. 'This is our *Jihad*. Our time is now!'<sup>2171</sup>

*Sufism* is no exception to the rule that the closer a movement adheres to the fighting and dominating ideals set forth in the *Koran*, the more popular it is. Some propagandists would like non-*Muslims* to believe *Sufis* are not interested in *Jihad*, but in the past *Sufis* have been successful proselytizers and propagandists for *Islam*, the mortal enemy of all non-*Muslims*. *Sufis* have also been fervent promoters and cheerleaders for *Jihad* against non-*Muslims* and for the oppression of *Dhimmis*. Andrew Bostom wrote:

*Sufism* is not a sect, nor is it a heretical or schismatic movement; it is an integral part of orthodox *Islam*...*Sufism* has been linked integrally to the *Muslim* institution of *Jihad* war since the 11th century C.E.<sup>2172</sup>

*Sufi* scholar *Abu-Hamed Muhammad Al-Ghazali* (1058-1127 AD) wrote that *Muslims* ought to go on *Jihad* at least once per year. Ghazali wrote that *Muslims* may use catapults against, or set fire to, a fortress filled with non-*Muslim* women and children.<sup>2173</sup>

Ghazali's theology also made terrorism possible by justifying fighting the enemy from the midst of civilians. Ghazali used the term *Tattarrus* in his book *Al-Mustasfa* (The Place of Purification) to describe the practice of using ordinary *Muslims* as human shields for *Islamic* combatants against infidel fighters.<sup>2174</sup>

About the earthly spoils of *Jihad*, one can refer to *Ibn Ammar*'s eleventh-century AD poem about generous *Al Andalus* (Spanish *Muslim*) *Jihad* leaders:

When he gives girls he gives the full-breasted ones, when he gives thoroughbred stallions he gives the shorthaired ones, when he gives swords he gives the jeweled ones.<sup>2175</sup>

While *Jihadists* generally cannot hope to gain a wife or sex-slave from *Jihad* in modern times unless they are deluding themselves, some are enthralled by the sense of domination and power they wield, and the loot. *The Brussels Journal* reported:

In a new Sociological survey, the wave of robberies the city of *Malmö* has witnessed during this past year is part of a 'war against Swedes.' This is the explanation given by young robbers with immigrant background. 'When we are in the city and robbing, we are waging a war, waging a war against the Swedes.'

<sup>2170</sup> Murphy, B. "Muslim Brotherhood Feels Homeland Pressure," news.yahoo.com, 14 May 2005.

<sup>2171</sup> Murphy, Brian. "Muslim Brotherhood Feels Homeland Pressure," news.yahoo.com, *Idem*.

<sup>2172</sup> Bostom, Andrew G. "Sufi Jihad?" americanthinker.com, 16 May 2005, *JW*.

<sup>2173</sup> Bostom, Andrew G. "Sufi Jihad?" americanthinker.com, 15 May 2005.

<sup>2174</sup> "Sheikhs debate whether killing Muslim non-combatants is permissible," *JW*, 11 Jun 2005.

<sup>2175</sup> Nicolle. *Moors*, p. 21.

This argument was repeated several times. ‘Power for me means that Swedes shall look at me, lie down on the ground and kiss my feet.’ The boys explain, laughingly, that ‘there is a thrilling sensation in your body when you’re robbing, you feel satisfied and happy, it feels as if you’ve succeeded, it simply feels good.’ ‘It’s so easy to rob Swedes, so easy.’ ‘We rob every single day, as much as we want to, whenever we want to.’<sup>2176</sup>

The heavenly spoils are still on the minds of *Jihadists* today, as *The Washington Post* reported in 2005 concerning the *Iraqi* insurgency:

‘O brother, I love to sleep on the floor and I need no mattress,’ Tuhami was quoted as telling one fellow foreign fighter. ‘He was to have been married in February. Instead, he chose to be with the virgins of paradise,’ the [*Jihadi* Web site] announcement said. ‘He used to talk frequently about the virgins of paradise and their beauty, and he wished to drink a sip from the sustenance of paradise while a virgin beauty wiped his mouth.’<sup>2177</sup>

### *A Personal Experience*

*Muhammad* said that *Allah* granted laughter and tears, evidently meaning through the *Koran* (K 053:043). *Muhammad*’s eyes flooded with tears when he heard the *Koran* recited (*Sahih Bukhari* vol. 6, bk. 60, no. 106; vol. 6, bk. 61, nos. 570, 575; *Muslim* bk. 004, no. 1750).

*Muhammad* said that those who believe feel fear and rest when *Allah*’s name is mentioned (K 008:002; 013:028). *Muhammad* said that those who are guided by *Allah* tremble and have a heartwarming experience (K 039:023), have a sensation of wonderment and are left in tears (K 005:083; 019:058).

The *Koran*’s graphic descriptions of hell with its tortures may well agitate a person and give him heartburn—or bring on tears. The preachers in the *Mosques* do not ignore the *Koranic* material either, as *The Jerusalem Post* reported:

The *Sheikhs* in the local *Mosques* shout and scream into the loudspeakers during Friday sermons, scaring people with warnings about the evil deeds that will land them in hell.<sup>2178</sup>

The fears of hell causes tears, heart palpitations, cold sweats and heartburn, but these very same symptoms are mistaken for *Allah*’s guidance.

A *Muslim*’s faith in *Islam* is above all else based on feelings, but the prophet Jeremiah said “The heart is deceitful above all things and desperately wicked: who can know it?” (Jer 17:09) Thus it would seem that *Muhammad* and his followers, who put so much credence into their heartwarming experience and tears, all mistook their subjective feelings as proof of guidance from *Allah*.

### *What Their Itching Ears Wanted to Hear*

*Muhammad* presents the *Koran* as being a complete revelation without error (K 036:005; 039:028) so there is no need to rely on any other scripture. *Muhammad* denigrated the Bible and said it had been corrupted beyond recognition (K 005:064).

<sup>2176</sup> Fjordman. “People Worry About *Islam*, Its Leaders About *Islamophobia*,” brusselsjournal.com, 26 Apr 2006.

<sup>2177</sup> Glasser, Susan B. “Saudi ‘martyrs’ fuel *Iraq*’s insurgency,” washpost.com, 14 May 2005.

<sup>2178</sup> Alvi-Aziz, Hayat. “Sinful Arab neglect,” jpost.com, 31 Mar 2005.

Rejecting the Bible was no great loss to *Muslims*, *Muhammad* thought, because the *Koran* confirms and explains the Scriptures given before to Jews and Christians (K 002:101; 005:048; 010:037-038).

*Muhammad* taught that it is best not to give credence to the Bible since the *Koran* will unify all people into one belief system (K 042:015). After all, *Muhammad* says, Christians and Jews did not differ in belief until the Bible had been revealed (K 003:019).

*Muhammad* told *Muslims* to tell Christians that the Old and New Testaments were irrelevant to *Muslims* because *Muslims* are *Hanifs* like *Ibrahim* (K 002:135) and the Bible had not yet been revealed by *Ibrahim*'s era (K 003:065).

The corrupted Bible only led Christians and Jews into polytheism, *Muhammad* thought (K 002:135). Many *Muslims* put a lot of stock in *Islam*'s unitarianism but Saint James says that even the demons believe in monotheism and shudder nonetheless (Jam 02:19).

These are just some of the ways *Muhammad* and *Muslims* sidestep any serious discussion of Biblical truths and prophecies. All these teachings and ruses freed *Muhammad* to teach whatever he wanted to without fear of anyone crosschecking and fact-checking his teachings against the Bible. It allowed him to make Noah, *Ibrahim*, Moses, Jesus, Mary and other Bible characters out to be good *Muslims* who dutifully taught *Islamic* doctrine.

Christians search the scripture to find out about salvation history (Joh 05:39; Act 17:11; 2Ti 03:15-17; 2Pe 01:10-12, 19-21). Saint Paul said that in these latter times, people would gather around them a great number of teachers who teach what their itching ears want to hear (2Ti 04:03).

*Muhammad*'s saying that the Bible was corrupted (*Tahrif* and *Tabdill*) is like the serpent in the Garden of Eden saying to Eve "Did God really say that?" (Gen 03:01). *Muhammad*'s substituting the *Koran* for the Bible and establishing *Islam* to supplant Christianity is similar to how the serpent rejected God's command to Adam and Eve and replaced it with the statement, "You will not surely die but you will become like God..." (Gen 03:03). That the fruit was useful for gaining wisdom was exactly what Eve's itching ears wanted to hear because Eve also noticed the fruit was pleasing to the eye and senses (Gen 03:06).

*Muhammad* was beloved by those who refuse to believe in the truth (2Th 02:10-12), whose god is the Devil (Deu 32:17; Psa 106:37; 1Jo 05:19), because *Muhammad* issued demonic doctrine that the willingly deceived cherished (1Ti 04:01-02). Also, *Muhammad* engaged in the Devil's favorite pastime of accusing Christians of wrongdoing and hypocrisy (Job 01:09; 02:05; Zec 03:01-02; Rev 12:10).

The Arabs of *Muhammad*'s day wanted to hear a scripture in the form of Arabic poetry, so *Muhammad* gave them what they wanted (K 012:002; 013:037; 016:103; 020:113; 026:195; 039:028; 041:003; 042:007; 043:003; 046:012). H.A.R. Gibbs wrote:

Mohammed's utterances were delivered in a sinewy oracular style cast into short rhymed phrases...a loose rhyme or assonance marking the end of each verse.<sup>2179</sup>

Some have said the rhyme at the end of many *Koran* verses makes the verse ring like a bell. Thus the *Koran*'s insinuating itself into the culture of the Mideast is similar to

---

<sup>2179</sup> Gibb. *Survey*, p. 36.

how horrendous political ditties became nursery rhymes in the last several centuries in the West.<sup>2180</sup>

*Muhammad's* Arabic poetry and message scratched itching ears so well, that he was confident that no one could produce ten chapters comparable to those in the *Koran* (K 011:013; see also K 002:023; 010:038; 052:034).

#### *Facile Explanations as to Why Others Do Not Accept the "Truth" of Islam*

There are many all too facile reasons that *Muslims* offer when others do not see *Islam* as being the "truth" and these explanations confirm *Muslims* in their faith:

- ☉ Infidels are stubborn traditionalists: *Muhammad* taught that all people were born *Muslim* but their parents raise them as Jews or Christians.<sup>2181</sup>
- ☉ Infidels are committed to the devil: The *Koran* says unbelievers are of the devil's party and infidels fight for idols (K 004:076, 119; 016:098-100; 034:020; 058:019).]
- ☉ Infidels eat non-*Halal* food: *Muhammad* even said Jews eat non-*Kosher* foods (K 005:062-063, 066). This allegedly degenerates their spiritual faculties and hence they reject *Islam*. The *Birmingham Mail* reported:

*Islam* decrees that followers cannot eat meat from a pig as it creates 'lowliness in character and destroys moral and spiritual faculties in a man.'<sup>2182</sup>

#### *Might Makes Right*

People like to feel confident that they hold spiritual truth. Unfortunately, *Muslims* gain the feeling of surety of truth partly by the principle of "might makes right" rather than by serious Bible study and soul searching.

There can be no serious two-way dialogue about doctrine since the *Koran* says that Christians and Jews are under a curse (K 002:159; 004:047; 009:030). By contrast with Jesus' statements, "Do to others as you would have them do to you" (Luk 06:31) and "Love your neighbor as yourself" (Mar 12:31), the *Koran* tells *Muslims* to be harsh on (K 009:073, 123; 048:029; 066:009), make *Jihad* war on, tax and *Dhimmify* non-*Muslims* (K 009:029). Just so *Muslims* are not afraid to go too far in mistreating *Dhimmi*s, *Muhammad* said:

No *Muslim* should be killed [suffer the death penalty] for killing a *Kafir* [an infidel] (*Hadith Sahih Al Bukhari*, vol. 9, bk. 83, no. 50; also vol. 1, bk. 3, no. 111).

*Muslims* are like Lamech and Khidr in that they both thought they could murder with impunity as long as they had a pretext—as when Lamech said the other man had wounded him (Gen 04:23-24). Khidr's pretext was that the unbelieving lad would have grown up to vex his *Muslim* parents (K 018:080-081) (see the Khidr-Second Lamech Logic table).

<sup>2180</sup> For instance, "Mary, Mary, quite contrary" is about Queen Bloody Mary's graveyard, and torturing and beheading Protestants, "Jack and Jill" is about a king and queen being beheaded, and a "Ring around the Rosies...A tissue!... We all fall down" is about a bubonic plague welt, sneezing and dying ("Nursery Rhymes—lyrics and origins!" famousquotes.me.uk, accessed 20 Feb 2005).

<sup>2181</sup> K 030:030; *Sahih Bukhari*, vol. 2, bk. 23, nos. 440, 441 & 467; *Sahih Muslim*, vol. 4, ch. 1107, nos. 6423 & 6426; Yeor. *Dhimmi*, p. 75, fn. 31.

<sup>2182</sup> Smith, Adam. "Muslim fury over prison food," *Birmingham Mail*, icbirmingham.icnetwork.co.uk , 2 Mar 2006, C&R.

That *Islam* is a formidable opponent does not mean that *Islam* is right. Michael the Archangel was coldly polite toward the Devil (Jud 01:09). Similarly, the disciples were not able to drive out every demon since some were more powerful or more numerous than others and would take a lot of prayer to drive out (Mat 12:45; Mar 05:15; 09:28-29; 16:09; Luk 11:26).

The situation between Christians and Jews and *Muslims* can be likened to how the Seven Sons of Sheva, a Jewish priest, tried to exorcise a demon, but instead the demon beat them up and kicked them out of the house at Ephesus. The demon said that he knew of Jesus and Paul, but did not recognize the authenticity of the Sons of Sheva (Act 19:14-17).

Similarly, the demon masquerading as Gabriel (1Ti 04:01) had *Muhammad* claim that he knew all about Jesus and other Bible notables but yet rejected the spiritual authenticity of Jews or Christians.

If Christians try to exorcise the demon *Allah* out of *Muslims* through proselytizing, Christians are liable to be insulted, assaulted or killed either by vigilantes or via *Sharia* law. The reason is the message would need to be hard-hitting enough to make an impact, yet *Muslims* would classify such content as defaming *Islam* or *Muhammad*. Here is a *Fatwa* on the subject from *Islam Q&A*:

There is no one among us who is unaware of what the Christians say defaming the Prophet...If the person who defames him is a non-*Muslim* living under a treaty with the *Muslim* state [i.e. a *Dhimmi*], then this is a violation of the treaty and he must be executed...<sup>2183</sup>

Some *Muslims* think that the willingness of *Muslims* to become suicide-bombers shows that *Islam* is correct and invincible too but in reality this shows *Islam*'s weakness. Suicide-bombing has only been used in the last few decades and has prompted surprisingly little debate among *Muslims* and *Fatwas* about its legitimacy.

In the past suicide-attacks were rare because most *Jihadists* could reasonably expect to survive battles and go home to enjoy loot and a sex-slave or two. Modern warfare has made the battlefield more deadly and few *Jihadists* hold delusions about obtaining any loot and sex-slaves that they could actually keep for long. So they go after what they think is obtainable: loot and seventy-two *Houris* in the afterlife. *Abu Musab Al-Zarqawi* of *Al-Qaeda* in *Iraq* confirms that the deadliness of the battlefield is a reason *Jihadists* have despaired of living a long life and so have turned to suicide attacks. Zarqawi...

...said *Iraq*, unlike *Afghanistan*, lacks the mountains and forests to hide in, so insurgents have been forced to pursue 'direct confrontation,' such as suicide car bombings. It is 'very difficult for us, especially in *Baghdad*, which led us to increase our martyrs' attacks,' a reference to suicide bombings.<sup>2184</sup>

Some *Muslims* think that *Islam* is correct because it has so many "Samson" suicide-bombers. *Muslim* suicide-bombers remind one of how demons want to kill people in fire and water (Mat 17:15).

Samson's strength came from the Spirit (Jdg 13:25; 14:06, 19; 15:14; 16:28), but *Muslim* suicide-bombers remind one of the Samson-like demon-possessed man from Ephesus who beat up the Seven Sons of Sceva, a Jewish priest (Act 19:13-16)).

<sup>2183</sup> Question #14305, Shaykh 'Abd Al-Rahmaan Al-Barraak, Majallat *Al-Da'wah*, Muharram, issue no. 1933, *Islam Q&A*, *Islam-qa.com*, *JW*, 10 Jun 2005.

<sup>2184</sup> Faraj, Caroline. "Tape justifies killing innocent *Muslims*," CNNArabic.com, 19 May 2005.

The demons had Legion take up residence in a cemetery where Legion cut himself on stones and cried out day and night (Mar 05:05). Legion reminds one of how *Muslims* throughout *Islamdom* cut each other to perform male and female circumcisions (FGM). *Muslims* also cry out *Allah Akbar* during the *Adhan* from before dawn to dusk in the *Mosque* and from their *Minarets*.

Legion's affinity for graveyards (Mar 05:05) reminds one of how *Muhammad*:

- ☉ Built his first *Mosque* over a pagan cemetery. He had the entire peninsula of Arabia to choose from, yet he built it over a cemetery in a palm grove.
- ☉ Liked to teach in graveyards, though other ancient teachers liked to use gardens as classrooms (*Sahih Muslim*, bk. 2, no. 0483; bk. 4, nos. 2128+2127; *Sunan Abu-Dawud*, bk. 20, no. 3158).
- ☉ Talked to the dead of *Badr* whom *Muslims* had thrown into a well (*Sahih Muslim*, Bk. 40, No. 6869).
- ☉ Prayed for and talked about the dead that he thought were being tortured in their graves (*Sahih Bukhari*, vol. 8, bk. 73, nos. 78+81).
- ☉ Prayed for the dead whom he said could hear him but not speak back.<sup>2185</sup>

When Jesus passed by the cemetery, the demon asked that it not be tortured (Mar 05:05-07). This unfriendly behavior reminds one of how *Muslims* in the past greeted non-*Muslim* visitors to *Mosques* with instant death since unbelievers are unclean and sully the purity of the *Mosque* (K 009:028). When Laura Bush, wife of President George Bush, entered the Dome of the Rock in 2005, hecklers called out:

‘How dare you come in here and why are you hassling our *Muslims*?’ ...one man seethed ‘None of you belongs in here.’<sup>2186</sup>

Similarly, *Muslims* rioted when Ariel Sharon visited the temple mount in 2000.<sup>2187</sup>

When Jesus drove the demons out of the man Legion, they asked to go into some pigs. The pigs then rushed over a cliff and drowned (Mar 05:06-07). This reminds one of how *Muslims* gain assurance that *Islam* is right due to their monotheism and ritual purity, yet even demons are pig-killing monotheists (Jam 02:19).

### *Islam: the “Only Game In Town”*

In Old Testament times, Queen Jezebel tried to kill off all the prophets of *Yahveh*, including Elijah (1Ki 18:04-22 1Ki 19:02). King Ahab and Jezebel were the worst of the kings of *Israel* (1Ki 21:25). The public was too fearful to say anything against *Baal*, the god of the theocracy (1Ki 18:21). Only the elect held to *Yahvism* despite the persecution (1Ki 19:18).

Like Jezebel, *Muhammad* killed off his competition (see the Assassinated Wordsmiths table) and, on his deathbed, he ordered the expulsion of all non-*Muslims* from the Arabian Peninsula. *Muhammad* also burned down the houses of those who failed to show up for Friday prayers.<sup>2188</sup>

*Islam* suppressed Christianity and Judaism and terminated paganism within the expanding sphere of *Islamdom* in accordance with *Muhammad*'s Jezebel-like example as recorded in the *Koran*, *Hadith* and *Sharia* law.

<sup>2185</sup> Haykal. *Life*, pp. 231, 496, quoted in Geisler & Saleeb. *Answering*, pp. 155-156.

<sup>2186</sup> Teibel, Amy. “Laura Bush Heckled at *Islamic Holy Shrine*,” news.yahoo.com, 22 May 2005.

<sup>2187</sup> Winston, Emanuel A. “*CNN Slants The Story Of The Church Of The Nativity Siege or The Evil Empire Strikes Again*,” cnn.com, 6 May 2002.

<sup>2188</sup> *Sahih Bukhari*, vol. 1, bk. 11, nos. 617, 626; vol. 9, bk. 89, no 330; *Muslim* 4:1370.

The effort to restrict speech does not end with unbelievers but applies to *Muslims* as well. One of *Muhammad's* proofs that *Islam* was the true religion was that Jews and Christians have different sects (K 030:030-032; 042:013-016). So this proof is not cancelled out altogether; *Muslims* try hard to reduce the number of *Islamic* sects by legislation, violence and by propagating reform movements among *Muslims* (e.g. *Wahhabism*, *Deobandism*). *Muslims* also water down *Islam* to a mere Five Pillars to reduce in importance those beliefs on which *Muslims* disagree.

*Muslims* try to squeeze out all other thought that challenges *Islam* by insulting, assaulting or killing anyone who blasphemes *Islam* or the *Koran*—even if the person recants his so-called blasphemy. Here is a *Fatwa* on the subject from *Islam Q&A*:

There is no one among us who is unaware of what the Christians say defaming the Prophet...the [*Islamic*] authorities have to defend the cause of *Allah* and His Messenger...by executing the one who defamed him. If the one who defamed him repents openly and is sincere, that will benefit him before *Allah*, although his repentance does not waive the punishment for defaming the Prophet...which is execution. If the person who defames him is a non-*Muslim* living under a treaty with the *Muslim* state [i.e. a *Dhimmi*], then this is a violation of the treaty and he must be executed... But if they insult *Allah* and His Messenger...first, then we must respond and punish them so as deter them from their *Kufr* [unbelief] and enmity. If we leave the *Kuffaar* [unbelievers] and atheists to say whatever they want without denouncing it or punishing them, great mischief will result, which is something that these *Kuffaar* love.<sup>2189</sup>

For instance, during “The Great *Koran* Toilet-flushing Riots” of 2005 that started after a retracted *Newsweek* article stated that *Guantanamo* Bay interrogators flushed a *Koran* down the toilet, cleric Hafiz Hussain Ahmad in *Islamabad, Pakistan*, incited his parishioners during a fiery sermon with these words:

By insulting the *Koran*, they have challenged our belief. We are hurt...If we don't rise against Americans, if we don't give them a strong message today, they will do it again.<sup>2190</sup>

About “The Great *Koran* Toilet-flushing Riots” of 2005, *Reuters* reported that 300 clerics met in the main *Mosque* in the provincial capital named *Faizabad* and said...

...they wanted President Bush to...hand the culprits over to an *Islamic* country for punishment. ‘If that does not happen within three days, we will launch a *Jihad* against America.’<sup>2191</sup>

Notice that there were no riots when it was found out that terrorists used pages from Bibles for toilet paper in the Church of the Nativity in Bethlehem in 2002.<sup>2192</sup> Also, the *Buddhists* did not riot when in 2001 the Afghan *Taliban* destroyed two 35-meter tall, fifth- or six-century AD *Buddha* statues at *Bamiyan*.

It was hypocritical for *Koran*-flushing rioters to call out “Death to America” and burn their millionth American flag while demanding that Americans respect the killing manual, the *Koran*! *Muslims* do this because threats of genocidal terrorism have always worked to garner respect for *Islam* and the *Koran* in the past.

<sup>2189</sup> Question #14305, Shaykh ‘*Abd Al-Rahmaan Al -Barraak*, *Majallat Al -Da'wah*, Muharram, issue no. 1933, *Islam Q&A*, *Islam-qa.com*, *JW*, 10 Jun 2005.

<sup>2190</sup> “Protests spread in *Afghanistan* over *Koran* desecration,” *jpost.com*, 13 May 2005.

<sup>2191</sup> Ali Hamzi, *Qurban*. “Afghan clerics threaten *Muslim* holy war over *Koran*,” *news.yahoo.com*, 15 May 2005, *LGF*.

<sup>2192</sup> Raab, David. “The Beleaguered Christians of the Palestinian-controlled Areas,” *IMRA*, *imra.org.il*, 10 Oct 2002, *USS Neverdock* blog.



Numberless good-will gestures cannot assuage *Islamists*, as the West is finding out post-9/11. The annals of missionaries and welfare agencies are full of incidents such as those that occurred during the “The Great *Koran* Toilet-flushing Riots” of 2005:

...Westerners were fleeing for their lives....For foreigners caught up in it, the mayhem was terrifying and not a little heartbreaking. Veteran aid group Care International had its offices destroyed by a 2000-strong mob in a small town 40 miles south of *Kabul*. The mob was made up of mostly schoolchildren from a school which had been built by [the NGO] Care a year ago.<sup>2193</sup>

Other examples of *Islam* squeezing out all other thought are how:

- ☉ The front pages of *Muslim* and Mideast newspapers, are filled with terrorism news and graphic photos.
- ☉ TV sets watched in *Muslim* living rooms<sup>2194</sup> and waiting rooms<sup>2195</sup> are often tuned in to *Koran* readers and reciters.
- ☉ The *Adhan* is played five times per day between dawn and dusk.

Since the advent of loudspeakers, *Islam*'s roosters (the *Muezzins*) no longer need to crow out their cock-a-doodle-doo. Now light sleepers up to a kilometer or two away are awakened by *Islam*'s alarm clock—the pre-recorded *Adhan*, which is broadcast at the crack of dawn and then again at sunrise. Sleep-deprivation-by-*Adhan* is a mind control technique and is what *Muhammad* and the founder of the *Muslim* Brotherhood wanted. *Al-Banna* wrote:

It is a duty incumbent on every *Muslim* to struggle towards the aim of making every people *Muslim* and the whole world *Islamic*, so that the banner of *Islam* can flutter over the earth and the call of the *Muezzin* can resound in all the corners of the world: God is greatest [*Allahu Akbar*]!<sup>2196</sup>

*Imam Al-Qaradhawi*'s comments on suicide-bombers applies equally to the *Adhan*:

What weapon can harm their enemy, can prevent him from sleeping and can strip him of a sense of security and stability...<sup>2197</sup>

The *Adhan* and *Islamic* chanting is ubiquitous because anyone restricting the “Call to success” *Adhan* is seen as impeding *Dawa* evangelism, and *Muslims* “must remove any obstacle in the way of implementing the *Islamic* ruling system.”<sup>2198</sup> While bell use at churches is often restricted with impunity, the *Hadith* record that *Muhammad* attacked towns where the *Adhan* was not heard:

Whenever the Prophet went out with us to fight (in *Allah*'s cause) against any nation, he never allowed us to attack till morning and he would wait and see: if he heard *Adhan* he would postpone the attack and if he did not hear *Adhan* he would attack them (*Sahih Bukhari*, vol. 1, bk. 11, no. 584).

So in malls in *Jiddah*, *Saudi* Araba, *Islamists* are given free booths, free advertizing, are allowed “to bring in chanters to sing the praises of the prophet” and “*Islamic*

<sup>2193</sup> “Karzai demands action on *Koran* abuse,” sundayherald.com, 15 May 2005.

<sup>2194</sup> Hilir, Ban S. “More TV means less *Koran*, say *Muslims*,” expressindia.com, 30 Aug 2005, *DW*.

<sup>2195</sup> Halpern, Orly. “Watching warily,” jpost.com, 25 Aug 2005.

<sup>2196</sup> Spencer, Robert. “The Lies of Naomi Klein,” *FPM*, 19 Aug 2005, *JW*.

<sup>2197</sup> “*Al-Qaradhawi* Speaks In Favor of Suicide Operations at an *Islamic* Conference in Sweden,” memri.org, 24 Jul 2003, No.542.

<sup>2198</sup> Lindner, John M. “*Islamic* Radicals Agitate Judges in Indonesian Christianization Court Case,” assistnews.net, 18 Aug 2005, *WND*, *DW*.

songs” are “broadcast through a loudspeaker.”<sup>2199</sup> In the *Gaza Strip*, even parks are saturated with the *Koran* and the *Adhan*, as *Haaretz* reported:

They [*Hamas*] are bringing their spokesmen to public parks in the *Gaza Strip*, praising their martyrs, talking about victory and reading verses from the *Koran* in the few places that are intended, in essence, for the recreation of secular families.<sup>2200</sup>

The *Adhan* and *Islamic* singing and preaching is ubiquitous, as a convert from *Islam* testifies about Egypt:

My father hated Christians. He taught me that they are infidels who contradict themselves by saying that Jesus Christ is God while their distorted book has verses that prove he is a prophet. It was all part of the rhetoric we got used to hearing from booming *Mosque* loudspeakers, and from the playing of radios and audio cassettes in the streets. In such an atmosphere, a *Muslim* child in Egypt is breast-fed hatred along with his mother’s milk.<sup>2201</sup>

The *Adhan* and *Islamic* singing and preaching is ubiquitous, wherever there are concentrations of *Muslims*—even in universities, as *The Jerusalem Post* reported:

As students bought lunch and coffee at London’s School of Oriental and African Studies (SOAS) campus [in Cairo], the *Islamic* call to prayer, *Allahu Akbar*, blasted repeatedly through several speakers situated around the student union. ‘If you want to work for *Islam*, you must give your heart, if you want to get to heaven, do what the prophet said, peace be upon him,’ bellowed a melody.<sup>2202</sup>

If you ride the ‘women only’ car of the *Cairo* subway, you are likely to witness a remarkable phenomenon. Someone will stand up and start preaching *Islam*. She may be a girl as young as 12 years old, or a young adult or middle-aged. The preachers may vary in age but have some traits in common: they wear the *Islamic* headscarf, recite verses from the *Koran* and they are loud. Most of the captive audience responds positively, even chanting the prayers they are asked to repeat. What is the preachers’ message to the masses? They emphasize the importance of obeying the commands of *Allah*, performing the five daily prayers and wearing the *Hijab*, or headscarf. Similarly, *Cairo* taxis, shops, homes, offices and even some medical labs have recitations of the *Koran* blaring in their audio speakers. The *Sheikhs* in the local *Mosques* shout and scream into the loudspeakers during Friday sermons, scaring people with warnings about the evil deeds that will land them in hell.<sup>2203</sup>

Even in downtown Brussels, an important European political and business center, the *Adhan* is nearly ubiquitous. During an interview with Gijs de Vries, a counter-terrorism coordinator for the European Union, Mark Houser reported:

‘We are not engaged in a war of civilizations between *Muslims* and non-*Muslims*. That is what *Bin Laden* is trying to make us believe,’ de Vries said. As he spoke, the amplified voice of a man chanting in Arabic rose from the streets of downtown Brussels and floated through de Vries’ open window.

<sup>2199</sup> Ambah, Faiza Saleh. “*Islamic Activism Sweeps Saudi Arabia*,” *washingtonpost.com*, 23 Mar 2006, p. A18, *terrorismunveiled.com*.

<sup>2200</sup> Hass, Amira. “Palestinian after party,” *haaretz.com*, 17 Aug 2005.

<sup>2201</sup> Shalakamy, Ahmed. “Confessions of a Former *Islamist*,” *FPM*, 24 May 2005, *FreeWorldNow*.

<sup>2202</sup> Lappin, Y. “UK student warned to stop protesting anti-Semitism,” *jpost.com*, 12 May 2005.

<sup>2203</sup> Alvi-Aziz, Hayat. “Sinful Arab neglect,” *jpost.com*, 31 Mar 2005.

Thus day and night *Muslims* serenade the very people who are supposed to watch and police them, as Alvarus Paulus, a Spanish Christian, wrote in 854 AD:

Everyday they [*Muezzin*] cry out...this ritual of shouting and, through this superstitious effort, infect the souls of noble men with the evil spirit.<sup>2204</sup>

The reformist Egyptian writer Sayyid *Al-Qimni* sums up how *Islam* not only is the sole game in town but the sole game going on inside each *Muslim's* head:

While for the Christian it is enough to make the sign of the cross, which only takes one second, the *Muslim* is required to be a mechanical instrument, performing the same action every day. He is required to go to the *Mosque* five times a day, and is required to constantly read the *Koran*, and to force himself to weep if he cannot weep, and to spend an entire work day in the *Mosque*. No one can make him work so long as he is reading the *Koran* and reciting endless supplications and devotions. [Such recitations] accompany his every motion and position, from the moment he gets up at dawn to the moment he retires to the conjugal bed...

‘There is a barrier separating the [*Muslim's*] mind from the real world around him, so that he falls into a state of constant hallucination and, as a result, loses the capacity to distinguish between good and evil. He only recognizes the value of *Halal* and *Haram* [i.e. permissible vs. prohibited] according to the *Islamic* point of view. *Muslims* are burdened with many repressive restrictions... Freedom of thought and expression are fenced in by *Islamic* restrictions ...’  
 ‘There are stipulations and rules concerning clothing, such as the veil (*Hijab*)...’  
 ‘*Muslims* are forbidden to participate in carnivals which bring together all fellow citizens of the homeland to meet each other in the streets in an atmosphere of mutual love and love for the homeland...’  
 ‘*Muslims* are forbidden to enjoy refined dance...forbidden to enjoy cinema, novels, theater and music...’  
 ‘The *Muslim* is fenced in to the point where his mind is paralyzed and thus he surrenders his mind to the deputies of *Islam* upon Earth, because there is someone [else] to think for him...’  
 ‘As for the *Muslim* woman, she is consigned to wretched slavery. According to the foremost of [*Koranic*] exegetes *Al-Razi* ‘...she is like a prisoner in a man’s possession.’”

‘Proper education and teaching create an individual who loves life—not one who hates life and thus destroys himself and others. However, our universities have turned into religious associations that discuss what is *Halal* [permissible] and what is *Haram* [prohibited], and they research religious commentaries instead of researching the laws of physics and mathematics. Our universities now research the issue of the head covering, the veil, modesty, virtue and the pillars of *Islam*...The universities have forgotten their role as the primary place for scientific research—that is, to examine the country’s ills, whether in medicine or in culture, in order to fight against them... The universities have abandoned their field of expertise and have assumed the role of the *Mosque*...‘To be specific, when you visit the University of *Zaqaziq*—which is where the suicide bomber from the *Al-Azhar* [Seminary] incident studied and was an outstanding student—you will find slogans everywhere, none of which have anything to do with science. They are all about hatred, the veil and *Jihad*.<sup>2205</sup>

<sup>2204</sup> Wolf. *Antichrist*, found in Meyerson & English. *Spain*, pp. 12-13.

<sup>2205</sup> *Al-Qimni*, Sayyid. “Reformist Egyptian Writer Critiques *Islamist* Education and Propaganda,” 13 Jun 2005, *MEMRI*, Dispatch No. 922, *JW*.

### *Ethnic Cleansing During Wartime*

Ethnic cleansing in *Islam* did not come from Judaism since ethnic cleansing existed before and after the time of Moses and Joshua. The Pentateuch authorized ethnic cleansing of pagans from the Promised Land by war (Deu 07:01-16; 20:12-18) and by judicial means (Deu 17:03-07).

Mesha, King of Moab, practiced ethnic cleansing during his holy war. Lines 14-18 of the *Mesha Inscription* state that after *Kemosh* told Mesha to seize *Nebo* from *Israel*, Mesha “devoted” to *Kemosh* seven thousand Hebrews, meaning he made a human sacrifice of them. Mesha also dedicated all vessels of the Hebrew temple at *Nebo* to his god *Kemosh*.<sup>2206</sup>

Nebuchadnezzar ethnically cleansed much of his empire by destroying nations and moving the people around geographically. Several nations around *Israel* such as Moab ceased to exist (Eze 25:8-11). Many Jews were brought to Mesopotamia and various peoples were transported to Samaria. The temple at Jerusalem was destroyed and all the vessels were transported to temples in Babylon (Dan 01:02; 05:02-04).

### *Ethnic Cleansing During Peacetime*

Various provisions in the *Koran* and in the *Sharia* law code work to force conversions and ethnically cleanse an area of non-*Muslims* after which *Muslims* seize the property left behind. *Muhammad* ethnically cleansed three Jewish tribes from the *Madinan* area, killing hundreds of men and enslaving their wives and children. From reading *Islamic* history, it seems *Muhammad* went out of his way to make Jews his enemies so he would have a pretext to ethnic cleanse.

The Pentateuch authorized ethnic cleansing of pagans from the Promised Land by war (Deu 07:01-16; 20:12-18) and by judicial means (Deu 17:03-07). *Islamic* ethnic cleansing does not come from the Bible but rather other sources. *Muhammad*’s lying about how Christians and Jews changed their scriptures and corrupted their faith so that *Muslims* would kill them or subdue and tax them and otherwise mistreat and discriminate against them. Sounds likes something the Devil would do.

Jews called Jesus *Baalzebub*, meaning “the Lord of the Flies” (Mat 10:25; 12:24, 27; Mar 03:22; Luk 11:15, 18). This seems to have been an attempt to engender hatred and have the crowd stone him and his disciples (Joh 08:59; 10:32), or throw Jesus off a cliff (Luk 04:28-30). Similarly, *Muslims* historically have killed or expelled pastors or missionaries who stood up for the Gospel within *Islamdom*.

During Elijah’s time the Northern Kingdom of *Israel* was a theocracy ruled by the *Baal* worshippers Ahab and his queen, Jezebel. When Ahab wanted Naboth’s vineyard, Queen Jezebel wrote a letter to have two men level false charges against Naboth saying that he blasphemed God and cursed the King. After Naboth was stoned to death, Ahab took possession of Naboth’s vineyard (1Ki 21:07-16). *Yahveh* then had Elijah say to Ahab, “Have you murdered and also inherited? (1Ki 21:19).

*Islam* is the religion of Queen Jezebel on a worldwide scale. *Muhammad*, like Jezebel, wrote a long letter, i.e. the *Koran*, saying that Christians were blasphemers:

They do blaspheme who say: ‘God is Christ the son of Mary’ (*Yusuf Ali K* 005:072).

<sup>2206</sup> Dearman, Andrew (Editor). *Studies in the Mesha Inscription and Moab*, Scholars Press, Atlanta, Georgia 1989, p. 98.

*Muhammad* implied Jews were blasphemers too since similar to Christians, they worshipped Ezra along with *Allah* (K 002:259-260; 009:030). Believing that Christians and Jews were blasphemers made it all-too-easy for *Muslims* to conquer and tax non-*Muslims* (K 009:029-030) or kill them (K 009:005) and take their vineyards, homes and places of worship and family members (see the ethnic cleansing verses)—whenever it suits their fancy, of course.

One can see that *Islamic* expansionism was based mainly on Jezebel's principle that *Muslims* ought to accuse the other of blasphemy and then murder and inherit (1Ki 21:19). Even today in Pakistan blasphemy laws are used to acquire vineyards and house by steadily ethnically cleanse the land of millions of non-*Muslims*. The US State Department reported:

The blasphemy laws also have been used to 'settle scores' unrelated to religious activity, such as intra-family or property disputes.<sup>2207</sup>

Blasphemy laws are not uniformly applied in *Islamdom* despite the fact that *Muslims* claim to prosecute blasphemy against Moses, Christ and Mary. It is only the *Muslim* versions of Biblical figures that are protected. For instance, *Mahaz* party speaker Irfan Shah said...

...The *Difa-e-Islam Mahaz* (Front for *Islam's* Defense) is not against the Christian community but want to punish the culprit. We are also ready to lodge a blasphemy case against any *Muslim* who commits blasphemy against [the *Muslim* version of] Christ or [the *Muslim* version of] his mother Mariam (AS).<sup>2208</sup>

Another reason the blasphemy laws are not enforced equally is the "fine print" specifically cites *Islam* but not Judaism or Christianity. For instance, only "insulting *Islam*" is punishable, only apostasy from *Islam* is illegal, only heresy involving *Islamic* doctrine is condemned and only evangelizing among *Muslims* is considered seditious against the *Islamic* state.<sup>2209</sup> Still yet another reason these types of laws are not carried out uniformly is the laws are only invoked when someone is offended but only *Muslims* dare to take umbrage in an *Islamic* society.

### *Fighting When Strong, Relying on Allah When Weak*

When two religions co-existed and there was no theocracy, people often swallowed their pride and let the gods determine the losers and winners. For instance, when Gideon broke down *Baal's* altar, the pagans wanted to kill Gideon. Gideon's father however warned the *Baal* worshippers than anyone who fought to kill Gideon would be dead by morning. Evidently, he meant by the hand of *Yahvists*. The *Baal* worshippers relented and instead gave Gideon the nickname *Jerub-Baal*, meaning "Let *Baal* contend with him" (Jdg 06:25-32).

*Islam* also tries to pretend that it is peaceful when *Muslims* are weak, as they were in *Makka* at first. As soon as they are strong, they must fight and conquer and kill for their faith in accordance with the War verses in the *Koran*, the *Hadiths* and such.

<sup>2207</sup> "U.S. Department of State Country Reports on Human Rights Practices—2001," 4 Mar 2002.

<sup>2208</sup> Waqar, Ali. "Blasphemy case against Younis Masih: Extremists demand immediate hanging of blasphemer," *dailytimes.com.pk*, 20 Sep 2005, C&R.

<sup>2209</sup> Marshall, Paul. "Apostates from *Islam*: The case of the Afghan convert is not unique," *weeklystandard.com*, 10 Apr 2006, vol. 11, issue 28.

*False Messianism*

When things are going badly for a religion, it is a comfort to have a doctrine of a future messiah who will fight the forces of evil marshaled under an antichrist. This however is an absolute necessity when things are going badly for a supersessionist (K 003:067) and supremacist religion like *Islam* (K 003:139; 005:056; 008:030; 009:029, 033; 048:028; 061:009).

Even though the *Koran* often promises success (see citations below) and says that the schemes of Satan are weak (K 004:076), it says that toward the end of the world things will go badly for *Islam*. *Islamic* eschatology states that Jesus will have to overthrow Christianity and *Dajjal*, the Antichrist, when he returns a second time.

*False Signs*

The magicians of Egypt produced some of the same signs that Moses performed (Exo 07:11, 22; 08:07). The fact that the magicians could do this with sleight of hand and with the help of demons hardened Pharaoh in his religion and against *Yahvism* (Exo 07:22). The NT warns that false religions would rise after Christianity and would gain adherents by false signs and wonders (Mat 24:24; Eph 02:02; 2Th 02:09).

*Muhammad's* prophethood was supposedly validated to the Makkans by the phenomenon of the moon splitting (K 054:001). The ancients were avid sky-watchers, yet no one besides *Muhammad* ever recorded the moon as having split. Which is not so great a miracle, after all. Get yourself a bag of ice, a bottle of Jack Daniels whiskey, and you too can see double.

*False Prophecy*

Christians study prophecies and whether they came true or not (Deu 18:22; Jer 28:09; Eze 33:33). The *Koran* contains only one prophecy by *Muhammad* and it is ambiguous. It is about the Byzantines beating the Persians, or the Persians beating the Byzantines, depending on what vowel pointing is added to the original consonants (K 030:002-004).<sup>2210</sup> This is rather like the vague prophecies issued at the Oracle at Delphi.

*Self-Fulfilling Prophecies: Catastrophes and Tribulations*

Robert Spencer wrote:

For the *Jihadist*, natural disasters suffered by *Muslims* are a sign that they should practice *Islam* more fervently; natural disasters suffered by non-*Muslims* are a sign of *Allah's* wrath for their unbelief. But neither natural disasters nor anything else ever lead to any introspection or self-criticism—except insofar as that introspection leads to the discovery that more *Islam* is needed.<sup>2211</sup>

<sup>2210</sup> Shamoun, Sam. “*Muhammad's* False Prophecies,” answering*Islam.org*, accessed 2 Apr 2005.

<sup>2211</sup> Spencer, Robert. “Senior *Kuwaiti* Official: ‘Katrina is a Wind of Torment and Evil from *Allah* Sent to This American Empire,’” *JW*, 1 Sep 2005.

For instance:

- ☉ After 9/11 and other terror incidents, many had their hopes repeatedly dashed that *Muslims* would rouse out of complacency and reject extremism as being bad for the *Umma*...

Yet, instead, the community circled the wagons; many more French *Muslim* girls began to wear headscarves, he says. French *Muslims* became irritated at a generalized suspicion they felt and hence felt that *Islam* was more at risk than America.<sup>2212</sup>

- ☉ When the Boxer Day *Tsunami* of 2004 killed over two hundred thousand *Muslims* in Indonesia, *Muslims* said it was because *Sharia* law was not implemented fully.<sup>2213</sup> Then in 2005, *Muslims* said that Hurricanes Katrina and Rita, which hit the US and killed about a thousand people total, were in fulfillment of *K* 013:031 and 017:016-017 which say that *Allah* sends disasters to non-*Muslims*.<sup>2214</sup>

In October 2005, 79,000 people died in a *Pakistani* earthquake,<sup>2215</sup> yet “*Jihadists* viewed the ravages of hurricanes Katrina and Rita as signs that *Allah* was pleased with their WMD plans for ‘the American *Hiroshima*’... ‘*Allah* has punished America with winds and water,’ one *Imam* is quoted in the GIS report as saying. Another *Imam* reportedly quipped that America, as evidenced by the natural disasters, is ‘under the curse of the Jews.’”<sup>2216</sup> Right in the aftermath of the earthquake, a popular *Pakistani Imam* called on *Muslims* to...

...donate money and sons for *Jihad* and your glorious days will return. The entire world will be under your control. Bush and Blair will become your slaves and lick your boots.<sup>2217</sup>

Prophecies about weather catastrophes are similar to self-fulfilling prophecies in that one is predicting, and providing an interpretation in advance of, events that will happen repeatedly no matter what.

### *Self-Fulfilling Prophecies: Muslims Will Fight Until the Last Day*

At Babylon, the magi’s powers of prescience and analysis were honed so they could make predictions and issue self-fulfilling prophecies (Dan 02:09). *Muhammad* went a step further and went about setting up the circumstances whereby his prophecies would be fulfilled. For instance, *Muhammad* prophesied that:

- ☉ *Muslims* would conquer Persia, *Byzantium* and Rome. In order to make his prophecies come true, *Muhammad* wrote the 164 War verses to spur *Muslims* on to conquer the world.
- ☉ The preaching and practice of *Islam* would engender hatred in non-*Muslims* until the Last Day (*K* 005:014, 064; 048:029), and ‘The infidels will never stop fighting us until we follow their way’ [*K* 002:217], as terrorists are fond

<sup>2212</sup> Kempe, Frederick S. “Europe’s Middle East Side Story,” *Wall Street Journal*, July 29, 2003, aicgs.org.

<sup>2213</sup> Meo, Nick. “They tap into idea that God sent the wave as punishment,” *San Francisco Chronicle*, sfgate.com, 25 Dec 2005, JW.

<sup>2214</sup> Ham. “Katrina: Tornado ‘Divine Punishment,’ *Al-Qaeda* Sympathizers,” adnki.com, 1 Sep 2005, C&R.

<sup>2215</sup> Pennington, M. “*Pakistan* earthquake death toll rises to 79,000,” boston.com, 20 Oct 2005.

<sup>2216</sup> “Messianic madness of nuclear Osama,” *WND*, 23 Oct 2005, Jawa Report, mypetjawa.mu.nu.

<sup>2217</sup> “Bush and Blair will lick your boots,” us.rediff.com, 26 Oct 2005.

of quoted the *Koran* as saying.<sup>2218</sup> In order to make these prophecies come true, *Muhammad* wrote the 164 War verses to spur *Muslims* to attack non-*Muslims* who would, naturally, try to defend themselves as best they could. *Muhammad* also commanded *Muslims* to be harsh with non-*Muslims* (*K* 009:073, 123; 048:029; 066:009). Notice how *K* 048:029 tells *Muslims* to be harsh to non-*Muslims* and the same verse says that *Allah* would enrage the disbelievers. A self-fulfilling prophecy could not be more obvious!

When infidels profess and practice multiculturalism well beyond the point of needlessly endangering Western civilization as we know it, still *Muslims* believe they are hated based on *Muhammad's* predictions that non-*Muslims* will always hate *Muslims*. In other words, *Muhammad's* prophecies about hatred of *Muslims* can go unfulfilled in many places and times, yet *Muslims* believe them to be true, as in the *Muslim-hugging* country of Australia where...

...four men said they were targeted because they wished to practice a 'pure form' of *Islam*. 'They don't tell you in front of you, 'We hate your religion,' but we believe this is the case,' the group's leader said. 'We would like to practice our religion, not according to the Western understanding or according to their legislation but according to the *Koran* and the prophet *Muhammad*. 'According to the Australian Government, if you are *Muslim* you can practice your religion but...when you try to do it properly, then the problem comes,' he said.<sup>2219</sup>

*Muhammad* also provided fail-safes for his prophecies—just in case. For instance, if *Muslims* found that infidels were not really interested in fighting *Muslims*, then it must not be because the *Koran* is wrong about infidels being enraged about *Islam* and always wanting to fight *Muslims* but it must be...

...Whenever they kindle a fire for war *Allah* puts it out (*K* 005:064).

### *Self-fulfilling Prophecy: The Promises of Success*

One of the biggest draws of *Islam* and copycat religions like Mormonism, is the promise of earthly and heavenly personal success. *Islam* promises success if *Muslims* would only believe because *Allah* favors *Muslims* above all other people (*K* 007:140). The *Adhan* called from the *Minaret* five times each day says "Come to *Islam*. Come to success."

Many figure that if the deity blesses them on earth, this is assurance that they will be blessed in the afterlife but the Bible says this is not necessarily so. According to the Bible, unbelievers may have a comfortable life and grand retirement (Dives) but the believers may be sickly beggars (Lazarus), or have many troubles and ill health (Job).

*Islam* does not just make claims about who the winners will be in this life and in the next but tries hard to make *Muslims* into winners and non-*Muslims* into losers in this life (for more on that, see the Khidr-Second Lamech's Logic table).

Getting ahead by converting to *Islam* is not hard to do since *Muslims* generally are the only ones who do not play by the rules. *Muslims* are authorized to lie (*Takiya*) and go on *Jihad* and do whatever it takes to get ahead.

<sup>2218</sup> Ismail, Noor Huda. "Schooled For *Jihad*, They Turned to Terrorism: I wanted to know why," [washingtonpost.com](http://washingtonpost.com), 26 Jun 2005, p. B01, *JW*.

<sup>2219</sup> Munro, Ian & Tom Allard. "Raided men defend their part in *Jihad*," [smh.com.au](http://smh.com.au), 2 Jul 2005.



Christian neighbors try to play by the rules but *Muslims* make them into losers by preying on them. For instance, when an earthquake in *Pakistan* left many *Muslims* homeless in 2006, *Muslims* simply evicted Christians from their homes and lands.<sup>2220</sup>

*Islam* is by far the most political of all religions, and *Islam* tends to create an *Islamic* state from grassroots support. If there is no *Islamic* state to enforce the *Muslim* will and *Sharia* law on the populace, *Muslims* will take it upon themselves to enforce *Sharia* law.

Much of what passes for *Sharia* law is institutionalized criminality and depravity whereby non-*Muslims* and *Muslim* girls and women are deprived of their rights, property and even family members, especially when a *Muslim* male is party to a dispute.

In short, *Sharia* law makes *Muslim* men into winners because *Sharia* law makes crime pay for *Muslims*. Meanwhile, non-*Muslims* pay dearly not only for any crimes they might commit but they are taxed for the air they breathe. The *Jizya* protection racket money benefits not the mob, the *Muslim* community (*Umma*).

In the perception of many, a successful man is one who has a woman or women at his disposal. The *Koran* creates a gender imbalance by encouraging *Jihad* war, with the result that there are more marriageable women than marriageable men. In other ways, the *Koran* works to keep women subservient to men no matter what the women might desire to do with their lives.

*Muslim* men are allowed the right to: 1) be wife-beaters (*K* 004:034), 2) enter temporary marriages, 3) easy divorce while their wives do not, 4) be polygynists with up to four wives, 5) be slavers who have an unlimited number of sex-slaves (*K* 004:003, 023-024; 023:005; 033:050; 070:030) and 6) pimp their sex-slaves. They are assured of *Allah's* forgiveness even if they force their unwilling slaves into prostitution (*K* 024:033).

### *Self-fulfilling Prophecy: Supersessionism and Supremicism*

*Muhammad* knew that people find supersessionist and supremacist attitudes attractive because they make people feel safe from perceived or imagined threats. These attitudes also make people feel like powerful winners. *Muhammad* said:

As to those who turn (for friendship) to God, His Apostle and the (fellowship of) believers, it is the fellowship of God that must certainly triumph (*K* 005:056).

You shall have the upper hand if you are believers (*K* 003:139).

Inspired by sayings such as this, *Islamists* are constantly boasting of victory as though they are already taking their armor off (1Ki 20:11). For instance, during the Cartoon Riots of 2006, Khaled Mash'al, the leader of *Hamas*, told Denmark:

Hurry up and apologize to our nation, because if you do not, you will regret it...This is because our nation is progressing and is victorious....By *Allah*, you will be defeated....Tomorrow, our nation will sit on the throne of the world. This is not a figment of the imagination but a fact. Tomorrow we will lead the world, *Allah* willing. Apologize today, before remorse will do you no good.<sup>2221</sup>

<sup>2220</sup> Tsuei, Hudson. "Authorities Evict *Pakistani* Christians from Winter Shelters, Reports Claim," christianpost.com, 12 Dec 2005.

<sup>2221</sup> Karsh, Efraim. "Islam's Imperial Dreams," *WSJ*, opinionjournal.com 4 Apr 2006.

*Muhammad* also made people feel good about winning by telling that them that they were actually spreading the truth of *Islam* around. *Muhammad* said that *Islamic* victory made for successful proselytizing:

When the help of God and victory comes, you will see people enter God's religion [*Islam*] in droves (*K* 110:001-002).

Osama *bin* Laden for instance, sees himself as an evangelist. One of his famous quotes goes:

...when people see a strong horse and a weak horse, by nature, they will like the strong horse. This is only one goal; those who want people to worship the lord of the people, without following that doctrine, will be following the doctrine of *Muhammad*, peace be upon him.<sup>2222</sup>

What male scoundrel would not want to promote a system in which they are considered intellectually correct, morally upright and smart, and have more rights than: 1) *Muslim* women (*K* 002:282; 004:034) and 2) unbelievers, especially unbelieving slaves and sex-slaves? (*K* 024:033). For instance:

☉ Iranian *Shia Islamists* are enthusiastic promoters of *Sharia* law since it dictates that a life of a *Muslim* man is worth twice as much as that of a *Muslim* women, and twelve times as much as that of a non-*Muslim*.<sup>2223</sup>

☉ In Saudi Arabia's *Sunni Sharia* code, a *Muslim* man is worth twice as much as a *Muslim* woman or a Christian man, fifteen times as much as a *Hindu* man, and thirty-three times as much as a *Hindu* woman.<sup>2224</sup>

☉ UK *Islamists* believe: "The toe of the *Muslim* brothers is better than all the *Kuffar* on the earth...*Islam* is superior, nothing supersedes it and the *Muslim* is superior," sermonized Omar Bakri.<sup>2225</sup>

The *Hadith* collector, *Bukhari*, records that many Arab tribes took a wait-and-see approach to *Muhammad* and *Islam*:

...the Arabs (other than *Kuraish*) delayed their conversion to *Islam* till the Conquest (of *Makka*). They used to say: 'Leave him (i.e. *Muhammad*) and his people *Kuraish*; if he overpowers them then he is a true Prophet.' So, when *Makka* was conquered, then every tribe rushed to embrace *Islam* and my father hurried to embrace *Islam* before (the other members of) my tribe.<sup>2226</sup>

Many *Mekkans* took a wait-and-see approach to *Muhammad* in the hopes of gaining power and riches. This is why the *Mekkans* only half-heartedly attempted to squash the threat that *Islam* posed to their freedom of conscience and pagan religion, as *Muhammad's* biographer, *Ibn* Ishaq records a pagan *Mekkan* saying:

Take my advice and do as I do. Leave this man entirely alone for, by God, the words which I have heard will be blazed abroad. If (other) Arabs kill him, others will have rid you of him; if he gets the better of the Arabs, his sovereignty will be your sovereignty, his power your power and you will be prosperous through him.<sup>2227</sup>

<sup>2222</sup> "Video: Usama bin Laden videotape released by the Pentagon," foxnews.com, 13 Dec 2001.

<sup>2223</sup> "Iran: Christian life worth only a twelfth that of a *Muslim*," *Pakistanchristianpost.com*, 5 Nov 2004, *DW*, 4 Nov 2004.

<sup>2224</sup> *The Wall Street Journal*, April 9, 2002, as quoted in Glazov, Jamie. "Symposium: Gender Apartheid and *Islam*," *FPM*, 31Dec 2004.

<sup>2225</sup> "Focus: Undercover in the academy of hatred," timesonline.co.uk, 7 Aug 2005, *DP*.

<sup>2226</sup> *Sahih Bukhari*, vol. 5, bk. 59, no. 595.

<sup>2227</sup> *Ibn* Ishaq. *Sirat*, p. 133.

*Muhammad's* assertion that victory brings converts (*K* 110:001-002) leads *Islamist* politicians to view themselves as proselytizers for *Islam*, as one said:

If we were united and strong, we'd elect our own *Emir* [leader] and give allegiance to him. . . . [T]ake my word, if 6-8 million *Muslims* unite in America, the country will come to us.<sup>2228</sup>

Terrorists also see themselves as proselytizers for *Islam*:

The writer [Usama *Bin Laden's* top lieutenant, Ayman *Al* *Zawahiri*] referred to the attacks [9/11 and others] as 'the blessed battle' [*Jihad*] that exposed 'America's true face' and said the number of youths who have joined the *Muslim* religion since the attacks has greatly increased. 'Their numbers have increased by a degree that you can't even imagine in such a short period,' the message says.<sup>2229</sup>

The *Islamic* terrorists—evangelists by another means—do have a point since terrorism does produce some converts, as was discussed above in the section on the Violence-induced Conversion Syndrome (see the ToC). Even self-professed moderates believe that 9-11 produced converts:

Dr. Dewidar and *Sheik Al-Gamei'a*...were extremely positive on the future of *Islam* in America and discussed a trend of Americans converting to *Islam* following September 11, 2001.<sup>2230</sup>

It should be noted that many crypto-*Islamists* try to hide and even deny their supremacist agenda and their non-acceptance of pluralism from the non-*Muslim* public in a bid to avoid unwanted attention from the authorities.<sup>2231</sup> Often this just involves changing their tune when talking to non-*Muslims* in English.

*Islamists* and terrorists are practiced in the art of *Takiya*, and besides it is unnecessary to always reaffirm the supremacism already set forth so clearly and forcefully in the *Koran*. The *Koran* says that through *Jihad* and *Dawa*, *Islam* will prevail over all other religions even though other religionists may resist (*K* 009:029, 033; 048:028; 061:009) or even plot (*K* 008:030).

*Islam* further creates the perception of *Muslims* being successful by the *Koran's* saying thirty-six times that non-*Muslims* are **losers** and that they are: 1) of the devil's party, 2) firewood that will fuel hell's fires, 3) diseased in the heart, 4) unclean, 5) vile animals, 6) cattle and 7) enemies of *Allah* (see the Khidr-Second Lamech Logic table for *Koran* citations).

The *Koran* says that non-believers are followers of Satan and fight for Satan, yet they can still be easily overcome because the schemes of Satan are weak (*K* 004:076).

That infidels are the party of Satan and fight for Satan is a reason why *Muslims* often say *Allah Akbar*, literally "*Allah* is greater (than Satan)," especially whenever a *Jihadist* cuts off an infidel's head or otherwise fights the infidel. *Islamic* banners and posters often say *Allah Akbar*, and these are shown in beheading videos and in suicide-bomber last testament videos.<sup>2232</sup> Protesters, who often throw stones and

<sup>2228</sup> Pipes, Daniel. "The Danger Within: Militant *Islam* in America," *DP*, Nov 2001.

<sup>2229</sup> "Top *Bin Laden* aide reportedly urges further attacks: No violence in Egypt, says alleged *Al* *Zawahiri* e-mail," *CNN.com*, 6 Jan 2003.

<sup>2230</sup> Stalinsky, Steven. "Exposed in Translation [from Arabic]," *FPM*, 8 Jul 2005.

<sup>2231</sup> Moore, Art. "Should *Muslim Quran* be USA's top authority?" *WND*, 1 May 2003.

<sup>2232</sup> Rioters chanted *Allah Akbar*: "Arab riot at temple mount..." israelinsider.com, 9 May 2005.

clash with the police, say *Allah Akbar*, as was the case with *Muslims* who in 2005 rained down stones on Jews at the Western Wall.<sup>2233</sup>

The creedal exclamation “*Allah Akbar!*” is so closely associated with crime and terror that it has come to mean “Crazed fanatical mass murderer at work!” Mohamed Atta, one of the leaders of the 9/11 terrorists, wrote:

Shout, *Allahu Akbar*, because this strikes fear in the hearts of the non-believers.<sup>2234</sup>

*The Courier* reported:

...passengers ‘screamed with terror’ when a man of *Muslim* origin started shouting *Allah Akbar* or ‘God is Great’ as their plane taxied for take-off at *Larnaca* Airport in Cyprus yesterday afternoon.<sup>2235</sup>

During the *Adhan* Call to Prayer the *Muezzin* says *Allah Akbar* twice, and he says “Come to success”—the idea being that success will come to *Muslims* because *Allah* is greater than Satan and the party of Satan.

That *Allah Akbar* is used to declare the victory of *Islam* is confirmed by the fact that after paid proselytizing associations of Egypt succeeded in luring away a *Copt* Christian girl to *Islam*, *Muslims* would parade the girl through the streets to taunt Christians. During the parade, *Muslims*...

...played loud music and waved flags while shouting *Allahu Akbar* to declare the victory of *Islam*.<sup>2236</sup>

Someone might ask how *Muslims* maintain the illusion that *Allah* meant for *Islam* to overcome all other religions when after fourteen hundred years only one-fifth of the planet’s population is *Muslim*. Christians do not have this problem because Christ says the way to hell is broad, while the way to heaven is narrow (Mat 07:13-14). Someone might also ask how *Muslims* defend their claim that Christianity and other religions are easily overcome because they are inspired by the devil whose schemes are weak (*K* 004:076).

The answer to the two questions posed above is that *Muslims* find assurance in their eschatology. *Muhammad* said that *Islam* would be plagued by an antichrist, be saved by a messiah, and would fall on rough times where even the *Kaaba* would not be safe. *Muhammad* even predicted that an...

...Abyssinian with short legs who will seek to take out the treasure of the *Kaaba* (*Sunan Abu-Dawud*, bk. 37, no. 4295).

*Muslims* also believe that as long as *Muslims* can wage *Jihad* and terrorism, *Islam* is in the process of overcoming all religion. Furthermore, the mere fact that *Islam* can wage *Jihad* and terror proves that Christianity and Judaism are wrong, for *Muhammad* said in one of the last *Suras* to be written:

The Jews and the Christians say: ‘We are sons of *Allah* and his beloved.’

Say: ‘Why then does He punish you for your sins? Nay, you are but men. He forgives whom He wishes and punishes whom He pleases’ (*K* 005:018).

*Muhammad* is saying that because he was able to slaughter and terrorize Jews and Christians at *Allah*’s command (*K* 008:067), this proves that Jews and Christians abandoned *Islam* and that Judaism and Christianity are the devil’s religions.

<sup>2233</sup> Weiss, Efrat. “2 Israelis wounded in Jerusalem clash: Palestinians hurl stones at Jewish worshippers, clash with police at Jerusalem holy site,” ynetnews.com, 6 Jun 2005.

<sup>2234</sup> “Last words of a terrorist,” *The Observer*, guardian.co.uk, 30 Sep 2001.

<sup>2235</sup> Alexander, M. “Holiday jet passenger tells of terror alert,” thecourier.co.uk, 11 May 2005.

<sup>2236</sup> Shalakamy, Ahmed. “Confessions of a Former *Islamist*,” *FPM*, 24 May 2005, FreeWorldNow.

*Muslims* down through history have operated using this same thinking. The historian Utbi, a contemporary of the *Afghan* Sultan Mahmud of *Ghazni* (971?–1030 AD), wrote:

The *Sultan* returned in the rear of an immense booty, and slaves were so plentiful that they became very cheap and men of respectability in their native land were degraded by becoming slaves of common shopkeepers in *Muslim* lands. But this is the goodness of *Allah*, who bestows honor on his own religion and degrades infidelity.<sup>2237</sup>

Still, in 2005, in *Islamic* thinking, to kill or maim a people is to humble that people and exult *Islam*. For instance, in 2005, a Tunisian group in Germany planned to bomb in order to...

...kill or injure a large number of people...The group's aim was to 'humble western society and hallow the *Muslim* world and its moral concepts.'<sup>2238</sup>

Similarly, in 2005, in London, *Imam* Au Yahya said that...

*Muslims* were constantly being subjected to derogatory names by non-believers in an effort to de-motivate them. The solution was aggression...It says in the *Koran* that we must try as much as we can to terrorize the enemy . . . we terrorize those people who terrorize us.<sup>2239</sup>

*Muhammad's* proof that *Islam* was the true religion and Christian and Judaism were false merely because he could bully Christians and Jews is rather like proof that the Assyrian commander who besieged Jerusalem gave. He said that *Yahveh* had sent him to attack *Israel*, and as proof he asserted that those behind Jerusalem's walls had to eat their own feces and drink their own urine just to survive (2Ki 18:25-27; Isa 36:10-12). *Yahveh* said this was blasphemy, and for this blasphemy *Yahveh* slaughtered 185,000 Assyrian warriors (Isa 37:36-38).

*Muslims* are different in one aspect from the Assyrian commander: *Muslims* actually believe they are doing a service for *Allah* by slaughtering Christians and Jews, similar to what Jesus predicted would happen between Christians and Jews (Joh 16:02).

*Muhammad* had a carnal understanding of religion and did not realize that Christ's kingdom is not of this world (Joh 18:36; 2Co 10:03-05; Eph 06:12-18). Besides, the messiah was prophesied to rule in the midst of his enemies (Psa 110:02), and only promised that Hades would never overcome the church altogether (Mat 16:18). Furthermore, God loves the whole world and gives everyone a time of grace wherein they might repent and believe, so God causes rain to fall on the just and the unjust (Mat 05:45).

*Muhammad* believed that there were only a fixed number of unbelievers sent in order to try *Muslims* to see if they were vigilant in *Jihad* (K 074:031). Therefore, even if *Muslims* do not win the battle, as long as more non-*Muslims* died, *Islam* progresses statistically towards its destiny of dominating all other religions. Thus if suicide bombers take out more unbelievers than *Muslims*, *Islam* wins.

That *Muhammad* thought *Islam* and *Allah* were winning as long as he could inflict casualties on unbelievers becomes apparent from events after the Battle of

<sup>2237</sup> Ghosh, A. "Islam in Action, I," chapter 9, hinduunity.org, accessed 18 Jan 2005.

<sup>2238</sup> Rach, Claudia. "Tunisian Planned 'Violent Jihad' Involvement, Berlin Court Says," bloomberg.com, 6 Apr 2005, *JW*.

<sup>2239</sup> "Focus: Undercover in the academy of hatred," timesonline.co.uk, 7 Aug 2005, *DP*.

*Uhud*, which battle *Muslims* lost. *Al Kalbi* wrote in his *Book of the Idols* about the incident:

*Hubal* was also the same idol which [the Makkan] *Abu Sufyan Ibn Harb* addressed when he emerged victorious after the Battle of *Uhud*, saying: ‘*Hubal*, be thou exalted’ (i.e. ‘may thy religion triumph’); to which the Prophet replied: ‘*Allah* is more exalted and more majestic.’<sup>2240</sup>

*Ibn Ishaq* records that *Muhammad* further said:

We are not equal. Our dead are in paradise; your dead are in hell.<sup>2241</sup>

Thus losing a battle could not prove that *Islam* was a false religion. In *Islamic* thinking, *Muslims* always win because unbelievers can only send *Muslims* to heaven, while *Muslims* send more and more of the “fixed number” of unbelievers to hell, leaving *Islam* stronger globally, if not locally. *Jihadists* often talk about their murders as sending infidels to their predetermined fate, i.e. hell (see the Khidr-Second Lamech Logic table).

*Muhammad* said that despite any losses in battle, *Muslims* would eventually gain mastery because success and loss in battle came in turns (*K* 003:139-140). *Allah* gives power to the true believers (*K* 061:014).

Following *Muhammad*’s example of turning a defeat for *Islam* into a mere test of faith (*K* 003:139-140), *Islamists* who suffer setbacks take comfort and experience *Schadenfreude* when their enemies suffer, whether from terrorism, accidents or disease. For instance, an *Islamist* woman in Egypt, who reads aloud from an oversized *Koran* on a wood stand, had three sons arrested for terrorist-related activities. She then took comfort in the fact that the informers and unwitting informers, including her own moderate *Muslim* husband, suffered while her sons were in jail. *Egypt Today* reported:

God, his wife adds, also stood at her side when her sons were sentenced. ‘While women were screaming and rolling on the floor after we heard the sentences, I kept praying: ‘God! Show me the wonder of Your power against everyone who harmed my sons and bring Your vengeance on them. You destined us for this fate, so keep Your eye on them and me.’” She almost smiles as she describes the calamities that soon befell her sons’ enemies: ‘The one who laid his eye on them and reported them to State Security lost his sight. Another had a heart attack. Even their father [her husband], who stood against them, who led a path different from theirs, suffered his fate [is mostly bedridden but uses a walker around the house].’<sup>2242</sup>

In order to counter the common belief that material wealth indicated God’s favor, *Muhammad* turned this concept on its head and turned non-*Muslim* wealth into potential booty for *Muslims*. *Muhammad* enticed *Muslims* with the vision of a succulent heaven and of looting the Persian and Byzantine palaces. One of *Muhammad*’s early followers said:

*Muhammad* used to promise us that we should eat the treasures of *Chosroes* and *Caesar*.<sup>2243</sup>

<sup>2240</sup> *Al Kalbi. Idols*, p. 24.

<sup>2241</sup> *Ishaq. Sirat*, p. 386.

<sup>2242</sup> *Khattab, Azza. “A House Divided,” egypttoday.com, May 2005, vol. 26, issue 05.*

<sup>2243</sup> *Ishaq. Sirat*, pp. 222, 454.

Later, the “*Andalusian* jurist, *Ibn Hazm* of *Cordoba* (died 1064), wrote that *Allah* has established the infidels’ ownership of their property merely to provide booty for *Muslims*.”<sup>2244</sup>

Whenever non-*Muslims* are wealthier than *Muslims*, *Muslims* figure it is only because *Muslims* are not being faithful enough concerning *Jihad* and ethnic cleansing. *Muslims* also figure that infidels’ having riches is *Allah*’s way of enticing them to go on *Jihad*, and if they did not attack non-*Muslims* and *Dhimmis*, it would be tantamount to denying their religion of *Islam*.

So whenever non-*Muslims* are wealthy and are not well protected against insurgents and terrorists, they are attacked and hated all the more, for instance:

☉ It was reported about Indonesia: “Fletcher cited testimony by a Southeast Asian Studies professor, Sylvia Tiwon of the University of California-Berkeley, that ethnic Chinese, who tend to be more prosperous than their *Muslim* neighbors, remain scapegoats for the country’s economic problems.”<sup>2245</sup>

☉ In *Pakistan* a Catholic man was beaten and left for dead in a field. The victim “*Shahbaz*, drove a tractor for a *Muslim* landlord who was very kind to the young man, which Father Hakim said did not go well with some *Muslims* who want Christians to remain subservient and dependent. This same group, he continued, is unhappy that Christians attend school and do well in their studies.”<sup>2246</sup>

☉ Israelis are often attacked, including *Israeli* Christian Arabs, as *Haaretz* reported: “Some 18,000 people live in *Maghar* [just west of the Sea of Galilee]. Of them, *Druze*, a *Shiite* sect, comprise 50 percent [9,000] of the population, 35 percent [6,300] are *Muslims* and 15 percent [2,700] are Christians. Many people encounter economic hardships in the village, and the ethnic tensions may be a result of animosity between the wealthier Christian population and the poorer *Druze*. *Druze* leaders have been complaining that despite the fact that their sons serve in the military and in the security forces, the government is not rewarding the community, while at the same time Christian youths acquire a higher education and land better jobs.”<sup>2247</sup> From 10 to 13 February 2005, thousands of *Druze* attacked Christian homes and businesses, causing 6,000 Christian Arabs to flee to adjacent towns.<sup>2248</sup> The roof of the only church in *Maghar*, a Greek-Catholic church, was damaged.<sup>2249</sup> The pretext was a rumor that a Christian youth pasted *Druze* girls’ mug shots into a porn picture and posted it on the Internet—a claim police computer experts found to be entirely fabricated.<sup>2250</sup>

<sup>2244</sup> Arnaldez. “*La guerre sainte selon Ibn Hazm de Courdoue*,” vol. 2, 1962, pp. 445-459, as quoted in Boston, Andrew. “*Jihad* begot the Crusades, part 1,” americanthinker.com, 5 May 2005.

<sup>2245</sup> “Violence Against Chinese Christian Women in Indonesia Warrants Asylum, Ninth Circuit Panel Rules Metropolitan,” *News-Enterprise*, metnews.com, 21 Mar 2005, *DW*, 23 Mar 2005.

<sup>2246</sup> “Young *Pakistani* Catholic in critical condition after assault,” *AsiaNews.it*, 26 Apr 2005, *DW*.

<sup>2247</sup> Khoury, Jacky. “*Druze-Christian* clashes cool off in *Maghar*,” *Haaretz.com*, 13 Feb 2005.

<sup>2248</sup> Stern, Yoav. “PID will not try any officers over violent clashes in *Maghar*,” *haaretz.com*, 29 Sep 2005.

<sup>2249</sup> Zur, Yigal. “Sea of Galilee: Cradle of Christianity,” *ynetnews.com*, 9 Jan 2006.

<sup>2250</sup> Khoury, Jack. “Catholic leaders: Israel has abandoned our security,” *haaretz.com*, 15 Feb 2005.

*The Circular Reasoning Used to Get Around the Obvious—That Islam Is Just One Big Self-fulfilling Prophecy*

Someone might ask “How can *Muslims* believe that their bullying Christians and Jews is proof that *Islam* is the true religion and all other religions are false?” Most people would need to see a miracle or an act of God, or God working through history, or some independent process, in order to believe that God favors a particular people or religion.

Otherwise, if people make a prediction and then make the prediction come true through their own determined efforts, they are only fulfilling a self-fulfilling prophecy and God may not have had anything to do with it.

*Muslims* get around the above-mentioned quandary about self-fulfilling prophecies by making themselves out to be agents of *Allah*. First, *Allah* said that he would punish Jews and Christians if they did not convert to *Islam* (K 004:047). Second, *Muslims* believe that when they fight in *Jihad*, they are acting for *Allah*'s cause and with *Allah*'s help, and they believe that *Allah* is acting through them (K 008:012-013, 017; 009:014; 009:123; 059:005).

The thinking that *Allah* acts through *Muslims* to kill even permeates *Muslim* eschatology. The *Sufi* Martin Lings wrote: “God will slay him [the Antichrist] at the hand of Jesus, who will show them his blood upon his lance.”<sup>2251</sup> Terrorists often quote these above-mentioned verses to claim that they are agents of *Allah*:

C In 2005, *CNN* reported about Ayman *Al-Zawahiri*, the No. 2 man in *Al-Qaeda*:

The Arabic language television network *Al-Jazeera* aired on Friday portions of the video by Ayman *Al-Zawahiri*, the No. 2 man in *Al-Qaeda*, ‘Reform and expulsion of the invaders out of the *Muslim* land will only be accomplished by fighting for the sake of God’...He then cited a *Koranic* verse: ‘God said fight them and God will torture them through your hands’ [K 009:014].<sup>2252</sup>

C Bouyeri, the killer of moviemaker Theo van Gogh, said during his trial in 2006:

‘Kill them. Through your hands, *Allah* will punish them’ [allusion to K 009:014]...‘There is no room for ambiguity here,’ Bouyeri noted with satisfaction. “It all very clear, yes, very clear.”<sup>2253</sup>

Of course, even though terrorists and *Jihadists* could quote chapter and verse to supposedly prove they are agents of *Allah*, they often choose not to do so. For instance:

C In 2006, *Shaikh* Abdur Rahman of *Bangladesh* said during his trial over the murder of two judges:

The judges were murdered at the instruction of *Allah*. We should be rewarded, not punished for following the order of killing judges...Those who are engaged in man-made courts, especially lawyers, police and judges, will be punished in the court of *Allah*....Murder to those who are against *Allah*'s law [There are many *Koran* verses against obeying both infidel leaders and non-*Sharia* law

<sup>2251</sup> Lings. *Sources*, p. 330.

<sup>2252</sup> “Bin Laden deputy...message cites *Al-Qaeda*'s three pillars for reform,” *cnn.tv*, 18 Jun 2005.

<sup>2253</sup> Vermaat, Emerson. “Mohammed Bouyeri's Day in Court,” *FPM*, 9 Feb 2006.



that he could have quoted]....I have finished my task by leading a squad to kill the judges according to the instructions of Abdur Rahman.<sup>2254</sup>

☪ *Muslim Sultan Tipu (1753-1799 AD)* said:

I am the chosen servant of prophet *Muhammad*, predestined in the eternal book of fate to root out the infidels from India and cast them into the bottomless pit of hell [There are many verses on *Jihad*].<sup>2255</sup>

---

<sup>2254</sup> “Murder of *Bangladeshi* judges was *Allah*’s will,” khaleejtimes.com, 16 May 2006, *JW*.

<sup>2255</sup> Ghosh, A. “*Islam* in Action, I,” chapter 9, hinduunity.org, accessed 18 Jan 2005.

## Chapter 04: Moon-o-theistic Scripture

### The Legacy of *Muhammad's* Pagan Past

*Ibn Al Kalbi* (died 821-822 AD/206 AH) relates that sometime before 610 AD, *Muhammad* sacrificed to a false god. More than one tradition relates that *Muhammad* sacrificed to Venus. These traditions seem to indicate that at the time *Muhammad* was an independent adult. *Muhammad* admitted:

I have offered a white sheep to *Al 'Uzza* [Venus], while I was a follower of the religion of my people.<sup>2256 2257</sup>

In 605 AD, *Muhammad* still seemed content with his native religion and even took a prominent role in the reconstruction of the *Kaaba* at *Makka*. It was not until *Muhammad* was forty years old, in 610 AD, that he received his prophetic call from the angel *Gabriel*. He then began his twenty-two year career as a prophet that lasted until his death in 632 AD.

Someone might say that the *Koran* shows that *Muhammad's* God was *Yahveh* because it references Jewish and Christian literature. The truth however is that most of the early *Makkan Suras* are filled with astral content. This reflects how *Makka* was a pagan astral worship center barely touched by Jewish and Christian influences.

It is only when *Muhammad* meets Jews in *Makka* that a lot of Jewish content is inserted into the *Koran*. Not until a half dozen years later at *Madina*, during *Muhammad's* last few years of life—did some Christian content get inserted into the *Koran*, as Muir wrote:

The new and leading feature of these chapters is the close connection springing up between Mahomet and the Jewish religion....Up to this period [fifth to the tenth Year of the “Mission” of *Muhammad*, i.e. 615-620 AD] there is hardly any mention of the Christian Scriptures. The available sources of information regarding them were probably as yet imperfect...<sup>2258</sup>

Of the Life of Christ, the statements are accountably meager and mingled with fable. It is remarkable that the passages in which they occur belong solely to the prophet's later years at *Madina*.<sup>2259</sup>

This shows that *Muhammad's* god *Allah* was the moon-god of *Makka* but then *Muhammad* later tried to say *Allah* was the God of the Bible too.

*Muhammad's* message during his first five years of prophethood was not free of astral paganism, as evidenced by many of the *Sura* titles, let alone the content.

Some <i>Makkan</i> Astral and Pagan <i>Suras</i>		
<i>Sura</i>	Order	<i>Sura</i> Name
17	67 <sup>th</sup>	The Night Journey
34	85 <sup>th</sup>	The <i>Sabeans</i>
36	60 <sup>th</sup>	<i>Ya Sin</i> , meaning “Oh [Moon-god] <i>Sin</i> ”
53	28 <sup>th</sup>	The Star
54	49 <sup>th</sup>	The Moon
72	62 <sup>nd</sup>	The <i>Jinn</i>
73	23 <sup>rd</sup>	The Enshrouded One

<sup>2256</sup> *Al Khargushi. Sharaf Al Mustafa*, as cited by Peters. *Origins*, p. 127.

<sup>2257</sup> *Al Kalbi. Idols*, pp. 16-17.

<sup>2258</sup> Muir. *Life*, vol. 2, ch. 5, pp. 183, 189.

<sup>2259</sup> Muir. *Life*, vol. 2, ch. 7, p. 283.

85	22 <sup>nd</sup>	The Celestial Stations
86	15 <sup>th</sup>	The Nightly Visitant
89	35 <sup>th</sup>	The Dawn
91	16 <sup>th</sup>	The Sun
92	10 <sup>th</sup>	The Night
93	13 <sup>th</sup>	Morning Bright
103	21 <sup>st</sup>	Eventide
113	46 <sup>th</sup>	Daybreak

*Muhammad* did not start *Islam* with a clean slate. The astral religion that had filled his life until age forty continued to permeate his religion until he died at sixty-two. For two-thirds of his active life *Muhammad* was a thoroughgoing pagan who sacrificed to pagan deities on a regular basis.

When *Muhammad* became a prophet, he mistakenly thought that *Allah* the moon-god was *Yahveh* of the Bible. So *Muhammad* just mixed in a few Judaistic concepts into the moon-god religion he grew up with and knew well.

*Muhammad* always remained a moon-god worshipper at heart and this affected how the Judeo-pagan religion of *Islam* developed, for instance:

- Ⓒ *Muhammad* said that the astral gods were really godly male angels (*K* 043:016-020; 037:149-153; 043:016; 052:039; 053:019-021, 026-027). This contrasts to how Moses and the New Testament writers unmasked the astral gods as being demons (*Deu* 32:17; *Psa* 106:037; *1Co* 10:20-21).
- Ⓒ In matters of sex and divorce, *Muhammad* selectively followed Abraham and Solomon’s examples (*Gen* 25:06; *1Ki* 11:03). *Muhammad* chose to ignore the example of Adam and Eve as well as Jesus’ dictum that marriage be monogamous (*Mat* 19:07-09; *Mar* 10:04-09). Undoubtedly, Jesus’ view on marriage was one main reason why the lecherous *Muhammad* gave Jesus and the New Testament short shrift.

If *Muhammad* had been able to start from a slate clear of astral religion, his oaths would have been like those of *Yemeni* Christians, as Trimmingham wrote:

‘*Abd Al Malik Ibn Marwan*. Of him the *Aghani* says: ‘I see him as being a Christian because I find him in his poetry swearing by the *Injil* [Gospel], the *Burhan* [clear proofs] and the *Iman* [preacher], which are the oaths employed by Christians’ (*Aghani*, VI, 151).<sup>2260</sup>

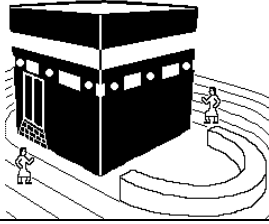
Instead of swearing like a Christian, *Muhammad* swore as though he espoused astralism. The *Koran* has oaths by the night (*K* 027:049; 084:017; 086:001), the sun (*K* 091:001), the sunrise (*K* 089:001; 093:001), the sunset (*K* 084:016), a star (*K* 053:001; 081:015), meteors (*K* 056:075) and constellations (*K* 085:001). *Muhammad* even swears by the moon (*K* 074:032; 084:018).

In addition to the astral oaths, *Koranic* chapters 053, 054 and 081 reek of astralism. Swearing by *Allah* the moon-god right next to the crescent-shaped *Hatim* Wall was the highest form of oath in pre-*Islamic* times (*K* 006:109; 016:038; 024:053; 035:042). Even in early *Islamic* times, oaths mentioned the crescent-shaped *Hatim* Wall, as evidenced in the *Thousand and One Nights*:

By Almighty *Allah*, Lord of the well *Zemzem* [*Zamzam*] and [Lord] of the *Hatim* Wall but that I fear the Omnipotent, the Most High.<sup>2261</sup>

<sup>2260</sup> Trimmingham. *Arabs*, p. 284.

<sup>2261</sup> Burton. *Nights*, vol. 7 (see the sentence annotated by fn. 271).



**Figure 04-01.** *Muslims circumambulating the Kaaba at Makka. Note the crescent-shaped Hatim Wall.*

### **Whether Allah was a War-god from Pre-Islamic Times**

Someone might say that *Allah* could not have been a war-god from Pre-Islamic times since the early *Makkan Suras* were pacific and *Muhammad* and his followers were initially pacifists. This however is an old tale that *Muslims* spun in order to make *Islam* look good. The warlike verses of the early *Makkan Suras* and the warlike nature of nascent *Islam* are discussed in their own sections (see the ToC).

### **Muhammad Selectively Copied the Values That Abraham Retained from the Syncretism of Paganism and Yahvism**

From the Biblical account where it was decided Hagar would be a surrogate mother, it becomes obvious that Abraham and Sarah were making up the rules as they went along (Gen 16:01-03). *Yahveh* had given no command about monogamy but he had given the example of monogamy starting with Adam (Rom 05:14; Mat 19:08).

The surrogate mother idea was partly based on the practice of the pagan indigenous culture and partly on the promise that Abraham would have an heir from his own body (Gen 15:04). In other words, Sarah made Gen 15:04 into a self-fulfilling prophecy just as later Jacob made Gen 25:23 into a self-fulfilling prophecy (Gen 27:36). Later, *Yahveh* said the descendant would come from Sarah's body too (Gen 17:16). This meant that the surrogate mother idea was an erroneous deduction.

Because Abraham came from an astral religion culture, *Yahveh* seems to have used astral religion imagery to describe Abraham's descendants. *Yahveh* said that Abraham's "descendants would be like the stars of the sky" (Gen 15:05).

Sarah may have thought that it was acceptable to resort to an astral religion fertility practice common in her culture, for:

In the *Nuzu* texts the primary purpose of marriage was clearly that of procreation....Quite frequently the marriage contract obliged a wife who subsequently proved to be sterile to supply her husband with a concubine by whom he could obtain an heir. One clause of a marriage contract read as follows:

...The position of the wife was generally protected by the contract so that the concubine was of inferior status in the household.

Abraham was most apprehensive when Sarah determined to expel Hagar and Ishmael because such action was in direct contravention of *Nuzu* law. However, Sarah could have appealed in defense to the ancient *Sumerian* law-code of *Lipit-Ishtar* (~1850 B.C.) which stated that the freedom received by a dispossessed slave was adequate compensation for the act of expulsion.<sup>2262</sup>

Based on the surrogate mother practice as well as Abraham's practice of slavery and polygyny, one can see that Abraham and Sarah were making ethical judgments based in part on the laws and morality prevalent in the moon-god worship centers in

<sup>2262</sup> Harrison, R.K. *The Archeology of the Old Testament*. Harper & Row, NY, 1963, pp. 26-27.

*Ur* and *Haran*. The laws and morality of the *Canaanites* disgusted the patriarchs (Gen 15:16; 27:46—28:08).

Abraham may have limited himself to one wife based on Adam's example (Gen 02:22-24; Mat 19:07-09; Mar 10:04-09) but then deferred to the moon-god morality prevalent in the Mideast by taking several concubines (Gen 25:06).

Even Moses did not think that the Bronze Age was the right time to crusade against divorce (Mar 10:05), polygyny (Deu 21:15), slavery and servitude (Exo 21). Moses only regulated such practices, which does not amount to excusing, condoning or promoting them. Israel was the only place in the world where slaves had any protections at all (Exo 21:20-21; Lev 19:20; 22:11; 25:39-41; Deu 21:11; 23:15). Later, St. Paul says slave-traders were on the same level as adulterers, perverts, perjurers and liars (*NIV* 1Ti 01:09-10).

### Abrahamic Values

Some *Muslims* would like the West to adjust its terminology to be more inclusive. Rather than saying the West is built on Judeo-Christian values, *Muslims* want everyone to say “Judeo-Christian-Islamic” values, or just plain “Abrahamic” values. “After all,” *Muslims* say “the three world religions stem from Abraham.”<sup>2263</sup>

The reason however that the phrase “Judeo-Christian values” is hyphenated is that Jews and Christians recognize that our set of moral values is to a great extent comparable, compatible and complementary, for instance:

- We both follow the Ten Commandments, though with differing interpretations of them.
- Christians are monogamous and for the most part Jews are too. The *Ashkenazi*, meaning European, Jews became monogamous as a rule starting in the eleventh century AD.<sup>2264</sup>

Polygyny is against the law for Jews in modern *Israel* but some *Israeli* Arabs are polygynous. Christians are monogamous as a rule. Jesus and Paul said that the ideal God set for marriage was one man and one woman (Mat 19:05, 08). Moreover, *polygynous* men were prohibited from being appointed bishops, deacons and elders (Eph 05:31, 33; 1Ti 03:02, 12; Tit 01:06). The reason the prohibition was necessary is that former pagans and Jews populated Christian churches during the Apostolic period.

Christians follow the Second and Greater Moses, Jesus, rather than the First Moses. Christians are not bound by Jewish temple, civil and ceremonial regulations (Joh 04:21-23). Similarly, Jews determined that many parts of the Mosaic law code do not apply at this time, mostly because the temple was destroyed and the Jewish state ended in 70 AD. Since that time Judaic practice gradually has become comparable to Christianity in many respects.

Jews no longer have a theocracy and religious freedom is known in *Israel*, but it does not permeate *Israeli* society and law as thoroughly as in many countries. In Old Testament times, the priests were responsible for day-to-day ritual maintenance but the rulers were to police the populace (Deu 17:03-05).

Jesus also established the Doctrine of the Two Kingdoms, the Kingdom of Power and the Kingdom of Grace, when he said “pay unto Caesar what is Caesar's,

<sup>2263</sup> Spencer, Robert. “Judeo-Christian-Islamic Values?” *FPM*, 26 May 2003.

<sup>2264</sup> Smith, Christopher. “Polygyny's Practice Stirs Debate in Israel,” *Salt Lake Tribune* (posted at polygynyinfo.com), 7 Dec 2001.

and unto God what is God's" (Mat 22:21). Jesus and later Paul, legitimated "the powers that be," whether they were pagan or not, insofar as they intimidate evildoers more than they intimidate law-abiding citizens (Rom 13:01-04).

A theocracy was part of the Old Covenant where believers were treated as though they were servants or children (Gal 03:24-25; 04:01-06). Under the New Testament covenant, Christians are treated as spiritual adults rather than as minors, because Christians are sent a greater measure of the Spirit (Joh 14:16, 26; 15:26; 16:07; Gal 03:02, 03, 05, 14; 04:06, 29).

### Is Christianity Morally Equivalent to Islam?

Knowing the information in the above section helps to dispute the following mistaken and wildly optimistic assertion made in *The Jerusalem Post*:

The reason Christians don't kill or persecute Jews anymore isn't because those differences [between the three main monotheistic faiths] have been resolved but because they primarily live in democratic societies which in varying degrees maintain a church/state separation and where religious discrimination has been outlawed. Radical *Islam* will also abate when *Muslim* states go down the same path of development.<sup>2265</sup>

Unfortunately, the above op-ed writer speaks of separation of church and state as a policy imposed upon Christianity rather than as a policy that modern states inherited from Christianity (Mat 22:21). The only thing that has changed is totalitarian elitists have used the courts and the separation of church and state doctrine to hijack the school system and turned it into a propaganda organ and lengthy re-education camp that teaches children about the glories of socialism, evolutionism, multiculturalism, moral relativism and political correctness.

If evolution was so factual and indisputable, why not use evolution textbooks from forty or fifty years ago? Do the earth layers containing fossils re-shuffle themselves every few years? Or is nature evolving so quickly that evolution textbooks become dated within a mere decade?

The courts have abused both science and the separation of church and state doctrine because if there were no Bible, scientists would now be seriously investigating the theory that the universe was created, and that theory would be considered science and reverse-engineering and not religion at all. Yet because the Bible says the universe was created, the court deem the idea that the universe was created as religion and not science, so that branch of research cannot receive any funding nor be taught in public schools.

Far from being a panacea, the potential democratization and secularization of *Muslim* society ought to be a major cause of concern since it was only after evolutionists hijacked the public school system, and only after secularist forces came to the fore that the Armenian genocide occurred in Turkey (confer Young Turks), the Holocaust occurred in Europe, and genocides occurred under Stalin, Mao and other dictators.

Killing Jews is antithetical to God's message of love found in the New Testament. Killing Jews is completely compatible with the 164 War verses in the *Koran*.

In the past Christians only killed Jews when Western society lapsed from the norms of love set in the New Testament, ignored the clear message of the Parable of

<sup>2265</sup> Ben-David, Calev. "Snap Judgment: There's something about Mary," jpost.com, 31 Dec 2003.

the Tares and followed other philosophies, becoming Christian in name only. It should be noted that scoundrels such as the Nazis are commonly thought to be Christian, yet they despised Christianity and wanted to eliminate it.

As to Ben-David's assertion that *Islam* will follow the separation of church and state route—this is doubtful. Ideally, Jews had a constitutional monarchy because this is what Moses commanded (Deu 17:18-19; 31:28; 2Ki 23:02-03).

The Christian West developed better forms of government because the populace read the New Testament. The New Testament teaches a certain separation of church and state or, as it is better called, the Doctrine of the Two Kingdoms—the Church ruled by Scripture, and the State ruled by right reason.

By contrast, terrible *Muslim* governments arise because the governed are reading the hate-literature called the *Koran*. Governments are only a reflection of the people's values and outlook, but unfortunately, *Muslims* get their values and outlook from the *Koran*. "People get the government they deserve," as the saying goes.

Unlike the New Testament, the *Koran* seeks no Separation of *Mosque* and State. In fact, the *Koran* promotes the idea of a theocratic *Caliphate* that systematically discriminates against minorities via *Sharia* law and attempts to conquer the world whenever the opportunity presents itself.

The *Koran* with its 164 War verses is ethnocidal and genocidal, so *Muslim* rulers that govern *Koran* readers tend to be repressive, ethnocidal and genocidal—as the situation warrants.

So to conclude this section, even if there were true separation of church and state in *Islamic* lands, that government would be considered an apostate or infidel occupying power. It is unlikely that such a government would last long since it would not have the consent of the governed. *Muslims* would tend to vote in *Islamist* governments that would enforce *Sharia* law.

### Free Speech is a Judeo-Christian Value but Not an Islamic Value

Separation of church and state means the absence of a theocracy, so free speech reigns even when religion is the topic of discussion. Saint Paul stated the rationale for freedom of speech in religious matters. Paul stated that the proponents of truth could be identified through discussion and debate:

When you come together as a church, there are divisions among you...No doubt there have to be differences among you to show which of you have God's approval (1Co 11:18-19).

Perhaps the most explicit and consistent modern proponent of free speech, John Stuart Mill (1806-1873), was inspired by Paul's words. Stanley Kurtz wrote:

Our modern notion of free speech and the related concept of academic freedom, derive from John Stuart Mill's *On Liberty*. In that great work, Mill argued that free speech is premised on society's need to discover the truth. By banning a right opinion, we deprive ourselves of the opportunity to exchange an error for truth. But by banning a mistaken opinion, said Mill, we lose something almost as precious—the clearer perception of truth that is produced by its collision with error. If no opponents are available to put your ideas to the test, said Mill, you should invent arguments against your own beliefs.<sup>2266</sup>

Freedom of speech and religion were evident even in Old Testament times in that God allowed whole nations to stray, yet sent erring peoples rain and put joy in

<sup>2266</sup> Kurtz, Stanley. "Reforming the Campus: Congress targets Title VI," *NRO*, 14 Oct 2003.

their hearts (Mat 05:45; *Acts* 14:17; 17:30). Saint Stephen said that, even during the forty years in the desert when *Yahveh* sent *Manna*, the *Israelites* of the *Exodus* still sacrificed to false gods (Act 07:42). When the *Israelites* did grievous wrongs, *Yahveh* separated himself from them so as not to destroy *Israel* (Exo 33:03, 05).

Even in the theocracy of ancient *Israel*, people were free to leave and many did. The Old Testament is, for the most part, about powerless and unheeded prophets who warned people about the wages of sin over a period of a thousand years.

Some complain that the Old Testament may seem a bit harsh at times but not compared to graphic violence promoted in the *Koran* or reported in the everyday newspaper. The violent passages in the Old Testament have not been implicated for any genocide or ethnocide that approaches the killing done in the name of *Islam*, *Naziism* or communism.

Most of the Old Testament punishments were long in coming and did not come directly from the hand of *Yahveh* or his representatives. *Israel's* hereditary enemies caused most of the suffering recorded in the Old Testament, such as the *Babylonian Exile*. This meant that God was responsible for the peace by protecting *Israel* but war resulted when the protecting Father was forced to abandon *Israel* because they ran away from *Yahveh's* protection.

By contrast, the *Koran* was written within a period of twenty-three years, and heaven help anyone who hesitated to convert to *Islam*. In *Islam*, most of the punishments that befell unbelievers came at the hands of *Muslims* at *Muhammad's* behest. Not surprisingly, another Judeo-Christian concept that is sadly lacking in the modern theocratic *Islamic* world is the practice of freedom of speech.

Shockingly, the West has imported many extremists (i.e. literalists) from the Mideast. These *Islamic* terrorist sympathizers find a home in many university Mideast Studies departments, most of which are tax-subsidized and tax-exempt.

The situation is similar to how during the Cold War (1917-1991 AD), many universities were staffed with tenured communist sympathizers. Barry Rubin writes about the current situation:

Equally startling is how weak the liberal forces remain. There is no great liberal theorist or reform advocate who galvanizes people in the Arab world. There is no major original book which provides a manifesto for moderation and no powerful political party or movement pushing for democratic change...

Contrary to what many people are saying the Middle East has been more effective at exporting authoritarian and extremist (i.e. literalist) thought to the West than the West has been in exporting democratic thinking to the Middle East.

Look, for example, at the global wave of anti-Semitism; the wacky views of the region held by so many in Europe and America; the intellectuals who apologize for terrorism; media coverage which is becoming increasingly bizarre; radical *Islamist* activities in Europe; and the way that Middle East studies are taught in university classrooms. Who is having more impact on whom?<sup>2267</sup>

That "true-believer" *Muslims* staff Mideast Studies departments definitely is a boon to the terrorists. This undoubtedly means the War on Terror will be prolonged just as having the universities and newspapers staffed by communist sympathizers undoubtedly prolonged the Cold War by decades. For instance, how can the *Koran*

<sup>2267</sup> Rubin, Barry. "The Region: Arab liberals—endangered species," jpost.com, 16 Dec 2003.



and its 164 War verses be delegitimized any time soon when “academic research on the *Quran* lags centuries behind academic study of the Bible”?<sup>2268</sup>

Before WWII, the *Nazi* and communist sympathizers in universities and newspapers kept America in its isolationist mode and out of the war for a long while, and this delay may have led to the US to arm communist Russia. This allowed the communists to steamroll over East Europe toward the end of WWII, which suited many professors and journalists just fine.

Communists who passed themselves off as “campus liberals” organized most of the demonstrations against the war against Vietnamese communists, and against the superpower arms race with the communists. Similarly, *Muslims* have organized most of the demonstrations on campuses. These demonstrations have been against wars with terrorist-hosting countries, against laws meant to combat terrorism and against critics of *Islam*.

Nowadays, in many universities the tenured Marxists and *Islamists* teach side-by-side since there is no shortage of either school of thought in *Muslim* countries. Most Mideast academics and aca*Dhimmis* subscribe to the teachings of Karl Marx, Michel Foucault (1926-1984) and Edward Wadi Said (1935-2003).

These totalitarian professors believe that any competitive and free market is oppressive, whether the product being bought and sold is widgets or ideas. In keeping with their anti-competitive spirit, totalitarian professors have been successful at freezing out of the universities all thought and scholarship that does not conform to their version of orthodoxy.

*Islamist* sympathizer professors also relish killing the academic careers of students with conservative values by giving them mediocre grades. Those students who do not fight thought control are rewarded with good grades, while students who commit the “thought crime” of freethinking are punished with bad grades. Pundits have observed that conservative students and scholars who are marginalized or winnowed out of academia entirely, tend to end up working in think tanks or working for the government.

All too many, perhaps the vast majority of, wayward universities have become autocratic, one-party regimes—totalitarian bastions that dot the landscape of every democracy. The common thread in all the major ideologies popular on campus is that they involve totalitarianism and mass death. Professors, it seems, find “beautiful ideas that kill” very appealing. Death is why:

- ☉ Environmentalism is popular on campus, because it involves reducing the planet’s human population by two-thirds down to two billion.
- ☉ Abortion, euthanasia and assisted suicide are sacred rites for academicians.
- ☉ The death penalty is despised on campus because convicted murderers and fallen dictators are folk heroes to academics.
- ☉ Evolutionism and Natural Selection are unquestionable theories on campus.
- ☉ Marxist communism is popular with professors since it killed 100 million people in less than a century.<sup>2269</sup>

<sup>2268</sup> Schub, Michael B. “That Which Gets Lost in Translation,” *Middle East Quarterly*, meforum.org, Fall 2003.

<sup>2269</sup> *The Black Book of Communism: Crimes, Terror, Repression*, as quoted by Reedy, Jeremiah. “The Black Book of Red Blood,” *FPM*, 8 Oct 2003.

- ⊙ The anti-Christmas holiday called *Kwanzaa*, invented by a convicted felon, is popular on campus since it celebrates Marxist collectivist principles at the expense of individual freedoms (*Swahili: Uhuru*).<sup>2270</sup>
- ⊙ *Islamic, Jihadist* and terrorists' causes are popular, as well as economically and academically boycotting the terrorists' primary victims.

### Equality of All Men and Women a Judeo-Christian Value

More can be said about Judeo-Christian values versus *Islam's* pagan values. For instance, Judeo-Christian values largely stem from the teaching that both men and women are created in the image of God (Gen 01:26-27; 09:06). This belief elevates the position of women in society *vis-à-vis* men. Also, because humans are made in the image of God, possessing orthodox opinions or beliefs is not deemed more important than possession of human life since human life is precious in God's sight.

Because life is precious, God is patient with those in error in the hope that they will eventually come around to the truth (Act 17:27). Also, *Yahveh* cares for believers as though they were the pupil of his eye (Deu 32:10; Psa 017:08; Pro 07:02; Zec 02:08).

Of course if the sign of one's god is a sharp, pointy crescent-moon, then human life and opinions are cheapened. That is because the moon rises and sets the same regardless of whether there are massacres occurring right underneath the moon's glare. The moon-god never even appears to look askance at any great evil happening below.

*Islam's* symbol could have been the peaceable tool of harvest, the sickle; instead they inverted it to the unnatural purpose of murder, and made it the scimitar.

*Muslims* have a book that incites them to threaten others with knives, swords and other arms. In fact, photos of many parades in the Mideast show swarms of angry *Muslims*, some holding a bowie knife, machete or assault rifle in one hand and a *Koran* in the other. This is entirely fitting since the *Koran* is war-and-moon-god literature.

Not surprisingly, the *Koran* provides no constructive solution to the problematic human condition. The *Koran's* answer for problems encountered in proselytizing and policing is to kill or maim. *Sharia* law's solution to most problems is to amputate hands, feet and ears, as well as to whip, torture, behead and stone people to death.

Moses by contrast always kept in mind that people were made in the image of God (Gen 01:26-27; 09:06). Moses commanded that even "a wicked man worthy of being beaten" should first receive due process before a judge. Moreover, the judge should not absent himself when the punishment is administered.

In Mosaic law, no man was supposed to receive more than forty lashes lest the man seem degraded (dehumanized), and to avoid brutalizing the citizenry and executioner in the sight of the *Israelites* (Deu 25:03). Notably, this gives rise to the dictionary term "civil death." Civil death is the maximum penalty that can be exacted short of execution. It is recognized that if forty stripes will not reform an evildoer, neither will any number. In other words, if someone deserves more than forty stripes, he should be executed as an incorrigible to avoid brutalizing the flogger.

Jews reduced the forty lashes down to thirty-nine just in case there was a miscount. So though Jews hated Saint Paul, each of the five times he was whipped by Jews, Paul received only forty-minus-one lashes (2Co 11:24). *Islam* however

<sup>2270</sup> Rosendall, Richard J. "Shopping for Roots," *FPM*, 24 Dec 2003.

routinely exacts more lashes, even hundreds of lashes, because *Islam* is in the business of dehumanizing non-*Muslims* and disliked *Muslims*.

There is no verse in the *Koran* that says humans are made in the image of God. This is not surprising given the fact that in moon-god religions, the crescent is the main symbol of the moon-god, and humans are not made in the image of a crescent. One CAN however find in the *Koran* that unbelievers are “enemies” (K 002:098; 008:060; 009:114; 041:019, 028), “unclean” (K 009:028), “vile animals” (K 008:022, 055) and cattle (K 007:179).

*Muhammad* encouraged subduing and humiliating non-*Muslims* and killing them if they did not submit and willingly pay excessive taxes. Moses, in contrast, said that there was to be only one manner of law for both Jew and gentile (Lev 24:22), so no unbeliever was supposed to be dehumanized nor considered “vile” (Deu 25:03).

If Moses thought forty-one lashes would cheapen a person so that he no longer seemed human surely Moses would have objected to some of *Sharia* law’s punishments. One cannot find in the Mosaic law any punishments such as amputation of feet, hands and ears.

You can find an eye and an eye and a tooth for a tooth but that is not for things like thievery; it is ONLY in case another person destroyed an eye or a tooth. Mahatma Ghandi sounded very pious and humane when he said that the result of it would be that the whole world would be blind and toothless but in fact that is not the way it works. With 3500 years of Jewish history to examine, we do not find that blood feuds were common in Judaism.

Given *Muhammad*’s low valuation on human life, it is not a surprising that history records *Muhammad* having three men lashed eighty times. They received this whipping merely because they spread gossip—gossip that may have been true.<sup>2271</sup> Moreover, *Muhammad* said the damned in hell were to be whipped with whips of iron and would otherwise be dehumanized (K 022:021).

So what *Islamic* values do *Muslims* bring to the Judeo-Christian values mix? Draconian punishments even for misdemeanor offenses and petty theft? Polygyny? Misogyny? Easy divorce? Preteen marriage? Subjugation of women? Rampant bisexuality? Slavery? Blind hatred of “the other”? Religious intolerance? Khidr-Second Lamech Logic terrorism? Bigotry? Anti-Semitism? Anti-Christianity? Tyrannical governments? Governments run on nepotism and bribery?

One can see that hyphenating “*Islamic*” to “Judeo-Christian” values makes about as much sense as hyphenating other antonyms and antithetical concepts. Why not also hyphenate Christ-Antichrist, capitalism-communism, matter-antimatter, thesis-antithesis, liberal-conservative, the left-the right and whatnot? Thus the only sign between “Judeo-Christian” and “*Islamic*” values ought to be the “not equals sign” (<> or ≠), or the “vs.” abbreviation, meaning “versus.”

### Marrying One’s Own Relatives

In a discussion of what values Abraham retained from paganism, one must discuss another sexual practice that moon-god worshipping cultures gleaned from the sky, specifically, consanguineous marriages, i.e. inbreeding (Gen 20:12).

It was generally accepted in the pagan Mideast that the moon-god fathered many astral beings and had several favorites and many concubines along the ecliptic. There are only five thousand stars visible to the naked eye, so it was thought that if every

<sup>2271</sup> Ishaq. *Sirat*, pp. 494-497.

male astral being followed this practice, the sky would be a tribe where everyone was closely related. This marital practice was transferred from the sky down to the earth.

Moon-god religion was dominant in Arabia, especially in southern Arabia. So it is not surprising that *The New York Times* reported:

Across the Arab world today an average of 45 percent of married couples are related...in some parts of *Saudi* Arabia, particularly in the south...the rate of marriage among blood relatives ranges from 55 to 70 percent, among the highest rates in the world, according to the *Saudi* government.

Widespread inbreeding in *Saudi* Arabia has produced several genetic disorders, *Saudi* public health officials said, including the blood diseases of thalassemia, a potentially fatal hemoglobin deficiency, and sickle cell anemia. Spinal muscular atrophy and diabetes are also common, especially in the regions with the longest traditions of marriage between relatives. [A doctor] said she had also found links between inbreeding and deafness and muteness.<sup>2272</sup>

The same situation pertains elsewhere in the Mideast, for instance:

According to Shalev's statistics for villages in northeastern *Israel*, 24 percent of Arab men marry their first cousins, 9 percent second cousins and 13 percent third cousins. This obviously increases the chances for genetic defects among these closely related couples.

'The congenital malformation rate in these groups is 6-9 percent which is among the highest in the world. In the Western world the rate is only 3 percent, so there are lots of potential consequences to deal with here, especially recessive and chronic disorders-sickle cell anemia, cystic fibrosis etc.,' Shalev pointed out.<sup>2273</sup>

In 1997, the Palestinian Academy Society for the Study of International Affairs (PASSIA) notes that 27.2 percent of marriages in *Gaza* and 31.6 percent of marriages in the West Bank involved first cousins. Likewise, 47.4 and 51.8 percent involved the extended family, and 3 and 4.4 percent were polygamous.<sup>2274</sup>

In *Israel* "in 2002, the annual infant mortality rate was 4.0 per 1,000 live births among Jews and 9.0 among Arabs.<sup>2275</sup> In 2004, the figures were 2.46 among Arab Christians, 3.17 among Jews, 9.52 among *Muslims*, and 15.8 among *Negev Bedouin*. According Prof. Yona Amitai, director of the ministry's Department of Mother, Child and Adolescent Health, half of the difference in rates is attributable to prevalent socio-economic conditions and the other half is attributable to birth defects arising from inbreeding (consanguineous marriages) prevalent among *Muslims*.<sup>2276</sup>

In Turkey in 2006, the *BBC* produced a documentary that supposedly supports monkey-to-man evolution. The de-humanized subjects were a retarded family that walks hunched over on its palms and feet due to an unfortunate genetic mutation. The parents probably were first cousins.<sup>2277</sup>

<sup>2272</sup> Kershaw, Sarah. "Saudi Arabia Awakes to the Perils of Inbreeding," nytimes.com, 1 May 2003.

<sup>2273</sup> Stephens, Kenneth and Biolsrael. "Genetic testing makes a difference for Israeli Arab families," 21<sup>st</sup>-century Israel, Israel21c.com, 14 Mar 2004.

<sup>2274</sup> "12: Society & Living Conditions," Palestinian Academy Society for the Study of International Affairs, passia.org/palestine\_facts/pdf/pdf2004/12-SOCIETY-LIVING.pdf passia.org, p. 294.

<sup>2275</sup> Siegel-Itzkovich, Judy. "Experts: Inbreeding main cause of Arab infant mortality," jpost.com, 15 Aug 2005.

<sup>2276</sup> Reznick, R. "Infant mortality gap widens between Jews and Arabs," haaretz.com, 25 Aug 2005.

<sup>2277</sup> Looy, Mark. "A feet of imagination: A TV program tonight stoops low to showcase evolution," AiG-USA, answersingenesis.org, 17 Mar 2006.

The habits and mores of the moon-god religion, such as FGM and inbreeding, are spread throughout *Islamdom*, so that *Pakistanis* marry their in-laws even if they emigrated to Britain and must import them from *Pakistan*, as the *BBC* reported:

It is estimated that more than 55 per cent of British *Pakistanis* are married to first cousins, resulting in an increasing rate of genetic defects and high rates of infant mortality. The likelihood of unrelated couples having the same variant genes that cause recessive disorders are estimated to be 100 to 1. Between first cousins, the odds increase to as much as one in eight. In Bradford, more than three quarters of all *Pakistani* marriages are believed to be between first cousins. The city's Royal Infirmary Hospital has identified more than 140 different recessive disorders among local children, compared with the usual 20 to 30.<sup>2278</sup>

Similarly, German *Muslims* pay “handsome” prices for “underage girls” who are flown from *Anatolia* in the Turkish heartland to Berlin to serve as “imported brides,” adding to “the parallel society.” German *Muslims* must accede to their families’ desires, which often means marrying a cousin, because otherwise...

...A groom who chooses his own wife faces threats...the groom as well as the bride must go underground to escape the families’ revenge.<sup>2279</sup>

Widespread inbreeding for fourteen centuries in *Islamdom* remind one of how the royal families of Europe engaged in inbreeding for centuries, most evident by the high incidents of hemophilia and other congenital ailments. One wonders though how many senseless slaughters in the past were a result of inbreeding-induced madness wherein it seemed right and proper to national decision makers that soldiers, even millions of soldiers, sacrifice their lives merely for the sake of national honor. Today, with terrorism becoming more prevalent than ever, one wonders whether the *Koran* has a greater and more destructive hold over *Muslims* after fourteen centuries of cousins marrying cousins than it did in *Muhammad*'s time.

### Astral Stories in the *Koran*

Scholars have readily noted that, especially regarding the *Hajj*, obvious pagan elements were spiritualized to give *Islam* its astral religion form. *AcaDhimmis* have largely left unstudied how the doctrines of *Islam* are derived from astral-religion sources. Some of these astral doctrines are derived from astral stories in the *Koran*.

*Muhammad*'s contemporary critics noted that the *Koran* was composed of many ancient stories (*K* 006:025; 008:031; 016:024; 023:083; 025:005; 027:068; 046:017; 068:015; 083:013). Astral worshippers composed many of the ancient stories in the Mideast with which *Muhammad* would have been familiar. So naturally, the *Koran* contains a few astral stories in addition to the stories borrowed from other sources such as Jewish and Christian folklore.

### *Zulqarnain*

*Muhammad* tells of king *Zulqarnain* who went on some travels and found that the sun set in a “muddy spring” (*Pickthall K* 018:086) or “a spring of murky water” (*Yusuf Ali*). *Tabari* (839–923 AD) also confirms the “muddy spring” interpretation.<sup>2280</sup>

<sup>2278</sup> Giannangeli, M. “Ban Asian marriages of cousins, says MP,” telegraph.co.uk, 16 Nov 2005.

<sup>2279</sup> Schneider, Peter. “The New Berlin Wall,” translated by Philip Boehm, nytimes, 4 Dec 2005.

<sup>2280</sup> *Al Tabari. History*, vol. i, p. 234.

The meaning of this particular moon-god tale is rather obvious. That the traveling king wore a crown with a crescent indicates that the king is a moon-god worshipper. In the ancient Mideast, the two highest gods were the sun and the moon. The lone crescent rather than a crescent-and-orb, or a ring crescent and sun, indicates the king's preference for the moon.

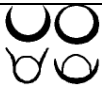
Curved animal horns, due to their shape, were associated with the moon. The crescent-moon was thought to have two horns or cusps. That the cusps of the moon are conjoined mattered not because some species of bull appear as though their horns conjoined over the forehead.

That horns represented the moon is why moon-god priests wore headgear with two horns, moon-god idols appeared as humans with heads fitted with two horns and moon-god altars had two horns. For instance, one *Haran* Roman-era coin shows a moon-god altar with very large horns.<sup>2281</sup> Gibb and Kramers say about *Zulqarnain*:

The two horns go back to an old mythological idea. *Naram-Sin* was for example represented as *Adad* with two horns (on the stele of *Susa*; cf. *Fouilles a Suse*, i., pl. x).<sup>2282</sup>

The *Larousse Encyclopedia of Mythology* provides an example of a myth where the two horns of the moon are mentioned. In this creation myth, the Jupiter god *Marduk* happens to be the high god who instructs *Sin* the moon-god. By the way, the role of high god is sometimes flip-flopped in the Mideast between the sun and moon, and Jupiter and the moon, due to religio-political anomalies. The *Larousse Encyclopedia of Mythology* reads:

At the month's beginning to shine on earth,  
Thou [i.e. you meaning *Sin*] shalt show two horns to mark six days.  
On the seventh day divide the crown in two;  
On the fourteenth day, turn thy full face.<sup>2283</sup>



**Figure 04-02.** Crescent, Ring *Clypeus* (*Clypeus* is Latin for “round shield”) Crescent, Horns and Orb, and Crescent-and-Orb.

That the sun set in a mud puddle while the king stood by wearing a moon crown was tantamount to promoting moon-god monotheism. The sun was denigrated and the moon-god monotheism was affirmed. Thus the purpose of this story is the same as most stories in the *Koran*. It is to call people to monotheism and away from idol worship and polytheism.

This interpretation is congruent with the fact that the *Koran* has chapters entitled “The Moon” (*K* 054) and *Ya Sin* (*K* 036)—*Ya Sin* meaning “Oh moon-god *Sin*”—and a miracle of *Muhammad* is associated with each of these *Suras*.<sup>2284</sup> There is however no corresponding *Koran* chapter entitled “The Sun.” The *Koran* espouses moon-god monotheism. The anti-solar *Koran* rejects the sun since it is the only astral object that outshines the moon-god *Allah*.

### *Who Is King Zulqarnain?*

Ameer Ali wrote about King *Zulqarnain*:

<sup>2281</sup> These artifacts are discussed elsewhere in this book (see the Thumbnail Gallery).

<sup>2282</sup> Gibb & Kramers. *Encyclopedia*, p. 76, *Dhu'l-Karnain* entry.

<sup>2283</sup> *Larousse*, *Sin* entry, p. 56.

<sup>2284</sup> *K* 054:001 is about the Splitting of the Moon miracle, and *Muhammad* said *K* 036:001-008 when he hypnotized some *Mekkan* pagans and sprinkled dust on their heads (Wakidi (W.), 51, as reference by Margoliouth. *Rise*, p. 154 & fn. 3; also see Ishaq. *Sirat*, p. 222.)

There is considerable doubt as to the identity of *Zu'lkarnain*. Several Mohammedan historians have thought that the *Zu'lkarnain* referred to in the *Koran* is identical with Alexander the Great. This opinion however is open to question. *Zu'lkarnain* in its primitive sense means 'the lord of two horns.' When we remember the headdress worn by the ancient *Sabaeans* sovereigns, the crescent-shaped moon with its two horns, borrowed probably from Egypt about the period of this king, there can be little room for doubt that the reference in the *Koran* is to some sovereign of native origin, whose extensive conquests became magnified in the imagination of posterity into a worldwide dominion. Lenormant thinks that *Shaddad* [King of the Tribe of *Ad*, whose prophet was *Hud* (*K* 007:065; 011:050, 060)], *Zu'lkarnain* and [Queen] *Balkis* were all Kushites [Ethiopians].<sup>2285</sup>

What Ameer Ali wrote agrees with what *Muhammad's* biographer, *Ibn Ishaq*, thought of *Zulqarnain*. *Ishaq* seemed to believe that the Queen of *Sheba*, *Zulqarnain* and King *Tubba* of *Yemen* were all good *Muslims* in a single dynastic line.<sup>2286</sup>

### *The Legend Behind Zulqarnain*

It seems that *Zulqarnain* was a legendary figure from *Yemen*, as was stated above. However, the stories about *Zulqarnain* were probably derived from different sources. For instance, legends about *Gilgamesh* may have become legends about *Zulqarnain*.

Both *Zulqarnain* and *Gilgamesh* were travelers to seas and mountain passes (*K* 018:093-094). *Gilgamesh* passed through a mountain pass called *Mashu* that was guarded by scorpion men in order to talk to *Shamash* the sun-god.<sup>2287</sup> *Gilgamesh* was searching for eternal life. This spiritual aspect to *Gilgamesh's* story, *Muhammad* may have thought, qualified him for inclusion in the *Koran*.

That this crescent-wearing pre-Islamic king is described as though he were a good *Muslim* shows that *Muhammad* thought that *Zulqarnain* worshipped *Allah* the moon-god (*K* 018:089-098). *Muhammad* equated *Allah* with *Sin*. Significantly, *Gilgamesh* also worshipped *Sin* the moon-god. The *Gilgamesh Epic* reads:

At night when he [*Gilgamesh*] came to the mountain passes *Gilgamesh* prayed: 'In these mountain passes long ago I saw lions, I was afraid and I lifted my eyes to the moon; I prayed and my prayers went up to the gods, so now, O moon-god *Sin*, protect me.'<sup>2288</sup>

*Gilgamesh's* prayer to *Sin* for protection against lions while he was traveling is rather like *Muhammad's*. The *Hadith* writer *Abu-Dawud* records:

When the Apostle of *Allah*... was traveling and night came on, he said... 'I seek refuge in *Allah* from lions...'<sup>2289</sup>

### *What Muhammad Thought Zulqarnain May Have Looked Like*

Believe it or not, *Muhammad* the storyteller sometimes described the looks of various biblical figures he mentioned such as Jesus and Moses. Naturally,

<sup>2285</sup> Ali. *Spirit*, p. lxiii.

<sup>2286</sup> Ishaq. *Sirat*, p. 12.

<sup>2287</sup> Pritchard. *Ancient*, I:62, from what remains of Tablet IX.

<sup>2288</sup> Anonymous. *Gilgamesh*, "The Search for Everlasting Life." Also, Pritchard. *Ancient*, I:62, middle of Tablet IX.

<sup>2289</sup> *Sunan Abu-Dawud*, bk. 14, no. 2597.

*Muhammad* claimed that *Ibrahim* looked most like himself.<sup>2290</sup> To assuage fears that he, *Muhammad*, might be the Antichrist, he described the Antichrist as looking like someone else. *Muhammad* said:

Once upon a time I was shown the Antichrist (*Al Dajjal*), and behold he was a one-eyed man of brown complexion and curly hair. The one among the *Banu-Amr* who resembleth him the most is Aktham Ibn-‘Abd-Al ‘Uzza. Thereupon Aktham sprang to his feet and said ‘O Apostle of God, doth the fact that I resemble him in looks do me any harm?’ The Apostle replied, ‘No, thou art a *Muslim* but he was an unbeliever.’<sup>2291</sup>

Interestingly, *Muhammad* said that *Zulqarnain* visited *Gog* and *Magog* from whence the Antichrist would come (*K* 018:083-94; 021:096).

*Muhammad*’s description of *Zulqarnain*, literally “the two-horned one,” suggests that the people knew *Zulqarnain* more by his portrait rather than by name. The situation with *Zulqarnain* would have been similar to how today we only have artists’ conceptions of Jesus and *Muhammad*.

So what did *Zulqarnain* look like? The art with which *Muhammad* and his audience would have been familiar narrows the field somewhat. Religious art and idols were created individually, so they could not provide a consensus view of what *Zulqarnain* looked like. Most coins however were mass-produced from a set of dies cast using the “lost beeswax” method, so coins could provide a consensus view.

Many coins were created with the same or similar dies, so *Muhammad* probably figured *Zulqarnain* looked like the portrait on either a Byzantine or *Sassanian* coin. The Zoroastrians and Christians were the major minters of the coins that *Muhammad* would have seen. Significantly, during the first decades of the *Islamic* conquest, *Muslims* minted imitation coins that numismatists call Arab-*Sassanian* and Arab-Byzantine coins.

The Arabs were familiar with Greek coinage and in fact the etymology of the names of *Islamic* coins comes from the Greek. This shows the dominance of Greek commerce in Arabia:

☉ *Dinar*: a unit of coinage. *Dinar* is derived from the Latin *denarius*, and came into Arabic by way of Greek and Syriac.

☉ *Dirham*: a unit of coinage derived from the Greek *Drachma*.<sup>2292</sup>

A *Dinar* is mentioned in the *Shakir* translation of *K* 003:075 but the word *Dinar* does not seem to appear anywhere in the original Arabic *Koran*. However, *Dinar* and *Dirham* appear hundreds of times in translations of the *Hadiths*. Jeffery says that in the tradition called “The Beatitudes and Maledictions of the Prophet,” *Dinar* and *Dirham* are the literal words found in the Arabic.<sup>2293</sup>

The Byzantine Christians had some crescents on their coins but there were very few, if any, Byzantine coins that showed crowns sporting crescents. In contrast, the Persian *Sassanians* (224–651 AD) minted a popular coin showing a king with a crescent crown on the obverse side and a Zoroastrian fire altar on the reverse. In addition, four crescents were found in the margin of the coin at the right, left, top and bottom. The camel caravans from *Makka* plied the “sandy ocean” on routes to Persia, so *Muhammad* would have seen many *Sassanian* coins.

<sup>2290</sup> *Al Bukhari*, vol. 7, bk. 72, no. 795.

<sup>2291</sup> *Al Kalbi*. *Idols*, pp. 50-51.

<sup>2292</sup> Jeffery. *Islam*, p. 243

<sup>2293</sup> Jeffery. *Islam*, p. 27.



*Muhammad* often referred to the *Sassanian* king as *Khosrou*. *Muhammad* mentioned *Khosrou* and the Byzantine *Caesar* in the same breath often according to traditions. The glory of the *Sassanians* did capture the imagination of *Muhammad* and of *Muslims*. “The Sons of *Sásán*” are mentioned in the *Arabian Nights* lore.<sup>2294</sup>

*Muhammad* may have liked how *Sassanians* were monotheists of sorts, especially since they minted coins with crescents. Serge Trifkovic wrote:

The *Sassanians*, who gave their name to the [Persian] empire, followed Zoroastrianism, a form of monotheism...a dualist variety known as *Mazdaism* was the *Sassanide* state religion that legitimized the secular order.<sup>2295</sup>

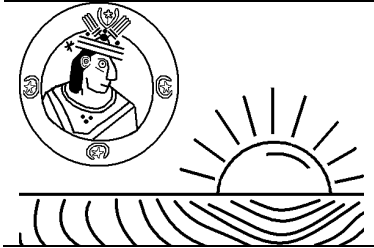
Though there is a strong dualist element in Zoroastrianism, Zoroastrianism is still monotheistic since the good god *Ahura Mazda* is worshipped and not “the lie.” “The lie was almost personified as the *Druj*, chief in the kingdom of the demons.”<sup>2296</sup>

The *Larousse Encyclopedia of Mythology* states:

This dualism was then subordinated to a deep-seated monotheism. Even in the most dualistic form of the *Iranian* religion there is a dignity about the god which makes him more than the correlative of the demon; just as he must have existed alone in the golden age of the past so would he exist alone in the future after he had exterminated his adversary.<sup>2297</sup>

Though Zoroastrian gods do not sound very astral by their names at least, Zoroastrianism was very astral in character, a fact that *Muhammad* would have appreciated

Zoroaster means “star sacrificer,” or “star worshipper.” *Muhammad* equated Zoroastrianism with Magianism, and the Magians are well known for their having been sky watchers and astrologists (Num 24:17; Mat 02:01, 07, 16).



**Figure 04-03.** Perhaps *Muhammad* thought the two-horned king on a certain *Sassanian* coin was *Zulqarnain* who, as the *Koranic* story goes, watched the sun set in a muddy puddle (K 018:086).<sup>2298</sup>

*Muhammad* said that Jews, *Sabeans*, Christians and the *Magians* partnered others deities with *Allah* (K 002:017). The “*Magians*” refers to the Persian Zoroastrians. Since the *Sassanian* coin has a star with the crescent on both the obverse and reverse sides, *Muhammad* may have figured that the otherwise monotheistic Zoroastrians had come to partner Venus with the moon-god *Allah*.

The Arab *Muslims*, once they took over the *Sassanian* Empire, continued to mint the *Sassanian* coin with a few modifications. This suggests that the Arabs may have figured that the coin depicted the *Zulqarnain* mentioned in the *Koran*. In *Muslim*

<sup>2294</sup> Burton. *Nights*, vol. i, page 1 (Introduction) & fn. 2.

<sup>2295</sup> Trifkovic. *Sword*, pp. 19-20.

<sup>2296</sup> EB, accessed 27 Feb 2003, “Iran, history of” entry.

<sup>2297</sup> Larousse, “The Antagonism Between *Ormazd* and *Ahriman*” entry, p. 328.

<sup>2298</sup> Typical Arab-Sassanian coin with crescents and stars. *Muslims* minted these imitative coins in the eighth century. This is one of the earliest *Muslim* minted coins. Reverse has a fire altar, two attendants holding swords, and a crescent to left, star to right (Anonymous Yazdgar III type, circa 652-665 AD [AH 32-45], AR Drachm, Date: ‘frozen’ year 20 YE, Album 2; Mitchiner ACW; Mitchiner WOI; Nikitin/Roth NC 155 no. 9).

eyes, he was a hero because like *Ibrahim* (K 006), *Zulqarnain* was spiritually astute enough not to worship the sun.



**Figure 04-04.** *Sassanian* drachma coin with crescents and stars on the obverse and reverse sides. This particular *Sassanian* coin depicts King Shapur I (241-272 AD), protector of Mani. “He placed Mani, the founder of *Manichaeism*, under his protection” (CEE, “Shapur I” entry). Note the C on a stick above the crown.

*Muhammad* may have thought that *Zulqarnain* looked like the *Sassanian* king Shapur I (241-272 AD). Shapur’s coins show a crown with a crescent-and-star. Shapur’s theologian, Mani, held to doctrine that was highly syncretistic. *The Columbia Electronic Encyclopedia* states:

Mani (called Manes by the Greeks and Romans) was born near *Baghdad*, probably of Persian parents; his father may have been a member of the Mandaeans. After wandering for several years as a meditative ascetic he came forward (~240 AD) as the inspired prophet of a new religion. He went to *Bactria* in NW India, where he came in contact with *Buddhism*.

He returned to Persia after the coronation (241 AD) of Shapur I, who was tolerant of new religious movements; at the *Sassanide* capital of Ctesiphon he began preaching (~242 AD) the doctrine that was to become *Manichaeism*, a great synthesis of elements from Gnosticism, Zoroastrianism, other Persian religions, Christianity, *Buddhism* and *Taoism*, as well as from the teachings of Marcion.

Rejecting all of the Old Testament and parts of the New Testament, *Mani* claimed *Buddha*, Zoroaster, *Hermes* and Plato as his predecessors. He always called himself ‘*Mani*, Apostle of Jesus Christ’ and held that he was the *Paraclete* promised by Christ.<sup>2299</sup>

Significantly, *Muhammad* also claimed to be the coming “Counselor” (Greek: *Paraclete*; Joh 14:16, 26; 15:26; 16:07) too—as *Ibn Ishaq* wrote:

The *Munahhemana*...in Syriac is *Muhammad*; in Greek he is the *Paraclete*.<sup>2300</sup>

### The Astral Tale of Two Angels at Babylon: *Harut* and *Marut* (K 002:102)

Arthur Jeffery wrote:

These two angels are mentioned in *Sura II*, 102/96 (K 002:102) as teachers of sorcery and magic arts. The story is that when Adam and Eve had to be driven out of their paradise, some of the angels said to *Allah*: ‘We told you so,’ whereupon *Allah* responded that under like conditions they would have done no better. Three angels accepted the challenge and came down to live on earth by day but at night mounted up to heaven again. One of them soon gave up but *Harut* and *Marut* continued until they were presently seduced by a fair woman named *Az-Zuhra*, who as her price [payment for prostitution] learned from them the secret of how they mounted up from earth to heaven at night. *Allah* changed her into a star and set her in the firmament, where she is *Venus* (*Az-Zuhra*), while the punishment of the two angels was that they were to hang downward till

<sup>2299</sup> CEE, *Manichaeism* entry.

<sup>2300</sup> Ishaq. *Sirat*, p. 104 and note 1.

Judgment Day in a well somewhere near *Babylon*. It is to them that wizards and sorcerers go to learn their magic arts.<sup>2301</sup>

It is mythology like this, which is canonized in the *Koran*, that leads *Muslims* to hold women accountable for sex outside marriage—even when *Muslim* men rape them. For if women are SO seductive that they can lead two out of three angels into sin, mere mortal men do not even stand a chance.

This magical thinking is reflected in *Islamic* legislation, as when the *Iranian* journalist *Amir Taheri* wrote:

In 1981, *Abol-Hassan Bani-Sadr*, the first president of the *Islamic Republic [Iran]*, announced that ‘scientific research had shown that women’s hair emitted rays that drove men insane’ (*Sic*). To protect the public, the new *Islamist* regime passed a law in 1982 making the *Hijab* mandatory for females aged above six, regardless of religious faith. Violating the *Hijab* code was made punishable by 100 lashes of the cane and six months imprisonment.<sup>2302</sup>

While the rapist may only serve a short jail sentence or receive some lashes, the rape victim is liable to be killed by her own family or tribe. Such “honor-killings” erase the memory of the victim, who is blamed for having been raped. The “honor-killing” restores and even increases the *Muslim* family’s honor and purity. For instance, when a woman doctor was raped in *Pakistan*, the tribal *Jirga* council wanted the doctor killed so as “to restore the ‘lost honour’ of her tribe.”<sup>2303</sup>

Incidentally, women have been killed merely “for having sex outside marriage, dating, [or] simply talking to men.”<sup>2304</sup> In *Iraq*, where supposedly more moderate *Muslims* live, honor-killings occur all the time:

Shaker [a *Baghdad* coroner] said that such a crime was called ‘washing the shame.’ Honor-killing is an old custom in *Iraq*, he said, though in this case there was a new element: before the war [when the state was secular], the family would have burned or drowned the woman to disguise the murder. ‘Now you can kill and go,’ Shaker said. ‘No need to cover the crime.’ The standard sentence for ‘washing the shame’ is six months.<sup>2305</sup>

In the West Bank and *Gaza*, two-thirds of murders are honor-killings of women.<sup>2306</sup> David Aaronovitch wrote for the *Guardian*:

In 2003 an aide to the governor of the *Iranian* province of *Khuzestan* told the press that his office had received reports of the murder of 45 young women in a two-month period in honour killings. None of these crimes were prosecuted. Honour killings are rife in *Pakistan* and there are a large number in *Iraqi Kurdistan*. In *Jordan* the sentence for carrying out an honour killing is set at six months. In the first part of this year more than a dozen *Jordanian* women were killed by their relations for having ‘sullied the reputation of their family.’<sup>2307</sup>

Under these circumstances, it extremely hard to convict a *Muslim* of rape under *Sharia* law. To avoid punishment, nearly always the rapist claims not to have had any sex, or that the sex was consensual.

<sup>2301</sup> Jeffery, *Islam*, pp. 25-26, fn. 4.

<sup>2302</sup> Taheri, Amir. “*Islamic* headgear is not essential,” townhall.com, 19 Aug 2003.

<sup>2303</sup> “*Jirga* wants doctor killed,” dailytimes.com.pk, 28 Jan 2005, *DW*.

<sup>2304</sup> “*Jordanian* kills sister to ‘cleanse family honor,’ jpost.com, 22 Apr 2004.

<sup>2305</sup> Packer, George. “Caught in the Crossfire: Will Moderate *Iraqis* Embrace Democracy—or *Islamist* Radicalism?” newyorker.com, 17 May 2004.

<sup>2306</sup> Gibson, Eetta Prince. “A woman’s worth,” jpost.com, 24 Oct 2004.

<sup>2307</sup> Aaronovitch, David. “‘Culture’ is no excuse,” observer.guardian.co.uk, 16 May 2004.

Once a rapist is cleared of the charge of rape, the rape victim is convicted for fornication or adultery, which are stoning offenses. *Muhammad* even had a repentant mother stoned who admitted to adultery. Astonishingly, *Muhammad* commanded that the stoners to “be gentle” with the victim:

...she was put in a ditch up to her chest and he commanded people and they stoned her. Khalid b Walid came forward with a stone which he flung at her head, and there spurted blood on the face of Khalid and so he abused her. *Allah's* Apostle...heard his (Khalid's) curse that he had hurled upon her. Thereupon he...said: ‘Khalid, be gentle. By Him in Whose Hand is my life, she has made such a repentance that even if a wrongful tax-collector were to repent, he would have been forgiven.’ Then giving command regarding her, he prayed over her and she was buried (*Sahih Muslim*, vol. 3, bk. 17, no. 4206).

“According to Sisters in *Islam*, a *Malaysian* advocacy group for *Muslim* women, in *Pakistan* ‘three out of four women in prison...are (there because they’re) rape victims.’”<sup>2308</sup> Women “adulteresses” are stoned in *Saudi Arabia* and *Iran* often,<sup>2309</sup> but are for the most part just jailed in *Nigeria*, *Pakistan*, *Dubai* and in *Islamic* countries where the West has more influence. In rural areas of most *Muslim* countries, wherever the media has little access, stonings occur more frequently.

The astral element of the *Harut* and *Marut* tale is evidenced by two details. Every night the angels ascended to the stars and then returned the next day. Medieval *Muslims* thought angels manned the stars, so if the angels did not return each night to guide his star, one or two constellations would be incomplete.

The second astral detail pertains to how *Az-Zuhra* became the planet Venus. This means that many Arabs believe that Venus was a glorified prostitute who was sultry enough to entice angels away from their chastity. Khairat *Al Saleh* wrote:

*Al Zuhara* [variant of *Az-Zuhra*], the morning and evening star, in the form of a beautiful woman, was in turn a winter goddess, a goddess of fertility and the daughter of God. She also acted as the goddess of women and of marriage, and was often linked with *Al 'Uzza* and *Allat*, other daughters of God...As Queen of Heaven, the sight of her would bring consolation to lovers and joy to all.<sup>2310</sup>

That *Muhammad* had *Al Zuhara* in mind when he spoke of *Harut* and *Marut* is evidenced by *Muhammad's* statement that these two angels taught magic, such as casting spells that cause divorce (*K* 002:102).

So the gist of the myth is that *Al Zuhara*, a.k.a. *Uzza*, was Venus, and she dispensed blessings on the marriages of her supplicants. Meanwhile, two angels, who are being punished for fornicating with Venus, teach magic that wrecks the marriages of Venus devotees.

There is another Arabian legend that suggests that the “God” who made *Al Zuhara* into Venus in the *Harut* and *Marut* myth is actually *Allah* the moon-god. Khairat *Al Saleh* wrote:

According to legend, *Al Dabaran*, one of the stars in the *Hyades* group, fell deeply in love with *Al Thurayya*, the fairest of the *Pleiades* stars. With the approval of the moon, he asked for her hand in marriage.<sup>2311</sup>

<sup>2308</sup> Hawkins, John. “An Interview With Robert Spencer,” rightwingnews.com, 19 Nov 2003.

<sup>2309</sup> Hawkins, John. “An Interview With Robert Spencer,” rightwingnews.com, 19 Nov 2003.

<sup>2310</sup> *Al Saleh*. *Fabled*, p. 29.

<sup>2311</sup> *Al Saleh*. *Fabled*, p. 30.

### **Allah a Light in a Niche**

*Muhammad* said in the famous Light Verse:

*Allah* is the light of the heavens and the earth; a likeness of His light is as a niche in which is a lamp...*Allah* guides to His light whomever He pleases (*K* 024:035).

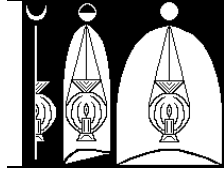
Tamara Green wrote that *Sin* was called “the lamp of heaven and earth...a perfectly obvious appellation for a moon-god.”<sup>2312</sup> *Muhammad* knew the moon was not itself divine but he believed the moon reflected *Allah*’s glory as though it were a niche reflecting the light of a lamp.

Astral worshippers did not think of the orb in the sky as being the deity but only a perch where the deity resided. Sometimes the ancients thought the light emanated from a physical fire that was telepathically tended by the god.

Sometimes the light of an astral orb was thought to be the glory of the god or goddess. For instance, *Helios* is sometimes pictured driving a quadriga that carries a ball of fire representing the sun, and sometimes a sunburst is shown emanating from *Helios*’ crown.

The moon however has a softer glow than the sun or stars, so moonlight especially was thought to be the glory shed by the moon-god. This is why *Muhammad* referred to *Allah* as being a lamp in a niche. *Allah* provided the light, and the moon reflected the light like the walls of a niche.

The crescent-moon would be comparable to a sidelong view of a niche and light, a half-moon would be like an oblique view of a niche, and the full-moon would be similar to a head-on view of a niche.



**Figure 04-05.** Moon phases as compared to a lamp in a niche. Different angles of viewing a niche simulate a crescent, half-moon and full-moon.

When *Muhammad* said that *Allah* was the only god and there was no longer a sun deity, he had to explain how divine glory emanates from the sun and moon. Tabari (839–923 AD) informed his readers of *Muhammad*’s creative solution to this quandary:

*Gabriel* brings to the sun a garment of luminosity from the light of the Throne [of *Allah*], according to the measure of the hours of the day. It is longer in the summer and shorter in the winter, and of intermediate length in the autumn and in the winter...but *Gabriel* brings it [the moon] a garment from the light of the Footstool [of *Allah*]. He [*Muhammad*] continued. This is (meant by) God’s word: ‘He made the sun a luminosity and the moon a light’ [*K* 010:005]...<sup>2313</sup>

Someone might ask “What did *Muhammad* mean by *Allah* guiding people to his light?” (*K* 024:035). *Muhammad* gave the example of *Ibrahim* who was shown the heavens by *Allah* so “he might have certitude” and guidance (*K* 006:075, 077). Once *Ibrahim* saw the moon, he became entranced and referred to the moon as “Lord,” saying:

If my Lord had not guided me I should certainly be of the erring people (*K* 006:077).

<sup>2312</sup> Green. *Moon*, p. 38.

<sup>2313</sup> *Al Tabari. History*, p. 232.

*Muhammad* compared putting trust in his successors to being guided by the stars. The *Sufi* Martin Lings wrote that *Muhammad* said:

My Companions are even as the stars; whichsoever of them ye follow, ye shall be rightly guided.<sup>2314</sup>

*Muhammad* also said that a person who was guided by *Allah* trembled and had a heartwarming experience. This is consistent with pagan thinking. For instance, pagans believed that infatuation and lust were the workings of Venus or *Cupid*, and waxing poetic was the work of the *Muses*. So a heartwarming experience or feeling wonderment at the moon and Moon Illusion must be a supernatural experience—*Allah* the moon-god's guidance *Muhammad* reasoned. *Muhammad* said:

*Allah* hath (now) revealed the fairest of statements, a Scripture consistent...whereat doth creep the flesh of those who fear their Lord, so that their flesh and their hearts soften to *Allah*'s reminder. Such is *Allah*'s guidance, wherewith He guideth whom He will. And him whom *Allah* sendeth astray, for him there is no guide (*Pickthall K 039:023*).

*Muhammad* referred to the crescent-moon's guidance and alludes to *Allah*'s association with the moon, as the *Sufi* Martin Lings wrote:

On one of their first evenings, looking across the water towards the *Nubian* Desert, they saw the new-moon of the month of *Rabi'al-Awwal*. 'O crescent of good and of guidance, my faith is in Him who created thee.' This the Prophet would say when he saw the new [crescent] moon.<sup>2315</sup>

So when *Ibrahim* saw the moon, he had a heartwarming experience and wanted to sing the praises of *Allah* the moon-god. However, when *Ibrahim* saw the stars and the sun, he felt nothing extraordinary. This gave *Ibrahim* "certitude" that *Allah* the moon-god was the high and only god—according to the tale recorded in the *Koran*, that is.

According to the *Koran*, those who do not experience a heartwarming experience by looking at the moon, or hearing the *Koran*, are the damned who are not guided by *Allah* (*K 039:023*).

The idea of a niche being a religious guide was common in ancient times. The idea stems from Venus altars in pre-*Islamic* temples and pre-*Islamic* Mosques. Venus altars are also known as prayer portals or *Mihrabs*.<sup>2316</sup> The ancients hung lamps in the apex of the portal arch to represent Venus. The lamp and niche formed a Venus-moon couplet symbol.

Later in history the astral scriptures were kept in the niche. The lamp at the apex of the Venus altar meant the priest could easily read his religions' scriptures. The priest and people prayed facing the niche. Not only would facing the niche show the priest was reverent toward Venus and the moon but the niche would serve as an acoustic aid to project his voice during prayer.

Jews borrowed the concept of prayer portal but changed it into a *Torah* shrine at the front of the synagogue. The *Torah* shrine can be seen at *Dura-Europos* in *Mesopotamia* and Byzantine-era synagogues in Palestine.

Evidently, some Christians copied the *Torah* shrine since the Christian *Negus* of *Abyssinia* said that *Islam* and "what Jesus brought have come from the same

<sup>2314</sup> F. xxvi, *Manaqib as-Sahabah*, as quoted in Lings. *Sources*, p. 329.

<sup>2315</sup> Lings. *Sources*, p. 120.

<sup>2316</sup> Goldman. *Portal*.

niche.”<sup>2317</sup> In contrast with the Jewish and Christian scroll shrines however the *Muslim* Venus altars point toward a thoroughly pagan Venus altar, specifically, the Black Stone at the *Kaaba*.

The Arabs especially probably thought of lights in niches as guides. The caravans largely operated at night to avoid the oppressive heat of the day. The desert has few memorable features, especially since sand dunes shift with the wind. Lighted niches surely served as lighthouses to guide the camel “ships of the desert” toward caravansaries.

The niches served as lighthouses. *Muhammad* noted that sailors and caravaners both used the stars to navigate on the featureless sea and deserts (*K* 006:097), so they surely both used lights on the shore and inland too. Of course when an enemy was on the horizon, the lights in the niches in towns were extinguished so as to not guide the enemy by night.

*Muhammad* applied this concept to his religion in his doctrine of double predestination. *Muhammad* figured that *Allah* only guided certain elect people to certainty regarding moon-god monotheism but chooses not to guide others. *Allah* treats the ones he does not guide as enemies and so predestines them to hell.

Some try to deny that *Allah* was a pre-*Islamic* moon-god on the grounds that the *Koran* says the moon and sun were created (*K* 007:054; 010:005; 021:033; 029:061; 039:005; 041:037). This is spurious argumentation presented by those who wish to shackle people with *Islam*.

The ancients moon-god worshippers did not think the moon itself was divine. Similarly, idol worshippers and pantheists did not worship the stone or wood itself but the spirit in the object, or the spirit represented by the object. Thus the *Koran* says nothing to which ancient moon-god adherents would object since moon-god worshippers commonly thought the moon rock was created.

The ancients thought the moon was a symbol of a canoe-like boat, a lamp, a scimitar, the throne of the Man-in-the-Moon and the like. The moon-god was in no way restricted to the moon just as kings are not restricted to their palaces.

It was thought that the moon-god was a spirit but could assume the appearance of a man or bull. The moon-god was thought to visit his temples and shrines and even reside in them periodically. Examples will be provided later in this chapter.

### The Queen of *Sheba*

The fifth-century church historian Philostorgios wrote:

[Emperor] Constantius [ruled 337-361 AD] sent ambassadors to the people once called the *Sabeans* and now named Himyarites [in *Yemen*]. These descendents of the people born of Abraham’s daughter Kethura. The region where they dwell is called ‘Great and Happy Arabia’ by the Greeks and touches the ‘Outer Ocean.’ Its capital is *Saba*, whose queen once journeyed to visit Solomon. These are people of the circumcision and are circumcised on the eighth day. They sacrifice to the sun and moon and to native gods. A considerable number of Jews live mixed in among them.<sup>2318</sup>

The *Pickthall*, *Shakir* and *Yusuf Ali* translations of the *Koran* treat the word *Sabian* and *Sabeian* (alternate spelling: *Sabaeian*) as synonyms in three parallel passages, as the following table shows:

<sup>2317</sup> Ishaq. *Sirat*, p. 152.

<sup>2318</sup> Philostorgios. *Church History*, vol. 3, p. 4, quoted in Peters. *Origins*, pp. 44-45.

<b><i>Sabean and Sabian Used as Synonyms in Koran</i></b>			
Verse/Translation	<i>Pickthall</i>	<i>Shakir</i>	<i>Yusuf Ali</i>
<i>K 002:062</i>	<i>Sabaeans</i>	<i>Sabians</i>	<i>Sabians</i>
<i>K 005:069</i>	<i>Sabaeans</i>	<i>Sabians</i>	<i>Sabians</i>
<i>K 022:017</i>	<i>Sabaeans</i>	<i>Sabeans</i>	<i>Sabians</i>

There is however some debate among scholars as to whether the *Sabian* (with an “i”) practitioners should be equated with the *Sabeans* (with an “ea”) from *Saba*, *Yemen*. Similar debates occur over the identity of many of the persons and tribes mentioned in the *Koran*.

*AcaDhimmis* home in on issues of whether *Muhammad* would have known of the *Sabeans* because the *Sabean* nation was only a memory by *Muhammad*’s time. This however is silly since *Saba* was neither distant, nor a distant memory. The Kingdom of *Saba* was just to the south of *Makka*, and lasted until about the sixth century AD.

Just as *acaDhimmis* debate about the *Sabeans*, *acaDhimmis* wonder whether *Muhammad* would have known of the distant city of *Haran* in Syria. Of course the debate-ending detail that *Haran* was a caravansary on major camel-trading routes never seems to be mentioned.

*Haran* was a storied and famous city and is even mentioned in certain *Islamic* traditions as being a caravansary, as ‘Ali Dashti wrote:

‘*Otaba b. Abi Lahab* sent a message to the Prophet saying that he did not believe in the [angelic being connected with the] stars of the *Qor’an*. The Prophet took offence and cursed him, praying, ‘O God, may one of Your beasts of prey overpower him!’ *Otaba*, on hearing of it, was frightened. At that time he was traveling in a caravan. When the caravan stopped at *Haran*, ‘*Otaba* lay down and slept in the midst of his friends. God sent a lion, which took ‘*Otaba* from the midst of his friends and tore his body but did not eat any of that accursed, unclean thing. So all the people knew that the lion had not taken him to eat him but to fulfill the Prophet’s prayer.’<sup>2319</sup>

In passing, this lion tradition ties in with the *Gilgamesh* Epic quite well:

At night when he [*Gilgamesh*] came to the mountain passes *Gilgamesh* prayed: ‘In these mountain passes long ago I saw lions, I was afraid and I lifted my eyes to the moon; I prayed and my prayers went up to the gods, so now, O moon-god *Sin*, protect me.’<sup>2320</sup>

That ‘*Otaba b. Abi Lahab* was by *Haran*, the City of the moon-god *Sin*, when the lions attacked, shows that the *Muslims* thought that *Allah* was *Sin* the moon-god. *Lahab* slighted *Allah*, a.k.a. *Sin* the moon-god, so *Sin* did not save *Lahab* from the lions as *Sin* previously saved *Gilgamesh* from lions.

Scholars note that *Muhammad* thought the *Sabeans* and the *Haranians* were fallen monotheists, as *Sinasi Gunduz* wrote:

...according to the *Quran*, every community from Adam to the prophet *Muhammad* adhered to the true religion, i.e. *Islam*, before the people changed the religion with polytheism. Consequently God sent to them the prophets with the

<sup>2319</sup> Dashti. *Career*, p. 72.

<sup>2320</sup> Anonymous. *Gilgamesh*, “The Search for Everlasting Life.” Also, Pritchard. *Ancient*, I:62, middle of Tablet IX.



true religion, *Islam*, in order to establish monotheism again (K 007:59-93; 021:51-93).<sup>2321</sup>

Scholars wonder whether there is any archeological, literary or other proof to connect the *Sabians* to the *Sabeans*, and the *Hanifs* to the *Haranians*. There is literary proof since the *Koran's* accounts of the *Sabeans* and *Haranians* were inspired by those parts of the Bible that touch on *Saba* and *Haran* (Gen 11—12; 1Ki 10; 2Ch 09).

Since *Haran* and *Sabeans* are mentioned in connection with Abraham and Solomon, respectively, *Muhammad* thought it reasonable to suppose that the *Haranians* and *Sabeans* were fallen monotheists. After all, characters such as Melchizedek and Balaam show that there were more than a few *Yahvists* in the Mideast. *Muhammad* however erred because he did not have a deep understanding of Scripture nor modern archaeology.

In regard to the *Sabeans*, Tamara Green notes that Johs. Pedersen argued:

Before the time of *Muhammad* the word [*Sabeans*] must have had a meaning that connects it closely with his [*Muhammad's*] doctrines—otherwise he would not be able to use it [*Sabeans*] this way [in the *Koran*]. The prophet himself is called a *Sabian*, and *Sabi'ah* is used about those who go over to *Islam*.<sup>2322</sup>

In regard to the *Sabeans*, William St. Clair-Tisdall noted:

The *Sabians* had certain religious rites, among which are seven fixed times of prayer, five of which correspond with that of the *Muslims*... They prayed over the dead without either bowing down or prostration, and fasted thirty days [similar to the *Muslims' Ramadan* fast, a fast that lasts for one lunar month]; and if the month of the new-moon were a short one, then they kept the fast for twenty-nine days. The connexion with their fast they [the *Sabians*] observed the festivals of *Fitr* (breaking the fast at the end of the lunar month) and *Hilal* (new-moon [meaning “crescent-moon”])... The supposition that many of these religious customs were borrowed by *Muhammad* from the *Sabians*, and that their religion in general (owing perhaps in a measure to its supposed antiquity) had great influence on *Islam* at its foundation is confirmed by the fact that, when the *Banu Jadhimah* of *Taif* and *Makka* announced to Khalid their conversion to *Muhammadanism*, they did so by crying out, ‘We have become *Sabians*.’<sup>2323</sup>

In regard to the *Sabeans*, Tamara Green noted that...

...J. B. Segal surveyed the problem of the *Sabians* once again in 1963 [AD].

Segal agreed with Pedersen in maintaining that *Muhammad's* intent in using the name *Sabian* was to describe a category of monotheist...<sup>2324</sup>

*Muhammad* surely believed that the *Sabeans* had once been monotheists because he believed that even the *Makkans* and even all Arabs had once been monotheists! In fact, Bat Yeor wrote:

*Muhammad* is recorded as having said that all children are born *Muslims* but that their parents raise them as Jews or Christians.<sup>2325</sup>

Incidentally, this belief about infants is why *Muslims* like to say that people “revert to *Islam*” rather than “convert to *Islam*. *Muslim* think “Everyone was *Muslim*

<sup>2321</sup> Gunduz. *Life*, p. 44.

<sup>2322</sup> Green. *Moon*, p. 110.

<sup>2323</sup> St. Clair-Tisdall. *Sources*, ch. 2, pp. 52-53.

<sup>2324</sup> Green. *Moon*, p. 111.

<sup>2325</sup> K 030:030; *Sahih Bukhari*, vol. 2, bk. 23, nos. 440, 441 & 467; *Sahih Muslim*, vol. 4, ch. 1107, nos. 6423 & 6426; Yeor. *Dhimmi*, p. 75, fn. 31.

at one time and can be again.” Likewise, this belief that all are born *Muslim* is why even those whose culture was never *Islamic* are still called “infidels,” meaning “those who did not keep the faith.”

That *Muhammad* believed the ancient *Makkans* were fallen monotheists is well evidenced in the *Koran* and the traditions. For instance, *Muhammad* believed that the ancient *Makkans* against better knowledge deified male angels and then gave them female names, as was noted above.

Indeed, the Arabian pantheon’s hierarchy was such that *Muhammad* and his followers were easily led into believing that Arabs were fallen monotheists. Wherry wrote:

The idolatry of the Arabs then, as *Sabians*, chiefly consisted in worshipping the fixed stars and planets and the angels and their images, which they honored as inferior deities and whose intercession they begged, as their mediators with GOD. For the Arabs acknowledged one supreme GOD, the Creator and LORD of the universe, whom they called *Allah Taala*, the most high GOD; and their other deities, who were subordinate to him, they called simply *Al Ilahat*, i.e. the goddesses...<sup>2326</sup>

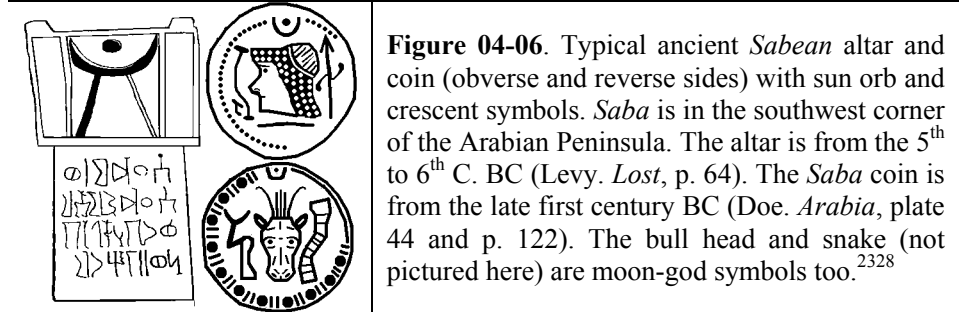
Many statues and pictures of deities sported crescent-and-orb symbols merely to show the god was an astral god—whether or not the astral god was associated with the sun, moon or Venus. The crescent ornamentation led some ancient observers to conclude that:

- ☪ Deities such as Fate were Daughters of *Allah* the moon-god (*K* 053:020).
- ☪ *Allah* was the Lord of the crescent-and-orb wearing *Sirius-Isis* (*K* 053:049).

H.A.R. Gibb wrote:

The existence of a supreme God *Allah* is assumed as an axiom common to *Muhammad* and his opponents. The *Koran* never argues the point; what it does argue is that He is the one and only God.<sup>2327</sup>

Whether the *Haranians* and *Sabeans* really ever were monotheists does not affect *Koran* interpretation at all. The *Koran* is all about what *Muhammad* thought to be true, regardless of whether it really was fact or fiction.



**Figure 04-06.** Typical ancient *Sabean* altar and coin (obverse and reverse sides) with sun orb and crescent symbols. *Saba* is in the southwest corner of the Arabian Peninsula. The altar is from the 5<sup>th</sup> to 6<sup>th</sup> C. BC (Levy. *Lost*, p. 64). The *Saba* coin is from the late first century BC (Doe. *Arabia*, plate 44 and p. 122). The bull head and snake (not pictured here) are moon-god symbols too.<sup>2328</sup>

There are however other reasons why some *acaDhimmis* like to say the “jury is still out” on exactly who the *Sabians* were. *Muhammad* says the *Sabians* worshipped the sun “besides” *Allah* (*Yusuf Ali* *K* 027:024).

<sup>2326</sup> Wherry. *Commentary*, vol. i, section i, p. 36.

<sup>2327</sup> Gibb. *Survey*, p. 26.

<sup>2328</sup> Werner Daum wrote: “*Almaqah*, the *Sabean* imperial and national god...His symbolic animal is the Ibex (later on also the steer). In *Ma'in* [the *Mineaan* kingdom north of the kingdom of *Saba*] also the snake is a symbol of this imperial god, beside the Ibex” (Daum. *Ursemitische*, pp. 30-31). The curvy sticks may be moon-god symbols just as scimitars, bows and throwing sticks were.

*AcaDhimmis* know that the two highest gods that the *Sabeans* worshipped were the sun and the moon. So apparently *Muhammad* faulted the *Sabeans* for worshipping the sun-goddess beside *Allah* the moon-god! In fact, *Muhammad* probably assumed that partnering the sun-goddess and moon-god was the downfall of the Kingdom of *Saba*.

In any discussion about whether the *Makkans* and *Sabeans* worshipped a moon-god, one must consult the scholars as to whether such an idea is plausible. A few scholars have taken the time to evaluate the evidence and declared their belief that *Allah* was, or might be, a pre-Islamic moon-god:

☉ In 1927 Robert Briffault quotes a certain Prince Teano as saying:

There are abundant indications which seem to demonstrate that...the *Allah* of *Islam* are merely transformations of the primitive lunar deity of Arabia (Briffault v3 106).<sup>2329</sup>

☉ Egerton Sykes wrote this entry in his encyclopedia in 1952:

*Allah*. Islamic name for God. Is derived from *Semitic El*, and [*Allah*] originally applied to the moon; he [*Allah*] seems to have been preceded by *Ilmaqah* [aka *Almaqah*] the moon-god. *Allat* is the female counterpart of *Allah*.<sup>2330</sup>

☉ Alfred Guillaume wrote in 1956:

Some scholars trace the name [*Allah*] to the South Arabian *Ilah*, a title of the moon-god but this is a matter of antiquarian interest.<sup>2331</sup>

☉ Authors of popular books and Internet reference sites have analyzed the evidence and are convinced that *Allah* was a pre-Islamic moon-god.<sup>2332</sup>

☉ Christians since John of Damascus (~675 to ~749 AD) have noted the astral origin of upstart *Islam*. Several of today's evangelists, such as Pat Robertson, recognize that *Allah* was a moon-god, as *The Jerusalem News Wire* reported:

Referring to the global War on Terror and the resurgence of international anti-Semitism, the American said the entire world was 'being engulfed by a religious struggle.' Central to this battle was not money or territory but question of who was God. '[T]he struggle is whether...the moon-god of *Makka*, known as *Allah*, is supreme, or whether the Judeo-Christian *Jehovah*, God of the Bible, is Supreme'....

'If God's chosen people turn over to *Allah* control of their most sacred sites...then in that event, *Islam* will have won the battle. Throughout the *Muslim* world the message will go forth, '*Allah* is greater than *Jehovah*. The promises of *Jehovah* to the Jews are meaningless. We can now, in the name of *Allah*, move to crush the Jews and drive them out of the land that belongs to *Allah*.'<sup>2333</sup>

<sup>2329</sup> Briffault, Robert. *The Mothers A Study of The Origins of Sentiments and Institutions* (3 volumes). George Allen & Unwin, London, 1927, vol. 3, p. 106 (Note: There also is an abridged one-volume version), as quoted at "The Origin of *Sin* and the Queen of Heaven, Part I: The Moon God and Goddess," *Genesis of Eden Diversity Encyclopedia*, dhushara.com, accessed 6 Jan 2005.

<sup>2330</sup> Sykes. *Mythology*, p. 7, *Allah* entry.

<sup>2331</sup> Guillaume. *Islam*, p. 7.

<sup>2332</sup> Use web search engines, or use the "Search Inside" feature at Amazon.com, to find popular books mentioning *Allah*'s having been a moon-god. Here is a suggested search string: +*Allah* + "moon-god."

<sup>2333</sup> "CBN chief: It's a religious war," *Jerusalem Newswire*, 17 Dec 2003.

Robertson's *Hubal* moon-god speech did not go unnoticed by *Muslims*. *Al Jazeera*'s web site reprinted an op-ed piece from *The Atlanta Journal-Constitution* that mentions the subject.<sup>2334</sup>

Conventional wisdom has always had it that *Allah* was a moon-god. For instance:

- ☉ The eighth-century Byzantine writer, Georges the Monk, said that *Muslims* worshipped “god...the moon and *Aphrodite*.”<sup>2335</sup> *Aphrodite* is the Greek Venus, which Georges the Monk probably equated with the Arabian *Uzza* and the Venus Black Stone. This suggests that *Muslims* were using the crescent-and-orb symbol in the eighth century.
- ☉ In 1645 AD, the Frenchman Michel Baudier produced a book that showed *Muslims* worshipping the Man-in-the-Moon (see “Baudier” in the Index). A Hollywood film from 1962 has several mentions about *Muslims* worshipping a moon-god.<sup>2336</sup>
- ☉ Serge Trifkovic wrote:

The dominant deity was the moon-god in several variations, whose title was *Al-Ilah*—the chief among all gods—shortened by frequency of usage to *Allah*. The evidence of those pagan times is scant as *Muslims* were loath to preserve any remnants of pre-*Islamic* pagan traditions, with the notable exception of those shrines and artifacts co-opted by *Muhammad*. Nevertheless, the frequency with which the crescent-moon appears in pre-*Islamic* archaeological artifacts throughout *Arabia* attests to its special status.<sup>2337</sup>

Serge Trifkovic's observation that the evidence is scant is correct. In all the archaeology books in the Mideast, one can see many statues and paintings that were defaced. While the minority of Christians who were iconoclasts was satisfied with defacing objects that were currently in religious use, no aboveground art was safe from *Muslim* iconoclasts throughout the entire Mideast due to *Muhammad*'s prohibitions against, and example of destroying, figural art.<sup>2338</sup> Even in modern times *Muslims* have made news for their iconoclastic activities:

- ☉ In 2006, the Cartoon Riots killed dozens over caricatures of *Muhammad* drawn by Danish artists.
- ☉ In 2001 AD the *Taliban* destroyed two 35-meter tall, fifth- or six-century AD *Buddha* statues at *Bamiyan* in a countrywide purge of *Afghanistan*'s relics. This reminds one of how in 653 AD, *Muslims* melted down the bronze *Colossus* at *Rhodes*, one of the Seven Wonders of the Ancient World that was completed in 282 BC.

Due to the iconoclasm, the fact that there is sufficient but not an overwhelming, amount of evidence showing *Allah* was a moon-god is not a concern. This is the case even though there are researchers who put a twist on the “*Allah* was a moon-god”

<sup>2334</sup> Nelson, Craig, “Christian Zionists: Evangelicals a new lifeline for Israelis,” *The Atlanta Journal-Constitution*, 25 Dec 2003, as reprinted in *aljazeera.info*, accessed 29 Dec 2003.

<sup>2335</sup> Tolan. *Saracens*, p. 44, fn. 19, p. 296: “Alain Ducellier. *Chrétiens d'Orient et Islam au Moyen Age*. Armand Colin, Paris, 1996, pp. 161-164; Migne, J.P. (editor), *Patrologiae Graecae Cursus Completes* (162 vols.), Paris, 1857-1886, vol. 110:873.

<sup>2336</sup> Shaheen, Jack G. *Reel Bad Arabs: How Hollywood Vilifies a People*, Interlink Pub Group, 2001, pp. 200-201, “Five Weeks in a Balloon,” with an alternative title “Five Weeks in Arablands.”

<sup>2337</sup> Trifkovic. *Sword*, p. 22.

<sup>2338</sup> Iconoclasm: *Sahih Bukhari* v. 7, bk. 72, nos. 834-837; v. 7, bk. 72, no. 844.

theory. These authors say that *Allah* replaced *Hubal* and that *Hubal* was the erstwhile pre-Islamic moon-god of *Makka*. Thus *Allah* is the current moon-god of *Makka*.<sup>2339</sup>

*Hubal* however is not *Allah* and *Hubal* was not a moon-god. Most of the researchers who advance the *Hubal equals Allah* theory rely on:

- ☉ A selective reading of traditions that leads to a faulty logical process of elimination.
- ☉ Eisegesis (reading preconceived notions into a text) rather than exegesis (thorough analysis of the text).

Their process of elimination goes as follows: The *Kaaba* was an astral shrine and every astral shrine in Southern Arabia had to have a male, lunar high-god. These scholars argue that *Hubal* is the most likely candidate for the “old” moon-god slot of any of the gods mentioned in the traditions. That *Hubal* is not *Allah* will be discussed further but later, in this book.<sup>2340</sup>

Authors who say that *Allah* was a moon-god and do not hedge their assertions with words such as “maybe” or “possibly,” include Morey, Stortroen and several evangelical writers such as John Hagee.<sup>2341</sup> A non-partisan author, Jamal *Elias* wrote:

Many Arabs viewed the god of the moon and traveling, named *Allah* (literally ‘The God’), as the ancestor and leader of the others.<sup>2342</sup>

Another example is the web reference *Liber Paganum*, which states:

*Sin (Babylonian/Akkadian/Sabaeen)*...might be the god which was worked over into *Allah* by *Muhammad*.<sup>2343</sup>

There is another reason that acaDhimmis are reticent to say the *Sabian* practitioners should be equated with the *Sabeans* in *Yemen*. *Muhammad* mentions the Queen of *Sheba* (*K* 027:022) without noting whether her people are the *Sabeans* (or *Sabians*) discussed elsewhere in the *Koran* (*K* 002:062; 005:069; 022:017).

A lack of details in the *Koran*’s Queen of *Sheba* story however is not a major concern. If translators did not replace many pronouns with nouns, and commentators did not provide many details from tradition, the *Koran* would be even more obscure than it already is.

When *Muhammad* retold stories in the *Koran*, all but the most essential details are omitted. This is the case even though several stories are repeated *ad nauseam*, as Don Richard wrote:

If every statement or story that is repeated in the *Koran* were given only once, the entire *Koran* would slim down to approximately 40 percent of its published length.<sup>2344</sup>

*Muhammad* often does not mention whom his audience is, or what battle he is referring to. Incredibly, there are few *Koranic* chapters about which is known with absolute certainty when and where they were written. Some scholars classify certain

<sup>2339</sup> Brockelmann. *Peoples*, p. 9. Use web search engines, or use the “Search Inside” feature at Amazon.com, to find other books that mention who *Hubal* the moon-god morphed into *Allah*: +*Hubal* +*Allah* + “moon-god”.

<sup>2340</sup> See *HaBaal* in the Index to find proofs that *Allah* was not *Hubal*.

<sup>2341</sup> Hagee, John. *The Battle for Jerusalem*. Thomas Nelson, New York, 2003. Morey and Stortroen can be found in the Selective Biography section.

<sup>2342</sup> Elias & Lewis. *Guide*, p. 25.

<sup>2343</sup> *Liber Paganum* [Latin: *Book of Paganism*], version 0.5.7, Editors Karsten Dykow *et al*, liberpaganum.org, accessed 28 Sep 2003, *Sin* entry.

<sup>2344</sup> Richardson. *Secrets*, p. 98.

chapters as *Makkan*, while other scholars classify the same chapters as *Madinan*. Other examples of *Muhammad*'s lack of specificity include:

- ☉ The location and identity of the main character in a story are often not specified in the *Koran* but only in the traditions, and the traditions show that *Muhammad* was confused. For instance, *Muhammad* told a tale about an unnamed person riding a donkey around a ruined city (*K* 002:259). The traditions say *Muhammad* taught it was the Prophet Ezra but in Jewish lore (*Muhammad*'s source material) it was Nehemiah (*Neh* 02:11-16).<sup>2345</sup>
- ☉ The main character in a story is described but not named in the *Koranic* text, so the true identity of the person remains a matter of debate, for example, "the two-horned one" (*Zulqarnain*) (*K* 018:086) and "the green one" (*Al-Khidr*) (*K* 018:065-082).
- ☉ Fictitious events in the life of *Ibrahim* are related without ever mentioning a locality (*K* 002:258-260; 006:075-084; 019:041-050; 021:051-070; 026:069-104; 029:016-025; 037:083-098; 043:26-27).
- ☉ The story of *Sodom* and *Gomorrhah* is repeated at least eight times without ever mentioning the names of the doomed cities (*K* 007:080-084; 011:077-083; 015:058-076; 021:074; 022:043; 026:165-175; 027:056-059; 029:027-033).
- ☉ *Ibrahim* retells stories about Nimrod without ever mentioning Nimrod's name (*K* 021:051-071; 029:016-017; 037:097-098).
- ☉ The confrontation between Moses and Pharaoh is retold twenty-seven times in the *Koran* but the Passover is not noted.<sup>2346</sup> Pharaoh (*Firon*) is mentioned about seventy-nine times but the country Egypt only receives three mentions (*K* 010:087; 012:099; 043:051).

Another reason for the debate as to whether the *Sabians* are the *Sabeans* is the word *Sabian* is not quite the same word as *Sabean*. Some speculate that the *Sabeans* were from *Yemen*, while the *Sabians* were located elsewhere.

It was however normal in ancient times, before the advent of dictionaries, to have different spellings and pronunciations of the same word, like *Shibboleth* and *Sibboleth* (*Jdg* 12:06).

This is especially the case for transliterations from one language to the next just as *Salah ad-Din* became *Saladin* in English. Another example is the English, *Ozymandias*, is a transliteration of the Greek transliteration of the throne name of *Ramses II*, *User-maat-re Setep-en-re*. Another example is how the Hebrew for *Yahveh* became *Jehovah* and *Yahweh* in English. Thus phonetic objections and etymological objections are always somewhat tenuous.

The name *Sabian* may simply be a play on the word *Sabean* according to the scholar R. Bell.<sup>2347</sup> Like much of *Muhammad*'s material, his pronunciations of *Sabean* and *Sabian* may have come through different languages. The *Encyclopedia Britannica* notes:

*Sheba*...is frequently mentioned in the Bible (notably in the story of King Solomon and the Queen of *Sheba*) and variously cited by ancient *Assyrian*,

<sup>2345</sup> Sell. *Quran*, pp. 169-170, footnote.

<sup>2346</sup> Richardson. *Secrets*, p. 33.

<sup>2347</sup> Bell, R. *The Origin of Islam in its Christian Environment*. London, 1926/1968, p. 60, as quoted in Gunduz. *Life*, p. 19.

Greek and Roman writers from about the 8th century BC to about the 5th century AD.<sup>2348</sup>

One can safely assume that the Queen of *Sheba* ruled the *Sabeans* (also spelled *Sabians*). Based on this safe assumption, the *Sabeans* worshipped the sun-goddess *Allat* in addition to *Allah* the moon-god. A bird told Solomon that the Queen of *Sheba*'s people worshipped the sun in addition to *Allah* (*K* 027:024).

The *Pickthall* and *Shakir* translations of *K* 027:024 say that the *Sabeans* worshipped the sun “instead of *Allah*,” but *Yusuf Ali* says “besides *Allah*,” meaning “in addition to *Allah*.” The “instead of” translation is used because the translator wanted to avoid the “sun besides *Allah*” translation. The “besides” translation suggests that the *Sabeans* worshipped the sun-goddess plus *Allah* the moon-god.

The “besides *Allah*” translation is correct for a number of reasons:

☉ The “instead of” translation is unusual since *Shakir* uses the preposition “besides” 132 times and “instead of” only four times.

☉ The entire theme of the *Koran* is that Jews, *Sabeans*, Christians and *Magians* all wrongly partnered other gods with *Allah*. *Muhammad* never said anyone worshipped another god such as the sun-goddess instead of *Allah*.

☉ Archaeologists know that the *Sabeans* worshipped the sun and moon.<sup>2349</sup>

*Muhammad* apparently thought all Arabs believed in *Allah* but did not worship him regularly (*K* 029:061). So the translation that the *Sabeans* worshipped gods “along with” *Allah* is better than saying the *Sabeans* worshipped the sun “instead” of *Allah*.

To Arabs, the Biblical Queen of *Sheba*'s name was *Bilqis*. An ancient moon temple that modern Arabs call *Mahram Bilqis* is located in northern *Yemen*. Bill Graveland wrote:

It is Arabic folklore that preserves that connection with the Queen of *Sheba* to the site itself. That's why the sanctuary is called in Arabic, *Mahram Bilqis*. It means the sanctuary of *Bilqis*, Arab folklore [name] for the Queen of *Sheba*.

The sanctuary was a sacred site for pilgrims throughout Arabia from 1200 BC to 550 AD, and the time fits with history's record of the Queen of *Sheba* and her visit to King Solomon of *Israel*. The Temple of the Moon fell into disuse after the sixth century. Glanzman said the *Marib* dam collapsed for the last time, making the area useless for agriculture.<sup>2350</sup>

The collapse of the dam meant the irrigated land reverted to desert sand. This led to the ruination of the temple and the demise of the kingdom of *Sheba*. This likely is why ancient writers did not mention the Queen of *Sheba* much after the fifth century AD.<sup>2351</sup>

Archaeologists opine about the Queen of *Sheba*'s link to the moon-god temple *Mahram Bilqis*:

The reasoning seems indisputable. If the Queen of *Sheba* or *Bilqis* existed, she would certainly have come to *Marib* and participated in ceremonies at *Mahram Bilqis*, the biggest temple and an important center of pilgrimage of the time. People came or were brought from far away to pray and even to be buried there....

<sup>2348</sup> *EB*, accessed 15 Mar 2003, *Saba* entry.

<sup>2349</sup> Phillips. *Sheba*, pp. 226-227.

<sup>2350</sup> Graveland. *Queen*.

<sup>2351</sup> *EB*, accessed 15 Mar 2003, *Saba* entry.

*Almaqah* however was the main god worshipped by the *Sabeans*. Symbolized first by a bull and then by an *Ibex*, he was also associated with a crescent, which led certain archaeologists to call him the moon-god and therefore name *Mahram Bilqis* “the moon temple.”<sup>2352</sup>

An *Ibex* is primarily a symbol of the moon-god *Almaqah*, possibly because of the visual equation of the characteristic horns with the crescent-moon.

The *Kunsthistorisches* Museum at Vienna wrote about *Ibex* relief:

The *Ibex* plays an important role in South Arabian religious motifs...Here the *Ibex* is primarily a symbol of the moon-god *Almaqah*, possibly because of the visual equation of the characteristic horns with the crescent-moon.<sup>2353</sup>

Werner Daum wrote about ancient toy *Ibexes* that had the face, nose and beard of an old man:

The traditional, wholly unrealistic [*Sphinx*-like] figures of an *Ibex*, with the face of an old man, are made in the *Hadramût*...Whom do they represent?...There is only one explanation. It is the god of the pilgrimage...One is thinking about him as an old *Ibex*, with the face of a man...the *Ibex*...is the imperial *Sabean* god '*Almaqah*—whose symbolic animal was the *Ibex*.'<sup>2354</sup>

Tradition says *Muhammad* was born in 570 AD and died around 632 AD. So *Muhammad* was born just twenty years after pilgrims stopped journeying to *Bilqis'* moon-god temple in northern *Yemen*.

*Islamic* tradition tells how *Makkans* at the *Kaaba* discussed how a Christian ruler, *Abraha*, tried to distract Arabs from *Kaaba* worship by building a cathedral at *Sana*.<sup>2355</sup> Indeed, *Muhammad* talked about the demise of the *Marib* dam in the *Koran*—the catastrophe that led to the *Bilqis* temple being abandoned (*K* 034:016-019). *Muhammad* said:

But they [the *Sabeans*] turned aside, so We [*Allah*] sent upon them a torrent of which the rush could not be withstood, and in place of their two gardens We gave to them two gardens yielding bitter fruit and (growing) *Tamarisk* and a few *Lote* [lotus] trees (*K* 034:016).

It is significant that *Muhammad* thought *Allah* sent the flashfloods that doomed the *Sabeans*, because the *Sabeans* thought that the moon-god *Almaqah* was the deity who occasionally flooded the *Wadis*. Egerton Sykes wrote that *Ilmaqah* [aka *Almaqah*] was the predecessor of *Allah*.<sup>2356</sup> Werner Daum wrote:

*'Il Muqah* is '*IL*, 'The Intensively Watering One,' the god of the rainstorm.

With this by-name we also find him in the (South Arabian) fairy tales. He is the god of the mighty, horrible rainstorm. He is 'filling the *Wadis* and the flat land' far too much. He is the god of the destroying water.<sup>2357</sup>

“The place of two gardens” to which *Koran* 034:016 refers are the two lakes around *Marib*, as Nicholas Clapp explains:

<sup>2352</sup> Donnet, Joel. “Quest for a Queen: A team of archaeologists excavates the site of an ancient temple in *Yemen* seeking to find any trail of the Queen of *Sheba*,” *Frontline*, “India’s national magazine” from the publishers of *The Hindu*, vol. 19, Issue 03, 02-15 Feb 2002.

<sup>2353</sup> Relief Slab with *Ibex* Motif, *Yemen*, 4th to 3<sup>rd</sup> C. BC (?), acquired in 1894 from the Glaser Collection, ÄOS Inventory Number Sem 125, The *Kunsthistorisches* Museum at Vienna, khm.at.

<sup>2354</sup> Daum. *Ursemitische*, pp. 64-66.

<sup>2355</sup> Ishaq. *Sirat*, p. 21.

<sup>2356</sup> Sykes. *Mythology*, p. 102, *Ilmaqah* entry.

<sup>2357</sup> Daum. *Ursemitische*, pp. 80-81.



Its [the *Wadi*'s] bed [is] a mosaic of dried and cracked mud, the *Wadi Adana* is the key to how and why the *Sabeian* civilization flourished on the edge of the desert. Two to three times a year, in the past as now, rains drenched the *Yemeni* highlands to the west. Beginning in late Neolithic times, the *Wadi Adana*'s waters were slowed and tamed by a succession of dams. The mightiest of these, built in the fifth century BC, was 680 meters across, half again as wide as Colorado's Boulder Dam.

Long since washed away [in parts], the Great Dam of *Ma'rib* was a massive earthen barrier faced with stone slabs set with lime mortar. It was built to withstand the assault of seasonal flash floods surging down the wadi at a rate of 1,700 cubic meters a second—that is, bearing 2,000 or more tons of water and silt per second. The dam's purpose was not to create a reservoir but to divert this turbulent mass into two sluices, north and south, and then into stilling basins. From there two broad canals further calmed the water before distributing it through a vast network of smaller and then smaller canals and an irrigation system that reached twenty miles or more into the open desert. All told, 24,000 acres (9,600 hectares) were brought under cultivation, enough to sustain a city of 30,000 to 50,000 people. This man-made oasis became known as the 'Garden of the Two Paradises.'<sup>2358</sup>

One lake is 6.8 miles (11 KM) from *Marib*'s combination dam-weir and the other lake is 3.1 miles (5 KM) away. Each lake has its own canal and irrigation system—hence the acclaim for “two gardens” or “Garden of the Two Paradises.”

The common speculation is that the *Marib* dam was not repaired for some time and finally burst. This is probably true since, in *Yemen*, from the fourth through seventh centuries, there was an off and on four-front war among Jews, Christians, pagans and the opportunistic desert-dwelling *Bedouins*.

The *Bedouins* were an ever-present threat to any Arabian civilization since without warning they could amass and attack out of the vast deserts. Anything needing regular maintenance during these centuries was likely neglected to some extent. *Muhammad* however knew the immediate reason why the *Marib* dam gave way—a rushing torrent of water (*K* 034:016).

Roman geographers called *Yemen* “Happy Arabia” (Latin: *Arabia Felix*) because of its two rainy seasons that allowed for irrigated crops. The rainy seasons lasted from March to May, and from July to August. The rain was stored in the three man-made lakes—two diversionary lakes and one behind the dam-weir, and was used for irrigation.

*Muhammad* noted how the *Marib* disaster meant that only “bitter fruit, *Tamarisk* and a few *Lote* [lotus] trees,” grew where formerly the *Yemenis* used to grow wheat, wine grapes, palm dates, fruit, spice and incense (*K* 034:016). *Muhammad* was engaging in *Schadenfreude* since the *Marib* area was no longer any more verdant than *Makka*.

That the *Koran* is correct about a flood destroying the *Marib* civilization can be inferred from modern information. In 1986 a modern *Marib* dam was completed upstream from the ancient dam.<sup>2359</sup> Measurements taken over a decade show that the

<sup>2358</sup> Clapp. *Sheba*.

<sup>2359</sup> Articles and photographs of the dams and the three lakes are readily found on the Web.

biannual flooding varies greatly. From 1986 to 1996, the inflows were 85, 135, 90, 50, 50, 25, 130, 196, 27, 48 and 370 million cubic meters.<sup>2360</sup>

From 1994 to 1995, when the floods only amounted to 27 and 48 million cubic meters respectively, the lakes developed algae blooms said to be as thick as a cardboard mat, which perhaps means 5+ millimeters. Also, the lakebed became infested with insects. Cleaner fish were trucked in to eat all the critters.

During the drought from 1994 to 1995, doctors reported drastic increases in malaria, schistosomiasis [parasitic worms], typhoid, diarrhea and blue babies (from lack of oxygen in the blood). Then in 1996 a flood occurred that was so severe (370 million cubic meters) that, even with modern hydrology, *Marib* had to be declared a disaster area.<sup>2361</sup>

Here is how the disaster likely unfolded that led to the depopulation of *Marib*. After years of neglect, a large flood broke through the dam and upstream weirs (low dams). This had happened before but this time there was not enough expertise and social cohesion left to fix the dam before the next rainy season. Thus for years only small amounts of water were diverted to the two holding lakes and no water remained in the *Wadi* behind the dam.

The lakes started drying up and this led to algae blooms and insect infestation. Without crops and water, diseases became epidemic in the hungry populace. The wells started going dry because water was no longer being impounded behind weirs, dams and in the two lakes. Without constant seepage, the water table dropped to levels out of reach of wells dug with handpicks and shovels. So basically the populace of thirty thousand plus people faced the choice of leaving, starving or dying of disease.

Surely, if *Muhammad* knew about the recent history of the *Marib* dam, he also knew of the ruins of *Bilqis'* temple. *Bilqis'* temple at one time competed for pilgrims with *Makka*.

The *Bilqis* moon-god temple probably claimed the Queen of *Sheba* as its patroness already in pre-Islamic times. This would help explain why *Makka* came to claim *Ibrahim*, Ishmael and Hagar as patron saints. It would also go a long way toward explaining how *Muhammad* came to think that *Yahveh* was *Allah* the moon-god.

Wendell Phillips wrote about *Sheba's* moon-god temple:

Near the top of the delicate stone shaft was a beautifully carved circular sun with a crescent-moon, while below was a long *Sabean* inscription in perfectly chiseled characters.... Like nearly all *Semitic* peoples they worshipped the moon, the sun and the morning star. The chief god, the moon, was a male deity symbolized by the bull...<sup>2362</sup>

That both the sun and moon were worshipped at *Sheba's* temple suggests that *Muhammad* transformed the Biblical Queen of *Sheba* account into a story promoting monotheistic moon worship.

The moral of the story was that *Allah* caused the *Marib* dam to fail (*K* 034:015-016) because the *Yemenis* forgot Solomon's warning and reverted to worshipping the sun in addition to *Allah* the moon-god (*K* 027:024).

<sup>2360</sup> Basahi, I.A.A. "Marib Dam: the importance of environmental and health impact studies for development projects," *Eastern Mediterranean Health Journal*, vol. 6, Issue 1, 2000, pp. 106-117.

<sup>2361</sup> Basahi, I.A.A. "Marib Dam: the importance of environmental and health impact...*Idem*."

<sup>2362</sup> Phillips. *Sheba*, pp. 226-227.

This interpretation is congruent with the fact that the *Koran* has a chapter entitled “The Moon,” but there is no corresponding *Koran* chapter entitled “The Sun.” The *Koran* espouses moon-god monotheism. The anti-solar *Koran* rejects the sun since it is the only astral object that outshines the *Allah* the moon-god.

Both the Queen of *Sheba* (K 027) and the *Marib* dam disaster chapters (K 034) are *Makkan Suras*. *Muhammad*’s message to the *Makkans* was that *Allah* the moon-god had brought disaster on *Marib* and ended the pilgrimages to the north *Yemen* moon temple on account of the *Yemenis* worshipping the sun (K 027:024).

It is well known from many sources that, along with other gods, the sun (*Shams*) was worshipped at the *Kaaba* in pre-Islamic times along with many other gods.

*Muhammad*’s implication was that if the *Makkans* continued to associate other deities with *Allah* the moon-god, *Allah* would send a disaster and cause the *Makkan Kaaba* to fall into disuse too. This would hurt the *Makkans*, especially because they derived many economic and political benefits from the two annual solstice pilgrimages to the *Makka* (K 105—106; see also K 028:057).<sup>2363</sup>

*Muhammad* said that the *Marib* dam had been ruined by a flashflood (K 034:016). Similarly, in another *Makkan Sura Muhammad* preached that *Allah* drowned the Antediluvians first in a flood and then in hellfire because they did not abandon gods besides *Allah* (K 071:023-025). By these accounts *Muhammad* suggested the apocalyptic ending *Makka* might face if the *Makkans* continued in polytheism.

Notably, *Makka* was subject to flash flooding until the twentieth century, as Snouck Hurgronje wrote in the 1880’s:

God gave to His guests only stones, sand and an intolerable temperature.

And not content with this, He placed, to the east of the vale [wadi valley] of *Makka*, a permanent threat to their lives and their goods, the *Sayl*.<sup>2364</sup>

The *Sayl* probably explains why *Muhammad* mentions Noah in 28 of the *Koran*’s first 71 chapters, once every 2.5 chapters in the *Koran*!<sup>2365</sup>

Concerning the above quotation, F. E. Peters notes that “God’s guests” was “a name the *Makkans* liked to give themselves.”<sup>2366</sup> F. E. Peters wrote:

The *Sayl* is the torrential flooding that has plagued *Makka* for most of its history and has succeeded in leveling even the most substantial structures, to say nothing of the humble abodes of the fifth- and sixth-century *Quraysh*. As Hurgronje noted, showers to the east of the city inevitably resulted in flash flooding in *Makka* itself, with its holiest place, the *Haram* [sacred area] and its *Kaaba*, situated directly athwart the drainage line of the valley where the city was built.<sup>2367</sup>

The fact that *Muhammad* probably witnessed more than one *Sayl* flood at *Makka*, and that he knew a similar flood destroyed *Marib* during his lifetime, had a profound effect on *Muhammad*. *Muhammad* thought *Allah* was about to destroy *Makka* by a flood, so he became *Allah*’s Warner (K 002:119).

The *Sabeans* will be mentioned again later in this chapter regarding *Ibrahim* and the moon (K 006).

<sup>2363</sup> Peters. *Makka*, p. 32.

<sup>2364</sup> Peters. *Makka*, pp. 23-24.

<sup>2365</sup> Richardson. *Secrets*, p. 97.

<sup>2366</sup> Peters. *Makka*, p. 24.

<sup>2367</sup> Peters. *Makka*, p. 24.

### The Calendar Reform

*Muhammad* ended intercalation at *Makka* (K 009:036-037). *Makka* had a solilunar calendar where a thirteenth month was added every three years. This was the “epact” period—time added to harmonize the solar and lunar calendars. The epact period kept the calendar roughly in sync with the seasons and solar equinoxes.

From the Christian apocryphal story of the Sleepers in the Cave, it seems it was common knowledge in *Makka* that 300 solar years roughly equaled 309 lunar years.<sup>2368</sup> The story shows that *Muhammad* also knew that Christians counted their years using a solar calendar. *Muhammad* said:

They stayed in their Cave [sleeping] for three hundred [solar] years [according to the Christian solar reckoning] but add nine more years [to arrive at the *Islamic* lunar-year reckoning] (K 018:025).

*Muhammad* believed that *Allah* had designated four months each year as being sacred (K 002:194, 217; 005:002, 097; 009:005, 037). In these four months, there was to be no fighting. One of the four sacred months was the twelfth month, *Dhu’l Hijja*, when the *Hajj* pilgrimage to *Makka* was, and still is, undertaken.

Intercalation had the affect of delaying the sacred months by about one month every three years. There were intercalators at the *Kaaba* who made astral observations and adjusted the calendar accordingly. The process was called *Nasi*.

The *Kaaba* at *Makka* was considered to be the House of *Allah*.<sup>2369</sup> According to *Muhammad*’s perception, the sun caused a one-month delay in pilgrimages to *Allah*’s house every three years.

That *Muhammad*’s religious calendar had to be lunar rather than solar or solilunar suggests that *Allah* was a moon-god. *Sin*, another ancient moon-god, was called “lord of the calendar and of wisdom.”<sup>2370</sup> A moon-god monotheist such as *Muhammad* could not countenance a solilunar calendar since this implied that the sun and moon were co-rulers of the religious calendar.

The fact that Jews followed a solilunar calendar, and the Christians a solar calendar, seemed to indicate in *Muhammad*’s mind that they worshipped sun-gods besides the moon-god *Allah*. Ali Dashti wrote:

In the *Qor’an*, the old Arab use of the lunar year is seen as an inviolable law of nature, and intercalation is prohibited in verse 37 of *Sura* 9: ‘Postponement is an increase in unbelief.’ The Lord who made observance of ancient Arab lunar time reckoning compulsory everywhere and forever must have been either a local Arabian god or the Prophet *Mohammad*.<sup>2371</sup>

*Ibn Warraq* writes similarly:

According to the *Koran*, *Allah* created the moon and its phases for man to know the number of the years (*Sura* 10.5). Again, a rather primitive Arabian notion, since all the advanced civilizations of the *Babylonians*, *Egyptians*, *Persians*, *Chinese* and *Greeks* [and *Romans*] used the solar year for the purpose of time reckoning.<sup>2372</sup>

<sup>2368</sup> 365.25-day solar year x 300 = 354.36-day lunar year x 309.

<sup>2369</sup> *Kaaba* was House of *Allah*: K 002:125; 003:096-097; 005:002, 097; 008:035; 014:037; 022:026, 029, 033; 033:033; 052:004; 106:003.

<sup>2370</sup> *CEE*, *Sin* entry.

<sup>2371</sup> Dashti. *Career*, p. 164.

<sup>2372</sup> Warraq. *Why*, p. 136.

Jews and Christians intercalated days and months, a practice that *Muhammad* banned (K 009:036-037). Because Jews used a solilunar calendar, *Muhammad* must have deduced that Jews worshipped Ezra as a sun-god. Because Christians used a solar calendar that retained the month time unit, *Muhammad* thought that Christians worshipped Jesus as a sun-god.

A solilunar calendar necessitated ongoing observation of the sun and moon. The calendar was then tweaked so the same seasons occurred during the same months each year. A lunar calendar merely required observations of the moon at the end of each month.

The pre-*Islamic* Arabs were skilled at intercalation since the Arabic names of the months suggest their former position in the solar year. For instance, *Rabi* means “Spring,” *Jumada* means “Dry month” and *Ramadan* means “Scorcher.”

*Muslims* even in modern times consider watching for the crescent-moon an act of worship, which suggests that *Allah* was a moon-god. Abdulkader Tayob wrote:

The basic forms of *Islamic* worship were also determined by God, in the *Quran*, as well as by the Prophet *Muhammad*'s example. This means that, in many cases, the forms were regarded as ends in themselves. Riding a camel to *Makka* would be regarded as a means to an end but *Mufti* Shafi, like most other contemporary jurists, regards watching the crescent of the new-moon to signal the change of month as an end in itself. Unlike riding a camel, watching the new-moon is an act of worship.<sup>2373</sup>

To *Muhammad*, watching both the sun and moon and adjusting the calendar accordingly, was polytheistic worship of the sun-goddess and moon-god *Allah*. Watching only for the crescent-moon reinforced monotheistic belief in *Allah* the moon-god. This is why *Muhammad* mentions fighting the “polytheists” in the same verse where he forbids inserting intercalary months (K 009:036).

That *Allah* had sacred months suggests that *Allah* was a moon-god. *Muslims* celebrate the sacred lunar month of *Ramadan* because during this month is when the *Koran* was first revealed (K 002:185).

Significantly, other ancient moon deities had sacred months.

“In the *Assyrian* period...the month of *Siwan* (May-June) was dedicated to the moon-god [*Sin*].”<sup>2374</sup> *Artemis*, the sister of *Apollo* the sun-god,<sup>2375</sup> had a sacred month. An ancient Roman proconsul declared:

This is the greatest sign of her cult, that we have called a month after her name, *Artemision*...the month *Artemision* is holy in all its days and during its days the monthly and the yearly festivals and the celebration of the *Artemisia* and the [other] holidays shall be held, since the whole month is consecrated to the goddess.<sup>2376</sup>

The *Koran* was first revealed at night too—during “the Night of Power” (*Laylat Al Qadr*) (K 097:001-005). This night is the holiest date on the *Muslim* religious calendar, as the *Koran* states “This grand night is better than a thousand months” (K 097:003). Sins are forgiven on the Night of Power when *Gabriel* and other angels descend from heaven to answer prayer (K 097:004).

<sup>2373</sup> Tayob. *Islam*, p. 27.

<sup>2374</sup> Green. *Moon*, pp. 30, 157.

<sup>2375</sup> The resources seems unanimous that *Artemis* was a moon-god for instance, *The New Dictionary of Cultural Literacy*, 3<sup>rd</sup> Edition, Edited by E. D. Hirsch, Jr., Joseph F. Kett, and James Trefil, 2002, *Artemis* entry.

<sup>2376</sup> MacMullen & Lane. *Sourcebook*, p. 41.

The Night of Power always falls on an odd numbered night near the end of the sacred month of *Ramadan* (K 002:185). *Muslims* are not unanimous about when the Night of Power is supposed to fall. If the Night of Power falls during the interregnum period when the moon is not visible, it would be a chthonic (relating to the underworld) festival.

That *Allah* has an end of lunar month celebration pegs *Allah* as being a moon-god. These end-of-lunar month celebrations were not uncommon to lunar religions, as the *Encyclopedia Britannica* notes:

The mythology of the moon emphasizes especially those periods when it [the moon] disappears—the three days of darkness in the lunar cycle and eclipses.<sup>2377</sup>

*Sin* the moon-god also had a special day toward the end of the lunar month in Babylon, as Tamara Green wrote:

The 28<sup>th</sup> of the month was a day of lamentation when prayers were offered, because the moon had disappeared from view and was to remain hidden for a few days in the power of the dragon.<sup>2378</sup>

Sinasi Gunduz wrote:

He [*Al Biruni*] records the feasts of the *Haranians* in honor of the moon, one of which is the ‘Feast of the *Dayr Sini*’ (‘Shrine of *Sin*’), which was celebrated on the twenty-eighth of April.<sup>2379</sup>

The link between *Islam* and *Haranian* and ancient Mesopotamian *Sin* moon-god worship is clearest in that each religion regards the twenty-seventh day of the lunar month as special, as Tamara Green wrote:

The clearest link with the ancient Mesopotamian form of lunar worship that can be found in either calendar is the remark in the *Catalog* that on the 27<sup>th</sup> of every month they go out to *Dayr Kadhi*, where they ‘slaughter and burn offerings to the god *Sin*, who is the moon.’<sup>2380</sup>

Many *Muslims* believe the 27<sup>th</sup> day of the lunar month *Ramadan* is special and it is called the Night of Power (*Lailat-ul-Qadr*):

During the last 10 days of *Ramadan*, the night of power, or *Lailat-ul-Qadr*, is observed. *Lailat-ul-Qadr* is the night the *Quran* was given to *Muhammad* but the actual date is unknown. ‘It is the night when you can pray the most to God, when the blessings from heaven come down to Earth and when your prayers are answered,’ Khan said. ‘Some *Muslim* countries have declared the actual night as the 27<sup>th</sup> day of *Ramadan*...’<sup>2381</sup>

Perhaps these lunar celebrations while the moon was battling it out in the underworld were like the night-sun celebrations, as Joseph Campbell notes:

We are told also why the sublimer scenes in the Mysteries were always in the night. The life of the interior spirit is the death of the external nature; and the night of the physical world denotes the day of the spiritual. *Dionysus*, the night-sun, is therefore worshipped rather than *Helios*, orb of day.<sup>2382</sup>

<sup>2377</sup> *EB*, accessed 29 Mar 2003, “Moon Worship” entry.

<sup>2378</sup> Green. *Moon*, p. 29.

<sup>2379</sup> Gunduz. *Life*, p. 201.

<sup>2380</sup> Green. *Moon*, p. 153-154.

<sup>2381</sup> Trier, Maddie. “Religious revelation: Local *Muslims* gather to honor holy month,” *The State News*, statenews.com, 19 Oct 2004.

<sup>2382</sup> Campbell, Joseph. *Theosophy*, vol. 46, no. 5, Mar 1958, pp. 223-229, wisdomworld.org.

*Muslims* fast during the daytime in the month of *Ramadan*. When the sliver of the crescent-moon appears at the end of the month of the *Ramadan*, this marks the end of the fast and the *Eid Al Fitr* feast is celebrated. Tamara Green wrote “The 30<sup>th</sup> day is his [*Sin*’s] day.”<sup>2383</sup>

*Sin* worshippers marked off their months by the moon, and so do *Muslims*. The dates that *Sin* and *Allah* worshippers celebrate occur approximately when the crescent-moon appears in the sky. The Night of Power celebrates the waning crescent and the *Eid Al Fitr* feast celebrates the waxing crescent.

### Moses’ Solilunar (Solar-lunar) Calendar

The purely lunar calendar suggests that *Allah* was a moon-god and *Muhammad* was a moon-god monotheist. In contrast, the Jewish solilunar calendar and the Christian solar calendar show that Jews and Christians were not moon-god monotheists, nor sun-god monotheists.

Some uninformed *Muslims* have asserted that the *Muslim* and Jewish calendars are both lunar. This assertion is erroneous since the calendar handed down from *Yahveh* to Moses was a solilunar calendar. In the Jewish calendar, months were inserted when necessary so the calendar would keep in alignment with the seasons.

Exo 12:02 indicates that the Hebrew solilunar calendar was first instituted during the *Exodus* since *Exodus* 12:02 says the first Passover marks the start of the year. Note however that the Hebrew Year One is the Creation Day, with 2004 AD being Year 5764 in the Jewish calendar.

Solilunar calendars utilize intercalation to stay in alignment with both the sun and the moon. That *Yahveh* and Moses instituted a solilunar calendar with intercalation ought to be troubling for *Muslims*. *Muslims* consider Moses to be a prophet, yet *Muhammad* contradicted what Moses taught. *Muhammad* taught that *Allah* ordained a calendar at creation that had no intercalation.

*Muhammad* said that intercalation constituted polytheism, specifically, partnering the sun-goddess with the moon-god *Allah* (K 009:036-037). Moses however wrote about the sun and moon:

And God said ‘Let there be lights in the expanse of the sky to separate the day from the night, and let **them** serve as signs to mark seasons and days and years, and let **them** be lights in the expanse of the sky to give light on the earth.’

And it was so. God made two great lights—the greater light to govern the day and the lesser light to govern the night. He also made the stars (Gen 01:14-16).

Notice that “them” in Gen 01:14 refers to the sun and the moon.

That both the sun and moon were created for marking “seasons” and “years” implies God created the sun and moon so that humans would make solar or solilunar calendars with intercalation. Purely lunar calendars like the religious calendar that *Muhammad* instituted ignore the sun and thus do not track with the seasons.

There are other proofs that Moses’ calendar was solilunar. Moses said the fall harvest festival *Sukkoth* should always start on the 15<sup>th</sup> day of *Tishri*. This is only possible when a solilunar calendar is used (Lev 23:39-41).<sup>2384</sup> *Sukkoth*, also called

<sup>2383</sup> ANET, 386, as quoted by Green. *Moon*, p. 24.

<sup>2384</sup> In Biblical times, *Tishri* was the seventh month, and corresponded to September or October of the Gregorian calendar. Judaism came to treat *Tishri* as the first month ever since the time of the Babylonian captivity.

the Festival of Booths or the Feast of the Ingathering, was said to occur at the year's end (Exo 23:16; 34:22).

If Moses' calendar were lunar however the seasonal harvest festivals would need to be "moveable feasts." If one uses a lunar calendar, one cannot schedule a seasonal festival to be on a certain day and month into perpetuity. If one used a lunar calendar, seasonal feasts would land eleven days later each year and would need to slide throughout the lunar year.

Besides the 15<sup>th</sup> of *Tishri* date, one can tell from several facts that Moses' *Sukkoth* harvest festival occurred in the fall season. Moses mentioned fruit from trees in connection to *Sukkoth* (Lev 23:39-41), as well as barley and wine (Deu 16:13). During *Sukkoth* the tree branches were leafed out and were suitable for making booths (Neh 08:14-15).

God says that *Sukkoth* would be at year's end (Exo 23:16; 34:22). In Biblical times "year's end" probably referred to the autumnal equinox, which is September 21 in the Gregorian calendar. The autumnal equinox signaled the end of the last growing season of the year before the winter hiatus.

*Sukkoth* must have occurred in the fall because the other harvest festival of the year, called *Shavuot*, occurred in the spring (Lev 23:10-14). Only barley and not fruit is mentioned in connection with the *Shavuot*. The first harvest of the year was of barley. This barley was planted in the fall and was harvested in the spring. This is similar to how modern "winter" wheat is planted in the fall and harvested in the spring.

*Shavuot* is also called Feast of Weeks, or Pentecost, and occurs in the third month called *Sivan*—around the month of May in the Gregorian calendar.<sup>2385</sup> Pentecost occurred seven weeks after a wave offering was made of the first sheaf of barley that was put to the sickle. The wave offering occurred in the first month of *Nisan*—around March in the Gregorian calendar (Lev 23:15; Deu 16:09).<sup>2386</sup>

### ***Ibrahim and Moon-god Monotheism (Koran 006)***

K 006:075. So also did We [*Allah*] show *Ibrahim* the **kingdoms** of the heavens and the earth, that he might (with understanding) have certitude.

076. So when the night overshadowed him, he saw a **star**. He said 'Is this my Lord?' **So when it set**, he said 'I do not love **the setting ones**.'

077. Then when he saw the **moon** rising, he said 'Is this my Lord?' **So when it set**, he said '**If my Lord had not guided me** I should certainly be of the erring people.'

078. Then when he saw the **sun** rising, he said: 'Is this my Lord? Is this the greatest?' **So when it set**, he said 'O my people! Surely, I am clear of what [idols to the stars and sun] you set up (with *Allah*) [the moon-god].

079. Surely I have turned myself, being upright, wholly to Him Who originated the heavens and the earth, and I am not of the polytheists.'

### *Short Explanation of the Story of Ibrahim and the Star, Moon and Sun*

As one would expect in an astral religion, *Allah* guided people by means of the sky. *Muhammad* even thought that *Allah* guided shadows by means of the sun:

<sup>2385</sup> Judaism however treats *Sivan* as the ninth month ever since the Babylonian Captivity.

<sup>2386</sup> Judaism however treats *Nisan* as the seventh month ever since the Babylonian Captivity.



Have you not seen how your Lord has spread the shade. If He willed He could have made shadows stationary but We have made the sun shade's pilot (K 025:045).

*Muhammad* thought those who took refuge in a cave were guided by *Allah's* use of the sun:

You might have seen the sun when it ascended toward the right and descended toward the left...That was a sign of *Allah*. He whom *Allah* guides, he indeed is led aright, and he whom He sends astray, for him you will not find a guiding friend (The Cave *Sura* K 018:017).

*Allah* guided *Muhammad* and *Ibrahim* by the sun, moon and a star (K 002:144; 006:075, 077). *Allah* told *Ibrahim* that *Allah* would give *Ibrahim* a guided tour of the constellations, a.k.a. "the kingdoms," and *Ibrahim* just needed to figure out which celestial object was *Allah's* own to determine whether *Allah* was a sun-, moon- or star-god.

The "kingdoms of the heavens" (*Palmer, Pickthall, Rodwell, Sale, Shakir, Sher Ali* K 006:075) refer to the zodiacal constellations. Besides "kingdoms," various *Koran* translations call the zodiacal constellations "zodiacal signs" "mansions," "houses" and "stages" (K 010:005; 015:016; 025:061; 036:039; 085:001).

Why did *Ibrahim* need to watch a star, the moon and the sun rise and then set? The practice of watching the sky before sunrise and sunset was important in the Mideast for three reasons:

- ☉ Venus is mostly seen before sunrise and after sunset and was best worshipped then.
- ☉ Calibration of the astrological charts based on what constellation the sun was in. When the ancients wanted to determine what zodiac sign the sun was in, they would look at the east horizon before sunrise and at the western horizon after sunset.
- ☉ Calendar intercalation—since the sun ought to be in a certain constellation during certain months and seasons.

The five prayer times per day that *Muslims* observe preserve these sky-watching aspects of pre-*Islamic* astral worship. Note how one Call to Worship occurs before sunrise and one after sunset. The Call to Prayer (*Adhan*) goes out at:

- 1) The crack of dawn about eighty minutes before sunrise (*Fajr* or *Subh*), 2) Right after high noon (*Zuhr*), 3) Mid-afternoon ('*Asr*), 4) Right after sunset (*Maghrib*) and 5) Just after nightfall ('*Isha*').

What one observes by watching the moon, sun and planets rise and set is that they move through the constellations at different speeds. Stars of course have no perceptible movement and move along with the zodiacal constellations.

The sun moves from one zodiacal constellation to the next in about a month. The inner planets track with the sun through the zodiac, for the most part, and the outer planets move more slowly than the sun.

The moon however moves through the entire zodiac in about a month, so about every 2.5 days the moon is in the next zodiac sign. There are twelve zodiacal constellations. One can easily detect how the moon moves faster than planets and stars by how the moon occults stars and planets as it moves across the sky.

The movement of the celestial objects in fact constitutes "guiding" in astrology. The quicker the movement, the more effect the celestial object has on earthlings. Moreover, when the planets and the moon move into different constellations, and

when there are different conjunctions, the influences of the planets are enhanced and different forces come into play. Spengler and Sayles wrote on the subject:

The basis of astrology centers around the principle of change. The Greek philosopher Aristotle had drawn a distinction between the uniform motion of the stars and the irregular motion of the planets and this interaction formed the basis for classical astrology which was eventually adopted by Arabs of the *Jazira*. Among the greatest of Arabian astrologers was *Abu Mashar* who studied at *Baghdad* in the 9<sup>th</sup> century (AD) and formulated the doctrine that the more rapidly and erratically a body in the heavens moves, the more influence it will exert on things below. The moon being the swiftest object in the heavens thusly exerts the greatest effect on human affairs.<sup>2387</sup>

So the story of *Ibrahim* and the star, moon and sun shows that *Allah* the moon-god is the highest god in heavens because he is the swiftest, and he guides all the events of *Ibrahim's* life via the zodiac and astrology. This is why when the moon rose and set, *Ibrahim* called the moon "Lord" (K 006:077).

In contrast, *Ibrahim* noticed that neither the sun nor the planets moved any perceptible distance in the zodiac between one rising and setting, so they have little to no effect on *Ibrahim's* life compared to that of the moon. The sun and stars are more like angels than gods to *Ibrahim*.

#### *Short Analysis of Ibrahim and Moon-god Monotheism (K 006)*

The setting of the story is *Haran* since *Ibrahim's* father *Terah* was said to be alive (K 006:074). The author knew that *Terah* had lived out his life in the moon-god centers of *Ur* and then *Haran* (Gen 11:26-28; 31-32; Jos 24:02).

The author may have known several bits of information that confirmed in his mind that *Allah* was a moon-god such as:

- ⊕ *Jerah*, the fourth son of Joktan, was the progenitor of the Arabian people. *Jerah* is a theophoric name meaning "new-moon" (Gen 10:26).
- ⊕ The name *Terah* means "*Ibex*," which in ancient times was a well-known symbol for the moon on account of the *Ibex's* curved horns.<sup>2388</sup> Egerton Sykes wrote that *Terah* was a theophoric name:
  - ★ "*Terah*. Ancient Semitic name for the moon, equated with *Terah*, father of Abraham. It [the moon] was also known as *Eterah* and *Jerah*."<sup>2389</sup>
  - ★ "*Elom*. Name given to the moon by the southern Hebrews. Variants of *Elom* were *Eterah*, *Ilmaqah*, *Jerah*, *Sahar* and *Terah*."<sup>2390</sup>
- ⊕ Abraham's younger brother was named after the city *Haran* (Gen 11:26). *Haran* was the ancient "City of the Moon," so the name *Haran* seems to have become a theophoric name synonymous with the moon-god *Sin*. So *Haran* received a name that referred to the moon similar to *Jerah* and *Terah*.
- ⊕ The temple of *Bilqis*, Queen of *Sheba*, was a moon-god temple, which fact misled the Arabs to think that Solomon's god *Yahveh* must have been a moon-god too.

<sup>2387</sup> Ma'shar. *Albumasaris*, as cited by Wedel. *Attitude*, pp. 56-57, cited in turn by Spengler & Sayles. *Turkoman*, p. 22.

<sup>2388</sup> Brown, Driver & Briggs: *Hebrew-Aramaic and English Lexicon of the Old Testament (BDB)*, entry 11034: *Terah*.

<sup>2389</sup> Sykes. *Mythology*, p. 207, *Terah* entry.

<sup>2390</sup> Sykes. *Mythology*, p. 70, *Elom* entry.



**Figure 04-07.** *Yemeni* marble frieze with *Ibex* and crescent with orb motif.<sup>2391</sup> *Ibex* and other animals with curved horns were associated with the moon-god.

So this story of *Ibrahim* and the *Haranites* ought to be understood as a moon-god monotheism story. *Ibrahim* saw the stars, moon and sun but was only impressed by, emotionally moved by, and guided by the moon. Then *Ibrahim* said:

O my [moon worshipping] people! Surely, I am clear of what you set up (with *Allah* [the moon-god]) (K 006:078).

*Muhammad* said that *Ibrahim* rejected the stars (K 006:076) but referred to the moon as his Lord who had just guided him (K 006:077). *Allah* elsewhere was compared to a light in a niche (K 024:035).

Then when the sun rose, *Ibrahim* asked himself whether the sun was greater than the moon. When the sun set, *Ibrahim* rejected the sun because the sun did not give him a warm spiritual feeling. *Ibrahim* therefore concluded that others had set up the sun and stars as gods to be worshipped along side *Allah* the moon-god (K 006:078).

#### *In-depth Analysis of Ibrahim and Moon-god Monotheism (K 006)*

Traditionally, the phrase “I do not love the setting ones” has been thought to be the key to unlocking the meaning of this story about *Ibrahim* (K 006:076). The phrase has been taken to mean that *Ibrahim* rejected the sun, moon and stars as gods based on the fact that they set.<sup>2392</sup>

In keeping with this idea, *Pickthall* and *Yusuf Ali* repeatedly translate the phrase “so when it set” (*Shakir* K 006:076, 077, 078) as “but when it set.” The “but” grammatical conjunction implies that *Ibrahim* somehow was surprised and disappointed that the astral object actually set.

This “but” translation and the pious interpretation of *Ibrahim*’s episode in *Koran* 0006 are ludicrous. *Ibrahim* surely already knew from an early age that certain astral bodies set below the horizon. There was no need for *Allah* to personally show *Ibrahim* that the sun, moon and stars set (K 006:075).

The pious explanation of *Koran* 006 probably arose a century or two after *Muhammad*’s time. *Muhammad* undoubtedly taught that *Ibrahim* recognized the guidance of *Allah* the moon-god. The later pious explanation was an attempt to sanitize the story of its “*Allah* was a moon-god” implications. The still later translations of the *Koran* 006 set the pious interpretation into cement by using the “but” translation, as was just mentioned above.

The pious explanation shows unfamiliarity with ancient astral paganism. *Muslims* who were several centuries removed from hardcore pagan astralism assumed that setting diminished the sun, moon and star gods, and that the “out of sight, out of mind” principle applied. However, it nearly goes without saying that the gods of planets such as Jupiter and Venus were worshipped during the day as well as at night, whether they were visible or not.

<sup>2391</sup> “A portion of a marble entablature, or frieze, probably from *Marib*, has the crescent-and-Venus orb as a central motif flanked by crouching Ibexes” (Doe. *Arabia*, p. 36, fig. 10).

<sup>2392</sup> Ruthven. *World*, pp. 16-17.

Many of the astral deities were worshipped **especially** during those times when they were not visible. It was thought that when the sun, moon and stars were below the horizon, they were actually traveling from west to east through the underworld.

Chthonic or underworld powers that pagans thought they had better appease at night included the night-sun, stars that rise seasonally such as *Sirius*, and the moon during its monthly three-day interregnum period. The interregnum period, when the moon is not visible between the waning and waxing crescent phases, was a special time for moon-god worshipping cultures.

The Egyptian *Book of the Dead* and the mystery sects in the Roman Empire during the first centuries AD dealt heavily with appeasing chthonic underworld deities. Worshipping astral deities while they were below the horizon allowed for astral religion activities during daylight hours.

A more forensic analysis reveals that the *Ibrahim* story in *K 006* is supposed to communicate that there are gradations between astral objects. The story was meant to debunk the belief in astral triads prevalent in the Mideast.

*Muhammad* wanted to disprove the popular pre-Islamic belief that *Allah* the moon-god was part of a moon-sun-Venus triad, or in *Muhammad's* words, he wanted to disprove that *Allah* was just “the third of three” (*K 005:073*).

Most triads were formed from a combination of the sun, moon and Venus. The monotheistic logic of the story was that since one astral object made the greatest impression on *Ibrahim*, the other less impressive astral objects must be mere creatures.

*Muhammad* came to believe that male angels manned the sun and stars. *Muhammad* believed that the ancients had mistakenly given female names to the sun and many stars and elevated them to a divine status, as was noted above.

Why did *Muhammad* think the angels needed to be male angels (*K 037:150; 042:019; 053:027*)? First, they had to fight the *Jinn* and demons that eavesdrop and even attack heaven. Meteors and meteorites were heaved by male angels at these *Jinn* and demons (*K 041:012; 072:008-009*). Second, in ancient Arabia male progeny were preferred over female progeny (*K 016:059; 017:040; 037:149, 153; 043:016; 052:039; 053:021*).

*Muhammad* believed that *Allah* the moon-god could not have a divine, begotten son (*K 039:004*). *Muhammad's* proof that Jesus was a mere human was that he ate food (*K 025:020*), though Jesus ate food to prove, among other things, that he was not a ghost (Luk 24:39). *Muhammad* seems oblivious to the fact that Christians believe Jesus was the God-man and therefore could eat food as a man and still be God too.

The *Koran* endlessly polemicizes against those who believed *Allah* had gods as sons or daughters,<sup>2393</sup> or has guardians, intercessors or associates.<sup>2394</sup> The reason

<sup>2393</sup> *Allah* has no sons or daughters (*K 006:100; 016:057-058; 017:040; 037:149, 153; 043:016; 052:039*).

<sup>2394</sup> *Allah* has no partners (*K 003:064; 004:036, 048, 116; 005:072; 006:022, 051, 070, 094, 100, 136, 148, 151, 163; 007:033, 053, 173, 190, 191, 195; 010:003, 018, 028, 034, 066; 011:054; 012:038, 106; 013:16, 033, 036; 014:022; 016:001, 003, 027, 035, 054, 086, 100; 017:022, 039; 018:026, 038, 042, 052; 022:017, 026, 031; 023:059, 092; 024:055; 025:002; 026:100; 027:059, 063; 028:062, 064, 068, 074; 029:008, 065; 030:013, 033, 035, 040; 031:013, 015; 032:004; 034:027; 035:014, 040; 037:022; 039:038, 043, 065, 067; 040:012, 042, 084; 041:047; 042:021; 060:012; 072:020*).

*Muhammad* gave for *Allah* having no divine son was that *Allah* has no divine consort (K 006:101; 006:100-101).

*Allah* does not have any daughters because if *Allah* had any progeny at all, his progeny would be male (K 016:059; 017:040; 037:149, 154; 043:016; 052:039; 053:021). *Muhammad* came to believe that there was only “one god” and that angels manned the sun, stars and other astral objects besides the moon.

*Muhammad*'s assumption that “hierarchy implies monotheism” appears elsewhere in the *Koran*. In K 053:007 and in the recap of K 053 (K 081:023), *Allah* the moon-god is spoken of being on the horizon. Later in the chapter, *Muhammad* said of *Allah*, “He is the Lord of the *Sirius*” (K 053:049). *Muhammad* also said that *Allat* (the sun), *Uzza* (Venus) and *Manat* (Fate) were male angels whom the pagans had given female names, as was noted above.

In the story about *Ibrahim* (K 006:075), *Allah* showed himself to be an astral deity when he chose to communicate spiritual truths through the medium of the night sky. In K 006:076, *Ibrahim* said that he did not love “the setting ones.” “The setting ones” is similar to the descriptive name for the planets—“the wanderers.” Notably, the English word “planets” comes from the Greek verb meaning “to wander.”

*Muhammad* did use other descriptive names for objects in the sky. *Muhammad* called the “zodiacal signs” “mansions,” “houses,” or “stages”—depending on the translation (K 010:005; 015:016; 025:061; 036:039; 085:001). *Muhammad* thought of the heavens as “kingdoms” (*Shakir* K 006:075).

“The setting ones” describes those stars positioned away from the north celestial pole. The stars that appear to rotate around the north celestial pole do not set below the horizon but just fade from view when the sun rises.

While discussing the Egyptian sun-god *Set*, Egerton Sykes wrote about the difference between setting stars and stars that do not set:

While the main story of the conflict is given under *Horus*, *Isis* and *Osiris*, some additional light is given by the division of the stars between [the sun-god] *Set* and *Horus*, *Set* taking all the circumpolar stars, i.e. those which never set, and *Horus* those which rise and set like the sun. To watch over *Set* [from stars that do not set], the four sons of *Horus*...were given places in...the north polar constellation of the Great Bear [which contains the Big Dipper].<sup>2395</sup>

The above myth shows that the Egyptians realized that the circumpolar stars do not set even during the day. The Egyptians gained this knowledge by observing the daytime sky during total eclipses, and at dusk and dawn, and also through deduction.

Notably, the Egyptians are known for building long shafts in their pyramids, ostensibly to view stars during dusk, dawn and at night. The star shafts tend to point toward the north and south.

The star shafts may have been used to align higher layers of the pyramid both for level and pitch (slope) just as was done with the base. The star shafts may have been connected to Egyptian mythology about the Pharaoh.

Perhaps it ought to be mentioned that this theory is suspect: that the three pyramids of *Giza* representing three stars in the Orion constellation. The arrangement of the pyramids does not match the constellation well. Also, the pyramids and star shafts were not aligned with Orion since this would require the pyramids to have

<sup>2395</sup> Sykes. *Mythology*, pp. 188-189, *Set* entry.

been built in 10,450 BC rather than during 2700 to 2500 years BC—the consensus dates for their building.<sup>2396</sup>

*The Turks Believed That Ibrahim Called the Moon His Lord in K 006*

That *Allah* is a moon-god explains this traditional Turkish *Blessing* that refers to the moon-god as the Friend (*Khalil*) or Crescent (*Halil*) of *Ibrahim*:

May the moon shine in front of you. | May the moon-god | Protect you and us. | I saw the moon, oh God. | May the months be auspicious. | I saw the moon | I saw light, | I saw *Halil Ibrahim*, | I gave thanks | And forswore my sins, | Thanks be to God.<sup>2397</sup>

“*Halil Ibrahim*” in the above poem means “Crescent of *Ibrahim*.” Perhaps this should read “*Khalil Ibrahim*,” meaning “Friend of *Ibrahim*.” *Khalil* means “friend.” Either way, the poem still indicates that the Turks widely believed that *Allah* was a moon-god.

By the way, many *Mosques* with crescent finials are named “*Khalil Ibrahim*.” The *Encyclopedia Britannica* gives this information about Abraham’s tomb:

This place is venerated today in *Hebron*, at the *Haram Al-Khalil* (Holy Place of the Friend), under the *Mosque*<sup>2398</sup>

The *Encyclopedia Britannica* gives this information about “the Oaks of *Mamre*” (Gen 13:18, etc.). *Mamre* is...

...1.5 miles (3 KM) northwest of *Hebron* at *Ramat Al-Khalil*, an Arabic name which means the “Heights of the Friend,” the friend (of God) being Abraham.<sup>2399</sup>

*The Persians Believed That Ibrahim Called the Moon-god His Lord in K 006*

The *Parsees*, a.k.a. the Zoroastrians, drew the same conclusions about *K 006*. The *Parsees* rejected the traditional interpretation of *K 006:075-079*. The *Parsees* did not believe that either *Muhammad* or *Ibrahim* automatically rejected any astral body just because it happened to set. The *Parsees* believed that...

...*Ibrahim* (Abraham), the friend of God, pursued the same conduct [as *Muhammad*]; that is, he rejected the idols which were not of the planetary forms; and the reverence paid by him to the Black Stone [at the *Kaaba*], according to ancient tradition, seems to prove that point.<sup>2400</sup>

The Zoroastrians were correct in that *Islam* is an astral religion. That *Muhammad* revered the circumpolar stars can be inferred by the assertion that at least Solomon kept the pre-*Islamic* pagan practice of circumambulation around the *Kaaba*. *Muslims* walk around the *Kaaba* seven times. The stars rotate around the North Pole once per day, and seven times per week.

Some have suggested that the seven circuits around the *Kaaba* honors the five visible planets and the sun and moon. This very well may be the case but one needs to use his imagination to see how the sun and moon make a complete circle by

<sup>2396</sup> Bauval R.G. & A. Gilbert, *The Orion Mystery*, London, 1994, p. 193.

<sup>2397</sup> Turkey Ministry of Culture and Tourism, Culture > Stereotypical Expressions > Prayers–Blessings > m, kultur.gov.tr/portal/kultur\_en.asp?belgeno=5598, “Moon,” accessed 13 Nov 2003 (search the Google cache, or web.archive.org, if necessary).

<sup>2398</sup> *EB*. Abraham entry, accessed 16 Aug 2004.

<sup>2399</sup> *EB*. Abraham entry, accessed 16 Aug 2004.

<sup>2400</sup> Fani. *Dabistan*, p. 30.

making their circuit through the underworld. By contrast, one can easily observe the circumambulation of the polar stars.

The easiest explanation is that circumambulation mimics the motion of the Big Dipper, a cluster of seven stars in the constellation *Ursa Major*. This asterism (i.e. a small group of stars) rotates around the north celestial pole seven times per week. The Big Dipper has seven bright stars: three stars form the handle and four stars form the bowl.

The historian Azraqi said that the angels circumambulated in heaven around a celestial *Kaaba*, and the *Kaaba* on earth was similar to the one in heaven.<sup>2401</sup> The historian Tabari (839–923 AD) related that *Muhammad* connected the worship of *Allah* and the movement of the stars. Tabari says that *Muhammad* said:

These five stars [the visible planets] rise and run like the sun and the moon and race with them together. All the other stars are suspended from heaven as lamps are from *Mosques*, and circulate together with heaven praising and sanctifying God with prayer...their circulation today is what you see, and that is their prayer.<sup>2402</sup>

*Ibn Ishaq* reports that the common perception was that the stars sang in worship of *Allah* the moon-god. In a poem of repentance by *Al Husayn*, he composed:

I repent of what I said before; I realize that it was the speech of a liar.  
Would that my tongue were [split] in two, half of it dumb and the other half singing your praise [literally ‘in the course of the stars’].<sup>2403</sup>

Only the speed but not the circular path, of circumambulation is suggested by the planets, as Zwemer wrote:

Then the pilgrim runs between the hills of *Safa* and *Marwa*....He then runs around the *Ka'aba* seven times—thrice very rapidly and four times very slowly—in imitation of the motions of the planets.<sup>2404</sup>

The Prophet followed this method of circumambulation around the *Kaaba*, four times fast and three times slow, on his Farewell Pilgrimage.<sup>2405</sup> It probably was his custom.

Long before the advent of magnetic compasses, the Big Dipper guided sailors. Also, the camel caravans rode during the cool night and were guided through the featureless deserts by the Big Dipper.

Since the deities or angels manning the stars were obviously lesser beings than the moon, it was appropriate that they circumambulated in the heavens like the Big Dipper rather than just make a straight line from east to west. *Muhammad* figured that *Ibrahim* loved the Big Dipper stars but did not love the non-circumpolar stars that set.

In modern times, Polaris (the polestar) seems stationary to the naked-eye viewer. In *Muhammad's* time (570-632 AD) and before, even Polaris made a circle around a black empty spot in the sky. Polaris' apparent position has changed due to the precession of the earth. “In 2300 BC the polestar was in the constellation *Draco*, and by AD 12,000 the star *Vega* in the constellation *Lyra* will be the polestar.”<sup>2406</sup>

That Polaris rotated around a black empty space in the sky might explain why the ancient *Makkans* circumambulated around a *Kaaba* made of black stone. The

<sup>2401</sup> Jeffery. *Islam*, p. 207.

<sup>2402</sup> *Al Tabari. History*, vol. i, pp. 235-236.

<sup>2403</sup> Ishaq. *Sirat*, p. 43, & fn. 2.

<sup>2404</sup> Zwemer. *Animism*, ch. 8.

<sup>2405</sup> Ishaq. *Sirat*, pp. 530-531.

<sup>2406</sup> *CEE, Polaris* entry.

black spot at the north pole of the sky was thought to be a black *Kaaba*, as suggested by what Gibson records:

The star was added to the crescent-moon in 1793 by *Sultan* Selim III (possibly because the *Kaaba* is said to lie directly beneath the Pole Star), its points being set to five in 1844.<sup>2407</sup>

So if circumambulation mimics the Big Dipper constellation, *Muhammad*'s three quick and four slow circumambulations would not mimic the inner and outer planets but would mimic the Dig Dipper constellation.

The three quick circumambulations would mimic the inner stars of the ladle handle, and the four slow circumambulations would mimic the four stars that compose the ladle scoop.

Someone might then say that the seven circumambulations around the *Kaaba* indicate that the *Kaaba* was built for the stars and not the moon. It seems however that most temples in Arabia were moon temples, and all these included the rite of circumambulation. So it was thought that the stars circumambulated around the North Pole to honor the moon-god.

That circumambulation was in honor of the moon-god is suggested by the Biblical *Jericho* account. *Jericho* means "His [*Yerah*'s] Moon," from the *Semitic* word *Yareach*. *Jericho* was across the Jordan from Mount *Nebo* (Deu 32:49). *Nebo* is the Hebrew name for the *Babylonian* moon-god *Sin*'s scribe. Achan's saying that he coveted a *Babylonian* robe shows *Babylon*'s influence at *Jericho* (Jos 07:21).

*Beth Haran* was near *Jericho* (Num 32:36). *Beth Haran* was east "of the Jordan River, not far northeast of its mouth into the Dead Sea."<sup>2408</sup> The name *Haran* seems to have become synonymous with the name of the moon-god, so though "*Beth Haran*" literally means "House (or "temple") of *Haran*," it probably should be translated "House of the Moon-god [*Sin*]."

Temples as far as *Huraydah*, *Yemen*, were dedicated to the moon-god *Sin*, showing *Babylon*'s far-flung influence.<sup>2409</sup> So the moon-god *Yerah* worshipped in *Canaan* and in *Jericho* surely was modeled on the moon-god *Sin* worshipped in Mesopotamia.

The moon-god centers *Ur* and *Haran* on either end of the *Tigris* and *Euphrates* were sister cities. *Jericho* may have also had a sister moon-god city on the Jordan River. *Beth Yerah* is just south of the Sea of *Galilee* on a Jordan ford, and *Jericho* is just north of the Dead Sea on a Jordan ford. *Beth Yerah* means "the House of the Moon-god." "*Beth Yerah* was settled in the Early Bronze Age (~3100–2300 BC)."<sup>2410</sup>

The tell mound of *Jericho* is about twelve hundred feet long by fifty feet high.<sup>2411</sup> People may have circumambulated around the moon-god temple in *Jericho* and also around the entire city of *Jericho*.

The circumambulation around *Jericho* would be similar to the rites at *Makka* where *Muslims* circumambulate around the *Kaaba*, and also the longer distances from Mount *Safa* to Mount *Marwa*, and from Mounts *Mina* to *Arafat* at *Makka*.

<sup>2407</sup> Gibson. *Symbols*, p. 109.

<sup>2408</sup> CEE, *Beth-Haran* entry.

<sup>2409</sup> Doe. *Arabia*, pp. 237-240.

<sup>2410</sup> EB, "*Beth Yerah*" entry, accessed 11 Sep 2003.

<sup>2411</sup> ISBE, *Jericho* entry.



*Yahveh* the Son appeared as the Malek *Yahveh* and told the *Israelites* to circumambulate around *Jericho* once per day for six days, and seven times on the seventh day. This circumambulation was a mockery of the moon-god *Yerah*.

This mocking of *Yerah*, the *Canaanite* moon-god, was psychological warfare at its best. Most of the Promised Land relied on this false god, so seeing the moon-god city of *Jericho* fall would make many *Canaanites* flee.

To show his superiority over the *Canaanite* moon-gods, *Yahveh* toppled the walls of *Jericho*. The writer of Hebrews says that *Yahveh* honored the *Israelites'* faith (Heb 11:30). The siege that might have lasted years only lasted a week. The gold and silver of *Jericho* eventually all went to *Yahveh's* tabernacle (Jos 06:19). *Joshua* also laid a curse on *Jericho* (Jos 06:26; 1Ki 16:34).

This was all done to show *Yahveh's* superiority over *Yerah* the moon-god just as at a later time *Yahveh* showed his superiority over *Dagon* and the Babylonian gods (1Sa 05; Dan 04:17).

This interpretation of the *Jericho* account is confirmed by the fact that later, *Yahveh* showed his dominance over sun and moon-gods by stopping the sun and moon for a half-day (Jos 10:12-14). Also, earlier, *Yahveh* showed his superiority over the gods of Egypt by sending the plagues that the Egyptian nature gods and goddesses were powerless to stop or even replicate.

When *Ibrahim* saw the Man-in-the-Moon, who had set out to guide *Ibrahim* (K 006:075), *Ibrahim* said "If my Lord [the moon-god] had not guided me I should certainly be of the erring people" (K 006:077). What this means is if *Ibrahim* thought a star or the Sun was as great as the moon-god *Allah*, he would have ascribed partners to *Allah* (K 022:026; 006:161, 163). As it was, he recognized that the stars and sun were mere angels.

Tamara Green describes what *Ibrahim* saw in *Koran* 006:077:

The Man-in-the-Moon is seen not merely because human features can be discerned but because the moon, more than any other of the heavenly bodies, is alive; he comes to life, he grows and then begins to disappear from the visible heavens, only to be recreated anew.<sup>2412</sup>

The ancients often anthropomorphized the Man-in-the-Moon along with all their astral gods.<sup>2413</sup> For instance, it was said of *Hubal* at the *Kaaba*:

"These are the **lords** (*Arbab*) whom we have chosen, having [simultaneously] the form of the celestial temples (*Al Hayakil Al `ulwiyya*) and that of Human beings."<sup>2414</sup>

Wherry wrote about the moon-god *Wadd* of the *Minaeans* of the kingdom of *Ma'in*, north of *Saba* (not too far south of *Mekka*):

...*Wadd* was supposed to be the heaven and was worshipped under the form of a man by the tribe of *Qalb* in *Daumat Al Jandal*.<sup>2415</sup>

*Wadd* was mentioned as being an Antediluvian idol in the *Koran* (K 071:023-025). Ryckmans wrote that South Arabian gods...

...appear in anthropomorphic form (or as winged angels) in funerary reliefs or in statuettes as a young male deity or as a fertility goddess with cornucopia, sitting on a throne.<sup>2416</sup>

<sup>2412</sup> Green. *Moon*, p. 24.

<sup>2413</sup> Goldman. *Portal*, p. 71 (image 1 shows a human-like solar-god).

<sup>2414</sup> Lewis. *Islam*, p. 536, *Hubal* entry.

<sup>2415</sup> Wherry. *Commentary*, vol. i, section i, p. 40.

The *Haranian* moon-god worshippers had a feast called “the Feast of the Living Being of the Moon.”<sup>2417</sup> Bernard Goldman wrote:

One standard mode in Persian art of the *Achaemenid* period [550-330 BC] has winged *genii* with raised arms holding the solar disk as a lintel over a *Clypeus* that contains the portrait of the god....The ring of the *Clypeus* in these Persian examples has a swelling at the bottom, serving as lunar crescent and solar disk, a conflation of the moon and sun.<sup>2418</sup>

The ring crescent *Clypeus* seems to be a portrait of the Man-in-the-Moon. The bust with arms extended seems to be an attempt to anthropomorphize the moon’s *lava mares seas* as a moon-god, otherwise known as the Man-in-the-Moon.



**Figure 04-08.** A moon-god likely is depicted in a crescent-moon ring (cartouche) of this stele from the *Achaemenid* period (~550–330 BC).<sup>2419</sup> The Egyptians moon-god *Osiris* is depicted similarly in a moon disk with crescent border.<sup>2420</sup>

*Sin* was even thought to be a cowboy, as the *Encyclopedia Britannica* explains:

...from being depicted as a bull or boat, because of his crescent emblem, he came to be represented as a cowherd or boatman.<sup>2421</sup>

Tamara Green wrote that *Nabonidus*? ...

...mother, Adad-Guppi, a priestess of the moon-god, had witnessed the sack of *Haran* by the Medes when ‘*Sin*, king of all gods, became angry with his city and his temple and went up to heaven, and the city and the people in it became desolate.’<sup>2422</sup>

Tamara Green also wrote:

When Esarhaddon came to *Haran* in 675 BCE, ‘he saw in the outskirts (?) of *Haran* a temple of cedar wood, (in it) the god *Sin* was leaning upon a staff, with two crowns upon his head.’<sup>2423</sup>

Tamara Green wrote about artifacts from the *Haran* area:

One of the figures is the bust of a male behind whose shoulders appears a lunar crescent; the inscription to the left of the niche...reads...‘Sila made the image to *Sin* the god’...It would seem that the lunar crescent must designate the figure as the god himself. Certainly such an interpretation is supported by earlier iconography and numismatic evidence...Drijvers has described the cave relief as ‘a horned pillar of oval shape, resembling a stylized human person wearing horns on his head’ and has suggested that the horns are those of the lunar crescent.<sup>2424</sup>

The *Assyrians* and *Babylonians* also believed that the moon-god was a person separate from the moon itself since their steles show *Sin* rowing his crescent boat

<sup>2416</sup> Ryckmans. *Anchor*, v. 6, p. 173.

<sup>2417</sup> Gunduz. *Life*, pp. 179, 201.

<sup>2418</sup> Goldman. *Portal*, p. 81 & fn.

<sup>2419</sup> Goldman. *Portal*, p. 81 & fn.

<sup>2420</sup> See “*Osiris*” in either the Index or the Thumbnail Gallery.

<sup>2421</sup> *EB*, accessed 20 Jun 2002, *Sin* entry.

<sup>2422</sup> *ANET*, 560-562, as quoted by Green. *Moon*, p. 21.

<sup>2423</sup> *ANET*, 605, as quoted by Green. *Moon*, p. 65.

<sup>2424</sup> *ANET*, 605, as quoted by Green. *Moon*, pp. 66-67.

with an oar.<sup>2425</sup> The moon was always the moon-god's object, not body or person. *The Larousse Encyclopedia of Mythology* states:

*Sin*...in his physical aspect *Sin*...was an old man with a long beard the color of *lapis lazuli*. He normally wore a turban. Every evening he got into his barque [i.e. boat]—which to mortals appeared in the form of a brilliant crescent-moon—and navigated the vast spaces of the nocturnal sky. Some people however believed that the luminous crescent was *Sin*'s weapon. But one day the crescent gave way to a disk, which stood out in the sky like a gleaming crown. There could be no doubt that this was the god's own crown; and then *Sin* was called 'Lord of the Diadem.'<sup>2426</sup>

In the *Hadramawt* in Southern Arabia, the moon-god *Sin* (*Syn*) is depicted on coins with the bust of a man.<sup>2427</sup> The fact that "houses" were built for *Sin* suggests a certain level of anthropomorphism, and that *Sin* was a separate entity than his throne of the moon. This reminds one of how the *Kaaba* at *Makka* was called "The House of *Allah*." *The 1911 Encyclopedia Britannica*'s entry on "*Sin*" states:

The name of *Sin*'s chief sanctuary at *Ur* was *E-gish-shir-gal*, 'House of the Great Light'; that at *Haran* was known as *E-khul-khul*, 'House of Joys.' On seal-cylinders he [*Sin*] is represented as an old man with flowing beard, with the crescent as his symbol.<sup>2428</sup>

The Egyptians also saw a Man-in-the-Moon as being separate from the moon boat, as *Yusuf Ali* wrote:

The Egyptian *Khonsu*, traversing the sky in a boat, referred to the moon.<sup>2429</sup>

That *Allah* was a moon-god separate from the moon is suggested by traditions that say *Allah* left footprints on the crescent-shaped Rock of *Ibrahim* at the Dome of the Rock. Oleg Grabar wrote:

On early traditionalist is said to have repeated that the Syrian *Muslims* 'pretend that God put His foot on the Rock in Jerusalem'...According to another source, '*Abd Al-Malik* [the *Caliph* who had the Dome of the Rock built] is alleged to have said that the Rock is the one which 'the Compassionate One [God] had set His foot.'<sup>2430</sup>



**Figure 04-09.** A typical *Semitic* moon-god rowing across the sky. This is an artist's adaptation of artwork found on *Assyrian* steles. Also, an early *Muslim* tradition that says *Allah*'s feet touched the crescent-shaped Rock of *Ibrahim* at the Dome of the Rock.

That a deity makes an astral object his or her throne can be seen in ancient myths. The great god, who might be the sky god, made the astral objects and then divvied them up among his offspring. Then the great god generally took as residence the planet Jupiter, the moon or the sun. Lester Ness gives an example:

<sup>2425</sup> Caption: "Late *Assyrian* or Neo-Babylonian Seal, Baltimore, Walters Art Gallery" (Morey. *Invasion*, p. 211).

<sup>2426</sup> *Larousse*, *Sin* entry, p. 56.

<sup>2427</sup> Doe. *Southern*, p. 122.

<sup>2428</sup> NationMaster.com, accessed 28 Mar 2004, "*Sin* (god)" entry.

<sup>2429</sup> *Yusuf Ali*. *Holy*, p. 1621, App. XIII.

<sup>2430</sup> Nuseibeh & Grabar. *Dome*. p. 51.

In the creation epic, *Enuma Elish*, he [*Marduk*] assigned the gods to their stars, and took Jupiter for himself. The remaining planets visible to the naked eye are Saturn, Mars and Mercury, associated with the gods *Ninurta* [war-god], *Nergal* [war and plague god] and *Nabu* [scribe and messenger of the gods], respectively.<sup>2431</sup>

That the ancients thought the astral gods manned the astral bodies is evidenced in the Bible. In Iconium in Asia Minor the townsfolk thought that Paul was *Hermes* (Mercury) and Barnabas was *Zeus* (Jupiter) (Act 14:12-13).

The Ephesians worshipped a meteorite betyl that they thought to be an image of *Artemis* the moon-goddess (Act 19:35). The Asia Minor *Artemis* was variously known to the Greeks as the moon-goddess *Selene*, and to the Romans as the moon-goddess *Diana*.

Even the medieval *Muslim* astrologers believed that humans or angels manned the moon and the planets. For instance, Moshan Fani wrote in *The Dabistan* (~1645 AD):

...although the planets are simple bodies of a spherical form, yet the reason why the above-mentioned images have been thus formed is that the planetary spirits have appeared in the world of imagination to certain prophets, saints and holy sages under such forms; and under which they are also connected with certain influences; and as they have appeared under forms different from these to other persons, their images have also been made after that fashion.<sup>2432</sup>

The *Dabistan* also relates *Muhammad*'s "Night Journey" through the "Seven Heavens" when *Muhammad* met some astral spirits and other persons. Here is the description of the First and Third Heaven:

The learned possess a great number of versions on this subject but the best of all interpretations is that of the Lord Rais, the wise *Shaihk Abu Ali Sina*, who declares: 'So said the prophet of God, *Muhammad*... 'I arrived at the heaven of the universe; the gates yielded and I entered. There I saw Ismail seated upon a throne and a crowd before him, with their eyes fixed upon his face. I made my salute, looked at him and went on.' By 'heaven' is understood the moon; by 'Ismail,' the body of the moon; and by 'the crowd,' those whose conditions are under the influence of the moon...What the prophet said 'When I arrived into the Third Heaven, I there saw an angel, equal to whom in excellence and beauty I had seen none, placid and joyful, he was seated upon a throne; and a circle of angelic effulgence was diffused about him.' This was the heaven of Venus, and it is not necessary to comment its beauty; it denotes gladness and festivity.<sup>2433</sup>

The "crowd" that Lord Rais says is standing before Ishmael on the moon refers to *Muslims* who claim Ishmael as a patron saint, ancestor, prophet, ruler and the like. *Muhammad* even said "70,000 of my people shall enter Paradise like the full-moon."<sup>2434</sup>

It is *Muslims* who are most famous for watching and waiting for the appearance of the crescent-moon and then adjusting their calendar and feasts accordingly. *Muslims* are also known for praying toward the lunettes of the *Mihrab* Venus altars, a subject that will be discussed in later chapters.

<sup>2431</sup> Ness. *Mosaics*, p. 41.

<sup>2432</sup> Fani. *Dabistan*, pp. 25-26.

<sup>2433</sup> Fani. *Dabistan*, pp. 398, 404.

<sup>2434</sup> Ishaq. *Sirat*, p. 305.

Similarly, the Man-in-the-Moon guided *Muhammad* while the moon was on the clear, high part of the horizon (K 053:007; 081:023). Early *Muslims* also believed that the Man-in-the-Moon was *Allah*, so it was thought the moon could not tell a lie, as one of *Muhammad*'s followers, Ka'b b. Malik, said:

Like the full-moon that cannot lie, when he [*Muhammad*] appeared [like the full-moon], we followed him and held him true.<sup>2435</sup>

It was thought a prophet could best hear the words of the Man-in-the-Moon when the moon seemed to be close and on the horizon. That is why we read in the *Koran* that *Muhammad*'s message was not muddled or murky because it was communicated while *Allah* was on the "clear" horizon (K 053:007; 081:023).

The horizon was clear of fog because the moon was on the highest part of the horizon," meaning above a mountain range near *Makka*. *Muhammad* got as close as he could to the moon by staying in mountain caves such as Mount *Hira*.

Even if *Muhammad* failed to make contact with *Allah*, staying in a cave on Mount *Hira* was not a waste of time. That is because watching for the appearance of the moon was considered an act of worship, as Abdulkader Tayob wrote:

Unlike riding a camel, watching the new-moon is an act of worship.<sup>2436</sup>

It was commonly thought that the heights made for better communication with astral gods and that is why the ziggurats and even giant phalluses were constructed as Trimmingham notes:

Lucian of *Samosata* [~117 to ~180 AD] writes ([in] *De Dea Syria*) of a rite in honor of the goddess *Atargaris* at *Hierapolis* in Syria in which the celebrant spends a week at the top of a 170-foot-high stone phallus [by way of comparison, the Lighthouse at Alexandria was 384 feet tall]. 'The crowd is convinced that the man in this lofty place speaks to the gods, asks them to grant prosperity to the whole of Syria, and that the gods are in a position to hear his request more clearly.'<sup>2437</sup>

*Muhammad* spoke of how he was high enough so fog and dust did not obscure his view of the heavens:

I [*Allah*] swear by the star when it goes down; your companion does not err, nor does he go astray; nor does he speak out of desire. It is naught but revelation that is revealed, The Lord of Mighty Power has taught him, The Lord of Strength; so he attained completion and he is in the highest part of the horizon (K 053:001-007).

But nay! I [*Allah*] swear by the stars, that run their course (and) hide themselves and the night when it departs, and the morning when it brightens, most surely it is the Word of an honored messenger, the possessor of strength, having an honorable place with the Lord of the Dominion, one (to be) obeyed and faithful in trust. Your companion is not gone mad. Of a truth he himself saw on the clear horizon (K 081:015-023).

So once *Muhammad* told the *Makkans* about his communicating with the Man-in-the-Moon, many of the *Makkans* were satisfied that *Muhammad* was indeed a prophet, as Ka'b b. Malik said:

<sup>2435</sup> Ishaq. *Sirat*, p. 422.

<sup>2436</sup> Tayob. *Islam*, p. 27.

<sup>2437</sup> Trimmingham. *Arabs*, p. 234, fn. 53.

Like the full-moon that cannot lie, when he [*Muhammad*] appeared [like the full-moon], we followed him and held him true.<sup>2438</sup>

From elsewhere in the *Koran*, we know that *Allah* and *Muhammad* made first contact with *Allah* during the Night of Power near the end of the lunar month of *Ramadan* (K 002:185; 097:001-005). An end of lunar month festival suggests *Allah* was a moon-god, as Tamara Green wrote:

...the end of the month was traditionally devoted to the moon-god.<sup>2439</sup>

A *Hadith* suggests that *Allah* can be seen as though he were an astral body but does not go so far as to say *Allah* was actually the moon itself. This is consistent with the idea that *Muhammad* thought *Allah* sometimes appeared as the Man-in-the-Moon but was not the moon itself:

The people said ‘Oh *Allah*’s Apostle! Shall we see our Lord on the Day of Resurrection?’ He replied, ‘Do you have any doubt in seeing the full-moon on a clear (not cloudy) night?’ They replied, ‘No, Oh *Allah*’s Apostle!’ He said ‘Do you have any doubt in seeing the sun when there are no clouds?’ They replied in the negative. He said ‘You will see *Allah* (your Lord) in the same way’ (*Sahih Bukhari*, bk. 12, no. 770).

According to several sources, *Muhammad* reported seeing *Allah* as a human. This suggests *Muhammad* thought he saw the Man-in-the-Moon, as Jim Wafer wrote:

There is also the *Hadith* (existing in a number of variants) according to which the Prophet said ‘I have seen my Lord in a form of the greatest beauty, as a youth which abundant hair, seated on the throne of grace, clad in a garment of gold, on his hair a golden crown, on his feet sandals’ (Wilson, Peter Lamborn and Weischer, Bernd Manuel 1978:8; also see Ritter, Hellmut 1928:257; Corbin, Henry 1969:272-277). The variants mention that the youth was in a heavenly garden; that his robe was green rather than gold; that he was beardless; or that he wore his cap awry (Ritter, Hellmut 1928:257; Corbin, Henry 1969:272; Schimmel, Annemarie 1982:67-68).<sup>2440</sup>

Many modern *Muslim* believe they will see *Allah* physically, as *A Short [Islamic] Creed* by *Al Ash’ari* attests:

We believe that God at the Day of Resurrection (*Yawm Al Qiyama*) will be visible to the eyes, as the moon is seen upon the night of the full-moon; the believers will see Him, according to traditions which have come down from the Prophet.<sup>2441</sup>

*Whether Muhammad Modified His Astral Beliefs*

*Muhammad*’s *Makkan Suras* (K 006, 053, 054, 081) were decidedly more astral than his later *Suras*. That is because in *Madina*, *Muhammad* had more extensive contact with Jews. In *Madina Muhammad* toned down but did not entirely discard, many of his astral religion ideas. For instance, the light of the moon and sun were still seen as being divine light rather than just fire. Tabari (839–923 AD) reports *Muhammad* as saying:

*Gabriel* brings to the sun a garment of luminosity from the light of the Throne, according to the measure of the hours of the day. It [the wrap] is longer

<sup>2438</sup> Ishaq. *Sirat*, p. 422.

<sup>2439</sup> Green. *Moon*, p. 192.

<sup>2440</sup> Murray. *Culture*, p. 90.

<sup>2441</sup> MacDonald, Duncan B. (1863-1943 AD). *Development of Muslim Theology, Jurisprudence and Constitutional Theory*, Charles Scribner, New York, 1903, p. 295 (online).

in the summer and short in the winter, and of intermediate length in autumn and spring...The same course [through the sky] is followed by the moon in its rising, its running on the horizon of the heaven, its setting, its rising to the highest, Seventh Heaven, its being held underneath the Throne, its prostration, and its asking for permission. But *Gabriel* brings it a garment from the light of the Footstool [as opposed to the Throne proper]. He continued. This is (meant by) God's word: 'He made the sun a luminosity and the moon a light' [K 010:005].<sup>2442</sup>

*Ibrahim* then saw a sunrise and asked himself whether the sun was the greater than *Allah* the moon-god. When *Ibrahim* was unimpressed with the sun, he said "O my people! Surely, I am clear of what you set up (with *Allah* [the moon-god])" (K 006:078). Thus *Ibrahim* became a moon-god monotheist, as did *Nabonidus* and *Muhammad*. That moon crescents top *Mosques* the world over is a throwback and atavism to the very earliest days of *Islam*.

That *Ibrahim* received guidance from the celestial North Pole and the moon agrees with Arab astral religion, as *Khairat Al Saleh* wrote:

In addition to the sun, moon and the star *Al Zuhara*, the Arabs worshipped the planets Saturn, Mercury and Jupiter, the stars Sirius and *Canopus* and the constellations of *Orion*, *Ursa Major* and [*Ursa*] *Minor* and the seven *Pleiades*.

Some stars and planets were given human characters. According to legend, *Al Dabaran*, one of the stars in the *Hyades* group, fell deeply in love with *Al Thurayya*, the fairest of the *Pleiades* stars. With the approval of the moon, he asked for her hand in marriage.<sup>2443</sup>

That *Ibrahim* received guidance from the celestial North Pole and the moon agrees with *Sabeen* doctrine to—as *Tamara Green* wrote:

'They have adopted one direction for prayer, which they have fixed towards the North Pole in its course. The intelligent thus seek to inquire for wisdom.' So states *Sarakhsi*, as cited by *Ibn Al Nadim*, in his account of *Sabian* doctrine; and in fact one of the most obscure references in the *Catalog's* calendar is that which joins the celebration of 'the Lord who is the moon' with the performance of the 'Mystery to the North' on the 24<sup>th</sup> day of II *Kanun*. In addition, in the months of *Haziran* and *Aylul*, this mystery is celebrated on the 27<sup>th</sup> and 28<sup>th</sup>. Although the moon is not mentioned in these two months, we have already noted that the end of the month was traditionally devoted to the moon-god...<sup>2444</sup>

The *Parsees* (Zoroastrians) also understood the K 006 story of *Ibrahim* to indicate that *Ibrahim* believed in an astral religion. The *Dabistan*, a comparative-religions text written around 1645 AD, records:

...among the images of the *Kaaba* was one of the moon, exceedingly beautiful, wherefore the temple was called *Mahgah* (Moon's Place) which the Arabs generally changed into *Makka*. They also say that among the images and statues left in the *Kaaba* by *Mahabad* [a pre-Islamic Persian ruler] and his renowned successors, one is the Black Stone, the emblem of Saturn. They also say that the prophet of Arabia worshipped the seven planets, and he therefore left undisturbed the Black Stone or Saturn's emblem, which had remained since the time of the *Abadian* dynasty; but that he broke or carried away the other figures

<sup>2442</sup> *Al Tabari, History*, vol. i, p. 232.

<sup>2443</sup> *Al Saleh. Fabled*, pp. 29-30.

<sup>2444</sup> *Green. Moon*, p. 192.

introduced by the *Kuraish*, and which were not formed according to the images of the stars. In most of the ancient temples of Persia they had formed the symbol of Venus [the bulbous lamp] in the figure [arch] of a *Mihrab*, or arch, like the altar of the *Mosques*; consequently, the present [*Muslim*] *Mihrab*, or altar, is that identical symbol; which assertion is also proved by the respect paid to Friday or [in astrology] the day of Venus [i.e. *Islam*'s Day of Prayer].

*Ibrahim* (Abraham), the friend of God, pursued the same conduct; that is, he rejected the idols which were not of the planetary forms; and the reverence paid by him to the Black Stone, according to ancient tradition, seems to prove that point... They also say that in *Madina*, the burial place of the prophet, there was formerly an image of the moon; the temple in which it was, they called *Mahdinah*, or the 'Moon of Religion,' as religion is the moon of truth, from which the Arabs formed *Madina*.<sup>2445</sup>

The *Muhammadan* doctors say that *Islamism* is connected with this planet [Venus], from which source proceeds the veneration paid by them to Friday, or the day of Venus [the *Muslim* day of prayer].<sup>2446</sup>

Before *Muhammad* came to town, *Madina* was named *Yathrib*. *Madina* in Arabic means "The city," with "The City of the Prophet" being implied. So since *Mahdinah* in Persian meant "the Moon of Religion" and *Madina* meant "the city," it is conceivable that this convergence between the Persian and Arabic led to the choosing of the name *Madina*.

This is quite possible because Jeffery and Margoliouth both wrote that *Muhammad* used many foreign words in the *Koran*, including Persian words.<sup>2447</sup> Not only did *Muhammad* have trade and diplomatic contacts with the Persians (*Sassanians*), whom *Muhammad* spoke of often but also one of his own followers, Salman, was Persian.

Salman suggested digging the defensive trench around *Madina* that became the centerpiece of the Battle of the Trench.<sup>2448</sup> Salman got the idea from seeing Persian defensive alignments. Salman may have suggested the name *Madina* because the word meant "City [of the Prophet]" in Arabic, and the similar-sounding Persian word meant "Moon of Religion." The early *Muslims* were fond of thinking of *Muhammad* as being the full-moon:

Like the full-moon that cannot lie, when he [*Muhammad*] appeared [like the full-moon], we followed him and held him true.<sup>2449</sup>

The *Parsees* were correct about *Muhammad* worshipping the planets. At least once *Muhammad* sacrificed to Venus according to tradition, and *Muhammad* had an attachment to the Venus Black Stone. Also, consider how *Muhammad* circumambulated the *Kaaba*. Zwemer wrote:

Then the pilgrim runs between the hills of *Safa* and *Marwa*... He then runs around the *Ka'aba* seven times—thrice very rapidly and four times very slowly—in imitation of the motions of the planets.<sup>2450</sup>

This follows the speed pattern that *Muhammad* set for circumambulation during his farewell pilgrimage.<sup>2451</sup>

<sup>2445</sup> Fani. *Dabistan*, pp. 30-31.

<sup>2446</sup> Fani. *Dabistan*, p. 194.

<sup>2447</sup> Jeffery. *Foreign*, and Margoliouth, as quoted in Warraq, *What*, pp. 193-200.

<sup>2448</sup> Lings. *Sources*, p. 216.

<sup>2449</sup> Ishaq. *Sirat*, p. 422.

<sup>2450</sup> Zwemer. *Animism*, ch. 8.



Evidently, the *Haranians* (from *Haran*, “the City of the Moon”) interpreted *K 006* as the *Parsees* (Zoroastrians) did (see *The Dabistan* quote above). The *Haranians* and *Parsees* believed that *Ibrahim* worshipped the moon and the planets but not the other astral objects in the sky. *Al Biruni* quotes ‘*Ibn Sankila* as to what the *Haranians* claimed about *Ibrahim*:

Abraham left their community [not on account of polytheism but] simply because leprosy appeared on his foreskin, and that everyone who suffered from this disease was considered impure and excluded from all society. Therefore he cut off his foreskin, i.e. he circumcised himself. In this state he entered one of their idol-temples, when he heard a voice speaking to him, ‘O Abraham, you went away from us with one sin and you returned to us with two sins. Go away and do not again come to us.’ Thereupon Abraham, seized by wrath, broke the idols in pieces and left their community. After this Abraham repented and wished to sacrifice to the planet Saturn.<sup>2452</sup>

Here the *Haranians* agree with the *Parsees* in thinking that the *Ibrahim* worshipped the moon and planets.

### ***Koran 006:136 Shows That Allah Is a Moon-god***

The conquered tribes around *Makka* mostly worshipped moon-gods as their high god. However, to show their subordination to *Makka*, they had to give offerings to *Allah* the moon-god at *Makka*. Since however this was forced tribute, they naturally skimmed on their offerings to *Allah* in deference to their own moon-gods. *Muhammad* decried this practice in the *Koran* and he called their moon-gods mere associates to *Allah*.

They set apart a portion for *Allah* out of what He has created of cultivated land (tilth) and cattle, and say: This is for *Allah*—so they assert—and this for our associates [their moon-gods]; then what is for their associates, it reaches not to *Allah*, and whatever is (set apart) for *Allah*, it reaches to their associates [their moon-gods]; evil is that which they judge (*K 006:136*).

This lesson found in *Koran 006:136* about dividing offerings between *Allah* and other deities fits well with the lesson earlier in *Koran 006* where *Ibrahim* was said to decry the practice of setting up associates with *Allah* (discussed above). G. R. Hawting wrote about *Koran 006:136* and the identity of the “associated” idol:

Isaiah Goldfeld was impressed by the fact that the report about the practice of *Khawlan* in sharing out their agricultural produce unfairly between God and their idol mentions by name a specific sub-tribe which he thought it possible to identify as a deformation of a word found in the south Arabian inscriptions, apparently referring to agricultural serfs. Furthermore, he suggested that the name of the idol as variously given in the different versions of the story in *Muslim* tradition could be related to names of the moon-god found in South Arabian inscriptions. On that basis he supported an argument, developed in his doctrinal thesis, that in the period before *Muhammad*, the tribes of Arabia customarily paid a ‘temple tax’ to the sanctuary of *Makka* and its [moon-]god *Allah*, as a sign of their submission to the *Quraysh* of *Makka* but that immediately before the Prophet, the authority of the *Quraysh* had begun to decline and the tribes once again devoted their tithes to their own deities [moon-

<sup>2451</sup> Peters. *Origins*, p. 229.

<sup>2452</sup> Gunduz. *Life*, pp. 162-163.

gods]. *Muhammad's* mission was to restore the crumbling authority of *Makka* and [the] *Quraysh*.<sup>2453</sup>

*Muhammad* applied a similar tribute model to Jews and Christians whom he said worshipped *Allah* the moon-god but under different a different name. Thus while doing homage to *Yahveh*, the Christians and Jews also had to give the *Jizya* poll tax to the *Muslim* moon-god worshipping community.

### The Overall Astral Flavor of the *Koran*

The many mentions in the *Koran* of the sun, moon, stars and meteors give the *Koran* a decidedly astral flavor. The moon is mentioned twenty-nine times in the *Koran*, one mention for each day of the lunar month. (The lunar month is approximately 29.5 days long.)

The fact that the *Koran* has twenty-nine mentions of the moon (see table) and twenty-nine *Suras* prefixed by mystical characters (see table and associated discussion) indicates the lunar orientation of the *Koran*.

The <i>Koran's</i> Twenty-nine Mentions of the Moon					
1	002:189	10	021:033	19+20	041:037 (two mentions)
2	006:077	11	022:018	21	054 (entitled "The Moon")
3	006:096	12	025:061	22	054:001
4	007:054	13	029:061	23	055:005
5	010:005	14	031:029	24	071:016
6	012:004	15	035:013	25	074:032
7	013:002	16	036:039	26	075:008
8	014:033	17	036:040	27	075:009
9	016:012	18	039:005	28	084:018
				29	091:002

Though the *Koran* is about the size of the New Testament, the *Koran* mentions the moon twenty-nine times. The New Testament mentions the moon only ten times and the much larger Old Testament mentions the moon fifty-eight times.

How the Bible and *Koran* speak of the moon is different too. The *Koran* speaks of the moon shining and rising. The *Koran* speaks of the moon phases and how the moon marks the lunar months and pilgrimages. The Bible however mentions the moon mainly in warnings against idolatry and in apocalyptic passages.

Regarding the apocalyptic passages that mention the moon, God may have been hinting that in the end times, Christianity would butt heads with an astral religion, namely *Islam*.

### The Lunar Schedule for Reading the *Koran*

Having a moon-god scripture calls for a lunar reading schedule. Arthur Jeffery wrote:

For devotional reading or recitation, the *Quran* is commonly divided into thirty parts, one part to be read or recited each day of the lunar month, or into seven parts that the whole may be finished in a week.<sup>2454</sup>

The weekly reading would be in honor of a phase of the moon and the monthly reading celebrated a moon cycle.

<sup>2453</sup> Hawting. *Idolatry*, p. 41.

<sup>2454</sup> Jeffery. *Islam*, p. 222.

The idea of reading some moon-god literature each night on a schedule likely goes back to pre-*Islamic* times, at least among the moon-god priests. After all, the moon-god was the god of the religious lunar calendar, so it just would not do to read the *Koran* haphazardly, especially when the moon ruled other aspects of religious life.

Since *Muslims* usually start reading the *Koran* on the first day of the lunar month, they address the crescent-moon with the words of the first *Koranic* chapter called *Al Fatiha*, meaning “The Opening”:

All praise is due to *Allah*, the Lord of the Worlds. | The Beneficent, the Merciful. | Master of the Day of Judgment. | Thee do we serve and Thee do we beseech for help (*K* 001:001-004).

*Abdullah Yusuf Ali* wrote concerning his translation of the *Koran*:

I have retained the numbering of sections as it is universally used in the Arabic copies and marks a logical division of the *Suras*.<sup>2455</sup>

Scholars have noted that the *Koran* is about the same size as the New Testament *Yusuf Ali*'s pocket-sized *Koran* is 520-pages long. This averages out to 17.33 pages of reading per night over the lunar month.

The exact division of these sections probably has changed since *Caliph* Uthman produced his recension of the *Koran*. In fact, some claim that Uthman's editors excised entire verses, sections and chapters from the *Koran*. For instance, some claim that there was once a verse stating that stoning is the punishment for married adulterers.

As with the current section divisions, the verse divisions are relatively modern. The verse citations vary from *Koran* version to *Koran* version. For example, in the longer chapters near the start of the *Koran*, many verses are a paragraph in length. In the shorter chapters, the verses tend to be much shorter.

In the shorter chapters, often a sentence that does not even stretch from margin to margin is designated as a verse. Thus in the table that follows shortly, page count is the unit of length rather than section divisions or verse count.

Notably, the *Koran* still seems to indicate its earliest divisions, probably from the time before *Caliph* Uthman produced his recension of the *Koran*. The chapter headings still indicate these earliest divisions that seem to follow the moon phases.

There are four weeks in a lunar month bookended by the major changes in the moon phases: 1) waxing half, 2) full, 3) waning half and 4) the dark phase, which is bookended by the waning and waxing crescents.

Appropriate for moon-god literature, the *Koran* is divided into four parts. Each part is bookended by a major moon phase change. There are 114 chapters in the *Koran*, which breaks down to a bit over four chapters of reading per night if one wants to finish the *Koran* during the 27 days when the moon is visible some time during the night or early morning.

The *Koran*'s chapters, except for the first chapter, are collated by length. The longer chapters tend to be nearer the beginning of the *Koran* and shorter chapters tend to be nearer the end of the *Koran*.

The length of the first weeks' readings is the longest. This arrangement mirrors how the waxing crescent phase of the moon was most important to moon-god worshippers. Not only did the crescent mark the start of the lunar month but also the

---

<sup>2455</sup> *Yusuf Ali. Meaning*, p. vii.

moon has just resurrected itself after a three-day stint in the underworld. The moon worshippers' king had returned!

The full-moon phase was next in importance, so the chapters during the second week were slightly less long each night. As the moon phase goes past full, the moon slowly tapers off. Thus it seemed appropriate for the chapters to slowly taper off in length. As the moon turned into a waning crescent sliver and finally the dark phase, the corresponding *Koranic* reading was just a sliver of text. The last chapters of the *Koran* are very short.

Another reason for the *Koranic* readings to go from long to short is that the right side of the moon is always lit first at the start of the lunar month. Then the full-moon appears and finally the left side of the moon is lit. The lit side of the moon goes from a D (waxing crescent) to an O (full-moon) to a C (waning crescent). This is how the moon appears in the northern hemisphere where *Makka* is located.

In the ancient world, the right side was good or lucky and the left side was evil or unlucky. For instance, in Latin “right” was *Dexter* and “left” was *Sinister*. That’s why the Latin words *Dexter* and *Sinister*, meaning merely “right” and “left” respectively, took on their connotations of “dextrous” and “sinister.”

So it made sense to honor the moon-god with longer *Koranic* readings when the moon was lit on the happy right side, and make the readings shorter when the moody, baleful side of the moon showed its face.

Thus the crescent to half-moon’s readings averaged 41+ pages per night, the half to full-moon’s readings averaged 18+ pages per night, the full to waning half-moon’s readings averaged 9+ pages per night, and the waning half to waning crescent to the dark phase averaged only 3+ pages per night. Notice that each week, the length of the reading is more than halved.

Another reason for the shorter readings at the end of the month is, starting at the full-moon, the moon is out fewer hours each night. The full-moon rises at sunset and is visible all night. A waning half-moon rises at midnight and consequently is only seen half the night. A waning crescent-moon rises earlier in the morning and is only seen for a few hours before daylight emerges.

It is worth noting that dividing the lunar month was made easier by the fact that: In the Arabian moon-calendar, these are the two full-moon days.<sup>2456</sup>

Even after Uthman’s recension, the *Koran*’s appropriately entitled chapters closely mark the moon phases, or nearly mark the moon phases. To indicate the:

- ☉ Half waxing moon, there is the 29<sup>th</sup> *Sura* called “The Light.”
- ☉ Full-moon, the *Koranic* chapters are entitled *Sura* 53 “The Star” and *Sura* 54 “The Moon.”
- ☉ Waning half-moon, the *Koranic* chapters are called *Sura* 85 “The Celestial Station” and *Sura* 86 “The Nightly Visitant.”
- ☉ Dark phase of the moon, the very short last chapter of the *Koran* has the words “The Utterly Dark Night” (*K* 113:003).

Incidentally, *K* 113 should be considered the start of the last *Sura* in the *Koran* since *K* 113 and *K* 114 were “revealed” together as a pair. Together these last two *Suras* are called the *Mu’awwidhatan* (*Sahih Abu-Dawud*, bk. 34, no. 4210). *Muhammad* believed that the eleven verses of this pair of *Suras* form an antidote to

<sup>2456</sup> Daum. *Ursemitische*. p. 60.

bewitching. In passing, K 105 and K 106 are another pair of *Suras* that were originally one *Sura*.<sup>2457</sup>

The Lunar Month Cycle for Reading the <i>Koran</i>					
<i>Koranic Chapters Read By The Week</i>	<i>Days of Lunar Month</i>	<i>Moon Phases</i>	<i>Astral Chapter(s) Grouped Near the End of Each Week &amp; at the Change in Moon Phase</i>	<i>Page Count in Yusuf Ali's Koran</i>	<i>Pages of Reading Per Night</i>
1: 001-028	1-7	☾ to ☽	29. The Light	001-288	41.41
2: 029-056	8-14	☾ to ☉	53. The Star. 54. The Moon.	289-424	18.29
3: 057-084	15-21	☉ to ☽	85. The Zodiacal Constellations. 86. The Morning Star	424-492	9.14
4: 085-114	22-28+	☽ to ☾ to ●	K 113:003 The Utterly Dark Night.	492-520	3.71

Legend: Moon Phases: Waxing crescent=☾; First Quarter=☽; Full=☉; Last Quarter=☾; Interegnum=●

### *The Koran's Mysterious Letters*

It has been posited that the mystical letters in front of twenty-nine *Suras* (see table below) have no meaning because they had no vowels in the original, though some modern translators insert vowels so *T.H.* becomes *Ta Ha* (K 020) and *Y.S.* becomes *Ya Sin* (K 036). This argument is absurd since based on that logic the entire *Koran* has no meaning since the entire *Koran* was originally written without vowels. Copyists later inserted the vowels in the form of dots and marks placed above and below the consonants.

It is hard to believe that letters without any meaning whatsoever would prefix *Koran* chapters, and *Muslims* have generally assigned some meaning to the letters, so it is safe to assume that the letters are abbreviations of words or phrases or both.

The fact that the *Koran* has twenty-nine mentions of the moon (see table), and twenty-nine *Suras* prefixed by mystical characters (see table), suggests the lunar orientation of both the *Koran* and the mystical letters.

The *Muslim* translator, *Muhammad Asad*, wrote about the “Disjointed Letters”:

About one-quarter of the *Quranic Suras* are preceded by mysterious letter-symbols called *Muqattaat* (‘Disjointed Letters’) or, occasionally, *Fawatih* (‘openings’) because they appear at the beginning of the relevant *Suras*. Out of the twenty-eight letters of the Arabic alphabet, exactly one-half—that is, fourteen, occur in this position, either singly or in varying combinations of two, three, four or five letters. They are always pronounced singly, by their designations and not as mere sounds—thus: [A.L.M.] *Alif Lam Mim* or [H.M.] *Ha Mim*, etc.<sup>2458 2459</sup>

The *Muslim* commentator and translator, *Yusuf Ali* wrote that an early tradition stated the letters *Ta Ha* were a vocative expression meaning “O Man!”<sup>2460</sup> Similarly,

<sup>2457</sup> Peters. *Makka*, p. 32.

<sup>2458</sup> Asad. *Message*, App. II, p. 992.

<sup>2459</sup> Shamoun, Sam. “Responses to Akbarally Meherally’s [Web] site: Meherally’s latest posting of Nov 6,” AnsweringIslam.org, accessed 1 Dec 2003.

<sup>2460</sup> *Yusuf Ali. Meaning*, p. 226, Introduction to K 020, the “*Ta Ha*” *Sura*.

the letters *Ya Sin* mean “O [moon-god] *Sin*,” just as “*Ya Allah*” means “O *Allah*,” as will be discussed later in this section. *Yusuf Ali* also wrote that:

...the Abbreviated Letters *A.L.M.* which...I have suggested as symbolical of Past, Present and Future [or]...the mystery of Creation, the mystery of Time and the mystery of *Ma'ad* (the Final End).<sup>2461</sup>

*Yusuf Ali* translates *Ma'ad* variously as “the Future,” “the Final End” and “the Hereafter,” and *Ma'ad* is the name for the doctrine of “the final return of man to *Allah*.”<sup>2462</sup>

*Yusuf Ali* wrote that *H. M. (Ha Mim)* stands for “friend,” “helper” and “protector,” which are all references to *Allah*. Thus from what *Yusuf Ali* tells us, one can conclude that *Mim* only means “future” when it is paired up with A.L. This is similar to how the English Z has a different meaning in the phrase “A to Z,” and the Greek letter *Omega* takes on deeper meaning in the phrase “*Alpha and Omega*.”

The *Min* may stand for “protector” and the “*Ha*” may stand for the definite article “the.” Torrey wrote about “*Ha*” in Arabic:

There is no need to look for Hebrew influence in this grammatical feature, especially since the demonstrative element *Ha* is so pervasive in all *Semitic* speech.”<sup>2463</sup>

*Yusuf Ali* continues:

The very word *Hamim* in that sense [friend, helper and protector] is used in *Suras* 040 and 041 (040:018 and 041:034), while in the other *Suras* we have words of equivalent import, e.g. *Wali* or *Nasir* (042:008 and 031); *Qarin* (043:036, 038); *Maula* (044:041); *Auliyaa* or *Nasirin* (045:019, 034); and *Auliyaa* (046:032).<sup>2464</sup>

The suggested meanings of several letters, as noted above, may help to decipher other combinations of mystical letters, as shown in the chart below. So far it has been established that:

*Alif* = Past, *Ha Mim* = The Protector, *Lam* = Present, *Mim* = Future,

*Sin* = “[moon-god] *Sin*,” *Ta Ha* = “Oh Man!” and *Ya Sin* = “O [moon-god] *Sin*”

If “*Ta Ha*” means “Oh Man!” and “*Ya Sin*” means “Oh *Sin*!” then it follows that, when *Ta* and *Ya* precede a noun, they both mean “Oh” and indicate a vocative noun.

When the mystical-letter combination “*Ta, Sin, Mim*” is compared to the phrase “*Ta Ha*” (Oh Man) and “*Ha Min*” (The Protector), one may conclude that “*Ta, Sin, Mim*” means “Oh [moon-god] *Sin*, Protector.” Thus “*Ta, Sin, Mim*” is similar to “*Ya Sin*,” meaning “O [moon-god] *Sin*.”

Interestingly, saying “*YaSin*” is how *Gilgamesh* addressed *Sin* in the *Gilgamesh Epic*. *Gilgamesh* thought of *Sin* as a protector:

At night when he [*Gilgamesh*] came to the mountain passes *Gilgamesh* prayed: ‘In these mountain passes long ago I saw lions, I was afraid and I lifted my eyes to the moon; I prayed and my prayers went up to the gods, so now, O moon-god *Sin*, protect me.’<sup>2465</sup>

That *Muhammad* knew *Allah* to be *Sin* the Protector is seen from how he was said to have sprinkled dust on the heads of his *Mekkan* opponents by putting them in

<sup>2461</sup> *Yusuf Ali. Meaning*, pp. 302, Introduction to *Sura* 30.

<sup>2462</sup> *Yusuf Ali. Meaning*, pp. 296, 302, 312 & 353, Intro. to *Suras* 29, 30, 32 & 39.

<sup>2463</sup> Torrey. *Foundations*, p. 20.

<sup>2464</sup> *Yusuf Ali. Meaning*, p. 360, Introduction to *Sura* 40.

<sup>2465</sup> Anonymous. *Gilgamesh*, “The Search for Everlasting Life.” Also, Pritchard. *Ancient*, I:62, middle of Tablet IX.

a trance state using hypnosis while reciting *K* 036:001-008, starting with “*Ya Sin*, by the Wise *Quran*.”<sup>2466</sup> *Sura* 036 is entitled *Ya Sin*. Interestingly, *Muhammad*’s miracle of the splitting of the moon is recorded in *K* 054:001, which *Sura* is entitled “The Moon,” meaning that two instances of *Muhammad* practicing magic are associated with the moon in the *Koran*.

That *Muslims* knew *Allah* to be *Sin*: 1) the protector of travelers and soldiers, especially at night, 2) the lunar fertility deity and 3) the deity who controlled the tides and by extension, floods. This is known from the widespread use of magic in *Islamdom*, as Bess Allen Donaldson wrote in 1937 AD:

...if the entire *Sura Ya Sin* [*K* 036] be written out and hung up in a garden, that garden will produce in abundance. Moreover if it is kept on the person, no illness nor dangerous animal will afflict the wearer...Then if some of this is eaten every morning, the traveler will not thirst. If one is journeying on foot, he should bind verse 25 of the *Sura Ya Sin* to his feet [which reads “Lo! I have believed in your Lord, so hear me! (*K* 036:025)], and he can then walk any desired distance and not suffer fatigue...For the one who wears verse 48 of *Ya Sin*, even though, the whole world be flooded; even the soles of his feet shall not be wet...If one writes the 58th verse of *Ya Sin* [“They will be greeted with ‘Peace’—a word of greeting from the Merciful Lord” (*K* 036:058)], which is called, the heart of the *Sura* and therefore the heart of the *Koran*, in the form of a square at sunset, and keeps it on his person, no snake, scorpion or other injurious animal will molest him... Physical strength is obtained by writing verse ten of *sura Ya Sin* on paper [“It is the same whether you warn them or not, they cannot believe” (*K* 036:010)], then tying it up with blue cord and burying it in an old grave. In the same way the memory can be strengthened and ability to learn may be increased...If the whole of the *Sura Ya Sin* be written on a white muslin shirt, no bullet can penetrate it... It is related that Mohammed said that on the Judgment Day, God will not account with the person who reads *Ya Sin* but will grant him forgiveness and will make him an intercessor for many others. The *Sura al-Saff* (*K* 037), if combined with *Ya Sin* and if read over the head of one who is dying, will quickly bring an end to his suffering and will allow him to pass away quietly. The *Sura Ya Sin* has seven parts, each ending with the word *Mubin*, which means ‘open’ or ‘clear.’ If one has an enemy he wishes to harm, and that without injury to himself, or one whose love he wishes to gain, he reads this *Sura* [*K* 036] and at each *Mubin* he ties a knot in a cord he has ready at hand. When the reading is completed he nails the cord into the ground, and he gets his desire...At the vernal equinox, which is the Persian New Year, one should have a *Koran* in his lap when the sun gives the signal that ‘the year has changed.’ This gives him good luck for the coming year. But this blessing may be increased if he has learning, for by reading the *Sura Ya Sin*, this time, he is given the assurance that he will remain secure in his employment for the whole year [this last bit seems to be an anti-solar rite where one observes the sun but holds dear the *Koran* because it is moon-god literature, especially the *YaSin* chapter which shows that *Allah* is *Sin* the moon-god].<sup>2467</sup>

<sup>2466</sup> Wakidi (W.), 51, as reference by Margoliouth. *Rise*, p. 154 & fn. 3; also see Ishaq. *Sirat*, p. 222, where Ishaq says *Muhammad* said “*Ya Sin*,” and sprinkled dust.

<sup>2467</sup> Donaldson, Bess Allen. “The *Koran* as Magic,” *The Muslim World* (1937 AD), vol. 27, pp. 254-266, answering-Islam.org.

That the *Shias* views *Allah* to be *Sin*, the protector of travelers and such, can be assumed from the fact that they called the mystical characters “light-possessing, light-giving” and “the bright ones,”<sup>2468</sup> and they believed that...

The power of this code [the mystical characters], whether written or read, is believed to afford protection from thieves and from disaster at sea; to provide plenty of the means of living; and to safeguard a person from enemies, from plots and from all injurious animals. It is written on four pages of paper and placed at the four cardinal points about field or garden to cause locusts to leave the place.<sup>2469</sup>

That *Allah* was known to be *Sin*, a protector of soldiers and others in distress, is known also from the fact, as David Nicolle wrote, that *Muslim* armies shouted out *K 036* on the battlefield. The *Ya Sin* chapter (*K 036*) is “traditionally recited [by *Muslims*] at times of adversity.”<sup>2470</sup>

The *Ya Sin* chapter (*K 036*) of the *Koran* “is believed to possess magical powers” that “cover all the experiences of life, from an easy birth to a painless and peaceful death and the journey on to bliss in heaven,” and the *Ya Sin* chapter is spoken at funerals.<sup>2471</sup> Bess Allen Donaldson wrote: “... *Sura Ya Sin*... is much used in *Koranic* magic since it is called ‘the heart of the *Koran*.’”<sup>2472</sup>

Of all the mystical letters, only a few scattered ones are not here deciphered: ‘*Ain*, *Kaf*, *Nun*, *Qaf*, *Ra* and *Sad*. These are all crescent-shaped letters, as shown on the chart of Arabic letters with crescent shapes found elsewhere in this book.

Each of these letters probably is the first letter of several titles for *Allah*. *Muslim* tradition says that *Allah* has ninety-nine names but Arthur Jeffery wrote:

...Redhouse, in his article in the *Journal of the Royal Asiatic Society* for 1880, collected from various lists no less than 552 different names for *Allah*.<sup>2473</sup>

The *Ra* mystical letter found prefixed to *Suras* 10 through 15 may stand for *Rabb*, meaning “Lord,” or *Rahman*, a title of *Allah*’s meaning “The Merciful.” *Rabb* and *Rahman* is found scattered throughout the *Koran*, *Rahman* is the title of *Sura* 55 and *Rahman* is found in the dedicatory phrase that prefixes every *Sura* except *K 019*: “In the Name of *Allah*, the Beneficent, the Merciful [*Rahman*].”

<b><i>Koranic</i> Mystical Letters That May Stand for Titles of <i>Allah</i></b>		
<b><i>Sura</i> Number(s)</b>	<b>Letter</b>	<b>Title and Meaning</b>
19, 42	<i>‘Ain</i>	<i>‘Aziz</i> : Mighty or <i>‘Aliyy</i> : Most High
19	<i>Kaf</i>	<i>Kabir</i> : Most Great
68	<i>Nun</i>	<i>Nur</i> : Light or <i>Nafi</i> : Benefiter
42, 50	<i>Qaf</i>	<i>Qawiyy</i> : Strongest or <i>Qadir</i> : Omnipotent
10, 11, 12, 13, 14, 15	<i>Ra</i>	<i>Rahman</i> : Merciful or <i>Rashid</i> : Guide
19, 7, 38	<i>Sad</i>	<i>Samad</i> : Besought

<sup>2468</sup> Donaldson, Bess Allen. “The *Koran* as Magic,” *The Muslim World* (1937 AD), *Idem*.

<sup>2469</sup> Donaldson, Bess Allen. “The *Koran* as Magic,” *The Muslim World* (1937 AD), *Ibid*.

<sup>2470</sup> Nicolle, David. *The Moors*, p. 17.

<sup>2471</sup> Gilchrist. *Islam*, “The Social Laws and Customs of *Islam*, C. Cultic Trends in Popular *Islam*.”

<sup>2472</sup> Donaldson, Bess Allen. “The *Koran* as Magic,” *The Muslim World* (1937 AD), vol. 27, pp.

254-266, answering-*Islam.org*.

<sup>2473</sup> Jeffery, *Islam*, p. 93.



The <i>Koran's</i> Seemingly Nonsensical Letters (Summary) (Found at the Start of Twenty-Nine Chapters)			
Com- bination	Letter Combinations	Possible Meanings of the Mystical Letters	<i>Sura</i> (s) Involved
No. 01	<i>Alif, Lam, Mim</i>	Past, Present, Future	2, 3, 29, 30, 31, 32
No. 02	<i>Alif, Lam, Mim, Ra</i>	Past, Present, Future, Merciful One ( <i>Ra</i> )	13
No. 03	<i>Alif, Lam, Min, Sad</i>	Past, Present, Future, Besought ( <i>Sad</i> )	7
No. 04	<i>Alif, Lam, Ra</i>	Past, Present, Guide ( <i>Ra</i> )	10, 11, 12, 14, 15
No. 05	<i>Ha Mim</i>	The Protector	40, 41, 43, 44, 45, 46
No. 06	<i>Ha Mim, 'Ain Sin Qaf</i>	The Protector, Most High (' <i>Ain</i> ) [moon-god] <i>Sin</i> , Omnipotent ( <i>Qaf</i> )	42
No. 07	<i>Kaf, Ha Ya 'Ain, Sad</i>	Most Great, The ( <i>Ha</i> ) O ( <i>Ya</i> ) Most High, Besought (One) ( <i>Sad</i> )	19
No. 08	<i>Nun</i>	Light	68
No. 09	<i>Qaf</i>	Omnipotent	50
No. 10	<i>Sad</i>	Besought	38
No. 11	<i>Ta, Ha</i>	Oh Man!	20
No. 12	<i>Ta, Sin</i>	Oh [moon-god] <i>Sin!</i>	27
No. 13	<i>Ta, Sin, Mim</i>	Oh [moon-god] <i>Sin</i> , Protector ( <i>Mim</i> )	26, 28
No. 14	<i>Ya, Sin</i>	Oh [moon-god] <i>Sin!</i>	36

### ***Koran* Chapters Dedicated to *Sin* the Moon-god**

*K* 036 is entitled *Y.S.*, which is pronounced “*Ya Sin.*” The first verse is only two letters long: *Y.S.* Other *Koranic* chapters are entitled after the mystical letters with which they begin, as with *K* 020, 038, 041, 050 and 068.

*Y.S.* might appear to be two nonsensical Arabic letters but it must be remembered that in the Mideast, each letter of many alphabets used to be pictograms that stood for words just as in Hebrew the *Aleph* character meant “ox,” *Beth* meant “house,” *Ayin* meant “eye” and so forth.

In Arabic, the letter names rather than letter sounds were spoken. This occurs in most languages where the letter symbol has a different name than its sound. When saying the alphabet, an English speaker says “be” for “b,” not “ba,” and “double-u” for “w,” not “wa.” In ancient Arabic, the “s” was probably read not as “ssss,” but as “*sin*” or “*Sin.*”

This practice of saying the letter name turns some or all of the Arabic letters into sounds that can be construed as words with meaning. Thus the title and heading of *K* 036 “*Y.S.*” is “*Ya Sin*” and means “O moon-god *Sin.*” *Sin* the moon-god was probably well known by the initials *Y.S.*, and especially by his initial *S* since *S* was once a pictogram for an ox and by extension, the *Yemeni* moon-god *Sin*.

That the letters *Y.S.* refer to the moon-god is confirmed by the fact that nearly all the *Koran's* chapters carry titles that relate to nouns mentioned within the chapter

itself. *Ya Sin* would be an appropriate title for *K 036* since the moon is mentioned twice in that chapter (*K 036:39, 40*).

The <i>Koran's</i> Chapters Addressed Specifically to <i>Sin</i>	
Citation	Seemingly Nonsensical Letter(s) at Start of <i>Suras</i>
<i>K 026:001</i>	<i>Ta Sin Mim</i>
<i>K 027:001</i>	<i>Ta Sin</i>
<i>K 028:001</i>	<i>Ta Sin Mim</i>
<i>K 036:001</i>	<i>Ya Sin</i>

Reportedly, Thuraya Manqoosh, a *Yemeni* Arabist, provides an indication that the letters *Y.S.* refer to the moon-god. Manqoosh notes that modern *Yemenis* still say “*Ya Sin* be upon you,” a traditional expression meaning “Good for you.”

“*Ya Allah*” and the blessing “*YaSin* be upon you,” is similar to the traditional English expressions “Goodbye” and “Godspeed.” “Goodbye” is the contraction for the blessing: “God be with you (ye).” “Godspeed,” meaning “God prosper you,” is a contraction of “God” and “*Spede*,” an archaic verb.

*Ya* is a common Arabic word meaning “Oh.” For instance, when *Muhammad* was injured during the Battle of *Uhud*, the *Mekkan* pagans shouted “Oh *Al-‘Uzza* and Oh *Hubal!* (Arabic: *Ya lal-‘Uzza, Ya La-Hubal!*).<sup>2474</sup> “*Ya Adamu*” means “Oh Adam” (*K 002:033*), “*Ya Banee Isra-eela*” means “Oh Children of *Israel*” (*K 002:040*) and *Ya Musa* means “O Moses” (*K 002:055*). “*Ya Sin*” is similar to the common Arabic vocative expression “*Ya Allah*” meaning “Oh *Allah*.”<sup>2475</sup>

The plausibility that a *Koranic* chapter starts with such a vocative expression is strengthened by the fact that there is another *Koranic* chapter that does the same, as *Yusuf Ali* wrote:

The mystic letters *Ta-Ha* are prefixed to this *Sura* [*K 020*]. What do they mean? The earliest tradition is that they denote a dialectical interjection meaning ‘O man!’ It takes up the story from the last *Sura*, of man as a spiritual being, and illustrates it in further detail.<sup>2476</sup>

So based on the evidence, one can say that just as the vocative expression “O Man!” (*Ta Ha*) prefixes a *Sura* dealing with humanity, the vocative expression “O [moon-god] *Sin*” (*YaSin*) prefixes a *Sura* dealing with the moon (*Koran 036:039, 040*). Furthermore, if *Ta Ha* means “O Man!,” then similarly *Ta Sin* must mean “O [moon-god] *Sin*.” *Ta-Sin* is the first letters of *Suras 026, 027 and 028*.

That *Muhammad* and *Muslims* called upon *Allah* as though he were *Sin* reminds one of how in the *Gilgamesh Epic*, *Gilgamesh* called upon *Sin* during times of adversity:

At night when he [*Gilgamesh*] came to the mountain passes *Gilgamesh* prayed: ‘In these mountain passes long ago I saw lions, I was afraid and I lifted my eyes to the moon; I prayed and my prayers went up to the gods, so now, O moon-god *Sin*, protect me.’<sup>2477</sup>

<sup>2474</sup> Lings. *Sources*, p. 186.

<sup>2475</sup> Search the web for “*Ya Sin*” and “*Ya Allah*.” Another Arabic word for “Oh *Allah*” is *Allahumma*. Permutations of the letters *Ya Allah* are: *Yalla(h)!*, which is Arabic for, “Come out!,” or “Let’s go!” In 2004 Israelis have been saying “*Yalla-bye*” instead of *Shalom* (Peace), perhaps because it sounds like the English “alabi” (Gilbert, Nina. “No more *yalla-bye*,” PM says,” jpost.com 5 Jan 2005).

<sup>2476</sup> *Yusuf Ali. Meaning*, p. 226, Introduction to *K 020*, the “*Ta Ha*” *Sura*.

<sup>2477</sup> Anonymous. *Gilgamesh*, “The Search for Everlasting Life.” Also, Pritchard. *Ancient*, I:62, middle of Tablet IX.

Maududi wrote in his commentary on *K* 036:

*Imam Ahmad, Abu Daud, Nasai, Ibn Majah and Tabarani* have related on the authority of *Hadrat Ma'qil Bin Yasar* that the Holy Prophet said: ‘*Sura Ya Sin* is the heart of the *Quran*.’<sup>2478</sup>

That *Sura Ya Sin* is the heart of the *Koran* indicates that *Islam* is at heart a moon-god religion.

*Yusuf Ali* wrote in his introduction to *K* 036:

This particular *Sura* is devoted to the Holy Prophet and the Revelation which he brought. The abbreviated letters **Ya-Sin** are usually construed as a title of the Holy Prophet. . . This *Sura* is considered to be ‘the heart of the *Quran*,’ as it concerns the central figure in the teaching of *Islam* and the central doctrine of revelation and the Hereafter. As referring to the Hereafter, it is appropriately read in solemn ceremonies after death. In chronology it belongs to the middle or early *Makkan* period. In *S[ura]37:130* (a cognate *Sura*) occurs the word **Il-ya-sin**.<sup>2479</sup>

At the end of the above quotation, *Yusuf Ali* implies that *IYaSin* is related to the word *YaSin*. In *K* 037:130, *IYaSin* is the Arabic translation for *Elijah*, which in Hebrew is “*Eli* is *Yah[veh]*,” meaning “My God is *Yahveh*.”

The Arabic word commonly used to translate *Elijah* is *Ilyasa* from the Greek *Elias*. However, if *Yusuf Ali* is right, then *Il-YaSin* here means “[My] god is [the moon-god] *Sin*.” This further implies that the word *Ilyas*, found in *K* 006:085 and *K* 037:123, is short for *IYaSin* and thus has the same meaning as *IYaSin*: “My god is *Sin*.”

Assuming that *Yusuf Ali* is correct, whether the *Sin* in *IYaSin* is spelled exactly the same as *Hadramawt*’s *Syn* or *Mesopotamia*’s *Sin* (or *Su-en*) is irrelevant since consonants change over time. For instance, *Richard Burton* (1821–1890 AD) wrote that the word *Sirat* changed consonants three times (from *Sin* to *Sad* to *Za*) in less than thirteen hundred years even though this period was more literary than in ancient times.<sup>2480</sup>

If *Yusuf Ali* is correct, then *Il-YaSin* reminds one of the debate about the Hebrew word *Abdullah*. Some have said that the Arabic *Abdullah* and *Obied Allah* are translations of the Hebrew *Obadiah*. One of *Muhammad*’s uncles was named “*Obied Allah*.”<sup>2481</sup> *Obadiah* however means “Servant of *Yah[veh]*,” whereas *Abdullah* means “Servant of *Allah*.”

*Pickthall, Yusuf Ali* and *Shakir* agree in that “Peace be upon *Il-YaSin*” (*K* 037:130) refers to the Old Testament prophet *Elijah*. The “*Elijah*” translation is consistent with how *K* 037:109 says “Peace be on *Ibrahim*,” *K* 037:120 says “Peace be on *Moses* and *Aaron*” and *K* 037:181 says “Peace be on the *Apostles*.”

There are some translations that say that *Il-YaSin* ought to instead be translated as the “People of *YaSin*” (*K* 037:130). Since *YaSin* was one of *Muhammad*’s titles, *Muslim* commentators go on to say that “the people of *YaSin*” refers to *Muhammad*’s family and followers. This alternative translation would mean that *Muhammad*’s family and *Muslims* are “the people of the moon-god *Sin*.” This is similar to how South Arabians saw the moon-god as their “patron god and mythical ancestor.” The

<sup>2478</sup> Maududi. *Meaning, Ya Sin Sura* Introduction.

<sup>2479</sup> *Yusuf Ali. Meaning*, p. 335.

<sup>2480</sup> *Burton. Nights*, vol. 4, fn. 318.

<sup>2481</sup> *Morey. Invasion*, p. 51.

*Minaeans* said of their moon-god: “*Wadd-‘Abb* (“*Wadd* is father”), the *Qatabanites* called themselves the “children of ‘*Amm*,”<sup>2482</sup> and the *Sabeans* called themselves “the progeny [*wld*] of ‘*Alumqah*.”<sup>2483</sup>

### ***Muhammad’s Titles YaSin and IYaSin***

*Yusuf Ali* wrote in his introduction to *K 036* (as was quoted previously):

This particular *Sura* is devoted to the Holy Prophet and the Revelation which he brought. The abbreviated letters *Ya-Sin* are usually construed as a title of the Holy Prophet.<sup>2484</sup>

So one of *Muhammad’s* titles was *Ya Sin*, meaning “O moon-god.” The title *Ya Sin* pegs *Muhammad* as being a moon-god prophet and is one reason why he was widely known as a moon-god prophet.<sup>2485 2486</sup>

*Ya Sin* or *IYaSin* must have been one of *Muhammad’s* most important titles since scholars consider the *Ya Sin* chapter (*K 036*) to be “the heart of the *Koran*,”<sup>2487</sup> and *Muhammad’s* favorite wife *Aisha* said: “The character of the Apostle of *Allah* was the *Koran*” (*Sahih Muslim*, bk. 4, no. 1623). *Muhammad* told people to say *Ya Sin* to those on their deathbed and at funerals, so *Ya Sin* was the last thing they would hear before dying.<sup>2488</sup>

Why was *Ya Sin* such an important title? *Allah* was known by the name *Sin* long before *Allah* was known by the name *Allah*. Claiming to be a prophet of *Sin* gave *Muhammad* added legitimacy in the eyes of Mideast pagans. They supposed that *Ibrahim* had known the moon-god by his ancient and most common name—*Sin*.

Parallel passages show that the *Ya Sin* of *K 036* is the moon-god *Sin*, who was worshipped by that name in Southern Arabia. *K 036:001-005*, *K 053* and *K 081* all claim that *Muhammad* was a legitimate prophet of *Allah* because *Muhammad* was guided by the moon, and *Koran 006* says the same of *Ibrahim*:

- ☉ *Ya Sin*. By the wise *Quran*. Surely you [*Muhammad*] are among those sent on a straight path. A revelation of the Mighty, the Compassionate (*K 036:001-005*).
- ☉ Then when he [*Ibrahim*] saw the moon rising, he said: Is this my Lord? So when it set, he said: If my Lord [*Allah* the moon-god] had not guided me I should certainly be of the erring people (*K 006:077*).
- ☉ Your companion [*Muhammad*] does not err, nor does he go astray...It is naught but revelation that is revealed...The Lord of Mighty Power has taught him...And he [*Allah* the moon-god] is in the highest part of the horizon...and certainly he saw him [*Allah* the moon-god] in another descent (*K 053:002, 004-005, 007, 013*).
- ☉ Your companion [*Muhammad*] is not gone mad. Of a truth he saw him [*Allah* the moon-god] on the clear horizon (*K 081:022-023*).

These parallel passages are discussed elsewhere in connection to the title *Ya Sin*.

<sup>2482</sup> Breton. *Felix*, p. 121.

<sup>2483</sup> Simpson. *Sheba*, p. 68, right column.

<sup>2484</sup> *Yusuf Ali. Meaning*, p. 335.

<sup>2485</sup> A follower compares *Muhammad* to a full-moon (*Ishaq. Sirat*, p. 422).

<sup>2486</sup> *Safiya* dreams that *Muhammad* is a moon that fell in her lap (*Muir. Life*, vol. 4, pp. 70-71).

<sup>2487</sup> *Yusuf Ali. Meaning*, p. 335.

<sup>2488</sup> *Maududi. Meaning, Ya Sin Sura* Introduction.

There is definitely a conclusion that can be drawn from the fact that one of *Muhammad's* titles was “O [moon-god] *Sin*” (*Ya-Sin*). That conclusion is that this statement does NOT exonerate *Islam*:

Even though *Allah* is a poor caricature of *Yahveh*, it is clear that *Muhammad* **thought** he was worshipping the God of Abraham.

The fact that *Muhammad* **thought** he was worshipping the God of Abraham is negated by the fact that *Muhammad* **thought** that *Ibrahim's* God was the moon-god *Sin*—the god of *Haran*. So once again we see that the road to hell is paved with good intentions and culpable ignorance.

### Archeological Evidence That Explains the Disjointed Letters

The disjointed letters represent fourteen letters of the alphabet<sup>2489</sup> and there has been much speculation as to how to translate these letters. Each letter could represent a word, or one can add vowel pointing to the disjointed letters to make a word.

One can surmise that individuals disjointed letters stand for important religious words such as *Allah*, *Halah* (the *Safaitic* Inscriptions' way of spelling *Allah*),<sup>2490</sup> *Oh* (*Ya*), *Sin*, *Taala* (“Most High,” as in *Allah Taala*<sup>2491</sup>), *Tahlil* (the credo, ‘There is no deity save *Allah*’<sup>2492</sup>), *Takbir* (“*Allah* is (Most) Great” (*Allahu Akbar*)<sup>2493</sup> and the like.

That a single letter could be a symbol for a god is not uncommon. Alexander Hislop says that the Mystic *Tau*, the T-letter found in the earliest alphabets, was the sign of the shepherd god *Tammuz* because *Tau* was the initial letter of *Tammuz's* name.<sup>2494</sup> By the way, the *Encyclopedia Britannica* says the *Sabeans* in South Arabia worshipped *Tammuz* as a grain god.<sup>2495</sup>

*Alpha* and *Omega* (*A W*) is a title of Jesus (Rev 01:08; 21:06; 22:13). In the Greek New Testament the *Alpha* is spelled out but the *Omega* is the single letter *W* (*Alpha Kai to W*). In the Latin *Vulgate* the *A* and *W* are not spelled out (*A et W*).

There is archeological evidence that shows the South Arabians did use the first letter of a god's name to represent a god. In fact, these inscriptions are very similar to the *Koran's* disjointed letters.

This archeological evidence strengthens the interpretation that the “disjointed letters” at the start of fourteen *Koran* chapters stand for the names *Allah* and *Sin* and other words.

Werner Daum wrote about a three-meter-wide petroglyph and rock inscription which represents the central ancient rain-myth of the Holy *ibex* Hunt. The single letter “A” (or “T”) refers to *Almaqah* (also spelled *Ilmaqah*) and the single letter “S” refers to *Shams*:

The text is written from right to left. The word to the left...of the *ibex* has three letters, D, Th and A, vocalized *Dithâ'*, ‘spring-rain.’ The right word is Ch, R, F. It means *Charif*, ‘autumn’. That is, the rainy season of late summer. But behind *Charif* another letter is standing. It is a vowel (the same as the one at the end of *Dithâ'*). It could mean each one of the three Arabic vowels A, I or U. U is

<sup>2489</sup> Asad. *Message*, App. II, p. 992.

<sup>2490</sup> Hastings. *Ethics*, “Arabs (Ancient)” entry, p. 664, right column.

<sup>2491</sup> Wherry. *Commentary*, vol. i, section i, p. 36.

<sup>2492</sup> Jeffery. *Islam*, p. 247.

<sup>2493</sup> Hughes. *Dictionary*, “*Allahu Akbar*” entry, p. 14.

<sup>2494</sup> Hislop. *Babylons*, pp. 197-200.

<sup>2495</sup> *EB*, *Tammuz* entry, accessed 1 Mar 2004.

theoretically possible. But such words are practically not found in the Arabic stock of words. Hence, only A and I remain. Such a single letter is an abbreviation... when the letter is standing so plainly beside the *Ibex*, it must refer to him... There is only one single important word in the Old Arabic used in religion that begins with *A*: '*Almaqah*. (If one vocalizes the name of the *Sabean* imperial god as '*Il Muqah*, the writing remains the same.) And the *Ibex* is also the symbolic animal of [the moon-god] '*Almaqah*.'<sup>2496</sup>

The *Encyclopedia Britannica* states that animals often represented the god:

The South Arabian deities are usually evoked by a symbol—as for instance, a bull's head, snake or thunderbolt.<sup>2497</sup>

Werner Daum wrote that this practice of abbreviating gods' names by the first letter was used elsewhere:

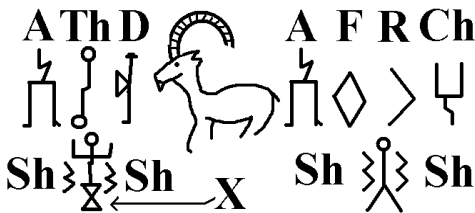
The use of the initial letter as an initial for the deity has also been found, by the way, on the perhaps finest *Sabean* gem, preserved now in the British Museum. In its center the three letters '*A*, '*A* or '*I* and *Sh* are standing, connected with each other. Grohmann has explained them already in 1914 as the *Sabean* triad of '*Athar*, '*Almaqah* and *Shams*.<sup>2498</sup>

So the A. A. (or "I") and *Sh* on the gem stood for the triad: *Athar* (Venus), '*Almaqah* (moon-god) and *Shams* (a sun-goddess).

Following the Semitic practice, the text is written from right to left. The D Th and A letters stand for the word *Dithâ*', meaning "spring-rain." The Ch, R and F letters stand for the word *Charîf*, meaning "autumn." The A letter to the right of the *Ibex* stands for A or I, the *Sabean* imperial god *Ilmaqah* (also spelled *Almaqah*).

The stick men are "two well-known symbols of calendar mythology" used since Sumerian times.<sup>2499</sup> The stick man on the right literally refers to first *Sumerian* month, and the stick man with the X below literally refers to the tenth *Sumerian* month. As new calendars were instituted, these stickmen symbols eventually just meant spring equinox and autumnal equinox.

The zigzag lines on either side of the stick men are the Old Arabic letter *Sh*. In Mesopotamia, the zigzag letter represented the male Sumerian sun-god *Samas* (or *Shamas*), who was known to the Arabs as the female sun-goddess *Shams* (or *Shamash*). *Ilmaqah* was the *Sabeans*' national god and was at the head of the pantheon. *Shams* was *Almaqah*'s wife or consort.



**Figure 04-10.** *Charîf* = Spring-rain. *A* = *Almaqah*. *Ibex* = Sign of Moon-god. *Dithâ*' = Autumn Rain. The *Sh* by both stick men = *Shams*, a sun-goddess. **Stickman on right:** spring equinox. **Stick man with X (tenth month):** autumnal equinox.<sup>2500 2501</sup>

<sup>2496</sup> Daum. *Ursemitische*, pp. 76-78.

<sup>2497</sup> Ryckmans, Jacques. *EB*, "Arabian Religions" entry, 2004.

<sup>2498</sup> Daum. *Ursemitische*, pp. 76-78.

<sup>2499</sup> Krause, Hans. *Ancient Arabia and its Religion 1* (hanskrause.de), "Ch. 6: South Arabia's popular Religion," accessed Feb 2004.

<sup>2500</sup> An ancient rock-relief, 3-meters wide, in the wild wadi near the old town of *Al Haçi, Sabâ*' (near modern *Al Baidâ*'), Southern Arabia (Daum. *Ursemitische*, p. 77).

<sup>2501</sup> Note that the English letters A, Ch, D, F, R, Sh, Th and X are the transliterations of *Yemini* characters as provided by Daum. A "*Yemini* Script Translator" by garyvey@viewzone.com,

The calendar symbols should be interpreted merely as references to the equinoxes rather than as pleas to the sun-goddess, so the inscription reads:

Oh moon-god *Ilmaqah*, bring the spring and autumn rains around the spring and autumnal equinoxes.

This type of inscription suggests that the *Koran's* “disjointed letters” are in fact combinations of words and single-letter abbreviations (just as Y. S. = *Ya Sin*) that together either entreat or praise *Allah*, a.k.a. *Sin*.

### Alternate Reading Cycles in the *Koran* Using the Disjointed Letters

*Muhammad* mentions *Muslims* reading the *Koran* a third or even half the night (*K* 073:020). As was discussed above, *Koran* readers commonly follow a weekly and a monthly reading cycle. Apparently, there are alternate reading cycles covering two weeks and thirty days made possible by the mysterious “disjointed letters” prefixing twenty-nine *Koran* chapters.

The weekly reading cycle was important since one week equals one moon phase. The two-week reading cycle would represent the Dark Phase to full-moon waxing phases, or the full-moon to Dark Phase waning phases. The thirty-day cycle represents one lunar month.

*Muhammad* Asad states that the disjointed letters found at the *Koran's* chapter headings constitute fourteen of the twenty-eight letters of the Arabic alphabet.<sup>2502</sup> It is easy to imagine early *Muslims* reading fourteen *Koranic* chapters in alphabetical order in a two-week period. The order would be according to this reduced alphabet of the fourteen disjointed letters.

In the thirty-day reading cycle, the *Fatiha* chapter (*K* 001) is read on the first night of the lunar month, and then the twenty-nine chapters marked by seemingly nonsensical Arabic characters are read once per night for the rest of the month.

In the thirty-day reading cycle, the reader may have read the chapters moving from the front to the back of the *Koran*. Alternatively, the reader could read the chapters in alphabetical order as indicated by the mysterious letters. In cases where several chapters are headed by the same “disjointed letter” combination, the reader would read only one chapter per night until exhausting the chapters with that letter combination.

The reader might ask “Why weren’t the chapters lettered singly like A, B, C, D?” Since:

- ☉ The cycle is over thirty days, there were not enough letters in the twenty-eight letter Arabic alphabet to label each chapter with one letter only.
- ☉ Adding several nonsensical characters to the chapter headings seems to have been an ingenious way to camouflaging the fact that, by using the disjointed letter “S,” five of the *Koran's Suras* are addressed to the moon-god *Sin* (*K* 026, 027, 028, 036 and 042).
- ☉ As will be discussed in a later chapter, the presence of the disjointed letters indicates that *Allah* gave the Arabic alphabet in addition to the *Koran* and “the pen” (*K* 031:027; see “Alphabet” and “Disjointed” in the Index).

---

viewzone.com, accessed 21 Jan 2005, translated the characters in the illustration as follows: A (*Bin*=Son, child, member), Th (*Tav*), D (*Gimmel*), A (*Bin*=Son, child, member), F (*Peh*), R (*Resh*), Ch (*Forsee*), Sh (*Shim*), X (*Mem* ?). Yoel Natan has no explanation for the discrepancies.

<sup>2502</sup> Asad. *Message*, App. II, p. 992.

Interestingly, the *Suras* prefixed with non-signifying characters were written at *Makka*, except two *Suras* were written early in *Muhammad's Madinan* "ministry." This is the period where *Muhammad* was most affected by his native astral religion beliefs.

Maududi states that *K 002* belongs to the early *Madinan* period. Maududi writes that the "first discourse" of the next chapter (*K 003:001-032*) came from the early *Madinan* period after the Battle of *Badr*. *Badr* is Arabic for "full-moon."

### Pre-Islamic Moon-god Literature in the *Koran*

That *Muhammad* was interested in moon-god literature, and also putting together a *Sin* moon-god reading cycle during his *Makkan* "ministry," is suggested by the fact that the moon is mentioned 29 times in the *Koran* altogether, and many occurrences are in *Makkan Suras* (listed above).

*Yusuf Ali* also notes the connection between *Makkan Suras* and pagan moon worship. *Yusuf Ali* wrote that *K 074* was one of the earliest *Makkan Suras*.<sup>2503</sup> *Yusuf Ali* also comments on *Muhammad's* swearing "Nay, verily by the moon" (*K 074:032*):

The moon was worshipped as a deity in times of darkness.<sup>2504</sup>

Tisdall also notes the connection between a *Makkan Sura* and pagan moon worship. Tisdall wrote about *K 054*, which is entitled "The Moon":

It is sometimes said in the East at the present day that *Muhammad* not only adopted many of the ancient habits and religions rites of the heathen Arabs and incorporated them into *Islam* but that he was also guilty of plagiarism in borrowing parts of certain verses of *Imrau'l Qais*, an ancient Arabic poet. These, it is asserted, may still be found in the *Quran*. I have even heard a story to the effect that one day when *Fatimah*, *Muhammad's* daughter, was reciting the verse 'The Hour has come near and the moon has split asunder' (*Sura LIV [54], Al Qamar, 1*), a daughter of the poet was present and said to her, 'That is a verse from one of my father's poems, and your father [*Muhammad*] has stolen it and pretended that he received it from God.'<sup>2505</sup>

*Imrau'l Qais* died about the year 540 AD but must have left an anthology of poems. These old poems were probably kept in the *Kaaba*, as the *medieval Sourcebook* notes:

In the *Ka'aba* there were a number of poems 'hanged' [hung] on the walls. Some of these 'hanged [hung] poems' were allowed to remain after the *Muslim* order was established. They allow us some insight into the literature of pre-Islamic Arabia." These included the poems of *Imru-Ul-Quais*, *Antar* and *Zuhair*.<sup>2506</sup>

*Muhammad* thought that poems from former generations were forgotten and so could be reworked without anyone noticing. In contrast, Saint Paul quoted pagan poets and prophets but gave credit where credit was due (*Acts 17:28; Tit 01:12*).

<sup>2503</sup> *Yusuf Ali. Meaning*, pp. 469, 471.

<sup>2504</sup> *Yusuf Ali. Holy*, p. 1644, fn. 5798.

<sup>2505</sup> St. Clair-Tisdall. *Sources*, Ch. 2 "...Ancient Arabian Beliefs and Practices."

<sup>2506</sup> *Medieval Sourcebook: Pre-Islamic Arabia: The 'Hanged' Poems, before 622 CE*, fordham.edu/halsall/source/640hangedpoems.html



*Muhammad* did not anticipate that the daughter of a poet would remember her father's poem. After all, Imrau'l Qais had been dead for decades. So it seems that *Muhammad*, by creating the *Koran* as he did, is guilty of plagiarizing.

Interesting, the early *Suras* are known for their spirituality and poetry. The later *Suras* are known for their superficiality and prose style, especially those written at *Madina*. This suggests that the early *Suras* were largely the reworked moon-god poetry of *Makkan* poets. When *Muhammad* produced the later *Suras*, he did so without the aid of dead poets because he was not able to take the *Kaaba's* collection of poems to *Madina*.

So the *Makkan Suras* were largely reworked from a collection of poetry from many poets that addressed various gods at the *Kaaba*. The *Suras* that start with the mystical letters *Y.S.* or *S.* were specifically addressed to the moon-god *Sin*. The other disjointed letters may have been added to camouflage the fact that several *Suras* were addressed to the moon-god *Sin*. See the ToC for the section discussing the *Suras* dedicated specifically to *Sin*.

## Chapter 05: Moon-o-theistic *Haran* Connection

### How Pagan Shrines Were Transformed into Christian Pilgrimage Sites or Places of Worship

J. S. Trimingham wrote how new converts to Christianity saved their pagan shrines and pilgrimage sites by concocting a Biblical-sounding narrative that placed a Biblical figure or two at the site. Typically, the supposed remains of a Biblical figure or Christian martyr were deposited at the site:

Aramaean Christians, it is true, were uninterested in visitations to holy sites in Jerusalem, but a peculiar feature of their Christianity is their resurrection of Aramaean [cultural<sup>2507</sup>] heroes under the guise of Old Testament prophets. The Aramaeans were immune to direct Judaic influence, yet they incorporated Old Testament traditions into the very structure of their mythology. Certain Old Testament heroes they regarded as universal figures. Those upon which Arabs placed most stress, Abraham and Ishmael, Amos and Job, were actually Arab pastoral nomads. Moses naturally joins them as a desert wanderer, and so does John the Baptist, desert ascetic. Western churches did not feel the same relationship with Old Testament figures. They did not for instance, commemorate them in the liturgy, as did the eastern churches... This exploitation was extended to the very bones of the Old Testament patriarchs and prophets, and the demand for relics soon produced a good supply, for they were running out of the remains of martyrs. Egeria relates how shortly before her visit (~385 AD) the site of Job's burial was discovered near the village of *Shaikh Sa'd* in the *Hawran*, where his tomb and that of his wife can still be seen, as well as the ruins of a monastery (*Dair Ayyub*) dedicated to him. This cult of Job in the *Hawran* was probably a pagan cult given new life under Christian auspices. Tradition claims that Job was a native of the *Hawran*, but internal evidence in the Book of Job rather indicates that he belonged to the northern *Hijaz*.<sup>2508</sup>

J. S. Trimingham wrote that fabricated personal histories of saints and martyrs were used to reinterpret pagan relics and places of worship:

The Arabs of the *Sinjar* region had a red stone associated with a spring, to which they paid homage for its healing properties and for facilitating the recovery of strayed camels. A Syriac legend explains how the transference of values took place. A Jewish youth name Asher *Ben Levi*, having received a call to dedicate himself to Christ, had been baptized in this spring under the name of 'Abd Al Masih. His outraged father had his son sacrificed on this red stone. The date of this sacrifice was 27 July 701 of the year of Alexander, which is equivalent to AD 390...<sup>2509</sup>

J. S. Trimingham wrote how astral shrines were converted to Christian use:

The cult of the prophet *Elias* [*Elijah*] is known to have replaced the cult of the sun in Hellenistic places, and the similarity between the names *Elias* and *Helios* [Greek sun-god popular in late antiquity] is adduced.<sup>2510</sup>

An additional factor in the conversion of sun-god temples into Christian sites honoring *Elijah* is that the Aramaic for "God" (*Eli* or *Eloi*) was sometimes misheard

<sup>2507</sup> Trimingham. *Arabs*, p. 316.

<sup>2508</sup> Trimingham. *Arabs*, pp. 240-241.

<sup>2509</sup> Trimingham. *Arabs*, p. 242, fn. 78.

<sup>2510</sup> Trimingham. *Arabs*, p. 79, also see p. 241.

as “*Elijah*” (Mat 27:46-49; Mar 15:34-36). To many in the Mideast touched by Hellenism, the appellative “the god,” referred to the highest pagan god, *Helios*.

### How the Pagan *Kaaba* Was Transformed into an *Islamic* Pilgrimage Site

When reading about syncretism in the pre-*Islamic* era, one must remember that in the seventh century, Judaism and Christianity still competed for converts from paganism.

Judaism was once a missionary religion like Christianity. In fact, as late as the eighth century AD, the nobility of the Khazar Turks embraced Judaism.<sup>2511</sup> So it is not surprising that a Jewish kingdom arose in *Yemen* as late as the fifth century AD.

The process of syncretization in *Makka* backfired. The process was supposed to result in pagans discarding all their gods but one, and then that god was swapped for *Yahveh* of the Bible. In *Makka* however the switch never occurred since there were too few Jews there to encourage and guide the process along. Instead *Muhammad* merged moon-god literature and doctrine with Christian apocryphal and Jewish *Haggadic* material. So instead of the situation being as in *Athens*:

What you worship as something unknown I [Apostle Paul] am going to proclaim to you (Act 17:23),

the situation in *Makka* and *Madina* was reversed. *Muslims* have said by their deeds:

Now that *Muhammad* has concocted a false identity and personal history for *Allah* the moon-god, woven from Jewish, Christian and pagan folktales, we are going to force our *Biblicized* god down the throats of Christians and Jews.

Normally Christians and Jews declared that the pagan gods and goddesses were demons. *Muhammad* however merely demoted the astral gods and goddesses to an angelic status, and the goddesses were resexed to be male angels. In *Muhammad's* syncretization, *Yahveh*, the God of the Bible, never replaced *Allah*. Judaism and Christianity were largely replaced by pagan astralism, and *Allah* the moon-god replaced *Yahveh*.

Instead of pagans voluntarily deciding to discard their sacred literature in favor of the Bible (Act 19:19), *Muhammad* intervened with a crude amalgamation of Judaism, Christianity and paganism. In fact, Christianity is mentioned for the most part when *Muhammad* wanted to deny its distinctive doctrines. Then *Muhammad* said that the Bible and the *Koran* and *Hadiths* were irreconcilable due to Jews and Christians altering the Bible (K 002:174; 004:046; 005:015, 044).

Still, the syncretization in *Makka* had some similarities to textbook examples of syncretization. Trimmingham notes that Arameans “incorporated Old Testament traditions into the very structure of their mythology.”<sup>2512</sup> This definitely was the case with how the *Koran* and the *Makkan Kaaba* and *Hajj* were *Biblicized*.

Trimingham notes that the Arameans considered Abraham and Ishmael to be cultural heroes, and *Muhammad's* favorite prophet is *Ibrahim*. This compromised form of Aramean Christianity helped lead *Muhammad* to the conclusion that he really was resurrecting the Religion of *Ibrahim* (K 002:130, 135; 003:095).

Besides some Old and New Testament characters, *Muhammad* incorporated Arabian cultural heroes into his narrative. These heroes were transformed into Old Testament-styled prophets including Salih of the *Thamuds* (K 007:073), Aad of the

<sup>2511</sup> CEE, *Khazars* entry.

<sup>2512</sup> Trimmingham. *Arabs*, p. 240.

*Huds* (K 026:123-124), *Shu'aib* of the *Madyans* (K 007:085) and *Zulqarnain* (K 018:089-098).

Trimingham notes that the “exploitation [of the Biblical tradition] was extended to the very bones of the Old Testament patriarchs and prophets.” A well-known *Islamic* tradition says that Ishmael, his mother Hagar, and “a whole series of prophets, numbering hundreds, is said to have been buried round the *Kaaba*.”<sup>2513</sup>

J. S. Trimingham wrote that fabricated personal histories of saints and martyrs were used to reinterpret pagan relics and places of worship. In the case of *Islam*, *Muhammad* said that the *Kaaba* was built by Adam and rebuilt by *Ibrahim* and Ishmael. The three *Jamara* phallic symbols at *Mina* in the environs of *Makka* were said to represent Satan, whom it was said *Ibrahim* stoned. The Black Stone was also reinterpreted. The early *Muslims* told John of Damascus “Abraham had sexual intercourse with Hagar on it [the Black Stone].”<sup>2514</sup>

Trimingham noted that a patron saint might be adopted based on a loose and fictional association between a Biblical personage and the pagan astral temple or shrine. For instance, *Elijah* pilgrimage sites often took over sun worship shrines since the Greek for *Elijah* (*Elias*) sounds similar to the Greek for sun (*Helios*).

*Muhammad* and the *Hanifs* chose *Ibrahim* as their main patron saint of *Makka* because the *Kaaba* was a moon-god shrine. The Bible associated *Ibrahim* and his family with *Haran*, the City of the Moon. The *Haranians* apparently told the caravaneers and pilgrims that *Ibrahim* sacrificed to the moon at *Haran*.<sup>2515</sup> Perhaps the *Haranians* even told *Muhammad* this.

*Haran* was well known to the *Makkans* and Arabs since *Haran* and *Makka* were both caravansaries. In his lament over the Mediterranean seaport of *Tyre*, *Ezekiel* mentions that both the *Haranians* and the *Yemenites* from the kingdom of *Sheba* traded with *Tyre* (Eze 27:21-23). The shrines at *Haran* were well known for millennia, and were important enough for an *Assyrian* conqueror to mention (2Ki 19:12; Isa 37:12).

The rest of this chapter will discuss the various connections between *Haran* and the Arabian Peninsula, and how *Haran* and *Makka* eventually became sister pilgrimage cities featuring *Ibrahmic* pilgrimage sites and moon-god worship.

### How *Islam* Came to Be

*Muhammad* felt his doctrine was related to the monotheism underlying Christianity, Judaism, Zoroastrianism (Magianism) and *Sabeanism*. *Muhammad* however referred to himself as a *Hanif*,<sup>2516</sup> a follower of the Religion of *Ibrahim* (K 002:130, 135; 003:095).

Even though *Islam* was hostile to Christianity, uninformed persons mistook nascent *Islam* for Christianity or *Sabeanism*. For instance, a priest of *Uzza* not far from *Makka* thought *Muslims* were Christian.<sup>2517</sup> *Muhammad* was even called a *Sabean*.<sup>2518</sup>

<sup>2513</sup> Gibb & Kramers. *Encyclopedia*, p. 197, *Kab'ah* entry.

<sup>2514</sup> Sahas. *Heresy*, pp. 88-89.

<sup>2515</sup> *Al Kindy*. *Apology*, p. 17.

<sup>2516</sup> Green. *Moon*, p. 110.

<sup>2517</sup> Ishaq. *Sirat*, “Khalid’s Journey to Destroy *Al 'Uzza*,” p. 565 & fn. 2.

<sup>2518</sup> Ishaq. *Sirat*, p. 205 & fn. 2.

The Christian *Negus* of *Abyssinia* said that *Islam* and “what Jesus brought have come from the same niche.”<sup>2519</sup> The Christian *Negus* may have held to some moon-god religion notions due to the architectural features in the Ethiopian capital that survive to this day:

- ☉ The *Lutu*, the Ethiopian royal family, regularly attended service at...  
...the Central Temple, a massive windowless boxy stone building left over from the days before Christianity. The temple was adorned with bas-relief carvings of traditional moon and sun-gods and certain crude earthenware figures of pagan deities.<sup>2520</sup>
- ☉ The tallest of the pillars of monumental size in *Aksum*, some of which still stand, ‘ended in a crescent-shape, which was the symbol of *Mahram*, the *Abyssinian* god of war.’<sup>2521</sup> The last of the monumental pillars may have been built as late as the fourth century AD before Christianity became the national *Abyssinian* religion.

It is too bad that the *Negus* did not know that *Muhammad* referred to Ethiopians as “raisin heads.”<sup>2522</sup> Also, *Muhammad* identified the pagan Arabian Venus, whom the *Muslim* Khalid supposedly killed with a sword, as *Al Uzza* as “a Black women, entirely naked, with long and wildly flowing hair.”<sup>2523</sup> Furthermore, *Muhammad* interpreted a Black woman in a dream to be a disease carrier, as Bukhari wrote:

The Prophet said ‘I saw (in a dream) a Black woman with unkempt hair going out of *Madina* and settling at *Mahai'a*, i.e. *Al Juhfa*. I interpreted that as a symbol of epidemic of *Madina* being transferred to that place (*Al Juhfa*).’<sup>2524</sup>

*Muhammad* said that those who were saved would have white faces and those who were damned would have black faces (*K* 003:106-107). *Ibn Ishaq* said that *Muhammad* said: “Whoever wants to see Satan, let him take a look at Nabtal b. *Al-Harith*! He was a sturdy Black man...”<sup>2525</sup>

Tellingly, the Arabic word for “Blacks” (*‘abed*) is a derivative of the word “slave” (*‘abd*). *Muslims* mined Africa for slaves for fourteen centuries. *Muslims* have enslaved more Blacks than anyone else by far, and still do enslave Blacks in *Sudan* and elsewhere. In fact, the West got the idea of transporting Black slaves from Africa to the New World from *Islamdom*.

Worse still, *Muhammad* himself owned Black slaves and lived like a Mideast despot, and subjected many slaves to his vile embraces; apparently a couple dozen wives were not a big enough brothel for him. Yet, *Muhammad* engaged in self-pity and considered himself destitute. In fact, Bukhari wrote:

‘Umar *Bin Al Khattab*...went to *Allah’s* Apostle’s residence and behold, he was staying in an upper room of his to which he ascended by a ladder, and a Black slave of *Allah’s* Apostle was (sitting) on the first step...*Allah’s* Apostle smiled while he was lying on a mat...I [*Al Khattab*] replied, ‘Oh *Allah’s* Apostle! Caesar and [the Persian] *Khosrau* are leading the life (i.e. luxurious life) while you, *Allah’s* Apostle though you are, are living in destitution.’ The Prophet

<sup>2519</sup> Ishaq. *Sirat*, p. 152.

<sup>2520</sup> “Africa,” *The Publishing Group*, publishinggroup.org, 10 Jun 2003.

<sup>2521</sup> Creswell. *Architecture*, pp. 2-3.

<sup>2522</sup> *Sahih Bukhari*, vol. 1, bk. 11, nos. 662 & 664, and vol. 9, bk. 89, no. 256.

<sup>2523</sup> Lings. *Sources*, p. 302.

<sup>2524</sup> *Sahih Al Bukhari*, vol. 9, bk. 87, nos. 161 & 162.

<sup>2525</sup> Ishaq. *Sirat*, p. 243.

then replied. ‘Won’t you be satisfied that they [Caesar and Khosrau] enjoy this world and we the Hereafter?’<sup>2526</sup>

Notice how the racist slave owner *Muhammad* bemoaned his own estate rather than the lot of his lowly slaves.

*Muhammad* said that one of his ancestors was compared to a Black man. *Muhammad* said someone once commented after viewing his relative:

Methinks I see a Black man with blubber lips like those of a camel eating bitter herbs...<sup>2527</sup>

Given *Muhammad*’s obvious prejudice, it is not surprising that the *Saudis* are prejudiced too:

Anyone who has visited *Saudi* Arabia knows the racism with which ordinary *Saudis* treats the brown- and Black-skinned masses that come for *Hajj*. Like hundreds of *Bangladeshis* every year, my parents endured these indignities during their recent pilgrimage. When he returned from *Makka*, my father told me, ‘To them, we will always be *Miskeen* (beggar). Doesn’t matter what we do, or where we come from. They see our skin and don’t need to see more.’<sup>2528</sup>

Given all this prejudice, it is not surprising that Africans are turning to the religion of the Jewish carpenter and are rejecting the religion of the violent slave owner.

The *Negus* gave *Muslim* immigrants shelter when they were persecuted<sup>2529</sup> and the example of *Negus* serves as a warning to other nations who do the same. If only the *Negus* could have seen the future, and if only the European Union and Canada especially, could see the future.

Actually, everyone can see the future of their countries just by reading a history book on how nations were *Islamized* and medievalized, and by reading media reports about events in *Israel*, *Chechnya*, *Kashmir*, or any of the 28 out of the world’s 30 conflicts that *Muslims* are involved in at the moment.<sup>2530</sup>

After the rise of *Islam*, *Muslims* took over some Red Sea ports, and then the entire Red Sea coast by the ninth century.<sup>2531</sup> After 975 AD only the highlands of Ethiopia remained Christian.<sup>2532</sup> Eventually, Christian...

...*Nubia* united with Ethiopia but fell to *Muslims* in the 14th century. Much of the region was flooded by the completion of the *Aswan* High Dam in the 1960s.<sup>2533</sup>

To conclude this section, it seems ironic that the Alex Haley’s “fictionalized chronicle,” *Roots* (1976), bemoans how a Black African *Muslim* slave *Kunta Kinte* struggled to remain a *Muslim* in the early American South.<sup>2534</sup> Ayaan Hirsi Ali, a Black woman and former *Muslim* who champions women’s rights, “finds it as unfathomable that African Americans would convert to *Islam* as that Jews would

<sup>2526</sup> *Sahih Bukhari*, vol. 6, bk. 60, no. 435.

<sup>2527</sup> Ishaq. *Sirat*, p. 787, note 896.

<sup>2528</sup> Mohaiemen, Naeem. “Slaves in *Saudi*,” thedailystar.net, v5n61, 27 Jul 2004.

<sup>2529</sup> Ishaq. *Sirat*, p. 152.

<sup>2530</sup> De Borchgrave, Arnaud. “2002 Yearend: Whither radical *Islam*?” upi.com, 8 Dec 2002.

<sup>2531</sup> Nicolle. *Caliphates*, p. 40.

<sup>2532</sup> Nicolle. *Caliphates*, p. 40.

<sup>2533</sup> *Heritage*, *Nubia* entry.

<sup>2534</sup> Answers.com, “Haley, Alex” entry; “Sorry Kids, But Alex Haley’s *Roots* Was A Fraud,” tommcmahon.net, 11 Feb 2004; “Another...,” tompaine.com, 3 Aug 2000.

convert to Nazism,” and she says that a black person “converting to *Islam* is like converting voluntarily to slavery.”<sup>2535</sup>

Not only were *Muslims* the worst and cruelest Black slavers of all time, but many *Muslims* are unapologetic about the past, and would be slavers if given the chance to follow *Muhammad*’s example. In fact, many *Muslims* still are slavers. “*Muslim Hausas, Fulanis, Arabs, Libyans and Somalis*” are slaveholders in these modern times.<sup>2536</sup> There is also “a ‘slavery triangle’ that stretches from the southern town of *Maradi* in Niger to *Kano* in Nigeria. The girls are sold on markets for between *R4000* and *R5000*,” (about 30-39 USD).<sup>2537</sup> Furthermore, it is known that many “employees” of *Muslims*, from housemaids to camel jockeys, are treated as virtual slaves, not to mention *Muslim* wives who can be beaten by their husbands (*K* 004:034).

Some *Muslim* slave “masters,” such as in Sudan, are unapologetic about torturing and killing slaves since this is all perfectly legal under *Sharia* law—as long as the masters have some pretext for do so. Even now, it is not unheard of for a *Sudanese* slave to be beaten, crucified and then splashed with skin-eating acid.<sup>2538</sup>

Back in Africa, *Kunta Kinte* and his *Muslim* family, as “good” *Muslims*, would have tried to be slave owners and slavers themselves. They would have promoted and defended *Jihad* and *Sharia* law, as well as the practice of slavery and all it entails. They would have viewed non-*Muslims* as “enemies” (*K* 002:098; 008:060; 009:114; 041:019, 028), as “unclean” (*K* 009:028), as “vile animals” (*K* 008:022, 055) and as cattle (*K* 007:179), and then treated non-*Muslims* accordingly.

*Kunta Kinte*’s *Muslim* tribe would have been unabashed about their many masters having sex with slave girls and even boys since such practices were squarely based on the *Koran*, traditions and *Sharia* law (*K* 002:178; 004:092; 012:030; 016:075; 024:032; 024:033; 039:029).

The Christian West forced an end to Black slavery both in the Americas and Africa but also in *Islamdom*. In the last century missionaries in Africa have paid *Muslims* to free many Africans from slavery. All this is because while slavery ultimately proves to be incompatible with the principles of Christianity as set forth in the New Testament, slaving and enslaving are promoted and defended in the *Koran*.

Even though *Kunta Kinte* was exposed only to the worst of Western family values, this led him to treat his family better than he would have if he had stayed a *Muslim* in Africa, for there one reads of families...

- ☉ Force-feeding daughters until they are grossly obese—as is commonly done in *Mauritania* and in much of *Muslim* Africa and the Middle East.<sup>2539</sup> Incidentally, *Mauritania* is not far from *The Gambia* where *Kunta Kinte* was said to have lived.
- ☉ Beating children at age ten to make them pray five times per day per *Muhammad*’s command.<sup>2540</sup>
- ☉ Caging his own kids for a year, or even years, while they memorized the *Koran* (as is discussed next).

<sup>2535</sup> Romano, Carlin. “Freedom fighter,” *Philadelphia Inquirer*, phillynews.com, 1 Jun 2006, *JW*.

<sup>2536</sup> Richardson. *Secrets*, p. 207.

<sup>2537</sup> Louw, Liesl. “Slavery lives on,” news24.com, 2 Sep 2004, *DW*, 8 Sep 2004.

<sup>2538</sup> “Sudan slave ‘crucified’ by master: but Christian teen rescued, redeemed...” *WND*, 7Apr 2004.

<sup>2539</sup> “Weblog: The Middle East Explodes with Obesity,” *DP*, 29 Dec 2004.

<sup>2540</sup> *Sunan Abu Dawud*, bk. 2, nos. 494, 495.

*Ibn Battuta* traveled to *Mali*, West Africa, and arrived in 1352 and stayed until 1353 AD. *Kunta Kinte* was said to have lived from 1750 to 1767 AD in *The Gambia*, West Africa, which is not far west of *Mali*. *Ibn Battuta* reported:

They put their children in chains if they show any backwardness in memorizing it, and they are not set free until they have it by heart. I visited the *Qadi* in his house on the day of the festival. His children were chained up, so I said to him, 'Will you not let them loose?' He replied, 'I shall not do so until they learn the *Koran* by heart.'<sup>2541</sup>

Just in 2003, eleven teenagers from *Kenya*, the UK, Sweden and Ethiopia had to be saved from similar torture in *Kenya*, as the *BBC* reported:

They were kept in chains and secured by padlocks in small rooms with little ventilation or light in *Eastleigh*, a *Nairobi* suburb...the children narrated their ordeal at the hands of *Islamic* teachers bent on turning them into good *Muslims*...*Ahmed* from *Leicester* in the UK, says he spent eight months at the centre: 'It was a terrible place, they chain both legs and both arms, sometimes hands and feet together,' he said. 'They beat you at lunch time, dinner time and grab both legs and hands and give you lashes on the buttocks.' Fellow student *Abdikalik*...from *Eldoret* in western *Kenya* talked of four months of torture and beatings: 'We sleep in chains, eat in chains, go to the toilets in chains. Sometimes we are hooked on the roof in chains and left hanging. We have to memorize the *Koran* and get punished if we cannot recite the *Koran* in the classroom...*Ahmed*: 'It was a terrible place. Our food was tea and bread in the morning, plain rice for lunch and rice and sugar for dinner,' he said.'<sup>2542</sup>

### The City of *Haran*

The *Hanifs* originated in *Haran*. *Haran* was a moon-god center for upwards of two millennia before *Muhammad*'s time. *Haran* retained its reputation as the City of the moon even centuries after the *Muslim* invasion. *Haran* was finally abandoned in the face of *Mongol* invasions in the late medieval period, as *Sinasi Gunduz* wrote:

It [*Haran*] was also called *Hellenopolis*, [the negative connotation being] 'the heathen city,' by the Fathers of the Church because of the pagan religion of its inhabitants. As a matter of fact pagan religion among the *Haranians* survived in its Christian and *Muslim* environment until *Haran* and the last pagan sanctuary were destroyed by the *Mongols*.<sup>2543</sup>

There is a record of *Haran*'s Abrahamic pilgrimage sites in Byzantine times, as well as sites dedicated to Jacob and Rachel. *Haran* may have had Abrahamic sites that catered to Jewish interests as far back as *Nabonidus*' time. The pilgrim *Egeria* reports that in 386 AD, a Christian bishop interpreted the sites for Christians, but there were few if any Christians living in *Haran*. *Lester Ness* wrote:

In the Acts of the Council of Chalcedon, 449 CE, the bishop of *Haran*, *Daniel*, was listed as 'bishop of a pagan city.'

<sup>2541</sup> *Ibn Battuta*, *Travels in Asia and Africa 1325-1354*, translated and edited by H. A. R. Gibb, Broadway House, London, 1929, pp. 323-335, online at the *Medieval Sourcebook: Ibn Battuta: Travels in Asia and Africa, 1325-1354 AD*, fordham.edu.

<sup>2542</sup> *Phombeah*, Gray. "Students freed from Kenyan 'torture,'" news.bbc.co.uk, 28 Jan 2003.

<sup>2543</sup> *Gunduz. Life*, p. 127.



In 549 CE, the Persian King Khusrau I invaded Syria and extorted ransom from many cities. But he refused to take a ransom from *Haran*, not out of friendliness, but because he did not wish to touch the money of polytheists.<sup>2544</sup>

So for centuries before and after Egeria's pilgrimage, there were few Christians in *Haran*. Pagans made the pilgrimage to sacrifice mostly to the moon but also to Venus and other gods.

Pagan camel drivers using the caravansary facilities would naturally find out about Abraham through the pagans, especially when they visited pagan temples dedicated to the moon-god but named after *Ibrahim* and his father.

Because of the concentration of pagans at *Makka*, the interpretive tours of *Haran* that *Muhammad* would hear about through the grapevine were those given by pagans for pagans.

Arabic was spoken in *Haran* as is evidenced by a pre-Islamic Arabic and Greek bilingual inscription found in *Haran*. The inscription is in *Kufic* Arabic script and is a dedication for a martyrrium that was consecrated to John the Baptist in 568 AD.<sup>2545</sup>

*Haran* was a caravansary crossroads throughout its long history, so it had contacts throughout the entire Mideast and especially with Arabia. History relates that northwest Arabia was especially connected to *Haran* and *Ur* during the reign of *Nabonidus*.

Jewish literature about *Nabonidus* suggests that he was convinced of monotheism or more probably, henotheism (i.e. monolatry). It is interesting that henotheistic threads show up in the histories of both *Haran* and *Nabonidus*, and these threads are interwoven with the religious fabric of Arabia.

*Muhammad* went on camel caravans and may have toured *Haran* at some point. *Muhammad* may have heard of *Haran* indirectly through the "Religion of *Ibrahim*" pilgrims who had toured *Haran*. These *Hanifs* would have told others of the *Haranian* notion that *Ibrahim* was a moon-god worshipper but added that *Ibrahim* was a moon-god monotheist rather than a henotheist.

*Islamic* sources relate that there was a temple in *Haran* dedicated to *Terah* (*Azar*), *Ibrahim*'s father. Perhaps this temple formed the basis for the *Koranic* story where *Ibrahim* confronts his father and the *Haranians* concerning their idol worship (*K* 006:074).

*Muslim* scholars report that the *Haranians* represented Adam as a moon-god prophet. The *Haranians* said that *Ibrahim* was a confirmed moon-god worshipper who even sacrificed to Saturn. *Islamic* sources also relate that there was a monotheistic sect in *Haran* that held that all the gods were one. Notably, the *Makkans* accused *Muhammad* of teaching the same thing. All these points will be discussed later in this chapter.

The upshot of all this information is that there likely was a nexus between *Muhammad*, *Makka*, the Religion of *Ibrahim* adherents and *Haran*. The most tenuous connection between *Makka* and *Haran* would be that *Muhammad* and his Religion of *Ibrahim* friends and relatives heard the Biblical account of Abraham and *Haran*, and then heard reports about *Haran* "the City of the Moon."

Since *Makka* had long been *Allah*'s moon-god shrine, in keeping with the practice of the day, the *Hanifs* adopted *Ibrahim* as the patron saint of *Makka*. Later,

<sup>2544</sup> Ness. *Mosaics*, p. 114.

<sup>2545</sup> Warraq. *What*, p. 772.

*Muhammad* accepted the *Hanif* tradition, expanded upon it greatly, and gave the Religion of *Ibrahim* both a scripture—the *Koran*, and a prophet—himself.

F. E. Peters wrote that the *Hanifs* venerated the *Kaaba* in pre-*Islamic* times:

...doubtless as the Holy House built by Abraham...allusions and traditions add to the certainty that the *Hanifs* conducted their rituals at the *Kaaba* at *Makka*.<sup>2546</sup>

F. E. Peters says the Standing Place of *Ibrahim* (K 002:125; 003:097) was a notable pre-*Islamic* feature of the *Kaaba*.<sup>2547</sup> The *Hanifs* probably were the ones who carved the footprints that mark the Standing Place of *Ibrahim*. In fact, *Ibn Ishaq* quotes a poem from *Muhammad*'s time that suggests the carvings were recent:

By Abraham's footprint in the rock still fresh, with both feet bare, without sandals.<sup>2548</sup>

The *Hanifs* also sacrificed at the *Kaaba* during pre-*Islamic* times, as stated in this excerpt of a *Hanif* poem:

We lead the sacrificial animals walking obediently in iron, their shoulders exposed under the clothes.<sup>2549</sup>

*Muhammad* figured that since *Ibrahim* was the wellspring of Judaism, Christianity and the Religion of *Ibrahim*, *Ibrahim* was near the ancient source of all the major religions around him, including the astral religions. The assumption that *Ibrahim* represented a pristine monotheistic moon religion was the start of *Muhammad*'s syncretizing all the major religions around him. Sinasi Gunduz wrote:

...according to the *Quran*, every community from Adam to the prophet *Muhammad*, adhered to the true religion, i.e. *Islam*, before the people changed the religion with polytheism. Consequently God sent to them the prophets with the true religion, *Islam*, in order to establish monotheism again (K 007:59-93; 021:51-93).<sup>2550</sup>

*Muhammad*'s syncretism was based on the lowest common denominator between the religions—their use of the moon symbol. Obviously, *Muhammad*'s sub-literacy aided the syncretistic process by greatly reducing the number of sticky details that had to be harmonized.

The conclusion that most religions had fallen from moon-god monotheism was deceptively simple to make because the crescent and sun, or crescent and Venus couplet, was a common symbol, especially on coins. These symbols gave the impression that each religion really only took three gods seriously: the sun, moon and Venus.

That most pagans only thought of a triad of gods as being important is logical since it is hard to love even two masters (Luk 16:13). Many pagans had their favorite triad, and the rest of the gods were considered to be both aloof and distant or of minor importance.

*Muhammad* concluded that he could reform the major religions merely by eliminating Venus and sun worship, while leaving the moon worship intact. The other astral gods were changed into male angels, and the earthly gods were changed into demons and *Jinn*.

<sup>2546</sup> Peters. *Origins*, p. 124.

<sup>2547</sup> Peters. *Origins*, p. 165.

<sup>2548</sup> Ishaq. *Sirat*, p. 123.

<sup>2549</sup> Ishaq. *Sirat*, p. 201, as quoted by Peters. *Origins*, p. 124.

<sup>2550</sup> Gunduz. *Life*, p. 44.

*Muhammad* concluded that all the major religions that he knew of started out worshipping the moon-god *Allah*—by different names, of course. Each religion fell into polytheism (*Shirk*) in the distant past and needed to be reformed.

*Muhammad's* plan was to reform these fallen religions by giving the Religion of *Ibrahim* a scripture (the *Koran*), a prophet (himself) and a mission (to conquer all other religions).

### The Religion of *Ibrahim* Began in *Haran*

*Islamic* tradition and the *Koran* mention that *Ibrahim* was a *Hanif*, and that there was a Religion of *Ibrahim*:

They say: ‘Be Jews or Christians, you will be on the right course.’ Say: ‘Nay! We follow the Religion of Abraham, the *Hanif*, and he was not one of the polytheists’ (K 002:135; see also K 003:067, 095; 004:125; 016:123; 022:078).

Tamara Green wrote how the *Haranians* were called *Hanifs* from the earliest *Islamic* times:

Although the connection is not made in the *Quran*, the association of the patriarch with the City of the Moon-god had been established by *Muslims* as early as the seventh century by *Ibn Al 'Abbas*, cousin of the prophet and collector of *Hadith* (died 687 CE), and *Ka'b Al Ahbar*, a Jewish convert to *Islam* and scholar at the court of *Mu'awiyah* (died 652 CE?).<sup>2551</sup>

*Ibn Hazm* (died 1063 AD) maintained that the religion of the *Haranians*, then, was identical with the Religion of Abraham as restored by *Muhammad*, except that they had reintroduced the worship of the stars and idols, a practice which Abraham had attempted in vain to abolish. This account, according to *Margoliouth*, would explain *Muhammad's* calling himself a *Hanif*, and why he was called *Sabi'* [Sabian/*Sabean*] by his enemies, and would imply of course that the name *Sabi'ah* was applied to the *Haranians* before the visit of *Ma'mun*.<sup>2552</sup>

*Biruni* (973-1048 CE) in his *Chronology of Nations* describes the *Sabians* in the following way, as Tamara Green notes:

The name is also applied to the *Haranians*...Although they themselves did not adopt this name before A.H. 228 [842 AD] in order to be considered ‘among those from whom the duty [*Jizya* poll tax] of *Dhimma* [*Dhimmis*] are accepted, they are better known by this name than the true *Sabians*. But before this time they were called *Hanifs*, idolaters and *Haranians*’ (*Biruni, Chronology*, [pp.] 318-319).<sup>2553</sup>

In later *Islamic* centuries, there was some confusion as to whether the *Haranians* were *Hanifs* or *Sabeans* or neither. *Biruni's* assessment noted just above is correct. Confusion crept in mainly because there were competing claims for the label “*Sabean*.” Under *Islamic* rule, the coveted label of *Sabean* conferred special rights and protections to a favored minority.

Today, there is confusion over who the *Hanifs* and *Sabeans* were. The reason is that *acaDhimmis* have searched down through history looking for groups that fit their arbitrary, idealistic and anachronistic vision of who the *Hanifs* and *Sabeans* were. Reasons that there is a debate at all include:

<sup>2551</sup> Green. *Moon*, p. 12.

<sup>2552</sup> Green. *Moon*, p. 107.

<sup>2553</sup> Green. *Moon*, p. 116.

- ⊕ Academics give short shift to the Bible's accounts of Abraham in *Haran* and the Bible's account of the Queen of *Sheba*. In other words, the academics do not take most of the available source material seriously.
- ⊕ Time and pious *Muslims* have not preserved, but have destroyed many archeological artifacts and writings from paganism.

### Reconstructing the Reasons Why *Muslim* Scholars Thought The Religion of *Ibrahim* Began in *Haran*

*Muhammad* apparently assumed that the Religion of *Ibrahim* began in Mesopotamia. This can be inferred from his mentions of *Ibrahim* together with *Ibrahim's* father, *Terah* (Arabic: *Azar*) (K 006:074). Abraham did not leave Mesopotamia for the Promised Land or Egypt until after his father *Terah* died in *Haran* (Gen 11:32—12:01; Jos 24:02).

*Muhammad* might have had *Ur* in Mesopotamia in mind, except for the fact that the Biblical *Ur* was all but forgotten by *Muhammad's* time. The *Encyclopedia Britannica* states:

It was perhaps at this time [317 BC] that the *Euphrates* changed its course; and with the breakdown of the whole irrigation system, *Ur*, its fields reduced to desert, was finally abandoned.<sup>2554</sup>

By the logical process of elimination, one can assume that *Muhammad* placed *Ibrahim* and his father *Terah*, in the environs of *Haran*. *Haran* was a caravansary and a center of moon worship, as the *Encyclopedia Britannica* notes:

Like its predecessor, the Persian Royal Road began at *Susa*, wound northwestward to *Arbela*, and thence proceeded westward through *Nineveh* to *Haran*, a major road junction and caravan center.<sup>2555</sup>

*Haran* had declined in importance by *Muhammad's* time, as Tamara Green notes...

...raids on the caravans made the crossing of the plain of *Haran* an increasingly dangerous business; as a consequence, caravan routes had shifted to the north of the city, and *Haran* became merely a town on the frontier that 'divides Romans from *Assyrians*.'<sup>2556</sup>

Significantly, both *Haran* and *Makka* are located in near barren deserts. By *Muhammad's* time, both *Haran* and *Makka* were moon-god centers some ways off the main caravan routes.

Ironically, both *Haran* and *Makka* became more important than ever to the pagans. As Christianity prospered, there were fewer and fewer pagan pilgrimage sites and temples to cater to the many remaining pagans. *Haran* and *Makka* were able to preserve their pagan heritage because they were located in cultural backwaters.

Notably, there were Ibrahimic pilgrimage sites in *Haran* that existed since the Christian era, if not long before. This Ibrahimic cult surely could not have escaped the attention of the camel caravans that commonly sported crescent decorations (Jdg 08:21, 26). *Haran* had something to interest all the camel drivers whether they were Christians, Jews, pagans or Religion of *Ibrahim* adherents.

So it seems inconceivable that *Muhammad* and his comrades would not know of *Haran*, especially since *Haran* is mentioned in the Bible, and the Religion of *Ibrahim*

<sup>2554</sup> *EB*, accessed 15 Mar 2003, *Ur* entry.

<sup>2555</sup> *EB*, accessed 10 Feb 2003, "roads and highways" entry.

<sup>2556</sup> Green. *Moon*, pp. 52-52.

adherents who traveled the Mideast sacrificed at the *Kaaba* at *Makka*. How could *Muhammad* say he wanted to restore the Religion of *Ibrahim* to its former glory and purity and not know all about *Haran*?

Significantly, there is a tradition where a Religion of *Ibrahim* adherent traveled to *Mosul* in the Fertile Crescent. *Mosul* is not very far from *Haran*:

The outcast [from *Makka*] thereupon left the *Hijaz* and went as far as *Mosul* in the north of *Iraq* and from there southwest into Syria, always questioning monks and *Rabbis* about the Religion of Abraham...<sup>2557</sup>

In his quest for the pure Religion of *Ibrahim*, he probably visited his fellow adherents in the environs of *Haran* on his way to *Mosul*, that is, if he had not visited *Haran* several times before while on caravan trips.

Since the *Makkans* were running a cult shrine longer than anyone at *Makka* could remember, they likely were curious about entertainments provided at other moon-god shrines. The moon-god shrines surely copied each other based on the reports of pilgrims, travelers and traders.

*Makka* was remote but not THAT remote. Peters provides a map that says Damascus was a thirty-day journey from *Madina*, and *Kufa*, nearby *Baghdad*, was a twenty-seven day journey from *Makka*.<sup>2558</sup> So another week or two's journey from Damascus or *Baghdad* would put the caravan in sight of *Haran*.

Nevertheless, aca*Dhimmis* have taken the skeptical view that *Muhammad* knew nothing of *Haran*, as Carl Brockelmann wrote:

He can scarcely have known anything of the *Haranians* in Mesopotamia, who likewise had a March fast [similar to *Ramadan*] in honor of the moon.<sup>2559</sup>

Tamara Green wrote about the pilgrimage sites at *Haran*:

...at *Haran* was the monastery of Abraham, where the stone that Jacob had rolled from the top of the well at which he first met his cousin Rachel was venerated.<sup>2560</sup>

Trimingham wrote about the Abrahamic pilgrimage sites at *Haran*:

She [Egeria] visited the various sites associated with Abraham in *Haran*, then called *Carrhae*. Christian fostering of the Abraham cult may be associated with the fact that pagan cults were especially deeply rooted in this city. None of its citizens had become Christians, though a church had been built there...Egeria says that on her arrival at *Carrhae* she 'went straight to visit the church inside the city and was soon seeing the bishop of the place. He was a very godly man, and he was both monk and confessor. He readily agreed to show me all the places I wanted to see.' These included a church built on the site of Abraham's house. Rebecca's well, and a well where Jacob watered Rachel's animals. But she confirms that 'absolutely no Christians live in this city, apart from a few clergy, and any holy monks who happened to be living there. The whole city is heathen.' And it remained heathen until [well] after the *Muslim* conquest.<sup>2561</sup>

*Muslim* scholars note that there was a cult of *Ibrahim* at *Haran* even in *Islamic* times, as Sinasi Gunduz wrote:

<sup>2557</sup> Lings. *Sources*, p. 73.

<sup>2558</sup> Peters. *Hajj*, p. xxv.

<sup>2559</sup> Brockelmann. *Peoples*, p. 22.

<sup>2560</sup> Green. *Moon*, p. 55.

<sup>2561</sup> Trimingham. *Arabs*, pp. 241-242.

According to his [‘*Ibn Hazm’s* (994-1063 AD)] statement there were still some people in *Haran* who claimed that they were adherents of the religion of the prophet Abraham.<sup>2562</sup>

The Abrahamic cult at *Haran* likely existed in pre-*Islamic* times, perhaps going back to the time of *Nabonidus*. The Abrahamic cult at *Haran* probably was intimately connected to the Religion of *Ibrahim* adherents, the *Hanifs*, mentioned in the *Koran* (*K* 002:135).

One can assume that the “Religion of *Ibrahim*” had been around at least since the time Josephus wrote at the end of the first century AD. F. E. Peters wrote:

That the pre-*Islamic* Arabs circumcised their young was well-known, though not on the eighth day like the Jews; and Josephus was confident he knew where they had gotten the custom: the Arabs ‘circumcise after the thirteenth year because Ishmael, the founder of their nation, who was born to Abraham of the concubine (Hagar), was circumcised at that age’ (Josephus, *Antiquities of the Jews*, bk. 1, ch. 12, para. 2).

Josephus was not telling his readers something of which they were unaware: that the Arabs were descended from the Biblical Ishmael and had lapsed from their original faith into forms of idolatry was commonplace in the history of both the post-Exilic Jews and the Christians (*Jubilees* 20:11-13; *Babylonian Talmud Sanhedrin* 91a).<sup>2563</sup>

F. E. Peters also mentions the fourth-century AD historian Sozomen:

This tribe (of *Saracens*) takes its origins from Ishmael the son of Abraham and had that appellation as well: the ancients called them Ishmaelites from their ancestry. And avoiding the charge of bastardy and the low birth of the mother of Ishmael, they called themselves ‘*Saracens*’ as if descended from Abraham’s wife Sarah. Possessing this kind of descent, all of them are circumcised like the Hebrews and abstain from the flesh of swine and observe among themselves many of the latter’s customs. Nor should one think that they have always lived in the same manner, whether by reason of the passage of time or by their intercourse with the surrounding peoples....Afterward some of them became acquainted with the Jews and learned whence they had come. They reverted back to their ancestry and took up the Hebrew customs and laws. From that time many among them still live in the Jewish fashion (Sozomen, *Church History* VI, 38, 1-13).<sup>2564</sup>

Sozomen, then, writing in southern Palestine no more than a century and a half before *Muhammad*, knew that the Arabs were Abrahamites in their ancestry and that ‘many among them still live in the Jewish fashion.’ It [southern Palestine] is not the *Hijaz* but it is very close.<sup>2565</sup>

In *Islamic* times the *Haranians* said that Adam was a moon-god prophet, as Sinasi Gunduz wrote:

They [*Haranians*] deem Adam to have been an individual born of male and female like other human individuals, but they glorify him and say that he was a prophet, the envoy of the moon, who called people to worship the moon...<sup>2566</sup>

<sup>2562</sup> Gunduz. *Life*, p. 44.

<sup>2563</sup> Peters. *Origins*, p. 120.

<sup>2564</sup> Peters. *Origins*, pp. 120-121.

<sup>2565</sup> Peters. *Origins*, p. 121.

<sup>2566</sup> Gunduz. *Life*, p. 162.

Information the *Haranians* gave during *Islamic* times is probably indicative of what information the *Haranians* disseminated during pre-*Islamic* times.

The *Haranians* probably reminded the pilgrims that people in Abraham's family such as *Jerah*, *Terah* and *Haran* all had theophoric moon-god names, as was noted in a previous chapter. The *Haranians* probably dispensed other fatuous "Yahveh was a moon-god" information too—as will be discussed shortly.

If *Muhammad* or the Religion of Abraham sect's members visited *Haran*, they would naturally seek out the pagans while studiously avoiding Christians. One can see that if *Muhammad* received his information about *Ibrahim* from the pre-*Islamic* pagans at *Haran*, *Muhammad* would have been informed that *Ibrahim* worshipped the moon-god.

### What the *Haranians* Thought of Christianity and Islam

The pagan *Haranians* examined the doctrinal differences between Jews, Christians and *Muslims*, especially as those practices affected *Haranians*. The *Haranians* noticed that Jesus said "Love your enemies" (Mat 05:43), while *Muhammad* taught *Muslims* to be kind to *Muslims* and harsh to non-*Muslims* (K 009:073, 123; 048:029; 066:009).

The *Haranians* also noticed that *Muslims* imposed an onerous poll tax (*Jizya*) on pain of death or the enslavement of adults and children. Over the centuries the taxation became ever more confiscatory as there were fewer and fewer non-*Muslims* to tax. The *Haranians* felt as though they were mired in quicksand and were sinking deeper—that is until the *Mongols* dealt a deathblow to *Haran* in the twelfth century.

The *Haranians* did provide *Muslim* culture with scholars and scientists. The *Haranians* would be chagrined—just as Christians are—that modern *Muslims* pride themselves about their medieval science and how Classical Greek writings were preserved in Arabic. Many of the scientists and most of the Greek-to-Arabic translators were not *Muslim*.

Besides, science would have progressed and the Greek writings would have survived just fine if *Muslims* had not savaged and ruined the Greek Byzantine Empire and made everyone speak Arabic. Zwemer quoted Renan in this regard:

Science and philosophy flourished on *Mussulman* soil during the first half of the middle ages; but it was not by reason of *Islam*, it was in spite of *Islam*. Not a *Mussulman* philosopher or scholar escaped persecution. During the period just specified persecution is less powerful than the instinct of free enquiry, and the rationalistic tradition is kept alive; then intolerance and fanaticism win the day. It is true that the Christian Church also cast great difficulties in the way of science in the middle ages; but she did not strangle it outright, as did the *Mussulman* theology. To give *Islam* the credit of Averroes and of so many other illustrious thinkers, who passed half their life in prison, in forced hiding, in disgrace, whose books were burned and whose writings almost suppressed by theological authority, is as if one were to ascribe to the Inquisition the discoveries of Galileo and a whole scientific development which it was not able to prevent.<sup>2567</sup>

The practice of having Christians, along with an endless supply of slaves, do all the work while *Muslims* taking the credit seems to have started in 605 BC. That is

<sup>2567</sup> Zwemer. *Essay*, Ch. 5: "The Relation of *Allah* to His World," pp. 74-75.

when a *Copt* carpenter helped rebuild the *Kaaba*,<sup>2568</sup> but one only hears about how *Muhammad* refereed (coached) the placement of the Black Stone.

Later, a portion of seven years' worth of taxes on Egypt paid for the construction of the Dome of the Rock (691 AD). The vast majority of Egyptians at the time were Christian and most of the artisans who worked on the Dome of the Rock were Christian. Yet, all the credit for the Dome of the Rock goes to *Muslims*.

Someone had to support *Muslims*' insatiable desires for polygyny, *Harems* and continual *Jihad* warfare. Someone had to pay the bills so *Muslims* could perform ablutions and *Salat* to *Allah* five times per day and still carry on in heated bathhouses while leisurely smoking hashish through water-pipes.

If it were not for Christians, the *Muslim* culture would have at all times been primitive and poor. Not only are the religious requirements of being a *Muslim* onerous, but widespread *polygyny* nearly always leads to poverty—at least among subsequent generations,<sup>2569</sup> unless of course there are a lot of *Dhimmis* to overtax.

*Islam* however ran into problems when the majority of the population became *Muslim*. This put a crimp in the *Muslims*' ability to enjoy a leisurely lifestyle at the expense of others. The solution that preserved their lifestyle was to buy infidels from *Viking* raiders, to abduct infidels on the high seas and from Africa, Europe, India and coastal towns as far away as Britain, Ireland and even Iceland.

Between 1609 and 1616, 466 English trading ships were seized and their crews forced into slavery. In 1625 the mayor of Plymouth estimated that more than a thousand townsfolk had been kidnapped.<sup>2570</sup> Olufur Eigilsson, an Icelandic Lutheran pastor and his village was raided by Barbary Corsairs in 1627 AD.<sup>2571</sup>

Rory Carroll, reporting on Robert C. Davis' book *Christian Slaves, Muslim Masters* (2003), wrote that *Muslim* North African pirates kidnapped and enslaved one million Europeans between 1530 and 1780 AD. They were used as common laborers and concubines, and as Turkish *Sultan* galley slaves who often "rowed for decades without ever setting foot on shore."<sup>2572</sup> In the naval Battle of *Lepanto* in 1571 AD, Christians managed to free ten thousand Christian galley slaves even though many no doubt went down with their frigates.<sup>2573</sup> Robert Davis wrote:

The widespread depopulation of coastal areas from *Malaga* to Venice, the impoverishment caused by the kidnapping of many breadwinners, the millions paid by the already poor inhabitants of villages and towns to get their own people back—all this is only just beginning to be understood by modern-day historians.<sup>2574</sup>

Between 1574 and 1681 AD, *Islam* enslaved three million Hungarian Catholics. They were "shipped off to garnish the *bagios* and *seraglios* of their masters in

<sup>2568</sup> Lings. *Sources*, p. 41.

<sup>2569</sup> Riley, N. Schaefer. "Harem, Scare 'Em: Worrying about polygamy," *WSJ.com*, 6 Jan 2006.

<sup>2570</sup> Milton, Giles. White Gold, as quoted in the *Times Literary Supplement*, in turn quoted by Fitzgerald, Hugh. "Islam for Infidels, Part Two," *JW*, 21 Jan 2005.

<sup>2571</sup> Lewis, Bernard. "Race and Slavery in the Middle East," Oxford Univ Press, 1994, ch. 1: "Slavery" (online).

<sup>2572</sup> Carroll, Rory. "New book reopens old arguments about slave raids on Europe," *The Guardian*, guardian.co.uk, 11 Mar 2004 (*JW*, 12 Mar 2004).

<sup>2573</sup> "Battle of *Lepanto*" entry, answers.com, accessed 23 Mar 2005.

<sup>2574</sup> Davis, Robert. "British Slaves on the Barbary Coast," bbc.co.uk, 21 Dec 2004.



*Istanbul*, all over the Balkans and the *Ottoman Empire*, all the way to Egypt and the *Euphrates*.<sup>2575</sup> Slaves were even used to man the armies, as Serge Trofkovic wrote:

The ‘blood levy’ [*Devshirme*] was the most hated of all taxes by far, and it necessitated deliberate mutilation of many healthy Christian boys by their parents to render them safe from capture. The practices left a deep scar on the collective memory of the Balkan Christians, notably *Serbs* and *Bulgarians*, and contributed to their thorough loathing of all things Turkish that persists to this day. And yet contemporary Turkish propagandists present the tragedy of the kidnapped boys and their families as the *Ottoman* equivalent of a full scholarship to Harvard or Yale: ‘From the poor families’ point of view, it was a great chance for their sons to be offered a high level of education, especially in the palace which would provide good future prospects.<sup>2576</sup>

Notably, a *Janissary-Devshirme*-like system continued in southern Arabia until 2005 and undoubtedly would have continued if it were not for international pressure. The AFP news service reported that the United Arab Emirates (UAE)...

...will become the second Gulf Arab state, after *Qatar*, to use robots and ban child jockeys following criticism that infants, some as young as four, were being brought in from poor countries to race the camels...The UAE had in principle already banned the use of children under 15 [only] since 1993 but abuses remain widespread and no one has ever been brought to justice. The US State Department and human rights groups say children are exploited by traffickers who pay their impoverished parents a paltry sum or simply kidnap their victims. The children, mostly from *Bangladesh*, *Sri Lanka* and *Pakistan*, are then smuggled into the Gulf states. They are often starved by employers to keep them light and increase their racing potential. Mounting camels three times their height, the children face the risk of being thrown off and trampled.<sup>2577</sup>

*CNN* reported that in 2005 there were “about 40,000 boy jockeys.”<sup>2578</sup>

All this past and present chattel slavery has never caused the slightest twinge of conscience for many *Muslims* since the *Koran* and *Muhammad* condone slavery. The *Sufi* Martin Lings wrote that *Muhammad* told an apprentice...

...if ye keep safe and live yet a little while, ye shall have abundance of provisions and leave abundantly for your families. Ye shall abound in *Dirham* [money] and in slaves...<sup>2579</sup>

A *Muslim* abolitionist akin to Christian Abolitionists surely would have been stoned for blasphemy and false doctrine. Paul Fregosi wrote:

For *Muslims*, slavery was divinely ordained since it has the sanction of the *Koran* and of the *Hadith*. For many *Muslims* there was and is nothing reprehensible about it. Even today it is still practiced in a number of *Muslim* lands [as in Arabia<sup>2580</sup>]. *Muhammad* himself by his example showed that he was in favor of slavery. He refused to set at liberty four of the six slaves who has

<sup>2575</sup> Fregosi. *Jihad*, p. 329.

<sup>2576</sup> Yenen, Serif. *Turkish Odyssey*, Part 3: *Turkish Period*, 23 Jan 1998, *Turkish odyssey.com/turkey/history/history3.htm*, as quoted in Trifkovic. *Sword*, p. 116.

<sup>2577</sup> “Robots will replace child camel jockeys in UAE,” news.yahoo.com, 11 Apr 2005, natashatynes.org, 13 Apr 2005.

<sup>2578</sup> “*Qatar* to replace camel riders with robots,” cnn.com, 20 Apr 2005.

<sup>2579</sup> Lings. *Sources*, p. 264.

<sup>2580</sup> Fregosi. *Jihad*, p. 185.

been freed by his disciple Imran *Ibn Al Husain* at his death (*Mishkat*, book xiii, chapter xx) ‘and he spoke severely of the man who had set them free.’

In his *Dictionary of Islam* Thomas Patrick Hughes rather forcefully insists that ‘Slavery is in complete harmony with the spirit of *Islam*, while it is abhorrent to that of Christianity.’ The *Koran* allows a master all the rights he wants over his slaves. It even allows him (in *Sura* iv. 28 [K 004:028]) to commit adultery with a married woman if she is a slave, a toleration hardly in harmony with more straitlaced Christian doctrine...<sup>2581</sup>

### Some *Haranian Propaganda Dispensed During Islamic Times*

*Al Biruni* quotes ‘*Ibn Sankila* concerning the *Haranians*’ claim about *Ibrahim* during *Islamic* times:

Abraham left their community [not on account of polytheism but] simply because leprosy appeared on his foreskin, and that everyone who suffered from this disease was considered impure and excluded from all society. Therefore he cut off his foreskin, i.e. he circumcised himself. In this state he entered one of their idol-temples, when he heard a voice speaking to him, ‘O Abraham, you went away from us with one sin and you returned to us with two sins [leprosy and circumcision]. Go away and do not again come to us.’ Thereupon Abraham, seized by wrath, broke the idols in pieces and left their community. After this Abraham repented and wished to sacrifice to the planet Saturn.<sup>2582</sup>

The *Haranians* mentioned Saturn in connection with *Ibrahim* and *Muhammad*, and some traditions associate the *Kaaba* with Saturn worship.<sup>2583</sup> In the stories of *Muhammad*’s Night Journey and Ascent, *Ibrahim* is associated with the Seventh Heaven, which is itself associated with Saturn.<sup>2584</sup>

The reason that *Ibrahim*, *Muhammad*, the Black Stone and the *Kaaba* are connected to Saturn has to do with the fact that in astrology, the color black is associated with Saturn.

It was assumed that since *Islamic* tradition said that *Ibrahim* once installed the Black Stone with Ishmael, and *Muhammad* installed the Black Stone in 605 AD, that they all worshipped Saturn along with the other planetary forms.

Another reason traditions mention Saturn in connection to *Ibrahim* was the Jewish *Sabbath*. It was assumed that *Ibrahim* kept the Jewish *Sabbath*, though the Bible does not mention this. The Jewish *Sabbath* starts at Friday sunset and ends on Saturday sunset. Thus three-quarters of the *Sabbath* falls on Saturday.

In the astrological reckoning of the week common to the ancient world, Saturday was Saturn’s day. In fact, Saturday comes from Latin and means “Saturn’s Day.” So it was assumed that *Ibrahim* honored the planets but especially Saturn.

This just-mentioned belief is very old for the Roman historian Tacitus (~55 AD to ~120 AD) wrote that “some” people believed Saturn worship was why Jews worshipped on the seventh day.<sup>2585</sup>

The Black Stone was dedicated to Venus, not Saturn. There is ample evidence to this fact, even though the astrological color of Venus is white and Saturn’s

<sup>2581</sup> Fregosi. *Jihad*, p. 290.

<sup>2582</sup> Gunduz. *Life*, pp. 162-163.

<sup>2583</sup> Wherry. *Commentary*, vol. i, section i, p. 38.

<sup>2584</sup> Fani. *Dabistan*, pp. 404-406; *Hadith Sahih Al Bukhari*: vol. 5, bk. 58, no. 227.

<sup>2585</sup> Tacitus, *Histories*, 5.3ff, quoted in MacMullen & Lane. *Sourcebook*, p. 161.

astrological color is black. The ancients knew of the discrepancy and that the Black Stone represented Venus. That is why they developed legends saying that the Black Stone was once white, the color of Venus.<sup>2586</sup>

Further attestation that the *Haranians* represented *Ibrahim* as a moon worshiper is the fact that there was a temple at *Haran* named after *Ibrahim*'s father, *Terah* (Arabic: *Azar*). Since *Terah* also was a Semitic name for the moon,<sup>2587</sup> this temple undoubtedly was a moon temple. Sinasi Gunduz wrote:

*Al Mad'udi* remarks that this is the only temple of the *Haranians* which remained until his time (10th century AD) and that it is the temple of *Azar* [*Terah*], Abraham's father. Moreover, he narrates from '*Ibn 'Ishun Al Harani Al Qadi* that there were four underground corridors for various idols representing heavenly bodies, i.e. planets [Venus, for instance] and saints [Abraham and *Terah*, for instance].<sup>2588</sup>

*Muhammad* probably knew about the moon-temple named after *Ibrahim*'s father, *Terah*. Perhaps this *Haranian* temple and *Joshua*'s mention of *Terah* being an idol worshipper (Jos 24:02, 14-15) form the basis for the Jewish *Haggadah* stories found in the *Koran* about *Ibrahim*'s struggle against his father's idols (K 006:074).

Apparently, for centuries before and after *Muhammad*'s time, the *Haranians* were telling people that *Terah* and *Ibrahim* were moon worshippers. This misinformation would help promote pilgrimages to *Haran*, the City of the Moon.

*Muhammad* and early *Muslims* believe the *Haranians*' claim about *Ibrahim* worshipping the moon, as evidenced by K 006. This misinformation helps explain why the *Islamic* conqueror of *Haran*, 'Iyadh *Ibn* Ghanam, built a moon temple for the *Haranians*. *Haran* was conquered in late 639 or early 640 AD, so the moon-temple was probably built shortly afterward. Tamara Green wrote:

In 1081 CE, *Haran* was occupied by the *Bedouin Sharaf Al Dawlah*, an ally of the *Seljuk* Turks, who installed as governor his supporter, *Yahya Ibn Al Shatir*, a man said to have once been the slave of a *Numayrid*. According to *Ibn Shaddad*, it was *Al Shatir* who destroyed the moon temple that had been built for the *Sabians* by the *Muslim* conqueror of the city, ['Iyadh] *Ibn* Ghanam, in the 7<sup>th</sup> century.<sup>2589</sup>

The *Haranians*' claim that *Ibrahim* and his father were moon worshippers may explain why the Arab Christian *Al Kindy* wrote in his *Apology* around 830 AD:

We know from the *Book of Genesis* that Abraham lived with his people four-score years and ten, in the land of *Harrân*, worshipping none other than *Al Ozza* [*Uzza*], an idol famous in that land and adored by the men of *Harrân* under the name of the moon [actually, *Uzza* is Venus, not the moon], which same custom prevails among them to the present day. They conceal no part of their ancestral practices, save only the sacrifice of human beings. They cannot now offer up human sacrifices openly; but they practice the same in secret.<sup>2590</sup>

Notice that two centuries after *Islam* stamped out most Mideast paganism, *Al Kindy* did not know that *Uzza* was Venus and not the moon.<sup>2591 2592</sup> This mistake is

<sup>2586</sup> Zamakhshari, *Tafsir*, 311, as quoted in Peters. *Origins*, p. 5.

<sup>2587</sup> Sykes. *Mythology*, p. 207, *Terah* entry.

<sup>2588</sup> Gunduz. *Life*, p. 149.

<sup>2589</sup> Green. *Moon*, p. 97.

<sup>2590</sup> *Al Kindy*. *Apology*, p. 17.

<sup>2591</sup> Guillaume. *Islam*, p. 7.

<sup>2592</sup> *Yusuf Ali*. *Holy*, p. 1623, App. XIII.

not surprising since earlier Greeks traveling scholars thought that the Abyssinian moon-and-war god, *Mahrem*, was the god of Mars (*Ares*) on account of *Mahrem*'s male gender and his preoccupation with war-making. This mistake was even made during the heyday of *Mahrem* worship—not at some later time.<sup>2593</sup>

The confusion about *Uzza* being the moon crept in because of Western pagan notion about the moon being female and the sun being male. Christians knew that *Islam* was derived from an Arab astral triad of the sun, moon and Venus, but on account of this gender confusion, many apparently assumed that *Allah* had been the Arab sun-god. *Al-Kindy* seems to have thought *Allah* had been the sun-god, for he wrote:

...that [the *Hajj*] which ye perform in nothing differs from the idolatrous ceremonies of the sun-worshippers and idolaters of India.<sup>2594</sup>

Greek, Roman and Arab writers made the same exact mistake about *Sin*, as Tamara Green wrote:

Although Greek and Roman authors, as well as later Arabic sources often give the deity a feminine gender in references to the cult of the moon at *Haran*, such references probably represent a cultural blind spot, rather than the reality of the female aspect of the *Haranian* god.<sup>2595</sup>

Since the Venus orb was most often found coupled with the crescent-moon, it is easy to see how *Al Kindy*'s confusion might have occurred—especially given the fact that *Uzza* was worshipped in *Haran*, the City of the Moon, as Isaac of Antioch wrote:

...the *Bedouins* left her [*Haran*] not, for with them she sacrificed to 'Uzza [Venus].<sup>2596</sup>

The *Khuzistani Chronicle* may refer to a *Haranian* moon temple. Hawting wrote:

The earliest [extant] external source to associate the sanctuary of the Arabs with Abraham seems to be the so-called *Khuzistani Chronicle*, probably dating from around AD 660-670. That refers to the Dome of Abraham at which the Arabs worshipped but does not say where it was.<sup>2597</sup>

This Dome of *Ibrahim* may have set the precedent for the distinctive green-domed architecture of *Mosques*, the Dome of the Rock and domed *Sheiks*' tombs. Also, the dome is incorporated into many *Muslim* homes and is a signature style of *Islamic* buildings.

The *Khuzistani Chronicle* was written about two decades before the Dome of the Rock in Jerusalem was completed in 691 AD, so the Dome of *Ibrahim* does not refer to the Dome of the Rock. Also, the *Kaaba* at *Makka* does not have a dome, so the Dome of *Ibrahim* cannot refer to the *Kaaba*.

The Dome of *Ibrahim* probably was a moon temple in *Haran*. To maintain its "City of the Moon" reputation, *Haran* had several moon temples, as Green wrote:

...there were at least three moon temples, including two outside the city itself.<sup>2598</sup>

The Roman historian Ammianus Marcellinus...

...maintains that the moon was especially venerated in that region (*Res Gestae*, xxiii.3.2).<sup>2599</sup>

<sup>2593</sup> Nielsen, 1912, pp. 593-594, as translated in Krause, "*Haram-Harimat*."

<sup>2594</sup> *Al Kindy. Apology*, pp. 92-93.

<sup>2595</sup> Green. *Moon*, p. 27.

<sup>2596</sup> Green. *Moon*, p. 58.

<sup>2597</sup> Hawting. *Idolatry*, p. 39, note 46.

<sup>2598</sup> Green. *Moon*, p. 27.

If the Dome of *Ibrahim* was a moon temple, that would explain this quote from *Al Kindy's Apology* written around 830 AD:

We know from the *Book of Genesis* that Abraham lived with his people four-score years and ten, in the land of *Harrân*, worshipping none other than *Al Ozza* [*Uzza*], an idol famous in that land and adored by the men of *Harrân* under the name of the moon [actually, *Uzza* is Venus, not the moon], which same custom prevails among them to the present day.<sup>2600</sup>

### ***Haran's Former Reputation For Being Mono- or Henotheistic***

The literary and archeological evidence for *Haran's* having been henotheistic (i.e. monolatristic) will be presented later in this chapter. Now however the *Koranic* information will be evaluated.

*Muhammad* considered the *Haranians* to be fallen monotheists. The *Haranians* were in the same “fallen moon-god monotheist” category as Christians, Jews, *Sabeans* and *Magians*, as well as the *Makkans* and the Arabs.

That *Muhammad* thought the *Haranians* were fallen monotheists is evident in the *Koran* where *Ibrahim* accuses his father *Terah* and the *Haranians* of setting up images in addition to *Allah* (*K* 006:075-079).

The implication of *K* 006 is that the *Haranians* did not inherit a very ancient practice of polytheism but in fact the *Haranians* were among the first to dabble in partnering gods with *Allah*.

*Muhammad* figured that even if the majority of *Haranians* never reverted back to their former monotheism, *Ibrahim* was a charismatic prophet who must have left a legacy in and around *Haran*. Indeed, *Muhammad* figured that the Religion of *Ibrahim* adherents were not a recent startup group but were spiritual descendants of *Ibrahim*—similar to Jews and Christians.

*Muhammad* knew that if *Haran* ever did reform itself after *Ibrahim* confronted the *Haranians*, it surely had backslid into polytheistic state. This was evident to anyone who knew of *Haran*, took an Ibrahimic pilgrimage to *Haran* and saw the temples and steles, or came across *Haran* coins with sun, moon and Venus symbols. Bradley Schaefer wrote:

Mesopotamia's star and crescent: the symbol of the moon-god (*Sin*) who was worshipped in the cities of *Ur* and *Haran*. On this stele are shown, a crescent-moon flanked by an eight-pointed star on the left and an eight-pointed sun on the right.<sup>2601</sup>



**Figure 05-01.** *Haranian* coins with a crescent-moon, sun and Venus.<sup>2602</sup>

The *Haranian* coins however suggested to *Muhammad* that *Haran* had not backslid beyond hope of restoration. The coins suggested that *Haran* took only two

<sup>2599</sup> Green. *Moon*, p. 27.

<sup>2600</sup> *Al Kindy. Apology*, p. 17.

<sup>2601</sup> Schaefer, Bradley. “Heavenly Signs,” *New Scientist*, 21/28 Dec 1991, p. 48.

<sup>2602</sup> Coin 1: Roman-era *Haran* (*Carrhae*) coin with a *Sin* crescent-moon and Venus star. The upright *Asherah* pole representing Venus.

Coin 2: Winged sun disk under *Sin* Crescent-and-Venus-star (Segal. *Sabian*)

Coin 3: *Sin* crescent-and-Venus-star. A *Haran* coin from the time of Roman Emperor Hadrian (117-138 AD) (Lovette. *Coins*, p. 35).

or three gods seriously. To revert to moon-god monotheism, the *Haranians* merely needed to downgrade the sun and Venus to angelic status.

### The *Hanifs*

If the Arabic cognate *Hanif* comes from the Syriac, then it means “heathen.” By late antiquity and early medieval times, Syria was mostly Christian, so it must have been the Christians who stamped the “heathen” label on the Religion of *Ibrahim* adherents.

If the label *Hanif* is from Hebrew rather than Syriac, its Hebrew cognate means “heretic” or “profane.” *Hanif* then shows what Jews at the time thought of the Religion of *Ibrahim* upon which *Islam* is based—that they were heretics.

So Jews and Christians evidently agreed with *Muhammad* that the *Hanifs*, the Religion of *Ibrahim* adherents, were neither Jew nor Christian (*K* 002:135, 140; 003:067).

It is very telling that *Muhammad*'s main spiritual progenitors were thought to be “heathen” by the Christians and “heretics” by Jews. H.A.R. Gibb wrote on the subject:

The existence of a supreme God *Allah* is assumed as an axiom common to *Muhammad* and his opponents. The *Koran* never argues the point; what it does argue is that He is the one and only God...but it is more doubtful whether this is to be regarded as the direct deposit of Christian or Jewish teaching. In the *Koran* it is connected with a different tradition altogether, an obscure Arabian tradition represented by the so-called *Hanifs*, pre-*Islamic* Arab monotheists whose very name shows that the Syrians regarded them as non-Christians (Syriac *hanpa*, ‘heathen’). *Mohammed* glories in the name and attaches it as a distinctive epithet to Abraham, who was ‘neither Jew nor Christian.’ There is even a suggestion in an early variant reading of the *Koranic* verse (003:017 [K 003:019]) that at one time *Hanifiyya* [‘heathenism’] was used to denote the doctrine preached by *Muhammad* and was only later replaced by *Islam*.<sup>2603</sup>

The Syrian historian Bar Heebraeus (1226-1286 AD) records that the *Al Sabi* Thabit *Ibn Qurra Al Harani* (836-901 AD) said:

...this blessed city [*Haran*] has never been defiled with the error of Nazareth [Christianity]. We are the heirs and transmitters of *hanputho*...the wise men of the *hanpe*...<sup>2604</sup>

Historically, the supreme god of *Haran* was *Sin* the moon-god. Tamara Green wrote...

...although this Syriac word, like its Arabic cognate *Hanif*, is often translated as ‘pagan’ when applied to pre-*Islamic* religions, it may also have here the same meaning as *Hanif* seems to be given in the *Quran*: ‘a possessor of pure religion.’<sup>2605</sup>

So the *Hanifs* were neither Jews nor Christian but were heathens and pagans purporting to possess a pristine, pure paganism. To be “pagan” in the Mideast suggests that the *Hanifs* were astral worshippers. To be “pagan” in *Haran* suggested that one worshipped the moon-god *Sin*.

<sup>2603</sup> Gibb. *Survey*, p. 26.

<sup>2604</sup> Green. *Moon*, p. 114.

<sup>2605</sup> Green. *Moon*, p. 114.

The Christians called the religion of *Haran* “the old faith” (*palaia doxe*).<sup>2606</sup> The Religion of *Ibrahim* adherents and *Muhammad* might have misinterpreted this slur on paganism as a compliment, and as an admission on the Christians’ part that they had rejected the pristine Religion of *Ibrahim*.

### How the Moon-god Monotheism Brand of Paganism Came to Arabia

The *Hanifs* in Arabia likely were the adherents of the monotheistic strain of moon religion transplanted to Arabia by *Nabonidus*. *Nabonidus*, along with his viceroy son, Belshazzar, were the last *Chaldean* rulers of *Babylonian* Empire. Michael Wise *et al.* wrote:

*Nabonidus* was the last king of the Neo-*Babylonian* Empire, reigning from 556-539 BCE. Beset by political problems and economic difficulties in *Babylonia*, *Nabonidus* decided to appoint his son Belsharusur as regent (‘King Belshazzar’ in the Bible: *Daniel* 05:22; 07:01 and 08:01), while he himself moved [south]west to *Teima* [also spelled *Tema*, *Tama*, *Tayma*, etc.], an oasis in northwest Arabia. By removing to this locality, the king hoped to secure the trade routes from southern Arabia and thereby to ameliorate his money problems. He remained in *Teima* for a full decade, establishing garrisons and planting colonies to the south of his base of operations. Among these colonies were five oases that, at the time of *Muhammad* a millennium later, were occupied by Jews. Almost certainly, then, *Nabonidus* had a strong contingent of Jews among his colonists, whether drawn from those in exile in *Babylonia* or from those left behind in Judah. The presence of ‘a Jew, a member of the community of exiles’ in the scroll here translated may be an accurate memory of this historical situation.<sup>2607</sup>

Tamara Green wrote...

...one of the divine names on the [*Taima* fifth-century BC] stele may represent the moon-god, and that the choice of *Taima* by *Nabonidus* as a royal residence may have been influenced by an indigenous worship of the [moon-god] deity, which the king then overlaid with the cult of the moon-god of *Haran*.<sup>2608</sup>

It is easier to imagine that the Arab caravan traders imported *Haran*-styled paganism to Arabia at an even earlier date than *Nabonidus*’ time. Tamara Green wrote how integrated *Haranian* religion had become in the Mideast:

In every ancient source that deals with *Haran*, beginning in the early second millennium BCE, the deity who occupied that supreme position was *Sin* the moon-god and Lord of the City. It was the multifarious powers of this god [*Sin*] that were, 2500 years after the founding of *Haran*, to provide one of the strongest links between *Muslims* and the pre-*Islamic* culture of the ancient Near East.<sup>2609</sup>

The Bible mentions camels often, even in at an early date in *Genesis*. The Bible locates camels in Egypt and near *Haran* in Syria (Gen 12:16; 24:10). Archaeology has confirmed that the mention of camels during the time of Abraham is not an anachronism.

<sup>2606</sup> Green. *Moon*, pp. 53-54, 56.

<sup>2607</sup> Wise, Abegg & Cook. *Scrolls*, pp. 265-266.

<sup>2608</sup> Green. *Moon*, p. 38.

<sup>2609</sup> Green. *Moon*, p. 23.

The Bible speaks of crescent-moon decorations in connection to the Ishmaelites' camels (Jdg 08:21, 26). Tracy Marks notes:

Arabian camels were...hung with gold chains and crescents to win the favor of the gods...<sup>2610</sup>

A psalmist wrote that the Ishmaelites were among those who hated *Yahveh* and who worshipped some other god as their most high god (Psa 083:01, 05-06, 18). Evidently, the Ishmaelites' high god was *Sin* the moon-god, a.k.a. *Allah*.

That the Arabs and *Muhammad* would identify themselves as Ishmaelites<sup>2611</sup> is quite interesting given the Biblical connection between the Ishmaelites and crescent decorations, as was just mentioned. Also interesting is the fact that *Muslims* made crescent ornaments for their horses:

☉ A rock-crystal crescent carved in Egypt is inscribed with the name of the *Fatimid Caliph Al-Zahir* (ruled 1021-1036 AD).<sup>2612</sup>

☉ A *Mozarab* illuminated manuscript produced in 975 AD in *Tavera, Andalusia*. It shows two crescent ornament dangling from the saddle strap that loops around the front of the horse just below the neck. The rider is a *Muslim* wearing Persian dress and a turban.<sup>2613</sup>

*Yerach* is sometimes translated *Jerah* (*KJV, NIV*) and means “new-moon” (Gen 10:26; 37:09, etc.). *Sahar(on)* means “crescent” (Jdg 08:21, 26; Isa 03:18). Egerton Sykes wrote this entry in his book on mythology: “*Sahar*...also spelt *Shahar*: moon-god of the north and south *Semites*.”<sup>2614</sup>

Abraham's father *Terah* was named after the moon since the name *Haran* was a Semitic name for a moon-god.<sup>2615</sup> Around *Haran* and *Ur* especially, the name *Terah* probably was synonymous with the moon-god *Sin*. This was noted in a previous chapter. *Terah* lived out his life in the moon-god centers of *Ur* and *Haran* (Gen 11:26-28; 31-32; Jos 24:02).

All the above evidence suggests that *Nabonidus* made *Tema* Oasis his home for ten years because caravan traffic had long made this oasis a moon-god worship center styled on *Haran* and *Ur*. Then *Nabonidus* improved on what already existed, as Robert Morey wrote:

In Old Testament times, *Nabonidus* (555-539 BC), the last king of *Babylon*, built *Tayma* (*Teima*), Arabia, as a center of moon-god worship.<sup>2616</sup>

The *Chronicle of Nabonidus* says *Nabonidus* traveled as far south in Arabia as *Iatribu* Oasis. *Iatribu* later became *Yathrib*, which the *Muslims* renamed *Madina*, meaning “The City [of the Prophet].”<sup>2617</sup> *Nabonidus* may have also visited *Madina* for the same reason—because it was a moon-god worship center.

A fragment in the Dead Sea Scrolls (*DSS*) suggests the reasons why *Nabonidus* established himself in Northern Arabia for a decade, and why he later lost the *Babylonian* empire. The braces { } represent lacunae (gaps) in the original text where the text is reconstructed.

<sup>2610</sup> Marks. *Makeda*.

<sup>2611</sup> Peters. *Origins*, pp. 120-121.

<sup>2612</sup> Blair. *Inscriptions*, p. 192.

<sup>2613</sup> Nicolle. *Moors*, p. 12, illustration from Beatus' *Commentaries on the Apocalypse*.

<sup>2614</sup> Sykes. *Mythology*, *Sahar* entry, p. 183.

<sup>2615</sup> Sykes. *Mythology*, p. 207, *Terah* entry.

<sup>2616</sup> Morey. *Invasion*, p. 215.

<sup>2617</sup> Pritchard, James B. *Ancient Near Eastern Texts Relating to the Old Testament*. Princeton, 1950. Translation by A. Leo Oppenheim, ot-studies.com/Documents/chronnab.htm.



DSS 4Q242: ‘The Healing of King *Nabonidus*,’ Fragments 1-3. Words of the prayer which *Nabonidus*, king of the la{nd of Ba}bylon, {the great} king, prayed {when he was afflicted} by a malignant inflammation, by decree of the G{od Most} High, in *Teiman*. {I, *Nabonidus*,} was afflicted {by a malignant inflammation} for seven years and was banished far {from men, until I prayed to the God Most High} and an exorcist forgave my sin. He was a Je{w} from {the exiles, who said to me:} Make a proclamation in writing, so that glory, exal{tation and honour} be given to the name of the G{od Most High. And I wrote as follows: When} {I was afflicted by a malig{nant} inflammation, {and remained} in *Teiman*, {by decree of the God Most High, I} prayed for seven years {to all} the gods of silver and gold, {of bronze and iron,} of wood, of stone and of clay, because {I thought} that they were gods{...}<sup>2618</sup>

The story of *Nabonidus* being exiled over his unclean disease sounds rather like the *Haramians*’ story of *Ibrahim*’s exile over leprosy (quoted earlier in this chapter). The *Ibrahim* disease story may have been inspired by the *Nabonidus* disease story.

The Jewish sorcerer who healed *Nabonidus* and convinced him of monotheism or henotheism was likely associated with the Jewish mercenaries helping *Nabonidus*. The *Encyclopedia Britannica* states:

There [*Taima* in northern Arabia] he [*Nabonidus*] organized an Arabian province with the assistance of Jewish mercenaries.<sup>2619</sup>

Note that in DSS 4Q242 the phrase “from men” is the best guess of the scholar in his bid to fill in a lacuna to make sense of the fragment. *Nabonidus* however exiled himself to Northern Arabia. This suggests the reading should be far “from *Babylon*,” not far “from men.”

The reason the scholar chose the words “from men” is that scholars generally attempt to make DSS 4Q242 read like Dan 04:25, 32-33. This is Daniel’s account of how *Nebuchadnezzar* was driven “from men” during his seven years of madness. Scholars like to think that DSS 4Q242 is the source of Dan 04 or *vice versa*.

DSS 4Q242 and Dan 04 have similarities but also important differences. *Nabonidus*’ inflammation is hardly the same as *Nebuchadnezzar*’s lupine madness.

Scholars insert details from Dan 04 (“from men”) into the *Prayer of Nabonidus* to bolster the claim that the *Prayer of Nabonidus* was the original reading of Dan 04. They claim the *Nabonidus* record is “a previously unknown source for the Bible.”<sup>2620</sup>

Similarly, Michael Wise inserts the words “becoming like a beast, I prayed to the Most High.”<sup>2621</sup> This however does not make sense. No one so deranged as to be called a “beast” would be able to consciously pray to the Most High—and also remember doing so.

At the end of the fragment, *Nabonidus* says he prayed to idols all seven years he had the inflammation. By contrast, *Nebuchadnezzar* only prayed to the Most High after his sanity was restored at the end of seven years (Dan 04:34).

Scholars have a tendency to exaggerate the similarities between cuneiform documents and the Bible so they can say the content of the Bible was culled from

<sup>2618</sup> Martinez, Florentino Garcia. *Scrolls Translated: The Qumran Texts in English*, 2<sup>nd</sup> Ed. Wilfred G. E. Watson, Translator. Eerdmans, Grand Rapids, 1996, p. 289.

<sup>2619</sup> *EB*, accessed 10 Feb 2003, “Mesopotamia, history of” entry.

<sup>2620</sup> Wise, Abegg & Cook, *Scrolls*, pp. 265-266.

<sup>2621</sup> Wise, Abegg & Cook, *Scrolls*, pp. 265-266.

ancient folklore. The Bible however reads more like history and, unlike folklore, the Bible is replete with verifiable details.

What scholars do not tell the reader is that there are hundreds of thousands of cuneiform tablets, so it would be surprising not to find a few documents with similarities to the Bible. Also what scholars do not mention is that ancient records are often full of *lacunae* where words are missing from the document.

Scholars guess at the missing words in ancient texts, and this is why the reconstructed wording is often bracketed [ ] or braced { }. If one skips over the braced words, documents purported to be sources for the Bible often lose their supposed resemblance to the Bible! For instance, the above account of *Nabonidus* is a typical ancient story about disease and its cure but scholars make it read almost like Dan 04.

Scholars want to cast doubt on the book of Daniel while maintaining the authenticity of *DSS 4Q242*. One area of attack is whether or not Belshazzar was related to *Nebuchadnezzar* as Daniel says (Dan 05:02, 11, 18). Cuneiform tablets say that Belshazzar was the son of *Nabonidus* but the Bible says Belshazzar was the son of *Nebuchadnezzar*.

When Daniel says Belshazzar's father (Aramaic: *Ab*) was *Nebuchadnezzar*, the Aramaic could function like the Hebrew *Ab* and mean "grandfather." For instance, Jacob calls his grandfather Abraham *Ab* (Gen 32:09). So Daniel could be understood as saying that Belshazzar's grandfather was *Nebuchadnezzar* (Dan 05:02, 11, 18).

"Father" can also be used as a term of endearment or respect, such as when Naaman's servants called him "my father" (2Ki 05:13). The word "father" could be understood as meaning "adoptive" father or "foster" father (Isa 49:23).

Similarly, Elisha called *Elijah* "my father," though there was no blood relationship (2Ki 02:12). Elisha however did inherit a double portion (the first son's allotment) from *Elijah* (2Ki 02:09-10).

This suggests that *Nebuchadnezzar* was Belshazzar's "father" in the sense that the coregents *Nabonidus* and Belshazzar had inherited a kingdom from *Nebuchadnezzar* as though *Nebuchadnezzar* was their father.

*Nebuchadnezzar* may have been *Nabonidus* and Belshazzar's father in the sense that *Nebuchadnezzar* initially dabbled in Jewish monotheism and promoted *Sin* moon-god worship, as evidenced by his rebuilding *Ur*.<sup>2622</sup> *Nabonidus* rebuilt the moon-god temples at *Haran* and *Ur* and also dabbled in Jewish monotheism. In other words, the *Marduk* priests resented both kings for the same religious reasons.

The *Encyclopedia Britannica* states:

After a popular rising led by the priests of *Marduk*, chief god of the city, *Nabonidus*, who favoured the moon-god *Sin*, made his son *Belshazzar* coregent and spent much of his reign in Arabia.<sup>2623</sup>

*Nabonidus* means "reverer of *Nabu*," the scribal god associated with *Sin*. *Belshazzar* means "*Bel* protects the King," which name explains why *Belshazzar* had less strained relations with the priests of *Bel* in *Babylon*.

Some cuneiform tablets say that *Nabonidus* "was not of *Nebuchadnezzar*'s family, and it is possible that he usurped the throne."<sup>2624</sup> The *Encyclopedia Britannica* states that *Nabonidus*' wife, Nitocris, "perhaps [was] a daughter of

<sup>2622</sup> *EB*, accessed 17 Aug 2004, *Ur* entry.

<sup>2623</sup> *EB*, accessed 16 Apr 2006, *Nabonidus* entry.

<sup>2624</sup> *CEE*, *Nabonidus* entry.

*Nebuchadnezzar*.<sup>2625</sup> In discussing *Nabonidus*' lineage, one must take politics into account. The *Encyclopedia Britannica* states:

He [*Nabonidus*] gave preference to his [moon] god *Sin* and had powerful enemies in the priesthood of the [Jupiter-god] *Marduk* temple. Modern excavators have found fragments of propaganda poems written against *Nabonidus* and also in support of him. Both traditions continued in Judaism.<sup>2626</sup>

In ancient times, the priests wrote most of the cuneiform tablets. It would be a powerful piece of propaganda to say *Nabonidus* was a usurper and not even a royal. If *Nabonidus* was not a son of *Nebuchadnezzar II*, perhaps he was an adopted son or a relative.

The Jupiter-god priests of *Marduk* hated *Nabonidus* for favoring the moon-god, even though the public outside of Babylon generally favored the moon-god over the Jupiter-god [*Marduk*] or sun-god. Perhaps the priests needed to distort history to escape the odium of their handing *Babylon* over without a fight to the foreigner, Cyrus the Mede, a subject discussed elsewhere.

So some modern scholars who favor extra-Biblical material over the Bible's recounting of events may be duped by ancient propaganda. The Bible writers however being closer to the events they wrote about, knew their subject and were not so easily fooled.

The rift between the priests of *Marduk* likely started as early as the reign of *Nebuchadnezzar II*. Not only did he rebuild *Ur*, an ancient moon-god center,<sup>2627</sup> but also he eventually proclaimed that *Yahveh* was the Most High God (Dan 04).

*Nebuchadnezzar*'s letter (Dan 04) saying that *Yahveh*, rather than any astral god, was the high god, probably led to dynastic succession problems. Any new candidate had to garner the support of the pagan priests. This led to an opening for *Nabonidus* and *Belshazzar* to succeed *Nebuchadnezzar*. When *Nabonidus* favored *Sin* the moon-god over the Jupiter-god, the *Marduk* priests were annoyed.

That *Nabonidus* was a monotheistic or henotheistic moon-god worshipper is evident from the stele of *Nabonidus*. Tamara Green wrote:

...the stele of *Nabonidus* that records the king's predicted exile of ten years ended 'on the very day which the king of the gods, the Divine Crescent, had (in the dream) predicted, the 17<sup>th</sup> day of *Tashritu*, of which it is said in the hemerologies [i.e. calendars]: a day on which *Sin* [the moon-god] is gracious.'<sup>2628</sup>

That *Nabonidus* was a moon henotheist can be inferred by his neglecting the Jupiter-god *Marduk*'s New Year's *Akitu* festival. Moon-god monotheists kept a lunar religious calendar, while the solstices and equinoxes were important for sun-moon worshippers. So *Nabonidus*' actions were similar to *Muhammad*'s. *Muhammad* ended intercalation at *Makka* to slight the sun-goddess and honor the moon-god (K 009:036-037).

The *Akitu* festival occurred during the month of *Nisanu*. *Akitu* was held at the *Esagila*, the "House of the New Year," as well as in the environs of *Babylon*. The *Babylonian* kings traditionally attended the *Akitu* festivals, as *Nebuchadnezzar* did before he became a Yahvist. The *Encyclopedia Britannica* states:

<sup>2625</sup> *EB*, accessed 16 Apr 2006, *Belshazzar* entry.

<sup>2626</sup> *EB*, accessed 10 Feb 2003, "Mesopotamia, history of" entry.

<sup>2627</sup> *EB*, accessed 17 Aug 2004, *Ur* entry.

<sup>2628</sup> *ANET*, 562-563, as quoted by Green. *Moon*, p. 154.

He [*Nebuchadnezzar II*] claimed to be ‘the one who set in the mouth of the people reverence for the great gods’ and disparaged predecessors who had built palaces elsewhere than at *Babylon* and had only journeyed there for the New Year Feast.<sup>2629</sup>

This stele that is quoted by the *Encyclopedia Britannica* also reads a bit like *Babylonian Jupiter-god priest propaganda*.

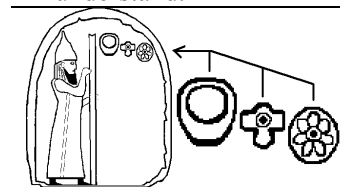
The stele, the *Chronicle of Nabonidus*, records that from the seventh year of his reign (549 BC) *Nabonidus* neglected the New Year’s *Akitu* festival. Then in the seventeenth and last year of his reign (539 BC), *Nabonidus* celebrated the *Akitu* festival. The stele however does not mention *Marduk*’s Jupiter temple. The stele does mention that *Nabonidus* entered the temple of *Eturkamma*.

*Eturkamma* is the main temple of *Ishtar* [Venus] in *Babylon*. Apparently, *Nabonidus* had a compromised form of monotheism. Perhaps *Nabonidus* considered Venus and the sun to be intercessors to the moon-god. Sinasi Gunduz wrote:

The children of *Sin*—*Ishtar* his daughter, and *Shamash* his son—are mentioned with him in one of the *Nabonidus* inscriptions from *Haran*.<sup>2630</sup>

The sun and the common crescent-and-star symbol representing *Sin* the moon-god, and *Ishtar*, Venus, would symbolize *Nabonidus*’ gods. Polat Kaya wrote:

The star used in the crescent-and-star motif represented the sun and hence the sun-god most of the time. In other times it represented the planet Venus and hence the goddess *Inanna* of Sumerians also known by the name *Ishtar* to *Babylonians*. Particularly when the planet Venus makes conjunction [occults] with the moon in its crescent phase, it makes an unusual celestial crescent-and-star appearance that must have awed the earliest believers of astral objects as their gods, believing that their gods were sending a message for them to understand.<sup>2631</sup>



**Figure 05-02.** Upper part of a *Nabonidus* stele found at *Haran*. The symbols are (from left to right): *Sin* (ring crescent-moon), *Ishtar* (bird-like Venus), *Shamash* (daisy-like sun) (see inset).<sup>2632</sup>

The *Hanifs* may have followed the tradition set down by *Nabonidus* of relying on Venus to be an intercessor to *Sin* the moon-god. This would explain the abrogated Satanic Verses deleted from *K 053:019-020*.

Many unimpeachable early *Muslim* sources tell us that *Muhammad* originally stated in the Satanic Verses that *Allat* (the sun-goddess), *Uzza* (Venus) and *Manat* (Fate) were Daughters of *Allah* and intercessors to *Allah*.<sup>2633 2634</sup>

The events recorded by the stele, the *Chronicle of Nabonidus*, jibe with the facts related by *DSS* fragments of “The Healing of King *Nabonidus*.” The *DSS* account

<sup>2629</sup> *EB*, accessed 10 Feb 2003, “*Nebuchadnezzar II*” entry.

<sup>2630</sup> Gunduz. *Life*, p. 137.

<sup>2631</sup> Kaya, Polat. “Search For the Origin of the Crescent and Star Motif in the *Turkish Flag*,” 1997, [compmore.net/~tntr/crescent\\_stara.html](http://compmore.net/~tntr/crescent_stara.html).

<sup>2632</sup> Pritchard, *Ancient*, vol. ii, fig. 68.

<sup>2633</sup> *Yusuf Ali. Holy*, fn. 5096, p. 1445.

<sup>2634</sup> Saifullah, Dr. M S M. “Responses to *Islamic Awareness: Muhammad* and the Satanic Verses,” [answeringIslam.org.uk](http://answeringIslam.org.uk), accessed 4 July 2005.

states that *Nabonidus* was afflicted for seven years while he worshipped idols the whole while.

*Nabonidus*' sickness must have occurred between the year of his ascension to the throne (556 BC) and the seventh year of his reign (549 BC). In fact, the *Chronicle of Nabonidus* says he was sick in the third year (553 BC). Perhaps the disease was only severe one year out of the seven.

The *Chronicle of Nabonidus* first mentions that *Nabonidus* did not attend the *Akitu* ceremony in *Babylon* in the seventh year of his reign (549 BC). The *Chronicle of Nabonidus* mentions that in the third year of his reign (553 BC), *Nabonidus* fell sick but recovered. *Nabonidus* then left "*Babylonia* around 552 [BC]...to reside in *Taima (Tayma)* in northern Arabia..."<sup>2635</sup>

*Nabonidus* apparently was healed and became a moon-god monolatrist (henotheist) in 549 BC. That is the first year the *Chronicle of Nabonidus* mentions his non-attendance at the Jupiter-god *Marduk*'s annual ceremony. *Nabonidus*' seven-year illness must have begun around his coronation but one bout that occurred during the third year of his reign was worthy enough to note in the *Chronicle of Nabonidus* (553 BC).

Apparently, from 552 BC to 548 BC, *Nabonidus* could not attend the *Akitu* festival. *Nabonidus*' ailment made him unclean as far as the *Marduk* priests were concerned. The illness is why he left *Babylon* and went to North Arabia. *Nabonidus* left his son, *Belshazzar*, in charge of *Babylon*.

The fact that *Nabonidus* was cured and became a moon monolatrist surely caused quite a stir in *Babylon*. Also, the fact that he mainly restored moon-god temples in *Haran* and *Ur* ruffled the feathers of the Jupiter-god priests. The *Encyclopedia Britannica* states:

He [*Nabonidus*] also devoted himself to the renovation of many temples, taking an especially keen interest in old inscriptions. He gave preference to his [moon] god *Sin*....He appointed his daughter to be high priestess of the god *Sin* in *Ur*, thus returning to the Sumerian-Old *Babylonian* religious tradition.<sup>2636</sup>

The *Encyclopedia Britannica* states:

After a long period of relative neglect, *Ur* experienced a revival in the Neo-*Babylonian* period, under *Nebuchadrezzar II* (605–562 BC), who practically rebuilt the city. Scarcely less active was *Nabonidus*, the last king of *Babylon* (556–539 BC), whose great work was the remodeling of the *Ziggurat*, increasing its height to seven stages.<sup>2637</sup>

*Sinasi Gunduz* wrote:

In 553-552 BC ...*Nabonidus* was able to commence the work of which he had dreamed dreams; *E-hul-hul* [*Sin* moon temple at *Haran*] was restored. Not only did *Nabonidus* restore the temples; his native city *Haran* was rebuilt, and his parent [mother] who had patiently served the god through years of desolation lived to see the restoration. *Nabonidus* was closely attached to the deity *Sin* who had from the old days had a magnificent temple in his native town of *Haran*, so that *Marduk* in *Babylonia* was neglected for the benefit of *Sin*. The priesthood

<sup>2635</sup> *EB*, accessed 10 Feb 2003, "Mesopotamia, history of" entry.

<sup>2636</sup> *EB*, accessed 10 Feb 2003, "Mesopotamia, history of" entry.

<sup>2637</sup> *EB*, accessed 15 Mar 2003, *Ur* entry.

was therefore opposed to him, especially when he failed to celebrate the *Akitu* festival—the *Babylonian* New Year’s feast.<sup>2638</sup>

How the Jewish sorcerer convinced *Nabonidus* to be a moon henotheist can be reconstructed from the sources just mentioned. Abraham had stayed at *Haran* for some time (Gen 11—12), and *Nabonidus* and his mother were from *Haran*, as the *Encyclopedia Britannica* states:

The next king was the Aramaean *Nabonidus* (reigned 556–539 BC) from *Haran*, one of the most interesting and enigmatic figures of ancient times. His mother, Addagoppe, was a priestess of the god *Sin* in *Haran*; she came to *Babylon* and managed to secure responsible offices for her son at court. The god of the moon rewarded her piety with a long life—she lived to be 103—and she was buried in *Haran* with all the honours of a queen in 547.<sup>2639</sup>

Since *Nabonidus* was from *Haran*, he likely knew the story of Abraham’s stay at *Haran* from Jewish pilgrims to *Haran*. The Jewish sorcerer seems to have convinced *Nabonidus* of monotheism but not of making the switch from *Sin* to *Yahveh*. The *Hanif* story that convinced *Nabonidus* of moon henotheism might well be preserved in *K* 006:075-079, the *Ibrahim* and the moon story discussed earlier.

Here it should be discussed whether *Nabonidus* knew the difference between *Sin* and *Yahveh*. We know that the Babylonians pillaged the temple of *Yahveh*, and one would think that they would not pillage a temple to their own god *Sin*.

The evidence suggests that the *Assyrians* also knew that the gods of *Haran*—*Sin* included, were not *Yahveh* (2Ki 19:12). Job, who predated or was a contemporary of the patriarchs, knew that *Yahveh* was neither a sun- nor moon-god. Job wrote:

If I see the light [the sun] when it shines, and the precious moon[-god] walking [across the sky], and my heart is enticed [to worship] in secret, and my mouth kissed my hand, it also is a judicial iniquity, for I had lied to God [*Yahveh*] above (*Job* 31:26-28).

Pharaoh must have known that *Sin* was not *Yahveh* since Pharaoh said he did not know *Yahveh* (Exo 05:02). Pharaoh would have known *Sin* since *Sin* was worshipped in the Nile river valley as well as in Mesopotamia. Also, the *Sinai* Peninsula was named after *Sin*. Moses may have told Pharaoh that *Yahveh* was not a moon-god (Deu 04:19; 17:02-05).

That *Nabonidus* turned monotheistic or henotheistic is evidenced from *Haranian* history. Originally, no monotheism is evidenced at *Haran*. Inscriptions show that *Nabonidus*’ mother, Adad-Guppi, was a polytheist who was a votress of *Sin*, *Ningal*, *Nusku* and *Sadarnunna*.<sup>2640</sup> Adad-Guppi called *Sin* “the king of all gods, the lord of the gods of heaven and the nether world.”<sup>2641</sup>

Interestingly, the archaeological finds suggests that henotheism or monotheism was the norm at *Haran* for several centuries after *Nabonidus*. Tamara Green wrote:

Almost all our sources for *Haranian* religion during the earlier period, prior to the *Achaemenid* (~538 BC) conquest, refer exclusively to the moon-god; it is not until the third century CE that other deities and cults are specifically referred to at *Haran*.<sup>2642</sup>

<sup>2638</sup> Gunduz. *Life*, p. 129.

<sup>2639</sup> *EB*, accessed 10 Feb 2003, “Mesopotamia, history of” entry.

<sup>2640</sup> Gunduz. *Life*, p. 129, fn. 34.

<sup>2641</sup> Green. *Moon*, p. 21.

<sup>2642</sup> Green. *Moon*, p. 22.

The three-century interval between the third century AD and 570 AD when *Muhammad* was born is not that long in terms of Mideast history. A strain of this *Haranian* moon henotheism lasted until *Islamic* times, not only among the Religion of *Ibrahim* adherents but also among a sect of *Haranians*, as Tamara Green wrote:

For Shahrastani (died 1153 AD), the label of ‘*Sabian*’ embraced a great variety of beliefs, but all were grounded in one way or another in astral doctrine, and he described the *Haranians* as ‘a class of *Sabians* who maintain the adored Creator is both One and Many.’<sup>2643</sup>

Notably *Muhammad* seems to have held the same belief as this sect of *Haranians*, for a *Makkan* objection to *Muhammad*’s teaching was:

Do you want to make all the gods into one God, *Muhammad*? That would be an extraordinary thing...(*K* 038:005).<sup>2644</sup>

To conclude this chapter, it can be said that *Haran* and Arabia were not isolated from each other but were interconnected in a number of ways. *Haranians* and the Religion of *Ibrahim* adherents who traveled throughout the Mideast seem to have shared moon henotheistic doctrines and a warped *Ibrahamic* history. *Muhammad* incorporated all these beliefs into *Islam*.

---

<sup>2643</sup> Chwolsohn II:442, as quoted by Green. *Moon*, p. 166.

<sup>2644</sup> Ishaq. *Sirat*, p. 192.

## Chapter 06: Moon-o-theistic Christian Connection

### Introduction

*Muhammad* wrongly believed that the Jewish and Christian belief systems imitated the polytheism of ancient pagan religions. He said: “They imitate what the unbelievers of old used to say” (K 009:029). This chapter will document how *Muhammad*:

- ☉ Came to think that the Christian Trinity was comprised of *Allah* the moon-god, Mary was *Allah*’s consort and wife (K 072:003) and Jesus the sun-god (K 005:116). Incidentally, *Muhammad* thought Jews worshipped *Allah* the moon-god, along with Ezra as a sun-god (K 002:259-260; 009:030).
- ☉ By making Jesus and Ezra out to be sun-gods, was able to cast the *Muslim* dispute against Jews and Christians as being pro-lunar and anti-solar in nature, as well as being pro-monotheistic and anti-polytheistic. This type of dispute went back to antiquity, as history records a similar Jupiter (*Bel*) vs. lunar (*Sin*) conflict brought down the Babylonian Empire during *Nabonidus*’ reign. *Nabonidus*’ mother, Adad-Guppi, was a priestess of *Sin* at *Haran*. The *Encyclopedia Britannica* states:

The last king of Babylon, *Nabonidus* (reigned ~556–539 BC), attempted to elevate *Sin* to a supreme position within the pantheon.<sup>2645</sup>

Gunduz wrote:

The [*Bel*] priesthood were therefore opposed to him, especially when he failed to celebrate the [*Marduk*] *Akitu* festival—the Babylonian New-Year’s feast—and this also turned the people against him.<sup>2646</sup>

H.G. Wells wrote:

But there were many signs of disunion in his [*Nabonidus*]’ empire and he sought to centralize it by bringing a number of the various local gods to Babylon and setting up temples to them there. This device...roused the jealousy of the powerful priesthood of *Bel Marduk*, the dominant god of the Babylonians. They cast about for a possible alternative to *Nabonidus* and found it in Cyrus the Persian, the ruler of the adjacent Median Empire.<sup>2647</sup>

### Ancient Syncretism

Normally one might think that the ancients syncretized two religions at a time: their own with the one they admired. *Muhammad* however tells the *Koran* reader that he created *Islam* by distilling and syncretizing complementary elements of Arabian astral paganism (*Sabeanism*, *Sabianism*), Judaism, Christianity, Zoroastrianism (Magianism) and the Religion of *Ibrahim* (*Hanifism*) (K 002:062, 135; 005:069; 022:017).

How did *Muhammad* go about syncretizing these religions? Syncretism was a standard pagan practice and was more art than science. One could import deities or merge two into one.

A culture merely needed to match a name or trait of two gods in order to effect a synthesis. These characteristics included position in hierarchy, function, the meaning

<sup>2645</sup> *EB*. *Sin* entry, accessed 16 Aug 2004.

<sup>2646</sup> Gunduz. *Life*, p. 129.

<sup>2647</sup> Wells, H.G. (1866–1946). *A Short History of the World*. bartleby.com, 1922, chapter xx.



of the name, an appellation, a personality trait, accouterments, purpose (job), gender and especially the associated astral symbol.

Greek historians developed comparative taxonomies on other nations' pantheons. These would compare the various outstanding traits of each god. Often the match was not perfect. For instance, the *Abyssinian* god of war, *Mahram*, was a moon-god. Nevertheless, the Greeks compared *Mahram* to *Ares* [Mars], the Greek god of war, despite the fact that *Mahram*'s monument-sized pillars terminated in large crescents.

The Greeks miscataloged *Mahram* because their moon deity was a goddess known more for wisdom than for warfare.<sup>2648</sup> So *Mahram* the moon-god did not match the Greek moon-god in gender or role.

Semitic moon-gods were easier to merge since each phase of the moon was given a different name. There were plenty of names that yielded many possible matches. Also, Arabian moon deities were all male.

Udi Levy gives an example of merging the traits of two cultures' goddesses based on their astral symbol:

The most ancient reference to the goddess *Al Uzza*, 'the powerful one,' originates in the fourth century BC, the first time that the *Nabateans* are mentioned in classical history. An inscription in *Nabatean* and Greek, which contains her name and equated her with *Aphrodite*, was found on the Aegean island of *Kos*. Nevertheless, *Al Uzza* appears to have been originally a *Nabatean* deity who only gradually took on the features of a Greek goddess. *Avraham Negev* notes in this respect that the power which comes to expression in the name of the goddess is linked to the morning star, and that a relationship can be established between her and Venus (*Aphrodite*) on the astral level....The transformation and development of *Nabatean* consciousness after the departure [emigration] from *Saba* [*Yemen*]...brought about not least through contact with Judaic messianic expectations and the influence of Greek culture—meant that they [the gods] were transformed into Hellenomorphic deities with human characteristics.<sup>2649</sup>

Arabian syncretism was especially easy since most of the names and titles of the gods were rather generic, as in "the god" (*Allah*), "the goddess" (*Allat*) and "the power" (*Al Uzza*). Popular moon-gods had these generic-sounding titles: *Wadd* (love), *Hukm* (wisdom), *Rahmanan* (the compassionate), *Sin* or *Su-en* (crescent), 'Amm or 'Anbay (uncle), *Mahram* (holy one) and 'Ilumquh (*Il Umquh*, meaning "god of the rainstorm").

### **Muslim Objections to the Standard Etymology for Allah**

Not all *Muslims* agree that *Allah* was a generic title. Many *Muslims* assert that *Allah* is an indeclinable proper noun and so has no plural or feminine form. This contention is based more on polemics than on scholarship.

Some *Muslims* claim that, unlike Christians, they never use the word "God" to refer to *Allah*, because "God" indicates gender (maleness). They also claim that the word *Allah* cannot be feminized and pluralized.<sup>2650</sup>

<sup>2648</sup> Nielsen, 1912, pp. 593-594, as translated in Krause, "*Haram–Harimat*."

<sup>2649</sup> Levy. *Lost*, pp. 79-80.

<sup>2650</sup> Fitzpatrick, Veronica. "Sheik ["Etymologist" Yusuf Estes] speaks on *Islam*, relation to Christianity," *dailytargum.com*, vol. 135, no. 35, 20 Oct 2003.

Unbiased scholars know better since *Allat* is the feminine form of *Allah*. *Allah* is the abbreviation for *Al Ilah*, meaning “The god,” and *Allat* is the abbreviation for *Al Ilat*, meaning “The goddess.”<sup>2651</sup> <sup>2652</sup> *Al-Ilat* is “mentioned in *Sabaeen* inscriptions.”<sup>2653</sup> So there is a feminine form of *Allah* and in pre-*Islamic* times there may have been a plural form that referred to *Allah* and *Allat*.

To say that the abbreviation *Allah* cannot be pluralized is silly since many abbreviations cannot be pluralized. For instance, one cannot append an “s” to pluralize the abbreviations “he’s” or “it’s,” since the normal plural is “they are.” Furthermore, many words cannot be pluralized such as sheep, trousers and cosmos.

The names of the gods have a long history and went through many transformations. The reasons why include the fact that incremental changes in phonics over many centuries add up to significant change. Also, the masses were subliterate and could not see the spelling decided upon in a previous generation. Enn Kasak and Raul Veede provide an example of the transformation a god’s name:

*Sîn* itself was originally written *EN-ZU* ‘lord of wisdom’ (later also written as <sup>d</sup>*ZU-EN*), with the earlier reading <sup>d</sup>*Su’en* soon shortened to <sup>d</sup>*Sîn*. Though the moon-god’s name can sometimes be written as <sup>d</sup>*NANNA-SUEN*, this form was not used to denote the celestial body. There is also a variant <sup>d</sup>*ZU* [meaning “lord”], which has shortened from *ZU-EN*.<sup>2654</sup>

The forms *Allah* and *Allat* are not special in that they follow the standard *Semitic* rule for inflection between the masculine and feminine forms. The *-ah* ending is masculine and the *-at* ending is feminine. Jeffery wrote:

The name *Allah*, as the *Quran* itself is witness, was well known in pre-*Islamic* Arabia. Indeed, both it and its feminine form *Allat*, are found not infrequently among the theophoric names in inscriptions from North Arabia.<sup>2655</sup>

Not all *Muslims* agree that *Allat* was a generic title. Otherwise, this would suggest that *Allat* was the goddess consort of *Allah*. Hence, many *Muslims* attempt to distance *Allah* from *Allat* by speaking of *Allat* as though her real name really was *Al Lat* (Arabic: “the *Lat*”). *Lat* however was the abbreviation for *Ilāt* the sun-goddess,<sup>2656</sup> who is elsewhere called *Allat*.

This type of etymological gymnastics is often used in *Islam* to explain away embarrassing facts. This exposes just how deep *Muslim* denial and self-deception are concerning the pagan roots of *Islam*.

Those who interact with *Muslims* will encounter many fact-defying statements similar to those noted above—about *Allah* being indeclinable and about *Al Lat* being *Lat* rather than *Allat*, the consort of *Allah*. An example is called for.

*Muslim* literature often mentions *Allah*’s ninety-nine names and *Muslims* discuss with each other *Allah*’s ninety-nine names. But if a non-*Muslim* speaks of *Allah*’s ninety-nine names, then the *Muslim* may correct the non-*Muslim* and say that *Allah* only has one name, that being *Allah*. He’ll claim the other “names” are just attributes.

<sup>2651</sup> Jeffery. *Islam*, p. 85.

<sup>2652</sup> Wollaston. *Life*, p. 149, Ch. V. “The *Quran*.”

<sup>2653</sup> Ryckmans, Jacques. *EB*, “Arabian Religions,” 2004; also see Warraq. *What*, Ch. 8.2: “On the *Koran*,” by Julius Wellhausen, Translated by G. A. Wells, p. 647.

<sup>2654</sup> Kasak, Enn and Raul Veede. “Understanding Planets in Ancient Mesopotamia,” *Folklore*, vol. 16, Editors Mare Kõiva & Andres Kuperjanov, Folk Belief and Media Group of ELM, [haldjas.folklore.ee/folklore/vol16/planets.pdf](http://haldjas.folklore.ee/folklore/vol16/planets.pdf), pp. 17-18.

<sup>2655</sup> Jeffery. *Islam*, p. 85; also see Wollaston. *Life*, p. 149, Ch. V. “The *Quran*.”

<sup>2656</sup> Goel. *Hindu*, vol. ii, ch. 11 “Religion of Pagan Arabia.”

Enforcing a double standard for scholarship, one standard for *Muslims* and another standard for critics, is in keeping with K 009:029. *Muslims* feel favored by *Allah* if they make *acaDhimmis* acknowledge *Islam*'s superiority and "are made to feel their state of subjection." Also, *Muslims* are commanded to be kind to *Muslims* but harsh to non-*Muslims* (K 009:073, 123; 048:029; 066:009).

Here is another instance of fact-defying argumentation. To avoid the charge that *Muslims* celebrate when non-*Muslims* suffer terrorist attacks, *Muslims* resort to splitting hairs, sophistry and obfuscation. For instance, some *Muslims* deny having celebrated terrorist attacks by using the common refrain:

*Muslims* only celebrate two days, *Eid Al Fitr* and *Eid Al Adha*.

*Muslims* engage in magical thinking when they expect that Westerners will forget the newsreels of *Muslims* dancing and parading in the streets, ululating and handing out candy whenever there is a major terrorist attack. Is this not celebrating?!

True, *Muslims* do have only two prescribed feasts per year, but *Muslims* do celebrate many local feasts and holy days, as well as these three holidays: 1) *Muharram*, the *Muslim* New Year, 2) *Mawlid an-Nabi*, *Muhammad*'s birthday and 3) *Lailat Al Miraj*, *Muhammad*'s Night Journey.<sup>2657</sup>

### ***Muhammad* Figured That *Allah* Was *Yahveh* Based on a Common Appellation**

The *Encyclopædia Britannica* gives examples of Arab gods with generic-sounding names:

Other *Lihyanite* gods were *Han-Aktab* 'the Scribe' and *Baalshamin* 'the Lord of Heavens.'<sup>2658</sup>

Arabian moon-gods were especially easy to syncretize. That is because in the patriarchal society of Arabia, the moon-god was considered the high god nearly everywhere. Also, in Arabic the words for the moon are masculine, while the words for the sun and Venus are feminine. This grammatical framework encouraged uniformity in mythology, which explains why Arabian moon-gods were always male.

Many of the appellations used in the worship of the other moon-gods around Arabia were the same, leading *Muhammad* to believe that all Arabs worshipped *Allah*. Hawting wrote:

Wellhausen argued that each tribe had come to refer to its own deity simply as 'the god' [*Al Ilah* or *Alaha*] and this paved the way for the emergence of the idea that the tribes in fact worshipped the same god.<sup>2659</sup>

James Hastings wrote:

In the *Nabataean* inscriptions we repeatedly find the name of a deity accompanied by the title *Alaha* 'the god.' Hence Wellhausen argues that the Arabs of a later age may also have applied the epithet *Allah*, 'the god,' to a number of different deities, and that in this manner *Allah*, from being a mere appendage to the name of the great god, may gradually have become the proper name of the Supreme God.<sup>2660</sup>

The polytheistic *Makkans* seem to have referred disapprovingly to the practice of merging gods based only on their common appellations. It was a slippery slope,

<sup>2657</sup> Jeffery. *Islam*, pp. 225-226.

<sup>2658</sup> Ryckmans, Jacques. *EB*, "Arabian Religions," 2004.

<sup>2659</sup> Hawting. *Idolatry*, p. 27.

<sup>2660</sup> Hastings. *Ethics*, "Arabs (Ancient)" entry, p. 664, right column, bottom.

because each god had so many similar titles, one could easily end up with monotheism, so the *Makkans* said:

Do you want to make all the gods into one God, *Muhammad*? That would be an extraordinary thing... (K 038:005).<sup>2661</sup>

Why would the *Makkans* think this? Perhaps it refers to how *Muhammad* has *Allah* saying “we,” “us” and “our” so often in the *Koran*. The plural indicated to the *Makkans* that *Muhammad* had merged *Allah* and his daughters into one god as though they were Russian nesting dolls (*Matryoshki*).

To the *Makkans*, the fact that *Muhammad* said that *Allah* had at least “ninety-nine” names meant that *Muhammad* had merged *Allah* with other gods and that *Allah* had absorbed the other gods’ names in the process. The most obvious example is how *Muhammad* called *Allah* by the Aramaic foreign word “*Rahman*,” meaning “Merciful” (K 017:110). Jacques Ryckmans wrote about the title *Rahman*:

After about AD 350 [in *Yemen*] monotheistic invocations to *Rahmanan*, ‘the Merciful’ (an epithet of Aramaic origin used for God by both Jews and Christians), or to the ‘Lord of Heaven and Earth,’ take the place of former polytheistic formulas and dedications. These early monotheistic texts probably emanated from Jewish immigrants from the oases of the *Hejaz*, although Christianity had already been introduced in South Arabia by Byzantine and Syrian missionaries.<sup>2662</sup>

This process of syncretization using names was not without its critics. Disputes over deities’ names are mentioned in the traditions and the *Koran* often, for instance:

What! Do you dispute with me about names that you and your fathers have given? *Allah* has not sent any authority for them (K 007:071).

You worship nothing besides *Allah* but mere names that you have named, you and your fathers; *Allah* has not sent down any authority for them (K 012:040; also see 007:071, 180; 012:040; 017:110; 020:008; 053:023; 059:024).

*Muhammad* easily discarded the names of deities that he did not want *Allah* to assume. In K 053:020-023 *Muhammad* says that *Allat*, *Uzza* and *Manat* were just pseudonyms that his *Makkan* forebears had applied to male angels. These goddesses however were worshipped throughout the Mideast and their names exist in inscriptions that predate *Muhammad* by centuries!

During one of *Muhammad*’s long nights of meditation in the *Hira* Cave, he became convinced of what the Religion of *Ibrahim* adherents told him—that *Allah* the moon-god was the God of the Bible. The *Hanifs* believe this because of the *Haranian* influence, which was discussed in a previous chapter.

*Muhammad* once thought like Pharaoh who said “Who is *Yahveh*...I do not know *Yahveh*” (Exo 05:02). *Muhammad* however came to believe that all the major religions he knew of were essentially the same since they all used moon icons in some manner.

*Muhammad* also saw how the Religion of *Ibrahim* disciples sacrificed at the *Kaaba*’s crescent-shaped *Hatim* Wall. The Religion of *Ibrahim* devotees worshipped *Allah* the moon-god as though he were the God of the Bible, as will be discussed shortly. This, in *Muhammad*’s mind, legitimized *Makka* as a place to worship the God of the Bible.

<sup>2661</sup> Ishaq. *Sirat*, p. 192.

<sup>2662</sup> Ryckmans, Jacques. *EB*, “Arabian Religions,” 2004; also see Warraq. *What*, Ch. 8.2: “On the *Koran*,” by Julius Wellhausen, Translated by G. A. Wells, p. 647.

Based on these observations, *Muhammad* mistakenly figured that all major Mideast religions originally were moon-god religions that could somehow be traced back to *Makka*.

*Muhammad* accepted as the genuine expression of each faith only those commonalities found in each religion. *Muhammad* rejected everything he did not borrow and incorporate into *Islam* as being mere accretions and inventions.

Example of peculiar doctrines that *Muhammad* borrowed are: 1) the Balance, used to weigh good and evil deeds, 2) the Bridge of the *Sirat*, the sword between earth and heaven that everyone would be forced to attempt to cross and 3) the *Houris*.

### The Religion of Ibrahim (Hanifism)

The idea that monotheistic ideas were native to Arabia even before Jewish ideas infiltrated Arabia is a misreading of history peculiar to *Muslim* apologists. There may have been some moon henotheistic ideas floating around Arabia. Pure monotheism however was a creed only of *Yahvists*. G. R. Hawting wrote:

Where the early *Muslim* scholars saw a corruption of monotheism in Arabia before *Islam*, modern scholarship has generally perceived a gradual alleviation of polytheism. Where traditional scholarship saw *Muhammad* as sent to restore what had once existed in Arabia, modern scholars have tended to portray him as a part of the evolutionary process....The *Urmonotheismus* or 'high god' approach again reflects monotheistic suppositions and premises. Much of the evidence on which this general theory was based is now considered of questionable value, reflecting either the interpretations of monotheist observers of 'primitive' religions or the impact of monotheist missionaries and rulers on the societies of which the religions were a part.<sup>2663</sup>

By *Muhammad*'s time, the prevailing winds of monotheism had blown across the Arabian Peninsula from Judea for centuries. The *Encyclopedia Britannica* states:

In *Yemen* (southwestern Arabia) the last of the Simyarite rulers (reigned from ~2nd century CE), *Dhu Nuwas*, proclaimed himself a Jew and finally suffered defeat (~525 [AD]) as a consequence of Christian influence on the *Abyssinian* armies. Jewish missionaries however continued to compete with Christian missionaries and thus helped lay the groundwork for the birth of an indigenous Arabic monotheism—*Islam*—that was to alter the course of world history.<sup>2664</sup>

*Makka* felt monotheistic pressure from the direction of *Yemen*. Guillaume wrote that pagan...

...temples were few and far between. Outside of the famous sanctuary of the *Kaaba* at *Makka* there was a *Kaaba* in *Nejran* [or *Najran*] on the *Sa'udi-Yaman* [*Saudi Arabian-Yemeni*] border...and one at *San'a* [*Sanaa, Yemen*]. In these last two places Christian cathedrals once stood. Doubtless the extraordinary pains that were taken in their construction and decoration were directed toward weaning the pagan population from their age-long practices.<sup>2665</sup>

*Ibn Ishaq* wrote:

<sup>2663</sup> Hawting. *Idolatry*, pp. 32-33.

<sup>2664</sup> *EB*, accessed 5 Oct 2002, Judaism entry.

<sup>2665</sup> Guillaume. *Islam*, p. 10.

*Abraha* [a Christian] built a cathedral in *Sana* [*Yemen*], such a church as could not be seen elsewhere in any part of the world at that time. He wrote to the *Negus* [in *Abyssinia*] saying: ‘I have built a church for you, O King, such as has not been built for any king before you. I shall not rest until I have diverted the Arabs’ pilgrimage to it.’ When the Arabs were talking about this letter of his, one of the calendar intercalators [at the *Kaaba* at *Makka*] was enraged.<sup>2666</sup>

To the northwest of *Yemen* in *Makka*, there were only a few Christians and Jews, most likely of the unorthodox kind. No church or synagogue was ever established in *Makka* or its environs, though there were a few in *Makka* who professed to be Christian and Jewish.

Missionaries seem not to have been welcome in *Makka*. It was feared that this would divert traffic away from the *Kaaba* just as Demetrius feared Christian missionaries for the same reason (Act 19:24, 38).

Around *Makka* the main monotheists were *Hanifs*. They claimed to adhere to the Religion of *Ibrahim*. The *Hanifs* recognized the local moon-god in any pagan pantheon as their high god and only god. The rest of the astral religion was downgraded to mere astrology in which angels manned the planets and stars and influenced human events and the weather.

For the *Hanifs*, the moon-god’s name did not particularly matter much. In *Makka* the *Hanifs* worshipped *Allah* the moon-god. Brian Doe wrote about other moon-gods in South Arabia:

The national god of each of the kingdoms or states was the moon-god known by various names: ‘*Ilumquh* by the *Sabaeans*, ‘*Amm* and ‘*Anbay* by the *Qatabanians*, *Wadd* by the *Minaeans*, and *Sin* by the *Hadramis*. The sun-goddess was the moon’s consort...another dominant deity was the male god known as ‘*Ahtar* corresponding to the *Phoenician* ‘*Ashtarte*.’<sup>2667</sup>

F. E. Peters wrote that the *Hanifs* venerated the *Kaaba* in pre-Islamic times:

...doubtless as the Holy House built by Abraham...allusions and traditions add to the certainty that the *Hanifs* conducted their rituals at the *Kaaba* at *Makka*.<sup>2668</sup>

The *Hanifs* probably were the ones who carved footprints near the *Kaaba* that were said to be the Standing Place of *Ibrahim*. The Standing Place of *Ibrahim* is discussed in more detail elsewhere.

Since the *Kaaba* was *Allah*’s house, *Allah* the moon-god happened to be the god of the *Hanifs* in the environs of *Makka*.<sup>2669</sup> The *Hanifs* probably called every moon-god around Arabia *Allah*, in addition to whatever name the locals used. After a few centuries, the influence of the *Hanifs* rubbed off. Then the Arabs thought all the moon-gods around Arabia were one and the same *Allah*.

When *Muhammad* came, the *Hanifs*’ *Allah* moon-god religion was prevalent across Arabia. *Muhammad* merely consolidated the religion by invalidating the other lesser known *Allah* moon-god prophets and shrines.

*Muhammad* co-opted the jobs of other moon-god prophets who dared to be his equal—such as *Al Aswad*,<sup>2670</sup> the prophetess *Sajah* of *Tamim*<sup>2671</sup> and *Musaylima* “the

<sup>2666</sup> Ishaq. *Sirat*, p. 21.

<sup>2667</sup> Doe. *Arabia*, p. 25.

<sup>2668</sup> Peters. *Origins*, p. 124.

<sup>2669</sup> K 002:125; 003:096-097; 005:002, 097; 008:035; 014:037; 022:026, 029, 033; 033:033; 052:004; 106:003.

<sup>2670</sup> Ishaq. *Sirat*, p. 648.

Liar” (died 633 AD/12 AH). Musaylima was the nickname *Muslims* gave to Maslama.

This excerpt from a *Hanif* poem explains the *Hanif* perspective on Christianity and Judaism:

Were it not for our Lord [*Allah*] we should be Jews, and the religion of the Jews is not convenient. Were it not for our Lord [*Allah*] we should be Christians, along with the monks on Mount *Jalil*.<sup>2672</sup>

Judaism is an inconvenient religion (Act 15:10). The *Hanif* comment on Christianity needs explanation, however. The Christians on Mount *Jalil* were ascetic monks. There were many monks in the deserts of Arabia. Not only did most monks hold a variety of heretical beliefs but also their asceticism gave the Arabs a misperception of what Christianity was about.

Asceticism in a mountain cave or monastery complex was definitely not to the *Hanifs*' liking. The austere *Yahveh* whom the monks presented to the Arabs was not the festive *Yahveh* that Saint Paul spoke of:

Yet he [*Yahveh*] has not left himself without testimony: He has shown kindness by giving you rain from heaven and crops in their seasons; he provides you with plenty of food and fills your hearts with joy (*NIV* Act 14:17).

The *Hanifs* were of the Religion of *Ibrahim*, so they likely indulged in polygynous practices and easy divorce. The divorce of Abraham that the *Hanifs* copied was the sending of Hagar and Ishmael out with food and a skin of water (Gen 21:14). The difference though is Abraham knew *Yahveh* would make Ishmael into a great nation (Gen 16:12; 17:20). In the same manner Abraham almost sacrificed Isaac believing that perhaps *Yahveh* would resurrect him (Heb 11:17-19). *Muslims* however have no such promises about the well-being of the wives they divorce.

Christianity learns from the patriarchs' mistakes but *Islam* revels and wallows in these same mistakes. Christians learned that *polygyny* causes all kinds of problems and makes for angry offspring too (Gen 16:12).

*Islam* is like Isaac who did not learn from Abraham's mistakes brought on by a lack of faith (Gen 12:18-20; 20:09-13; 26:08-10). *Islam* is like Belshazzar who met his demise because he did not learn from *Nebuchadnezzar's* entanglement with *Yahveh* (Dan 05:22).

The lesson to be learned from the Patriarchs' dalliances with *polygyny* is that the ideal marriage is one husband and one wife—the way it was from the beginning (Mat 19:05, 08; Eph 05:31). If four wives were better than one, *Yahveh* would have favored Adam with Eve I, II, III and IV rather than just Eve (Gen 02:02).

One wife is more than a match for a husband, if a society allows women to develop socially and intellectually to be men's complement (Gen 02:18-20). Of course it is another situation entirely if women are kept illiterate or subliterate, secluded, and are kept wearing veils, *Hijabs* (*Muslim* headscarfs) and *Burkas* (baggy clothing). The many strictures and indignities that *Muslim* women must endure may explain to a great extent why some *Muslim* men feel unsatisfied having just one wife at a time.

Nevertheless, *Muslims* refuse to learn that sometimes fewer is better, and so they condemn their culture to a Sisyphean existence of making the same mistakes over and over.

<sup>2671</sup> Lings. *Sources*, p. 336.

<sup>2672</sup> Ishaq. *Sirat*, p. 201, as quoted by Peters. *Origins*, p. 124.

Not only are *Muslims* outside the will of *Yahveh* but *polygyny* detracts from quality of life and life expectancy in the Mideast. Polygyny tends to breed poverty with all its attendant woes, especially when the woes of *Islam* are piled on.

The *Hanifs* surely did not want to hear their spiritual master say what Jesus said:

Moses permitted you to divorce your wives because your hearts were hard. It was not this way from the beginning. I tell you that anyone who divorces his wife, except for marital unfaithfulness, and marries another woman, commits adultery (Mat 19:07-09; Mar 10:04-09).

The *Hanifs* wanted their wives to think along the same lines as *Muhammad's* wives thought after *Muhammad* took so many sexual liberties:

They [*Muhammad's* wives] well knew that he was altogether within his rights—rights which had been recognized from the time of Abraham and before. Were they not all, except Safiyyah [a Jewess], descended from the union of Abraham with the bondmaid Hagar? Moreover, the law revealed to Moses had corroborated such rights, and the *Koran* itself expressly allowed a master to take his bondmaid as concubine on condition of her free consent.<sup>2673</sup>

Obviously, *Muhammad's* many wives did not know that Moses said that kings “ought not take many wives or his heart will be led astray” (Deu 17:17). Moreover, the Bible shows by repeated examples that the family life of polygynists was often wrecked by jealousy, strife, contemplation of murder, selling a sibling into slavery, and even greater sins.

*Muhammad's* wives did not know that Jesus said marriage should be monogamous. *Muhammad's* wives also did not know that Moses allowed divorce and other objectionable cultural practices only because the Hebrew hearts were hard (Mat 19:07-09; Mar 10:04-09). The same could be said of slavery—it was not prohibited in Scripture because the options in a society too poor and primitive to afford prisons were either slavery or death—*tertium non datur*.

That Jesus disapproved of polygyny in the NT is likely another reason that Christianity was kept out of *Makka* as far as was possible. Even the *Hanifs* preferred Abraham's relative laxity in morals and ethics compared to Christianity's austerity. Robert Morey wrote:

*Muhammad* utilized the *Testament of Abraham* to teach that a scale or balance will be used on the Day of Judgment to weigh good and bad deeds in order to determine whether one goes to heaven or hell (*Suras* 042:017; 101:006-009 [Also see *K* 007:008; 018:105; 021:047; 023:102; 042:017; 057:025 and 101:006-009]).<sup>2674</sup>

The scale image found in the *Testament of Abraham* comes directly out of the pagan Egyptian *Book of the Dead*.

From the *Koran* and from *Muhammad's* biography one can tell that *Muhammad* figured that only his every other deed needed to be good. *Muhammad* also rationalized that all his good deeds could be entirely financed by other people's money in the form of loot, tribute or taxes.

Truly, most religions have a despicably low standard for morality where the adherents believe they can enter heaven as long as their good works outweigh their evil deeds. The flaw in this approach to religion is that even career criminals and their mothers feel their good works outweigh their bad.

<sup>2673</sup> Lings. *Sources*, p. 277.

<sup>2674</sup> Morey. *Invasion*, p. 150.



Whenever a population feels that they can escape hell as long as the ratio between their good works and evil deeds is at least 1:1, the unintended consequence is that evil flows forth and good deeds become rare. Not surprisingly, those regions of the world where such religions predominate tend to be insufferable to live in due to poverty, crime and corruption, and they are harrowing to visit—except for touristy areas. The reason is that one good work cannot undo the damage of one evil deed any more than adding a gallon of the purest distilled water can eliminate a previous pint of pollution, so evil consequences are compounded over time.

Biblical Christianity believes that the Spirit creates faith and motivates the Christian to do good works created for him to do from eternity (Joh 06:29; Rom 04:05; 09:32; Eph 02:10; 1Th 01:03). So while the indwelling of the Spirit and the presence of faith determine whether one is saved, Christians would never dream of having a low standard of morality. No Christian thinks that merely balancing one good deed for one evil deed is ever good enough.

The *Hanifs* worshipped at the *Kaaba* and even sacrificed at the *Kaaba*. The native religions in Arabia were astral, so though the *Hanifs* were monotheistic, their belief system had an astrological bent. This allowed the *Hanifs* to continue to worship at the *Kaaba* moon-god shrine.

The *Hanifs* were able to worship *Allah* the moon-god but downgraded the lesser gods to an angelic status. The astral angels still retained the powers they had when they were gods.

Being an astral angel was a step up from being a mere patron saint like those found in the Catholic Church. Patron saints were thought to have special intercessory privileges, whereas the astral angels were thought to be empowered by *Allah* to dispense help directly.

In the *Hanif* system the male angels picked up directly where the deities left off. *Uzza* (the Venus goddess) imparted sexual energy and *Allat* (the sun-goddess) promoted vegetative growth. *Manat* (Fate) had no known astral association but was an angel nonetheless according to *Muhammad* (*K* 053:020-023).<sup>2675</sup> The star *Sirius* rose in Autumn and brought the fall season, and certain stars brought rain.<sup>2676</sup>

That a male angel would impart sexual energy might seem strange to Christians who believe the angels are platonic (Luk 20:35-36). *Muhammad* however believed that supernatural entities were sexual because that was the prevalent pagan belief.

*Muhammad* apparently thought that angel-like creatures called *Jinn* were sexual because he had to assure *Muslims* that the *Jinn* had not deflowered the *Houris*. *Houris* are the *nymph* nymphomaniacs supposedly awaiting *Muslims* in heaven. The nymphs are said to be as beautiful as rubies and pearls (*Houris* are discussed in the Khidr-Second Lamech Logic table).

Well-known *Muslim* traditions and the *Koran* record *Muhammad* saying that the Garden of Eden had been, and still is, in heaven and that the Fall not just a fall into sin, but a literal descent from heaven. *Muhammad* thought that Adam and Eve had been given clothes in heaven, but after they had been kicked out of heaven down to earth, Satan stripped them of their clothing to shame them (*K* 007:019-027).

That *Muhammad* thought Eden was in heaven helps explain why *Muhammad* thought of heaven as being a *Harem* in a garden. Significantly, *Muslim* suicide-

---

<sup>2675</sup> Ishaq. *Sirat*, p. 207, fn. 3.

<sup>2676</sup> Ishaq. *Sirat*, p. 358 & fn.

bombers believe they are going to the heavenly Garden of Eden, as *The Jerusalem Post* reported:

‘Blowing myself up is the only chance I’ve got to have sex with 72 virgins in the **Garden of Eden**,’ a 14-and-a-half-year-old Palestinian boy told his *Israeli* investigators after being caught wearing an eight kilogram explosives belt.<sup>2677</sup>

*Ynet News* reported one terrorist as saying:

‘Thank God, this is our part in this life in this world: To live as a *Mujahid* (*Muslim* fighter) in the hope that in the end we will live near Prophet *Mohammed* in the Garden of Eden,’ says *Abu Sai*’d.<sup>2678</sup>

*Muhammad* may have been led to believe that angels were sexual after hearing the Jewish myth concerning Gen 06:01-04. St. Clair-Tisdall explains that this interpretation resulted from the influence of a faulty Hebrew etymological study and a *Babylonian* myth that Jews heard during their exile in *Babylon*.<sup>2679</sup>

The myth says that before the Flood, fallen angels and women mated to create the grotesque *Nephilim* species. The natural reading of the text refutes this myth:

The *Nephilim* were on the earth in those days—and also afterward—when the sons of God [*Yahvists*, i.e. believers in *Yahveh*] went to the daughters of men [unbelievers] and had children by them (Gen 06:04).

Thus *Muhammad* may have believed Jesus was the same species as the *Nephilim*.

The commonsense reading of Gen 06:04 with its phrase “also afterward” indicates that the *Nephilim* (Antediluvian bandits) existed even before the *Yahvists* and unbelievers began to intermarry. The time before the Flood was over a millennium, so the passage is speaking of events that occurred over centuries. The conclusion can be drawn that the *Nephilim* were not angel-human offspring but just bandits.

What Moses implies in Gen 06:04 is that *Yahveh* would rather be the friend of righteous Noah than keep company with unbelieving, immoral celebrities and hero warriors or huntsmen. While the bandits drowned in the flood, it was Noah’s righteousness that saved his whole family from the floodwaters (Eze 14:14, 20).

The fact that Venus was a male angel who radiated sexual energy explains why the *Koran* has no explicit mention of male *Houris* for *Muslim* women in heaven. *Muslim* men already had to be assured that the *Jinn* had not deflowered the *Houris* awaiting them (as mentioned above). So the mention of Chippendale Dancer warlocks in heaven awaiting *Muslim* women would unnecessarily arouse jealousy in *Muslim* men over their wives.

Not only would *Muslim* men feel jealous of male sexual angels, but also they would feel inadequate about their sexual performance compared to that of an angel. This is revealed by this conversation between *Muhammad* and a follower:

When another asked him how one man could have the strength to (be intimate with) seventy girls in one day he responded: ‘He would be given the strength of one hundred men!’<sup>2680</sup>

So the closest *Muhammad* came to saying that there were male *Houris* in heaven was his saying that there were preadolescent serving boys wearing pearls (*Houris* are discussed in the Khidr-Second Lamech Logic table). Surely the *Muslim* men would

<sup>2677</sup> Dudkevitch, M. “Palestinian boy, 14, captured with explosives vest,” jpost.com, 24 Mar 2004.

<sup>2678</sup> Waked, Ali. “Life under the gun,” ynetnews.com, 2 Nov 2005.

<sup>2679</sup> St. Clair-Tisdall. *Sources*, Ch. III. “. . . Sabian and Jewish Ideas and Practices.”

<sup>2680</sup> Serene, *Ibn. Kitab ul Isra'a wal Mu'raj*, quoted in Caner. *Unveiling*, p. 193.

not find these effeminate boys sexually intimidating. In fact, many *Muslim* men would actually find the boys inviting, as Serge Trifkovic wrote:

The righteous [in heaven] will be served also by boys, ‘pure as pearls,’ dressed in green garments of fine silk and heavy brocade, adorned with bracelets of silver, and used [accustomed] to drinking wine. The presence of intoxicating youths in such a luxurious environment must have some unusual purpose. They do not seem to be ordinary servants, who would not need to be ever young, breathtakingly beautiful and adorned in sumptuous dresses and jewelry. According to some interpretations of the Tradition, and in the considered opinion of a contemporary *Islamic* commentator, ‘The men in Paradise have sexual relations not only with the women [who come from this world] and with ‘the black-eyed’ [*Houris*], but also with the serving boys....In Paradise, a believer’s penis [phallus] is eternally erect’ [Galal *Al Kushk*, as quoted in *Al Quds Al Arabi*, London, May 11, 2001].<sup>2681</sup>

Hans Krause wrote:

*Muhammad* Djalal Kischk writes in his book *Khawatir Al-Muslim Fi Al-Mas'ala Al-Djinsiyya* that these paradisiacal boys are available to those, who have a desire for them.<sup>2682</sup>

The presence of the boys wearing pearls is why *Muhammad* said that *Muslims* would have the sexual strength of a hundred men (quoted above) even though there are only seventy-two *Houris*. *Muhammad* believed that every day *Muslim* men would have sex with seventy-two *Houris* and twenty-eight serving boys.

Disgustingly loose sexual behavior, even pederasty, was copied from the heavens into *Islam*, especially through the medium of pederastic Arabic poetry and prose. This behavior transfer may sound rather far-fetched but this link explains why astral religions have historically been fertility religions.

Venus commonly was a fertility deity in the ancient world, the consort of either the sun or the moon. The idea that the sky was one big orgy lent itself naturally to the development of earthy, uncouth, even swinish astral phallic cults.

That astral and fertility religions go hand-in-hand may account for some imagery in *Genesis*. Abraham was familiar with the cultural myth that the sun and moon, or Venus and the moon, populated the sky with star children.

This may be why *Yahveh* told Abraham that his “seed,” seemingly a reference to a Mesopotamian farmers’ seed, would be like the stars of the sky (Gen 15:05; 22:17; 26:04; Exo 32:13). Not that *Yahvism* was an astral religion of course but Bible imagery and analogies are chosen based on what the listener is familiar with.

### The Psychology of Astral Fertility Religion

Certain stars in the sky along with the sun and moon were thought to promote vegetative growth and human and animal productivity. In astral religion, this power was in the domain of the gods but the new astrology had handed over these functions to angels.

Human fertility was less important than in former times since the ancients were farmers who found having many children was helpful, but classical and medieval astrologers lived in cities where children were more of an expense than help.

<sup>2681</sup> Trifkovic. *Sword*, pp. 63-64.

<sup>2682</sup> Krause, Hans. *Hans Krause's Research Reports: Islam: Its Fight for World Domination 5*, kruse.de, “Ch. 3: *Islam* and the Gospel.”

While some Christians may claim to see “The Gospel in the Stars,” for a *Muslim* to “think upon a star” usually meant that his interests had steered toward sensuality. A star field is erotic reading for *Muslims* who know their astrology well just as the sky was soft porn to pre-*Islamic* Arabs who knew pagan mythology.

*Muslim* artists often used the nighttime sky as their backdrop and filled their artwork with decorations. This style was an imitation of art in pre-*Islamic* fertility cults where curling vines indicate fertility. Eva Baer notes how star patterns are often used in *horror vacui* art:

These small-scale motifs are fitted into star and polygonal shapes of the geometric grid...This urge of the *Islamic* artist to fill any void has often been termed *horror vacui*, the fear of empty space...<sup>2683</sup>

Astral fertility religions expressed the concept of fertility in many ways, but especially with undulating vines that filled every space of a trellis or frame. This verdant plant growth represented vigorous human reproduction and was already a main facet of *Islamic* art in the seventh century, as can be seen in the Dome of the Rock.

Eva Baer notes the connection between filler geometric decoration and plant life:

The impact of gardens on *Islamic* aesthetics, and the mental connotations of abundant vegetation and ornament, suggested by Ettinghausen, is in fact already manifested in tenth- to eleventh-century Persian and Arab literature. One might recall, for example, the equation of lavish gardens with ornamentation by Manuchihrī (died 1040 [AD]), who in describing flowering gardens likens them to rich brocade. Similarly, *Al Bayhaqi* (995-1077 [AD]) compares the richly decorated throne of Bu Kalijar, allegedly a compatriot of Manuchihrī, to a garden ‘whose flowers are made of gold and silver and many kinds of jewels.’<sup>2684</sup>

The scholar Ettinghausen also identified the psychological need for *horror vacui* styled artwork. It was a felt need in the Mideast to populate barren or sparsely populated areas. The stars and astral imagery were included in *horror vacui* art because the stars, it was thought, promoted animal and human reproduction. Eva Baer wrote on the subject:

...he [Ettinghausen] suggested a connection between the crowded living conditions in Near Eastern cities and the artistic taste for density, arguing that living in close quarters probably increased the sense of security of the individual...Since the areas outside the protective city walls were mostly arid and hostile, closeness was associated with pleasantness, while emptiness evoked opposite connotations.<sup>2685</sup>

That religious artifacts, as well as *Mosques* and shrines, were commonly decorated with astral imagery in the *horror vacui* style shows *Islam* to be an astral fertility cult. Eva Baer writes that the *horror vacui* style, the...

...geometric interlacings and star motifs [were applied] to *Minbars*, domes, leather bindings, manuscript illuminations and so forth.<sup>2686</sup>

---

<sup>2683</sup> Baer. *Ornament*, p. 4.

<sup>2684</sup> Baer. *Ornament*, p. 126.

<sup>2685</sup> Baer. *Ornament*, p. 126.

<sup>2686</sup> Baer. *Ornament*, p. 127.

### The Connection Between Astral and Fertility Religions

It is a well-known phenomenon that astral religions tended to be fertility religions too. To illustrate how *Islam* is an astral fertility religion, it is helpful to compare it to two other astral fertility religions: Judaism of antiquity (discussed next) and Mormonism (discussed later in this chapter).

#### *Judaism of Antiquity as an Astral Religion*

Abraham engaged in polygyny and had many sons and daughters by concubines (Gen 16:15-16; 25:06, 12). There was no divine sanction for his having concubines. The Bible explains Abraham and Sarah's rationale for obtaining Hagar, and the explanation does not involve any command from God but only their mistaken deductive logic.

Abraham and Sarah inherited their father's moon-god morality regarding concubines. Abraham and Sarah's father *Terah*, meaning "moon," would have worshipped astral deities at *Haran*, the City of the Moon (Jos 24:02).

Jews appropriated pagan astral symbolism that periodically had to be cleared out of the temple during periods of reformation (2Ki 23:11). Jews had coins with astral imagery before 70 AD, about which Meshorer wrote:

It is logical to assume that the symbol filtered into Judaism as an object related to fertility and then acquired additional Jewish connotations.<sup>2687</sup>

Bernard Goldman notes that in the *Maccabean* period "the star of the *Maccabees*" was placed over the temple façade."<sup>2688</sup> The temple that was destroyed by the Romans likewise had astral symbols, according to Josephus. Many Byzantine-era synagogues had mosaic zodiac circles, as discussed in a later chapter.

Jews embraced the five-pointed star, a pentagram, which they called the "Seal of Solomon." Also, Jews called the six-pointed star *Magen David*, the "Shield of David."<sup>2689</sup> The "Shield" is a reference to *Yahveh*, so astral imagery is used to depict *Yahveh*. The *Encyclopedia Britannica* states:

The term *Magen David*...in Jewish liturgy signifies God as the protector (shield) of David...<sup>2690</sup>

A Star of David was found in the ruins of the third-century synagogue at Capernaum. The star is located prominently on an entablature. Above the dentals of the entablature is a crescent-and-orb motif.<sup>2691</sup> The association with the crescent-and-orb motif suggests that the origin of the Star of David was sometimes confused with astral fertility religion symbols.

The Star of David seems to have been of the same genre as another Jewish astral symbol—the double cornucopia with a pomegranate orb on a stem between the horns of plenty. The double cornucopia is mentioned again in a later chapter. Ya'akov Meshorer wrote about double cornucopia (as was quoted above):

It is logical to assume that the symbol filtered into Judaism as an object related to fertility and then acquired additional Jewish connotations.<sup>2692</sup>

The accounts of David and Solomon's many wives and concubines suggest that the Shield of David and Seal of Solomon represent Venus, a planet associated with

<sup>2687</sup> Meshorer. *Coinage*, vol. i, pp. 67-68 & plates 8-55 have cornucopias, especially coins Jc1-Jc7.

<sup>2688</sup> Goldman. *Portal*, p. 68.

<sup>2689</sup> *EB*, "David, Star of" entry, accessed 28 Aug 2003.

<sup>2690</sup> *EB*, "David, Star of" entry, accessed 28 Aug 2003.

<sup>2691</sup> Swinton. *Stone*, pp. 11, 162.

<sup>2692</sup> Meshorer. *Coinage*, vol. i, pp. 67-68 & plates 8-55 have cornucopias, especially coins Jc1-Jc7.

fertility. Similarly, “the Star of the *Maccabees*” was located over the temple façade, as noted above, and may have been a fertility symbol.

The *Maccabees* may have placed a huge gold leaf grape vine over the temple façade. At least, it is known that the *Herodian* temple had such a vine from coins from the first centuries BC.<sup>2693</sup> Josephus mentions a vine with grape clusters as tall as a man.<sup>2694</sup> Such a vine would indicate that the Star of the *Maccabees* represented Venus.

When Stephen mentioned the Star of *Rephan*, he was quoting *LXX* Amo 05:25-26. The Hebrew *Kaiwan* is translated into Greek as *Rephan* (RSV Amo 05:26). *Kaiwan* refers to Saturn.<sup>2695</sup> Based on these Biblical passages, the *Damascus Document* 7:14-15<sup>2696</sup> and other literature, it is thought that Saturn was once considered the planet protector of Jews.

In Act 07 Stephen seems to be chastising Jews of his time over their dabbling in astrology and astralism:

Did you bring me sacrifices and offerings forty years in the desert, O house of *Israel*? You have lifted up the shrine of *Molech* and the star of your god *Rephan*, the idols you made to worship. Therefore I will send you into exile beyond *Babylon* (Act 07:42-43; quote of Old Testament *LXX* Amo 05:25-26).

A later chapter will discuss how astralism infected first century AD Judaism. But it is interesting to note that the *Kabala* carried on the astral tradition in Judaism to the present day. The *Encyclopedia Britannica* states:

*Kabbalists* popularized the use of the symbol [Star of David] as a protection against evil spirits. The Jewish community of Prague was the first to use the Star of David as its official symbol, and from the 17th century on the six-pointed star became the official seal of many Jewish communities and a general sign of Judaism.<sup>2697</sup>

Given the fact that Judaism has astral fertility elements, it is not surprising that Jews also practiced polygyny since ancient times as evidenced by the Bible. Josephus around 70 AD related:

It is the ancient practice of us [Jews] to have many wives at the same time.<sup>2698</sup> Jews in *Muslim* lands still practice polygyny. The *Sephardic* Jews who emigrated out of *Muslim* lands practice polygyny in secret in *Israel* since polygyny is illegal in modern *Israel*.

Anthropologist S. Zev Kalifon of *Bar-Ilan* of the University in *Israel* says modern polygyny is seen as being Jewish by some:

‘Advocating polygyny reminds these [*Ashkenazim*] *Rabbis* that they ‘gave in’ to outside pressures, changed tradition to fit in to the European world and strayed from the way of our forefathers,’ said Kalifon. Polygyny says that

<sup>2693</sup> Meshorer. *Coinage*, vol. ii, p. 143, as quoted in Tameanko. *Coins*, pp. 48-49.

<sup>2694</sup> *The Jewish War*, bk. V, ch. V. and *Jewish Antiquities*, bk. XV, ch. XII, as noted in Tameanko. *Coins*, pp. 48-49.

<sup>2695</sup> *Strong’s* 3594: “*Chiun*...*Assyrian*-*Babylonian* god of the planet Saturn.”

<sup>2696</sup> *Institute for Biblical & Scientific Studies*, “Genesis 1:14-19 Day 4 Wandering Stars,” bibleandscience.com, accessed 20 Dec 2003.

<sup>2697</sup> *EB*, “David, Star of” entry, accessed 28 Aug 2003.

<sup>2698</sup> *Jewish Antiquities* 17:1, 2, 15, as quoted by Schmidt. *Divide*, p. 81.

*Sephardic* Jews are closer to the tradition, purer in their observation of Judaism and less assimilated into the modern world.<sup>2699</sup>

If it were not for the ancient Roman and later Christian influence, polygyny might still be a common Jewish practice. Christopher Smith wrote:

Stories in the Old Testament indicate polygyny was an accepted part of the social order and is technically legal under Jewish law. But the practice has been banned for (*Ashkenazi*) Jews in Europe since the 11th century, when *Rabbinate* leaders sought to ease tensions between Jews and their Christian neighbors, who considered polygyny barbaric.<sup>2700</sup>

### ***Islam as an Astral Fertility Religion and The Saladin Complex***

What characterizes an astral religion is overall loose sexual norms, though there were exceptions. Evidently, culture must always draw the line for immoral sexual behavior somewhere. Stephen Murray and Will Roscoe wrote:

For more than a millennium...the choicest specimens were pale Christian boys, generally sold by their parents (but occasionally stolen), and often transported by Christian merchants to Egypt, Syria or Turkey. One reason William of Adam criticized trading with the enemy in the late thirteenth century was that *Muslim* merchants ‘take suitable boys and fatten them up, and wash them often in all kinds of baths, and dress them in soft garments so that they are ‘plumper and pinker and more delightful’ and so sell them as male prostitutes on a market where a man and an effeminate may live as man and wife’ (N. Daniel<sup>2701</sup>). The slave trade placed throngs of beautiful boys at the disposal of rich conquerors (M. Daniel<sup>2702</sup>,<sup>2703</sup>).

Stories with pedophilic imagery are scattered throughout the *Arabian Nights* anthology such as *The Tale of Nur Al Din Ali and His Son Badr Al Din Hasan*. Richard Burton, the famous British explorer and Orientalist, wrote in his Terminal Essay: Section D: Pederasty: “I have noted in *The Nights* that the great and glorious *Saladin* was a habitual pederast.”

Because *Islam* is an astral fertility religion, loose sexuality factors into every aspect of *Muslim* life. Of course this might be expected since Arab *Muslims* figured they were all the descendants of Abraham’s union with the slave Hagar.<sup>2704</sup>

The fact that *Saladin* was a pederast also explains a lot of Mideast politics. Jim Wafer wrote:

Bell quotes another *Hadith* to the same effect: ‘According to Anas, the Prophet said ‘Keep not company with the sons of kings, for verily souls desire

<sup>2699</sup> Smith, Christopher. “Polygyny’s Practice Stirs Debate in Israel,” *Salt Lake Tribune* (posted at polygynyinfo.com), 7 Dec 2001.

<sup>2700</sup> Smith, Christopher. “Polygyny’s Practice Stirs Debate in Israel,” *Idem*.

<sup>2701</sup> *De modo Saracenas extirpandi* 2:523-25, as quoted in Daniel, Norman. *The Arabs and medieval Europe*. Longman, London, 1975, p. 224.

<sup>2702</sup> Daniel, Marc. “Arab civilization and the male love,” *Gay Sunshine*, 1977, vol. 21:1-11, 27, 1977, p. 4.

<sup>2703</sup> Murray. *Culture*, p. 303.

<sup>2704</sup> Lings. *Sources*, p. 277.

them in a way they do not desire freed slave-girls” (1979:21; cf. Bellamy 1979:37).<sup>2705</sup>

So many would-be heroes in *Islam* seek martyrdom status and would rather die than live to fight another day. They seek the seventy-two *Houris* awaiting them in *Muslim* heaven. This is in contrast to the *Islamic* rulers like *Saladin* who already have a *Harem* even larger than their outsized sexual appetites. For them, heaven can wait, unless of course the rulers are sexually impotent.

Commentators on *Islam* have noticed the disharmony between *Islamic* leaders sending men to die, while they themselves sleep well at night and live the high life.

Someone might say that the *Saladin* Complex does not apply to Arafat since he lived estranged from his wife almost their entire marriage, but this anomaly is explained away by the fact that Arafat was bisexual and some experts are convinced he died from complications of AIDS in 2004 (as is discussed elsewhere).

Arafat was a lot more like *Saladin* than *Muslims* care to admit, but these leaders remain popular anyway because their reputation as a murderer precedes their reputation for perversion. Daniel Pipes wrote:

The Middle East, I have said many a time, is a sick place politically. Nothing so exactly encapsulates its diseased qualities than these massive outpourings of grief for extremist murderers who grabbed power.<sup>2706</sup>

The seventy-two *Houris* mean that *Muslims* can never truly make peace with non-*Muslims*. As soon as peace is about to prevail, it dawns on *Muslims* that their pipedream of becoming a martyr and gaining the seventy-two *Houris* and other benefits is about to go up in smoke. So when *Israeli* Prime Minister Ehud Barak offered Arafat a Palestinian state with part of Jerusalem as its capital in 2000—97 percent of what Arafat had demanded—he launched the *Jihad* called *Intifada* II.

The youths and terrorists gladly joined in *Intifada* II because the Palestinian state-run media regularly reminded *Muslims* that martyrs gain seventy-two *Houris*.<sup>2707</sup> Growing up with *Koranic* teaching at home, at school and via the media, a female suicide-bomber stated in a video:

It was always my wish to turn my body into deadly shrapnel against the Zionists and to knock on the doors of heaven with the skulls of Zionists.<sup>2708</sup> Arafat believed in his own propaganda and alleged that his “life’s dream is to become a *Shahid*,”<sup>2709</sup> which in part explains why Arafat was unwilling to make any compromises with *Israel*.

Now, in April 2004, it appears that the Palestinians may well never receive again as good a “land for peace” offer as the one Arafat received from PM Barak back in 2000, after the *Israelis* and Americans had reached certain “understandings.”

The seventy-two *Houris* also negatively affect *Muslim* society in terms of education and the war arms industry, as the Prime Minister of *Malaysia* admits:

“We need guns and rockets, bombs and warplanes, tanks and warships for our defense. But because we are discouraged from learning of science and mathematics as giving us no merit in the afterlife, we have no capacity to

<sup>2705</sup> Bellamy, James A. “Sex and society in *Islamic* popular literature,” *Society and the sexes in medieval Islam*. Edited by Afaf Lutfi Al Sayyid Marsot. Undena, Malibu, California, USA, pp. 23-42, as quoted in Murray. *Culture*, p. 90.

<sup>2706</sup> Pipes, Daniel. “Scenes from Three Funerals: Arafat, Khomeini, Nasser,” *DP*, 12 Nov 2004.

<sup>2707</sup> PA TV airs music video promising ‘maidens of paradise’ to martyrs,” *Jpost.com*, 13 Aug 2003.

<sup>2708</sup> Glick, Caroline. “Column One: Israel’s case,” *jpost.com*, 16 Jan 2004.

<sup>2709</sup> Golan, Matti. “Why should the Left save Arafat?,” *Jpost.com*, 23 Oct 2003.



produce our own weapons for our own defense. We have to buy our weapons from our detractors and enemies,' he said.<sup>2710</sup>

So we can see why *Saladin* was such a great warrior relative to other *Muslims*. He was one of the few who would rather not die so that he could live to fight and love another day. While *Muslim* martyrs tend to find the seventy-two *Houris* and twenty-eight serving boys enticing, *Saladin* thought “What? So few boys?”

*Saladin*'s “profile” explains why so many *Muslim* leaders, past and present, see themselves as “modern-day *Saladins*”—minus the pedophile predilection—but not always.

*Saladin* drummed up support for *Jihad* warfare and then lorded it over Christian majority populations in Egypt and the Fertile Crescent. Naturally, *Saladin* did not care to join the ranks of *Muslims* he sent on ahead to the afterlife.

These would-be *Saladins* often goad their followers on to conquer or suppress non-*Muslim* majority populations such as Jews in *Israel*, Christians in Armenia, the *Copts* in Egypt, Christians in the Mideast, Ethiopia, *Sudan*, Nigeria, the Balkans, Indonesia, the southern Philippines and elsewhere.

Some modern-day *Saladins* are sex addicts and live in ostentatious Oriental opulence by embezzling state funds. Meanwhile, they send their poverty-stricken troops on “sacred” suicidal missions against the “crusaders,” “Zionists” and “imperial colonialists.” These troops hope to create a *Caliphate* super-state.

Yet, *Muslims* are drawn to would-be *Saladins* like flies to feces. Even though their *Jihadist* leaders would be disgraced a thousand times over by Western standards, *Muslim* affection for their leaders never waivers.

Since many *Muslims* are taught to think about nothing but martyrdom and heavenly sex, Mideast rulers easily become despots. In fact, many *Muslims* think of democracy as being un-*Islamic* since the ideal ruler for the suicide/killing cult called *Islam* is a *Caliph*, a theocrat. And since *Islam* has already decided on everything—or at least, the ruler's sect has—democracy is anathema to *Islamists* since by definition nearly any decision decided democratically contradicts *Islam*.

Mahatir *Mohammad*, the Prime Minister of *Malaysia*, who has been in power for twenty-two years, remarked at an *Islamic* summit in 2003 that democracy was the nemesis of *Islamic* theocratic states, and democracy was a speed bump that got in the way of the killing of Jews. He was quoted as saying:

Apart from the new nation-states we also accepted the western democratic system. This also divided us because of the political parties and groups that we form, some of which claim *Islam* for themselves, reject the *Islam* of other parties and refuse to accept the results of the practice of democracy if they fail to gain power for themselves. They resort to violence, thus destabilizing and weakening *Muslim* countries... We are up against a people [Jews] who think. They survived 2000 years of pogroms not by hitting back but by thinking. They invented and successfully promoted socialism, communism, human rights and democracy so that persecuting them would appear to be wrong, so they may enjoy equal rights with others. With these they have now gained control of the most powerful countries and they, this tiny community, have become a world power. We cannot fight them through brawn alone. We must use our brains also.<sup>2711</sup>

Appallingly, *CNN* reports:

<sup>2710</sup> Chafets, Zev. “How to be a *Muslim* moderate,” *jewishworldreview.com*, 21 Oct 2003.

<sup>2711</sup> “Dr. Mahatir opens 10th OIC Summit,” *The Star*, *thestar.com*, 16 Oct 2003.

The [*Islamic*] leaders [from over fifty states] gave Mahathir a standing ovation afterward. Also, this speech was not given in secret but before the entire world on a big screen. Even the Russian President Vladimir Putin and Philippine President Gloria Macapagal Arroyo were in attendance “as special observers because of their large *Muslim* minorities.”<sup>2712</sup>

### The Moon-god Scriptures’ Connection to Anti-Semitism and Poverty

The reader might ask “Where does this *Muslim* anti-Semitism arise?” The answer is the anti-Jewish attitude of the *Koran* and *Hadith*. So where did *Muhammad* get his anti-Semitism from? His anti-Semitism resulted from envy of the Jews who were getting ahead in life as metalworkers, goldsmiths and as owners of palm date plantations. *Muhammad* saw that the Jews at *Madina*, *Khaybar* and other oases were comparatively rich.

Why have *Muslims* never been known for producing wealth themselves? The main reason is that under the ill influence of the moon-god scripture, the *Koran*, *Islamic* society has degenerated into an anti-Semitic abyss and cannot compete in the global marketplace. The U.N. reported that the economic output of all twenty-two Arab states combined is smaller than that of Spain.<sup>2713</sup> Daniel Pipes wrote:

[Though] *Muslims* make up just one-fifth of the world’s total population, they constitute more than half of the 1.2 billion people living in abject poverty.<sup>2714</sup>

Whatever index one employs, *Muslims* can be found clustering toward the bottom—whether measured in terms of their military prowess, political stability, economic development, corruption, human rights, health, longevity or literacy.<sup>2715</sup>

Arab states’ economies are stuck in the seventh century because *Muhammad* outlawed taking any interest on loans (*K* 002:275-278; 003:130; 004:161; 030:039). Observant *Muslims* must engage in creative financing to get around this restriction such as rent-to-own and lease-to-own.

Why would *Muhammad* outlaw interest rates? In moon-god cultures, some lunar months became holy:

- ☉ The crescent-moons marked the times of pilgrimage (*K* 002:189).
- ☉ The lunar month of *Ramadan*, from waxing crescent to the next waxing crescent, is a religious fast for *Muslims*. This fast came from the surrounding moon-god culture (*K* 002:185).
- ☉ In Arabia there was a general truce forbidding fighting during four months each lunar year (*K* 002:217; 009:005). Two of the four months were pilgrimage months, so the truce allowed pilgrims to travel unhindered (*K* 005:002, 097).
- ☉ Hunting was also forbidden during these months (*K* 005:002).

In ancient Arabia, interest was most likely collected on a lunar month or lunar year cycle. This probably explains why moon-gods such as *Sin* and *Allah* were

<sup>2712</sup> “Malaysian leader seeks *Muslim* unity vs. Jews: Prime Minister Mahathir says ‘Jews rule the world by proxy,’ *CNN (Associated Press)*, 16 Oct 2003.

<sup>2713</sup> Stern, L. “Lessons in hate, on a campus near you,” *Ottawa Citizen*, 14 Dec 2002.

<sup>2714</sup> Pipes, Daniel. “*Islam* and *Islamism*—Faith and Ideology,” *DP*, Spring 2000.

<sup>2715</sup> Pipes, Daniel. “*Islam* and *Islamism*—Faith and Ideology,” *DP*, Spring 2000.

considered gods of contracts.<sup>2716 2717</sup> These contracts surely involved the collection of interest because some Arabs said that even trade was like interest (*K* 002:275).

*Muhammad* however thought that collecting of interest detracted from the sacredness of the months just like fighting or hunting did. *Muhammad* thought “How could *Muslims* fast and pilgrims make pilgrimages if they knew that at the end of each lunar month they had to pay the creditors—or else!?”

What hurt *Muhammad* even more than the distraction of collecting interest was, whenever a waxing crescent would appear at the start of the lunar month, legions of Mideast debtors would curse the moon, while a lesser number of lenders would rejoice.

And, because *Muhammad* fancied himself a prophet in the tradition of Moses (who was superceded by Christ), he banned the taking of interest on loans (*K* 002:275-278; 003:130; 004:161; 030:039). This is a main reason most *Muslim* economies do not improve in the modern era even with the windfall of oil profits.

### Why Rulers Over Moon-god Worshipping Populations Have Always Been Despotic

Let the reader imagine him- or herself as a ruler over *Muslims*. Instead of having normal political parties, there are terrorist entities that vie for leverage and popularity with the masses. Instead of “get out the vote” initiatives, terrorist organizations and leaders gain popularity by killing more of a targeted population than the next group.

As soon as a *Muslim* ruler starts talking democracy, his (or rarely, her) approval rating goes down. Bret Stephens notes that this was the case with one Prime Minister:

But the task goes beyond making sure the Palestinian Authority stops funding or tolerating incitement. The problem is a culture that in some very basic way has gone berserk. Take *Abu Mazen*. Here’s a guy who stands up in *Aqaba* and, in Arabic, gives a speech about ending terrorism and incitement, about a Palestine that is ‘a qualitative addition to the family of democratic nations.’ And the instant effect is that his popularity among Palestinians drops to one percent.<sup>2718</sup>

The other reason democracy is always troubled in the Mideast is that *Islam* is a suicide/killing cult, a subject broached elsewhere. Thus *Muslim* despots view their underlings as expendable.

Despots fancy themselves as marital matchmakers since the *Muslim* dead are paired up with seventy-two *Houris* in heaven. This thinking drives *Muslim* rulers to employ torture techniques, because the ruler knows that many *Muslims* invite martyrdom but no sane person laughs at the prospects of being tortured.

### Pederasty in *Islam*

Richard Burton noted:

The pederasty of *The Nights* may briefly be distributed into three categories. The first is the funny form [by historic *Islamic* standards, that is], as the unseemly practical joke of masterful Queen Budur (vol. iii:300-306) and the not less hearty jest of the slave-princess Zumurrud (vol. 4:226). The second is in the

<sup>2716</sup> Combe. *Culte du Sin*, p. 61, as quoted in Green. *Moon*, p. 35.

<sup>2717</sup> Brockelmann. *Peoples*, p. 9.

<sup>2718</sup> Stephens, Bret and Michael Oren. “Perle’s horizons,” jpost.com, 19 Oct 2003.

grimmest and most earnest phase of the perversion, for instance where [the poet] *Abu Nuwas* [mentioned above] debauches the three youths (vol. v:64-69); whilst in the third form it is wisely and learnedly discussed, to be severely blamed [condemned], by the *Shaykhah* [i.e. *Shaykh*, meaning a learned *Muslim*] or Reverend Woman (vol. v:154).

Westerners generally do not recognize exactly how homoerotic Arabic poetry is. The reason is that the gender of the pronouns is regularly changed in translation so the Arabic poetry is transformed from homoerotic to heteroerotic. Stephen Murray wrote on the subject:

The famed medieval poets who wrote in Persian or Turkish all wrote poems about desired boys. Indeed, not only in poetry but all genres were written about men, by men and for exclusively male audiences. Often, its pederastic content has been obscured in translation with female pronouns.<sup>2719</sup>

### The Sexual Angels

That angels are sexual males may explain why the *Koran* does not speak of guardian angels. Having these incubuses floating around would make parents nervous and men would feel jealous. *Muslims* would fear the Jewish myth about Gen 06:04 would reoccur and the guardian angels would father grotesque *Nephilim* children (as was discussed a bit earlier in this chapter).

*Muslims* believed that angels were intimately involved in all aspects of fertility. The *Dabistan* (~1645 AD) states:

...with every drop of rain an angel comes down and no leaf appears without an angel fostering it.<sup>2720</sup>

Zwemer wrote of *Muhammad*'s account of Jesus' conception (*K* 019:16-21):

...when she [Mary] retired from her family into an eastern place; and she took a veil to screen herself from them; and we sent unto her our spirit [the angel *Gabriel*], and he took for her the semblance of a well-made man. Said she, 'Verily, I take refuge in the Merciful One from thee, if thou art pious.' Said he, 'I am only a messenger of thy Lord to bestow on thee a pure boy.' Zamakhshari comments on this verse in the usual coarse, materialistic way by saying that the virgin conceived 'when the angel *Gabriel* blew up her garment' (vol. ii, p. 4). It is impossible to translate the gross and utterly sensual ideas of *Muslim* commentators on the miraculous birth of Jesus Christ.<sup>2721</sup>

The *Hadiths* speak of angels in connection with the uterus:

Narrated Anas *Bin* Malik: The Prophet said 'At every womb *Allah* appoints an angel who says, 'O Lord! A drop of semen, O Lord! A clot. O Lord! A little lump of flesh.' Then if *Allah* wishes (to complete) its creation, the angel asks, '(O Lord!) Will it be a male or female, a wretched or a blessed, and how much will his provision be? And what will his age be?' So all that is written while the child is still in the mother's womb.<sup>2722</sup>

That the Venus angel was thought to be male and bubbling with sexual energy may be one reason why historically, *Mosques* have been a men-only affair. Tradition shows why it was important for men to have this sexual energy and not women:

<sup>2719</sup> Murray. *Culture*, pp. 132, 136.

<sup>2720</sup> Fani. *Dabistan*, p. 317.

<sup>2721</sup> Zwemer. *Essay*, Ch. 6: "Mohammedan Ideas of the Trinity," pp. 84-85.

<sup>2722</sup> *Sahih Bukhari*, vol. 1, bk. 6, no. 315; also see vol. 4, bk. 55, no. 550; vol. 8, bk. 77, no. 594.

Narrated Anas: When the news of the arrival of the Prophet at *Madina* reached ‘*Abdullah Bin Salam*...[he] said ‘I am going to ask you about...things which only a Prophet can answer...Why does a child attract the similarity to his father or to his mother?’ The Prophet replied, ‘*Gabriel* has just now informed me of that.’ *Ibn Salam* said ‘He (i.e. *Gabriel*) is the enemy of the Jews amongst the angels’...As for the child, if the man’s discharge precedes the woman’s discharge, the child attracts the similarity to the man, and if the woman’s discharge precedes the man’s, then the child attracts the similarity to the woman.’<sup>2723</sup>

So the reason *Muhammad* wanted the women to stay home was so he could induce or encourage satyriasis in the men. The *Mosque* was basically a fertility clinic where *Muhammad* encouraged his men to sexually experiment with their wives and to use different sexual positions. *Muhammad* said:

Your women are your fields—plow them however you want (*K* 002:223).

The idea of *Muhammad* inducing satyriasis may seem rather strange, given the fact that this suggests *Muhammad* had engaged in pre-Islamic pagan *Satyr* worship as well as in worship to Venus. *Satyr* worship was not foreign to Arabia.

The word *Satyr* is the Greek name for a part man, part goat who would chase after *nymphs*. It is entirely possible that when *Muhammad* was a pagan, he engaged in *Satyr* worship as well as Venus worship, because *Satyr* worship was well known throughout the Mideast.

During the Exodus in the Sinai not far from Arabia, the *Israelites* were said to have “prostitute[d] themselves” to goat idols (Hebrew: *Se’irim*) (*NIV* Lev 17:07). One can see that the word *Satyr* and *Se’irim* are distantly related. *Fausset’s Bible Encyclopedia*, entry 3108.01, says “At *Mendes* in Lower Egypt the goat was worshipped with foul rites.”<sup>2724</sup>

The Hebrew word for *Satyr* (*Se’irim*) was applied to goats and to the demons who animated goat idols (RSV Lev 17:07; RSV 2Ch 11:15; “*Satyr* will dance” (RSV Isa 13:21); “*Satyr* shall cry to his fellow” (RSV Isa 34:14)).<sup>2725</sup> Since Arabia is entirely desert and few animals of any size besides goats and camels can adapt to it, *Satyrs* were undoubtedly worshipped in pagan *Makka*.

It was not hard for *Muhammad* to sexually stimulate the Arab in the *Mosque* and induce satyriasis. Nor was it hard to interest the *Muslim* men in their wives and in the *Houris* of Paradise. That is because of the sexual mores common in modern Arab culture, at least among non-Christians, over-sexualizes *Muslim* men **from infancy**. Psychologists report on the...

...barbarous family and clan dynamics in which children, both boys and girls, are routinely orally and anally raped by male relatives; infant males are sometimes sadistically over-stimulated by being masturbated; boys between the ages of 7-12 are publicly and traumatically circumcised; many girls are clitoridectomized; and women are seen as the source of all shame and dishonor and treated accordingly: very, very badly. According to Dr. Nancy Kobrin, ‘The little girl lives her life under a communal death threat—the honor-killing.’ Both

<sup>2723</sup> *Sahih Bukhari*, vol. 5, bk. 58, no. 275.

<sup>2724</sup> *Fausset’s Bible Encyclopedia*, entry 3108.01, *Satyr*.

<sup>2725</sup> *Fausset’s Bible Encyclopedia*, entry 3108.01, *Satyr*.

male and female infants and children are brought up by mothers (who are debased and traumatized women).<sup>2726</sup>

Badruddin Khan reports similarly on modern Arab society:

In Arab societies for instance, mothers routinely pacify their male children by playing with their genitals.<sup>2727</sup>

That *Muhammad* himself was easily aroused and had few sexual inhibitions can be ascertained from his lusty biography—a point discussed elsewhere in this book.

The men would be sexually aroused during the *Mosque* service, and would be physically stretched out from repeatedly prostrating during the performance of *Salats*. The men were so libidinized at the *Mosque* that back home the sex act would be over even before the woman knew it had begun. This is especially the case if the woman had undergone FGM.

Most FGM women can experience only slight sexual stimulation and arousal, and even this takes concentrated effort. Lecturer Dr. *Muhammad* Wahdan of Cairo's *Al-Azhar* seminary stated on *Kuwaiti Al-Rai* TV on 28 Mar 2006:

In Egypt, we have four and a half million spinsters. The definition of a spinster is a woman who has reached 30, without ever receiving a marriage proposal. We have a spinster problem in the Arab world and the last thing we want is for them to be sexually aroused. Circumcision of the girls who need it makes them chaste, dignified and pure.<sup>2728</sup>

So the main reason for men-only *Mosque* attendance, and apparently FGM too, is so the man's discharge precedes hers so the children will all look like the father (according to the *Hadith* quoted above). Undoubtedly, this meant *Muhammad's* hope was that the woman would produce more males than females, since sons tend to look more like their father than daughters do.

Having the children look like the father was especially important in a patriarchal society, especially if a fair-skinned *Muslim* impregnated Black sex-slaves. The fairer the slave progeny, the higher the property value for the master. Moreover, *Muhammad* needed his men and their wives and sex-slaves to produce more male minions for the marching militaristic mymidons of seventh-century savages. That this was *Muhammad's* goal becomes apparent from this *Hadith*:

*Allah's* Apostle said 'Once Solomon, son of David said '(By *Allah*) Tonight I will have sexual intercourse with one hundred (or ninety-nine) women each of whom will give birth to a knight who will fight in *Allah's* Cause'...but he did not say '*Allah* willing.' Therefore only one of those women conceived and gave birth to a half-man. By Him in Whose Hands *Muhammad's* life is, if he had said '*Allah* willing,' (he would have begotten sons) all of whom would have been knights striving in *Allah's* Cause.'<sup>2729</sup>

That the propagation of *Muslims* was what *Muhammad* intended is known from conversations that Theodore *Abu-Qurra* (~750-825 AD), *Melkite* bishop of *Haran*, had with *Muslims*. John Meyendorff wrote:

<sup>2726</sup> Chesler, Phyllis. "The Psychoanalytic Roots of Islamic Terrorism," *FPM*, 3 May 2004, an article on an upcoming book by Kobrin, Nancy & Yoram Schwitzer. *Sheik's New Clothes: the Psychoanalytic Roots of Islamic Suicide Terrorism*.

<sup>2727</sup> Murray. *Culture*, p. 292.

<sup>2728</sup> "Egyptian Experts on Islamic Religious Law Debate Female Circumcision," memritv.org, 28 Mar 2006, Clip No. 1090.

<sup>2729</sup> *Sahih Bukhari*, vol. 4, bk. 52, no. 74i; vol. 4, bk. 55, no. 635; vol. 7, bk. 62, no. 169; vol. 8, bk. 78, no. 634; vol. 8, bk. 79; no. 711; vol. 9, bk. 93, no. 561.

And when the *Muslim* still maintains that he prefers polygyny because it secures quicker multiplication of the human race, Theodore answers that since God did not care for a quick multiplication of men when man was *alone* on earth [i.e. Garden of Eden], he certainly does not desire too great a proliferation today.<sup>2730</sup>

The *Muslim* myrmidon armies have been continually produced throughout *Islamic* history. Nowadays, radical clerics actually encourage *Muslims* women to breed suicide-bombers,<sup>2731</sup> and Arafat was fond of saying that “the Palestinian womb is a biological weapon.”<sup>2732</sup> Women are glad to do so too since having a “martyred” son or daughter means they will be more rewarded in heaven. They will also be able to skip Purgatory since *Imams* teach that each martyr can choose seventy people who will then go straight to heaven and bypass Purgatory. Blair and Bloom wrote:

At some point God’s judgment is meted out. This is always to be feared, but it is hoped that His mercy will prevail or that others, such as saints or one’s predeceased children, will intercede and tip the balance in one’s favor.<sup>2733</sup>

Another reason that *Mosque* attendance is mostly a men-only affair is Venus has always represented infatuation and betrayal more than fidelity. Isaiah even compared Venus to Satan (Isa 14:12-14).

It may have been feared that the male Venus angel would see the *Muslim* women in the *Mosque* and be tempted to leave his Venus-altar *Mihrab* to chase some *Burqas*. After all, it is *Muslim* doctrine that Gabriel appeared to the Virgin Mary as well-formed man and then blew up her skirt to impregnate her so she later gave birth to Jesus (*K* 019:017).<sup>2734</sup> In other words, a *Mihrab* Venus angel who left his post could cause much mischief in the *Muslim Umma* (community). (Venus altars are discussed in upcoming chapters).

People might think a Venus angel on the loose would be about as frivolous a matter as *Cupid* with his arrow is in the West. Honor and chastity however are deadly serious affairs in much of the Mideast. In the country of Jordan alone, dozens of girls are killed each year by their own families for eloping, or for running away from emotional, physical or sexual abuse. Thus a Venus angel on the loose is no laughing matter in the Mideast. Similarly, *Muhammad* in fact had to assure his men that in heaven his followers would not find the promised *Houris* deflowered by *Jinn* or by other men (*K* 055:056, 074).

Due to astral religion and then astrology, ideas embedded in Mideast culture are:

☉ The man is supposed to be overwhelmingly bright and bold like the moon.

☾ The woman is supposed to be dimmer and often hidden like Venus.

Kristen Gillespie Amman wrote about how age-old customs still rule in the Mideast:

Whether society changes laws or laws change society, Jordan is seeing little tangible movement in either direction. Here, legal rights, such as they are, are trumped by instant vigilante justice. Asha the social worker says the issue is

<sup>2730</sup> Meyendorff. *Byzantine*, p. 98.

<sup>2731</sup> “*Muslim* cleric wants ‘women of mass destruction: Says mothers should breed children to become suicide-bombers,’” WND.net, 9 Oct 2004, *JW*.

<sup>2732</sup> Blum, Ruthie. “ONE on ONE: It’s the demography, stupid [interview with Arnon Soffer],” *jpost.com*, 20 May 2003.

<sup>2733</sup> Blair & Bloom. *Paradise*, p. 28.

<sup>2734</sup> Zwemer. *Essay*, Ch. 6: “Mohammedan Ideas of the Trinity,” pp. 84-85.

about changing people's mentality, a prospect involving nothing less than a social revolution.

Back at the house in Jebal Manara, the women agree that while religion and state play a significant role in their lives, tradition is most important. Words to live and die by, says Um Khalid, as she repeats an old Arabic proverb: 'Hell is better than shame.'<sup>2735</sup>

Many women in *Islam* can feel little sexual pleasure on account of having their clitoris removed during *FGM*, and so are not as inclined toward promiscuity—or so *Muslim* thinking goes. Even so, *Muhammad* still found it necessary to further assuage the jealousies of *Muslim* men concerning the sexual angels. *Muhammad* told a story about Potiphar's wife and her friends:

When she heard of their malicious talk, she sent for them and prepared a banquet for them...she gave each of them a knife...she said (to Joseph), 'Come out before them.' When they saw him, they did extol him and (in their amazement) cut their hands: they said 'Allah preserve us! No mortal is this! This is none other than a noble angel!' (*Yusuf Ali K* 012:031).

*Muhammad's* intended meaning was that *Muslim* men need not fear that their wives were having sex with angels while all the men are at the *Mosque*. If their wives would look upon angels, they would spontaneously slash themselves with any available sharp object.

The question arises "Why are *Houris* found in *Muslim* heaven if they are not terribly attractive?" The reason is that *Muhammad* thought there would be a shortage of women in heaven. *Muhammad* told a group of women "I have seen that the majority of the dwellers of hellfire were you (women)."<sup>2736</sup> When the women asked why the majority in hell were women, *Muhammad* said:

I have not seen anyone more deficient in intelligence and religion than you...Is not the evidence of two women equal to the witness of one man? [*K* 002:282]...This is a deficiency of your intelligence...Is it not true that a woman can neither pray nor fast during her menstrual period? This is the deficiency in your religion.<sup>2737</sup>

So *Islam* imposes a gender-discriminatory hell both now and in the afterlife.

These facts all lead to an interesting quandary. If the angels are sexual, with whom do they have sex? According to *Muhammad*, every last angel is male, and the *Houris* and earthly women in heaven are off-limits. The angels are not bachelors because according to *Muhammad*, "There is no bachelor in paradise."<sup>2738</sup>

The *Koran* states that angelic armies, evidently staffed by homosexual or eunuch angels, kept the demon and *Jinn* hordes from storming heaven's gates. If *Islamic* ethics about sodomy indicate at all what *Muslims* thought occurred in heaven, it would hold that *Muslims* thought angels sodomized demons and *Jinn*. Stephen Murray and Will Roscoe wrote:

Some [*Muslims*] (such as [the poet] *Abu Nuwas* [died 195 AH/810 AD] and the [*Madinan*] jurists of the *Maliki* school) rationalized the practice of making non-believers [men and women] submit to penetration [sodomizing] by believers

<sup>2735</sup> Amman, Kristen Gillespie. "Middle East: Anything But Shame," *The Jerusalem Report*, jrep.com, 6 Oct 2003.

<sup>2736</sup> *Sahih Bukhari*, vol. 1:28, 301; vol. 2:161; vol. 7:124-126. The *Hadith* is often repeated—see "The Majority in Hell are Women," AnsweringIslam.org, 2004.

<sup>2737</sup> *Sahih Al-Bukhari*, vol. i, *Hadith* no. 301; vol. iii, no. 826, as quoted in Trifkovic. *Sword*, p. 159.

<sup>2738</sup> Serene, *Ibn. Kitab ul Isra'a wal Mu'raj*, as quoted in Caner. *Unveiling*, p. 193.



[*Muslims*] as a means of glorifying the superiority of *Islam*—a duty for *Muslims* rather than as a sin.<sup>2739</sup>

The supposed behavior of the angelic armies was then transferred to *Muslim* earthly armies, which were noted for their many eunuchs and homosexuals. Homosexuals and eunuchs carried out many functions in the *Islamic* evil empires for centuries. An African eunuch slave corps manned the *Kaaba* and *Zamzam* Well at *Makka* as late as the nineteenth century.<sup>2740</sup> David Nicolle wrote:

During the *Abbasid Caliphate* [862-1098 AD] ‘the lure of wealth and promotion even led men from beyond *Islam*’s frontiers to volunteer as *ghulams* or *Mamluks*—soldiers of the slave origin. There were even cases of voluntary castration since a eunuch’s prospects were brighter—at least in career terms...Homosexuality flourished in such an environment and was widely accepted in Persia, though not in Arab areas, and this also caused problems of jealousy and cruelty.’<sup>2741</sup>

*Ibn Warraq* wrote that homosexuals even headed up the army:

During the *Abbasid* period [862-1098 AD] there seem to have been many *Caliphs* who were homosexual: *Al Amin* (ruled 809); *Al Mutasim* (833); the *Aghlabid Ibrahim* (875); at *Cordoba*, *Abd Al Rahman* (912); and the great *Saladin* (*Salah Al Din*, 1169), famous for his *Jihad* against the Crusaders. As for *Muslim* Spain in the eleventh century, Henri Peres tells us: ‘Sodomy is practiced in all the courts of the *Muluk Al Tawaif*....Homosexuality was common in all parts of society, from schools to religious brotherhoods. The *Hammams* or Turkish *Saunas*, decorated most un-*Islamically* with erotic mosaics, paintings or statues, were a meeting point for many homosexuals. Male prostitution was also common in most large towns; often young boys offered themselves for a price to travelers in hostels....Our greatest evidence for the prevalence and tolerance of homosexuality of course comes from the poets. Some of the greatest poets in the Arabic language have gloried homosexual love, often in the most overt and frank language imaginable. Here, once again, the name of *Abu Nuwas* stands out.’<sup>2742</sup>

### ***Muslims* Believed That the Stars Controlled Life on Earth**

Medieval *Muslims* used the stars to develop personal horoscopes and even predict the weather. *Muslim* astrology was much more deterministic and fatalistic than its Western spin-off (the medieval West imported *Muslim* astrology).

Cold winds, it was thought, came from *Gemini*,<sup>2743</sup> perhaps because *Gemini* rises highest in February. Also, the annual *Gemini* meteor shower occurs on December 13, nearly the time when the nights are longest and coldest in the Northern Hemisphere.

Other annual meteor showers may have lead the ancients to connect certain weather or certain seasons to the constellation from where the meteors seem to radiate. Annual meteor showers include *Lyrids* (April 21), *Perseids* (August 12), *Orionids* (October 20), *Taurids* (November 4) and *Leonids* (November 16). E. M. Wherry wrote on the subject:

<sup>2739</sup> Murray. *Culture*, p. 304.

<sup>2740</sup> Peters. *Makka*, p. 283.

<sup>2741</sup> Nicolle. *Caliphates*, pp. 6-7.

<sup>2742</sup> Warraq. *Why*, p. 342.

<sup>2743</sup> Ishaq. *Sirat*, p. 415.

...the Arabs, by long experience, observed what changes happened in the air and at length, as has been said, came to ascribe divine power to them, saying that their rain was from such or such a star, which expression *Muhammad* condemned and absolutely forbade them to use it in the old sense, unless they meant no more by it than that GOD had so ordered the seasons, that when the moon was in such or such a mansion or house, or at the rising or setting of such and such a star, it should rain or be windy, hot or cold.<sup>2744</sup>

### The Christian View of Astrology

Though Jews incorporated astrological art into their synagogues during the Late Antique era, Christians were antithetical to astrology from New Testament to medieval times.

Stephen's speech (Act 07:43) was against the astrology in the temple at Jerusalem during his day, as will be discussed in a later chapter. Jude compared false teachers to the "wandering stars," which are the planets visible to the naked eye. The ancients thought the astral objects were gods but the Hebrews knew the gods were demons (Deu 32:17; Psa 106:37).

Jude also compared false teachers to "wild waves of the sea, foaming up their shame." This is a reference to how the fertility goddess Venus-*Aphrodite* was said to born from sea froth (Jud 01:13). The Hebrews associated planetary gods with demons and Venus was associated with Satan himself. This evidence suggests that Jude, along with other Bible writers, considered astrology to be a false and misleading so-called science.

Astrology was reintroduced to Christianity during the Middle Ages from *Andalusia* (*Muslim* Spain). The variety of astrology that some Christians imbibed was more about "influence" than fate, so it was much less deterministic and fatalistic than the *Muslim* form.

The church was not anti-astronomy. The simple fact was that during the period from the New Testament era to medieval times, there was not much science that separated astronomy from astrology.

Even during the Renaissance, Galileo (1564–1642 AD), Kepler, Newton and other astronomers delved into astrology and metaphysics, so the friction between scientists and the Church was not entirely about pure science.<sup>2745</sup> Theodore Wedel wrote:

So it was that when Christianity, at the close of the second century, began to assume a position of prominence in the social and intellectual life of the Roman Empire, it found astrology everywhere, battenning [i.e. thriving at another's expense] on the superstitions both of populace and kings. The Church attacked astrology with all available weapons. The reasons for its hostility are fairly obvious. As a part of paganism, the practice of all divinatory arts was forbidden the Christian; and, in the writings of the earlier apologists, astrology is hardly differentiated from soothsaying, oracles and magic. In its philosophical dress, astrology was even less acceptable. The fatalism implied in the belief that the stars are arbiters of human destinies never found more unyielding opponents than the Church Fathers...After Augustine, in his trenchant condemnation of

<sup>2744</sup> Wherry. *Commentary*, vol. i, section i, pp. 58-59.

<sup>2745</sup> Wedel, Theodore Otto. *The Medieval Attitude Toward Astrology—Particularly in England*. Yale University Press, New Haven, Connecticut, USA, 1920.

astrological divination, had finally formulated the doctrine of the Western Church, astrology virtually disappeared from the social and intellectual life of western Europe for eight centuries....Not until the twelfth century, with its discovery of Aristotle and the science of the *Moors*, did astrology regain a position of prominence in the intellectual life of Europe.<sup>2746</sup>

Neil Spencer wrote:

With the collapse of the Western Roman Empire early in the fifth century, astrology effectively disappeared from the Western world for several hundred years...The hostility of the emergent Christian church towards anything that smacked of paganism...ensured astrology remained in exile until it was reimported from the Middle East early in the medieval era.<sup>2747</sup>

So the *Hanifs* and *Muslims* likely were not very interested in orthodox Christianity on account of Christianity's aversion to astrology and astral religion.

### **Muhammad's Hira Cave Experience**

*Muhammad's* family had a lively history at the *Kaaba* at *Makka*. *Muhammad's* grandfather *Muttalib* is a central character in *Muhammad* bibliographies and these stories mostly revolve around the *Kaaba*. In 605 AD, *Muhammad* helped reconstruct the *Kaaba*. *Muhammad* even refereed (coached) the placement of the Black Stone betyl.

*Muhammad* found it distressing that every year there were more Christians on the Arabian Peninsula. Fewer pagan pilgrims came to the *Kaaba* as a result. Previously, to attract pilgrims, the *Makkans* added idols to the *Kaaba* and the environs of *Makka*. This method served only to turn away the new monotheists in disgust.

As the monotheistic spirit strengthened, even the *Hanifs* lost patience with the polytheism at the *Kaaba*. *Islamic* tradition records how four *Hanifs* left *Makka* to search for the pure Religion of *Ibrahim*. Two *Hanifs* ended up being Christians, a third became a *Muslim* and the fourth remained a *Hanif*.<sup>2748</sup>

So *Muhammad's* ideal solution was to make the *Kaaba* into a monotheistic temple and convert the pagans—by force, if necessary. To enable the *Hanif* religion to compete with Christianity and Judaism, *Muhammad* became a *Hanif* prophet and wrote a *Hanif* scripture—the *Koran*.

The *Koran* attacks some doctrines, but generally dismisses any practice or doctrine of Christianity or Judaism that went beyond the simplicity of the Religion of *Ibrahim*. The *Koran* also sides with the *Hanifs* in matters such as polygyny and what constituted *Kosher* (*Halal*) food. This is exactly what the *Hanifs* wanted, as indicated by this account:

*Abu Amir* came to the Apostle in *Madina* to ask him about the religion he had brought. 'The *Hanifiyya*, the Religion of *Ibrahim*,' [*Muhammad* answered]. 'That is what I follow,' said *Abu Amir*. 'You do not,' [*Muhammad* said]. 'Yes, I do,' [said *Abu Amir*]. But you, *Muhammad* have introduced into the *Hanifiyya* things which do not belong to it.' 'I have not,' [*Muhammad* answered]. 'I have brought it white and pure...'<sup>2749</sup>

<sup>2746</sup> Wedel. *Attitude*, p. 25.

<sup>2747</sup> Spencer. *True*, p. 12.

<sup>2748</sup> Al Khargushi. *Sharaf Al Mustafa*, as cited by Peters. *Origins*, pp. 122-123.

<sup>2749</sup> Ishaq. *Sirat*, p. 278, as cited by Peters. *Origins*, pp. 123-124.

Since the *Hanifs* already worshipped at the *Kaaba*, more *Hanif* pilgrims meant more income for the *Kuraish*. *Muhammad* even mentions how the *Kaaba* brought in provisions from pilgrims twice per year (*K* 106:003-004).<sup>2750</sup>

In this regard, *Muhammad* was thinking like the Ephesian silversmith Demetrius, who worshipped the moon-goddess *Artemis* (Act 19:24-28). The *Makkans* of course resisted *Muhammad* because they liked “that old-time religion” and the shrine keepers were not convinced that the *Hanif* religion had any chance of near-term profitability.

*Muhammad* did not want to convert too many Christians and Jews because the Arabs knew Jews and Christians were a source of easy income. For a long while the pagan Arab *Bedouins* had a *Mafia*-like “protection racket” relationship with the Christians and Jews, who generally lived in walled towns.

It was agreed that each year the towns would turn over a fixed amount (the *Jizya*) and the *Bedouins* would spare the town from *razzias*, plundering raids. This arrangement was carried over into *Islam* where the Christian and Jewish *Dhimmis* pay a steep price for so-called toleration (*K* 009:029).

*Muhammad*, naturally, was proud of *Makka* and the *Kaaba* just as most people were proud of community shrines during ancient times. For the most part, the pride was genuine and not a result of cynical interest in money.

Genuine pride can be detected in the Biblical account of the Samaritan woman at the well. The woman was an outcast for having five husbands and for having an affair with a sixth man. She seems to have had nothing personally to gain by becoming argumentative about whether *Yahveh* ought to be worshipped at Mount *Gerizim* rather than in Jerusalem (Joh 04:04-42).

When Jesus and his disciples were traveling north, the Samaritans were glad to sell them food (Joh 04:08, 31). However, when traveling south past Mount *Gerizim* shrine to worship at Jerusalem, the Samaritans would not extend a helping to Jews in order to make a point (Joh 04; Luk 09:52-55). The Samaritans could have had a thriving business selling food to Jewish pilgrims but decided to put their theology before profits.

### ***Muhammad* Reforms a Pagan Astral Religion**

*Muhammad* carried out the monotheistic reforms that the *Hanifs* were powerless to enact. *Muhammad*, drawing on Jewish law, did a lot to reform the *Kuraishi* tribe’s diet. The Arab *Al Kindy* wrote in 830 AD:

The Arabs, as every one acquainted with history knew, were a needy and barbarous race, feeding on lizards and such-like food, with no shelter from the hot blast of summer, nor covering from the cold winds of winter, hungry and naked.<sup>2751</sup>

*Islamic* sources confirm that early *Muslims* ate large lizards though Moses forbade eating lizards (Lev 11:29-30):

There were certain kinds of food which the [*Halal*] law allowed and which he [*Muhammad*] encouraged his companions to eat but would not eat himself, such as the large lizards which were not to be found in *Makka* but which were common in *Yathrib* and elsewhere.<sup>2752</sup>

<sup>2750</sup> Peters. *Hajj*, pp. 33-34, 368, note 142.

<sup>2751</sup> *Al Kindy*. *Apology*, under section: “Worldly Inducements for the propagation of *Islam*,” p. 84.

<sup>2752</sup> Lings. *Sources*, p. 167.

The *Kuraish* could even stoop to cannibalism at times, such as what *Ibn Ishaq* records:

They [*Kuraish* women] cut off their ears and noses and Hind made them into anklets and collars...She cut out Hamza's liver and chewed it but she was not able to swallow it and threw it away.<sup>2753</sup>

Alfred Guillaume notes:

This seems to be a survival of prehistoric animism. By devouring an enemy's liver it was hoped to absorb his strength.<sup>2754</sup>

If anyone doubts that the above-described cannibalistic event happened, one need only take a look at photos and newsreels of ghoulish modern *Muslims* in action, of which here are just three examples of the many that could be offered:

Recall for a moment the lynching of two *Israeli* soldiers gone astray into *RamAllah* early in the *Intifada*. They were taken to the police station and there they were lynched by policemen—one of whom placed his bloodied palms on the windows—and the mob below cheered. It is through such mobs that Palestinian political culture now speaks—and routinely.<sup>2755</sup>

Here is another example of ghoulish *Muslim* crowds celebrating a grisly death:

Moments after the thunderous blast, which shook the heart of the capital, young men raced into the street, hurling stones at the flaming wreckage, looting personal belongings of the victims and chanting slogans against the occupation...Crowds chanted 'Down with the USA!' and set fire to an American flag...As the police left, the crowd poured kerosene into one of the vehicles and set it on fire. Heavy, black smoke poured from the vehicle. About 20 youths danced around a charred body...The chaotic scene Monday was reminiscent of...the March 31 slaying in Fallujah of four Americans, whose bodies were mutilated and hung from a Euphrates river bridge.<sup>2756</sup>

*Israel National News* reported on one of many "car swarm" incidents:

Six *Israeli* soldiers are dead after their armored personnel carrier drove over a 100-kilogram explosive planted under the road in *Gaza*. *Hamas* terrorists gleefully displayed and played with the body parts in front of cameras. A large IDF force continues to operate in the *Zeitoun* neighborhood of *Gaza* at this time, carrying out house-to-house searches in the hope of recovering the remains of the six soldiers. Terrorists took body parts from the scene of the blast before IDF troops could secure the area and have claimed that they intend to use them as a bargaining chip...Two news agencies transmitted video from the scene showing *Gazan* Arabs dancing in the streets with pieces of the destroyed IDF vehicle and the dead soldiers' body parts. The Arab TV channel *Al-Jazeera* broadcast a video it showing two masked *Islamic Jihad* terrorists taking responsibility for the attack and displaying what they said was the head of an *Israeli* soldier on a table in front of them [as always in these photo-ops, the terrorists always hold up a copy of the *Koran*].<sup>2757 2758</sup>

<sup>2753</sup> Guillaume. *Islam*, p. 385.

<sup>2754</sup> Guillaume. *Islam*, p. 385, fn. 1.

<sup>2755</sup> Peretz, Martin. "Impossible Routine," Jewishworldreview.com, 23 Sep 2003.

<sup>2756</sup> Reid, Robert H. "Crowds Celebrate 13 Deaths in *Iraq* Blast," news.yahoo.com, 14 Jun 2004.

<sup>2757</sup> "Six Soldiers Dead as *Gaza* Battle Continues," ArutzSheva.com, 11 May 2004.

<sup>2758</sup> Dudkevitch, Margot. "IDF: Troops will stay in *Gaza* until bodies recovered," jpost.com, 11 May 2004.

In a previous chapter the church historian Sozomen was quoted as saying that some fourth-century AD Arabs abstained from pork. He probably was referring to Arabs near the Holy Land, and not to Arabs in hardcore pagan towns such as *Makka*. The New Testament Gospels reveal that pigs were common even in the Holy Land (Luk 08:32). Breton reveals that a wood carving of a boar's head was found in the kitchen of a farmhouse near *Shabwa* in ancient *Yemen*.<sup>2759</sup> Moshan Fani wrote in *The Dabistan* (1645 AD) that a *Sunnite* of his day believed that:

...the *Koresh* [*Kuraish*] all drank wine and ate pork, the prophet, who associated with them, ate the same food in the house of his paternal uncles, and so did the lord, the godly Ali. The *Shiah* had no suitable reply to this observation.<sup>2760</sup>

There is almost no chance that the pre-*Islamic* *Mekkans* ate kosher or *Halal* foods when it is recorded that the Arabs ate lizards and a *Mekkan* woman ate a man's liver (see quotes above). No one seems to have thought worse of that *Mekkan* woman save the *Muslims*, and *Ibn Ishaq*'s account shows they were not too concerned about the cannibalism aspect, but rather about how the dead had been mutilated!

*Muhammad* also pared the native pagan religion down to the one god who happened to be the high god in *Mekka* at the time—*Allah* the moon-god. If *Muhammad* had not been in *Makka* but had lived in another South Arabian locale, *Muslims* would be worshipping another moon-god: '*Amm*, '*Anbay*, *Ilumquh* or *Wadd*.

If *Muhammad* had live outside the Mideast, *Muslims* would now be worshipping some other god such as the sun-god, *Ahura Mazda*, the good entity of the Zoroastrians, *Aton*, the Egyptian sun-god or whomever. As it is, *Islam* is basically a reformed *Mekkan* moon-god religion that retained most of its astral doctrines and rites, as Malise Ruthven wrote:

The earliest *Muslim* sources suggest that the pre-*Islamic* cult of the *Kaaba* had some astronomical significance. The historian *Masudi* (896-956 [AD]) [in *Murudj*, iv. 47] stated that certain people had regarded the *Kaaba* as a temple dedicated to the sun, moon and the five visible planets (making up the mystical figure of seven, the number of circumambulations required for each *Tawaf*). The story that there were exactly 360 idols placed round the temple also points to an astronomical significance. Among the votive gifts said to have been offered to the idols were golden suns and moons [*Al Azraki*, p. 155 sqq.].<sup>2761</sup>

The number 360 equals twelve lunar months of thirty days each. Also, 360 equals six sixty-day periods. The Babylonian number system was not decimal-based but was based on the numbers twelve and sixty.

*Ibn Ishaq* wrote that there was a plaque at the *Kaaba* that said:

I am *Allah* the Lord of the *Bakka* [*Sic*]. I created it [the *Kaaba*] on the day that created heaven and earth and formed the sun and moon, and I surrounded it with seven pious angels.<sup>2762</sup>

This all suggests that the *Kaaba* was meant as an astral temple. The seven angels may refer to the planetary spirits—gods in former times, who were thought to man the five visible planets and the sun and moon.

<sup>2759</sup> Breton. *Felix*, p. 90.

<sup>2760</sup> Fani. *Dabistan*, p. 354.

<sup>2761</sup> Ruthven. *World*, p. 18. The intertextual notes in brackets [ ] are gleaned from Gibb & Kramers. *Encyclopedia*, p. 198, *Kab'ah* entry.

<sup>2762</sup> Ishaq. *Sirat*, pp. 85-86.

That *Makka* had an astral religion agrees with this historical account written about *Muhammad*:

The Prophet slaughtered a ewe for one of the idols...then he roasted it and carried it with him. Then *Zayd Ibn Amr Nufayl* met us in the upper part of the valley; it was one of the hot days of *Makka*. When we met we greeted each other with the greeting of the Age of Barbarism...The Prophet said: ‘Why do I see you, O son of Amr, hated by your people? He said ‘This (happened) without my being the cause of their hatred; but I found them associating divinities with God and I was reluctant to do the same. I wanted (to worship God according to) the Religion of *Ibrahim*’...The Prophet said ‘Would you like some food?’ He said ‘Yes.’ Then the Prophet put before him the (meat of the ewe). He [*Zayd Ibn Amr*] said: ‘What did you sacrifice to, O *Muhammad*?’ He said ‘To one of the idols.’ *Zayd* then said: ‘I am not the one to eat anything slaughtered for a divinity other than God [*Allah*],’<sup>2763</sup>

*Ibn Al Kalbi* (died 821-822 AD/206 AH) relates that *Muhammad* said:

I have offered a white sheep to *Al 'Uzza* [Venus], while I was a follower of the religion of my people.<sup>2764 2765</sup>

That *Muhammad* was an astral religion adherent is also suggested by this account related by *Ibn Ishaq*:

*Muhammad* answered, ‘O my uncle [*Abu Talib*], by God, if they put the sun **in my right hand** and the moon **in my left** [hand] on condition that I abandon this course, until God has made it victorious, or I perish therein, I would not abandon it.’<sup>2766</sup>

Goodenough relates “Symbols of the sun and moon are likewise to be considered as marking an astral orientation of religion.”<sup>2767</sup> Goodenough states that in astral religions, the sun and moon symbols held in the hands have various purposes:

- ☉ “The whole seems a reference to astral piety, in which the symbol of divinity brought to the hero is not a wreath or a palm branch but the sun and moon.”
- ☉ On amulets “Eternity is often represented on coins as a veiled goddess holding in either hand the sun and moon [symbols]. As such she could represent, as she seems to do on coins, the eternal power of the state.”
- ☉ “In this place [the hub of zodiac circles] in analogous mosaics we find *Apollo* [sun-god] surrounded by the signs of the zodiac, very often *Bacchus* [wine god] or even *Mercury* [a messenger] with *Abundance*, or even *Annus* [Latin: year] holding the sun and moon in his hands.”<sup>2768</sup>

So this last information tells us that in the above quote of *Muhammad* talking to his uncle, *Abu Talib*, *Muhammad* seems to be saying that even if the astral-minded *Makkans* made him into a hero or a head of state, he still would not abandon his religious aspirations.

Notably just as there were images of the moon in the *Kaaba* and at the temple mount in Jerusalem, there were pairs of suns and moons carved into the outside and internal ceiling of the Gate of the Prophet on the temple mount.<sup>2769</sup>

<sup>2763</sup> *Al Khargushi. Sharaf Al Mustafa*, as cited by Peters. *Origins*, pp. 126-127.

<sup>2764</sup> *Al Khargushi. Sharaf Al Mustafa*, as cited by Peters. *Origins*, p. 127.

<sup>2765</sup> *Al Kalbi. Idols*, pp. 16-17.

<sup>2766</sup> *Ishaq. Sirat*, p. 119.

<sup>2767</sup> Goodenough. *Symbols*, p. 120.

<sup>2768</sup> Goodenough. *Symbols*, pp. 120, 130, 135.

<sup>2769</sup> Elad. *Jerusalem*, p. 99.

The Gate of the Prophet was on the south side of the *Haram*—the temple mount in Jerusalem. *Muhammad* was said to have walked through this gate on his Night Journey. This gate was probably built or rebuilt by early *Muslims*. This suggests the astral character of *Muhammad*'s religion, as well as the astral character of the Dome of the Rock.

The *Dabistan*, a comparative-religions text written around 1645 AD, records the *Parsees*' (Zoroastrians') claim that *Makka* had an astral religion...

...among the images of the *Kaaba* was one of the moon, exceedingly beautiful, wherefore the temple was called *Mahgah* (Moon's Place) which the Arabs generally changed into *Makka*. They also say that among the images and statues left in the *Kaaba* by Mahabad [a Persian ruler] and his renowned successors, one is the Black Stone, the emblem of Saturn. They also say that the Prophet of Arabia [*Muhammad*] worshipped the seven planets, and he therefore left undisturbed the Black Stone or Saturn's emblem, which had remained since the time of the *Abadian* dynasty; but that he broke or carried away the other figures introduced by the *Kuraish*, and which were not formed according to the images of the stars. In most of the ancient temples of Persia they had formed the symbol of Venus [the bulbous lamp] in the figure [arch] of a *Mihrab*, or arch, like the altar of the *Mosques*; consequently, the present [*Muslim*] *Mihrab*, or altar, is that identical symbol; which assertion is also proved by the respect paid to Friday or [in astrology] the day of Venus [i.e. *Islam*'s Day of Prayer].

*Ibrahim* (Abraham), the friend of God, pursued the same conduct [as *Muhammad*]; that is, he rejected the idols which were not of the planetary forms [K 006:075-079]; and the reverence paid by him to the Black Stone, according to ancient tradition, seems to prove that point...They also say that in *Madina*, the burial place of the prophet, there was formerly an image of the moon; the temple in which it was, they called *Mahdinah*, or the 'Moon of Religion,' as religion is the moon of truth, from which the Arabs formed *Madina*.<sup>2770</sup>

The *Muhammadian* doctors say that *Islamism* is connected with this planet [Venus], from which source proceeds the veneration paid by them to Friday, or the day of Venus [the *Muslim* day of prayer].<sup>2771</sup>

The *Dabistan* is correct in this assertion about Friday. There were many pre-*Islamic Mosques* in Arabia.<sup>2772 2773</sup> The main gods worshipped in these *Mosques* undoubtedly were the triad of the sun, moon and Venus.

The main day of worship in pre-*Islamic Mosques* probably was Friday due to the popularity of fertility rites. The monotheistic *Hanifs* likely retained Friday as the main day to worship in *Mosques* and the *Hanifs* retained the use of the *Mihrab* Venus altar.

*Muhammad* copied the *Hanif* practice of having Friday as a day of prayer, especially because the day of Venus was the pagans' favorite day to worship. Friday worship is why *Muhammad* was careful to say that *Ibrahim* was a *Hanif* rather than a Jew or Christian (K 002:135, 140; 003:067). Otherwise, *Muslims* would wonder why they were not *Sabbath*- or Sunday-observant.

<sup>2770</sup> Fani. *Dabistan*, pp. 30-31.

<sup>2771</sup> Fani. *Dabistan*, p. 194.

<sup>2772</sup> Ishaq mentions many pre-*Islamic Mosques* (Ishaq. *Sirat*, pp. 56, 102, 123, 132, 157, 163, 166, 169, 172-173, 175, 177, 530, etc.)

<sup>2773</sup> Guillaume wrote that there were pre-*Islamic Mosques* (Ishaq. *Sirat*, p. 56, fn. 1).



### ***Muhammad's Method of Synthesis***

*Muhammad* wanted a simple, low-maintenance religion but all the religions were too complicated for his liking. *Muhammad* noticed that, at least according to his Arabic sources, the common denominators among the major Mideast monotheistic religions were the use of the moon symbol and the appellation *Allah* (*Koran* 002:062; 005:069; 022:017). These religions were:

- ☉ The *Hanifiyya* (the Religion of *Ibrahim*) (*K* 002:135).
- ☉ The *Sabians* (*Semitic* astral worshippers) (*K* 002:062; 005:069).
- ☉ Jews, Christians and *Magians* (*Zoroastrians*) (*K* 022:017).

As was discussed in a previous chapter, *Muhammad's* conception of a moon-god was not that the moon itself was divine. The moon served as a symbol for the moon-god and was sometimes said to be the moon-god's throne, boat or scimitar.

To *Muhammad*, *Allah's* glory was like the flame of a lamp, and the moon reflected that glory like the lunette of a niche (*K* 024:035). *Muhammad* later felt he had to explain the light of the sun too since he said the sun was not a deity, yet it would seem that no mere angel could be as bright as the sun. The angels were made from fire (*K* 002:034; 015:027) but were only as bright as the stars or flames of fire.

*Muhammad's* solution was to say that the light of the sun and moon were *Allah's* glory rather than an angel's glory. This was in keeping with his native astral-religion sensibilities that dictated that the gods directly or indirectly empowered and lit their own astral symbol. Tabari (839–923 AD) related that *Muhammad* said:

*Gabriel* brings to the sun a garment of luminosity from the light of the Throne [of *Allah*], according to the measure of the hours of the day. It is longer in the summer and shorter in the winter, and of intermediate length in the autumn and in the winter...but *Gabriel* brings it [the moon] a garment from the light of the Footstool [of *Allah*]. He [*Muhammad*] continued. This is (meant by) God's word: 'He made the sun a luminosity and the moon a light' [*K* 010:005]...<sup>2774</sup>

What *Muhammad* did not realize was that the *Allah* appellation was only used in Arabic translations of Greek, Hebrew, Persian and the like. That Christians used the word *Allah* was a relatively recent innovation. The fact that Christians used the word *Allah* no more meant that *Allah* was *Yahveh* than the Christian use of *Theos* meant that *Zeus* was *Yahveh*.

### **Moon Symbol Usage In the Religions *Muhammad* Synthesized**

#### *Moon Symbol Usage in the Hanifiyya Religion*

As was noted above, the monotheist *Hanifs* worshipped at the *Kaaba*. The *Kaaba* was a shrine to the sun, moon and planets. In the Mideast the moon-god was the high god. Therefore the *Kaaba* was called the House of *Allah*. Thus the *Hanifs* worshipped *Allah* the moon-god.

#### *Moon Symbol Usage in the Magian (Zoroastrian) Religion*

Serge Trifkovic wrote:

<sup>2774</sup> *Al Tabari. History*, p. 232.

The *Sassanians*, who gave their name to the [Persian] empire, followed Zoroastrianism, a form of monotheism...a dualist variety known as *Mazdaism* was the *Sassanide* state religion that legitimized the secular order.<sup>2775</sup>

That the *Sassanians* considered themselves to be monotheistic probably is how they got so well with Jews and also those Christians who were not aligned with Constantinople. The *Sassanians* were rather proud of their monotheism, as Lester Ness wrote:

In 549 CE, the Persian King Khusrau I invaded Syria and extorted ransom from many cities. But he refused to take a ransom from *Haran*, not out of friendliness but because he did not wish to touch the money of polytheists.<sup>2776</sup>

To find out that another religion used the moon symbol and at least made a pretense of being monotheistic, was enough for *Muhammad* to assume the adherents worshipped *Allah* the moon-god—especially if Arabic-speaking Zoroastrians referred to *Ahura Mazda* as *Allah*.

Zoroastrians not only used moon symbols but they even invoked a “moon” plant, as Ameer Ali wrote:

*Ormuzd* [also spelled, *Ohrmazd* or *Ahura Mazda*] was first invoked, and then not only heaven, earth, the elements and stars [were invoked], but trees, especially the moon-plant [*Soma*], and beasts.<sup>2777</sup>

The *Soma* plant also was the sign of the *Vedic* and *Hindu* male moon-god *Chandra*. By the way, *Buddha* is said to have been born, attained enlightenment and died all on full-moon days. *Buddhists* often go to shrines on *Poya* (i.e. full-moon) days.

The *Zend-Avesta*, the sacred body of Zoroastrian scripture, mentions the moon in its expression of Zoroastrian monotheism:

The God that has established the laws in nature is the heaven God. He is the greatest of gods since there is nothing above him nor outside of him; he has made everything since everything is produced or takes place in him; he is the wisest of all gods since with his eyes—the sun, moon, and stars—he sees everything.<sup>2778</sup>

*Muhammad* only knew the Arabian paradigm where the high god was most often the moon-god. The moon was considered the head of the astral household and the sun was a consort or daughter. So he assumed that every major monotheistic religion conformed to the Arabian model.

Someone might ask “How did *Muhammad* come to think that Zoroastrianism had anything to do with the God of Abraham?” By *Muhammad*’s time, Christianity and Judaism had long penetrated the *Sassanian* Empire where the Zoroastrians were dominant. So the three religions were in close proximity to each other and they did have several points of commonality.

As was noted in a previous chapter, the *Sassanian* coins with a Zoroastrian fire temple on the reverse side had several crescent-moons on the obverse side. *Muhammad* would have seen many *Sassanian* coins since the ancient camel caravans’ two main customers were the Byzantine and *Sassanian* Empires.

<sup>2775</sup> Trifkovic. *Sword*, pp. 19-20.

<sup>2776</sup> Ness. *Mosaics*, p. 114.

<sup>2777</sup> Ali. *Spirit*, p. 161.

<sup>2778</sup> Darmesteter, James (translator). *The Zend-Avesta, Part I, The Vendidad*. Sacred Books of the East, vol. 4, Oxford University Press, 1880, Ch. 4: “The Origin of the *Avesta* [Zoroastrian scriptures] Religion,” hinduwebsite.com/sacredscripts/zoroscrites/venindex.htm.

*How Muhammad Came to Think That Zoroastrianism, Christianity and Judaism Had a Common Source*

What *Muhammad* knew about Christ centered mainly on the Nativity accounts in apocryphal sources. Since *Muhammad* was weaned on astral paganism, he naturally preferred apocryphal sources to the New Testament Gospels.

The apocryphal sources were written by semi-pagan astrologists for semi-pagan astrologists. Goodenough mentions the following apocryphal books that syncretized astral religion with either Judaism or Christianity:

II *Buruch*, IV *Esdras*, the Slavonic, Ethiopic and Hebrew *Enoch*, the *Apocalypse of Abraham*, IV *Maccabees* and the *Wisdom of Solomon*.<sup>2779</sup>

Due to the influence of these apocryphal books, *Muhammad* probably did not see any significant difference between Christianity and Byzantine-era astral-Judaism and astral religions such as *Sabeanism*, Zoroastrianism and *Hanifism*.

*Muhammad* also may have been convinced that Zoroastrianism (Magianism in *Islamic* lingo) and Christianity had a common origin based on the fact that the stargazing *Magi* came to worship Jesus by following the Star of Bethlehem—as predicted by Balaam (Num 24:17; Mat 02:02).

These *Magi* may have also delved into pagan astral religion but Balaam's prophecy about the Star of Bethlehem was not preserved in pagan sources. Believers in *Yahveh* served in pagan empires, yet without embracing paganism. Examples include Joseph, Naaman and Daniel (Gen 44:05, 15; 2Ki 05:18-19; Dan 04:08; 05:11).

Many people besides *Muhammad* have thought the Star of Bethlehem somehow validates astrology—or at least a watered down form of astrology. The *Magi* however did not really see a literal star but a light that looked like a star.<sup>2780</sup> The Greek word used for star (*Astron*) can mean “a flame, light, fire” (*Liddell-Scott Lexicon* 6288). The word “star” is used figuratively several times in the Bible (e.g. Num 24:17; Isa 14:12; Rev 02:28; 08:10-11; 09:01, 16).

The “a flame, light or fire” (*Astron*) that the *Magi* saw likely refers to the “Glory of the Lord” that the shepherds saw (Luk 02:09; also see Isa 60:02; Mat 17:05; Rom 09:04). This “glory” was the *Shekinah*, Hebrew for “that which dwells,” meaning the two “Presences” (Hebrew: *Panim*) of *Yahveh* the Father mentioned elsewhere in the Bible (e.g. Exo 33:14-15). The two Presences are the Son and Spirit.<sup>2781</sup>

Some people have been led to believe that the *Magi* saw a star because the *Magi* said they saw it in the east. However, the “east” here may refer the region of Babylon, not to a quadrant of the sky. If a star that was east of Babylon led the *Magi*, they would have ended up in China rather than in Jerusalem. The same “star” they saw in Babylon led them from Jerusalem south to Bethlehem (Mat 02:02, 09).

The *Magi* said that the “star” appeared to them two years earlier (Mat 02:07, 16). It seems the angel of the Lord and the host of angels probably made an appearance to the *Magi* on the day of Jesus' birth—the same day they appeared to the shepherds near Bethlehem (Luk 02:09-15).

The *Magi* seem to have timed their travels in order to attend the celebration of the weaning of the child that most scholars and the *Talmud* says occurred on the

<sup>2779</sup> Goodenough. *Symbols*, pp. 156-157, 161.

<sup>2780</sup> Fruchtenbaum, A. G. “How Did the Wise Men Know? or Is Astrology Valid?” ariel.org, 2003.

<sup>2781</sup> See the chapter on the *Panim* in Yoel Natan's book, *The Jewish Trinity*, 2003.

child's second birthday.<sup>2782</sup> Some scholars and folklore say weaning occurred on the third birthday.<sup>2783</sup>

The *Magi* were Persian, so they may have been going by a Persian weaning tradition—if one existed. The *Koran* indicates that weaning among the Arabs generally took two years (*K* 002:233; 031:014) or two-and-a-half years (*K* 046:015).

Some have said that God sent the *Magi* just in time to fund the flight and stay in Egypt however this does not make sense since if the *Magi* had not come, Joseph and Mary and Jesus would not have had to flee to Egypt. The events did however fulfill two prophecies (Jer 31:15 & Mat 02:18; Hos 11:01 & Mat 02:15).

It did not take the *Magi* two years to travel from Babylon to Jerusalem. The straight-line distance from *Baghdad* to Jerusalem is 543 miles (873 kilometers). If the *Magi* used camels and traveled 30 miles per day, it would have taken only 18 days. Ezra took four months to make the same trip but he had a large retinue and was laden down with goods for the temple (Ezr 07:09, 19, 22).

### *Moon Symbol Usage in the Sabian (Sabean) Religion*

The *Sabean* religion was astral. How *Muhammad* came to think that the *Sabeans* were fallen monotheists was discussed in a previous chapter. To restate it briefly, the *Koran* tells the story of how the Queen of *Sheba* supposedly was chided by Solomon for worshipping *Allah's* consort, the sun-goddess *Allat*, along with the moon-god *Allah* (*K* 027:024).

### *Moon Symbol Usage in the Christian Religion*

In pre-modern times, coins stayed in circulation for centuries at a time as revealed by coin-hoard finds and archaeological digs. So there may have been some old pagan *Yemeni*, *Abyssinian* and Roman Empire coins in circulation in *Muhammad's* day. These old pagan coins often sported the popular crescent-and-orb symbol.<sup>2784</sup>

Even in Christian times, the crescent was used, but without its pagan connotations. The crescent was often relegated from being a main symbol to being just a mintmark.<sup>2785</sup> The aforesaid kingdoms were Christianized a century or two before *Muhammad's* time:

- ✠ Constantine's rule (324–337 AD) began only 246 years before *Muhammad* was born (570 AD).
- ✠ King Ezana, the "*Abyssinian* [Ethiopian] Constantine," converted to Christianity in the fourth century.<sup>2786</sup>
- ✠ *Yemen* first became a Christian kingdom when the *Negus* of *Abyssinia* defeated the Jewish King *Dhu Nuwas* (ruled 515-525 AD).

*Muhammad* could not read the names of the rulers whose portraits were on foreign coins or the dates of the coins. For instance, he refers to a ruler who may

<sup>2782</sup> Gen 21:08; *Easton's Bible Dictionary*, "Isaac" entry 1894; Zoloth, Laurie. "Each One an Entire World: A Jewish Perspective on Family Planning," religiousconsultation.org, accessed 4 Jan 2005.

<sup>2783</sup> "The Jewish writers Jarchi and Ben Melech say Isaac was weaned at two years; Gedaliah says three" (Turvey, Les. "How...?" biblestudy.org, accessed 4 Jan 2005).

<sup>2784</sup> Munro-Hay, Dr. Stuart. *Aksum: An African Civilisation of Late Antiquity*. 1991, Ch. 4: "*Aksumite* History," online edition.

<sup>2785</sup> Munro-Hay, Dr. Stuart. *Aksum: An African Civilisation of Late Antiquity*, 1991, Ch. 8: "The Economy," online edition.

<sup>2786</sup> Creswell. *Architecture*, p. 3.

have been pictured on coins, *Zulqarnain*, literally as “the two-horned one” (K 018:083, 086, 094).

There is another indication that *Muhammad* did not know how to read coins. *Muhammad* retold the Christian fable of the Sleepers in the Cave (*Ashab-i-Kahf*) (K 018: 008-026), which is the prototype of the “Rip Van Winkle” tale. *Muhammad* spoke of a silver coin in the Sleepers’ possession while they were in the cave (K 018:019), yet he never mentions the important detail of the use of the coin to buy bread, nor the shopkeeper’s reaction to the coin.

The salient details of the Sleepers tale are that seven Christians fled persecution during the time of the pagan Emperor Decius (249-251 AD). Unfortunately, pagans walled up the cave that the Christians were hiding in. Miraculously, the Christians slept 196 years until the reign of Theodosius II (reigned 408–450 AD).<sup>2787</sup>

The Christians did not know how long they had slept until one Sleeper tried to buy bread with a two-century-old Decian coin in an era with Christianized coins. The shopkeeper saw the pagan emperor’s portrait and pagan symbolism and immediately assumed the Sleeper had discovered a long-lost hoard of coins.

The baker seems to have wanted to ascertain on whose property the hoard had been found. It seems there was a Roman law that made treasure troves the property of the landowner since the ground was used as a primitive bank (Mat 25:25).

The maxim “Finders keepers, losers weepers,” did not apply to buried treasure in Roman times. The reason is that people buried money on their property often, so any buried money was assumed to be the property of the landowner. Otherwise, in order to rob the “bank,” neighbors could just spy on their neighbors and then dig the treasure up in the middle of the night or when the neighbor was traveling.

This is why, when someone found evidence of a long-buried treasure, he immediately set out to buy the property. The land sale would prove that the previous owner knew nothing of the buried treasure or else he would have dug the treasure up before selling the land (Mat 13:44).

In fact just such a scandalous situation is found in *Muhammad*’s biography. *Muhammad* wanted Kinana’s money and tortured him by applying fire to his chest to find out where it was buried. A fellow Jewish captive reported that “he had seen Kinana going around a certain ruin every morning early.”<sup>2788</sup> *Muhammad* then had the ruin excavated and some of the treasure was found.

The fact that *Muhammad* seemingly was oblivious to these details about the coin—details that made sense of the rest of the story—means he did not know how to read the print on foreign coins which told when they were minted. Foreign coins were all that existed around *Makka* since no coins were minted locally at that time.

Because *Muhammad* did not read coins, he probably mistakenly assumed that old pagan coins with crescent-and-orb symbols were Christian. Also, *Muhammad* likely saw some contemporary Byzantine coins with a decorative crescent along with a cross.<sup>2789</sup>

One particularly interesting Byzantine coin had a large “M” denomination mark on the reverse side. Though the Byzantine Empire’s official language was Greek, the

<sup>2787</sup> St. Clair-Tisdall. *Sources*, Ch. IV. “...Christian *Apocryphal* Books.”

<sup>2788</sup> Ishaq. *Sirat*, p. 515.

<sup>2789</sup> Two of many examples of Byzantine coins with crosses and crescent are *Follis* D103 (SB 65) of Justin I, emperor from 518–527 AD, and *Follis* A282 (SB 22) of Anastasius I, circa 430–518.

“M” denomination was a carryover from the Latin (*mille*) meaning “a thousand.” The Greek denomination mark for a thousand (*chilioi*) would have been “X.”

*Muhammad* may have thought that: 1) the “M” denomination mark, 2) the crescent and 3) the cross decorations on the “standing emperor” coins stood for the Christian Trinity. This would have confirmed in *Muhammad*’s mind that the Christian Trinity was the Father, Jesus (*Isa*) and Mary (*K* 004:169; 005:077, 116). *Muhammad* may have been told that on this Byzantine coin the:

- 1) Crescent stood for the moon-god, *Allah* the Father.
- 2) Cross stood for the Son, Jesus.
- 3) “M” denomination mark stood for Mary (Latin and Greek: *Maria*, Arabic: *Marium*).

*Muhammad* no doubt saw Christians use the crescent symbol in other ways and this led him to believe that the Christians worshipped *Allah* the moon-god. *Muhammad* addressed Christians and Jews in the *Koran* saying:

We believe in what has been sent down to us and in that which was sent down to you; our God and your God is One; and we are submissive to him (*K* 029:046; see also *K* 002:062; 003:064; 006:107; 016:035; 021:108; 029:061-063; 039:003).

According to the Mideast paradigm that *Muhammad* knew, the crescent signified *Allah* the moon-god. However, he would not have known that outside the Mideast a crescent would not designate *Yahveh*. In the Mideast the words describing phases of the moon were generally masculine and the moon deities were male, like *Sin* and *Allah*. Outside the Mideast the moon deities were female, like *Diana*, *Luna* and *Artemis*.<sup>2790</sup>

The Romans generally could not envision worshipping a male moon-god. Emperor Caracalla was assassinated after worshipping a *Haranian* moon-god—almost certainly *Sin*. One Roman historian assumed however that Caracalla had worshipped *Luna*, while another chronicler figured it had to have been the goddess *Selene*.<sup>2791</sup>

These gender assignments were based on cosmological myths, as Sinasi Gunduz wrote:

In ancient Mesopotamia the moon-god was considered the oldest of the planets, preceding the sun as night precedes day. He was the father of the divine sun, as well as of *Ishtar*, and thus deserved precedence both by virtue of age and of family status.<sup>2792</sup>

One might wonder how the Mideast ancients could believe that the night preceded the day and not the reverse. It was reasoned that before the Creation, there was darkness and a void, meaning that light is part of the creation. Darkness was primary and uncreated and thus preceded the light, which was secondary and created.

In *Semitic* time keeping, the “day” starts in the evening and continues through the nighttime and through daylight hours. This follows the pattern set during the Creation Week when darkness preceding the light: “...there was evening and there was morning—the first day” (Gen 01:05; see also Gen 01:08, 13, 19, 23, 31).

In *Semitic* timekeeping, the night and moon were primary, and the night was not divided between one day and the next. In the West however the sun was paramount

<sup>2790</sup> Green. *Moon*, p. 27.

<sup>2791</sup> Green. *Moon*, p. 27.

<sup>2792</sup> Gunduz. *Life*, p. 162.

for timekeeping. The realm of night was divided in half, and one part was assigned to previous day and the later half was assigned to the next day.

### ***Muhammad's Information Concerning the New Testament***

*Muhammad* mentions the Gospel (*Injeel*) twelve times (*Koran* 003:003, 048, 065; 005:046, 047, 066, 068, 110; 007:157; 009:111; 048:029; 057:027). Gibb and Kramers wrote on the subject:

That *Muhammad* at any rate later heard something of the parables in the Gospels is shown by xlvi,29 [*K* 048:029], from which however it can once more be seen that he possessed no real [detailed, deep] knowledge of the New Testament.<sup>2793</sup>

From whence did *Muhammad* get his information about Christianity? C. C. Torrey wrote similarly:

It is a patent fact that the prophet knew next to nothing about Jesus; also, that there are no distinctly and peculiarly Christian doctrines in the sacred book. All those who have studied the matter know and declare that the great bulk of the *Koranic* material is of Jewish origin; and we have certain knowledge that *Mohammed* resorted habitually to learned Jewish teachers...I believe that it will eventually be recognized that whatever knowledge (or pseudo-knowledge) he possessed in regard to the person and life of Jesus was derived from two sources: first, the facts and fancies which were common property in the *Hijaz* and elsewhere in Arabia; and second, a small amount of information supplied to him by his *Israelite* mentors....The conclusion expressed seventy years ago by Muir in his *Life of Mahomet*, II, p. 289, is still very near the truth if it is limited to *Mohammed* and the *Koran*: 'We do not find a single ceremony or doctrine of *Islam* in the smallest degree molded, or even tinged, by the peculiar tenets of Christianity.'<sup>2794</sup>

Most of what the *Koran* relates about Jesus (*Isa*) concerns Nativity scenes where the *Koran's* storyline is based on apocryphal sources that diverge from the Gospel accounts. Reading the snippets about Jesus' adult life, one would be at pains to distinguish the character of Jesus from say, Noah (*Nuh*), as C. C. Torrey wrote:

His characters are all alike and they utter the same platitudes...In *Sura* 11:27-51 is given a lengthy account of Noah's experiences...It contains very little incident, but consists chiefly of the same religious harangues which are repeated scores of times throughout the *Koran*, uninspired and uniformly wearisome. We have the feeling that one of Noah's contemporaries who was confronted with the prospect of forty days and forty nights in the ark would prefer to take his chances with the deluge.<sup>2795</sup>

The persons of the Trinity are the Father, Son and Spirit. *Muhammad* however thought that the persons of the Trinity were the Father, Jesus (*Isa*) and Mary (*K* 004:169; 005:077, 116).

*Muhammad* also thought that Christians taught that *Allah* had carnal relations with Mary to conceive Jesus (*K* 003:045-049; 002:116; 019:035; 037:151; 043:082). While this agrees with pagan notions about pagan triads, this contradicts the Biblical teaching that Mary conceived as a virgin (*virgo intacta*) (*Isa* 07:14; *Mat* 01:23).

<sup>2793</sup> Gibb & Kramers. *Encyclopedia*, p. 276, *Al-Kur'an* entry, right column, middle.

<sup>2794</sup> Torrey. *Foundations*, pp. 72-73, 82.

<sup>2795</sup> Torrey. *Foundations*, p. 108.

*Muhammad* came to these carnal misunderstanding of the Trinity due to the ancient practice of recycling artwork upon switching gods or syncretizing a religion.

*A Case Study on Syncretization: Hubal as Ibrahim*

A Muslim tradition suggests how Biblicizing pagan artwork worked. F. E. Peters wrote:

Finally, among the pictures that decorated the interior of the *Kaaba* in pre-Islamic days, there was one, as Azraqi says, ‘of Abraham as an old man.’ But because the figure was shown performing divination by arrows, it seems likely that it was *Hubal*. The suspicion is strengthened by the fact that when *Muhammad* finally took over the sanctuary, he permitted the picture of Jesus to remain but had that of ‘Abraham’ removed with the dry comment, ‘What has Abraham to do with arrows?’ Has *Hubal* depicted as ‘Abraham the Ancient’ anything to do with the ‘Ancient House,’ as the *Kaaba* is often called? Or, to put the question more directly: Was it *Hubal* rather than *Allah* who was ‘Lord of the *Kaaba*’? Probably not. The *Quran*, which makes no mention of *Hubal*, would certainly have raised the contention. *Hubal* was, by the Arabs’ own tradition, a newcomer to both *Makka* and the *Kaaba*, an outsider introduced by the ambitious Amr Ibn Luhayy, and the tribal token around which the *Quraysh* later attempted to construct a federation with the surrounding *Kinana* [tribe], whose chief deity *Hubal* was. *Hubal* was introduced into the *Kaaba*, but he never supplanted the god *Allah*, whose House it continued to be.<sup>2796</sup>

*Muhammad* was not impressed by *Hubal* because *Hubal* probably spelled the end to many infants. Whenever there was doubt about the paternity of an infant, *Hubal* was consulted for drawing lots. If the drawn arrow said that the infant was a “consociated alien,” the tribe rejected the infant.<sup>2797</sup> The infant may then have been killed, especially if it was a girl, and this was a practice that *Muhammad* abhorred (*K* 006:151; 016:058-059; 017:031).

Another reason that *Muhammad* did not like *Hubal* was, as tradition has it, his grandfather *Muttalib* used *Hubal*’s arrows to divine how many camels *Muttalib* needed to sacrifice to *Allah* as a substitute for sacrificing *Muhammad*’s father, *Abdullah*. *Abdullah*, interestingly enough, means “Slave of *Allah*.” The price dictated by *Hubal* was steep—a hundred camels.<sup>2798</sup>

*Hubal* could have cost *Muhammad*’s father and *Muhammad* their earthly existence. Moreover, *Muhammad* figured it was all for nothing since *Hubal* was a fraud and had no true connection to *Allah*. Furthermore, the arrow-divination was certainly rigged.

It was the priests who determined whether an infant would live or die by fixing the “luck of the draw.” Also, when *Muhammad*’s grandfather wanted to determine which of his ten sons would be the human sacrifice...

...He told them to make each his mark on an arrow. Then, each son gave his arrow to the diviner.<sup>2799</sup>

Mostly likely, all ten sons put the name of the youngest son, *AbdAllah*, on his arrow. *Muhammad* secretly rued the fact that his father nearly lost his life because his

<sup>2796</sup> Peters. *Hajj*, p. 25.

<sup>2797</sup> *Al Kindy, Idols*, p. 23.

<sup>2798</sup> Lings. *Sources*, p. 13.

<sup>2799</sup> Lings. *Sources*, p. 13.



brothers were like Jacob's sons, who were willing to sell their own brother Joseph into slavery.

This would explain why *Muhammad* showed animosity toward, and lacked the support of, most of his relatives in *Makka*. In fact, *Muhammad* produced a chapter of the *Koran* to curse his aunt and his uncle, *Abu Lahab*:

Perdition overtakes both hands of *Abu Lahab* and he will perish. His wealth and what he earns will not avail him. He shall soon burn in fire that flames, and his wife, the bearer of fuel, upon her neck a halter of strongly twisted rope (K 111:001-005).

Ishaq wrote that *Abu Lahab* later died a terrible death after hearing the bad news about the Battle of *Badr*.<sup>2800</sup>

### **Isis and Horus as Mary and Jesus**

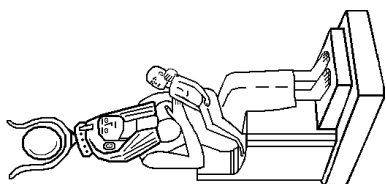
Just as the deity *Hubal*, who held divination arrows and other accouterments, was thought to depict *Ibrahim*, so *Isis* with her crescent and Venus orb headdress was thought to be Mary. *Isis*' infant *Horus* was thought to be the infant Jesus.

That *Isis* was in the pantheon of gods in *Makka* is without doubt since *Isis* worship was ubiquitous throughout the Mideast and Roman Empire.

*Muhammad* mentions *Isis*' star, *Sirius*, when *Muhammad* said that *Allah* was the Lord of *Sirius* (K 053:049). This *Sirius* verse is in the same chapter as the mentions of the other three Daughters of *Allah* (K 053:020). *Sirius* may have been considered a daughter or consort of *Allah*.

---

**Figure 06-01.** An *Isis* and *Horus* statue.<sup>2801</sup> *Isis* and *Horus* were members of the



Egyptian triad: *Isis* (Sirius-goddess), *Horus* (sun-god) and *Osiris* (moon-god). The star *Sirius* was important since its helical rising once presaged the Fall flooding on the Nile River. This is no longer the case due to the precession of the earth and the damming up of the Nile.

**Note:** Rotate book to view figure upright.

---

That *Isis* and *Horus* statues and paintings were recycled into Mary and Jesus around *Makka* is suggested by the fact that the depictions said to be Mary and Jesus were among many pictures of pagan deities. The *Sufi* Martin Lings wrote:

...the walls inside [the *Kaaba*] had been covered with pictures of pagan deities.<sup>2802</sup>

Hughes wrote:

*Al Azraqi*, quoted by Burckhardt, says that the figure of the Virgin Mary and the infant Jesus was sculptured as a deity upon one of the six pillars [inside the *Kaaba*] nearest the gate.<sup>2803</sup>

There also may have been vases and figurines, as well as niches with *Isis* and *Horus* statues carved into the rock faces around *Makka* like those still found at *Petra*.<sup>2804</sup>

---

<sup>2800</sup> Ishaq. *Sirat*, pp. 310-311.

<sup>2801</sup> A depiction of *Isis* and *Horus* can be found at Pritchard. *Ancient*, vol. i, fig. 146.

<sup>2802</sup> Lings. *Sources*, p. 300.

<sup>2803</sup> Hughes, *Dictionary*, *Kaaba* entry, p. 258, left column.

<sup>2804</sup> Lindner. *Petra*, pp. 121-122, 155 (images 10-12, 36).

*Muhammad* probably did see a lot of Christian artwork, especially on his travels since early Christians were not iconoclasts. Iconoclasm was not a widespread phenomenon until the eighth and ninth centuries AD.<sup>2805</sup> Ramsay MacMullen wrote:

Statues of Jesus, Mary and the apostles in both church buildings and private homes receive mention in literary sources of the sixth and later centuries and are uncovered by excavation in both the east and the west during the same period. It is assumed they were common.<sup>2806</sup>

Since *Makka* seems not to have had a library or synagogue or church, *Muhammad* received most of his information from hearsay and artwork. This explains how *Muhammad* came to independent and *non sequitur* conclusions such as that the Trinity is the Father, Jesus and Mary, and that Jews worshiped Ezra as the Son of God (*K* 009:030).

The *Koran* itself suggests that *Muhammad* received no formal instruction from Jews, as Norman Geisler wrote:

In this *Sura Muhammad* is told: ‘If thou wert in doubt as to what We have revealed unto thee, then ask those who have been reading the Book [the Bible] from before thee; the truth hath indeed come to these from thy Lord; so by no means be among those who doubt.’ Abdul Haqq notes that ‘the learned doctors of *Islam* are sadly embarrassed by this verse, referring the prophet as it does to the People of the Book who would solve his doubts.’<sup>2807</sup>

It seems that *Muhammad* was very familiar with the *Isis* and *Horus* cult. *Isis* was the Egyptian goddess of *Sirius* and the mother of *Horus* the moon-god. Their cult was found throughout the Mideast and throughout the Roman Empire in its Hellenized form.

*Muhammad* seems to have fit whatever little information about Christianity that he received into the *Isis* and *Horus* cult paradigm. *Muhammad* seems to have pictured Mary and Jesus as being like the familiar statues of *Isis* and *Horus*.

The *Isis* and *Horus* stories are mostly about:

- ☉ The nativity of *Horus*
- ☉ The motherhood of *Isis*
- ☉ The struggle and death of the moon-god, *Horus* at the hands of the sun-god *Set*
- ☉ The rebirth of *Horus* that involved his mother *Isis*

That *Muhammad* interpreted Christianity through the lens of the *Isis* and *Horus* nativity statutes goes a long way in explaining why much of the *Koran*’s limited information about Christianity concerns the Nativity. Kenneth Cragg wrote:

The immediate impression on the general reader from what the *Quran* has to tell him about Jesus is that of its brevity....It is further surprising that within the limits of some ninety verses in all no less than sixty-four belong to the extended, and partly duplicate, Nativity stories....This leaves a bare twenty-six or so verses to present the rest [of the information about Jesus] and some reiteration here reduces the total still further. It has often been observed that the New Testament Gospels are really passion narratives with extended introduction. It could well be

---

<sup>2805</sup> CEE, Iconoclasm entry.

<sup>2806</sup> MacMullen. *Eighth*, pp. 130-131.

<sup>2807</sup> Geisler & Saleeb. *Answering*, p. 211.

said that the Jesus cycle in the *Quran* is Nativity narratives with attenuated sequel.<sup>2808</sup>

The Nativity account in the *Koran* is from apocryphal sources, as when Mary gives birth, not accompanied by Joseph at a Bethlehem stable but alone and under a palm tree (*K* 019:022-027).

Of the twenty-six non-Nativity verses about Christianity, a few verses are expended in *Muhammad's* denial of Christianity's distinctive doctrines. Other verses just show *Muhammad's* confusion about Christian doctrine, such as:

*Allah* will say: 'O *Isa* [Jesus] son of Mary, did you say to men, 'Take me and my mother for two gods besides *Allah*?' He [Jesus] will say: 'Glory be to You! It did not befit me that I should say what I had no right to (say); if I had said it, You would have indeed known it; You know what is in my mind, but I do not know what is in Your mind; surely You are the great Knower of the unseen things' (*K* 005:116).

So the reader can see that the *Koran* treats Christianity in a dismissive fashion. Nevertheless the *Koran's* rehashes of the Nativity Story fool gullible readers into thinking that the *Koran* agrees with Christianity to a great extent. This is not just known anecdotally but is a matter of sad history, as the *Muslim* Maududi reports:

We learn from authentic Traditions that [a *Muslim* immigrant] *Hadrat Ja'afar* recited verses 1-40 [a *Koranic* Nativity Story] of this *Sura* [*Koran* 019:001-040 of "*Marium*"] in the court of [the] *Negus* when he called the migrants to his court....The King [of *Abyssinia*] listened to it and wept, so much so that his beard became wet with tears. When *Hadrat Jafar* finished the recital, he [the *Negus*] said: 'Most surely this Revelation and the Message of Jesus have come from the same source.'<sup>2809</sup>

### More on the *Isis* and *Horus* as *Jesus* and *Mary*

One can easily imagine that *Muhammad* had *Isis* and *Horus* statues in mind when he said that Christians held that *Jesus* AND his mother were gods (*K* 005:116; see quote above).

The deduction that *Muhammad's* misperceptions were derived from artwork is supported by yet another tradition that suggests *Muhammad* saw pre-Islamic recycled images of *Isis* and *Horus*:

The *Quraysh* had put pictures in the *Kaaba* including two of *Jesus*, son of *Mary*, and *Mary*...*Ibn Shihab* said 'Asma' the daughter of *Shaqr* said that a woman of the *Banu* [tribe] *Ghassan* had joined in the pilgrimage of the Arabs, and when she saw a picture of *Mary* in the *Kaaba* she said 'My father and my mother be your ransom! (*Mary*), you are surely an Arab woman!' The Messenger ordered that the pictures be erased, except those of *Jesus* and *Mary*.<sup>2810</sup>

The likely reason the Arab women said that *Mary* was an Arab is that she had seen *Coptic* and Arab Christian versions of *Mary*, as well as the Egyptian *Isis* version of *Mary*. *Robert Eisler* agrees that the *Kaaba* had an *Isis* version of *Mary*:

Finally, I would like to mention that especially in *Cyprus* the innumerable clay-figures of the goddess...Other *Terra Cottas* are showing the goddess with

<sup>2808</sup> Cragg. *Jesus*, pp. 25-26.

<sup>2809</sup> Maududi. *Meaning*, Introduction to *Sura* 19.

<sup>2810</sup> Peters. *Origins*, p. 236.

the divine child. That is, as *Beltumullidât Ilani* (giver of birth to the gods equals Greek, *Theôtochos*, translated by Herodot[os] as *Mulitta*. Such a representation of the suckling *Chaabou* with the *Dusares*-child now, has Mohammed—not without a reason—identified with *Isus [Isis]* and *Maryam [Mary]*. And thus has saved of all the wall paintings within the *Ka'aba* from destruction, by spreading his hands over them (Burckhardt I 221; Caussin I 198; Wüstenfeld, *Gesch. der Stadt Makka*, p. 105).<sup>2811</sup>

Each culture produces its own conception of the Biblical figures. Jesus has been rendered as a Greek, a Caucasian, a Hispanic, a Black man and even as a Chinese “Confucius” hung on a cross.

Marian Edwardes and Lewis Spence wrote about what the *Isis* statues looked like that were commonly mistaken for Mary:

She [*Isis*] is figured as a woman and represented in the costume of an Egyptian queen, with the headdress of the queen mother; her head at times is surmounted by horns and the solar disk...She was astrally associated with the star *Sept* [i.e. *Sirius* the Dog Star which rises in Autumn in the northern hemisphere].<sup>2812</sup>

*Muhammad's* preaching about Mary was not a corrective that would clear up any confusion as to what cultural dress Mary would have worn. *Muhammad* confused Mary, the mother of Jesus, with *Miriam* the sister of Moses, as will be discussed shortly.

It may have been thought appropriate to depict Moses and *Miriam* in Egyptian dress since Moses grew up in the Pharaonic court (Act 07:22). Since *Muhammad* confused Mary with *Miriam*, he may have thought that Mary had worn Egyptian dress too—just like the dress that *Isis* was depicted in.

The *Muslim* Syed Ameer Ali wrote that some Christians were guilty of Mariolatry.<sup>2813</sup> At *Muhammad's* time (570-632 AD), the vast majority of Christians were Trinitarian and only a handful of mistaken individuals ever thought that Mary was a member of the Trinity. Samuel Zwemer wrote:

On the Christian monuments found by Dr. Edward Glaser in *Yemen*, *Allah* is also mentioned. The *Sirwah* inscription (AD 542) opens with the words: ‘In the power of the All-merciful and His Messiah and the Holy Ghost,’ which shows that, at least in *Yemen*, Arabian Christians were not in error regarding the persons of the Trinity.<sup>2814</sup>

Of course there always are going to be obscure, wrongheaded sects that appear and vanish. For instance, there was the very early *Collyridian* sect worshipped Mary as a goddess.<sup>2815</sup> This women-only sect existed three centuries before the time of *Muhammad*. The sect probably never existed in Arabia and was all but forgotten by *Muhammad's* day.<sup>2816</sup>

Though Christians called Mary the “Bearer of God” (*Theotokos*), this does not mean that Christians thought Mary was a divine consort like Venus or *Isis*. Christians did, unfortunately, leave themselves open to the charge of syncretism by being sensitive to pagan sensibilities, as Guillaume wrote:

<sup>2811</sup> Eisler. 1909.

<sup>2812</sup> Edwardes & Spence. *Mythology*, *Isis* entry, p. 93.

<sup>2813</sup> Peters. *Hajj*, pp. 251-252, 329.

<sup>2814</sup> Zwemer. *Essay*, Ch. 2: “*Allah*, the Divine Essence,” p. 27.

<sup>2815</sup> Trimmingham. *Arabs*, p. 68.

<sup>2816</sup> Zwemer. *Essay*, Ch. 6: “Mohammedan Ideas of the Trinity,” pp. 88-89.

...the term ‘Mother of God’ given to the Virgin Mary could mean only one thing to an Arab—the sexual trinity [triad] of the old heathen world, which was never a unity.<sup>2817</sup>

*Muhammad* figured that a triad of gods would not be possible without one being the father, another being the mother and the third being the son or daughter. As *Muhammad* said on the subject:

☉ How could He [*Allah*] have a son when He has no consort (*K* 006:101).

☉ He [*Allah*]...has not taken a consort or a son (*K* 072:003).

Thinking that a deity could only exist only as a product of sexual activity is quite primitive. That *Muhammad* would believe this is not surprising given his astral-fertility religion background. *Muhammad* even sacrificed to *Uzza* at *Makka* and *Uzza* had her own shrine nearby *Makka* at a place called *Nakhla*.<sup>2818 2819</sup>

It seems that *Muhammad* had the Arabian Venus (*Uzza*) as well as *Isis* in mind when he spoke of Mary. *Muhammad* taught that Christians believed the Father, Son and Mary were a sexual triad (*K* 005:116). Also, the *Koran*’s Nativity story has details that remind one of *Venus*.

*Muhammad* said that Mary gave birth to Jesus under a palm tree (Arabic: *Nakhla*) (*K* 019:23, 25). *Muhammad* said that Mary withdrew from her family to “a remote place” in the east (*K* 019:016, 022). This seems to be an allusion to the *Nakhla* (Arabic: Palm Tree) oasis that is just east of *Makka* and north of the *Taif* shrine. *Nakhla* was a Venus (*Uzza*) shrine.

The *Koran* says a voice came from underneath the palm tree and a rivulet proceeded forth. The rivulet and voice sound eerily like the haunted, cultic oasis setting of *Nakhla*. Perhaps this was *Muhammad*’s twisted attempt at Biblicizing *Nakhla* just as he had Biblicized *Makka* by placing *Ibrahim*, Hagar and Ishmael there.

*Muhammad* thought that a divine son could only come into existence as a product of procreation between a male and a female. *Muhammad* may have been confirmed in his interpretation that the Christian Trinity was a standard astral triad because a few Christians used zodiac circles as decorations. Bernard Goldman wrote:

In one well-preserved zodiac mosaic, the hall floor of the sixth-century monastery at *Beth Shan*, both sun and moon are personified in the hub of the wheel.<sup>2820</sup>

Ramsey MacMullen wrote of decorations that seem to mimic zodiac circles with *Helios* in the center surrounded by Seasons:

...in Augustine’s day, at *Kourion* in Cyprus, the town senators eloquently thanked their richest citizen for his wonderful munificence toward the town, he a Christian but they subtly pagan still. The buildings he paid for were decorated with grateful inscriptions, roundly acknowledging Christ but at the same time hailing the benefactor as a new *Phoebus* [i.e. a new sun-god], surrounded by quite traditional, that is, not specially Christian, personifications of *Reverence*, *Temperance* and *Obedience-to-Law*. Similar inscriptions and abstractions might be cited from *Ephesus* or *Aphrodisias* of the fifth or a later century.<sup>2821</sup>

<sup>2817</sup> Guillaume. *Islam*, pp. 52-53.

<sup>2818</sup> Al Khargushi. *Sharaf Al Mustafa*, as cited by Peters. *Origins*, p. 127.

<sup>2819</sup> Al Kalbi. *Idols*, pp. 16-17.

<sup>2820</sup> Goldman. *Portal*, p. 63.

<sup>2821</sup> MacMullen. *Eighth*, p. 147.

*Muhammad* also figured the Trinity was a standard astral sexual triad after seeing a *Copt* Christian symbol. The *Copts* had extensive contact with Arabia and a *Copt* even helped rebuild the *Kaaba* in 605 AD. The *Encyclopedia Britannica* states:

The ancient Egyptian hieroglyphic symbol of life—the *Ankh*...was adopted and extensively used on *Coptic* Christian monuments.<sup>2822</sup>

The *Coptic* syncretism of the *Ankh* and cross is illustrated by a third-century clay mummy coffin in Egypt that shows a girl with an *Osiris* beard on her chin. She also holds a lotus flower, the sign of rebirth, in her right hand and a cross in her left hand. One would think the cross was an *Ankh* except for the chain and ring, the serrated edges on the cross and the fact that *Ankhs* were traditionally held in the right hand.<sup>2823</sup>



**Figure 06-02.** Ancient Egyptian *Ankh* phallic and vulviform symbol of life.

The *Copts* reinterpreted the *Ankh* symbol. The loop at the top of the *Ankh* was said to be a stylized representation of Jesus head while he was on the cross. *Muhammad* likely recognized the *Ankh* for what it was—a combination phallic-vulviform fertility rite symbol representing “life.”

Another factor that would lead *Muhammad* to think Christianity had an astral triad is the number of pagan customs retained by the newly converted. Christianity was spread mostly by persuasion, so no absolute uniformity of beliefs could be enforced. *Islam* is worse in this regard even though it was mostly spread by sword.

Unlike *Muslim* cultures that stagnate because the *Koran* and *Sharia* law codifies the early-medieval Arabian moon-god culture as the law of the land, the Bible has timeless truths. Cultures undergo repeated reformations as the reality is relentlessly compared to the timeless ideals that *Yahveh* set forth in the Bible.

### Other Pagan Infiltrations into Christianity

There were other pagan infiltrations into Christianity that may have confused *Muhammad* about the true nature of Christianity. Ramsay MacMullen wrote that as late as the beginning of the fifth century AD, Christians perhaps only constituted about half the population of North Africa.<sup>2824</sup>

What would have interested *Muhammad* was the influence of pagan moon worship in Christianized areas. For instance, Ramsay MacMullen wrote about the lingering influence of the moon deity in the former Western Roman Empire:

...fears that the moon would disappear for good: to an eclipse or the end of the month, the response that we hear about from the western provinces was to make a great racket with horns and bells. The bishops from the fifth century on called the practice sacrilege, the Devil’s work, and tried to end it by their conciliar legislation on solemn occasions and by their preaching far more often; but it persisted till the ninth century.<sup>2825</sup>

Given the prevalence and persistence of paganism, it is not surprising that among the customs borrowed from paganism, Christians in Rome and Greece borrowed “the

<sup>2822</sup> *EB*, accessed 22 Apr 2003, Cross entry.

<sup>2823</sup> Jeremias. *Four*, pp. 66-67, illustration p. 65

<sup>2824</sup> MacMullen. *Christianizing*, p. 83.

<sup>2825</sup> MacMullen. *Eighth*, p. 70.

honorific bow in the direction of the rising sun.<sup>2826</sup> Some Christians used the crescent-Venus orant posture for prayer. The orant position is holding uplifted hands. This subject is discussed in a later chapter.

Locating a shrine or church over an old pagan site invites confusion between paganism and Christianity. For instance, Alfred Guillaume wrote concerning two ruined cathedrals in *Yemen* (not far from *Makka*):

In these last two places Christian cathedrals once stood. Doubtless the extraordinary pains that were taken in their construction and decoration were directed toward weaning the pagan population from their age-long practices.<sup>2827</sup>

### ***Muhammad's Confusion Over the Christian Trinity and Pagan Triads***

Christians left themselves open to the charge of syncretism by being somewhat sensitive to pagan sensibilities. In other words, Christians did not ruthlessly root out every residue of paganism simply because Christianity is not a totalitarian ideology.

Pagan practices lent to Christianity may have contributed to *Muhammad's* misconception that the Christian god was a typical pagan sexual astral triad.

Even in modern times some try to make the case that the doctrine of the Trinity has pagan origins. Jehovah's Witnesses and the *Muslim* writer Syed Ameer Ali are among those who argue from this perspective.

Pagans however never conceived of a trinity like the Trinity described by the Bible where three persons are one god. Pagan so-called "trinities" were in fact three gods, i.e. triads. Most often these triads were astral triads comprised of the sun, moon and Venus. Guillaume wrote:

...the sexual trinity [triad] of the old heathen world...was never a unity.<sup>2828</sup>

The real, unstated reason Syed Ameer Ali made his assertions about the Trinity having been a pagan sexual trinity was to bail *Muhammad* out of a predicament. *Muhammad* mistakenly thought that the Father, Son and Mary constituted a triad.

Besides getting the persons of the Trinity wrong, *Muhammad* thought that Christians worshipped a triad of gods rather than the Trinity. This may not be readily apparent by reading the *Koran* since the word "Trinity" is found in some modern translations (as in *Yusuf Ali's Koran* 004:171; 005:073). The word Trinity is not found in the Arabic *Koran*, even though the word Trinity had been coined centuries before *Muhammad's* time.

*Muhammad* did not realize that Christians believed in the Trinity—that the Father, Son and Spirit were one God, not three gods. *Muhammad* thought that Christians taught that *Allah* is "the third" person of three gods (*K* 005:073).

*Muhammad* thought that Christians believed in a triad: Mary, Jesus and *Allah* the Father (*K* 005:116), and that Christians thought that the Angel *Gabriel* was the Spirit. Ameer Ali wrote the following in an attempt to exculpate *Islam* from this difficulty:

The esoteric conceptions regarding the birth, death and resurrection of *Osiris*, the idea of the *Isis-Ceres*, the virgin mother 'holding in her arms the newborn sun-god *Horus*,' were in vogue in Egypt and Syria...the Egyptians, *Osiris*, *Isis* and *Horus*, the Trinitarian belief was common...among the peoples of Asia Minor, Syria and the Mediterranean littoral [shores], excepting the Jews, the idea of a god who had died and risen again, and of a divine Trinity, was

<sup>2826</sup> MacMullen. *Eighth*, p. 157.

<sup>2827</sup> Guillaume. *Islam*, p. 7.

<sup>2828</sup> Guillaume. *Islam*, pp. 52-53.

universal. It was an essential part of the *Serapean* [*Osiris-Apis Bull*] cult; and with the spread of *Isis*-worship every part of the Roman world was permeated by the trinitarian conception....Among the masses *Isis*-worship was transformed into Mariolatry; and Mary the mother of Jesus became, instead of the Egyptian goddess, ‘the haven of peace’ and ‘the altar of pity.’ Thenceforth she was worshipped, as she still is among the Latin races, as the ‘*Madre de Dios*’ [Mother of God].<sup>2829</sup>

### ***Muhammad’s Confusion Over Mary and Isis***

Ramsey MacMullen notes that some early Christians who were in need of healing frequented *Isis*’ healing shrines. Saint Cyril reveals what went on at these healing shrines when he contrasts Christianity to *Isis* worship...

...let them come to the true healing without cost; for no one invents dreams for us, no one says to those who come, ‘The Mistress [*Isis*] has said, do thus and so.’<sup>2830</sup>

As Syed Ameer Ali pointed out, *Osiris*, *Isis* and *Horus* worship were common in Syria. Syria was one place camel caravans from *Makka* frequented as they plied the Fertile Crescent. Scholars argue and *Islamic* tradition suggests that much of the Arabian religion came from the Fertile Crescent, as does this account about pre-*Islamic* times:

Amr *Ibn* Luhayy brought with him (to *Makka*) an idol called *Hubal* from the land of *Hit* in Mesopotamia. *Hubal* was one of the *Quraysh*’s greatest idols. So he set it up at the well inside the *Kaaba* and ordered the people to worship it.<sup>2831</sup>

*Muslim* traditions record that at least three idols were brought to the *Kaaba* from Syria (*Asaf*, *Nailah* and *Hubal*).<sup>2832</sup> One could easily imagine that at some point *Isis* and *Horus* and *Osiris* were made on location in *Makka*, or were hauled from *Yemen* or Syria to *Makka* in a camel *Howdah*. Then at some point these three gods were said to represent the Christian Trinity. This would mirror the practice of recycling religious art in Egypt and elsewhere. Philip Jenkins wrote:

Within the first few centuries of Christianity’s existence, its adherents in Egypt used figures of the goddess *Isis* with her child *Horus* as the model for devotional imagery of Mary and the infant Jesus. Across the Mediterranean, the functions of numerous local deities were transferred to Christian saints. Borrowings from paganism are well known, to the extent that the pope himself takes his title of *Pontifex* from one of the chief priests of pagan Rome. Christianity has been highly flexible about these adaptations and there is no obvious reason why the age of absorption should have ceased in the fifth or tenth centuries...<sup>2833</sup>

There are many examples of how pagan idols were Biblesized or brought into the cult of the saints, but Ramsay MacMullen provides two interesting examples of cult objects that lasted into modern times:

[1] In the nineteenth century the inhabitants of *Eleusis* still attributed the fertility of their fields to Saint Demetra, hung garlands on her *Kanephorus*

<sup>2829</sup> Ali. *Spirit*, pp. xxxix-xliii.

<sup>2830</sup> MacMullen. *Eighth*, p. 124.

<sup>2831</sup> Peters. *Hajj*, p. 25.

<sup>2832</sup> Wherry. *Commentary*, vol. i, section i, pp. 42-43. Also see Ishaq. *Sirat*, p. 37, as quoted in Peters. *Hajj*, p. 19.

<sup>2833</sup> Jenkins. *Next*, p. 110.



[holding basket containing offerings; also spelled *Canephorus*] statue, and lit lamps on her on festival days. [2] A female image of pagan times near a spring in *Savoie*, a mother-goddess-made-Saint-Mary, wrought miracles of healing attested from the seventeenth century, through the water that flowed first from her breasts and, then, when for decency's sake these were hammered off, from a pipe issuing at the image's base, into the second half of the twentieth century.<sup>2834</sup>

*Muhammad* could have also received the impression that the Trinity was *Osiris*, *Horus* and *Isis* from two *Copts* who visited *Makka*. In 605 AD, the head carpenter involved in rebuilding the *Kaaba* was a *Copt*<sup>2835</sup> and a *Copt* artist painted the interior of the *Kaaba*.

James Hastings wrote that the artist's name Baqum, otherwise known as Pachomios, shows that he was an Egyptian Christian.<sup>2836</sup> A *Coptic* artist probably would have painted Mary and Jesus in Egyptian dress, and may have added the *Isis* crescent-orb headdress according to the prevailing custom.

F. E. Peters quoted *Al Azraqi* whose ninth-century history says a painting AND a statue of Jesus and Mary were in the pre-*Islamic Kaaba*. There also was a painting of *Ibrahim* showing him holding divining arrows.<sup>2837</sup> This painting probably was originally of *Hubal*, whose idol was in the *Kaaba* and whose idol held divining arrows. The *Encyclopedia Britannica* states:

Many *Sabaeen* texts mention the oracles, but only one inscription mentions arrows in connection with them. A bunch of sticks possibly used for that purpose was found in 1987 in a *Sabaeen* temple.<sup>2838</sup>

The painting of *Hubal* eventually was mistaken for *Ibrahim* by the religion of *Ibrahim* adherents. This suggests that an *Isis* and *Horus* statue likewise eventually was mistaken for Mary and Jesus. The unconscious and conscious recycling of statues was a common occurrence in the Mideast.

Interesting, these statues of Mary and Jesus remained in the *Kaaba* from the time of *Muhammad* until the *Kaaba* was destroyed by fire in 683 AD. Peters quotes from *Al Azraqi*:

Ata *Ibn Rabah* said that he saw in the House a decorated statue of Mary with a decorated Jesus sitting on her lap. The House contained six pillars...and the representation of Jesus was on the pillar next to the door. This was destroyed in the fire at the time of *Ibn Al Jubayr* [also spelled *Zubair*]. Ata said he was not sure that it was there [had been] in the time of the Prophet but he thought it was.<sup>2839</sup>

This was the same period when crescents were displayed in the interior of the *Kaaba*, which suggests that, in the mind of *Muhammad*, Jesus and Mary may have been associated with crescents:

A fascinating document is provided by the list of objects sent to *Makkah* and kept there in the *Kaaba*. This list can be made up [compiled] from different authors, especially from *Al Azraqi* whose early date (ninth century) is of particular significance to us...In *Islamic* times a new series of objects was brought into the holy place. Umar [the second Orthodox *Caliph* (634-644 AD)]

<sup>2834</sup> MacMullen. *Eighth*, p. 159.

<sup>2835</sup> Lings. *Sources*, p. 41.

<sup>2836</sup> Hastings. *Ethics*, "Arabs (Ancient)" entry, p. 667, bottom of the right column.

<sup>2837</sup> *Al Azraqi*, 1858, pp. 108-109, 111, as quoted in Peters. *Origins*, pp. 140-141.

<sup>2838</sup> Ryckmans, Jacques. *EB*, "Arabian Religions," 2004.

<sup>2839</sup> *Al Azraqi*, 1858, p. 111, as quoted in Peters. *Origins*, p. 141.

hung there two **crecident**-shaped ornaments taken from the capital city of the Persians. [*Umayyad Caliph*] Yazid I [680-683 AD] gave two ruby-encrusted **crecidents** belonging to a Damascene church, together with two cups. [*Caliph*] *Abd Al Malik* [685-705 AD] sent two necklaces and two glass cups, [*Caliph*] *Al Walid I* [705-715 AD] two cups, [*Caliph*] *Al Walid II* [743-744 AD] a throne and two **crecident**-shaped ornaments with an inscription, and [*Abbasid Caliph*] *Al Saffah* [750-754 AD] a green dish.<sup>2840</sup>

Besides the *Copts*, there were many other Christians roundabout *Makka* who held some strange doctrines and vacuous ideas. They probably personally told the *Makkans* many Gnostic-Christian apocryphal stories, some of which ended up in the *Koran*. Wilson Bishai wrote that the *Copts* were probably the source for the *Koranic* story of the Creation of Adam and the Fall of Satan (*K* 007:007-018; 038:72-79).

The information Bishai provides is applicable to all the apocryphal Christian content in the *Koran* and the traditions, as well as *Muhammad*'s mixed-up perception that the Christian Trinity was *Osiris*, *Horus* and *Isis*. Bashai wrote:

From the above comparisons, it becomes quite clear that the *Quranic* text concerning the fall of Satan bears more resemblance to the *Coptic* account than either the Cave of Treasures or *Vita Adae et Evae* [Life of Adam and Eve], giving rise to the assertion that the *Coptic* account constitutes a very likely source for the *Quranic* text. This assertion is strengthened by the fact that the *Copts* of Egypt during the early Christian centuries were known for their massive production of apocrypha and pseudepigrapha. This characteristic of the early *Copts* should not be surprising to us in light of the evidence of Gnostic influence on the early *Coptic* Christian thought. The Gnostics were literate people and well acquainted with ancient religions and mythology. As Christianity was spreading in Egypt, a group of these Gnostic Christians apparently made an effort to tie old Egyptian myths to Christian beliefs. In this respect C. J. Bleeker mentions the following:

It can be proved that a number of Gnostic conceptions go back to ancient Egyptian religious thoughts. What is even more important, there is some evidence that to a certain extent there existed a typological affinity between the ancient religion of the valley of the Nile on the one hand and Gnostics at the other side [Leiden, 1967].

A very plausible story of ancient Egypt that fit very well into the Biblical record of creation was the legend of the rebellion of *Seth* against *Horus*. *Seth*, a synonym of hatred and disobedience in Egyptian mythology, caused all sorts of trouble to befall man in revenge for his banishment by *Horus* and the rest of the Egyptian Ennead [meaning "a group or set of nine"]. In the minds of the early Egyptian Christians, Satan, as a parallel to *Seth*, became the rebel and the enemy of man, who began to lurk in ambush in order to drag him (man) into disobedience. As a matter of fact, Wallis Budge himself, commenting on the story of the fall of Satan in The Cave of Treasures, recognized its possible *Coptic* origin and remarked that the early Egyptian Christians were known for compiling various apocryphal stories, drawn mainly from ancient Egyptian legend. He even mentioned the story of the struggle of *Seth* against *Horus* as a possible source for the account of the fall of Satan in The Cave of Treasures.

<sup>2840</sup> Grabar. *Art*, pp. 55-57.

Since the early *Coptic* Church (at least until the fifth century) was among the leading churches in early Christendom, it is not surprising to find that many of its apocryphal stories spread throughout the Christian Middle East. By way of *Abyssinia*, *Coptic* ideas could have spread into Arabia, at least during the *Abyssinian* occupation of *Yemen* between 525 and 571 CE, if not before, due to trade and religious persecution. In pre-*Islamic* times, Arabia was a haven of refuge to all dissatisfied and persecuted Christians, especially the *Copts* after the Council of Chalcedon had ruled against them in 451 CE. *Muhammad* must have come in contact with many of these *Copts* and listened to their stories. *Muhammad*'s friendship to Christians of *Coptic* faith is reflected in many aspects of his life. He is known to have had cordial relations with the *Negus* of *Abyssinia*, as indicated by the fact that he advised his followers at a time of persecution to flee there. He married a *Coptic* wife named Mariya, and he is reported to have advised his followers to be especially kind to the *Copts* of Egypt, considering them his in-laws. Such friendly gestures to the *Copts* add more credence to the possibility that *Coptic* was the most likely source of the *Quranic* account of the fall of Satan.<sup>2841</sup>

*Isis* and *Horus* worship originated in Egypt but had spread over the entire Mideast and Mediterranean areas. That *Isis* looked like a stylized Egyptian woman would explain why, in the account recounted earlier, while looking at one of the two pictures of Mary and Jesus, the Arab woman exclaimed that Mary was an Arab woman. The Arab woman seems to have voiced approval for the traditional representation of Mary and Jesus, while rejecting the Egyptian-looking *Isis* and *Horus* version.

*Muhammad* however seems to have thought that the *Osiris*, *Isis* and *Horus* version was the authoritative depiction of the Trinity. *Muhammad* came from an astral religion background, so the crescent and sun associated with *Isis* and *Horus* appealed to *Muhammad*.

*Muhammad* thought that *Zulqarnain* was an authoritative person on matters of religion (K 018:086). His name means 'the lord of two horns,' indicating that he had a crescent headdress just like that associated with *Isis*, *Horus* and *Osiris*.

That *Muhammad* mistook the Egyptian *Isis* for Mary would explain why *Muhammad* thought that the persons of the Christian Trinity were the Father, Mary and Jesus (K 005:116). Also, it made logical sense to *Muhammad* that Christians would believe that Mary was *Allah*'s consort.

Not only did the pagans already claim that *Allah* the moon-god had consorts and daughters, but Mary being *Allah*'s consort would explain how Christians could claim that Jesus was God the Son. Remember that elsewhere, *Muhammad* said that *Allah* could have no son because he had no consort (K 006:101; 006:100-101).

That *Muhammad* mistook *Isis* for Mary helps to explain why *Muhammad* thought that the Virgin Mary was *Miriam*, the sister of Moses (Exo 15:20; Num 27:59).

John of Damascus (~675 to ~749 AD), who was an Arab who knew Arabic and Greek, knew that *Muhammad* had confused Mary with *Miriam*. John was schooled in

<sup>2841</sup> Bishai, Wilson B. "A Possible *Coptic* Source for a *Quranic* Text," *Journal of the American Oriental Society* (JAOS), 91, no. 1 (1971): pp. 125-128, as reprinted in Warraq. *What*, pp. 293-294.

“the books of the *Saracens*,” which has been taken to mean “memorizing the *Quran* and the *Hadith* literature as well as Arabian poetry.”<sup>2842</sup> John wrote:

He [*Muhammad*] says that Christ...was born without seed from Mary, the sister of Moses and Aaron.<sup>2843</sup>

*Miriam*, the sister of Moses, was the:

☉ Daughter of Amram (*Imran*) (K 003:035-036; 066:012)

☉ Sister of Aaron (*Haroun*) (K 019:027-028)

That *Muhammad* thought that Mary, the mother of Jesus, was also *Miriam* the sister of Moses, seems to be illustrated in early *Islamic* traditions. For instance, *Muhammad* said that he was married to the Virgin Mary during the Night Journey, but later he said it was *Miriam*, Moses’ sister. Salman Hassan Jabbaar wrote:

It was there too that he received from God’s hand all the teachings which he transmitted to his followers. When he returned to earth from that trip he was unable to hide the fact from his first wife, Khadija—the eldest. He told her as she lay dying: ‘Oh Khadija, know that God has wedded me to Mary, Christ’s mother in paradise.’ He repeated this story to his favorite wife, Aiysha, after the *Hejira*, saying: ‘Oh Aiysha, didn’t you know that God Almighty in heaven wedded me to **Mary** [Mother of Jesus] the daughter of Imran [*Amram (Sic)*], to Kulthum, Moses’ sister, and to Assiya, wife of the Pharaoh’ (related by *Abu Umama*).<sup>2844</sup>

*Muhammad* thought that if the “*Isis*” Mary (whom *Muhammad* confused with *Miriam*) was in Egyptian costume—that must mean that Mary was in Egypt at the time of the *Exodus*. *Isis* statues commonly had *Isis* in Egyptian dress, as Edwardes and Spence wrote (as quoted above):

She [*Isis*] is figured as a woman and represented in the costume of an Egyptian queen, with the headdress of the queen mother; her head at times is surmounted by horns and the solar disk...She was astrally associated with the star Sept [*Sirius* the Dog Star, which rises in Autumn].<sup>2845</sup>

Another reason *Muhammad* seems to have confused *Miriam* with Mary was the names might have been the same in Arabic during *Muhammad*’s day—at least around *Makka*. Bible translators often take care to translate Old Testament names and their New Testament cognates differently so as to avoid unnecessary confusion, for example, *Joshua* and Jesus, and *Miriam* and Mary. Evidently, popular culture, and the Arabic Old Testament and New Testament portions with which *Muhammad* was familiar, translated “*Miriam*” and “*Mary*” with the same Arabic word (*Miriam*).

There are other points of similarity between *Miriam* and Mary that may have confused *Muhammad*. *Muhammad* probably heard that both *Miriam* and Mary were called out of Egypt (Hos 11:01; Mat 02:15).

The “*Exodus*” Elizabeth was the wife of Aaron (Exo 06:23) and sister-in-law of *Miriam*. The New Testament’s Elizabeth was Mary’s relative or cousin (Luk 01:36), and the New Testament’s Elizabeth was a descendant of Aaron of the tribe of Levi (Luk 01:05).

*Miriam*, Moses and Aaron were all from the tribe of Levi (Exo 06:16, 19-20; Num 26:57-59). What *Muhammad* did not know is that both Mary and Joseph were

<sup>2842</sup> Sahas. *Heresy*, p. 40.

<sup>2843</sup> Sahas. *Heresy*, p. 133.

<sup>2844</sup> Jabbaar, Salman H. “The Place of Women in Christianity & Islam.” Answeringislam.org, 1994.

<sup>2845</sup> Edwardes & Spence. *Mythology*, *Isis* entry, p. 93.

descended from the tribe of Judah and not from Aaron's clan or the tribe of Levi (Mat 01:02-03; Luk 03:33).

All these factors may have misled *Muhammad* to think that the Egyptian *Isis* was a genuine representation of Mary. This in turn misled *Muhammad* to think that Christians believed Mary was a member of the Trinity.

### The Plausibility of *Muhammad's* Mistaking Mary for *Isis*

That *Muhammad* would confuse *Isis* for Mary may seem farfetched, but consider how *Muhammad* thought that Jews worshipped Ezra as a god-man just as Christians worshipped the God-man Jesus (*K* 002:259-260; 009:030). A later chapter will discuss how Jewish artwork misled *Muhammad* to believe this about Jews and Ezra—just as artwork misled *Muhammad* about Mary.

If *Muhammad* confused *Miriam* with Mary, *Muhammad* must have thought that Moses (*Musa*) was Jesus' uncle. This explains why *Muhammad* spoke of Jews and Christians parting ways upon receiving knowledge, seemingly meaning about the same time:

They [Jews and Christians] did not become divided until after knowledge had come to them out of envy among themselves (*K* 042:014).

The “knowledge” evidently means the *Torah* (*Taurat*) and the Gospels (*Injeel*). The “divided” and “envy” part probably refers to how *Muhammad* thought Jews promoted Ezra to be the Son of God (*K* 009:030) in order to counter Christian claims.

That *Muhammad* compresses history is confirmed by *K* 007:157 where *Allah* anachronistically talks to Moses about the New Testament Gospels. *Muhammad* did not realize that the Gospels were written fifteen hundred years after Moses. C. C. Torrey wrote on this subject:

He [*Muhammad*] associated Moses with Jesus, evidently believing that very soon after the revelation to the Hebrew lawgiver there had followed the similar revelation which had produced the Christians and their sacred book. This appears in his identification of Mary the mother of Jesus with *Miriam* the sister of Moses and Aaron.<sup>2846</sup>

Of course one can take a lot of time to attempt creative solutions to resolve this historical anachronism but no satisfactory answer is forthcoming. While the Bible and archeology have proven Bible critics wrong over and over, the *Koran* has no such track record. The *Koran* represents a mix of *Muhammad's* stream of consciousness, his faulty recall and his rehash of stories heard once or twice.

The *Koran* even alludes to how *Muhammad's* opponents took him to task for getting the details of his stories wrong while claiming to be divinely inspired (*K* 018:022). *Muhammad* said that the *Koran* cannot be changed (*K* 010:064) but, ironically, *Muhammad* then said *Allah* “abrogated” some stories in favor of better ones (*K* 002:106, 016:101).

*Muhammad* corrected mistakes in the face of criticism via awfully convenient and timely revelations, for instance:

When We substitute one revelation for another—and *Allah* knows best what He reveals—they say ‘Thou art a forger.’ But most of them understand not. Say ‘the Holy Spirit has brought the revelation from thy Lord in truth’ (*K* 016:101).

None of our revelations do we abrogate or cause to be forgotten but We substitute something better or similar. Do you not know that *Allah* hath power

<sup>2846</sup> Torrey. *Foundations*, p. 70.

over all things?...Would you question your Apostle as Moses was questioned of old?’ (K 002:106, 108).

Even after being called a forger, *Muhammad* claimed the *Koran* was contradiction-free, for instance:

- ☉ Do they not then meditate on the *Koran*? If it were from any other than *Allah*, they would have found in it many discrepancies (K 004:082).
- ☉ No change can there be in the Words of *Allah* (K 010:064).
- ☉ There is none that can alter the Words of *Allah* (K 006:034).

### Why Moon-god Worshipers Could Be So Careless in Their Thinking

Many volumes have been written on contradictions and anachronisms in the *Koran*. These can easily be located on the Internet and some are noted in this moon-o-theism book. Even the grammar of the *Koran* is atrocious, as Ali Dashti points out:

The *Quran* contains sentences which are incomplete and not fully intelligible without the aid of commentaries; foreign words, unfamiliar Arabic words and words used with other than the normal meaning; adjectives and verbs inflected without observance of the concords of gender and number; illogically and ungrammatically applied pronouns which sometimes have no referent; and predicates which in rhymed passages are often remote from the subjects...To sum up, more than one hundred *Quranic* aberrations from the normal rules and structure of Arabic have been noted.<sup>2847</sup>

*Muhammad* maintained that the *Koran* was error-free with a straight face. When the symbol of one’s god looks like a scimitar, one can win many arguments by assertion. Also, according to *Muhammad* and his fellow moon-god worshippers’ thinking, revelation from a moon-god ought to wax and wane and then be renewed again. The old revelation would fade over time just as *Muhammad* thought the moon faded and shriveled like an old palm frond each month (K 036:039).

The lunar cycle meant that abrogating *Koranic* passages was perfectly acceptable, as long as the excised passages were replaced by new passages. Just as the moon disappears and reappears, the *Koran* teaches that some verses wax and wane and disappear and then are renewed again in a process called abrogation (K 002:106; 16:101).

*Muhammad* quoted books written by former prophets—prophets who never existed (K 002:213). These books were like the “moons” of former months that had their fifteen days of fame but then their glory waned and they were never seen again. Thus it was natural for *Muhammad* to come with a new book, the *Koran*—as though it were a new month’s moon.

*Muhammad*’s followers thought that the moon-god scripture ought to be like the moon, about which *Muhammad* said:

As for the moon, We [*Allah*] have ordained for it stages till it becomes again as an old, dry palm branch (K 036:039).

*Muhammad* thought that the moon was kind of a “cut and paste” production, so the last sliver of the moon could be compared to, not part of a sphere, but an old, dry palm branch.

*Muhammad*’s moon worshippers could easily compare the disjointed and partly abrogated *Koran* to the moon. An instance of how the ancients thought the moon progressively edits and deletes itself on a monthly basis comes from Egypt:

<sup>2847</sup> Dashti. *Career*, pp. 48-50.

*Horus* had two eyes, the sun and the moon, of which *Set* managed to steal the sun, but was attacked by *Horus*...*Thoth*, acting as mediator, made a treaty between them, allotting the day to *Horus* and the night to *Set*, and making them of equal length. *Set* however continued to persecute *Horus*, but cutting off pieces from his other eye, the moon, for a fortnight each month, until there was none of it left. *Thoth* managed to frustrate him by making a new-moon each month.<sup>2848</sup>

This type of thinking, where evil was the presumed cause of the waning moon, could easily been applied to the *Koran*. *Muslims* may have figured that verses were abrogated because of the sinfulness of non-*Muslims*, or in the case of the “Satanic Verses,” because Satan had sneaked a few lines of poetry into the *Koran*.

Indeed, early *Muslims* even thought of *Muhammad* as being a kind of a moon. Muir reported that a Jewess, Safiya, compared *Muhammad* to the moon. The reason Safiya wanted to flatter *Muhammad* was she had just watched her father Huyayy and her two brothers being killed by *Muslims*.<sup>2849</sup> In addition, her husband Kinana was tortured with fire and then decapitated on *Muhammad*'s orders.<sup>2850</sup> Muir wrote how Safiya saved herself:

It is related that she [Safia] bore the mark of a bruise upon her eye; when the Prophet asked her tenderly the cause, she told him [i.e. lied under duress] that while yet Kinana's bride, she saw in a dream as if the moon had fallen from the heavens into her lap; and that when she told Kinana, he struck her violently, saying: 'What is the dream but that thou covetest [covet] this king of the *Hejaz* [*Hijaz*], the Prophet, for thy husband!' The mark of the blow [the bruise] was the same [one] which Mahomet saw.<sup>2851</sup>

At *Makka Muhammad* was associated with the moon. Ka'b b. Malik, said:

Like the full-moon that cannot lie, when he [*Muhammad*] appeared [like the full-moon], we followed him and held him true.<sup>2852</sup>

Similarly, the *Muslim* named Hassan said:

The day that God's apostle came to them [the *Makkans*] like a brilliant moon.<sup>2853</sup>

A famous *Muslim*, Ka'b b. Malik, recounted a conversation with *Muhammad*:

[*Muhammad* said] 'Good news to you!' I said 'From you or from God?' 'From God of course' he said. When he told good news [from *Allah* the moon-god] his [*Muhammad*] face used to be like the moon, and we used to recognize it.<sup>2854</sup>

### Assassinating the Fact Checkers and Critics

Another reason that *Muhammad* was never challenged about his confusing Mary with *Isis* has to do with his habit of assassinating would-be fact checkers. This practice silenced the rest of his critics. This is similar to how dictators can claim to be elected and how they can claim unanimous consent to govern.

The *Koran* cannot be vindicated, nor is it worthy of any such attempt. Just a few errors include how the *Koran* has:

<sup>2848</sup> Sykes. *Mythology*, *Horus* entry, p. 97.

<sup>2849</sup> Gilchrist. *Prophet*, “4. Evaluating *Muhammad*'s Many Marriages.”

<sup>2850</sup> Ishaq. *Sirat*, p. 515.

<sup>2851</sup> Muir. *Life*, vol. 4, pp. 70-71.

<sup>2852</sup> Ishaq. *Sirat*, p. 422.

<sup>2853</sup> Ishaq. *Sirat*, p. 480.

<sup>2854</sup> Ishaq. *Sirat*, p. 613.

- ☉ Solomon talking both to an ant (*K* 027:018-019) and to a bird (*K* 027:020-028).
- ☉ The sun setting in a mud puddle and rising amongst a people without any shade (*K* 018:086, 090).
- ☉ *Allah* revealing chain-mail to King David (*K* 021:080; 034:010-011).
- ☉ The mountains serving as tent-pegs that kept the earth from moving (*K* 016:015 [see also 031:019 and 078:06-07]).<sup>2855</sup>
- ☉ The Sodomites as the first homosexuals ever (*K* 007:080).
- ☉ A Samaritan making the golden calf of the Exodus—and the calf mooed (*K* 007:148; 020:088). The Samaritans did not even exist as a people until many centuries had passed after the Exodus (*K* 020:085-088, 095).

The *Koran* is not even internally consistent—as when the *Koran* says Pharaoh was saved alive in one place (*K* 010:090-092) and drowned in another (*K* 017:103; 028:040; 043:055). The Bible says that *Yahveh* himself killed Pharaoh with a spear (Hab 03:13-14). Similarly, *Muhammad* has Noah and his family saved alive (*K* 021:076; 037:077) but elsewhere one of Noah's sons is said to have drowned (*K* 011:042-043).

### ***Muhammad's Problem With Names***

*Muhammad* seems to have a problem distinguishing between people mentioned in the Bible, especially if they had similar names or political positions. One reason is that *Muhammad* received his information from *Haggadic* and apocryphal sources. Unlike the Bible where a chronology can be ascertained from the text, these apocryphal sources often provide no contextual setting.

The *Koran* reads somewhat like the religious scenes painted on Byzantine-era synagogue walls such as at *Dura-Europos*. These pictures were arranged according to artistic and pedagogical factors, not according to chronology. *Muhammad* likely saw such synagogues inside and outside Arabia during his caravan travels.

The *Koran's* Jewish content largely came from daydreaming over synagogue paintings. The supposed Christian content in the *Koran* came largely from the same process. The Nativity scenes in the *Koran* read as though *Muhammad* was daydreaming over a picture of Mary and Jesus, which the artist had originally intended to depict *Isis* and *Horus*. The artist may have finished the artwork a generation or century before paganism reached its nadir around *Muhammad's* time.

*Muhammad* would have only seen synagogues at caravan towns like *Dura-Europos* but not *Dura-Europos* itself. *Dura-Europos* was an outpost on the Roman frontier in Mesopotamia that was destroyed by the *Sassanians* (Persians) in 256 AD. Joseph Gutmann wrote about the *Dura-Europos* synagogue in the Fertile Crescent:

Who would believe that in this desert fortress, this frontier town, this third-century caravan city, there should have been and still was preserved a synagogue, its great walls covered with paintings?<sup>2856</sup>

Though not much archaeology has been allowed in *Saudi* Arabia, the early synagogues there may have had a lot of artwork. Much artwork may have survived despite more than a millennium of iconoclasm.

<sup>2855</sup> Burton. *Nights*, vol. 4, fn. 238.

<sup>2856</sup> Gutmann. *Dura-Europos*, p. 16.



Tradition says the *Kaaba*'s interior walls were covered with pictures. These paintings would have looked similar to the wall paintings of the *Dura-Europos* synagogue except of course for the subject matter.

Unlike most *Mosques* and temples around Arabia, the *Kaaba* was located in a *Wadi* that flash-flooded every few decades. A flashflood in *Mekka* is called a *Sayl*.<sup>2857</sup> The last *Sayl* to affect the *Kaaba* seems to have been in 1941—before flood control measures were put into place.<sup>2858</sup>

The *Sayl* probably was a factor that invited religious innovation and syncretism. The idols in the *Kaaba* probably were brought to higher ground as the waters rose. If the idols and movable paintings had to be saved from flooding every few decades, the locals may have thought twice about putting some idols and paintings back in the *Kaaba* after the waters receded. Thus room was made in the *Kaaba* for new idols and this may have resulted in continuous religious innovation.

As a result of *Muhammad* deriving his information from synagogue wall paintings and oral instruction, the *Koran* is filled with anachronisms and geographical mistakes. For instance:

- ☉ *Muhammad* told a tall tale about the Prophet Ezra riding a donkey around a ruined city (*K* 002:259) but he probably meant to refer to the Prophet Nehemiah (*Neh* 02:11-16), so the tall-tale is even less convincing.<sup>2859</sup>
- ☉ *Muhammad* says both Lot and Noah's wives were unbelievers who went to hell (*K* 066:010).
- ☉ One of Noah's sons supposedly drowns in the Flood waters (*K* 011:42-43).
- ☉ *Muhammad* confused Haman (*Book of Esther*) with Potiphar (*Gen* 37:36; 39:01, 04-05; *K* 028:006, 008; 028:038; 029:039; 040:024, 036). Potiphar lived ~1800 BC and Haman lived ~480 BC. *Muhammad* has Haman, a.k.a. Potiphar, living through the entire 430 years of the *Israelite* captivity in Egypt since *Muhammad* has Haman building the Pharaoh of the *Exodus* the Tower of Babel (*Gen* 11) (*K* 028:038; 029:039; 040:024, 036). The Biblical account has Haman building a 75-foot high gallows in *Susa*, Persia, for King Xerxes (*Est* 05:14). The Tower of Babel was built ~2800 BC whereas Haman's gallows were built around 480 BC. Incidentally, *Muhammad* also has Pharaoh threatening Moses with crucifixion even though crucifixion was not yet invented (*K* 007:124). The Persians and Romans were the first to crucify people.

Jews of course figured that students would derive a Biblical chronology from reading but according to *Islamic* tradition, *Muhammad* was illiterate. This tradition that *Muhammad* was illiterate was meant to give *Muhammad* the air of veracity, for as conventional wisdom would have it, a sub-literate unschooled person could not possibly produce a *Koran* or bamboozle the public.

The Mormons, the “*Muslims* of America” who copied *Islam* in many respects, make use of this conventional wisdom too. The *Book of Mormon* was first produced when Joseph Smith (1805-1844 AD) was in his twenties. Mormons had to fend off the criticism that Joseph Smith concocted or plagiarized the *Book of Mormon*.

Joe Smith was arrested and sued during his late teens for fraud involving the occult quackery and divining for hidden treasure. Thus in their “official” history, the

<sup>2857</sup> Peters. *Makka*, pp. 23-24.

<sup>2858</sup> A 1941 AD picture of chest-high floodwaters by the *Kaaba* can be seen in Nasr. *Makka*, p. 27.

<sup>2859</sup> Sell. *Quran*, pp. 169-170, footnote.

Mormons backdated the rediscovery of the fictional golden plates of the *Book of Mormon* to when Joseph Smith was just fourteen.

The Mormon Church has had ever more trouble bamboozling the public about the charlatan Joe Smith, so Joe “the Prophet” has been downplayed in favor of Brigham Young. Young’s reputation however is only a shade better than Joe’s.

The snake in the Garden of Eden was illiterate and unschooled but claimed to have so much wisdom (Gen 03:05-06). *Muhammad* is similar to the snake and to Joseph Smith in that *Muhammad* did not really believe in the *Koran*. For instance, in *K* 033, *Muhammad* exempted himself from a host of regulations that the *Koran* sets down for others to follow.<sup>2860</sup> Also, *Muhammad* did not concern himself with ensuring that the *Koran* was internally consistent.

One of many contradictions in the *Koran* is that the Creation was said to be six days long (*K* 007:54, 010:003, 011:007 and 025:059) but eight days elsewhere (*K* 041:009-012). Whole books have been written on the internal contradictions in the *Koran*, and contradictions between the *Koran* and the traditions, science and history. Such material is readily found on the Internet.

The *Koran* is a mass of internal contradictions and *Allah* even admits as much in *K* 002:106 and 16:101 where *Allah* says he had to substitute better material for inferior-grade revelation. Facetiously speaking, *Allah* did not do enough editing, even though he had half of eternity to work on the *Koran*. But being *Allah* means you never have to say you’re sorry.

So the fact that *Allah* and *Muhammad* did not really believe in the *Koran* makes their relationship to the *Koran* like the snake’s relationship to the forbidden fruit, and like Joseph Smith’s relationship to the fictional *Book of Mormon*. *Allah*, *Muhammad*, Joseph Smith and the snake in Eden knew they were just dictating fiction.

### Other Name Mix-ups

The *Koran* does not survive scrutiny well even in terms of a purely human document, much less a supposedly inspired document.

*Muhammad* thought that Pharaoh’s wife rather than Pharaoh’s daughter adopted Moses (Exo 02:01-10; *K* 028:008-009).

Similar to how *Muhammad* confused Mary and *Miriam*, *Muhammad* did not realize that there are many Johns in the Bible. *Muhammad* misunderstood the statement “None of your kindred is called by this name” (Luk 01:61). *Muhammad* took Luk 01:61 to mean that no one ever had the name John (*Johan*) before John the Baptist (*Pickthall*, *Yusuf Ali* and George Sales’ *K* 019:007).

The Bible however lists plenty of Johns before John the Baptist (2Ki 25:23; 1Ch 03:15, 24; 06:09f; 12:04, 12; Ezr 08:12; Neh 12:22f; Jer 40:08, 13, 15; 41:11, 13; 42:01, 08; 43:02, 04).

*Muhammad* also mixed up Gideon with Saul. In a historical compression, *Muhammad* has Gideon, David, Goliath and Saul all living at the same time (*K* 002:246-251).

In another historical compression, *Muhammad* has Nimrod throwing *Ibrahim* in a fire (*K* 021:051-071; 029:016-017; 037:097-098). According to some historians, Nimrod lived sometime after 2800 BC, while Abraham lived after 1960 BC.

---

<sup>2860</sup> Dashti. *Career*, p. 128.

*Muhammad* thought that Abraham nearly sacrificed his son Ishmael, instead of Isaac as *Genesis* reports. *Muhammad* also thought the incident happened before Isaac (*Ishaq*) was even born (K 037:102, 112).

It is interesting in that *Muhammad* made his grandfather out to be an *Ibrahim*, and his father out to be an Isaac (or Ishmael, according to *Muhammad's* thinking). *Muhammad* related that his grandfather *Muttalib* took an oath and nearly sacrificed his father *Abdullah* to *Allah*.<sup>2861 2862</sup>

Instead of *Allah* providing a ram as *Yahveh* had for Abraham (Gen 22:13-14), *Allah* “the tax collector” required 100 camels from *Muttalib* in exchange for *Abdullah's* life.

Similar to *Muhammad's* Isaac-Ishmael switch, *Muhammad* thought that Jews crucified someone *Allah* made to look like Jesus (K 004:157). *Muslim* tradition suggests that *Muhammad* believed that Simon from Cyrene, Judas Iscariot or another person died in Jesus' stead. Curiously, even though *Muhammad* thought Christ never died, *Muhammad* spoke as though Christ was made a sacrifice for sin. Zwemer wrote:

As a parody of the mystery of the Lord's Supper, *Mohammed* is said to have sanctioned the drinking of his own blood. When [at the Battle of *Uhud*] Malik *Bin Sinan* sucked his wounds, swallowing the blood, the prophet exclaimed, ‘Anyone whose blood touches mine, him the fire of hell shall not destroy.’<sup>2863</sup>

*Muhammad* also thought that the Garden of Eden was in heaven, and that Adam and Eve were kicked out of heaven and down to earth (K 007:019-025; compare Gen 03:23-24). *Muhammad's* thinking that the Garden of Eden had been in heaven explains in part why *Muhammad* thought heaven was such a sensual place.

*Muhammad* seems to have thought during his *Makkan* days that Ishmael, Isaac and Jacob were all sons of *Ibrahim*, rather than Jacob being a grandson of Abraham through Isaac (K 006:084-086; 011:071; 019:049-050; 021:072-085; 038:045-048). F. E. Peters wrote:

The conclusion seems inescapable. While still at *Makka*, *Muhammad* was under the impression that Isaac and Jacob were Abraham's sons, then at some point, probably at *Madina*, he corrected the genealogy ([K 014:39])...<sup>2864</sup>

One of *Muhammad's* main name mix-ups was saying that *Allat*, *Uzza* and *Manat* were male angels to whom the ancients had given female names (K 043:016-020; 037:149-153; 053:019-021, 026-027).

### ***Muhammad's* Chief Name Mix-ups**

*Muhammad* put in a prophecy in Jesus' mouth—a prediction that a certain *Ahmad* would come after him (K 061:006). *Muhammad* taught that this referred to himself, even though *Ahmad* means “more praiseworthy” while *Muhammad* means just “praiseworthy.” Thus the *Koran* would have us look forward to someone more praiseworthy than *Muhammad*, which could point to nearly anyone since *Muhammad* was such a vile and wicked lowlife.

<sup>2861</sup> Peters. *Origins*, p. 82.

<sup>2862</sup> Shamoun, Sam. “Abraham and the Child of Sacrifice—Isaac or Ishmael?” Answeringislam.org, accessed 26 Nov 2003.

<sup>2863</sup> Zwemer. *The Muslim Christ*, ch. 2, pp. 155-173; Lings. *Sources*, pp. 186-187

<sup>2864</sup> Peters. *Origins*, p. 119.

*Muhammad's* biggest name mix-ups was assuming that *Yahveh* was *Allah* the moon-god (*K* 002:062; 003:064; 006:107; 016:035; 021:108; 029:046, 061-063; 039:003).

*Muhammad* was familiar with many pagan sexual triads such as *Osiris*, *Isis* and *Horus*. Thus *Muhammad* naturally made the equivocation between *Yahveh* and *Allah* on the basis of his misconception that *Yahveh* was a triad of closely partnered gods, rather than a trinity. *Muhammad* assumed that Jews, Christians and *Hanifs* had these similar triads:

- ☉ Jewish: *Yahveh* (translated *Allah*), Ezra and the Zodiacal Seasons filling out the triad
- ☉ Christian: Father (translated *Allah*), Son and Mary.
- ☉ *Hanif*: *Allah* the moon-god along with *Allah's* consort and daughters filling out the triad.

### The Plausibility of the *Hanif* Triad Having Two Male and One Female

Someone might wonder at the *Hanifs* having a male Venus-god as part of their triad. Since *Muhammad* categorized the *Hanifs* with Christians and Jews, he must have thought they had similar triads.

According to *Muhammad's* thinking, which will be examined later in this book, Jews and Christians had two males and a female component in their triads. The Satanic Verses episode seems to show that *Muhammad* thought the *Hanifs* worshipped *Allah's* daughters.

The pagans in Southern Arabia did have at least one male Venus god. Egerton Sykes wrote that in Southern Arabia *Attar* was the Venus-goddess, and *Atter* (or *Athtar*<sup>2865</sup>) was the male Venus.<sup>2866</sup> Brian Doe wrote “Another dominant deity was the male god known as ‘*Athtar*’ corresponding to the *Phoenician* ‘*Ashtarte*.’<sup>2867</sup>

The Arabs also had “two *Uzzas*”—perhaps one *Uzza* being male and the other *Uzza* female.<sup>2868 2869</sup> The logic behind the two *Uzzas* is that it was thought that the Morning Star and Evening Star were of the opposite sex.

A popular Arabian sun-god was *Shams* whom James Hasting says “...was construed as feminine.”<sup>2870</sup> Hastings wrote that the Greek geographer and historian, Strabo (~64 BC to ~23 AD) equated the northern Arabian *Dusares* with *Helios* the sun-god most commonly found in zodiac circles of late antiquity.<sup>2871</sup>

Levy notes that *Dusares' sun-god* designation was blurred over time:

*Dushrat* or *Dushara* (*Dusares* in Greek) was no longer expressly a sun-god.<sup>2872</sup>

So it is important to note that Hastings also mentions two other Arabian sun-gods (*Shariq* and *Dharir* or *Dhirrih*) who were male:

In both of these cases the sun is treated as masculine, contrary to the general [Arabic] usage [of sun deities being female].<sup>2873</sup>

<sup>2865</sup> Phillips. *Sheba*, p. 64.

<sup>2866</sup> Sykes. *Mythology*, *Attar* entry. p. 22.

<sup>2867</sup> Doe. *Arabia*, p. 25.

<sup>2868</sup> “The Arabs swore by ‘the two *Uzzas*’ (Isaac Antiochenus), presumably referring to the morning and the evening star” (Harris, R. *Boanerges*, Cambridge, 1913, p. 256).

<sup>2869</sup> Hastings. *Ethics*, “Arabs (Ancient)” entry, p. 660, middle of right column.

<sup>2870</sup> Hastings. *Ethics*, “Arabs (Ancient)” entry, p. 660, left column.

<sup>2871</sup> Hastings. *Ethics*, “Arabs (Ancient)” entry, p. 660, left column.

<sup>2872</sup> Levy. *Lost*, pp. 67-68.

### **That Muhammad Went to the Grave Thinking that Allah Was a Moon-god Is Entirely Plausible**

*Muhammad* never came to a correct understanding of Judaism since in one of his last *Madinan Suras* before his death, *Muhammad* said that Jews called Ezra the Son of God (K 009:030). Also, in one his last *Madinan Suras* soon before his death, *Muhammad* said that the Christians thought of Mary as being a goddess (K 005:116).

The *Hadith* is clear that *Muhammad* thought that Jews worshipped Ezra and Christians Mary (*Sahih Bukhari*, vol. 6, bk. 60, no. 105; vol. 9, bk. 93, no. 532s; *Sahih Muslim*, bk. 001, no. 0352).

*Muslim* commentators were mostly at a loss to explain *Muhammad's* confusion about what Jews believed. For instance, Yusuf Ali wrote:

I have quoted passages from the Old Testament, showing how freely the expression 'sons of God' was used by the Jews. A sect of them called *Uzair* (Ezra) a son of God, according to Baidhawi [or Baidawi, died 1292 AD].<sup>2874</sup>

Zwemer wrote:

Baidhawi, the well-known commentator, says that it must have been true, because the Jews themselves, to whom the passage was read, did not deny it.<sup>2875</sup> Obviously, these explanations are entire unsatisfactory since by *Muhammad's* time, the basic tenets of Judaism and Christianity were well known throughout the Mideast. Further, more of *Muhammad's* statements about Christianity and Judaism were clearly never directed at a particular sect.

So the fact that *Muhammad* never came to a correct understanding of the Jewish conception of *Yahveh* and the Christian Trinity, suggests that *Muhammad* went to the grave thinking that *Allah* was a moon-god.

### **The Title Allah in Pre-Islamic Arabia**

*Allah* is a contraction that means "the god." F. E. Peters wrote:

The cult of the deity termed simply the god (*Allah* < *Al Ilah*) was known throughout southern Syria and northern Arabia, and was obviously of central importance in *Makka*, where the building called the *Kaaba* was indisputably his house.<sup>2876</sup>

James Hastings wrote:

In the *Nabataean* inscriptions we repeatedly find the name of a deity accompanied by the title *Alaha*, 'the god.'<sup>2877</sup>

So *Allah*, meaning "the god," was likely an appellation just as "Lord" (*Baal*, *Bel*) was a title. The Bible clearly uses titles when it uses the plurals "the *Baals*" and "the *Asherahs*" (Jdg 03:07). Sinasi Gunduz wrote:

The epithet *Ba'al Samin*, 'the Lord of Heaven,' is used in ancient Near Eastern inscriptions as a divine name and usually denotes the supreme god of any local pantheon.<sup>2878</sup>

<sup>2873</sup> Hastings. *Ethics*, "Arabs (Ancient)" entry, p. 660, left column.

<sup>2874</sup> Bailey, Rev. Richard P. "Jihad: The Teaching of Islam From Its Primary Sources—The *Quran* and *Hadith*," Answeringislam.org, accessed 4 May 2004.

<sup>2875</sup> Zwemer. *Christ*, ch. 1, note 2.

<sup>2876</sup> Peters. *Origins*, p. 107.

<sup>2877</sup> Hastings. *Ethics*, "Arabs (Ancient)" entry, p. 664, right column.

<sup>2878</sup> Gunduz. *Life*, p. 139.

The *Encyclopedia Britannica* comments on the title *Baal*:

As a Semitic common noun *baal* (Hebrew *ba'al*) meant 'owner' or 'lord,' although it could be used more generally....But *Baal* was not exclusively a fertility god. He was also king of the gods....*Baal* was also worshiped by various communities as a local god. The Old Testament speaks frequently of the *Baal* of a given place or refers to *Baalim* in the plural, suggesting the evidence of local deities or 'lords' of various locales. It is not known to what extent the *Canaanites* considered those various *Baalim* identical, but the *Baal* of *Ugarit* does not seem to have confined his activities to one city, and doubtless other communities agreed in giving him cosmic scope.<sup>2879</sup>

Sinasi Gunduz mentions that *Sin* the moon-god was called *Baal*:

*Sin* was widely worshipped as 'lord of *Haran*' (*bel-Haran*) in the first millennium BC. An Aramaic inscription on a slab from *Zinjirli* in Northern Syria, which can be dated to about 730 BC, mentions *Ba'al Haran*, referring to *Sin of Haran*: 'My lord is *Ba'al Haran*...' <sup>2880</sup>

Tamara Green wrote about a similar appellation:

*Marelahe*, i.e. the Lord of the Gods...title seems not to be specific to any one deity, but rather is used to denote the chief divinity of various local pantheons...Such an understanding of the title *Marelahe* would point clearly to the survival of the indigenous cult of the moon... <sup>2881</sup>

The same appellations were applied to the highest god in a local pantheon no matter whether the high god was a moon-god or a sun-god. In the Mideast, wherever the title *Allah* was used, it was generally applied to the local moon-god. That is because a male moon-god generally was the high god in Mideast pantheons.

In passing, while *Allah* the moon-god was the high god in pre-Islamic times, other gods could still be called "lord," as Ronald Lewcock wrote:

The ancient religions of South Arabia all focused on the worship of a male moon-god, with a consort, the sun-goddess *Shams*, who was the mother of the moon-god's child, the evening star *Athtar*. Great temples to their cult, and to the cults of numerous deities who were 'lords' of the seasons, rains, agriculture, irrigation, crafts, etc., were built all over the densely populated and cultivated lands of South Arabia. <sup>2882</sup>

### The Title *Allah* As Used by Jews and Christians in Pre-Islamic Arabia

The word *Allah* is not found in the Bible. Some *Muslims* say that the Old Testament forms *Elah* and *Eloah*, meaning "God," ought to be translated "*Allah*." *Elah* and *Eloah* are found much less frequently than *Elohim*, the normal Old Testament word meaning "God."

One can see that the forms for "God" found in the Bible have different vowels than "*Allah*." Also, the forms for "God" found in the Bible have only one *Lamedh* (*l*), while *Allah* has two *Lams* (*ll*). The forms for God in the Bible are not contractions but the word *Allah* is a contraction (*Allah* < *Al Ilah* ("the god")).

Even if *Yahveh* were called by some form of *Allah*, meaning "the God," in the OT (which is not the case, by the way), it would not prove that *Allah* is the God of

<sup>2879</sup> *EB*, accessed 10 Jul 2002, *Baal* entry.

<sup>2880</sup> Gunduz. *Life*, pp. 195-196.

<sup>2881</sup> Green. *Moon*, p. 67.

<sup>2882</sup> Lewcock. *San 'a*, pp. 20-21.

the Bible. The reason is both *Yahveh* and pagan gods were called *Elohim/eloхим* in the Old Testament, yet it was understood that the pagan *eloхим* were demons (Deu 32:17; Psa 106:037; 1Co 10:20-21).

Some *Muslims* like Ahmed Deedat, who are desperate to find the word *Allah* in the Hebrew Bible, have said that the *-alle-* syllables in *Hallelujah* is the word *Allah*.<sup>2883</sup> However, *Hallelu-* means “praise!” and *-yah* suffix is short for *Yah[veh]*.

Incidentally, this short form for *Yahveh*, *Yah*, is found both by itself in the Hebrew Scriptures<sup>2884</sup> and as a syllable in theophoric names like *Yo-el* (*Yah[veh]* is God (*El*) and *Eli-jah* (God (*El*) is *Yah[veh]*).

Pre-Islamic-era Arab Christians used the theophoric name ‘*Abdullah* (“Servant of *Allah*”) as a baptismal name.<sup>2885</sup> *Abdullah* was also *Muhammad*’s father’s name.

Some have said that the Arabic *Abdullah* and *Obied Allah* are translations of the Hebrew *Obadiah*. One of *Muhammad*’s uncles was named “*Obied Allah*.”<sup>2886</sup> *Obadiah* however means “Servant of *Yah[veh]*,” whereas *Abdullah* means “Servant of *Allah*.” The *Encyclopedia Britannica* states:

*Allah* is the standard Arabic word for ‘God’ and is used by Arab Christians as well as by *Muslims*.<sup>2887</sup>

Though Arab Christians spoke the Arabic language and they used the appellation *Allah*, meaning “the God,” they clearly were Trinitarian. The *Koran* states that Christians and Jews referred to *Yahveh* by the title *Allah* (“the God”), and Christians called Jesus *Allah*’s Son (*K* 002:079; 005:018; 009:030).

Arab Christians also used the theophoric name ‘*Abdullah* (“Servant of *Allah*”) as a baptismal name.<sup>2888</sup> When Christians used the title *Allah*, they had “The God” of the Bible in mind. By contrast, *Abdullah* was also the name of *Muhammad*’s pagan father. He however was named after *Allah* the *Makkan* moon-god just as *Makkans* with the names *Hilal* (crescent) and *Qamar* (moon) were named in honor of the *Makkan* moon-god.<sup>2889</sup>

That the pre-Islamic Arab Christians called *Yahveh* by the title *Allah* (“the God”) and the Arabs called their high moon-god *Allah* (“the God”) does not show the slightest commonality between Christianity and *Islam* and the deity of each.

It is easy to imagine that any number of pagan deities were called upon by the generic title of “the god” (*Allah*) in pre-Islamic times. That some Christians and *Muslims* used, and still use, the same title *Allah* (“the God/god”) in reference to their respective deities does not mean they ever had the same proper name or identity, despite what is commonly asserted.<sup>2890</sup>

Christians using the name *Allah* is similar to how the Hebrews occasionally called *Yahveh* “*Baal*,” meaning “Master” or “Husband” (2Sa 05:20-21; Isa 54:05; Jer 03:14; 31:32; Hos 02:16 [*BHS* 02:18]). When referring to *Yahveh*, Jews used the word *Baal* as an appellation rather than as a proper noun or name.

<sup>2883</sup> Morey. *Invasion*, p. 226, fn. 1.

<sup>2884</sup> Exo 15:02; 17:16; Psa 068:05, 19; 077:12; 089:09; 094:07, 12; 102:19; 104:35; 105:45; 106:01, 48; 111:01; 112:01; 113:01, 09; 115:17f; 116:19; 117:02; 118:05, 14, 17; 122:04; 130:03; 135:01, 03, 21; 146:01, 10; 147:01, 20; 148:01, 14; 149:01, 09; 150:01, 06; Isa 12:02; 26:04; 38:11.

<sup>2885</sup> Trimmingham. *Arabs*, p. 295.

<sup>2886</sup> Morey. *Invasion*, p. 51.

<sup>2887</sup> *EB*, accessed 30 May 2003, *Allah* entry.

<sup>2888</sup> Trimmingham. *Arabs*, p. 295.

<sup>2889</sup> Warraq. *Why*, p. 40.

<sup>2890</sup> Pipes, Daniel. “Is *Allah* God?” *DP*, 28 Jun 2005.

Just as using the name *Baal* does not mean Jews equated the false god *Baal* with *Yahveh*, so Christians using the name *Allah* does not mean Christians equated the false god *Allah* with *Yahveh* or the Trinity.

When Arab Christians said *Allah*, they had in mind the meaning “the God.” Arab Christians surely rued the fact that *Makkans* referred to a moon-god as *Allah*. Arab Christians surely tried to convince the *Makkans* that the *Makkan Allah* was a demon, and that the only true *Allah* (“the God”) was *Yahveh*, the God of the Bible and not the god of the *Koran*. Samuel Zwemer wrote:

On the Christian monuments found by Dr. Edward Glaser in *Yemen*, *Allah* is also mentioned. The *Sirwah* inscription (AD 542) opens with the words: ‘In the power of the All-merciful and His Messiah and the Holy Ghost,’ which shows that, at least in *Yemen*, Arabian Christians were not in error regarding the persons of the Trinity.<sup>2891</sup>

So Arab Christians were by no means referring to the *Makkan* moon-god named *Allah*. Moreover, Christians were not even referring to the Jewish unitarian conception of *Yahveh*. So even if the *Allah* of *Islam* was the unitarian god of Jews, *Allah* still is once removed from the God of the Bible.

#### *Whether Muhammad Ever Saw Jewish or Christian Literature With the Word Allah*

Some *Muslims* like to point out that modern Arabic translations of the Bible use the word *Allah*. Even if *Muhammad* could read, it was doubtful that he would have seen a Jewish or Christian Old Testament or New Testament with the Arabic word *Allah*. Christians and Jews of *Muhammad*’s time generally used Aramaic translations, as Shea and Troyer wrote:

The first certain traces of a translation of the Hebrew sacred books into Arabic are to be found in the tenth century. Pocock mentions Saadias, a learned Jew, who lived from 892 to 941 AD, as translator of all the books of the Old Testament into Arabic; and another Jew (not named) who made a version of the book of Kings into the same language.<sup>2892</sup>

Trimingham says “...little credence can be given to this story” that John of *Sedra* translated the Gospels into Arabic between 631-640 AD. Trimingham says the earliest extant Arabic Gospel is from the eighth or ninth century.<sup>2893</sup> *Muhammad* would not have seen the New Testament in Arabic since he died in 632 AD.

Another tradition says that *Muhammad*’s wife Aisha related that Waraqa, cousin of *Muhammad*’s first wife Khadija on her father’s side, translated the Gospels into Arabic.<sup>2894</sup> This however is contradicted by a very similar tradition that says the language was Hebrew (not Arabic).<sup>2895</sup>

If there ever were a Christian named Waraqa in *Makka*, who happened to be bilingual and well versed in the New Testament, would he have not corrected *Muhammad*’s impression that the Christian Trinity included Mary? (*K* 005:116).

Thus it seems Waraqa was Jewish rather than Christian, and he was not particularly concerned about Christian doctrine. *Muhammad*’s Jewish genealogy is discussed elsewhere (see the ToC).

<sup>2891</sup> Zwemer. *Essay*, ch. 2, p. 27.

<sup>2892</sup> Fani. *Dabistan*, p. 303.

<sup>2893</sup> Trimingham. *Arabs*, p. 225 & fn. 33.

<sup>2894</sup> *Sahih Bukhari* 004.055.605; 006.060.478; 009.087.111; *Sahih Muslim* 001.0301.

<sup>2895</sup> *Sahih Bukhari*, vol. 1, bk. 1, no. 3.



The reason the Gospels were not translated into Arabic is that Aramaic was well known and was the language of commerce in Arabia.<sup>2896</sup> Moreover, the Arabic script was in the process of refinement for centuries before and after *Muhammad's* time.

Arabic originally lacked a system to indicate most vowels and to distinguish several similar consonants.<sup>2897</sup> Thus many variant readings were possible. There was one redeeming quality of Arabic, however:

The root system in Arabic, where most words follow standard forms based on trilateral roots, makes it possible, though difficult, to read such undotted texts.<sup>2898</sup>

With so many similar looking letters and without diacritical marks, many sets of three or four letters could represent two or more words. For instance, when one runs across *hll*, does it stand for *Halal* (Kosher food), *Hilal* (a dwelling (rough “h”)), *Hilla* (dwellings), *Hulul* (the indwelling of *Allah* in a *Sufi*), *halla* (the moon appearing) or *Hilal* (the crescent-moon)?

Readers of early Arabic had the same problem that dyslexics experience where a word is sometimes perceived to be another word due to the transposition of letters.

Many dyslexics try to memorize a story to minimize the struggle of making sense of the text later on. This undoubtedly is a main reason why many *Muslims* throughout *Islam's* history have attempted to memorize the *Koran*.

Even when diacritical marks were introduced as vowels, they were not well formed shapes like the letters A, E, I, O and U—English vowels easily distinguishable from ink dribbles. Arabic vowels and other diacritical marks were mostly arrangements of dots. This led to frustration, because as James A. Bellamy points out:

...the Arab commentators were well acquainted with drippy pens and copyists' errors brought on by fatigue.<sup>2899</sup>

Extra dots could also come from dust, fly-specks, poor-quality paper and such.

The reason many Arabic letters look very similar is that *Muslims* wanted many of their letters to look like the crescent-moon—the symbol of *Allah*. The dotted vowels and diacritical marks were meant to imitate the stars. This subject will be discussed further in a later chapter (see “curvy letters” in the Index).

One reason Jews and Arab Christians came to refer to *Yahveh* as “*Allah*,” among other names, is Jews stopped using the name *Yahveh* long before the time of Christ. Jews and Christians referred to *Yahveh* as God, Lord, *HaShem* (Hebrew meaning “the Name”) and the like, as evidenced in the Greek *LXX* translation of the Old Testament, Intertestamental literature the New Testament.

Even when Jews read straight from the Hebrew, the word *Adonai* (Lord) was substituted for the word *Yahveh*. This substitutionary practice meant that Jews and Christians had no scruples against calling *Yahveh* “*Allah*.”

Also, there is the fact that in early Arabic, *Allah* was written without vowels similar to *aUl* (English transliteration: *ALLH*). In *Semitic* languages the “*A*” (*Aleph*, *Alif*) is a semi-vowel treated as though it were a consonant.

<sup>2896</sup> Trimmingham. *Arabs*, p. 225.

<sup>2897</sup> Warraq. *Why*, p. 108.

<sup>2898</sup> Blair. *Inscriptions*, p. 24.

<sup>2899</sup> Bellamy, James A. “Some Proposed Emendations to the Text of the *Koran*,” *Journal of the American Oriental Society (JAOS)*, no. 13, 1993: pp. 562-573, as quoted in Warraq. *What*, p. 490.

Notably, both Arabic and Hebrew seem to have first received vowel pointing during the same period. The Masoretes first added Hebrew vowel pointing between the sixth and tenth centuries AD. Vowel pointing—like the dot above an i or j—was inserted around existing letters because it was thought the text was too sacred to change by insert actual vowel letters.

Jews and Christians may have thought that the four-letter title *ALLH* (*Allah*) was a good substitute for the Tetragrammaton, *YHVH* (*Yahveh*). “Tetragrammaton” is Latin for “four root-consonant word.” The pagans however liked the appellation *Allah* for different reasons other than the letter count. The word *Allah* is similar (but not necessarily metathetically related) to the word *Hilal*, meaning “crescent.”

The pair of Arabic *Lam* letters (ll) joined at the bottom like (U) in the word *Allah* reminded the Arabs of the horns of the crescent-moon, especially the abbreviated form “to / for *Allah*” (*aU* = *Li-’llah*). If cattle and onyx horns reminded the Arabs of the moon crescent surely the *aU* abbreviation did too. Metathetical words are discussed in a later chapter, but one can already see that *Allah* was a most fitting name for a moon-god! (see “metathesis” in the glossary).

The process whereby moon-god worshippers, as well as Christians and Jews, were able to agree on the appellation *Allah* is similar to how sun-god worshippers were able to settle on the Christianized name, *Elijah*, for their sacred sites. J. S. Trimmingham wrote how astral shrines were converted to Christian use:

The cult of the prophet *Elias* [*Elijah*] is known to have replaced the cult of the sun in Hellenistic places and the similarity between the names *Elias* and *Helios* [Greek sun-god popular in late antiquity] is adduced.<sup>2900</sup>

An additional factor in the conversion of sun-god temples into Christian sites honoring *Elijah* is that the Aramaic for “God” (*Eli* or *Eloi*) was sometimes misheard as “*Elijah*” (Mat 27:46-49; Mar 15:34-36). To many in the Mideast, “the god” first meant *Helios*.

In pre-*Islamic* times, the pagan Arabs applied the appellation *Allah* to the moon-god. Since the moon-god was the national war-god for each tribe and nation in Arabia—as Ditlef Nielsen noted,<sup>2901</sup> each Arab tribe had its particular name for its moon-god. This is similar to how each city-state in the Fertile Crescent had its own uniquely named *Baal*.

The *Makkan* Arabs knew *Allah* as *Sin* but were loath to call *Allah Sin* since their potential enemies called their national war-and-moon-god *Sin*. Other names that *Makkans* preferred not to use for *Allah* were *Wadd*, ‘*Amm*, *Mahram* and *Ilmaqah*, even though the *Sabean Ilmaqah* was predecessor of the *Makkan Allah*.<sup>2902</sup>

*Muhammad* dictated for the *Koran* “*Allah*’s name is much remembered in cloisters, churches, synagogues and *Mosques*” (K 022:040). This is evidence that *Allah* was a pre-*Islamic* moon-god since the high god worshipped in the pre-*Islamic Mosques* of Arabia surely was a moon-god.

*Muhammad* just did not realize that every high god in Arabia, whether it was a sun-god or moon-god, went by the title “*Allah*,” meaning “the god.” The common appellation surely does not make every god in Arabia the God of the Bible!

<sup>2900</sup> Trimmingham. *Arabs*, p. 79 (also see p. 241).

<sup>2901</sup> Nielsen, 1912, pp. 593-594, as translated in Krause, “*Haram–Harimat*.”

<sup>2902</sup> Sykes. *Mythology*, *Ilmaqah* entry, p. 102.

### Whether *Allah* is the God of the Bible

Those Christians who agree with *Muslim* propaganda that *Muhammad's* god and the God of the Bible are the same god agree with the *Koran*. Many of these people are unfamiliar with the *Koran*, do not know the *Allah* of pre-*Islamic* paganism, nor are they versed in *Islamic* and Christian doctrine.

Christians need to be forthright and say that *Muslims* worship a demon who poses as *Allah*. Moses, a psalmist and Paul were forthright about how pagans worship demons (Deu 32:17; Psa 106:37; 1Co 10:20-21; 1Ti 04:01). Christians need to reject *Muhammad's* assertion that *Muslims* and Christians worship the same God (K 002:062; 003:064; 006:107; 016:035; 021:108; 029:046, 061-063; 039:003).

Besides, there is no point in treating *Islam* as a mere heresy since there is little in *Islam* worth salvaging. *Allah* is a demon, *Muhammad* was a false prophet, and the *Koran* teaches Satanic doctrines.

*Islam* has all but a few Biblical facts wrong, so it is best for converts from *Islam* to forget what they “think” they know about the Bible. They need to discount the entire religion of *Islam* and learn Christianity from scratch just as being an experienced alchemist would not help one get a job in chemical engineering.

Sometimes out of wishful thinking, many Christians try to treat *Islam*, not as a different world religion but as though *Islam* were a Judeo-Christian heresy. In fact, *Muslims* are quite happy to be included inside the big Judeo-Christian tent, and happy that many Christians think that *Allah* is *Yahveh*. That is why *Muslims* constantly say that they believe in Jesus as a prophet, so they can get their foot in the door of a church so as to convert it into a *Mosque* (K 002:062; 003:064; 006:107; 016:035; 021:108; 029:046, 061-063; 039:003).

*Muslims* are like the Mormons in this regard. The Mormons work hard to make everyone think that *MormonIslam* is just another Christian denomination. Mormons in fact hide their many wildly distinctive doctrines from would-be converts for years, so as not to let on that they are an entirely different world religion than Christianity.

Only after the Mormon convert is thoroughly integrated and even married into *MormonIslam* and otherwise indoctrinated, do the Mormons tell the convert about how he ought to aspire to be a god among millions of other Mormon gods supposedly populating the universe.

By practicing such stealth and discretion, Mormons are able to fool many people. The worst that most Christians can say about *MormonIslam* is that it follows some heresies. A closer inspection of Mormons doctrines however shows that *MormonIslam* is indeed another world religion. Mormons are, for one thing, polytheists. Either there is only one God or there are many more. No agreement is possible between the two propositions. Monotheism is as different from polytheism as it is from atheism.

### The “Heresy” Approach to *Islam* Does Great Damage to Christianity

Unfortunately the “heresy” approach to *Islam* does not alert anyone to exactly how greatly *Islam* distorts and maligns the truths of the Bible. Thus the “heresy” approach to *Islam* aids and abets the violent takeover of the world by *Muslim* proselytizers, apologists, propagandists and *Jihadists*.

Saying that *Yahveh* and *Allah* are the same God also leads pundits to make damaging comments about *Yahveh* as though he were *Allah*. The misdeeds of *Allah's* followers are then misattributed to *Yahveh* and his followers. The situation is just as

Paul said:

If anyone comes to you and does not bring this teaching, do not take him into your house or welcome him. Anyone who welcomes him shares in his wicked work (2Jo 01:10-11).

What Paul has described has already happened a million times over. When the Patriot Defenders, a Veterans group went to see President Bush in Sacramento, California, they reported:

The RC [Roman Catholic] priest was a real dufus.<sup>2903</sup> Not only did he mumble something incomprehensible about pursuing the war ‘with the minimum loss of human life’ (without a word about ‘justice’ or ‘righteousness’) but then he said ‘we know that these acts [on 9/11/2001] were committed in Your Name....’ I was ready to go down and strangle him (I wondered whether the Secret Service would protect the dufus or just stand by and protect the Prez [short for President]). Obviously, this guy had a little trouble distinguishing between *YHWH* and *Al-Ilah* (a.k.a. *Allah*) the moon-god. One of the things we can be thankful for is that the Mohammedans carefully give the moon-god credit for all their deeds and don’t blaspheme *YHWH*—as the RC dufus managed to do.<sup>2904</sup>

*Muslims* committed terrorist acts in the name of *Allah* the war-and-moon-god, not *Allah*. Anyway, this priest was just following the Catholic Church’s wrongheaded official stance toward *Islam*.<sup>2905</sup>

Ann Coulter reported another instance of people defaming *Yahveh* as though he were *Allah*. She mentioned how the liberal broadcaster-turned-columnist, Walter Cronkite, accused Christians of...

...worshipping the same God as the people [*Muslims*] who bombed the World Trade Center and the Pentagon [on 9/11/2001].<sup>2906</sup>

The *PBS* (Public Broadcasting System in the US) likes to smear Christianity in this way. For instance, *PBS* says a common stereotype is that “*Islam* is fundamentally different from Christianity and Judaism.” To counter this supposed misperception, the tax-subsidized and tax-exempt *PBS* quango issued their very own *Fatwa* edict declaring that:

*Muslims*, Christians and Jews worship the same god. All three are monotheistic religions, with many common doctrines, texts and beliefs.<sup>2907</sup>

What *PBS* is saying is that Christianity and *Islam* are merely tweedledum and tweedledee, i.e. two nearly indistinguishable groups. This grouping makes it easier for *PBS* to criticize organized religion. Another *PBS* contention is that today’s *Islam* is comparable to say, fifteenth-century Christianity before the Reformation.

*PBS*’ hypocrisy is rife, because viewers in the West have heard so much negativity about the whole history of Christianity from *PBS*. When it comes to modern *Islam* however the *PBS* position is not to criticize but actually to defend *Islam*.

<sup>2903</sup> “Dufus” is American slang coined in the 1980’s. Dufus means “One who does stupid things.”

<sup>2904</sup> Patriot Defenders, patriotwatch.com/freep/repost2.htm, 15 Oct 2003.

<sup>2905</sup> *Catechism of the Catholic Church* (CCC), para. 841, and *Nostra Aetate*, 28 Oct 1965.

<sup>2906</sup> Coulter, Ann. *Slander: Liberal Lies about the American Right*. Crown Publishers, New York, 2002, p. 5.

<sup>2907</sup> “PBS Global Connections with the Middle East,” *AOL Research & Learn*, aolsvc.pbs.aol.com, accessed 28 Oct 2003, *LGF*.

Christians who accept *Muslim* claims that *Allah* really is the God of the Bible crown *Islam* with undeserved and unearned legitimacy. They also hand *Muslims* the very Bible that should serve as a shield for Christians. Thus *Muslims* can use the Bible as a shield in addition to their *Koranic* sword, while the Christian disarms himself spiritually.

### The Makkans Knew Their Allah Was Not The God of Jews and Christians

The *Makkans* were not convinced that *Yahveh* and *Allah* was the same god just because they had the *Allah* title in common. The *Makkans* continued to think of *Allah* as their pagan moon-god, while *Muhammad* came to believe that *Yahveh*, the God of the Bible, and *Allah* the moon-god, were one and the same.

After all, *Muhammad* knew from his caravan travels that the moon shone in the Promised Land as surely as it shown at *Makka*. In fact, as he traveled along at night, the ever-protecting moon serenely accompanied him on the caravan.

That the *Makkans* did not approve of merging gods based on common appellations is evident in their rhetorical question:

Do you want to make all the gods into one God, *Muhammad*? That would be an extraordinary thing... (K 038:005).<sup>2908</sup>

The *Makkans* here are saying that *Muhammad* was on a slippery slope. If a person merged gods based merely on their common appellations, where would one stop? *Muhammad* already merged the *Makkan* high god *Allah* with the God of Christians, Jews, *Magians*, *Sabians* and *Hanifs* (K 002:017). The *Makkans* thought “Would he end up merging the high gods of Africa, India and China too?”

The issue came to a head when *Muhammad* tried to apply the *Rahman* (“the Merciful”) appellation to *Allah*. The *Encyclopedia Britannica* states about *Rahman*:

After about AD 350 [in *Yemen*] monotheistic invocations to *Rahmanan*, ‘the Merciful’ (an epithet of Aramaic origin used for God by both Jews and Christians), or to the ‘Lord of Heaven and Earth,’ take the place of former polytheistic formulas and dedications. These early monotheistic texts probably emanated from Jewish immigrants from the oases of the *Hejaz*, although Christianity had already been introduced in South Arabia by Byzantine and Syrian missionaries.<sup>2909</sup>

One can sense from the *Koran* that this appellation was newly applied to *Allah* during *Muhammad*’s “ministry.” *Muhammad* said:

Call upon *Allah* or call upon *Rahman*: by whatever name ye call upon Him, (it is well); for to Him belong the Most Beautiful Names (K 017:110).

That the *Makkan Allah* had not been known as *Rahman* indicates that before *Muhammad*’s time, *Allah* the *Makkan* moon-god was not equated with *Yahveh*, the God of Jews and Christians.

Jews called *Yahveh Rahman*, but the *Makkans* knew better than to think that *Allah* the moon-god and the *Yahveh* of the Bible were one and the same. Julius Wellhausen wrote:

The divine name *Ar-Rahman* is generally translated as ‘the merciful one’ and is regarded as a Jewish-Aramaic foreign word [to Arabic speakers].<sup>2910</sup>

<sup>2908</sup> Ishaq. *Sirat*, p. 192.

<sup>2909</sup> Ryckmans, Jacques. *EB*, “Arabian Religions,” 2004; also see Warraq. *What*, Ch. 8.2: “On the *Koran*,” by Julius Wellhausen, Translated by G. A. Wells, p. 647.

<sup>2910</sup> Warraq. *What*, Ch. 8.2: “On the *Koran*,” by Julius Wellhausen, p. 647.

The *Koran* records how the *Makkans* rejected the identification of *Allah* with *Yahveh*, a.k.a. *Rahman*:

When it is said to them, ‘Adore ye ‘the Compassionate’ [*Al Rahman*], they say ‘And what is the Compassionate? Why should we adore what you command?’ (K 025:060).

They [the *Makkans*] blaspheme at the mention of [*Allah* being addressed as] ‘the Compassionate’ [*Al Rahman*] (K 021:036).

The *Makkans* seem not to have to have agreed with *Muhammad*’s assertion made early in his career that *Rahman* was *Allah* (K 017:110). K 017 is a *Makkan Sura*, written down early in *Muhammad*’s career. The *Makkans* saw *Rahman* as being *Yahveh*, the God of the Bible, while *Allah* was their *Makkan* moon-god. F. E. Peters wrote:

Some [*Makkans*] may have thought that *Muhammad*’s *Rahman* and their own *Allah* were two distinct gods, as they might well have been.<sup>2911</sup>

After all, mercy hardly appears to be an attribute of this gory god of warfare, wife-whipping, flogging-posts, torture, amputation, beheading, rape, mass-murder and boundless blood-lust The *Sufi* Martin Lings wrote:

When they had finally reached an agreement the Prophet told ‘Ali to write down the terms, beginning with... ‘in the Name of God, the Good, the Merciful (*Al Rahman*),’ but Suhayl objected. ‘As to *Rahman*,’ he said ‘I know not what he is.’ But write... ‘In Thy Name, O[h] God,’ as thou wert wont [i.e. accustomed] to write.<sup>2912</sup>

Notably, the *Sura* that bans both naked circumambulation and non-*Muslims* from the *Kaaba* (K 009:017-018, 028) is the only *Sura* that is not prefixed with the words “In the Name of *Allah*, Most Gracious, Most Merciful [*Rahman*].” Perhaps, Suhayl’s objection to the name *Rahman* being applied to *Allah* had something to do with this.

E. F. Peters wrote about the connection between *Allah* and *Rahman*:

What changes in the portrait of South Arabian religion is the replacement of the normal formula in the fourth and fifth centuries by inscriptions with a very different and apparently monotheistic terminology. There now appears to be recognized a supreme god, perhaps a unique God, who is generally called by the name the Merciful (*Rahmanan*)....Most of these monotheistic inscriptions...are Jewish...<sup>2913</sup>

Margoliouth commented on traditions like the above:

From some texts and traditions we should gather that the *Makkan* objection was not to the glorification of *Allah* but to the identification of their familiar deity with him whom the Jews called *Rahman* (the Merciful), a title applied to pagan deities also.<sup>2914</sup>

So it would seem the *Makkans* accepted that *Rahman* was an appellation that could be applied to any god, whether pagan or Jewish. The *Makkans* however objected to the idea that just because both *Yahveh* and *Allah* happened to be called *Rahman*, this meant they were the one and the same god. The *Makkans* knew that *Allah* was the standard Arabian high moon-god, not the *Yahveh* of the Bible. The *Makkans* did not accept or believe in *Muhammad*’s Biblicization of *Makka* nor *Allah*.

<sup>2911</sup> Peters. *Origins*, p. 157.

<sup>2912</sup> Lings. *Sources*, p. 252.

<sup>2913</sup> Peters. *Origins*, pp. 48-49.

<sup>2914</sup> Margoliouth. *Rise*, p. 143, as quoted in Gilchrist. *Islam*, vol. 1.

Nevertheless, since some titles applied to *Allah* were also applied to *Yahveh*, *Muhammad* felt that *Allah* was *Yahveh*. Thus *Muhammad* assumed the right to merge *Allah* and *Yahveh*'s traditions and scriptures and other extraneous material, to create the *Koran*.

*Muhammad* created the *Koran* by splicing Jewish scripture, the Jewish *Haggadah*, Christian *Apocrypha* and Christian folklore such as the Sleepers of the Cave, as well as *Hanif* Arabian moon-god stories.

*Allah* is not the only demon for whom *Muhammad* created a fake passport, false travelogue and made-up personal history. *Muhammad* said that the astral gods that Moses and Christians had identified long ago as being demons (Deu 32:17; Psa 106:037; 1Co 10:20-21) were instead male angels whom the pagans had given female names and then promoted to a divine status (*K* 043:016-020; 037:149-153; 043:016; 052:039; 053:019-021, 026-027).

There is an obvious reason why *Muhammad* could not say all the former astral gods were demons. The Arabs once thought that all the astral deities were progeny of *Allah* the moon-god. Moreover, the stars in the heaven never stopped shining, indicating that they had *Allah*'s approval. Due to this astral thinking, Arabs thought it would not be appropriate to call any of *Allah*'s progeny demons.

The worst that could be said of *Allah*'s progeny is that there were some mischievous offspring and a few bad apples. *Muhammad*'s solution to the matter was to say that the ancient *Makkans* gave male angels female names and had elevated angels to a divine status.

Thus *Muhammad* taught that the many astral gods were angels when in fact they were demons. This is not surprising since even *Muhammad*'s *Gabriel* was a demon posing as an angel of light (2Co 11:14).

There is a reason why *Muhammad* could not say the former astral gods were demons while Christians could. Unlike *Muhammad*, Christians did not believe in astrology and Christians did not believe that angels projected energies or forces from the stars to control the weather and people's lives (Deu 32:17; Psa 106:037; 1Co 10:20-21).

The Bible writers and Christians thought that demons merely impersonated astral gods and that the stellar link was fictitious and metaphorical. To Christians the sky was just a lightshow, and this lightshow was not run by demons since they had been thrown to the earth (Luk 08:31; 10:18; 2Pe 02:04; Jud 01:06; Rev 12:04).

There were many idols that even *Muhammad* could not redeem by making them into angels, so he gave them a false history in an attempt not to offend the sensibilities of the Arabs who worshipped these idols. *Muhammad* said that six idols of obviously Arabian origin were Antediluvian and were known to Noah (*K* 071:023-025). James Hastings wrote:

It is hardly necessary to remark that the transferring of all these Arabian deities to the age of Noah was a fantastic anachronism due to *Muhammad* himself.<sup>2915</sup>

Significantly, idolatry is **not** mentioned as being one of the sins for which the Antediluvians were drowned (Gen 06:01-05). Hafiz Sarwar wrote about the six Arab gods that were the idols of the Antediluvians according to *K* 071:023-025:

<sup>2915</sup> Hastings. *Ethics*, "Arabs (Ancient)" entry, p. 663, right column, bottom.

Thus *Wadd* was shaped like a man, *Naila* like a woman, so was *Suwa*. *Yaghuth* was made in the shape of lion, *Yauq* like a horse and *Nasr* like a vulture.<sup>2916</sup>

### ***Muhammad* Was Not the First to Confuse Christ for a Sun-god**

Another reason that *Muhammad* had the misconception that Jesus was a sun-god was that Christ was depicted in the Roman Empire both as *Horus* and *Apollo*. Ian Wilson wrote:

Many pre-sixth-century portraits of Jesus show him as an *Apollo*-like, beardless youth.<sup>2917</sup>

*Apollo*, also called *Helios*, was the Greek god of the sun. In Latin, the sun-god was called *Sol*. Ramsay McMullen wrote:

Roman tomb paintings...Jesus is shown as a bearded male figure and sometimes...as a shepherd or as the sun-god.<sup>2918 2919</sup>

On many sixth century icons, the halos are large and reddish-gold and could easily be mistaken for the orb of the sun behind the head of Jesus. Similarly, the halos with rays of light beaming forth could be mistaken for the sun, leading pagans to believe that Jesus was a sun-god.

Christians probably felt comfortable depicting Christ as a sun-god because he is described as being bright with light like the sun (Mal 04:02; Luk 01:78; Rev 01:16) and the morning star (2Pe 01:19; Rev 02:28; 22:16).

Comparison with an astral object does not necessarily indicate divinity since already in the Old Testament a righteous ruler is compared to the sun (2Sa 23:03-04). In the New Testament the church is described as being clothed with sun, moon and twelve stars (Rev 12:01). That the Father and Son are not astral gods is indicated by how the sun and moon will not be found in heaven (Rev 21:23).

*Muhammad's* biographer, *Ibn Ishaq*, seems to indicate that *Muhammad* saw these *Helios*-like depictions since *Muhammad* said that Jesus had a ruddy complexion:

...the apostle described to his companions Abraham, Moses and Jesus as he saw them that night, saying... 'Jesus, Son of Mary, was a reddish man of medium height with lank hair with many freckles on his face as though he had just come from a bath.'<sup>2920</sup>

The sun-god *Helios* was often depicted as having horses and a chariot as far back as King Josiah's time (seventh century BC) (2Ki 23:11). Zodiacs became popular in the Greek world by the third century BC. Perhaps that is when sun-gods and their chariots were commonly featured in the middle of zodiac circles.

Lester Ness wrote the *Sepphoris* synagogue zodiac had no charioteer but just "a fiery ball riding a four-horse chariot."<sup>2921</sup> Notably, in *Muhammad's* description of the sun and moon, there is no driver but angels held the sides of the sun and moon

<sup>2916</sup> Sarwar. *Prophet*, pp. 18-19. Zwemer says the same in Zwemer. *Animism*, ch. 1.

<sup>2917</sup> Wilson. *Shroud*, p. 110.

<sup>2918</sup> MacMullen. *Eighth*, p. 130.

<sup>2919</sup> A ceiling mosaic from the tomb of *Julii* in the necropolis under St. Peter's mid-third-century *Grotte Vaticane*, Rome, shows Christ as a sun-god (Halsall, Paul. EUH 3300 Byzantine History, U. of N. Florida, Fall 2004, unf.edu/classes/byzantium).

<sup>2920</sup> Ishaq. *Sirat*, pp. 183-184, and also *Hadith Sunan Abu Dawud*, bk. 37, no. 4310.

<sup>2921</sup> Ness. *Mosaics*, p. 19.



chariots.<sup>2922</sup> Perhaps *Muhammad* developed his idea of the sun and moon from zodiac circles similar to those at the *Sepphoris* synagogue.

*Muhammad* may have felt confirmed in his identification of Jesus as a Christian sun-god because *Muhammad* thought Jews depicted Ezra as a sun-god too—as is discussed in the “Jewish Connection” chapter.

The fact that Jews followed a solilunar calendar, and the Christians a solar calendar, seemed to indicate in *Muhammad*’s mind that they worshipped sun-gods besides the moon-god *Allah*.

Because Jews and Christians intercalated days and months, a practice *Muhammad* banned (*K* 009:036-037), *Muhammad* thought Jews worshipped Ezra as a sun-god and *Muhammad* thought the Christians worshipped Jesus as a sun-god.

Like *Muhammad*, the Emperor Constantine (~280-337 AD) seems to have initially thought that Christ was a sun-god. Less Nester wrote:

Already in the first century, Vespasian’s soldiers...saluted the rising sun...by the third century CE the emperor Aurelian had made the Syrian sun-god, *Sol Invictus*, the official protector of the Roman Empire. Even Constantine promoted *Sol Invictus* early in his career. His nephew Julian, the last pagan emperor, was a Mithraist, who wrote a famous hymn to the sun [*Mithra*].<sup>2923</sup>

Eusebius tells us in his *Church History* that Constantine was converted when he dreamt that he heard the words “By this sign you will conquer!” The Latin was “*In Hoc Signo Vinces*.” This bit of Latin is similar to a title for the sun-god promoted by the Roman Empire: *Sol Invictus*, “the Unconquerable Sun.”

In the same dream Constantine saw in the sky the *Chi-Rho* sign as though it were in the field of the sun. *Chi* and *Rho* are the first two Greek letters of the word *Christos*. The *Chi-Rho* sign looks like a *P* (*Rho*) superimposed over an *X* (*Chi*).

That Constantine thought that Jesus was a sun-god is suggested by the fact that for a decade after his conversion in 312 AD, Constantine had some coins minted with his portrait and *Sol* and other coins with his portrait and the *Chi-Rho* Christogram.<sup>2924</sup>  
2925

Interestingly, there are pre-sixth-century portraits of a beardless Christ that look like a sun-god with a *Chi-Rho* sign positioned behind the head as though it were rays of the sun.<sup>2926</sup> Also, the Staff of *Apollo* looked much like a Latin Cross. *Apollo* was a sun-god and *Apollo* was the son of *Zeus*.<sup>2927</sup>

Lester Ness wrote about Constantine’s pagan notions:

Certainly the era of Constantine saw a great deal of solar symbolism in art and imperial symbolism.<sup>2928</sup>

MacMullen wrote that Constantine held on to some other pagan ideas:

If at first—at various points throughout his reign—he demonstrated quite eccentric ideas about Christianity....There is a good example in his [Constantine’s] resort to entrail-divination [i.e. *Haruspex* auguring] in *CT* 16.10.1 (320)...On the disputed question, how well informed and orthodox was

<sup>2922</sup> *Al Tabari. History*, vol. i, p. 234.

<sup>2923</sup> Ness. *Mosaics*, p. 109.

<sup>2924</sup> MacMullen. *Christianizing*, pp. 44, 49.

<sup>2925</sup> *EB*, accessed 2 Mar 2003, “Constantine I” entry.

<sup>2926</sup> Wilson. *Shroud*, p. 111, image 22.

<sup>2927</sup> *Symbols '98 Encyclopedia*, symbols.com, “3:1: The Latin cross, *crux immissa*, *crux capitata*.”

<sup>2928</sup> Ness. *Mosaics*, p. 13.

Constantine's Christianity...I would now diminish the role of formal instruction [catechizing] he might have had before AD 315...<sup>2929</sup>

Alvin Schmidt wrote:

While there is no evidence that the early Christians during the first three centuries abstained from work on Sunday, for some reason the Emperor Constantine in AD 321 decreed that 'the venerable day of the sun' was to be a day of rest for urban residents. However, the decree did not apply to rural people. Constantine's act of making Sunday a legal holy day also gave official status to the seven-day planetary week among the Romans.<sup>2930</sup>

The above quote suggests that Constantine thought of Christ as being a sun-god.

There are some other reasons that Constantine may have thought that Christ was a sun-god. The Persian god of light, *Mithras*, was pictured as a man riding a bull. *Mithras* was often identified with the sun.

The mystery religion Mithraism was promoted heavily among Roman troops throughout the second century AD. This shows how the Romans too easily identified men as being gods and even sun-gods.

Still another reason Constantine may have thought that Christ was a sun-god was that the Trinity was worshipped on Sunday since New Testament times (Act 20:07; 1Co 16:02-03). The switch from the Saturday *Sabbath* to Sunday was not made because of sun-god worship or by any Papal order. The New Testament mentions the disciples meeting together on the first day of the week include:

- † Jesus appeared to the Emmaus disciples and to ten disciples gathered together on the first day of the week in the evening (Luk 24:21-22, 33-36).
- † Jesus appeared the Sunday after the resurrection to the eleven disciples who were again gathered together (Joh 20:18-19, 26). Thomas was with the disciples during this appearance (Joh 20:24, 26).
- † The church was gathered together on Pentecost, the first day of the week. Pentecost always fell on the day after a *Sabbath* since Pentecost occurred fifty days after a *Sabbath* Day (Lev 23:15-16). The Resurrection and Pentecost are the two most pivotal days at the founding of the New Testament Church, and would naturally have been commemorated in addition to the *Sabbath* rather than as a replacement for it. But when the Church stopped being Jewish and understood that the *Sabbath* was a Jewish rather than a universal festival—Colossians 02:16-17—it simply stopped being celebrated.

Alvin Schmidt wrote:

In extra-Biblical literature the first reference to Christians worshipping on 'the Day of the Sun' is from Justin Martyr, a Christian apologist (defender) of the mid-second century (*Apologia* 1.67). A half-century later (between 190-200 AD) Tertullian, another Christian apologist, argued that the Christian practice of worshipping on Sunday had nothing to do with the sun-god and denied that their praying toward the east conveyed any pagan influence (*Ad Nations* 13).<sup>2931</sup>

Another reason Constantine may have thought that Christ was a sun-god was Christians celebrated Christmas on 25 December. The Christmas celebration is not commanded in the NT, nor are any of its attendant rituals with pagan antecedents.

<sup>2929</sup> MacMullen. *Christianizing*, pp. 44, 141, fn. 29.

<sup>2930</sup> Schmidt. *Influence*, p. 376.

<sup>2931</sup> Schmidt. *Influence*, p. 376.

Christmas was celebrated at least since 221 AD, as reported by Sextus Julius Africanus in his *Chronographiai* (221 AD).<sup>2932</sup>

The winter solstice was probably chosen to celebrate Christ's birth since the New Testament described Christ as being as bright as the sun (Mal 04:02; Luk 01:78). Also, Christians were worshipping on the first day of the week—Sunday.

Notably, pagan emperors tried to paganize Christianity through syncretism. Alvin Schmidt wrote:

...the Roman emperor Aurelian's edict in AD 274...established the festival of *Natale Solis Invicti* (Birth of the Unconquered Sun) as he dedicated a new temple to the sun as god near the Mausoleum of Augustus...the emperor, by establishing the Birth of the Unconquerable Sun, may have tried to paganize the Christian observance of the birth of Christ, the 'Sun of Righteousness' [Mal 04:02]. The later gains added plausibility when one recalls that Emperor Diocletian in the Great Persecution of 293-305 reinforced Aurelian's edict in order to 'expunge Christianity.' Moreover, also in the fourth century, Christians considered March 25 [i.e. around Passover] 'to be the actual date of both Christ's Passion and Resurrection and his conception [*Sic*] so that December 25—exactly nine months later—was originally chosen from a computation based on the assumed date of Jesus' death, resurrection and conception.'<sup>2933</sup>

The reader might be asking "Was *Muhammad* like Emperor Aurelian, Emperor Diocletian or Emperor Constantine?" The question is whether *Muhammad* tried to paganize Christianity with astral worship as Emperor Aurelian attempted. Or was *Muhammad* like Emperor Diocletian who attempted to corrupt and expunge Christianity by imposing astral worship? Or, was *Muhammad* like Emperor Constantine in that he at first assumed Christianity was an astral religion? The answer: *Muhammad* was like all three emperors in certain respects:

- ☉ *Muhammad* assumed, like Constantine, that Christianity and Judaism were really one bifurcated (split) astral religion in need of a reformation.
- ☉ While at *Madina*, *Muhammad* forcefully attempted to syncretize the *Hanif* astral religion with Christianity and Judaism. In *Madina Muhammad* instilled global aspirations into *Islam* so as to syncretize moon-god monotheism and Christianity and Judaism everywhere. This is similar to Emperor Aurelian's attempt to paganize Christianity throughout the Roman Empire.
- ☉ On his deathbed *Muhammad* commanded the next *Caliph* to have Christianity and Judaism expunged from the Arabian Peninsula.<sup>2934</sup> The pagans in Arabia of course were only given the choice of converting or dying rather than expulsion. This is similar to how Diocletian tried to expunge Christianity from the Roman Empire.

<sup>2932</sup> EB, accessed 8 Jan 2003, Christmas entry.

<sup>2933</sup> Schmidt. *Influence*, pp. 377-378.

<sup>2934</sup> *Muhammad's* expulsion order that only *Muslims* be left on the Arabian Peninsula: Ishaq. *Sirat*, p. 689; Koelle. *Mohammedanism*, section ii:19, p. 231; *Sahih Bukhari*, vol. 4, bk. 52, no. 288; vol. 4, bk. 53, no. 393; vol. 5, bk. 59, no. 716; *Sahih Muslim*, bk. 019, no. 4366; and *Malik's Muwatta*, bk. 45, no. 5.18.

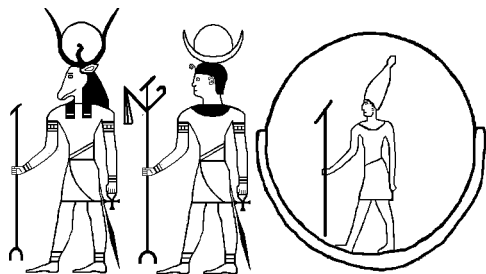
## How Muhammad Came to Believe *Yahveh* the Father was a Moon-god—The Christian Connection

In the Mideast the astral triads nearly always involved the sun, moon and Venus—the sexual triad of father, mother and son. The *Muslim* writer, Ameer Ali, wrote that Christians got their idea for the Trinity from the Egyptian *Osiris-Isis-Horus* triad.<sup>2935</sup>

If what Ameer Ali wrote is true, it is safe to assume that *Muhammad* thought that the Son was *Horus*, Mary was *Isis*, and the Father was *Osiris* the moon-god. The orb and crescent headsets that *Isis*, *Horus* and *Osiris* wore would lead *Muhammad* to believe that the Christian Trinity involved the sun and moon, and either Venus or *Sirius*.

So what depictions of *Osiris* did *Muhammad* see? During Roman times the moon-god *Osiris* was depicted as a child riding a lion—the child representing the moon controlling the solar-god animal. One such statue was found in *Timna, Yemen*. “The motif of lion-rider survived in *Islam* art as an astrological illustration.”<sup>2936</sup> For this study however we are more interested in *Osiris* depicted with a crescent.

*Osiris* was depicted with a crescent in two forms: sometimes as a man and sometimes as a man with a bull’s head. The later was called the *Apis* Bull, a.k.a. *Serapis*. Bulls commonly have curved horns like a crescent-moon, so they were often associated with moon-gods.



**Figure 06-03.** Three depictions of *Osiris*: 1) As *Serapis*, the *Apis* Bull moon-god (left) and 2) As the moon-god *Osiris-Aah* (center and right).<sup>2937</sup> *Osiris* in the orb reminds one of the Man-in-the-Moon, which may have been the artist’s intention. See the Index or the Thumbnail Gallery for an ...<sup>2938</sup>

*Osiris* was known as a moon-god at least since the time of *Ramesses IV* (1153-1147 BC) as a hymn reveals.<sup>2939</sup> *Osiris* wore a crescent-moon and orb headdress whether *Osiris* was depicted as the *Apis* bull or as a man.

Wallis Budge wrote:

***Osiris-Aah, i.e. Osiris the moon-god.*** He appears in the form of a human-headed mummy, with a crescent-moon and full-moon on his head. In his hands he holds symbols of stability, life, serenity, power and dominion.<sup>2940</sup>

...at one period *Osiris* was identified with the moon. This fact was well known to *Plutarch* (46 to ~120 AD), who says that on the new-moon of the month of *Phamenothis*, which falls in the beginning of the spring, the Egyptians

<sup>2935</sup> Ali. *Spirit*, pp. xxxix-xliii.

<sup>2936</sup> Bowen & Albright. *Arabia*, p. 158.

<sup>2937</sup> Concerning the moon-god on the right: “*Osiris* in the disc of the moon, wearing the crown of Upper Egypt and holding a scepter (from John Layard, *The Lady of the Hare*, p. 146)” (Cashford. *Moon*, p. 24, fig. 13). The left and center *Osiris* moon-god images are drawn from images in Budge. *Osiris*, vol. i, p. 59, and other sources.

<sup>2938</sup> ... *Achaemenid* (Persian) moon-god that is pictured similarly in a ring crescent.

<sup>2939</sup> Bowen & Albright. *Arabia*, p. 159.

<sup>2940</sup> Budge. *Osiris*, vol. i, p. 59.

celebrate a festival which is expressly called by them ‘the Entrance of *Osiris* into the moon.’ He goes on to say that by *Osiris* are meant the power and influence of the moon just as by *Isis* they understand the generative faculty which resides in it [*Sirius*]. This statement is supported by a passage in the *Book of Making the Spirit of Osiris*, which reads:

Thou (*Osiris*) risest into the sky,

Thou are united (thereto) [i.e. united to the sky] like *Ra* (the sun).

The sailors in (thy [your]) boat (crescent-moon) give thee acclamation.

The mouths of the gods of the horizon rejoice....

The beings on earth flourish (or, become fertile)....

....the moon is addressed as a ‘bull, that groweth young in the heaven each day’....Thus it is quite clear that *Osiris* was regarded as the Power of the moon, which produced the Nile-flood and therefore all the fertility in Egypt....The identification of the moon with the power which produces vegetation on the earth is common among many peoples, as Mr. J. G. Frazer has shown...<sup>2941</sup>

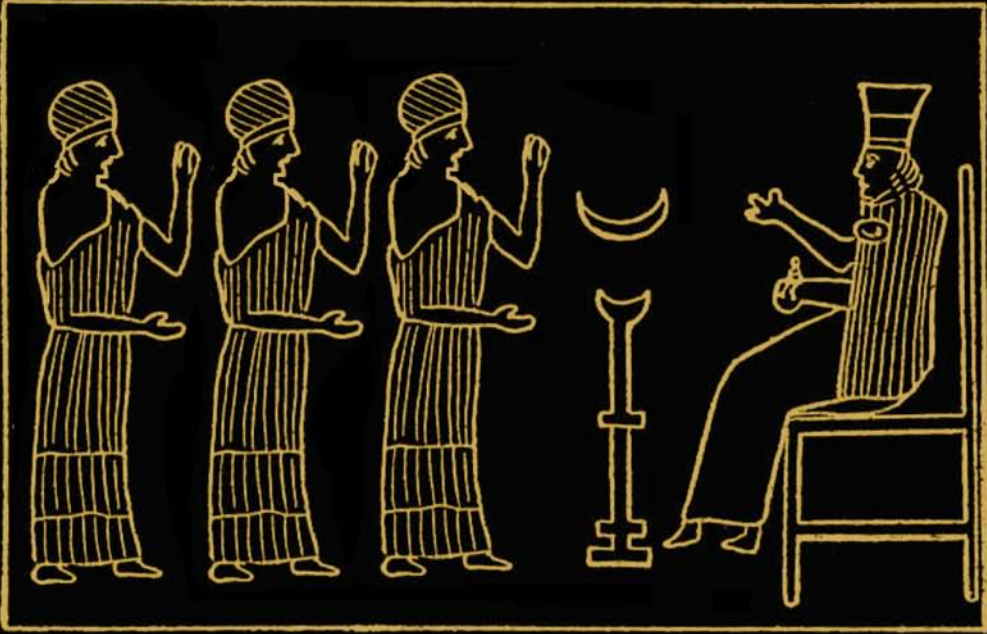
So to conclude this chapter, *Muhammad* thought of the Christian Trinity, not as Father, Son and Spirit but as a triad of Father *Osiris*, Son *Horus* and Mother *Isis*.

### End of Chapter 06

### Book Continued in Volume II of II

---

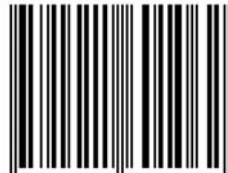
<sup>2941</sup> Budge. *Osiris*, vol. i, pp. 384-385.



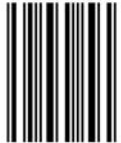
**Yoel Natan writes  
about Mideast Moon  
God Religions**

**ID: 11269**  
**www.lulu.com**  
**The Marketplace**  
**for Digital Content**

ISBN 1-4116-0106-8



90000



9 781411 601062

MOON



THEISM



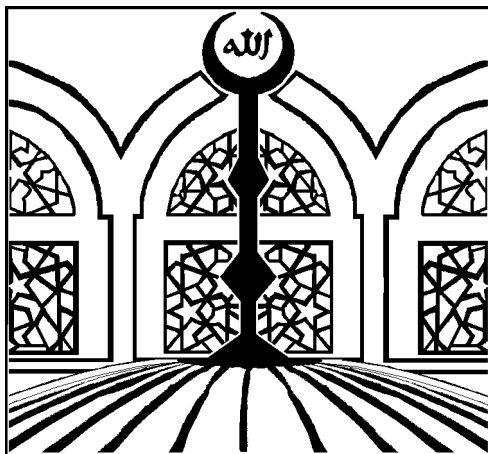
YOEL NATAN

# Moon-o-theism

## Religion of a War and Moon God Prophet

### Volume II of II

By Yoel Natan



*Allah* (Arabic: *aUI*) in the crescent of a finial in front of windows with a star-field motif. *Al-Aksa Mosque*, Temple Mount, Jerusalem.<sup>1</sup>

Yoel Natan is the author of:  
The Jewish Trinity,  
The Jewish Trinity Sourcebook,  
Baptism &  
Lutheran Eschatology  
Web site: [www.Yoel.Info](http://www.Yoel.Info)

Edition 1.0  
Copyright © 2006 by Yoel Natan.  
All Rights Reserved.

Without limiting the rights under copyright reserved above, no part of this publication may be reproduced, stored in or introduced into a retrieval system, or transmitted, in any form or by any means (electronic, mechanical, photocopying, recording, or otherwise), without the prior written permission of both the copyright owner and the publisher of this book.

---

<sup>1</sup> Figure 00-01 (doubles as Figure 12-18). *Allah* (Arabic: *aUI*) in crescent in front of *Mosque* windows with a star field motif. Caption for the source picture is: “The ‘*alam* (finial [*sic*]) of the small dome above the entrance to the *Aqsa Mosque* [at the temple mount]” (Nuseibeh & Grabar. *Dome*, pp. 175-176). For more information on the association of the name *Allah* with crescent finials, see the *Lahut* and *Turkish Blessing* entries in the Index.



## Table of Contents

### Table of Contents (ToC)

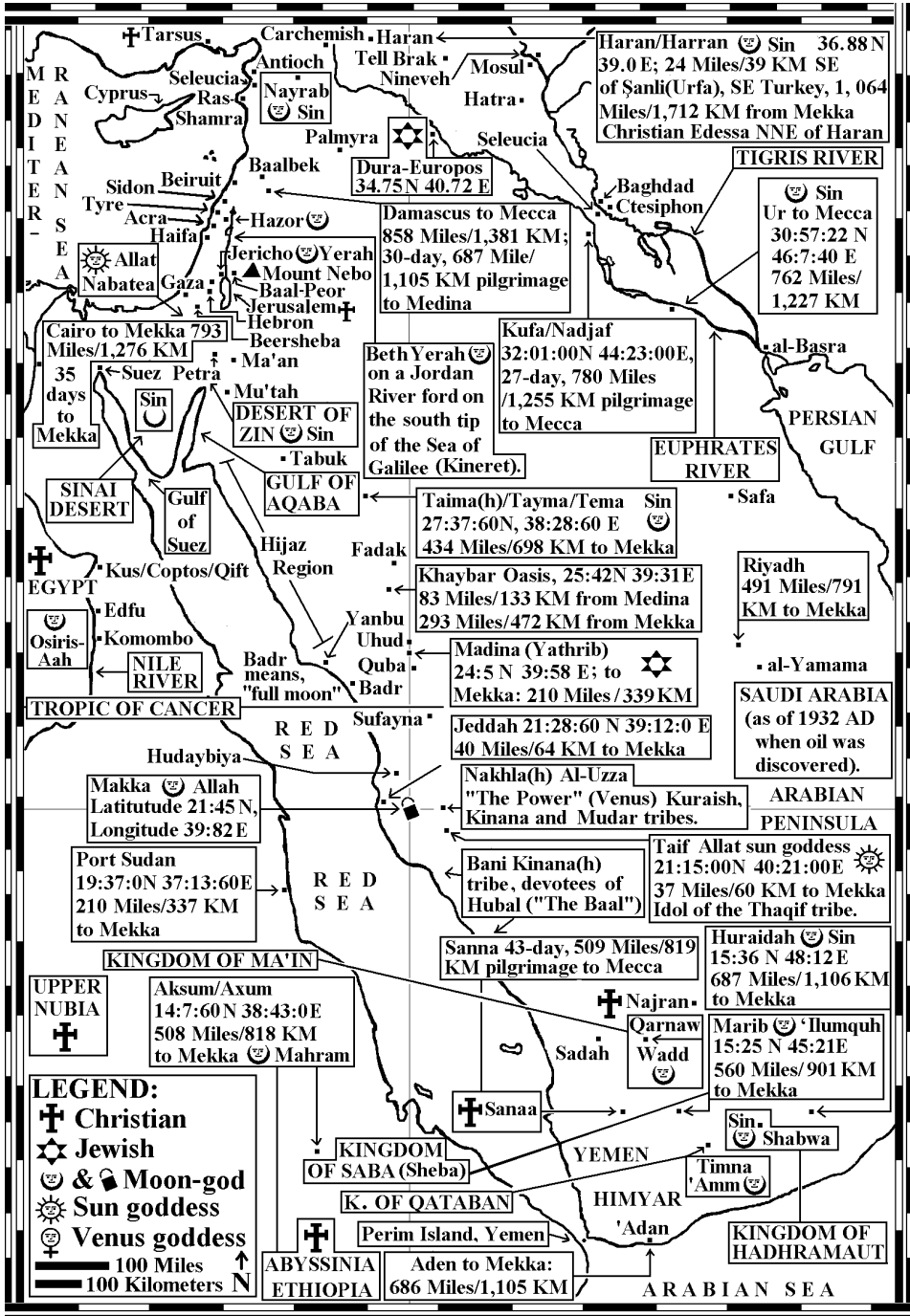
#### VOLUME II OF II

<b>CHAPTER 07: MOON-O-THEISTIC JEWISH CONNECTION .....</b>	<b>609</b>
SUMMARY OF <i>MUHAMMAD'S</i> GENEALOGY AND JEWISH EXTRACTION.....	613
<b>CHAPTER 08: MOON-O-THEISTIC TEN COMMANDMENTS.....</b>	<b>629</b>
<b>THE MOON-GOD RELIGION BEGETS DOUBLE PREDESTINATIONISM.....</b>	<b>646</b>
<b>THE MEANINGS OF THE <i>ISLAMIC</i> MONTHS' NAMES.....</b>	<b>667</b>
<b>THE IDEAL ALIGNMENT OF THE JEWISH ZODIAC &amp; <i>ISLAMIC</i> MONTHS.....</b>	<b>674</b>
<b>HUMAN SACRIFICE AT THE <i>KAABA</i> IN THE PRE-<i>ISLAMIC</i> ERA .....</b>	<b>676</b>
<b><i>MUSLIMS</i> VIEW THE SLAUGHTER OF INFIDELS AS HUMAN SACRIFICES .....</b>	<b>679</b>
<b>HUMAN SACRIFICE AT THE <i>KAABA</i> DURING THE <i>ISLAMIC</i> ERA.....</b>	<b>689</b>
<b>CHAPTER 09: MOON-O-THEISTIC <i>KAABA</i>.....</b>	<b>746</b>
<b>THE VULVIFORM BLACK STONE WITH ITS SILVER CASING .....</b>	<b>752</b>
<b>THE SECOND AUSPICIOUS STONE AT THE <i>KAABA</i> DEDICATED TO <i>ALLAT'S</i></b>	
<b>NIPPLES.....</b>	<b>761</b>
<b>A THIRD AUSPICIOUS STONE AT THE <i>KAABA</i> DEDICATED TO <i>MANAT</i>.....</b>	<b>762</b>
<b><i>HUBAL AS BAAL</i> .....</b>	<b>768</b>
<b>CHAPTER 10: MOON-O-THEISTIC VENUS ALTARS.....</b>	<b>776</b>
<b><i>THE RAKAH CRESCENT-ORB ORANT POSITION (THE RAISING OF THE HANDS)</i> .....</b>	<b>799</b>
<b>WHETHER THE ORANT POSITION IS BIBLICAL OR NOT .....</b>	<b>801</b>
<b>CHAPTER 11: MOON-O-THEISTIC <i>MOSQUES</i>.....</b>	<b>852</b>
<b>CHAPTER 12: MOON-O-THEISTIC TEMPLES .....</b>	<b>863</b>
<b>CHAPTER 13: MOON-O-THEISTIC PILGRIMAGES .....</b>	<b>915</b>
<b>CHAPTER 14: MOON-O-THEISTIC PROPHET.....</b>	<b>931</b>
<b>CHAPTER 15: MOON-O-THEISTIC DRUG .....</b>	<b>950</b>
<b>CHAPTER 16: MOON-O-THEISTIC RELIGIOUS CULTURE .....</b>	<b>991</b>
<b>THE <i>KORAN'S</i> SEEMINGLY NONSENSICAL LETTERS (DETAILED).....</b>	<b>998</b>
<b><i>HALAL</i> FOOD IS FOOD SACRIFICED TO DEMONS.....</b>	<b>1020</b>
<b>APPENDIX: MOON-O-THEISTIC COINS .....</b>	<b>1038</b>
<b>NUMISMATIC METAL ABBREVIATIONS .....</b>	<b>1063</b>
<b>SELECTED <i>ISLAMIC</i> COIN REFERENCES .....</b>	<b>1064</b>
<b>BACK MATTER.....</b>	<b>1065</b>
<b>18 ETHNIC-CLEANSING VERSES IN THE <i>KORAN</i> .....</b>	<b>1065</b>
<b>THE <i>KORAN'S</i> 164 WAR VERSES (DETAILED).....</b>	<b>1067</b>
<b>ABBREVIATIONS.....</b>	<b>1094</b>
<b><i>Bible Book Name Abbreviations</i> .....</b>	<b>1094</b>
<b><i>Other References (Also see the Selective Bibliography)</i> .....</b>	<b>1095</b>
<b>GLOSSARY.....</b>	<b>1098</b>
<b><i>English-Arabic Who's Who</i>.....</b>	<b>1098</b>

## **Moon-o-theism by Yoel Natan**

<i>English-Arabic Glossary Index</i> .....	1099
<i>English-Arabic Glossary</i> .....	1099
<i>The Five Stages of the Dreaded PC-AIDS and PC-ASS Diseases</i> .....	1121
<b>SELECTIVE BIBLIOGRAPHY</b> .....	1144
<b>THUMBNAIL GALLERY</b> .....	1157
<b>ABOUT THE BOOK COVER</b> .....	1162
<b>INDEX</b> .....	<b>1163</b>

# Notable moon-god worship centers in the Mideast



## Chapter 07: Moon-o-theistic Jewish Connection

### Introduction

*Muhammad* copycatted what he knew of Judaism. Jews had dissected the Old Testament Trinity and then denied that the Son and Spirit were divine persons.<sup>2942</sup>

*Muhammad* took paganism and followed a track parallel to Judaism's theological development. *Muhammad* disassociated *Allah* from his goddess daughters and said that the daughters were in fact male angels.

Though *Islam* is a mishmash of various religious beliefs, *Muhammad* thought of himself more as a reformer and not as a copycatter or innovator. *Muhammad* felt he had the pure, pristine religion from which all the other religions sprang and then become corrupted.

*Muhammad* believed that Judaism and Christianity were originally strictly monotheistic but over time had developed similar astral triads. *Muhammad* figured that Christians especially were guilty of polytheism since as Guillaume wrote:

...the term 'Mother of God' [*Theotokos*] given to the Virgin Mary could mean only one thing to an Arab—the sexual trinity [triad] of the old heathen world, which was never a unity.<sup>2943</sup>

When evaluating *Islam*, one must keep in mind *Muhammad*'s perception of the facts and the "history according to *Muhammad*." To phrase it lightly, no one ever accused *Muhammad* of being a historian or a scholar of comparative religions!

*Muhammad* considered Jews guilty by association with Christians. *Muhammad* saw that Jews and Christians did not pillage each other, which by the medieval Arabian standards of the day, meant Jews and Christians must be friends and allies (*K* 005:051).

*Muhammad* also suspected that Jews were polytheistic because of their shared tradition with Christians, whom *Muhammad* thought were especially polytheistic.

The ecumenical-minded Jews, Christians and pagans confused *Muhammad* into thinking that Jews and Christians and pagans were not too distant from each other in their theology. For instance, Lester Ness wrote:

Later magicians, Jewish or pagan, did not hesitate to invoke Jesus' name.<sup>2944</sup>

Ecumenical-minded non-Christians were persons like Bar-Jesus (Act 13:06) and the seven sons of Sceva (Act 19:13-15). They were the ones whom Jesus warned against—unbelievers who did miracles in his name yet were not Christians (Mat 07:21-23).

Because *Muhammad* thought Christian claims to be monotheistic were false, he considered Jewish pretensions at monotheism suspect at best (*K* 002:259-260; 009:030). As was discussed in a previous chapter, *Muhammad* thought that Moses (*Musa*) was Jesus' uncle.

*Muhammad* thought Jews and Christians could not differ much in doctrine, despite Jews and Christians' protestations to the contrary. *Muhammad* thought Jews and Christians only parted company because of envy and not doctrine:

They [Jews and Christians] did not become divided until after knowledge had come to them out of envy among themselves (*K* 042:014; also see *K* 010:093).

<sup>2942</sup> See Yoel Natan's books *The Jewish Trinity* and *The Jewish Trinity Sourcebook*.

<sup>2943</sup> Guillaume. *Islam*, pp. 52-53.

<sup>2944</sup> Ness. *Mosaics*, p. 149.

So based in part on *Muhammad's* perception that Christians were polytheistic, he assumed that synagogue zodiac circles meant Jews worshipped this triad:

- ☉ *Allah* the moon-god
- ☉ *Allah's* son Ezra the sun-god (*K* 002:259-260; 009:030)
- ☉ *Allah's* daughters, as the Four Seasons

### The Pagan Zodiac Circles

Zodiac circles were common among pagans. *Muhammad* mentioned the sun, moon, stars and constellations often. *Muhammad* even mentions the “zodiacal signs” “mansions,” “houses,” or “stages”—depending on the translation (*K* 010:005; 015:016; 025:061; 036:039; 085:001). *Muhammad* seems to connect the constellations and the succession of day and night to worship:

Blessed is He Who made the constellations in the heavens and made therein a lamp and a shining moon. He it is Who made the night and the day to follow each other for him who desires to be mindful or desires to be thankful (*K* 025:061).

It is worth noting one pagan connection between *Muhammad* and zodiacal constellation worship. Tamara Green wrote that *Ibn Hisham* (died in 828 or 833 AD/213 or 218 AH) noted that the prophet's adversaries called him a *Sabean*.<sup>2945</sup> The reason was, as *Ibn Hazm* (died 1063 AD) relates:

...the *Sabeans*...honor the seven planets and the twelve constellations and paint them in their temples; they have five prayers similar to the *Muslim* ceremony, fast in *Ramadan*, turn to the *Kaaba* in prayer and regard the same meats as unlawful as do the *Muslims*.<sup>2946</sup>

### Zodiac Circles Formed Part of the Basis for Pagan Doctrine and Syncretism

As one might expect, the pagans did not display zodiacal circles just for art's sake or as a perpetual, cyclical calendar. Zodiac circles were threaded into pagan belief systems. Also, Zodiac circles came into play during the syncretism process between two religions. For instance, Tamara Green wrote that zodiac astrology was used to syncretize *Haran* and *Iranian* religion during late antiquity.<sup>2947</sup>

### Jewish Zodiac Circles Were the Moon-o-theists' Ten Commandments

Various threads of information confirmed, in *Muhammad's* mind at least, that *Yahveh*, the God of the Bible, was a moon-god. Lester Ness wrote:

The motif of Abraham the astrologer is found in many places in Jewish literature of both the Second Temple and the *Talmudic* periods....Artapanus, an Egyptian Jew (late third or early second century BCE)...claimed that Abraham taught astrology to the Egyptian priests of Heliopolis. He also believed that *Hermes Trismegistus* [Egyptian priest, father of Hermeticism] was really Moses...Similarly, Eupolemus (late third or early second century BCE) claimed that Enoch had learned astrology from the angels, and that Abraham later taught the technique to *Phoenicians* and Egyptians.<sup>2948</sup>

<sup>2945</sup> Green. *Moon*, p. 106.

<sup>2946</sup> Green. *Moon*, p. 107.

<sup>2947</sup> Green. *Moon*, pp. 198-199.

<sup>2948</sup> Ness. *Mosaics*, pp. 140-141.

That *Muhammad* had plenty of contact with Jews is beyond doubt. The *Koran* is full of *Muhammad's* rendition of Jewish material. Many articles have been written on the subject, including a book by Charles Cutler Torrey.<sup>2949</sup>

### Jewish Sources of the *Koran*

Not as much however has been written about the Jewish artwork that *Muhammad* might have seen during his caravan travels in Arabia, Syria and even Persia. The reason Jewish artwork has not been discussed much is that not much Jewish art had been excavated until the last century. The art historian Goodenough had this to say about art in classical Judaism:

When the painted walls of the synagogue at *Dura-Europos* emerged into the light in November 1932, the modern perspective on the character of Judaism in Greco-Roman time had to be radically refocused. Until that time it was possible to ignore the growing evidence, turned up for decades by archeologists, of a kind of Judaism substantially different from that described in Jewish literary remains of the period. Those remains specifically contained in the *Talmud* and *Midrash* were understood to describe an aniconic [literally “without icons,” meaning without figural art], ethically and socially oriented religion...<sup>2950</sup>

Also, not as much has been written about the Jewish side of *Muhammad's* genealogy. Before exploring what Jewish artwork *Muhammad* seems to have seen, exploring *Muhammad's* Jewish genealogy is in order. *Muhammad's* part-Jewish background would gain him more exposure to Jewish art. Also, having a Jewish extended family would mean Jewish art would carry more religious meaning for *Muhammad*.

### *Muhammad's* Jewish Familial Connections

Emanuel Deutsch wrote:

It seems as if he [*Muhammad*] had breathed from his childhood almost the air of contemporary Judaism, such Judaism as is found by us crystallized in the *Talmud*, the *Targum* and the *Midrash*.<sup>2951</sup>

It is possible that *Muhammad's* source of information on contemporary Judaism was from Judaized Arabs who either professed Judaism, or Arabs who associated with Jews but followed the laxer Noahide Covenant or Religion of *Ibrahim*. *Ibn Ishaq* gave a long list of names of Jews living at *Madina*, and Guillaume comments:

It is noteworthy how few Hebrew names are to be found among Jews of *Madina*.<sup>2952</sup>

F. E. Peters wrote that though *Muslim* scholars traced back the descent of *Madinan* Jews to Levi or to Abraham through Isaac rather than Ishmael, most European scholars “thought that they were far more likely Judaized Arabs, converts made by active Jewish missionaries elsewhere.”<sup>2953</sup> Trimmingham wrote:

This may be contrasted with the Arab attitude towards Judaized Arabs in *Yathrib*, whom they regarded as true Jews since they were distinguished by a

<sup>2949</sup> Torrey. *Foundations*, p. 2.

<sup>2950</sup> Goodenough. *Symbols*, p. xxi.

<sup>2951</sup> Warraq. *Why*, p. 54.

<sup>2952</sup> Ishaq. *Sirat*, p. 240, fn. 2.

<sup>2953</sup> Peters. *Origins*, p. 192.

distinct change in their attitude towards pagan Arabs, whence came their determined opposition to the mission of the Prophet *Muhammad*.<sup>2954</sup>

This demographic explains why *Muhammad* was disappointed he did not gain more converts from Jews since *Muhammad* was an Arab and these particular Jews were mostly of Arab decent.

The Judaized Arabs would probably have incorporated even more pagan astral art than those Jews who were more or less homogeneously Hebrew. The Judaized Arabs' culture would have more pagan roots, and the Judaized Arabs would have had more pagan relations.

*Ibn Ishaq* wrote in his biography on *Muhammad* that envoys from the tribe of *Kinda* spoke to *Muhammad* at *Madina*:

Then *Al Ash'ath* [a *Kinda* envoy] said 'We are the son of the eater of bitter herbs and so are you [*Muhammad*].' The apostle smiled and said that to *Al 'Abbas b. [b. is short for Bin meaning "son of"] 'Abdu'l-Muttalib* and *Rabi'a b. Al Harith* of *that* ancestry was attributed.<sup>2955</sup>

*Ibn Ishaq* felt that compromising references to *Muhammad's* Jewishness had to be explained away, so he inserted the following note in *Muhammad's* biography:

*Ya'qub b. 'Utba* told me that he was informed that that year [the "Year of the Elephant" when *Muhammad* was born] was the first time that measles and smallpox had been seen in Arabia; also that it was the first time that bitter herbs like rue, colocynth and *Asclepias Gigantea* [Willdenow] were seen.<sup>2956</sup>

*Ibn Hisham* annotated *Ibn Ishaq's* biography on *Muhammad* and he gives an unlikely explanation for the phrase "son of the eater of bitter herbs." *Ibn Hisham* wrote that *Muhammad* had an ancestor who ate bitter herbs that stained and swelled the lips. *Muhammad's* ancestor was told by one viewing him, "Methinks I see a Black man with blubber lips like those of a camel eating bitter herbs..."<sup>2957</sup>

Bitter herbs are not mentioned in the *Koran*. It seems safer to assume that the phrase "son of the eater of bitter herbs" means one either has Jewish ancestry or Judaized Arabs for relatives. The bitters herbs would then refer to Passover meal seasonings (Exo 12:08; Num 09:11).

One bitter herb eater, *Al 'Abbas b. 'Abdu'l-Muttalib*, was *Muhammad's* uncle. The other bitter herb eater mentioned above was *Rabi'a b. Al Harith* that was the brother of *Muhammad's* first wife, *Khadija*.<sup>2958</sup> *Ibn Ishaq* shed more light on the subject by quoting *Muhammad* at a later date:

The first claim on blood I abolish is that of *b. Rabi'a b. Al Harith b. 'Abdu'l-Muttalib* (who was fostered among the B. Layth and whom Hudhayl killed). It is the first bloodshed in the pagan period which I deal with.<sup>2959</sup>

*Abdul Muttalib* is *Muhammad's* grandfather and *Al Harith* is an uncle of *Muhammad's*. So *Rabi'a* seems to be *Muhammad's* cousin. In the above quote, the "*b. Rabi'a*" means "son of *Rabi'a*," so *Muhammad* must have cancelled the blood vengeance claim of his second cousin(s).

Also interesting is the tradition related by *Muhammad's* wife *Aisha*. She said recalled that *Waraqah*, the cousin of *Muhammad's* first wife *Khadija* on her father's

<sup>2954</sup> Trimmingham. *Arabs*, p. 122.

<sup>2955</sup> Ishaq. *Sirat*, p. 641.

<sup>2956</sup> Ishaq. *Sirat*, p. 27.

<sup>2957</sup> Ishaq. *Sirat*, p. 787, note 896.

<sup>2958</sup> Darnell. *Quraish*.

<sup>2959</sup> Ishaq. *Sirat*, p. 651.

side, translated the Gospels into Arabic.<sup>2960</sup> This however is contradicted by a very similar tradition that says the language was Hebrew (not Arabic).<sup>2961</sup> So this Waraqa may have been Jewish or part Jewish.

The specifics on *Muhammad's* genealogy are not terribly important given the fact that pre-*Islamic* genealogy in Arabia involved small tribes. Moreover, there were many orphans adopted into different families and serial divorcing may have been common. Even *Muhammad* swiped the wife of his adoptive son Zayd, meaning that for murky reasons, Zayd transferred his wife Zaynab to *Muhammad*.<sup>2962</sup>

Zayd had to replace his wife on his own but this was no big concern since *Ibn Ishaq* records Ali as saying “Women are plentiful and you can easily change one for another.”<sup>2963</sup> Of course with the slave trade and all the murders going on in Arabia, it is not surprising there was an abundance of women.

Arabia during pre-*Islamic* times was similar to before the flood when violence ruled the earth and polygyny was practiced (Gen 04:23; Gen 06:11-13). Genealogies did not matter too much before the Flood, or in Arabia during *Muhammad's* day. After several generations of such mixing, everyone ended up being related to everyone else either directly or indirectly.

We just saw how *Muhammad* admitted that Jewesses had married into his extended family. Assuming however that marriage patterns were consistent going back several generations, *Muhammad* himself may have had some Jewish ancestry. There are in fact traditions that say *Muhammad* was part Jewish.

### Summary of *Muhammad's* Genealogy and Jewish Extraction

*Muhammad's* relatives include:

- ☉ Qusayy (or Quasi) (Arab great, great, great grandfather) (ruled 400 AD) + an Arabess = Zuhra
- ☉ Zuhra (Arab great, great grandfather) (born 378 AD) + Nabatean Jewish woman named Qami (Jewish great, great grandmother<sup>2964</sup>) = *Hashim*
- ☉ *Hashim* (half Jewish great grandfather) + Salma (Jewish woman from *Madina* from the Jewish *Nadhira* (*Najjar*) tribe<sup>2965</sup>) = *Abd Al Muttalib*
- ☉ *Abd Al Muttalib* (three-quarters Jewish grandfather) (died 578 AD) + Halah (Arab woman) = *AbdAllah*
- ☉ *AbdAllah* (one-quarter Jewish father) (died 570 AD) + Amina (Arab woman) = *Muhammad* (one-eighth Jewish) (died 576 AD).

Notably, the fourth *Muslim Caliph* Ali (lived 602–661 AD) was at least one-eighth Jewish. Ali was *Muhammad's* cousin and adoptive son and *Abd Al Muttalib* (three-quarters Jewish) was the grandfather of both *Muhammad* and Ali.

Ali's father was *Abu Talib* (died 540 AD) (one-quarter Jewish) and *Abu Talib* was the brother of *Muhammad's* father *Abd Allah* (one-quarter Jewish). Ali married *Fatima*, who was one-sixteenth Jewish on account of her being *Muhammad's* daughter.

<sup>2960</sup> *Sahih Bukhari* 004.055.605; 006.060.478; 009.087.111; *Sahih Muslim* 001.0301.

<sup>2961</sup> *Sahih Bukhari*, vol. 1, bk. 1, no. 3.

<sup>2962</sup> *Muhammad's* adoptive son is Zayd (or Zaid or Zeid) and Zayd's wife (later *Muhammad's* wife) is Zaynab (or Zainab or Zeinab). See Muir. *Life*, vol. 2, ch. 2, and vol. 3, ch. 16.

<sup>2963</sup> *Ishaq. Sirat*, p. 496.

<sup>2964</sup> Lecker. *Arabia*, II:27.

<sup>2965</sup> Lecker. *Arabia*, II:28.



### Details of Muhammad's Genealogy

There are many contradictory traditions regarding *Muhammad's* genealogy, but Michael Lecker's comparison of the relevant data shows which traditions are more or less reliable.<sup>2966</sup>

Tradition says that Qusayy (ruled ~400 AD) was the first ruler of the *Kuraishites* at *Makka*. Qusayy was the great grandfather of *Muttalib*, who was the grandfather of *Muhammad*. Qusayy fathered Zuhra (born 378 AD). Zuhra was the great, great grandfather of *Muhammad*.

Zuhra married a *Nabatean* Jewish woman named Qami and they had a son named *Hashim b. Abd Manaf* (born 430 AD). Notably, the name *Hashim* seems like a variant of the Jewish word *HaShem*, which means "The Name." *HaShem* refers to *Yahveh*. The *Abd Manaf* means "Slave of *Manaf*," *Manaf* being an idol.<sup>2967</sup>

*Muslim* tradition does contain some folk etymology that says "*Hashim* means one who breaks bread in a cup to make it a kind of porridge." This attempt at an explanation seems implausible. It is an explanation that one would expect from an Arabic speaker who is not familiar with Hebrew.

*Hashim* fathered *Al Muttalib b. Abd Manaf* by a woman other than Qami. *Hashim* is the great grandfather of *Muhammad*. *Hashim* was also the founder of the *Hashimite* clan—*Muhammad's* clan. So perhaps the name of *Muhammad's* clan is derived from the Hebrew for "The Name" (*HaShem*), though this fact was lost on both *Muhammad* and *Muslim* historians.

*Hashim* (half-Jewish) met and married the divorcee Salma, a Jewish noble woman, while on a business trip to *Madina* (*Yathrib*). There were two Arab tribes around *Madina*—the *Aus* and *Khazraj*, and the three Jewish tribes (*Banu*) in *Madina* were the *Nadir*, *Kuynuqa* and the *Kurayza*.<sup>2968</sup>

*Muhammad* banished or slaughtered these *Madinan* Jewish tribes. Later, on his deathbed, *Muhammad* banished all non-*Muslims* from the Arabian Peninsula. To a great extent *Muhammad's* dying wish was carried out.<sup>2969</sup>

Jews in *Madina* and the *Hijaz* allegedly fled Palestine when *Nebuchadnezzar* approached but many of their number were undoubtedly Judaized Arabs. The two Arab tribes derived from a common tribe named *Azd* that emigrated from *Yemen* after Jews were long settled in *Madina*.

Salma was born into the *B. Adi* clan of the *B. an-Najjar* (*Banu Nadhir*) Jewish tribe at *Madina*. Before Salam married *Hashim*, Salma had been married to a leader named Uhayha b. *Al Julah* of the Arab tribe *Amr b. Awf* at *Madina*. *Al Julah* however divorced Salma, because she allegedly forewarned her Jewish tribesmen of an impending attack being planned by her Arab husband.

Salma gave birth to Shaybah (born 497 AD; died 578 AD). Shaybah was later nicknamed *Abd Al Muttalib*, meaning "Slave of *Al Muttalib*," because Shaybah was raised by his uncle *Muttalib* from 576-578 AD. *Abd Al Muttalib* (three-quarters

<sup>2966</sup> Data on *Muhammad's* Jewish ancestry was derived from the article "Links between *Qurashis* and Jewish women" in Lecker. *Arabia*, II:27-29, and from Darnell. *Quraish*.

<sup>2967</sup> Darnell. *Quraish*.

<sup>2968</sup> Warraq. *Why*, p. 49.

<sup>2969</sup> *Muhammad's* expulsion order that only *Muslims* be left on the Arabian Peninsula: Ishaq. *Sirat*, p. 689; Koelle. *Mohammedanism*, section ii:19, p. 231; *Sahih Bukhari*, vol. 4, bk. 52, no. 288; vol. 4, bk. 53, no. 393; vol. 5, bk. 59, no. 716; *Sahih Muslim*, bk. 019, no. 4366; and *Malik's Muwatta*, bk. 45, no. 5.18.

Jewish) married Halah, presumably an *Arabess*. *Abd Al Muttalib*, the grandfather of *Muhammad*, fathered *Abd Allah (AbdAllah)* (one-quarter Jewish) by his wife Halah.

*Abd Allah* married Amina (died 576 AD), an *Arabess*. Amina then gave birth to *Muhammad* (born 570 AD; died 632 AD). This means *Muhammad* was one-eighth Jewish, unless of course *Muhammad* has still more Jewish ancestors unknown to early *Islamic* genealogists.

*Muhammad's* father, *Abd Allah*, died the year *Muhammad* was born. *Abd Allah* died in the care of his partly Jewish uncles and cousins at *Yathrib*. *Muhammad's* mother Amina, died when *Muhammad* was six years old.

*Muhammad* was raised from age six to age eight by his three-quarters Jewish grandfather, *Abd Al Muttalib*. When *Abd Al Muttalib* died, *Muhammad's* uncle *Abu Talib* raised *Muhammad* from age eight to the age of maturity.<sup>2970</sup>

### ***Muhammad* Mistakenly Thought Jews Worshipped an Astral Triad**

*Muhammad* wrongly believed that the Christian and Jewish belief systems imitated the polytheism of ancient pagan religions. *Muhammad* wrote that Jews believed Ezra to be the Son of *Allah* (K 002:259-260; 009:030). *Muhammad* also wrote that both Jews and Christians “imitate what the unbelievers of old used to say” (K 009:029). The question must therefore be asked:

What made *Muhammad* think Jews worshipped Ezra as the Son of *Allah* in imitation of how the ancients worshipped their triads?

Alfred Guillaume wrote similarly:

The charge against the Jews of worshipping Ezra has always remained a mystery; monotheism is of course the center of the Jewish creed.<sup>2971</sup>

The answer to this mystery is found in the astrological art of Jews. *Muhammad* figured that Jews were originally monotheistic based on their Scripture, but the Jewish astral artwork led *Muhammad* to believe that Jews had since turned polytheistic.

Astrology had made inroads into classical Judaism, as Josephus wrote sometime after 70 AD:

It was a *Babylonian* curtain...this [Jewish temple] curtain had also embroidered upon it all that was mystical in the heavens, excepting that of the [twelve] signs, representing living creatures.<sup>2972</sup>

Moses indeed calls this [priestly vestment] belt *Albaneth*; but we have learned from the *Babylonians* to call it *Emia*, for so it is by them called... and the girdle that encompassed the high priest round signified the ocean, for that goes round about and includes the universe. Each of the sardonyses [an onyx with alternating brown and white bands of sard, carnelian and other minerals] declares to us the sun and the moon; those, I mean, that were in the nature of buttons on the high priest's shoulders. And for the twelve stones, whether we understand by them the months, or whether we understand the like number of the

<sup>2970</sup> Peters. *Makka*, p. 46.

<sup>2971</sup> Guillaume. *Islam*, p. 52.

<sup>2972</sup> Josephus, Flavius. *Wars of the Jews*, bk. V: “From The Coming Of Titus To Besiege Jerusalem, To The Great Extremity To Which The Jews Were Reduced,” Ch. 5, “A Description Of The Temple,” para. 4. Note: The curtain that Josephus described likely hung in the temple from some time after the crucifixion (*circa* 30 AD) to the destruction of the temple in 70 AD. The curtain hanging in the temple during the crucifixion was ripped in two, and would have been replaced or repaired (Mat 27:51; Mar 15:38; Luk 23:45).

signs of that circle which the Greeks call the Zodiac, we shall not be mistaken in their meaning.<sup>2973</sup>

Common *Maccabean* and *Herodian* coins look suspiciously like a crescent and Venus orb couplet on a pole or finial. The coin of course purported to portray a double cornucopia with a pomegranate orb on a stem between the horns of plenty. Ya'akov Meshorer wrote:

It is logical to assume that the symbol filtered into Judaism as an object related to fertility and then acquired additional Jewish connotations.<sup>2974</sup>



**Figure 07-01.** Popular *Maccabean* and *Herodian* coin. The double cornucopia with pomegranate orb on a stem is a crescent-and-orb.

Bernard Goldman notes that in the *Maccabean* period “the star of the *Maccabees*” was placed over the temple façade.<sup>2975</sup> Perhaps Stephen was alluding to *Maccabees*’ star when he said:

Did you bring me sacrifices and offerings forty years in the desert, O house of *Israel*? You have lifted up the shrine of Molech and the star of your god *Rephan*, the idols you made to worship. Therefore I will send you into exile beyond *Babylon* (Act 07:42-43).

### The Astral Menorah

Lester Ness wrote:

[Flavius] Josephus [37 AD-?2976] and Philo [Judaeus (~20 BC to ~AD 40)<sup>2977</sup>]...do not hesitate to identify the twelve signs with the twelve loaves of [show]bread offered each day in the temple or the seven planets with the seven branches of the *Menorah*.<sup>2978</sup>

Erwin Goodenough wrote:

From these independent sources [Philo and Josephus], then, we have evidence that Jews actually made their temple cultus, made Judaism itself, into an astral religion.<sup>2979</sup>

Significantly, even after the wear and tear of centuries, the Arch of Titus in Rome still shows the parade of war spoils from the 70 AD conquest of Jerusalem. The damaged relief shows that the Jerusalem temple’s *Menorah* once had seven orbs atop—the five visible planets and the sun and moon. Moreover, the branches of the *Menorah* looks suspiciously like three crescents on a central stem. Bernard Goldman wrote about similar devices:

The crescent on a pole, the symbol of the lunar god, is found in the ancient Orient, and persists in later *Nabataean* art where it crowns columns.<sup>2980</sup>

<sup>2973</sup> Josephus, Flavius. *Antiquities of the Jews*, bk. III “Containing the Interval of Two Years. From the Exodus Out of Egypt, to the Rejection of That Generation,” Ch. 7 “Concerning the Garments of the Priests, and of the High Priest,” Paras. 2 and 7.

<sup>2974</sup> Meshorer. *Coinage*, vol. i, pp. 67-68 & plates 08-55 have cornucopias, especially coins Jc1-Jc7.

<sup>2975</sup> Goldman. *Portal*, p. 68.

<sup>2976</sup> Josephus. *Antiquities of the Jews*, III,vii,7 confer III,vi,7; V,v,5. Philo Judaicus, *Quis Rerum Divinarum Heres*, XLV:224-225.

<sup>2977</sup> Philo, *De Vita Mosis*, II, 12. See Goldman. *Portal*, p. 111.

<sup>2978</sup> Ness. *Mosaics*, p. 141.

<sup>2979</sup> Goodenough. *Symbols*, p. 167.

<sup>2980</sup> Goldman. *Portal*, p. 108.



**Figure 07-02.** The Jerusalem temple *Menorah* relief on the Arch of Titus built in 81 AD on the *Via Sacra*. “The Arch of Titus, now restored and standing outside the ancient entrance to the *Palatine*, was erected by Domitian [ruled 81–96 AD] to commemorate [his brother] Titus’ conquest of Jerusalem” in 70 AD.<sup>2981</sup>

That the branches of the temple *Menorah* became crescents during Intertestamental times is supported by the fact that the lamps atop look like planets. In some Byzantine-era synagogue *Menorahs*, the central lamp was elevated and made to look like the sun among planets.<sup>2982</sup> During the same period, some synagogue overhead lamps were made to represent zodiac circles.<sup>2983</sup>

Even today the candle or lamp on the central stem of the *Hanukka Menorah* is commonly known as the *Shamash*. It is also called the “lighting” or “starter” or “helper” candle. *Shamash* was a popular Semitic sun god. *Shemesh* is the Hebrew word for the sun but has different vowels than *Shamash*.

The astral character of the *Hanukka Menorah* is further indicated by Rabbis who teach that *Hanukka* first started when Adam was sky watching:

*Hanukka* is called The Festival of Lights (*Hag Urim*) by the great historian Josephus. One of the most fundamental reasons for this appellation is a *Talmudic* passage about Adam: ‘When Adam the first saw that the day was becoming shorter and shorter, he said: ‘Woe unto me, lest, because I sinned, the world is darkening because of me and is returning to emptiness and void [*Tohu Ve Vohu*]... But then, when he saw that the day began to grow longer, he realized that the comparative length of night and day is part of the immutable order of the world. He then went and established eight days of festival. The next year two types of festivals for eight days were held at that time, with one group giving praise to God and the other group giving praise to idols...’ (B. T. Avoda Zara 8a).<sup>2984</sup>

The *Shamash* light and its central stem are usually higher than the branches. The branches are level with each other. This seems to indicate the central stem represents the sun while the branches represent the planets. So it would seem that the *Menorah* became a sun-planet-crescent symbol during the Intertestamental period.

### The Detrimental Effects of Astral Religion on Classical Judaism

Goodenough wrote:

As the astral conception came in from the East, most of the older myths and divine personalities and a large part of the ancient ritual, were interpreted or altered to express the sense of fatalism and determinism that astral control of the universe and of man’s fate indicated.<sup>2985</sup>

That the *Menorah* had an astral design rather than a tree design was a great spiritual loss since it no longer reminded the observer of the Tree of Life in the Garden of Eden or the Burning Bush. Moreover, it was not in compliance with God’s decree:

<sup>2981</sup> CEE, “Titus” entry.

<sup>2982</sup> Goodenough. *Symbols*, p. 119.

<sup>2983</sup> Goodenough. *Symbols*, p. 118.

<sup>2984</sup> Riskin, Shlomo. “*Hanukka* marks the turning point,” jpost.com, 9 Dec 2004.

<sup>2985</sup> Goodenough. *Symbols*, p. 116.

See that you make them according to the pattern shown you on the mountain (Exo 25:40; Heb 08:05).

The message that *Muhammad* received from astral *Menorahs* was that spiritual light only shines forth from the moon and stars—as is indicated by *Koran*'s “Light Verse” (K 024:035). Lamps were often kept out of the way in niches.

A crescent on a pole was a sign of moon-god worship, as was noted above. So the astral *Menorahs* helped lead *Muhammad* to the wrong conclusion that *Ibrahim* and Moses worshipped *Allah* the moon-god.

The *Menorah* was and is a ubiquitous symbol in Judaism. If the *Menorah* had resembled a tree with branches (Exo 25:32-36; 37:16-22), as was directed by *Yahveh* (Exo 25:40; Heb 08:05), perhaps the crucifixion of the God-man would have made theological sense to Jews and *Muhammad* (Gal 03:13; 1Pe 02:24).

Since Jews and *Muhammad* were thinking more in astrological terms, it made no sense in such a framework for the Son of God to come to earth to die to save many from their sins.

Conversely, Jews and *Muslims* thought it entirely appropriate for the high god and his angels to command or influence his followers to fight to the death rather than be slaughtered like lambs. In the Mideast it was commonly thought that the moon and stars predetermined everyone's fate just as surely as astrology influenced the seasons and weather, and besides, the astral deities thought that human life was cheap.

This astral thinking shaped the theology of astrology-minded cultures. The Greeks imbibed Mideast thought, so their mythology featured heroes who, at the whim of the gods, fought to the death even in foreign lands such as *Troy*. The gods sat back and watched the heroics and by apotheosis the slain hero like *Hercules* became a constellation in the heavens.

As Rome became more astrological minded, the idea of coliseums and circuses with dangerous or “fight to the death” spectator sports appealed to their sensibilities. The crowd of spectators probably imagined they were like the astral deities who watched and betted on human events and perhaps even rooted for the underdog. As Shakespeare said “The whole world is a stage.”

As Jews become more astrology-minded, their theology became more like the Greeks and Romans, except more democratized. Instead of just heroes like *Hercules* undergoing an apotheosis, all Jews who died in battle were thought to be especially honored in heaven, as the Roman historian Tacitus (~55 AD to ~120 AD) wrote:

They hold that the souls of all who perish in battle or by the hands of the executioner are immortal. Hence a passion for propagating their race and a contempt for death.<sup>2986</sup>

With clear desert skies and many relatively warm nights, at least compared to the rest of the world, the pre-*Islamic* Arabs were inveterate star watchers and astral religionists. So in keeping with astral religion morality, human life was cheap in Arabia and the violence of pre-*Islamic* Arabs was proverbial.

*Muslims* continued the astrological tradition and refined and improved it. So it is not surprising that *Jihad* is the “Sixth Pillar” of *Islam*, after these five pillars: Confessing Monotheism (*Shahada*), Praying (*Salat*), Almsgiving (*Zakat*), Fasting (*Sawm*) and Pilgrimage (*Hajj*). It is also no wonder that slain *Muslims* are guaranteed a pagan-like heaven (K 003:157-158; 022:058-059).

<sup>2986</sup> MacMullen & Lane. *Sourcebook*, p. 162.

So *Muslims* often consider themselves to be expendable and *Muslims* consider non-*Muslim* life cheap and disposable. No wonder *Muslim* history and present day newspapers are full of *Jihad*-fueled butcheries. It is as though non-*Muslims* are fighting for their lives in a Roman coliseum.

### Christians Have Been Mostly Antithetical to Astrology Since the New Testament Era

Jews seem to have been more readily seduced into astrological thinking because the number seven and twelve are often used in Old Testament religion. Seven was associated with the five planets and the sun and moon. Bernard Goldman wrote:

As is to be expected, the twelve signs of the zodiac were aligned with the twelve loaves of showbread, the twelve bulls of the 'Brazen Sea' in the Temple, the twelve stones set in the dress of the high priest, the twelve tribes of *Israel* and other groups of twelve.<sup>2987</sup>

Goodenough wrote:

Jewish acceptance of the zodiac appears from its identification with Moses and the twelve tribes at the springs of *Elim* in one of the paintings at the *Dura* synagogue.<sup>2988</sup>

The archeological remains, which put the astral signs within the synagogues and catacombs, or with Jewish tokens on graves, seem to witness the genuine fusion of Judaism and astralism...The *Rabbis* often said that the Biblical references to the number twelve are allusions to the zodiac.<sup>2989</sup>

The numbers seven and twelve however have to do with the solilunar calendar and other spiritual considerations. It is anachronistic to think all the twelves in the Old Testament had to do with signs of the zodiac since,<sup>2990</sup> as the *Encyclopedia Britannica* points out:

The size and number of zodiacal constellations varied in antiquity and became fixed only with the development of mathematical astronomy,<sup>2991</sup>

Deborah Houlding notes...

...the zodiac we know today is a relatively recent refinement that appeared around the 6th century BC and spent several centuries struggling to gain common acceptance,<sup>2992</sup>

and Goodenough notes...

...astronomical conceptions...played so rare a part in the Old Testament and so [were] little integrated into the religious thinking of *Israel* and early Judaism. Not until much later were all these twelves...made into explicit references to the zodiac.<sup>2993</sup>

Christians however were not fooled by astrology and early Christians even castigated the Jewish leadership over the issue of Judaism being transformed into astral worship.

<sup>2987</sup> Goldman. *Portal*, p. 60.

<sup>2988</sup> Goodenough. *Symbols*, p. 119.

<sup>2989</sup> Goodenough. *Symbols*, p. 149.

<sup>2990</sup> Goldman. *Portal*, p. 60 (note).

<sup>2991</sup> *EB*, accessed 19 Apr 2003, Zodiac entry.

<sup>2992</sup> Houlding, Deborah. "Heavenly Imprints: Development of the Zodiac and the early origins of *Aries* & *Taurus*," (skyscript.co.uk), accessed 19 Apr 2003.

<sup>2993</sup> Goodenough. *Symbols*, p. 149.

The issue of astral worship in the temple explains much of Saint Stephen's speech to the Sanhedrin. Stephen had to defend himself against the charge of speaking against the temple, Mosaic law and customs (Act 06:13-14). This shows that the New Testament Jews had fooled themselves into thinking it was Moses who handed down an astral religion!

Stephen's defense was that he was merely speaking against the accommodation of astral worship in the temple and the Jewish leaders' rejection of the Messiah. Stephen mentions Abraham's call from *Haran*, the famous "City of the Moon" (Act 07:02).

This brings to mind the fact that Abraham's father *Terah* worshipped false gods at the astral-god worship center called *Haran* (Jos 24:02, 14-15). Stephen then mentions how Jacob's clan rejected Joseph (Act 07:09). This also brings to mind how Jacob's clan brought false gods from *Haran* to *Israel* (Gen 31:19, 32; 35:02).

Stephen mentioned that during the *Exodus* the *Israelites* longed for Egypt, worshipped the golden calf and rejected Moses (Act 07:35, 39, 41). Stephen quoted Amo 05:25-27 to show that even during the forty years in the wilderness, the *Israelites* never stopped worshipping "the heavenly bodies" (Act 07:42).

Stephen makes the point that the forefathers were better than the New Testament Jewish leaders in that they at least made the tabernacle, not with astral accouterments but "as God directed Moses, according to the pattern he had seen" (Act 07:44). Also, the early *Israelites* did not assign an astral interpretation to every grouping of seven or twelve objects.

Jews under *Joshua* were better than the later pre-exilic Jews because they were allowed entry into the Promised Land (Act 07:45-50). The pre-exilic *Israelites* however made shrines to Moloch and the star of the god *Rephan*, and so were expelled to Mesopotamia (Act 07:43).

Still, the New Testament Jewish leaders were worse than the pre-exilic Jews because they only persecuted the prophets, killing some. By contrast, the New Testament Jewish leaders killed the God-man Messiah (Act 07:51-53).

Stephen's speech also mentions Solomon building the temple according to the directions given David (1Ki 06:12; Act 07:46-50). This brings to mind how Solomon built shrines for idols on a hill east of Jerusalem (2Ki 23:13).

The Sanhedrin acted worse than Solomon. At least Solomon kept the idol worship separate from the temple. The Sanhedrin however probably had a say in deciding its astral imagery.

Jews took down an eagle that Herod had placed over the temple in 5 BC (*War* I:648-655). In 26 AD, Jews protested Pilate installing an image of Caesar in Jerusalem (*Antiquities* 18:55-59; *War* 2:169-174). So it seems telling that Jews did not object to the astral imagery placed in the temple, though the Christian Stephen did (Act 07).

Herod's temple accommodated astral worship and had an astral curtain and other accouterments. Solomon's temple however was not corrupted during his lifetime. When Solomon was older however he had some shrines for false gods built east of the temple across the *Kidron* Valley at the request of his foreign wives (1Ki 11:04).

Solomon caved in to pressure from his hundreds of wives and concubines. He did not heed Moses' warning:

The king must not take many wives or his heart will be led astray (Deu 17:17).

Solomon's wives probably told him that they grew up in a certain religion and these religions were what worked for them (Jer 44:16-19). His wives probably said

that they have feelings too—the implication being that their faith ought to be beyond critical analysis.

The wives probably cast doubt on the Old Testament written up to that point, saying that no one really knew what Moses wrote and if Moses really existed. They probably told Solomon they found it deeply offensive if they could not practice their faith freely, meaning that they wanted pagan temples built at taxpayer expense.

Josephus described the temple curtain before 70 AD as having astral images. This curtain probably was the replacement for the temple curtain that was ripped into two at Christ's death (Mat 27:51; Mar 15:38; Luk 23:45). When the sun stopped shining when Jesus died (Luk 23:45), the powerlessness of astrology was exposed.

The sun was blocked out on account of the Son of God. The pagan sun-god, whether *Helios* or *Apollo*, was most often the deity depicted in the hubs of zodiac wheels. Still, even after Christ's death, the priests and Jewish rulers opted for a temple curtain tainted with astrological symbolism. In contrast, Christians largely eschewed astrology and astrological symbolism.

If Act 07 was Stephen's reaction to the astrological symbols that had crept into the *Herodian* temple, imagine what Stephen's reaction to the *Makkan Kaaba* of yesteryear would have been! Even the stripped down *Islamic* version of the *Kaaba* is instantly recognizable as a former astral temple. The crescent-shaped *Hatim* Wall indicates moon worship and the Black Stone and circumambulation show planetary worship.

Someone might wonder "If Jews were syncretizing Judaism with astral religion, why did they care about the temple or Mosaic law and custom at all? (Act 06:13-14). Goodenough explains:

Cumont has shown how inscriptions indicate, even in the first century BC, the widespread conception that the soul goes to the stars at death, as the body returns to the dust. This was a popularization of the apotheosis of kings and other great ones just as the general hope of immortality seems to have developed in Egypt from a popularization of the divine nature of the king. Most men, then as always, who had such hopes of ascent as that through the stars to the pure fire or ether, or to the immaterial nature behind all matter, based their hopes largely upon the effectiveness of ritualistic ceremonies, what is generally called 'magic.'<sup>2994</sup>

The Jewish priests, like many ancients, were quite content with their ritualism, even though it had been emptied of meaning by syncretization with astral religion. Mere ritualism was satisfying because the moral standards of astral religions were quite low.

Even the ethical Greek philosophers had low moral standards. For instance, they wrote that hebephilic sex (i.e. sexual attraction of men for post pubescent boys) was superior to heterosexual sex.

In astral religions there was little angst over sin and little felt need of sacrifice for sin and atonement. That is because once the soul shed the material body in death, it was thought that it would float back to the stars. Goodenough wrote:

The astral system promised immortality, as the soul returned to its cosmic or hypercosmic origin.<sup>2995</sup>

---

<sup>2994</sup> Goodenough. *Symbols*, p. 134.

<sup>2995</sup> Goodenough. *Symbols*, p. 168.



The only impediment to apotheosis might be if the soul were waterlogged with evil deeds to the point where the evil part was heavier than the good part. The ancients thought that only career criminals need worry about this predicament.

Only a scoundrel would teach that one would be accepted into heaven as long as the scale of deeds does not balance, nor tip the wrong way. With this low standard, one need only perform one more good deed than evil deed during an entire lifetime to consider oneself moral.

Since not many people envision doing evil every other deed, *Sheol* (hell) is no longer taken seriously by the masses. Goodenough wrote that in the Ethiopic apocalyptic book of *Enoch I* “the old *Sheol* [hell] has quite disappeared.”<sup>2996</sup> Of course this is what one expects since *Enoch I* is laden with astralism.

That *Islam* has a balance scale concept of morality is not surprising since the crescent-moon has similarities to the arms of a balance scale, especially when the limbs of the moon point downward. So naturally *Allah* the moon-god assumed the role of “god of contracts,”<sup>2997</sup> just as *Allah*’s role model *Sin*, was a god of contracts.<sup>2998</sup> *Muhammad* said that the contract had to be entered into at the *Kaaba* (“the Sacred *Mosque*”), probably over the *Hatim* wall was meant (*K* 009:007).

*Muhammad* said “...the sky, He [*Allah*] raised it high and He made the balance” (*K* 055:007). Mentioning the sky and the balance together like this suggests that *Muhammad* thought of the crescent-moon as a balance.

*Muhammad* did not realize that the moon slanted because *Makka* is located at 21.45 N latitude. Due to the curvature of the earth, the horns or cusps of the crescent-moon only appear level at or near the equator.

Because the crescent-moon always appears canted to one side, *Muhammad* thought that *Allah* must secretly put his thumb on the scales (see below). *Muhammad* thought that *Allah*, to show his grace and favor, tipped the scales in favor of his moon-god followers.

*Allah*’s tipping the scales means that some *Muslims* figure they can be as evil, mean and inhumane as they want and yet they will appear righteous on the Last Day. The ethical situation in *Islam* is much worse than even that of ancient astral religions.

That *Muhammad* thought *Allah* tipped the scales in favor of *Muslims* so that *Muslims* can sin more than half the time can be ascertained from:

☉ The *Koran*, which says that as long as a *Muslim* does not commit the great sins, *Allah* will forgive the small sins (*K* 004:031).

☉ The account of the Night Journey:

...finally He [*Allah*] said: ‘O *Muhammad*, it shall be five prayers each day and night, but each prayer service I will count as ten, so that will make it fifty prayer services. The fact is that when a man intends a good deed, but does not perform it, I write it to his account as a good deed, but if he performs it, I write it as ten good deeds. Also, when a man intends an evil deed, but does not perform it, I write to his account nothing, but if he performs it, I write it as one evil deed in his account.’<sup>2999</sup>

<sup>2996</sup> Goodenough. *Symbols*, p. 157.

<sup>2997</sup> Brockelmann. *Peoples*, p. 9.

<sup>2998</sup> Combe. *Culte du Sin*, p. 61, as quoted in Green. *Moon*, p. 35.

<sup>2999</sup> *Al Baghawi. Masabih as-Suna*. Khairiyya Edition, Cairo, 1900 AD/1318 AH, vol. ii, pp. 169-172, as translated in Jeffery. *Islam*, pp. 39-40. Also, see Lings. *Sources*, p. 103.

In *Islam*, grace is connected to the crescent-moon, not only because of its association with *Allah* and the lunar religious calendar, but *Muhammad* entered heaven on the Night Journey through the gate of the moon. Moreover, tradition says that grace is connected to the circumambulation of the *Kaaba*, where a *Muslim* rounds the crescent-shaped *Hatim Wall*:

If anyone circumambulates the House seven times...ten of his evil deeds will be blotted out, ten good deeds will be recorded to his credit, and by it he will be advanced ten degrees [Jeffery: “in rank in Paradise”]...he will wade with his feet in mercy as one wades in water.<sup>3000</sup>

This helps to explain why the moon is found on top of every *Mosque*. Not only does the crescent, with its sharp, pointy shape indicate *Jihad* but a tilted crescent shows *Allah*'s grace for *Muslims*.

So for a *Muslim*, the tilted crescent is somewhat like the Christian cross when it comes to grace and forgiveness. The more the moon crescent is tipped, the more a *Muslim*'s “cup overflows” (*KJV Psa 023:05*). When the crescent is level, *Allah* is withholding favor and grace.

*Muhammad* thought the tilting of the crescent-moon showed *Allah*'s favor. So the fact that the moon crescent tilted further the more *Muhammad* traveled north from *Makka* explains why *Muhammad* thought *Allah* the moon-god wanted him to conquer the Persians and the Byzantines.

Whenever *Muhammad* returned to *Makka* or journeyed south of *Makka*, the moon became less tilted. Hence, *Muhammad* thought *Allah* favored conquering north more than to the south. Perhaps this is why, when the *Muslim* armies could easily have conquered all of Africa, they instead took on the tough targets, the empires to the north.

Of course *Muhammad* did not know that the horns (cusps) of the moon became closer to level in the south only because *Yemen* is twelve degrees latitude north of the Equator. Moreover, *Muhammad* did not realize that the moon became more slanted when he traveled north only because say, *Haran* in Turkey is thirty-six degrees north latitude. It had nothing to do with *Allah*'s favor increasing as *Muhammad* traveled north but this science was beyond the grasp of *Muhammad*.

Let us return to the discussion of the ethical balance. *Muhammad* reasoned that there are always a few “bad apples” who cannot even manage to sin less than half the time. Moreover, some *Muslims* fail to tip the scales even when *Allah* tries to tilt the ethical scales in *Muslims*' favor. So the idea of a Purgatory and a balance were introduced for these iniquitous *Muslims*.<sup>3001</sup> That way, all *Muslims* will get to heaven—eventually but some get rather tasty on the way there.

*Muhammad*'s rationale for the doctrine of Purgatory may have been that he figured that even *Allah* the moon-god spent a few days in the underworld at the end of each lunar month. Then however *Allah* resurrects himself as a crescent and ascends to the heavens. It follows that many *Muslims* would spend some time in the underworld before rising to heaven, as Robert Morey wrote:

*Muhammad* utilized the [apocryphal Jewish] *Testament of Abraham* to teach that a scale or balance will be used on the Day of Judgment to weigh good and

<sup>3000</sup> Jeffery. *Islam*, pp. 204-205.

<sup>3001</sup> See the Glossary for information on *Islam*'s version of Purgatory.

bad deeds in order to determine whether one goes to heaven or hell (*Suras* 042:017; [057:025;] 101:006-009).<sup>3002</sup>

In the following section Judaism's deeper dive into astrology during the Byzantine period will be discussed. Before proceeding however it is worth noting just how far *Islam* is removed from Biblical Trinitarianism. All that *Muhammad* accomplished was to bring astral paganism a little closer to astral Judaism and then harden *Muslims* against any further change.

Today, *Muslims* have Judeo-pagan values in contrast to Judeo-Christian values. The relative positioning of Christianity, Judaism and *Islam* on the religious spectrum is as follows:

Yahvistic Biblical Trinitarianism >> Judaic extra-Biblical unitarianism >> Judaic astral unitarianism >> *Islamic* unitarianism >> Astral polytheistic paganism

Even if *Islam* incorporated more elements of Judaism, *Islamic* unitarianism would still be a long way off from Old Testament and New Testament Trinitarianism. Moreover, the character of *Islam* would be like that of Judaism. Christianity is based on love between the Father and his children (Mat 17:25-27). *Islam* and Judaism is one of submitting and servitude.

Paul used a metaphor to say that Christians were free children of Sarah, whereas adherents to Judaism were slave children of the slave Hagar (Gal 04:22-26). Ironically, *Muslims* admit both points with pride:

- ☉ *Muslims* believe that they are spiritual, if not the blood descendants, of *Ibrahim* through the slave woman Hagar and her disinherited son Ishmael.
- ☉ *Muslims* never tire of pointing out their slave status by saying that "*Islam*" means "submission."

Moreover, *Islam*'s heaven with endless sex and other carnal pleasures sounds like a slave's or a prisoner's idea of what heaven will be like.

### Jewish Astral Art During the Byzantine Period

At first Jews used non-living, non-portraiture astral art during the first and second century AD. However, during late antiquity and the Byzantine Period, persons were represented in figural paintings and mosaics in synagogues. This fact was already noted in the above quotation of the art historian Goodenough.

Paganism was subtly synthesized with Judaism during this period. Even the *Torah Shrine* with a citrus *ethrog* hanging in the apex looks similar to a Venus altar with a lamp. *Ethrog* is the fruit eaten on *Sukkoth*, the harvest festival called the Feast of Tabernacles.

Other Jewish decorations that were affected by astral paganism include:

- ✧ Stars of David and Solomon.
- ✧ Astral-looking *Menorahs* with crescent-shaped branches and planet orb-shaped lamps.
- ✧ White ram's horn *Shofars* painted on *Torah Shrines*, some of which look like an artistic representation of a lunar crescent. In moon-god religions a ram's horn is a sign of the moon-god.
- ✧ *Ibrahim's* knife used in the scene where Isaac (not Ishmael) is nearly sacrificed sometimes crescent-shaped.

<sup>3002</sup> Morey. *Invasion*, p. 150.

Another pagan element found in Judaism was David depicted as *Orpheus*. Joseph Gutmann wrote:

Another of his [Goodenough's] identifications [at the *Dura-Europos* synagogue], that of *Orpheus* with David, has been brilliantly vindicated by the discovery of the *Gaza* synagogue mosaic pavement (dated 509 [AD]) in which a royal figure is shown surrounded by animals while playing the lyre and is described expressly as 'David.'<sup>3003</sup>

In Greek mythology *Orpheus* was a *Thracian* musician. His mother was *Calliope*, the muse of epic poetry. *Orpheus'* father was the sun-god *Apollo*. *Orpheus* married the *nymph Eurydice* whom *Orpheus* later failed to rescue from *Hades*. *Orpheus* played the lyre so beautifully that wild beasts were pacified, trees danced and rivers stood still.

Many synagogues in Arabia and in the Fertile Crescent may have had *Orpheus* paintings like the *Gaza* and *Dura-Europos* synagogues. Camel caravans wended their way through Mesopotamia where the *Dura-Europos* synagogue and caravansary are located. Also, *Gaza*, in Palestine, was a major destination for camel caravans. In *Gaza* camel drivers unloaded their goods for Mediterranean transport.

*Muhammad* probably saw the "David as *Orpheus*" paintings and mosaics since the *Koran* talks about David speaking and singing to birds (*K* 021:079; 027:016; 034:010; 038:019).

That David was pictured playing a harp for animals may in part explain why *Muhammad* thought *Allah* had turned some Jews into apes and pigs (swine) (*K* 002:065-066; 005:060; 007:166). *Muhammad* may have thought that David was playing for Jews who were morphed into animals. All this magical kind of thinking is possible when sub-literate persons try to make sense of the world, of art, of literature and the like.

David was depicted as an *Orpheus*, who was the supposed son of *Apollo* the sun-god by copulation with a muse. Perhaps *Muhammad* thought that Jews thought of David as having god-like powers. *Muhammad's* misperception that Jews had godlike superheroes would go a long way in explaining why *Muhammad* thought Jews taught that Ezra (*Uzair*) was the Son of *Allah* (*K* 002:259-260; 009:030).

Another piece of Jewish Late Antique period artwork explains more about how *Muhammad* came to think that Jews thought of Ezra as being the son of *Allah*—the synagogue zodiac circles. Lester Ness wrote:

The Jewish variety of astrology, in turn, will help explain the famous zodiac mosaics. A zodiac in the synagogue meant the same thing as it meant in a temple; it was a symbol of the Supreme Deity, Who ran the universe by the laws of astrology. It is important to emphasize this, for some major scholars of ancient synagogues deny that the ancient Jews did anything as irrational as practice astrology.<sup>3004</sup>

Though not much archaeology has been carried out in *Saudi* Arabia, Arabian Jewry was probably as astral and iconic as elsewhere in Judaism. In fact, Jews were the unchallenged masters of astrology during medieval times who taught the *Muslims* more than they needed to know about astrology, as Wedel wrote:

Astrology had been introduced into the Mohammedan world in the eighth century, at the time when *Caliph Al-Mansur*, calling to his aid the learned Jews,

<sup>3003</sup> Gutmann. *Dura-Europos*, p. 119.

<sup>3004</sup> Ness. *Mosaics*, p. 137.

Jacob *ben Tarik* [*Tarik* is Arabic for the Morning Star], founded at *Baghdad* for the mathematical sciences. It was in this school that, in the ninth century, the greatest of Arabian astrologers, *Albumazar*, received his training....Arabo-Judaeen astrology was a jumble of systems and doctrines....Greek astrology...had been contaminated with the demonology and magic of the *Talmud* and the mysticism of the Cabala. Throughout the Middle Ages, astrology constituted an integral part of the necromancy and divination of Jews and *Moors* alike—a relationship which proved embarrassing when astrology tried to win converts in Christian lands, where intercourse [trafficking] with demons was not tolerated.<sup>3005</sup>

If the idea that Jewish synagogues had zodiac circles sounds strange in a discussion of *Islam*, it is on account of the persistent myth that Judaism was aniconic, as Gordon Newby wrote:

The myth of the existence of a normative Judaism obscured the investigation of the unique character of the several Arabian Jewish communities.<sup>3006</sup>

Goodenough wrote that zodiac circles in synagogues was not a rarity:

One of the best-attested designs from Jewish religious art of the late Roman Empire and the ‘Byzantine’ centuries is the circle of the zodiac with its twelve signs, in the center of which *Helios* drives his quadriga. Jews squared this circle in the usual way of the period by putting the Season in each of the four quarters outside it.... Considering the few synagogue floors whose mosaic design is still preserved at all, the high proportion with the zodiac, *Helios* and Seasons makes it inevitable to presume that such decoration must have been very common indeed [in synagogues].<sup>3007</sup>

Goldman wrote similarly:

The frequency with which the zodiac appears in synagogue floors indicates not simply the popularity of the theme, but also its importance in Jewish metaphysics and a glance at the ceremonial art of the later European Jewry shows that all the zodiac signs were accepted and widely used as important elements in more recent Jewish iconography.<sup>3008</sup>

The Jewish zodiacs sometimes had personifications of the seasons that looked like a stylized crane with a woman’s head. These Seasons had some similarities to the well-known personification, Mother Nature.

The Seasons were thought to be quite powerful in astral religion since according to the Ethiopic apocalyptic literature, the Seasons used their power to lead the stars (*I Enoch* 82).<sup>3009</sup> Goodenough wrote:

The four seasons of the year bring about achievement by bringing all things to perfection, all sowing and planting of crops and the birth and growth of animals.<sup>3010</sup>

<sup>3005</sup> Wedel. *Attitude*, p. 51-53.

<sup>3006</sup> Newby. *Arabia*, p. 106.

<sup>3007</sup> Goodenough. *Symbols*, pp. 116-117.

<sup>3008</sup> Goldman. *Portal*, pp. 60-61.

<sup>3009</sup> “The seasons and their power to lead the stars are set forth in greater detail in chapter lxxxii” (Goodenough. *Symbols*, p. 156).

<sup>3010</sup> Goodenough. *Symbols*, p. 171.

The Seasons were subordinate of course to the *Helios* figure in the central hub of the zodiac, who...

...like a charioteer grasping the reins or a pilot the tiller, God guides all things in what direction he pleases as law and right demand.<sup>3011</sup>

The zodiac also had a personification of the sun in the middle driving four bulls pulling a two-wheeled *quadriga* chariot. The four bulls have an upturned crescent on their foreheads and a crescent-moon is seen in the background.

Lester Ness described Jewish zodiacs at *Beth Alpha* synagogue overlooking the *Jezreel* Valley:

The corners contain winged female busts [the Seasons] representing the seasons. Each is labeled with its Hebrew name, such as *Tequphat Tishri*, as well as with appropriate attributes. Spring, or *Nisan*, holds a shepherd's crook, for example, while Summer (*Tammuz*) sits among fruit and grain crops. Fall has a star overhead, as at *Naaran* [another synagogue near modern Jericho]. Winter is marked by red cheeks. The *Beth Alpha* Seasons are somewhat closer to the usual Greco-Roman iconography than *Naaran's*, although still not too close. Both seasons and signs run counterclockwise.

The space between the circles is again divided into twelve segments. The figures generally follow the usual Greek iconography but at a distance. Marianos and Hanina [mosaic artists who left their signature in the mosaics] took a traditional design and made it their own by means of style and details. The Ram is a male Middle Eastern fat-tailed sheep and the Bull is the Indian *Zebu*. *Gemini* is a pair of Siamese Twins. The Crab is a species found in the *Jezreel* Valley, *Potamion Potamios*. *Virgo* is portrayed as a queen, sitting on a throne and wearing shoes of Imperial purple. *Libra* is a man holding the scales, which is not unusual; but he has only one leg! The other is omitted because it is behind the balance. In two cases, the image is based on the Hebrew name rather than the traditional iconography. *Sagittarius* is... 'Bow' in Hebrew; at *Beth Alpha*, the bow is held by a man, rather than the usual *centaur*....

As at *Naaran*, the center circle contains *Sol Invictus* and a four-horse chariot. It is in a particularly abstract style. The head and forelegs of the horses are visible, two on either side of the chariot. *Sol* wears a crown of rays and is surrounded by the moon and stars. Only his head and neck are shown. Beneath is a square covered with curving colored stripes, perhaps representing the rainbow colors seen at dawn and dusk. The square is probably *Sol's* chariot, not his torso, since it is attached to small wheels.<sup>3012</sup>

Lester Ness noted in regard to the zodiac circle at the *Naaran* synagogue that the star associated with the personification of Fall is perhaps "*Sirius*, the Dog-star, which appears in the autumn."<sup>3013</sup> Of course *Sirius* is mentioned often in astrological literature and Mideast mythology and even once in the *Koran* (053:049). So it would seem the star associated with Fall at *Naaran* and *Beth Alpha* synagogues could be none other than *Sirius*.<sup>3014</sup>

<sup>3011</sup> Goodenough. *Symbols*, p. 169.

<sup>3012</sup> Ness. *Mosaics*, pp. 7-8.

<sup>3013</sup> Ness. *Mosaics*, p. 5.

<sup>3014</sup> Ness. *Mosaics*, pp. 5, 7.



Figure 07-03. What remains of the *Beth Alpha* synagogue mosaic zodiac panel.<sup>3015</sup>

The bird-women are called “harpies.” The Satanic Verses episode and other information show that *Muhammad* initially interpreted the Jewish zodiac circles thus:

- ☉ The crescent represented *Allah* the moon-god.
- ☉ The quadriga charioteer was Ezra, the Son of *Allah* (*K* 009:030). *Muhammad* rejected the idea that the charioteer was Jesus (*K* 005:116).
- ☉ Summer was *Allat* the sun-goddess since the sun was highest in summer.
- ☉ Fall was *Isis*, whose star *Sirius* has a helical rising in Autumn.
- ☉ Winter was the goddess *Manat*, who had no known astral affiliation.
- ☉ Spring was the fertility goddess *Uzza*, whose planet was Venus.

After the Satanic Verses episode, *Muhammad* thought the four goddesses actually were male angels and he rejected the idea that *Allah* had a Son altogether.

<sup>3015</sup> The *Beth Alpha* synagogue mosaic zodiac wheel can be seen online in full color, or see Ness. *Mosaics*, p. 237, or Goldman. *Portal*, Plate 5.

## Chapter 08: Moon-o-theistic Ten Commandments

### Introduction

The Jewish zodiac circles explain several statements in the *Koran*. In the Mideast, zodiac circles were sometimes used as calendars. In the Mideast, the start of each month was determined by the appearance of the crescent-moon, hence the Mideast largely marked time using solilunar calendars.

By contrast, the West used solar calendars. The Julian calendar, introduced by Julius Caesar in Rome in 46 BC, was a solar calendar similar to the modern Gregorian calendar. In solar calendars, the crescent-moon can appear on any date or dates in a month. The second appearance of a crescent-moon in any month is called the “Blue Moon.”

In the Mideast, it was duly noted that about each month, the sun was seen in a different constellation of the zodiac shortly after sunset. Since Mideasterners were using a solilunar calendar, the moon seemed to be in charge of the pace of the sun. Thus the moon-god was thought to be in charge of the sun and hence the calendar too. So it follows that “*Sin*, another ancient moon-god, was called ‘lord of the calendar and of wisdom.’”<sup>3016</sup>

The crescent-moon was often included in the hub of the zodiac circle offset from the center. A crescent looked over the shoulder of the sun deity who was in the very center of the zodiac. In the Mideast the sun deity generally was thought to be the son or daughter of the moon.

Though not much archaeological work has been conducted in Arabia, Nelson Glueck provides an example of a north Arabian, *Nabataean* zodiac circle. The crescent overlooks the shoulder of *Tyche*, the goddess of Fortune, who determines fortunes by the zodiac circle.<sup>3017</sup>



**Figure 08-01.** *Helios* in his quadriga with the sun and stars in the background. This is a cutout of the hub of the larger *Beth Alpha* Synagogue Mosaic Zodiac (illustrated a page back).<sup>3018</sup>

A portrait of say, *Ezra*, in a zodiac circle could easily be construed to indicate that the pictured persons were divinized through an apotheosis. Goldman wrote:

The lesser gods also are enshrined in the zodiac canopy on the cult *stelea* [stone slabs]. Semi-divine figures such as *Heracles*, and worldly princes, are represented as carried to the heavens in scenes of apotheosis by the symbolic wheel of the zodiac that frames them. Like the charioteer in the *Beth Alpha* mosaic, they are lifted in their horse-drawn vehicles. By the fourth century AD it became a common practice to indicate the celestial residence of the dead by

<sup>3016</sup> CEE, *Sin* entry.

<sup>3017</sup> Glueck. *Dolphins*, pp. 108-112, plates 46, 48.

<sup>3018</sup> The *Beth Alpha* synagogue mosaic zodiac wheel can be see online, or see Ness. *Mosaics*, p. 237, or Goldman. *Portal*, Plate 5.



placing their portraits within a wheel supported by the personified Four Seasons.<sup>3019</sup>

The sun-god often was shown driving a chariot pulled by bulls that each had a crescent on their foreheads. That the crescent-moon was freestanding and overlooked the sun-god showed the moon's superiority. By contrast, the sun-god and bulls in the hub of the zodiac were on the constellation treadmill. The crescent on the bulls' heads showed that the moon controlled and powered the movement of the zodiac constellation treadmill in the sky.

### What Convinced Muhammad That Jews Were Polytheistic

Synagogue zodiac circles seem to explain how *Muhammad* got the impression that Jews worshipped an astral triad. It is however necessary to discuss some background information first.

Some Arabian Jews called *Yahveh* "*Allah*," though they surely used many appellations for *Yahveh*. Since *Muhammad* grew up near the astral shrine at *Makka*, he assumed his *Allah* the moon-god was the Jews' *Allah* too. Of course it should be noted that *Muhammad* thought the *Sabeans*' *Ilumquh* and the *Zoroastrians*' *Ahura Mazda* were *Allah* too (*K* 002:062, 135; 005:069; 022:017).

The *Koran* implies in several places that *Muhammad* was a pupil of Jews (e.g. *K* 010:094). Since Jews had a pagan-looking zodiac and other pagan inspired artwork in their synagogues, *Muhammad* initially assumed Jews were polytheists too.

Jews probably used plurals when quoting *Allah*—plurals they had for some time understood to be majestic plurals, an extra-biblical syntax. So whenever the Arabic-speaking Jews quoted *Allah*, they had *Allah* saying "We" and "Us." *Muhammad* thought the "we" and "us" that *Allah* spoke were references to *Allah*, the Son Ezra and the Four Seasons.

*Muhammad* seems to not have ever caught on to the finer points of Judaism such as the fact that majestic plurals should be treated as singulars that indicate majesty rather than plural persons. So based in part on the Jewish "*Allah*" saying "we" and "us," *Muhammad* concluded that the Jewish god was an astral triad—*Allah* the moon-god, Ezra the sun-god, along with the Four Seasons (*Allat*, *Uzza*, *Manat* and *Sirius*).

*Muhammad* never become informed of the true persons of the Christian Trinity because his errors in these matters are all recorded in *Madinan* chapters, which were written late in his career (regarding Ezra: *K* 002:259-260; 009:030; regarding Mary: *K* 004:169; 005:077, 116).

*Muhammad* assumed that both Jews and Christians had similar astral triads. *Muhammad* thought Christians worshipped *Allah* the moon-god, Jesus the Son god and Mary the goddess of Venus. *Muhammad* figured Jews worshipped *Allah* the moon-god, Ezra the sun-god (*K* 002:259-260; 009:030) and *Allah*'s daughters, the Seasons (confer the Satanic Verses).

The reader might wonder how exactly *Muhammad* came to think Jews thought of Ezra as being the Son of God (*K* 009:030). This is especially surprising given the fact that Jews once had a law with a capital punishment clause against anyone who would dare claim to be the Son of God (Joh 19:07). Also just why did *Muhammad* conclude that the Ezra was the Jewish Son of God rather than say, Moses or David or Enoch?

<sup>3019</sup> Goldman. *Portal*, p. 61.

Gentiles generally do not consider Ezra to be as notable a Biblical figure as Moses, David, *Elijah* and many others. By contrast, the *Encyclopedia Britannica* reports that Ezra was a...

...religious leader of the Jews who returned from exile in *Babylon*, [and a] reformer who reconstituted the Jewish community on the basis of the *Torah* (law, or the regulations of the first five books of the Old Testament). His work helped make Judaism a religion in which law was central, enabling the Jews to survive as a community when they were dispersed all over the world. Since his efforts did much to give Jewish religion the form that was to characterize it for centuries after, Ezra has with some justice been called the father of Judaism; i.e. the specific form the Jewish religion took after the *Babylonian Exile*. So important was he in the eyes of his people that later tradition regarded him as no less than a second Moses.<sup>3020</sup>

The *Muslim* scholar Ameer Ali wrote:

The veneration of the Jews for Moses went so far, says Josephus, that they revered his name next to that of God; and his veneration they transferred to Ezra, the restorer of national life and law under the *Kyanian* [or *Kayanian*] dynasty.<sup>3021</sup>

The above quotes explain why *Muhammad* thought Jews called Ezra the Son of God rather than say, reverence David, Moses or Enoch with such a title. The above information does not entirely explain how *Muhammad* arrived at his misconception that Ezra was the Jewish Son of God. The answer however is to be found in synagogue artwork.

Jews borrowed the zodiac circle from pagans and then Judaized it. Lester Ness relates that a Jewish magician invoked the sun as though it were an angel named “Holy *Helios*” and *Orpiel*, meaning “Marvelous light of God.”<sup>3022</sup> Goodenough notes that some Jewish amulets called the sun by the theophoric name the “Existing One” (*ho wn*).<sup>3023</sup>

Jews may have nicknamed the zodiac *Helios* as “Ezra.” Jews who supposed the charioteer was Ezra may have taken their cue from the book of Ezra:

Ezra began his journey from *Babylon* on the first day of the first month and he arrived in Jerusalem on the first day of the fifth month, for the gracious hand of his God was on him (Ezr 07:09).

Since Jews followed a solilunar calendar, this meant that the crescent-moon was visible shortly after sunset when Ezra left *Babylon* and when Ezra arrived in Jerusalem. So Jews decided to nickname the picture of *Helios* driving his *quadriga* with the crescent over his shoulder “Ezra.”

Other traditions that may have led Jews to say that Ezra was the zodiacal charioteer include apocryphal literature, such as the story that Enoch was translated into heaven via “four creatures of the chariot” (3 Enoch 48C:01-04).

One apocryphal book states that Ezra was translated into heaven (4 *Ezra* 14:09, 50). Recall that it was *Elijah*, not Ezra, who was translated into heaven by chariots of fire (2Ki 02:11). Also, Enoch was translated into heaven by unspecified means (Gen 05:24), as Gordon Newby wrote:

<sup>3020</sup> *EB*, accessed 4 Mar 2003, Ezra entry.

<sup>3021</sup> Ali. *Spirit*, p. 140.

<sup>3022</sup> Ness. *Mosaics*, pp. 157-158.

<sup>3023</sup> Goodenough. *Symbols*, p. 120 (compare p. 238).

Enoch was of the generation of the Flood, of those who transgressed. In the popular books of Enoch, he was taken to heaven so that he would not be destroyed when God abandoned the earth and as a sign of God's mercy that one pious man would be saved. When translated into heaven, he was stripped of his humanity and transformed into the powerful angel, *Metatron*, who was taught by God all the secrets, more than any other creature, indeed, and was given guardianship over the treasures of God and became a lesser God.<sup>3024</sup>

*Muhammad* probably figured every Old Testament luminary translated into heaven went by way of quadriga chariot, and once in heaven the luminary was transformed into a god-like figure—as apocryphal literature mythologized about Enoch.

Since in Jewish literature Ezra was equal to or second only to Moses, *Muhammad* concluded that Ezra was transformed into the loftiest personage in heaven besides *Allah*. That is because Moses was not bodily translated into heaven. Both Moses and Aaron died and were buried (Deu 10:06; 34:05-06) and by all accounts, Ezra was a greater personage than Enoch.

When the pagan *Muhammad* was told the *Helios* figure was Ezra, he naturally assumed that Ezra was the Jewish sun-god. *Muhammad* figured that Jews had started worshipping a sun-god just as he thought that the people of the Queen of *Sheba* once took up the worship of the sun-goddess *Allat* in addition to *Allah* the moon-god, also known as *Illumquh* to the *Sabeans* (K 027:024).

*Muhammad* presumed the crescent in the zodiac's hub symbolized *Allah* the moon-god. *Muhammad* was steeped in astral paganism, so he was not going to make any fine distinctions or nuanced interpretations that art historians call for in interpreting Jewish zodiac. Goodenough wrote:

That *Helios* has the moon sickle beside him at *Beth Alpha* cannot be pressed as meaning more than that the moon and the stars with it show his heavenly setting.<sup>3025</sup>

The astral religionist *Muhammad* interpreted the Jewish zodiac as showing the Jewish god to be a typical astral triad—just as *Muhammad* interpreted the New Testament to mean that the Father, Mary and Jesus were a triad. Guillaume wrote:

...the term 'Mother of God' given to the Virgin Mary could mean only one thing to an Arab—the sexual trinity [triad] of the old heathen world, which was never a unity.<sup>3026</sup>

That *Muhammad* made this mistake is not far-fetched since even the art historian Goodenough thought Jews used a mosaic of *Helios* to represent *Yahveh*, as Goldman wrote:

Professor Goodenough however would see the representational aspect of heavenly signs at *Beth Alpha* carried still further. He does not hesitate to suspect that '*Helios* and the chariot symbolize the divine charioteer of Hellenized Judaism, God himself.'<sup>3027</sup>

Goodenough of course had a Western perspective where the sun was the male high god and the moon was the sun's consort. This is the reverse of the Mideast view. *Muhammad* had a Mideast perspective where the crescent always represented

<sup>3024</sup> Newby. *Arabia*, p. 60.

<sup>3025</sup> Goodenough. *Symbols*, p. 120.

<sup>3026</sup> Guillaume. *Islam*, pp. 52-53.

<sup>3027</sup> Goldman. *Portal*, p. 64.

the male high god. Only after *Muhammad* became a *Muslim* did he believe that the sun was a male angel.

Since Ezra was so important to Jews, Jews probably told *Muhammad* more about Ezra than any other Biblical figure save Moses. *Muhammad* probably would have heard that Ezra's Persian-given title was the "scribe of the law of the God of Heaven" (Ezr 07:12, 21). *Muhammad* may have assumed that Ezra had become both a scribal god and a sun-god just as the apocalyptic literature said that Enoch had become the angel *Metatron*.

Every pantheon had to have its scribal god. In *Muhammad's* mind Ezra would have been like:

- ☉ *Hermes-Mercury*.
- ☉ The Egyptian scribal god *Thoth*, who himself was an early moon-god, but in later myth gambled for the intercalary days with the moon-god *Osiris*.
- ☉ The *Babylonian* scribal god *Nabu*, who worked closely with the moon-god *Sin*.

*Muhammad* perhaps felt confirmed in his interpretation that Ezra had worshipped *Allah* the moon-god when he heard the Bible say that Ezra sacrificed on the first day of the month (Ezr 03:06). Also, *Muhammad* noted that Ezra began an investigation on the first day of a month and ended it on the first day of a month (Ezr 10:16-17). The first day of the month was always a big day in moon-god religions.

*Muhammad's* interpretation of the Jewish zodiac is apparent in the Satanic Verses account. The account tells how *Muhammad* tried to convince the *Makkans* that his newly synthesized religion was plausible and viable.

By referring to the Jewish zodiacs, *Muhammad* tried to convince the *Makkans* that their four main pagan goddesses were just the zodiacal Seasons ("the Cranes") found at the four corners of Jewish zodiacs. (Such a zodiac is illustrated earlier in this chapter). *Muhammad* asked the *Makkans* in verse:

Have you thought upon *Allat* and *Uzza* and *Manat*, the third, the other? (*K* 053:019-020). These are the exalted Cranes [the Seasons], whose intercession is to be hoped for [the abrogated Satanic Verses]....He [*Allah*] is the Lord of the *Sirius* (*K* 053:049).

The reason why *Muhammad* mentioned the three goddesses together is that the ancient moon-god *Sin* was sometimes depicted with three Muses. Theodoret says that *Manat* was the muse Fate and *Uzza* was Venus.<sup>3028</sup> The goddess *Allat* was the sun-goddess and *Allah* was the moon-god.



**Figure 08-02.** *Sin* and Three Muses. Assyrian cylinder showing *Sin* the moon-god with three female muses and the "Eternally Fruiting Orb," which refers to the recurrent cycle of moon phases.<sup>3029</sup> Another artist's conception of *Sin* and three muses is on the back cover of this book.

The reason *Manat* is called "the third, the other" is *Manat* (Fate) had no known astral affiliation—stress on "known."<sup>3030</sup> *Yusuf Ali* wrote:

<sup>3028</sup> Theodoret, *Ecclesiastical History*, III:21, as quoted in Green. *Moon*, pp. 59-62.

<sup>3029</sup> "*Sin* (*Nannar*) with the three muses and the 'Eternally Fruiting Orb,' *Ur-Nammu*" (Maspero. *Dawn*, p. 655). Also, the stele has been described as "*Ur-Nammu*, king of *Ur*, deified as the god *Sin*. Cylinder in the British Museum" (*Larousse*, p. 55, picture).

<sup>3030</sup> Guillaume. *Islam*, p. 8.

The origin of Manât is not quite clear but it would not be surprising if it also turned out to be astral.<sup>3031</sup>

*Muhammad* mentioned *Manat* together with the astral goddess *Allat* and *Uzza* because all three had their betyls emplaced in the walls of the *Kaaba*, and *Muhammad* considered each goddess to be one of the Four Seasons in the Jewish zodiac. The Seasons were as follows

- ☉ Summer was *Allat* the sun-goddess since the sun was highest in summer.
- ☉ Fall was *Isis*, whose star *Sirius* has a helical rising in Autumn.
- ☉ Winter was *Manat*, who had no known astral affiliation.
- ☉ Spring was the fertility goddess *Uzza*, whose planet was Venus.

*Sirius* is mentioned later in *Koran* 053 for the same reasons *Manat* was mentioned, as was just discussed. *Sirius* is probably the *Koran*'s name for *Isis* since *Isis*' star is *Sirius*, otherwise called the "Dog Star" and "*Sothis*." During ancient times when *Sirius* rose with the sun (helical rising), it presaged the annual Nile floods.

Due to the precession of the earth, *Sirius*' helical rising no longer presages the seasonal Nile floods which incidentally do not occur any longer due to the installation of dams. Michelin Pausanias reported in the 160's AD:

The Egyptians celebrated a festival for *Isis* when they say she grieves for *Osiris*; at that time the Nile begins to rise and many people say that it is the tears of *Isis* that swell the river and water the ploughed land.<sup>3032</sup>

The heavy summer rains in Ethiopia were the source of the floodwaters that once deposited rich alluvial soil in Lower Egypt in autumn. In Egypt and in the Mideast, *Isis*, the wife of the *Osiris*, was equated both with fertility and with *Demeter*, the Greek goddess of the autumn harvest. *Isis* was also thought to prevail over life and death.<sup>3033</sup>

It is not surprising that *Muhammad* considered one of the Four Seasons of the Zodiac circle to be *Manat*. In northern Arabia, the *Nabataeans* displayed *Tyche*, the Greek goddess of Fortune, in the hub of a zodiac circle.<sup>3034</sup> *Tyche* and *Nemesis* were the Greek equivalents of the Arabs' *Manat*, Goddess of Fortune or Fate.<sup>3035 3036</sup>

In one *Nabatean* zodiac wheel, behind one of *Tyche*'s shoulders is a crescent mounted on a wand, and behind the other shoulder is another mounted crescent. This suggests that the *Nabataeans* considered *Tyche* (or the Arabian equivalent, *Manat*) to be a daughter of *Allah* the moon-god. Goldman wrote:

It is appropriate that she [*Tyche*] reigns in this celestial [zodiac] circle, for the fortunes of a man are determined by zodiac signs dominant at the critical moments in his life.<sup>3037</sup>

So in *Nabatean* mythology, *Tyche* controlled the zodiac circle and used it to determine an individuals' gain or loss. The zodiac circle was the Mideast's version of the Fates spinning their threads of destiny.

*Ibn Ishaq* relates that *Muhammad* said "...these are the exalted *Gharaniq* whose intercession is approved." Alfred Guillaume noted: "The word [*Gharaniq*] is said to

<sup>3031</sup> *Yusuf Ali. Holy*, p. 1621, App. XIII.

<sup>3032</sup> MacMullen & Lane. *Sourcebook*, pp. 45-46.

<sup>3033</sup> Lindner. *Petra*, p. 122.

<sup>3034</sup> Glueck. *Dolphins*, pp. 108-112, plate 48.

<sup>3035</sup> Lindner. *Petra*, p. 121.

<sup>3036</sup> Levy. *Lost*, p. 77.

<sup>3037</sup> Goldman. *Portal*, pp. 62-63 and Photo 22a.

mean ‘Numidian [northwest African] cranes’ which fly at a great height.”<sup>3038</sup> So in poetic terms, *Muhammad* thought of the divine zodiacal Seasons as being like migratory birds.

To refer to the Seasons as Cranes is quite appropriate since migratory birds presage certain seasons. In fact, *Muhammad* and the artists who fashioned the bird-women (harpies) may have had the same idea in mind. Ilse Lichtenstadter thought along similar lines and theorized that the *gharaniq* were water *nymphs* who were equated with the goddesses of fertility.<sup>3039</sup>

Even though *Manat* has no known astral affiliation, her divine powers did make it into *Islamic* theology along with the powers of the other Daughters of *Allah*:

- ☉ The Sun (*Allat*) and the Moon (*Allah*) retained their divine glory. According to the historian Tabari (839–923 AD), the Sun and Moon shine because Gabriel daily brings a shining garment from *Allah*’s throne.<sup>3040</sup>
- ☉ Venus’ altar is still worshipped at the *Kaaba* (the Black Stone with vulva casing) and in every *Mosque* (the *Mihrab*).
- ☉ Sirius is one of the male angels—the stars guarding heaven (*K* 053:023, 027).
- ☉ *Manat*’s power of deciding Fate was transformed into the *Islamic* doctrine of double predestination. *Muhammad* said “We have fastened on every man his augury [literally “bird of omen” (Arberry translation)]. On the Day of Resurrection we will hand him his record (*K* 017:013). Just as *Manat*, Fate, was considered a bird, so double predestination is considered a “bird of omen.”

*Muhammad* later revised the Satanic Verses, but there is no doubt *Muhammad* spoke the verses that historians record.<sup>3041</sup> *Ibn Warraq* wrote:

[S]ince the story comes from impeccable *Muslim* sources (*Al Tabari*, *Ibn Sa’d*, *Waqidi*], *Muslims* are not justified in blaming infidels for its fabrication.<sup>3042</sup>

*Muhammad* revised the Satanic Verses with verses explaining that the Seasons were not female deities but were in fact male angels. *Muhammad* said that the *Makkan* forefathers had given female names to male angels (*K* 053:023, 027).

Unlike *Allah*’s daughters, these male angels were not privileged as though they were *Allah*’s offspring but only had intercessory powers as *Allah* willed (*K* 007:191-194; 053:021-027).

The *Makkans* seem to have once equated the zodiacal Seasons with goddesses—almost like Mother Nature. This is suggested by the fact that *Muhammad* felt impelled to mention the obvious more than once—that birds are mere creatures (*K* 002:260; 003:049; 005:110; 016:079).

It is telling that *Muhammad* also used birds to say that anyone who added partners to *Allah* was like someone who fell from heaven and was swooped upon and snatched up by birds (*K* 022:031). Interestingly, in *K* 105, *Muhammad* said that birds dropped stones on an army of Christians coming from *Yemen* toward *Makka*. *Muhammad* of course considered Christians to be polytheistic.

<sup>3038</sup> Ishaq. *Sirat*, p. 166, fn. 1.

<sup>3039</sup> Lichtenstadter, Ilse. “A Note on the *Gharaniq* and Related *Quranic* Problems,” *Israel Oriental Studies*, 5, 1975, p. 60, as quoted in Stortroen. *Makka*, p. 55 & fn. 26.

<sup>3040</sup> *Al Tabari. History*, p. 232.

<sup>3041</sup> Guillaume. *Islam*, pp. 189-190.

<sup>3042</sup> Warraq. *Why*, pp. 77, 101.

The assumption that the “exulted cranes” *Muhammad* spoke of were the bird-women of the Jewish zodiac circle is supported by similar traditions. The prophet Zechariah had a vision of two women with stork wings carrying a basket (Zec 05:09). During *Muhammad*’s famous Night Journey, his highflying Pegasus-like winged steed *Buraq*, had the face of a woman. Also, there is this curious tradition:

According to a tradition of *Muhammad*, God created, in the time of Moses, a female bird, called *Enka*, having wings on each side and the face of a man. God gave it a portion of everything and then created a male of the same species. They propagated after the death of Moses, feeding on ferocious beasts and carrying away children, until the intervening time between Jesus and *Muhammad*, when, at the prayer of Khaled, this race was extinguished. Proverbially, the *Enka* is mentioned as a thing of which everybody speaks without having ever seen it.<sup>3043</sup>

Hawting provides some background information that is helpful for understanding where *Muhammad* got his source material for the Satanic Verses:

Although the exact significance of the phrase must remain uncertain, *Al Ula*, often understood as ‘high-flying,’ could also punningly reflect designations of the angels as the ‘exalted ones’ or ‘high beings.’ In *Koran* 037:008 and 038:069 there is a reference to the ‘high assembly’ (*Al Mala’ Al a-’la*), referring to the heavenly court of God and the angels. The former verse is part of a passage in which it is said that the stars are set in the lower heaven (*Al Sama’ Al Dunya*) so that the rebellious satans may not overhear what passes in the high assembly.

Although *gharaniq* is understood in a variety of ways in the *Muslim* lexicographical tradition, the most obvious sense is that of ‘cranes’ or some other kind of a long-necked waterfowl such as storks, herons or even swans. There is a possible conceptual link with angels: apart from traditional angelic imagery, such birds may have a role in popular belief as messengers of God or the gods just as an angel is a messenger of God. In European folklore the stork is the deliverer of new babies. Some association of the ideas of angel and stork is perhaps shown in the [Biblical] *Book of the Prophet Zechariah* 05:09, where the angel shows him a vision of two women with wings ‘like those of a stork’ (*Kekanke Ha-hasidah*) who carry away the barrel of wickedness to the land of *Shinar*.<sup>3044</sup>

*Muhammad* seems to have had Ezra and the Seasons in mind in *K* 002:259-260. Ishaq *Ibn* Bishr reported, on the authority of *Ibn* Abbas and others, that *K* 002:259 concerns Ezra (*Uzair*). The *Shakir* translation even mentions Ezra by name.

*Muhammad* said that Ezra was traveling with his donkey. This allusion to Ezra is meant to denigrate Ezra in the minds of *Muhammad*’s listeners. *Muhammad*’s listeners thought the Jewish zodiac circle depicted Ezra with sunrays in a quadriga driven by four bulls or horses.

*Muhammad* said that *Allah* had to teach Ezra a lesson about *Allah*’s power to resurrect life, so *Allah* killed Ezra and then after a hundred years brought him back to life. *Muhammad* told this story, which is an obvious parallel to Jesus’ death and resurrection, because he thought that Jews believed Ezra to be the Son of *Allah* (*K* 002:259-260; 009:030).

Ezra is disparaged thus because *Muhammad* felt inferior to the Biblical prophets and to Jesus, no doubt because *Muhammad* really **was** inferior to the Biblical

<sup>3043</sup> Fani. *Sufis*, p. 47.

<sup>3044</sup> Hawting. *Idolatry*, pp. 147-148.

prophets. So *Muhammad* made up stories to belittle the prophets and to make himself feel better, for instance:

- ☉ *Muhammad* has *Allah* asking the *Muslim* Jesus whether he taught people to worship Mary (K 005:116).
- ☉ *Muhammad* said the *Muslim* Jesus said “Go in peace,” to pigs.<sup>3045</sup>
- ☉ *Muhammad* said that the prophets always included a portion that came from Satan (K 022:052).
- ☉ *Muhammad* said that a worm finally toppled mighty *Muslim* King Solomon! *Muhammad* said Solomon died while leaning on his staff but did not fall over until a worm gnawed the staff away (K 034:014).

*Muhammad* also felt inferior when he compared his fledgling flock to sprawling community of Christians and Jews, who before the advent of *Islam* were still quite numerous. To belittle Jews especially, *Muhammad* taught tall tales about how Moses was an apprentice to another prophet named Khidr (K 018:060-082).<sup>3046</sup> *Muhammad* also taught that Jews speculated about Moses’ health and said that a mischievous stone stole Moses’ clothing while he was naked bathing:

The Prophet said ‘The *Bani* (people of) *Israel* used to take baths naked (all together) looking at each other. The Prophet Moses used to take a bath alone. They said ‘By *Allah*! Nothing prevents Moses from taking a bath with us except that he has a scrotal hernia’ [where the intestines drop into the scrotum]. So once Moses went out to take a bath and put his clothes over a stone and then that stone ran away with his clothes. Moses followed that stone saying ‘My clothes, O stone! My clothes, O stone! Till the people of *Bani Israel* saw him and said ‘By *Allah*, Moses has got no defect in his body. Moses took his clothes and began to beat the stone.’ *Abu* Huraira added, ‘By *Allah*! There are still six or seven marks present on the stone from that excessive beating.’<sup>3047</sup>

To belittle Jews and Christians, he taught that all their prophets and notables, and in the case of Christians, Jesus, were all having a great time in *Islam*’s debauched and lecherous heaven, as Robert Spencer wrote:

Fallaci [wrote]: ‘Our Jesus of Nazareth...they put him in their *Danna* [*Janna*] where he eats like Trimalchio [gaudy, fat man in a Roman satire (~66 AD) by Nero’s novelist, Gaius Petronius], drinks like a drunkard, screws like a sexual maniac.’ ‘*Danna*,’ or *Janna*, is *Islamic* Paradise, where the food, drink and women are indeed plentiful (confer *Koran* 013:035, 044:054, 047:015, etc.). As Jesus is considered a prophet of *Islam*, he would indeed be considered to be in Paradise. Fallaci’s description of that Paradise is pejorative but undeniably accurate.<sup>3048</sup>

So one can see that *Muhammad* smeared Jesus in the same way that the Jewish rulers did during his earthly ministry. They made him out to be “a glutton and a drunkard, a friend of tax collectors and ‘sinners’ (Mat 11:19; Luk 07:34). The “sinners” no doubt alluded to prostitutes.

*Muhammad* has Jesus being a glutton and drunkard and a friend of *Houris* (whores) in *Muslim* heaven. *Muhammad* also has Jesus being a friend of tax

<sup>3045</sup> *Malik’s Muwatta*, no. 56.1.4.

<sup>3046</sup> Arlandson, James. “*Muhammad* and the Jews,” *americanthinker.com*, 30 Jun 2005.

<sup>3047</sup> *Sahih Bukhari*, vol. 1, bk. 5, no. 277; vol. 4, bk. 55, no. 616, and *Sahih Muslim*, bk. 030, nos. 5849 & 5850.

<sup>3048</sup> Spencer, Robert. “*Muslim Target*,” *FPM*, 14 Jun 2005, *JW*.



collectors, in other words, the very *Muslims* who impose the *Jizya* poll tax on non-*Muslims* in accordance with the *Koran* (K 009:029).

Another way *Muhammad* tried to belittle Christians is his eschatology has Jesus coming back to destroy all the churches and synagogues. Jesus will then put all Christians to the sword who do not acknowledge *Muhammad* as the greatest prophet.

Notably, *Muhammad* denied that Jesus was crucified, but *Muslims* do say that Jesus will die in the End Times after fighting the one-eyed Antichrist [*Dajjal*] and *Gog* and *Magog*. In fact, Zwemer describes the coffin that *Muslims* have prepared for Christ, and it sits next to *Muhammad*.<sup>3049</sup>

To denigrate the Four Seasons whom *Muhammad* once called the “exalted cranes,” birds were used to teach *Ibrahim* about *Allah*’s power to resurrect life. The *Koran* says that *Ibrahim* trained four birds to follow him. Then God told *Ibrahim* to...

...cut their bodies to pieces. Scatter them over the mountaintops, [and] then call them back. They will come swiftly to you (*Yusuf Ali K 002:260*).

Note that in Gen 15:10, it specifically says that Abraham did not cut up the birds during the oath ceremony and Abraham kept the scavenging birds away. So it seems that K 002:260 is a clear allusion to “the exulted cranes” that were thought to be goddesses.

*Muhammad* humiliated these birds in a story where *Ibrahim* killed them and then *Allah* raised them from the dead. Thus the birds that were thought to be goddesses were humiliated just as *Muhammad* humiliated Ezra and Jesus. Ezra was humiliated because *Muhammad* thought Jews called him the Son of God, and Jesus was humiliated, *Muhammad* thought, because Christians believed he was the Son of God.

### Summary of the What the Satanic Verses Were All About

The *Makkans* were delighted that *Muhammad* equated the Daughters of *Allah* with the Four Seasons, but once *Muhammad* determined that the *Koranic* words about the “exulted cranes” were from Satan, he figured that *Allah* would replace those words with something better (K 022:052).

*Muhammad* deleted the mention of highflying cranes. He also added some corrective material that disparages the Jewish zodiac: The corrective stories include:

- ⊙ One where *Ibrahim* chopped-up four birds (K 002:259-260). The four chopped-up birds suggested that the depiction of the Four Seasons were mere creatures and not even angels, much less goddesses. *Muhammad* said that at the prayer of a *Muslim* named Khaled (mentioned above), the race of birds with human faces became extinct.
- ⊙ Another that denigrated Ezra because *Muhammad* mistakenly taught that Jews believed Ezra was a Son of God (K 009:030), and *Muhammad* thought the Apollo in the zodiac circles was actually Ezra. *Muhammad* said *Allah* killed Ezra and resurrected him after a hundred years just to prove to his listeners that Ezra was a mere man and not a god (K 002:259-260).

### The Consequences of *Muhammad*’s Re-sexing the Heavens

Ideas always have consequences. When a prophet in an astral-religion society re-sexes the heavens, as *Muhammad* did, there are bound to be society-wide consequences.

<sup>3049</sup> Zwemer. *Christ*, pp. 107-109, as noted in Geisler & Saleeb. *Answering*, p. 114.

Because many *Muslims* are consummate traditionalists, the influence of the stars extends into modern times. This is the case even though the belief in astrology has subsided in the face of modern science.

Tabari (839–923 AD) says that *Muhammad* said:

These five stars [the visible planets] rise and run like the sun and the moon and race with them together. All the other stars are suspended from heaven as lamps are from *Mosques*, and [they] circulate together with heaven praising and sanctifying God with prayer...their circulation today is what you see, and that is their prayer.<sup>3050</sup>

Believing that male angelic hosts exclusively staffed the astral bodies led *Muslims* to believe that *Allah* was not very interested in women worshipping *Allah*. In fact, *Muhammad* said that a woman, Jew, Magian, dog, donkey or a pig passing in front a praying *Muslim* closer than a stone's throw away annuls the *Muslim's* prayer.<sup>3051</sup> Therefore, it is not surprising that many, if not most, *Mosques* are men-only affairs.

Usually women stay home for Friday prayer, but if women are allowed in *Mosques* at all, they pray in separate halls or behind the men. Usually, women cannot enter the *Mosque* through the front entrance. In oil-rich, Western-influenced *Muslim* countries, sometime women have their own separate *Mosques*. Serge Trifkovic noted that women are excluded “from many [*Muslim*] religious rituals and ceremonies...”<sup>3052</sup>

Venus (*Uzza*) was considered female in pre-*Islamic* times. That a female deity led women gave the pagan women enough self-confidence to chant at the Battle of *Uhud*:

We are daughters of the Star of the Morn (*Tarik*); we tread softly on silken cushions (*Namarik*); face the enemy boldly and we will press you in our arms; fly and we shall shun you with disgust.<sup>3053</sup>

After the leader of women, Venus, was deemed to be a male angel (*K* 053:023, 027), women were put entirely at the disposal of men. Not only was the male *Muslim* Venus biased towards men, but also *Allah* was deemed to be a male ruler of the typical Mideast despot variety (*Est* 01:10-19).

In an astral-religion society, if the men are associated with a male moon and women are associated with Venus, this diminishes women's importance. If Venus suddenly switches from a goddess to a male angel who is the leader of women, women's importance is especially diminished.

The reason is that the moon is so much larger and brighter than any other objects in the nighttime sky. Also, the moon occults the planets and Venus, and never is the situation reversed. A sun or moon comparison exaggerates men's importance and value if women are at the same time compared to tiny Venus—as viewed with the naked eye.

A more equitable astral-oriented comparison would be to say that women are from Venus and men are from Mars. The most equitable comparison is found in the

<sup>3050</sup> *Al Tabari. History*, vol. i, pp. 235-236.

<sup>3051</sup> Women passing by annuls prayer: *Sahih Bukhari*, v. 1, bk. 9, nos. 490, 493; *Sahih Muslim*, bk. 4, nos. 1032, 1034, 1038; and *Sunan Abu-Dawud*, bk. 2, nos. 703-704.

<sup>3052</sup> Trifkovic. *Sword*, p. 158.

<sup>3053</sup> Quoted from *Ibn ul-Athir*, vol. ii, p. 118, in Ali. *Spirit*, p. 69, fn. 1.

Bible however where the man and woman are both made in the image of God (Gen 01:26-27; 09:06).

In pre-*Islamic* times in the Mideast, the sun and Venus most often were thought to be female and the moon male. In the Greek and Roman Empires, the moon was thought to be female and the sun male. Perhaps this bit of mythology made for some equality between the genders in these astral-oriented societies. In the myths at least, the goddesses have quite a bit of power, especially over humans.

When *Muhammad* populated the skies with male angels and *Allah*, a god who seems to act and think as a male, this changed the equation. Not only did women find themselves sex objects in a “man’s world,” but also in a fertility religion with a “man’s cosmos.”

While moderns see stars circling the sky at night, *Muhammad* believed that the whole sky was populated with male angels marching around in lockstep night after night. *Allah* the moon-god ruled the whole sky along with his minions, the planets.

Not surprisingly in this celestial setup, the Mideast war-and-moon-god *Allah* was a despot, as Herbert Muller wrote:

*Allah* was an Oriental despot, inscrutable, in some moods implacable, before whom men had no rights; they could be saved only by his grace....He seemed inscrutable chiefly because he was arbitrary and gave no reason for willing that some men go straight, more go astray. He was comprehensible enough to men familiar with Oriental gods and despots. They were grateful that he could be Compassionate and Merciful—to whomever he willed his favors. So they prostrated themselves in prayer, as they had long been wont [i.e. accustomed] to do in the royal presence. They were proud to be his slaves, the more so because he was so lavish in his rewards. They were not too unhappy about his scheme of predestination. In bad times they could fall back on their long tradition of fatalistic resignation. In good times, especially when *Islam* was on the rise, his scheme was a form of assurance.<sup>3054</sup>

So to make a long story short, that is how the *Islam*, which now threatens and dragoons the world, came into existence. *Islam* and the despot *Allah* are the “the heaviest chains that ever shackled humanity,” as Ernest Renan put it.<sup>3055</sup>

There was the lingering pagan belief about the moon that *Encyclopedia Britannica* notes:

...the moon is frequently regarded as male and, particularly in regard to women, is understood as a preeminently evil or dangerous figure...<sup>3056</sup>

Since *Allah* was a dangerous moon-god, it is not surprising then that *Islam* has endangered all of humanity these last fourteen centuries. Non-*Muslims* and women in general ought to be especially concerned.

Since *Allah* the moon-god was especially dangerous to women, it is not surprising that the *Koran* states:

Women shall with justice have rights similar to those exercised against them, although men have a status above women (*K* 002:228).

Men have authority over women because *Allah* has made the one superior to the other (*K* 004:034).

<sup>3054</sup> Muller. *Loom*, pp. 21, 271-272.

<sup>3055</sup> Spencer. *Disturbing*, p. xi.

<sup>3056</sup> *EB*, accessed 29 Mar 2003, “Moon Worship” entry.

The *Koran* also has forty-six insults to women.<sup>3057</sup> Early *Islamic* tradition even records *Muhammad* as saying:

- ☛ A man will not be asked as to why he beat his wife” (*Sunan Abu Dawud*, bk. 11, no. 2142).
- ☛ Look after women kindly! They are prisoners, not having control of themselves at all.<sup>3058</sup>
- ☛ Stay in your homes and do not display your finery as women used to do in the days of ignorance (*K* 033:033).
- ☛ If I were to command anyone to make prostration before another I would command women to prostrate themselves before their husbands.<sup>3059</sup>

Men have a direct relationship and bond with *Allah* but a women’s relationship is second-rate, as *Muhammad* said:

I have not seen anyone more deficient in intelligence and religion than you...Is not the evidence of two women equal to the witness of one man? [that is, according to the *Koran*]...This is a deficiency of your intelligence...Is it not true that a woman can neither pray nor fast during her menstrual period? This is the deficiency in your religion.<sup>3060</sup>

Since *Allah* the moon-god was dangerous to women, *Muhammad* taught that women must not even pray during their monthly period, much less attend *Mosque*.<sup>3061</sup> *Muhammad* also said:

O women! Give alms, as I have seen that the majority of the dwellers of hellfire were you (women).<sup>3062</sup>

With a male angel leading women in matters of sex, under *Islam* law, adult *Muslims* men are allowed to:

- ☛ Beat their wives (*K* 004:034).
- ☛ Practice limited polygyny and unlimited concubinage.
- ☛ Have sex with slaves and captives of war, whether they consent or not (*K* 004:023-024; 023:005; 033:050; 070:030).
- ☛ Marry preteen girls (*K* 004:003).

Polyandry by contrast was not practiced at all. Moreover, men were allowed to prostitute their slaves unless they objected, but even if owners forced slaves into prostitution, *Muhammad* assured the sex-slave pimps of *Allah*’s forgiveness (*K* 024:033).

Daniel Pipes wrote about *Islam*’s treatment of women...

...no commentator is so impolite as to note that however admirable this was in the seventh century, *Muslim* women today suffer widely from genital mutilation, forced marriages, *Purdah* [seclusion and veil], illiteracy, sexual [gender] apartheid, polygyny and honor-killings.<sup>3063</sup>

<sup>3057</sup> *The Skeptic’s Annotated Quran*, skepticsannotatedbible.com/quran/index.html, “Ibn Warraq on How to Debate a *Muslim*, Part III” plus comment, *DW*, 11 Dec 2004, updated 28 Nov 2005.

<sup>3058</sup> Dashti. *Career*, p. 113, and Ishaq. *Sirat*, p. 651.

<sup>3059</sup> *Sunaan Abu Dawud* bk.11, no. 2135; also see *Mishkat* I, p. 210, as quoted in Trifkovic. *Sword*, p. 160.

<sup>3060</sup> *Sahih Al Bukhari*, vol. i, *Hadith* no. 301; vol. iii, no. 826, as quoted in Trifkovic. *Sword*, p. 159.

<sup>3061</sup> *Sunan Abu-Dawud*, bk 1, nos. 0284, 0286 & 0287.

<sup>3062</sup> *Sahih Al Bukhari*, vol. i, *Hadith* no. 301; vol. iii, no. 826, as quoted in Trifkovic. *Sword*, p. 159.

<sup>3063</sup> Pipes, Daniel. “PBS: Missionary for *Islam*?” Nypost.com, 17 Dec 2002.

Daniel Pipes also notes that in thirty-eight percent of forced marriages, it is the boy or man who is forced.<sup>3064</sup>

Arab women cannot defend themselves since they are mostly unschooled. MEMRI reports that over fifty percent of Arabs are illiterate and ten percent of Arabs have never attended school.<sup>3065</sup> The vast majority of the 50 percent of illiterate *Muslims* are women.

Even whether women felt much pleasure at all during sex was entirely up to the discretion of men. Lawrence Kelemen wrote how *Muhammad* approved of FGM and how this affects *Islam* into modern times, as Lawrence Kelemen wrote:

In one of the six undisputed *Hadith* collections (*Sunan of Abu Dawud*, ch. 1888 [bk. 41, no. 5251]), *Muhammad* states, ‘If you cut, do not overdo it, because it brings more radiance to the face and it is more pleasant to the husband,’ and ‘Cut slightly without exaggeration, because it is more pleasant for your husbands.’

A report in *Pediatrics* (102:1 July 1998, pp. 153-156) explains that *Muslim* parents ‘feel obligated to request the procedure because they believe their religion requires female genital alteration.’

Although *Muslim* authorities often deny the existence of this custom when speaking with Westerners, Amnesty International recently discovered that in Egypt...97 percent of little girls have their genitals mutilated.

Alvin Schmidt wrote about FGM:

Although clitoridectomy is not mentioned in the *Koran*, it is referred to in the *Shariah* as being ‘obligatory’ (*Reliance of the Traveler*, e4.3).

In 1996 the Egyptian minister of health banned FGM, but in 1997 that ruling was challenged by *Sheikh* Youssef Badri. The Egyptian courts then overturned the ban and permitted FGM once more. *The Jerusalem Post* reported:

*Sheikh* Badri commented, ‘Female circumcision is *Islamic*; the court has said that the ban violated religious law. There’s nothing which says circumcision is a crime.’ He later told Germany’s *Der Spiegel*, ‘Many *Muslim* women are pleased with this victory of *Islam* over its enemies.’<sup>3066</sup>

*Muhammad*’s biography, *Ibn Ishaq*, mentions that a mother of one of *Muhammad*’s followers was a “son of a female circumciser” at *Makka*.<sup>3067</sup> One can tell that it was the opinion of *Muslims* from the very beginning that women ought to be circumcised based on *Muhammad*’s command, for John of Damascus wrote in 743 AD in *The Heresy of the Ishmaelites*:

He [*Muhammad*] made a law that they [*Muslim* men] and the women be circumcised, and he commanded (them) neither to observe the *Sabbath*, nor to be baptized and, on the one hand, to eat what is forbidden in the [Old Testament] law and, on the other, to abstain from the other ones (which the law permits); he also forbade drinking of wine altogether.<sup>3068</sup>

B. Chernitsky wrote:

According to demographic surveys conducted in Egypt in 1995 and 2001, 97 percent of married women of childbearing age had been circumcised. 100-130

<sup>3064</sup> Pipes, Daniel. “Weblog: Grooms Who Marry in Fear,” *DP*, 21 Mar 2005.

<sup>3065</sup> “MEMRI News Ticker Highlights: Nov 2003—Jan 2004,” *MEMRI*, 14 Jan 2004.

<sup>3066</sup> Kelemen, Lawrence. “Learning from sadism,” *Jpost.com*, 20 Nov 2002.

<sup>3067</sup> Ishaq. *Sirat*, p. 375.

<sup>3068</sup> Sahas. *Heresy*, p. 141, App. I, M.P.G., XCIV:773.

million girls have been circumcised in Africa—a figure that grows by another million each year worldwide.<sup>3069</sup>

Dr. Kamel *Al-Najjar* wrote:

In 28 countries in Africa, the Middle East and Asia, 138 million women and girls undergo this procedure every year, and according to Amnesty International, Egypt heads the list.<sup>3070</sup>

Robert Spencer wrote that FGM is practiced...

...among *Muslims* in Egypt, Ethiopia and the rest of East Africa, and elsewhere, and is justified in religious terms.<sup>3071</sup>

FGM is practiced among US and European *Muslims*, with an estimated eight thousand cases in Austria alone.<sup>3072</sup>

Circumcision, castration, FGM and the cutting off of body parts as punishment for crime are all to be expected when one's god is depicted everywhere by a knife-like crescent. The *Koran* even mentions the amputation of hands (*K* 005:038; 012:031, 050) and the amputation of a hand and foot on opposite sides (*K* 005:033, 038; 007:124; 020:071; 026:049).

That a moon-god religion would be especially severe toward criminals is not surprising since the moon-god *Sin* was known for being the enemy of criminals:

Because he [the moon-god] illuminated the night *Sin* was an enemy of evildoers whose criminal enterprises were favored by darkness.<sup>3073</sup>

With *Allah* depicted everywhere as a knife-like crescent, it is not surprising that *Halal* (*Kosher*) ritual processing of meat and sacrifice involves a “large, curved skinning knife.”<sup>3074</sup>

Also, traditionally circumcision is done with a curved scalpel. This may be in keeping with the *Hadith* that *Ibrahim* used an adze, an ax-like tool with a curved blade, to circumcise the males of his family.<sup>3075</sup> The *Hadith* of course reflected moon-god religion sensibilities.

A later chapter will discuss how *Allah*, the crescent-moon, scimitars and curved knives used in various *Muslim* ceremonies are all related. One key piece of evidence establishing the connection is metathesis, a topic to be discussed in a later chapter.

The Mesopotamian moon-god *Sin* was known by the scimitar (*gamlu*) symbol since *Akkadian* times.<sup>3076</sup> Evidently, many converts to Judaism from the moon worshipping cultures of the Mideast were castrated as pagans. Isaiah had to write an exception to a certain Mosaic law, specifically, Deu 23:01. Isaiah wrote:

Let no foreigner who has bound himself to *Yahveh* say ‘*Yahveh* will surely exclude me from his people.’ And let not any eunuch complain, ‘I am only a dry tree.’ For this is what *Yahveh* says: ‘...I will give them an everlasting name that will not be cut off’ (Isa 56:03-05).

<sup>3069</sup> The same 97% figure is given in Chernitsky, B. “Inquiry and Analysis Series—no. 152: The Egyptian Controversy Over Circumcising Girls,” 7 Nov 2003.

<sup>3070</sup> *Al-Najjar*, Dr. Kamel. “International Islamic Conference: Genuine Call for Tolerance or Reiteration of Hollow Slogans?” *MEMRI*, no. 721, 25 May 2004, *LGF*.

<sup>3071</sup> Spencer. *Disturbing*, p. xi.

<sup>3072</sup> “Genital Mutilation ‘On the Increase in Europe,’” *scotsman.com*, 26 Nov 2004.

<sup>3073</sup> *Larousse*, *Sin* entry, p. 56.

<sup>3074</sup> “Religious slaughter and animal welfare,” *Meat Focus International*, Mar 1994, pp. 115-123, published by CAB International, *grandin.com* & *colostate.edu*.

<sup>3075</sup> *Sahih Bukhari*, vol. 4, bk. 55, nos. 575 & 576; vol. 8, bk. 74, no. 313.

<sup>3076</sup> *Assyrian Dictionary*, Chicago, 1956, entry 5.35.

The *Haranians*, whom, by the way, Isaiah mentions (Isa 37:12), performed castrations as a cult ceremony. Will Roscoe wrote:

In nearby *Haran*, the syncretistic cult of the *Sabians/Sabaeans*, in which castration and other elements of pagan religion played a role, flourished well into *Islamic* times (Pellat 1978:1088a, 1090b; Noldeke 1907:151-152; see also Gunduz 1994).<sup>3077</sup>

The moon worshipping cultures of Arabia also produced many castrated individuals. Will Roscoe wrote:

As Rowson (1991) relates, in the first *Islamic* century, networks of these non-masculine singers, dancers and entertainers were prominent in *Madina* and *Makka*. Their appearance in prophetic *Hadith* suggests that their role was well defined in [the] pre-*Islamic* [moon worshipping] Arabian society.<sup>3078</sup>

The impact of the crescent symbol in *Islam* is seen in the poetry of *Muhammad* Allama Iqbal (1873–1938 AD). He was an *Islamist* and the spiritual founder of the largely *Muslim Pakistan*. He wrote:

The sickle-dagger of *Hilal* [Arabic/*Urdu* meaning “the crescent-moon”] is our national symbol.<sup>3079</sup>

The Arab Christian John of Damascus saw a connection between how *Muslims* practiced sexual mutilation and how they mutilated the Trinity. John was referring to how *Muslims* reject the Biblical doctrine of the Trinity by saying that the Son and Spirit are not divine.

John of Damascus wrote: “...you call us Associators; we however call you Mutilators...of God.”<sup>3080</sup> Just as many *Muslims* cannot accept the Trinity “as is,” neither can they accept man and women who are made in the image of God “as is” (Gen 01:26-27; 05:01-02; 1Co 11:07). Thus many *Muslims* engage in FGM practices.

Eunuchs staffed many functions in *Islam*’s evil empires, and African eunuch slaves staffed the *Kaaba* and *Zamzam* as late as the nineteenth century.<sup>3081</sup> Many other slaves were castrated, as Dr. Koenraad Elst explains:

In the *Muslim* world, male slaves were often castrated, which partly explains why *Iraq* has no Black population even though it once had hundreds of thousands of Black slaves. The practice also existed in India on a smaller scale, though the much-maligned *Moghul* Emperor Aurangzeb tried to put an end to it, mainly because eunuchs brought endless corruption in the court.<sup>3082</sup>

Don Richardson wrote about North African mass castration of Blacks, which is really another form of genocide:

This is where encyclopedias, *National Geographic* magazine and other media err or simply hide a truth well known to Black elders across the sub-*Saharan* Africa. The grim horror is that *Muslim* slavers customarily castrated Black males that they captured. Why?...*Muslim* slave owners themselves wanted to be the only ones to have sex with captive Black women and girls, as *Muhammad* made lawful for them to do (see *Koran* [004:023-024;] 023:005 and

<sup>3077</sup> Murray. *Culture*, p. 77.

<sup>3078</sup> Murray. *Culture*, p. 77.

<sup>3079</sup> *Tarana e malli* by *Pakistani* poet *Muhammad* Allama Iqbal (see Iqbal in Index).

<sup>3080</sup> Sahas. *Heresy*, p. 137, App. I, M.P.G., XCIV:768.

<sup>3081</sup> Peters. *Makka*, p. 283.

<sup>3082</sup> Elst, Koenraad. “Was There an *Islamic* ‘Genocide’ of *Hindus*?” sarvadharm.org, accessed 23 Jun 2004.

070:030). *Muslim* slave owners did not want Black men competing with them as cohabiters with Black women, so Black men had to be emasculated.

*Muslim* slavers saw no need to breed slaves from slaves. Supplies were plentiful, prices reasonable. Thus adding cynicism to depravity, *Muslim* slavers denied male African slaves not only freedom and wages, but even worse, the sacred human privileges of marriage, sex and parenting.

Evidence exists that *Muslim* slave owners did indeed step in to do what emasculated Black males could not. Tens of millions of brown-skinned *Haratin*—people descended from the offspring of Arab fathers and Black mothers—are found all across North Africa and, under different designations, in the Middle East. *Mauritania* alone is reported to have some one million *Haratin*.<sup>3083</sup>

Even today Arab *Muslims* carry out ethnic genocide in *Sudan* by killing Black male Christians and Animists, and even Black non-*Salafist Muslim* males, and raping the women. *Salafists* are associated with the *Muslim* Brotherhood and *Wahhabis*.

The goal of *Sudan's Islamists* is to simultaneously drive Blacks off their own land, and populate the conquered territory with lighter-skinned *Muslims*. The goal is to Arabize and *Islamize* all of *Sudan* by 2070.<sup>3084</sup> *The Washington Post* reported:

1.2 million Africans have been driven from their lands by government-backed Arab militias, tribal fighters known as *Janjawid*...dressed in military uniforms and clutching satellite phones roamed the markets and the fields, guns slung over their shoulders....

The rapes are often accompanied by dehumanizing epithets, stressing the ethnic nature of the joint government-*Janjawid* campaign. The rapists use the terms 'slaves' [*Abid*] and 'Black slaves' [*Zurga*] to refer to the women, who are mostly from the *Fur*, *Masalit* and *Zaghawa* ethnic groups."

[The rapists say,] 'Black girl, you are too dark. You are like a dog. We want to make a light [skinned] baby...You get out of this area and leave the child when it's made...The government gave me permission to rape you. This is not your land anymore, *Abid* [i.e. slave], go.'

These rapes are built on tribal tensions and orchestrated to create a dynamic where the African tribal groups are destroyed. It's hard to believe that they tell them they want to make Arab babies but it's true. It's systematic, and these cases are what made me believe that it is part of ethnic cleansing and that they are doing it in a massive way."

She [a U.N. aid worker] showed a list of victims from *Rokero*, a town outside of *Jebel Marra* in central *Darfur* [region] where 400 women said they were raped by the *Janjawid*. 'It's systematic,' the aid worker said. 'Everyone knows how the father carries the lineage in the culture. They want more Arab babies to take the land [once they grow up]. The scary thing is that I don't think we realize the extent of how widespread this is yet.'<sup>3085</sup>

That was in mid-2004. In March 2005, it is now estimated that 180,000 people have died as a result of violence, disease or malnutrition.<sup>3086</sup>

<sup>3083</sup> Richardson. *Secrets*, p. 210.

<sup>3084</sup> MacDonald, G. Jeffrey. "In *Sudan* crisis, a duty to intervene? The Christian Science Monitor, csmonitor.com, 21 Jul 2004, DP weblog.

<sup>3085</sup> "Militia uses rape as weapon in *Sudan*," *The Washington Post*, 1 Jul 2004.

<sup>3086</sup> "UN: Nearly 180,000 people have died in *Darfur*," jpost.com, 16 Mar 2005.



So one can see that though some Christians copied *Muslims* and enslaved Blacks, these Christians were only interested in economic slavery. *Muslim* slavery however was religious, racist, economic and genocidal. That is why there is no large Black population in the Mideast comparable to the Black populations in the Caribbean and the Americas. It is especially troubling that there is no large Black population in the Mideast because *Muslims* enslaved more Blacks than Christians ever did.

Christendom can claim a better track record than *Islam* on slavery, but no society can claim to be altogether righteous in regard to slavery since Thomas Sowell says every society participated in this economic arrangement at some time or another.

### The Effects of Medieval Astrology on Women in Society

Astrology had no control over early Christians. In Christianity, all the astral deities, including Venus, were deemed to be either a figment of one's imagination or demons, but never male angels as in *Islam* (Deu 32:17; Psa 106:037; 1Co 10:20-21).

Unfortunately, later in the medieval era, *Islamic* astrology was imported into the West. Yet, Christian women were saved from some of the negative impact of the idea of male angels administrating nature from the stars. Jesus said that the angels engage in no sex and so would not be prone to discriminate based on sex (Mat 22:30).

Western astrology never became as popular, authoritative, deterministic or as fatalistic as *Islamic* astrology. In *Islamic* astrology, the male angels who man the stars have the power to direct both the discretionary and necessary acts of humans. Wedel wrote that this...

...was as little to the liking of the Church as the fatalistic philosophy of the Arabs in general.<sup>3087</sup>

Other New Testament concepts helped women in the West. Men and women are equal in the sight of God (Rom 02:11; Eph 06:09; Col 03:25), and showing favoritism is a sin (Jam 02:01, 09).

### The Moon-god Religion Begets Double Predestinationism

In the West, astrology was watered down so that the stars were thought to influence events, but not fatalistically control events. Neil Spencer wrote:

With the collapse of the Western Roman Empire early in the fifth century, astrology effectively disappeared from the Western world for several hundred years...the hostility of the emergent Christian church towards anything that smacked of paganism...ensured astrology remained in exile until it was reimported from the Middle East early in the medieval era.<sup>3088</sup>

In *Muslim* astrology however the moon, planets and stars were more controlling of persons and events. The reason is that, despite *Muslim* claims about *Allah's* transcendence, *Allah* is no more transcendent than the typical ancient moon-god. Since *Islam* started out as an astral religion, it is not surprising that Mideast astrology was so fatalistic. The stars and moon of astrology took over where the astral gods and moon-gods left off.

Since *Islam* started out as an astral religion, it is not surprising that *Muslims* think in fatalistic terms. *Allah* the moon-god did not change much when he became

<sup>3087</sup> Wedel. *Attitude*, p. 59.

<sup>3088</sup> Spencer. *True*, p. 12.

the god of *Islam*, and that is why the *Koran* is full of fatalistic statements such as the double predestination verses (see below).

Since *Allah* was so visible in the nighttime sky, *Muslims* could not think of *Allah* as being somewhat aloof or transcendent—even when the subject of the existence of evil in heaven or earth was broached. *Muhammad* said that he felt *Allah* the moon-god was so close that he was only two arrow shots away (*K* 053:008-009). Due to guilt by close association, *Allah* was thought to be the creator and cause of evil on earth.

Besides *Allah* the moon-god's apparent proximity to good and evil on earth, most of the month the moon shows a bright and a dark side. In *Muhammad's* pre-*Islamic* thinking especially, *Allah* was the moon personified.

The dark side of the moon represented *Allah's* evil side and the bright side was *Allah's* good side. Just as the moon has phases, *Allah* has mood swings. Sometimes he's brighter and more righteous, and sometimes he's darker and more evil. Of course this type of thinking was not original to *Muhammad*, as the *Encyclopedia Britannica* notes:

...the moon is frequently regarded as male and, particularly in regard to women, is understood as a preeminently evil or dangerous figure...<sup>3089</sup>

Just as the moon has a bright and dark side, *Allah* basically was a dualistic god with the evil and good principles wound together. *Allah* is a mass of contradictions that consistently changes night by night but then resets itself each month and starts the cycle over.

The moon's pattern of rising and setting and phases is so regular, it was fairly predictable by the ancients. *Muhammad* knew *Allah* was orderly, and a timekeeper as far as months and years go. Thus in *Muhammad's* mind, it would be inconceivable that *Allah* would leave anything to chance, especially exactly who would be elect and who would be damned.

*Muhammad* married the doctrine of the orderliness of *Allah* with the evil-good dualism characteristic of *Allah*, and he came up with the *Islamic* doctrine of double predestination. Conveniently, this doctrine meant that *Muhammad* would never need to take the blame for anything bad that happened to *Muslims* since it was all *Allah's* doing (*K* 004:078).

*Muhammad* had some bizarre ideas about double predestination and fate—ideas that the few Christian double predestinationists never considered. For instance:

☉ *Muhammad* taught that if a *Jihad* battle did not take place merely because *Muslims* stayed home, those who were supposed to have died during the battle-that-never-happened would mindlessly go to the place where the battle was supposed to have taken place, and there they would somehow be slain (*K* 003:154).

☉ *Muhammad* advised *Muslims* NOT to bother practicing *Coitus Interruptus* with captives of war, even with those who were to be ransomed or sold into slavery. Fatalistic *Muhammad* figured that no form of contraception works when *Allah* wants someone to be born:

It does not matter if you do not do it [*Coitus Interruptus*], for every soul that is to be born up to the Day of Resurrection will be born.<sup>3090</sup>

<sup>3089</sup> *EB*, accessed 29 Mar 2003, "Moon Worship" entry.

*Muhammad* also reasoned that just as the bright, good side of the moon guides *Muslims*, the evil force emanating from the dark side of the moon must guide non-*Muslims*. Given these beliefs, it logically follows that *Allah* causes unbelievers to err (K 022:026; 004:088, 142-143; 006:039; 007:178, 186; 016:093; 017:097; 018:017; 040:033, etc.) *Muhammad* said:

*Allah* makes whom He pleases err and He guides whom He pleases (K 014:004).

*Muhammad* never entirely abandoned his former moon-god thinking, so it is not surprising that *Muhammad* believed that *Allah* was:

- ☉ A supernatural terrorist (K 003:151; 008:012; 052:045; 059:002).
- ☉ A paranormal torturer and tormenter (K 004:056; 022:019-022).
- ☉ A double predestinationist, who specifically made irredeemable creatures to populate a fiery hell. Not content to allow the damned to make their own way to hell, *Allah* also is “the best of schemers” (K 003:054; 008:030), who leads the damned astray and then to hell (K 002:026; 004:046, 088, 142-143; 006:039; 007:178, 186; 009:037; 013:027, 031-033; 014:027; 016:093; 017:097; 018:017; 039:023, 040:033).

Stortroen wrote about *Allah* being a double predestinationist:

In retrospect, *Allah*, the unknowable god who is fatalistic and the playwright to all atrocious acts on the earth, the *Shamanistic* perception of *Muhammad*, eludes the teaching of the Judaic-Christian revelation of *Yahveh*. Hence, paganism excuses the teaching of a transcendent God in Pantheism and Spiritism, while the *Islamic* dogma also adheres to a fatalistic, sadistic creator. In contrast, both concepts make God the cohort of all wickedness and unrighteousness.<sup>3091</sup>

Why, someone might ask, is a double predestinationist war-and-moon-god appealing to *Muslims*? The answer is that honor-shame based societies are cultures prone to willingly submit to a double predestinationist god.

The doctrine of double predestination also ultimately clears every *Muslim* of personal responsibility for his or her own actions, and also that of the *Umma*. One might as well give up on trying to make a *Muslim* feel guilty for any of *Islam*'s many terrorist acts, genocides and ethnicides committed over the last fourteen centuries.

*Muhammad* explains how the system works where every *Muslim* gets off scot-free every time and never needs to feel guilty or have a pang of conscience:

Verily your creation is on this wise. The constituents of one of you are collected for forty days in his mother's womb in the form of blood, after which it becomes a clot of blood in another period of forty days. Then it becomes a lump of flesh and forty days later *Allah* sends His angel to it with instructions concerning four things, so the angel writes down his livelihood, his death, his deeds, his fortune and misfortune. By Him, besides Whom there is no god, that one amongst you acts like the people deserving Paradise until between him and Paradise there remains but the distance of a cubit, when suddenly the writing of destiny overcomes him and he begins to act like the denizens of hell and thus enters hell, and another one acts in the way of the denizens of hell, until there

<sup>3090</sup> Trifkovic. *Sword*, p. 43; also see *Sahih Bukhari* vol. 003, bk. 034, no. 432; vol. 005, bk. 059, no. 459; vol. 007, bk. 062, nos. 135, 136; vol. 009, bk. 093, no. 506; *Sahih Muslim*, bk. 8, nos. 22, 29 & 3371; K 004:024; Spencer. *Disturbing*, pp. 50-51, 53.

<sup>3091</sup> Stortroen. *Makka*, p. 107.

remains between him and hell a distance of a cubit that the writing of destiny overcomes him and then he begins to act like the people of Paradise and enters Paradise.<sup>3092</sup>

This double predestinationist type of thinking affects the entire honor-shame-based society, so rarely will *Muslims* take responsibility for their state of affairs, nor apologize for any misdeed, no matter how reprehensible. Instead, all blame is cast on non-*Muslims*—the very people who lately are paying billions for humanitarian aid. David Gutmann wrote:

Human societies can be loosely divided into two groups: those governed by shame and those governed by guilt....shame-vulnerable individuals are constantly vigilant toward aggressions of others against their sense of honor. If insulted, they feel humiliation and rage. The shame-prone willingly submit only when the external power appears so invincible that there is no alternative but surrender. Beneath their outward defiance, the shame-prone often hold unconscious yearnings to be submissive; the seemingly omnipotent conqueror allows them to be passive without shame....

The cultivation of victimhood is common in shame societies. Shame-prone men will look for malign external agents to rationalize any humiliation, for the victim is, by definition, not responsible for his own troubles. And the claims of victimhood eliminate any guilty inhibitions against aggression and unlock the fury that drives the terrorist legions of shame-based societies....

Shame societies are most likely to attack an enemy who appears weak, rather than strong and threatening. The weak enemy is corrupt, effeminate and ready to surrender his honor. The enemy's perceived weakness is like catnip to shame-mongers, as they fantasize about the foe's humiliation.<sup>3093</sup>

### What About Christian Double Predestinationists?

Someone might say that some Calvinistic Christians believe in double predestination. In fact, only Supralapsarian Calvinists believe in double predestination, and only the hyper-Calvinists believe that God is as active in reprobating the non-elect as he is in redeeming the elect (Equal Ultimacy).<sup>3094</sup> All hyper-Calvinists are Supralapsarians but not all Supralapsarians are hyper-Calvinists. Most Calvinists are Infralapsarians. Besides, most Christians do not regard Calvin fondly. Durant wrote:

We shall always find it hard to love the man who darkened the human soul with the most absurd and blasphemous conception of God in all the long and honored history of nonsense.<sup>3095</sup>

Evidently, the Apostle Paul was dialoguing with some believers in Rome who were philosophizing about election and predestination. Paul confronted them with a rhetorical question (Rom 09:21) and two "What if" questions (Rom 09:22-23). Paul

These hypothetical passages are not the type of Biblical material to base a serious doctrine on, though Paul does provide food for thought. In fact, Paul even

<sup>3092</sup> *Sahih Muslim*, bk. 033, No 6399. Also, see Jeffery. *Islam*, p. 150.

<sup>3093</sup> Guttman, David. "Only U.S. Strength Can Defeat *Islamism*," The View from Abroad, The American Enterprise Institute, americanenterprise.org, Dec 2003.

<sup>3094</sup> Sproul, R. C. *Chosen by God*, 142.

<sup>3095</sup> Durant. *Story of Civilization*, vol. VI, p. 490, Simon & Schuster, New York, 1957.

says in Romans that he occasionally used “human arguments” in order to make his point (Rom 03:02).

That Paul sometimes uses human arguments and quotes pagan poets occasionally, means that one ought not draw too many conclusions based on Paul’s argumentation but rather let Paul draw the conclusions for us. In any event, Paul never concedes to the proponents of double predestination but only says that God would be within his rights to be a double predestinationist.

One ought not base doctrines on one passage, especially if that passage is not a declarative sentence. For instance, one ought not base doctrines on questions like the Mormons do with their baptism of the dead (1Co 15:29). Also, one ought not to base doctrine on a pun as Catholics base their entire system on Mat 16:18.

Paul says that God “bore with great patience the [hypothetical] objects of his wrath” (Rom 09:22), seemingly rejecting the notion that God actively caused the damned to stray (as *Islam’s Allah* does).

The themes of grace and love that run throughout the Bible militate against the idea of God being a double predestinationist. Other passages teach that damned deserve all the blame for damnation, while God has earned all the credit for the elect’s salvation.

No matter how one looks at it, the double predestination doctrine does not square with *Yahveh’s* loving and just character but the doctrine does jibe well with *Allah’s* demonic character.

## Transference of Doctrine from the Heavens to the Earth

### *Fatalism*

Astrological fatalism has been transferred from the moon and stars to *Islamic* societies. Fatalism not only affects the afterlife but this life too. In the Mideast, the fatalistic mindset is common.

*InshAllah* is commonly heard, which is Arabic for “If *Allah* wills it.” *Kismet* is the *Muslim* doctrine of fatalism—everything that happens and everything that *Muslims* do is already pre-ordained.

An example of fatalism in practice among *Muslims* is the conduct of the *Hajj*. People needlessly die each year at the *Hajj*. When 251 *Muslims* died in a stampede, no one was shocked and *Saudi* authorities merely blamed the “will of God” even though the stampedes occur every few years.<sup>3096</sup>

*MSNBC* reports on another case where *Muslims* carelessly put the lives of other *Muslims* at risk not really caring whether they live or die:

*Israel* fears part of Jerusalem’s most sensitive shrine may collapse under the weight of *Muslims* due to pour in for *Ramadan* rites soon and wants curbs on the number of worshippers, officials said on Sunday...Fissures had formed in the roof—where *Muslims* also pray—and the eastern wall of the underground cavern, according to the Authority. *Israeli* media said the findings were based on a recent on-site examination by Egyptian engineers...The *Islamic* trust overseeing the site, known to *Muslims* as *al-Haram al-Sharif* (Noble Sanctuary) and Jews as temple mount, denied the *Mosque* in its Solomon’s Stables area was unsafe and accused *Israel* of looking for a pretext to take control...‘I think there will be no disaster here. This place has existed for 1,400 years and we have

<sup>3096</sup> Mahjoub, Taieb. “Pilgrims long to see *Makka* and die,” *aljazeera.net*, 2 Feb 2004.

always received hundreds of thousands of people without any danger,' Husseini told *Reuters*. 'Ramadan is coming and I wish that *Israel* will allow *Muslims* coming from all over Palestine to enter and pray.'<sup>3097</sup>

Another example of the fatalism is that the more faithful among *Muslims* resist taking out any form of insurance.

Faithful *Muslims* generally do not wear seatbelts in car and trucks. *Muslims* "often cavalier attitude toward safety precautions" based on the *Koranic* verse "death will overtake you even if you be inside a fortress" (*K* 004:078).<sup>3098</sup> Not surprisingly, though only thirteen percent of *Israeli* drivers are Arab, Arabs are involved in twenty-one percent of fatalities involving vehicles.<sup>3099</sup>

When there is an accident, many *Muslims* frown on Good Samaritans saving their lives because "that was their time to go." Good Samaritans have even been sued for applying First Aid at an accident instead of letting the accident victim die.

Another example of fatalism is the constant shooting of AK-47's into the air at wedding, funerals, parades and such. Not only do the shooters risk the bullet coming back down on themselves or others (which has happened before) but they might even shoot an airliner out of the sky. In 2002 a warplane thought it was being fired at in Afghanistan, and returned fire on a celebratory wedding party in Afghanistan, killing twenty people.<sup>3100</sup>

*Muslim* terrorists practice fatalism which helps to explain why so many of them go on suicidal missions, or send others on terrorism missions to kill innocents:

On the morning of Black Monday, March 23, his son *Mohammad* warned him [the founder of *Hamas*], three hours before his martyrdom, that an *Israeli* surveillance aircraft had flown over the *Sabra* quarter in *Gaza* City, which could be the prelude to a hostile act aimed at him personally. He reportedly replied "We aspire to martyrdom." *Sheikh YaSin* was a fatalist because of the faith that filled his heart.<sup>3101</sup>

### *Muslim Men Under the Control of the Moon*

*Shaihk Abu Ali Sina*'s interpretation of *Muhammad*'s "Night Journey" provides an example of fatalism connected to astrology, namely how *Muslim (Ishmaelite)* men are controlled by the moon:

And what he said 'I arrived at the heaven of the universe; the gates yielded and I entered. There I saw *Ismail* seated upon a throne, and a crowd before him, with their eyes fixed upon his face. I made my salute, looked at him and went on.' By 'heaven' is understood the moon; by 'Ismail' the body of the moon; and by 'the crowd,' those whose conditions are under the influence of the moon.<sup>3102</sup>

Then *Abu Ali Sina* goes on to describe the male angel in the Venus level of heaven, and then the other levels of heaven.

<sup>3097</sup> "Israel says Jerusalem shrine could cave in," MSNBC.com, 26 Sep 2004.

<sup>3098</sup> De Atkine, Norvell B. "The Arab Mind [by Raphael Patai] Revisited," meforum.org, Summer 2004, vol xi, no. 3.

<sup>3099</sup> "Arabs Involved in Proportionately More Fatal Accidents," arutzsheva.com, 20 May 2005.

<sup>3100</sup> "Afghan: U.S. bomb hits wedding party," cnn.com, 1 Jul 2002.

<sup>3101</sup> "The assassination of *Sheikh Yassin*, presage of life for Palestine," *Monday Morning*, mmorning.com, 5 Apr 2004.

<sup>3102</sup> Fani. *Dabistan*, p. 404.

### *Muslim Women Under the Control of Venus*

The pre-Islamic women of *Makka* considered themselves the women of *Tarik*, a reference to Venus.<sup>3103</sup> Because *Muhammad* and *Muslims* thought women were under the control of Venus, it was thought that women ought to act like Venus.

While the “male” stars and planets transverse the skies, Venus stays on the horizon and is only seen briefly compared to most other stars and planets. Moreover, Venus is seen in proximity to the sun or moon when they happens to be just above or below the horizon early in the morning or late evening. This explains the pagan myths about Venus being the consort or son or daughter of the sun or moon, depending on the culture.

That women should act like Venus explains why in most *Muslim* countries, women are not to travel out on their own very far. They hug the horizon, so to speak, and stay near their guardians (male family members) as Venus stays near the sun.

Venus stays close to the sun. Venus is never more than forty-eight degrees away from the sun. Venus also stays on the ecliptic where the sun, moon and planets travel. In the same way, most *Muslim* women have no serious employment, career or education, and they most often stay on the periphery of society.

Venus’ diminutive status in the eyes of Mideasterners as compared to the moon-god’s exalted status is apparent from Isaiah’s mocking words about the king of *Babylon*. Isaiah said the king’s aspirations and vanity would be like Venus saying:

I will ascend into heaven, I will exalt my throne above the stars of [the moon-]God...I will ascend above the heights of the clouds; I will be like the most High [the moon-god] (Isa 14:13-14).<sup>3104</sup>

### **The Effects of Associating Women First with Venus and Then the Venus Angel**

In the West, men tend to be more interested in sex, and women tend to be more interested in romance and relationships. It is recognized that the sex drive in some men is so strong that they occasionally treat women as sex objects.

In *Islamdom* by contrast men are considered helpless before the power of female sexual manipulation. That is why they demand the veils; they think they cannot control themselves. This thinking is a holdover from the old astral days when pagan women sung about how they were empowered sexually by Venus, for instance:

We are daughters of the Star of the Morn (*Tarik*); we tread softly on silken cushions (*Namarik*)...we will press you in our arms...<sup>3105</sup>

*Islam* took these exaggerated pagan notions about women’s sexuality seriously and implemented draconian measures to curb their tendency to wander. Furthermore, *Islam* has always treated women’s sexuality as some mysterious power radiating from Venus. This astral explanation of sexuality seems to be the thinking even modern times, as *Iranian* journalist *Amir Taheri* wrote:

In 1981, *Abol-Hassan Bani-Sadr*, the first president of the *Islamic Republic [Iran]*, announced that ‘scientific research had shown that women’s hair emitted rays that drove men insane’ (*Sic*). To protect the public, the new *Islamist* regime passed a law in 1982 making the *Hijab* mandatory for females aged above six,

<sup>3103</sup> Quoted from *Ibn ul-Athir*, vol. ii, p. 118, in Ali. *Spirit*, p. 69, fn. 1.

<sup>3104</sup> More often than not, in Mideastern religion, Venus was a female, e.g. *Ishtar*, as was the case in Greece and Rome. To strengthen the comparison between Venus and the moon, Isaiah referred to the Morning Star as *Helel* (Isa 14:13). The host high in *Babylon*’s astral religion was the male moon, often called *Hilal*. So the Venus-moon couplet was *Helel-Hilal*.

<sup>3105</sup> Quoted from *Ibn ul-Athir*, vol. ii, p. 118, in Ali. *Spirit*, p. 69, fn. 1.

regardless of religious faith. Violating the *Hijab* code was made punishable by 100 lashes of the cane and six months imprisonment.<sup>3106</sup>

*Islam* always had a deterministic view of astrology, so it was thought that when women used this power emanating from Venus, it had irresistible effects on men. Thus under *Sharia* law, women are commonly found to be at fault for men's sexual dalliances, and women are accused of adultery even when they were clearly raped.

In 1975, *Fatima* Mernissi wrote the book, *Beyond the Veil: Male-Female Dynamics in a Modern Muslim Society*. Informed by this book, Daniel Pipes wrote:

Considering the *Muslim* reputation for archaic customs, it is ironic to note that *Islamic* civilization not only portrays women as sexually desirous but it sees them as more passionate than men. Indeed, this understanding has determined the place of women in traditional *Muslim* life...*Muslims* generally believe female desire to be so much greater than the male equivalent that the woman is viewed as the hunter and the man as her passive victim. If believers feel little distress about sex acts as such, they are obsessed with the dangers posed by women. So strong are her needs thought to be, she ends up representing the forces of unreason and disorder.

A woman's rampant desires and irresistible attractiveness gives her a power over men that even rivals God's [power]. She must be contained, for her unbridled sexuality poses a direct danger to the social order. (Symbolic of this, the Arabic word *Fitna* means both "civil disorder" and "beautiful woman.")

The entire *Muslim* social structure can be understood as constraining female sexuality. It goes to great lengths to separate the sexes and reduce contact between them. This explains such customs as the covering of women's faces and the separation of women's residential quarters, or the *Harem*. Many other institutions serve to reduce female power over men, such as her need for a male's permission to travel, work, marry or divorce. Revealingly, a traditional *Muslim* wedding took place between two men—the groom and the bride's guardian.

Even married couples should not get too attached; to insure that a man does not become so consumed with passion for his wife that he neglects his duties to God, *Muslim* family life restricts contact between the spouses by dividing their interests and duties, unbalancing their power relationship (she is more his servant than his companion), and encouraging the mother-son bond over the marital connection.

On the whole, *Muslims* lived up to these *Islamic* ideals for male-female relations in pre-modern times. Yet the anxiety persisted that women would break loose of their restrictions and bring perdition to the community...For many *Muslims*, the West poses not just an external threat as the infidel invader; it also erodes traditional mechanisms to cope with the internal threat, woman...Sexual apprehensions constitute a key reason for *Islam's* trauma in the modern era.<sup>3107</sup>

As a result of the association between women and Venus, women are expected to hide themselves away most of the day in their homes in seclusion just as the planet Venus only makes brief appearances in the morning and evening. *Muhammad* said that "the planets" (*Yusuf Ali, Pickthall*) run their course and hide themselves (*K* 081:015-016).

<sup>3106</sup> Taheri, Amir. "Islamic headgear is not essential," townhall.com, 19 Aug 2003.

<sup>3107</sup> Pipes, Daniel. "Female Desire and *Islamic* Trauma," *DP*, 25 May 2004.



Another result of the association between women and Venus is: women seldom attend the *Mosque*, even for Friday prayers, as was noted above. The *Mosque* is for worshipping the moon-god *Allah*, but Venus controls women, so there is no need for women to attend *Mosque* since they were born under the wrong “sign.”

Because *Muhammad* thought Venus controlled women, he considered them creatures of a lesser god, so to speak. *Muhammad* said that they have a deficiency in their knowledge and religion.<sup>3108</sup> *Muhammad* said that they are not even allowed to pray, much less attend *Mosque*, during their monthly period.<sup>3109</sup>

Another result of the association between women and Venus is: the veil (*Shakir K* 024:031; 033:059) was imposed on *Muslim* women, as *Muhammad*'s favorite wife Aisha relates.<sup>3110</sup> Having *Muslim* women veil was *Muhammad*'s way of keeping *Muslim* men attentive to the moon-god rather than ogling the women of Venus.

Keeping women veiled and separate from men in *Mosques* meant that *Muhammad* could hold the men's attention on the seventy-two *Houris* in the afterlife without being unduly distracted by earthly women controlled by Venus.

If men divided their loyalties between *Allah* the moon-god and women controlled by Venus, this was a form of polytheism or compromised monotheism, as Mernissi wrote:

What is feared is the growth of the involvement between a man and woman into an all-encompassing love, satisfying the sexual, emotional and intellectual needs of both partners. Such an involvement constitutes a direct threat to the man's allegiance to *Allah*, which should be the unconditional investment of all the man's energies, thoughts and feeling in his God.<sup>3111</sup>

### Some Non-astral Reasons That *Muslim* Women Are Veiled

In one respect, the imposition of the veil is quite understandable. The early *Muslims* were robbers, bandits and terrorists. It would not have been above early *Muslims* to sneak around wearing women's clothing since *Muslims* gloried in their sneakiness and treachery. Interesting, *Muhammad*'s biographer even relates that *Muhammad* once wore a wrapper (a loose gown or negligee) of one of his wives!<sup>3112</sup>

So today, *Muslims* want women to wear baggy and concealing clothing so that male terrorists can easily pass for a woman just by wearing women's clothing. Not only does the baggy clothing conceal the wearer's identity from observers and from surveillance cameras but also *Muslim* women are not checked as thoroughly at security check points. It is just too much of a bother, especially when *Muslims* generally put up a fuss over security measures. Hence, *Muslim* men wearing women's clothing typically are not checked as thoroughly.

It is especially easy for criminals and terrorists, both male and female, to pass as unidentifiable *Muslim* women by driving a car while donning a veil.<sup>3113</sup> Terrorists and criminals, both male and female, take advantage of the fact that security is relaxed in the case of women. Since female security guards generally check women,

<sup>3108</sup> *Sahih Bukhari*, vol. 1, bk. 6, no. 301.

<sup>3109</sup> *Sunan Abu-Dawud*, bk 1, nos. 0284, 0286 & 0287.

<sup>3110</sup> Ishaq. *Sirat*, pp. 457, 462, 494. Also, see Lings. *Sources*, p. 241.

<sup>3111</sup> Mernissi. *Beyond the Veil*, viii, as quoted by Schmidt. *Divide*, p. 98.

<sup>3112</sup> Ishaq. *Sirat*, p. 460.

<sup>3113</sup> Goodenough, Patrick. “Islamic Attire Debate Continues Around the World,” CNSNews.com, 6 Apr 2006, townhall.com.

a male terrorist can more readily overcome the female guard if he is discovered wearing women's clothing.

Another reason for *Muhammad's* imposition of the veil was the vast majority of *Muslims'* wives, concubines and slaves were stolen from other tribes. Naturally, he wanted to hide the identity of his hostages so they could not be easily rescued. What follows is a record of how one Indian saw his deported mother and sisters.

The *Muslim Sultan* Tipu (1753-1799 AD) was one of the many native rulers of India with whom the colonialists had to contend through treaties and warfare. Tipu put the *Mangalorean* Christians through a holocaust for fifteen years (1784-1799 AD). In one campaign 60,000 Christians were forced to march 210 miles (338 KM) over a six-week period and 20,000 died on the way due to poor conditions.

At the end of the road, the girls and young women were distributed to *Muslims* to be wives, concubines or slaves in the *Harem*. The remainder was given a choice of conversion or death (K 009:029). Many were thrown down a precipice but some were mutilated by cutting off their noses, ears or hands. These were further degraded into the "Untouchable" (*Dalit*) caste, and then were forced to perform menial tasks such as cleaning latrines. Records indicate that...

...One poor youth writes of how his soul screamed to God, on seeing his mother and sisters all converted to *Islam*, married to *Muslim* men, his nephews and nieces being brought up as *Muslims*. More poignant, both his mother and sister were pregnant. In their wombs were being carried a new generation of *Muslims*. He writes that when he passed his mother and sisters in the street, their eyes would meet and he could see the pain and suffering in their tormented souls.<sup>3114</sup>

Still in modern times, veils are instrumental in kidnappings leading to forced conversions and in marriages by abduction, throughout *Islamdom* such as in Egypt (examples below),<sup>3115</sup> Bethlehem,<sup>3116</sup> *Pakistan*,<sup>3117</sup><sup>3118</sup> the *Sunni Circassian* villages of *Israel* such as at *Kfar Kama* near Mount *Tabor* near Galilee,<sup>3119</sup> in Ethiopia<sup>3120</sup> and in *Zanzibar* (example below). For instance, this account comes from Egypt where...

...Hundreds of young *Coptic* women disappear and are reported kidnapped each year [...and where] security officials frequently prevent Christian parents from having contact or private access to their daughters once they have been located, instead leaving them in the custody of the *Muslim* 'protector' who abducted them.

*Compass Direct* reported on how veils complicate missing-persons searches:

The SSI [Egyptian State Security Investigators] has continued to stonewall the Attallah family's attempts to recover their daughter. On August 11, a security officer called the father, suggesting that he buy a cell phone so that the police could contact him whenever they learned his daughter's whereabouts. Attallah scraped together enough money to buy the phone and gave the police his number. Soon afterwards the officer called, telling him that his daughter was in

<sup>3114</sup> Lobo, Joe. "Sarasvati's Children." Indian Catholic Association of Florida, Inc. The lengthy article summarizes the book *Sarasvati's Children*.

<sup>3115</sup> Shalakamy, Ahmed. "Confessions of a Former *Islamist*," *FPM*, 24 May 2005, FreeWorldNow.

<sup>3116</sup> *Abu* Toameh, Khaled. "Bethlehem erupts in sectarian discord," *jpost.com*, 9 May 2005.

<sup>3117</sup> "Christians protest against ASP," *dailytimes.com.pk*, 19 Aug 2005, *DW*.

<sup>3118</sup> "Pakistan...600 people a year are forcibly converted to *Islam*," *asianews.it*, 30 May 2006, *DW*.

<sup>3119</sup> Aisenberg, Lydia. "A quiet minority," *jpost.com*, 22 Jun 2005.

<sup>3120</sup> "Police: Lions free kidnapped girl," *CNN*, 21 Jun 2005.

Alexandria and promising that if he went to meet her, he could bring her back home. Burning with hope, the father traveled the 200 miles north to Alexandria, where the officer called him again. ‘Your daughter is across the street from you,’ he was told. Spotting a veiled woman, the father approached and tried to speak with her but she ran away from him and got on a bus. When he followed and tried again to speak with her, other passengers thought he was harassing the woman and started beating him, finally forcing him to get off the bus. ‘They are enjoying torturing that poor father,’ commented a human rights activist who interviewed Attallah in late August.<sup>3121</sup>

The islanders of *Zanzibar* are 97 percent *Muslim* and the remainder is Christians and *Hindus*. This demographic mix along with *Islamist* politicians and police, and the use of full-body veils, all make it easy for *Islamists* to take girls hostage and transport them elsewhere in *Islamdom*. *CBN News* reported:

Young Christian girls are being abducted, forced to convert to *Islam* and, in some cases, [are] shipped to parts of the *Islamic* world....In July 2004, Flora’s 14-year-old Christian daughter Joyce was kidnapped by members of *Uamsho* [short for: Revival and Propagation Organization], a radical *Muslim* group on the island. ‘I was told that from this day on, I would not be going back home to my family. You will become a *Muslim*,’ Joyce said. Her kidnapper was Mariam, a 45-year-old *Muslim* woman. Mariam refused to talk to *CBN News* on camera, but she insisted that Joyce had voluntarily become a *Muslim*....Joyce said ‘I was forced to wear *Islamic* dresses that covered my entire body...so that my mother could not know me [recognize] me....One of the other kidnappers, Mohammed, told me that wherever I will go [if she escaped], they would find me, and that I would eventually come back to their side [i.e. faith]. I will remember him forever, what he did to me.’ [*CBN News* reported that] Four days after she was rescued, Joyce was kidnapped again by the same group. This time, she landed in the hands of *Sheikh* Azzani Khalid Hamdan. ‘We don’t kidnap the Christian children and force them to convert to *Islam*,’ Hamdan insisted. ‘We only educate them on the ways of *Islam* once they have converted on their own’...After being kidnapped for the second time, Joyce spent the next several weeks in an *Islamic* school. Day after day, she was forced to memorize the verses of the *Koran* in Arabic. They even made her change her name...[to]...Yoha Suleiman Mohammed. [Her mother Flora said] ‘I was warned that if I continue looking for my child they would arrest me...In fact, I met some police officers who were *Muslims* and they said to me how happy they were that my daughter had become a *Muslim*. They don’t care about what is going on to the Christian children on this island. They want to see more children converted to *Islam*.’ In the meantime, Joyce’s kidnappers were preparing to smuggle her out of the country. So far, no one has been charged with Joyce’s kidnapping. Hamdan is awaiting trial for his alleged role in a string of bombings against churches on the island.<sup>3122</sup>

<sup>3121</sup> “Police Obstruct Search for Missing Christian Woman,” [compassdirect.org](http://compassdirect.org), 28 Sep 2005.

<sup>3122</sup> Thomas, George. “*Muslims* Kidnap, Force Christian Girls to Convert,” *CBN News Service*, [cbn.com](http://cbn.com), 16 May 2006, *DW*.

### The Effects of Associating Women with Sirius

Another Season, *Sirius*, is a seasonal star that was not visible year-round. Stars anywhere near the ecliptic are not visible whenever the sun happens to be between them and observers on earth.

*Muhammad* as a pagan however thought that *Allah* secluded stars in the underworld for a time or even forever. This may explain why women guilty of adultery were to be under house-arrest for the rest of their lives (or until they starve, as some take the passage to mean) (*K* 004:015).

### Zodiac Circles Provided the Basis for Many *Islamic* Tenets

Zodiac circles may have been used as calendars at first. Months would need to be intercalated every so often so as to keep the sun, moon and zodiac constellations aligned with the seasons. However, the precession of the earth eventually meant zodiac circles made of stone or mosaic were out of sync with the heavens.

So why were zodiac wheels used if they were out of sync with the skies? Astrologers have long known that astrology is all about self-fulfilling prophecies and expectations, the law of averages and probability, and the placebo effect.

One might think that constant disappointments would tire the superstitious people who rely upon astrology, but astrology's dismal track record actually increases expectations in many people due to a certain gambling reflex or addiction.

The same gambling reflex is found in laboratory rats. If a rat receives cheese every time it pulls a lever, it only pulls the lever when it is hungry. However, if cheese is delivered only sporadically when a lever is pulled, the rat will spend all day pulling the lever regardless of whether it is hungry, or whether the rat already has a large pile of cheese.

This same Pavlovian reflex is cultivated and honed by gambling interests in their clientele, who like a laboratory rat will spend all their free time either pulling the handle of slot machines, or thinking about doing so at the first opportunity.

Since astrologers know they are charlatans, even today they do not even bother to base their predictions on current star charts, as Neil Spencer wrote:

Due to the phenomenon known as the precession of the equinoxes—which is caused by a wobble in the Earth's axis—the zodiac slips backwards in the sky, by a degree every seventy-two years, making a complete backward revolution every 26,000 years...At the time *Ptolemy* wrote his textbooks [flourished 127-145 AD], the spring equinox, on 21 March, fell at 0 degrees *Aries*. Thanks to the precession, it now falls at around 6 degrees *Pisces*, yet Western astrology has continued to measure the zodiac from 0 degrees *Aries*. As a result, none of the planets is actually where Western astrology claims it is but 24 degrees further backwards in the sky. So while astrology describes Venus at say, 10 degrees *Libra*, its physical location is halfway through the constellation of *Virgo*. Indian astrology, on the other hand, still uses the real life positions of the planets for its deliberations: this is the Sidereal zodiac, as opposed to Western astrology's Tropical Zodiac.<sup>3123</sup>

Thus most zodiacs used in the West are out of alignment with the heavens. At least Indian astrologers use Sidereal Zodiacs, so their astrology charts match current star charts. Anyway, despite the tortured logic used to defend astrology, it is pure superstition—not even as scientific as the fear of black cats.

<sup>3123</sup> Spencer. *True*, p. 21.

That Jews did not use the zodiacs as calendars is confirmed by the fact that most of the synagogue zodiacs were out of alignment with the constellations and seasons. Lester Ness wrote about the Byzantine-era *Hammath-Tiberias* synagogue:

Both signs and seasons run clockwise and unlike the other zodiacs, the seasons are aligned with the correct signs.<sup>3124</sup>

Lester Ness also wrote that a...

...zodiac results in a solar calendar, while the Jewish calendar is [solar-] lunar... The best conclusion is that zodiacs do not equal a Jewish calendar.<sup>3125</sup>

That the zodiac was not used as a perpetual calendar confirmed in *Muhammad's* mind that the zodiac showed *Israel's* triad (*Allah*, Ezra, the Seasons) just as pagan zodiacs showed pagan deities. Lester Ness wrote:

The Jewish variety of astrology, in turn, will help explain the famous zodiac mosaics. A zodiac in the synagogue meant the same thing as it meant in a temple; it was a symbol of the Supreme Deity, Who ran the universe by the laws of astrology. It is important to emphasize this, for some major scholars of ancient synagogues deny that the ancient Jews did anything as irrational as practice astrology.<sup>3126</sup>

Jews however did not believe that the Seasons and constellations were mere personifications of mindless forces of nature. Jews and other ancients believed that male angels staffed the stars and sun. Thus Jews and *Muslims* could still be astrologers and monotheists since all the petty gods manning the stars were demoted to an angelic status. By contrast, the early Christians declared the astral gods to be demons, so Christians foreswore astrology for several centuries.

### The Zodiac, *Allah's* Bisexual Habits and the Afterlife

*Allah's* sexual habits also apply to the afterlife. There are about five thousand stars visible to the naked eye. *Muhammad* estimated that each month the moon occulted at least seventy-two stars on or near the ecliptic upon completing its lap around the zodiac. So it followed that *Allah's* followers, especially the martyrs for the faith, would receive seventy-two *Houris* in heaven.

According to Arabic stargazers and pre-*Islamic* myths, some stars were male and some female. Khairat *Al Saleh* tells of a pre-*Islamic* myth where *Al Thurayya* is a female, *Al Dabaran* and *'Ayuq* are males, and the string of stars around *Al Dabaran* are camel drivers with a herd of camels.<sup>3127</sup> Many stars retained their female names even in *Islamic* times despite *Muhammad's* declaration that astral angels are male.

Occulting in pre-*Islamic* times meant that *Allah* went into the constellation's "house" or "mansion"—depending on the translation (*K* 010:005; 015:016; 025:061; 036:039; 085:001). There *Allah* had sex with the astral goddess, or sodomized the astral god. Then during *Islamic* times, *Muhammad* believed *Allah* sodomized the astral angels.

*Muhammad* copied *Allah's* behavior by having at least nine little houses built for his wives by the *Madinan Mosque*.<sup>3128</sup> Then like the moon, *Muhammad* made the rounds of his zodiac of wives.

<sup>3124</sup> Ness. *Mosaics*, p. 12.

<sup>3125</sup> Ness. *Mosaics*, pp. 20-21.

<sup>3126</sup> Ness. *Mosaics*, p. 137.

<sup>3127</sup> *Al Saleh. Fabled*, p. 30.

<sup>3128</sup> Gibb & Kramers. *Encyclopedia*, p. 331, *Masjid* entry.

The moon's occulting and sodomizing various male planets and stars was not meant to increase fertility, but was to show the moon-god's superiority and rule. This way of dominating others was transferred first into the ancient moon-god religion culture and then into *Islam*. Stephen Murray and Will Roscoe wrote:

Some [*Muslims*] (such as *Abu Nuwas* [died 195 AH/810 AD] and the [*Madinan*] jurists of the *Maliki* school [founded by *Abu Abd Allah* (94-179 AH/716-795 AD)]) rationalized the practice of making non-believers [men and women] submit to penetration [sodomizing] by believers [*Muslims*] as a means of glorifying the superiority of *Islam*—a duty for *Muslims* rather than as a sin.<sup>3129</sup>

*Allah's* bisexual routine also affected *Muhammad's* view of the afterlife. In accordance with *Allah's* bisexuality, *Muhammad* determined that the faithful in heaven would be served by seventy-two *Houris* AND by an unspecified number of boys, as Stephen Murray and Will Roscoe wrote:

Pederasty has not been the only form of homosexuality in Arabic culture (and still less so in other *Islamic* cultures—especially in the eastern reaches of *Islam*), but it has long been the idealized form...within *Islamic* cosmology, male sexual pleasure is 'good-in-itself' not merely as a means to procreation, but as a prefiguring paradise, which according to the *Quran* is staffed with beautiful serving boys (*Al Fata*) as well as girls (the term *Houri* includes both) ([*K* 0]56:17ff; 52:17ff; 52:24; 76:19)...<sup>3130</sup>

Of course such orgies and pederasty could not be shelved until the heavenly afterlife. *Muhammad* saw the morality of the moon-god and astral beings and told *Muslims* of it. *Muhammad* became the Arab *Prometheus* who stole fire (i.e. the sick perversion) from the gods and gave it to *Muslims*. As a result, the *Koran* only legislates against homosexuality but not bisexuality, as was discussed in a previous chapter.

### Sexual Mores and the Zodiac Wheel

*Muhammad* gleaned some other lessons from the zodiac wheel. *Muhammad* believed that Jews worshipped an astral triad as represented in the zodiac wheel.

*Muhammad* thought that the crescent was *Allah* the moon-god, the charioteer was Ezra as a sun-god, and the Winged Seasons in the four corners were the daughters of *Allah* or female angels.

After the Satanic Verses episode, *Muhammad* came to believe that the Four Seasons were just angels—and male angels at that. They then appeared to be worshipping *Allah* and the charioteer in the hub of the zodiac circle. *Muhammad* may have come to believe that the charioteer was Adam and not Ezra or Jesus at all.

Based on *Muhammad's* own interpretation of the zodiac circle, he bought into other tales circulating at the time. *Muhammad* said that *Allah* ordered the angels to bow down to Adam:

Behold, We [*Allah*] said to the angels: 'Bow down to Adam.' And they [the angels] bowed down. Not so *Iblis* [Satan]. He refused and was haughty: He was of those who reject the Faith...(Allah) said: 'What prevented you from prostrating when I commanded you?' He [Satan] said: 'I am better than he [Adam]. You [*Allah*] did create me from fire and him from clay.' (*Allah*) said: 'Get you down from here [heaven]. It is not your right to be arrogant here. Get

<sup>3129</sup> Murray. *Culture*, p. 304.

<sup>3130</sup> Murray. *Culture*, pp. 302, 307 (also see p. 90).

out! For you are one of the meanest (creatures)' (K 002:034; repeated 007:011-013; 015:031-039; 017:061; 018:050; 020:116; 026:095; 038:074-082).

Note that in *Muhammad's* estimation, clay was better than fire.

That the male angels, around the zodiac circle seem to be adoring or even worshipping the man in the chariot may explain some other points about *Islam*. Based on *Muhammad's* interpretation of the zodiac, *Muslim* women are basically to serve and worship their husbands, while the men worship *Allah*. Even the five daily prayers (*Salat*) to *Allah* and *Mosque* attendance are enjoined only on men. That is why *Mosques* are mostly men-only affairs, as Gibb and Kramers noted:

...anyone who deliberately omits the *Salat* because he does not recognize it as a legal duty is to be regarded as *Kafir*. Even deliberate neglect without any such theoretical basis makes him liable to the death penalty.<sup>3131</sup>

While the men could be killed for neglecting the five daily prayers (*Salat*), surprisingly "there is no obligation on women [to perform *Salat*]; it is even not recommended for them."<sup>3132</sup> If women do the *Salat*, it is supererogatory, i.e., beyond the call of duty. Instead, in keeping with *Muhammad's* interpretation of the zodiac, there are many traditions that nearly enjoin wives to worship their husbands:

- ☉ The woman who dies and with whom the husband is satisfied, will go to paradise.
- ☉ If it had been given to order someone to prostrate themselves in front of someone other than God, I would surely have ordered women to prostrate themselves in front of their husbands...a woman cannot fulfill her duties toward God without first having accomplished those that she owes her husband.
- ☉ The virtuous woman is the one who engenders joy every time her husband looks at her; and who obeys him as soon as he orders her, and who preserves her chastity and his belongings in his absence.<sup>3133</sup>

### The Zodiac Circle Shows That a Father and Son Can Swap Wives

Since *Allah* and Ezra were in the center of the zodiac circle with four goddesses in the corners, this meant that *Allah* and Ezra could share the marriage bed with the same woman (K 033:037). So *Muhammad* figured that *Allah* thought it was acceptable conduct for his adopted son, Zayd, to divorce his wife, Zaynab, so *Muhammad* could marry her.

This caused a scandal among the *Muslim* community since a father swiping the son's wife was unheard of, even in no-holds-barred Mediterranean port cities such as Corinth, as Saint Paul wrote:

It has been reported that there is sexual immorality among you [the Corinthians] of a kind that rarely occurs among pagans: A man has taken his father's wife (1Co 05:01).

*Muhammad* noticed that the moon occults many stars and planets along the ecliptic. So taking both the ecliptic and the zodiac circle into consideration, *Muhammad* thought that *Allah* approved of having four wives (Seasons) at a time (K 004:003) and an unlimited number of concubines and sex-slaves (K 004:023-024; 023:005; 033:050; 070:030).

<sup>3131</sup> Gibb & Kramers. *Encyclopedia*, p. 493, left column, *Salat* entry.

<sup>3132</sup> Gibb & Kramers. *Encyclopedia*, p. 495, right column, *Salat* entry.

<sup>3133</sup> Warraq. *Why*, p. 313.

Since the Seasons were at the four corners of the Zodiac, and each was juxtaposed next to approximately three months of the calendar, it was thought that *Allah* wanted to give his four favorites equal time in bed each year.

### Marriage and the Zodiac Wheel

That *Muhammad* thought of marriage in terms of a zodiac circle is evident from the *Koran*. If a husband rashly swears that he would never have sex with a wife again, *Allah* would forgive him if he waited four months before copulating again (*K* 002:225-226).

The idea behind the four-month waiting period to escape the oath is that the wife is considered the next Season and thus is not the same wife anymore. After all, the husband was allowed up to four wives, and this breaks down to one for each season.

Before a divorce can be finalized, the husband must have had no sex with that wife for three months. The idea behind this is that the wife as a Season is due her three months—the length of a season. When the season is over, it as though the wife as a Season is over with too (*K* 065:001, 004).

This waiting period after divorce also applied to preteen marriages involving prepubescent girls.<sup>3134</sup> In the *Koran* chapter entitled “The Divorce,” *Muhammad* said:

As for those of your women who have despaired of menstruation [past menopause], if you have a doubt, their prescribed time shall be three months [waiting period before divorce is final], along with those who have it [menstruation] not [i.e. prepubescent girls] [the Arabic literally says “and those who never had menses”] (*K* 065:004a).

Notice how many events in *Islam* occur at one, two, three, four and twelve lunar month intervals: *Ramadan*, the *Haji*, divorce and remarriage and the like. It is imperative that everything happen according to schedule too—as though *Muslims* were in a life-long military training camp.

If an event does not happen on schedule, *Allah* does not honor the activity and does not dispense his forgiveness or favors. This is exactly what one would expect of a war-and-moon-god religion!

That *Muhammad* thought of marriage in terms of a zodiac circle is evident from his biography. With *Muhammad*, sexual relations were, for the most part, serial and rotational and by the lunar month.

Sometimes *Muhammad* made the round of all his wives in one night and sometimes the wives took turns while he slept with one wife per night. It was as though he were the sun moving through the zodiacal constellations, or the moon occulting one star or planet after another.

*Allah* however did not make *Muhammad* adhere closely to the zodiac circle. *Sura* 033 is full of liberties allowed *Muhammad* that are not allowed other *Muslims*, for instance:

You may defer the [conjugal] turn of any of them [*Muhammad's* wives] that you please, and you may receive any that you please; there is no blame on you if you invite one whose turn you had set aside. This is better for the wives so they do not grieve but gain satisfaction (*K* 033:051).

This probably goes back to how the lunar month is sometimes twenty-nine days and other times thirty days, meaning that *Allah* and *Muhammad* could go as slow or

<sup>3134</sup> Spencer. *Disturbing*, p. 47.



as fast as they pleased. Aisha however saw *Muhammad's* entire pattern of conduct and called the score as she saw it:

I feel that your [*Muhammad's*] Lord [*Allah*] hastens in fulfilling your wishes and desires (*Sahih Bukhari*, vol. 6, bk. 60, no. 311).

So the zodiac circle and night sky seemed to provide the answer to *Muhammad's* moral and ethical questions. This is similar to how *Muhammad* said that *Allah* guided *Ibrahim* by seeing the moon (*Koran* 006).

The Bible however condemns astralism and implicitly condemns people who follow the mores of moon-god cultures. The Bible shows what problems arise when Abraham, Jacob, David, Solomon and others followed the custom of the moon-god worshipping cultures around them.

Some of the Bible Greats got the idea of polygyny from the moon-god culture around them. Also, Sarah got the idea from the surround cultures of having the handmaid Hagar serve as a surrogate mother (Gen 16:01-04).

Unfortunately, *Muhammad* was not repulsed by moon-god religion morality but actually codified it into *Sharia* law. This shows *Muhammad* to be a moon-god worshipper at heart.

### The Zodiac and Legalized Prostitution

At first *Muhammad* had an even more liberal interpretation of the zodiac and moon phases and he allowed *Muta* temporary marriages. *Muslims* once contracted for temporary marriages lasting days, weeks, months or years. *Sunnis* allege but *Shias* deny that *Muhammad* had second thoughts and then abolished this form of legalized prostitution and wrongful cohabitation.

One *Hadith* pertaining to the subject of *Muta* marriages is:

Sabra *Al Juhanni* reported on the authority of his father that while he was with *Allah's* Messenger...he said: O people, I had permitted you to contract temporary marriage with women, but *Allah* has forbidden it (now) until the Day of Resurrection. So he who has any (woman with this type of marriage contract) he should let her off, and do not take back anything you have given to them (as dower [or brideprice]) (*Sahih Muslim*, bk. 008, no. 3255).

*Shias* allege that *Sunnis* omitted certain phrases out of the *Koran* so as to outlaw the concept of *Muta* marriages. One passage that probably pertained to *Muta* marriages is *K* 024:033 where men are allowed to pimp their slaves unless the slave objected. The text says that even if the slave objected, nevertheless the sex-slave owner is assured of *Allah's* forgiveness anyway.

*Muta* (or *Siqeh*<sup>3135</sup>) marriages are still a common practice among *Shias*.<sup>3136</sup> Significantly, *Sunnis* seem to be splitting hairs when they condemn the *Shias* over *Muta* marriages. This is because *Sunnis* advise against but do not condemn similar types of marriage. These include *Urfi*, meaning “not registered (marriage),” and *Mesyar*, meaning “traveler’s (marriage).”<sup>3137</sup>

In *Mesyar* [or *Misyar*] marriages, a traveler or foreign worker may serially cohabit with one, two or more women while away from his home town. *Urfi*

<sup>3135</sup> “Iranian Women Demand Change in the Constitution,” iran-press-service.com, 13 June 2005, C&R.

<sup>3136</sup> Guillaume. *Islam*, pp. 103-104.

<sup>3137</sup> *Al Salak*, Omaimah. “Mesyar: A Convenience or Contentious Issue,” arabnews.com, 22 Jun 2003, and Kamel, Yomna & Rasha Mehyar. “Yet another marriage without strings,” *Middle East Times*, metimes.com, 7 Apr 2000.

marriages are commonly used in Egypt for couples who want to have what the West refers to as pre-marital sex. *Urfi* marriages involve a signed and witnessed document but are not registered and end simply by destroying the document.<sup>3138</sup>

All these forms of temporary marriages are just forms of prostitution. Of course the real reason these temporary marriages are not immediately condemned is that traditional *Muslim* marriage arrangements are not much different. Under *Sharia* law a man can tell the women three times “I divorced you” and the marriage is over. *Muslims* practice easy divorce, a practice condemned by Jesus (Mat 19:03-09).

### The Zodiac and the Four Favorite Wives

Since the Four Seasons of the Zodiac circle each have three months with zodiac signs, *Muhammad* thought that *Allah* wanted the four wives treated equally (*K* 004:129). Moreover, each of the four wives or favorites represented by the Seasons ought to get at least three times the attention of any one sex-slave or concubine, who were represented by the twelve zodiacal constellations.

So *Muhammad* divided his wives into two classifications: “intimate” (*Muqarribat*) and “remote” (*Ghair Muqarribat*). *Muhammad*’s four intimates corresponding to the Seasons were Aishah, Hafsa, *Umm* Salma and Zaynab. Some of his remote wives were *Um* Habeeba, Maimoona, Sawda, Juweiriyeh and *Sufia*.<sup>3139</sup>

*Sirius* was not a star in a zodiacal constellation, yet *Sirius* represented the Season Fall on the zodiac circle and seemed to be a favorite of *Allah*’s (*K* 053:049). Since *Sirius* was not near the ecliptic, *Allah* the moon-god does not occult it. What this told *Muhammad* is that it was acceptable to marry women but not consummate the marriage, or stop have sex for a time or altogether. *Muhammad* put these provisions into practice.

*Muhammad* never consummated his marriages with wife number sixteen, Asma, daughter of No’man, nor with wife number seventeen, *Fatima*, daughter of *od-Dahhak*.<sup>3140</sup> Also, wife number two, Sawda, apparently reached menopause and so could have no children. It was agreed that another wife, Aisha, would receive Sawda’s allotted time for sexual intimacy with *Muhammad*.<sup>3141</sup>

Once in keeping with *K* 004:034, *Muhammad* had no sex with his *Harem* for an entire lunar month because he thought they were becoming unruly. During this month *Muhammad* cohabited exclusively with his new “flame,” the Christian *Coptic* concubine Mary.

### The Zodiac and Sexual Domination

Since the male moon was the only highly visible object occulting other objects in the sky, *Muhammad* concluded that polyandry was not acceptable.

### The Zodiac Circles and the End of Intercalation

Since *Muhammad* thought that the crescent in the center of the zodiac was *Allah*, *Muhammad* figured that the cycle of months and moon phases were most important. Thus he unhitched the *Mekkan* calendar from the sun to create a lunar calendar.

<sup>3138</sup> “Single mom [Hind *el-Hinnawy*] breaks taboos in Egypt,” *cnn.com*, 27 Feb 2005.

<sup>3139</sup> Caner & Caner. *Unveiling*, p. 135.

<sup>3140</sup> Dashti. *Career*, p. 125.

<sup>3141</sup> Dashti. *Career*, p. 123.

A lunar calendar is consistent with the Mideast view that the moon-god was the high-god. It is also consistent with how *Muhammad* said *Ibrahim* came to know the moon as *Allah*, and the sun and stars as mere creatures (K 006).

The West's calendar was solar, unlike the Mideast lunar calendar, because the high-god in the West was the sun-god. The West unhitched its calendar from the moon so the waxing crescent drifts through the months rather than always landing at the start of the months. This was discussed in a previous chapter.

Therefore, *Muhammad* decided to end the age-old practice of intercalation where every third year was thirteen months long. The practice of intercalation had been old enough so that the meanings of the Arabic names for the months actually correlated to the seasons that they were in. Now that the *Muslim* calendar is lunar, the months and festivals drift through the West's solar year.

The zodiac commonly had twelve wedges with twelve zodiac signs that *Muhammad* took to mean twelve months. *Muhammad* said:

Surely the number of months with *Allah* is twelve months in *Allah's* ordinance since the day when He created the heavens and the earth, of these four being sacred (K 009:036).

The reason *Muhammad* felt so sure that *Allah* had designated only twelve months is that *Allah's* crescent-moon was usually found in the middle of the zodiac circles. For a moon-god worshipper like *Muhammad*, zodiac circles were analogous to the stone tablets of the Ten Commandments that were handed down to Moses.

The zodiacs were often carved or made out of mosaics and had twelve wedges for the twelve constellations that roughly lined up with the twelve months of the year. So *Muhammad* thought that *Allah* had set in stone the number of months at twelve.

*Muhammad* disliked the idea of mentally adding a thirteenth wedge month to the zodiac circles. Intercalation was done to bring the months in alignment with the seasons and to ensure that the vernal equinox landed in a certain month each year.

Another account that may have confirmed in *Muhammad's* mind that the number of months was twelve was the spiritual rock in the wilderness (1Co 10:04). It is recounted in the *Koran*:

We [*Allah*] divided them into twelve tribes, as nations; and We revealed to *Musa* [Moses] when his people asked him for water: 'Strike the rock with your staff, so out flowed from it twelve springs; each tribe knew its drinking place' (K 007:160).

The picture of the "Well in the Wilderness" scene in the *Dura-Europos* synagogue shows Moses next to a well with twelve rivulets gushing forth. Each stream winds its way to one of the twelve tribes who are represented by an *Israelite* standing in a tent.<sup>3142 3143</sup>

Art historians have said the zodiac circle inspired the "Well in the Wilderness" scene.<sup>3144</sup> This agrees with how each of the twelve tribes of *Israel* has been assigned a zodiac sign. Many *Menorahs* and other Jewish objects sport zodiac signs that are said to represent the twelve tribes of *Israel*.

Which tribe has which sign varies according to the Jewish authority cited. Signs are usually assigned to each tribe based on descriptions of the tribal founder in: 1)

<sup>3142</sup> Gutmann. *Dura-Europos*, pp. 141, 176 (fig. 2).

<sup>3143</sup> Goodenough. *Symbols*, Plate 47.

<sup>3144</sup> Goodenough. *Symbols*, pp. 119, 235, 254-256.

Gen 49, 2) the order the tribes were blessed in Deu 27:12-13 and Deu 33 and 3) other Bible imagery such as is found in Ezekiel.

To the astral-minded *Muhammad*, the watering stone may have represented the sun or moon, and the twelve streams the divisions of the zodiac. *Muhammad* probably figured the men in the twelve tents were the astral angels in their zodiacal constellations. This was close to the Jewish interpretation anyway. In Jewish thought a zodiac sign represented each of the twelve tribes.

In some English translations of the *Koran* the zodiac signs are called “mansions” and “houses.”<sup>3145</sup> This strengthens the supposition that when *Muhammad* looked at the “Well in the Wilderness” scene in a synagogue, he would have thought of the men by their twelve tents as being angels manning zodiac constellations.

*Muhammad* thought that calendar intercalation meant there was undue deference to the sun and Seasons, whom the pagans thought were deities (*K* 027:024; Satanic Verses).

*Muhammad* came to believe that mere angels manned the sun and constellations, so *Muhammad* believed that any form of intercalation was a manifestation of polytheism, so he put these words in the *Koran*:

Surely the number of months with *Allah* is twelve months in *Allah*'s ordinance since the day when He created the heavens and the earth, of these four being sacred; that is the right reckoning; therefore be not unjust to yourselves regarding them, and fight the polytheists all together as they fight you all together; and know that *Allah* is with those who guard (against evil) (*K* 009:036).

*Muhammad* knew that others thought intercalating a month here and there had the effect of actually delaying the designated holy months. *Muhammad* however thought that the cycle of holy months never adjusted for the seasons. The historian *Al Tabari* (839–923 AD) wrote:

The third function [of the group called the *Mudar*] was the *Nasi*, the delaying or postponement of the sacred months (by intercalation)...When *Islam* came, the sacred months had returned to their original times and God established them firmly and abolished the ‘postponement’ (*Nasi*).<sup>3146</sup>

Due to intercalation, *Muhammad* thought that the people were lucky if they happened to be celebrating the holy months in the correct months:

Postponing (of the sacred month) is only an addition in unbelief, wherewith those who disbelieve are led astray, violating it one year and keeping it sacred another, that they may agree in the number (of months) that *Allah* has made sacred and thus violate what *Allah* has made sacred; the evil of their doings seems fair to them; and *Allah* does not guide the unbelieving people (*K* 009:037). Notice how in the above verse *Allah*'s guiding is connected to keeping a lunar religious calendar.

*Muhammad* thought that other nations that used a solar calendar or a solilunar calendar were not guided by *Allah* the moon-god because they did not use the lunar religious calendar. *Muhammad* thought that Jews intercalated out of deference to Ezra the sun-god, and the Christians intercalated out of deference for Jesus the sun-god.

<sup>3145</sup> Compare the *Yusuf Ali*, *Shakir* and *Pickthall* translations of *K* 010:005; 015:016; 025:061; 036:039; 085:001.

<sup>3146</sup> *Tabari*, *Annals*, vol. 1, 1988 AD, p. 1134, p. 55, quoted in Peters. *Origins*, p. 12.

*Muhammad* often said that *Allah* guided. Interestingly, Moshan Fani wrote that the *Muslim Sufis* see the moon as being a spiritual guide:

The sight of *Halal* [*Sic*], ‘the new-moon,’ is seeing the eyebrows of the perfect spiritual guide.<sup>3147</sup>

Anthony Troyer remarked on Moshan Fani’s above statement thus:

The apparition of the new-moon is to the *Muhammadans* an important phenomenon, as it marks the beginning of their feasts and other religious practices, which to be valid must be observed exactly at the prescribed time. On that account, the magistrates in the *Mussulman* empire are attentive to announce the right epoch; the *Muezzins*, or ‘criers,’ of the highest *Mosques*, at the approach of the new-moon pass the whole night on the top of *Minaret* to observe the precise moment [the appearance of the sliver of the moon]. Thus the fast of the *Ramazán* [*Ramadan*] which lasts thirty days, begins at the apparition of the new-moon; the commencement of the moons *Shewel* and *Zilhijah* are important for the celebration of the two only feasts in the *Muhammadan* year: the first is the *Aid-Fitr*, ‘the feast of breaking fast,’ which occupies one or three days, and seventy days after this is the *Aid-Kurban*, ‘the feast of the sacrifice,’ which lasts four days; thus the grave [i.e. serious-minded] *Mussulmans* allow but seven days of their whole year to festivity. As their years are lunar, these two feasts run in the space of thirty-three years through all the seasons of the year (D’Ohsson, tome II, p. 227; tome III, pp. 4-5 and elsewhere).<sup>3148</sup>

Tamara Green wrote that *Sin* the moon-god was viewed as a kind of an all-knowing guide:

The political prominence of *Haran* in the *Assyrian* period was due in large measure to its protecting deity. *Sin*, the god of the moon and giver of oracles, guardian of treaties, whose eye sees and knows all.<sup>3149</sup>

*Muhammad* told how *Allah* regulates the movement of the moon so humans can follow the lunar calendar for their fasts and festivals and so be saved:

...each one [the sun and moon] pursues its course to an appointed time; He regulates the affair, making clear the signs that you may be certain of meeting your Lord (*K* 013:002).

### Exactly When are the Four Sacred Months?

The whole idea of four sacred months has gone by the wayside in *Islam*. In fact, some *Muslims* debate exactly which four months of *Islamic* year were held sacred. This situation is ironic since *Muhammad* made a big deal out of not postponing the four sacred months via intercalation (*K* 009:037).

Any reader can figure out which four months were sacred by their meaning. This is especially the case if the reader knows that the sacred months were months of truce and the pilgrimages were bi-annual events occurring during the winter and summer equinoxes (*K* 106:002).<sup>3150</sup> In other words, the pilgrimages occurred approximately every six months.

<sup>3147</sup> Fani. *Sufis*, p. 56. The text has *Halal*, but perhaps it ought to read *Hilal*.

<sup>3148</sup> Fani. *Sufis*, p. 56.

<sup>3149</sup> Green. *Moon*, p. 21.

<sup>3150</sup> Peters. *Hajj*, pp. 33-34, 368, note 142.

To prove the above assertion, dear reader, please complete the following quiz and choose the four sacred months from the following list. Once you have selected four months, turn to the answers in footnote 3151.

The Meanings of the <i>Islamic Months'</i> Names			
<i>Islamic Month</i>	Meaning	<i>Islamic Month</i>	Meaning
1. <i>Muharram</i>	Sacred Month	7. <i>Rajab</i>	Respected
2. <i>Safar</i>	To be empty	8. <i>Shaban</i>	To gather [harvest]
3. <i>Rabia I</i>	Spring, fourth	9. <i>Ramadan</i>	Scorcher
4. <i>Rabia II</i>	Spring, fourth	10. <i>Shawwal</i>	To Rise
5. <i>Jumada I</i>	Dry Month I	11. <i>Dhul-Qada</i>	Truce
6. <i>Jumada II</i>	Dry Month II	12. <i>Dhul-Hijja</i>	Pilgrimage

The reason *Muslims* conveniently forget about the four sacred months is that *Muhammad* said offensive warfare during the holy months was heinous (K 002:217), unless the enemy attacks during a sacred month (K 002:194). Of course, with 164 War verses prompting offensive warfare all the time, *Muslims* cannot see themselves putting off fighting for four months each year, so *Muslims*:

- ☪ Pretend not to know about the *Koranic* prohibition against fighting during the sacred months and exactly which months are the sacred months,
- ☪ Figure K 002:217 no longer exists and was abrogated by the Sword Verse, or
- ☪ Find some form of persecution as a pre-text for *Jihad* or retaliation in order to meet the conditional waiver for fighting stated in K 002:217.

There ought not be any debate about which months the pagan Arabs held sacred. *Muhammad* even said that the two pilgrimages held during two of the holy months were held in “the well-known months” implying these months were long considered holy (K 002:197).

During *Muhammad's* time, the pilgrimages were six months apart on the equinoxes, but no longer fall on the equinoxes ever since *Muhammad* ended intercalation (K 009:036). There is no need to sleuth as to exactly which months these were since the *Hadith* records *Muhammad* naming the months as:

*Dhul-Qa'dah, Dhul-Hijjah, Muharram and Rajab.*<sup>3152</sup>

There are a few reasons why some *Muslims* want to obfuscate which months are sacred. In conflicts with the West, *Muslims* have claimed that *Ramadan* was a holy month where it would be sacrilegious to fight. *Muslims* do fast during *Ramadan*, but *Ramadan* is not one of the four holy months wherein *Muslims* are not supposed to fight. Besides, its name simply means “scorcher” which implies nothing sacred.

Ironically, *Muslims* have no compunctions about fighting during *Ramadan*. Egypt and Syria surprise-attacked *Israel* in October 1973 during *Ramadan*, even though Jews were celebrating the High Holy Day of *Yom Kippur*. *Muslims* even call this war The *Ramadan* War, showing they are not conflicted about having initiated a war during *Ramadan*. Jews call the *Ramadan* War the *Yom Kippur* War.

During the *Iran-Iraq* War (1980-1988), there was no letup during *Ramadan*. So obfuscation over the holy months means that *Muslims* can attack during any month

<sup>3151</sup> The four sacred months were: 1. The Sacred Month, 7. Respected, 11. Truce, 12. Pilgrimage (‘*Abd Al Fadi*, ‘*AbdAllah, Is the Quran Infallible?* light-of-life.com, p. 127). Also see Also, Curtiss. *Ursemitische*, p. 276.

<sup>3152</sup> *Sahih Bukhari*, vol. 4, bk. 54, no. 419; vol. 6, bk. 60, no. 184; vol. 7, bk. 68, no. 458; vol. 9, bk. 93, no. 539; *Sahih Muslim*, bk. 16, no. 4160; *Sunan Abu Dawud*, bk. 10, no. 1942.

of the year, but it would be sacrilegious for non-*Muslims* to counterattack during *Ramadan*, during the *Hajj* in the month *Dhul-Hijja* and so forth.

*Muslims* have other self-serving, one-sided restrictions on war-making. *Muslims* are always outraged if a *Mosque* is attacked or *Imams* are arrested in *Mosques*. *Mosques* though are used for *Jihadist* training, and are where bombs are made. Insurgents shoot out of *Mosque* doors and windows and snipe from *Minarets*. The US military stated about *Mosques* in *Iraq* in 2004:

The *Mosques* are suspected of participating in spectrum of insurgent activity, including harboring known terrorists, storing illegal weapons caches, promoting violence and encouraging insurgent recruitment.<sup>3153</sup>

The main reason *Muslims* feign not knowing which months are sacred is they want to dodge a command that *Muhammad* gave them. The command is not to ambush innocent pagans during the four sacred months (K 009:005). *Muslims* want “open season” on pagans to last all year long.

Four sacred months without fighting is just too much to bear for many *Muslims* because the 164 ethnocidal and genocidal verses that incite warfare and terrorism are read and discussed year-round.<sup>3154</sup> With this constant barrage of incitement, there can be no off-season when it comes to bagging infidels.

The Arab pagans, based on the zodiac circles, believed that *Allah* the moon-god held four months to be sacred. The other lesser deities divided up the remaining eight months of the calendar year.

Because pagans used an intercalated calendar, *Muhammad* thought the pagans sacrifice to *Allah* on the wrong months. So even when they intended to sacrifice to *Allah* during the four sacred months, the sacrifice failed to honor *Allah* and the honor went to other deities instead. The same could be said for pilgrimages. The foregoing explains why *Muhammad* thought that intercalation, or “delaying the sacred months,” was a sin (K 009:037).

The strict observance of the twelve months was important because the zodiac signs seemed to have indicated what offering *Allah* was to receive on what month. That the zodiac circle “guided” *Allah*’s followers in worship practice is consistent with astral religions, which is why zodiacs were common in the Mideast in the first place.

That Jewish zodiac circles influenced *Muhammad* may explain why he thought the sky, the sun, the moon, birds and other facets of nature were “signs” of *Allah* (K 010:005; 013:002; 016:079; 041:037).

Zodiac circles contain representations of astral objects, so *Muhammad* swears by the sun (K 084:016; 091:001), the moon (K 074:032), stars (K 053:001; 081:015), constellations (K 085:001) and meteors (K 056:075). *Muhammad* said:

O ye who believe! Violate not the sanctity of the [zodiac] symbols of *Allah*, nor of the sacred month, nor of the animals brought for sacrifice, nor the garlands that mark out such animals, nor the people resorting to the sacred house, seeking of the bounty and good pleasure of their Lord (K 005:002).

*Muhammad* came to believe that the *Helios* figure on a quadriga in the middle of the zodiac circle was not a sun-god, nor Ezra or Jesus. *Muhammad* believed the man was a moon-god worshipper, owing to the fact that a crescent-moon was displayed behind the figure. In fact, the zodiac imagery may explain this *Hanif* poem:

<sup>3153</sup> “Iraq:US-Iraqi forces raid Ramadi Mosques,” keralanext.com, 12 Oct 2004, LGF.

<sup>3154</sup> See the Contents section to locate the table on the *Koran*’s 164 War verses.

We lead the sacrificial animals walking obediently in iron, their shoulders exposed under the clothes.<sup>3155</sup>

In imitation of the quadriga in the Zodiac circle, the *Hanifs* may have hitched their steers to a chariot and then drove them to the *Kaaba* to be sacrificed.

*Muhammad* figured the worshipper was driving four bulls to be sacrificed and discounted the idea that the four “bulls” were in fact horses pulling a chariot. Driving animals to sacrifice at the *Kaaba* was celebrated in the *Hanif* verse quoted just above.

The bull was both a common moon-god symbol and sacrificial animal, so *Muhammad* probably dismissed the idea that the hoofed animals with crescents on their foreheads could be anything but bulls.

*Muhammad* even seems to have changed the sacrifice from camels to bulls in accordance with the zodiac circle. The *Koran* happens to mention sacrificing cattle to *Allah* (*K* 006:136, 138).

The reason that *Muhammad* made the switch probably has to do with the fact that the zodiac had no camels. The Jewish zodiac however does seem to have four bulls in the hub, and of course the *Taurus* bull zodiac symbol.

The early historian Tabari (839–923 AD) thought the switch from camel to bull sacrifices occurred because bulls were plentiful but camels were few. Tabari wrote:

The apostle ordered them to change the (normal) sacrificial animal and did so himself. Camels were hard to come by so he allowed them to offer oxen [an ox is an adult castrated bull bovine].<sup>3156</sup>

This explanation seems ludicrous since one would think that in the deserts around *Makka*, there would be many more camels than bulls.

There is another bit of *Islamic* tradition that seems to connect the zodiac to the *Kaaba*, specifically, the *Helios* sun character in the quadriga in the zodiac who drives the oxen. The historian Tabari wrote that Ka’b, a *Rabbi* convert to *Islam* said...

...on the Day of Resurrection, the sun and the moon will be brought as if they were two hamstrung oxen and flung into hell.<sup>3157</sup>

*Muhammad* thought that *Allah* wanted four bulls every twelve months based on the four “bulls” being driven to sacrifice in the middle of the zodiac circle. Since each bull’s forehead was marked with a waxing moon crescent, this suggested to *Muhammad* that *Allah* wanted one bull near the start of each of four sacred months. *Allah*’s four sacred months are usually given as the first, seventh, eleventh and twelfth months.

The *Umra*, the lesser pilgrimage, occurs in the month of *Rajab*, the seventh month. The *Hajj*, called the greater pilgrimage (*K* 009:003), occurred in the month of *Dhu Al Hijja*, the twelfth month.<sup>3158</sup> F. E. Peters wrote about the *Hajj* and *Umra*:

On the likelihood that the Arabs’ pilgrimage festivals of the seventh and twelfth months—the ordinal numbers are unimportant in this context—like the *Israelites*’ Tabernacles and Passover *Haggim*, [the *Hajj* and *Umra*] were both originally equinoctial feasts.<sup>3159</sup>

<sup>3155</sup> Ishaq. *Sirat*, p. 201, as quoted by Peters. *Origins*, p. 124.

<sup>3156</sup> Ishaq. *Sirat*, p. 531.

<sup>3157</sup> *Al Tabari. History*, vol. i, p. 233.

<sup>3158</sup> Peters. *Origins*, p. 216.

<sup>3159</sup> Peters. *Hajj*, p. 368, note 142; see also Peters. *Hajj*, pp. 33-34.



### **Islam's Pro-Lunar, Anti-solar Rites**

*Muhammad* said that the Queen of *Sheba* wrongfully worshipped the sun and did not exclusively worship *Allah* the moon-god, a.k.a. the *Sabian Ilumquh* (K 027:024). This was discussed in an earlier chapter (see *Sheba* in the Index).

There are other pro-lunar, anti-solar stories in the *Koran*. Given the anti-solar, pro-lunar stance in the *Koran*, it is not surprising that *Muhammad* revised the *Hajj* to be an anti-solar, pro-lunar rite.

The equinoxes fall six months apart, so in the Gregorian calendar, the equinoxes fall on March 21 and September 23. On the equinoxes, the sun is in the same constellations year after year. This can be verified with naked eye by viewing the constellations on the horizon shortly before sunrise and shortly after sunset.

Note how the pilgrimages in the *Islamic* calendar are only five months apart rather than six. This means that no two annual pilgrimages can ever fall on both equinoxes of any one year. *Muhammad* probably tweaked the calendar to bring about this change. This would have suited *Muhammad's* moon-god monotheism purposes since then the pilgrimages became a pro-lunar, anti-solar rite. Thus the *Hajj* and *Umra* would be like the *Muslim* pro-lunar, anti-solar rite of *Ramadan*.

The name *Ramadan* means “the scorcher.” During pre-*Islamic* times before *Muhammad* forbid intercalation, the month of *Ramadan* occurred during the hottest part of the summer every year. During the lunar month of *Ramadan*, *Muslims* are not allowed to eat, drink or have sex during daylight hours. All these said activities are allowed at night however indicating that *Ramadan* is a pro-lunar, anti-solar rite.

The lunar month after *Ramadan* is *Shawwal*, meaning “to rise.” This probably refers to how the pre-*Islamic* fast of *Ramadan* ends when the crescent-moon marking the month of *Shawwal* is sighted, or so to speak, “rises.” This moon marks the end of the month of *Ramadan* and the beginning of the next lunar month, *Shawwal*.

So during pre-*Islamic* times, the *Ramadan* fast during the daytime was a protest against the sun-god's oppressive heat. Breaking the fast each night was a celebration of the kindness of the moon-god who provided soft light and ushered in the coolness of the night. The fact that the sighting of the waxing crescent-moon starts and terminates the month-long fast further shows that *Ramadan* was a pro-lunar, anti-solar rite.

### **Solar and Lunar Religion Conflicts in the Ancient World**

The norm in the ancient world was to have the major festivals on the equinoxes. Ancient pagans generally were both pro-lunar and pro-solar just as the Indians had ceremonies similar to the *Hajj* and their pilgrimages fell on the vernal and autumnal equinoxes. This was the case with the *Makkan Hajj* and *Umrah* too.

Wherry wrote that “the ancient Arabians [i.e. Arabs] and Indians...[had] a great conformity of religions.”<sup>3160</sup> *Al Kindy* (830 AD/215 AH) wrote:

Knowest thou not that the same is the practice of the sun-worshippers and *Brahmas* in India at the present day? They make the circuit of their idol temples, with just these ceremonies, shaved and naked, or with the dress they call *Ihrām*. The only difference is that ye perform it once in the year at a movable season while they do it twice at certain solar conjunctions, one in the spring when the heat begins, the other in autumn when the cold sets in.<sup>3161</sup>

<sup>3160</sup> Wherry. *Commentary*, vol. i, section i, p. 38.

<sup>3161</sup> *Al Kindy*. *Apology*, under the section “Pilgrimage and rites of *Makka*,” p. 92.

Politics and wars were interpreted through mythology in the ancient world, as in Homer's *Troy*. Astral-god mythology drove religion and politics in the ancient world since the priests were usually powerbrokers too. The well-known rivalry between *Babylon's* Jupiter-god priests of *Marduk* and the priests of the moon-god *Sin* at *Haran* and *Ur* affected royal succession.

Examples also come from Egypt where *Amenhotop* promoted henotheistic *Amen-Ra* sun-god worship while his nephew *Akh-en-aton* championed the old polytheism. Egerton Sykes wrote about a solar versus lunar dispute in Egyptian mythology that undoubtedly affected politics, especially since the Pharaohs were considered sons of the solar deity:

Frazer attributes a lunar origin to *Osiris*, as did *Plutarch*. This might explain the violence of the fight with *Set* [an Egyptian solar deity].<sup>3162</sup>

Jews also practiced anti-astral rites as handed down from Moses, as the Roman historian Tacitus (~55 AD to ~120 AD) wrote:

They [Jews] slay the ram, seemingly in derision of *Hammon* [a sun-god], and they sacrifice the ox, because the Egyptians worship it as *Apis* [a moon-god]...the Jews have purely mental conceptions of deity, as one essence.<sup>3163</sup>

In a moon-god religion, it would seem that more bulls would be sacrificed as the moon waxed and fewer as it waned. In Num 29 however the number of bulls to be sacrificed during a lengthy Hebrew festival has no direct or inverse relationship to the day of the lunar month or phase of the moon.

Moses wrote down these rules in the *Sinai*, the Wilderness of *Sin*, some time after the *Israelites* made a golden calf to honor *Sin* the moon-god. Also, the whole while the *Israelites* were in the desert, some of them were secretly sacrificing to astral gods (Amo 05:25-27; Act 07:42-43). That some Mosaic sacrifices were anti-moon-god rites shows that *Yahveh* never was a moon-god.

The famous Jewish *Rabbi*, Moses Maimonides (1138-1204 AD), agreed that Moses' laws were written to counter *Sabeanism*. By Maimonides' day, *Sabeanism* had become synonymous with ancient Mideast astralism, as one can tell from his statement that *Sabeanism* had been "out of practice and entirely extinct since two thousand years":

I say that my knowledge of the belief, practice and worship of the *Sabeans* has given me an insight into many of the divine precepts and has led me to know their reason...Most of the 'statutes' (*Hukkim*), the reason of which is unknown to us serve as a fence against idolatry...If we knew all the particulars of the *Sabean* worship and were informed of all the details of those doctrines, we would dearly see the reason and wisdom of every detail in the sacrificial service, in the laws concerning things that are unclean and in other laws, the object of which I am unable to state...Every positive or negative precept, the reason of which is unknown to thee, take as a remedy against some of those diseases with which we are unacquainted at present, thank God.<sup>3164</sup>

By making some adjustments, *Muhammad* made other aspects of the *Hajj* into anti-solar rites too—as *Ibn Warraq* wrote:

The *Muslim* rites of running between *Arafat* and *Muzdalifah*, and *Muzdalifah* and *Mina*, had to be accomplished after sunset and before sunrise. This was a

<sup>3162</sup> Sykes. *Mythology*, *Osiris* entry, p. 164.

<sup>3163</sup> MacMullen & Lane. *Sourcebook*, pp. 161-162.

<sup>3164</sup> Maimonides. *Perplexed*, ch. XLIX (49).

deliberate change introduced by *Muhammad* to suppress this association with the pagan solar rite.<sup>3165</sup>

Similarly, Samuel Zwemer wrote about *Muhammad*'s "attempt to destroy the solar rite":

As soon as the sun was visible, the *Ifada* to *Mina* used to begin in pre-Islamic times. *Mohammed* therefore ordained that this should begin before sunrise; here again we have the attempt to destroy a solar rite. In ancient times, they are said to have sung during the *Ifada*: "*Ashrik Thabir Kaima Nughir*." The explanation of these words is uncertain; it is sometimes translated: 'Enter into the light of morning *Thabir*, so that we may hasten.'<sup>3166</sup>

*Muhammad* even made every noontime prayer an anti-solar rite, as Samuel Zwemer wrote:

The noonday prayer is never held at high noon but a short time after the sun reaches the meridian. Wensinck points out that this is due to the belief that the sun-god is really a demon and must not be worshiped by the monotheist. According to *Al Bokhari* [*Al Bukhari*] the Prophet postponed the noonday prayer until after high noon for 'the greatest heat of the day belongs to the heat of hell.' Nor is it permitted to pray shortly after sunrise for 'the sun rises between the horns of the devil.'<sup>3167</sup>

The *Shias* also have an anti-solar rite, as Bess Allen Donaldson wrote in 1937 AD:

At the vernal equinox, which is the Persian New Year, one should have a *Koran* in his lap when the sun gives the signal that 'the year has changed.' This gives him good luck for the coming year. But this blessing may be increased if he has learning, for by reading the *Sura Ya Sin*, this time, he is given the assurance that he will remain secure in his employment for the whole year.<sup>3168</sup>

So while a *Shia* observes the sun, he or she holds dear the *Koran* because it is moon-god literature, especially the *YaSin* chapter, which *Muhammad* called "the heart of the *Koran*,"<sup>3169</sup> and shows that *Allah* is *Sin* the moon-god.

### ***Muhammad* Rearranged the Months When He Instituted the Lunar Year**

*Muhammad* seems to have rearranged the months to further distance the pilgrimages from the equinoxes. Else, even with a lunar calendar, the *Hajj* and *Umra* would more or less line up with the equinoxes, March 21 and September 23, every dozen years or so. The reason is that the *Hajj* and *Umra* cycle through the solar calendar at a rate of eleven days per year since the lunar year is only 354 days long.

One can tell that the months were rearranged by looking at which months are currently sacred months. 'AbdAllah 'Abd Al Fadi wrote:

In *Bulugh Al 'Arab Fi Ahwal Al 'Arab*, we read, 'The four sacred months, *Rajab* [seventh month], *Dhu Al Qa'da* [eleventh month], *Dhu Al Hijja* [twelfth month] and *Muharram* [first month], had been considered sacred during the pre-Islamic period [the *Jahiliya*]'...Obviously, *Islam* borrowed the hallowing of

<sup>3165</sup> Warraq. *Why*, p. 40.

<sup>3166</sup> Zwemer. *Animism*, ch. 8.

<sup>3167</sup> Zwemer. *Animism*, ch. 3.

<sup>3168</sup> Donaldson, Bess Allen. "The *Koran* as Magic," *The Muslim World* (1937 AD), vol. 27, pp. 254-266, answering-*Islam.org*.

<sup>3169</sup> Maududi. *Meaning, Ya Sin Sura* Introduction.

these months from Pre-Islamic Arabs and introduced nothing new into the world.<sup>3170</sup>

*Muhammad* rescheduled the holy months so their ordinal numbers are first, seventh, eleventh and twelfth. However, in order for the holy months to fall on the equinoxes, they would need to be six months apart say, the first, sixth, seventh and twelfth.

That it was *Muhammad* who rescheduled the pilgrimages to be five months apart seems plausible since it seems inconceivable that pre-Islamic intercalators would have perpetually misaligned the pilgrimages with the equinoxes. Also, this would explain why *Muhammad* said the minor pilgrimage could be done during any month and not just the month of *Rajab*. This would serve to disassociate the *Umrah* pilgrimage from an equinox event, turning the *Umra* into an anti-solar event.

The bi-annual pilgrimage scheduling change probably occurred when *Muhammad* ended intercalation during his Farewell Pilgrimage (~631 AD) (K 009:037). One can ascertain this because in 632 AD, the *Umra* and *Hajj* still occurred in the same seasons as the equinoxes, spring and fall. In fact, in 632 AD the *Hajj* coincided with the Passover and Easter, which generally occurs near the Vernal Equinox.<sup>3171</sup>

Festivals tied to lunar calendars cycle backward through the solar calendar at a rate of about eleven days per year. That the Farewell Pilgrimage in 632 AD was in the same season as an equinox suggests that the *Hajj* and *Umra* pilgrimages had been equinoctial for centuries or even a millennium.

F. E. Peters agrees and wrote that intercalation was “certainly” banned during the Farewell Pilgrimage.<sup>3172</sup> This would explain how *Muhammad* was able to ban the pagans from attending the *Hajj* after his Farewell Pilgrimage (K 009:017-018, 028).<sup>3173</sup>

The following year the pagans would come during the equinoxes. *Muslims* however were following the new lunar religious calendar where the *Umra* and *Hajj* were five months apart and the lunar year was eleven days shorter than the solar year. Thus the pagans would come to the pilgrimages at the wrong time. Obviously, pagan pilgrims would no longer be able to blend in with *Muslim* pilgrims, so pagans could easily be kept away from the *Kaaba en masse*.

No one at the time gave much thought to *Muhammad's* scheduling the two pilgrimages only five months apart. The switch from the solar to the lunar religious calendar perhaps made the other schedule changes seem inconsequential. Besides, intercalators had added months and delayed the sacred months as long as anyone could remember, so it was of little concern (K 009:037).

### **The Ideal Alignment of the Jewish Zodiac and the Islamic Months**

Notably, the new scheduling of the pilgrimages jibed well with the zodiac circle icons. *Muhammad's* ideal alignment of the twelve zodiac signs and the twelve *Islamic* months are reproduced in the table just below.

*Muhammad* placed the *Umra* and *Hajj* five months apart (seventh and twelfth months rather than the sixth and twelfth months) so they would better line up with

<sup>3170</sup> ‘Abd Al Fadi, ‘AbdAllah, *Is the Quran Infallible?* light-of-life.com, p. 127.

<sup>3171</sup> Peters. *Hajj*, p. 58, and Peters. *Origins*, p. 252.

<sup>3172</sup> Peters. *Origins*, p. 251.

<sup>3173</sup> Peters. *Origins*, p. 251.

the 7. Archer, 8. Goat, 11. Ram and 12. Bull zodiac signs. Note that the Greco-Roman fishtailed Sea-goat sign commonly became the goat sign in Semitic zodiacs.

Since *Muhammad's* calendar is lunar, the constellation signs cycle through the lunar year. So every thirty-three years the zodiac signs line up with *Islamic* months as listed in the table below.

<b>The Ideal Alignment of the Jewish Zodiac &amp; Islamic Months</b>			
<b>Zodiac Sign</b>	<b>Meaning</b>	<b>Islamic Month</b>	<b>Meaning</b>
<i>Gemini</i>	Twins	1. <i>Muharram</i>	The Sacred Month
<i>Cancer</i>	Crab	2. <i>Safar</i>	To be empty
<i>Leo</i>	Lion	3. <i>Rabia I</i>	Spring, fourth
<i>Virgo</i>	Virgin	4. <i>Rabia II</i>	Spring, fourth
<i>Libra</i>	Scales	5. <i>Jumada I</i>	Dry Month I
<i>Scorpio</i>	Scorpion	6. <i>Jumada II</i>	Dry Month II
<i>Sagittarius</i>	Archer	7. <i>Rajab</i>	Respected
<i>Capricorn</i>	Goat	8. <i>Shaban</i> , or <i>Sha'aban</i>	To gather [harvest], disperse [winnow]
<i>Aquarius</i>	Water Bearer	9. <i>Ramadan</i>	Scorcher
<i>Pisces</i>	Fishes	10. <i>Shawwal</i>	To Rise
<i>Aries</i>	Ram	11. <i>Zulkadah</i> , or <i>Dhul-Qada</i>	Truce
<i>Taurus</i>	Bull	12. <i>Zulhijjah</i> , or <i>Dhul-Hijja</i>	Pilgrimage

In *Muhammad's* ideal calendar, the eleventh and twelfth months align with a Ram (*Aries*) a Bull (*Taurus*), two favorite moon-god sacrifices. Cattle, camels, rams or wethers (i.e. castrated rams), have historically been sacrificed during the *Hajj*. These animals are all moon-god sacrifices so this suggests *Allah* was a moon-god.<sup>3174</sup>

Significantly, camels were considered unclean by Jews (Deu 14:07). Perhaps this had less to do with their anatomy than with their association with moon-gods. The Bible speaks of crescent-moon decorations in connection to camels (Jdg 08:21, 26). Tracy Marks notes “Arabian camels were...hung with gold chains and crescents to win the favor of the gods...”<sup>3175</sup>

The twelfth month was the *Hajj* month and both the *Koran* and the traditions speak of “cattle” sacrifices (Shakir 005:095, 097; 022:026-037). Wendell Phillips wrote:

In ancient *Sheba*, the bull always represented *Ilumquh*, who was known under other names, one of which was *Thor* (Bull).<sup>3176</sup>

Remember that Egerton Sykes wrote that *Allah* “seems to have been preceded by *Ilmaqah* [also spelled *Ilumquh*] the moon-god.”<sup>3177</sup>

Religious connotations, practices and beliefs were derived from zodiac circles in the ancient world. After all, the zodiac circle represented God’s agents who affected the universe, weather and personal horoscopes. Lest Ness notes that *Rabbis* believed that even God read and heeded horoscopes in order to find the most propitious time and proper zodiac sign for taking action:

<sup>3174</sup> Daum. *Ursemitische*, p. 123.

<sup>3175</sup> Marks. *Makeda*.

<sup>3176</sup> Phillips. *Sheba*, p. 299.

<sup>3177</sup> Sykes. *Mythology*, p. 7, *Allah* entry.

In the *Midrash Pesikta Rabbati* [20:2; 53:2], we are told that the planets and signs of the zodiac were among God's first creations. The same work tells us that the law was revealed to Moses in the month of *Sivan* because *Sivan* is equivalent to [the Twins] *Gemini*, the first human sign, and it was more appropriate that the law be praised by a human than a ram or a bull [20].<sup>3178</sup>

*Muhammad*, thinking along the same lines as this *Midrash* writer, figured that the Twins and the Archer were good signs and months for pilgrimages. The Archer in Greco-Roman zodiacs was a *Centaur* holding a bow and arrow but in Jewish zodiacs the *Centaur* is replaced with a man. The Twins and the Archer signs happen to be next to moon-god sacrifices (see the above chart), which suggested to *Muhammad* what animals pilgrims ought to sacrifice to *Allah*.

The Twins are next to the Bull, a common moon-god symbol owing to its crescent-shaped horns. The Bull was next to the Ram, a common moon-god symbol owing to its curled horns. The Archer is next to the goat, another common moon-god symbol owing to its slightly curved horns. In Jewish zodiacs, common goats replaced the mythical fishtailed "sea-goats."

*Muhammad* noted that the Archer was a single man and the *Gemini* sign was two men. So the Archer represented the less well-attended *Umra* pilgrimage, while the Twins represented the *Hajj*, which was the greater pilgrimage (*K* 009:003).

Regarding the zodiac sign, the goat represented sacrifices at the *Umra* since it is next to the Archer sign. The Twins are next to the Bull. Clearly, the Bull is a greater sacrifice than the Goat, so the Bull must indicate the sacrifices at the greater pilgrimage, the *Hajj*.

The *Koran* may allude to how *Muhammad* thought some zodiac signs represented sacrifices and how the Archer represented a pilgrim. Note how *Muhammad* mentions sacrifices, pilgrimage and hunting all in the same verse:

O you who believe! Do not violate the [zodiac] signs appointed by *Allah* nor the sacred month, nor (interfere with) the offerings, nor the sacrificial animals with garlands, nor those going to the sacred house seeking the grace and pleasure of their Lord; and when you are free from the obligations of the pilgrimage, then hunt (*K* 005:002).

That the *Kaaba* had a zodiac circle is a given considering the strength of the evidence about the *Kaaba* being an astral temple. As was noted in a previous chapter, the historian *Masudi* (896-956 AD) said the learned thought the *Kaaba* was dedicated to the sun, moon and the five visible planets.

The 360 idols placed in a wide circle around the *Kaaba* stood for the 360 days of the year (twelve months with thirty days each). The seven circumambulations stood for the planetary days of the week, combined with the spiral motion of the sky. Otherwise, it may represent the rotation of the seven stars of the Big Dipper constellation. Ryckmans wrote about zodiacs in South Arabia:

Astrology also played a role; people asked for children endowed with 'a good astrological configuration,' and late reliefs figure the signs of the zodiac.<sup>3179</sup>

<sup>3178</sup> Ness. *Mosaics*, p. 152.

<sup>3179</sup> Ryckmans. *Anchor*, v. 6, p. 174.

### Human Sacrifice at the *Kaaba* in the Pre-Islamic Era

The knife-like crescent suggested to moon-god worshippers around the globe that sacrifice was required—even human sacrifice. In the New World, the pre-Aztec city of *Teotihuacan* north of Mexico City is known for its two towering pyramids dedicated to the sun and moon. The Pyramid of the Moon was “the site of horrifically gory sacrifices.” In just one tomb discovered so far there were ten decapitated bodies tossed against a wall. “Two other bodies were richly ornamented with beads and a necklace made of imitation human jaws.”<sup>3180</sup>

Apparently, *Makka* was no exception to the rule that Moon-gods demanded human sacrifice. Unfortunately however we do not have the unabridged version of *Ibn Ishaq’s* biography of *Muhammad*. The editor *Ibn Hisham* (died in 828 or 833 AD/213 or 218 AH) admitted that he omitted interesting details from *Ibn Ishaq’s* biography of *Muhammad*. Hisham wrote “...things which it is disgraceful to discuss; matters which would distress certain people...all these things I have omitted.”<sup>3181</sup> Guillaume admitted:

...a great deal of the original...may well be...lost—for it is clear that the scurrilous attacks on the prophet which *Ibn Hisham* mentions in his Introduction are not to be found anywhere.<sup>3182</sup>

*Ibn Hisham* may have omitted the fact that human sacrifices were offered at the *Kaaba*, human sacrifices that *Muhammad* seems to allude to in the *Koran*:

Even so, in the eyes of most of the pagans, their ‘partners’ made alluring the slaughter of their children in order to lead them to their own destruction and cause confusion in their religion. If *Allah* had willed, they would not have done so; but leave them and their inventions alone (*K* 006:137).

Human sacrifices were often offered up to Arabian gods and goddess, judging from various accounts of pre-Islamic Arabia.<sup>3183</sup> James Hastings wrote:

Testimony of a somewhat earlier date is supplied by *Porphyry*, who tells us (*De Abstin.* II 56) that ‘the people of *Duma*, in Arabia,’ annually sacrificed a boy and buried him under the altar, which served also as an idol...here we have another instance of the same object being used for both purposes [as a sacrifice and as an idol].<sup>3184</sup>

Ryckmans wrote:

But in the kingdom of *Himyar*, the historical rock inscriptions of the 3<sup>rd</sup> century AD at the sanctuary of the goddess *Shams* [the sun goddess] in *al-Mi’sal* mention the ritual slaughter of civilian and military prisoners as a sacrifice in gratitude for a military victory. A similar custom is mentioned in inscriptions of Ethiopian kings in the 4<sup>th</sup> century AD.<sup>3185</sup>

Gordon Newby wrote about a ruler in sixth-century AD *Yemen*:

*Mundhir* is reported to have sacrificed 400 Christian maidens to the goddess *Al ’Uzza* [Venus] and later sacrificed the son of his *Ghassanid* [tribe] enemy, *Arethas*, to the same goddess.<sup>3186</sup>

<sup>3180</sup> “‘Pyramid of Moon’ yields up grisly secrets: Archaeologists find decapitated bodies in *Aztec* tomb,” msnbc.msn.com, 2 Dec 2004.

<sup>3181</sup> Ishaq. *Sirat*, p. 691, “*Ibn Hisham’s* Notes.”

<sup>3182</sup> Ishaq. *Sirat*, p. xxxi, “Introduction.”

<sup>3183</sup> Hastings. *Ethics*, “Arabs (Ancient)” entry, p. 660, right column.

<sup>3184</sup> Hastings. *Ethics*, “Arabs (Ancient)” entry, p. 665, right column.

<sup>3185</sup> Ryckmans. *Anchor*, v. 6, p. 174.

<sup>3186</sup> Newby. *Arabia*, p. 45.

Human sacrifices were also offered up to moon-gods and not just to Venus. The *Sin* moon-god priests at *Haran* practiced human sacrifice.<sup>3187</sup> Tamara Green wrote:

An eight-century BCE judicial text from *Haran* declares that in case of a violation of contract, the delinquent must burn his eldest son on the altar of *Sin* [the moon-god] and his eldest daughter on the altar of *Belit-Seri*, who is Venus.<sup>3188</sup>

That *Sin* was a god of contracts is interesting because *Allah* was too. Carl Brockelmann wrote: “*Allah* was actually the guardian of contracts...”<sup>3189</sup> The *Makkans* were known as merchants. To broker deals with other Arabs and Mideasterners was probably much easier if both parties honored the same high god. In the Mideast, this “same” god most often would have been a moon-god.

*Muhammad* said that the contract had to be entered into at the *Kaaba* (“the Sacred *Mosque*”), probably over the *Hatim* wall was meant (*K* 009:007). The *Koran* has a surprising number of verses on interest payments too (*K* 002:275-283; 003:130; 030:039).

In connection with contracts, the *Koran* indicates that the *Kuraish* worshipped *Allah* (*K* 029:061, 063; 043:087) and the strongest pre-*Islamic* oaths were by *Allah* (*K* 006:109; 016:038; 024:053; 035:042).

One can presume that upon violation of a *Makkan* contract, hostages were slaughtered upon the crescent-shaped *Hatim* Wall at the *Kaaba*. For instance, in one well-known tradition, when *Muhammad*’s grandfather *Muttalib* wanted to break his vow to sacrifice a son (*Muhammad*’s father) to *Allah*, *Muttalib* had to instead sacrifice one hundred camels. The steep price showed how badly the demon *Allah* wanted a human sacrifice.

Tamara Green wrote about a human sacrifice in a moon temple at *Haran*:

...Theodoret, the fifth-century ecclesiastical historian and Bishop of *Cyrrhus*, who reports that when the sealed temple at *Haran* [the “City of the Moon”] was opened after the death of the Julian [the Apostate], ‘there was seen a woman hung on high by the hairs of her head and with her hands outstretched. The villain had cut open her belly and so, I suppose, learned from her liver his victory over the Persians [sarcastically speaking].’<sup>3190</sup>

*Al Kindy* wrote in his *Apology* around 830 AD that the *Haranians* were still practicing human sacrifice in his day:

We know from the *Book of Genesis* that Abraham lived with his people four-score years and ten, in the land of *Harrân*, worshipping none other than *Al Ozza* [*Uzza*], an idol famous in that land and adored by the men of *Harrân* under the name of the moon [actually, *Uzza* is Venus, not the moon], which same custom prevails among them to the present day. They conceal no part of their ancestral practices, save only the sacrifice of human beings. They cannot now offer up human sacrifices openly; but they practice the same in secret.<sup>3191</sup>

A well-known *Islamic* tradition says that Ishmael, his mother Hagar, and...

...a whole series of prophets, numbering in the hundreds, is said to have been buried round the *Kaaba*.<sup>3192</sup>

<sup>3187</sup> *Al Kindy. Apology*, p. 17.

<sup>3188</sup> Combe. *Culte du Sin*, p. 61, as quoted in Green. *Moon*, p. 35.

<sup>3189</sup> Brockelmann. *Peoples*, p. 9; also see *K* 009:006.

<sup>3190</sup> Theodoret, *Ecclesiastical History*, III:21, as quoted in Green. *Moon*, p. 51.

<sup>3191</sup> *Al Kindy. Apology*, p. 17.

<sup>3192</sup> Gibb & Kramers. *Encyclopedia*, p. 197, *Kab’ah* entry.



The semicircular area called the *Hijr* even has two marble grave markers for Hagar and Ishmael—so *Muslims* at the *Kaaba* circumambulate around a graveyard!

Another well-known tradition is that *Muhammad's* grandfather *Muttalib* nearly made a human sacrifice of *Muhammad's* father, *Abdullah* [Servant of *Allah*] to *Allah*.<sup>3193</sup>

When evaluating these traditions, one must consider how pagan artwork and myths were recycled and how the pagan *Kaaba* and its environs were reinterpreted into a pseudo-Biblical context, as Zwemer wrote:

Pagan practices are explained away by inventing *Muslim* legends attributed to Bible characters, and the whole is an incomprehensible jumble of fictitious lore.<sup>3194</sup>

So the tradition of hundreds of burials round the *Kaaba* can be taken as an admission that the *Makkans* recollected a time when male and female virgins were sacrificed on the crescent-shaped *Hatim* altar and then buried in the *Hijr* area and near the *Kaaba*. This agrees with the conclusions of other scholars, as John Van Ess wrote:

At *Makka*, *Allah* was the chief of the gods and the special deity of the *Quraish*, the prophet's tribe. *Allah* had three daughters: *Al Uzza* (Venus) most revered of all and pleased with human sacrifice.<sup>3195</sup>

Hafiz Ghulam Sarwar wrote:

The blood of the sacrificial animals brought by the pilgrims was offered to the deities in the *Kaaba* and sometimes even human beings were sacrificed and offered to the god...Besides idol worship, they also worshipped the stars, the sun and the moon.<sup>3196</sup>

So, one can see that *Muslims* at the *Kaaba* circumambulate around a graveyard full of human sacrifices.

Someone might ask why sacrifices to a moon-god would be buried in a plot of ground next to a crescent-shaped altar rather than burned on the altar? Perhaps the sacrifice was burned and only the ashes were buried.

Many ancient astral deities such as the gods associated with the sun and moon were considered both heavenly and chthonic, underworld deities. During the night the sun was thought to be traveling through the underworld, so the night-sun was worshipped as a chthonic or underworld power.

The ancients did not have a problem with multi-form and multi-phase gods. Prime examples include Venus, the Morning and Evening Star, and the moon with its phases.

The *Encyclopedia Britannica* states:

...sacrifices to the chthonic or underworld powers were frequently buried rather than burned or, if burned, burned near the ground or even in a trench.<sup>3197</sup>

Many people were more concerned about appeasing the underworld deities. They sensed that most of their existence would be spent in the hereafter and that their ultimate fate was in the hands of underworld powers. Joseph Campbell wrote:

<sup>3193</sup> Peters. *Origins*, p. 82.

<sup>3194</sup> Zwemer. *Animism*, ch. 8.

<sup>3195</sup> Van Ess, John. *Meet the Arab*. The John Day Company, New York, 1943, p. 29.

<sup>3196</sup> Sarwar. *Prophet*, pp. 18-19.

<sup>3197</sup> *EB*, accessed 15 Mar 2003, Sacrifice entry.

We are told also why the sublimer scenes in the Mysteries were always in the night. The life of the interior spirit is the death of the external nature; and the night of the physical world denotes the day of the spiritual. *Dionysus*, the night-sun, is therefore worshipped rather than *Helios*, orb of day.<sup>3198</sup>

Moshan Fani wrote in *The Dabistan* (~1645 AD) that the learned regard the *Kaaba* and the *Zamzam* well by the *Kaaba* as emblems of the sun.<sup>3199</sup>

The fact that *Zamzam* is a well and the color of the *Kaaba* is black may suggest that the “learned” had the night-sun in mind. Gibb and Kramers wrote:

One typical characteristic of the lower world is certainly possessed by *Makka*. It is described as a tomb. Not only *Isma'il* [Ishmael] but a whole series of prophets numbering hundreds is said to have been buried round the *Kaaba*.<sup>3200</sup>

For three days at the end of each lunar month, the moon did not make an appearance and was thought to be in the netherworld. Since the sacrifices were buried next to a crescent-shaped altar, they may have been chthonic sacrifices made at the end of the month when the moon was not visible.

The zodiac circle may have helped the *Makkans* come to the conclusion that *Allah* wanted human sacrifice. Naturally, one or more of the Seasons, *Allah's* daughters, would be adjacent to a human zodiac signs such as the Twins, the Virgin, the Archer and the Water Bearer.

Instead of thinking the human sign meant the goddess wanted pilgrims to go on pilgrimage, some pagans may have thought that the goddess and *Allah* wanted human sacrifice during that month and season.

Depending on the particular zodiac circle (no two were exactly alike), the Seasons would often align with both human and non-human figures. Perhaps in the zodiac that *Muhammad* used, the Season he thought was *Uzza* was juxtaposed next to *Aries* the Ram (a male sheep). This may be why *Muhammad* offered a white ewe (female sheep) to Venus.<sup>3201 3202</sup>

*Muhammad's* sacrificing to the goddess of love, Venus, might show the early onset of *Muhammad's* out-of-control sexuality. This “*Muhammad* as a pagan” incident goes a long way in explaining how *Muhammad* later bought into the idea of there being *nymph* nymphomaniacs *Houris* in heaven.

### **Muslims View the Slaughter of Infidels as Human Sacrifices**

*Muslims* did not actually stop offering *Allah* human sacrifices. Other forms of human sacrifice to *Allah* include: slaughtering non-*Muslims* in *Jihad* warfare and terrorism, and Legal *Jihad* whereby blasphemers and apostates from *Islam* are killed.

*Muhammad* said that in *Jihad* *Muslims* ought to “smite the necks” of infidels (*K* 008:012; 047:004). Why did he not say to just run infidels through with a sword or a spear? Because a knife to the throat is the proper form of *Halal* sacrifice to *Allah*. *Islamists* who think of infidels as sheep to be slaughtered include:

• In 2005, the *Imam* of Omar *Al Mukhtar Mosque* in *Baghdad* said:

<sup>3198</sup> Campbell, Joseph. *Theosophy*, v46n5, Mar 1958, pp. 223-229, wisdomworld.org.

<sup>3199</sup> Fani. *Dabistan*, p. 394.

<sup>3200</sup> Gibb & Kramers. *Encyclopedia*, p. 197, *Kab'ah* entry.

<sup>3201</sup> *Al Khargushi*. *Sharaf Al Mustafa*, as cited by Peters. *Origins*, p. 127.

<sup>3202</sup> *Al Kalbi*. *Idols*, pp. 16-17.

I say to the *Iraqis* whoever cannot slaughter (a sheep) on the Feast of Sacrifice, should take and American soldier and slaughter him.<sup>3203</sup>

- ☉ In 2001, Mohamed Atta, one of the leaders of the 9/11 terrorists, wrote in his notes to himself:

Check your weapon before you leave and long before you leave. (You must make your knife sharp and must not discomfort your animal during the slaughter)...If God decrees that any of you are to slaughter, dedicate the slaughter to your fathers...because you have obligations toward them. Do not disagree, and [but] obey. If you slaughter, do not cause the discomfort of those you are killing, because this is one of the practices of the prophet, peace be upon him.<sup>3204</sup>

- ☉ In a trial during 2005, it was revealed that Bouyer, the *Islamist* who was just a few strokes shy of cutting off the head of Theo van Gogh, “stole sheep from a farm to practice slaughtering.”<sup>3205</sup>
- ☉ Andrew Bostom wrote:

Lord Kinross described the slaughter of the Armenian community of *Urfa* [Turkey] in December 1895:

When a large group of young Armenians were brought before a *Sheikh*, he had them thrown down on their backs and held by their hands and feet. Then, in the words of an observer, he recited verses of the *Koran* and ‘cut their throats after the Mecca rite of sacrificing sheep.’<sup>3206</sup>

Several observers of *Islamdom* have called *Islamic* terror attacks, especially those with high body counts, “human sacrifice.”<sup>3207</sup> The mothers of so-called martyrs refer to their terrorists sons and daughters as “sacrifices.”<sup>3208</sup> One terrorist said he...

...wanted to carry out the sacrificial murder because of his hate for *Israel*.<sup>3209</sup>

Even women’s magazines specifically printed for *Muslim* terrorists make this point about suicidal attacks on non-*Muslims*:

*Al-Khansa* also appears to be linked to the most well known *Jihadist* outlet on the Internet, *Sawt Al-Jihad*—or ‘*Voice of Jihad*’. The first edition of the magazine uses fierce language similar to that found on *Sawt-Al-Jihad*. One of its encouragements to *Jihad* reads: ‘The blood of our husbands and the body parts of our children are our **sacrificial offering**.’<sup>3210</sup>

In ancient times third parties could participate in sacrifices and purifications merely by paying for the purification rite (Act 21:24) or sacrifice (2Sa 24:24). This

<sup>3203</sup> “*Iraqi Sunni Imam Tells of Tortures and Calls on Iraqis to Slaughter American Soldiers for the Muslim Holiday*, MEMRI, 22 Nov 2005, Clip No. 937, *JW*.

<sup>3204</sup> “Last words of a terrorist,” *The Observer*, guardian.co.uk, 30 Sep 2001.

<sup>3205</sup> Broere, Wendel. “Dutch *Islamist* trial hears of gruesome films,” yahoo.com, 5 Dec 2005, *C&R*.

<sup>3206</sup> Bostom, Andrew. “Goebbels and the *Jihadist* Youth,” americanthinker.com, 11 Apr 2006.

<sup>3207</sup> Peters, Ralph. “Nothing *Islamic* about human sacrifice [meaning terrorism is is human sacrifice, but it is not *Islamic*, or so says Peters],” usatoday.com, 16 Nov 2004; also Charles Johnson, LGF, points this out. Google “human sacrifice” or “child sacrifice”

site:littlegreenfootballs.com, or use the LGF web blog’s search function.

<sup>3208</sup> “MEMRI TV Project: Mothers of *Hizbullah* Martyrs: ‘We are Very Happy and Want to Sacrifice More Children,’” MEMRI, Dispatch 819, 25 Nov 2004, *LGF*.

<sup>3209</sup> “Israeli Arab admits attempting to kill Jewish man,” Haaretz.com, 26 Nov 2004.

<sup>3210</sup> Usher, Sebastian. “‘*Jihad*’ magazine for women on web,” news.bbc.co.uk, 24 Aug 2004, *LGF*, *JW*, 25 Aug 2004.

reminds one of how *Muslims* regularly pay the families of suicide-bombers and dead terrorists, for instance:

Meanwhile, Interior Minister Bhokin Bhalakula [of *Thailand*] said Sunday that a *Malaysian* youth group's offer last week to raise 1 million *Ringgit* (USD \$264,000, *Euro* 204,000) for the [*Muslim*] families of [*Muslim*] victims of the Oct. 25 [*Muslims*] riot was 'unacceptable' and an 'act of interference by Malaysia.'<sup>3211</sup>

*Muslims* will send money to the families even though in many cases there is no financial need. Suicide-bombers often came from middle-class families and the miniskirt-chasing suicide-bomber was not the breadwinner supporting the family. Furthermore, if anyone was really in need, it would be the victims of the skirt-chasing suicide-bomber.

This all shows that when Saddam Hussein of *Iraq* sent up to 25,000 USD to the miniskirt-chasing suicide-bomber's family in Palestine, they actually are paying to participate in the human sacrifice to *Allah*. Interestingly, Saddam sent money he received from the U.N. Food-for-oil Scam, an over 20-billion dollar scam (the biggest scam in history), so corrupted U.N. officials indirectly paid for terrorism and human sacrifice.<sup>3212</sup>

The *Ramadan* 2004 issue of *Sawt Al-Jihad* (see above quote) had this exhortation to human sacrifice:

Come closer to *Allah* through the blood of infidels; do not relent in spilling [their blood] and through [this blood] wipe out **humiliation and disgrace** from among your *Muslim* nation!<sup>3213</sup>

Incidentally, *Muslims* say that honor-killings accomplish the same thing—wiping out a family's "**humiliation and disgrace**."

During the slitting of an infidel's throat or beheading an infidel, as though the infidel was a sheep for slaughter, terrorist say "*Allah Akbar*" loud enough to cover up the pleas for mercy and then the screams. For any *Halal* (*Kosher*) sacrifice, the *Muslim* slaughterer must pronounce the name of *Allah*.

After the dastardly deed of slitting the throat of an infidel or beheading an infidel, the terrorist say things like "We ask *Allah* to accept this offering from your hands."<sup>3214</sup> This is what is commonly said after *Halal* animal sacrifices too. Terrorists themselves note that their slitting of the throat is similar to animal sacrifice, as *The Australian* reported:

The men [terrorists] said that they sever the heads of those who malign them like they cut off the heads of sheep.<sup>3215</sup>

In 2005 it was reported:

The video also showed an *Iraqi* who said the insurgents practiced beheading animals to train for decapitating hostages.<sup>3216</sup>

<sup>3211</sup> Tang, Alisa. "Two Die in *Thailand*'s Separatist Violence," news.yahoo.com, 14 Nov 2004.

<sup>3212</sup> Butler, Desmond. "Probe: *Iraq* U.N. Cash Sent to Bombers' Kin," news.yahoo.com, 16 Nov 2004, LGF.

<sup>3213</sup> "*Al-Qa'ida* Internet Magazine *Sawt Al-Jihad* Calls to Intensify Fighting During *Ramadan*—'the Month of *Jihad*,'" MEMRI, 22 Oct 2004, dispatch No. 804.

<sup>3214</sup> Commander of the *Khobar* Terrorist Squad Tells the Story of the Operation," MEMRI, SDS no. 731, 15 Jun 2004.

<sup>3215</sup> "Insurgents' deadly take on editorial interference," theaustralian.news.com.au, 18 Dec 2004, *JW*, 19 Dec 2004.

The *Muslim* capital in Palestine since Medieval times is named *RamAllah* and means “the High Place of *Allah*.” The deaths of infidels and *Muslims* in *RamAllah* therefore take on special significance as human sacrifices to the demonic moon-god *Allah*. A perusal of victims lists shows that there are many victims of terror in *RamAllah* and in its vicinity.<sup>3217</sup> The *Jewish World Review* mentions an example:

Recall for a moment the lynching of two *Israeli* soldiers gone astray into *RamAllah* early in the *Intifada*. They were taken to the police station and there they were lynched by policemen—one of whom placed his bloodied palms on the windows—and the mob below cheered. It is through such mobs that Palestinian political culture now speaks—and routinely.<sup>3218</sup>

An *Islamic* tradition that testifies to human sacrifice at the *Kaaba* is how *Muhammad*’s grandfather *Muttalib* wanted to sacrifice *Abdullah*, *Muhammad*’s father. *Muttalib* was reluctantly persuaded to slaughter one hundred camels instead of his own son.<sup>3219</sup>

Unlike the account in Gen 22 with Abraham and Isaac, there is no hint that this was just *Allah*’s test of *Muttalib* and that *Allah* really did not want human sacrifice. The implication of the tradition is that for centuries *Allah* accepted, even demanded human sacrifice, but now it is permissible to substitute animals in the place of *Muslims*. Besides, *Allah* gets enough human sacrifice from *Muslims* dying during *Hajj*, or from *Muslims* and infidels dying during *Jihad*.

*Muhammad*’s biographer, *Ibn Ishaq*, records an incident where some *Makkans* were heckling *Muhammad* as he circumambulated the *Kaaba* three times. One can tell that this was similar to playground taunting, because as soon as *Muhammad* threatened the hecklers’ lives, they “spoke to him in the kindest way possible” asking him to go away.<sup>3220</sup>

The threat that *Muhammad* made against the *Makkans* at the *Kaaba* showed that he wanted to sacrifice the hecklers as human sacrifices to *Allah*. At the time the *Makkans* made sacrifices to *Allah* the moon-god on the crescent-shaped *Hatim* Wall, which altar *Muhammad* had just circumambulated three times.

Maududi says that *K 007* is a *Makkan Sura* and in this very chapter *Muhammad* said that he considered infidels to be “cattle” (*K 007:179*).<sup>3221</sup> Cattle and bulls were archetypal moon-god sacrifices on account of their curved horns. Cattle were slaughtered on the curved *Hatim* Wall to *Allah* the moon-god and the hecklers were probably between the *Hatim* Wall and the *Kaaba*.

Notably, the crescent-shaped *Hatim* Wall was where animals and even humans once were sacrificed to *Allah* the moon-god using the *Dhabh* method. The priest used a crescent-shaped knife like a *Jambiya* or scimitar in order to honor the moon-god *Allah* with the sacrifice. *Muhammad* threatened the heckling *Makkans*:

Will you listen to me, O *Quraysh*? By him [*Allah*] who holds my life in His hand I bring you slaughter [*Dhabh*] [compare *K 008:067*].<sup>3222</sup>

<sup>3216</sup> Michael, Maggie. “*Iraqi* TV Airs Tape of Purported Confession,” abcnews.go.com, 23 Feb 2005, *LGF*.

<sup>3217</sup> israelnewsagency.com/israelterrorvictims.html

<sup>3218</sup> Peretz, Martin. “Impossible Routine,” Jewishworldreview.com, 23 Sep 2003.

<sup>3219</sup> Lings. *Sources*, p. 13.

<sup>3220</sup> Ishaq. *Sirat*, p. 131.

<sup>3221</sup> Maududi. *Meaning*, Introduction to *Sura 7*.

<sup>3222</sup> Ishaq says the word for “slaughter” that *Muhammad* used was *Dhabh* (Ishaq. *Sirat*, p. 131).

Alfred Guillaume reports that the Arabic word used for “slaughter” in the above quotation was *Dhabh*. *Dhabh* is the method that *Muslims* use to slit the throat of animals when sacrificing to *Allah*. A *Hadith* reported by Bukhari states that the prophet slaughtered a horse at *Makka* using the *Dhabh* method and then he ate the horse.<sup>3223</sup> This shows that *Muhammad* threatened to ritually slaughter the *Makkans* to *Allah* on the crescent-shaped *Hatim Wall*.

During the *Dhabh* ritual slaughter, a curved knife is used to honor the moon-god *Allah*. During the throat slitting the name of the moon-god *Allah* is mentioned. Meat produced using this method is *Halal*, meaning *Kosher*. The word *Halal* reminds one of the world *Hilal*, meaning “crescent-moon.”

So given the context and location especially, *Muhammad* was basically saying that he wanted to make a human sacrifice of the *Makkan* infidels whom he considered to be animals to be slaughtered.

This reading of history is confirmed by a curious example. Ghulam Mustafa Khan did a study on the *Muslim* rite of *Dhabh*. Khan knew that *Allah* was so obsessed about how animals were killed, that he thought it worth it to sacrifice his own life, if need be. Khan wrote:

The convulsive movements made by an animal after the brain has been suddenly deprived of blood are caused by the excitation of the lower nervous centers by the sudden deprivation of oxygen. Such movements may be induced in man by compression of one carotid artery. I have done this on myself and have felt, to my astonishment, my arm making up-and-down movements and striking the arm of the chair. Of the nervous impulsion to movement I was wholly unconscious. All I felt was the arm rhythmically hitting the chair and the feeling of faintness induced by cutting off half the blood brought to the brain by the carotid arteries.<sup>3224</sup>

This particular reading of history is also affirmed by traditions, history and other facts. For instance, throughout *Islamic* history *Muslims* have thought that performing suicide combat missions was worth it, if only more infidels were sacrificed for *Allah*'s cause.

Nowadays, *Muslim* think that even terrorist suicide missions that kill infidel children are worth it, as long as more infidels are sacrificed than *Muslims*. Moreover, *Muslim* mother even mention how they became mothers and raised their children specifically to be terrorists and suicide-bombers. One mother said:

I wish I had 100 boys like *Mohammad*. I'd sacrifice them for the sake of God.<sup>3225</sup>

Another tradition confirms this interpretation that *Muhammad* saw killing infidels as a form of human sacrifice to *Allah*. Bukhari recorded this *Hadith*:

The Prophet [*Muhammad*] said ‘On the Day of Resurrection Abraham will meet his father Azar [*Terah*] whose face will be dark and covered with dust. (The Prophet Abraham will say to him): ‘Didn’t I tell you not to disobey me?’ His father will reply: ‘Today, I will not disobey you.’ ‘Abraham will say: ‘O Lord! [*Allah*] You promised me not to disgrace me on the Day of Resurrection; and what will be more disgraceful to me than cursing and dishonoring my father?’ Then *Allah* will say (to him): ‘I have forbidden Paradise for the disbelievers.’ Then he will be addressed, ‘O Abraham! Look! What is

<sup>3223</sup> *Sahih Bukhari*, vol. 7, bk. 67, no. 419.

<sup>3224</sup> Khan. *Al-Dhabh*, pp. 50-51.

<sup>3225</sup> “Palestinian mother proud of two sons killed on *Hamas* missions,” Jpost.com, 19 Feb 2003.

underneath your feet?' He will look and there he will see a *Dhabh* (an animal), blood-stained, which will be caught by the legs and thrown in the (hell)fire.<sup>3226</sup>

In this *Hadith*, *Muhammad* said that in order to spare *Ibrahim* the embarrassment of cursing his own father for idolatry, *Allah* would change *Ibrahim*'s father into an animal on the Last Day.

The animal that used to be *Ibrahim*'s father just happens to be already slaughtered using the *Dhabh* sacrificial method, a moon-god religion sacrificial method that was discussed above. The dead animal sacrifice will then been taken by the legs and thrown into hell.

This *Hadith* shows that Gen 22 inspired *Muhammad*. In the Bible, instead of Abraham needing to sacrifice Isaac (or Ishmael, as *Muslims* say), a ram was provided.

So instead of *Ibrahim* needing to curse his own father, *Allah* morphed *Ibrahim*'s father into an animal ready to sacrifice to the moon-god *Allah*. The animal was thrown into hell, which meant *Ibrahim* did not need to curse his own father.

So one can easily tell from the above traditions that *Muhammad* viewed the slaughter of infidels as being the equivalent of human sacrifice to *Allah*. Orthodox Christian theologian Andrei Kuraev commented on the human sacrifice side of *Islamic* terrorism after the *Beslan* school massacre where about 331 were killed:

What happened in *Beslan* is not just a crime. It was a religious crime. It was ritual murder, the murder of children with prayers in the background. The terrorists killed in the name of their faith. They killed people shouting '*Allah Akbar*' and sacrificed innocent children on the altar of their religious ideas... They were not just gangsters who killed. They were people of one faith who killed Christians in the name of their creed.<sup>3227</sup>

### **Muslim Terrorists Sacrifice Many Non-Muslim Hostages As They Would a Halal (i.e. Kosher) Sacrifice of Sheep**

Writers like Khan argue that slitting the throat of an animal is a kindest way to butcher an animal and less painful than shooting it or shocking it with high voltage.<sup>3228</sup> Why is this an issue? Because:

- ☉ Animal rights activists and legislators have been critical of the *Halal* method of sacrificing.
- ☉ *Sharia* law is specific as to how *Halal* butchering is to be done.
- ☉ Tradition says a "long knife" was used to slaughter sheep and goats in the presence of *Muhammad* (*Sahih Muslim*, bk. 23, no. 5055).
- ☉ *Muhammad* had 600 to 900 men beheaded with swords. *Muhammad* is the "excellent exemplar" that *Muslims* emulate (*K* 033:021), so *Muslims* figure that if a sword is good enough for humans, a large knife will do for animals.

Based on *Muhammad*'s beheading example, *Muslim* executioners have used swords to behead. Unfortunately, videos show that even practiced executioners, such as in *Saudi* Arabia, often fail to sever the head from the torso in one blow. Amateur terrorists often need six or a dozen whacks with machetes.

<sup>3226</sup> *Sahih Bukhari*, vol. 4, bk. 55, no. 569.

<sup>3227</sup> "RUSSIA: Slaughter of *Beslan* children done as murderers shouted 'God is Great,' says theologian," *asianews.it*, 17 Sep 2004, *JW*.

<sup>3228</sup> Khan. *Al-Dhabd*.

Unlike killing criminals, some terrorists view killing non-*Muslims* as being a sacrifice to *Allah*. Thus *Muslim* terrorists behead non-*Muslims* in a *Halal* fashion with a knife starting at the front of the neck just as they would a sacrificial sheep.

Before slitting the throat, the terrorist with the knife and his assistants often yell *Allah Akbar*. Some commentators have said this yelling was to drown out the screams of the victim, which may true. However, the mention of *Allah*'s name is mandatory for *Halal* sacrifice. Mudir *Badr Haloum*, a lecturer at a Syrian University, confirms that these are *Halal* human sacrifices:

*Islam* is in the names of all of the organizations that decapitate using knives, all the while saying the *Fatiha* [MEMRI note: the first chapter of the *Koran*, said as a prayer] before the slaughter. The victims are butchered in the *Islamic* way ...Christians, *Buddhists* and Jews...After all, they are only infidels, fuel for the blaze, enemies or potential enemies, or the friends of enemies, or [friends of] their [enemies'] neighbors, and so on. The soul has no value and the body parts are laid out and displayed on the tables of *Islam*...Religious *Muslims* prepare an offering to heaven—a fresh bit of human flesh, meant to be evidence of the truth and the proof of *Jihad* for the absolute truth.<sup>3229</sup>

Another *Muslim* adds this information about beheading “infidels” that ties the practice to *Halal* sacrifice:

‘*Sharia (Islamic)* law and our history say that traitors or collaborators should be killed in this manner,’ says Hamid Ayad, 23, a *Fallujah* native now living in *Baghdad*. ‘It is permitted to behead them in this way, like a sheep is beheaded, as long as the cut is towards the direction of *Makka*. This is *Islamic* punishment and the *Mujahideen* (holy warriors) are simply following the words and deeds of the prophets...NGOs (non-governmental organizations) like the Italians are innocent but the Americans and British, they deserved it.’<sup>3230</sup>

In defense of such *Halal* knife beheadings, some *Muslims* have argued that it is a more humane way to kill than shooting with a gun. This contention is based on the specious argument that *Halal* sacrifice is the most humane way to butcher animals. This “*Halal* is humane” argument is advanced only to answer animal rights activists who are trying to outlaw such *Kosher* and *Halal* butchering practices.

The reality of the matter is that the *Halal* method of sacrifice is used only because cutting the jugular veins results in more blood loss than would say, a spear wound. *Muslims* are not supposed to eat blood with the meat (*K* 002:173; 005:003; 006:145; 016:115; 022:037).

The slit-throat method of butchering is NOT chosen on account of its being the least painful method, because it does not result in instantaneous death. A method that results in instant death is the least painful overall.

Slitting the throat results in massive blood loss over a short period of time because major veins and arteries are affected and the autonomous systems keep the heart pumping and the lung breathing. Other kinds of wounds would not keep the autonomous system working, or the blood loss would not be as significant, or would not result in death within a minute.

<sup>3229</sup> “...Terrorism Nests within Us as *Muslims* and that We Must Exorcise It,” MEMRI, SDS no. 787, 22 Sep 2004, *JW*.

<sup>3230</sup> Zoroya, Gregg & Larry Copeland and Csar G. Soriano. “Beheadings ‘theater of terror’ amplifies insurgents’ message,” *usatoday.com*, 23 Sep 2004, p. 1A.



The *Halal* technique is NOT used because it is the least painful or the quickest method of killing a sacrifice. CAB International reported:

Any *Muslim* may slaughter an animal while invoking the name of *Allah*....Observations of *Halal* cattle slaughter without stunning done by a *Muslim* slaughterman with a large, curved skinning knife resulted in multiple hacking cuts. Sometimes there was a vigorous reaction from the animal.<sup>3231</sup>

Videos of *Muslim* terrorists beheading humans reveal the same holds true for human sacrifice—meaning that there is a vigorous reaction by the victim. It is no wonder that the French invented the guillotine rather than rely on a swordsman, hangman or headsman.

*Islamists* of course will argue that if the knife were razor sharp, the animal would not even know that its throat had been cut before passing out. Of course, that is the **theory** and that may happen sometimes but what normally occurs is another story altogether. Furthermore, while an animal might not know what is going on, a human would know his throat had been cut whether it was painless or not.

After seeing a few beheading videos, one can deduce that the human victim writhes in fear and pain and is conscious for ten to thirty seconds after the first deep cut. The reason is the jugular and carotid veins are not the only veins connected to the brain. Even if a person was instantly beheaded as with a guillotine, the brain may remain conscious for a few seconds. Dr. Khan explains the effect of cutting off some of the blood-flow to the brain:

The convulsive movements made by an animal after the brain has been suddenly deprived of blood are caused by the excitation of the lower nervous centers by the sudden deprivation of oxygen. Such movements may be induced in man by compression of one carotid artery. I have done this on myself and have felt, to my astonishment, my arm making up-and-down movements and striking the arm of the chair. **Of the nervous impulsion to movement I was wholly unconscious.** All I felt was **the arm rhythmically hitting the chair and the feeling of faintness** induced by cutting off half the blood brought to the brain by the carotid arteries.<sup>3232</sup>

Videos show that the human victim screams as the terrorist cuts away in a sawing motion. It seems the terrorists rarely use razor-sharp knives but use machetes and buck knives or whatever is at hand. If the person does not react much to the knife, it may be because he is already dead or drugged. Executioners in *Saudi* Arabia reportedly give the victim opium. It was reported that an insurgent hideout had:

...two bottles of *Ketamine*—a rapid acting dissociative anesthetic similar to phenylcyclidine, better known as PCP—used to subdue victims.<sup>3233</sup>

Anatomy books show that when a neck is cut, skin, muscles, organs, glands, veins and such are all being cut at once and without even the application of localized anesthetics. Some hostages do appear to be drugged before beheading but it probably is just a look of exhaustion. The *Jerusalem Post* reported:

‘They used a knife which was not sharp...It seems they wanted to kill him slowly to torture him,’ said another Palestinian who saw the footage.<sup>3234</sup>

<sup>3231</sup> “Religious slaughter and animal welfare,” *Meat Focus International*, Mar 1994, pp. 115-123, published by CAB International, grandin.com & colostate.edu.

<sup>3232</sup> Khan. *Al-Dhadb*, pp. 50-51.

<sup>3233</sup> “Iraqi Police Take Down Kirkuk ‘Hostage House,’” American Forces Press Service, defenselink.mil, 14 Oct 2004, C&R.

<sup>3234</sup> Lahoud, Lamia. “DVD of American’s beheading is hot item in *Gaza*,” jpost.com, 29 Sep 2004.

One *Islamist* watched a beheading film in Netherlands and remarked:

A throat must be cut from the front but not entirely so there is maximum suffering.<sup>3235</sup>

Because a beheaded person's heart rate is quickened, the blood flows at a steady rate and a pool forms on the floor. There is no spurting of blood because the front of the neck only has jugular veins. The blood in veins is not under pressure like the blood coursing through an artery. In other words, oxygenated blood keeps going through the brain and the victim remains conscious.

Early in 2004 the videotaped victims of beheading in *Iraq* were Westerners and they seemed to have had hopes of being ransomed or released, and it seems beheaded was the further thing from their minds. According to friends of victims, the victims were naïve and had PC-AIDS and PC-ASS attitudes towards *Islam* such as “*Islam* is a Religion of Peace.”<sup>TM</sup>

The PC-AIDS and PC-ASS victims probably read Karen Armstrong and John Esposito's books on *Islam* before traveling to the Mideast. Thus at the start of the video the hostage was surprising calm having no idea what was coming. They only panicked when they saw the knife coming for their throat..

After many people around the globe had seen or heard of the beheading videos and knew that *Islam* was not a Religion of Peace,<sup>TM</sup> the victims actually looked more and more resigned to their fate. The later beheading videos were not the heart-stopping stomach-turners they were at first.

#### *Description of a Beheading of a Muslim*

*The Times Online* reported an account of a Lebanese *Muslim*, Mohammed Raad, who witnessed a beheading. He provides some details not widely available from the clipped video footage that has flooded the web:

A man [an Egyptian] covered in bruises and dressed only in underwear was pulled from the boot [the auto's trunk]... ‘They took me into one of the huts. The floor was covered with dried blood and it reeked of death. The *Emir* [leader] told me that this is where they slaughtered their captives. The man who was to kill him was known as ‘the butcher.’ He sharpened his knife on a stone as they prepared the Egyptian. They dressed their victim in a white gown and he then identified himself and confessed to his ‘crime.’ At the end of his confession he recited the *Shahada*, a prayer used by *Muslims* who hope to enter heaven.’ Mr. Raad said: ‘The butcher grabbed him by the throat and sliced off the tip of his tongue. The *Emir* said: ‘You are a traitor and have disgraced your religion. You cannot recite the *Shahada* out loud.’ Flanked by two armed men, the ‘butcher’ stood behind the Egyptian and read a short statement to a video camera. Then the butcher's assistants pushed the Egyptian to the ground, face down, and one of them held his feet. The butcher yanked back his head by the hair and cut his throat. When the knife hit the bone, there was a sawing noise, and then the butcher cut from the back of the neck, severing the head. While the butcher was doing this he chanted ‘*Allahu Akbar*’ (God [*sic*, really should be translated as “*Allah*”] is greatest). It took about ten seconds. The butcher raised the head up and I saw the eyes were still moving up and down and the skin on his face was still twitching.’ Mr. Raad collapsed and was dragged out of the hut. ‘The stench of the blood was the worst thing I have ever smelt,’ he said. ‘They said

<sup>3235</sup> Broere, Wendel. “Dutch *Islamist* trial hears of gruesome films,” yahoo.com, 5 Dec 2005, C&R.

afterwards that he was the first person they had slaughtered whose blood smelt so bad.’ The body was put into a bag in the boot of the car. ‘I asked if they would bury him. The *Emir* told me, ‘No, we will throw him into the river for the benefit of the fish.’<sup>3236</sup>

### *Description of Beheadings of PC-AIDS and PC-ASS Individuals*

What follows is a description of beheadings of people with PC-AIDS and PC-ASS. By the way, the fact that these victims had the PC-AIDS and PC-ASS syndromes does not reflect badly on them so much as on academics in the West who say *Islam* is a Religion of Peace™ even though they know better or ought to know better.

It seems the dull blades are used on PC-AIDS and PC-ASS infidels, so the following describes a longer beheading sequence—half a minute rather than ten seconds with a sharpened knife.

The person struggles against the handcuffs and other bindings but is usually subdued by three of the knife wielder’s assistants. Overwhelming fear causes the PC-AIDS and PC-ASS person to go into shock and quiver. The *Jerusalem Post* reported that Palestinians said:

The worst thing I remember is the howl of the poor hostage...He was shaking all over. It’s hard to imagine how anyone can watch it.<sup>3237</sup>

One kidnapped Italian who was shot (not beheaded) tried to pull the hood off his head and yelled “I will show you how an Italian dies.”<sup>3238</sup> It would be glorious if a Christian would praise *Yahveh* and mock *Allah* the moon-god even while the cold steel touches the neck, even if *Islamists* later edited this out of the videotape.

The victims scream in bursts until the windpipe is cut. This usually takes about eight seconds after the knife touches the neck. Then, for about ten to fifteen seconds after the windpipe is cut, the person attempts to scream but only deep wheezing noises are heard if the cut was below the voice box (larynx). If the cut was above the larynx, then there may be a few muffled, gurgling screams.

The screams stop when the person goes unconscious. At this time the **non**-autonomous systems, like the muscular system, cease to function, so the body goes limp or nearly so. Surprisingly, for five or ten seconds **after** the body goes limp, there are several gasping breaths, and profuse bleeding continues. This probably is because the heart and lungs are controlled by the autonomous system. Then there is the last long exhalation—the one where the ancients thought the spirit left the body.

The terrorists usually struggle cutting the spine. In Nov 2004, the *Fox News* Special Report *Eurabia* said that it took *Jihadists* two minutes and five seconds to lop off one Russian soldier’s head, even though they were using a hunting knife. Because of the embarrassing delay, video clips usually stop and then restart as the terrorists finally lifts up the head and then cradles it in the small of the victim’s back.

<sup>3236</sup> Blandford, Nicholas. “‘Thank God I’m alive,’ says captive forced to watch hostage beheaded,” [timesonline.co.uk](http://timesonline.co.uk), 15 Oct 2004.

<sup>3237</sup> Lahoud, Lamia. “DVD of American’s beheading is hot item in *Gaza*,” *Idem*.

<sup>3238</sup> Steyn, Mark. “The Quality of Mersey,” [steynonline.com](http://steynonline.com), 12 Oct 2004; “Italian hostage ‘defied killers,’” [news.bbc.co.uk](http://news.bbc.co.uk), 15 Apr 2004, Belmontclub, *LGF*.

The headless bodies are usually dumped on the roadside or in a river. The head however is shown around as a short-lived trophy. This is in keeping with *Islamic* history where:

- ☉ *Muhammad*'s men brought him trophy heads.
- ☉ The heads of general were paraded around Arabia and the *Islamic* empire as a warning to those who might rebel.
- ☉ Some of the *Umayyad* “Standing *Caliph*” coinage had the *Caliph* holding a spear in his right hand and the severed head of an enemy suspended from his left hand!<sup>3239</sup>
- ☉ The *Serbs* in the 1990's captured pictures of *Muslims* showing their buddies severed *Serb* heads. One picture even shows three heads in a box and another shows a bag of heads.<sup>3240</sup>

After reading the CAB report, seeing the above-described videos and one of a pig that squealed for a while even after its throat had been cut, it is evident that *Halal* butchering is not a humane way for either animals or humans to die, no matter what *Halal*- and *Kosher*-slaughtering apologists say.

Since I wrote the above paragraph, rabbis in the US have been equipped with stun guns to stun steers that “continue to thrash about and try to stand after their throats have been slit.” The PETA video that precipitated this measure showed “steers walking or bellowing up to three minutes after their throats were slit.”<sup>3241</sup>

### Human Sacrifice at the *Kaaba* During the *Islamic* Era

Human sacrifice never really stopped at *Makka*. Malise Ruthven wrote about the circumambulation around the *Kaaba*:

Later Wolfe observes that some of the [carried] litters are actually biers carrying corpses, which jostle oddly under their coverlets. The liminal state [i.e. “sensory threshold”] in which boundaries separating individuals are temporarily dissolved also weakens the frontier between the living and the dead.<sup>3242</sup>

Some *Muslims* are offended that some infidels have made insensitive statements about *Muslims* dying at the *Hajj* but how many *Muslims* cheered 9/11 when 3,000 died and then named their newborns Usama? And how many *Muslims* have approved of beheading videos? Besides, many *Muslims* think it is not a tragedy for pilgrims to die at *Hajj* since those who die are considered blessed martyrs—just like the suicide-bombers. Blair and Bloom wrote:

Martyrs [Arabic: *Shahids*] (‘witnesses,’ ‘those who go before’) are immediately received into Paradise at their death. In *Islamic* tradition martyrs are not merely warriors who have died in defense of the faith but women who die in childbirth, plague victims and others.<sup>3243</sup>

Why is it important to be a martyr in *Islam*? Only the martyrs go to heaven right away, while the rest of *Muslims* “soul sleep” until Judgment Day, after which most go to Purgatory. Blair and Bloom wrote:

At death, after the inquisition by the angels *Munkar* and *Nakr*, all but martyrs repose in their graves, the virtuous in a peaceful sleep, the wicked

<sup>3239</sup> Milstein, Rachel. “A Hoard of Early Arab Figurative Coins” as found in Barag. *Balog*, pp. 8-10 (especially 10, bottom), coins nos. 126-136, plates 3:126, 132-133.

<sup>3240</sup> [kosovo.com/kladecapit.pdf](http://kosovo.com/kladecapit.pdf); [kosovo.com/kla\\_decapit.pdf](http://kosovo.com/kla_decapit.pdf), accessed 2004.

<sup>3241</sup> “*Kosher* meatpacker making changes after activists cry cruelty,” [haaretz.com](http://haaretz.com), 9 Dec 2004.

<sup>3242</sup> Ruthven. *World*, p. 13.

<sup>3243</sup> Blair & Bloom. *Paradise*, p. 15, fn. 6.

nightmarishly pressed by the earth around them and tortured by visions and portents of their fate [in hell]. The ordinary world and the repose of the dead is brought to an end by the cataclysm of the Judgment...<sup>3244</sup>

There are a lot of dead who may be considered “martyrs” at each *Hajj*, as Malise Ruthven wrote:

Despite these precautions however the [*Hajji*] pilgrims often suffered appalling casualties. Those who survived the extremes of heat and cold, hunger and thirst or attacks by *Bedouin* marauders often succumbed to the plague....The *Maha Kumbh Mela* festival on the *Ganges* attracts up to 10 million *Hindu* worshippers without experiencing anything like the casualties regularly sustained by the *Hajj*.<sup>3245</sup>

The *Hajj* currently attracts about two million pilgrims. *Makka* most of time is a hot, dry desert without any shade, and is as cruel to life as any concentration camp. Many *Hajjis* suffer severe sunburn, heat stroke and heart attacks, especially because several rituals involve walking, jogging or “stampeding” several kilometers at a time.

The *Sa'i*, the straight-line circumambulation between Mounts *Safa* and *Marwa* is 3.5 KM.<sup>3246</sup> 3.5 KM is like a marathon to many *Hajjis* since some have had bypass heart surgery, others are over- or underweight, or are elderly.

*Ibn Warraq* wrote about the dangerous run from Mount *Arafat*:

Here [at Mount *Arafat*] the pilgrim recites the usual prayers and listens to another oration on the theme of repentance. He then hurries (the Arabic word [literally] means ‘stampede’) to *Mazdalifah*, a place between *Mina* and *Arafat*, where he is required to arrive for the sunset prayer.<sup>3247</sup>

Zwemer wrote:

Then the pilgrim runs between the hills of *Safa* and *Marwa*....He then runs around the *Ka'aba* seven times—thrice very rapidly and four times very slowly—in imitation of the motions of the planets.<sup>3248</sup>

Considering all the congested pedestrian traffic and running events, it is not surprising that nearly every year stampedes crush *Hajj* pilgrims. In the year 1990, 1,426 people died in a stampede.<sup>3249</sup> It was reported in 2003 that “more than 2,500 have been killed since 1987.”<sup>3250</sup> In 2003 “14 pilgrims were killed in a stampede during the first day of the stoning ritual and 35 in 2001, while the 1998 *Hajj* saw 118 killed and more than 180 hurt at the pillars.”<sup>3251</sup> In 2005, ten people died in a stampede at the pillars of *Mina* even though the area had just been rebuilt with crowd-control in mind.<sup>3252</sup> In October 2005, a passenger liner “carrying pilgrims collided with a cargo ship at the southern entrance to the Suez Canal...causing a stampede among passengers trying to escape the sinking ship. Two people were killed and 40 injured.”<sup>3253</sup> In 2006, 76 people died when a hotel collapsed, 345

<sup>3244</sup> Blair & Bloom. *Paradise*, p. 15.

<sup>3245</sup> Ruthven. *World*, pp. 3, 11.

<sup>3246</sup> Ruthven. *World*, p. 20.

<sup>3247</sup> Warraq. *Why*, p. 36.

<sup>3248</sup> Zwemer. *Animism*, ch. 8.

<sup>3249</sup> “Muslim pilgrims gather in Saudi Arabia for Hajj,” msnbc.com, 18 Jan 2005.

<sup>3250</sup> “Stampede kills 14 Hajj pilgrims,” washtimes.com, 11 Feb 2003, *DW*, 22 Dec 2005.

<sup>3251</sup> “Hajj tragedy fails to stop faithful,” english.aljazeera.net, 3 Feb 2004, *DW*, 22 Dec 2005.

<sup>3252</sup> Mohammad, Fawaz. “Ten Pilgrims Die in Minor Stampede,” *Islamonline.net*, 22 Jan 2005.

<sup>3253</sup> “Red Sea disaster: Egyptian ship sinks,” ynetnews.com, 3 Feb 2006.

pilgrims died in a stampede by a ramp leading up to the *Mina* pillars.<sup>3254</sup> In February 2006, some late returning pilgrims may have been on a ferry that capsized in the Red Sea, drowning over a thousand passengers.<sup>3255</sup>

The stampedes at various locations on the *Hajj* occur like clockwork. In fact, a 2004 *Hajj* manual read:

79. Every year there is invariably a stampede or stampede condition at the site of stoning of the *Jamarat*.<sup>3256</sup>

Sure enough—just as the *Hajj* manual predicted—the news service *Al-Jazeera* (a.k.a., *JihadTV*) reported that during the Year 2004 *Hajj*, 244 *Muslims* died in a stampede that lasted 27 minutes, and another eleven later died from their wounds.<sup>3257</sup>

*Aljazeera* also reported on the mind-boggling tragedy:

The death of 251 [the count varied] *Muslims* in a stampede shocked no one, with many pilgrims certain that those who die on the *Hajj* enter paradise and the *Saudi* authorities pointing to the ‘will of God’.<sup>3258</sup>

In 1997 *Hajj* the tent city at *Mina* caught on fire and 340 *Muslims* died. In 2004 there are now 40 thousand fireproof tents so *Muslims* have no more graphic examples of *Muhammad*’s “garments of fire” (*K* 014:050; 022:019).<sup>3259</sup>

Considering all the death that occurs at *Makka* each pilgrimage, this *Koran* verse is rather ironic:

Have they not seen that We [*Allah*] have appointed a sanctuary [the *Kaaba*] immune (from violence), while mankind is ravaged all around them? (*K* 029:067).

The unnecessary mass-deaths at *Hajj* are replicated elsewhere in *Islamdom* especially because *Allah*’s *Jihadists* have made *Muslims* jumpy. In the West the public treats most bomb threats as hoaxes but in *Islamdom* the public reacts to bomb threats as though they are real, for instance:

C In 2005 a bomb threat was phoned in to *Sri Lanka*’s Colombo airport, a *Saudi* Arabian Airlines jet that was set to fly to *Jiddah* (near *Mekka*) “opened the emergency exits and passengers panicked and jumped off. Most of them were injured in a stampede.” The flight had 400+ passengers. One woman was killed and 62 required hospitalization, meaning about one out of every 6.5 persons were hurt over a hoax.<sup>3260</sup>

C From 2003 to 2005, *Sunni Muslims* in *Iraq* sniped at and roadside bombed *Shia Muslims* as they walked and rode to *Shiite* shrines.<sup>3261</sup> Insurgents’ films of the attacks on pedestrians can be found on the Web. *Sunnis* also car- and suicide-bomb and mortar *Shiite* shrines, *Mosques* and outside processions. As a result, in 2005, while *Shia* pilgrims crossed a bridge over the *Tigris* River toward *Baghdad*’s *Kadhimiya* shrine, a rumor spread that there was a suicide-bomber in their midst. This caused a thousand deaths from trampling

<sup>3254</sup> Hundreds killed in stampede at pilgrimage,” msnbc.com, 12 Jan 2006.

<sup>3255</sup> “Red Sea disaster: Egyptian ship sinks,” ynetnews.com, 3 Feb 2006.

<sup>3256</sup> *The Haj—An Orientation Manual for Trainers of Indian Pilgrims of Haj—2004* (1424 AH), p. 14, point 79, hajcommittee.com (*Haj* is a variant spelling of *Hajj*).

<sup>3257</sup> “*Hajj* stampede toll rises,” aljazeera.net, 2 Feb 2004.

<sup>3258</sup> Mahjoub, Taieb. “Pilgrims long to see *Makka* and die,” aljazeera.net, 2 Feb 2004.

<sup>3259</sup> “*Muslim* pilgrims gather in *Saudi* Arabia for *Hajj*,” msnbc.com, 18 Jan 2005.

<sup>3260</sup> “Stampede on *Saudi* aircraft leaves one woman dead, 62 injured,” forbes.com, 8 Sep 2005.

<sup>3261</sup> “Suicide bombers strike as *Shiite* pilgrimage underway,” forbes.com, 19 Sep 2005.

and drowning as people ran and fell or jumped into the *Tigris* River from the bridge.<sup>3262</sup>

Of course the deaths along pilgrimage roads and at the *Hajj* do not greatly disturb *Muslims* enough to deter them from going since...

...Dying while on *Hajj* is considered to be very auspicious....The deaths have not shocked many people, with several pilgrims certain that those who die during *Hajj* enter paradise. 'I wish I was among the pilgrims who died on Sunday,' Kamal Shahada, an Egyptian pilgrim, said. 'I would have gone to heaven, because dying in these holy sites of *Islam* would assure one a place in heaven,' he said, echoing a widespread conviction in the *Islamic* world. Libyan *Muhammad* Taylamun agreed. 'The two million faithful who gathered every year at the holy sites for the pilgrimage hope to have the honour of being buried in this sacred soil,' he said. The scale of the tragedy which cast a shadow over the *Hajj* certainly provoked compassion among the gathering but fatalism predominates among 'the guests of God.' 'Those who died will be missed by their families and friends but they have a chance no one else can have by dying on the holy land of *Islam* where they are then buried,' said a *Bangladeshi*.<sup>3263</sup>

Some *Muslims* have defended the *Hajj* saying that dozens of sports fans have died at soccer matches before but one can see that many *Hajj*-goers are more like *Islamic* suicide-bombers than sports fans. Sports fans have no death-wish and death is the farthest thing from their minds. By contrast, many *Hajj*-goers hope to die at *Mekka*!

Charles Johnson wrote about a 2004 *Hajj* manual that nonchalantly predicted a tragedy in 2004 months before 244 *Muslims* died in a stampede (mentioned above):

This [2004 *Hajj*] manual supports my point that the 'stoning' ritual and accompanying deadly stampedes are a form of human sacrifice that is tacitly condoned. Everyone involved knows there is a great likelihood of mass casualties, yet the pilgrims do not modify their behavior and the authorities do not institute effective countermeasures. It's a state-sanctioned blood ritual; they're not putting people on altars and ripping their hearts out like the *Aztecs* did but it is only one step away.<sup>3264</sup>

One can see that the *Hajj* ritualism that *Muslims* go through, and the *Ihram* dress that *Muslims* wear, are really just ways *Muslims* prepare themselves for their own human sacrifice—if they think they should be so lucky as to be chosen by *Allah* to die during the *Hajj*.

The dying for *Allah* has been going on since pre-*Islamic* times when humans were offered up to *Venus* and the moon-god. All the *Hajjis* dying in the merciless desert led to the abandonment of sacrificing *Muslims* since pre-meditated sacrifice of humans now seemed like overkill.

Besides, *Muhammad* thought, it is fine for *Hajjis* to die for *Allah* due to dehydration or whatnot but *Muslims* ought to kill non-*Muslims* if they kill anyone at all. Thus countless non-*Muslims* have been dying at the hands of *Muslim Jihadists* ever since.

In 1819, John Lewis Burckhardt wrote about cruel conditions that *Hajjis* fell victim to ever since *Muhammad*'s day:

<sup>3262</sup> "Iraq: Terror on the Tigris," newsweek.com, 6 Sep 2005.

<sup>3263</sup> "Hajj tragedy fails to stop faithful," aljazeera.net, 3 Feb 2004, *DW*, 22 Dec 2005, plus caption.

<sup>3264</sup> *LGF*, "Handy Tips for Avoiding Stampedes," 1 Feb 2004.

It will readily be conceived that the danger and fatigue incident to the journey prove fatal to great numbers of the pilgrims; perhaps one-sixth fall victim to their zeal. The greater part of the diseases by which they are attacked on the road arise from their being almost destitute of clothing; many perish in the desert through want and fatigue and others are murdered...<sup>3265</sup>

The harshness of the environment and overcrowding dangers pale in comparison to the disease problem. F. E. Peters notes that throughout the nineteenth-century, *Hajjis* brought cholera, especially from *Java*, *Singapore* and the *Indus River Valley*.<sup>3266</sup> Diseases traveled East to West, and in Europe ‘episodes of the disease [cholera] were unmistakably connected with the *Hajj*’ in the nineteenth century.<sup>3267</sup>

In May 1865, 15,000 of the 90,000 pilgrims died from cholera during the *Hajj*. On the trip from *Jiddah* back to Egypt, over one hundred *Hajjis* died and were thrown into the Red Sea. By June 1865, cholera reached Alexandria and then Europe and killed 60,000 Egyptians in three months. By November 1865, cholera reached New York City.<sup>3268</sup>

Since *Muhammad* ended intercalation, the *Hajj* occasionally occurs during the rainy season at *Mekka*, and this would tend to promote drowning and disease from stagnant, polluted water. This is especially the case because *Mekka* and the *Hajj* tract lie in two big drainage ditches called *Wadis* that flood every few years, as in:

☉ 1629 AD when a flashflood (a *Sayl*) engulfed the *Haram* [sacred area] and “everyone within it was drowned.”<sup>3269</sup>

☉ One can find pictures of people wading by a flooded *Kaaba* in 1941.<sup>3270</sup>

☉ During the *Hajj* of 1877-1878, the *Haram* was flooded with seven feet of water, the worst flood in seventeen years.<sup>3271</sup> John Keane wrote:

The worse result of the flood was the sickness that prevailed after it; cholera, small-pox and typhus epidemics broke out and raged wildly together for about three weeks...Men in the agonies of cholera might frequently be seen lying at the sides of the streets and never a good Samaritan went near them.<sup>3272</sup>

Rainwater is still a problem during the *Hajj* even though much of the terrain has been altered by flood-control projects. In 2005 *Islam Online* related:

...unseasonable heavy rains caused unexpected crowding and traffic jams in *Makka* and *Mina*. Torrential rain flooded the streets and uprooted pilgrims’ tents in *Mina*...The downpour also destroyed a main tunnel used by pilgrims in *Mina* which could trigger a serious traffic jam, with many of the pilgrims running for cover and seeking shelter, adds our correspondent.

Disease is not the only cause of death after the *Hajj* is over. *Muslims* often have celebrations after returning from *Hajj* and they fire bullets into the air. In 2005 a Palestinian girl was killed by a falling bullet during a post-*Hajj* celebration.<sup>3273</sup>

<sup>3265</sup> Peters. *Hajj*, Ch. VI: “Steam Ships and Cholera,” especially pp. 301-315.

<sup>3266</sup> Peters. *Hajj*, p. 301.

<sup>3267</sup> Peters. *Hajj*, p. 301.

<sup>3268</sup> Peters. *Hajj*, p. 301.

<sup>3269</sup> Peters. *Mekka*, p. 289.

<sup>3270</sup> A 1941 AD picture of chest-high floodwaters by the *Kaaba* can be seen in Nasr. *Makka*, p. 27.

<sup>3271</sup> Peters. *Mekka*, p. 137.

<sup>3272</sup> Peters. *Mekka*, p. 140.

<sup>3273</sup> Regular, Arnon & Amos Harel. “IDF says schoolgirl was probably killed by Palestinian gunfire,” *haaretz.com*, 31 Jan 2005, *LGF*.



Even though many Palestinians have died from falling bullets and misfired weapons in crowded situations, the practice continues. In one incident a man fired a weapon in the air after his relative was released from prison. When he went back to carrying it by the strap, it misfired and shot four men—killing one.<sup>3274</sup> Nevertheless, because *Islam* teaches fatalism, *Muslims* figure that if anyone dies, *Allah* must have willed it (*Inshallah*)—meaning that normal and prudent safety precautions are a waste of time.

Also, because *Muslims* study the *Koran* during *Hajj* and often visit *Madina* afterward where *Muhammad* killed many people, including 600 to 900 Jewish men in one day, *Muslims* come home feeling super-spiritual and are super-dangerous. So, it was not surprising to read that a *Kuwaiti* father returned from *Hajj* in 2005 and blindfolded and slit the throat of his thirteen-year-old daughter in front of her siblings because he suspected her of having sex. The coroner found that her *hymen* was intact and she was in fact a virgin.<sup>3275</sup>

### The Plague at *Makka* the Year *Muhammad* Was Born

The memory of plagues among pilgrims seems to be preserved in the *Koranic* story of the Year of the Elephant (*K* 105). It seems that an embarrassing fact had to be covered up, specifically, that a plague occurred in *Makka* at the *Hajj* during the year of *Muhammad*'s birth (570 AD). Not only that but *Muhammad*'s father contracted some illness and died the year of *Muhammad*'s birth.

*Muslim* traditions often cover up the ugly truth by introducing historical anachronism, or by casting the victim as the perpetrator, or vice versa, as Carleton Coon wrote:

*Muslims* are notoriously loath to preserve traditions of earlier paganism and like to garble what pre-*Islamic* history they permit to survive in anachronistic terms.<sup>3276</sup>

The plague during the year of *Muhammad*'s birth involved measles and small pox. *Ibn Ishaq* wrote:

Ya'qub *b.* 'Utba told me that he was informed that that year [the "Year of the Elephant" when *Muhammad* was born] was the first time that measles and smallpox had been seen in Arabia.<sup>3277</sup>

This of course would be an inauspicious start for *Muhammad*'s prophetic career, so an elaborate story was concocted. Instead of the plague being brought by pilgrims and spread among pilgrims, an invading army of Christian suddenly becomes the victims.

The plague was blamed on the invasion of *Makka* launched from *Yemen* by the *Abyssinian* Christian *Abraha* in the year that *Muhammad* was born (570 AD). A *Sabeian* inscription however shows that *Abraha*'s excursion north to the *Hijaz* from *Yemen* took place in 552 AD while *Muhammad* was born in 570 AD.<sup>3278</sup>

The inscription and history leave us no reason to believe *Abraha*'s mission had anything to do with a desecration of a church. Also, the *Hijaz* was invaded, not the

<sup>3274</sup> Toameh, Khalid *Abu*. "Lawlessness in West Bank," jpost.com, 22 Feb 2005.

<sup>3275</sup> "Kuwaiti 'slit daughter's throat,'" news.bbc.co.uk, 26 Jan 2005, *LGF*.

<sup>3276</sup> Coon. *Southern*, p. 398.

<sup>3277</sup> Ishaq. *Sirat*, p. 27.

<sup>3278</sup> Peters. *Origins*, p. 88.

backwater town called *Makka*. Moreover, the inscription says the invasion was entirely successful and there was no disaster.

Archaeologists estimate that sometime between 550 and 570 AD the *Marib* dam broke. *Muhammad* mentions the downfall of *Marib* (K 034:016-019). Just as *Ur* became desert and was abandoned in 317 BC when the Euphrates River changed course,<sup>3279</sup> so *Marib* returned to desert when its dam became irreparable. The hapless *Sabean* civilization disbanded and between 30,000 and 50,000 *Sabeans* trekked to northern Arabia and to parts unknown.

It is unlikely that *Abraha* would launch an invasion north in 570 AD when his branch of civilization was collapsing all around him. An Arab defecating in a church would be the least of *Abraha*'s worries. Indeed, *Abraha* may not have even been alive in 570 AD!

The most plausible explanation for the *Koran*'s and *Islamic* tradition's accounts of the Year of the Elephant is this. Many of the *Sabeans* fleeing the demise of *Marib* traveled through *Makka* in 570 AD and they brought various diseases to *Makka*.

In order to sanitize official *Islamic* history of the plague of 570 AD and make the *Makkans* look invincible from the start, the storyteller changed some details. A disease-afflicted Christian army from *Yemen* replaced the disease-carrying *Sabean* refugees of 570 AD in 552 AD.

That the stories from 552 and 570 AD are conflated explains why during the Story of the Elephant, the *Makkans* were hiding in the hills rather than fighting *Abraha*. The *Makkans* were in the hills because they feared the diseases that the *Sabean* refugees brought as they headed north through *Makka*. Townsfolk often abandoned their towns during plagues from ancient times up until the last century.

Significantly, tradition records that a *Bedouin* woman nursed *Muhammad*. The *Sufi* Martin Lings says this was a custom of rich parents because of the frequent epidemics and high infant mortality rates found in large ancient cities.<sup>3280</sup>

*Muhammad*'s family however was not rich and neither was *Makka* very populated. So the fact that a *Bedouin* nursed *Muhammad* suggests that *Makka* experienced plagues during the year of *Muhammad*'s birth, especially if *Muhammad*'s mother *Amina* was taken ill.

Tellingly, *Muhammad*'s father, *Abdullah*, caught one of the diseases brought from *Yemen*. He probably caught the disease and died in *Makka*. Tradition says *Abdullah* died at his relatives' house in *Madina* after being on a caravan journey to Syria.<sup>3281</sup>

If *Abdullah* died in *Madina* at all, he probably was there until the plagues at *Makka* subsided. Unfortunately, the *Sabeans* traveled all the way to Syria, so just escaping *Makka* was not enough for *Abdullah* to dodge the bullet, so to speak.

### The Intended Meaning Behind the Story of the Elephant

The *Koranic* chapter "The Elephant" is named after *Abraha*'s elephant that refused to attack the *Kaaba* but only kneeled to it. The elephant only kneeled in the direction of the *Kaaba*—the *Kiblah*.

<sup>3279</sup> *EB*, accessed 15 Mar 2003, *Ur* entry.

<sup>3280</sup> Lings. *Sources*, p. 23.

<sup>3281</sup> Lings. *Sources*, p. 21.

Peters wrote that the elephant had “quite exemplary prayer habits...like a good *Muslim* of a later generation.”<sup>3282</sup> In fact, tradition refers to the elephant as “*Mahmoud* the Praise worthy,” as though the elephant were a *Muslim*.

The underlying truth of the story “The Elephant,” seems to be that even one *Muslim* praying toward the *Kaaba* can be so unsanitary as to bring plague and death on his fellow travelers or fellow pilgrims. In fact, the vector of the plague is even mentioned in the story. *Ibn Ishaq* wrote:

The *Kinanite* went forth until he came to the cathedral and defiled it [*Ibn Hisham* wrote “he defecated in it.”] Then he returned to his own country. Hearing of the matter *Abraha* made inquiries and learned that the outrage had been committed by an Arab who came from the temple in *Makka* where the Arabs went on pilgrimage, and that he had done this in anger at his threat to divert the Arabs’ pilgrimage to the cathedral, showing thereby that it was unworthy of reverence. *Abraha* was enraged and swore that he would go to this temple and destroy it.<sup>3283</sup>

So it seems the storyteller knew that poor sewage sanitation standards at *Makka* led to the plague of 570 AD, as in other years. The fabricated story says that the *Kinanite* defecated right in the shrine. Here the storyteller lets on that he knew sewage near the *Kaaba* led to epidemics. The *Makkans* knew that disease was rampant because during each pilgrimage, thousands of pilgrims defecated in the holy precincts without even bothering to kick sand over the piles. Many pilgrims then stepped in the excrement and tracked it around the *Kaaba* as they circumambulated. Then *Allah* became, so to speak, the Lord of the Flies (*Beelzebub*).

The *Sufi* Martin Lings wrote about *Muhammad*’s father in connection to the Story of the Elephant:

‘*Abd Allah*, the son of ‘*Abd Al Muttalib*, was not in *Makka* at the time of the miracle of the birds [the birds dropping stones caused the small pox and measles plague in 570 AD, according to legend]. He had gone for trade to Palestine and Syria with one of the caravans; and on his way home he had lodged with his grandmother’s family in *Yathrib* and there he had fallen ill [and died].<sup>3284</sup>

This seems to be an all too convenient explanation and suggests that *Muhammad*’s father died in the small pox and measles plague that hit *Makka* the year of *Muhammad*’s birth (570 AD).

This kind of sanitizing of *Muhammad*’s history is evidenced elsewhere. In fact, the editor of *Muhammad*’s main biography admits to sanitizing the account. The editor, *Ibn Hisham* (died in 828 or 833 AD/213 or 218 AH) wrote:

...things which it is disgraceful to discuss; matters which would distress certain people...all these things I have omitted.<sup>3285</sup>

To make the fact that *Muhammad*’s father died the same year *Muhammad* was born less damaging, *Muhammad*’s biographers stated that *Abdullah* was returning from Syria and died in *Madina*. How convenient that *Abdullah* died in *Yathrib*, which would later be called *Madina*, “the City of the Prophet”!

<sup>3282</sup> Peters. *Origins*, p. 87.

<sup>3283</sup> Ishaq. *Sirat*, pp. 22 and 696, note 35.

<sup>3284</sup> Lings. *Sources*, p. 21.

<sup>3285</sup> Ishaq. *Sirat*, p. 691, “*Ibn Hisham*’s Notes.”

Another example of such editing to clean up *Muhammad's* life involves eclipses. Evidently, it was embarrassing that there were a number of lunar eclipse traditions that involved the prophet of the moon-god *Allah*.

Unlike eclipses of the sun where the corona around the sun is reddish and the landscape fills with eerie gray shadows (Joe 02:31; Act 02:20; Rev 06:12), lunar eclipses produce unexpected colors. Lunar eclipses were perceived as ominous to the ancients—especially to moon-god worshippers:

Total lunar eclipses come in many colors, from dark brown and red to bright orange, yellow and even gray, depending on how much dust and clouds are in the Earth's atmosphere at that time...In ancient times, the phenomenon was believed caused by some unseen monster bloodying the moon, an omen of disaster.<sup>3286</sup>

So the lunar eclipses were read out of the early *Muslim* traditions and solar eclipses inserted in their place. This had the effect of transforming traditions that were damaging to the moon-god *Allah* into anti-solar propaganda. This editing of *Islamic* traditions is similar to how *Muhammad* transformed pro-solar rites at the *Hajj* into anti-solar, pro-lunar rites.

The editors forgot to change the heading (rubric) under which eclipse traditions were gathered. Arthur Jeffery quoted one tradition about *Muhammad* traveling in haste to a *Mosque* to pray for the duration of a solar eclipse, but then Jeffery notes:

It may seem surprising that while the rubric speaks of eclipse of the moon, the Traditions under the rubric deal exclusively with eclipses of the sun.<sup>3287</sup>

It is statistically unlikely that there would only be solar eclipse traditions involving *Muhammad* but no lunar eclipse traditions. Lunar eclipses occur much more frequently than solar eclipses. Astral-oriented societies such as seventh-century Arabia may have seen a few lunar eclipses per year, while only experiencing a solar eclipse every other decade.

Not only do lunar eclipses occur more frequently but also more people can see lunar eclipses. Anyone on the night side of the earth can view a lunar eclipse but each solar eclipse can only be seen by a small fraction of people on the dayside of the earth.

### **Lack of Personal Hygiene Led to the Death of Many Muslims**

Samuel Clemens in *The Innocents Abroad* records how *Hajjis* commonly neglected personal hygiene, even by lax nineteenth-century standards:

Hundreds of *Moors* come to *Tangier* every year and embark for *Makka*. They go part of the way in English steamers and the ten or twelve dollars they pay for passage is about all the trip costs. They take with them a quantity of food and when the commissary department fails they 'skirmish'...From the time they leave till they get home again, they never wash, either on land or sea. They are usually gone from five to seven months and as they do not change their clothes during all that time, they are totally unfit for the drawing room when they get back.<sup>3288</sup>

<sup>3286</sup> "Lunar eclipse to turn moon red: Latest in string of cosmic shows," *CNN.com*, 6 Nov 2003.

<sup>3287</sup> Jeffery. *Islam*, p. 179 & fn. 1.

<sup>3288</sup> Twain, Mark. *The Innocents Abroad*, 1869, ch. 9 (etext).

This lack of hygiene probably is the main reason that many pilgrims get a sacred hair cut near the end of the *Hajj* pilgrimage. *Al Kalbi* wrote in his *Book of Idols* that in a pre-Islamic pilgrimage site in Syria a pilgrim said:

‘I swore by the betyls of *Al Uqaybir* a solemn oath, where the foreparts of the heads and the lice are shaven.’<sup>3289</sup>

Pilgrims got a haircut near the end of *Hajj* because they did not want to share their *Hajji* status with thousands of lice that tagged along.

Even *Muhammad*, who was known for meticulous standards of hygiene, contracted hair lice (*Sahih Bukhari*, vol. 9, no. 130).<sup>3290</sup> On his final pilgrimage *Muhammad* had his hair cut,<sup>3291</sup> even though *Muhammad* was able to afford a louse-resistant hair preparation. *Ibn Ishaq* wrote that *Muhammad* said “I have matted my hair.” Guillaume wrote that a more literal translation of the phrase indicates that *Muhammad* used *Labbadtu*. Guillaume explains:

*Labbadtu* is explained in the *Nihaya of Ibnu 'l-Athir* as a sort of gum that is put on the hair to prevent it becoming disheveled and lousy.<sup>3292</sup>

Diseases dispersed at the *Hajj* still are a biohazard since two million people camp out for nearly two weeks and touch and even kiss the same cult objects. Diseases with incubation periods such as leprosy are harder to associate with the *Hajj* but surely are spread there. Here follows some reports of diseases with shorter incubation periods spread at *Hajj*. *MSN Slate* reported:

Another longtime *Hajj* hazard has been the spread of communicable diseases. Last year, for example, the British Medical Journal reported that one-fifth of pilgrims returning to the UK were found to be carrying a rare bacterium that can cause fatal meningitis.<sup>3293</sup>

During *Hajj* 2006, two *CNN* reporters wrote:

Just before prayer time, when the crowd levels are at their peak, human traffic is so dense it can take half an hour to walk only few hundred meters. My producer and I have decided to wear surgical masks in the busiest areas to shield ourselves from dust and germs. Pharmacies here sell them in boxes of 25 or 50, as they've become very popular with tourists.<sup>3294</sup>

The *Encyclopedia Britannica* states:

In spite of careful checking, pilgrims may sometimes bring various illnesses, particularly cholera and cerebro-spinal infections, into the city [of *Makka*].<sup>3295</sup>

The *Strategy Page* reports on a disease that could have been transferred via *Makka*:

Since you can track where a polio strain came from [i.e. similar to DNA fingerprinting], it is now known that the ‘Nigerian strain’ is responsible for outbreaks as far away as Indonesia. So far, there are only about 1,300 cases in Nigeria and elsewhere.<sup>3296</sup>

<sup>3289</sup> *Al Kalbi. Idols*, p. 33 “*Al Uqaysir*.”

<sup>3290</sup> Trifkovic. *Sword*, pp. 45-46.

<sup>3291</sup> Lings. *Source*, p. 334.

<sup>3292</sup> Ishaq. *Sirat*, p. 650, note 1.

<sup>3293</sup> Koerner, Brendan I. “Why Is the Muslim Hajj So Dangerous?” *MSN Slate Explainer*, slate.msn.com, 12 Feb 2003.

<sup>3294</sup> “Gorani: Masks and business at Hajj,” cnn.com, 8 Jan 2006.

<sup>3295</sup> EB, *Makka* entry, accessed 22 Dec 2004.

<sup>3296</sup> “NBC: Islamic Biological Warfare,” strategypage.com, 10 May 2005, *JW*, 12 May 2005.

Daniel Pipes wrote:

The common element, the *New York Times* notes, is that incidents of polio are now located ‘almost exclusively in *Muslim* countries or regions.’ That’s because, scientists hypothesize, the polio infection traveled from Nigeria in a uniquely *Muslim* way—via the *Hajj*, or pilgrimage to *Makka*, which took place in January 2005. Testing confirms that all three Asian strains of the disease originated in northern Nigeria.<sup>3297</sup>

What is worse, despite a worldwide joint project by the Rotary Club and World Health Organization to eradicate polio, paranoid and doctrinaire *Imams* still stuck in the Dark Ages denounce the vaccine as an American plot to poison the populace.

One can see from the pilgrim accounts that for the last fourteen centuries, *Hajj* pilgrims spread diseases throughout the known world. *Hajji Ibn Jubayr* wrote in 1183 AD of a major disease vector with the rather generic name of “the Black Stone.”

The Stone, when kissed, has a softness and moistness which so enchants the mouth that he who puts his lips to it would wish them never to be removed. This is one of the special favours of Divine Providence...May God profit us by the kissing and touching of it. By His favour may all who yearn fervently for it be brought to it.<sup>3298</sup>

Why do *Muslims* kiss the Black Stone? *Caliph Umar* said it was on account of the example that *Muhammad* set (*Sahih Al Bukhari* 002:667+675+676+679+680).

The *Hajj* is different from the other shrines because since the dawn of *Islam* so many pilgrims have come from so far, all at once, and camped out in relative proximity to each other for nearly two weeks. Then in quick procession thousands touch and plant wet kisses on one sacred stone.

Unlike pilgrims elsewhere, *Hajjis* French wet kissed the Black Stone—but really it was oral sex since the stylized Black Stone and its silver frame looks vulviform (a point discussed elsewhere). One could say that any diseases that pilgrims picked up from the Black Stone were STDs: Sexually Transmitted Diseases. These STDs were then spread around the world.

A petri dish could hardly outdo the Black Stone as a vector in spreading contagion. Basically, the Black Stone is a biological Weapon of Mass Destruction (WMD). In the past the Black Stone and the *Hajj* affected tens of thousands of *Hajjis* but now it affects two million pilgrims.

Contagious *Hajjis* then return home spreading contagions globally. Cumulatively over fourteen centuries, the *Hajj* has probably been responsible for millions of deaths by disease.

Furthermore, the camp conditions at *Mina* and the lodging in *Makka* have been terrible. The poor sanitation and squalid living conditions of the pilgrims could not fail but to pass on many diseases. No doubt *Muslims* noticed how many *Hajjis* succumbed from deprivations on the march to *Makka* and while camping at *Makka* and *Mina*.

### Nudity and *Ihrams* at the *Kaaba*

The zodiac icons seem to have influenced the dress code during the pilgrimage. Most of the male zodiac figures wore standard attire for ancient times, a skirt that ended at the knee. *Virgo* often wore loose-fitting clothes that covered the body.

<sup>3297</sup> Pipes, Daniel. “A Conspiracy Theory Spreads Polio,” *DP*, 24 May 2005.

<sup>3298</sup> Jubayr. *Travels*.

Lester Ness wrote that the typical Greek portrayals of *Libra* and *Aquarius* were nude.<sup>3299</sup> In one Jewish zodiac...

...*Sagittarius* is a nude human, not a *centaur*, holding a bow and draped in a mantle, somewhat like a *Hercules*' lion skin.<sup>3300</sup>

Some of the humans signs depicted in the zodiacs may have been interpreted as being pilgrims. These were nude or had partial body wraps, or were fully clothed.

The zodiac circle icon "pilgrims" could be thought of as being in a ring that circumambulates around the sun and moon figure. They were like the *Makkans* who circumambulated around a moon-god shrine. So it is not surprising that the pre-Islamic dress code at the *Kaaba* mimicked the zodiac dress code, as *Ibn Ishaq* reports:

Nor could they [pilgrims] circumambulate the House except in the garment of the *Hums*. If they had no such garments they had to go round naked. If any man or woman felt scruples when they had no *Hums* garments, then they could go round in their ordinary clothes; but they had to throw them away afterwards so that neither they nor anyone else could make use of them...The men at least went naked, while the women laid aside all their clothes except a shift [a chemise] wide open back and front.<sup>3301</sup>

Elsewhere *Ibn Ishaq* reported on naked circumambulation:

Outsiders used to circumambulate the temple naked, both men and women...When a woman went round naked she would put one hand behind her and the other in front.<sup>3302</sup>

*Ibn Ishaq* provided a verse that *Muhammad*'s grandfather, *Muttalib*, wrote about how the *Kaaba* was built: "None of our workers wore clothes."<sup>3303</sup> *Ibn Hisham* wrote about a variant reading: "...our *pudenda* [genitalia] were not covered."<sup>3304</sup>

Naked circumambulation was the background for the clothing rule in *Koran* 007:031, 033. *Muhammad* ruled that every male pilgrim (*Hajji*) must wear a linen wrap called an *Ihram*. This wrap is not much more substantial than what some of the zodiac icon men wore. *Ibn Ishaq* reports that *Muhammad* said...

...prohibit men from praying in one small garment unless it be a garment whose ends are doubled over their shoulders, and forbid men from squatting in one garment which exposes their person [i.e. their privates] to the air...<sup>3305</sup>

Even today when *Hajjis* wear just the *Ihram* and sandals (or are barefoot), they still pretty much look the part of certain zodiac icons from whence the style of dress came.<sup>3306</sup>

### Sex at the *Kaaba*

Every month had a zodiac sign based on a constellation in the ecliptic. It is not known what constellation stood for the thirteenth month for intercalary years, though the sign seems to have inspired orgies. Ameer Ali wrote:

<sup>3299</sup> Ness. *Mosaics*, p. 13.

<sup>3300</sup> Ness. *Mosaics*, p. 9.

<sup>3301</sup> Ishaq. *Sirat*, pp. 87-88.

<sup>3302</sup> Ishaq. *Sirat*, p. 89.

<sup>3303</sup> Ishaq. *Sirat*, p. 87.

<sup>3304</sup> Ishaq. *Sirat*, p. 711, note 133.

<sup>3305</sup> Ishaq. *Sirat*, p. 647.

<sup>3306</sup> Nasr & Nomachi. *Makka*, photos on pp. 48-49, 55, 58 66, 71, 76-77, 80, 86, 88-89 and 91.

Since the suppression of the *Nasi* [intercalation], on account of the orgies and various heathen rites observed in the intercalary years, the names of the [*Muslim*] months have no relation to the seasons.<sup>3307</sup>

Besides, the loose dress code inspired by the zodiac signs was bound to increase sexual appetites. *Ibn Ishaq* records:

An Arab woman who was going round the house thus [nearly naked] said:

Today, some or all of it [privates] can be seen,

But what can be seen I do not make common property!<sup>3308</sup>

Of course sexual passion was bound to arise while worshipping *Allah*'s divine daughters. Apparently, a common interjection was "Suck *Allat*'s Nipples!"—*Allat* being the sun-goddess.<sup>3309</sup> After all, arousing passion was the purpose of worshipping Venus (*Uzza*), *Allah*'s daughter and the goddess of lust. For instance, the pagan women at the Battle of *Uhud* chanted:

We are daughters of the Star of the Morn (*Tarik*) [Venus]; we tread softly on silken cushions (*Namarik*); face the enemy boldly and we will press you in our arms; fly and we shall shun you with disgust.<sup>3310</sup>

John of Damascus said that in his day, which is after the *Hajj* pilgrimage was reformed by *Muhammad*, the "rubbing and kissing [the Black Stone]...was extremely passionate." The reason *Muslims* gave for this fertility rite was "Abraham had sexual intercourse with Hagar on it [the Black Stone]."<sup>3311</sup>

John of Damascus said that during his day the Black Stone still had traces of the head "of the *Semitic Venus* (Greek *Aphrodite*)."<sup>3312</sup> Moshan Fani wrote similarly in *The Dabistan* (~1645 AD):

According to the learned, the...*Hajer Ul Asvad*, 'the Black Stone at *Makka*,' represents the body of Venus, which on the border of the heavens is a star of the planets.<sup>3313</sup>

Interestingly, another eighth-century Byzantine writer, Georges the Monk, said that *Muslims* worshipped "god...the moon and *Aphrodite*."<sup>3314</sup> *Aphrodite* is the Greek Venus, whom Georges the Monk probably equated with the Arabian goddess *Uzza* and the Venus Black Stone. What this suggests is *Muslims* were using the crescent-and-orb symbol in the eighth century.

The "traces" in the stone that John of Damascus heard about may have been shallow cuts, or just a reflection of light that pilgrims attributed to Venus. Many betyls like those found at *Petra* are quite featureless but some have the god's eyes, nose and mouth notched into the stone.<sup>3315</sup>

The betyl stone did not need to bear an exact resemblance to the god worshipped. The important thing to the Arabs was that the spirit was thought to

<sup>3307</sup> Ali. *Spirit*, p. 50.

<sup>3308</sup> Ishaq. *Sirat*, p. 88.

<sup>3309</sup> Ishaq. *Sirat*, p. 502.

<sup>3310</sup> Quoted from *Ibn ul-Athir*, vol. ii, p. 118, in Ali. *Spirit*, p. 69, fn. 1.

<sup>3311</sup> Sahas. *Heresy*, pp. 88-89.

<sup>3312</sup> Sahas. *Heresy*, pp. 88, 137.

<sup>3313</sup> Fani. *Dabistan*, p. 394.

<sup>3314</sup> Tolan. *Saracens*, p. 44, fn. 19, p. 296: "Alain Ducellier. *Chretiens d'Orient et Islam au Moyen Age*. Armand Colin, Paris, 1996, pp. 161-164; Migne, J.P. (editor), *Patrologiae Graecae Cursus Completes* (162 volumes), Paris, 1857-1886, vol. 110:873.

<sup>3315</sup> Auge & Dentzer. *Petra*, p. 34; and Levy. *Lost*, p. 72, fig. 11.



inhabit the stone. In fact, the stone could even be smooth and featureless, as F. E. Peters wrote:

One aspect of the worship of the pre-*Islamic* Arabs that attracted the attention not only of Greek and Latin authors who came in contact with Arab society, but also of later *Muslim* authorities on the Age of Barbarism was a widespread cult of stones. For both sets of observers it seemed odd to venerate stones, whether they were totally unshaped or fashioned into some kind of very rudimentary idol. It was not of course the stones that were being worshipped, but an animated spirit within them.<sup>3316</sup>

That the Black Stone is a Venus stone is significant since *Muhammad* kissed the Black Stone, as *Ibn Ishaq* noted.<sup>3317</sup> *Caliph Umar* also kissed the Black Stone:

‘Umar came near the Black Stone and kissed it and said ‘No doubt, I know that you are a stone and can neither benefit anyone nor harm anyone. Had I not seen *Allah’s* Apostle kissing you, I would not have kissed you.’<sup>3318</sup>

There are indications preserved in the traditions that there were orgies even at the *Kaaba*. *Ibn Ishaq* provides an account given by *Aisha*, one of *Muhammad’s* wives:

(The *Quraysh*) adopted *Asaf* (or *Isaf*) and *Na’ila* [as idols]...they were (originally) a man and a woman of *Jurhum*...who copulated in the *Kaaba*, so God transformed them into two stones.<sup>3319</sup>

### Bisexuality at the *Kaaba*

To *Muhammad*, the *Gemini* Twins, *Castor* and *Pollux*, represented two pilgrims. Of course few in Arabia knew the original Mesopotamian and Greek mythology behind the zodiac sign depicting two *Gemini* men. To those who took part in nude circumambulation and orgies during the Pre-*Islamic* period, the *Gemini* twins apparently represented bisexuality and nudism. This would especially be the case if the Arabian zodiac circles depicted the Twins as nudes. As was noted above, other human zodiac signs were often shown nude. James Hastings wrote:

...a *Bedawi*, who belonged to the neighboring tribe of *Hudhail*, marched round the *Kaaba* with his buttocks uncovered, apparently imagining that this was a peculiarly effective means of appealing to the god.<sup>3320</sup>

Not all ancient horoscopes were positive. For instance, it was believed (but not necessarily in medieval Arabia) that if the ascendant at one’s birth was in *Aries* the Ram, this predisposed a person to a life of homosexual lust.<sup>3321</sup> This of course would tend to be a self-fulfilling prophecy.

The *Kuraish* may have thought that *Allah* approved of bisexuality, as indicated by the *Gemini* Twins. This might explain why in the prophet’s tribe, the *Kuraish*, homosexuality was rather common. Jim Wafer wrote:

...*Al Tifashi*...says that ‘inverts’ were common in the Prophet’s own tribe, the *Quraysh*, and the Prophet is supposed to have been particularly amused by

<sup>3316</sup> Peters. *Hajj*, p. 21.

<sup>3317</sup> Ishaq. *Sirat*, p. 131.

<sup>3318</sup> *Sahih Al Bukhari* 002:667, 675, 676, 679, 680; see also *Al Kindy. Apology*, under the section ‘Pilgrimage and rites of *Makka*,’ p. 93; Zwemer. *Animism*, ch. 8.

<sup>3319</sup> Ishaq. *Sirat*, p. 37, as quoted in Peters. *Hajj*, p. 19.

<sup>3320</sup> Hastings. *Ethics*, ‘Arabs (Ancient)’ entry, pp. 667-668.

<sup>3321</sup> Wedel. *Attitude*, p. 126.

the wit of one invert called Hayth. He is also reported to have permitted inverts to be in the same room as his wives when the latter were not veiled.<sup>3322</sup>

A number of *Hadiths* confirm that “effeminate” men were allowed access to *Muhammad’s Harem*, but one was barred because he joked about how obese a particular woman was. Traditions relate that it was customary to allow men with no sexual inclination to enter freely where there were women.<sup>3323</sup>

Bisexuality was common in urban *Makka*, even though “homosexuality seems to have been comparatively little known among the rural *Bedouins* of Arabia in pre-*Islamic* times.”<sup>3324</sup> How *Makkans* were seduced into bisexuality can be learned from *Ibn Ishaq’s* biography. The loose dress code began already in early childhood, as *Ishaq* reports:

The apostle, so I was told, used to tell how God protected him in his childhood during the period of heathenism, saying ‘I found myself among the boys of *Quraysh* carrying stones such as boys play with; we had all uncovered ourselves, each taking his shirt...a wrapper which covered the lower part of the body...and putting it round his neck as he carried the stones. I was going to and fro in the same way, when an unseen figure slapped me most painfully saying ‘Put your shirt on’; so I took it and fastened it on me and then began to carry the stones upon my neck wearing my shirt alone among my fellows.’<sup>3325</sup>

Alfred Guillaume wrote that traditions relate that an angel was sent once in *Muhammad’s* childhood and once when *Muhammad* was an adult. In other words, it took angelic intervention just to keep *Muhammad’s* pants on in public:

Suhayli, [p.] 120, after pointing out that a somewhat similar story is told of the prophet’s modesty and its preservation by supernatural means, at the time that the rebuilding of the *Kaaba* was undertaken when *Muhammad* was a grown man, says significantly that if the account here is correct, divine intervention must have occurred twice.<sup>3326</sup>

So while *Muhammad’s* grandfather, *Muttalib* gleefully composed a poem about how “None of our workers wore clothes” while building the *Kaaba*,<sup>3327</sup> *Muhammad* was fretting about taking his clothes off.<sup>3328</sup> Of course *Muhammad* knew why he needed to keep his clothes on, because bisexuality was common among his fellow *Makkans*. The *Sufi* Martin Lings wrote that a male *Muslim*...

...would tell in after [later] years of the great beauty of the Prophet as he remembered him at the trench, girl with a red cloak, his breast sprinkled with dust and his black hair long enough to touch his shoulders. ‘More beautiful than him I have not seen,’ he would say. Nor was he alone [among the *Muslims*] conscious of this beauty.<sup>3329</sup>

That many *Makkans* were bisexual or had the attitude that bisexuality was acceptable conduct, led to some curious situations, for instance:

<sup>3322</sup> Khawam, Rene R. *Les delices des coeurs par Ahmad Al Tifachi (1184-1253)*. Jerome Martineau, Paris, 1971, p. 255, as quoted in Murray. *Culture*, p. 89.

<sup>3323</sup> *Malik’s Muwatta*, bk. 37, no. 6.5; also see *Sahih Bukhari*, vol. 5, bk. 59, no. 613; vol. 7, bk. 62, no. 162; vol. 7, bk. 72, nos. 774-775; vol. 8, bk. 082, no. 820

<sup>3324</sup> Murray. *Culture*, p. 155.

<sup>3325</sup> *Ishaq. Sirat*, p. 81 & fn. 1.

<sup>3326</sup> *Ishaq. Sirat*, p. 81 & fn. 2.

<sup>3327</sup> *Ishaq. Sirat*, p. 87.

<sup>3328</sup> Muir. *Life*, vol. ii, p. 34, fn. 44.

<sup>3329</sup> Lings. *Sources*, p. 217.

- ☉ ‘Abbas told *Muhammad* to take off his “waist sheet,” but, as luck would have it, *Muhammad* did not comply with the suggestion.<sup>3330</sup>
- ☉ *Abu Bakr* and *Muhammad* stayed together for three days in a dark cave in Mount *Thawr* just south of *Makka*. While they were in the cave, the *Sakina* spirit of peace came upon the two (*K* 009:040).<sup>3331</sup> Let’s just hope the both of them were not wearing the skimpy *Ihram* outfit.

*Abu Bakr* was *Muhammad*’s “Companion.” Also interesting is the fact that *Muhammad* said that he “loved a man,” namely, *Mu’adh Ibn Jabal*, who also just happened to be another “Companion.”<sup>3332</sup> *Muhammad* appointed *Jabal* as *Qadi* (Arabic for “judge”) of *Yemen*, perhaps because things were just getting too steamy in *Madina*, so to speak.

The *Makkans* went out looking for *Muhammad* but when they approached the cave, they did not enter it. Since the men were probably skilled trackers, they hardly could have missed all the footprints leading up to the cave, yet they said “that there was no need to enter the cave since no one could possibly be there.”<sup>3333</sup>

The caves around *Makka* may have been used to provide privacy for sexual exploits as parks around major cities often do. The searchers for *Muhammad* seem to have been politely backing out of a situation where they did not want to intrude on what they supposed was bisexual activity. Prominent *Makkans*, they figured, would be annoyed by such an intrusion, especially if they were discovered in the act.

- ☉ *Muhammad* had either a birthmark or mole on his back that he said was a seal showing he was marked to be a prophet. When a follower wanted to look at it...

...he [*Muhammad*] threw off his cloak laying bare his back and I looked at the seal and recognized it. Then I bent over him kissing him and weeping.<sup>3334</sup>

- ☉ A *Muslim* recounts meeting *Muhammad* at the *Kaaba*, saying “Then he [*Muhammad*] rubbed my breast and prayed that I might be steadfast.”<sup>3335</sup>
- ☉ *Muhammad* stroked *Abu Baker*’s father’s “chest and asked him to accept *Islam* and he did so.”<sup>3336</sup>
- ☉ A convert, “*Addas*, bent over him [*Muhammad*] and kissed his head, his hands and his feet.”<sup>3337</sup>
- ☉ *Anas b. Malik* played footsie with *Muhammad*. He said “So he [*Muhammad*] rode and we rode with him, and I rode behind *Abu Talha* with my foot touching the apostle’s foot.”<sup>3338</sup>
- ☉ *Muhammad* exposed himself, as *Anas* reported “When *Allah*’s Apostle invaded *Khaybar*...the Prophet rode...and my knee was touching the thigh

<sup>3330</sup> *Sahih Bukhari*, vol. 5, bk. 58, no. 170.

<sup>3331</sup> *Armstrong. Biography*, p. 224.

<sup>3332</sup> *Al Farid, Ibn. Poems*, p. 53, note 24. This note is reproduced in full in a footnote found in the following pages.

<sup>3333</sup> *Lings. Sources*, p. 119.

<sup>3334</sup> *Ishaq. Sirat*, p. 97.

<sup>3335</sup> *Ishaq. Sirat*, p. 158.

<sup>3336</sup> *Ishaq. Sirat*, p. 549.

<sup>3337</sup> *Ishaq. Sirat*, p. 193.

<sup>3338</sup> *Ishaq. Sirat*, p. 511.

of the Prophet. He uncovered his thigh and I saw the whiteness of the thigh of the Prophet.”<sup>3339</sup>

- ⊕ “Abdul ‘Aziz reported “The Prophet, laying bare his own belly...whereupon Sawad stooped and imprinted a kiss...‘What made thee do this?’ said the Prophet. And he answered: ‘O Messenger of God, we are now faced with what thou seest [see]; and I desired that at my last moment [before dying in battle] with thee [you]—if so it be [that he actually is killed]—my skin should touch thy skin;’ and the Prophet prayed for him and blessed him.”<sup>3340</sup>
- ⊕ Usayd *Ibn Hudayr*, a man of the *Ansar*, said that while he was given to jesting and was talking to the people and making them laugh, the Prophet...poked him under the ribs with a stick. He [Hudayr] said: ‘Let me take retaliation.’ He [*Muhammad*] said: ‘Take retaliation.’ He [Hudayr] said: ‘You are wearing a shirt but I am not.’ The Prophet...then raised his shirt and the man embraced him and began to kiss his side. Then he said: ‘This is what I wanted, Apostle of *Allah*!’ (*Sunan Abu-Dawud*, bk. 41, no. 5205).

Stephen O. Murray and Will Roscoe wrote that in *Islam*, bisexuality and even pederasty flourished:

Pederasty has not been the only form of homosexuality in Arabic culture (and still less so in other *Islamic* cultures—especially in the eastern reaches of *Islam*), but it has long been the idealized form...within *Islamic* cosmology, male sexual pleasure is ‘good-in-itself’ not merely as a means to procreation, but as a prefiguring paradise, which according to the *Quran* is staffed with beautiful serving boys (*Al Fata*) as well as girls (the term *Houri* includes both [girls and boys]) ([*K* 0]56:17ff; 52:17ff; 52:24; 76:19)...there is the famous tale in which *Mohammad* saw God in the form of a beautiful youth (Schimmel, Annemarie, 1982:67-68; Ritter, Hellmut, 1955:445-46), the tradition that the Prophet loved a man [the “Companion,” Mu’adh *Ibn Jabal*],<sup>3341</sup> and the report of *Al Jahiz* (~776 to ~868 [AD]) concerning the ease with which early companions discussed sexuality in the introduction of *Kitab Mufakharat Al Jawari Wa-Al Ghulman* (a book of the debate comparing the advantages of [sex with] women and [or, versus] young men; see *Abu Khalil*, As’ad, 1993:33).<sup>3342</sup>

Richard Burton (1821–1890 AD), a famous British explorer and Orientalist, wrote:

*Mohammed* seems to have regarded [pederasty] with philosophic indifference.”<sup>3343</sup>

<sup>3339</sup> *Sahih Bukhari*, vol. 1, bk. 8, no. 367; also see *Sahih Muslim*, bk. 019, no. 4437.

<sup>3340</sup> Lings. *Sources*, p. 146.

<sup>3341</sup> Arthur J. Arberry wrote: “Note 24: The reference is to Mu’adh *b. Jabal*, the Companion, a famous transmitter of Traditions whom the Prophet appointed as *Qadi* [Judge] of *Yemen*; a man of many virtues, remarkably handsome; the Prophet once said to him, ‘O Mu’adh, truly I love thee’; he died a martyr’s death in his thirties in the year 17/638 or 18/639 (see *Ibn Hajar*, x, 186-8; *Ibn Al ‘Imad*, i, 29-30; Hitti, 397). The choice of his name is thus particularly apposite [appropriate], apart from its rhetorical elegance. The reference suggests that the poet now has in mind a mortal beloved, no doubt a handsome disciple, in whom he is seeing after *Sufi* fashion the embodiment of Divine Beauty. Note the *Jinas* between *L-ma’adi* and *Mu’ada*” (*Al Farid*, *Ibn. Poems*, p. 53).

<sup>3342</sup> Murray. *Culture*, pp. 302, 307 (also see p. 90).

<sup>3343</sup> Burton. *Essay*.

Since *Muslims* reject the validity of the Old and New Testaments, *Muslims* are left without any clear scriptural command against bisexuality. The *Hadith* are equally open to interpretation.<sup>3344</sup>

The *Koran* and *Hadith* only speak against homosexuality but not necessarily bisexuality. The *Koran*'s message is that men and women can enjoy, and even prefer bisexuality, as long as one does not entirely abandon sexual relations with the opposite sex (*K* 011:079). Stephen O. Murray and Will Roscoe wrote on the subject:

Despite the Prophet's familiarity with the *Talmudic* tradition and his view that sodomy ran contrary to God's will (*Fasiq*), he did not include it among the 'abominations' offensive to *Allah* for which he related specific punishments. Nor did subsequent *Islamic* commentators draw on accounts of *Sodom* and *Gomorrah*...to condemn homosexuality, as did Biblical commentators.<sup>3345</sup>

The *Koran*...mentions the story of *Sodom* and *Gomorrah* at least eight times.<sup>3346</sup> Each accounts suggests that the abandonment of the opposite sex was the troubling issue but not the attempted homosexual encounter (*K* 007:081; 011:079; 026:165-166; 027:055; 029:028). That the *Sodomites* had abandoned women is shown by how the *Sodomites* were only interested in the two male visitors—even after Lot offered his two daughters.

According to *Muhammad*'s thinking, if the *Sodomites* had only been bisexuals rather than homosexuals (*K* 011:078-079; 015:071), than *Sodom* would have been spared. *Ibn Warraq* wrote:

...some scholars find the *Koranic* attitude [towards homosexuality], at worst, mildly negative or even ambiguous...<sup>3347</sup>

Jim Wafer wrote:

There is however only one passage in the *Quran* that can be interpreted as prescribing a particular legal position toward sexual relations between males within the *Umma* (community of believers). It is translated by *Pickthall* as follows:

And as for the two of you who are guilty thereof, punish them both. And if they repent and improve, then let them be. Lo! *Allah* is Relenting, Merciful ([*K*] 4.16).<sup>3348</sup>

The *Hadith* also suggest that *Muhammad*'s problem with the *Sodomites* was over their homosexuality—not necessarily their bisexuality. *Muhammad* said:

If you find anyone doing as Lot's people did, kill the one who does it and the one to whom it is done (*Sunan Abu-Dawud*, bk. 38, no. 4447).

If a man who is **not married** is seized committing sodomy, he will be stoned to death (*Sunan Abu-Dawud*, bk. 38, no. 4448).

Being a practicing *Muslim* would exempt homosexuals from most punishment, as suggested by this tradition about a cross-dresser:

A hermaphrodite (*Mukhannath*) who had dyed his hands and feet with *Henna* was brought to the Prophet...He asked: 'What is the matter with this man?' He was told: 'Apostle of *Allah*! He affects [wears a] women's get-up [clothing].' So he ordered regarding him and he was banished to *An-Naqi*. The

<sup>3344</sup> *Sunan Abu-Dawud*, 38.4447-4448; *Malik's Muwatta*, 41.1.11.

<sup>3345</sup> Murray. *Culture*, p. 307.

<sup>3346</sup> *K* 007:080-084; 011:077-083; 015:058-076; 021:074; 022:043; 026:165-175; 027:056-059; 029:027-033.

<sup>3347</sup> Warraq. *Why*, p. 341.

<sup>3348</sup> Murray. *Culture*, p. 88.

people said: ‘Apostle of *Allah*! Should we not kill him?’ He said: ‘I have been prohibited from killing people who pray.’ *Abu Usamah* said: ‘*Naqi*’ is a region near *Madina*...<sup>3349</sup>

So authentic *Islam* does not condemn *Muslim* homosexuals, as long as they do not swear off bisexuality entirely. Given *Islam*’s laxity or love-hate relationship toward homosexual conduct, it naturally follows that *Imams* were often of that “persuasion,” as Stephen Murray and Will Roscoe noted:

The sarcastic maxim of the Persian wit ‘Obeyd-e Zakani (~1300 to ~1370), ‘Do not withhold your posterior favors from friends and foes when [you are] young, so that in old age you can attain the status of a *Sheik*, a preacher or a man of fame and dignity,<sup>3350</sup> surely is an exaggeration—but one does not exaggerate what does not exist, nor satirize what has no relation to what the audience recognizes as reality.<sup>3351</sup>

Stephen Murray and Will Roscoe also wrote:

The most acclaimed lyricist of this brilliant era, *Ibn Quzman* (~1080-1160 [AD]), has been called one of the greatest of medieval poets. An irreverent *Bohemian* of the cut of Francois Villon [1431–1463? AD], he composed racy, colloquial *Zajals*, far removed from the canons of classical Arabic verse. Tall, blond and blue-eyed, *Ibn Quzman* led a licentious life resembling that of [*Caliph*] Haroun *Al Rashid*’s boon companion in *Baghdad*, the poet *Abu Nuwas* [died 195 AH/810 AD], who was also unabashedly explicit about his homosexuality. In short, terse lines and elliptical stanzas that are almost untranslatable, he celebrates ‘wine, adultery and sodomy’ (*Ibn Hazm* 1931:268). Like the troubadours of *Provence* [in southern France] he complains of the *hauteur* [haughtiness] and disdain of his lovers, who are often male, but laughs at the refined conventions of idealistic love: ‘What do you say about a beloved, when he and you, without anyone else, are alone and the house door is locked?’ (*Ibn Hazm* 1931:283 and *Passim*). Poverty-stricken, he ended his days, not on the gallows, but as an *Imam* teaching in a *Mosque*.<sup>3352</sup>

Samuel Zwemer wrote that *Imams* preached in *Mosques* using erotic verse:

Into the sermon he introduced compliments to the *Khalifah* [*Caliph*] and his mother and prayers for them; he further recited many verses, some encomia [praise] on the sovereign, others of the *Sufi* erotic style, which affected the audience powerfully.<sup>3353</sup>

Stephen Murray and Will Roscoe wrote that *Islam* officially introduced bisexuality into the conquered territories:

Some [*Muslims*] (such as *Abu Nuwas* [died 195 AH/810 AD] and the [*Madinan*] jurists of the *Maliki* school rationalized the practice of making non-believers submit to penetration [sodomizing] by believers [*Muslims*] as a means of glorifying the superiority of *Islam*—a duty for *Muslims* rather than as a sin.<sup>3354</sup>

<sup>3349</sup> *Sahih Abu-Dawud*, bk. 41, no. 4910.

<sup>3350</sup> ‘Obeyd-e Zakani, *Nezam Al Din. The Ethics of the Aristocrats [1350 AD] and Other Satirical Works*. Hasan Javadi (translator and editor), Jahan Books, Piedmont, California, USA, 1985, p. 65, as quoted in Murray. *Culture*, p. 21.

<sup>3351</sup> Javadi, Hasan. *Satire in Persian Literature*. Dickinson University Press, Rutherford, New Jersey, USA, 1988, as cited in Murray. *Culture*, p. 21.

<sup>3352</sup> Murray. *Culture*, p. 154.

<sup>3353</sup> Zwemer. *Heirs*, ch. 4, pp. 46-47.

<sup>3354</sup> Murray. *Culture*, p. 304.

The *Maliki* school of law in *Madina* was founded by *Malik Ibn Anas, Abu Abd Allah* (94-179 AH/716-795 AD). Cyril Glassé wrote:

He [*Malik Ibn Anas*] was born and died in *Madina* and received traditions from *Sahl Ibn Sa'd*, one of the last surviving Companions [of the Prophet]...*Malik Ibn Anas* studied with *Ja'far as-Sadiq*, the great scholar and descendant of the Prophet...His book, the *Muwatta* (*The Path Made Smooth*) is the earliest collection of *Hadith* and the first book of the law. The *Maliki* School of law, which derives from him [*Malik Ibn Anas*], is dominant in the Arab West and is also found in southern Egypt.<sup>3355</sup>

*Muslims* took the *Maliki* school's sodomy *Fatwa* seriously, as Jim Wafer wrote:

...although the great Arabic poet *Abu Nuwas* said that he slept with Christians, Jewish and Zoroastrian boys because he regarded it as 'the duty of every *Muslim* to sleep with them' (Wagner 1965:188). A number of other poets also had a predilection for boys who were not *Muslims* (Schimmel 1979:140)...it seems fairly clear that it [homosexual pederasty] was because he [*Abu Nuwas*] was making non-*Muslims* submit to a *Muslim* [*K* 009:029].<sup>3356</sup>

Evidently, this conduct continues. In 2001, an Australian soldier...

...was told by a group of children that Jordanian [*Muslim* U.N. peacekeeping] soldiers had offered food and money in exchange for oral sex and intercourse. The allegations involved East *Timorese* minors, all boys, the youngest of them just 12 years old...The board of inquiry found in its report that Jordanian troops regularly offered food and money in exchange for sexual favours from women and boys, including the procuring of prostitutes from across the border in West *Timor*.<sup>3357</sup>

...in early 2001, two Jordanians were evacuated home with injured penises after attempting sexual intercourse with goats.<sup>3358</sup>

*Islam* cannot blame the sexual habits prevalent in *Islam* on pre-*Islamic* cultures because homosexuality had been in decline everywhere in the world prior to *Islam*. The ancient Greeks had written the last well-known literature that spoke of pederasty long before the *Islamic* conquest. After the *Islamic* invasions, homosexuality and pederasty resurfaced and became resurgent everywhere *Muslims* conquered. Will Roscoe wrote that:

- ☉ The Mesopotamians and *Assyrians* had proscribed homosexuality since ancient times.
- ☉ The Zoroastrians in Persia "severely condemned homosexuality."
- ☉ The Egyptian *Book of the Dead* displays a negative attitude towards homosexuality.
- ☉ The literature shows "there is little evidence of status-differentiated homosexuality in ancient India."<sup>3359</sup>
- ☉ The Byzantines considered homosexual acts to be adultery.<sup>3360</sup>
- ☉ The *Visigoths* in Spain punished homosexual acts by castration.<sup>3361</sup>

<sup>3355</sup> Glassé. *Encyclopedia*, p. 250, "*Malik Ibn Anas, Abu Abd Allah*" entry.

<sup>3356</sup> Murray. *Culture*, p. 92.

<sup>3357</sup> Dodd, Mark. "Diggers in *Timor* 'sex' clash," theaustralian.news.com.au, 21 Mar 2005, *LGF*.

<sup>3358</sup> Dodd, Mark. "Hushed rape of *Timor*," theaustralian.news.com.au, 26 Mar, 2005, *LGF*.

<sup>3359</sup> Murray. *Culture*, pp. 60-62.

<sup>3360</sup> Murray. *Culture*, p. 62.

<sup>3361</sup> Murray. *Culture*, p. 63.

The Christian West generally frowned on and even criminalized sodomy. When some nineteenth-century European elites wanted to experiment sexually, they had to go to *Muslim* lands. Richard Burton wrote in his terminal essay that some European elite especially, vacationed in *Islamic* lands specifically to experiment in the sexual perversions that were rampant, as confirmed by Murray & Roscoe and others.<sup>3362 3363</sup>

Even today homosexuality in the West remains at about one percent of the population, despite the exaggerated pseudo-statistics offered by pro-homosexuals.

One hard statistic about homosexuality in the West is the fact that there were only twenty-four compensation claims by same-sex partners after 9/11, though claimants stood the chance of receiving substantial awards.<sup>3364</sup> There were approximately 2,797 persons murdered by *Islamo*-fascist terrorists at the New York World Trade Center on 9/11/2001, meaning that less than one percent of the victims were homosexual.

New York City is a large metropolitan area where one might expect a higher concentration of homosexuals. The above statistics means New York compares favorably to large cities in the *Islamic* world. Why? Due to the dowry system, older men take the most desirable women out of the marriage market (Gen 35:22). Polygamous marriages produce many children with distant fathers and these children tend to be unemployable and not candidates for marriage. These many singles then engage in sex outside of marriage—often homosexual sex.

### Moon-gods and the Underworld

The horns or limbs of the crescent-moons that *Muhammad* would have seen in zodiac circle would have been nearly level. That is because the observer in the Mideast is near the equator where the horns of the crescent-moon appear nearly level.



**Figure 08-03.** The nearly level scimitar-like (or frown) waning crescent as seen in the Mideast near the equator. This view is most often seen toward the end of the lunar month in the morning. The frown crescent is often seen on *Islamic* coins.



**Figure 08-04.** The nearly level smile (or “Cheshire grin”) waxing crescent as seen in the Mideast near the equator. This view is most often seen near the start of the lunar month in the evening. The smile crescent is often seen on *Islamic* coins.

In the Mideast the moon was sometimes reckoned to be the moon-god’s boat or the horns of a bull. At higher or lower altitudes on earth, the limbs of the crescent appear canted. Thus in the northerly latitudes the crescent was thought to be an archer’s bow, because a boat at such an angle would capsize and sink.

In moon-god religions, generally it was thought that whenever the moon set, it went into the underworld. As the moon passes near the sun (conjunction) at the end of each lunar month, it is not visible for about three days. During these three days, it was thought that the moon was delayed in the underworld.

In his pre-*Islamic* days *Muhammad* figured that the moon-god did in the underworld what the moon-god did in the sky. *Muhammad* figured the moon-god transversed the underworld wielding his sword while sodomizing all the underworld

<sup>3362</sup> Murray. *Culture*, pp. 204-221.

<sup>3363</sup> Burton. *Essay*.

<sup>3364</sup> Raab, Barbara, “Same-sex partners face discrimination: Unique legal, emotional troubles for gay survivors,” *NBC News*, [msnbc.com/news/675127.asp](http://msnbc.com/news/675127.asp), 20 Dec 2001.



deities. These included the astral deities such as *Sirius-Isis* and constellations that only appeared seasonally but otherwise hid out in the underworld below the horizon.

Why did *Muhammad* think *Allah* did this? In moon-god worshipping cultures, the kings sometimes sodomized their rivals “to show who is the boss.” In fact, Richard Burton wrote that even in the nineteenth century, Persian princes sodomized Christian missionaries to show them who was the boss.<sup>3365</sup> Gordon Newby gives an example that an early *Islamic* historian provides:

In *Ibn Ishaq's* chronology of [pre-Islamic] *Yemen*<sup>3366</sup>...Hassan was overthrown by *Dhu Shanatir*...His [King Hassan's] policy for consolidation of power was either to kill the leaders of the society or to sodomize them, rendering them unfit for rule because of their shame.<sup>3367</sup>

*Muhammad* saw that at the end of each lunar month, the frowning moon headed toward the underworld most often looking like a sickle-sword. Then, at the first appearance of the moon at the start of lunar month, the moon appeared to have a smile like a Cheshire cat. Between the smiling and frowning phases, the moon waxed full where *Allah* showed his martial glory and also his person or face, otherwise known as “the Man-in-the-Moon.”

The pagan *Muhammad* figured from the smiley moon face that *Allah* must like wielding his scimitar during his end-of-lunar-month *Jihad* stint-and-sodomizing fling through the underworld. Apparently, to *Allah* the underworld was both a sodomist's heaven and a kind of a Norse *Valhalla* warrior heaven. Of course for the damned humans the underworld was more like Dante's *Inferno*.

In *Muhammad's* cosmos the angels were all male that threw meteors at *Jinn* and demons on earth. Whenever there was just one meteor, *Muhammad* thought it had been thrown at a *Jinni* spotted eavesdropping (*K* 041:012). Whenever there were meteor showers, *Muhammad* thought a big battle was raging (*K* 072:008-009). *Muhammad* thought a psychotic, scimitar-wielding, fanatical moon-god led this male army of rock-throwing angels.

---

<sup>3365</sup> Burton. *Essay*.

<sup>3366</sup> Ishaq. *Sirat*, pp. 13-14.

<sup>3367</sup> Newby. *Arabia*, p. 39.

### The Pagan *Makkans* Wanted to Keep Their Friendly Skies

The *Makkans* wanted to keep their friendlier skies with its mix of zoological constellations and heroic gods and lovely goddesses. The friendly gods more than offset the few bad apples like the warlike Mars, grouchy Saturn and the moon with its scimitar phase at the end of month.

In the pagan era in the Fertile Crescent, the moon-god mostly rowed his boat across the sky and was the farmers' friend who was associated with bulls, sickles and scythes. In Southern Arabia however the moon-gods were also national war-gods, as Ditlef Nielsen noted.<sup>3368</sup>

Pagans believed that most of the pagan astral gods would gladly hear an earthly supplicant and then answer the prayer themselves, or intercede with *Allah* the moon-god, especially when it was not a moonless night.

The best time for the other gods to approach *Allah* was when he showed a smiley crescent face at the beginning of the month. Otherwise, *Allah* became increasingly hard to approach as the moon became fuller, which is why his brightness rendered other astral objects nearly invisible.

In *Muhammad's* schema however *Allah* became omnipotent and less friendly. Heaven help the astral angel like Venus who approached *Allah* at the end of the month when he appeared as a scimitar. In a moon-o-theistic sky, *Allah* became like the Persian monarch in the Biblical *Book of Esther*:

All the king's officials and the people of the royal provinces know that for any man or woman who approaches the king in the inner court without being summoned the king has but one law: that he be put to death. The only exception to this is for the king to extend the gold scepter to him and spare his life (Est 04:11).

So this partly answers the question of why the *Makkans* were so adamant about wanting to keep their intercessors to *Allah* such as *Allat*, *Manat* and *Uzza*. As Hawting describes it, the *Makkans* had only "some limited and grudging acceptance of *Allah*."<sup>3369</sup> *Allah* the moon-god was unapproachable because of his criminally deranged, warlike disposition and his sodomistic tendencies.

That the *Makkans* knew *Allah* to be implacably harsh and sexually perverted is evident from the *Koran*, the *Hadith* traditions and the character of *Muhammad* and *Islam* itself. The *Koran* shows that *Mekkans* knew *Allah* not to be compassionate:

Call upon *Allah* or call upon *Rahman*: by whatever name ye call upon Him, (it is well); for to Him belong the Most Beautiful Names (*K* 017:110),

When it is said to them, 'Adore ye 'the Compassionate' [*Al Rahman*], they say 'And what is the Compassionate? Why should we adore what you command?' (*K* 025:060).

They [the *Makkans*] blaspheme at the mention of [*Allah's* being] 'the Compassionate' (*K* 021:036).

That the *Makkans* thought "compassion" was uncharacteristic of *Allah's* is evident from this bit of history. The *Sufi* Martin Lings wrote:

When they had finally reached an agreement the Prophet told 'Ali to write down the terms, beginning with... 'in the Name of God, the Good, the Merciful (*Al Rahman*),' but Suhayl objected. 'As to *Rahman*,' he said 'I know not what he

<sup>3368</sup> Nielsen, 1912, pp. 593-594, as translated in Krause, "*Haram-Harimat*."

<sup>3369</sup> Hawting, *Idolatry*, p. 34.

is.’ But write...In Thy Name, O God, as thou wert [were] wont [i.e. accustomed] to write.<sup>3370</sup>

*Muhammad* did nothing to improve *Allah*’s character and in fact made *Allah*’s personality even more malevolent. Most *Makkans* recognized this but were forced to accept *Islam* or else be beheaded during one of *Islam*’s early *Jihad* conquests.

### The Fact That *Allah* is a Demon Leads to a Demonic Religion

The reader need not be reminded here of *Islam*’s disturbing practices and sordid doctrines mentioned elsewhere in this book. However, a point not addressed elsewhere is the fact that *Islam* celebrates quite alarming historical events is quite telling about how *Islam* is a demonic religion, for instance:

☉ The *Islamic* New Years Day falls on the first day of the lunar month in which *Muhammad* escaped assassination in *Makka* and fled to *Madina*. This flight (Arabic: *Hijri*) gives the name to the *Hijri* lunar religious calendar.

*Muhammad* had to flee *Makka* because the *Makkans* took *Muhammad*’s sworn terrorist threats seriously, such as:

Will you listen to me, O *Quraysh*? By him [*Allah*], who holds my life in His hand, I [*Muhammad*] bring you slaughter [compare *K* 008:067].<sup>3371</sup>

So *Muslims* celebrate how *Muhammad* literally was “the terrorist who got away.” *Muhammad* started his own terrorist network in *Madina*, which promptly grew into the global terrorist network commonly known as *Islam*,

☉ *Laylat Al Isra & Al Me’raj* (or *Shab-E-Me’raj*) means “the Night Journey and the Ascension” to heaven (*K* 017:001). During this two-part journey *Muhammad* got a glimpse of hell.<sup>3372</sup> The account later inspired Dante’s *Inferno*.<sup>3373 3374</sup> The *Koran* and the traditions teach that many *Muslims* will taste of hellfire, in other words, Purgatory, before reaching heaven.<sup>3375</sup> So *Muslims* celebrate how they are going to go to hell for an extended period,

☉ During the entire month of *Ramadan* *Muslims* drink no water, eat no food and have no sex, except at night. This suggests a celebration spiritual darkness (*Pro* 04:18-19; *Joh* 08:12; 11:10) and a celebration of the powers of darkness, powers that include the moon-god *Allah* (*Eph* 06:12). Christians by contrast are “all sons of the light and sons of the day. We do not belong to the night or to the darkness” (1Th 05:05).

☉ *Laylat Al Qadr* means “night of power” and refers to the night when the first verses of the dreadful book, the *Koran*, were revealed toward the end of *Ramadan*. A demon that *Muhammad* supposed was the angel *Gabriel* came to *Muhammad*’s cave and choked him three times to the point of death.<sup>3376</sup>

*Muhammad* feared that he had been demonically possessed and he thought his Mount *Hira* cave was haunted.<sup>3377</sup> *Muhammad*’s initial instincts were correct. Notably, Paul said that demons can masquerade as an angel of

<sup>3370</sup> Lings. *Sources*, p. 252.

<sup>3371</sup> Ishaq. *Sirat*, p. 131.

<sup>3372</sup> Fani. *Sufis*, p. 405.

<sup>3373</sup> Ishaq. *Sirat*, pp. xx-xxi.

<sup>3374</sup> Guillaume. *Islam*, p. 150.

<sup>3375</sup> See the Glossary for information on *Islam*’s version of Purgatory.

<sup>3376</sup> Ishaq. *Sirat*, p. 106.

<sup>3377</sup> Haykal. *Life*, p. 74, as quoted in Geisler & Saleeb. *Answering*, p. 155.

light (2Co 11:14), but this demon does not play the part of the angel *Gabriel* well at all.

*Muhammad* seems to have had the same type of demonic possession as a certain man who heard Jesus' sermon in a synagogue, but no one seems to have known that *Muhammad* was possessed (Luk 04:33). So during *Ramadan*, *Muslims* celebrate how a demon choked *Muhammad* three times before possessing him.

- ⊙ *Eid Al Adha* means “feast of sacrifice” and celebrates when *Ibrahim* nearly sacrificed one of his sons. *Muslims* think this son was *Ishmael*, who they adore as a saint and prophet, even though it was prophesied of him:

He will be a wild donkey of a man; his hand will be against everyone and everyone's hand against him and he will live in hostility toward all his brothers (Gen 16:12).

That *Muslims* think this “wild donkey of a man” *Ishmael* is their progenitor, prophet, saint and role model, may explain why *Muslims* think that violent *Jihad* and other barbaric behavior is godly conduct.

### ***Allah* as the Night-god and Chthonic (Underworld) Moon-god**

The belief that moon-gods rule over hell goes back to primitive times, as the *Encyclopedia Britannica* notes:

...the moon is frequently regarded as male and, particularly in regard to women, is understood as a preeminently evil or dangerous figure...The moon is viewed in terms of the rhythmic life of the cosmos and is believed to govern all vital change. The cyclical process of disappearance and appearance of the moon is the basis of the widespread association of the moon with the land of the dead...<sup>3378</sup>

After *Muhammad* became a monotheist, the astral deities of the underworld were no more. *Muhammad* now figured that the underworld was a hell for the damned and demons. The night-sun and the moon traveling through the underworld provided the heat of hell to torment and burn the damned.

It was thought that the sun went to the underworld each night and the moon was in the underworld whenever it could not be seen in the sky. Thus the moon was in the underworld daily and the moon had an extended three-day stay at the end of each lunar month.

The sun and moon are not both seen above the horizon together for very long, so one or the other is nearly always in the underworld keeping hell toasty. One can tell that *Muhammad* believed the foregoing from various traditions, such as:

According to *Al Bokhari* [*Al Bukhari*] the Prophet postponed the noonday prayer until after high noon for ‘the greatest heat of the day belongs to the heat of hell.’ Nor is it permitted to pray shortly after sunrise for ‘the sun rises between the horns of the devil.’<sup>3379</sup>

The above quote means *Muhammad* recognized that the noonday sun provided the heat of hell during the nighttime. Also, *Muhammad* thought that when the sun rose, it came out of the underworld, in other words, hell—where the horned devil makes his abode.

<sup>3378</sup> *EB*, accessed 29 Mar 2003, “Moon Worship” entry.

<sup>3379</sup> Zwemer. *Animism*, ch. 3.

The historian Tabari (839–923 AD) wrote that Ka’b, a *Rabbi* convert to *Islam*, said...

...on the Day of Resurrection, the sun and the moon will be brought as if they were two hamstrung oxen and flung into hell.<sup>3380</sup>

Tabari wrote that *Muhammad* said that the light of moon supposedly comes from the glory of *Allah*’s footstool, whereas the glory of the sun comes from the throne itself.<sup>3381</sup> Tabari wrote that *Muhammad* said the light was delivered from *Allah* in the form of glowing garments.

Significantly, *Muhammad* said that the denizens of hell would be given “garments of fire” to wear (*K* 022:019). So the glory of *Allah* in the form of garments of fire covers both the sun and the moon. These garments radiate light, and heat the underworld and the damned as though it were an oven.<sup>3382</sup>

The glory of *Allah* would serve to keep the damned in hell forever. That is because extreme heat causes the damned to worship gods other than *Allah*. Hence, the damned became perpetual idolaters and so remained in hell forever. This can be inferred from a quotation of *Muhammad* that the historian Tabari provides:

If the sun were to emerge from that ocean [ethereal sphere], it would burn everything on earth, including even rocks and stones, and if the moon were to emerge from it, it would afflict (by its heat) the inhabitants of the earth to such an extent that they would worship gods other than [*Allah* the moon-]god.<sup>3383</sup>

So the moon afflicts the damned with heat, and since the moon is the symbol of *Allah* the moon-god, people worship gods other than *Allah* out of spite.

The *Koran* also speaks of the sun as being a tormenter (*K* 018:090; 020:119; 076:013). This is natural since *Makka* is located in a *Saudi* Arabian desert not too far from the equator, relatively speaking.

That the sun and moon both transverse hell explains the different descriptions of the torments. Evidently, when heated by the passing moon, peoples’ skins and bellies would merely melt (*K* 022:020). However, when the sun passed by, the skins would be so thoroughly burned the skin would need to be regenerated anew. The renewed skin meant the damned would suffer again and again each time the sun passed through the underworld (*K* 004:056).

That *Muhammad* was formerly a pagan worshipper of astral deities explains why *Muhammad* thought of hell so often—as evidenced by the *Koran*. For astral worshippers, the sun became the night-sun when it traveled through the underworld. In some places in the ancient world, the night-sun was worshipped as, or even more, fervently than the daytime sun.

As was the case with the sun, when the moon made its end of month extended stay in the underworld, often this is when moon-god worship intensified. Tamara Green wrote that in polytheistic *Haran*, “...the end of the month was traditionally devoted to the moon-god.”<sup>3384</sup> That *Muhammad* was a former astral worshipper and he thought hell was heated by the sun and moon, explains why hell is mentioned so often in the *Koran*. In other words, *Muhammad* thought of *Allah* as being a chthonic underworld god whenever the moon was not hanging in the sky.

<sup>3380</sup> *Al Tabari. History*, vol. i, p. 233.

<sup>3381</sup> *Al Tabari. History*, vol. i, pp. 231-232.

<sup>3382</sup> *Al Tabari. History*, p. 232.

<sup>3383</sup> *Al Tabari. History*, vol. i, p. 235.

<sup>3384</sup> Green. *Moon*, p. 192.

The contrast between the Bible (especially the Old Testament) and the *Koran*, on the frequency of mentions of hell is instructive. The Bible barely mentions suffering in hell throughout its pages, but in the *Koran*, which is comparable in size to the New Testament, the word “hell” is found ninety-seven times. Added to this number are all the times hell is described without specifically using the term “hell.” The *Koran* mentions the threat of hell, on average, every 7.9 verses (783 verses out of 6,151 total verses)!<sup>3385</sup>

*Muhammad* must have thought of hell every time the moon set since that was where his god was. This would explain the frequent mention of hell in the *Koran* and the traditions.

*Muhammad* believed that the sun set into a mud puddle (*Pickthall K* 018:086). *Muhammad* must have thought the moon set similarly, but in some dignified place. The sun and moon then both made their way through the cavernous underworld.

At the end of the lunar month *Muhammad* saw *Allah*'s scimitar swoop into hell as a sickle and then stay there two or three days. Moon-god religions typically thought the moon-god was fighting a dragon or holding court in the underworld. In *Muhammad*'s mind, these ideas gave way to the idea that hell was a hot place of judgment for the demons, for the damned and for *Muslims* waiting for their release.

### Why *Islam* is the Religion of Submitters and Surrenderers

Christians see themselves as being sons and daughters of God (Gal 04:06). Christians consider the unsaved to be slaves to sin. Thus evangelism is carried out with the attitude that one is helping the Spirit free brothers and friends from the shackles of sin.

*Muslims* however see themselves as submitters and surrenderers, as though *Allah* conquered them against their will. This attitude affects *Muslim* proselytizing too since *Muslims* think *Allah* wants them to conquer others whether they want to have anything to do with *Islam* or not.

*Muhammad* got this notion of proselytizing from the fact that *Allah* was a war-god, as well as a moon-god. *Muhammad* saw *Allah* leaving the underworld at the start of the lunar month as a smiley face. So *Muhammad* figured that *Allah* loved tormenting the damned in the underworld.

*Muhammad* also figured out that long ago the crescent-moon sword got its bent shape from vigorously slashing infidels. *Muhammad* in fact said that it was every sword's “right” to be bent by vigorously slashing infidels.<sup>3386</sup>

*Muhammad* derived his doctrine of hell from his beliefs that the moon was a hot scimitar slashing unbelievers in hell (the underworld). This can be seen in the *Koran*, *Islamic* doctrine and several traditions.

That *Allah*'s primary symbol was the scimitar-looking crescent explains why *Islam* is a religion of surrenderers. Night after night *Allah* relentlessly plies the night skies with his shining sword and there is no escape since one can hide from the light of the moon only so long.

Anyone who thought of the moon as the high god's scimitar would only think of surrender. So it is not surprising that *Muslims* are constantly pointing out that *Islam* is Arabic for “submission” and *Muslim* is Arabic for “one who submits.” Both words

<sup>3385</sup> Richardson. *Secrets*, p. 92.

<sup>3386</sup> Ishaq. *Sirat*, p. 373 & fn. 1.

are derived from the Arabic word *'aslama*, meaning “to surrender, resign oneself.”<sup>3387</sup>

Because *Muslims* have themselves surrendered their lives to *Allah* the moon-god, they expect non-*Muslims* to do likewise. So whenever the opportunity presents itself, *Muslims* give non-*Muslims* the choice of becoming *Muslims*, surrendering and paying tax to *Muslims* (K 009:029) or the choice of death (K 009:005).

If non-*Muslims* try to choose any option other than those that *Muslims* offer, it is viewed as an act of unbelief that is outside the will of *Allah*. So *Muslims* often act as though non-*Muslims* do not even have a legitimate right to protect themselves, even against the murderous aggression of *Jihadists* and *Muslim* terrorists by any means.

It makes no difference to *Muslims* what form the protective measures take, whether they are offensive pinprick retaliatory strikes, or even defensive fences, walls and ditches. *Muslims* think that nothing less than unconditional surrender is acceptable.

The *Seerat* Bridge between earth and heaven is, as Norman Geisler described:

The edge of the *Seerat* is like a sword as fine as a hair and hotter than fiery charcoal.<sup>3388</sup>

The reason the *Seerat* sword bridge is hot is that *Muhammad* associated it with the crescent-moon scimitar, which he thought was hot enough to melt skin (K 022:020), as was discussed before.

*Muhammad* related a clear preference for scimitars, saying that every sword's right is to be bent, preferably during battle with infidels, if not during the forging process. *Muhammad* said:

The apostle wore two coats of mail on the day of *Uhud* and he took up a sword and brandished it saying ‘Who will take this sword with its right? [Footnote: “i.e. use it as it ought and deserves to be used”]...He asked, ‘What is its right, O Apostle of God?’ He answered, ‘That you should smite the enemy with it until it bends.’<sup>3389</sup>

Interestingly, the straight sword that *Muhammad* was holding at the time he made the above statement was probably part of the loot obtained at the Battle of *Badr*, which means “full-moon” in Arabic.

Many gods were depicted carrying weapons in ancient times. What differentiated the war-god from other gods was his consuming interest in warfare. In Southern Arabia all the moon-gods were war-gods and the fact that *Allah* is so warlike pegs him as being a South Arabian moon-god. Hans Kraus wrote:

...the main god, the national god of war...this is in all South Arabian, yes, nearly in all Semitic monuments, a sure identifying mark of the moon-god.<sup>3390</sup>

That *Muhammad* considered *Allah* to be a war-and-moon-god is seen from the 164 War verses in the truculent *Koran*.<sup>3391</sup> Besides the violent *Koran*, *Muhammad* considered *Allah*'s two other greatest gifts to humanity to be the know-how to make iron coats of chain mail (K 016:081; 021:080; 034:010-011) and iron weapons of “great violence” (K 057:025). *Muhammad* also believed that *Allah* allowed demons to use “whips of iron” on the damned (K 022:021).

<sup>3387</sup> *Heritage*, the “*Islam*” and “*Muslim*” entries.

<sup>3388</sup> Geisler & Saleeb. *Answering*, p. 118.

<sup>3389</sup> Ishaq. *Sirat*, p. 373 & fn. 1.

<sup>3390</sup> Nielsen, 1912, pp. 593-594, as translated in Krause, “*Haram–Harimat*.”

<sup>3391</sup> See the Contents section to locate the table on the *Koran*'s 164 War verses.

*Allah's* taste for blood on steel shows that *Allah* is not *Yahveh*. *Yahveh* told David that he was not to build the temple because he had too much blood on his hands (1Ch 22:08-10).

### Why *Allah* had to be a Double Predestinationist

To imagine that people will stay in hell forever, *Muhammad* must have figured the damned must be quite depraved. That is why *Muhammad* never took an extended period of time trying to convert the lost. If they were predestined to heaven, a little preaching and the sword would convert them. If they were predestined to hell, nothing would save them. *Islam* was not at all a New Testament type of religion:

For God so loved the world that he gave his one and only Son, that whoever believes in him shall not perish but have eternal life (Joh 03:16).

The double-predestination doctrine creates a major difference in the character of *Islam* and Christianity that many people can readily discern. Christians will try to evangelize everyone and even save everyone from death so as to extend everyone's "time of grace." So while Christians try to save everyone from hell, many *Muslims* actually want to send people to hell, if they can get away with it.

### *Dhimmitude* Becomes the Lot of the Denizens of Hell

*Muhammad* spoke with gusto of hell, the underworld and how *Allah* predestined certain humans for damnation. Not only did *Muhammad* need to show his followers that the damned were deserving of their fate, but also as *Allah's* messenger he had to express *Allah's* contempt for those categorically damned simply because they were not *Muslims*.

So *Muhammad* said non-*Muslims* were "cattle" (*K* 007:179) and the "vilest animals" in *Allah's* sight (*K* 008:022, 055). *Muhammad* even thought that all unbelievers are not only influenced by but are possessed by demons, as Samuel Zwemer wrote:

The *Qurana* (plural of *Qarina*) [a familiar spirit] come into the world from the *Alalam Ul Barzakhiya* [*Hades*] at the time the child is conceived before it is born; therefore during the act of coition [copulation], *Muslims* are told by their Prophet to pronounce the word '*Bismillah*' [meaning "In the name of *Allah*"]. This will prevent the child from being overcome by its devil and turned into an infidel or rascal. The *Qarina* exists with the fetus in the womb. When the child is born the ceremony of pronouncing the creed in its right ear and the Call to Prayer in the left is to protect the child from its mate [its familiar 'evil twin' spirit].<sup>3392</sup>

Gibb and Kramers wrote:

Owing to the profession of faith frequently occurring in the *Adhan* [the *Muezzin's* Call to Prayer] the *Muslims* pronounce it in the right ear of a child shortly after its birth (confer Lane, Arab. *Society in the Middle Ages*, p. 186; Snouck Hurgronje, *Makka*, ii. 138) as well as in the ear of people supposed to be possessed of *Jinn* (evil spirits).<sup>3393</sup>

Like water inevitably flowing downhill, these beliefs led *Muhammad* and *Muslims* to treat Christians and Jews as domesticated animals and not as friends (*K* 005:051).

<sup>3392</sup> Zwemer. *Animism*, ch. 6.

<sup>3393</sup> Gibb & Kramers. *Encyclopedia*, p. 16, right column, *Adhan* entry.



When a religion gives short shift to persuasion as a method of proselytizing and relies on force rather than friendship, and when a religion believes that major segments of the population are predestined to be the denizens of hell, that doomed population ends up being vilified and mistreated. Meanwhile, the population seen as being predestined to heaven is lionized and rewarded at the expense of those who are considered damned.

Pagans of course are considered “vile” and are only given the option of converting or dying. Bat Yeor wrote about what happens whenever a group of people is considered animals:

The politics of a cynical negationism, based on deceit and ignorance, is being coupled with an even more grave moral violence. The obfuscation of *Jihad*, a war continually pursued on three continents and qualified as ‘just,’ implies the abolition of the human rights of its victims. Only by the criteria of justice established in *Islam* can *Jihad*—a war to impose *Koranic* law on the world—be considered just.

Likewise, *Dhimmitude* can be considered tolerant only through the dehumanization of millions of non-*Muslims*: Jews, Christians and others who endured this religious, apartheid-like system for over 1,000 years. It is arrogant to dismiss those countless masses whose children were enslaved, or the distress of the deported young victims—or to disregard the suffering of those dispossessed and condemned to exploitation and humiliation. Their testimonies, which can still be heard today from the *Sudan* and elsewhere, cannot simply be ignored. Because such a system has been cloaked in ‘justness,’ today the lives of Jews, Christians, *Hindus* and others are held so cheap that they can be dispensed with by the thousands in *Israel*, America, Russia, *Sudan*, *Kashmir*, Indonesia and elsewhere; it is under the excuse of *Jihad* that such crimes against humanity are perpetrated with impunity.<sup>3394</sup>

Andrew Bostom wrote about what happens when people are considered animals:

Said the great [*Muslim*] philosopher Averroes: ‘Most scholars agree that fortresses may be assailed with mangonels [catapults], no matter whether there are women and children within them or not. This is based on the fact that the Prophet used mangonels [catapults] against the population of *Al-Ta’if*.’

According to the renowned *Sufi Al-Ghazali*: ‘One must go on *Jihad* at least once a year...one may use a catapult against them [non-*Muslims*] when they are in a fortress, even if among them are women and children. One may set fire to them and/or drown them...’

And *Ibn Taymiya*, Osama’s favorite classical *Muslim* theologian: ‘As for those who cannot offer resistance or cannot fight, such as women, children, monks, old people, the blind, handicapped and their likes, they shall not be killed unless they actually fight with words [e.g. by propaganda] and acts [by spying or otherwise assisting in the warfare]. Some jurists are of the opinion that all of them may be killed, on the mere ground that they are unbelievers, but they make an exception for women and children since they constitute property for *Muslims*.’<sup>3395</sup>

<sup>3394</sup> Yeor, Bat. “*Eurabia*: The road to Munich,” *NRO*, 9 Oct 2002.

<sup>3395</sup> Spencer, Robert (quotes provided by Andrew Bostom). “Two Bus Bombs in Southern Israel Kill 15,” *JW*, 31 Aug 2004.

The above quotations are typical of the curriculum at *Al-Azhar* seminary in Cairo and in nearly all *Muslim* seminaries since they are nearly all extremist (i.e. literalist).<sup>3396</sup> Finally, Michael Coren also wrote about what happens when people are considered animals especially, the Christians and Animists from southern *Sudan*:

Women and children abducted in slave raids are roped by the neck or strapped to animals and then marched north. Along the way, many women and girls are repeatedly gang-raped. Children who will not be silent are shot on the spot. In the north, slaves are either kept by individual militia soldiers or sold in markets. Boys work as livestock herders, forced to sleep with the animals they care for.

Some who try to escape have their Achilles tendons cut to hamper their ability to run. Masters typically use women and girls as domestics and concubines, cleaning by day and serving the master sexually by night. Survivors report being called *Abeed* (a Black slave), enduring daily beatings and receiving awful food. Masters also strip slaves of their religious and cultural identities, giving them Arabic names and forcing them to pray as *Muslims*.<sup>7</sup>

Thus says one leading slavery abolitionist group. A former slave writes of ‘the rape of girls and boys alike, the forced circumcision of boys and girls, often with them fully conscious and screaming and having to be held down by many people. Sodomy and sadistic torture are common. Living hell.’

Another says, ‘Families were broken up, with children sometimes murdered in front of their mothers as a warning and because they were too much trouble. We cried out to the West, to the countries who said they believed in human rights but they were indifferent to our agony.’<sup>3397</sup>

### How the Moon-god Goads Muslims on to Jihad as a Form of Human Sacrifice

*Muhammad*'s biographer, *Ibn Ishaq*, records:

While they [*Makkans*] were thus discussing him [*Muhammad*] the apostle came towards them and kissed the Black Stone, then he passed them as he walked round the temple [the *Kaaba*]. As he passed they said some injurious things about him. This I could see from his expression. He went on and as he passed them the second time they attacked him similarly. This I could see from his expression. Then he passed the third time and they did the same. He stopped and said ‘Will you listen to me, O *Quraysh*? By him [*Allah*] who holds my life in His hand I bring you slaughter [compare *K* 008:067].’ This word so struck the people that not one of them but stood silent and still; even one who had hitherto been most violent spoke to him in the kindest way possible, saying ‘Depart, O *Abu'l-Qasim*,<sup>3398</sup> for by God you are not violent.’<sup>3399</sup>

So *Muhammad* went past the hecklers three times while he was circumambulating the *Kaaba*. Each time *Muhammad* saw the crescent-shaped *Hatim* wall wax and then wane and disappear behind the *Kaaba* and then reappear as he rounded the *Kaaba*.

Circumambulation reminded *Muhammad* of how each month the moon rose from the underworld with a smile and set like a scimitar back into the underworld. In

<sup>3396</sup> “Egyptian Intellectual: *Al-Azhar* University Curricula,” *MEMRI* SDS no. 790, 28 Sep 2004.

<sup>3397</sup> Coren, Michael. “*Sudan*'s Slaves,” *Sun Media* (reprinted in *FPM*), 25 Nov 2003.

<sup>3398</sup> *Abu'l-Qasim* means “Father of *Qasim*,” who was *Muhammad*'s firstborn son who died at age 2.

<sup>3399</sup> *Ishaq*, *Sirat*, p. 131.

other words, *Muhammad* depicted the slow-motion slicing of *Allah*'s scimitar on the evil forces and the damned in the underworld.

*Allah* considered the damned to be “enemies” (K 002:098; 008:060; 009:114; 041:019, 028), “unclean” (K 009:028), “vile animals” (K 008:022, 055) and cattle (K 007:179). *Koran* 007, by the way, is a *Makkan Sura*, meaning that *Muhammad* considered infidels to be fit sacrifices for *Allah*.

Notably, the crescent-shaped *Hatim* Wall was where animals and even humans once were sacrificed to *Allah* the moon-god using the *Dhabh* method. The priest used a crescent-shaped knife like a *Jambiya* or scimitar in order to honor the moon-god *Allah* with the sacrifice.

*Muhammad* figured that *Allah* would have whacked the hecklers if they had been in hell, so *Muhammad* was resolved to send them there. *Muhammad* said:

Will you listen to me, O *Quraysh*? By him [*Allah*] who holds my life in His hand I bring you slaughter [*Dhabh*] [compare K 008:067].<sup>3400</sup>

*Muhammad*'s use of the word *Dhabh* meant that he threatened to kill the *Makkans* as a human sacrifice to *Allah* the moon-god using the *Dhabh* method of slitting an animals throat while mentioning the name *Allah*.

### Moon-god Religions Promote Violence

Some *Muslims* and *Muslim* sympathizers would like to justify *Islam* in terms of Mosaic history and law.<sup>3401</sup> This however is no comfort to the non-*Muslims* who are thus transformed into *Canaanites* about to lose their land and lives.

Ironically, while *Muslims* justify their acts in terms of Mosaic law, they then condemn Jews who conquered Palestine in the twentieth century based on the Mosaic precedent.

*Muslims* fault Jews for daring to reconquer their homeland in keeping with their view of the *Pentateuch*. *Muslims* however have no scruples about attempting to conquer and impose *Sharia* law on the entire world in accordance with *Allah*'s command (K 002:193; 008:039).

Since *Allah* is not *Yahveh* and *Yahveh* is not a moon-god, *Muslims* cannot justify modern global land grabs by referring to *Yahveh*'s ancient command to Moses to conquer the Promised Land. *Muslims* justifying worldwide *Jihad* by referring to Moses would be like the *Ammonites*, whose god was *Kemosh*, using the *Pentateuch* to press their land claims against the *Israelites* (Jdg 11:23-24).

It is one thing for *Yahveh* to command killing, but it is altogether different for a demon posing first as a moon-god and then as the God of the Bible, to command killing. Besides, when God promised Palestine to Canaan to Abraham, his descendants had to wait 400 years until “the iniquity of the *Amorite* inhabitants was not yet complete” (Gen 15:16).

By the time Israel returned to *Canaan*, every abusive outrage that a society could think up was standard operating procedure, so they had to leave the Holy Land. This is quite a different thing from *Allah* or *Muhammad*'s commanding the slaughter or enslavement of every last one of the good, kind and decent people you can think of.

Jesus already commanded Christians to persuade all nations of the truth of the Gospel (Mat 28:19). For *Allah* and *Muhammad* to come along six hundred years later to command *Jihad* against all nations is rather like *Kemosh* and the *Ammonite* king

<sup>3400</sup> Ishaq. *Sirat*, p. 131.

<sup>3401</sup> Lings. *Sources*, p. 232, note 1.

contesting *Israel's* conquest of the Promised Land a full three hundred years after the event (Jdg 11:26).

It is folly to use Moses' one-time conquest of a small strip of land as a precedent to justify the worldwide conquest that *Islam* envisions (*K* 002:193; 008:039; 009:033). Besides, Jesus showed that there were pitfalls in extrapolating too much from Mosaic law (Mat 19:08-09, 20-21; Joh 04:20-21; confer Deu 12:05-11).

The reader should note that not once in the *Israelites'* fourteen-hundred-year history as recorded in the Bible do we read that *Israelites* invaded Mesopotamia or Egypt. Yet, as soon as the *Koran* was written, *Muslims* began attacking anyone and everyone and the *Islamic* war machine has rarely idled in fourteen-hundred years! As the Vatican said "...in all of its history, *Islam* has shown a warlike and conquering face."<sup>3402</sup>

Unlike the *Koran*, there is little incitement in the Bible. One indication of this is how after a few years of *Koranic* incitement, *Muslims* drove most non-*Muslims* out of Arabia. They also stormed out of the desert and conquered the Mideast, North Africa and Spain. By contrast, after hearing the *Pentateuch* for forty years in the wilderness, the *Israelites* made an incomplete conquest of the Holy Land and did not drive many of the former inhabitants out.

Even when the *Israelites* entered the Holy Land, they did not undertake much hand-to-hand combat. Their warfare was mostly symbolic since *Yahveh* himself did most of the "heavy lifting" when it came to clearing out the Promised Land of its inhabitants, as *Joshua* wrote:

I [*Yahveh*] sent the hornet ahead of you, which drove them out before you...you did not do it with your own sword and bow (Jos 24:12; see also Exo 23:28; Deu 07:20).

Nowadays the *Israelis* do not have *Yahveh* clearing out the Holy Land, but instead the *Israeli* army takes up this role for the settlers, as *Ha'aretz* reported:

'I don't plan to argue with them about the *Tabu* (the Land Registry) and ownership deeds,' says one [Jewish] settler from *Susiya* Farm. 'My *Tabu* is the Bible. They're our enemies and they're sitting on land that isn't theirs and they have to be thrown off. There's no such a thing as an Arab fellah [peasant] who only wants to tend to his little garden, they've been murdering us for over 120 years'....

The turning point in the lives of the [Arab] *Susiya* cave dwellers was the murder of...a settler and the ensuing events. In June 2001, [settler] Har Sinai was murdered while grazing his sheep in the area. A few hours after the murder, settlers began, with army reinforcements, to raze the village and harm its residents. 'They destroyed everything, didn't leave a thing,' says Nawaja. The soldiers, with the aid of a bulldozer, razed all the buildings, sealed up the caves and cisterns and kicked the residents out. 'They also destroyed cars. They crushed one car and tossed it into a cistern,' relates Nawaja. The car still lies at the bottom of the destroyed cistern. Visitors are invited to have a look inside.<sup>3403</sup>

Even early medieval Christians were not impressed by any comparisons between *Muhammad* and Moses and *Joshua*, as *Al Kindy* wrote in 830 AD:

Now, we say that the bent of thy Master's life doth not answer to the boast that he 'was sent a Mercy and Blessing to the human race.' On the contrary, his

<sup>3402</sup> Keinon, Herb. "Sharon dismisses Papal criticism," jpost.com, 20 Nov 2003.

<sup>3403</sup> Hasson, Nir. "Should 250 cave dwellers interfere with the fence?" haaretz.com, 13 Sep 2004.

chief object and concern was to take beautiful women to wife; to attack surrounding tribes, slay and plunder them and carry off their females for concubines. His chief delights were, by his own confession, sweet scents and women—strange proofs these of the prophetic claim!<sup>3404</sup>

Someone might ask “If *Islam* did not get its violent streak from reading the *Pentateuch*, from where did it come?” As was noted before, walking three times around the crescent-shaped *Hatim Wall*, the altar of the war-and-moon-god *Allah*, had an alarming effect on *Muhammad* and made him threaten the *Makkans* with slaughter.

Reading the *Koran* and seeing the moon-god’s scimitar in the sky and at the tip of *Mosque* finials goads *Muslims* on to evermore *Jihad* conquests and terrorist acts, as *Muhammad* said ominously:

Most surely there are signs in this [sun, moon and stars] for a people who ponder (*K* 016:012).

Because the pointy crescent was known for inspiring heroics, it was often found on war standards as early as the Battle of *Siffin* (657 AD)<sup>3405</sup> and on sixteenth-century AD Moorish *Hajji* banners.<sup>3406</sup> The crescent in a *Sultan*’s dream goaded him on to conquest, as Clare Gibson notes:

*Sultan* Osman had a vision of a crescent-moon before his conquest of the lands now known as Turkey in 1299 [AD], and it [the crescent] became the emblem of his dynasty, to whose scion [descendent], Mehmed II, Constantinople fell in 1453 [AD].<sup>3407</sup>

*Muhammad* worshipped the moon-god along with Venus (*Uzza*) from childhood. *Muhammad* saw in the moon what other moon worshippers saw—a scimitar. Moon-gods in general were considered rather warlike since *Akkadian* times.

Moon-god religions make their adherents violent even though individual adherents usually do not have a violent disposition from the start. In fact, many *Muslims* would have made good Christians and still could be good Christians if they ditched their *Islamic* thinking and attitudes. For instance, it was surprising for the *Makkans* to hear *Muhammad* mouth the “I bring you slaughter [compare *K* 008:067]” threat over what amounted to playground taunting. *Ibn Ishaq*’s account of the incident is noted above.

*Mosques* even have architectural features that speak of warfare! The niche in *Mosque* walls that indicates the direction to *Makka* is called a *Mihrab*. *Mihrabs* have an ancient history and were Venus-moon altars.<sup>3408</sup> The moon-gods in Southern Arabia were national war gods too—as Ditlef Nielsen noted.<sup>3409</sup>

The word *Mihrab* comes from the Arabic root stem *hrb* meaning “to fight,” or “perform a certain ritual in a temple.”<sup>3410</sup>

This peculiar etymology stems from that fact that the high god in Southern Arabia was a war-and-moon-god, so his moon-Venus *Mihrab* altar became associated with a spear. Gibb and Kramers wrote:

<sup>3404</sup> *Al Kindy. Apology*, under the section “Pilgrimage and rites of *Makka*,” pp. 49-50.

<sup>3405</sup> Nicolle. *Conquest*, Illustration C.

<sup>3406</sup> Blair & Bloom. *Paradise* p. 74.

<sup>3407</sup> Gibson. *Symbols*, p. 109.

<sup>3408</sup> Fani. *Dabistan*, pp. 30-31.

<sup>3409</sup> Nielsen, 1912, pp. 593-594, as translated in Krause, “*Haram–Harimat*.”

<sup>3410</sup> *Heritage*, App. II, Semitic Roots, *hrb* (central Semitic root).

*Mihrab* [dot under *h*] has been derived from [the word] *Harba* [with dot under *H*] “spear,” and from South Arabic *Mikrab*, Ethiopian, *Mekrab* “temple,” but the etymology is not certain...<sup>3411</sup>

So *Harb* means “war” and is related to the Arabic root meaning “fight” (*hrb*), “spear” (*Harba*) and *Mihrab*. The *Mihrab* altar is always on the *Kiblah* line at a *Mosque* and points to the *Kaaba* at *Makka*. So every *Muslim* at a *Mosque* prays through a war-oriented *Mihrab* altar to the war-god and moon-god *Allah*.

That *Muhammad* knew the *Mihrab* altar referred to a spear shows from his practice of praying toward a *Sutra* pole or spear stuck in the ground when he prayed outside *Mosques*. The spear was the outdoor equivalent of the *Mihrab*. The spear shows that the indoor *Mihrab* was used in worship of a war-and-moon-god, namely *Allah*. *Muhammad*'s *Sutra* pole and spear will be discussed further in a later chapter.

The moon was also thought of as the moon-god's boat but also as a sickle-sword, meaning a scimitar. Finn Rasmussen wrote:

In *Akkadian* we have the word *gamlu* = ‘scimitar,’ a sword in sickle form, symbol for the Mesopotamian moon-god *Sin* (*Assyrian Dictionary*, Chicago, 1956, 5.35).<sup>3412</sup>

In *Islamic* countries, crescent-shaped daggers, sickles and scimitars remained popular from pre-*Islamic* to modern times, as Wendell Phillips wrote:

I was particularly struck by a sheathed [curved] dagger or *Jambiya* [also spelled *Jambiah*] fastened in the man's belt. It was similar to those used today [in *Yemen*], twenty-five centuries after the time of the statue, except that it was straight at the end where those of this time have points that turn up abruptly...An inscription ran from the shoulders to the bottom of the skirt, ending at the right knee. It told us this statue of *Ma'adkarib* [also spelled *Ma'dikarib*] was dedicated to the moon-god, *Ilumquh*.<sup>3413</sup>

David Nicolle wrote:

From the early 12<sup>th</sup> century onwards the [curved] saber was the most popular form of sword in eastern and central regions, although straight swords did not disappear.<sup>3414</sup>

Some of *Saladin*'s forces probably did use curved sabers or scimitars since three centuries earlier *Al Jahiz* of *Basra* (died 869 AD) said the *Khurasanis* used slightly curved sabers in the *Abbasid* civil war of 811-813 AD.<sup>3415</sup>

There are other ninth to eleventh-century saber archaeological finds.<sup>3416</sup> The *Ghaznawid* army in the eleventh century emphasized the use of “the curved *Qalachur* saber,” and the arms of *Saladin*'s predecessor, the *Fatimids* of Egypt, “probably included slightly curved *Qalachur* sabers.”<sup>3417</sup>

Curve-bladed daggers appeared on *Buyid* coinage as early as 1017 AD.<sup>3418</sup> Crescent-shaped scimitars were already pictured *Ardabil* coins (1145-1174 AD) and

<sup>3411</sup> Gibb & Kramers. *Encyclopedia*, p. 343, middle of the left column, *Masjid* entry.

<sup>3412</sup> Rasmussen. Letter.

<sup>3413</sup> Phillips. *Sheba*, p. 287.

<sup>3414</sup> Nicolle. *Saladin*, p. 40.

<sup>3415</sup> Nicolle. *Islam*, p. 14.

<sup>3416</sup> Nicolle. *Caliphates*, p. 17.

<sup>3417</sup> Nicolle. *Islam*, pp. 18, 22.

<sup>3418</sup> Treadwell. *Buyid*, coin Sh437a.

*Rasulid* coins.<sup>3419</sup> Some twelfth-century army officers of the Egyptian *Fatimids*, to whom *Saladin* was a successor, “carried curved swords of the *Turco-Iranian* form.”<sup>3420</sup>

Curved sabers became popular among the *Berbers* in *Morocco* in the late medieval period. In fact, a huge altarpiece, painted well before 1492 AD when the last *Muslims* were defeated in Spain, shows a North African *Berber* volunteer wielding a curved saber against Christians in Spain.<sup>3421</sup>

Moon-gods usually carried scimitars and sometimes were the gods of war in the Mideast. The *Kaaba* that *Muhammad* helped to construct was built using alternating courses of stone and wood. The same-layered look was carved into the monolithic pillars dedicated to the *Abyssinian* war-god and moon-god *Mahram*. These pillars were topped by a crescent.<sup>3422</sup>

*Allah* is also presented as a god of war. *Muslims* cannot help but notice the sharp, menacing crescent seen everywhere in *Islamdom*, especially on top of *Mosques*. Iqbal called it “The sickle-dagger of *Hilal*,” as was noted above.<sup>3423</sup> The martial side of *Mosques* was seen in medieval Spain, where the army standards were kept in the *Cordoba Mosque* until the troops went out to battle.<sup>3424</sup>

For centuries *Muslim* preachers gave sermons with a sword in their right hand.<sup>3425</sup> Of course in modern time swords are not used in battle, so some *Imam* preachers have turned to guns to make their point, for instance:

C The Middle East Media Research Institute reported in 2003:

The Friday sermon delivered by *Sheik Abd Al Ghafour Al Qaysi* at *Abd Al Qadr Al Gaylani Mosque* in *Baghdad* was aired on *Al Arabia TV* (1) in *Dubai* in collaboration with *Al Haram Mosque* in *Makka*. Throughout the sermon, the preacher hoisted a gun. The following are excerpts from the sermon:

Oh *Mujahideen* believers! We have sworn *Jihad* before *Muhammad*... We are the army of *Allah*. We who are fighting against those who are fighting us. Oh *Mujahideen*-believers everywhere...The evil has arrived. The Satan and his army. The *Mujahideen* have declared *Jihad* for the sake of *Allah* to bring down the banners of the infidels and those full of hatred...<sup>3426</sup>

C In 2004 in *Al-Hawi Mosque* in central *Basra*, in southern *Iraq*:

A senior aide of radical *Shia* cleric *Muqtada Al-Sadr* told worshippers during a Friday sermon in southern *Iraq* that anyone capturing a female British soldier can keep her as a slave...*Al-Bahadli*

<sup>3419</sup> *Sayyid Jamal Torabi Tabatabai's Sikkeha-yi Eslami Iran az aghaz ta hamle-yi Moghul* (Tabriz 1373 Sh) pp. 554-559. Nuetzel says a twelfth-century *Rasulid* (*Yemenis*) *Dirham* coin depicts three scimitars (Nützel 38, Zabid 783 H). There has been no comprehensive inventory of symbols depicted on *Islamic* coins, so perhaps there are earlier coins with scimitars.

<sup>3420</sup> Nicolle. *Saladin*, p. 13.

<sup>3421</sup> Nicolle. *Moors*, pp. 36, 46 (caption).

<sup>3422</sup> Creswell. *Architecture*, pp. 1-3.

<sup>3423</sup> *Tarana e malli* by *Pakistani* poet *Muhammed Allama Iqbal* (see Iqbal in Index).

<sup>3424</sup> Nicolle. *Moors*, p. 10.

<sup>3425</sup> *Shraga Qedar* wrote that the *Caliph* ‘*Abd Al Malik*’s right hand was “placed on a sword in the attitude prescribed for the *Imam* at the recitation of the public sermon—*Khutba*” (*Shraga Qedar*’s article “Copper Coinage of Syria—The 7<sup>th</sup> and 8<sup>th</sup> Century AD,” as found in *Barag. Balog*, p. 34, and plate 6, coins 19-23.

<sup>3426</sup> “Friday Sermon in *Baghdad*,” *MEMRI*, no. 487, *MEMRI*, 28 Mar 2003.

kept an assault rifle next to him as he spoke to an estimated 3,000 worshippers, occasionally lifting it as he screamed *Jihad!* and *Allahu Akbar!* or ‘God is greatest!’<sup>3427</sup>

- ☉ When 16 *Imams* were arrested for terrorism-related offences in *Pakistan* in 2006, the *Pakistani Daily Times* reported:

The Interior ministry...asked the *Islamabad* district administration to cancel the prayer leaders’ arms licenses and seize their weapons.<sup>3428</sup>

To conclude this section, fewer people would doubt that *Islam* truly is the Religion of the Sword if they bothered to read the *Koran*, and if they knew that *Muslims* throughout *Islamic* history:

- ☉ Prayed toward spears or their equivalent (mentioned above).
- ☉ Listened to sermons by *Imams* holding out swords (mentioned above).
- ☉ Worshipped in *Mosques* with sharp menacing crescents atop that look more like armories than places of worship.

### Warlike Moon-gods Always Had Great Territorial Ambitions

The great gods usually had their territories and cities the called their own (2Ki 17:26). The Israelites knew that these gods were demons (Deu 32:17; Psa 106:037; Dan 10:13, 20).

The Mideast moon-god *Sin*, *Allah*’s progenitor, had great territorial ambitions and claims. Sinasi Gunduz wrote that *Sin*...

...the Moon-god was regarded as the supreme lord and owner not only of the countries of *Haran* and *Ur*, but also of the vast territories described by the geographic term *Amurru*.<sup>3429</sup>

The Harranians of the Medieval period prayed to *Sin* for...

...the restoration to them of their empire and the days of their domination.<sup>3430</sup>

That *Sin* was seen as having territorial ambitions is also evidenced in the place names of the Mideast. The *Encyclopedia Britannica* states:

The name *Sinai* however seems to have been known much earlier and may have been derived from the original name of one of the most ancient religious cults of the Middle East, that of the Moon-god *Sin*.<sup>3431</sup>

Perhaps the Desert of *Zin* (meaning “flat”) also was originally named after the Moon-god *Sin* but then the name was altered (Num 13:21). This seems plausible given the fact that Mount *Nebo* was named after the close associate of *Sin*, the Sumerian god *Nabu*. *Zin* and *Nebo* are not too distant geographically and they are mentioned just two verses apart in the Bible (Deu 32:49, 51).

The names of other cities such as *Nebo* and *Baal Meon* were changed because they were named after the gods *Nabu* and *Baal* (Num 32:38). This suggests that there is a possibility that the Desert of *Sin* was changed to the Desert of *Zin* at some point.

For *Sin* to claim a vast territory makes him a war-god by default since he had to fight against all the conflicting land claims. The warlike empires of the Fertile Crescent thought that the entire Mideast, including *Moab*, was part of *Amurru*, the land of *Sin*.<sup>3432</sup>

<sup>3427</sup> “*Al-Sadr’s Basra Aide Offers Rewards,*” news.yahoo.com, 7 May 2004.

<sup>3428</sup> Malik, Shahzad. “Police asked to arrest 16 prayer leaders,” dailytimes.com.pk, 4 Jan 2006, *JW*.

<sup>3429</sup> Gunduz. *Life*, p. 193.

<sup>3430</sup> Green. *Moon*, p. 39.

<sup>3431</sup> See the note on the *Sinai* in the moon-o-theistic Mideast chapter.

<sup>3432</sup> Gunduz. *Life*, p. 193.



That moon-gods had wide-ranging territorial claims drove wars in the ancient Mideast just as *Allah's* land claims drive *Muslims* to warfare now. When ancient nations and empires went to war, it was viewed as being a war of “a god against god” more than one army versus another army (2Ki 18:33-34; 19:12).

The *Israelites* were not about to cede any land that *Yahveh* had given them, even though the god *Kemosh* wanted his *Ammonites* to get some of his lands back from the *Israelites* (Jdg 11:24). Similarly, the *Israelites* were not about to concede land whenever sun and moon-god worshipping empires came knocking.

That the moon-god *Sin* was a warrior god seems to have been recognized by *Gilgamesh*. *Gilgamesh* seems to have given *Sin* credit for his ability to take an ax and a sword to kill and scatter a pride of lions on the prowl at night.<sup>3433</sup>

*Allah* has even greater territorial ambitions than *Sin*, so one can see that *Allah* is a war-god. *Allah* wants the entire world to be ruled by *Muslims* and *Allah* wants to dominate all other religions through persuasion, if possible but by force if necessary. *Muhammad* said “fighting is enjoined on you until all religion is for *Allah*” (K 002:193; 008:039). There are 164 War verses altogether. *Muslims* also have a claim on the entire world, as discussed in the Irredentist Turf Wars section of the Khidr-Second Lamech's Logic table.

### Weapons Used to Advance *Allah's* Territorial Claims on the Entire World

Just as *Muhammad* seems to have grown up thinking that *Sin* the moon-god sodomized lesser male astral deities, so *Muhammad* and *Islam* were not above this practice. *Muhammad's* sodomizing the astral idols was a tool for religio-political domination just as King Hassan used sodomy to shame his would-be competitors in pre-*Islamic Yemen*. King Hassan got this idea of how to rule from growing up in pre-*Islamic Yemen* where moon worship was the dominant pre-*Islamic* religion.<sup>3434</sup>

In keeping with the idea that the Mideast and the world were moon-god territories, *Muhammad* sodomized the *Makkan* idols. Many of these idols were recognized as being the idols of the religions of the surrounding nations.

As was already noted, the *Maliki* school of *Islam* decreed that sodomy of non-*Muslims* was a duty. The goal was to dominate non-*Muslims* and eventually destroy their non-*Muslim* religion through attrition.

Sodomy indeed was used as a tool against Christianity. *The Passion of Pelagius* records how a thirteen-year-old boy fended off an *Andalusian* king and became one of many martyrs of *Cordoba*:

Then, when the king tried to caress him playfully, holy Pelagius said ‘Get back, you dog! Do you think that I am effeminate like yourselves?’ Pelagius ripped off the robes in which he had been dressed and made himself like a bold athlete in the arena, choosing to die honorably for Christ rather than to live shamefully with the devil and be defiled by his vices. The king, thinking that he could persuade him, instructed his attendants to seduce him with pandering speeches, so that he might apostatize and submit to his royal vanities. But Pelagius, with the help of God, stood strong and remained undaunted, professing only Christ and saying that he would obey his commands alone.

The king became angry. He ordered that Pelagius be strung up in pincers. When he saw that the boy remained steadfast, he called for further tortures to be

<sup>3433</sup> *The Epic Of Gilgamesh*, 16:4 “The Search for Everlasting Life.”

<sup>3434</sup> See sodomy, sodomizes, *Dhu Shanatir* and King Hassan in the Index.

inflicted. Pelagius called on God as he was cut limb from limb. At last he expired and his body was thrown into the river so that the faithful Christians would not be able to bury him.<sup>3435</sup>

Sodomy was a weapon that *Muslims* used to deal with Christian missionaries who were deemed too successful, as Richard Burton wrote in his “Terminal Essay”:

A favourite Persian punishment for strangers caught in the *Harem* or Gynaecium is to strip and throw them and expose them to the embraces of the grooms and Negro slaves. I [Richard Burton] once asked a *Shirazi* how penetration was possible if the patient resisted...he smiled and said ‘Ah, we Persians know a trick to get over that; we apply a sharpened tent-peg...’ A well-known [Christian] missionary to the East during the last generation was subjected to this gross insult by one of the Persian prince-governors, whom he had infuriated by his conversion-mania [evangelism]: in his memoirs he alludes to it by mentioning his ‘dishonored person;’ but English readers cannot comprehend the full significance of the confession.<sup>3436</sup>

*Muhammad* had other ideas in keeping with the mindset that the Mideast and the world was moon-god territory. *Muhammad* believed that no non-*Muslim* had any inalienable right to be in a *Muslim*-dominated country, no matter how many millennia that people may have lived there prior to the arrival of *Islam*.

No non-*Muslim* could live in peace without signing a peace treaty (*K* 009:007) and without paying confiscatory taxes (*K* 009:029). As soon as someone could not pay the taxes on account of poverty or even a temporary cash flow problem, he or she was liable to be tortured or enslaved.

Given *Allah*’s territorial ambitions, it is not surprising that the first of *Muhammad*’s three dying wishes was that Umar would clear Arabia of non-*Muslims*, thus make the Arabian Peninsula into *Allah*’s land.<sup>3437</sup> *Muhammad* said:

Fight with them until there is no persecution and religion should be only for *Allah* (*K* 002:193; 008:039).

In order to press *Allah*’s territorial claims, *Muhammad* believed that *Allah* had instructed him to be a terrorist and to set up an evil empire called a *Caliphate*:

It is not for a Prophet to have prisoners until he has spread fear of slaughter in the land. You people want casual gain (i.e. ransom payments [for hostages and prisoners]) in this lower world, while God wants (happiness in) the next world (for you) (*K* 008:067).<sup>3438</sup>

How was *K* 008:067 interpreted? *Ibn Taymiya* wrote that infidels could be slaughtered even if they do not engage in warfare, or were abducted while traveling:

If a male unbeliever is taken captive during warfare or otherwise, e.g. as a result of a shipwreck, or because he has lost his way, or as a result of a ruse, then the *Imam* may do whatever he deems appropriate: killing him, enslaving him, releasing him or setting him free for a ransom consisting in either property or

<sup>3435</sup> Christys. *Andalus*, pp. 10, 88-89.

<sup>3436</sup> Burton. *Essay*.

<sup>3437</sup> *Muhammad*’s expulsion order that only *Muslims* be left on the Arabian Peninsula: Ishaq. *Sirat*, p. 689; Koelle. *Mohammedanism*, section ii:19, p. 231; *Sahih Bukhari*, vol. 4, bk. 52, no. 288; vol. 4, bk. 53, no. 393; vol. 5, bk. 59, no. 716; *Sahih Muslim*, bk. 019, no. 4366; and *Malik’s Muwatta*, bk. 45, no. 5.18.

<sup>3438</sup> Dashti. *Career*, p. 97.

people. This is the view of most jurists and it is supported by the *Koran* and the *Sunna*.<sup>3439</sup>

*Muhammad* even encouraged *Jihad* and piracy in the earliest *Hadith*, which is not surprising since *Makka* was only forty-five miles from the Red Sea coast. The *Barbary* Pirates and other *Muslims* followed the jurists' rulings for over a millennium, until the West mostly put them out of business. Bukhari wrote:

Um *Haran* said 'Once the Prophet slept in my house near to me and got up smiling. I said 'What makes you smile?' He replied, 'Some of my followers who (i.e. in a dream) were presented to me sailing on this green sea like kings on thrones.' I said 'Oh *Allah*'s Apostle! Invoke *Allah* to make me one of them.' So the Prophet invoked *Allah* for her and went to sleep again. He did the same (i.e. got up and told his dream) and Um *Haran* repeated her question and he gave the same reply. She said 'Invoke *Allah* to make me one of them.' He said 'You are among the first batch.' Later on it happened that she went out in the company of her husband 'Ubada *Bin* As-Samit who went for *Jihad* and it was the first time the *Muslims* undertook a naval expedition led by Muawiya.<sup>3440</sup>

*Jihadi* crusaders managed to pillage Saint Peter's *Basilica* in Rome in 846 AD.<sup>3441</sup> *Jihadi* crusaders often captured Christians and either massacred them, ransomed them or sold them into slavery. Somewhere along the way *Muslims* perfected the ancient art of piracy, as David Nicolle wrote:

By the 10<sup>th</sup> [AD] century, naval warfare changed from raiding enemy coasts to attacking ships at sea, the *Muslims* being the first to do this on a large scale.<sup>3442</sup>

*Jihadi* crusaders continued to operate from the *Barbary* Coast until the nineteenth century. They raided ships in both the Atlantic and Mediterranean and extracted tribute from European and American powers. They also sold everyone into slavery whom they did not massacre or ransom first.

Significantly, the piracy problem persists even though most of the larger boats that would interest pirates have radios for emergency situations. *Muslims* have also been known to bomb ferries (an *Abu* Sayyaf terrorist bombed *Superferry 14* in the Philippines in 2004) and terrorize cruise boats (the PLO boarded the *Achille Lauro* in the Mediterranean Sea, 1985).

In the Strait of *Malacca*, there were 28 pirate attacks in 2003 and 37 in 2004:

Most of the pirate attacks involved vessels being fired on and crew kidnapped for ransom. Thirty-six seafarers were abducted in the strait last year; four were killed and three injured. The pirates struck despite *Malaysia*, Indonesia and Singapore launching coordinated naval patrols in the 550-mile route, which is used by 50,000 ships each year.<sup>3443</sup>

Similarly, "the London-based International Maritime Bureau said it knew of 27 pirate attacks off Somalia" between March and November 5<sup>th</sup>, 2005.<sup>3444</sup>

The first *Caliphs* who did the most to expand the Abode of *Islam* (*Dar Al Islam*) issued many coins with crescents on their obverse and reverse sides. This is appropriate given the fact that they were conquering territory that the moon-god

<sup>3439</sup> Peters. *Jihad*, p. 50.

<sup>3440</sup> *Sahih Bukhari*, vol. 4, bk. 52, no. 56.

<sup>3441</sup> Nicolle. *Islam*, p. 31.

<sup>3442</sup> Nicolle. *Moors*, p. 19.

<sup>3443</sup> "Malaysia Does Not Want Help Vs. Piracy," news.yahoo.com, 25 Feb 2005.

<sup>3444</sup> "Pirates fire on cruise ship off Somalia," theage.com.au, 6 Nov 2005.

*Allah* claimed. Many such coins are noted in the appendix on coins, but those of especial interest are noted below.

Some issues of the imitative “Standing Emperor” and “Standing *Caliph*” coins show a crescent over a cross and some have crescents atop scepters. Bernard Goldman explains these symbols:

The crescent on a pole, the symbol of the lunar god, is found in the ancient Orient [i.e. Mideast] and persists in later, *Nabataean* art where it crowns columns.<sup>3445</sup>

Gordon Newby wrote:

The crescent-moon began to appear, usually accompanied by a five- or six-pointed star, in the first *Islamic* century [622-722 AD] as a symbol on coins and decorations. By the fifth/eleventh century [AH/AD], the crescent was used to replace the cross when churches were converted to *Mosques*.<sup>3446</sup>

### Why Crescents Replaced Crosses on Coins, Places of Worship and Elsewhere

Why have a crescent replace a cross? *Muhammad* thought that Christians worshipped *Allah* the moon-god as Father, Mary as *Allah*'s consort, and Jesus as *Allah* and Mary's sun-god son. This was discussed in the section on Osiris, *Isis* and *Horus*.

*Muhammad* broke crosses and anything with the form of a cross that he happened to come across because he saw the cross as Christianity's sun-god emblem and he was a moon-god monotheist.<sup>3447</sup>

Naturally, *Muslims* felt it was appropriate to replace the sun-god symbol with their moon-god symbol, rather than say a spear or sword—*Islam*'s other favorite symbol found on flags and such. Besides, crescents on finials and poles have since ancient times been associated with moon-god temples and pre-*Islamic Mosques*.

*Ibn Warraq* wrote about the early *Muslim* penchant for destroying crosses:

The patriarch Sophronius of Jerusalem (634-638 AD) saw the invaders as ‘godless barbarians’ who burned churches, destroyed monasteries, profaned crosses and horribly blasphemed against Christ and the church.<sup>3448</sup>

A Maronite chronicle that terminates in 664 AD says that the *Umayyad Caliph* Mu'awiya tried to issue gold and silver coins but “the populace did not accept it because there was no cross on it.”<sup>3449</sup> Pseudo-Athanasius, a Christian Egyptian text dated to ~700 AD says that *Muslims* melted down gold coins with crosses and issued coins without crosses.<sup>3450</sup>

*Muslims* did however issue coins with “transformed” crosses, meaning without an intact crossbar.<sup>3451</sup> *Muslims* also issued coins with a crescent-and-star over the cross and coins with a crescent sliced into the cross (see illustration below).

The longest lasting *Muslim* evil empire was the *Ottoman* Empire, centered in Turkey from the thirteenth century until 1924 AD. The *Ottomans* conquered under the sign of the crescent. Everywhere the *Ottomans* conquered, the crescent symbol

<sup>3445</sup> Goldman. *Portal*, p. 108.

<sup>3446</sup> Newby. *Encyclopedia*, p. 81, *Hilal* entry.

<sup>3447</sup> Muir. *Life*, vol. iii, ch. 10, p. 61, and see also fn. 46.

<sup>3448</sup> Warraq. *Why*, p. 219.

<sup>3449</sup> Kaegi. *Byzantium*, pp. 224-225.

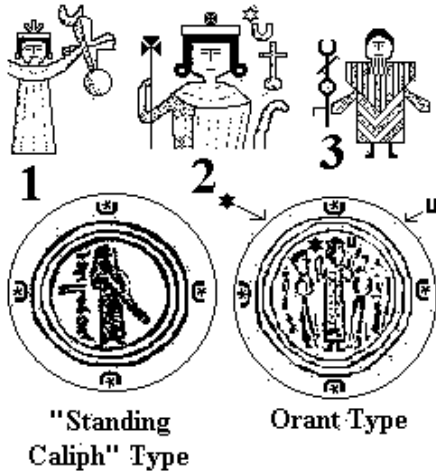
<sup>3450</sup> Kaegi. *Byzantium*, pp. 224-225.

<sup>3451</sup> Kaegi. *Byzantium*, p. 226.

was put to heavy use. The crescent motivated the *Ottomans* to conquest, as Clare Gibson notes (as quoted above):

*Sultan Osman* had a vision of a crescent-moon before his conquest of the lands now known as Turkey in 1299 [AD], and it [the crescent] became the emblem of his dynasty, to whose scion [descendant], *Mehmed II*, Constantinople fell in 1453 [AD].<sup>3452</sup>

**Figure 08-05. Caliph coins with crescents. Coin 1: Crescent sliced into cross**



**on orb (*Globus Cruciger*):** Ilisch. *Palastina*, coin 517 (70 AH/689 AD *Umayyad*).

**Coin 2: Star-and-crescent couplet over a *Globus Cruciger*:** Ilisch. *Palastina*, coin 521 (70 AH/689 AD *Umayyad*).

**Coin 3: Crescent over scepter with *Globus*:** Milstein, Rachel. “A Hoard of Early Arab Figurative Coins,” as found in *Barag. Balog*, plate 6, coins 21 and 22. Some of these coins have crescent on lower reverse “Standing *Caliph*” ANS coins 1998.25.12 and 1998.25.13: These have on the reverse from top to bottom: star, M denomination...<sup>3453</sup>

### The Making of a Moon-god Cult Leader

Saint Paul wrote in Rom 02:14-15 that though gentiles might not have the written commandments, the natural law is written on everyone’s heart. One might ask “Why does the immoral treatment that *Muslims* mete out to the world not bother the *Muslim* conscience enough to change their collective behavior?”

The reason is that the *Koran* instills *Muhammad’s* dysfunctional conscience into the hearts of *Muslims*. Also, the traditions and *Sharia* law militates against an otherwise healthy conscience and sears it like a branding iron on skin (1Ti 04:02).

*Muhammad’s* conscience was free to drift since *Muhammad* thought that *Allah* was utterly unconcerned about matters of conscience, as Zwemer wrote:

‘He [*Allah*] sees all things, even the steps of a black ant on a black rock in a dark night.’ This last expression shows how the idea of God’s omniscience remains purely physical, even in its highest aspect. How much loftier is the thought of God’s omniscience in the 139th Psalm than in any verse of the *Koran* or any passage of the Traditions. In the *Koran*, God’s eye is a big microscope by which He examines His creatures. In the Bible, his eye is a flame of fire laying bare the deepest thoughts and intents of the heart. The *Koran* has no word for conscience.<sup>3454</sup>

When *Muhammad* was a pagan his conception of morality was shaped by astral mythology. Anthropologists note that when there is no special revelation, primitive

<sup>3452</sup> Gibson. *Symbols*, p. 109.

<sup>3453</sup> ...mark, exergual line; crescent. See the “Standing *Caliph*” and “Orant” type coins at: Grabar. *Art*, images 18 and 19.

<sup>3454</sup> Zwemer, *Essay*, Ch. 4: “*Allah’s* Attributes Analyzed and Examined,” pp. 57-58.

mythology involves nature and the birth and death cycle. The reason is hunter-gatherers have not learned to control nature, so they are at the mercy of its whims.

When civilization develops and humans shape their environment, nature gods recede and astral gods form a pantheon that mirrors a city-state or empire power structure. In this structure, *Allah* the moon-god still had to relate positively with the other astral gods as though he were a father figure.

When *Muhammad's* mental abstraction, namely *Allah*, became the only god, *Allah* no longer needed to relate to other gods, nor even please his consorts. *Muhammad* figured that if the other gods were not mere angels, then they were demons or *Jinn*. *Allah* then became more asocial and even antisocial and pushy. *Allah* said, for instance:

Or have they [unbelievers] gods who can defend them against Us? They shall not be able to assist themselves, nor shall they be defended from Us (*K* 021:043).

As *Allah* became more asocial and even anti-social, so did *Muhammad*. *Muhammad* was an orphan since his father *Abdullah* died when he was an infant, and his mother died when he was six.

*Abdullah* means "Slave of *Allah*," so at first *Allah* became a suitable substitute father figure for *Muhammad*. Later in life however *Muhammad* came to believe that *Allah* was not at all social and had neither son nor daughter, as Zwemer wrote:

In *Islam* there is no fatherhood of god and no purpose of redemption to soften the doctrine of the decrees.<sup>3455</sup>

But neither can there be any doubt that *Mohammed's* conception of God is inadequate, incomplete, barren and grievously distorted. It is vastly inferior to the Christian idea of the Godhead and also inferior to the Old Testament idea of God. In the Book of Job alone there are more glorious descriptions of God's personality, unity, power and holiness than in all the chapters of the *Koran*. Carlyle in his praise of the hero-prophet acknowledges this and says, 'he makes but little of *Mohammed's* praises of *Allah*, borrowed from the Hebrew and far surpassed there.' Even the Fatherhood of God is clearly taught in the Old Testament but it is wholly absent from the *Koran*.<sup>3456</sup>

*Muhammad* also rejected the idea that *Allah* was a member of a triad (*K* 005:073). By contrast, the fact that *Yahveh* is so relational tends to place a high value on human relationships in Christian cultures. Man and wife (Gen 01:26-27) and humans in general (Gen 09:06) are made in the image of *Yahveh*. That the *Islamic Allah* was even less social than the pre-*Islamic Allah* meant he became even more loveless than the Mideast despot he already was, as Zwemer wrote:

The *Muslim's* fear of God is not the beginning of wisdom. *Allah* produces on them a servile, not a filial, fear. No one approaches God except as a slave. Hegel's criticism, at the head of this chapter, shows the opinion of a philosopher on the elementary character of such monotheism. Where there is no Fatherhood toward man there can be no Brotherhood of Man. *Islam* is an exclusive brotherhood of believers, not an inclusive brotherhood of humanity. Assuredly, this characteristic of *Islam* is responsible for much of its fanatic spirit and its gigantic pride. The denial of God's Fatherhood changes Him into a desolate abstraction. Who can love Ghazali's definition of *Allah* or feel drawn to such a

<sup>3455</sup> Zwemer, *Essay*, Ch. 7: "Predestination vs. Fatalism," p. 100.

<sup>3456</sup> Zwemer, *Essay*, Ch. 8: "The Completed Idea and Its Insufficiency," pp. 107-108.

negative conception? The very contemplation of so barren a Deity ‘pours an ice floe over the tide of human trusts, and causes us to feel that we are orphaned children in a homeless world’...The *Muslim* idea of God is conspicuously lacking in the attribute of love. We have seen this in our study of *Allah*’s names. But in gathering up the few precious fragments of this idea from the *Koran* another thing is evident. Whatever *Mohammed* taught concerning God’s mercy, loving kindness or goodness, has reference only and wholly to what God is external to Himself. In the Bible, love is not a mere attribute of Deity. God is love. God’s love not only shines forth from *Genesis* to the *Book of the Revelation* but it is often declared to have existed from all eternity (Jer 31:03; Joh 03:16; 17:24; Eph 01:04; Rev 13:08). Fairbairn remarks: ‘The love which the Godhead makes immanent and essential to God gives God an altogether new meaning and actuality for religion; while thought is not forced to conceive monotheism as the apotheosis of an Almighty will or an impersonal idea of the pure reason.’

*Muslim* mysticism was a revolt against the orthodox doctrine of *Allah*. The human heart craves a God who loves; a personal God who has close relations with humanity; a living God who can be touched with the feeling of our infirmities and who hears and answers prayer. Such a God the *Koran* does not reveal. A being who is incapable of loving is also incapable of being loved. And the most remarkable testimony to this lack in the orthodox *Muslim* conception of Deity is the fact that the passionate devotional poetry of the *Sufis* is put down as rank heresy. *Allah* is too rich and too proud and too independent to need or desire the tribute of human love. In consequence *Islam* is a loveless creed. The Bible teaching that ‘God is love’ is to the learned [*Muslim*] blasphemy and to the ignorant [*Muslim*] an enigma.

Orthodox *Islam* is a religion without song [because *Muhammad* banned musical instruments (*Sahih Bukhari*, vol. 7, bk. 69, no. 494v)]. Where are there any psalms of devotion or hymns of spiritual aspiration in the *Koran* or the volumes of Tradition? There is neither precept nor example in *Islam* enjoining love to one’s enemies. It knows nothing of universal benevolence or of a humane tolerance (*Sura* 9:29). That [the] element of love is lacking in their idea of God is perhaps the reason also why the *Koran*, in contrast with the Bible, has so little for and about *children*. Of such is not the kingdom of *Mohammed*.<sup>3457</sup>

So *Allah* became distant and *Muhammad* felt disowned and deceived. The only way to regain his relationship with *Allah* was to become *Allah*’s prophet. When *Muhammad* received his initial call in the Mount *Hira* cave, he was choked three times by the angel *Gabriel*. Norman L. Geisler wrote:

During his call he [*Muhammad*] was choked by an angel. *Muhammad* himself said of the angel, ‘He choked me with the cloth until I believed I should die. Then he released me and said ‘Recite!’ (*Iqra*).’ When he [*Muhammad*] hesitated, he received ‘twice again the repeated harsh treatment.’<sup>3458</sup>

The choking seems to have reflected how *Muhammad*’s new unitarian beliefs about *Allah* were choking off and killing *Muhammad*’s former happy polytheistic self. From now on *Muhammad* would be a prophet of *Allah* and all his healthy

<sup>3457</sup> Zwemer. *Essay*, Ch. 8: “The Completed Idea and Its Insufficiency,” pp. 110-112.

<sup>3458</sup> Geisler & Saleeb. *Answering*, p. 154.

interpersonal friendships would be replaced with unhealthy suicide/killing cult relationships.

*Muhammad* said that *Gabriel* told him to recite. The revelation that *Muhammad* was to recite was K 096:001-005, according to *Islamic* tradition. Just as *Gabriel* choked off *Muhammad's* polytheistic beliefs, *Muslims* have used similar methods to forcefully convert non-*Muslims*.

Abducting and brainwashing is very cultish behavior and has been practiced throughout *Islamic* history, from *Muhammad's* enslaving and then converting slaves, down to the present time.

A famous example is the Blood Levy of Christian boys called the *Devshirme*, begun by Murad I (ruled 1362-1389) and ended in 1826 by Mahmud II. The Christian boys abducted from parts of the *Ottoman* Empire were forcefully converted to *Islam* and turned into *Janissaries*, the *Sultan's* shock troops.

Another example in modern times is how *Coptic* women are being abducted and forcefully converted to *Islam* in Egypt.<sup>3459</sup> Women are brought to hideouts or police stations where they are kept incommunicado and brainwashed until they say the *Shahada*. Many are never seen again and the *Muslim* police tell the family to just forget about the missing person. Then if the abducted person ever converts back to Christianity, he or she and the family are at risk of being killed for apostasy from *Islam!*<sup>3460</sup>

Not only do *Muslims* copy the demon *Gabriel's* example of forcefully converting *Muhammad* but they also copy *Gabriel's* command to recite on pain of death. The recitation is a *Shibboleth* whereby a *Muslim* can be discerned from a non-*Muslim*.

Usually mobs or terrorists can sniff out who is not *Muslim* by: 1) their dress, 2) their being in a church, 3) their civil, law-abiding behavior, 4) the fact that they are not yelling *Allah Akbar!*, meaning “*Allah* is great! or 5) by the fact that they are not barefoot kneeling on a mat with their rear ends in the air aligned with *Makka*.

If all the other *Shibboleths* fail, the mobs and terrorists take their cue from *Gabriel*. They demand that the intended victim recite portions of the *Koran*. The word *Koran* itself means “The recitation.” *The World on the Web* webzine provides another instance:

*Los Angeles Times* correspondent Davan Maharaj reported that ‘thousands of *Muslim* youths armed with knives and machetes [were] burning cars and assaulting bystanders they suspected were Christian. Rioters pulled a local journalist off a motorcycle and told him he would be killed unless he could recite verses from *Islam's* holy book, the *Quran*. The crowd released him unharmed when they realized he was *Muslim*.’<sup>3461</sup>

The *Associated Press* provides another instance:

The violence came hours after thousands of *Muslim* protesters—some carrying daggers, sickles and clubs—marched from the main *Mosque* in the northern city of *Kano*, traditionally a hotbed of religious tensions. Amina Usman, a 19-year-old university student, recounted seeing two mutilated bodies

<sup>3459</sup> Egypt: *Coptic* pope condemns forced conversions of Christians to *Islam*,” *Dhimmiwatch.org*, 26 Mar 2004.

<sup>3460</sup> Christian Solidarity Worldwide, *Annual Report*, May 2002, [csw.org.uk](http://csw.org.uk).

<sup>3461</sup> Olasky, Marvin. “Nigerian nightmare: Who will defend press freedom from the passions of the *Islamic* street?” *World on the Web*, [worldmag.com](http://worldmag.com), 7 Dec 2002, vol. 17, no. 47.



next to a makeshift checkpoint where young *Muslim* Hausa-speaking men armed with sticks, knives and clubs were searching cars for Christians and Animists and asking passengers to recite *Muslim* prayers. ‘It was hell,’ said *Mohammed Aliyu*, another university student, who said he saw five bodies in another part of *Kano*, Nigeria’s largest *Muslim* city, one with a burning tire around its neck. An *Associated Press* reporter saw youths at a makeshift checkpoint of burning tires strike three young women with machetes after accusing them of being ‘nonbelievers’ for wearing Western-style skirts and blouses. The women escaped with bleeding head wounds after several motorcycle taxi drivers intervened.<sup>3462</sup>

Forced recitation of *Koran* verses is now a part of execution-style murders:

The gunmen told the policemen to recite [the] *Kalima*, *Muslim* holy verses traditionally spoken before death [*YaSin*, no doubt], and then opened fire... They shouted they would not spare any policeman.<sup>3463</sup>

Daniel Pipes reports on another execution-style murder involving the recitation of the *Koran*:

They [terrorists] took a good 15 minutes in segregating the Christians and making sure that each one of their targets gets the most horrific death.’ A survivor of that slaughter recounts that the murderers separated Christians from *Muslims* by requiring each hostage to recite a verse from the *Koran*. Those who could not were seated at a table in the library, bound to chairs, gagged and shot in the head...<sup>3464</sup>

Sometimes *Muslim* terrorists know that the victim does not know the *Koran* but they feel they must make the victim recite something. Such was the case with *The Wall Street Journal* reporter, Daniel Pearl. He was forced to say “My father is Jewish. My mother is Jewish. I am a Jew,” right before his throat was slit.<sup>3465</sup> Another victim in a taped beheading had to say his name and who his family was.<sup>3466</sup>

The perception that the *Islamic Allah* was more relationally distant and aloof affected *Muhammad*’s psyche. Norman Geisler wrote:

Also clouding the alleged divine origin of his message is the fact that after this there was a long period of silence, which according to some accounts lasted about three years, during which time *Muhammad* fell into the depths of despair, feeling forsaken by God, and even entertaining thoughts of suicide. These circumstances strike many as uncharacteristic of a divine call.<sup>3467</sup>

Being the prophet of an anti-social god meant that *Muhammad* no longer had to please anyone. *Muhammad* did not need to take to heart any of the criticism of his opponents since unbelievers were “the vilest of animals in *Allah*’s sight” (*K* 007:179; 008:022, 055; 098:006). In contrast, Christians take the advice of outsiders seriously because:

- ☉ Even the residents of *Sodom* and *Gomorrah* might shame the self-righteous on the Last Day (Mat 11:23-24).
- ☉ Virtuous pagans may outshine the very hypocrites who condemn them (Rom 02:01; 03:09).

<sup>3462</sup> Samuel, Oloche. “Nigerian *Muslim* Protest Turns Violent,” news.yahoo.com, 11 May 2004.

<sup>3463</sup> Ashraf, Aamir. “Gunmen Storm Karachi Police Post, Kill 5,” *Yahoo! News*, 4 Apr 2004.

<sup>3464</sup> Pipes, Daniel. “A War Against What?” *New York Post, DP*, 1 Oct 2002.

<sup>3465</sup> Nirenstein, Fiamma. “Justification for murder? WorldNetDaily.com, 1 Mar 2002.

<sup>3466</sup> “Video Shows Beheading of American in *Iraq*,” news.yahoo.com, 11 May 2004.

<sup>3467</sup> Geisler & Saleeb. *Answering*, p. 156.

- Ⓒ “Even a broken clock is correct twice per day,” as the saying goes, meaning one must give credit to what is good even in a disagreeable or disliked person.

So it seems that *Muhammad* and, by extension, *Allah* tended to suffer from ailments that tend to afflict anyone who shuts himself off the stabilizing influences of polite society: anomie, egoism, myopia, narcissism and solipsism.<sup>3468</sup> Zwemer wrote:

...his [*Allah*'s] own...lone egoism in Himself is the cause and rule of His indifferent and unregarding despotism around. The first note is the key of the whole tune, and the primal idea of God runs through and modifies the whole system and creed that centers in Him.<sup>3469</sup>

Some *Muslims* have excused *Muhammad*'s conduct by stating that he was a statesman and not just a prophet, and he had to assassinate people as well as pillage and conquer in order to set up his theocracy. Of course if *Muhammad* gets a pass on all this, what then is wrong with Ariel Sharon doing the same things while he continues to establish and safeguard the state of *Israel*?

The fact that *Muhammad* is excused for his crimes and he is the “excellent exemplar” whom *Muslims* are supposed to emulate (*K* 033:021) dooms *Muslims* to wicked governance. That is because any tyrant, such as Saddam Hussein, can exonerate himself by pointing to the “excellent exemplar.”

Leaders of states that sponsor terrorism (Syria, *Iran*, Sudan, etc.) can also shamelessly point to *Muhammad*'s example of statesmanship. Arafat, the tyrant of Palestine, actually modeled himself on *Muhammad*. *The Jerusalem Post* reported:

**Giora Eiland said that Arafat's policy was based on four main elements:**

**1) sweet talk** [Arafat was following *Muhammad*'s manipulative talk found throughout *Koran* and the traditions. He was using *Kitman* and *Takiya*, which are religiously sanctioned dissembling, deception, and feigning false pretenses Arafat was following *Muhammad* policy of “War is deceit.”<sup>3470</sup> Arafat had even said he is using *Muhammad*'s *Hudaybiya* ploy.<sup>3471</sup>], **2) maintaining terror, which began a hundred years ago and has never ceased** [violence to put the *Dhimmis* in their place, also see the 164 War verses], **3) maintaining that Palestinian suffering is so great that it must first end** [“persecution is severer than slaughter” (*K* 002:190-191)] **and 4) demographics** [*Muhammad* said that *Muslims* can have up to four wives and an unlimited number of sex-slaves (*K* 004:003, 023-024; 023:005; 033:050; 070:030)].<sup>3472</sup> [Note: Text within brackets is Yoel Natan's comments.]

Arafat and other dictators follow *Muhammad*'s example by not making preparations for any transfer of power even when pressured to do so. *Muhammad*

<sup>3468</sup> Anomie: Social instability caused by erosion of standards and values. Egoism: The ethical doctrine that morality has its foundations in self-interest, and that self-interest is the just and proper motive for all human conduct. Egoism is opposed to altruism where the criterion of morality is what benefits others. Myopia: Lack of discernment or long-range perspective in thinking or planning. Narcissism: A psychological condition characterized by self-preoccupation, unconscious deficits in self-esteem, and lack of empathy. Empathy is the identification with and understanding of another's situation, feelings, and motives. Solipsism: The belief that all reality is just one's own imagining of reality, and that one's self is the only thing that exists.

<sup>3469</sup> Zwemer. *Essay*, Ch. 5: “The Relation of *Allah* to His World,” p. 68.

<sup>3470</sup> *Sahih Bukhari*, vol. 4, bk. 52, nos. 267-270; also see *Sahih Muslim*, bk. 32, no. 6303.

<sup>3471</sup> Pipes, Daniel. “How Dare You Defame *Islam*,” *DP*, Nov 1999.

<sup>3472</sup> “Eiland: Palestinians don't want a state,” *jpost.com*, 8 May 2004.

became sick and died, reportedly without leaving a Last Testament. Arafat had a bout of sickness back in 2003 but even then did not decide on a favorite to replace him.

*Muslims* claim that *Muhammad* died because of the cumulative effects of poisoned food served by a Jewish woman at *Khaybar*.<sup>3473</sup> It seems some *Muslim* rulers want to rule until the bitter end because they want to be martyrs. In other words, *Muslim* rulers want to be assassinated, or at least **reportedly** poisoned like *Muhammad* may have been.

*Muslim* culture glorifies martyrs. *Muhammad* taught that all *Muslims* except martyrs go to Purgatory before going to heaven.<sup>3474</sup> Martyrs of course receive the seventy-two *Houris* in heaven. Thus it is not surprising Arafat alleged that his “life’s dream is to become a *Shahid*.”<sup>3475</sup> It is not surprising that Arafat was stubborn about not leaving politics voluntarily, because he said he wanted to be assassinated in the Holy Land.

*Hamas* claimed that *Israel* poisoned Arafat.<sup>3476</sup> The *Al-Aqsa* Martyrs Brigade claimed that *Israel* had killed Arafat by keeping him from traveling for two years.<sup>3477</sup> Arafat had the services of Jordanian, Tunisian and Egyptian doctors, and then French doctors in a French hospital, and none of these doctors found evidence of poisoning. It seems they knew he died of AIDS and they never denied that he did die of AIDS. Thus it is apparent that the “poisoning” claims are made in order to: 1) Make their hero Arafat into a martyr modeled on *Muhammad* and 2) Avoid talk of how the bisexual Arafat died of AIDS.

The Arafat episode shows how *Muhammad* became a martyr through the invention of the poisoning story (mentioned above). The Palestinians wanted Arafat to be declared a martyr, for otherwise he would not be in Paradise enjoying the *Houris* and the serving boys with pearls (*Houris* are discussed in the Khidr-Second Lamech Logic table).<sup>3478</sup>

Even worse than the fact that the moon-god religion ensures bad governance, is the fact that *Muslims* shy away from criticizing a *Muslim* ruler. After all, this is tantamount to criticizing *Muhammad* since the *Muslim* rulers are all following *Muhammad*’s example. *Muhammad* is the “excellent exemplar” given by *Allah* for all *Muslims* to emulate (*K* 033:021). *Muhammad* is also called the *Al-insan Al-kamil*, “the perfect man.”

*Muslims* make up for not criticizing their rulers by criticizing non-*Muslim* leaders vociferously and unmercifully, usually over things the non-*Muslim* ruler ought to be praised for—such as promoting democracy in the Mideast.

### ***Muhammad*, the Moon-god Cult Leader in Full Bloom**

Some have excused *Muhammad*, and by extension *Allah*, by saying that they lived by the seventh-century behavioral norms in Arabia. This non-judgmental attitude arises from the fact that historians in the past were naïve about cult and group psychology. These historians think that if *Muhammad* got away with what he

<sup>3473</sup> *Sahih Bukhari*, vol. 5, bk. 59, nos. 551+713; Ishaq. *Sirat*, p. 516.

<sup>3474</sup> See the Glossary for information on *Islam*’s version of Purgatory.

<sup>3475</sup> Golan, Matti. “Why should the Left save Arafat?,” Jpost.com, 23 Oct 2003.

<sup>3476</sup> Keinon, Herb & Margot Dudkevitch. “Israel rejects claim it poisoned Arafat,” jpost.com, 11 Nov 2004.

<sup>3477</sup> “Call to avenge Arafat ‘assassination,’” theaustralian.news.com.au, 11 Nov 2004.

<sup>3478</sup> Trifkovic. *Sword*, pp. 63-64.

did, than every Arab must have been behaving the same way, or nearly so. For instance, Watt gives this assessment:

From the standpoint of *Muhammad's* time, then, the allegations of treachery and sensuality cannot be maintained...So much must be said in fairness to *Muhammad* when he is measured against the Arabs of his time.<sup>3479</sup>

Cult personalities can build a following and control an enclave, city or even state while violating well-established community standards. Examples include the Jewish false messiah figures such as *Bar Kochba* (132-135 AD), and the polygamous Joseph Smith, the “American *Muhammad*” of Nauvoo, Illinois.

It is easy to establish that *Muhammad* broke many of the spoken and unspoken rules of his day. Proofs will be provided in a moment. It is also easy to show that *Muhammad* was a cult leader. *Ibn Ishaq* provides a cultish example:

He [‘Urwa] got up from the apostle’s presence having seen how his companions treated him. Whenever he performed his ablutions they ran to get the water he had used; if he spat they ran to it; if a hair of his head fell, they ran to pick it up. So he returned to the *Quraysh* [at *Makka*] and said ‘I have been to *Chosroes* in his kingdom, and *Caesar* in his kingdom and the *Negus* in his kingdom, but never have I see a king among a people like *Muhammad* among his companions. I have seen a people who will never abandon him for any reason, so form your own opinion.<sup>3480</sup>

The *Hadiths* also show that people judged morality by *Muhammad's* example and not *Muhammad* by morality. This is very cultish. George Braswell wrote:

The answer is that the believers are conditioned to look at the whole thing through the eyes of faith. An infidel in his fundamental misguidance may find the Prophet rather sensual and cruel—and certainly many of the things he did do not conform to ordinary ideas of morality—but the believers look at the whole thing differently. To them, morality derives from the Prophet’s actions; the moral is whatever he did. Morality does not determine the Prophet’s actions, but his actions determine and define morality. *Muhammad's* acts were not ordinary acts; they were *Allah's* own acts.

It was in this way and by this logic that *Muhammad's* opinions became the dogmas of *Islam* and his personal habits and idiosyncrasies became moral imperatives: *Allah's* commands for all believers in all ages and climes to follow.<sup>3481</sup>

Another sign that *Muhammad* was a cult leader whose exaggerated sexual needs were well-served:

- Even though *Muhammad* had many wives, still four devout *Muslim* women “gave themselves” to sexually pleasure *Muhammad*.<sup>3482</sup>
- *Muhammad* also became a son-in-law to the first *Caliph* when *Abu Bakr* gave his six-year-old daughter, Aisha. *Muhammad* consummated the marriage when Aisha was nine.<sup>3483</sup>

<sup>3479</sup> Watt. *Statesman*, pp. 234-235.

<sup>3480</sup> Ishaq. *Sirat*, pp. 502-503.

<sup>3481</sup> Swarup, Ram, “Understanding *Islam* Through *Hadis*.” Voice of India, Delhi, 1983, xv-xvi, quoted in Parshall, *Inside the Community*, in turn quoted by Caplow, Michael. “*Islam* and Christianity: Some Truths About *Islam*, *Muhammad's* Followers, Part IV: *Allah* versus Jehovah—Are They the Same? dtl.org, 4 May 2002.

<sup>3482</sup> Morey. *Invasion*, p. 86.

*Muhammad* claimed to be the Greatest and Last Prophet of *Allah* in a long string of 128,000 prophets back to Adam. *Muhammad* vested himself with an apocalyptic dimension by saying that he was greater than both the *Mahdi* and *Isa* (Jesus), *Muslim* messianic figures prophesied to return before the Last Day. *Muhammad* said that he would lead the *Muslims* into heaven on Judgment Day and pronounce judgment on everyone.

That *Muhammad* could still have such a large following after making the above claims, especially without backing them up with miracle after miracle, shows that he was the leader of a cult.

And indeed, the *Koran* seems to indicate that *Muhammad* did not perform any miracles (*K* 017:090-098), except perhaps the moon being “cleft asunder” (*K* 054:001). Some *Muslims* speculate that the Splitting of the Moon verse is a prophecy of an End Time event. However, a search of the *Hadith* reveals that the “cleaving” of the moon were considered historical events.<sup>3484</sup>

Significantly, another *Muslim* who attracts a cult following is Usama Bin Laden (UBL). Some of his fighters admitted that they enlisted because they thought he was the *Madhi*. Some think that UBL is entertaining the thought that he is the *Mahdi*.<sup>3485</sup>

Now that *Muhammad* has been shown to be a cult leader, it is time to show that he broke nearly every written and unwritten rule that the Arabs had. If *Muhammad* was breaking no societal norms regarding sensuality or violence in the eyes of his followers, then why is the *Koran* filled with statements purportedly from *Allah* exonerating or endorsing *Muhammad*'s conduct? For instance, Ali Dashti wrote:

When the Prophet's marital privileges, specified in numerous verses of *Sura* 33, are added up, their astonishing range becomes apparent. He could have more than four wives, the maximum allowed to other believers; he was permitted to marry first cousins who had emigrated to *Madina* with him; he could take as a wife, without payment of dower and presence of witnesses, any female believer who gave herself to him; he was exempt from the obligation of respect for the equal rights of co-wives; he might postpone or terminate the turns of any of his wives; if he sought a woman's hand, any other suitor must desist; and after his death, no other men might marry his widows. Moreover the Prophet's wives had no right to demand higher subsistence allowances. In contrast with the privileges and freedoms given to the Prophet, exceptional restrictions were imposed on his wives.<sup>3486</sup>

We can see why Aisha once told *Muhammad* that “*Allah* was quick to fulfill his desires” (Suyuti's *Asbab Al-Nuzul* comments on *K* 033:049).

Even pagans have internalized standards of conduct, no matter what passes as acceptable conduct in that time and area. So even though the proverb runs “When in Rome, do what the Romans do,” Paul was able to write that the Romans were ruled by their conscience:

<sup>3483</sup> Lings. *Sources*, pp. 133-134; *Sahih Bukhari*, vol. 5, bk. 58, no. 234+236; vol. 7 bk. 62 no. 64+65+88; *Sunan Abu Dawud*, bk. 41, no. 4915.

<sup>3484</sup> *Sahih Bukhari*, vol. 5, bk. 58, no. 208; *Sahih al-Muslim*, ch. 8, bk. 39, no. 6726.

<sup>3485</sup> Warnings from *Islam*'s messianic whirlpool: *Jihadists* in global frenzy over coming of prophesied ‘*Mahdi*,’ *WorldNetDaily*, 29 Mar 2004, and ‘Is Bin Laden the ‘*Mahdi*’?: Some *Muslim* followers believe he is prophesied ‘awaited enlightened one,’ *WorldNetDaily*, 8 Sep 2003.

<sup>3486</sup> Dashti. *Career*, p. 128.

For when the Gentiles, who have not the law, do by nature the things contained in the law, these, having not the law, are a law unto themselves (Rom 02:14).

That the Judeo-pagan religion of *Islam* was exceptionally vicious even by seventh-century standards is evident from the statements of contemporaries in *Makka* and *Madina*. For instance, *Muhammad's* biographer, *Ibn Ishaq*, records an incident where a *Muslim* killed a Jew in cold blood. The brother of the killer told the murderer that he was an enemy of God. This is because the brother had not converted to *Islam* yet, so he still considered murdering Jews to be a dastardly deed.<sup>3487</sup>

A Palestinian *Muslim* who converted to Christianity, Anis Shorrosh, wrote:

The besieged Jews [the *Kaynuka* tribe], numbering over two thousand souls, surrendered...The Jewish men, with hands tied behind their backs, were kept in one place...A wounded chief named Sa'd was asked to decide the fate of the captives. His judgment was that the men should be put to death, the women and children sold into slavery and the spoil divided among the *Islamic* army. A shrill of horror ran through the assembly but *Muhammad* stopped all questioning. 'Truly,' said he, 'the judgment of Sa'd is the judgment of the Lord, pronounced on high from above the Seventh Heaven.'<sup>3488</sup>

So here we can see that *Muhammad* put *Allah's* stamp of approval on conduct that made even *Muslims* shudder. That *Muhammad* was considered barbaric even by early medieval standards suggests many contemporaries thought of *Muhammad* as a terrorist and the *Allah* of the *Koran* as a terrorist too.

Note that one had to be REALLY horrific to be judged a terrorist in the medieval period! In fact, the medieval era was so cruel that the term "medieval" has come to be used as an adjective to "suggest inhuman practices, such as torture of prisoners."<sup>3489</sup>

*Al Kindy*, a Christian scholar, wrote a defense of Christianity at the court of *Caliph Al Mamun* in 830 AD (215 AH). Surely, he was well informed about Christianity and *Islam* and the moral standard of Arabia. He had this to say about *Muhammad* and *Islam*:

The killing and shedding of blood, rapine [plundering] and robbery and making slaves of men and women—what are they but the works of the Devil?<sup>3490</sup>

That *Muhammad* was beyond the pale even in his own time can be seen by how often he had to invoke *Allah* while trying to make a virtue out of a vice or clear evil. Serge Trifkovic wrote on the subject:

*Allah* was invoked *Deus ex Machina*, providing revelations relevant not [only] to the Prophet's daily political objectives, but also to his personal needs. Nowhere was this more obvious than when it came to his exaggerated sensuality.

That *Muhammad's* actions and words, as immortalized in the *Koran* and recorded in the Traditions, are frankly shocking by the standards of our time—and punishable by its laws that range from war crimes and murder to rape and child molestation—[it] almost goes without saying.

<sup>3487</sup> Ishaq. *Sirat*, p. 369. The account is also found in *El Badyah Wa Alnihaya—Ibn Katheer*, vol. 4 (the chapter on killing Ka'ab Bin Al' Ashraf).

<sup>3488</sup> Shorrosh. *View*, p. 67.

<sup>3489</sup> *The Dictionary of Cultural Literacy* (2<sup>nd</sup> Edition), Medieval entry. Edited by E. D. Hirsch, Jr., Joseph F. Kett, & James Trefil. Houghton Mifflin Company, atomica.com, 1993.

<sup>3490</sup> *Al Kindy. Apology*, p. 97.

There are contemporary Western authors however who argue that we must not extend the judgmental yardstick of our own culture to the members of other cultures who have lived in other eras. In response, it should be pointed out that even in the context of seventh-century Arabia, *Muhammad* had to resort to divine revelations as a means of suppressing the prevalent moral code of his own milieu. Attacking caravans in the month of *Ramadan*, taking up arms against his own kinsmen, murdering people without provocation and indulging with considerable abandon one's sensual passions was so fundamentally at odds with the moral standards of his own Arab contemporaries that only the ultimate authority [*Allah*] could, and did, sanction it. As an Edwardian (1901-1910 era in England) author put...the problem with *Muhammad*'s behavior is not that he was *Bedouin* but that he was a morally degenerate *Bedouin*.<sup>3491</sup>

Interestingly, *Muhammad* even said that he did not live in a particularly evil time or place. The *Sufi* Martin Lings wrote:

It was his wont [i.e. custom] to warn them continually that the privilege of living with him in his community brought with it a grave responsibility, for God was just and would judge them more severely than those who lived in worse ages when it was more difficult to resist evil. He said:

Verily ye are in an age when whoso omitteth [omits] one-tenth of the law shall be doomed. But there will come an age when whoso fulfilleth [fulfils] one tenth of the law shall be saved.<sup>3492</sup>

Gregory Palamas, a fourteenth-century Byzantine saint, also knew the true nature of *Islam*. He was held captive by *Turks* who thought that *Muhammad* was the Son of Man (Mat 24:27). Gregory Palamas told them:

It is true that *Muhammad* started from the east and came to the west, as the sun travels from east to west. Nevertheless he came with war, knives, pillaging, forced enslavement, murders and acts that are not from the good God but instigated by the chief manslayer, the Devil. If the precedent of Moses and *Joshua* be urged, I demand miracles such as they wrought in justification of the commission to fight. Moreover, they fought against idolaters; but here, the horrors of war, bloodshed, rapine and slavery are hurled against the innocent, nay, against the very people of God—those who observe His ordinances, devote soul and body to His service, believe in His Messiah, worship Him and are guided into the right way—those whose leaders are blessed and renowned both in this world and that which is to come.<sup>3493</sup>

Similarly, the Mandaeans in Mesopotamia identified *Muhammad* with “the demon *Bizbat* and usually called [him] ‘the Son of Slaughter, the Arab.’”<sup>3494</sup> *Muhammad* of course would think “the Son of Slaughter” title was a compliment since *Allah* told *Muhammad* “It is not for a Prophet to have prisoners until he has spread fear of slaughter in the land” (*K* 008:067).<sup>3495</sup>

Note that *Al Kindy* and Gregory Palamas' mention of the Devil is an allusion to Joh 08:44 where Jesus says:

<sup>3491</sup> Trifkovic. *Sword*, p. 50.

<sup>3492</sup> Lings. *Sources*, p. 269.

<sup>3493</sup> “The *Muslim* Advance and American Collaboration,” by James George Jatras, May 1998 Speech, orthodoxinfo.com/general/*Muslim*advance.htm.

<sup>3494</sup> Gunduz. *Life*, p. 70.

<sup>3495</sup> Dashti. *23 Years*, p. 97.

You belong to your father the Devil and you want to carry out your father's desire. He was a murderer from the beginning, not holding to the truth, for there is no truth in him. When he lies, he speaks his native language, for he is a liar and the father of lies (Joh 08:44).

### A Moon-god Religion and a Moon-god Cult Leader: A Very Bad Combination

One of the troubling factors of a personality cult is that the social life of the entire community revolves around the cult leader. This is especially bad if the cult is a moon-god religion cult because nothing can be scheduled ahead of time precisely.

In moon-religions, every event of any importance hinges on the observations of the moon made by the religious establishment. This means the moon-god cult leader controls everyone's schedule, based on the moon-god's whim.

*Muhammad* explained that the months were roughly twenty-nine days long but *Allah* often defers (postpones) the crescent-moon's appearance by one day (*Sahih Muslim*, Bk. 6, Nos. 2392+2393).

Here is why *Muhammad* could get away with this: Before precise astronomical methods were introduced, no one knew whether the new-moon crescent would appear in twenty-nine or thirty days. So any event scheduled on a certain day of the month had to be moved up or back a day, depending on when the crescent-moon was actually observed by *Muslims* manning the *Minarets*.

This is just one of the ways that *Islamic* societies tend to become, and remain, ordered from the top down, with the clerics being on top. Even today, *Islamic* lunar religious calendars come printed with the disclaimer that they may be a day off!

The *Islamicist*, Martin Lings, provides one example of the calendar confusion this caused and how *Muhammad* took advantage of the situation. *Muhammad's* wives...

...were learning the bad ways from the women of *Madina* who for generations had been less restrained and more self-assertive than the women of *Makka*...[future *Caliph Umar*] said...when we came to *Madina*, we came unto a people whose wives have the upper hand over them.<sup>3496</sup>

It was now the time of the new [waxing crescent] moon, and the Prophet let it be known to his wives that he did not wish to see any of them until the month had passed. When the moon had altogether waned, he went first to Aishah's apartment. Delighted to see him, yet surprised, she said to him: 'It is but twenty-nine nights.' 'How dost thou know?' he asked, and she answered: 'I have been counting them—how I have counted them!' 'But this was a month of twenty-nine [days],' he said. She had forgotten that a lunar month is sometimes only twenty-nine days instead of thirty.<sup>3497</sup>

So the whole slate of events scheduled in a moon-religion calendar was controlled by the wink and nod of the moon, meaning that no religious festival occurred at the same time of the year, or even in the same season each solar year. Continuity with the seasons, and months that always start and end on time, are why nearly all societies long ago discarded lunar calendars in favor of solar calendars.

The moon has its phases, appears at different times of the night and does not track with the seasons. This means that moon-god adherents' daily and annual rhythms of life are disturbed and this leads to an unsettled mentality.

<sup>3496</sup> Lings. *Sources*, pp. 275, 278.

<sup>3497</sup> Lings. *Sources*, p. 279.



### The Observed Behavior of the Moon Becomes the Character of *Allah*

To the extent that the moon-god showed up whenever he pleased at the start of the month, this showed *Allah*'s omnipotence and whimsicality—a dangerous combination of traits.

To the extent that the moon had a schedule and is predictable, this characteristic of the moon was applied to the *Islamic* doctrine of double predestination, which is discussed elsewhere in this book.

The uncertainty as to exactly when the moon-god would appear each month perturbs the conscience and mind. So it is not surprising that *Islamic* theology and *Sharia* law reflect a certain instability of the mind, as in *Allah*'s whimsical and arbitrary character as outlined by Zwemer:

The conclusion we come to, both from the study of the *Koran* and of Tradition, is that *Allah* does not appear to be bound by any standard of justice. For example, the worship of the creature is heinous to the *Muslim* mind and yet *Allah* punished Satan for not being willing to worship Adam (*Sura* 2:28-31; repeated *K* 007:011-013; 015:031-039; 017:061; 018:050; 020:116; 026:095; 038:074-082). *Allah* is merciful in winking at the sins of His favorites, such as the prophets and those who fight in His battles but is the quick avenger of all infidels and idolaters. He reveals truth to His prophets, but also abrogates it, changes the message, or makes them forget it (*Sura* 2:105). The whole teaching of *Muslim* exegetes on the subject of *Nasikh* and *Mansukh*, or the **Abrogated Verses** of the *Koran*, is utterly opposed to the idea of God's immutability and truth. There are **twenty** cases given in which one revelation superseded, contradicted, or abrogated a previous revelation to *Mohammed*....What must have been *Mohammed*'s idea of the character of God when he named Him 'The Proud,' 'The All-Compelling,' 'The Slayer,' 'The Deferrer,' 'The Indulgent' and 'The Harmful?'<sup>3498</sup>

### The Observed Behavior of the Moon Becomes the Character of *Muhammad*

*Muhammad* copied what he perceived to be *Allah* the moon-god's behavior, as was described in the previous section. Thus it follows that *Muhammad* was known for his *Takiya*-speak, in other words, lying and otherwise withholding the truth. *Muhammad*'s main literary work, the *Koran*, is also known for extensive abrogation.

Notably, *Muhammad* swore by the moon (*K* 074:032; 084:018; 091:002), a practice that, as conventional wisdom had it, led to infidelity. This conventional wisdom is voiced by Shakespeare (1564-1616 AD) in *Romeo and Juliet* (1597 AD):

'Oh swear not by the moon, the fickle moon, the inconstant moon, that monthly changes in her [grammatical female in Western thinking] circle orb, lest that thy love prove likewise variable.'

### *Allah*'s Instability Adversely Affects *Muslim* Women and Non-*Muslims*

Just as the moon is constantly changing, *Muhammad* had no problem preaching from an unedited *Koran* that contradicted itself. The *Koran* reflects how at first *Muhammad* said one thing and then later said another thing, yet *Muhammad* felt no need to apologize for the contradictions. Perhaps the changes and "phases" of the

<sup>3498</sup> Zwemer, *Essay*, Ch. 4: "*Allah*'s Attributes Analyzed...Examined," pp. 55-56, 58.

*Koran* showed that the *Koran* was revelation from the ever-changing moon-god *Allah*!

Unfortunately, the fact that *Allah* the moon-god changes his mind in the *Koran* often negatively affects women and non-*Muslims*, especially. Whatever concessions were made to women and non-*Muslims* were taken back or abrogated.

This state of affairs affects the lives of non-*Muslims* living under *Sharia* law and *Muslim* women especially. The *Koran* has a few passages that say women have rights similar to those of *Muslim* men (K 002:228; 003:195; 004:034, 124; 016:097 040:040). There are passages and that say a woman's testimony is worth only half that of a man (K 002:282) and a thousand other passages and traditions that degrade women most severely (002:222-223, 228; 004:006, 034; 033:032-033, etc.)

In a few passages the *Koran* says that *Sabeans*, Christians and Jews and even Zoroastrians need not worry about the Last Day because they are right before *Allah* (K 002:062; 022:017); then however *Muhammad* lambastes all non-*Muslims* and says that all non-*Muslims* will go to hell.

### The Moon's Instability Encourages Suicide Missions and Incites Violence

Another more sinister aspect of the moon is that the moon appears to commit suicide each month. The moon waxes and wanes and looks as though it has a remarkably short life cycle of one month. Since the moon goes out of this life looking like a scimitar, it looks as though the moon goes down fighting into the underworld.

The moon of course reappears as a smiley face at the start of the lunar month. It is as though after a short period in the underworld, it reemerges into a heavenly paradise (the sky).

*Allah* the moon-god leads by example and his example may suggest to *Jihadists* that dying in suicidal battles is a beautiful and godly thing. The message the moon sends is after a brief stay in the underworld, the *Jihadists* ascend to heaven where seventy-two eager-to-please virgins put a smile on the *Jihadists*' faces.

So the reason that *Imams* continue to issue edicts (*Fatwas*) saying that suicide-bombing is pleasing to *Allah* and that terrorists are merely "freedom fighters," is due to *Muhammad*'s influence, who in turn was influenced by the moon—the "eternally fruiting orb," which refers to the recurrent cycle of moon phases.<sup>3499</sup> Enn Kasak and Raul Veede wrote:

*Sin* was depicted as a horned bull (*Qarnû*) and a 'fruit that grows by itself' (*Enbu Sa Ina Ramanišu Ibbanu*; a reference to the belief that the moon regenerates itself after each waning). 'Among the astral deities, the moon-god was considered to be the most gentle and reliable, intimately connected with the fertility and fruitfulness of man and beast' (Leick 1998:152–153). And moon's movement is really clear and simple to observe.<sup>3500</sup>

*Muhammad* seems to have been affected by the moon's suicide-resurrection or suicide-regeneration cycle and this influenced *Muhammad* and his suicide/killing cult

<sup>3499</sup> "*Sin (Nannar)* with the three muses and the 'Eternally Fruiting Orb' [i.e. moon phases], *Ur-Nammu*" (Maspero. *Dawn*, p. 655).

<sup>3500</sup> Kasak, Enn & Raul Veede. "Understanding Planets in Ancient Mesopotamia," *Folklore*, vol. 16, Editors Mare Kõiva & Andres Kuperjanov, Folk Belief and Media Group of ELM haldjas.folklore.ee/folklore/vol16/planets.pdf, p. 17.

called “*Islam*,” whose adherents commonly claim to love death more than life (see the Khidr-Second Lamech Logic table).

*Muhammad* watched the moon cycle many times at the entrance to the Mount *Hira* cave. Then, after he received his prophetic call, he avoided the *Hira* cave because he thought it was haunted and he might be possessed—and he was right!<sup>3501</sup>

After *Muhammad* did not receive another revelation for some time because he wisely avoided the haunted cave, he contemplated suicide. Norman Geisler wrote:

Also clouding the alleged divine origin of his message is the fact that after this [*Muhammad*’s calling] there was a long period of silence, which according to some accounts lasted about three years, during which time *Muhammad* fell into the depths of despair, feeling forsaken by God, and even entertaining thoughts of suicide. These circumstances strike many as uncharacteristic of a divine call.<sup>3502</sup>

It is somehow not surprising that the suicidal *Muhammad* had a very loose definition of what constituted a martyr. *Ibn Ishaq* wrote that *Muhammad* considered *Muslims* who died in the Battle of *Uhud* to be martyrs, even though the *Makkans* were only taking police action against *Muhammad*’s band of caravan robbers:

*‘Amr b.* ‘Ubayd told me from *Al Hasan* that the apostle swore that there was no believer who had parted from the world and wanted to return to it for a single hour—even if he could possess it with all it has—except the martyr who would like to return and fight for God and be killed a second time.<sup>3503</sup>

The martyr would want to be killed a second time to get back to his heavenly whores—which, by the way, was the motivating factor behind his first “martyrdom.”

After the waning scimitar crescent phase the dark conjunction phase occurs. That is when the *Siren* call of the moon no longer incites *Muslims* to violence. To end the deafening silence and to keep the *Siren* call of violence going day and night, year after year, *Muslims* install menacing crescent finials and display countless other “sickle-dagger[s] of *Hilal*.”<sup>3504</sup> Imad-ad-Dean Ahmad wrote:

The horns of the moon in the famous *Islamic* symbol are reversed from the more commonly seen lunar crescent symbol. They point to the right and not to the left. The horns of a new-moon point to the left. It seems that the horns in the star-and-crescent symbol must be the old moon, the one near the end of the [lunar] month. This would be an appropriate symbol for *Lailat-ul-Qadr* [Night of Power], which took place near the end of *Ramadan*.<sup>3505</sup>

So the most commonly recognizable symbol of *Islam* represents the waning “scimitar” phase of the moon. Also, the “scimitar” phase at the end of the month rather than the waxing “smiley face” crescent is when *Allah* first revealed the *Koran* to *Muhammad*. This means that since the *Islamic* scimitar crescents are mounted everywhere in *Islamdom*, *Muslims* are constantly nudged toward violence and not just on a few cloudless nights per month.

The moon teaches that after a period of warfare (the scimitar phase), *Muslims* may agree to a cease-fire, or *Hudna* in Arabic. This corresponds to the dark conjunction phase where the scimitar is apparently sheathed. Then after seeing *Allah*

<sup>3501</sup> Haykal. *Life*, p. 74, as quoted in Geisler & Saleeb. *Answering*, p. 155.

<sup>3502</sup> Geisler & Saleeb. *Answering*, p. 156.

<sup>3503</sup> Ishaq. *Sirat*, p. 400.

<sup>3504</sup> *Tarana e malli* by *Pakistani* poet Muhammed Allama Iqbal (see Iqbal in Index).

<sup>3505</sup> Ahmad. *Signs*, p. 51.

return as a crescent smiley face, *Muslims* are strengthened by *Allah's* glory emanating from the full-moon. Incidentally, the historian Tabari (839–923 AD) records that the moon is light from a cloth brought from *Allah's* throne.<sup>3506</sup> Then the ominous scimitar phase returns and the *Hudna* cease-fire is called off.

It seems that the scimitar phase that appears twice-monthly nudges and prods *Muslims* to initiate violence. The suggestive effect of the moon is strong enough that Mideast region watchers have long noticed that there is a *Muslim*-initiated and *Muslim*-perpetuated cycle of violence and retaliation going back to ancient times.

Instead of there being a long drawn out siege warfare, moon-god worshippers in the Mideast are better known for their *Bedouin*-like raiding parties and terrorist attacks that appear out of nowhere. The attacks seem to come and go like the locusts or tides, or one could say, like the moon phases.

One is tempted to look at the lunar calendar to see whether the raids and terrorist attacks occur according to the monthly lunar cycle or lunar year. It seems that in the battle for *Muslims'* minds and souls, “in the end...the war-and-moon-god wins out,” to paraphrase a famous phrase by Samuel P. Huntington.<sup>3507</sup>

---

<sup>3506</sup> *Al Tabari, History*, vol. i, p. 232.

<sup>3507</sup> Huntington came to the debatable conclusion: “In the long run however *Muhammad* wins out” (Huntington, *Clash*, p. 65; also quoted in Jenkins. *Next*, p. 5).

## Chapter 09: Moon-o-theistic Kaaba

### Traditions Show the Kaaba's Purpose

Moshan Fani wrote in *The Dabistan* (~1645 AD):

According to the learned, the *Kaaba* (the cubic temple at *Makka*) is an emblem of the sun, on which account it is right [for astral worshippers] to worship it; and the well *Zem Zem* signifies likewise 'the great luminary,' as Hakim Khakani said relative to both:

O *Kaaba*, thou traveler of the heaven!

O *Zem Zem*, thou fire of the world!

*Hajer Ul Asvad*, 'the Black Stone at *Makka*,' represents the body of Venus, which on the border of the heavens is a star of the planets.<sup>3508</sup>

In the above quotation, Venus is said to be "on the border of the heavens" because Venus is only observable near the east and west horizons shortly after sunset and shortly before sunrise. The inner planets and the moon normally cannot be seen against the backdrop of the sun.

How did "the learned" come to possess this knowledge that the *Kaaba* represented the sun? The information was passed down from pre-*Islamic* times. Of course the knowledge could only be discretely passed along for fear of the *Islamists* who tried to stamp out any untoward teaching about *Islam* or *Muhammad*. Without such discretion, many memes<sup>3509</sup> of information could easily become just so many nails in an academic's coffin.

The learned had plenty of facts at hand by which they could confirm the validity of traditions. For instance, *Al Kalbi* (died 821-822 AD/206 AH) wrote in *The Book of the Idols* that *Allat* had sacred "stones,"<sup>3510</sup> and that "*Allat* stood in *Al Ta'if*...She [*Allat*] was a cubic rock..."<sup>3511</sup>

There were other facts that showed the *Kaaba* was basically the betyl of a goddess. In pre-*Islamic* times, *Allah* the moon-god's consort would have been *Allat* the sun-goddess. The Satanic Verses suggest that *Allah*'s "house" was in fact a betyl for his consort and daughters:

☉ The Arabic word *Kaaba* is feminine. The cubic building actually represents *Allat*'s breast, as the etymology of the word *Kaaba* informs us: "Arabic *ka'ba*, cube, cubic structure, from *ka'aba*, to swell, be full (said of breasts)."<sup>3512</sup>

☉ The *Kiswa* blanket over the *Kaaba* indicates that the *Kaaba* is the home of a goddess. Such coverings have a long history. The Bible records that female shrine prostitutes wove such "houses" (Hebrew: *Beit*) for the Venus goddess *Ashtorah* (YLT 2Ki 23:07).

The *Kaaba* was called the *Bait Allah*, or "the House of *Allah*," but the *Kaaba* could just as well have been called *Bait Allat* after *Allah*'s consort. Francis Burton visited the *Kaaba* and reported on the presumed femininity of the *Kaaba*:

<sup>3508</sup> Fani. *Dabistan*, p. 394.

<sup>3509</sup> "Meme" is defined as: A unit of cultural information, such as a cultural practice or idea, that is transmitted verbally or by repeated action from one mind to another.

<sup>3510</sup> *Al Kalbi. Idols*, p. 15.

<sup>3511</sup> *Al Kalbi. Idols*, p. 14.

<sup>3512</sup> *The American Heritage Dictionary, Kaaba* entry, answers.com, accessed 12 Jan 2006.

The part of the cover [*Kiswa*], covering the door, is called [a] *Burka* just like the veil [*Burka*] the Arabic women are wearing in front of their face...<sup>3513</sup>

Robert Eisler wrote similarly:

In fact, Arab mystics even compare the *Ka'aba* to a virgin, adorned with her finest wedding-dress. Comp. Lenormant p. 154, quoted a verse of *Abd-er-Rahin el Buray* 'and the *Ka'aba*, the bride of *Makka*, is shining newly adorned with (wonder) signs'.... Then the clothing of the *Ka'aba* would be the remains of an old feast that represented the hierogamy [Greek: sacred marriage] of the deity.<sup>3514</sup>

The fact that *Allat* was an Arabian sun-goddess and that she was represented by cubic rocks helped confirm in the ancient's mind that the cubic *Kaaba* did indeed represent the sun-goddess. By extension, these facts allowed the ancients to refer to the sun as the heavenly *Kaaba* that traveled the skies.

Also by extension, the ancients knew that the Black Stone was Venus since the Black Stone was set into a corner of the cubic *Kaaba*. The planet Venus was always observed to be near the sun.

The crescent-shaped *Hatim Wall*, the cubic *Kaaba* and the Black Stone were the moon, the sun and Venus. An ancient way of symbolizing the moon, the sun and Venus would be: ☾◻★ (crescent-square-star), which looks a lot like the outline of an overhead view of the *Hatim Wall*, the *Kaaba* and the Venus Black Stone (see the Thumbnail Gallery for several drawing of the *Kaaba* and *Hatim Wall*).

Malise Ruthven recounts another astral tradition about the *Kaaba*:

The earliest *Muslim* sources suggest that the pre-*Islamic* cult of the *Kaaba* had some astronomical significance. The historian *Masudi* (896-956 [AD]) [in *Murudj*, iv. 47] stated that certain people had regarded the *Kaaba* as a temple dedicated to the sun, moon and the five visible planets (making up the mystical figure of seven, the number of circumambulations required for each *Tawaf*). The story that there were exactly 360 idols placed round the temple also points to an astronomical significance [360 = 12 months of 30 days each<sup>3515</sup>]. Among the votive gifts said to have been offered to the idols were golden Suns and moons [*Al Azraki*, p. 155 sqq.]<sup>3516</sup>

The 360 idols around the *Kaaba* reminds one of how the ancient *Babylonian* myth *Enuma Elish* relates that *Marduk*, god of Jupiter, lined the skies with 300 gods who acted as guards.<sup>3517</sup> Incidentally, *Allah's* ninety-nine names (*K* 007:180; 059:024)<sup>3518</sup> reminds one of *Marduk's* fifty names.<sup>3519</sup>

The historian *Masudi* (896-956 AD) provides information that tends to confirm the above-mentioned traditions. He wrote in the *Golden Meadows*:

The *Haranian Sabians* have temples according to the names of the intellectual substances and the stars...(the temple) of Saturn is hexagonal; of Jupiter, triangular; of Mars, long (rectangular); the sun square [like the cubic *Kaaba*]; that of Venus, a triangle in a quadrangle; that of Mercury, a triangle

<sup>3513</sup> Burton. *Narrative*, vol. iii, p. 295.

<sup>3514</sup> Eisler, Robert, 1909, pp. 120-121.

<sup>3515</sup> The intertextual notes [in brackets] are from Gibb & Kramers. *Encyclopedia*, p. 198, *Kab'ah*.

<sup>3516</sup> Ruthven. *World*, p. 18.

<sup>3517</sup> Ness. *Mosaics*, p. 44.

<sup>3518</sup> Zwemer. *Essay*, Ch. 3: "The Ninety-Nine Beautiful Names of *Allah*."

<sup>3519</sup> Ness. *Mosaics*, p. 44.

inside an elongated quadrangle, and that of the moon, octagonal [like the Dome of the Rock].<sup>3520</sup>

One can infer from Masudi's writing that the cube part of the *Kaaba*, not including the crescent-shaped *Hatim Wall*, is a sun-god temple. The medieval scholars knew because they went on the *Hajj* and they read about *Makka*. Masudi's information also shows that the Dome of the Rock is a moon-god temple as shown by its octagonal shape.

*Ibn Ishaq* wrote that there was a plaque at the *Kaaba* that said:

I am *Allah* the Lord of the *Bakka* [*Makka*]. I created it [the *Kaaba*] on the day [on Friday, according to *Al Tabari* (839–923 AD)<sup>3521</sup>] that I created heaven and earth and formed the sun and moon and I surrounded it with seven pious angels.<sup>3522</sup>

Friday was the day of Venus in the astrological week. Note how *Islamic* tradition places the creation of all the astral bodies on Friday, the same that *Muslims* weekly attend *Mosque* for Friday Prayers.

*Ibn Ishaq* also wrote:

By the Black Stone, when they stroke it,  
When they go around it morning and evening.<sup>3523</sup>

So the pre-*Islamic Makkans* made sure to touch the Black Stone in the morning and evening. Venus, the Morning and Evening Star, is often visible during these times.

### The Christian View of the *Kaaba* and Black Stone

John Meyendorff wrote:

In the ninth century, Nicetas also speaks of the 'idol of *Xoubar*'...said to represent *Aphrodite*.<sup>3524</sup>

John of Damascus identifies *Xabar* or *Xaber* (he uses two forms) with both *Aphrodite* herself and with the *Ka'aba*, which according to him represents the head of the pagan goddess.<sup>3525</sup>

John of Damascus (~675–749 AD) said that even during his day the Black Stone still had traces of the head "of the *Semitic Venus* (i.e. the Greek *Aphrodite*)."<sup>3526</sup>

John of Damascus knew Arabic but he was writing in Greek. His Greek transliteration of *Kaaba* was *Kabar*. John used the same term *Xabar* for the Black Stone affixed to the *Kaaba*.

John Tolan wrote that the eighth-century Byzantine writer, Georges the Monk, said that *Muslims* worshipped "god...the moon and *Aphrodite*."<sup>3527</sup> The moon might refer to the crescent-shaped *Hatim wall*, and *Aphrodite* is the Greek version of Venus and may refer to the Venus Black Stone.

Constantine Porphyrogenitus' book, *De Administrando Imperio* (*The Administration of the Empire*) (950 AD), states about *Muslims*:

<sup>3520</sup> Green. *Moon*, p. 71.

<sup>3521</sup> *Al Tabari. History*, vol. i, pp. 188, 190, 230.

<sup>3522</sup> Ishaq. *Sirat*, pp. 85-86.

<sup>3523</sup> Ishaq. *Sirat*, p. 123.

<sup>3524</sup> Meyendorff. *Byzantine*, p. 95.

<sup>3525</sup> Meyendorff. *Byzantine*, p. 95.

<sup>3526</sup> Sahas. *Heresy*, pp. 88, 137.

<sup>3527</sup> Tolan. *Saracens*, p. 44, fn. 19, p. 296: "Alain Ducellier. *Chrétiens d'Orient et Islam au Moyen Age*. Armand Colin, Paris, 1996, pp. 161-164; Migne, J.P. (editor), *Patrologiae Graecae Cursus Completes* (162 vols.), Paris, 1857-1886, vol. 110:873.

They pray also to the star of *Aphrodite* which they called *Koubar*, and in their supplication cry out ‘*Allah Oua Koubar*, that is, God and *Aphrodite*. For they call God ‘*Alla*; and *Oua* they use for the conjunction and they call the star *Koubar*. And so they say ‘*Alla Oua Koubar*.’<sup>3528</sup>

Evidently, the author Constantine Porphyrogenitus confused the word *Akbar* in the phrase, *Allahu Akbar* (*Allah* is great!), with the word for the *Kaaba*, or the word that John of Damascus used for the *Kaaba*: *Xaber*.

The author of this ruler’s training book wrote specifically for the Byzantine emperor. So one can see that the emperors believed the *Kaaba* was at least a Venus goddess shrine, if not a shrine for *Allah* the moon-god.

### Sex and the Black Stone

*Ibn Ishaq* notes that *Muhammad* kissed the Black Stone.<sup>3529</sup> *Al Bukhari* wrote:

‘Umar came near the Black Stone and kissed it and said ‘No doubt, I know that you are a stone and can neither benefit anyone nor harm anyone. Had I not seen *Allah*’s Apostle kissing you, I would not have kissed you.’<sup>3530</sup>

*Muhammad* as a pagan had been sentimental about *Uzza*, the Arab version of Venus. *Ibn Al Kalbi* (died 821-822 AD/206 AH) relates that *Muhammad* said:

I have offered a white sheep to *Al 'Uzza* [Venus], while I was a follower of the religion of my people.<sup>3531 3532</sup>

*Muhammad* sacrificed to the goddess Venus. He also had a custom dating from pre-*Islamic* times of kissing the Black Stone. These points tend to confirm that the Black Stone represented Venus.

The Black Stone is smooth, at least the portion that is visible to the public. How the statue’s head was worn down to a smoother state was from a millennium’s worth of “extremely passionate...rubbing and kissing,” as John of Damascus phrased it.<sup>3533</sup>

Early *Muslims* told John of *Damascus* that “Abraham had sexual intercourse with Hagar on it [the Black Stone].”<sup>3534</sup> There are traditions that suggest *Muslims* did believe that the Black Stone promoted sex and fertility. Stortroen wrote:

...in 1909 AD, another observer named Batanuni described the *Bedouin* rituals:

The women are clutched to the backs of the men. When they reach the Black Stone they all touch and kiss it. The husband knocks the head of his wife against the stone so that she will bear a visible mark of having made her *Haji*.<sup>3535</sup>

If *Muhammad* thought that *Ibrahim* and Hagar copulated in public, this would explain why *Muhammad* led his congregation at the *Mosque* with spots of semen on his clothes, as his favorite wife attests:

<sup>3528</sup> Meyendorff. *Byzantine*, p. 95.

<sup>3529</sup> Ishaq. *Sirat*, p. 131.

<sup>3530</sup> *Sahih Al Bukhari* 002:667, 675, 676, 679, 680; see also *Al Kindy. Apology*, under the section “Pilgrimage and rites of *Makka*,” p. 93; Zwemer. *Animism*, ch. 8.

<sup>3531</sup> *Al Khargushi. Sharaf Al Mustafa*, as cited by Peters. *Origins*, p. 127.

<sup>3532</sup> *Al Kalbi. Idols*, pp. 16-17.

<sup>3533</sup> Sahas. *Heresy*, pp. 88-89.

<sup>3534</sup> Sahas. *Heresy*, pp. 88-89.

<sup>3535</sup> Grunebaum. *Festivals*, p. 44, as quoted in Stortroen. *Makka*, pp. 22-23.



Narrated 'Aisha: 'I used to wash the semen off the clothes of the Prophet and even then I used to notice one or more spots on them' (*Sahih Bukhari*, vol. 1, bk. 4, no. 233).

Narrated 'Aisha: 'I used to wash the traces of *Janaba* (semen) from the clothes of the Prophet and he used to go for prayers while traces of water were still on it (water spots were still visible)' (*Sahih Bukhari*, vol. 1, bk. 4, no. 229).

If *Muhammad* thought that *Ibrahim* and Hagar copulated in public on the Black Stone, this would explain why *Muhammad* gave men permission to do the *Hajj* at *Makka* with an emission of semen for all time (even today):

Narrated *Ibn 'Abbas*: 'The Prophet (along with his companions) reached *Makka* in the morning of the fourth of *Dhul-Hijja* assuming *Ihram* for *Hajj* only. So when we arrived at *Makka*, the Prophet ordered us to change our intentions of the *Ihram* for 'Umra and that we could finish our *Ihram* after performing the 'Umra and could go to our wives (for sexual intercourse). The people began talking about that. Jabir said surprisingly, 'Shall we go to *Mina* while semen is dribbling from our male organs?' Jabir moved his hand while saying so [a pornographic gesture, no doubt]. When this news reached the Prophet he delivered a sermon...At that *Suraqa Bin Malik* stood up and asked 'Oh *Allah's* Apostle! Is this permission for us only or is it forever?' The Prophet replied, 'It is forever' (*Sahih Bukhari*, vol. 3, bk. 44, no. 683; also see vol. 9, bk. 92, no. 464).

Another tradition shows *Muhammad* implied that *Allah* was not interested in abstinence when it came to *Jihad* and the *Hajj*, and that the Black Stone involved a fertility rite, as Stortroen wrote:

He [*Muhammad*] proclaimed that the Lord gave the *Muslims* the *Hajj* and Holy War in exchange for monasticism.<sup>3536</sup>

If the Black Stone once were used as part of a platform for sex, this would also help explain how it was worn down from a Venus idol to its present shape. The stone might have been used for sex because, as Ameer Ali explains, pagans used to sacrifice their virginity to gods:

The composite race created *Babylon* and gave birth to a form of religion which, in its higher phases, was akin to natural pantheism. In its lower phases, with its pan-daemonism, its worship of the sun-gods and moon-gods, closely associated with the phallic cult and sexual instincts, the sacrifice of children to *Baal* and *Moloch*, of **virginity** to *Beltis* [Mother of the Gods] and *Ashtoreth* [Venus].<sup>3537</sup>

Fertility cult places also served as primitive fertility clinics and sperm banks, as *The Dabistan* reports:

The followers of this [*Saktian*] sect send their barren wives in order that they may become pregnant to the performers of such acts, and these men use the women before the eyes of their husbands.<sup>3538</sup>

This suggests that the Venus worship by the Black Stone at the *Kaaba* was much like Venus worship elsewhere in the ancient world. St. Augustine described the worship of Venus in North Africa, where Venus went by the name of *Tanit* and *Caelestis*:

<sup>3536</sup> Grunebaum. *Festivals*, p. 44, as quoted in Stortroen. *Makka*, p. 20.

<sup>3537</sup> Ali. *Spirit*, p. xix.

<sup>3538</sup> Fani. *Dabistan*, p. 253.

Where and when those initiated in the mysteries of *Caelestis* received any good instructions, we know not. What we do know is that before her shrine in which her image is set, and amidst a vast crowd gathering from all quarters and standing closely packed together, we were intensely interested spectators of the games which were going on, and saw, as we pleased to turn the eye, on this side a grand display of harlots, on the other the virgin goddess: we saw this virgin worshipped with prayer and the obscene rites. There we saw no shamefaced mimes, no actress overburdened with modesty: all that the obscene rites demanded was fully complied with. We were plainly shown what was pleasing to the virgin deity, and the matron who witnessed the spectacle returned home from the temple a wiser woman. Some, indeed, of the more prudent women turned their faces from the immodest movements of the players and learned the art of wickedness by a furtive regard. For they were restrained, by the modest demeanor due to men, from looking boldly at the immodest gestures; but much more were they restrained from condemning with chaste heart—[that] which, if practiced in one's home, could only be done in secret—was practiced as a public lesson in the temple; and if any modesty remained in men, it was occupied in marveling that wickedness which men could unrestrainedly commit should be part of the religious teaching of the gods, and that to omit its exhibition should incur the anger of the gods. What spirit can that be, which by a hidden inspiration stirs men's corruption and goads them to adultery and feeds on the full-fledged iniquity, unless it be the same that finds pleasure in such religious ceremonies, sets in the temples images of devils, and loves to see in play the images of vices; that whispers in secret some **righteous sayings** to deceive the few who are good, and scatters in public invitations to profligacy to gain possession of the millions who are wicked?<sup>3539</sup>

The last part of the above quote reminds one of the *Koran*, which has some “righteous sayings” that fool the naive, but plenty of material to entice the wicked, such as promises of power over women and non-*Muslims*, loot and sex, sex, sex—in heaven as well as on earth.

Someone might ask what was it about the Black Stone that would make it such an object of worship. The Black Stone was an earthly representation of Venus, which was the goddess *Uzza* in pre-*Islamic* times. In *Islamic* times the Black Stone represented an angel who took over the role of dispensing sexual powers from the Venus goddess. Moshan Fani wrote in *The Dabistan*:

...although the planets are simple bodies of a spherical form, yet the reason why the above-mentioned images have been thus formed is that the planetary spirits have appeared in the world of imagination to certain prophets, saints and holy sages under such forms; and under which they are also connected with certain influences; and as they have appeared under forms different from these to other persons, their images have also been made after that fashion.<sup>3540</sup>

Venus was assumed to be an orb like the sun and moon—just smaller. Thus the Black Stone had to have a spheroid shape and other oddly shaped meteorite finds just would not do. In passing, the Black Stone may be a *Wabar* Pearl, a meteorite encrusted with impact glass.

<sup>3539</sup> MacMullen & Lane. *Sourcebook*, pp. 46-47.

<sup>3540</sup> Fani. *Dabistan*, pp. 25-26.

The idea that a spheroid or a rounded cone could represent Venus is more than confirmed by ancient information. There are plenty of ancient coins that feature meteorite betyls such as the *Emessa Stone*, and these are nearly always shaped and polished into spheroids or rounded cones.

In *Ephesus* a meteorite was considered an image of the moon-goddess *Artemis* that had literally “fallen from *Zeus*” (Act 19:35). It seems most logical to suppose that the betyl was an orb similar to the moon, given the fact that other such betyls were rounded.

The Black Stone also was considered a betyl, as *Ibn Warraq* wrote:

The deity resided in a stone and was not necessarily in human form. Sometimes the sacred stone was a statue or sometimes simply a big block of rock whose shape resembled a human. The heathen Arabs evidently imagined that the block of stone that served as a fetish was pervaded by a divine power and, in its turn, exercised a divine influence.<sup>3541</sup>

The idea that spirits inhabit inanimate objects pervades *Islam*, so the idea behind betyls is still alive and well. *Muhammad* said that toward the Last Day, trees would call out to *Muslims* telling them to kill Jews hiding behind them,<sup>3542</sup> and trees and rocks talked to him.<sup>3543</sup> These traditions are not meant as hyperbole. They are discussed elsewhere in this book.

Ancient Arabian block betyls like those found at *Petra* have carved eyes, a nose and a mouth. Traditions speaks similarly about the Black Stone, as *Al Albani* notes:

And there is in touching the Black Stone a great excellence as the Prophet said: ‘*Allah* will raise up the Stone on the Day of Judgment, and [it] will have two eyes with which it will see and a tongue which it talks with, and it will give witness in favor of everyone who touched it in truth.’<sup>3544</sup>

Also of interest is the fact that *Muhammad* said the Black Stone used to pay him salutations when he was a pagan.<sup>3545</sup>

### The Vulviform Black Stone With Its Silver Casing

The Black Stone must also considered in context, meaning its positioning in a silver casing and its position in relation to the rest of the *Kaaba*. The Black Stone’s casing will be discussed first. Kanan Makiya wrote:

...the Black Stone broke into three pieces. The pieces...have been bound together with a band of silver and mounted in a silver chasing shaped like a woman’s vulva.<sup>3546</sup>

Similarly, Bob Trubshaw wrote:

What these [photographs] reveal is a polished Black Stone of which less than two feet is visible, set in a large, solid silver mount. The whole resembles—quite deliberately, for reasons which will emerge—the vulva of the goddess. That *Muslims* now refer to it as the Hand of *Allah* [*Yamin Allah*] does not

<sup>3541</sup> Warraq. *Why*, p. 39.

<sup>3542</sup> *Sahih Muslim*, bk. 041, nos. 6981-6985; also see *Sahih Muslim*, bk. 041, nos. 6981-6985, as well as *Sahih Bukhari*, vol. 4, bk. 52, nos. 176-177, and *Sahih Bukhari*, vol. 4, bk. 56, no. 791.

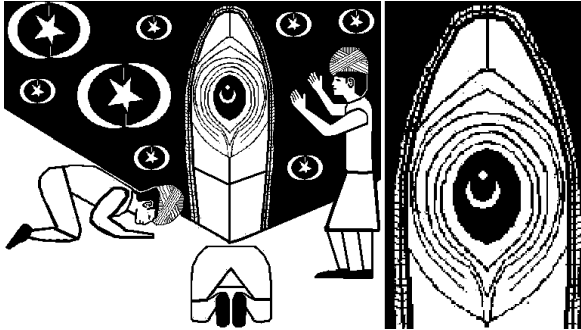
<sup>3543</sup> Dashti. *Career*, p. 26.

<sup>3544</sup> “Authenticated by at-Tirmidhee, *Ibn Khuzaimah*, *Ibn Hibbaan*, *Al Haakim* and *Adh-Dhahabee*. See ‘*Al Hajj-ul-Kabeer*’ (*Al Albani*. *Rites*, in the section “*Tawaaf of Quadoom* (Arrival)”, fn. 39). *Ibn Abbas* also passed on a similar Black Stone tradition (Hughes. *Dictionary*, pp. 154-155, *Hajar*).

<sup>3545</sup> *Sahih Muslim*, bk. 30, no. 5654.

<sup>3546</sup> Makiya. *Tale*, p. 59.

diminish the urge for all those who complete the pilgrimage to *Makka* to touch or kiss this sacred object...In an oasis of always-flowing water, the Black Stone in its mount became an unmatched image of the goddess as giver of life. Only in the Indian [sub-]continent do such physical symbols for the male and female generative powers—the *Lingam* and *Yoni*—continue to be worshipped with their original fervor...where sacred ‘prostitution’ or ritual promiscuity were part of the worship...invariably sacred objects depicting the genitals of either god and/or goddess were venerated.<sup>3547</sup>



**Figure 09-01.** Note the vulva-look of the Black Stone at the *Kaaba* (close-up on the right). The *Kaaba* was an astral religion temple in Pre-Islamic times, and so the *Kiswa* cover probably had astral imagery. Today, the *Kiswa* is embroidered with Arabic verses from the *Koran*.

Moshan Fani wrote in *The Dabistan* (~1645 AD).

The zealous of this sect [the *Saktians*] worship the *Siva-Linga* [*Siva* is a god, *Lingam* is a phallic symbol], although other *Hindus* also venerate it. *Linga* is called the virile organ, and they say on behalf of this worship that, as men and all living beings derive their existence from it, adoration is duly bestowed on it. As the *Linga* of *Mahadeva*, so do they venerate the *Bhaga* [*Yoni*, i.e. a stylized vulva], that is, the female organ. A man very familiar with them gave the information that, according to their belief, the high altar [the *Mihrab*], or principal place in a *Mosque* of the *Mussulmans* [*Kaaba*], is an emblem of the *Bhaga* [vulva]. Another man among them said that, as the just-named place emblems the *Bhaga* [vulva], the *Minar*[*et*], or turret of the *Mosque* represents the *Linga* [phallic symbol]; on which account both are found together [as a *Lingam* and *Yoni*].<sup>3548</sup>

Moshan Fani records in *The Dabistan* a distich where a Jew named Sarmed says the same about the Black Stone at the *Kaaba*:

In the *Kaaba* and in the idol temple is his stone the symbol of male energy [a *Lingam*], and his is the symbol of female productiveness [a *Yoni*]; in one place it is the Black Stone of the temple of *Makka*; in another place an idol [the *Lingam* and *Yoni*] of the *Hindus*.<sup>3549</sup>

These feminine aspects of the *Kaaba* are noted in the traditions. The *Dabistan* states:

According to the learned, [the] *Kaaba* (the cubic temple at *Makka*) is an emblem of the sun.<sup>3550</sup>

<sup>3547</sup> Trubshaw, Bob. “The Black Stone—the Omphalos of the Goddess,” *The Edge*, indigogroup.co.uk/edge. First published in *Mercian Mysteries*, no. 14, Feb 1993.

<sup>3548</sup> Fani. *Dabistan*, p. 251.

<sup>3549</sup> Fani. *Dabistan*, p. 251.

<sup>3550</sup> Fani. *Dabistan*, p. 394.

In pre-Islamic times in Arabia, the sun was the goddess *Allat*, daughter or consort of *Allah*.

*Ibn Ishaq*, in his biography of the prophet, notes that a pre-Islamic pagan specifically called the two stones “at the two corners” a “goddess” when the *Kaaba* was rebuilt in 605 AD. *Ishaq* wrote:

The people were afraid to demolish the temple and withdrew in awe from it. *Al Walid b. Al Mughira* said ‘I will begin the demolition.’ So he took a pick-axe, went up to it saying the while, ‘O god [literally “goddess” (see discussion below)], do not be afraid, O god [literally “goddess”], we intend only what is best.’ Then he demolished the part at the two corners [or “two stones” (see discussion below)].<sup>3551</sup>

Alfred Guillaume wrote about the above quote “O god, do not be afraid” that “The feminine form indicates that the *Kaaba* itself is addressed.”<sup>3552</sup> Thus it seems “god” in the above passage ought to be translated “goddess.”

About the phrase “two corners,” Guillaume says the alternative translation is “Or ‘two stones.’”<sup>3553</sup> Actually, the “two stone” reading was the original reading, no doubt, but *Ibn Ishaq*’s editor, *Ibn Hisham*, changed those words.

*Ibn Hisham* (died in 828 or 833 AD/213 or 218 AH) lived at a time and in a place where pagan betyl worship was less well understood. The betyl stones were however mounted in the corners of the *Kaaba*.

There were two main stones in the pre-Islamic *Kaaba*, each a betyl for a goddess. So it seems that at each corner *Walid* addressed the stone as though the stone were a goddess as he chiseled each precious stone out of the wall.

Modesty is why the *Kaaba* needs a *Kiswa*, the black brocade cover. *Hughes* notes that the literal translation of *Kiswa* is “robe,”<sup>3554</sup> as though the *Kiswa* covered a goddess or goddesses.

Later *Muhammad*’s grandfather *Muttalib* wrote a poem about the rebuilding that went “None of our workers wore clothes.”<sup>3555</sup> *Ibn Hisham* wrote that a variant reading is: “. . .our *pudenda* [*genitalia*] were not covered.”<sup>3556</sup> So the sight that *Ishaq* described (above) was indeed strange: a certain *Walid* was in the buff (naked) talking to a goddess in a stone while wielding a pickaxe.

The vulva-look of the silver case around the Black Stone probably extends back to pre-Islamic times when the *Kaaba* was circumambulated by nude worshippers. The vulva-look would have complemented the *Lingam* and *Yoni* worship that was prevalent throughout Arabia and India at the time, and Venus worship, too, since the Black Stone did represent Venus.

Venus was often represented by a woman holding a vase that stood for a vulva, and a vulva was used as a Venus symbol, as *Ryckmans* wrote:

‘*Attar* [the male Venus] is frequently named with the goddess *Hawbas*, probably his consort, also named in *Sabaeen* inscriptions of the 5<sup>th</sup>-4<sup>th</sup> centuries in Ethiopia, where her symbol was the **vulva**.’<sup>3557</sup>

<sup>3551</sup> *Ishaq*. *Sirat*, p. 85

<sup>3552</sup> *Ishaq*. *Sirat*, p. 85, fn. 2

<sup>3553</sup> *Ishaq*. *Sirat*, p. 85, fn. 3

<sup>3554</sup> *Hughes*. *Dictionary*, p. 279, *Kiswah* entry.

<sup>3555</sup> *Ishaq*. *Sirat*, p. 87.

<sup>3556</sup> *Ishaq*. *Sirat*, p. 711, note 133.

<sup>3557</sup> *Ryckmans*. *Anchor*, v. 6, p. 172.

Ryckmans also wrote that in South Arabia “figurines of male or female sexual organs [were] offered in view of obtaining children.”<sup>3558</sup>

The vulva shape was fitting for the sexually passionate kissing and rubbing said to have occurred at the Black Stone as late as John of Damascus’ day. Moreover, the *Yoni* Black Stone complements the three *Jamara* phallic symbols on Mount *Mina* that *Muslims* stone during the *Hajj* pilgrimage. These are the three famous *Lingam* pillars that *Muslims* say represent Satan.

Many *Muslims* writing travelogues would not be forthright about the vulva-look of the Black Stone.<sup>3559</sup> They did however mention that the Black Stone is positioned in its silver frame and is recessed in its casing, as *Ibn Jubayr* wrote in 1183 AD:

Its edges have been braced with a sheet of silver whose white shines brightly against the black sheen and polished brilliance of the Stone, presenting the observer a striking spectacle which will hold his looks.<sup>3560</sup>

If one reads between the lines, John Lewis Burkhardt’s description of the Black Stone suggests it was vulviform in 1829 AD:

Both the border and the stone itself are encircled by a silver band, broader below than above and on the two sides, with a considerable swelling below as if a part of the stone were hidden under it.<sup>3561</sup>

The Black Stone is now called the Hand of *Allah* (*Yamin Allah*). By its looks, the Black Stone has nothing to do with *Allah*’s hand or his power whatsoever, except of course the name may imply that *Allah* the moon-god’s hand caresses Venus’ vulva.

Though the Black Stone is called the Hand of *Allah*, still this does not free it from its former Venus vulva association altogether. This is similar to how renaming the “Thunderbolt of *Hadad*” to the *Islamic* “Hand of *Fatima*” or the Jewish *Hamsa* does not remove the obvious pagan association of that object, as Zwemer explains:

‘The Hand of *Fatima* [*Muhammad*’s daughter],’ says Tremearne, ‘is a great favorite in *Tunis* and one sees it above the great majorities of doorways; in Tripoli [to the east of *Carthage*] there is hardly one, and this is only to be expected, since the sign is an old *Carthaginian* one, representing not the Hand of *Fatima* at all but that of *Tanith* [or *Tanit*, meaning Venus]. It has been thought however that the amulet is so curiously similar to the thunderbolt of *Adad* [*Hadad*], worn in the necklet of the *Assyrian* kings along with emblems for the sun, the moon and Venus, that it may be a survival of that.’<sup>3562</sup>

*Ibn Jubayr* wrote in 1183 AD about how pilgrims French wet kissed the Black Stone—but really it was oral sex since the stylized Black Stone looks vulviform:

The Stone, when kissed, has a softness and moistness which so enchants the mouth that he who puts his lips to it would wish them never to be removed. This is one of the special favours of Divine Providence...May God profit us by the kissing and touching of it. By His favour may all who yearn fervently for it be brought to it. In the sound piece of the stone, to the right of him who presents himself to kiss it, is a small white spot that shines and appears like a mole on the blessed surface. Concerning this white mole, there is a tradition that he who

<sup>3558</sup> Ryckmans. *Anchor*, v. 6, p. 174.

<sup>3559</sup> Jubayr. *Travels*.

<sup>3560</sup> Jubayr. *Travels*.

<sup>3561</sup> Burkhardt, John Lewis. *Travels in Arabia*, London, 1830, as quoted in Hughes. *Dictionary*, p. 154, *Hajar* entry.

<sup>3562</sup> Zwemer. *Animism*, ch. 4.

looks upon it clears his vision, and when kissing it one should direct one's lips as closely as one can to the place of the mole.<sup>3563</sup>

The borders of the *Kiswa* curtain around the Black Stone either: 1) represented a nightie or lingerie folded back to reveal the vulva or 2) the curtains around the Black Stone represented the folds of skin and tissue, the *labia majora*, that form the external lateral boundaries of the vulva. *Ibn Ishaq's* biography of *Muhammad* mentions the pre-Islamic *Kiswa* a few times.<sup>3564</sup>

*Ibn Ishaq* mentions in the account of Umar's conversion that there was a pre-Islamic Mosque next to the *Kaaba*, the Black Stone and the *Kiswa*. The *Kiswa* was low enough to the ground that Umar was concealed behind the *Kiswa* while walking from the *Hijr* area to where *Muhammad* was praying.

*Muhammad* was praying there since his custom was to pray facing the *Kaaba* near the Black Stone between the southeast and southwest corner. *Muhammad's* original *Kiblah*, his first direction of prayer, ran through the *Kaaba* toward Syria or more specifically, Jerusalem.<sup>3565</sup>

The idea was common in the ancient world that the earth and the deities had body parts located in sacred spots, such as navels and vulvas. The idea behind the earth's navel is that there is an invisible umbilical between the god in the sky and the earth since a goddess had given birth to the earth. The *Encyclopedia Britannica* states:

Frequently, the altar is regarded as the center or the image of the universe.

For the ancient Greeks the grave marker (a mound of earth or a stone) was the earth altar upon which sacrifices to the dead were made and, like other earth altars, it was called the omphalos, 'the navel' of the Earth—i.e. the central point from which terrestrial life originated. In *Vedic* India the altar was regarded as a microcosm, its parts representing the various parts of the universe and its construction being interpreted as a repetition of the creation of the cosmos.<sup>3566</sup>

The worshippers of *Yahveh* knew that *Yahveh's* Faces (2Ch 07:14a) and his eyes, ears and heart were present at the temple (1Ki 09:03; 2Ch 07:15-16). By contrast, fertility cult worshippers were concerned that their gods and goddesses' reproductive organs were at the temple—the *Lingam* and *Yoni*.

The *Encyclopedia Britannica* describes a fertility cult situation not unlike the situation at the *Kaaba*:

Unlike the mother goddess, who is a specific source of vitality and who must periodically undergo intercourse [*Coitus*], the Earth Mother is a cosmogonic [from eternity] figure, the eternally fruitful source of everything. In contrast, mother goddesses are individual, possess distinct characters, are young, are not cosmogonic and are highly sexual.<sup>3567</sup>

That fertility goddesses were generally depicted as nubile women may explain why *Allat*, *Manat* and *Uzza* were considered daughters of *Allah* rather than wives.

That the *Kaaba* was a fertility shrine is not surprising since many Mideast astral shrines had a strong fertility aspect, as Ameer Ali wrote:

<sup>3563</sup> Jubayr. *Travels*.

<sup>3564</sup> Ishaq. *Sirat*, pp. 158, 192, 292.

<sup>3565</sup> Ishaq. *Sirat*, pp. 157-158.

<sup>3566</sup> *EB*, accessed 15 Mar 2003, Sacrifice entry.

<sup>3567</sup> *EB*, accessed 15 Mar 2003, "Mother goddess" entry.

The composite race created *Babylon* and gave birth to a form of religion which, in its higher phases, was akin to natural pantheism. In its lower phases, with its pan-daemonism, its worship of the sun-gods and moon-gods, closely associated with the phallic cult and sexual instincts, the sacrifice of children to *Baal* and *Moloch*, of virginity to *Beltis* and *Ashtoreth*.<sup>3568</sup>

The pre-Islamite Arabs had their groves, their oracle-trees and their priestesses, like the Syro-Phoenicians. Phallic worship was not unknown to them; and the generative powers received adoration, like the hosts of heaven, under monuments of stone and wood.<sup>3569</sup>

That the Black Stone is a stylized *clitoris* explains why *Muhammad* approved of clitoridectomy, a practice discussed elsewhere in this book. *Muslims* considered the Black Stone's stylized vulva to be an ideal looking vulva, so they clipped and cut girls' vulvas until they looked like the Black Stone's stylized vulva.

The situation is somewhat like the peer pressure that girls feel that they must have a "Barbie Doll" body-type, and this unhealthy pressure is associated with eating disorders. It ought to be added that while the eating disorders are a socio-psychological problem, clitoridectomy is a crime, or ought to be a crime universally.

Add two *Muslim* traditions to the above information and one can see why *Muhammad* liked the Black Stone so much. Ancient Arabian block betyls like those found at *Petra* have carved eyes, a nose and a mouth. Traditions speaks similarly about the Black Stone, as *Al Albani* notes (as quoted above):

And there is in touching the Black Stone a great excellence as the Prophet said: 'Allah will raise up the Stone on the Day of Judgment, and [it] will have two eyes with which it will see and a tongue which it talks with, and it will give witness in favor of everyone who touched it in truth.'<sup>3570</sup>

The second tradition of interest is that *Muhammad* said the Black Stone used to pay him salutations when he was a pagan.<sup>3571</sup> Thus as detailed in this chapter, the pagan *Muhammad* thought the Black Stone in its vulva-shaped frame was the Venus goddess in a betyl, and tradition says this Venus goddess talked to him. Thus for the pagan *Muhammad* the Black Stone was the seventh-century equivalent of "phone sex."

### What Circumambulation Was All About

That the *Kaaba* was a fertility shrine jibes well with traditions pertaining to the *Kaaba* such as one recounted by *Ibn Ishaq*:

The Messenger, after arriving in *Makka*, once the populace had settled down, went to the shrine and went round it seven times on his camel, touching the Black Stone with a stick which he had in his hand.<sup>3572</sup>

*Muhammad* used a staff to symbolically inseminate Venus' vulva which was represented by the Black Stone and its casing. The phallic stick was a *Lingam* and the Black Stone was the *Yoni* vulva. *Muhammad's* staff will be discussed further in the next chapter.

<sup>3568</sup> Ali. *Spirit*, p. xix.

<sup>3569</sup> Ali. *Spirit*, p. 139.

<sup>3570</sup> "Authenticated by at-Tirmidhee, *Ibn Khuzaimah*, *Ibn Hibbaan*, *Al Haakim* and *Adh-Dhahabee*. See 'Al Hajj-ul-Kabeer' (*Al Albani*. *Rites*, in the section "Tawaaf of *Quadoom* (Arrival)", fn. 39).

*Ibn Abbas* also passed on a similar Black Stone tradition (Hughes. *Dictionary*, pp. 154-155, *Hajar*).

<sup>3571</sup> *Sahih Muslim*, bk. 30, no. 5654.

<sup>3572</sup> Peters. *Origins*, p. 236.



The idea that what *Muhammad* did was an act of sexual symbolism is in keeping with the Old Testament information where sacred stones and *Asherah* poles are mentioned together (Exo 34:13; Deu 07:05; 12:03; 1Ki 14:23; 2Ki 17:10; 18:04; 23:14; 2Ch 14:03; 31:01). *Asherah* poles are often mentioned along with male prostitution (Exo 34:13, 15; 1Ki 14:23-24; 15:12-13; 2Ki 23:04, 06-07).

The imagery of *Muhammad* circumambulating and symbolically inseminating Venus' vulva has *Lingam* and *Yoni*, and *Yin* and *Yang* aspects.<sup>3573</sup> In addition, it is reminiscent of how farmers purposefully pollinate certain crops to increase the harvest. Gordon Newby wrote:

The Jews...employed the techniques of hand pollination of the date flowers to ensure more than a spotty yield. Dates were a major source of nourishment in the Arabian diet and provided the basis for fermented drink.<sup>3574</sup>

*Muhammad* mentions palm trees in the *Koran* often (*K* 016:011; 017:091; 018:032; 019:023; 020:071; 023:019; 036:034; 055:068; 059:005; 080:029). He spoke of the roots (*K* 013:004), the fact that dates were fermented into alcoholic drinks (*K* 016:067), that shaking a palm tree drops fresh, ripe dates (*K* 019:025), that palm branches shrivel up (*K* 036:039), that fibrous palm trunks tear (*K* 054:020) and that palm trunks hollow out when deteriorating on the ground (*K* 069:007).

*Muhammad* also showed familiarity with the sexual parts of palm trees: the date-bearing sheath and the pollen-bearing *spadix* (*K* 006:099, 141; 026:148; 050:010; 055:011). The similarity between pollinating date palms and human sexual relations was not lost on *Muhammad* or his contemporaries either, as the bewitching of *Muhammad* incident shows:

*Tal'* [a *spadix*] is defined as 'what comes forth from the palm-tree and becomes dates if the tree is female; and if the tree is male it does not become dates, but is eaten in its fresh state, or is left upon the palm-tree a certain number of days until there becomes produced in it a white substance like flour [i.e. the pollen], having a strong odor and with this the female [tree] is fecundated'...

Considering the role of the white substance [pollen] in nature, there is little wonder that its odor was compared to that of sperm. One lexicographer defines the *Tal'* as 'a certain white thing [a *spadix*] that appears from the *spathe* of the palm-tree, to the color of which that of the teeth is likened, and to the odor thereof that of the *sperma*.'

The employment of [a string with eleven knots in] a *spathe* of a male palm tree to bewitch the Prophet provides a clue to the desired effect (or at least one of the desired effects), namely harming the Prophet's sexual potency. This is expressly stated in the sources [e.g. the *Hadith*<sup>3575</sup>]...<sup>3576</sup>

Since *Muhammad* thought of the palm tree in such sexual ways, it is not surprising that dates were one of *Muhammad*'s favorite food items. *Muhammad* also thought of heaven in highly sexual terms, so it is not surprising that *Muhammad* called certain dates from *Madina Mina L-Janna*, meaning "they are from Paradise."<sup>3577</sup>

<sup>3573</sup> The *Yin-Yang* symbol is Chinese in origin. *Yin* is dark and stands for the moon and femininity, and *Yang* is bright and stands for the sun and masculinity.

<sup>3574</sup> Newby. *Arabia*, p. 75.

<sup>3575</sup> Some *Hadith* on the bewitching of *Muhammad* that left him impotent: *Sahih Bukhari*, v. 7, bk. 71, nos. 658, 660, 661; v. 8, bk. 75, no. 400; *Sahih Muslim*, bk. 26, no. 5428.

<sup>3576</sup> Lecker. *Arabia*, XII:563-564.

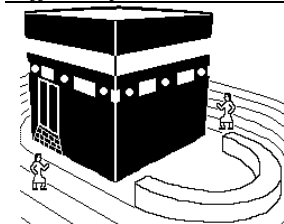
<sup>3577</sup> Lecker. *Arabia*, XII:562.

So the bewitching was an example of sympathetic magic. The string in the spathe represented the spadix, the male sexual organ of the plant, which in turn represented *Muhammad's* phallus. The knots represented the spell, which was meant to put knots in *Muhammad's* penis, or in other words, render *Muhammad* sexually impotent.

The reader might be asking what symbolically pollinated *Muhammad's* symbolic *spadix*, or what made his phallic symbol staff potent? The answer is walking past the crescent-shaped *Hatim Wall* that is considered part of the *Kaaba*. The moon was thought to increase sexual potency and fertility.

This fertility role of the crescent-moon was a major part of *Islamic* thinking up until a century or two ago. This thinking has diminished only to the extent that astrology has become discredited in the *Islamic* world.

The thinking that the moon has great potency can still be seen in the fact that pilgrims must walk around outside curve of the crescent-shaped *Hatim Wall* during *Hajj*. They cannot cut through the *Hijr* area between the *Hatim Wall* and the *Kaaba*.



**Figure 09-02.** Muslims walking around the *Kaaba* and the *Hatim Wall*.

### The Mating Habits of the Moon

When one considers the grammatically feminine gender of the sun (*Allat*), Venus (*Uzza*) and many other astral bodies, the masculine gender of the moon seemed especially important, as Tamara Green noted:

...the [grammatical] masculine gender of the moon in Mesopotamian cultures allows the establishment of a connection between the deity's dual functions in both the worlds of nature and human experience, for the moon-god serves as a divine bridge between male fertility and male political power. The most frequent iconographic representation of the moon is a lunar crescent, which is linked to the sphere of masculine sexuality by its further transformation into the horns of the bull, a universal symbol of male generative power; it is this animal that is most frequently sacrificed to the moon-god. His Sumerian title of *En-Su* designates him as 'Lord Wild Bull,' whose horns are mirrored in the crescent of the moon.<sup>3578</sup>

Since the waxing and waning crescent-moon has horns, the ancients pictured the moon as a bull. His herd was populated by the sun, the planets and the field of stars on the ecliptic.

The Mideast ancients noticed that though the moon strayed from the ecliptic, it did not stray very far. Most stars are some ways off from the celestial equator so they never receive the moon's attention (occultation) no matter how brightly they shine and twinkle. The moon, like a bull, had to keep his herd together and could not worry about other herds.

<sup>3578</sup> Green. *Moon*, p. 25.

The Arab pagans believed that *Allah* was the doting polygynist father of astral beings, as *K 053:019-020* mentions in passing. Khairat *Al Saleh* retells this pre-Islamic myth where one could surmise that the moon is *Allah*:

Some stars and planets were given human characters. According to legend, *Al Dabaran*, one of the stars in the *Hyades* group, fell deeply in love with *Al Thurayya*, the fairest of the *Pleiades* stars. With the approval of the moon [*Allah*], he asked for her hand in marriage.<sup>3579</sup>

The moral lesson gleaned from the moon's mating habits is that polygyny and concubinage is acceptable conduct (*K 004:003, 023-024; 023:005; 033:050; 070:030*) but promiscuousness was not (*K 004:020-024; 023:005-007*). That is because the moon strays only so far from the ecliptic and then no farther. So some astral beings receive *Allah's* attention but many never do.

The moon only occults planets and stars five degrees on either side of the ecliptic and not all the stars in the sky. Moreover, the zodiac circle with its Four Seasons clearly showed *Muhammad* that *Allah* the moon-god had four favorites (*Allat, Uzza, Manat* and *Sirius-Isis*) (*K 053:019-020, 049*).

The idea of the moon as a bull with his herd of stars is somewhat akin to the idea of the moon as shepherd who causes fertility, as Tamara Green wrote:

Yet another illustration of the extension of function from one realm of nature to another is illustrated by the moon-god's associations with herds, for he becomes the shepherd of the stars or celestial 'sheep' who come within the halo of his illumination; he is the herdsman who superintends his herds of stars as he sails across the evening sky...In the tale of *Nanna's* [*Sin's*] journey to *Nippur*, the god tells the gatekeeper of *Enlil's* temple that he has come in his boat to feed the herds and flocks and to make them multiply.<sup>3580</sup>

This aspect of the moon-god shepherding and fecundating the other stars in the sky is preserved in *Muslim* astrology, as Spengler and Sayles wrote:

The basis of astrology centers around the principle of change. The Greek philosopher Aristotle had drawn a distinction between the uniform motion of the stars and the irregular motion of the planets and this interaction formed the basis for classical astrology which was eventually adopted by Arabs of the *Jazira*. Among the greatest of Arabian astrologers was *Abu Mashar* who studied at *Baghdad* in the 9<sup>th</sup> century (AD) and formulated the doctrine that the more rapidly and erratically a body in the heavens moves, the more influence it will exert on things below. The moon being the swiftest object in the heavens thusly exerts the greatest effect on human affairs.<sup>3581</sup>

That the moon was a fertility symbol was also suggested by the moon phases, as Tamara Green wrote:

The Man-in-the-Moon is seen not merely because human features can be discerned, but because the moon, more than any other of the heavenly bodies, is alive; he comes to life, he grows and then begins to disappear from the visible heavens, only to be recreated anew.<sup>3582</sup>

<sup>3579</sup> *Al Saleh. Fabled*, p. 30.

<sup>3580</sup> Green. *Moon*, p. 25.

<sup>3581</sup> Ma'shar. *Albumasaris*, as cited by Wedel. *Attitude*, pp. 56-57, cited in turn by Spengler & Sayles. *Turkoman*, p. 22.

<sup>3582</sup> Green. *Moon*, p. 24.

If the crescent of the moon is the symbol of male virility and sexual power, the full-moon may be seen to portray the gravidity of a woman about to give birth [in some cultures]...the moon is born and dies in its masculine form, but it is as female that it reaches its fullness.<sup>3583</sup>

So we can see that circumambulating past the symbol of *Allah*, the crescent-shaped *Hatim* Wall, symbolically charged *Muhammad's* staff with sexual energy and symbolically loaded his *spadix* with pollen. *Muhammad* discharged the sexual energy collected from the crescent-shaped *Hatim* Wall, and using his staff he fecundated the Venus Black Stone vulva once each trip around the *Kaaba*.

### The Second Auspicious Stone at the *Kaaba* Dedicated to *Allat's* Nipples

Before the worshipper reached the Black Stone in the southeast corner on his counterclockwise trip around the *Kaaba*, he or she would pass an auspicious stone in the southwest corner. *Ibn Warraq* wrote:

Each time he passes around the *Kaaba* he [a pilgrim] touches the *Yamani* [*Yemeni*, southwest] corner, where another auspicious stone is encased, and also kisses the sacred Black Stone [in southeast corner].<sup>3584</sup>

Albani wrote:

And he [*Muhammad*] said: 'Touching the Black Stone and the *Yemeni* corner removes sins.' 'The Black Stone is from Paradise, and it used to be whiter than snow but the sins of the idolaters turned it black.'<sup>3585</sup>

*Al Kalbi* wrote in *The Book of the Idols* that *Allat* had sacred "stones,"<sup>3586</sup> and also that...

...*Allat* stood in *Al Ta'if* and was more recent than *Manah* [*Manat*]. She [*Allat*] was a **cubic** rock beside which a certain Jew used to prepare his barley porridge (*Sawiq*).<sup>3587</sup>

Nabih Amin Faris comments on the above quotation and says the word translated "cubic" literally means "square."<sup>3588</sup>

Simpson wrote that the sun goddess' name was written on walls of temples:

Names of South Arabian deities appear on walls of buildings and temples. These are to be considered as amulets of protection. Thus the amulet of *Shams* 'the sun goddess' was depicted on walls of houses.<sup>3589</sup>

The main symbols of the *Kaaba* that would carry over in a modified form into *Islamic* times would naturally relate to *Allah* and his daughters: the sun, Venus and *Manat*. This is confirmed by various facts:

- ☉ The word *Kaaba* is feminine and comes from the word *ka'aba*, to swell, be full (said of breasts).<sup>3590</sup>
- ☉ The *Kiswa* blanket over the *Kaaba* indicates that the *Kaaba* is the home of a goddess. Such coverings have a long history. The Bible records that female

<sup>3583</sup> Green. *Moon*, p. 26.

<sup>3584</sup> Warraq. *Why*, p. 36.

<sup>3585</sup> *Al Albani. Rites*, in the section "Tawaaf of *Quadoom* (arrival)."

<sup>3586</sup> *Al Kalbi. Idols*, p. 15.

<sup>3587</sup> *Al Kalbi. Idols*, p. 14. Note that the reference to the Jew is probably just an anti-Semitic remark with no basis in fact.

<sup>3588</sup> *Al Kalbi. Idols*, p. 14 & fn. 3.

<sup>3589</sup> Simpson. *Sheba*, p. 178, catalog 236.

<sup>3590</sup> *The American Heritage Dictionary*, *Kaaba* entry, answers.com, accessed 12 Jan 2006.

shrine prostitutes wove such “houses” (Hebrew: *Beit*) for the Venus goddess *Ashtorah* (YLT 2Ki 23:07).

☉ Francis Burton wrote “The part of the cover [*Kiswa*], covering the door, is called *Burka*, just like the veil [*Burka*] the Arabic women are wearing in front of their face...”<sup>3591</sup>

☉ The Black Stone was a Venus vulva symbol, as was noted earlier.

By process of elimination, one can tell the astral *Kaaba* was considered to be *Allat*’s breast since *Manat* seems to have had no known astral affiliation,<sup>3592</sup> and *Sirius* was not represented on the outside of the *Kaaba*, as is discussed elsewhere. Thus the auspicious stone in the corner of the *Kaaba* near the Black Stone must be the “*Allat*’s Nipples” of which *Abu Bakr* spoke.<sup>3593</sup>

The *Allat* nipples would complement the vulviform Venus Black Stone well. Ryckmans wrote that vulva symbols were used in the region:

‘*Attar* [the male Venus] is frequently named with the goddess *Hawbas*, probably his consort, also named in *Sabaeen* inscriptions of the 5<sup>th</sup>-4<sup>th</sup> centuries in Ethiopia, where her symbol was the **vulva**.’<sup>3594</sup>

That the stone was thought to be *Allat*’s Nipples explains the Prophet’s actions:

Then he kissed the [Black] Stone and went out trotting, as did his companions. When the temple concealed him from them and he had kissed the southern [*Yemeni*] corner [*Allat*’s Nipples], he walked to kiss the Black Stone [a second time].<sup>3595</sup>

Alfred Guillaume wrote concerning the above quote:

*Italama* [to kiss] means to embrace with outstretched arms, to stroke with the hand and to kiss.<sup>3596</sup>

*Muslims* are obliged to do the same as *Muhammad* did and kiss *Allat*’s Nipples, as Zwemer wrote:

...most *Muslims*, except the *Shafa’i* school, must touch the stone with both hands and apply their lips to it, or touch it with the fingers, which should be kissed, or rub the palms upon it and afterwards draw them down the face. Under circumstances of difficulty, it is sufficient to stand before the stone but the Prophet’s *Sunnat*, or practice, was to touch it.<sup>3597</sup>

### A Third Auspicious Stone at the *Kaaba* Dedicated to *Manat*

There was another auspicious stone in the *Kaaba* that probably represented *Manat*. Glassé wrote:

In the opposite corner [from the Black Stone], set somewhat lower, is another stone of a reddish color called the ‘Stone of Felicity’ (*Hajar As-Sa’adah*).<sup>3598</sup>

The stone “Felicity,” meaning “good fortune,” would seem to be connected to *Manat*, goddess of Fortune. This seems to be confirmed by the process of elimination.

<sup>3591</sup> Burton. *Narrative*, vol. iii, p. 295.

<sup>3592</sup> Guillaume. *Islam*, p. 8.

<sup>3593</sup> Ishaq. *Sirat*, p. 502.

<sup>3594</sup> Ryckmans. *Anchor*, v. 6, p. 172.

<sup>3595</sup> Ishaq. *Sirat*, p. 530.

<sup>3596</sup> Ishaq. *Sirat*, p. 530, fn. 2.

<sup>3597</sup> Zwemer. *Animism*, ch. 8.

<sup>3598</sup> Glassé. *Encyclopedia*, p. 214, left column, middle.

The Four Daughters of *Allah* and *Allah* himself would be the main personalities represented on the outside of the *Kaaba*. *Allah* was represented by the crescent-shaped *Hatim* Wall, *Uzza* by the Black Stone and *Allat* by the *Allat's* Nipples stone.

*Sirius* was probably represented by the corner of the *Kaaba* without any inset stone since evidently the *Kaaba* was not originally built to accommodate *Sirius* worship, as indicated by this pre-*Islamic* statement:

When it was sanctified, *Sirius* had not been created.<sup>3599</sup>

This was probably meant to explain why a corner of the *Kaaba* without an inset stone was dedicated to *Sirius*.

So it seems that one auspicious corner of the *Kaaba* represented *Allat*, the Black Stone represented *Uzza* (Venus) and the other two corners represented *Manat* and *Sirius*. This combination of corners and stones of the *Kaaba* may have mimicked a Zodiac circle with a personified Season on each corner of the squared circle.

The Dome of the Rock seems to have mimicked the *Kaaba* in regard to the Four Seasons. In the Dome, four-marble squares representing the Four Seasons are on the four pillars between the four sets of three pillars surrounding the Rock of *Ibrahim*. This is discussed and illustrated in the chapter on lunar temples.

### Circumambulation at the *Kaaba* and Fertility

One circumambulation around the *Kaaba* and *Hatim* Wall constituted a full lunar month. Rounding the *Hatim* Wall was like watching the moon transverse the sky during one month:

- ☉ Walking toward the crescent-shaped *Hatim* Wall would constitute a waxing crescent since the *Hatim* Wall would appear to get bigger with each step.
- ☉ Walking next to the wall would make the *Hatim* Wall appear large as though it were a full-moon.
- ☉ Walking away from the *Hatim* Wall on the way back to the Venus stone would constitute a waning crescent as the *Hatim* Wall receded from view.
- ☉ Walking on the side of the *Kaaba* opposite the *Hatim* Wall (where the crescent-shaped wall is not visible) was similar to the three-day period when the moon does not appear at the end of each lunar month.

By rounding the *Hatim* Wall, worshippers were showing that they were mindful of the menstrual cycle. Leo Dubal stated:

The moon is the matrilineal symbol *par excellence* as the full-moon provides the basic timing for the menstrual cycle.<sup>3600</sup>

Tracking the rhythm would ensure maximum fertility. That *Muhammad* was mindful of the menstrual cycle is shown by his mentions of menstruation in connection with circumambulation.

It was thought that women were not fertile, or as fertile, when they were menstruating. So it would not be acceptable for menstruating women to be kissing and touching the Venus stone for fear that the infertility would rub off on it. In fact, this is reflected in *Muslim* traditions, as Zamakhshari (died 1144 AD) wrote:

It was a white sapphire from the Garden, but when menstruating women touched it during the pre-*Islamic* period, it turned black.<sup>3601</sup>

<sup>3599</sup> Ishaq. *Sirat*, p. 28.

<sup>3600</sup> Dubal. *Riddle*.

<sup>3601</sup> Zamakhshari, *Tafsir*, 311, as quoted in Peters. *Origins*, p. 5.

This story was probably told since pre-Islamic times since it was wondered why the stone was black and not white if it represented Venus. In astrology, the color of Saturn is black and Venus is white. Zwemer wrote:

In astrology it is generally believed that Saturn resides over Saturday and his color is black; the sun presides over Sunday and his color is yellow; the moon presides over Monday and his color is green; Mars presides over Tuesday and his color is red; Mercury presides over Wednesday and his color is blue; Jupiter presides over Thursday and his color is sandal; Venus presides over Friday and her color is white.<sup>3602</sup>

That the prophet was aware of the fertility cult aspects of the Black Stone are shown by how he told his wife not to circumambulate the *Kaaba* while menstruating. Sayyid Saabiq (1915-2000 AD) wrote:

Most scholars are of the opinion that purification is not necessary for performing *Sa'i* [oval circumambulation] between *Safa* and *Marwah*, in light of what the Prophet...said to 'Aishah once when she menstruated. He told her, 'You may perform all rites (of *Hajj*) as other pilgrims do, except performing *Tawaf* [circumambulation] around the *Kaaba* which you may do after you are clean and no longer menstruating' (*Muslim*). 'Aishah and *Umm Salamah* said 'A woman who performs the *Tawaf*, offers a two *Rakah* prayer (by the Station of *Ibrahim*) and then finds that her period has started, may perform *Sa'i* between *Safa* and *Marwah*' (reported by Sa'id Bin Mansur).<sup>3603</sup>

### Circumambulation Around Mounts *Safa* and *Marwa* (The *Tawaf*)

*Muslim* tradition explains the running between Mounts *Safa* and *Marwa* thus:

Then Ishmael became very thirsty. His mother looked for water for him, but she could not find any. She listened for sounds to help her find water for him. She heard a sound at *Al Safa* and went there to look around and found nothing. Then she heard a sound from the direction of *Al Marwa*. She went there and looked around and saw nothing. Some also say that she stood on *Al Safa* praying to God for water for Ishmael and then went to *Al Marwa* to do the same.<sup>3604</sup>

Obviously, the Hagar tradition was meant to Biblicize the oval track circumambulation between Mount *Safa* and *Marwa*. The choice of Hagar as the Biblical figure, as opposed to another Bible great, helped explain why menstruating women ought to circumambulate there and not by the *Kaaba*.

*Muhammad* mentions *Safa* and *Marwa* in the *Koran*:

*Safa* and *Marwa* are among the indications of *Allah*. It is therefore no sin for him who is on pilgrimage to the House of God, or visiting it, to go round them (*K* 002:158).

Just like the *Kaaba*, the Mounts *Safa* and *Marwa* were the site of a fertility rite. This becomes clear upon reading the traditions and some background information. *Ibn Warraq* wrote:

The names of the two hills, *As-Safa* and *Al Marwa*, signify a stone, that is, an idol (Zwemer<sup>3605</sup>). Pagans ran between the two hills in order to touch and kiss

<sup>3602</sup> Zwemer. *Animism*, ch. 9.

<sup>3603</sup> *Fiqh-us-Sunnah*, vol. 5, p. 88b: "Purification for *Sa'i* between *Safa* & *Marwah*."

<sup>3604</sup> Peters. *Origins*, p. 3.

<sup>3605</sup> Zwemer. *Animism*, ch. 8.

*Isaf* and *Naila*, the idols placed there as a means of acquiring luck and good fortune.<sup>3606</sup>

Wherry wrote that *Muslim* tradition says:

*Asaf* and *Nailah*, the former the image of a man, the latter of a woman, were also two idols brought with *Hobal* [*Hubal*] from Syria, and placed the one on Mount *Safa* and the other on Mount *Marwa*. They tell us *Asaf* was the son of Amru, and *Nailah* the daughter of Sahal, both of the tribe of *Jorham*, who committing whoredom together in the *Kaaba*, were by GOD converted into stone and afterwards worshipped by the *Quraish*.<sup>3607</sup>

F. E. Peters wrote:

In the Age of Barbarism, there was on the *Safa* [Hill] an idol named *Na'ila* and on the *Marwa* [Hill] an idol named *Asaf*. They [the *Hums*] said: 'It is improper for us to make a turning (*Tawaf*) between them,' and therefore they did not make a turning between them (Muqatil, *Tafsir*, ms. 1.25b).<sup>3608</sup>

*Al Albani* wrote in his *Hajj* guide:

Then he [the pilgrim] begins with *as-Safaa*—climbing upon it until he can see the *Kaaba*....It is not easy these days to see the *Kaaba* except from certain points on *as-Safa*; it can be seen from the pillar which supports the second story of the *Mosque*, so he who is able to do so has attained the *Sunnah*, and if not then let him try his best and there is no harm.

Then he walks up to *Marwah* and ascends it and does upon it as he did upon *as-Safaa*—facing the *Qiblah* [the direction of the *Kaaba*], saying *Takbeer* [*Takbir*, i.e. *Allah Akbar*] and *Tahleel* and making *Du'aa*....As for seeing the *Kaaba*—it is not possible now because of the building between it and the *Kaaba*—so [he] should try his best to face the *Kaaba* and not do as the confused people do, who raise up their eyes and hands to the sky!<sup>3609</sup>

Since the man and women were said to have been turned into stone idols for their having copulated in the *Kaaba*, these idols undoubtedly were statuesque nudes, perhaps showing the signs of sexual arousal too. Such statues were not unheard of in the ancient world, especially when the idols were located in red light districts such as in *Pompeii*. Robert Eisler wrote about *Asaf* and *Na'ila*:

And also the legend that the two stone idols *Asaph* and *Naylâ* near the *Ka'aba* were the bodies of a pair of evil-doers, who were turned into stone, because they were found within the temple, while cohabiting...This is only another testimony that such a ceremony [*Coitus*] was celebrated at the stone-idols of the *Ka'aba*.<sup>3610</sup>

These surmises about the *Asaf* and *Na'ila* idols are strengthened by the fact that John of Damascus said that even the Black Stone still had traces of the head "of the *Semitic Venus* (Greek *Aphrodite*)."<sup>3611</sup> So if the Black Stone was once an image, *Asaf* and *Na'ila* could hardly have been a squared betyl.

<sup>3606</sup> Warraq. *Why*, p. 39.

<sup>3607</sup> Wherry. *Commentary*, vol. i, section i, pp. 42-43. Also see Ishaq. *Sirat*, p. 37, as quoted in Peters. *Hajj*, p. 19.

<sup>3608</sup> Peters. *Hajj*, p. 36.

<sup>3609</sup> *Al Albani. Rites*, in the section "Sa'ee Between *Safaa* and *Marwah*."

<sup>3610</sup> Eisler, Robert, 1909, pp. 123-124.

<sup>3611</sup> Sahas. *Heresy*, pp. 88, 137.



The fact that early *Muslims* told John of Damascus, “Abraham had sexual intercourse with Hagar on it [the Black Stone],”<sup>3612</sup> suggests that the *Asaf* and *Na’ila* idols may have been platforms for sex.

Using idols for sex platforms would be somewhat similar to Hagar giving birth on Sarah’s knees as a form of adoption—a pagan Mideast practice (Gen 30:03). Evidently, having sex on an idol, or at a Venus shrine, was supposed to increase the chances of conception and also may have been part of an orgiastic rite.

### The Mounts *Safa* and *Marwa* Circumambulation (The *Saee*)

The female statue, *Na’ila*, was positioned on the *Safa* hill that is southeast of the *Kaaba*. The side of the *Kaaba* with *Allat’s* Nipples stone (discussed above) and the Black Stone vulva would have been visible from the *Safa* hill. Thus the female sexual symbols, the female idol and the Black Stone vulva were within sight of each other.

The male nude, *Asaf*, was positioned on the hill *Marwa* right where the *Hatim* crescent wall of the *Kaaba* would have been clearly visible. Thus the male sexual symbols, the male idol and the crescent-shaped *Hatim* Wall were within sight of each other.

Just as the circumambulator at the *Kaaba* starts by the Black Stone vulva, so the pilgrim started by the vulva of the *Na’ila* nude on the *Safa* hill. While trekking to the phallic symbol on the *Marwa* hill, the pilgrim sees the crescent-shaped *Hatim* Wall gradually appear from the behind the *Kaaba* until it comes into full view.

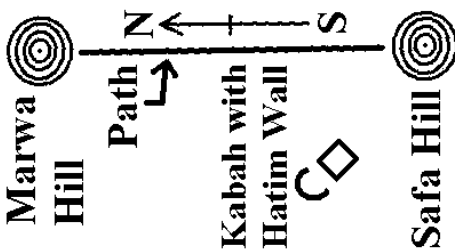
After rounding the phallic symbol on *Marwa*, the crescent *Hatim* Wall gradually disappears behind the *Kaaba*. Once back on *Marwa* hill, the worshipper sees the crescent disappear entirely behind the *Kaaba*.

The *Kaaba* was tall enough to block the view of the *Hatim* Wall from Mount *Safa*, even though the hill gave the viewer an elevated perspective. This is confirmed by *Ibn Hisham* who wrote in his notes to *Ibn Ishaq’s* biography of *Muhammad*:

The *Kaaba* at the time of the apostle was 18 cubits high.<sup>3613</sup>

The moon disappearing behind the *Kaaba* mimics how the moon does not show for about three days at the end of each lunar month. The worshipper saw the crescent-moon appear, wax, wane and disappear. This shows that one trek back and forth between *Safa* and *Marwa* hills constituted a symbolic lunar month.

The worshipper symbolically fecundates the *Na’ila* female nude on *Safa* hill with the male sexual energy collected from the *Asaf* male nude on *Marwa* hill and the crescent-shaped *Hatim* Wall—symbol of *Allah’s* sexual power. The pollinization by touching and by kissing both idols was thought to ensure virility and fertility.

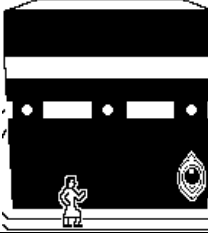


**Figure 09-03.** In Pre-Islamic times, the female nude *Na’ila* was on *Safa* Hill and the male nude *Asaf* was on *Marwa* Hill. In Islamic times, the *Sa’ee* circumambulation involved some walking and jogging between the *Safa* and *Marwa* Hills. The *Tawaf* circumambulation is around the *Kaaba* and *Hatim* crescent-shaped wall.

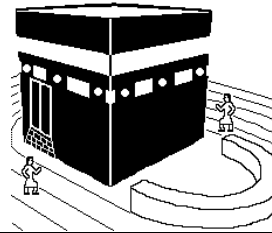
<sup>3612</sup> Sahas. *Heresy*, pp. 88-89.

<sup>3613</sup> Ishaq. *Sirat*, p. 711.

**Figure 09-04.** The *Kaaba* as seen from the SE (Mount *Safa*). From Mount *Safa* the Black Stone is visible but the C-shaped *Hatim* Wall is hidden. This is the interregnum dark conjunction phase of the moon.



**Figure 09-05.** Walkers by the *Kaaba* as seen from the NE (Mount *Marwa*).



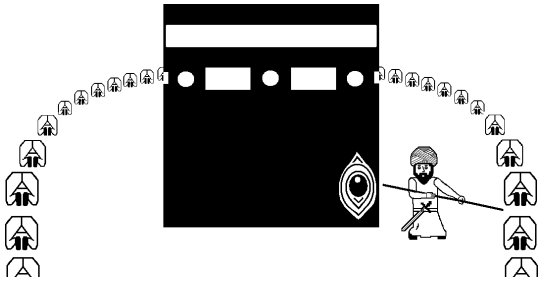
Since the C-shaped *Hatim* Wall is visible, this constitutes a waxing crescent-moon sighting.

### **Muhammad Sodomizes the 360 Idols**

The *Sufi* Martin Lings wrote:

The Prophet now turned away from the *Kaaba* toward the idols which surrounded it in a wide circle, three hundred and sixty in all. Between these and the House [the *Kaaba*] he now rode, repeating the verse of the Revelation: ‘The Truth hath come and the false hath vanished. Verily the false is ever a vanisher’ [K 017:081], and pointing at the idols one by one with his staff; and each idol as he pointed at it **fell forward on its face**.<sup>3614</sup>

Of course this was the same stick that *Muhammad* used to symbolically fecundate the Venus Black Stone in its vulviform casing. This shows that *Muhammad* symbolically sodomized the 360 idols.



**Figure 09-06.** *Muhammad* symbolically used his rod to: 1) fecundate the Black Stone vulva, and then 2) sodomize the 360 idols that ringed the *Kaaba* in honor of the sun-goddess *Allat*. Each idol stood for day in a 360-day idealized solar year: 12 months with 30 days each.

Sodomizing one’s rivals has a long history in the Mideast. Sodomizing was meant to shame and trivialize a would-be competitor and show domination over an opponent. This was a particularly effective technique in the honor-shame obsessive cultures of the Mideast. Gordon Newby wrote:

In *Ibn Ishaq*’s chronology of [pre-Islamic] *Yemen*<sup>3615</sup>...King Hassan was overthrown by *Dhu Shanatir*...His [King Hassan’s] policy for consolidation of power was either to kill the leaders of the society or to sodomize them, rendering them unfit for rule because of their shame.<sup>3616</sup>

After *Muhammad* symbolically charged up his phallic stick with *Allah*’s sexual energy at crescent-shaped *Hatim* Wall, he used it first to symbolically fecundate the vulviform Black Stone and then to symbolically sodomize the 360 images surrounding the *Kaaba*.

<sup>3614</sup> Lings. *Sources*, p. 300.

<sup>3615</sup> Ishaq. *Sirat*, pp. 13-14.

<sup>3616</sup> Newby. *Arabia*, p. 39.

This was part of *Muhammad's* anti-solar, pro-lunar cleansing of the *Kaaba*. Malise Ruthven wrote "...that there were exactly 360 idols placed round the temple also points to an astronomical significance."<sup>3617</sup>

If there had only been 354 idols, *Muhammad* could have said that the idols that ringed the *Kaaba* were angels. There are only 354 days in a lunar year (29.5 days per month times twelve months equals 354 days).

The idols had to go however since each idol represented a day in an idealized solar year—as measured by many ancients before intercalation was factored in. Intercalation made up for the difference between the 360-day calendar of the ancients and the true length of the solar year: 365.25 days. *Muhammad* eventually ended intercalation at his Farewell Pilgrimage just before his death (K 009:036).

The number 360 shows that the idols were not just garden-variety idols. They were in honor of the sun-goddess *Allat*, just as the shape of the cubic *Kaaba* was in honor of *Allat* the sun-goddess, as was discussed elsewhere.<sup>3618</sup> This arrangement reminds one of the *Babylonian* myth, *Enuma Elish*, which relates that *Marduk*, god of Jupiter, lined the skies with 300 gods who acted as guards.<sup>3619</sup>

### ***Muhammad Sodomizes Hubal***

*Muhammad* probably had some misgivings about humiliating *Hubal*. Many *Makkans* thought that the idol *Hubal* really was a statue of *Muhammad's* hero, *Ibrahim*, as is discussed elsewhere.

Ameer Ali wrote that "in the interior of the *Kaaba*" was "a statue representing Abraham with the ram beside him ready for sacrifice."<sup>3620</sup> The *Hubal* and *Ibrahim* statues probably were one and the same statue—just as the painting of *Hubal* on the wall of the *Kaaba* was misidentified as *Ibrahim*, as is discussed elsewhere.

This confusion over *Hubal* is why the *Makkans* brought *Hubal* out onto the battlefield in the first place. The *Muslims* would wonder whether this was a pagan idol, or perhaps it was a statue of the founder of the Religion of *Ibrahim*. Sowing doubt and confusion is the essence of psychological warfare.

That the *Makkans* put *Hubal* to such use meant *Muhammad* was more than glad to put aside his misgiving and then destroy *Hubal*, as Wherry wrote:

This [*Hubal*] idol is supposed to have been the same with the image of Abraham, found and destroyed by *Muhammad* in the *Kaaba* on his entering it, in the eighth year of the *Hijra*, when he took *Makkah*...<sup>3621</sup>

### ***Hubal as Baal***

#### *General*

The *Makkans* thought their collection of idols was superior to *Islam*. For instance, at the Battle of *Uhud* the *Makkans* won a battle but were in the midst of losing the overall war. As a taunt, *Ibn Ishaq* relates that *Abu Sufyan* "shouted

<sup>3617</sup> Ruthven. *World*, p. 18. The intertextual notes in brackets [ ] are gleaned from Gibb & Kramers. *Encyclopedia*, p. 198, *Kab'ah* entry.

<sup>3618</sup> Green. *Moon*, p. 71.

<sup>3619</sup> Ness. *Mosaics*, p. 44.

<sup>3620</sup> Ali. *Spirit*, p. 139.

<sup>3621</sup> Wherry. *Commentary*, vol. i, section i, p. 42.

loudly...‘Show your superiority *Hubal*,’ i.e. vindicate your religion.”<sup>3622</sup> *Al Kalbi* wrote in his *Book of the Idols* about the incident:

*Hubal* was also the same idol which *Abu Sufyan Ibn Harb* addressed when he emerged victorious after the Battle of *Uhud*, saying: ‘*Hubal*, be thou exalted’ (i.e. ‘may thy religion triumph’); to which the Prophet replied: ‘*Allah* is more exalted and more majestic.’<sup>3623</sup>

*Khairat Al Saleh* wrote:

*Hubal* was associated with the *Semitic* god *Ba’l* [*Baal*]...the gods of spring, fertility, agriculture and plenty.<sup>3624</sup>

That *Baal* gods dealt with springs is confirmed by *Tabari* (839–923 AD), who called spring-water “the *Ba’al* waters.”<sup>3625</sup> *Alfred Guillaume* notes that “*Baal’s* land” “probably” meant “land watered by underground streams” rather than by irrigation.<sup>3626</sup>

If *Hubal* was *Baal* and dealt with rain and springs, this may explain why the historian *Azraqi* (died 837) wrote that *Hubal’s* position inside the *Kaaba* was next to a dry well.<sup>3627</sup>

*Hubal*, meaning “the *Baal*,” was just a title. The scholars *Pocock* and *Dozy* believed that *Hubal* was the equivalent of “the *Baal*” (*HaBaal*), meaning “the lord.”<sup>3628</sup> A tradition seems to preserve *Hubal’s* personal name: *Ghanm*.<sup>3629</sup>

The reason that *Hubal* does not look like an Arabic word is that strong traditions say that *Hubal* was brought from Syria or Mesopotamia. *Azraqi* and other commentators relate that *Hubal* was one of the idols that *Amr Ibn Luhayy* brought back from the Fertile Crescent.<sup>3630 3631</sup>

That *Hubal* came from north of Arabia is suggested by the fact that...

Outside South Arabia, *Hubal’s* name appears just once, in a *Nabataean* inscription (*Corpus Inscript. Semit.*, vol. II: (189 or 198?); *Jaussen & Savignac, Mission Archéologique en Arabie*, vol. I (1907) pp. 169f); there *Hubal* is mentioned along with deities *Dusares* (دسارثلا وئ) and *Manutu*. On the basis of such slender evidence, it has been suggested that *Hubal* ‘may actually have been a *Nabataean* [god].’<sup>3632</sup>

The form *Hubal* need not come through Hebrew, as *Torrey* wrote:

As for the ‘Hebrew’ definite article [*Ha-*], it is also employed by those *Bedouin* tribes of South Arabia which migrated northward, as far as the upper *Euphrates*, at the beginning of the present era, scrawling their *Thamudenic* and *Safatenic* graffiti in debased *Himyarite* characters. There is no need to look for

<sup>3622</sup> *Ishaq. Sirat*, p. 386.

<sup>3623</sup> *Al Kalbi. Idols*, p. 24.

<sup>3624</sup> *Al Saeh. Fabled*, p. 28, right column, middle.

<sup>3625</sup> *Ishaq. Sirat*, p. 647.

<sup>3626</sup> *Ishaq. Sirat*, p. 647, fn. 5.

<sup>3627</sup> *Al Azraqi*, 1858, p. 73, as quoted in *Peters. Origins*, p. 127.

<sup>3628</sup> *Gibb & Kramers. Encyclopedia*, p. 140, *Hubal*.entry.

<sup>3629</sup> *Guillaume* wrote that *Hubal* “is the reading of *Al-Kalbi* [*Book of Idols*], but all [*Sirat Rasul Allah*] manuscripts have *Ghanm*, a deity unknown. Confer also *Yaq. iii. 665.8*” (*Ishaq. Sirat*, p. 100 & fn).

<sup>3630</sup> *Al Azraqi*, 1858, p. 73, as quoted in *Peters. Origins*, p. 127.

<sup>3631</sup> *Peters. Hajj*, p. 25.

<sup>3632</sup> *Rodinson, Maxime. Mohammed*, 1961, translated by *Anne Carter*, 1971, pp. 38-49, as quoted at [encyclopedia.thefreedictionary.com/Hubal](http://encyclopedia.thefreedictionary.com/Hubal), accessed 25 Apr 2004.

Hebrew influence in this grammatical feature, especially since the demonstrative element *Ha* is so pervasive in all *Semitic* speech.”<sup>3633</sup>

The common *Semitic* word *Baal*, as well as *Bel* and other variants, all mean “lord.” *Encyclopedia Britannica* states “As a *Semitic* common noun *Baal* (Hebrew *ba'al*) meant ‘owner’ or ‘lord’...”<sup>3634</sup> Hastings wrote that the title *Baal* survived in various forms such as *Ba'l* and *Al Ba'l(i)*.<sup>3635</sup>

That the title *Hubal* meant “the lord” is suggested by the following story about the acquisition of *Hubal* from Syria:

Having asked the local inhabitants [in Syria] what was the justification of their idols, `Amr b. Lullayy is said to have received the following reply: ‘These are **the lords** (*Arbab*) whom we have chosen.’<sup>3636</sup>

#### *The Likelihood of Tradition Being Right About Hubal Coming From Syria*

Someone might ask whether it was really plausible that an idol would be brought from Syria or Mesopotamia. The Mideast at the time was slowly becoming more Jewish and Christian, whose unused idols were sold off to fewer and fewer pagans, thereby creating a glut in the idol market. The pagan Demetrius was keen to this economic reality (Act 19:24-27).

The Arabs may have especially valued the Fertile Crescent idols. The thinking was that similar growing conditions could be had in Arabia if only the Arabs brought back Fertile Crescent idols to the Arabian deserts. At least that is what the *Makkan*, Lullayy, seemed to believe.<sup>3637</sup>

The Bible suggests that the pagan high deities *Baal* and *Asherah* were involved with bringing rain. When Ahab built a temple and altar for *Baal* and a pole for *Asherah*, it was then that *Yahveh* withheld the rain (1Ki 16:31-33; 17:01). When the 450 prophets of *Baal* and 400 prophets of *Asherah* were killed, then *Yahveh* sent rain (1Ki 18:42-46).

#### *Hubal is not Allah*

If *Hubal* is *Baal*, as is discussed above, than he is not *Allah*, for the *Koran* says:

Will ye call upon *Baal* and forsake the Best of Creators? [meaning *Allah*] (*Yusuf Ali K 037:125*).

*Allah* is more exalted and more majestic [than *Hubal*].<sup>3638</sup>

*Al Kalbi* wrote in his *Book of Idols* that in pre-Islamic times, a *Hanif* rejected the high god *Hubal* upon adopting monotheistic beliefs about the high god *Allah*. The *Hanif Zayd Ibn-`Amr Ibn-Nufay* said:

I have renounced both *Allat* and *Al `Uzza*,  
 For thus would the brave and the robust do.  
 No more do I worship *Al `Uzza* and her two daughters,  
 Or visit the two idols of the *Banu-Ghanm*;  
 Nor do I journey to *Hubal* and adore it,  
 Although it was our lord when I was young.<sup>3639</sup>

<sup>3633</sup> Torrey. *Foundations*, p. 20.!

<sup>3634</sup> *EB*, accessed 10 Jul 2002, *Baal* entry.

<sup>3635</sup> Hastings. “*Ethics, Arabs (Ancient)*” entry, p. 664, left column, middle.

<sup>3636</sup> Lewis. *Islam*, p. 536, *Hubal* entry.

<sup>3637</sup> Lewis. *Islam*, p. 536, *Hubal* entry.

<sup>3638</sup> *Al Kalbi. Idols*, p. 24.

<sup>3639</sup> *Al Kalbi. Idols*, p. 19.

That some, especially of the *Kinana* tribe near *Makka*,<sup>3640</sup> considered *Hubal* to be their “lord” and high god is evident from *Muhammad*’s statement:

Will ye call upon *Baal* and forsake the Best of Creators [meaning *Allah*] (*Yusuf Ali K 037:125*)?

If the polytheistic *Kinana* tribe had considered *Hubal* (“the *Baal*”) to be just a minor deity, they would have no need to “forsake” *Allah* for *Hubal*, and *Allah* would still be considered the Creator, though they might have forsaken *Allah* as high god if they considered *Hubal* a high god.

*Muhammad* said some people actually forsook *Allah* for *Baal* (*K 037:125*). Logically, this seems to indicate that *Baal*, a.k.a. *Hubal*, was a latecomer to *Makka*. This is just what early *Islamic* traditions record about *Hubal*.

It seems certain, based on the above information, that the *Baal* mentioned in *K 037:125* is indeed *Hubal*. There is no other *Baal* god prominently mentioned in the well-known traditions. Also, no other pagan high god ever competed with *Allah* for the top spot besides *Hubal*. Furthermore, the pertinent details of traditions square with the idea that *Baal* is *Hubal*. So G. R. Hawting probably is mistaken when he wrote:

*Hubal* plays a relatively prominent role in tradition but is nowhere mentioned in the *Koran*....Wellhausen (1844–1918 AD)<sup>3641</sup> suggested that *Hubal* had become identified with *Allah* and that is why *Muhammad* did not attack him in the *Koran*.<sup>3642</sup>

One can only say that *Hubal* was not mentioned in the *Koran* if one refuses to believe that *Hubal* is “the *Baal*.” Otherwise *Hubal*, a.k.a. *Baal*, is condemned in *K 037:125* (quoted above).

*Hubal* was *Allah*’s competitor. If *Hubal* and *Allah* ever seem to be one and the same god in the traditions, it is because *Hubal* was placed in *Allah*’s house, the *Kaaba*, at a late date in pre-*Islamic* times.

This god-blending promoted tribal-bonding and appealed to pagan pilgrim religious sensibilities and spiritual needs. Besides, having all the idols together in one place was practical—nearly as efficient as monotheism.

*Hubal* was the top god as far as the *Kinana* tribe was concerned.<sup>3643</sup> When the *Makkans* attacked the *Muslims* at the Battle of *Uhud*, one leader said that *Hubal* was superior to *Allah* because his army was partly populated by *Kinana* tribesmen.<sup>3644</sup>

While the *Kinana* tribesmen relied on *Hubal*, the *Makkans* relied on the goddesses *Allat* and *Uzza*, meaning “the strength,” and their battle-cry was, ‘Strength is ours, you have no strength’ (*‘izza*).<sup>3645</sup>

*Muhammad* himself seems to have been bothered by the circumstances and practices that led pagans to associate *Hubal* with *Allah*. In the *Koran* *Muhammad* repeatedly condemned calling upon *Allah* part of the time and calling upon *Allah* through his associates at other times:

When they ride in the ships they call upon *Allah*, being sincerely obedient to Him, but when He brings them safe to the land, lo! they associate others (with Him) (*K 029:065*; also *017:067*).

<sup>3640</sup> Peters. *Hajj*, p. 25.

<sup>3641</sup> Wellhausen, *Reste Arabisches Heidenthums*, p. 75.

<sup>3642</sup> Hawting. *Idolatry*, p. 112 & fn. 4.

<sup>3643</sup> Peters. *Hajj*, p. 25.

<sup>3644</sup> Ishaq. *Sirat*, p. 370.

<sup>3645</sup> Guillaume. *Islam*, p. 8.

*Hubal Was Not a Moon-god*

Some scholars figure that *Hubal* was a moon-god.<sup>3646</sup> Carl Brockelmann wrote:

Among the *Makkans* he [*Allah*] was already coming to take the place of the old moon-god *Hubal* as the lord of the *Kaaba*.<sup>3647</sup>

Glassé wrote that *Hubal* was “An idol, the god of the moon...”<sup>3648</sup> The reason however that scholars think *Hubal* was a moon-god is not because of early *Islamic* traditions, but merely because they think *Hubal* is a logical candidate for the moon-god slot at the *Kaaba*. Of course they never even consider *Allah*’s qualifications for ably filling the moon-god position (job).

Traditions say the *Kaaba* was an astral shrine. A *Semitic* moon-god usually was male. The process of elimination, scholars conclude that *Hubal* must have been a moon-god, or at least “the old moon-god” before *Allah* the moon-god came along.

Scholars who say that *Hubal* was a moon-god miss pertinent facts. *Islamic* tradition records that *Hubal* was a “newcomer” to the idols of the *Kaaba*, brought from Syria.<sup>3649</sup> A newcomer would have had to been something other than a moon-god, because that major position was surely taken in the *Kaaba*’s pantheon from ancient times.

Another point missed by scholars is that in Arabia the moon-god was the high god and *Muhammad* said that *Allah* was greater than *Hubal*.<sup>3650</sup> Thus *Allah* the moon-god is not *Hubal* since *Allah* cannot be greater than himself.

When *Abu Sufyan* “shouted loudly...‘Show your superiority *Hubal*,’ i.e. vindicate your religion,”<sup>3651</sup> *Muhammad* did not say that *Hubal* was trying to edge *Allah* out of the moon-god slot. So *Hubal* was not a new-moon-god trying to usurp *Allah* the moon-god’s top position in the *Makkan* pantheon.

*Hubal Was Jupiter*

If *Hubal* was not a moon-god, than his likely astral association is Jupiter. In Classical and late antiquity, Jupiter was the top god in the dominant Mediterranean pantheons, while the male sun-god was a contender.

When dealing with the formation of *Islam*, one must also take into consideration what the Romans and Greeks believed. The Romans’ cultural presence in the Mideast dates from well before the time of Christ and the Greeks’ cultural presence dates from Alexander the Great’s day (ruled 336–323 BC). Roman and Greek culture trickled down to *Makka* and *Yemen*.

In the Fertile Crescent, where Roman and Greek influence was strong during Classical and Late Antique times, the top god was Jupiter, while the male moon-god *Sin* was a contender. However, among the Arabs who were less influenced by Roman and Greek culture, the male moon-god was the top god, while Jupiter was only a contender.

In the mind of *Makkans*, *Hubal* was a contender for the top-god slot. The *Makkans* could have had no confidence that any god but Jupiter could take on *Allah*

<sup>3646</sup> Occhigrosso, Peter. *The Joy of Sects: A Spirited Guide to the World's Religious Traditions*, Doubleday & Company, 1996, pp. 394-397.

<sup>3647</sup> Brockelmann. *Peoples*, p. 9.

<sup>3648</sup> Glassé. *Encyclopedia*, p. 160, *Hubal*.

<sup>3649</sup> Peters. *Hajj*, p. 25.

<sup>3650</sup> *Al Kalbi. Idols*, p. 24.

<sup>3651</sup> Ishaq. *Sirat*, p. 386.

the moon-god in a pitched battle such as the Battle of *Uhud*. That is because in southern Arabia, the moon-god was also the national war-god.<sup>3652</sup> A national war god who happens to be the high moon-god too cannot be challenged by just any god. This fact suggests that the challenger *Hubal*, was Jupiter.

All around the Mediterranean and Mideast during the Classical and Late Antique periods, *Baal* always meant Jupiter, especially when the issue of top god, or contenders for the top-god slot, were being discussed.

Even among Jews the planet Jupiter was sometimes called *Baal*.<sup>3653</sup> The astral context of this Biblical passage seems to suggest that *Baal* refers to Jupiter:

He [Josiah] did away with the pagan priests appointed by the kings of Judah to burn incense on the high places of the towns of Judah and on those around Jerusalem—those who burned incense to *Baal* [Jupiter], to the sun and moon, to the constellations and to all the starry hosts (*NIV* 2Ki 23:05).

The *Encyclopedia Britannica* mentions that *Marduk*, the god of Jupiter, was known as *Bel* and *Baal*:

In Babylon “*Marduk*’s [*Bel* or *Baal*’s] star was Jupiter...*Marduk* was later known as *Bel*, a name derived from the Semitic word *Baal*, or “lord.” *Bel* had all the attributes of *Marduk* and his status and cult were much the same. *Bel* however gradually came to be thought of as the god of order and destiny. In Greek writings references to *Bel* indicate this Babylonian deity and not the Syrian god of *Palmyra* of the same name.<sup>3654</sup>

Lester Nest wrote about how the god of Jupiter, *Marduk*, was known as *Baal* in *Baalbek*, Lebanon, and in *Palmyra*, northern Syria:

Throughout much of Hellenized Syria the chief god was *Baal Shamin*, the Lord of Heaven...identified with *Zeus* [i.e. Jupiter] by Greek-speakers...*Bel-Marduk*, the chief god of Babylon, was also the chief god of *Palmyra*. In Greek inscriptions he was called *Zeus*. Probably he was originally *Bol*, the local pronunciation of *Baal*. *Bol* and *Bel* were used interchangeably in theophoric names...*Baal Shamin*, the West Semitic sky god, was also worshipped at *Palmyra*...Like *Bel*, he was called *Zeus* in bilingual inscriptions...The modern [city] name *Baalbek* is probably also the original name. Its exact etymology is uncertain, but the first syllable, *Baal*, means ‘Lord’ and probably refers to the local god later identified with *Zeus* and Jupiter.<sup>3655</sup>

Significantly, many Romans thought that any god with the title *Baal* was Jupiter, whether the locals thought of the god as being Jupiter or not. Likewise, many Greeks called any god with the title *Baal* “*Zeus*,” whether the locals thought of the god as being Jupiter or not.<sup>3656</sup> *The International Standard Bible Encyclopedia* states:

‘Jupiter’ was considered the Latin equivalent of the Greek ‘*Zeus*,’ the highest god in the developed Greek pantheon, and *Zeus* in turn, in accord with

<sup>3652</sup> Nielsen, 1912, pp. 593-594, as translated in Krause, “*Haram–Harimat*.”

<sup>3653</sup> “Names of the Planets in Ancient Times” table at *Institute for Biblical & Scientific Studies*, “Genesis 1:14-19 Day 4 Wandering Stars,” bibleandscience.com, accessed 20 Dec 2003.

<sup>3654</sup> *EB*, accessed 26 Aug 2004, *Marduk* entry.

<sup>3655</sup> Ness. *Astrology*, ch. 3.

<sup>3656</sup> Schaff, Philip (1819-1893 AD). *The New Schaff-Herzog Encyclopedia of Religious Knowledge*, vol. i: *Aachen–Basilians*, Baker Book House, Grand Rapids, Michigan, USA, 1952, online edition, *Baal* entry.



the syncretism of the period, was identified with countless deities [such as *Hubal*] in the local cults of Asia Minor and elsewhere.<sup>3657</sup>

The Romans and Greeks probably believed that *Hubal* was Jupiter since the Romans and Greeks assumed any god entitled *Baal* (Lord) represented the planetary god Jupiter. *Hubal*'s astral association may have been Jupiter from the start if he was supposed to represent *Marduk*, i.e. *Baal*, *Bel*.

*Muslim* tradition says that the *Makkan Hubal* was a celestial god that an Arab named Lullayy brought to *Makka*. Tradition indicates that the Syrians, who were heavily influenced by the Greeks and Romans, believed *Hubal* was **1) a “lord” (Arabic: *Arbab*) and 2) an astral god**, for that is what the Syrians told Lullayy:

Having asked the local inhabitants [in Syria] what was the justification of their idols, `Amr b. Lullayy is said to have received the following reply: ‘These are **[1] the lords (*Arbab*)** [*Hubal* being one of them] whom we have chosen, having [simultaneously] the form of **[2] the celestial temples [meaning a planetary orb or constellation]** (*Al Hayakil Al `ulwiyya*) and that of Human Beings. We ask them for victory over our enemies and they grant it to us; we ask them for rain in time of drought and they give it to us.<sup>3658</sup>

If *Hubal* was considered one of the “lords” (Arabic: *Arbab*), this suggests that *Hubal* means “The *Baal*,” which translates as “The lord.” Romans and Greeks who found themselves in the Mideast often referred to Jupiter and Zeus by the title *Baal*. This suggests that *Hubal* probably represented the planetary deity Jupiter.

Someone might ask how *Hubal* became associated with rain if *Hubal* really was Jupiter. Perhaps Jupiter’s lightning bolts or arrows (representing meteors) suggested rain to the *Makkans*. *Hubal* was said to have had arrows for divination but they could have also suggested rain. In fact, the accounts of *Hubal*'s arrows mention that he had several arrows, but the meaning of only a few of the arrows was known.<sup>3659</sup>

Jupiter in the ancient world was not too transcendent to handle requests for rain. One of Jupiter’s titles was *Urios*, because he presided over the Wind. The Greek version of Jupiter, was even called *Zeus the Apomuios*, meaning “the Averter of Flies.” This is similar to how *Baal* of Ekron, a town 25 miles west of Jerusalem, was called *Baal-zebub*, meaning “Lord of the Flies.”<sup>3660</sup>

### What Muslims Learned from Allah’s Prophet Sodomizing *Hubal*

*Hubal* was Allah’s competitor. *Muhammad* humiliated *Hubal* and other pagan gods by symbolically sodomizing them. Most of these gods were astral gods<sup>3661</sup> and *Hubal* was the planetary god Jupiter, as was established above. Zwemer says that...

...*Wadd* was supposed to be the heaven and was worshipped under the form of a man by the tribe of *Qalb* in *Daumat Al Jandal*.<sup>3662</sup>

As *Muhammad* made his way around the wide circle of idols around the *Kaaba*, he may have thought that this is what Allah the moon-god does every night to lesser astral deities. *Muhammad* felt he was symbolically doing what Allah the moon-god did as he made his way around the ecliptic during pre-Islamic times—sodomizing star gods, planetary gods, and even the sun-goddess *Allat*.

<sup>3657</sup> *ISBE*, “Jupiter,” entry 5183, authored by Burton Scott Easton.

<sup>3658</sup> Lewis. *Islam*, p. 536, *Hubal* entry.

<sup>3659</sup> Peters. *Hajj*, p. 25.

<sup>3660</sup> *The Catholic Encyclopedia*, 1912, NewAdvent.org, *Beelzebub*.

<sup>3661</sup> Ruthven. *World*, p. 18.

<sup>3662</sup> Wherry. *Commentary*, vol. i, section i, p. 40.

The lessons learned from the stars about domination through sodomy percolated into *Islam*, both officially and unofficially, as Stephen Murray and Will Roscoe wrote:

Some [*Muslims*] (such as *Abu Nuwas* [died 195 AH/810 AD] and the [*Madinan*] jurists of the *Maliki* school [founded by *Abu Abd Allah* (94-179 AH/716-795 AD)]) rationalized the practice of making non-believers [men and women] submit to penetration [sodomizing] by believers [*Muslims*] as a means of glorifying the superiority of *Islam*—a duty for *Muslims* rather than a sin.<sup>3663</sup>

Sodomy, bisexuality and pederasty are at least as common in *Islam* as they are in the West, and probably much more so, as was discussed in a previous chapter. One can even read in modern newspapers about *Muslims* sodomizing ethnic minorities, such as Kurds, with sticks. The same thing happened in the nineteenth century, as Richard Burton wrote in his “Terminal Essay”:

A favorite Persian punishment for strangers caught in the *Harem* or Gynaecium is to strip and throw them and expose them to the embraces of the grooms and Negro slaves. I [Richard Burton] once asked a *Shirazi* how penetration was possible if the patient resisted...he smiled and said ‘Ah, we Persians know a trick to get over that; we apply a sharpened tent-peg...’ A well-known [Christian] missionary to the East during the last generation was subjected to this gross insult by one of the Persian prince-governors, whom he had infuriated by his conversion-mania: in his memoirs he alludes to it by mentioning his ‘dishonored person;’ but English readers cannot comprehend the full significance of the confession.<sup>3664</sup>

*The New York Times* reported that recently that sodomy continues in *Islamdom*:

Only one Kurdish man was not afraid to be named...[he] has endured repeated bouts of torture and death threats. In one brutal session, he says, the commander called out, ‘Bring in the stick,’ used to rape men. ‘You can use your stick,’...[the Kurd] says he shouted back. ‘I still won’t talk even if you use a *Minaret!*’<sup>3665</sup>

Another lesson learned as a corollary to *Allah* sodomizing lesser astral deities was if *Allah* shows no respect for the persons of deities, humans deserve even less respect. So *Muslim* men can be polygynous (*K* 004:003) and have an unlimited number of concubines and sex-slaves (*K* 004:023-024; 023:005; 033:050; 070:030). Similarly, non-*Muslims* can be sodomized, enslaved and even killed with impunity.

Another corollary that flows from *Allah* sodomizing lesser astral deities is that *Allah*’s religion is not a religion based on love, nor on believers being sons and daughters of the king (Mat 17:25-27). *Islam* is one of submitting and slavery (Gal 04:22-26). As *Muslims* never tire of telling us, “*Islam*” means “submission.” Moreover, *Islam*’s heaven with endless sex and other carnal pleasures sounds like a heaven that would appeal the most to slaves.

---

<sup>3663</sup> Murray. *Culture*, p. 304.

<sup>3664</sup> Burton. *Essay*.

<sup>3665</sup> Kristof, Nicholas D. “Torture, Beyond Saddam,” *Nytimes.com*, 14 Mar 2003.

## Chapter 10: Moon-o-theistic Venus Altars

### The *Mihrab* Architectural Feature

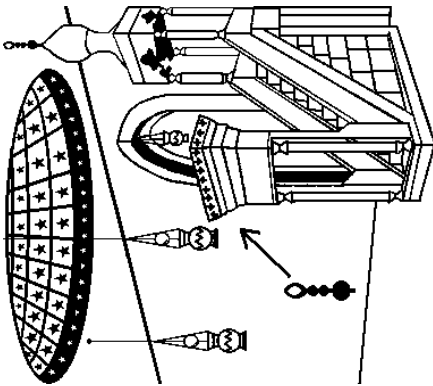
The *Mihrab* is an arched niche in a *Mosque*. The *Mihrab* marks the direction of prayer, the *Kiblah*, which is toward the Black Stone at the *Kaaba*. Frequently, a pulpit with stairs is found to the right of a *Mihrab* and a dome is located in front and above the *Mihrab*.

Creswell notes that the earliest surviving examples of *Mihrabs* with overhead domes are from the years 862-863 AD (248 AH).<sup>3666</sup> The *Mihrab*, *Minbar* and dome are so often found together that they ought to be thought of as one unit. Peters wrote about *Aksa Mosque* on the temple mount:

As in most *Mosques*, the dome is over the prayer niche signaling the direction toward *Makka*.<sup>3667</sup>

The dome most often has a crescent finial, showing that those who pray toward *Makka* are praying to the moon-god of *Makka*. Furthermore, the crescent finial found on top of the dome indicates that the *Mihrab* and *Minbar* below it are moon-god sanctuary features.

**Figure 10-01.** Typical arraignment of *Mihrab* Venus altar (behind stairs in this view) with dome in front of and above the *Mihrab*. The set of stairs is the *Minbar* pulpit with overhead canopy. Notice the stylized ring-crescent finial over the canopy (see inset and arrow).



The old-style overhead *Mosque* lamps and orbs have been replaced by electric lighting in many *Mosques*.<sup>3668</sup>

Most often the *Mosque* lamp hanging from the apex of the *Mihrab* arch, or set low in front of the *Mihrab*, has been removed, leaving nothing but ambient light to illuminate the lunette of the *Mihrab*. **Note:** Rotate book to view.

### The *Dabistan's* Analysis of the *Mihrab*

Moshan Fani wrote in *The Dabistan* (1645 AD):

In most of the ancient temples of Persia they had formed the symbol of Venus [the bulbous lamp] in the figure [arch] of a *Mihrab*, or arch, like the altar of the *Mosques*; consequently, the present [*Muslim*] *Mihrab*, or altar, is that identical symbol; which assertion is also proved by the respect paid to Friday or [in astrology] the day of Venus [i.e. *Islam's* Day of Prayer]. *Ibrahim* (Abraham), the friend of God, pursued the same conduct; that is, he rejected the idols which were not of the planetary forms; and the reverence paid by him to the Black Stone, according to ancient tradition, seems to prove that point.<sup>3669</sup>

<sup>3666</sup> Creswell. *Architecture*, p. 258.

<sup>3667</sup> Peters. *Jerusalem*, pp. 274-275, caption on picture of *Aksa Mosque*.

<sup>3668</sup> Drawings of *Mosques* with oil-burning lamps, and *Mihrabs* and *Minbars*, can be found at Rogers. *Spread*, pp. 85, 105; and Blair & Bloom. *Paradise*, p. 37, fig. 6.

<sup>3669</sup> Fani. *Dabistan*, pp. 30-31.

The *Muhammadan* doctors say that *Islamism* is connected with this planet [Venus], from which source proceeds the veneration paid by them to Friday, or the day of Venus [the *Muslim* day of prayer].<sup>3670</sup>

The great early medieval astrologer *Abu Mashar* (787-886 AD) wrote similarly about the *Islam*'s Friday Day of Prayer:

The Lord of the Day of the Gathering [Friday Day of Prayer] in the *Mosque* is Venus...<sup>3671</sup>

### Why Muslims Worship on Friday Rather Than Monday (Moon-day)

Someone might ask after reading the above *Dabistan* quote, "If *Allah* were a moon-god, then why is the *Muslim* weekly day of prayer on Friday, the day of Venus? Why is the *Muslim* Day of Prayer not on Monday, the day of the moon?"

The Friday day of worship in *Islam* is a carryover from pre-*Islamic* times. In this regard it is similar to the *Hajj* ceremonies and other pagan aspects of *Islam*. Polytheists worshipped on every day of the week in honor of that day's god say, to the Arabian sun-goddess on Sunday, to the Arabian moon-god on Monday.

*Muhammad* however had to choose one day for public worship, so he chose Friday because the Day of Venus, with its fertility and orgiastic rites, had long been a favorite day among astral worshippers everywhere. It is also interesting to note that the only deity that we know *Muhammad* ever sacrificed to was Venus.<sup>3672 3673</sup>

According to the early *Muslim* historian *Al Tabari* (839–923 AD), *Muhammad* declared that *Allah* created all the astral objects on Friday.<sup>3674</sup> This made all the astral worshippers at *Makka* happy, whether their favorite god was Venus, the sun or the moon. To convince skeptical solar worshippers to worship on Friday rather than Sunday, *Muhammad* said "The best day ever to see the sunrise is Friday."<sup>3675</sup>

### Why Venus Was So Popular

We know from the *Koran* and the Satanic Verses incident that the *Makkans* considered *Allah* the moon-god to be rather unapproachable. Therefore, the pagans made up partners, helpers and intercessors to *Allah*, Venus being one of these.

*Muhammad* complained about how when people were in a pinch, as when they were bailing water out of a boat just to stay afloat, they would call out to the top god *Allah*. However, when they were safely back onshore, they reverted back to going through "proper channels" before going directly to *Allah* about trivial matters (*K* 017:067; also 029:065).

Venus was thought to be a female. Since most of pre-*Islamic* religion was centered on a fertility cult, the day of Venus was the most important day of worship. Shrine custodians at the *Kaaba* accommodated and promoted Venus worship because they knew Venus worship sold the worship of other gods such as the war-and-moon-god *Allah*. This is similar to how advertizers today know that sex sells most commodities.

<sup>3670</sup> Fani. *Dabistan*, p. 194.

<sup>3671</sup> Ma'shar. *Astrology*, p. 38.

<sup>3672</sup> *Al Khargushi. Sharaf Al Mustafa*, as cited by Peters. *Origins*, p. 127.

<sup>3673</sup> *Al Kalbi. Idols*, pp. 16-17.

<sup>3674</sup> *Al Tabari. History*, vol. i, pp. 188, 190, 230.

<sup>3675</sup> *Al Tabari. History*, vol. i, p. 286.

### **Mihrab Venus Altars are from Pre-Islamic Times**

It is easier to show that *Mihrabs* are Venus altars if one can show that they came from Pre-Islamic times just as say, the *Hajj* is known for its pagan origins because it demonstratively originated in pre-Islamic times. The only problem with this approach is, as Carleton Coon pointed out:

*Muslims* are notoriously loath to preserve traditions of earlier paganism and like to garble what pre-Islamic history they permit to survive in anachronistic terms.<sup>3676</sup>

The subject of whether *Mihrabs* were a feature of pre-Islamic *Mosques* is taken up in the chapter on *Mosques*.

### **Mihrabs Were In Fact Venus Altars**

That the *Mihrab* is a Venus altar, as *The Dabistan* pointed out, is confirmed by the *Mihrab*'s outdoor substitute, the prophet's *Sutra* pole. Zwemer wrote:

The *Mihrab* in a *Mosque*...takes the place of the *Sutra* [i.e. prophet's staff or spear] outside of a *Mosque* and serves the same purpose.<sup>3677</sup>

The etymology seems to support the just-mentioned view. Gibb and Kramers wrote:

*Mihrab* has been derived from [the Arabic] *Harba* [meaning] 'spear' and from South Arabic *Mikrab*, Ethiopian *Mekrab* [meaning] 'temple,' but the etymology is not certain...<sup>3678</sup>

*Muhammad*'s *Sutra* pole was really an *Asherah* (Hebrew plural: *Asherim*) pole. During Old Testament times, *Asherah* poles were used in conjunction with sacred stones similar to the Black Stone at the *Kaaba* (Exo 34:13; Deu 07:05; 12:03; 1Ki 14:23; 2Ki 17:10; 18:04; 23:14; 2Ch 14:03; 31:01).

*Asherah* poles were used in connection with the worship of the sun, moon, stars and constellations and also temple prostitution (2Ki 23:05-07). The *Encyclopedia Britannica* states:

...*Asherim* (upright wooden poles symbolizing the female deities).<sup>3679</sup>

### **Why Poles Represented Venus**

Someone might ask "Why would a pole ever represent a female deity?" It was not that female fertility deities were thought to be as thin as a pole. The pole represented how male shrine prostitutes attended the shrines of female deities (Exo 34:13, 15; 1Ki 14:23-24; 15:12-13; 2Ki 23:06-07).

In the ancient world, houses of prostitution (brothels) often advertized with a phallic sign. Examples can be readily found in *Pompeii*. *The Larousse Encyclopedia of Mythology* says about *Ishtar* (Venus) that she aimed to please men, mostly:

Sacred prostitution formed a part of her cult and when she descended to earth, she was accompanied by 'courtesans, harlots and strumpets [i.e. high-, middle- and low-class prostitutes].<sup>3680</sup>

Hence, the male phallic symbol became a symbol of Venus.

Most often the symbol was exaggerated but sometimes to a great degree, as Trimmingham notes:

<sup>3676</sup> Coon. *Southern*, p. 398.

<sup>3677</sup> Zwemer. *Animism*, ch. 3.

<sup>3678</sup> Gibb & Kramers. *Encyclopedia*, p. 343, *Masjid* entry.

<sup>3679</sup> *EB*, accessed 3 Nov 2002, "High Place" entry.

<sup>3680</sup> *Larousse*, *Ishtar* entry, p. 57, left column.

Lucian of *Samosata* [~117 to ~180 AD] writes (*De Dea Syria*) of a rite in honor of the goddess *Atargaris* at *Hierapolis* in Syria in which the celebrant spends a week at the top of a 170-foot-high stone phallus. ‘The crowd is convinced that the man in this lofty place speaks to the gods, asks them to grant prosperity to the whole of Syria, and that the gods are in a position to hear his request more clearly.’<sup>3681</sup>

The phallus, then, was meant to catch the attention of the gods and direct the attention to the worshipper.

Male shrine prostitution was connected to Venus worship in the Holy Land right up to the time of Constantine (311 AD and afterward). Trimingham wrote:

It is revealing that the birthplace of Jesus in Judean Bethlehem was discovered in a cave in the still functioning sacred grove of *Adonis* [in Greek mythology, a strikingly beautiful youth loved by *Aphrodite*-Venus]. The site chosen on which to build the Church of the Resurrection had on it a temple to Venus (Eusebius, *Vit. Constant.*, iii. 26).<sup>3682</sup>

That the site of the Church of the Nativity formerly was a prostitute shrine is ironic considering how:

Palestinian terrorists, holed up in the Bethlehem Church in spring 2002, defiled one of the holiest sites in Christianity. They had sex there, leaving used condoms strewn about the Church.<sup>3683</sup>

In *Ephesus* a meteorite was considered an image of the moon-goddess *Artemis* (Act 19:35). Some translations have “image” (*KJV*) or “sacred stone” (*RSV*) but the literal Greek is “fallen from *Zeus*,” meaning that the object was a meteorite.

Therefore, sacred stones, sometimes meteorites, were frequently associated with female deities. A stone or wood phallic symbol would naturally complement a stone already associated with a female deity. Perhaps the phallic symbol was made to protrude from the stone, as the *Encyclopedia Britannica* describes:

The *Yoni*, which is the symbol of the female sexual organ...often forms the base of the erect *Linga* [phallic symbol]; the two together are a reminder to the devotee that the male and female principles are forever inseparable and that together they represent the totality of all existence.<sup>3684</sup>

The *Lingam-Yoni* combination symbol is also found in Egypt in the form of an *Ankh*, the ancient Egyptian symbol of life—a circle attached to a handle. The *Copts* likened the *Ankh* to a *Tau*-formed cross with a loop on top representing the head of Jesus on the cross. *Muhammad* however likely recognized the *Ankh* for what it was—a phallic-vulviform combination fertility rite symbol representing “life.”

### **Muhammad’s Phallic-vulviform Symbols**

The vulviform silver frame that wraps the Black Stone is rather like the top loop of an *Ankh* vulva. Therefore, in the incident mentioned earlier where *Muhammad* put his staff up to the Black Stone seven times, he created a *Lingam-Yoni* symbol like an *Ankh*.



**Figure 10-02.** Ancient Egyptian *Ankh* phallic-vulviform symbol of life. **Note:** Rotate book to view figure upright.

<sup>3681</sup> Trimingham. *Arabs*, p. 234, fn. 53.

<sup>3682</sup> Trimingham. *Arabs*, p. 239 & fn. 68.

<sup>3683</sup> Schlüssel, Debbie. “Sex & The *Islamic* Terrorist,” *debbieschlussel.com*, 31 Jan 2005.

<sup>3684</sup> *EB*, accessed 3 Apr 2003, *Linga* entry.

Evidently, *Muhammad* carried his *Sutra* pole as a walking stick everywhere, as numerous *Hadith* attest. Zwemer wrote:

Margoliouth tells of a late convert to *Islam* in *Mohammed's* day 'who remembered seeing him on a high place at *Taif* leaning like a *Kahin* [a *Bedouin* witch-doctor] on a staff or bow and reciting *Suras*.<sup>3685</sup>

While *Muhammad* had a prophet's staff and sword that served as phallic symbols, he also used a spear and *Sutra* pole as *Asherah* poles that were stuck into the ground and prayed toward. This is well attested in the *Hadith*, such as:

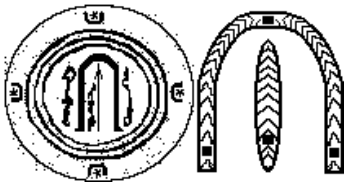
Narrated *Ibn Umar*: On the day of '*Id-ul-Fitr* and '*Id-ul-Adha* a spear used to be planted in front of the Prophet (as a *Sutra* for the prayer) and then he would pray (*Sahih Bukhari*, vol. 2, bk. 15, no. 89),

*Ibn Umar* reported: When the Messenger of *Allah*...went out on the '*Id* day, he ordered to carry a spear, and it was fixed in front of him and he said prayer towards its (direction), and the people were behind him. And he did it in the journey, and that is the reason why the *Amirs* [rulers] carried it (*Sahih Muslim*, bk. 004, no. 1010),

Narrated *Ibn 'Umar*: Whenever *Allah's* Apostle came out on '*Id* day, he used to order that a *Harba* (a short spear) to be planted in front of him (as a *Sutra* for his prayer) and then he used to pray facing it with the people behind him and used to do the same while on a journey. After the Prophet, this practice was adopted by the *Muslim* rulers... (*Sahih Bukhari*, vol. 1, bk. 9, no. 473).

The last two *Hadith* say that rulers, in imitation of *Muhammad*, used a spear as a substitute for a *Mihrab* when outdoors to mark the *Kiblah* for prayer. The association between the Prophet's spear and the *Mihrab* is pictured on an early type of *Islamic Mihrab* coin:

Experimental types produced during *Abd Al Malik's Caliphate* included the portrait of a Standing *Caliph*—which may have represented *Abd Al Malik* himself—and the '*anazah*, or Prophet's spear, in a *Mihrab*.<sup>3686</sup>



**Figure 10-03.** *Mihrab*-and-spear and C motifs pictured on an *Umayyad Mihrab* coin dated 695-698 AD (left)<sup>3687</sup> and a *Mihrab*-and-spear motif (right) found on an *Ayyubid Citadel's* iron gate, dated 1209-1210 AD, where *Saladin's* brother *Al-Adil Saphadin* ruled.<sup>3688</sup>

<sup>3685</sup> Zwemer. *Heirs*, ch. 3, p. 25.

<sup>3686</sup> Bacharach, Jere L. "Thoughts About Pennies and Other Monies," *Middle East Studies Association Bulletin*, Summer 2001.

<sup>3687</sup> ANS, "*Mihrab*" Coin ANS 1944.100.612, dated 695/698 AD, Arab-Sassanian, *Umayyad* dynasty. The crescent and star motif is found on the four compass points. The reverse middle says, "*Nasara/Caliphate/Allah*" next to the *Mihrab*. *Nasara*, meaning "protector," may refer to the *Sutra* spear, since *Sutra* can mean "protection." The "*Mihrab*" coin is found in publications: BMC Arab-Sas ANS.5; IC.4.3 & c; D. & J. Sourdel, *La civ. de l'Islam classique*, fig. 21 (reverse only), ANS, accessed 18 Mar 2003.

<sup>3688</sup> Caption: "The nails for a rectangular grid are filled with horseshoe- [rather, a *Mihrab*] or lance-like [i.e. spear] motifs and inscriptions in the name of [artisan and architect] *Al-Zahir Ghazi* (1209-1210 AD)" (Rogers. *Spread*, pp. 46-47). The picture shows part of the solid iron gate a grid of four vertical bars and three rows of spacers bolted to the door forming twelve frames. Each frame has an instance of the spear-and-*Mihrab* motif.

The spear-and-*Mihrab* coin has Arabic wording mentioning *Allah* and the *Caliphate*, but has four star-and-crescent symbols commonly found on Arab-*Sassanian* coinage.

The religious icon, the spear-and-*Mihrab*, was associated with the *Caliphate* because the *Caliphate* was a theocracy. Another reason for the association was at the front of the *Mosque* in front of the *Mihrab* where there was a space called the *Maksura*, which was partitioned off by a low wall or even a screen. Some *Mihrab* niches served as *Maksura* where rulers or *Imams* could sit.<sup>3689</sup>

Early *Islamic* rulers lead congregations of *Muslims* in *Mosques* and occasionally gave sermons. Therefore, whether an early *Islamic* ruler was indoors or outdoors, he led the *Muslim* congregation in worship, either by a *Mihrab* or spear stuck in the ground.

The spear-and-*Mihrab* symbolism may have been in vogue for several *Islamic* centuries. An iron gate at the citadel of *Aleppo* with *Ayyubid Al Zahir Ghazi* (1209-1210 AD) has a *Mihrab*-and-spear motif similar to that found on an early *Islamic* coin.

The spear in the *Mihrab* represents a *Sutra* pole. Why a *Sutra* pole would be on a citadel's gate is explained by the *Sutra* pole's purpose—to keep evil out. Gibb and Kramers wrote:

*Sutra*, [meaning] covering, protection, shelter, especially at the *Salat* [prostrations] where *Sutra* means the object which the worshipper places in front of him or lays in the direction of the *Kiblah* whereby he shuts himself off in an imaginary area within which he is not disturbed by human or demoniacal influences. “The *Sutra*, seems to have had among other objects [i.e. purposes] that of warding off demons” (Wellhausen, *Reste*, p. 158). In one tradition the man who deliberately penetrates into this imaginary area is actually called a *Shaitan* [Arabic for “demon”] (*Bukhari*, [vol. 1, bk. 9, no. 488]...) <sup>3690</sup>

### The *Sutra* Pole is an *Asherah* Pole

The *Mihrab*-and-spear motif, as well as a number of *Hadith*, shows that:

- ☉ *Muhammad's Sutra* pole was an *Asherah* pole.
- ☉ The *Mihrab* was indeed a Venus altar.
- ☉ The indoor *Mihrab* and outdoor *Sutra* pole had equivalent functions.

The size and shape of *Sutra* poles show that they are *Asherah* phallic poles. Gibb and Kramers quote a jurist as saying that a *Sutra* pole could be a “stick...about an arm's length in size...”<sup>3691</sup> Thomas Patrick Hughes, referring to the *Mishkat*, relates that a *Sutra* pole...

...may be a stick or anything a cubit in height [17 to 22 inches/43 to 56 centimeters] and an inch [2.54 centimeters] in thickness.<sup>3692</sup>

Many contemporary *Muslims* do not use the kind of *Sutra* pole that the just-mentioned jurists prescribe. Instead, many *Muslims* use a pillar or wall or even rosary-type beads as a *Sutra*.<sup>3693</sup> These latter *Muslims* are more orthodox than it may

<sup>3689</sup> Rogers. *Spread*, p. 90.

<sup>3690</sup> Gibb & Kramers. *Encyclopedia*, p. 555, *Sutra* entry.

<sup>3691</sup> *Abu Ishak Al-Shirazi*, ed. Juynboil, p. 29, as quoted by Gibb & Kramers. *Encyclopedia*, p. 555, *Sutra* entry.

<sup>3692</sup> *Mishkat*, bk. IV, ch. X, as referred to in Hughes. *Dictionary*, p. 623, *Sutra* entry.

<sup>3693</sup> Glassé. *Encyclopedia*, p. 382, *Sutra* entry.



appear because most prayer rugs have a *Mihrab* pattern with two pillars and an arch woven into the rug.

Woven prayer rugs often depict a *Mihrab* with a hanging *Mosque* lamp or an arch with a hanging planter. Some prayer rugs have a more artistic *Mihrab*—an arched window with a plant vase on the sill woven into the rug. These styles are more or less inspired by the “Light Verse” (*K* 024:035).

Someone might ask “What was the thinking behind using *Sutra* poles for prayer?” As was discussed earlier in this chapter, an *Asherah* pole was actually a phallic symbol, despite the feminine name *Asherah*.

The ancients figured that an erect phallic symbol would not fail to catch the attention of gods and goddesses as they scanned the earth from their heavenly perches. The reason is that the phallus was the sign of fertility cult temples and shrines and brothels. It was hoped that the gods would then see the worshipper near the phallic symbol.

Phallic worship and cult prostitution are clear cases of sympathetic magic. The belief—still common in *Voodoo*—was that the gods would see a small human action and would respond with a large one. Phallic worship suggested that the gods make the land fertile through rain and other means.

Since fertile land was always a concern of the ancients in their agricultural societies, they would most often pray beside or in front of a phallic symbol—just as *Muhammad* with his *Sutra* pole when he was outdoors.

One could say that the phallic worshipper was a fisherman, the phallic post was a fisherman’s pole and the deities were the fish. A worshipper with a *Sutra* pole does not want any distractions just as a fisherman does not want the fish to be scared away. It is not surprising, therefore, that Samuel Zwemer tells his readers:

A curious tradition is given by *Abu Dawud* [bk. 2, no. 0704], on the authority of *Ibn Abbas*, who said ‘I think the Apostle of God said ‘If one of you prays without a *Sutra* (a thing set up by a praying person) before him, his prayer is apt to be annulled by a dog or an ass or a pig or a Jew or a *Magi* or a menstruating woman; if they pass before him [a *Muslim* praying] they ought to be punished on that account; with the pelting of stones.’”<sup>3694</sup>

The use of phallic symbols to gain the attention of the gods was quite common in the Mideast. Trimmingham wrote (as quoted above):

Lucian of *Samosata* [~117 to ~180 AD] writes (*De Dea Syria*) of a rite in honor of the goddess *Atargaris* at *Hierapolis* in Syria in which the celebrant spends a week at the top of a 170-foot-high stone phallus. ‘The crowd is convinced that the man, in this lofty place, speaks to the gods, asks them to grant prosperity to the whole of Syria, and that the gods are in a position to hear his request more clearly.’<sup>3695</sup>

In India, a phallic symbol, similar to *Muhammad*’s prayer *Sutra* pole, was called a *Siva-Lingam*. The name is derived from the fact that the *Lingam* was used to call upon Lord *Shiva*, one of the three principal gods of the *Hindu* triad along with *Brahma* and *Vishnu*. Moshan Fani records:

In the house of Pertabmal [a *Hindu*] was an idol which the *Hindus* worshiped. A mouse having made a hole in his furniture, he put the whole idol, instead of a lump of earth, into the mouse-hole, in order to shut the passage. The

<sup>3694</sup> Zwemer. *Animism*, ch. 3 + fn 15: “Ad-Damiri’s *Hayat Al-Hayawan*, 3, v. i, p. 708.”

<sup>3695</sup> Trimmingham. *Arabs*, p. 234, fn. 53.

*Hindus* said ‘What are thou about?’ He answered, ‘The deity who cannot obstruct the road of a mouse and settle anything with a mouse, how will he protect me and preserve me from the tyranny of the *Mussulmans* [*Muslims*]?’ In like manner Pertabmal had in his house a *Siva-Lingam*, which is a post of stone which the *Hindus* venerate; having carried this *Lingam* out of his house, like a post, he tied a dog to it.<sup>3696</sup>

### The *Kaaba* as a *Mihrab* Venus Altar

Someone might wonder why *Muslims* aim their Venus-altar *Mihrabs* at the Black Stone of the *Kaaba* and then pray toward the *Kaaba*. The reason is the *Kaaba*, especially the Black Stone feature, is a Venus altar.

In a section earlier in this Moon-o-theism book that critiqued the Revisionist view on the sun- and moon-gods in Southern Arabia (see the ToC), there is an illustration of a *Sabean* moon-temple that had Venus altars halfway up the wall every few paces. The *Sabeans* no doubt prayed toward these altars or in their general direction when the temple was out of sight.

The *Kaaba* has always been associated with *Mihrabs*. The pre-Islamic Mosque by the *Kaaba* probably had a Venus-altar *Mihrab* made of pillars and marble. The vulviform Black Stone itself was a Venus-altar *Mihrab*.

During medieval times there were *Mihrabs* and *Minbars* around the *Kaaba*—a set for each of the several major schools of *Islam*.<sup>3697</sup> Drawings from the sixteenth to nineteenth centuries show several *Minbars* and *Mihrabs* around the *Kaaba*.<sup>3698</sup>

The Dome of the Rock was meant to mimic the *Kaaba* in many ways. Therefore, it is no surprise that there are several *Minbars* and *Mihrabs* in the courtyard around the Dome of the Rock.

Ishmael’s tomb marker in the *Hijr* area of the *Kaaba* was a *Mihrab*-shaped slab, as *Ibn Jubayr* wrote in 1183 AD:

Underneath the waterspout and in the court of the *Hijr* near to the wall of the blessed House is the tomb of *Isma’il* [Ishmael]...Its mark is a slab of green marble, almost oblong and in the form of a *Mihrab*.<sup>3699</sup>

There was also an embossed or inlaid *Mihrab* in the marble of the *Kaaba* facing the *Hijr* area underneath the waterspout, as *Ibn Jubayr* wrote in 1183 AD:

This place, I mean the surroundings of the wall [of the *Kaaba*, under the *Mizab*], is all tessellated marble, wonderfully joined [lacuna in manuscript] with bands of gilded copper worked into its surface like a chessboard, being interlaced with each other and with shapes of *Mihrabs*. When the sun strikes them, such light and brightness shine from them that the beholder conceives them to be gold, dazzling the eyes with their rays. The height of the marble wall of this *Hijr* is five and a half spans [50 inches/126 centimeters] and its width four and a half [spans] [41 inches/103 centimeters].<sup>3700</sup>

### How the *Kaaba* is a Horizontal *Mihrab* Venus Altar

<sup>3696</sup> Fani. *Dabistan*, pp. 232-233.

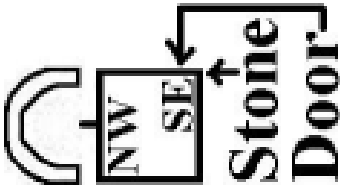
<sup>3697</sup> Jubayr. *Travels*.

<sup>3698</sup> Blair & Bloom. *Paradise*, pp. 75-76, fig. 9b, 10a+b.

<sup>3699</sup> Jubayr. *Travels*.

<sup>3700</sup> Jubayr. *Travels*.

Here is how the *Kaaba* is a horizontal *Mihrab*: The *Hatim* Wall represents the arch, the *Hijr* area between the *Hatim* Wall and the *Kaaba* is the lunette. The golden roof waterspout (*Mizab*) that empties into the *Hijr* area represents Venus planetary orb, or one could say a *Mosque* lamp. The *Kaaba*'s cubic walls represents the recessed niche surrounded by pillars as illustrated below.



**Figure 10-04.** Overhead view of the *Kaaba*. The golden waterspout (*Mizab*) points northwest toward the middle of the crescent-shaped *Hatim* Wall. The *Kaaba*'s door is on the right side toward the southeast corner where the Black Stone is located.

Interestingly, Sinasi Gunduz wrote that *Al Biruni* stated that *Haran* “was attributed to the moon” and was “built in the shape of the moon.”<sup>3701</sup> *Haran* being built in the shape of the moon supports the idea that the *Kaaba* at *Makka* was a horizontal *Mihrab*.

Since the invention of the airplane and space satellites, scientists have discovered many landscape monuments to the sky and astral gods that previously were undetected.

In the New World the AmerIndians made many totemic mounds in the form of undulating serpents and other animals. Other landscape monuments looked like giant airplane runways from overhead. Some such monuments may have mimicked constellations.

Stonehenge may have served a similar purpose as the *Kaaba* at *Makka* and Stonehenge's orientation happens to be horizontal too. *Makka* was a horizontal Venus altar meant to connect the earth and its inhabitants with the maleness of the moon for fertility purposes. The science editor Robin McKie wrote:

‘Evidence that the monument was dominated by ideas about creation and regeneration has been overlooked until now,’ says Perks.

Take the inner circle, which consists of pairs of massive capped rock pillars, one of which is rough and the other carefully smoothed. ‘To a biologist, the smooth and rougher stones arranged in pairs, united by heavy lintels, suggest that male and female, father and mother, joined together,’ he states.

‘Even more convincing,’ says Perks, ‘is the similarity between Stonehenge seen from above and the anatomy of the female sexual organ [vulva].’ His article includes a map of the former, which is compared, point-by-point, with a detailed diagram of the latter. Of these features, the most important concern the central empty area that is enclosed by the monument's inner circle of giant bluestones.

‘This central area is empty because it represents the opening to the world, the birth canal,’ says Perks. ‘Stonehenge was therefore constructed to honour the Earth Mother for ‘giving both life and livelihood.’

As to Stonehenge's alignment with various astronomical events such as the rising of mid-winter and mid-summer sun—discovered by astronomers many years ago—‘these fit with notions of an Earth Mother partnered with a sun Father,’ says Perks. Stonehenge celebrated their association, a place where

<sup>3701</sup> *Al Biruni, Abu Al Rayhan Muhammad Ibn Ahmad. The Chronology of Ancient Nations. C.E. Sachau (trans. and editor), London, 1879, pp. 187-188, as quoted in Gunduz. Life, pp. 42, 200-201.*

people celebrated the sun's closest approach to Earth in summer, while in winter they prayed for the pair to reunite.<sup>3702</sup>

*CNN*'s article on Stonehenge states:

Viewed from above, Perks suggests Stonehenge's inner bluestone circle represents the *labia minora* and the giant outer *sarsen* stone circle is the *labia majora*. The altar stone is the *clitoris* and the open center is the birth canal.

'Could the outer avenue of Stonehenge...represent the way by which new life entered?' the article wondered, adding that when comparing 'the layout of the henge [an enclosed, bounded space] with the anatomy of the human vulva. There is a distinct similarity'....

Perks said the ancient sacrificed child found at nearby Woodhenge bolsters his theory and said an excavation at Stonehenge could produce a similar find. 'In ancient societies, ideas of a dominant creator, a Mother or Earth Goddess, were widespread,' Perks wrote. 'If ideas of Earth Mother originated with, or were shared by, the people of the henge, Stonehenge could represent, symbolically, the opening by which Earth Mother gave birth to the plants and animals on which the ancient people so depended. The henge would honor her for giving them both life and livelihood.'<sup>3703</sup>

### The Dome of the Rock As a *Mihrab* Venus Altar

How the *Kaaba* was itself a Venus altar, and had a few Venus altars in its courtyard, was discussed above. Similarly, the Dome of the Rock has Venus altars in its courtyard, has its own built-in Venus altar, and has *Mihrab* Venus altars in various locations inside: two *Mihrabs* in the grotto cave and at least a dozen at ground level.<sup>3704</sup>

The illustration below shows on the left bottom a Venus altar *Mihrab* in the north entrance of the Dome of the Rock. The *Kiblah* passes over the crescent-shaped Rock of *Ibrahim*, goes through a *Mihrab*-like arch that has a squared crescent-and-orb symbol in the left and right spandrels. The *Kiblah* then passes through the *Mihrab*-like arched south entrance of the Dome of the Rock. The doorway-type of Venus altar has been used in the Mideast back to *Sumerian* times.<sup>3705</sup>

The *Kiblah* continues from the Dome of the Rock to the *Makkan Kaaba*, which is seen in the mind's eye of the worshipper. Finally, at the *Kaaba* the *Kiblah* passes over the crescent-shaped *Hatim* wall, through the *Kaaba* itself and on to the Venus Black Stone (as illustrated below).

How the Dome of the Rock is a moon-god temple is described in a later chapter, but it should be noted that the features described above have antecedents in ancient astral temples.

On the right top of the illustration (below) is a limestone slab from an altar in the *Sin* moon-god temple in the *Hadramawt* in *Yemen*. The center of this slab shows a

<sup>3702</sup> McKie, Robin. "The vagina monoliths: Stonehenge was ancient sex symbol," [observer.guardian.co.uk](http://observer.guardian.co.uk), 6 Jul 2003.

<sup>3703</sup> Stenger, Richard. "Stonehenge riddle 'solved.' It's a girl," *CNN*, 10 Jul 2003.

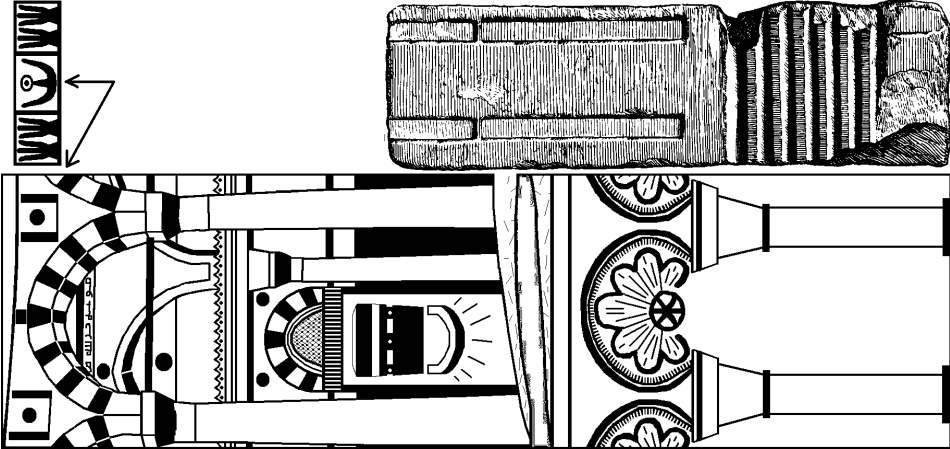
<sup>3704</sup> Nuseibeh & Grabar. *Dome*, pp. 64-65 show twelve *Mihrabs*: one in the south wall, one five feet high by the railing next to the rock, seven short *Mihrabs* in the north entrance, and three in the south east pier in the arcade. Some of these are pictured on pp. 69, 112, 116, 141. The grotto *Mihrabs* are seen on pp. 135 and 140.

<sup>3705</sup> Goldman. *Portal* (entire book).

crescent-and-orb and on either side is a stylized bull's head with three horns to represent a crescent-and-orb—the bull being a moon-god animal.

At the bottom right is a stylized Venus altar carved into a pillar that was found next to the altar described just above. Venus altars in the shape of pillars and steles are sometimes thought to be betyls but really represent a doorway—a prayer portal.

The simple doorway altars were sometimes embellished with inverted crescent-and-orb symbols. In Carthage for instance, some pillars from the same era and area have doors and some have inverted-crescent-and-orb symbols where the lintel or arch would be located.<sup>3706</sup> In larger versions of Venus altars, arches took the place of the crescent symbols—as in *Mosque Mihrabs* or the arches at the Dome of the Rock.



**Figure 10-05.** Comparison of Dome of the Rock and *Sin* moon-god temple Venus altars (see discussion above).<sup>3707</sup> **Note:** Rotate book to view figure upright.

Someone might suggest that the *Mihrabs* and the squared crescent are not original to the Dome of the Rock but were added during the Ottoman period. This seems unlikely for several reasons. First, Michael Rogers wrote that some of the *Mihrabs* might date to the origin of the Dome of the Rock:

Yet a small marble *Mihrab* was placed underneath the Dome of the Rock, very probably when it was built (691-692 AD).<sup>3708</sup>

The marble and the mosaics are nearly all original in the Dome of the Rock, except for repairs. This is known because the *Al Aqsa Mosque* and the *Great Mosque* at Damascus were built around the same time, and the same materials, techniques and designs are used in all three places.<sup>3709</sup>

The most precious marble at the Dome of the Rock, the veined and colored marble sawn so that it forms mirror-image panels, is still intact even though most of it is at eye-level. Thus the monochrome marble forming the squared crescents above

<sup>3706</sup> Punic funeral steles from 4<sup>th</sup> Century B.C. at *Tophet* near Carthage (Khader, Aicha Ben Abed Ben & David Soren. *Carthage: A Mosaic of Ancient Tunisia*. W.W. Norton & Co Inc., 1987, p. 151, photos 14+15.

<sup>3707</sup> The right half of the illustration is adapted from Grabar. *Shape*, p. 75, figure 26, and Nuseibeh & Grabar. *Dome*, pp. 57, 64-65. The left half is from Thompson. *Moon*, Venus altar: pp. 50-51, plate xxi; altar with crescent: p. 55, plates Lxviii, Lxiii.

<sup>3708</sup> Rogers. *Spread*, p. 84, left column.

<sup>3709</sup> Grabar. *Shape*, pp. 152-155.

the Rock of *Ibrahim* surely is the original marble since it has lesser street value than the quartered marble. Oleg Grabar wrote:

Quartered marble paneling inside the Dome of the Rock dates from the original *Umayyad* construction in the seventh century. Similar designs appear in the Great *Mosque* in Damascus (715 C.E.), built by the son of ‘Abd *Al-Malik*, patron of the Dome of the Rock.<sup>3710</sup>

### ***Muhammad* Thought That the *Kaaba* and Jerusalem Temples Were *Mihrabs***

There are several facts that suggest that *Muhammad* knew the *Kaaba* was a horizontal *Mihrab* to the heavens. *Muhammad* prayed on the side opposite the *Hatim* Wall.<sup>3711</sup> This is the side where one would pray if the *Kaaba* and *Hatim* Wall were stood on end as a vertical *Mihrab*.

*Muhammad* thought that the Biblical temple in Jerusalem had been built like a *Mihrab* and he describes it just as though it had been a *Kaaba*. *Muhammad* thought the Jerusalem Temple and the *Kaaba* were similar. This shows that *Muhammad* thought the *Kaaba* was a *Mihrab*.

Of course the Jewish temple had been destroyed centuries before *Muhammad*'s time and *Muhammad* never visited Jerusalem, so *Muhammad* did not know any better. Joseph Kenny wrote:

Zachariah won and kept her [the Virgin Mary] in a *Mihrab* [K 003:037, 039], which was a room in the Temple accessible only by a high door reached with a ladder, like the *Kaaba* in *Makka*. Zachariah kept the door locked and only opened it to bring her food and drink. Whenever he came he found out-of-season fruits brought to her by God.<sup>3712</sup>

Amikam Elad wrote:

Both the *Mihrab* of *Maryum* [Mary] and that of *Zakariyya* [Zechariah] were, according to *Islamic* tradition, on the *Haram* [sacred area]; the *Mihrab* of *Maryum* was interpreted as a room, an upper cell; and the *Mihrab* of *Zakariyya* was interpreted as a place of prayer in (the forward portion of) the *Mosque*, or beside the altar.<sup>3713</sup>

*Muhammad* also said that David slept in a *Mihrab*, often translated “an upper chamber” (K 038:020-021).<sup>3714</sup> Over the centuries the *Mihrab Dawud* has been located in several places in Jerusalem: in David's Citadel, in *Al-Aksa Mosque*, within the Dome of the Rock shrine and in its courtyard.<sup>3715</sup>

Perhaps *Muhammad* had heard that Samuel slept next to the Ark of the Covenant in the temple (1Sa 03:03) and assumed Mary and David did too. *Muhammad* said some litigants who wanted a judicial hearing scaled a wall in order to sneak into where David slept.

In most *Koran* translations the word *Mihrab* is not to be found anywhere since the word *Mihrab* has been translated as “sanctuary.” Nevertheless, the fact that *Muhammad* thought the Jerusalem temple was a *Mihrab* similar in construction to the

<sup>3710</sup> Nuseibeh & Grabar. *Dome*, p. 53.

<sup>3711</sup> Ishaq. *Sirat*, pp. 157-158.

<sup>3712</sup> Kenny (O. P.), Joseph. *Christian-Islamic Forum: Jesus and Mary in Islam: A Christian Look*. Dominican Publications, Lagos, 1997, christianIslamicforum.org/jesus\_and\_mary.htm.

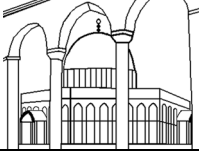
<sup>3713</sup> Elad. *Jerusalem*, p. 119.

<sup>3714</sup> Elad. *Jerusalem*, p. 131.

<sup>3715</sup> Elad. *Jerusalem*, pp. xxii-xxiii.

*Kaaba* temple suggests that *Muhammad* thought of the *Kaaba* as a horizontal *Mihrab*.

Another fact that suggests *Muhammad* thought of the *Kaaba* as a *Mihrab* is he thought the Jerusalem temple had arched *Mihrabs*, no doubt with a *Kiblah* pointing toward *Makka*'s Black Stone. *Muhammad* said "They [the spirit *Jinn*] work for him [Solomon] as he desired, making arches..." (*Yusuf Ali K* 034:013; also see *K* 027:017).



**Figure 10-06.** A freestanding arcade outside the Dome of the Rock. *Koran* 034:013 may have inspired the freestanding arches.

*Pickthall* however translates "arches" as "synagogues," which points to a religious purpose of the arches, even though *Muhammad* probably had *Mihrab* arches in mind. *Muhammad* probably was not thinking of generic arches since he probably thought that if the *Kaaba* had no such arches, the Jerusalem temple did not either.

It is well known that the Crusaders referred to the Dome of the Rock shrine as Solomon's temple. The *Muslim* architects of the Dome of the Rock seem to have been inspired by the *Koran*'s mention of arches in connection to Solomon. Consequently, inside and outside the Dome of Rock are plenty of arcades as well as *Mihrabs* and *Minbars*.

Oleg Grabar commented on the freestanding arches in the courtyard of the Dome of the Rock:

The second observation deals with the form of the arcade, a rather original architectural morpheme in the sense that no ensemble of the first millennium of our era, to my knowledge, exhibits a few arches as a unit of design independent of building (fig. 84). Its appearance in Jerusalem can be explained as the revival of the old, allegedly *Semitic*, practice of endowing single columns or groups of columns with holiness or with some symbolic value.<sup>3716</sup>

Columns were valued in the *Semitic* pagan religion for their phallic appearance however arches were valued for an additional reason: arches reminded moon-god worshipper of the moon. Also, a lamp hung from the apex of the arch would create a crescent-and-orb symbol at night if one stood close enough to see the insides of the arches.

There are many *Mosques* in *Islamdom* where lamps are hung from the apex of arches, especially the arches of *Mosques*. Modern pictures reveal that the *Umayyad Mosque* in Damascus has tall arches around the inside court, especially. From the apex of each arch hangs a globe-type lamp, which at night would create a large crescent-and-star symbol in each arch—visible to anyone in the courtyard.

The use of the arch in moon-god temples apparently goes back to the *Sin* moon-god worship at *Ur* and was used in ziggurats. The *Encyclopedia Britannica* notes:

In the ancient city of *Ur*, in Mesopotamia (modern *Iraq*), the first true arch of sun-baked brick was made about 4000 BC.<sup>3717</sup>

The excavations showed that by the 3rd millennium BC, Sumerian architects were acquainted with the column, the arch, the vault and the dome—i.e. with all the basic forms of architecture. The ziggurat exhibited its refinements.<sup>3718</sup>

<sup>3716</sup> Grabar. *Shape*, p. 64.

<sup>3717</sup> *EB*, accessed 17 Aug 2004, "Brick and Tile" entry.

The later extensive use of pointed arches of course ruined the crescent-and-orb lighting effect and the horseshoe arch did the same. *Muslims* borrowed the pointed arch and horseshoe arch from Christians and not moon worshipers:

- ‡ The first pointed arches held up a dome at Qasr *Ibn Wardan* built around 561-564 AD.<sup>3719</sup>
- ‡ A Baptistry built in 359 AD and churches built in 483 AD and the fifth and six centuries have horseshoe arches.<sup>3720</sup>

Other examples of the crescent-and-orb lighting effect can be found illustrated in the other chapters (see the thumbnail gallery). These include the *Mosque* lamp and *Mihrab* arch, the seventeenth-century tile inspired by *Mosque* lamps hanging from arches at the Grand *Mosque* at *Makka* and the candle in a hole drilled into the Rock of *Ibrahim*.

### What *Muhammad* Came to Think of the Venus Entity

Tradition says that initially *Muhammad* held to the standard pagan conceptions of Venus, as *Ibn Al Kalbi* wrote:

We have been told that the Apostle of God once mentioned *Al Uzza* [Venus] saying ‘I have offered a white sheep to *Al 'Uzza*, while I was a follower of the religion of my people.’<sup>3721</sup>

After becoming a confirmed monotheist however *Muhammad* said that the goddesses *Allat* (the sun), *Manat* (Fate) and *Uzza* (Venus) (*K* 053:019-020) were actually male angels that the ancients had given female names (*K* 053:023, 027).

Notably, the male angels had all the same powers as the goddesses whom they replaced but they had these powers only at *Allah*’s pleasure (*K* 053:026). Moshan Fani recorded in *The Dabistan* an interpretation of *Muhammad*’s “Night Journey.” This paragraph reflects *Muhammad*’s reinterpretation of Venus:

What the prophet said ‘When I arrived into the Third Heaven, I there saw an angel, equal to whom in excellence and beauty I had seen none, placid and joyful, he was seated upon a throne; and a circle of angelic effulgence was diffused about him.’ This was the heaven of Venus and it is not necessary to comment its beauty; it denotes gladness and festivity.’<sup>3722</sup>

The reason that *Muhammad*’s theological sex-change operation on Venus was acceptable to *Muslims* is that a male Venus was not without precedent in Arabia. Wendell Phillips notes that the *Yemenis* thought of the Venus morning star, *Athtar*, as being the male child of the moon and his sun consort.<sup>3723</sup>

Male Venuses are also found in the Bible and in Egypt. *The Encyclopedia Britannica* notes that *Lucifer* (Latin: “Light Bearer”) was the male planet Venus.<sup>3724</sup> Isaiah calls “the Morning Star” the “Son of the Dawn” (Isa 14:12-14). The usual triad in ancient Egypt was two males and a female, as *The Encyclopedia Britannica* states:

<sup>3718</sup> *EB*, accessed 17 Aug 2004, *Ur* entry.

<sup>3719</sup> Creswell. *Architecture*, pp. 102-103.

<sup>3720</sup> Creswell. *Architecture*, pp. 74-75.

<sup>3721</sup> *Al Kalbi*. *Idols*, pp. 16-17.

<sup>3722</sup> Fani. *Dabistan*, pp. 398, 404.

<sup>3723</sup> Phillips. *Sheba*, p. 64.

<sup>3724</sup> *EB*, accessed 29 Apr 2003, *Lucifer* entry.



The most common grouping, principally in the New Kingdom and later, was the triad. The archetypal triad of *Osiris*, *Isis* and *Horus* exhibits the normal pattern of a god and a goddess with a youthful deity, usually male.<sup>3725</sup>

Not only did the Arabs have a male Venus or two but also there was a lot of gender confusion about the stars. The Arabs had a hard time remembering which stars were female and male, and the surrounding non-Arab cultures often did not agree with how the Arabs sexed the stars, sun and moon.

### The Venus *Mihrab* Explained

Moshan Fani wrote in *The Dabistan*:

In most of the ancient temples of Persia they had formed the symbol of Venus [the bulbous lamp] in the figure [arch] of a *Mihrab*, or arch, like the altar of the *Mosques*; consequently, the present [*Muslim*] *Mihrab*, or altar, is that identical symbol.<sup>3726</sup>

What is this “symbol of Venus” in the “altar” of which Moshan Fani speaks? The most common iconic symbol for Venus was a star or orb next to a crescent-moon. The lunette of the recessed arched *Mihrab* served as the crescent-moon, especially when the lunette was lit up with an oil lamp hanging from the apex.



**Figure 10-07.** Ancient orb and crescent couplets inspired the *Mosque* lamp in *Mihrab* Venus altar.

The oil lamp was made in the form of a sphere (or orb) and represented Venus. The sphere shape was chosen because it would be hard to manufacture many star-shaped lamps by hand. Also the planets were thought to be shaped like the sun and full-moon, only smaller, in other words, an orb. Moshan Fani wrote in *The Dabistan*:

...the planets are simple bodies of a spherical form...their images have also been made after that fashion.<sup>3727</sup>

### Other Iconic Signs of Venus

The idea that a *Mosque* lamp represents Venus and the *Mihrab* lunette represents *Allah* may seem unusual until one investigates others ancient astral signs.

That lamps were artistically made to represent astral objects was nothing new. In the first century AD, the temple *Menorah* was modified to look like the planets and the moon on a stand, as was discussed elsewhere. Some Byzantine-era synagogue *Menorahs* were made into solar symbols<sup>3728</sup> and during the same era some synagogue lamps were made to represent zodiac circles.<sup>3729</sup>

In the Sign of *Tanit* (Venus), a person’s uplifted hands and outstretched arms in the orant (from the Latin *orans*, meaning “praying”) position represent the limbs of the moon. The person’s head represents a Venus orb.

Similarly, Roman coins had the cusps of the crescent-moon pointing up above and behind a person’s shoulders. Brian Doe wrote about a Syrian *Heliopolis-Baalbek* altar where the moon-goddess had a “crescent behind her back and with its horns

<sup>3725</sup> EB, accessed 24 Nov 2002, “Egyptian religion” entry.

<sup>3726</sup> Fani. *Dabistan*, pp. 30-31.

<sup>3727</sup> Fani. *Dabistan*, pp. 25-26.

<sup>3728</sup> Goodenough. *Symbols*, p. 119.

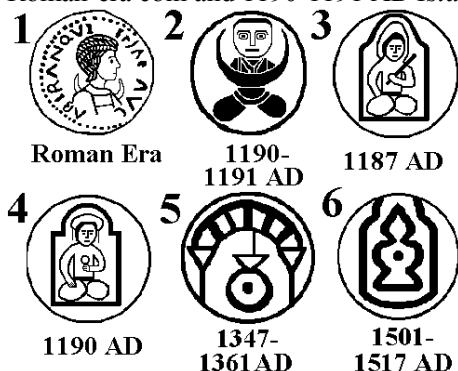
<sup>3729</sup> Goodenough. *Symbols*, p. 118.

appearing above her shoulders.”<sup>3730</sup> Albright and Bowen note that the gods *Attis*, *Sabazios* and *Men* had crescent wings behind their shoulders when represented as moon-gods.<sup>3731</sup>

Some have thought the crescent behind the portrait on Roman coins was the forerunner of the halo that appear in pictures of holy personages. True, the sun and moon often have halos visible in the sky however the crescent was not meant to depict a halo nor show how saintly the person was.

The purpose of the crescent behind a person’s head in a portrait was to transform the person’s head into the common sun-moon or Venus-moon fertility symbol, which symbol was found separately on Roman coins.<sup>3732</sup>

**Figure 10-08. Venus and Crescent Coins and *Mihrab* Coins: Coins 1 & 2:** Roman-era coin and 1190-1191 AD *Islamic* coin with Venus-crescent couplet



(the head is the orb). **Coins 3 & 4:** 1187 AD and 1190 AD coins with Venus angels in *Mihrab* Venus altars, one holding a planetary orb in his hand. In each coin, the head and lunette form a Venus-crescent couplet. **Coins 5 & 6:** 1347-1361 AD coin with Venus orb *Mosque* lamp in crescent arch, and 1501-1517 AD coin with Venus *Mosque* lamp in *Mihrab* lunette.<sup>3733</sup>

### **Muslim Coins With Venus-crescent Couplet Symbols**

*Muslims*, starting in the time of *Saladin*, minted a coin with a man holding a large crescent-moon. Some have thought this was a personification of the moon. This assumption however is the result of anachronistic thinking.

<sup>3730</sup> Doe. *Arabia*, p. 467.

<sup>3731</sup> Bowen & Albright. *Arabia*, p. 159, right column, p. 161, right column, plate 115, p. 178.

<sup>3732</sup> **Roman-Era coin:** The coin has three stars and a large crescent on the obverse is that of Emperor Geta (ruled 198-212 AD) minted in *Anchialus, Thrace* (Coin AE19, *Moushmov* 2882, *Verbanov* 862, no. 1897).

<sup>3733</sup> **1187 AD coin:** *Begteginid* prince Gokburi and his overlord the *Ayyubid* *Salah Al Din (Saladin)*, minted in *Haran*, 1187-1188 AD/583 AH (American Numismatic Society coins 1002.1.541, 1917.215.944, and 1917.215.2859).

**1190 AD coin:** “Attributed to *Salah-ad-Din [Saladin]* himself is the copper coin without mint name dated A.H. 586 which may be another product of *Mayyafariqin*, with enthroned seated figure apparently turbaned and holding an orb across his body (Plate 17:24), perhaps a planetary figure” (Curtis, B. Thomas. “*Salah-ad-din* and the *Jazira* Campaigns,” as found in *Barag. Balog*, p. 96).

**1190-1191 AD coin:** “Watermelon-eater” coin, minted by *Ayyubid* ruler of *Haran*, *Al Mansur Muhammad* in 587 AH, and one series issued by *Saladin* in 586 AH (*Balog*, Paul. *The Coinage of the Ayyubids* (RNS Special Publications #12), London, 1980, coin 175). Also, Nicol, Norman D. “Paul Balog’s ‘The coinage of the *Ayyubids*: additions and corrections,’” *Numismatic Chronicle*, vol. 146, 1986, coin 175a.

**1347-1361 AD coin:** *Mihrab* with *Mosque* lamp coin: ANS Accession No.: 1971.89.1; region: Syria; denomination: *fals*; Publications: B.374A, and see Khoury paper, 1990; *Sultan: Al Malik Al Nasir Hasan*; dynasty: *Mamluk*; mint: *Hamah (Hims)*.

**1501-1517 AD coin:** *Mihrab* with *Mosque* lamp coin: ANS Accession No.: 1972.209.11; denomination: *fals*; ruler: *Qansuh Al Ghuri*; dynasty: *Mamluk*; publication: NC 1962, no. 25; *Balog* 901; reference: B.901.

Moderns know that the sun, moon and stars are inanimate objects that act according to the rules of physics. Medieval *Muslims* however commonly believed that angels guided the astral objects, as stated in the *Koran* (K 041:012; 067:005). Therefore, a personification was not the intention of the artist because ancient and medieval Venus-moon symbols were meant to represent real persons.

The fact that the *Muslim* Venus is a male angel is in keeping with the *Koran's* pronouncement that the angels are male. In fact, *Muhammad* specifically mentions Venus in this context. To explain *Allah's* daughters, *Allat* (the sun), *Uzza* (Venus) and *Manat* (Fate), *Muhammad* said that ancient *Makkan* apostates had given female names to male angels (K 053:023, 027).

The “Light Verse” in the *Koran* attests to how the *Mosque* lamp in a *Mihrab* niche represents a wandering star, namely Venus, as was discussed previously (K 024:035):

*Allah* is the light [the moon] of the heavens and the earth. The parable of His light is as if there were a niche [*Mihrab*] and within it a [*Mosque* oil] lamp: the [oil] lamp enclosed in [bulbous] glass: the glass as it were a brilliant star [Venus]: lit from a blessed tree, an olive, neither of the east nor of the west [i.e. heavenly light], whose oil is well-nigh translucent, though fire scarce touched it: light [Venus] upon light [luminous oil]! *Allah* doth guide whom he will to his light [a lit lunette—i.e. the moon] (K 024:035).

Art historians have noted that the *Mosque* lamps were made to abstractly represent a living being, specifically, *Allah*. Closer study reveals however that the living being represented is the Venus angel. Sheila Blair wrote:

This late *Islamic* lamp follows a form established in earlier centuries, with a foot, a spherical belly and a flare at the top. Such lamps were commonly hung in *Mosques*, tombs and other religious structures where, because of the famous verse from the *Koran* (024:035 [quoted above]), they symbolized the actual presence of God [i.e. the lunette lit up by the *Mosque* lamp].<sup>3734</sup>

To anthropomorphize *Allah* in such a manner would have been forbidden in *Islam* but to anthropomorphize the male Venus angel as a living lamp was acceptable. Besides just as *Mosque* lamps were found in *Mihrabs*, so “*Mihrab*” coins show a male Venus angel in a *Mihrab*. The lit lunette of the *Mihrab* is what represents *Allah's* presence.

That this male figure in the *Mihrab* coin is Venus is attested by the fact that one of the figures in a *Mihrab* coin holds a planetary orb. The lunette of the *Mihrab* represents the crescent-moon and the man in the *Mihrab* and the planetary orb represent the Venus angel. Together they form a Venus-moon symbol.

The reason *Muslims* thought the Venus angel would crouch in the *Mihrab* and not stand, stems from the fact that *Muslims* thought the *Mihrab* was a freestanding representation of a vulva. This parallels how *Muhammad* believed that guardian angels were assigned to women's uteruses (*Sahih Bukhari*, vol. 1, bk. 6, no. 315; also see vol. 4, bk. 55, no. 550; vol. 8, bk. 77, no. 594).

The *Mosque* lamp that was used to light up the *Mihrab* was like those that lit up the rest of the *Mosque*. These overhead lamps were all made to represent the astral spirits, i.e. astral angels. According to the historian Tabari (839–923 AD), *Muhammad* told Ali:

<sup>3734</sup> Blair & Bloom. *Paradise*, p. 94, fig. 29.

These five stars [the visible planets] rise and run like the sun and the moon and race with them together. All the other stars are suspended from heaven as lamps are from *Mosques*, and circulate together with heaven praising and sanctifying God with prayer...their circulation today is what you see and that is their prayer.<sup>3735</sup>

Therefore, a *Mosque* lamp, whether positioned overhead or in a *Mihrab*, was thought of as an angel.

It is interesting to note that *Muslims* “campaigning against Christian states...liked to take church bells as war trophies, some of these then being made into *Mosque* lamps.”<sup>3736</sup>



**Figure 10-09.** *Mosque* lamp orbs were hung from chains above *Mosque* lamps from the late medieval era into modern times.

### ***Mosque* Lamps, Both Overhead and in *Mihrabs*, Show That the *Mihrab* is a Venus Altar**

*Mosque* lamps were positioned overhead in *Mosques*. During *Ottoman* times an orb was often hung above each lamp on a chain.<sup>3737</sup> With the lamps and orbs spread around the ceiling of the *Mosque* representing a field of stars, the lit up lunette of the *Mihrab* represented *Allah* the moon-god rising from off the horizon.

The lighting effect in *Mosques* recreates how, in the early *Makkan Suras*, *Muhammad* said that he saw *Allah* the moon-god on the horizon (*K* 053:007; 081:023). It also suggests that the moon is about to rise off the horizon, which contrasts nicely with how *Muhammad* thought the sun set in a muddy puddle (*K* 018:086). *Muhammad* probably pointed out that when the moon is full and in its glory, it rises off the eastern horizon just as the sun sets in a puddle in the west.

The *Minbar*, i.e. the pulpit with steps, is most often located to the right of the *Mihrab*. Preaching beside the Venus altar—which feature indicates the *Kiblah* (the direction to the *Kaaba*)—enhances the authority of the *Imam* since it suggests the preacher is guided by the moon-god. After all, both *Ibrahim* (*K* 006:077) and *Muhammad* were guided by the moon (*K* 053:002, 004-005, 007, 013; 081:022-023).

The lit lunette of the *Mihrab* is a symbol of *Allah* the moon-god. That is why *Muhammad* preached on a *Minbar* next to a *Mihrab*, as Dogan Kuban wrote:

*Muhammad*'s chair [a three-stair *Minbar*] stood, according to *Al Bukhari*, near the middle of the *Kiblah* wall [where the *Mihrab*'s lunette would be].<sup>3738</sup>

*Muhammad* probably pointed to the lit lunette of the *Mihrab* as he stood on the *Minbar* and recited the supposed words of *Allah* that said *Muhammad* was especially trustworthy since he spoke to *Allah* the moon-god while *Allah* was on the horizon:

I [*Allah*] swear by the star when it goes down, your companion [*Muhammad*] does not err, nor does he go astray, nor does he speak out of desire, it is naught but revelation that is revealed, The Lord of Mighty Power [*Allah*] has

<sup>3735</sup> *Al Tabari. History*, vol. i, pp. 235-236.

<sup>3736</sup> Nicolle. *Moors*, pp. 22-23.

<sup>3737</sup> “Stele in the Form of a Prayer Niche or *Mihrab*: *Seljuk Iran*, late 12<sup>th</sup> century C.E.” (Blair & Bloom. *Paradise*, p. 96, fig. 31b).

<sup>3738</sup> Kuban. *Architecture*, p. 5.

taught him, one vigorous; and he [*Allah*] grew clear to view, while He [*Allah*] was on the highest part of the horizon (K 053:001-007).

(O people!) your companion [*Muhammad*] is not one possessed. Surely, he beheld Him [*Allah*] on the clear horizon, neither doth he withhold grudgingly knowledge of the unseen, nor is this the utterance of Satan worthy to be stoned (K 081:022-025).

*Muhammad's* first *Mihrab* must have been relatively short since, according to Tabari (839–923 AD) and *Al Zurqani*, his *Minbar* only had three steps.<sup>3739</sup> In many *Mosques* the *Mihrab* and *Minbar* are tall—from three up to five meters high. In most cases no matter the height involved, the preacher ascends to the level of the *Mihrab* lunette to preach. This positioning gives the preacher added authority, but also shows that *Islam* is a moon-god religion.

The *Muslim* preacher has more authority the nearer he is to the lit up lunette of the *Mihrab* as one of *Muhammad's* followers, Ka'b b. Malik, said:

Like the full-moon that cannot lie, when he [*Muhammad*] appeared [like the full-moon], we followed him and held him true.<sup>3740</sup>

This also explains why above the pulpit of many *Minbars* is a little roof with a finial crescent. More crescents mean more authority. This is similar to how *Muhammad* established his authority by saying that he was only two bowshots away from the moon-god (K 053:008-009).

After climbing the *Minbar* stairs the preacher is also at the level of the *Minbar* and overhead *Mosque* lamps that represent the stars. Astral angels singing praises guide the stars to *Allah*. Thus the *Minbar* is somewhat like Jacob's ladder, or like *Muhammad* on his famous Night Journey climbing a ladder to talk to *Allah* the moon-god and other notables.

So the preacher always had his head up among dozens or even hundreds of *Mosque* lamps, which represented so many astral angels in the lower heavens.<sup>3741</sup> The intended effect of having the preacher in a *Minbar* at the level of the overhead *Mosque* lamps was to show that he was eavesdropping on the lower heaven.

Consequently, the preacher would hear the words of *Allah* the moon-god in his right ear since the *Mihrab* lunette was located to the preacher's right as he faced the congregation. The right ear was deemed particularly important since Gibb and Kramers wrote that the astral Call to Prayer (the *Adhan*) is said in a baby's ear at birth.<sup>3742</sup>

If the preacher did not hear the words of *Allah* from the *Mihrab* lunette, at least he would hear the angels gossiping from among the overhead *Mosque* lamps. The *Mosque* lamps represent the starry sky, which is the lower level of heaven.

In this respect, preachers were like the demons and *Jinn* who try to invade, or at least eavesdrop on, heaven. *Muhammad* said that the stars were astral angels who threw brimstone at eavesdropping *Jinn*.

*Muhammad* believed that whenever a meteor streaked through the sky, or there was a meteor shower, it was the angels throwing brimstone at *Jinn* and demons (K 041:012; 072:008-009).

<sup>3739</sup> Kuban. *Architecture*, p. 5 & fn. 1.

<sup>3740</sup> Ishaq. *Sirat*, p. 422.

<sup>3741</sup> Drawings of *Mosques* with oil-burning lamps, and *Mihrabs* and *Minbars*, can be found at Rogers. *Spread*, pp. 85, 105, and Blair & Bloom. *Paradise*, p. 37, fig. 6.

<sup>3742</sup> Gibb & Kramers. *Encyclopedia*, p. 16, right column, *Adhan* entry.

### Why It Is Important For *Mosques* to Have Venus Altars

Another reason preaching by the *Mihrab* was important is that the Venus altar was considered a wellspring of sexual power. Ancient pagans thought a god either provided a life force or was the life force of nature. For instance, the *Sabeans* believed that the god *Tammuz* [Venus] was “the power in the grain, dying when the grain was milled.”<sup>3743</sup> Also, many cultures had myths about a god who died and resurrected in cycles in order to explain the reoccurring growing seasons.

That *Muhammad* and *Muslims* held to this kind of superstition is evident by *Muhammad*'s blaming his sexual impotency and occasional erectile dysfunction on Jewish witchcraft. *Muhammad* thought that it could only be magic that would counter Venus' supernatural sexual prowess coursing through his body.

*Muhammad* thought that Jewish witchcraft had blocked the sexual power emanating from Venus and that his prayers for more sexual power had been blocked too. As Zwemer noted, *Muhammad* thought that a Jew walking between a *Muslim* in prayer and a *Mihrab* (or *Sutra* pole) would block the prayer.<sup>3744</sup>

Venus was one of the approved intercessory male angels (*K* 007:191-194; 053:021-027) who had the same powers as *Uzza* was thought to have had. Thus if no prayers were offered to *Allah* through the agency of the Venus angel, then men and their wives, concubines and sex-slaves might suffer from a lack of fertility. Even worse, the man might also suffer impotency.

Venus might also been thought to have had an intercessory role in keeping *Muhammad*'s progeny alive. *Muhammad* needed this kind of intercession because he had a son who died in *Makka*. In *Madina* Mary the *Copt* bore him a son, *Ibrahim*, who died in infancy.<sup>3745</sup>

Praying through a Venus angel did not seem strange to *Muslims* because of a main pillar of *Islam*, namely sex with seventy-two virgin *Houris* in heaven (*Houris* are discussed in the Khidr-Second Lamech Logic table).

The pillar that keeps *Islam* going is the seventy-two *Houri Harem* in heaven—endless sex that *Muslims* literally live and die for. Compared to the seventh pillar, the other six pillars of *Islam* look like toothpicks: 1) Affirmation, 2) Prostrations, 3) Charity, 4) *Ramadan* Fasting, 5) *Hajj*, 6) *Jihad* and 7) Sex with Seventy-two *Houris*.

### The Pagan Precedents for Venus-Altars in *Mosques*

Venus altars likely were found in most pre-*Islamic Mosques* and temples in Arabia. The Revisionist section earlier in this book has an illustration of a *Sabean* moon-temple with three Venus altars built into the side.

*Muhammad*'s grandfather provides another precedent for *Muhammad*'s asking Venus or another astral being to intercede with *Allah*. Tradition relates that *Muhammad*'s grandfather *Muttalib* prayed to *Allah* while standing next to *Hubal* to save *Abdullah* from human sacrifice. Later, *Muttalib* stood next to *Hubal* to thank *Allah* for his infant grandson *Muhammad* whom *Muttalib* held in his arms.<sup>3746</sup>

Why was there a big need for a Venus fertility altar? The warlike disposition of the Arabs meant that there was a constant severe shortage of marriageable males, which is still the case in modern times. Even with polygamy, many Arab women

<sup>3743</sup> *EB*, *Tammuz* entry, accessed 1 Mar 2004.

<sup>3744</sup> Zwemer. *Animism*, ch. 3.

<sup>3745</sup> Peters. *Origins*, p. 179.

<sup>3746</sup> Ishaq. *Sirat*, pp. 67-68, 70.

remain unmarried because many Arab men are illiterate, unemployed and unemployable. This is the kind of dysfunctional society that polygamy and *Islam* produce.

Because fathers could not count on garnering a large dowry from a son-in-law, many girls were killed at birth. *Muhammad* did his best to fix the problem by channeling Arab aggression away from *Muslims* toward non-*Muslims* and he declared that infanticide was a crime in *Islam*.

*Muhammad* must have found it incongruous that pagans would ask Venus for sexual prowess and fertility but then commit gendercide by burying infant girls after their fertility prayers had been answered (K 016:058-059). Besides, the sky showed that *Allah* had plenty of progeny in the form of the sun and stars.

### In Orthodox *Islam*, *Muslims* Rely on the Powers of the Astral Spirit World

*Muslims* praying to or through Venus as an intercessor is not at all unorthodox in *Islam*, as Samuel Zwemer wrote:

According to Tradition, *Mohammed* sanctioned the use of spells and magic so long as the names were only the names of God or of good angels. It is, therefore, lawful to use charms and amulets of this character....There is not a *Muslim* village from *Tangier* to *Teheran* where this encyclopedia of magic [*Shems Al Ma'arif Al Kubra* by Ahmed Ibn Ali Al Buni (died 1225 AD/622 AH)] cannot be found in daily use by some *Sheikh*.<sup>3747</sup>

*Muhammad's* intimate relationship with the spiritual world also extended down to the *Jinn*, who were unpredictable spirits with some magical powers. King Solomon "the Magician" had the *Jinn* build the arches around the temple itself (K 027:017; 034:012-013). *Muhammad* said he even converted the *Jinn* to *Islam* by his preaching (K 046:029-032; 072:001-019).<sup>3748</sup> Wedel wrote:

Belief in the power of *Jinns* was not forbidden [in *Islam*] (*Encyclopedia of Religion and Ethics*, 4.818). This accounts for the fact that black arts flourished in *Muslim* countries as much as did pure astrology. The two were taught side by side in the famous schools of *Toledo* and *Cordova* (J. W. Brown, *Life and Legend of Michael Scot*, Edinburgh, 1897, page 187)... The *Encyclopedia of Religion and Ethics* (4.817) gives an account of one treatise on magic, the famous *Goal of the Sage* of the eleventh century, and Brown's *Life and Legend of Michael Scot* (pages 183 ff.) discusses in some detail the magic of mediaeval Spain.<sup>3749</sup>

*Muhammad* said some angels were granted intercessory powers (K 053:026). Norman Geisler wrote that even *Muhammad* is an intercessor now that his spirit is on the "other side":

Closely related to the *Muslims'* hope for *Muhammad's* intercession and blessing is the universal *Islamic* formula of blessing the prophet, 'God bless him and give him peace.' (The *Shi'ite* version also asks for blessing on *Muhammad's* family). This practice finds its basis in the *Quran* itself, which claims, 'God and His angels send blessings on the Prophet: 'O ye that believe! Send ye blessings on him and salute him with all respect' ([K 0]33:56). Also, several *Hadiths* explain the advantages of often repeating this blessing on *Muhammad*. One

<sup>3747</sup> Zwemer. *Animism*, ch. 10, fn. 9 reads: "*Mishkat*, 21:1."

<sup>3748</sup> Geisler & Saleeb. *Answering*, p. 36.

<sup>3749</sup> Wedel. *Attitude*, p. 53, fn.

*Hadith* promises that for every blessing called on the prophet, God will return that blessing ten times. Another *Hadith* encourages believers to bless the prophet often on Fridays since the greetings are put before him on that day.<sup>3750</sup>

It is interesting that the intercessor *Muhammad* receives his greetings on Friday, the astrological day of Venus. Likewise, the *Muslim* congregation gathers for Friday Prayers and faces and prays through the *Mihrab*, which is a Venus altar according to Moshan Fani.

These facts suggest that both *Muhammad* and *Muhammad's* favorite angel Venus, perform an intercessory role together on the same day, especially. This parallels how *Allah's* daughter *Uzza* (Venus) was thought to have an intercessory role, as revealed by the Satanic Verses account.

*Muslims* praying to or through Venus as an intercessor is not at all unorthodox in *Islam*. Medieval *Muslims* were very enthusiastic about astrology, and *Muslim* delved into astrology at a time when it had been abandoned and banned in Christendom for centuries. Astrology is basically treating the supposed astral angels as though they had the same or similar powers as the gods who once manned the sun, moon, stars and constellations.

Also interesting is this use of the Venus altar would not provoke criticism from Jews of *Muhammad's* day. Some Jews had no scruples about invoking astral angels, as Lest Ness wrote:

Prayers to the planets in *Letter of Rehoboam* show that Jews in the *Talmudic* period saw the heavenly bodies as living beings, angels whom one might ask for help in a great variety of activities without ceasing to be a good Jew. Treatises of scientific astrology such as *4Q Cryptic* and the *Treatise of Sem* lead to the same conclusion... The fact that pious Jews could invoke the aid of the heaven bodies, helps to explain the existence and significance of these [Byzantine-era] zodiac mosaics... The angels carry out God's orders and to that extent substitute for His direct action. Portraying them visually is a way of showing God at work, maintaining the world He created. In a sense, they are a substitute for portraying the God Whom even Moses might not see.<sup>3751</sup>

### The Astral Symbolism of the Venus-Moon Altar and Its Meaning

Moon worshippers find the Venus altar-pulpit (*Mihrab-Minbar*) arrangement and symbolism meaningful because preaching next to a lunette enhances the veracity of the preacher, as one of *Muhammad's* followers, Ka'b b. Malik, said:

Like the full-moon that cannot lie, when he [*Muhammad*] appeared [like the full-moon], we followed him and held him true.<sup>3752</sup>

This also explains why, above the pulpit of many *Minbars*, is a little roof with a finial crescent. More crescents means more authority.

Another reason the lit lunette of the *Mihrab* was important for *Muslims* is watching for the crescent rising was an act of worship, as Abdulkader Tayob wrote:

The basic forms of *Islamic* worship were also determined by God, in the *Quran*, as well as by the Prophet *Muhammad's* example. This means that, in many cases, the forms were regarded as ends in themselves. Riding a camel to *Makka* would be regarded as a means to an end, but *Mufti Shafi*, like most other

<sup>3750</sup> Geisler & Saleeb. *Answering*, p. 86.

<sup>3751</sup> Ness. *Mosaics*, pp. 159-160.

<sup>3752</sup> Ishaq. *Sirat*, p. 422.



contemporary jurists, regards watching the crescent of the new-moon to signal the change of month as an end in itself. Unlike riding a camel, watching the new-moon is an act of worship.<sup>3753</sup>

The *Minbar* pulpit is next to the *Mihrab* with its lit lunette. This seems to point out that the crescent-moon has risen. In ancient times this would have been the time to worship, feast or at least begin the new month in a lunar or solilunar calendar.

The just-mentioned surmise is bolstered by the etymology of *Minbar* which may indicate that “He (*Allah* the moon-god) has risen,” as Zwemer wrote:

The Arabic word *Minbar* (pulpit) comes, we are told, from the root *nbr* which signifies, ‘he raised or elevated a thing...’<sup>3754</sup>

The moon is masculine in Arabic, so *Allah* the moon-god would have been frequently addressed as “He”—as in “He has risen.”



**Figure 10-10.** *Muhammad*, standing on his three-stair *Mihrab*, explains how a *Mihrab* correlates to the *Koran*’s “Light Verse” (*K* 024:035). The lunette stands for *Allah* the moon-god, and the *Mosque* lamp in the *Mihrab* stands for the Venus angel. The *Mosque* lamp over the palm trunk stands for an astral angel just as the many overhead lamps suspended by chains represented all the astral angels in the starry sky. **Note:** A larger version of this illustration can be found later in this chapter (see the Thumbnail Gallery).

The bottom of the *Mihrab* Venus altar between the pillars also had significance—as becomes obvious from this *Encyclopædia Britannica* excerpt:

In her [*Ishtar*’s] earliest manifestations she was associated with the storehouse and thus personified as the goddess of dates, wool, meat and grain; the storehouse gates were her emblem...in myths she is the daughter of *Nanna*, god of the moon...The *Akkadian Ishtar* is also, to a greater extent, an astral deity, associated with the planet Venus. With *Shamash* the sun-god, and *Sin* the moon-god, she forms a secondary astral triad. In this manifestation her symbol is a star with 6, 8 or 16 rays within a circle. As goddess of Venus, delighting in bodily love, *Ishtar* was the protectress of prostitutes and the patroness of the alehouse. Part of her cult worship probably included temple prostitution. Her popularity was universal in the ancient Middle East and in many centers of worship, she probably subsumed numerous local goddesses.<sup>3755</sup>

So the area between the pillars of the *Mihrab* was a throwback to the gates of Venus. That gates represented Venus explains the ubiquitous ancient prayer portals with doors found throughout the Mideast<sup>3756</sup> and the famous *Ishtar* Gate at *Babylon*.<sup>3757</sup> By *Muhammad*’s time, the Venus altar was an abstraction of its former self, consequently the gates and doors were omitted in favor of a *Mihrab* niche.

*Muslims* even today however revere the doors of the *Kaaba* at *Makka*. At one time these doors may have been considered the gates of Venus with the *Kaaba* being

<sup>3753</sup> *Tayob. Islam*, p. 27.

<sup>3754</sup> *Zwemer. Heirs*, ch. 4, pp. 33-34.

<sup>3755</sup> *EB, Ishtar* entry, accessed 10 Feb 2003.

<sup>3756</sup> *Goldman. Portal* (entire book).

<sup>3757</sup> *Pritchard, Ancient*, vol. i, fig. 193.

a prayer portal. The Gates of Venus in the *Kaaba* would well complement the stone called *Allat's* Nipples and the vulviform Black Stone and casing—a Venus altar.

## How Venus Altars Are Used

### *Introduction*

*Muslims* nearly always use a Venus altar in order to pray. In a *Mosque*, *Muslims* face a *Mihrab* niche in the *Kiblah* wall that is aimed at the ultimate Venus altar for *Muslims*—the vulviform Black Stone and silver casing. Also, the prayer rugs that are used inside and outside *Mosques* usually have an embroidered or woven arch pattern that represents a Venus altar.

On the woven prayer rugs either a *Mosque* lamp, or vase with vines is suspended from the apex of the arch. Also, a niche with a bulbous vase on a sill is an artistic interpretation of a Venus altar, as Richard Ettinghausen wrote:

The *Mosque* lamps suspended in the *Mihrab*-like arches of prayer carpets are perhaps best-known examples...They originally reflected verse 35 of *Sura xxiv* [K 024:035]...Later on the light-carrying lamp became a flower vase [*Mosque* lamps resemble bulbous vases] and it was eventually placed on a saucer at the bottom of the arch [the saucer was the artistic parallel to the foot ring of the *Mosque* lamp]. What is remarkable about the *Allah*-derived [*Sic*; Yoel Natan's comment: really, Venus-derived] motif is the fact that it preserves a certain innate power which gave it a magic, apotropaic [intended to ward off evil] quality.<sup>3758</sup>

### *The Rakah Crescent-orb Orant Position (The Raising of the Hands)*

When praying, *Muslims* face and bow toward a Venus altar either in the form of a *Mosque Mihrab*, the arch on the rug or a *Sutra Asherah* pole. Cyril Glassé describes the *Rakah* procedure:

A *Rakah* is a cycle of actions and sacred phrases, with minor variations between different schools of law, performed in Arabic—the sacred liturgical language of *Islam*. A prescribed number of these make up each *Salah*. The worshipper must be in a state of ritual purity to perform the five basic actions which are: 1) the raising of the hands to proclaim *Allahu Akbar* [God is great!]; 2) the standing position for the pronouncing of the *Fatihah*; 3) the bow (*Ruku'*) in which the phrase 'Glory be to God the Mighty' is repeated three times; 4) the prostration (*Sujud*), also accompanied by the formula 'Glory to My Lord the Most High'; [and] 5) the seated position (*Jalsah*).<sup>3759</sup>

The raising of the hands is called the *Takbir-i-Tahrimah* position. Hughes wrote:

The *Takbir-i-Tahrimah* [is said] with the thumbs touching the lobules of the ears and the open hands on each side of the face.<sup>3760</sup>

The *Rakah* cycle is a carryover from pre-*Islamic* times, as shown from the icon commonly known as the Sign of *Tanit* (Venus). This sign shows a person standing in front of a *Mihrab* Venus altar in the orant position, the equivalent of step one of *Rakah*, "the raising of the hands" step (mentioned above).

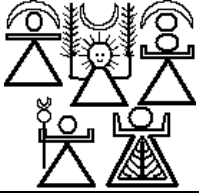
<sup>3758</sup> Ettinghausen. *Kufesque*, pp. 43-45.

<sup>3759</sup> Glassé. *Encyclopedia*, p. 392.

<sup>3760</sup> Hughes. *Dictionary*, "Prayer" entry, p. 466.

Muslim jurists and theologians say the raising of the hands is supposed to be to the level of the ears.<sup>3761</sup> In practice, some Muslims do not raise their hands above their shoulders, but only because these latter-day Muslims are not aware that their head and arms are supposed to form a crescent-and-orb.

In ancient carvings, the crescent-and-orb above the person in the Sign of *Tanit* shows that the worshipper is in front of a Venus *Mihrab* altar. The crescent-and-orb above the worshipper mirrors and accentuates how a person in the orant position with upraised arms forms his head and arms into a Venus orb and crescent-moon.



**Figure 10-11.** Sign of *Tanit* icons in the orant position.<sup>3762</sup> The upraised hands and head form a crescent-and-orb, as confirmed by the crescents and orb icons over some Sign of *Tanit* symbols. Note the pole with the crescent-and-orb in one Sign of *Tanit* (bottom, left). Another Sign of *Tanit* has upraised palm fronds that were used in astral worship (top, middle) (Eze 08:16-17).

In various versions of the Sign of *Tanit*, the crescent-and-orb are shown above the person with upraised hands. The crescent-and-orb represent a *Mihrab* lunette and *Mosque* Venus lamp in an abstract sort of way. The Venus altar prayer portal is very ancient and would have been used in conjunction with the Sign of *Tanit*.



**Figure 10-12.** The historical progression from the star-and crescent-and-orb-and-crescent couplets to the *Mosque* Venus lamp in a *Mihrab*.

### The Orant Position May Have Led Muhammad to Think Yahveh Was the Moon-god Allah

In ancient times, raising the hands and arms in prayer formed a crescent and the head became an orb. This is similar to the ancient Roman and *Islamic* coins mentioned above where a crescent-moon and the head form a moon-Venus symbol. This was meant to show the person was an astral worshipper or an ardent believer in astrology.

The Venus-moon symbol of course is a sexual symbol par excellence. The head represents the female Venus orb. The upraised arms indicate the horns of the moon. The moon represents male sexual potency and the lunar control over the monthly menstrual cycle.

Scholars seem to recognize that when icons of saints have upright arms this is a carryover of the pagan orant position. Ramsay MacMullen wrote of fourth to eight century *Coptic* icons:

...such postures as the *orans* [i.e. orant] with upraised arms or the rider a-horse for *Coptic* hero-saints...were granted a second life.<sup>3763</sup>

Muhammad may have seen these *Coptic* icons with upraised arms and figured that Christianity was an astral religion and that *Allah* was the moon-god *Allah*.

<sup>3761</sup> Muhammad Ali, Maulana. *The Muslim Prayer Book*, Lahore, Pakistan, 1938, see photos, as mentioned by Spengler. "Does Islam have a prayer?" *Asia Times*, atimes.com, 18 May 2004.

<sup>3762</sup> Sign of *Tanit* pictures: Glueck. *Dolphins*, plate 17 (pp. 31, 351); also see Dubal. *Riddle*, and in Cintas, Pierre. "The Sign of *Tanit*, Interpretations of a Symbol," [barca.fsnet.co.uk/Tanit-symbol.htm](http://barca.fsnet.co.uk/Tanit-symbol.htm), accessed 18 Mar 2003.

<sup>3763</sup> MacMullen. *Eighth*, p. 148.

### Whether the Orant Position is Biblical or Not

Someone might say that Saint Paul was advocating praying in the orant position when he wrote “I want men everywhere to lift up holy hands in prayer” (1Ti 02:08). Paul likely was suggesting that Christians pray as Jews did at that time—the way many Jews still pray today. The Jewish posture of prayer is standing with hands extended out with palms facing up, with the forearms spaced shoulder-width apart and nearly parallel to the ground. This method of prayer is also mentioned in the Old Testament<sup>3764</sup>

Many twentieth-century Pentecostals took Paul’s wish as their command. Paul’s advice about upraised hands however was culturally conditioned for his day so that it is descriptive but not prescriptive for today.

Because of their literalistic misreading of 1Ti 02:08, Pentecostals commonly pray with their arms straight up in the air. Raising the arms straight up goes way beyond Paul’s desire that worshippers raise their hands. Evidently, the Pentecostals followed a straight reading of the 1Ti 02:08 and were not even informed by the orant figures found in the catacombs of Rome.

Pentecostals were probably prone to thinking that the church had lost “the” proper mode of prayer because they already believed that the Western church had lost “the” proper mode of baptism.<sup>3765</sup> Just as Pentecostals immerse rather than sprinkle or pour water during baptism, so they raise their arms and not just their hands during prayer.

The Pentecostal posture of prayer seems to show a demanding and assertive, claiming attitude; whereas the Jewish posture of prayer is more supplicative. In the Bible the upraised hand is angry (Isa. 5:25; 9:12, 17, 21; 10:4). Job even speaks approvingly of the wicked man’s upraised arm being broken (Job 38:15). Perhaps this is why when Paul wished that all men lift holy hands he cautioned that they raise their hands without anger or disputing (1Ti 02:08).

### The Eastern Orthodox “Mary Orant” Icon

Fortunately, neither the Jewish lifting of hands nor the Pentecostal’s unique posture of prayer form a Venus orb and crescent Sign of *Tanit*. This however is not the case with the “Mary Orant” icons of the Eastern Orthodox Church.

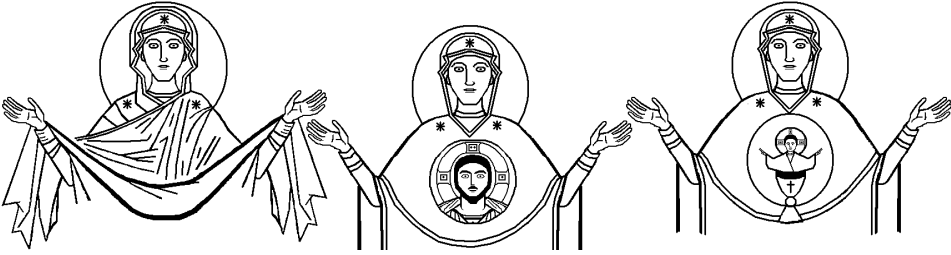
The Mary Orant icons first appeared on coins minted in the ninth century AD, well after the advent of *Islam*. Tenth- and eleventh-century Mary Orant icons are still intact on many Eastern Orthodox church and monastery walls.

The basic design: arms and head form the crescent-and-orb. Medallions (roundels) and halos sometimes serve as orbs, as does a tiny Jesus cast in the orant position standing in a Communion cup. A rolled up sheet sometimes fills out the crescent formed by Mary’s arms, or a hemline on Mary’s bodice or wimple fills out the crescent.

Some Eastern Orthodox icons featuring saints besides Mary pose in the orant prayer position. These however are later productions and the pose was probably copied from Mary Orant icons, or they were inspired by the orant position that *Muslims* make during *Salat*.

<sup>3764</sup> The Jewish orant position of prayer (different from the pagan version): Exo 09:29, 33; 1Ki 08:22, 38, 54; 2Ch 06:12-13, 29; Ezr 09:05; Psa 044:20; 088:09; 143:06; Isa 01:15.

<sup>3765</sup> See Yoel Natan’s book entitled *Baptism*, 2005.



**Figure 10-13.** The five common types of Eastern and Russian orthodox Mary Orant icons are: 1) Mary Protectress with no other prop (not illustrated here),<sup>3766</sup> 2) Mary Protectress with small cloth tucked into belt,<sup>3767</sup> 3) Mary Protectress with sheet in form of crescent moon (on the left),<sup>3768</sup> 4) Virgin of the Sign (in the middle)<sup>3769</sup> and 5) Virgin of the Inexhaustible Cup or Chalice (on the right).<sup>3770</sup>

The late date of adoption of orant icons suggests that *Islamic* influences may have precipitated their adoption—even if the Byzantines had to dip into their pagan heritage to revive a crescent-and-orb symbol. *Muslims* use the orant position during *Rakah* and *Salat*.

By the ninth century AD, the Byzantines were familiar with *Islamic* forms of worship. It is known there were *Mosques* in *Athens* for *Muslim* traders and artisans at least in the tenth century.<sup>3771</sup> There were even *Mosques* in Constantinople. Patriarch Nicholas Mysticus (901-925 AD) wrote to the caliph at the time that since...

...the Arab prisoners could pray in a *Mosque* in Constantinople without anyone obliging them to embrace Christianity, the caliph should also cease to persecute Christians.<sup>3772</sup>

The account of how the Mary Orant icons gained currency in ninth century AD *Byzantium* parallels how the crescent-and-orb formerly had been the symbol of *Byzantium* earlier. The *Encyclopedia Britannica* states:

In 343 BC, *Byzantium* joined the Second *Athenian League*, throwing off the siege of Philip II of *Macedon* three years later. The lifting of the siege was attributed to the divine intervention of the goddess *Hecate* and was commemorated by the striking of coins bearing her star and crescent.<sup>3773</sup>

*Hecate*, which means “hundred powers,” was worshipped for twelve centuries under different guises, sometimes identified with *Persephone* or with the moon-goddesses *Diana*, *Serene*, *Artemis* and *Luna*.

<sup>3766</sup> The basic Mary Orant icons showing just Mary are named *Blachernitissa*, meaning “She who meditates,” after the *Blachernae* Monastery in Constantinople.

<sup>3767</sup> Virgin Orant with small cloth example: A six-meter-high Mary Orant icon with a cloth tucked into her belt can be seen in a half-dome of the Saint *Sophia* cathedral in *Kyiv* (*Kiev*) (built 1037-1086 AD).

<sup>3768</sup> The *Pskov-Protection* icon is example of the Virgin Protectress icon with its crescent-shaped sheet. The Protectress icon day of celebration is 1 October.

<sup>3769</sup> Virgin of the Sign example: These icons are found in the apse of the sanctuary of many Eastern Orthodox churches. The Virgin of the Sign icon in St. *Sophia*, *Kiev*, dates to circa 1114 AD. This type is also called the Virgin *Platytera*, meaning “Greater than Heavens.”

<sup>3770</sup> The *Theotokos* of the Inexhaustible Chalice was first “glorified” in 1878 AD, and its feast day is 5 May. The icon is popular in Russia among alcoholics seeking a cure.

<sup>3771</sup> Ettinghausen. *Kufesque*, p. 32 and p. 46, endnote 10.

<sup>3772</sup> Meyendorff. *Byzantine*, p. 109.

<sup>3773</sup> *EB*, “*Istanbul*” entry, accessed 11 Dec 2004.

The *Encyclopedia Britannica* elsewhere comments on Byzantine-era crescent usage:

Later it became the symbol of the Byzantine Empire, supposedly because the sudden appearance of the Moon saved the city of *Byzantium* (Constantinople) from a surprise attack.<sup>3774</sup>

The Orthodox Church of America gives this additional information about the just-mentioned “surprise attack”:

- *The Primary Chronicle* of St. Nestor says the attack occurred between 864 and 867 AD.
- The Russian historian Vasiliev says the attack occurred on June 18, 860.
- A large pagan Russian fleet under the leadership of Askole and Dir threatened Constantinople.<sup>3775</sup>

Since *Byzantium* is on the *Bosphorus* surely many fleets of sea marauders were revealed by moonlight during its long history. However, it seems that in the ninth century AD there were many Christians around *Byzantium* who held onto some pagan notions. They seem to have thought that the moon represented Mary—similar to how Constantine and other early Christians thought that Jesus was a sun god (see Constantine and *Sol Invictus* in the index). MacMullen wrote about other similar west European Christians at the time:

...fears that the moon would disappear for good: to an eclipse or the end of the month, the response that we hear about from the western provinces was to make a great racket with horns and bells. The bishops from the fifth century on called the practice sacrilege, the Devil’s work, and tried to end it by their conciliar legislation on solemn occasions and by their preaching far more often; but it persisted till the ninth century.<sup>3776</sup>

Incidentally, one historian has suggested that the Mary Orant icon came from the West—from the Roman catacombs. P. W. de Ruyter wrote:

Also called the Virgin of the Incarnation or the Great *Panaghia* [Greek for “All Holy One] of *Yaroslavl*, the image of the Virgin Orant as we know it today, started to appear in the XIth [eleventh] Century. The image of a praying man or woman (the Orant figure) discovered in the *Giordani* Catacombs in Rome may be at its origin.<sup>3777</sup>

The catacombs however were not visited much after Christianity became legalized in about 330 AD. The catacombs quickly became inaccessible due to tunnel collapses, the filling in by air- and water-borne sediment and vegetation overgrowth. Eventually, the catacombs were forgotten and not rediscovered until the seventeenth century.

The influence of a few orant figure paintings in the Roman catacombs would have had little influence on ninth century Greek icons. In fact, the early orant paintings in the catacombs did not even have an effect on Western art.

The closest that Western art came to showing a Christian praying using the orant posture (besides in the catacombs) was in the *Pyrenean* church of *Sant Quirze de*

<sup>3774</sup> *EB*, “crescent” entry, accessed 11 Dec 2004.

<sup>3775</sup> “Feasts and Saints of the Orthodox Church (1 October): The Protection of the Most Holy *Theotokos*,” oca.org, accessed 12 Dec 2004.

<sup>3776</sup> MacMullen. *Eighth*, p. 70.

<sup>3777</sup> De Ruyter, P.W. “A Guide to Byzantine Icons on the Internet,” iconsexplained.com/iec/iec\_idb5s.htm, accessed 5 Dec 2004.

*Pedret* in Spain. One of its frescoes dates from 1000 AD and shows a man praying with outstretched arms. His arms however are straight out from his sides—more like a cross than a crescent-and-orb.<sup>3778</sup>

After the “surprise attack” on *Byzantium* between 860 and 867 AD, a crescent-and-orb coin was issued in honor of Mary. This recalls how in 343 BC a coin was eventually minted in honor of the moon-goddess *Hecate* (as was discussed above). Thus both *Hecate* and Mary seem to have been honored because of the unexpected appearance of the moon.

The earliest known example of the Mary Orant figure is on the obverse of a gold *Solidus* coin minted in Constantinople during the reign of Leo VI the Wise (AD 886-912). Later Mary Orant coins include: 1) Constantine IX minted between 1042-1055 AD, 2) Michael VI Stratiocus minted between 1056-1057 AD, 3) Alexius I minted between 1081-1092 AD and 4) Michael VIII Palaeologus minted between 1261-1282 AD.

The above information coincides with Eastern Orthodox doctrine that elevates and emphasizes Mary to unscriptural levels. The Eastern Orthodox even refer to Mary as “the Queen of Heaven”—the same title the ancients used to address goddesses such as *Juno* and *Astarte* (Venus) (Jer 07:18; 44:17-19, 25).<sup>3779</sup>

The Roman Catholic Church also elevated Mary. Pius IX in 1854 AD and later, Pius XII in 1954 AD, called Mary “the Queen of heaven and earth.” The Vatican II-era *Catechism of the Catholic Church*, paragraph 966, calls Mary “the Queen over all things.”

The sun, moon and star imagery associated with Mary in Rev 12:01 does not mean Mary should be depicted as a moon-goddess. The same sun, moon and star imagery is associated with Joseph but he is never depicted as a moon-god (Gen 37:09).

“The Queen of Heaven” title goes beyond the *Theotokos* (Mother of God) appellation that was approved at The Council of Ephesus (431 AD). To give birth to Jesus the King does not automatically make one the Queen of Heaven just as the concubine Hagar’s bearing a son to Abraham did not automatically make Hagar his wife (Gal 04:24-25).

Jesus is King by virtue of his divinity. The New Testament does not speak of there being any Queen of Heaven. Calling Mary the “Queen of Heaven” might have seemed more appropriate during Byzantine times but royal titles are now seen as a throwback to a past age.

Some women may be blessed to have great children but this does not necessarily elevate them to royalty. This is especially the case in heaven where the greatest among Christians are the servants (Mat 18:01; Luk 09:48). Jesus also said that Christians ought not be concerned who was the greatest (Mat 20:21-25; Mar 10:42; Luk 22:25).

Later Orthodox icon makers tried to de-paganize the Mary Orant and Protectress icons. Instead of Mary holding a large crescent-shaped moon, it became a bowed sheet, or the hemline of her bodice or whimple (or wimple). Instead of Mary’s halo or head serving as the orb, artists inserted a medallion (or roundel) of Christ. Later—

<sup>3778</sup> Fletcher. *Moorish*, fig. 3.

<sup>3779</sup> “Feasts and Saints of the Orthodox Church (1 October): The Protection of the Most Holy *Theotokos*,” oca.org, accessed 12 Dec 2004.

in the nineteenth century—artists inserted a small Christ in a Communion cup (as illustrated above).

The Christ in a roundel of the Virgin of the Sign may actually represent Christ in the womb with the “sign” referring to Isa 07:14: “Therefore the Lord himself will give you a sign: Behold, a virgin will be with child and bear a son.”

In narratives of the icon’s origin, Orthodox historians contributed to the Christianizing of the Mary Protectress icon by transforming the crescent into a shiny sheet.

The Orthodox Church of America (OCA) relates the various accounts that explain the origin of the Mary Protectress icon.<sup>3780</sup> There are obvious differences between the various accounts the OCA provides showing the original story had been further sanitized at some point.

The OCA also notes one “complication”: Saint Andrew saw the event between 860 and 867 AD in a church standing next to Bishop Epiphanius. Assuming that Andrew was twenty when he saw the vision—and using the late date of the vision (867 AD)—Andrew would have been nearly ninety when he died in 936 AD. During this period of wars and sieges reaching such a great age was rare. Moreover, one could expect that anyone standing next to Bishop Epiphanius would have been somewhat older than twenty.

While the Mary Orant icons celebrating the appearance of the moon were first created in the ninth century, the lunar influence of *Islam* continued to exert itself on Christendom so that the heads of the Greek and Latin churches came to see *Allah* the moon-god as being God:

- The Byzantine Emperor Manuel I decreed in 1178 AD that *Allah* was the God of the Bible.<sup>3781</sup>
- The Roman Pope Gregory VII wrote in 1076 AD that *Allah* the moon-god was the God of the Bible.<sup>3782</sup>

### **Muhammad Used the Sign of Tanit**

*Ibn Ishaq* relates that *Muhammad* prayed in this fashion:

Then the apostle arose and faced the *Qibla* and raised his arms so that his armpits could be seen and said ‘O God...’<sup>3783</sup>

*Muslim* passed on these *Hadith* showing that *Muhammad* used the Sign of *Tanit*:

Qatada...saw the Apostle of *Allah*...doing like this (i.e. raising his hands) till they were apposite the lobes of [his] ears (*Sahih Muslim*, bk. 4, no. 763).

The Messenger of *Allah*...raised his hands opposite his ears at the time of reciting the *Takbir* (i.e. at the time of beginning the prayer) and then again raised his hands opposite the ears at the time of bowing and when he lifted his head after bowing he said: ‘*Allah* listened to him who praised Him and did like it (raised his hands up to the ears)’ (*Sahih Muslim*, bk. 4, no. 762).

The reason *Muhammad* thought *Allah* listened was he knew that *Allah* was a moon-god, therefore he appreciated worshippers who made crescent-and-orb gestures.

<sup>3780</sup> “Feasts and Saints of the Orthodox Church (1 October): The Protection of the Most Holy *Theotokos*,” oca.org, accessed 12 Dec 2004.

<sup>3781</sup> Meyendorff, *Byzantine*, pp. 103-104.

<sup>3782</sup> St. Pope Gregory VII, Letter III, 21, dated 1076 AD to Anazir [*Al-Nasir*], King of *Mauritania* (*Bijaya*, present day Algeria), plate 148, column 451A (also Letter XXI, plate 148, columns 450f, same sender and recipient), *Nostra Aetate*, para. 3, 28 Oct 1965, vatican.va, accessed 1 Apr 2005.

<sup>3783</sup> Ishaq, *Sirat*, p. 562.



Gibb and Kramers wrote about *Muhammad* making the Sign of *Tanit*:

Some say that *Muhammad* used to lift up his hands at the *Salat* (e.g. *Al Bukhari (Adhan, bab 83-86; Muslim, Salat, tradition 21-26, Abu Dawud, Salat, bab 114-126; Al Nasa'i, Iftitah, bab 1-6, 85-87; Ahmad b. Hanbal, i. 93, 255, etc.)* Importance is attached (as may be seen in the passages just quoted) to giving the height to which it is permitted to raise the hands. Besides raising the hands, the spreading out of them also occurs (*Al Bukhari, Adhan, bab 130*). It is also evident from the passages of *Hadith* quoted that the raising of the hands took place not only after the *Ruku'* but also in other parts of the *Salat*.<sup>3784</sup>

### **Muezzins Use the Sign of *Tanit***

The *Muezzin's* Call to Prayer (*Adhan*) likewise has astral elements. Malek Chebel wrote:

Since the seventh century the *Muezzin*, an officiant specially trained in vocal technique, has been raising a Call to Prayer, his hand cupping his mouth.<sup>3785</sup>

Chebel's picture shows a *Muezzin* holding his hands up next to his head with his thumbs touching the ears. His palms face forward and the fingers extend straight up. This has the effect of making his hands and head into a crescent-and-orb, and it has the same effect as raising the arms and head to form the Sign of *Tanit*.



**Figure 10-14.** A *Muezzin* voices the *Adhan* often from *Minarets* topped with crescent finials. A crescent-and-orb is formed from the *Muezzin's* head and hands. *Muhammad* and many *Muslims* put their thumbs to their ears during the raising of the hands step of *Rakah*.<sup>3786</sup>

The *Muezzin's* droning Call to Prayer has seven elements, most likely in honor of the seven planets: 1) *Allah* is most great (*Allahu Akbar*), 2) I testify that there is no god but *Allah*, 3) I testify that *Muhammad* is the Prophet of *Allah*, 4) Come to prayer, 5) Come to salvation or deliverance, 6) *Allah* is most great and 7) There is no god but *Allah*.

By the way, *Muslims* receive an astral baptism of sorts, only without the water. Gibb and Kramers wrote:

Owing to the profession of faith frequently occurring in the *Adhan*, the *Muslims* pronounce it in the right ear of a child shortly after its birth (cf. Lane, Arab. *Society in the Middle Ages*, p. 186; Snouck Hurgronje, *Makka*, ii. 138) as well as in the ear of people supposed to be possessed of *Jinn* (evil spirits).<sup>3787</sup>

### **Muslims Use the Sign of *Tanit* at Least Five Times Daily While Doing *Salat***

There are several elements showing that *Salat*, the five daily prayers, is a throwback to ancient Venus-moon worship. These elements are discussed below.

<sup>3784</sup> Gibb & Kramers. *Encyclopedia*, pp. 493-494, *Salat* entry.

<sup>3785</sup> Chebel. *Symbols*, p. 80 (quotation), p. 81 (picture). Another *Muezzin* with his hands cupped to his face and ears is pictured in French, Ron. "Hamtramck immigrants create messy democracy," *Detroit News*, detnews.com, 28 May 2004.

<sup>3786</sup> Glassé provides a picture of a *Muslim* boy with his thumbs to his ears demonstrating *Rakah* (Glassé. *Encyclopedia*, p. 392). Also, see the previous section on the Sign of *Tanit* for *Hadiths* about *Muhammad* putting his thumbs to his ear lobes.

<sup>3787</sup> Gibb & Kramers. *Encyclopedia*, p. 16, right column, *Adhan* entry.

*The Times When Rakah Is Performed Show It Is Venus Worship*

That *Rakah* is related to Venus and sun worship and the Sign of *Tanit* is evident from the times when a *Muslim* should and should not pray, as Zwemer wrote:

‘Prayer is forbidden at three particular periods: at high noon because the devil is then in the ascendant; when the sun is rising because it rises between the horns of the devil; when the sun is at the setting because it sets between the horns of the devil...’ (*Ibn Maja*, vol. i, p. 195).<sup>3788</sup>

Similarly, the *Koran* says:

...sing the praise of your Lord before the rising of the sun and before the setting (*K* 050:039).

Notice that when the sun is most spectacular is when *Muhammad* thought it was most demonic: at sunrise, sunset and at the noon zenith. When the sun has risen enough to clear the horizon Venus is obscured by the brightness. Similarly, in the evening Venus often cannot be seen until the sun has set. This shows that *Muhammad* is pro-moon and pro-Venus and is anti-solar.

The practice of worshipping “the Morning Star before it vanished in the brightness of the dawn”<sup>3789</sup> is a throwback to pre-*Islamic* days as these two accounts show. Trimmingham wrote:

Another account of the killing and capture of hermits around AD 395-400 comes from Nilus, who resided for some years in *Sinai*. The deity of the Arabs, Nilus says, was the Morning Star... the planet Venus, to whom they offered sacrifices on an altar of rude stone. He gives an account of how his son Theodolus, after being captured by Arabs in *Sinai*, escaped being sacrificed owing to his captors having overslept after their carousal and missed the propitious offering-moment at sunrise as a result of which he was carried off and sold as a slave.<sup>3790</sup>

The *Sufi* Martin Lings wrote:

During the northward march it happened one day at dawn that the Prophet was delayed in making his ablution. The men were in lines for the prayers and they waited for him until they feared that the sun would rise before they had prayed.<sup>3791</sup>

*Proclaiming “God is Great!”*

The next part of the *Rakah* after the raising of the hands is proclaiming *Allahu Akbar* [God is great!]. The worshipper addresses the light in the Black Stone or *Mosque* lamp in a *Mihrab* or the lamp pattern woven into the prayer rug *Mihrab*, as the *Koran* intimates:

*Allah* is the light [the moon] of the heavens and the earth. The parable of His light is as if there were a niche [*Mihrab*] and within it a [*Mosque* oil] lamp: the [oil] lamp enclosed in [bulbous] glass: the glass as it were a brilliant star [Venus]: lit from a blessed tree, an olive, neither of the east nor of the west [i.e. heavenly light], whose oil is well-nigh translucent, though fire scarce touched it: light [Venus] upon light [luminous oil]! *Allah* doth guide whom he will to his light [a lit lunette—i.e. the moon] (*K* 024:035).

<sup>3788</sup> Zwemer. *Animism*, ch. 3, fn. 9.

<sup>3789</sup> Hastings. *Ethics*, “Arabs (Ancient)” entry, p. 669, left column.

<sup>3790</sup> Trimmingham. *Arabs*, pp. 254-255.

<sup>3791</sup> Lings. *Sources*, p. 318.

When *Muhammad* saw ambient light reflecting off the Venus Black Stone, he proclaimed “*Allah* is great!” The *Sufi* Martin Lings wrote:

He [*Muhammad*] rode straight to the southeast corner of the *Kaaba* and reverently touched the Black Stone with a staff, uttering as he did so a magnification. Those who were near him repeated it, *Allahu Akbar*, *Allahu Akbar* [“*Allah* is great!” x 2].<sup>3792</sup>



**Figure 10-15.** The reflection in the Black Stone is of Venus and the moon rising on the *Makka*’s east horizon. The Black Stone is *Islam*’s most realistic Venus altar, which *Mosque Mihrab*’s are meant to imitate. The reflection off the Black Stone is recreated using *Mosque* lamps.

*Muhammad* saw the light reflecting off the Black Stone and thought this was a supernatural manifestation of *Allah* the moon-god and the Venus angel. That is why *Muhammad* said to the Black Stone “*Allah* is great!” The reflection of a crescent might look like a cupped hand, and this may be why *Muslims* refer to the Black Stone as “the Hand of *Allah*,” the moon-god.

The tradition of referring to the reflected light in the Venus Black Stone continues to this day, as it did in the eighth century. Daniel Sahas wrote that John of Damascus (~675–749 AD) had this to say:

There is a stone which the *Muslims* embrace and kiss in their...(*Habathan* or *Chabathan*) [the *Kaaba*]...This—which they call ‘stone’—is a head of *Aphrodite*, whom they used to venerate and whom they used to call [address as]...(*Haber* or *Chaber* [*Akbar*])...Upon this stone, even to this day, traces of an engraved **image** are visible, for those who know about it...They venerated the morning star and *Aphrodite*, whom...they called in their language...(*Habar* or *Chabar* [*Akbar*]), which means ‘great.’<sup>3793</sup>

Pilgrim accounts about the “light” in the Black Stone suggest that the “image” that John of Damascus was told about was probably the reflection of Venus off the Black Stone or of ambient light reflecting off the Black Stone.

*Muslims* may have told John of imperfections in the Black Stone and that they could see an image of Venus in the Black Stone, so John of Damascus correctly assumed that the Black Stone was a Venus idol worn down from touching and kissing. Since paganism was still common in the Mideast before *Islam*, John would have had an abundance of examples for comparison.

That *Muhammad* would mistake a small light for *Allah* sounds incredible until one realizes that *Muhammad* thought the sun and moon were small enough to put in one’s hands. If an observer does not take distance into account, the sun and moon do appear as small disks on the horizon (*K* 053:007; 081:023). *Ibn* Ishaq relates:

*Muhammad* answered, ‘O my uncle [*Abu* Talib], by God, if they put the sun in my right hand and the moon in my left on condition that I abandon this course, until God has made it victorious or I perish therein, I would not abandon it.’<sup>3794</sup>

Significantly, *Muhammad* had a great attachment to lamplight, as William Muir points out:

<sup>3792</sup> Lings. *Sources*, p. 300.

<sup>3793</sup> Sahas. *Heresy*, pp. 86-87.

<sup>3794</sup> Ishaq. *Sirat*, p. 119.

The Prophet was of a high-strung and nervous temperament. So afraid was he of darkness, that, on entering a room at night, he would not sit down until a lamp had been lighted for him [perhaps because he feared assassination].<sup>3795</sup>

Supernatural lights appear often in early *Muslim* traditions. *Muhammad* said “When my mother was carrying me [pregnant] she saw a light proceeding from her which showed her the castles of Syria.”<sup>3796</sup> Another tradition says *Al Tufayl* came to the *Mosque at Makka*, saw *Muhammad* standing by the *Kaaba* and said:

‘O prophet of God, I am a man of authority among my people and when I go back and call them to *Islam*, pray to God to give me a sign which will help me when I preach to them.’ He [*Muhammad*] said ‘O God, give him a sign.’ So I went back to my people and when I came to the pass which would bring me down to the settlement a light like a lamp played between my eyes and I said ‘O God, not in my face! For I fear that they will think that a dire punishment has befallen my face because I have left their religion.’ So the light moved and lighted on the top of my whip. The people began to look at that light attached to my whip like a candle while I was coming down from the pass to them.<sup>3797</sup>

*Al Tufayl* seems to associate his light hallucination with the *Kaaba* since the light supposedly appeared as an answer to *Muhammad*’s prayer while he stood beside the *Kaaba*.

A process of elimination suggests that the spot of light had something to do with the Black Stone since there is nothing else permanent about the *Kaaba* that is reflective or gives off light.<sup>3798</sup>

*Ibn Jubayr*, who wrote in 1183 AD, wrote about the light reflection in the Black Stone:

In the sound piece of the stone, to the right of him who presents himself to kiss it, is a small white spot that shines and appears like a mole on the blessed surface. Concerning this white mole, there is a tradition that he who looks upon it clears his vision, and when kissing it one should direct one’s lips as closely as one can to the place of the mole.<sup>3799</sup>

### *The Opening*

Next part of the *Rakah*: The worshipper stands and says the *Fatihah*. *Fatihah* means the “Opening” and refers to the first chapter (*Sura*) of the *Koran*—about seven lines of text. *Muslims* generally recite the *Fatihah* thirty-two times a day.<sup>3800</sup>

The “Opening” seems suspiciously like a magical incantation like “*Abracadabra*” or “Open Sesame,” perhaps meant to open a prayer portal to *Allah* via the *Venus Mihrab* altar.<sup>3801</sup>

That *Islamic Mihrabs* represented a portal to heaven is further strengthened by an early *Islamic* tradition, as Cyril Glassé reports:

Between the Prophet’s tomb and a freestanding *Mihrab* a short distance away (this *Mihrab* is much sought after as a place of exceptional potency) is a

<sup>3795</sup> Muir. *Life*, vol. iii, ch. 10, p. 61, see also fn. 46.

<sup>3796</sup> Peters. *Origins*, p. 103.

<sup>3797</sup> Ishaq. *Sirat*, p. 176.

<sup>3798</sup> *Ibn Battuta* by Pedersen, *Encyc. of Islam*, p. 372, quoted in Zwemer. *Heirs*, ch. 4, pp. 42-43.

<sup>3799</sup> Jubayr. *Travels*.

<sup>3800</sup> Spengler. “Does *Islam* have a prayer?” *Asia Times*, atimes.com, 18 May 2004.

<sup>3801</sup> “Open Sesame,” incidentally, is the magical formula Ali Baba used in the *Arabian Nights* to open the door of the robbers’ cave.

space called the *Rawdah* ('Garden'). It is so named because the Prophet said: 'Between my house and my pulpit [next to the *Mihrab*] is a garden of the Gardens of Paradise.'<sup>3802</sup>

The idea of a *Mihrab* being an opening comes straight out of astral fertility religions. The pagans even referred to the *Mihrab* Venus altar as an "opening." For instance, one of *Baal*'s old titles was *Baal-Peor*, meaning "Lord of the Opening."<sup>3803</sup>

The King of *Moab*, Balak, led Balaam to three overlooks where he could see the *Israelites* to curse them. The last height was called the high place of *Baal* (Num 22:41), or *Baal-Peor* (Num 23:28; 31:16). The deity lent his name to the place since the Bible says that the *Israelites* who fell into sin joined themselves in a sexual rite "to" *Baal-Peor*, rather than "at" *Baal-Peor* (Num 25:03, 05, 18).

Balak reasoned that even though *Yahveh* had Balaam bless *Israel* twice, *Yahveh* would be unable to stop the curse the third time since this particular high place was especially propitious for cursing *Israel* (Num 23:27-28). There seems to have been a temple on *Baal-Peor* called *Beth-Peor* (Deu 03:29; 04:46; 34:06; Jos 13:20). *Beth* means "house" or "temple."

Balak thought this area, *Baal-Peor*, acted like an antennae pointing to god *Baal*, which suggests that there was a Venus prayer portal altar in the *Beth-Peor* temple. This Venus prayer portal "opening" was what gave the deity associated with this place the name, *Baal-Peor*, meaning "the Lord of the Opening."

That there was a Venus prayer portal altar at *Baal-Peor* seems obvious from the fact that many *Israelites* fornicated at *Baal-Peor* (Num 25:03, 05; Deu 04:03; Psa 106:028; Hos 09:10).

*Ashtorah* (Venus) was the main Semitic fertility goddess and she was the consort of *Baal*. Balaam's prophecy uses astral imagery and mentions a star (Num 24:17). This suggests that Balaam may have had Venus in mind. Also, Balaam's suggestion that Balak have the *Israelites* sin by fornication suggests that there was a Venus altar at *Baal-Peor* (Rev 02:14).

Those who prayed to *Baal-Peor* prostrated themselves in the nude. The *Sanhedrin Mishnah Gemara* 7.6 describes a person guilty of *Baal Peor* worship thus:

He who uncovers himself before *Baal Peor*...commits a nuisance...<sup>3804</sup>

Robert Eisler wrote about the similarity of *Muslim* prostration and the prostration to *Baal Peor*:

It says at a place in *Moses Maimuni (Epist. Ad Preselyt. Relig.)*, as quoted by Lenormant 326: 'In the cult of *Ba'al Peor*, one used to undress himself and to throw himself with uplifted private parts down to the ground (in the position, the *Ishmaelites* [i.e. *Muslims*] still do take, when praying).' With this, *Peor* 'cleft' agrees exactly'.<sup>3805</sup>

What Eisler means is that the "cleft" or "the opening" is a reference to the vagina. Evidently, there was at *Baal-Peor* a vulviform betyl similar to the Black Stone at the *Kaaba* at *Makka*.

<sup>3802</sup> Glassé. *Encyclopedia*, p. 277, "Mosque of the Prophet" entry.

<sup>3803</sup> *Easton's Bible Dictionary*, Article 2895, *Peor* means "Opening."

<sup>3804</sup> Saltshakers.com, accessed 29 Feb 2004.

<sup>3805</sup> Eisler, Robert. 1909.

*The Bow*

The next part of the *Rakah* is the bow where the *Muslim* says the phrase “Glory be to God the Mighty” three times. It seems appropriate for a moon-god worshipper to say this upon bowing and making his bent body appear as a crescent.

*The Prostration*

The next to last part of the *Rakah* before the kneeling seated position (*Jalsah*) is the prostration (*Sujud*). During this part, a *Muslim*, while on his knees, touches his forehead to the floor or ground.<sup>3806</sup> This movement is accompanied by the formula “Glory to My Lord the Most High.”

The custom of touching one’s forehead to the ground was derived primarily from solar rite worship. One could not look at the sun directly, so the worshipper worshipped the sun’s reflection off a betyl, or the sunshine that fell on his hand or the ground.

The Bible prophet Job wrote about the practice he avoided:

If I see the light [the sun] when it shines and the precious moon[-god] walking [across the sky], and my heart is enticed [to worship] in secret and my mouth kissed my hand, it also is a judicial iniquity, for I had lied to God [Yahveh] above (*Job* 31:26-28).

The *NASB* (*New American Standard Bible*) has “my hand threw a kiss from my mouth [to the sun- or moon-god]” (*Job* 31:27). Other translations read “my mouth kissed my hand,” which probably is the correct interpretation. D.S. Margoliouth wrote about *Job* 31:27:

Even Job in enumerating his acts of piety notices how he has abstained from kissing his hand to the moon (xxx. 27).<sup>3807</sup>

Samuel Zwemer wrote about the practice of kissing the hand:

Lucian mentions adorations of the sun by kissing the hand.<sup>3808</sup>

E. Cobham Brewer wrote about the practice of kissing the hand:

Adore: (2 syllables) means to ‘carry to one’s mouth’ ‘to kiss’ (Latin: *Ad-os, Ad-orare*). The Romans performed adoration by placing their right hand on their mouth and bowing. The Greeks paid adoration to kings by putting the royal robe to their lips. The Jews kissed in homage: thus God said to *Elijah* he had 7,000 in *Israel* who had not bowed unto *Baal*, ‘every mouth which hath not kissed him’ (1 Kings xix 18 [1Ki 19:18]; see also Hos. xiii. 2 [Hos 13:02]. ‘Kiss the Son lest He be angry’ (Psalm ii. 12 [Psa 002:12]), means worship, reverence the Son. Even in England we do homage by kissing the hand of the sovereign.<sup>3809</sup>

The Jewish sage Moses Maimonides (1138-1204 AD) spells out exactly what the ancients thought about astral light cast on earthly objects:

You know how widespread were in those days the opinions of the *Sabeans*...who once filled the earth...In accordance with the *Sabean* theories images were erected to the stars, golden images to the sun, images of silver to the moon, and they attributed the metals and the climates to the influence of the planets, saying that a certain planet is the god of a certain zone. They built temples, placed in them images and assumed that the stars sent forth their

<sup>3806</sup> Ruthven. *World*, p. 21.

<sup>3807</sup> Margoliouth. *Israelites*, p. 35.

<sup>3808</sup> Zwemer. *Animism*, ch. 8.

<sup>3809</sup> Brewer. *Fable*, Adore entry.

influence upon these images, which are thereby enabled (to speak) to understand, to comprehend, to inspire human beings and to tell them what is useful to them. They apply the same to trees which fall to the lot of these stars. When... a certain tree, which is peculiar to a certain star, is dedicated to the name of this star, and certain things are done for the tree and to the tree, the spiritual force of that star which influences that tree, inspires men and speaks to them when they are asleep. All this is written in their works [*Nabateas Agriculture*, translated by *Ibn Walishiya*], to which I will call your attention. It applies to the ‘prophets of *Baal*’ and the ‘prophets of *Asherah*,’ mentioned in Scripture, in whose hearts the *Sabean* theories had taken root, who forsook God and called, ‘*Baal*, hear us’ (I Kings xviii. 26 [1Ki 28:26]): because these theories were then general, ignorance had spread, and the madness with which people adhered to this kind of imaginations had increased in the world. When such opinions were adopted among the *Israelites*, they had observers of clouds, enchanter, witches, charmers, consultants with familiar spirits, wizards and necromancers.<sup>3810</sup>

Blowing a kiss from the hand may only be a relatively modern practice popularized by the cinema and theatre however it does occur at the *Kaaba* when there are big crowds. Stortroen wrote about a similar practice (*Istlam*) at the *Kaaba*:

The Stone was to be kissed when passing it; if the crowd makes this impossible, it was to be touched with the hand or staff and ‘the touch transferred to the face.’<sup>3811</sup>

The idea that water or sand was holy because it reflected moonlight is seen in the *Koranic* injunction that people wash before prayer (*K* 005:006). The water reflects the moon and this “liquid” moonlight was transferred to the face. If no water was available, then clean sand could be used as though it were water since sand reflects moonlight quite well.

The prostration is throwback to the days when astral worshippers would worship sunshine or moonshine seen on the ground, or a reflection of the sun or moon in a puddle. The worshipper would bow down to the reflection or the shine, as though it were an idol or a liquid betyl. They would see the sun or moon in the puddle and say “Glory to My Lord the Most High.”

That the puddle eventually evaporated was further proof that the sun or moon was somehow present in the water just as it was known the moon affected the tides on the seas. Stortroen wrote:

An *Akkadian* text demonstrates how these libations were poured out for the solar deity and the sun would evaporate the beer or wine as approval of the supplicant’s offering.<sup>3812</sup>

This thinking seems to explain why it was important for the writer of I Kings to report that when the fire consumed *Elijah*’s sacrifice on Mount Carmel, the trench full of water was also licked up (1Ki 18: 33, 35, 38). The evaporation was taken as a sign of divine approval of *Elijah*’s offering.

*Muhammad* may have obliquely alluded to this practice with derision when he said the sun set in a “muddy spring” (*Pickthall*) or “a spring of murky water” (*Yusuf*

<sup>3810</sup> Maimonides. *Perplexed*, Chapters lxiii (63)...xxix (29)...xxix (29).

<sup>3811</sup> Stortroen. *Makka*, p. 21.

<sup>3812</sup> Lipinski, Edward. ‘The Goddess *Atirat* in Ancient Arabia, in *Babylon*, and in *Ugarit*: Her Relation to the moon-god and the sun-goddess.’ *Orientalia Louvaniensia Periodica n.v.*, 1971:119, as quoted in Stortroen. *Makka*, p. 74.

*Ali K* 018:086). Still, *Muhammad* followed this custom in its modified form—kissing the reflection in the Black Stone.

That this thinking was the origin of the *Rakah* method of prayer can be ascertained by certain facts such as those reported by Zwemer:

The noonday prayer [*Zuhr*] is never held at high noon but a short time after the sun reaches the meridian. Wensinck points out that this is due to the belief that the sun-god is really a demon and must not be worshiped by the monotheist. According to *Al Bokhari* [*Al Bukhari*] the Prophet postponed the noonday prayer until after high noon for ‘the greatest heat of the day belongs to the heat of hell.’ Nor is it permitted to pray shortly after sunrise for ‘the sun rises between the horns of the devil.’<sup>3813</sup>

‘Prayer is forbidden at three particular periods: at high noon because the devil is then in the ascendant; when the sun is rising, because it rises between the horns of the devil, when the sun is at the setting, because it sets between the horns of the devil...’ (*Ibn Maja*, vol. i, p. 195).<sup>3814</sup>

Numerous *Hadith* attest that *Muslims* were forbidden to pray at sunrise, sunset and noon.<sup>3815</sup> *Allah* could not be worshipped at sunrise, sunset and at noon because it would be unseemly to worship a moon-god when the sun was at its most spectacular. Moreover, *Muhammad* said that at sunrise, sunset and noon was when solar worshippers (“infidels” and “unbelievers”) were wont [i.e. accustomed] to worship.<sup>3816</sup>

Another reason prayer was not conducted right after sunrise or right before sunset was the angles involved meant it was hard to resolve an image of the sun or moon in a puddle.

Like the end of the rainbow that can never be reached, the sun or moon image in a puddle would be too far away to put one forehead into. Most often no spherical image would appear but the puddle would reflect red light (2Ki 03:22-23).

Since the worshipper was not able to touch their foreheads to the reflection of the sun or moon to infuse themselves with divine glory, it was assumed the Devil was up to his old tricks. Rather than seek a geometric or optometric explanation, the phenomenon was explained by assertion that “the sun rises between the horns of the devil.”

The worshipper also was advised not to pray at high noon. This is because the worshipper would not see the sun reflected in the puddle but merely a silhouette of his or her own head. Worse, the red halo background would make it appear as though he or she was in Dante’s “*Inferno*,” or has *Muhammad* phrased it, “the greatest heat of the day belongs to the heat of hell.”<sup>3817</sup>

The silhouette—not the noon heat—was the real problem. This is obvious from the fact that the afternoon (when the worshipper is supposed to pray) is usually hotter than noon when the sun is at zenith (when the worshipper is forbidden to pray), as any weatherman will attest.

*Muslims* still prostrate themselves and put their foreheads to the ground. *Muhammad* of course did not teach putting the forehead into a puddle that reflected

<sup>3813</sup> Zwemer. *Animism*, ch. 3.

<sup>3814</sup> Zwemer. *Animism*, ch. 3, fn. 9.

<sup>3815</sup> For instance, *Sahih Muslim*, bk. 4, nos. 1275+1807.

<sup>3816</sup> *Sahih Muslim*, bk. 4, nos. 1272+1301+1812; *Sunan Abu Dawud*, bk. 4, no. 1272.

<sup>3817</sup> Zwemer. *Animism*, ch. 3 (quote is given above).



the sun or moon but the whole prostration procedure is a throwback to the days of astral worship. A *Hadith* shows how seriously this procedure was taken:

The Prophet recited *Suratan-Najm* ([*Sura*] 103) at *Makka* and prostrated while reciting it and those who were with him did the same except an old man who took a handful of small stones or earth and lifted it to his forehead and said ‘This is sufficient for me.’ Later on, I saw him killed as a non-believer (*Sahih Bukhari*, vol. 2, bk. 19, no. 173).

*Muhammad* said that the fires of hell (i.e. purgatory) would burn *Muslims* to a crisp except for their prostration mark—a callus or dark patch of skin formed by repeatedly touching the forehead to the ground during prayer. The angels will then fish the *Muslims* out of purgatory by locating their prostration mark and then reconstitute them from that.<sup>3818</sup>

To show their piety and gain assurance of salvation, some *Muslims* speed along the creation of the callus. If their *Mosque* is carpeted and soft, they place on the carpet rough unglazed fired tablets the size of a business card made from sand and clay from the Mideast.<sup>3819</sup>

The callus on a *Muslim’s* forehead is usually round like the moon signifying a *Muslim’s* devotion to the moon-god *Allah*. Louis Brighton wrote:

Brands or tattoos...were used in religious cults at the time of Paul and John to mark those who belonged to a particular deity. This brand often was the name of the deity to whom the individual belonged (U. Wilckens, *Xaragma*, *TDNT* 9:416-417).<sup>3820</sup>

It is known that the ancients looked at the sun and eclipses by glancing at standing water. The ancient moon-god worshippers probably thought up the idea that the moon was the moon-god’s boat by its reflection on the water. In the ancient *Akitu* festival the moon-god *Sin* arrived in *Babylon* by boat.<sup>3821</sup>

Concerning pre-*Islamic* times, *Ibn Warraq* quotes *Juynboll* who says that water was poured on the ground at *Makka*:

Its purpose in early times must have been to get a happy new year with plenty of rain and sunshine, prosperity and abundance of cattle and corn. Great fires were lit at *Arafat* and *Muzdalifah*, probably to induce the sun to shine in the new [i.e. upcoming] year. Water was poured on the ground ([in the] *Tarwiya* “moistening” ceremony) as a charm against drought.<sup>3822</sup>

Pouring water on the ground should be considered in context with other information that indicates the *Tarwiya* ceremony was a solar rite too. Pouring water on the ground allowed the solar worshipper to see his god without being a contortionist and without going blind by looking at the sun. These facts seem to be reflected in this *Hadith*:

*Jabir b. Samura* reported: The Messenger of *Allah* (may peace be upon him) said: The people who lift their eyes towards the sky in Prayer should avoid it or they would lose their eyesight.<sup>3823</sup>

<sup>3818</sup> *Sahih Bukhari*, vol. 8, bk. 76, no. 577; vol. 9, bk. 93, no. 532c; *Sahih Muslim*, bk. 1, no. 349.

<sup>3819</sup> “An American Faith: A mosque in Detroit stands as a testament to *Islam’s* integration,” cleveland.com, 13 Aug 2005.

<sup>3820</sup> Brighton. *Revelation*, p. 187, footnote 30; *TDNT* = *Theological Dictionary of the N.T.*

<sup>3821</sup> Green. *Moon*, p. 157.

<sup>3822</sup> *Juynboll*. *Encyclopedia and Religion and Ethics*, as quoted in *Ishaq*. *Sirat*, p. 41, “Pilgrimage.”

<sup>3823</sup> *Sahih Muslim*, bk. 4, no. 0862; also see bk. 4, no. 0863.

The *Zamzam* well at the *Kaaba* became important because solar worshippers used puddles of water to view the sun. The well purportedly never goes dry. This was important in pre-*Islamic* times for wetting down stone betyls or creating liquid betyl puddles so that one could see the reflection of the sun and moon.

The reliable well, *Zamzam*, is why the *Kaaba* is located where it is despite all the obvious disadvantages of *Mekka*'s desert location. The *Kaaba* is in a wadi bottom was susceptible to frequent flashfloods—that is, until the threat was reduced in recent times by extensive engineering projects.

The wadi bottom was also indefensible against raids since the enemy could throw and catapult projectiles from above. The wadi bottom does not catch any cool breezes either. Moreover, despite *Muslim* assertions to the contrary, the *Zamzam* well water was always rather brackish. The water purportedly pumped from *Zamzam* now probably is piped in from a distance, or is filtered and treated on site. James Hastings wrote:

...the water of *Zamzam*, it must be admitted, is of an inferior quality judged even by Arabian standards, and as compared with some other springs which are to be found no great way off.<sup>3824</sup>

Moshan Fani wrote in *The Dabistan* about the *Zamzam* well's solar association:

According to the learned, the *Kaaba* (the cubic temple at *Makka*) is an emblem of the sun, on which account it is right to worship it; and the well *Zem Zem* [*Zamzam*] signifies likewise 'the great luminary,' as Hakim Khakani said relatively to both:

O *Kaaba*, thou traveler of the heaven! O *Zem Zem*, thou fire of the world!<sup>3825</sup>

Zwemer wrote that prayer is granted at fifteen places in *Makka*:

...all of them connected...with the old idolatry of Arabia.<sup>3826</sup>

Three of these places are: 1) by the *Zamzam* well, 2) under the *Mizab* waterspout and 3) at the *Hatim* Wall. These three places just happen to be where water would tend to puddle most after a rain, and where solar and even lunar worshippers could prostrate themselves and see the reflection of their deity.

*Ibn Jubayr*, who wrote in 1183 AD, says that the *Hijr* under the waterspout was covered with brightly polished marble and was a special place of prayer:

This place, I mean the surroundings of the wall [of the *Kaaba*, under the *Mizab*], is all tessellated [i.e. mosaic pattern] marble, wonderfully joined [lacuna in manuscript] with bands of gilded copper worked into its surface like a chessboard, being interlaced with each other and with shapes of *Mihrabs*. When the sun strikes them, such light and brightness shine from them that the beholder conceives them to be gold, dazzling the eyes with their rays...The *Mizab* [waterspout] is on the top of the wall which overlooks the *Hijr*. It is of gilded copper and projects four cubits [about 2 yards or 2 meters] over the *Hijr*, its breadth being a span [9 inches or 23 centimeters]. This place under the waterspout is also considered as being a place where, by the favour of God Most High, prayers are answered.<sup>3827</sup>

The waterspout is positioned to drain the *Kaaba*'s roof water into the *Hijr* area where the crescent-shaped *Hatim* Wall formed a shallow reservoir. The puddles

<sup>3824</sup> Hastings. *Ethics*, "Arabs (Ancient)" entry, p. 667, right column, top.

<sup>3825</sup> Fani. *Dabistan*, p. 394.

<sup>3826</sup> Zwemer. *Animism*, ch. 8.

<sup>3827</sup> Jubayr. *Travels*.

made the *Hijr* area an excellent solar and lunar worship area especially after a rainstorm.

The golden waterspout was positioned up high on the *Kaaba* toward the northwest so that it would catch the last rays of the sun as it was setting. Thus the waterspout was sort of a betyl that captured the sun and moon's power.

### The Purpose of Betyls Such As The Black Stone

The ancients thought their betyls and the astral orbs served a similar purpose, as *Ibn Warraq* wrote:

According to *Al Sharastani*, one group of *Sabians* worship the stars, called temples, directly; the other group worships handmade idols representing the stars in temples made by man.<sup>3828</sup>

For sophisticated pagans, at least, the betyls, idols and heavenly orbs were not the essence of the deity. The deity or his power or glory pervaded the object however and emanated from the object like radiant light and heat.

Udi Levy wrote that betyl "stones marked the presence of a supersensory being."<sup>3829</sup> A meteorite was preferable to a stone with an earthly origin since meteorites originate in the heavens.

One can postulate what the Arabian pre-Islamic beliefs were about stones based on the Islamic-era beliefs about stones, as when *Muhammad* said that mischievous stones could steal clothing:

...once Moses went out to take a bath and put his clothes over a stone and then that stone ran away with his clothes. Moses followed that stone saying 'My clothes, O stone! My clothes, O stone!...Moses took his clothes and began to beat the stone.' *Abu Huraira* added, 'By *Allah!* There are still six or seven marks present on the stone from that excessive beating.'<sup>3830</sup>

Not only could stones steal clothes but *Muhammad* said stones and trees could talk too. *Muhammad* said:

The last hour would not come unless the *Muslims* will fight against the Jews and the *Muslims* would kill them until the Jews would hide themselves behind a stone or a tree and a stone or a tree would say: '*Muslim*, or the servant of *Allah*, there is a Jew behind me; come and kill him;' but the tree *Gharqad* [box-thorn or salt-bush] would not say [this], for it is the tree of the Jews.'<sup>3831</sup>

### How Betyls Were Used

Stortroen wrote about Greek beliefs about stones:

The Greek writer Theophrastus (fourth century BCE) regarded the religious individual 'as one who dares not pass the already oily stones at the crossroads without prostrating himself and pouring oil on them.' These were shaped as 'quadrilateral pillars, sometimes ending in a head and surrounded by a heap of stones and were called *herms*.' This name was equivalent to the god *Hermes* which means 'stone.' Eliade indicated: 'He is the stone as god or the god in stone.' Also, *Hermes* had been considered the 'god of crossroads.'

<sup>3828</sup> Warraq. *Why*, p. 65.

<sup>3829</sup> Levy. *Lost*, p. 181.

<sup>3830</sup> *Sahih Bukhari*, vol. 1, bk. 5, no. 277; vol. 4, bk. 55, no. 616, and *Sahih Muslim*, bk. 030, nos. 5849 & 5850.

<sup>3831</sup> *Sahih Muslim*, bk. 041, nos. 6981-6985; also see *Sahih Muslim*, bk. 041, nos. 6981-6985, as well as *Sahih Bukhari*, vol. 4, bk. 52, nos. 176-177, and *Sahih Bukhari*, vol. 4, bk. 56, no. 791.

In addition, there were many other deities of the Greek pantheon, which could ‘also be represented by either uncut or sculpted stones.’ One of the sculpted stone was ‘called *Apollo Aiguiesu* (‘[*Apollo*] of the Road’), commonly found set up in the street in front of a house door.’ It was a common sacred column...tapered to a point. Many of these stones were ‘annointed with oil, decorated with ribbons and identified as altars [*sic*].’<sup>3832</sup>

What Theophrastus relates suggests that the sunshine that glared off the oily stone was considered rays of glory from the sun-god *Apollo* himself. The rays themselves may have become personified as *Hermes* who was swift Mercury “the Messenger of the gods.”

In the daytime the crossroad marker would reflect *Apollo*’s glory and in the nighttime the oily stone would transmit the moon-god’s glow. Hence, *Hermes* was not identified with one god but was the “Messenger of the gods.”

When a betyl was in a building or in some permanent shade, no glaring reflection could be seen. Apparently this is why some betyls like those scattered around *Petra* (south of the Dead Sea) have carved eyes, noses and mouths. Similarly, a betyl that was housed in the shade of a roofed shrine at ancient *Byblos* had a *Helios* and zodiac wheel carved into it.<sup>3833</sup>

Not only was oil used to coat the betyls but evidently water was used to improve the betyls’ reflectivity. The “Idol of Water” of the moon-god worshippers of *Haran* perhaps was just a betyl onto which they poured water so that it would better reflect moonlight.<sup>3834 3835</sup> The worshippers may have drunk the water collected off the betyl as they did in *Makka*, as the *Islamist* Martin Lings wrote:

...they [Arabs making a pact] went in a body to the *Kaaba* where they poured water over the Black Stone, letting it flow into a receptacle. Then each man drank of the hallowed water...<sup>3836</sup>

Not only was water or oil used to create a reflection on the otherwise dull surfaces of rock betyls. Blood was also used, and blood created a bond between the worshipper and his or her deity, as James Hastings wrote:

...the blood of the victims was poured over them or smeared upon them, an act whereby the worshipper entered into communion with the god to whom the drink-offering of blood was presented. Upright blocks or slabs of stone formed an essential part of the cult...<sup>3837</sup>

### Why the Black Stone Was a Superior Betyl

The shiny Black Stone betyl is really just an upgrade from a regular stone betyl, which in turn is a step up from a liquid betyl puddle. *Muhammad* showed his disdain for using puddles as betyls by saying the sun set in a “muddy spring” (*Pickthall*) or “a spring of murky water” (*Yusuf Ali K* 018:086).

The Black Stone did not need any water to shine but water was applied to it for drink offerings, as was mentioned above.<sup>3838</sup> The Black Stone needed no olive oil to

<sup>3832</sup> Stortroen. *Makka*, pp. 61-62, with Theophrastus quotes from Eliade. *Religion*, 14:51.

<sup>3833</sup> Goldman. *Portal*, p. 138. Also, *Larousse*, p. 85.

<sup>3834</sup> Green. *Moon*, p. 156.

<sup>3835</sup> Gunduz. *Life*, p. 155.

<sup>3836</sup> Lings. *Sources*, p. 32.

<sup>3837</sup> Hastings. *Ethics*, “Arabs (Ancient)” entry, p. 665, left column, bottom.

<sup>3838</sup> Lings. *Sources*, p. 32.

shine since the oil from hands and saliva continually applied with tongues was sufficient to maintain a sheen.

*Ibn Jubayr* wrote in 1183 AD how he appreciated the appearance of the stone:

Its edges have been braced with a sheet of silver whose white shines brightly against the black sheen and polished brilliance of the Stone, presenting the observer a striking spectacle which will hold his looks.<sup>3839</sup>

*Ibn Jubayr* also notes how the Black Stone could always be counted on to reflect ambient light as a white spot even on cloudy days, or when the stone was in shade:

In the sound piece of the stone, to the right of him who presents himself to kiss it, is a small white spot that shines and appears like a mole on the blessed surface. Concerning this white mole, there is a tradition that he who looks upon it clears his vision, and when kissing it one should direct one's lips as closely as one can to the place of the mole.<sup>3840</sup>

Traditions also connect the Black Stone with light and with the moon, as *Stortroen* wrote:

...it had been said that Adam placed the Stone on Mt. *Qubays* near *Makka*; on dark nights it lighted upon the sky just as the moon does on clear nights.<sup>3841</sup>

The soft light from the heavenly jewel again [during *Ishmael's* day] illuminated the whole of the *Makkan* area.<sup>3842</sup>

The Black Stone needed neither oil coating nor a cloudless sky to produce sheen, unlike a regular *betyl*. A regular *betyl* is just a stone, chiseled or unchiseled, on which as astral worshipper poured water or oil, as *Jacob* did with the *betyl* he set up (Gen 28:18; 31:13; 35:14).

*Jacob* did not worship the astral images reflecting off the *betyl* but just set up the *betyl* as a memorial, marker and milestone so that he would know where to build a temple when he returned to the area. Nevertheless, *Jacob* did mimic the pagan practice concerning *betyls* to a certain extent.

The nearby city of *Luz* was renamed "*Bethel*" after the *betyl* stone *Jacob* set up, therefore one could say that *Bethel* means *betyl* as much as it does "House (*Bet*) of God (*El*)" (Gen 28:16-22). The Hebrews still made pilgrimages to *Bethel* during the time of Judge *Samuel* (1Sa 10:03-04).

For astral worshippers, unlike *Jacob*, the light shining off the oil and water was worshipped. The oil would becoming shiny and perhaps even glow somewhat in the sun or moonlight, as the *Koran's* "Light Verse" indicates:

*Allah* is the light [the moon] of the heavens and the earth. The parable of His light is as if there were a niche [*Mihrab*] and within it a [*Mosque* oil] lamp: the [oil] lamp enclosed in [bulbous] glass: the glass as it were a brilliant star [Venus]: lit from a blessed tree, an olive, neither of the east nor of the west [i.e. heavenly light], whose oil is well-nigh translucent, though fire scarce touched it: light [Venus] upon light [luminous oil]! *Allah* doth guide whom he will to his light [a lit lunette—i.e. the moon] (*K* 024:035).

<sup>3839</sup> *Jubayr. Travels.*

<sup>3840</sup> *Jubayr. Travels.*

<sup>3841</sup> *Peters, F. E. Judaism, Christianity, and Islam: The Classical Texts and Their Interpretation.* Princeton U. Press, Princeton, New Jersey, 1990, p. 908, as quoted in *Stortroen. Makka*, p. 14.

<sup>3842</sup> *Elek, Elizabeth & Paul (Editors). Makka the Blessed, Madinah the Radiant. Crown Publishers,* New York, 1963, p. 22, as quoted in *Stortroen. Makka*, p. 16.

That oil lamps in *Mihrabs* fascinated *Muhammad* shows his preoccupation with oily betyls, and why he did not do away with Venus altars such as the Black Stone, *Mihrabs* and woven prayer rugs.

The light verse, quoted above, is saying that oil lamps mimic the lighting effect of oily betyls. Oily betyls and the Black Stone reflect the light of the moon though the moon never touches the betyl. The surface of the oil in lamps reflects the flame and the oil in a glass container is luminous, even though the flame does not touch the oil. This may have been how *Muhammad* pictured the heavenly orbs. The orbs were like betyls that reflected the light of the deity without there being any flame.

### Why the Black Stone Was Entitled “The Hand of *Allah*”

*Ibn Ishaq* wrote that the Black Stone was honored mainly in the morning and evening when Venus was visible in the sky—when Venus could be seen as a reflection in the polished Black Stone:

By the Black Stone, when they stroke it,  
When they go around it morning and evening.<sup>3843</sup>

Moshan Fani wrote in *The Dabistan*:

According to the learned, the...*Hajer ul Asvad*, ‘the Black Stone at *Makka*,’ represents the body of Venus, which on the border of the heavens is a star of the planets.<sup>3844</sup>

The Black Stone seems to have been made and positioned to optimize the reflection of Venus. The Black Stone is made of an opaque, glassy substance. By *Muhammad*’s time the betyl could hold a reflection well because the “extremely passionate rubbing and kissing” had polished the visible part of the stone.<sup>3845</sup>

The Black Stone is on the southeast corner of the *Kaaba*. Since *Makka* is in the northern hemisphere, this angle meant the Black Stone could, in low light conditions such as at dawn and dusk, show the image of astral objects on the horizon near the ecliptic.

The fact that the Black Stone is recessed in its case somewhat means some ambient light is blocked. This means the image of objects on the horizon is shown more clearly. Venus is bright, confines itself to the horizon like few other astral objects and is on the ecliptic in plain view of the Black Stone.

The Black Stone would also catch the image of *Allah* the moon-god. It was already noted above that *Muhammad* thought that various spots of light were manifestations of *Allah*. These spots included the flame in a *Mihrab* lamp and the reflection seen in the Black Stone. *Muslims* had the habit of anthropomorphizing the moon, as Moshan Fani wrote:

The sight of *Hilal*, ‘the new-moon,’ is seeing the eyebrows of the perfect spiritual guide.<sup>3846</sup>

When the moon, or the moon and Venus were on the east horizon, they were both visible in the Black Stone as spots of light. The crescent-shaped reflection of the moon in the Black Stone was called *Allah*’s hand. By extension the Black Stone became known as “the Hand of *Allah*.”

<sup>3843</sup> Ishaq. *Sirat*, p. 123.

<sup>3844</sup> Fani. *Dabistan*, p. 394.

<sup>3845</sup> Sahas. *Heresy*, pp. 88-89.

<sup>3846</sup> Fani. *Sufis*, p. 56.

When *Muhammad* saw light in the Black Stone, particularly the reflection of Venus and the crescent-moon, he figured that the Hand of *Allah* was caressing Venus' vulva. To *Muhammad* this was happening both in the heavens and also in the vulviform Black Stone. In this way *Allah* was bringing fertility to *Muslims* themselves and to their herds and crops. As the *Koran* says, all bounty is in the Hand of *Allah* (K 003:073; 005:064).

*Muhammad* and *Muslims* wanted to help this fertility process along and not wait for *Allah* the moon-god to cast his crescent image in the Black Stone. It was thought that the process of fertility, whether human, animal or vegetable fertility, could be helped along through sympathetic magic. Therefore *Muslims* caressed the vulviform Venus Black Stone, especially in the morning and evening.

John of Damascus said that in his day, even after the *Hajj* was reformed by *Muhammad*, the "rubbing and kissing [the Black Stone]...was extremely passionate."<sup>3847</sup> This was in keeping with *Muhammad's* teaching that *Allah* was not interested in abstinence when it came to *Jihad* and the *Hajj*, as Stortroen wrote:

He [*Muhammad*] proclaimed that the Lord gave the *Muslims* the *Hajj* and Holy War in exchange for monasticism.<sup>3848</sup>

### Why *Muhammad* Needed a Venus Altar

Though *Muhammad* was intimate with over two dozen women, he was unable to produce a single viable male heir. *Muhammad* must have suffered from reproductive dysfunction since otherwise he could have had dozens of children.

This fact would not fail to attract the attention of critics because in the Arab culture the father is commonly known by a fatherly name, for example: *Abu Ibrahim* (Father of *Ibrahim*), *Abu Muhammad* (Father of *Muhammad*), *Abu Musab* (Father of *Musab*). Therefore for *Muhammad* not to be called "Abu something" stood out.

Already in *Makka*, *Muhammad* was lambasted by critics for not having a male heir. Ali Dashti wrote:

When ol-'As b. Wa'el derided the Prophet...for having no heir, verse 3 of *Sura 108 (ol-Kawthar)* came down: 'It is your derider who is sterile.'<sup>3849</sup>

This of course sounds like a playground retort to taunting like, "I'm not ugly! You're ugly!" Ameer Ali wrote that instead of calling *Muhammad* "Abu something," he was called "*Al Abtar*" instead—a derogatory term:

Such was the nature of the marriages of *Muhammad*. Some of them may possibly have arisen from a desire for male offspring, for he was not a god, and may have felt the natural wish to leave sons behind him. He may have wished also to escape from the nickname which the bitterness of his enemies attached to him...With savage bitterness the enemies of the Prophet applied to him the nickname of *Al Abtar* on the death of his last son. The word literally means 'one whose tail [euphemism for a phallus] has been cut off.' Among the ancient Arabs, as among the *Hindus*, a male issue was regarded as the continuation of the blessings of the gods; and the man who left no male issue behind was looked upon as peculiarly unfortunate. Hence the bitter word applied to the Prophet (K 108, the *Kashshaf*).<sup>3850</sup>

<sup>3847</sup> Sahas. *Heresy*, pp. 88-89.

<sup>3848</sup> Grunebaum. *Festivals*, p. 44, as quoted in Stortroen. *Makka*, p. 20.

<sup>3849</sup> Dashti. *Career*, p. 30.

<sup>3850</sup> Ali. *Spirit*, p. 237 & fn. 2.

While in *Madina* the expectation that a Prophet would be fertile did not abate, as the *Sufi* Martin Lings wrote:

Khadijah [*Muhammad's* first wife] was the only one of his wives who had borne him children [still, *Muhammad* had no male heir]. The people of *Madina* longed that a child should be borne to the Prophet in their city. Only two of his present wives—*Umm* [meaning “Mother”] Salamah and *Umm* Habibah—had borne children to their first husbands. But at each new marriage the citizens were filled with fresh hopes, which gradually faded, for not one of the later wives was destined to be the mother of a child [either male or female] to the Prophet.<sup>3851</sup>

Not only did *Muhammad* feel pressure to produce a male heir but he himself longed for a male heir, as ‘Ali Dashti wrote:

The *Qor’anic* verses which state that *Muhammad* was a human being with all the normal human instincts and emotions are perfectly clear and cannot be explained away. In verse 131 of the *Makkan Sura* 20 (*Taha*), the Prophet is told: ‘Do not stretch your eyes (i.e. look enviously) at what We have given certain couples among them to enjoy—the flower of life in the lower world—so that We may test them thereby! Your Lord’s provision is better and more enduring.’ Likewise in verse 88 of *Sura* 15 (*Ol-Hejr*), which is also *Makkan*: ‘Do not stretch your eyes at what We have given certain couples among them to enjoy! Do not grieve over them! And lower your wing (i.e. be meek) to the believers!’ From the wording of these two verses it is obvious that some sort of envy had crept into *Muhammad's* soul. Perhaps he had been wishing that he might enjoy the advantages of possessing wealth and sons, as the chiefs of the *Qoraysh* did.<sup>3852</sup>

*Muhammad* decided that he had to produce a male heir and he figured the-end-justifies-the-means principle applied. *Muhammad's* obsession with gaining a male heir led to satyriasis, the excessive, often uncontrollable, sexual desire in men. Consequently, he married a dozen women and had sex with about a dozen more concubines and sex-slaves.

*Muhammad* was willing to try anything to produce an heir, even marrying a preteen girl—not that this makes any sense biologically or ethically, of course. *Muhammad* married Aisha as a six-year-old and consummated the marriage when she was nine.<sup>3853</sup> Traditions say that *Muhammad* first saw Aisha when she was playing on swings and with dolls. ‘Aisha said:

I used to play with the dolls in the presence of the Prophet and my girl friends also used to play with me. When *Allah's* Apostle used to enter (my dwelling place) they used to hide themselves but the Prophet would call them to join and play with me. (The playing with the dolls and similar images is forbidden but it was allowed for ‘Aisha at that time, as she was a little girl, not yet reached the age of puberty) (*Fateh-Al-Bari*, vol. 13, p. 143).<sup>3854</sup>

*Muhammad* would have married another young girl had he not died first. He contracted her marriage when she was a toddler, as his biographer Ishaq wrote:

<sup>3851</sup> Lings. *Sources*, p. 286.

<sup>3852</sup> Dashti. *Career*, p. 68.

<sup>3853</sup> Lings. *Sources*, pp. 133-134; *Sahih Bukhari*, vol. 5, bk. 58, no. 234+236; vol. 7 bk. 62 no. 64+65+88; *Sunan Abu Dawud*, bk. 41, no. 4915.

<sup>3854</sup> *Sahih Bukhari*, vol. 8, bk. 73, no. 151; see *Sunan Abu-Dawud*, bk. 41, no. 4914.



(Suhayli, ii. 79: In the *Riwaya* of *Yunus Ibn Ishaq* recorded that the apostle saw her (Ummu'l-Fadl) when she was a baby crawling before him and said 'If she grows up and I am still alive I will marry her.' But he died before she grew up and Sufyan *b. Al-Aswad b. 'Abdu'l-Asad Al-Makhzumi* married her and she bore him Rizq and Lubaba...<sup>3855</sup>

Incidentally, this behavior of marrying toddlers is a cultural norm in many polygynous societies, as William Tucker explains:

If a society tolerates polygamy however the equation changes. When one man can take several wives, other men will have none. If there are five eligible males for every four eligible females for instance, one in five males must remain unmarried.

This creates social tensions. It also creates strategies to deal with these tensions. One is to allow child marriage. Because there is a[n artificially created] 'wife shortage,' men are permitted to reach further down into the female population marrying girls that have barely reached puberty. **In some ancient societies, grown men married infants and waited for them to grow up.**<sup>3856</sup>

### ***Muhammad's* Disastrous Example and Terrible *Koranic* Dictums**

*Ibn Warraq* wrote about what damage *Muhammad's* example has caused *Islamdom* right up to the present:

Child marriages continue to be practiced, and the fact that the Prophet himself married Aisha when she was only nine and he was fifty-three encourages *Muslim* society to continue with this iniquitous custom....This custom of child marriage has persisted to modern times and can lead to tragic [reproductive health] consequences [especially]. But *Muslims* are reluctant to criticize a habit established by the Prophet.<sup>3857</sup>

Besides marrying a preteen, another tawdry precedent that *Muhammad* set was an older man marrying a very young wife. Following *Muhammad's* example causes many family problems today just as Abraham's marrying a younger wife, Hagar, caused family problems for Abraham, Sarah, Hagar, Isaac and Ishmael. Of course, Abraham's soap-opera served as propaganda grist for *Muhammad* when he formed *Islam*. Here are two examples of what can happen when a husband marries, or plans to marry, a younger wife: 1) Reuters reported that a *Pakistani* wife beheaded her husband while he slept after he announced his intention to marry a fourth wife<sup>3858</sup> and 2) *The Jerusalem Post* reported:

On Wednesday Nadia (not her real name) who works for a Palestinian women's empowerment organization in *Nablus [Shechem]* sent her brother and father to pay her husband a visit. 'He decided to take a second wife behind my back,' explained Nadia coolly, 'so I am sending my father and brother to break his fingers.' As the family breadwinner Nadia said she 'will accept no more of my husband's philandering.' She acknowledged that the increasing empowerment of women by virtue of their contribution to society made her revenge possible. Nadia, who is in her fifth month of pregnancy, noted that her husband, the maestro in the local P.A. Police marching band, will surely miss his

<sup>3855</sup> Ishaq. *Sirat*, p. 311.

<sup>3856</sup> Tucker, William. "Terrorism and polygamy," jpost.com, 14 Nov 2004.

<sup>3857</sup> Warraq. *Why*, pp. 320, 349.

<sup>3858</sup> "Woman beheads husband who wanted 4th wife," msnbc.com, 3 May 2006.

fingers. Nadia added that if her husband does not divorce his new wife—who is 15 years younger than Nadia—she will divorce him.<sup>3859</sup>

Because older men were disadvantaged when it came to attracting a young wife, *Muhammad* enshrined the dowry system and polygyny in the *Koran*. This was entirely self-serving on *Muhammad*'s part. He was an older man, especially by the standards of that day, when he entered these precepts into the *Koran*.

Enshrining the dowry system in the *Koran* means that, unlike in India and other places, the dowry system cannot easily be quashed or at least regulated. It was much publicized that the Indian government has been able to quash much of the dowry system.

It turns out that *Hindu* mothers-in-law were the ones making the most demands on the wives' families for more dowry money. If no money was forthcoming, the wife or bride would suddenly die in a "cooking accident" or under other mysterious circumstances.

The *Koran*'s dowry and polygyny system means that old cronies can basically buy young wives or swap daughters. The daughters then become the wives of their father's friends! The dowry and polygyny system ensures that lechers have young wives right up until the time they are planted in the grave (*K* 002:236, 237; 004:004, 019, 024-025; 033:050; 060:010).

Because older men are the patriarchs of large families, they are often able to raise large sums of dowry money from various sources: their own employment, their wife's or wives' employment, investments, business(es), and from dowries they received for marrying off their own daughters.

The above situation artificially inflates the dowry market price of women to the point where many younger men cannot afford to buy a wife. That young men cannot afford a wife is reported in the press. *The Los Angeles Times* reported:

...young *Iraqi* men—too poor these days to make suitable husbands—are trolling discreet red-light districts with condoms and sex pills as prostitution has flourished and become more open under occupation.<sup>3860</sup>

Meanwhile, the older men are snatching up all the younger women, especially the better-looking ones. *The Los Angeles Times* reported that older men are buying a lot of sexual potency drugs because...

...more and more elderly men are marrying younger women because young men have no jobs and no money and can't afford to get married. And, these days, older men are going to need a little help if they have to satisfy three young wives.<sup>3861</sup>

*The Los Angeles Times* reported this as though it were a fluke however it is well known that all over the Mideast, young men often work until they are old men before they can afford to take a wife. Otherwise, they settle for what amounts to legalized prostitution (temporary marriages), mail-order wives, or pornographic magazines and movies, which are widely sold by street vendors in Egypt,<sup>3862</sup> Indonesia<sup>3863</sup> and elsewhere. Don Richardson wrote about another of polygyny's effect on society:

<sup>3859</sup> Gutman, Matthew. "Nablus women mean business," jpost.com, 13 Aug 2004.

<sup>3860</sup> Fleishman, Jeffrey. "Little blue pill emerges as big seller in Baghdad: Viagra in demand as desire for sex declines amid war," *Los Angeles Times*, 19 Jun 2004.

<sup>3861</sup> Fleishman, Jeffrey. "Little blue pill..." *Idem*.

<sup>3862</sup> "Playboy in Indonesia," *Big Pharaoh* (BP), bigPharaoh.blogspot.com, 9 Apr 2006.

<sup>3863</sup> "Tame Playboy sparks excitement in Muslim Indonesia," news.yahoo.com, 7 Apr 2006, *BP*.

In discussions about polygyny in *Islam*, occasionally someone jibes: ‘Men like it; women hate it.’ But polygyny, realistically appraised, is a curse for both sexes. Here is why: In polygamous cultures, married men with daughters yield to the temptation to form *de facto* daughter-trading clubs. One says to the fellow polygamist: ‘I will give you my daughter to be your third wife but only if you give me your daughter as my fourth wife.’ Where does that leave single men? Vehemently resenting the greed, [lust and] the avarice of already-married males. Single men have little option but to entice or steal a bride and elope—a cause of endless rancor, feuding and bloodshed. Relativist sophisms fail. Polygyny is a curse for men and women both!<sup>3864</sup>

William Tucker also wrote about polygyny’s effect on society:

Polygamous societies also tend to practice extreme puritanism and be restrictive toward women. Because they are [artificially made] scarce, women are hoarded by families. To marry, men must pay a ‘brideprice.’ (The ‘dowry,’ on the other hand—a cash bonus attached to an eligible daughter—is the signature of monogamy.) The brideprice tends to concentrate the unmarried among poorer men.

Faced with this exclusion from domestic society, men tend to join the ‘bachelor herd’—gangs of unattached males that adopt criminal, even warlike, behavior. Polygamy is widespread in tropical Africa and those countries are constantly plagued with ‘rebel armies’ that live in the bush for years, plotting conquest and kidnapping wives from villages.<sup>3865</sup>

Why are *Muslims* reluctant to criticize any of the many objectionable practices that *Muhammad* engaged in? Not only would polygamists object to questioning the practice of polygyny but any such questioning would be tantamount to putting *Muhammad* on trial. *Muhammad* said that those who question him were as wrong as the Israelites who were motivated by their unbelief to question Moses (*K* 002:108).

To fend off justified criticism of his objectionable practices, *Muhammad* said that *Muslim* ought not ask questions that, whether answered or not, would jeopardize their faith (*K* 005:101-102). *Muhammad* also said that everything he did was in accordance with revelation and therefore must be ethical. *Muhammad* said:

Oh you who believe, make not unlawful the good things that *Allah* has made lawful for you (*K* 005:087; see also *K* 006:146; 010:059; 016:116).

By trying to turn the table on his godly critics by positioning *Allah* against them *Muhammad* turned the justice system and social propriety on its head. The Old Testament Prophets decried the situation where the guilty were found innocent and the innocent were found guilty (Isa 05:23; 29:21). Albert Camus wrote similarly:

The day on which crime adorns itself with the effects of innocence, by a strange reversal...innocence is summoned to provide its own justification.<sup>3866</sup>

*Muhammad* implied that preteen marriages were acceptable when he wrote in the *Koran* that those wishing to divorce child brides had to wait out the three-month waiting period despite the fact that the girl was prepubescent.<sup>3867</sup> In the *Koran* chapter entitled “The Divorce,” *Muhammad* said:

<sup>3864</sup> Richardson. *Secrets*, p. 81.

<sup>3865</sup> Tucker, William. “Terrorism and polygamy,” jpost.com, 14 Nov 2004.

<sup>3866</sup> Littman, David G. “*Islamists’* Perpetual Crusade,” *FPM*, 15 Aug 2003.

<sup>3867</sup> Spencer. *Disturbing*, p. 47.

As for those of your women who have despaired of menstruation [past menopause], if you have a doubt, their prescribed time shall be three months [waiting period before divorce is final], along with those who have it [menstruation] not [i.e. prepubescent girls] [the Arabic literally says “and those who never had menses”] (K 065:004a).

Why would *Muhammad* promulgate a provision in the *Koran* about divorcing child brides? The reason is that the complications involved in girls giving birth often lead to death or to health problems that end in divorce.

Millions of girls suffer from *Obstetric Fistula*, a terrible, debilitating condition brought on by the delivery of a child through an immature pelvis. Yet millions more girls have suffered paralysis from giving birth.

Robert Spencer wrote that the U.N. Children’s Fund (UNICEF) “profiled a woman who is a double victim, both of preteen marriage and easy divorce.”

Zeinab is 26 years old. She was married at the age of 10, and at 12 gave birth to a girl. However, the trauma of the early delivery was too much for her young body, whose whole left side became paralyzed. As a result, her husband sent her back to her family. He eventually abandoned her completely and remarried. She and her daughter, now 13, are now living with an aunt and earn some money selling potatoes. But Zeinab cannot afford to send the girl to school.<sup>3868</sup>

Female circumcision increases the mortality rate among would-be mothers and their infants, as this excerpt of a report from *Mogadishu, Somalia*, reveals:

The cause of the fetus’ death was not known, but the most likely cause of complications was that the mother had been circumcised. During female circumcision in *Somalia*, the vagina is sewn together to leave a tiny aperture causing internal damage and prolonging childbirth for up to 10 days... babies frequently suffocate [asphyxiate] during labor.<sup>3869</sup>

### Why the *Madinan Mosque* Needed a *Mihrab*

Unfortunately, *Muhammad* involved the male *Muslim* congregation in his satyriasis addiction. *Muhammad* preached and formulated *Islamic* doctrine and practice with his own unsavory needs and perverted interests in mind. Zwemer wrote:

There is, it is true, a late and unorthodox tradition, *La Rahbaniya Fi’l Islam*—“There is no monasticism in *Islam*.”<sup>3870</sup>

*Muhammad* needed converts to support his lavish lifestyle and he needed fresh faces to man his *Jihad* armies. *Muhammad*’s long-term goal was to out-populate *Islam*’s religious and political opponents so that the borders of *Islam* would push ever outward. Hence it was natural *Islam* is all about “indulging the male sex drive as a ploy to entice pagan males into his fold.”<sup>3871</sup>

That *Mosques* were originally for inducing satyriasis, as opposed to nymphomania, is why even today the *Mosque* that allows women is the exception rather than the rule.

<sup>3868</sup> Spencer. *Disturbing*, p. 87.

<sup>3869</sup> “Doctor who saved life gets death threats,” *The Guardian*, smh.com.au, 19 May 2004, *DW*, 20 May 2004.

<sup>3870</sup> Zwemer. *Heirs*, ch. 2, p. 40.

<sup>3871</sup> Richardson. *Secrets*, p. 166.

This practice is a throwback to pre-*Islamic* days when men gazed at *Lingam* and *Yoni* paraphernalia and all prayed together at the Venus altar. Moreover, this is why the *Koran* speaks of *Houri nymph* nymphomaniacs in *Muslim* heaven but there is no explicit mention of gigolos to pleasure *Muslim* women.

Unfortunately, one cannot degrade morality in one area while keeping other areas intact and unaffected. Margoliouth wrote:

When he [*Muhammad*] was at the head of a robber community (in *Madina*) it is probable that the demoralizing influence began to be felt; it was then that men who had never broken an oath learned that they might evade their obligations, and that men to whom the blood of the clansmen had been as their own began to shed it with impunity in the cause of God; and that lying and treachery in the cause of *Islam* received divine approval, hesitation to perjure oneself in that cause being represented as a weakness. It was then too that *Muslims* became distinguished by the obscenity of their language. It was then too that the coveting of goods and wives (possessed by unbelievers) was avowed without discouragement from the prophet.<sup>3872</sup>

The first thing *Muhammad* did to induce satyriasis was change the *Kiblah*, the direction of prayers, to *Makka*. While at *Makka Muhammad's Kiblah* ran through the *Kaaba* northwest to Jerusalem.<sup>3873</sup> *Muhammad* initially kept this northwestern direction as the *Kiblah* for a while at *Madina*.

After Jews, by and large, did not convert to *Islam*, *Muhammad* figured there was not much to be gained in praying toward Jerusalem (*K* 002:145). Besides, in *Muhammad's* mind Jerusalem represented Judeo-Christian values, while *Makka* represented the pagan immorality with which *Muhammad* was more comfortable.

Changing the *Kiblah* south toward *Makka* would serve *Muhammad's* purposes because the ultimate Venus altar, the Black Stone, was at the *Kaaba*. The Black Stone betyl in its vulviform case was rubbed (i.e. masturbated) and kissed passionately.<sup>3874</sup> The early *Muslims* like *Caliph Umar* just followed *Muhammad's* example on this point (*Sahih Al Bukhari* 002:667, 675, 676, 679, 680).

*Muslims* knew what *Muhammad's* newly made Venus altar in *Madina* was about since in pre-*Islamic* times they worshipped, among other deities Venus (*Uzza*).

The pre-*Islamic Mosque* by the *Kaaba* undoubtedly had a Venus altar aimed toward the Black Stone. In his biography of *Muhammad*, *Ibn Ishaq* mentions this pre-*Islamic Mosque* by the *Kaaba* often.<sup>3875</sup> Alfred Guillaume notes concerning *Ibn Ishaq's* mentions of pre-*Islamic Mosques*, "This is not an anachronism."<sup>3876</sup> The reason Guillaume had to say this was an idea had gained currency that *Muhammad* or one of the *Caliphs* had invented *Mosques*.

The reader will remember the discussion earlier in this chapter about *Baal Peor* and the Venus altar. That discussion, along with the facts presented here, suggest that any use of a Venus *Mihrab* altar or its pattern woven into prayer rug is highly suggestive of the sex act.

The assertion that *Salat* involves the sex act is strengthened by the fact that *Muhammad* seems to have used the Venus Black Stone vulva, which *Muhammad*

<sup>3872</sup> Margoliouth. *Rise*, p. 149.

<sup>3873</sup> Ishaq. *Sirat*, pp. 157-158.

<sup>3874</sup> Sahas. *Heresy*, pp. 88-89.

<sup>3875</sup> Ishaq. *Sirat*, pp. 56, 102, 123, 132, 157, 163, 166, 169, 172-173, 175, 177, 530, etc.

<sup>3876</sup> Ishaq. *Sirat*, p. 56, fn. 1.

kissed often, as a *Mihrab* for doing his *Salat* prostrations. *Ibn Ishaq* wrote that *Muhammad*'s custom was to pray facing the *Kaaba* near the Black Stone between the southeast and southwest corner.<sup>3877</sup>

*Muhammad*'s original *Kiblah*, his first direction of prayer, ran through the *Kaaba* toward Syria or more specifically, Jerusalem. In other words, conceivably *Muhammad* used the Venus altar Black Stone as though it were a *Mihrab* in a *Mosque*.

Tradition says that *Muhammad* kissed the Black Stone and this suggests that doing *Salats* is like performing foreplay and *Coitus* with a Venus altar vulva. When *Muslims* lunge forward to prostrate (*Sujud*) themselves during *Rakah*, this is rather like mounting Venus or at least one of the seventy-two *Houris*.

*Muslims* must do many prostrations (*Rakah*) per day that comprise the mandatory five *Salat* sessions.<sup>3878</sup> Not only is this a holdover from the ancient astral fertility religions, but each *Muslim* must practice making the rounds in anticipation of keeping seventy-two *Houris* sexually satisfied.

That many *Muslims* viewed *Rakah* and *Salat* to be a warm-up practice for orgies in heaven seems to be the gist of this conversation recorded in *The Dabistan*:

The *Shiah* answered: 'Ali used to pray the whole night.' The *Sonnite* [*Sunni*] rejoined: 'According to your own account, the lord Ali wanted a woman every night; and his custom (called *Matah* [or *Muta* legalized prostitution]) was to engage one [woman] for a short time; and so many did he occupy that he seemed an unceasing bridegroom; how could a person so employed pray the whole night? Unless in your [*Shiite*] religion you call praying what we call by another name [sex].'<sup>3879</sup>

Since the ultimate target of prayer is the Black Stone at the *Kaaba*—a stone in a vulviform frame—"the Opening" (*Fatihah*), must refer not only to the opening of a Venus gate or opening chapter of the *Koran* but ultimately to the opening of Venus' vulva.

Considering the fact that the *Rakah* prostration is a Sign of *Tanit* holdover, the *Fatihah* prayer probably is a holdover from pre-*Islamic* times. In pre-*Islamic* times the first chapter of the *Koran* was the "Open Sesame" asking the Venus goddess to be receptive to prayer and manipulation—in short, to open her cosmic legs.

### The Mosque As a Sex Palace

Not only did *Muhammad* install a Venus *Mihrab* but the *Mosque* became part of his sex palace. The *Sufi* Martin Lings wrote "The *Mosque* was a prolongation of the Prophet's own dwelling."<sup>3880</sup> Gibb and Kramers wrote:

On the east side two huts of similar materials were built for the Prophet's wives Sawda and 'A'isha; their entrances opened on to the court and were covered with carpets; they were later increased so that there were nine little houses for the Prophet's wives.<sup>3881</sup>

*Muhammad* led his congregation at the *Mosque* with spots of semen on his clothes, as his favorite wife Aisha attests:

<sup>3877</sup> Ishaq. *Sirat*, pp. 157-158.

<sup>3878</sup> Glassé. *Encyclopedia*, p. 345, *Salah* entry.

<sup>3879</sup> Fani. *Dabistan*, p. 359.

<sup>3880</sup> Lings. *Sources*, p. 167.

<sup>3881</sup> Gibb & Kramers. *Encyclopedia*, p. 331, *Masjid* entry.

I used to wash the semen off the clothes of the Prophet and even then I used to notice one or more spots on them (*Sahih Bukhari*, vol. 1, bk. 4, no. 233).

I used to wash the traces of *Janaba* (semen) from the clothes of the Prophet and he used to go for prayers while traces of water were still on it [water spots were still visible] (*Sahih Bukhari*, vol. 1, bk. 4, no. 229).

*Muhammad* even gave permission to do the *Hajj* at *Makka* with a semen emission:

Narrated *Ibn ‘Abbas*: ‘The Prophet (along with his companions) reached *Makka* in the morning of the fourth of *Dhul-Hijja* assuming *Ihram* for *Hajj* only. So when we arrived at *Makka*, the Prophet ordered us to change our intentions of the *Ihram* for ‘*Umra* and that we could finish our *Ihram* after performing the ‘*Umra* and could go to our wives (for sexual intercourse). The people began talking about that. Jabir said surprisingly, ‘Shall we go to *Mina* while semen is dribbling from our male organs?’ Jabir moved his hand while saying so [a pornographic gesture, no doubt]. When this news reached the Prophet he delivered a sermon...At that *Suraqa Bin Malik* stood up and asked ‘Oh *Allah*’s Apostle! Is this permission for us only or is it forever?’ The Prophet replied, ‘It is forever’ (*Sahih Bukhari*, vol. 3, bk. 44, no. 683; also see vol. 9, bk. 92, no. 464).

Based on the above *Hadith*, many *Hajjis* are walking and stampeding around *Makka* in skimpy clothing (the *Ihram*) with a divinely sanctioned emission of semen. Keep in mind that two million *Muslims* go on pilgrimage each year, mostly men. This *Hadith* about semen and sex indicates that the *Hajj* is an ancient fertility rite.

### **Muhammad and the Sex Houris**

*Muhammad* increasingly talked about the *Houris* in heaven. In fact, those who died in *Jihad* battles were promised a whorehouse heaven. This all came from *Muhammad*’s imagination as affected by his induced satyriasis, as Tisdall wrote:

Most of the more unpleasant details and conceptions [about the *Muslim* paradise] are doubtless the offspring of *Muhammad*’s own sensual nature.<sup>3882</sup>

*Muhammad* described the *Houris* as looking like the mother of his child bride Aisha—as the *Sufi* Martin Lings wrote:

Of her [Aisha’s] mother the Prophet had said: ‘Whoso would behold a woman of the wide-eyed *Huris* [*Houris*] of Paradise, let him look on *Umm* [mother] Ruman.<sup>3883</sup>

Evidently, *Muhammad* could not wait for heaven to obtain the *Houri* of his dreams, therefore he contracted for a marriage for the girl Aisha when she was age six. *Muhammad* figured that in a few years she would blossom into one of the *Houris* of his fantasies. Evidently, *Muhammad* could not even wait until Aisha matured as a teen since he consummated the marriage with Aisha when she was only age nine.<sup>3884</sup>

*Muhammad* further described the *Houris* thus:

*Allah*’s Apostle said ‘The first batch (of people) who will enter Paradise will be (glittering) like a full-moon; and those who will enter next will be (glittering) like the brightest star. Their hearts will be as if the heart of a single man, for they

<sup>3882</sup> St. Clair-Tisdall. *Sources*, ch. 5.

<sup>3883</sup> Lings. *Sources*, pp. 132-133.

<sup>3884</sup> Lings. *Sources*, pp. 133-134; *Sahih Bukhari*, vol. 5, bk. 58, no. 234+236; vol. 7 bk. 62 no. 64+65+88; *Sunan Abu Dawud*, bk. 41, no. 4915.

will have no enmity amongst themselves, and everyone of them shall have two wives, each of whom will be so beautiful, pure and transparent [diaphanous] that the marrow of the bones of their legs will be seen through the flesh' (*Sahih Bukhari*, vol. 4, bk. 54, no. 469).

Evidently, the *Houris* also provided breast milk since *Muhammad* said there was a wet-nurse in heaven like his son's wet-nurse on earth:

We went with *Allah's* Apostle to the blacksmith *Abu Saif*, and he was the husband of the wet-nurse of *Ibrahim* (the son of the Prophet) (*Sahih Bukhari*, vol. 2, bk. 23, no. 390).

When *Ibrahim* (the son of Prophet) expired [i.e. died], *Allah's* Apostle said 'There is a wet-nurse for him in Paradise' (*Sahih Bukhari*, vol. 2, bk. 23, no. 464).

*Muslims* not afflicted with the satyriasis sexual addiction were daunted by the prospects of entertaining seventy-two *Houris* for an eternity, as *Ibn Serene* records:

When one of his followers posed the question: 'Oh Messenger of God, do we have sexual intercourse in paradise?' He replied in extravagant words, indicating the intensity and total preoccupation with sexual expression....Then he added: 'There is no bachelor in paradise.' When another asked him how one man could have the strength to (be intimate with) seventy girls in one day he responded: 'He would be given the strength of one hundred men!'<sup>3885</sup>

*Muhammad* eventually died from the over-exertions that were a part of his satyriasis sexual addition. *Muhammad* was nearly always in the mood for sex and he had to have sex no matter how risky. For instance:

☉ *Muhammad* had unsafe sex with war captives the night of their capture not knowing whether they had any venereal disease that he did not already have.

☉ *Muhammad* had sex with war captives in his tent the very night of their capture despite the risk of one of them being another Jael. Jael drove the tent peg through Sisera's head as he slept (Jdg 04:21). For instance, *Muhammad* slept with the Jewish captive Safiya the very evening *Muhammad* tortured and beheaded her husband Kinana, which was after her two brothers had been killed by *Muslims*.<sup>3886</sup> Unbeknownst to *Muhammad*, a follower, *Abu Ayyub*, took the initiative to guard *Muhammad's* tent one night as he slept with the Jewish captive Safiya. *Ayyub* explained to *Muhammad* the next morning:

I was afraid for you with this woman [Safiya] for you have killed her father [plus brothers], her husband [Kinana] and her people, and until recently she was in unbelief, so I was afraid for you on her account.<sup>3887</sup>

☉ *Muhammad's* favorite wife *Aisha* said that if she died, *Muhammad* would put her in the grave then proceed to have sex with another wife that very night.<sup>3888</sup>

*Aisha*, the prophet's wife, said: 'The apostle returned from the cemetery to find me suffering from a severe headache and I was saying 'O my head!' He said 'Nay *Aisha*, O my head!' Then he said [creepily],

<sup>3885</sup> Serene, *Ibn. Kitab ul Isra'a wal Mu'raj*, quoted in Caner. *Unveiling*, p. 193.

<sup>3886</sup> Gilchrist. *Prophet*, "4. Evaluating *Muhammad's* Many Marriages."

<sup>3887</sup> Ishaq. *Sirat*, p. 517.

<sup>3888</sup> Ishaq. *Sirat*, pp. 678-679.



‘Would it distress you if you were to die before me so I might wrap you in your shroud and pray over you and bury you?’ I [Aisha] said ‘Methinks I see you, if you had done that [i.e. buried Aisha], returning to my house and spending a bridal night therein with one of your [surviving] wives.’<sup>3889</sup>

C Carl Brockelmann wrote:

Although he was not more than sixty years at the most, his strength had waned considerably during the hardships of the past years and through the excess of pleasure taking in the *Harem*.<sup>3890</sup>

C *Muhammad* was in intense pain but kept making the rounds with his wives until he collapsed and then died a few days later. *Ibn Ishaq* wrote:

...his pain overcame him as he was going the round of his wives [having sex], until he was overpowered in the house of Maymuna. He called his wives and asked their permission to be nursed in my [Aisha’s] house and they agreed.<sup>3891</sup>

What did *Muhammad* claim he gained from using a Venus altar? Evidently, *Muhammad* thought that *Allah* gave him sexual potency through the *Mihrab* altar, as the *Koran* states:

To thee have We [*Allah*] granted the Fount [of fertility]? Therefore pray to your Lord and make a sacrifice. Lo! It is your insulter (and not you) who is sterile (*K* 108:001-003).

*Allah* made *Muhammad*’s “genitals like those of donkeys” and his “emissions were like that of horses” (*Eze* 23:20).

Since *Muhammad* was nearly infertile during his entire prophetic career, *K* 108:001-003 ought to be considered a false prophecy, similar to the false prophecies in *1Ki* 22:11-13 and *Jer* 28:10-14. The “insulter” was the one who said *Muhammad*’s “tail has been cut off,” meaning *Muhammad* had no male heir, as was noted above.

Serge Trifkovic wrote about *Muhammad*’s sexual escapades:

According to Bukhari, *Muhammad* sometimes had sex with all his wives in one night, and at that time he had nine wives, and he once said of himself that he had been given the power of forty men [*Sahih Al Bukhari*, vol. i, no. 268; vol. vii, no. 142].<sup>3892</sup>

The Spaniard Alvarus Paulus (flourished 854 AD) wrote:

...In their disturbing teachings, these ones [that is, the *Muslims*] recount and babble, as if proclaiming something noble, that this pimp of theirs, preoccupied with the activity of seduction, had obtained the power of *Aphrodite* [the Greek Venus] in excess of other men; that he had received, as a gift from his god [*Allah*], a more abundant ‘will of Venus’ than others; that he had a greater quantity of [seminal] liquid for his foul activities than the rest; that he could distribute this fluid with less effort than could other men; and that he had been given the endurance in *Coitus* and indeed the abundance of more than forty men for exercising his lust for women. The foul, fertile abundance of his rank loins [came] not from God, the begetter of all things, as this most evil robber dreamed, but from Venus, the ridiculous mate of *Vulcan*, that is, from the wife of fire. She

<sup>3889</sup> Ishaq. *Sirat*, pp. 678-679.

<sup>3890</sup> Brockelmann. *Peoples*, p. 35.

<sup>3891</sup> Ishaq. *Sirat*, pp. 678-679.

<sup>3892</sup> Trifkovic. *Sword*, p. 163.

is called *Afrodin* [*Aphrodite*] on account of this foamy liquid [Venus was thought to have been born of sea-froth and semen] and it is to her that venereal activity is ascribed. This shameless one [*Muhammad*] called her *Alkaufeit*. Excellent praise indeed! What an elegant gift of great carnality.<sup>3893</sup>

Ali Dashti wrote on the same subject:

*Qadi* ‘Ilyad (476 [AH]/1088-1149), an *Andalusian* [*Muslim Spain*] judge (Arabic: *Qadi*), theologian, poet and genealogist, wrote a book in praise of the Prophet entitled *Ketab Osh-shefa Be-ta’rif Hoquq Mostafa*... On the purported authority of the Prophet’s servant and prominent traditionalist Anas b. Malek, *Qadi* ‘Iyad credits the Prophet with a miraculous sexual potency which enabled him to have daily intercourse with all his eleven wives and reputedly equaled the potency of thirty ordinary men. Again claiming the authority of Malek b. Anas, *Qadi* ‘Iyad makes the Prophet say ‘I have four superiorities over other men: generosity, courage, frequency of copulation and frequency of *Bats’h*’ (an Arabic word meaning to strike down an enemy).<sup>3894</sup>

### **Muhammad Overcompensated for His Infertility**

*Muhammad* bragged about his sexuality potency but then felt it necessary to intimate that he had the sex organ to match that potency. He did this with big talk and large phallic symbols. Far from being a distraction to his “ministry” among the Arabs, *Muhammad* knew phallic symbols would bring in new converts. Ameer Ali wrote that his type of religion was common in the Mideast:

The composite race created *Babylon* and gave birth to a form of religion which, in its higher phases, was akin to natural pantheism. In its lower phases, with its pan-daemonism, its worship of the sun-gods [and Jupiter] and moon-gods, closely associated with the phallic cult and sexual instincts, the sacrifice of children to *Baal* and *Moloch*, of virginity to *Beltis* and *Ashtoreth*.<sup>3895</sup>

The pre-Islamite Arabs had their groves, their oracle-trees and their priestesses, like the Syro-*Phoenicians*. Phallic worship was not unknown to them; and the generative powers received adoration, like the hosts of heaven, under monuments of stone and wood.<sup>3896</sup>

Another reason for the phallic symbols was *Muhammad* had to overcompensate sexually to counter the *Al Abtar* label—a label discussed earlier in this chapter. *Muhammad*’s opponents even called him “womanish.”<sup>3897</sup> If *Muhammad* let on that he really was impotent, his Arabian prophet career would have been finished. Heightened sexuality to the Arabs was a sign of God’s favor, as Ameer Ali wrote:

With savage bitterness the enemies of the Prophet applied to him the nickname of *Al Abtar* on the death of his last son. The word literally means ‘one whose tail [a euphemism for the phallus] has been cut off.’ Among the ancient Arabs, as among the *Hindus*, a male issue was regarded as the continuation of the blessings of the gods; and the man who left no male issue behind was looked upon as peculiarly unfortunate. Hence the bitter word applied to the Prophet (*K* 108, the *Kashshaf*).<sup>3898</sup>

<sup>3893</sup> Wolf. *Antichrist*, p. 9.

<sup>3894</sup> Dashti. *Career*, p. 66.

<sup>3895</sup> Ali. *Spirit*, p. xix.

<sup>3896</sup> Ali. *Spirit*, p. 139.

<sup>3897</sup> Dozy, *Histoire des Musulmans d’Espagne*, v. i, p. 32, quoted in Ali. *Spirit*, p. 61.

<sup>3898</sup> Ali. *Spirit*, p. 237 & fn. 2.

### The Sword As a Phallic Symbol

One phallic symbol *Muhammad* utilized was holding his sword in a suggestive manner with his right hand while standing preaching next to the Venus *Mihrab* altar. This pose with a sword held in the right hand is pictured on later “Standing *Caliph*” coins which will be discussed next.

Notably, the word *Mihrab* is derived from the Arabic word for “spear.” Spears often served as an *Asherah* pole or *Sutra* pole—the outside version of an indoors *Mihrab*. Thus an *Imam* gives a sermon while holding a sword in a suggestive manner beside the *Mihrab* Venus altar—on Friday, no less, the Day of Venus. Etymologically, the sword and Venus altar thus complement each other well. They are sword-and-spear and sword-and-Venus altar *Lingam* and *Yoni* sex symbols.

Phallic customs had been embedded in Mideast culture since ancient times. For instance, the polygynists Abraham, Jacob and Solomon required that people take an oath by putting their hand, not on a Scripture scroll but on their thigh in the proximity of their phallus (YLT Gen 24:02, 09; 47:29; 1Ch 29:24).

Christianity rooted out polygyny along with many uncouth, phallic ceremonies since Christianity transforms every culture it encounters for the better.<sup>3899</sup> *Islamic* culture did not, as can be seen from the evidence gathered in this book.

*Muhammad* taught phallic customs such as *Muslims* are supposed to bless other people first by putting their hands on their thighs and then on the person blessed. *Muhammad* said:

This is enough for you that one should place one's hand on one's thigh and then pronounce salutation upon one's brother on the right side and then on the left.<sup>3900</sup>

*Muhammad* also prayed by putting his hands between his thighs.<sup>3901</sup>

*Islam* even enshrines a phallic customs by saying *Gabriel* practiced one such custom:

‘Umar said: ‘One day when we were sitting with the Messenger of God there came unto us a man whose clothes were of exceeding whiteness and whose hair was of exceeding blackness...He sat down knee unto knee opposite the Prophet, upon whose thighs he placed the palms of his hands, saying ‘O prophet, tell me what is the surrender (*Islam*)’...Then the stranger went away...and the Prophet said to me: ‘O Umar, knowest thou the questioner, who he was?...He said ‘It was *Gabriel*.’<sup>3902</sup>

The sword and sheath were *Lingam* (stylized phallus) and *Yoni* (stylized representation of a vulva) symbols long before *Muhammad*'s time. *Vagina* is in fact Latin for “sword sheath.” *Gladius* is Latin for “sword,” but was a slang word meaning “phallus.”

The *Koran* however was the main influence that led to *Imams* and *Caliphs* using swords as phallic symbols, at least until recent times. The practice may in fact continue in *Mosques* in out-of-the-way places that time forgot. *Muhammad* said that *Muslims* could have sex with captives of war:

<sup>3899</sup> Schmidt. *Influence*.

<sup>3900</sup> *Sahih Muslim*, bk. 004, no. 0866.

<sup>3901</sup> *Sahih Muslim*, bk. 4, nos. 1086+1088+1091.

<sup>3902</sup> Lings. *Sources*, pp. 330-331.

We [*Allah*] have made lawful to you...those whom your right hand possesses out of those whom *Allah* has given to you as prisoners of war (*K* 033:050 (twice) and 052).

For most persons, the right hand was used for wielding weapons such as swords. Since the *Koran* established the legal right to have sex with captives, the sword held in the right hand in a suggestive manner became a powerful phallic symbol. The traditions confirm the connection between captives of raids and the “right hand”:

*Muhammad* had dozens of them [slaves], both male and female, and he regularly sold, purchased, hired, rented and exchanged slaves when he became independently wealthy in *Madina* after *Badr* and the confiscation of Jewish property...as for the women, ‘whenever *Muhammad* took a woman as a captive, if he imposed the veil on her, *Muslims* would say he took her as a wife, but if he left her unveiled they would say ‘He owned her as a slave;’ that is, she became a property of his right hand.’<sup>3903</sup>

Therefore, what the *Imams* and *Caliphs* were saying by holding out a sword as a phallic symbol is that *Allah* did not expect *Imams* to be celibate, monogamous or even restrained in their sexuality. In fact, they were to preach *Jihad* as a means for procurement of sex, as Stortroen wrote:

He [*Muhammad*] proclaimed that the Lord gave the *Muslims* the *Hajj* and Holy War in exchange for monasticism.<sup>3904</sup>

That the *Imam*’s holding out a weapon indicates that *Muslims* ought to procure sex-slaves through *Jihad* seems to be confirmed by a modern-day example, except the *Imam* held up a gun instead of sword. The *Associated Press* reports from *Al-Hawi Mosque* in central *Basra*, in southern *Iraq*:

A senior aide of radical *Shia* cleric *Muqtada Al-Sadr* told worshippers during a Friday sermon in southern *Iraq* that anyone capturing a female British soldier can keep her as a slave...He held what he said were documents and photographs of three *Iraqi* women being raped at British-run prisons in *Iraq*...*Al-Bahadli* kept an assault rifle next to him as he spoke to an estimated 3,000 worshippers, occasionally lifting it as he screamed *Jihad!* and *Allahu Akbar!* or ‘God is greatest!’<sup>3905</sup>

Once *Imams* and *Caliphs* captured non-*Muslims* no legal niceties could keep them from having sex. The *Koran*, from which *Imams* read while holding the phallic sword, states that masters may have sex with their slaves whether the slaves were married or not (*K* 004:023-024; 023:005; 033:050; 070:030). The eleventh-century AD poet *Ibn Ammar* described a generous *Jihad* leader dividing up the loot in *Al Andalus* (*Muslim Spain*):

When he gives girls he gives the full-breasted ones, when he gives thoroughbred stallions he gives the shorthaired ones, when he gives swords he gives the jeweled ones.<sup>3906</sup>

Reading the *Koran* and holding the sword also meant that *Imams* were going to get their share of the loot whether they were at the head of the army of *Jihadists* or not. That is because, according to the *Koran*, legitimate treaties with non-*Muslims*

<sup>3903</sup> Trifkovic. *Sword*, p. 127; right hand (*K* 004:003; 016:071; 024:058; 030:028; 033:050, 052).

<sup>3904</sup> Grunebaum. *Festivals*, p. 44, as quoted in Stortroen. *Makka*, p. 20.

<sup>3905</sup> “*Al-Sadr’s Basra Aide Offers Rewards*,” news.yahoo.com, 7 May 2004.

<sup>3906</sup> Nicolle. *Moors*, p. 21.

could only be transacted in “the sacred *Mosque*” with representatives of the theocracy (*K* 009:007).

The sword-phallic symbol also had further connotations. Even if the captives were to be ransomed or sold into slavery, according to *Muhammad*, the *Imams* and *Caliph* captors were still within their rights to rape captives, and he said they need not practice *Coitus Interruptus* to reduce the chance of pregnancy.<sup>3907</sup>

Tradition suggests that the practice of holding a sword like a phallic symbol seems to extend back to *Muhammad*. The sources often mention *Muhammad* wearing a sword. Samuel Zwemer wrote that *Muhammad* had an underling *Khatib* (preacher), namely ‘Utarid *b.* Hajib. This preacher had a pulpit next to the *Kaaba* and he had a sword and whip in the *Minbar* pulpit:

In *Makka* he was once a very imposing figure, ascending the pulpit in black robe trimmed with gold and a tasseled turban; and accompanied ‘by two servants who carried banners and one who walked before him cracking a whip. After he had kissed the Black Stone, the chief *Muezzin* went quickly in front of him with the sword with which he girded him on the *Minbar* [i.e. the preacher put the sword on when he reached the pulpit]. A preacher with whip and sword and a pulpit at *Makka* and yet—‘there is no priesthood in *Islam*!’ [*Muslims* claim to have no clergy because *Muhammad* condemned Jews and Christians for elevating clergy “to be their lords in addition to *Allah*” (*K* 009:031)]. It is not generally known [Zwemer wrote this in 1946 AD] that in every *Mosque*, according to orthodox tradition, from West Africa to Western China [from the rise of *Islam* until lately], a sword or staff, is kept near or in *Minbar* and it is required that the *Khatib* hold it when preaching the Friday sermon. In some cases it is made of wood—but the symbol is always present.<sup>3908</sup>

If this *Makkan* preacher used the sword as a phallic symbol and kissed the Black Stone as though it were a sex object, perhaps the whip was meant as a sadistic sex symbol. After all, it is known that some *Imams* had large *Harems* that they found hard to control. *Muhammad* himself let his *Harem* get out of control, so that he had to deny them sex for a month<sup>3909</sup>—as if they cared after having FGM done to them. He also threatened to divorce them all if they did not do his bidding (*K* 066:001-005).

*Muslims* are incurable traditionalists, therefore it is not surprising that well over five hundred years later the precedents set by *Muhammad* and his *Khatib* underling were still being carried out. *Ibn Jubayr* wrote in 1183 AD:

When, on Fridays, the time of prayer approaches... Before him goes another of his people bearing a red staff, turned on a lathe, and having tied to its top a cord of twisted skin, long and thin, with a small thong at its tip. He cracks it in the air with so loud a report that it is heard both within the *Haram* [sacred area] and without, like a warning of the arrival of the preacher. He does not cease to crack it until they are near the pulpit. They call this whip the *Farqa 'ah*. Coming to the pulpit, the *Khatib* turns aside to the Black Stone, kisses it and prays before it. Then he goes to the pulpit, led by the *Zamzam Muezzin*, who is the chief of the *Muezzins* of the noble *Haram* and also dressed in black clothes. He bears on his

<sup>3907</sup> *Sahih Bukhari* vol. 003, bk. 034, no. 432; vol. 005, bk. 059, no. 459; vol. 007, bk. 062, nos. 135, 136; vol. 009, bk. 093, no. 506; *Sahih Muslim*, bk. 8, nos. 22, 29 & 3371; *K* 004:024; Spencer. *Disturbing*, pp. 50-51, 53; Trifkovic. *Sword*, p. 43.

<sup>3908</sup> *Ibn Battuta* by Pedersen, *Encyc. of Islam*, p. 372, as quoted in Zwemer. *Heirs*, ch. 4, pp. 42-43.

<sup>3909</sup> Lings. *Sources*, pp. 278-279.

shoulder a sword which he holds in his hand without girding it. The *Muezzin* girds the *Khatib* with the sword as he ascends the first step, which then, with the ferrule of his scabbard, he strikes a blow which all present can hear. He strikes it again on the second step and on the third. When he reaches the top step, he strikes the fourth blow and stands facing the *Kaaba* praying in low tones...He then sits down in the conventional sitting of the preacher and strikes with the sword [or rather, scabbard?] a fifth time.<sup>3910</sup>

In the above quote the *Khatib* preacher's banging the phallic symbol against the *Minbar* was meant to intimate that his "genitals were like those of donkeys" and his "emission was like that of horses" (Eze 23:20).

It is interesting to note that there is still an *Imam* of the *Kaaba* today. The current one, *Sheikh Abdur-Rahman Al-Sudais* [Sudayyis], is a notorious *Islamist*, *Jihadist* and raving anti-Semite. In 2002 *Sheikh* Sudayyis said that Jews were...

...the scum of the human race, the rats of the world...whom *Allah* cursed and turned into apes and pigs...These are the Jews, an ongoing continuum of deceit, obstinacy, licentiousness, evil and corruption...<sup>3911</sup>

Then in 2004 the *Imam* of the *Kaaba* turned up in London to dedicate a huge *Mosque*, where he said with the straight face:

'*Muslims* should exemplify the true image of *Islam* in their interaction with other communities and dispel any misconceptions portrayed in some parts of the media,' he said.<sup>3912</sup>

### Early Islamic Phallic Coins

The early *Caliphs* considered themselves to be the head spiritual authority of *Islam* and successors of the Prophet *Muhammad*. If the *Caliphs* did not preach the Friday sermon themselves, they sat or kneeled at the front of the *Mosque* near the *Kiblah* and the *Mihrab* in a low-walled area called the *Maksura*.

Since each *Caliph* was a part-time *Imam* and he headed up the theocracy, the *Caliph* struck the same pose as *Muhammad* and the *Imams* used. This meant holding a sword as though it were a giant phallus.<sup>3913</sup> It seems that the *Caliphs* and *Imams* followed each other's examples in other matters of sex too—as when both *Imams* and rulers maintained large *Harems* staffed by captured slave women.<sup>3914</sup>

The *Umayyad Caliph Abd Al Malik* reformed *Islamic* coinage by, for the most part, foregoing the use of human images around 695 AD. Perhaps, uncouth phallic images on coins had a part in rekindling the iconoclastic debates of the eight and ninth centuries among *Muslims*, Christians and Jews. The *Columbia Electronic*

<sup>3910</sup> Jubayr. *Travels*.

<sup>3911</sup> Solnick, Aluma. "Muslim Clerics State: The Jews Are the Descendants of Apes, Pigs, And Other Animals," *MEMRI*, , no. 11, 1 Nov 2002, *LGF*, 11 Jun 2004.

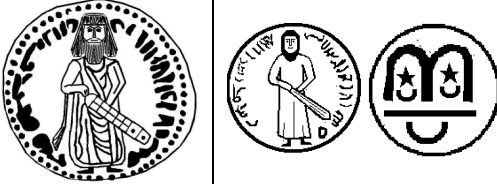
<sup>3912</sup> "New Muslim centre opens its doors," *bbc.co.uk*, 12 Jun 2004, *LGF*, 11 Jun 04.

<sup>3913</sup> Shraga Qedar wrote that the *Caliph 'Abd Al Malik's* right hand was "placed on a sword in the attitude prescribed for the *Imam* at the recitation of the public sermon—*Khutba*" (Shraga Qedar's article "Copper Coinage of Syria—The 7<sup>th</sup> and 8<sup>th</sup> Century AD," as found in Barag. *Balog*, p. 34, and plate 6, coins 19-23).

<sup>3914</sup> Zwemer. *Heirs*, ch. 4, pp. 45-46.

*Encyclopedia* states:

...in the 8th and 9th century. The [Christian iconoclastic] movement was paralleled by the iconoclasm of *Islam*, Judaism and Manichaeism...<sup>3915</sup>



**Figure 10-16.** Typical “Standing *Caliph*” coin (obverse & reverse sides).<sup>3916</sup> The sword is held in the manner prescribed for the *Khatib* [preacher] giving the *Khutba* [Friday] sermon—as though it were a phallic symbol.<sup>3917</sup>

**Figure 10-17.** Typical “Standing *Caliph*” coin with sword phallic symbol.<sup>3918 3919</sup>

Incidentally, Byzantine and *Muslim* traders used each other’s coins extensively. As one might expect, each side minted coins with propagandistic messages that irked the other side. The *Caliphs* may have been given over to boasting about their sexual prowess just as *Muhammad* was. Perhaps the phallic *Caliph* coins were meant to boast about the *Caliph’s* *Harem* since the Byzantine ceasar had no *Harems*.

Despite any iconoclastic controversies, *Imams* would not be deterred from using phallic symbols. Zwemer, writing in 1946 AD, notes that the widespread practice of the *Imams* holding a sword in the right hand extended down to his day:

The preacher sits in the *Minbar* and stands only for the delivery of the sermon. He must have a staff or a sword in his hand. Becker discusses the question [as to] why the preacher carries a staff or a sword. Some hold it was for his protection against unexpected attack from enemies. *Al Ghazali* in the *Ihya* (vol. i:130) says that the preacher holds the staff to prevent his gesticulating with his hand! There seems to be no question that the staff or sword was a necessary adjunct of the preacher from the earliest times. *Jahiz* [776-868 AD] is quoted as saying ‘As far as I am concerned, the preacher can mount the pulpit naked but he must have a turban and a staff,’<sup>3920</sup>

<sup>3915</sup> CEE, Iconoclasm entry.

<sup>3916</sup> Milstein, Rachel. “A Hoard of Early *Arab* Figurative Coins” as found in Barag. *Balog*, plate 6, coins 19-23. See also the images of ANS “Standing *Caliph*” coins such as 0000.999.15520, 1954.119.64, 1970.63.1, 1971.316.1100, 1991.3.163 and 1998.25.139.

<sup>3917</sup> Shraga Qedar wrote that the *Caliph* ‘*Abd Al Malik*’s right hand was “placed on a sword in the attitude prescribed for the *Imam* at the recitation of the public sermon—*Khutba*” (Shraga Qedar’s article “Copper Coinage of Syria—The 7<sup>th</sup> and 8<sup>th</sup> Century AD,” as found in Barag. *Balog*, p. 34, and plate 6, coins 19-23.

<sup>3918</sup> David Nicolle wrote in a caption under a picture of a “Standing *Caliph*” coin: “Gold dinar of the *Umayyad Caliph Abd Al Malik* (ruled 685-705 AD) made before a reform of *Islamic* money banned human representation from coins [circa 695 AD]. The bareheaded [meaning no *Kaffiya*] *Caliph* wears his hair long in the ancient Arab manner, has a long tunic, and carries his sword from a baldric [i.e. a sword belt slung over the sholder] (*Cab. des Medailles*, Bib. Nat. Paris)” (Nicolle. *Conquest*, p. 3, and picture). The photo of the “Standing *Caliph*” coin clearly shows the *Caliph’s* right hand on the sword handle, and his left hand is either on or behind the sword.

<sup>3919</sup> This illustrated coin depicts the *Umayyad Caliph Abd Al Malik* (685-705 AD). See the images of *Abd Malik* “Standing *Caliph*” coin at Nicolle. *Conquest*, p. 3. Standing *Caliph* coins can be seen online at the American Numismatic Society, accession numbers 0000.999.15520, 0000.999.19132, 1954.119.64 and 1971.316.1100, accessed Dec 2003.

<sup>3920</sup> Zwemer. *Heirs*, ch. 4, p. 37.

It is commendable, we are told, that the pulpit be an elevated place and that the preacher lean on a bow, a sword or a staff... They also point to the relation between the *Mohammedan* pulpit and the judge's seat in early Arabia; explain why the *Khatib* [preacher] must sit down between the two *Khutbas* [Friday sermons]; and also why he must lean on a staff, sword or bow, for these were the attributes of the old Arabian judge (Becker).<sup>3921</sup>

It is not generally known that in every *Mosque*, according to orthodox tradition, from West Africa to Western China, a sword or staff, is kept near or in *Minbar*, and it is required that the *Khatib* hold it when preaching the Friday sermon. In some cases it is made of wood—but the symbol is always present.<sup>3922</sup>

The bit about “the old Arabian judge” holding a sword may be conjectural, but there are plaques dedicated to a moon- and war-god—judging from the bucranium—that show devotees raising their right hand and holding swords in their left—one with a crescent-shaped pommel. There are also bronze statues dedicated to the moon- and war-god *Alumqah*, and most of them seem to have been holding swords or spears judging from the handholds. On one bronze, an inscription says it is the fourth bronze warrior dedicated to *Alumqah* from a certain devotee.<sup>3923</sup>

That the *Imam* was holding a large phallic symbol must have made it especially unpleasant to hear the *Imams* preaching in erotic verse, as Samuel Zwemer wrote:

Into the sermon he [the *Imam*] introduced compliments to the *Khalifah* [Caliphate] and his mother and prayers for them; he further recited many verses, some encomia [praise] on the sovereign, others of the *Sufi* erotic style, which affected the audience powerfully.<sup>3924</sup>

Significantly, the *Islamist* who beheaded Nick Berg in 2004 mentions *Imams* with swords engaged in *Jihad* battles. Joel Cohen translated and interpreted the Arabic introduction to the beheading video thus:

‘Are you not fed up with the *Jihad* of the conferences and the battles of giving sermons?’ the speaker said. ‘Has the time not come for you to lift the sword with which the master of the messengers was sent?’...Cohen continues: ‘This is a full call to arms: Lift the sword. The ‘master of the messengers’ refers to *Allah*, that is, in the [*Islamist*] writer’s mind all the messengers of the past were given the ability to fight the non-believers and so to the *Ummah* has it today.’<sup>3925</sup>

It is interesting to note that when *Muhammad* sodomized the idols, he used a sword and staff as phallic symbols. *Muhammad* had a “coat of mail and his helmet, he girt on his sword; but in his hand he carried a staff and his visor was up.”<sup>3926</sup> This point was discussed elsewhere.

That the sword was used: 1) as a phallic symbol and 2) to subdue infidels, led *Muslims* to think that sodomizing was also a legitimate means of subduing infidels. As Stephen O. Murray and Will Roscoe wrote:

<sup>3921</sup> Zwemer. *Heirs*, ch. 4, p. 41.

<sup>3922</sup> Zwemer. *Heirs*, ch. 4, pp. 42-43.

<sup>3923</sup> Simpson. *Sheba*, catalog 24 (fourth of four bronze warriors), 25, 124 (alabaster plaque showing devotee with raised right hand and crescent-shaped pommel in left), 125, pp. 59-60, 117.

<sup>3924</sup> Zwemer. *Heirs*, ch. 4, pp. 46-47.

<sup>3925</sup> “Berg video called how-to-kill demo: Translator-expert sees *Jihadist* message to *Muslims* worldwide,” WorldNetDaily.com, 17 May 2004.

<sup>3926</sup> Lings. *Sources*, p. 120.



Some [*Muslims*] (such as *Abu Nuwas* [died 195 AH/810 AD] and the [*Madinan*] jurists of the *Maliki* school rationalized the practice of making non-believers submit to penetration [sodomizing] by believers [*Muslims*] as a means of glorifying the superiority of *Islam*—a duty for *Muslims* rather than as a sin.<sup>3927</sup>

The *Maliki* school of jurisprudence in *Madina* was founded by *Malik Ibn Anas, Abu Abd Allah* (94-179 AH/716-795 AD). The *Maliki* school is followed in *Algeria, Tunis, Morocco, Mauritania, Libya, Kuwait, Bahrain, Dubai* and *Abu Dhabi*. It is no wonder that these countries have been nearly entirely *Muslim* since Medieval times since non-*Muslims* fled for fear of being sodomized—among other reasons.

### **Muhammad's Turban Was a Phallic Symbol**

The moon-gods such as *Sin* all wore turbans—often with two or more horns off to the side, or a crescent planted on top.<sup>3928</sup> Besides being the symbol of *Sin*, the turban was a not-so-subtle phallic symbol. Traditions confirm that *Muhammad* wore a turban, as when *Bukhari* records a *Hadith* narrated by *Ja'far Bin 'Amr*:

My father said 'I saw the Prophet passing wet hands over his turban and *Khuffs* (leather socks)' (*Sahih Bukhari*, vol. i, bk. 4, no. 204).

The Biblical prophet *Ezekiel* writes that the *Babylonian* chariot officers that were painted on walls in vermilion (red) had flowing turbans and belts. *Ezekiel* then contrasts this with hardcore pornography—the rather graphic image of Egyptians with private parts as big as those of donkeys (Eze 23:15-20).

*Ezekiel* seems to say that the flowing turbans were the soft porn equivalent of the hardcore porn, or in other words, the turbans were phallic symbols. To be more specific, the turban represents the foreskin or prepuce of the phallus, and the person wearing the turban represents the phallic shaft. This was in keeping with widespread use of phallic columns in all sizes found all over the ancient world.

It seems the *Sufis* and others made the turban into an obvious *Lingam* and *Yoni* symbol by having a suggestive foot-long pole with a rounded end project upward from the turban.<sup>3929</sup>

*Imams* wore turbans, especially in the pulpit, as *Zwemer* wrote:

Among the *Shi'ahs* it is ordained that the preacher shall wear a turban and the striped *Yemen* cloak. The *Umayyads* used to robe the preacher in white but in *Abbasid* times he wore black.<sup>3930</sup>

The preacher sits in the *Minbar* and stands only for the delivery of the sermon. He must have a staff or a sword in his hand...*Jahiz* [776-868 AD] is quoted as saying 'As far as I am concerned, the preacher can mount the pulpit naked but he must have a **turban** and a staff.'<sup>3931</sup>

Incidentally, a *Kaffiyah* cloth head covering and a Turkish *Fez* do not appear to be phallic symbols.

<sup>3927</sup> Murray. *Culture*, p. 304.

<sup>3928</sup> Larousse, *Sin* entry, p. 56.

<sup>3929</sup> Illustration from a manuscript of the *Divan* of *Hafiz* made for the *Safavid* Iranian prince *Sam Mirza* (1526-1527 CE)" (Blair & Bloom. *Paradise*, pp. 61, 107, image 46a). Also, see *Fani. Sufis*, illustration on the book cover jacket.

<sup>3930</sup> *Zwemer. Heirs*, ch. 4, p. 37, fn. 10.

<sup>3931</sup> *Zwemer. Heirs*, ch. 4, p. 37.

### **Muhammad's Palm Trunk Phallic Symbol**

It was discussed earlier that *Muhammad's* staff (also called a *Sutra* pole) served as a phallic symbol when he sodomized the 360 idols at the *Kaaba*. One of *Muhammad's* spears served as an *Asherah* pole that symbolized Venus and was another outside substitute for the Venus-altar *Mihrab*. Similarly, at his *Mosque* in *Madina*, *Muhammad* used a sawed off palm tree trunk as an additional phallic symbol.

A previous chapter mentions how the palm tree's date-bearing sheath and the pollen-bearing *spadix* (*K* 006:099, 141; 026:148; 050:010; 055:011) were associated with human sexuality (see semen, sheath, spadix and sperm in the Index). One *Muslim* lexicographer even compared the color and smell of palm pollen to human semen.<sup>3932</sup>

Given the just-mentioned facts, *Muhammad* must have thought that phallic energy was latent in the palm trunk and rubbing and embracing the trunk would release that sexual energy into humans.

Gibb and Kramers wrote about the palm stump and how *Muhammad* had his sex palace built right abreast the *Madinan Mosque*:

On the east side two huts of similar materials were built for the Prophet's wives Sawda and 'A'isha; their entrances opened on to the court and were covered with carpets; they were later increased so that there were nine little houses for the Prophet's wives...On the south side, later the *Kiblah* side, an arbor [open place for trees] was probably built also, for the Prophet used to preach leaning against a palm trunk and this must have been on the *Kiblah* side.<sup>3933</sup>

Zwemer wrote that while preaching...

...the prophet was accustomed to lean against a palm-stump.<sup>3934</sup>

...the pulpit took the place of the palm trunk against which *Mohammed* used to lean and which lamented when he abandoned it.<sup>3935</sup>

Evidently, *Muhammad's* escapades with his wives left him too exhausted to stand up without support, so he had to lean against a palm trunk. Making the marital rounds also left *Muhammad* too little energy and time to learn how to read. After all, *Muslims* assert that *Muhammad* was illiterate.

The way the *Koran*, *Hadiths* and *Muhammad's* biographies read, one can expect that *Muhammad's* palm stump thumping sermons were salacious and prurient. His sermons advised *Muslims* to try different sexual positions. *Muhammad* said:

Your women are your fields—plow them however you want (*K* 002:223).

*Muhammad's* sermon props included wearing clothes with spots of semen. As was quoted earlier in this chapter, Aisha said:

I used to wash the semen off the clothes of the Prophet and even then I used to notice one or more spots on them (*Sahih Bukhari*, vol. 1, bk. 4, no. 233).

I used to wash the traces of *Janaba* (semen) from the clothes of the Prophet and he used to go for prayers while traces of water were still on it [water spots were still visible] (*Sahih Bukhari*, vol. 1, bk. 4, no. 229).

<sup>3932</sup> Lecker. *Arabia*, XII:563-564.

<sup>3933</sup> Gibb & Kramers. *Encyclopedia*, p. 331, *Masjid* entry.

<sup>3934</sup> Zwemer. *Heirs*, ch. 4, p. 36.

<sup>3935</sup> Zwemer. *Heirs*, ch. 4, pp. 35-36.

*Muhammad* gave his sermons while leaning on a phallic symbol palm stump. Unfortunately, *Muhammad* did more than just lean against the stump:

The Prophet used to deliver his sermons while standing beside a trunk of a date palm...the Prophet went to it [the trunk], rubbing his hand over it... (*Sahih Bukhari*, vol. 4, bk. 56, no. 783).

The Prophet descended (the pulpit) and embraced it [the trunk] (*Sahih Bukhari*, vol. 4, bk. 56, no. 784).

So the prophet treated the phallic symbol stump similar to how he treated the Black Stone—by caressing and embracing it.

*Muhammad's* phallic worship should have raised some eyebrows if it were not for the fact that phallicism was common nearly everywhere outside of Christendom—from the British Isles to India to *Thailand*. A phallus was carried in Greek and Roman *Dionysian* processions. *Hindus* had their *Lingam* and *Yoni*.

Phallic columns could be found dotting many ancient landscapes in order to promote fertility in humans, animals and crops. The Latin god *Priapus* (Greek: *Priapos*) was used as a combination phallic column and scarecrow in gardens and vineyards.<sup>3936</sup>

Most of the pagan Arabs of *Muhammad's* day were by no means above phallicism. In fact, some *Makkans* were not even above animism and cannibalism. *Kuraish* women wanted to drink wine out of their enemies' skulls.

Some *Makkan* women actually cut the nose and ears off *Muhammad's* uncle Hamza and used them to make anklets and collars—necklaces that hug the neck. A woman named Hind actually cut out Hamza's liver and chewed it.<sup>3937</sup> Alfred Guillaume remarks on this:

This seems to be a survival of prehistoric animism. By devouring an enemy's liver it was hoped to absorb his strength.<sup>3938</sup>

*Muhammad* and his followers were not above mutilating their enemies and *Allah* said that any mutilation done out of retaliation was ethical but not mandatory. Ishaq wrote that *Muhammad* vowed:

If God give me victory over [the] *Quraysh* in the future I will mutilate 30 of their men.

The *Muslims* vowed similarly:

By God, if God gives us victory over them in the future, we will mutilate them as no Arab has ever mutilated anyone.<sup>3939</sup>

When the Arabs conquered more civilized lands, they became somewhat more sophisticated. Then *Muslims* became embarrassed by some of the uncouth practices that *Muhammad* followed but still they did not disavow these practices. For instance:

☉ Christians noted that *Muslims* kissed passionately and rubbed (i.e. masturbated) the Black Stone betyl in its vulviform case.<sup>3940</sup>

☉ *Caliph* Umar said that he saw no benefit in kissing the Black Stone but nevertheless, he kissed it anyway on account of the example that *Muhammad* set (*Sahih Al Bukhari* 002:667, 675, 676, 679, 680).

<sup>3936</sup> EB, "Priapus & Priapea" entry, accessed 18 Apr 2004.

<sup>3937</sup> Guillaume. *Islam*, p. 385.

<sup>3938</sup> Guillaume. *Islam*, p. 385, fn. 1.

<sup>3939</sup> Guillaume. *Islam*, p. 387.

<sup>3940</sup> Sahas. *Heresy*, pp. 88-89.

Of course the traditions do not forthrightly admit *Muhammad's* phallicism since all this material was edited out and lost. The editor *Ibn Hisham* (died in 828 or 833 AD/213 or 218 AH) even admitted that he omitted many interesting details from *Ibn Ishaq's* biography of *Muhammad*. Hisham wrote:

...things which it is disgraceful to discuss; matters which would distress certain people...all these things I have omitted.<sup>3941</sup>

Therefore, it is not surprising that in the traditions *Muhammad's* primitive phallic beliefs and practices are explained away. The *Hadiths* record that *Muhammad* merely rubbed (i.e. masturbated) and embraced the palm trunk when it whimpered after *Muhammad* began preaching at a distance.<sup>3942</sup> The traditionists would rather say that *Muhammad* was a grief counselor to a tree stump than admit *Muhammad* believed in phallicism!

**Figure 10-18.** *Muhammad* in a *Mosque* among some of his sex symbols. How many can you find? The phallic symbols include: 1) a palm tree stump, 2) a sword, either sheathed hanging on a baldric belt or held in a suggestive position,



3) a *Sutra* pole, 4) turbans, 5) an *Asherah* spear and 6) the *Muslim* men in a *Rakah* “foreplay and oral sex” position. The entire *Mihrab Venus* altar with a *Mosque* lamp in a lunette is stylized and vulviform. The *Lingam* and *Yoni* symbols are: 1) the *Venus* orb and crescent-moon couplet symbols on the wall and *Mihrab* lamp and 2) the worshipper making the *Sign of Tanit* (*Venus*) by forming a crescent and *Venus* orb with his arms and head in a *Rakah* position.<sup>3943</sup>

Someone might ask why early *Islamic* traditionists would sanitize accounts about *Muhammad* and his phallic palm trunk rather than just not mention the palm trunk at all. The traditionists felt they had to manufacture some story because the stories about *Muhammad* and his phallic palm trunk never stopped circulating. Pilgrims to *Madina* expected to see the palm trunk, as when a *Muslim* pilgrim *Ibn Battuta* wrote in 1326 AD that he...

...reverently touched the fragment that remains of the palm-trunk against which the Prophet stood when he preached.<sup>3944</sup>

<sup>3941</sup> Ishaq. *Sirat*, p. 691, “*Ibn Hisham's* Notes.”

<sup>3942</sup> Zwemer. *Heirs*, ch. 4, pp. 35-36.

<sup>3943</sup> All the sex symbols listed in the caption are discussed in this chapter.

<sup>3944</sup> Battuta, *Ibn. Travels in Asia and Africa (1325-1354)*. H. A. R. Gibb (translator and editor), Broadway House, London, 1929, pp. 74-77.

Incidentally, the scholar Carleton Coon wrote that he knew that *Muslim* traditionists obfuscated history too:

*Muslims* are notoriously loath to preserve traditions of earlier paganism and like to garble what pre-*Islamic* history they permit to survive in anachronistic terms.<sup>3945</sup>

### The Irony of It All

While *Muhammad* tried to practice satyriasis as much as possible, he did suffer periods of impotence and one such bout lasted an entire year.<sup>3946</sup> Perhaps intermittent periods of sexual dysfunction led *Muhammad* not to reject the pagan *Lingam* and *Yoni* paraphernalia just as *Muhammad* adapted for *Islamic* use other pagan objects and rituals that he found to be useful.

*Muhammad's* favorite wife Aisha related that while *Muhammad* was in *Madina*:

Magic was worked on *Allah's* Apostle so that he used to think that he had sexual relations with his wives while he actually had not (*Sahih Bukhari*, vol. 7, bk. 71, no. 660; also vol. 4, bk. 54, no. 490).

Interestingly, some *Makkan* critics early on in *Muhammad's* career thought *Muhammad* was “bewitched” (*Yusuf Ali K* 017:047).

Evidently, one of *Muhammad's* bouts of impotence drove Aisha into a tryst with a man named Safwan. ‘Ali Dashti wrote:

It is of course possible that ‘A’esha’s womanly feelings had been so hurt and incensed by the appearance of a rival that she deliberately either sinned or staged the adventure as a warning to her husband. Certainly there is difficulty in believing that when her *Howdah* was lifted onto the camel, nobody noticed that it was too light [meaning that Aisha was not in it]. Several more questions spring to mind. Why did not *Muhammad*, who was so fond of ‘A’esha, ask whether she was all right before the caravan set off? How could ‘A’esha have been so unaware of the departure preparations of several hundred *Muslim* warriors that she failed to get herself back to the caravan on time and was left stranded in the desert until Safwan found her? Although Safwan’s task was to ride some way behind when the caravan was in motion, would not he have caught up with it when it next had to halt to rest the men and the animals? The story of Safwan’s sudden appearance and rescue of ‘A’esha quite a long time after the caravan’s departure does not seem true to fact nor logically coherent. *Prima facie*, the evidence suggests that ‘A’esha stayed behind [the caravan] in collusion with Safwan.<sup>3947</sup>

Though the *Shia* Ali Dashti sounds noncommittal about what actually occurred, some *Shias* believe that Aisha committed adultery. This makes *Sunnis* angry and they say:

...they [*Shias*], who curse the Prophet’s wives and accuse [the Prophet’s wife] ‘Aisha of prostitution?<sup>3948</sup>

<sup>3945</sup> Coon. *Southern*, p. 398.

<sup>3946</sup> Ishaq. *Sirat*, p. 240, fn. 1.

<sup>3947</sup> Dashti. *Career*, p. 130.

<sup>3948</sup> “*Shi’a* Threat to *Sunni* Islamists No Less than the ‘Judeo-Christian’ Threat,” SDS: *Jihad and Terrorism Studies*, *MEMRI*, 2 May 2003, no. 498.

The most plausible explanation of why Aisha went off into the night with Safwan was that Aisha was interested in the sex with Safwan. Safwan most likely was young while *Muhammad* was past his prime, as Ali Dashti wrote:

She [Aisha] was seven years old when she was betrothed and nine years old when she was married to the Prophet, the gap between them being more than forty years. Her age when he died in 11 AH/632 AD was sixteen or seventeen years.<sup>3949</sup>

While Safwan was young and in shape, *Muhammad* was also fat and out of shape. Lifting *Muhammad* up while he wore two coats of chain-mail was as meritorious a deed as becoming a martyr, according to his biographer, Ishaq:

The apostle made for a rock on the mountain to climb it. He had become heavy by reason of his age, and moreover he had put on two coats of mail [6 to 20 kilograms each], so when he tried to get up he could not do so. Talha b. ‘Ubaydullah squatted beneath him and lifted him up until he settled comfortably upon it...*Al-Zubayr* said: ‘That day I heard the apostle saying ‘Talha earned paradise when he did what he did for the apostle.’<sup>3950</sup>

Aisha was one of many wives and concubines. Aisha only received a fraction of the attention that the polygynist *Muhammad* could muster, which often was nothing owing to his impotency. It was true that *Muhammad* **boasted** of having sex with all his wives in one night,<sup>3951</sup> but Aisha thought *Muhammad* was pathetic. She explained that *Muhammad* said he had raging sex only because he was bewitched.<sup>3952</sup> Aisha said that for a long while *Muhammad* had no sex at all.

Aisha figured that while *Muhammad* was “shooting blanks,” so to speak, Safwan would help her produce a male heir for *Muhammad*. Aisha thought that since *Muhammad* was under a spell that made him think he was having unbridled sex with all his wives, he would never suspect that the child was not his. The cuckolded *Muhammad* would be none the wiser when she became pregnant, and she would be queen.

### **Aisha Got the Idea of Surrogate Parenting From Muhammad**

Aisha got the idea of bearing an heir for *Muhammad* by another man from *Muhammad* himself. *Muhammad* was desperate to produce a male heir not only to affirm his own self-esteem but to silence his critics who called him *Al Abtar*, as was discussed earlier in this chapter.

Evidently, *Muhammad* knew that he was shooting blanks so he hoped that some of his wives and concubines were already pregnant by their just deceased husbands. He then would claim the progeny as his own. *Muhammad* may have come with this idea after hearing the account of David, Bathsheba and Uriah the Hittite (2Sa 11:06-13). Bathsheba’s son was Solomon, who is mentioned prominently in the *Koran*.

*Muhammad*’s attempts at claiming paternity of another man’s child include:

- ☛ *Muhammad*’s wife, Zaynab I, was the wife of his adopted son Zayd.
- ☛ *Muhammad* married and had sex with Safiya on the very night that her husband Kinana was tortured and beheaded on *Muhammad*’s orders.<sup>3953 3954</sup>

<sup>3949</sup> Dashti. *Career*, p. 123.

<sup>3950</sup> Ishaq. *Sirat*, p. 383.

<sup>3951</sup> *Sahih Bukhari*, vol. i, no. 268 and vol. vii, no. 142.

<sup>3952</sup> *Sahih Bukhari*, vol. 7, bk. 71, no. 660; also vol. 4, bk. 54, no. 490.

<sup>3953</sup> Ishaq. *Sirat*, p. 515.

<sup>3954</sup> Muir. *Life*, vol. 4, pp. 70-71.

This scheme of claiming paternity of another man's child never worked for *Muhammad*, even though he had sex with about two dozen women that historians know of, at least three of whom were recently wives of other men. This number does not even count the slaves *Muhammad* had sex with, who are called "those whom" *Muhammad's* "right hand possessed" (*K* 033:050 (twice) and 052).

Just on the off-chance that one of his wives would become visibly pregnant after *Muhammad's* death, either by *Muhammad* or another man, *Muhammad* commanded that his wives not remarry after his death unless he granted them a divorce before he died.<sup>3955</sup> Divorces were not finalized for three months, meaning that *Muhammad* could still claim an heir from the divorcee during the waiting period (*K* 065:004).

If *Muhammad's* wives did not remarry, *Muslim* historians claim that a baby born to one of his wives was *Muhammad's* a full seven years after his death. *Muhammad* knew that if any of his widows became pregnant out of wedlock she would claim that the baby was *Muhammad's* in order to avoid being flogged or stoned.

One might ask "How could *Muhammad* become a father up to seven years after he died without modern science?" *Sharia* law contains the laughable "Sleeping Fetus" provision. *Sharia* law jurists believed that the "Sleeping Fetus" gestation period could last up to seven years.<sup>3956</sup> The *Hanifa* school of *Islam* however stipulates that the maximum is two years, as Sanusi Lamido Sanusi (*Sic*) wrote:

*Abu Hanifa* places the bar at two years based on an opinion expressed by Aisha, the wife of the Holy Prophet.<sup>3957</sup>

If one of *Muhammad's* wives bore a child after his death, then *Muhammad's* legacy would be spared this bit of odium about his chronic infertility. Such was the state of *Islamic* morality that *Muhammad* was unconcerned about his reputation as a butcherer of Jews, but he was concerned about whether he fathered any princes and and princesses after becoming "King of the *Hijaz*."

### Repercussions of Aisha's One-night Stand

When the tryst between Safwan and Aisha became common knowledge, *Muhammad* and his associates concocted a story mostly to save *Muhammad's* reputation. *Muhammad* was already ridiculed for being heirless, therefore his career would have been over if it became public that *Muhammad* was both cuckolded and impotent.

*Muhammad* nearly was the victim of paternity fraud. For this reason he put a corrective in the *Koran* that women who accept *Islam* must swear not to tell such lies, as 'Ali Dashti wrote:

After the *Muslim* conquest of *Makka*, a large delegation of *Makkan* women went to the Prophet to swear allegiance and profess *Islam*. This was the occasion of the revelation of verse 12 of *Sura* 60 (*Ol-Momtahana*), which made their admittance to *Islam* conditional on their belief and behavior: 'O Prophet, when believing women come to you swearing allegiance to you, (it must be) on condition that they shall not engage in adultery and prostitution, shall not kill their children, shall not tell the slanderous tales which they invent about what is

<sup>3955</sup> Dashti. *23-Years*, p. 128.

<sup>3956</sup> Peters, Ruud. "Islamic Law in Nigeria," *Hauser Global Law School Program* (NYU), law.nyu.edu/magazines/autumn02/LSMGGLOB03.pdf, Autumn 2002, p. 85.

<sup>3957</sup> Sanusi, Lamido Sanusi. "Amina Lawal: Sex, Pregnancy and *Muslim* Law," Niger Delta Congress, nigerdeltacongress.com/articles/amina\_lawal.htm, Sep 2002.

between their arms and their legs (i.e. make false allegations about the paternity of expected children)...<sup>3958</sup>

The one-night stand did not go as planned because Aisha was spotted with Safwan. When Aisha got back to *Madina* she immediately became ill for about twenty days. This sickness suggests that Aisha took an abortifacient to ensure that if she were pregnant she would not bring Safwan's baby to term and embarrass *Muhammad* further.

This may explain why Aisha never did have children by *Muhammad* since abortifacients often leave women sterile. Then again, her childlessness may have been caused by:

- ☉ The physical and emotional trauma of having sex with *Muhammad* when she was only nine, or
- ☉ A sexually transmitted disease passed by *Muhammad* that rendered most of his sex partners infertile and caused some to have miscarriages (as will be discussed in the Moon-o-theistic drug chapter).

Abortion is a common subject in the *Hadiths*.<sup>3959</sup> Medicinal abortions were common long before *Muhammad*'s time, as Alvin Schmidt wrote:

...administering medicinal potions was a common way of inducing abortions among the Greco-Romans.<sup>3960</sup>

There were several plants known to have abortifacient properties including tansy, pennyroyal, hemlock and Savin-tops (*Juniperus Sabina* conifer).<sup>3961</sup> *Muhammad*'s biographer, *Ibn Ishaq*, mentions one abortifacient plant, the Willdenow:

Ya'qub *b.* 'Utba told me that he was informed that that year [the "Year of the Elephant" when *Muhammad* was born] was the first time that measles and smallpox had been seen in Arabia; also that it was the first time that bitter herbs like rue, colocynth and *Asclepias Gigantea* [Willdenow] were seen.<sup>3962</sup>

The *King's American Dispensatory* notes:

...*Asclepias Gigantea*, Willdenow...Habitat: East Indies and South India...Shrubs yielding *Mudar*-bark...the bark has a bitter, acrid, mucilaginous taste...the dry juice is said to be used in India as an abortivant and to destroy female babies.<sup>3963</sup>

This seems to explain why *Muhammad* according to tradition had to put a stop the killing of female babies for no other reason than that they were not boys.

The Willdenow preparation may have been produced locally since Ishaq says Willdenow grew in Southern Arabia. If the preparation was made in India, this does not preclude its use in Arabia since the Arabs were middlemen merchants for all sorts of trade between India, the Mediterranean and the Fertile Crescent. Moreover, *Muhammad* even recommends using an Indian herbal preparation:

I heard the Prophet saying 'Treat with the Indian incense ([*Ud Al Hindi* aloeswood], for it has healing for seven diseases; it is to be sniffed by one having throat trouble, and to be put into one side of the mouth of one suffering from pleurisy' [disease of the lungs]. Once I went to *Allah*'s Apostle with a son of

<sup>3958</sup> Dashti. *Career*, p. 119.

<sup>3959</sup> Search on "abort" and "abortion" in an online *Hadith* collection.

<sup>3960</sup> Schmidt. *Influence*, p. 57.

<sup>3961</sup> Felter. *Dispensatory*, "*Sabina* (U. S. P.)—*Savine*" entry.

<sup>3962</sup> Ishaq. *Sirat*, p. 27.

<sup>3963</sup> Felter. *Dispensatory*, "*Asclepias Incarnata*—Flesh-Colored *Asclepias*" entry.



mine who would not eat any food and the boy passed urine on him whereupon he asked for some water and sprinkled it over the place of urine.<sup>3964</sup>

The *Koran* chronicles how infant girls were killed *Post Partum* but the *Koran* does not mention that the babies likely were poisoned first:

When a daughter is announced to one of them his face becomes black and he is full of wrath. He hides himself from the people because of the evil of that which is announced to him. Shall he keep it with disgrace or bury it in the dust? Now surely evil is what they judge (*K* 016:058-059).

*Muhammad* did not want to make an issue out of Aisha's tryst since that would expose him to ridicule over his sexual impotence and his having been cuckolded. Therefore, after he was assured that Aisha was not pregnant, he had a most convenient revelation wherein *Allah* himself attested to Aisha's innocence.

In order to legally clear Aisha's name, *Muhammad* legislated that in order to convict someone in court of adultery or rape, four impeccable male witnesses were needed (*K* 024:004, 013). The reason the number was set at four was that only Safwan and Aisha knew what really happened between them. Also, there were only three male ringleaders who spread the rumor (or truth) about Aisha's affair. Robert Spencer wrote:

*Muhammad* demanded four witnesses [to prove rape] in order to exonerate Aisha of adultery (see *K* 024:013 and *Sahih Bukhari*, vol. 3, bk. 52, no. 2661).<sup>3965</sup>

Incidentally, another scandal led *Muhammad* to change another longstanding custom so no one could say that he wrongfully married his adoptive son's wife. First, *Muhammad* had *Allah* approve of his marrying his adoptive son's wife, Zaynab (*K* 033:037). Then he had *Allah* say that *Muhammad* was not wrong but that the adoption custom was bad.

*Muhammad* had *Allah* say that adoptive sons ought to keep their familial name rather than change it (*K* 033:004-005). So, according to *Muhammad*, when he adopted Zayd bin Harithah, he should not have changed his name to Zayd bin (i.e. son of) *Muhammad*.<sup>3966</sup> Thus *Islam* does not allow adoption but only "Kefala, a type of guardianship in which children retain their original family identities."<sup>3967</sup>

The *Koran* states that if an accuser of rape cannot produce four witnesses, he is a liar (*K* 024:013). Since a woman's testimony is devalued by half, eight women witnesses would be required (*K* 002:282). So the three men who accused Aisha were deemed liars and received eighty lashes each.<sup>3968</sup>

This four-witness requirement has been a disaster for *Muslim* women since in *Muslim* societies, *Muslim* males can rape with near impunity. If a woman accuses a *Muslim* male of rape but cannot produce four male witnesses or eight female

<sup>3964</sup> *Sahih Bukhari*, vol. 7, bk. 71, no. 596; also see 611, 613 and 616, and *Sahih Muslim*, bk. 26, nos. 5487 and 5488.

<sup>3965</sup> Glazov, Jamie. "Islam Symposium Part III: The Right to Dissent, Comedy and the *Burqa*," *FPM*, 6 Mar 2003.

<sup>3966</sup> Shamoun, Sam. "Revisiting *Muhammad*'s Marriage to His Adopted Son's Divorcee, Zaynab *Bint Jash*," answering-*Islam.org*, accessed 28 Sep 2005.

<sup>3967</sup> Duin, J. "Christian orphans stuck in limbo in *Iraq*," *washingtontimes.com*, 22 Dec 2005, *DW*.

<sup>3968</sup> Ishaq. *Sirat*, pp. 494-497.

witnesses, her charge and testimony is recycled into an admission of adultery or perjury.<sup>3969</sup> Robert Spencer wrote:

Yet that has created a situation in which women who are raped are accused of adultery after the accused male denies the act. Sisters in *Islam*, a *Muslim* women's rights group, estimates that as much as seventy-five percent of the women who now populate *Pakistani* prisons are actually victims of rape.<sup>3970</sup>

In *Pakistan*, one woman was raped but she was sentenced to death by stoning for adultery. The judge said that her testimony about being raped was inadmissible as testimony in the rape because she could not produce four witnesses to back up her story. Her testimony was however admissible as a confession of having sex outside of marriage. *The New York Times* (17 May 2002) noted that this case fit "a familiar pattern."<sup>3971</sup> The "pattern" applies everywhere *Sharia* law is enforced, as *Reuters* reports:

*Islamic* courts in Nigeria sentenced two women to death by stoning for having sex out of wedlock, but two men whom they said they slept with were acquitted for lack of evidence, authorities said on Tuesday.<sup>3972</sup>

Since recourse to the law can easily backfire on women under *Sharia* law, it is not surprising that to avoid rape at all costs, *Muslim* women must resort to wearing concealing clothing and a *Hijab* head covering even in sweltering weather.

### The Bewitching of Muhammad

Gordon Newby wrote on the bewitching of *Muhammad*:

During *Muhammad's* lifetime, Jewish magicians are supposed to have cast a spell on *Muhammad*, rendering him impotent for a period of time.<sup>3973</sup>

*Muhammad's* biographer, *Ibn Ishaq* wrote:

From *Bani Zurayq* [a Jewish tribe at or near *Madina*]: Labid *b. A'sam* who bewitched the apostle of God so that he could not come at his wives.<sup>3974</sup>

Michael Lecker wrote that the desired effect of the witchcraft was:

...harming the Prophet's sexual potency. This is expressly said in the sources...<sup>3975</sup>

Guillaume wrote:

In commenting on this [*Muhammad's* impotence] Suhayli [died 1185 AD/581 AH] asserts that the tradition is sound and is accepted by the traditionalists. He found in the *Jami'* of Mu'ammara *b. Rashid*...the statement that **the spell lasted for a year**. He adds that the *Mu'tazili* and Modernists rejected the tradition on the ground that prophets could not be bewitched otherwise they would commit sin and that would be contrary to the word of God 'And God will protect them from men' (*Sura* 5.71). He [Suhayli] finds the tradition unassailable. It is properly attested and intellectually acceptable. The

<sup>3969</sup> Glazov, Jamie. "Islam Symposium Part III: The Right to Dissent, Comedy and the *Burqa*," *FPM*, 6 Mar 2003.

<sup>3970</sup> Glazov, Jamie. "Islam Symposium Part III," *Idem*.

<sup>3971</sup> Trifkovic. *Sword*, pp. 154-155.

<sup>3972</sup> "Two Women Sentenced to Death by Stoning in Nigeria," *Reuters.com*, 12 Oct 2004, C&R.

<sup>3973</sup> Newby. *Arabia*, p. 73.

<sup>3974</sup> Ishaq. *Sirat*, p. 240, in the section "The Names of the Jewish Adversaries."

<sup>3975</sup> Lecker. *Arabia*, XII:563.

prophets were not preserved from bodily afflictions in which category sorcery falls.<sup>3976</sup>

There ought to be no doubts about the bewitching of *Muhammad* episode since the subject is often mentioned in the *Hadiths*. Maududi says in his commentary on *Suras* 113-114:

As far as the historical aspect is concerned, the incident of the Holy Prophet being affected by magic is absolutely confirmed, and if it can be refuted by scientific criticism, then no historical event of the world can be proved right and genuine. It has been related by Bukhari, *Muslim*, Nasai, *Ibn Majah*, *Imam Ahmad*, *Abdur Razzaq*, *Humaidi*, *Baihaqi*, *Tabarani*, *Ibn Sad*, *Ibn Mardayah*, *Ibn Abi Shaibah*, *Hakim*, *Abd Bin Humaid* and other traditionists on the authority of *Hadrat Aishah*, *Hadrat Zaid Bin Arqam* and *Hadrat Abdullah Bin Abbas*, through so many different and numerous channels that forgery is out of the question.<sup>3977</sup>

*Muhammad* thought he was bewitched and this caused his perennial impotency. Many authorities believe this bewitching affair is why *Muhammad* produced two *Koranic* chapters:

Commentators on the *Koran* relate that the reason for the revelation of the chapter quoted above [K 113] was that a Jew named Lobeid [or Labid] had, with the assistance of his daughters, bewitched *Mohammed* by tying eleven knots in a cord which they hid in a well. The Prophet falling ill in consequence, this chapter [K 113] and that following it [K 114] were revealed; and the angel *Gabriel* acquainted him with the use he was to make of them [K 113-114] and told him where the cord was hidden. The [future] *Khalif* Ali fetched the cord and the Prophet repeated over it these two chapters; at every verse a knot was loosed till on finishing the last words, he was entirely freed from the charm.<sup>3978</sup>

It is astounding that two short chapters of the *Koran* were written as an antidote to the spell that caused impotency. The *Hadiths* record:

The Prophet...disliked ten things...using spells except with the *Mu'awwidhatan* [the last two chapter of the *Koran*] (*Sahih Abu-Dawud*, bk. 34, no. 4210).

The string with knots represented *Muhammad's* penis. So basically every time *Muslims* say the eleven (5+6=11) verses of K 113-114, this repeats *Muhammad's* eleven-step counter spell for untying the knots that witchcraft had put in his penis.

That the last two chapters of the *Koran* are an antidote to a magic spell is less astounding when one realizes that *Islam* is chock full of Animistic practices and sexual rites.<sup>3979</sup> Moreover, a substantial portion of the *Koran* was transcribed off of amulets and talismans. This means much of the *Koran* was used as charms and as antidotes to spells and this partly explains why the *Koran* is so choppy and repetitive. Guillaume wrote:

The recording of the prophet's words in the beginning was haphazard. Verses were written on **palm leaves, stones, the shoulder blades of animals**—in short, on any material which was available. Tradition associates the collection of all this material, together with what men had committed to memory, to *Abu*

<sup>3976</sup> Ishaq. *Sirat*, p. 240, fn. 1.

<sup>3977</sup> Maududi. *Meaning, Suras* 113-114.

<sup>3978</sup> Zwemer. *Animism*, ch. 9, fn. 9.

<sup>3979</sup> Zwemer. *Animism*.

*Bakr*, the first *Caliph*, and alternately to his successor ‘Umar who died before the work was completed.<sup>3980</sup>

Gibb wrote in the same vein:

Whether the *Koran* was written down in full during *Mohammed*'s lifetime is a question on which there are conflicting traditions. The generally received account describes its first compilation a few years after his death from ‘**scraps of parchment** [the skin of a sheep or goat] **and leather, tablets of stone, ribs of palm branches, camels' shoulder-blades and ribs, pieces of board** and the breasts of men [i.e. their memory].’ To this, probably, is to be ascribed much of the unevenness and the rough jointing which characterize the present composition of the longer *Suras*.<sup>3981</sup>

Zwemer describes common *Muslim* amulets as being of the same material as the materials from which the *Koran* was compiled. This shows the real reason why many verses of the *Koran* had to be copied off of bones and branches years after *Muhammad* had died:

...**the most common amulets** among *Muslims* there are bits of rag [formed into a pouch], containing herbs or some drug. But more frequently they [pouches] contain a **small bit of paper with certain Arabic writings—verses from the *Koran*** and mysterious looking squares with letters and figures in the corners are also used. These they call their *power*...In the villages of the [Nile] Delta, where ninety-nine percent of the people are *Muslim*, and in the back streets of *Cairo*, the intellectual capital of *Islam*, I have collected **amulets made of bone, shell, skin** [i.e. leather], **horns of animals, teeth, claws**, mud from the tombs, etc., etc. *Islam* and Animism live, in very neighborly fashion, on the same street and in the same mind.<sup>3982</sup>

Consequently, much of *Muhammad*'s verses survived only on amulets after his death. One reason was that domesticated goats, used mainly for milk, came into *Muhammad*'s quarters and ate bread dough and the *Koran*.<sup>3983</sup> Aisha, *Muhammad*'s favorite wife, speaks of how a goat abrogated two verses permanently:

The verse[s] of stoning [an adulterer] and of suckling an adult ten times [?!]...they were (written) on a paper and kept under my bed. When the Messenger of *Allah*...expired and we were preoccupied with his death, a goat entered and ate away the paper.<sup>3984</sup>

### Blaming Jews for *Muhammad*'s Impotency

Worse still, *Muhammad* blamed his sexual impotence on Jews, saying that it was caused by their witchcraft. Evidently, superstitious thinking ran in *Muhammad*'s family since *Muhammad*'s mother Amina was involved in the occult:

*Muhammad*'s mother, Aminah, was of an excitable nature and often claimed that she was visited by spirit, or *Jinns*...She also at times claimed to have visions and religious experiences. *Muhammad*'s mother was involved in what we

<sup>3980</sup> Guillaume. *Islam*, p. 57.

<sup>3981</sup> Gibb. *Survey*, p. 33.

<sup>3982</sup> Zwemer. *Animism*, ch. 10.

<sup>3983</sup> *Sahih Bukhari*, vol. 5, bk. 59, no. 462.

<sup>3984</sup> Musnad Ahmad *Bin Hanbal*. vol. 6. p. 269; Sunan Ibn Majah, p. 626; Ibn Qutbah, *Tawil Mukhtalafi 'l-Hadith* (Cairo: Maktaba *Al-Kulliyat Al-Azhariyya*. 1966) p. 310; As-Suyuti, *ad-Durru 'l-Manthur*, vol. 2. p. 13.

call today the ‘occult arts,’ and this basic [spiritual] orientation is thought by some scholars to have been inherited by her son.<sup>3985</sup>

Thinking that Jews had jinxed him led *Muhammad* to attack a Jewish settlement at *Khaybar* (25:42N 39:31E), an oasis town 83 miles (133 KM) north of *Madina* (24.5N 39.58E). The *Sufi* Martin Lings wrote:

The sorcerer Labid [at *Madina*] had almost certainly been bribed from there [*Khaybar* Oasis], though that could have been the work of an individual...[who is one of]...the exiled *Bani Nadir* [formerly from *Madina*] and their *Khaybarite* [from the oasis *Khaybar*] kinsmen.<sup>3986</sup>

Why did *Muhammad* rationalize that these distant Jews had anything to do with *Muhammad*’s impotency while he was in *Madina*? *Muhammad* committed terrible deeds against Jews. For that reason it was natural for him to think that they would try to get even.

*Madina* once had three Jewish tribes. Though they never fought an offensive battle against the *Muslims*, *Muhammad* banished the *Nadir* and *Kyynuqa* tribes and made them leave most of their property behind. Some of these banished Jews went to the *Khaybar* Oasis north of *Madina*, some went to Syria and so forth.

After the Battle of *Uhud* against the *Makkans*, *Muhammad* turned on the remaining Jews in *Madina*, though they never fought an offensive battle against the *Muslims*.

All the men of the Jewish *Kurayza* tribe (between 700 and 900) surrendered. To their surprise they were not treated leniently but were beheaded and dumped into a trench. The Jewish *Kurayza* women and children were sold into slavery.

In the annals of history, this has to be one of the strangest reasons for attacking an enemy. It bears repeating in summary form. Jews supposedly cast a spell on *Muhammad* that caused impotency but the spell also made him think he was having great sex with all his wives. “For this,” *Muhammad* thought, “they must be conquered and suffer the ravages of war.”

### The Christian Reaction to *Muhammad*’s Salacious Teachings That Encouraged Satyriasis

Evidently, the Venus altar and salacious symbols were effective in inducing satyriasis in *Muslim* males for centuries after *Muhammad* and in far-off places. The Spaniard Alvarus Paulus (flourished 854 AD) wrote:

All those who come to the sect of this most foul one [*Muhammad*] are transformed into pimps and adulterers, for in accordance with [his] orders, they break their marriage vows and come together again in adultery to their greater shame. By multiplying their mistresses and being subject to three or four wives, these seducers or better yet, pimps, all become whinnying horses and braying asses. Thinking it shameful to refuse any request, they applaudingly make licit for themselves everything they seek regarding women, usurping natural laws and seeking...new paths for their lust.<sup>3987</sup>

<sup>3985</sup> McClintock, John & James Strong. *Cyclopedia of Biblical, Theological and Ecclesiastical Literature*. Baker Book House, Grand Rapids, Michigan, USA, 1981, 6:406, as quoted in Morey. *Invasion*, p. 71.

<sup>3986</sup> Lings. *Sources*, p. 263.

<sup>3987</sup> Wolf. *Antichrist*, p. 10.

Alvarus Paulus did not think much of *Ibn Serene's Hadith* about *Muslims* in heaven being given the sexual potency of a hundred men (quoted above).<sup>3988</sup> Nor did Alvarus Paulus appreciate *Muhammad's* teaching that *Houris* would always be virgins with a restored hymen after each sex act (*K 055:074; 056:034-036*).<sup>3989</sup> Alvarus Paulus wrote:

There is no one so lost to his lusts and so soiled with the dirt of his sty, as this pimp polluted with putridity. As we said, he enjoys the wives of other men, like a pimp, concealing the scabbiness of his filth behind an angelic command, promising as a gift for those who believe in him harlots [i.e. *Houris*] for the taking, scattered about in the paradise of his god; harlots [*Houris*] bound by no limit in *Coitus* so that the extreme heat [of passion] is not terminated in the usual space of one hour, but is multiplied by seventy times for the enjoyment of men—the same sort of flowing enjoyment that is typically associated with asses.

The *Encyclopedia Britannica* states:

The ass was sacrificed in his [i.e. phallic god *Priapus*] honour, probably because the ass symbolized lecherousness and was associated with the god's sexual potency.<sup>3990</sup>

Alvarus Paulus continues:

The lethargic inhabitant of this paradise will have an increased [quantity of] fluid and a heightened sexual desire. And the virginity lost [by the harlot] through each act of *Coitus* in the course of this prolonged villainy will be restored [*K 055:074; 056:034-036*], despite the perforation [of thy hymen] by the inflexible reed [phallus], so that it may be of [further] service to those enjoying it. And neither the tearing of the ruptured hymen nor its re-mending will inflict terrible pain on those who undergo it, but will delight both [partners] with the sweetness of pleasure, furnishing their minds with even more desire to engage in it again, thus not curtailing but extending their renewed and ardent gluttony.<sup>3991</sup>

With modern *Muslims* STILL going through the motions of an ancient fertility rite, praying toward a Venus altar (the *Mihrab*) while prostrating (mounting *Houri* virgins), it is not surprising that *Muslims* commit more than their share of sex crimes.

Daniel Pipes noted that in Denmark, authorities have problems with *Muslims* agitating for *Sharia* law, fomenting anti-Semitism, forced marriages, living on the dole, killing former *Muslims* who converted to Christianity and such. Pipes also reports the astonishing statistic that...

...76.5 percent of convicted rapists in Copenhagen belong to that 5 percent of the population [in Copenhagen]...an especially combustible issue given that practically all the female victims are non-*Muslim*. Similar, if lesser, disproportions are found in other crimes.<sup>3992</sup>

This last sex crime statistic is not surprising since studies show that *Muslims* are much more likely to go to jail than the general population (see the ToC for “The High Crime and Incarceration Rates Among *Muslims*” table).

<sup>3988</sup> Serene, *Ibn. Kitab ul Isra'a wal Mu'raj*, as quoted in Caner. *Unveiling*, p. 193.

<sup>3989</sup> Richardson. *Secrets*, p. 38.

<sup>3990</sup> EB, *Priapus* entry, accessed 23 Apr 2004.

<sup>3991</sup> Wolf. *Antichrist*, p. 11.

<sup>3992</sup> Pipes, Daniel & Lars Hedegaard. “Something Rotten in Denmark?,” Nypost.com, 27 Aug 2002, and *National Post*, “Letters,” 10 Sep 2002, *DP*.

## Chapter 11: Moon-o-theistic *Mosques*

### Introduction

Moshan Fani wrote in *The Dabistan* (1645 AD):

In most of the ancient temples of Persia they had formed the symbol of Venus [the bulbous lamp] in the figure [arch] of a *Mihrab*, or arch, like the altar of the *Mosques*; consequently, the present [*Muslim*] *Mihrab*, or altar, is that identical symbol; which assertion is also proved by the respect paid to Friday or [in astrology] the day of Venus [i.e. *Islam*'s Day of Prayer].<sup>3993</sup>

The *Muhammadan* doctors say that *Islamism* is connected with this planet [Venus], from which source proceeds the veneration paid by them to Friday, or the day of Venus [the *Muslim* day of prayer].<sup>3994</sup>

### *Mihrabs* Are Venus Altars

Moshan Fani was a later critic of *Islam*, but early critics such as John of Damascus (~675 to ~749 AD) probably knew that *Mihrab* niches were Venus altars. John of Damascus did write that the Black Stone was associated with Venus.<sup>3995</sup> The Spaniard Alvarus Paulus (flourished 854 AD) noted that *Muhammad* had obtained the power of *Aphrodite* (the Greek Venus).<sup>3996</sup> *Muslims* seem to have taken pains to edit out of their literature any allusion to the pagan origins of *Mihrab* altars—largely because Christians criticized *Islam* over its pagan elements.

Since a scholar is never better than the sources he happens to have on hand, even K.A.C. Creswell was fooled by sanitized *Islamic* literature about the origins of the *Mihrab*. Creswell wrote:

A most important innovation was made at this time, for *Ibn Duqmaq* and *Maqrize* (the latter quoting *Waqidi*, who died in 823 [AD]) say that the first who made a *Mihrab* [altar] in the form of a [concave] niche was 'Umar *Ibn 'Abd Al 'Aziz* when he rebuilt the *Mosque* of *Madina* by order of *Al Walid* [705-715/86-96 AH]...In 710-712 the *Mosque* of 'Amr was rebuilt and enlarged and on this occasion it was given a *Mihrab* [altar] in the form of a [concave] niche, this being the second [known] example in *Islam*.<sup>3997</sup>

The assertion that *Mihrabs* were first installed in 705 AD is just another example of what Carleton Coon wrote about:

*Muslims* are notoriously loath to preserve traditions of earlier paganism and like to garble what pre-*Islamic* history they permit to survive in anachronistic terms.<sup>3998</sup>

Sita Ram Goel wrote similarly:

*Islamic* theology bifurcates human history into two sharply defined periods. The period before the proclamation of *Muhammad*'s prophethood is the Age of Ignorance (*Jahiliya*) and the period that follows is the Age of Illumination (*Ilm*). Everything that prevailed in the Age of Ignorance is to be destroyed outright or

<sup>3993</sup> Fani. *Dabistan*, pp. 30-31.

<sup>3994</sup> Fani. *Dabistan*, p. 194.

<sup>3995</sup> Sahas. *Heresy*, pp. 86-87.

<sup>3996</sup> Wolf. *Antichrist*, p. 9.

<sup>3997</sup> Creswell. *Architecture*, pp. 41, 44.

<sup>3998</sup> Coon. *Southern*, p. 398.

to be converted in such a manner that it looks as if it came into existence after the dawn of the Age of Illumination.<sup>3999</sup>

Covering up the fact that *Islam* is recycled paganism is also why non-*Muslims* are not generally allowed to conduct archaeological digs in *Saudi Arabia*.<sup>4000</sup>

Michael Rogers wrote elsewhere about the early existence of *Mihrabs*:

Yet a small marble *Mihrab* was placed underneath the Dome of the Rock, very probably when it was built (691-692 AD).<sup>4001</sup>

Traditions say that *Muhammad's* first *Mosque* in *Madina* had a *Mihrab* niche in *Madina* even before he changed the direction of the *Kibla* to *Makka* (*K* 002:144), as the *Sufi* Martin Lings wrote:

Most of the building was done with bricks, but in the middle of the northern wall, that is, the Jerusalem wall, they put stones on either side of the prayer niche...[Later] a *Mihrab* was forthwith made in the south wall of the *Mosque*, facing toward *Makka*.<sup>4002</sup>

*Muhammad* was also buried in a grave with a niche *Mihrab* facing *Makka* +which is another indication as to how early the niche *Mihrab* was used in *Mosques*.<sup>4003 4004</sup>

*Muhammad* preached next to the *Mihrab* in his *Madinan Mosque* too since Dogan Kuban wrote that *Muhammad* was in the habit of preaching near the *Kibla* wall:

*Muhammad's* chair [a three-stair *Minbar*] stood, according to *Al Bukhari*, near the middle of the *Qibla* wall.<sup>4005</sup>

Though Creswell thought that *Walid's Mosque* was the first to have a *Mihrab* niche, there are in fact other traditions that say the *Mihrab* was earlier. This suggests that the use of *Mihrab* in *Mosques* goes back to *Muhammad's* time at least and almost certainly to pre-*Islamic* astral *Mosques*. F. E. Peters mentions these traditions:

It [the *Madinan Mosque*] was enlarged next by *Uthman* [ruled 644-656 CE]...He also constructed a prayer niche [*Mihrab*] in it; though others say that *Marwan* [*Marwan I* (684-685 AD)] was the first to build the prayer niche and others again say it was *Umar Ibn Abd Al Aziz*, during the *Caliphate* of *Al Walid* [*Al-Walid I* (705-715 AD)] (*Ibn Battuta* 1958:170).<sup>4006</sup>

*Ibn Ishaq* mentions pre-*Islamic Mosques* as was noted earlier in this chapter. Surely, these *Mosques* had *Venus altars*. There are plenty of traditions of *Muhammad* destroying idols but notably there is no record of *Muhammad* destroying any *Venus altars Mihrabs*.

In the *Koran's* "Light Verse," *Muhammad* describes *Allah* in terms of a *Venus-altar Mihrab*—strong evidence that *Muhammad* used *Venus-altar Mihrabs*:

*Allah* is the light [the moon] of the heavens and the earth. The parable of His light is as if there were a niche [*Mihrab*] and within it a [*Mosque oil*] lamp: the [oil] lamp enclosed in [bulbous] glass: the glass as it were a brilliant star [*Venus*]: lit from a blessed tree, an olive, neither of the east nor of the west [i.e.

<sup>3999</sup> Goel. *Calcutta*, ch. 8.

<sup>4000</sup> Howden, Daniel. "The Destruction Of Mecca: Saudi Hardliners Wiping Out Their Own Heritage," *The Independent*, news.independent.co.uk, 5 Aug 2005, *DP*, 3 Apr 2006.

<sup>4001</sup> Rogers. *Spread*, p. 84, left column.

<sup>4002</sup> Lings. *Sources*, pp. 125, 137.

<sup>4003</sup> Ishaq. *Sirat*, p. 688 and note 2, and *Sahih Muslim*, ch. 198, bk. 4, no. 2112.

<sup>4004</sup> Zwemer. *Animism*, ch. 8.

<sup>4005</sup> Kuban. *Architecture*, p. 5.

<sup>4006</sup> Peters. *Makka*, p. 102.



heavenly light], whose oil is well-nigh translucent, though fire scarce touched it: light [Venus] upon light [luminous oil]! *Allah* doth guide whom he will to his light [a lit lunette—i.e. the moon] (K 024:035).

The *Mihrab* niche was so entrenched in *Muslim* culture from *Muhammad*'s time that *Muhammad* was buried in a grave in *Madina* with a *Mihrab* facing *Makka*.<sup>4007</sup>  
<sup>4008</sup> Many *Muslims* follow this practice to this day. Zwemer notes “Coffins are never used for burial but a niche (*Lahdi*) is made on one side of the open grave.”<sup>4009</sup>

Given all this information on early *Mihrabs*, one knows exactly what to make of the traditions that say *Mihrabs* were a later *Islamic* development rather than a holdover from pre-*Islamic* times.

Some acaDhimmis think *Muslims* copied and modified the *Mihrab* architectural feature from Christian church apses or Jewish *Torah* Shrines. If one reads these traditions carefully, they do not deal with every type of *Mihrab*. These traditions refer specifically to concave, apse-style *Mihrabs*, as opposed to the simple freestanding *Mihrabs* formed out of an arch propped up on two pillars (imposts).

Evidently the apse-style *Mihrabs* were frowned upon because they looked too much like the apses found in churches, as Creswell wrote:

Duqmaq [died 1407 AD] and Maqrizi [1364-1442 AD] (the latter quoting Waqidi, who died in 823 AD) say that the first who made a *Mihrab* [altar] in the form of a [concave] niche was ‘Umar ibn ‘Abd Al-‘Aziz when he rebuilt the *Mosque* of *Madina* [707-709 AD] by order of [Caliph] Al-Walid...Lammens in fact quotes a passage from a work by as-Suyuti (fifteenth century AD) as follows: ‘At the beginning of the second century (*Hijra*, therefore shortly after AD 715) it was forbidden according to the Traditions, to make use of it [apse-like *Mihrabs*], as it was a feature of churches.’<sup>4010</sup>

Churches in many places did have apses, usually three in the front of the church on the east wall. They represented the Trinity or the three heavens that Paul mentioned (2Co 12:02). The churches in the *Negev* usually had three apses starting in the fifth century AD.<sup>4011</sup>

Aapse-like *Mihrabs* became taboo early in *Islam* because *Muslims* often confiscated half of the churches in an area that they conquered and turned these churches into *Mosques*. The apse or apses were usually on the east wall of churches but in the Mideast the *Kibla* prayer wall in *Mosques* usually was on the south wall, or in the southeast or southwestern corner. Therefore, *Muslims* quickly set up freestanding *Mihrab* pillars and arches until a *Mihrab* niche could be built.

The use of the apse of a Christian church was forbidden for use as a *Mihrab* because they faced east instead of toward *Makka*. After a few centuries, it seems it was forgotten that only eastwardly facing apses were not to be used as *Mihrabs*. Because historians knew many freestanding *Mihrabs* were built, it was mistakenly assumed that any apse-like *Mihrabs* had been forbidden in early *Islam*.

<sup>4007</sup> Ishaq. *Sirat*, p. 688 and note 2, and *Sahih Muslim*, ch. 198, bk. 4, no. 2112.

<sup>4008</sup> Zwemer. *Animism*, ch. 8.

<sup>4009</sup> Zwemer. *Animism*, ch. 2.

<sup>4010</sup> Creswell. *Architecture*, p. 44.

<sup>4011</sup> Levy. *Lost*, pp. 198, 202.

### Whether Venus Altars Were Incorporated into *Islam* Intact

As was noted above, Moshan Fani said “the symbol of Venus” was located in the arch of the *Mosque Mihrabs*. In modern times however many *Mihrab* niches have had no lamp, which represented the Venus orb, hanging from the apse.

Oil-burning lamps have largely been removed from *Mosques* since they produce soot, are expensive to maintain, are fire hazards and only emit dim light compared to electrical lamps.

The reason for disassociating the Venus altar with Venus is that, as the scientific principles behind the solar system became known, astrology and the idea that Venus was an angel receded. Also, looking at Venus as resolved through a telescope reveals that it has the same crescent phases as the moon. Consequently, the lunette of the *Mihrab* by itself can represent both the moon and Venus.

As more non-*Muslims* investigated *Islam* either directly or through reading books like *The Dabistan*, more people came to know exactly what the Venus *Mihrab* was. So stripping the *Mihrab* of a lamp also represents a belated, forlorn attempt on the part of *Muslims* to distance “the Prophet far from any taint of paganism.”<sup>4012</sup>

There is plenty of evidence besides just The Light Verse (*K* 024:035) that symbols of Venus (lamps) were found in the apex of *Mihrab* niches from pre-*Islamic* times onward. Michael Rogers wrote that one of the very first *Mosques* ever built greatly influenced *Islamic* art:

That [*Mihrab*] of *Al Walid* at *Madina*, though small, had gold mosaics, marble paneling, a *Sassanian* trophy known as ‘the mirror of *Chosroes*’ [*Khosrou*: Persian-*Sassanian* dynasty conquered by *Muslims*] and the only lamp in the building hanging before it, an association which was to become important [though not necessarily a new association], since *Mihrabs* are often decorated with carved images of a *Mosque* lamp. Thereafter, *Mihrabs* are often highly decorated.<sup>4013</sup>

Dogan Kuban wrote that oil lamps were used from an early date:

In the early days torches were employed, especially for the last *Salah* [the last of five daily prostrations just after nightfall]. Oil lamps were introduced during the time of Mu’awiya [the first *Umayyad Caliph* (661–680 AD)] and candelabras, [and] *Tannurs* [literally “oven,” but a typical glass *Mosque* lamp is meant, no doubt] in the *Fatimid* period. The main sources of illumination in later periods were great chandeliers and lamps suspended from domes or vaults and large candelabras on either side of the *Mihrab*.<sup>4014</sup>

The lamps near the *Mihrab* would tend to illuminate the lunette.

The bit about oil lamps being introduced by the first *Caliph* is probably anachronistic since *Muhammad* mentions an oil lamp already in the *Koran*’s “Light Verse.” Gibb and Kramers wrote:

A light was used particularly in the *Mihrab*, because it represented the holy cell, to which light belongs (cf. *Sura* xxiv. 35 [*K* 024:035]). Then, in *Makka*, lamps were placed before the *Imams* in the *Mihrabs* and there were considerable endowments for such *Mihrab* lamps (*Ibn Djubair* [1145-1217 AD], *Rihla*, pp. 103, 144).<sup>4015</sup>

<sup>4012</sup> Peters. *Origins*, p. 251.

<sup>4013</sup> Rogers. *Spread*, p. 84.

<sup>4014</sup> Kuban. *Architecture*, p. 10.

<sup>4015</sup> Gibb & Kramers. *Encyclopedia*, p. 346, *Masjid* entry.

Various writers note the connection between *Mosque* lamps and *K* 024:035. Sheila Blair wrote:

This late *Islamic* lamp follows a form established in earlier centuries with a foot, a spherical belly and a flare at the top. Such lamps were commonly hung in *Mosques*, tombs and other religious structures where, because of the famous verse from the *Koran* (24:35), they symbolized the actual presence of God [i.e. the lunette lit up by the *Mosque* lamp].<sup>4016</sup>

Richard Ettinghausen wrote:

The *Mosque* lamps suspended in the *Mihrab*-like arches of prayer carpets are perhaps best-known examples...They originally reflected verse 35 of *Sura* xxiv [*K* 024:035]...Later on the light-carrying lamp became a flower vase [*Mosque* lamps resemble bulbous vases] and it was eventually placed on a saucer at the bottom of the arch [the saucer corresponded to the foot ring of the *Mosque* lamp]. What is remarkable about the *Allah*-derived motif is the fact that it preserves a certain innate power which gave it a magic, apotropaic [intended to ward off evil] quality.<sup>4017</sup>

Indeed, the source of inspiration for the *Mosque* lamp is provided right on the lamp itself, as Sheila Blair wrote:

...*Mosque* lamps, the most characteristic form of enameled glass. The typical lamp...is about 30 cm high, with a wide and flaring neck, sloping shoulders with six applied handles, bulbous body and prominent foot or foot ring. A small glass container for water and oil with a floating wick was inserted inside the lamp and the lamp itself was suspended by chains from the ceiling....The inscription around the neck is written in blue enamel outlined in red and typically contains the opening part of the “Light Verse” (*K* 024:035):

God is the Light of the heavens and the earth; the likeness of His Light is as a wick-holder wherein is a light, the light in a glass, the glass as it were a glittering star, lit from a blessed tree.

Different lamps contain slightly different amounts of the verse. The most complete...goes as far as the word *Yaqadu* (meaning ‘lit’), but in most cases the *Koranic* text stops after the word ‘glass’ (*Al Misbah*). The verse describes a floating lamp in a glass and refers here to the glass lamp on which it is inscribed. When the enameled glass lamp was lit, the patron’s name and titles written...around the bulbous body would have glowed with divine light, a stunning visual realization of the beautiful *Koranic* metaphor inscribed around the neck in opaque blue.<sup>4018</sup>

Blair says the lamp represents *Allah* but in reality the glowing lamp orb represents the Venus angel and the illuminated lunette represents *Allah* the moon-god. That the lunette of *Mihrabs* represents *Allah* can be ascertained from other evidence such as:

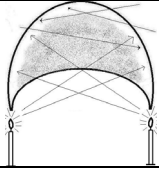
- ☉ The finial crescent over one of the entrances to *Al-Aksa Mosque* contains the word *Allah* (*aUI*), as illustrated on the title page of *Moon-o-theism*,
- ☉ The lunette over the arched entrance to the grotto cave under the Rock of *Ibrahim* in the Dome of the Rock has the word *Allah* (*aUI*) in a crescent, as illustrated elsewhere in this book (see the Thumbnail Gallery).

<sup>4016</sup> Blair & Bloom. *Paradise*, p. 94, figure 29.

<sup>4017</sup> Ettinghausen. *Kufesque*, pp. 43-45.

<sup>4018</sup> Blair. *Inscriptions*, pp. 185, 187.

- ☉ The base of the lunette of the *Mihrab* at the *Mosque-Madrassa* of *Sultan Hasan* (1356-1362 AD) in *Cairo* has three half-moons with the word *Allah* (*aUI*) inlaid in the thin marble veneer.<sup>4019</sup>

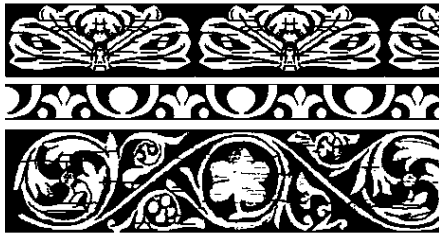


**Figure 11-01.** The illuminated lunette of a *Mihrab*. Candles on the floor off to the side of *Mihrab*, as well as ambient light, highlight a crescent in the lunette.

There are also many two-dimensional representations of *Mihrabs* from early *Islamic* times. These also have artistic representations of an oil lamp hanging from the apex. These two-dimensional *Mihrabs* came in several forms for different uses:

- ☉ Steles in places of prayer where a wall niche would be impractical
- ☉ Stele grave markers
- ☉ Stele *Lahdi* niches below ground in graves facing *Makka*
- ☉ Carved wood panels
- ☉ Ceramic tiles for wall decoration
- ☉ Art on coins
- ☉ Venus-altar *Mihrab* patterns woven into prayer rugs

The rest of the chapter will illustrate various two-dimensional *Mihrabs* that have representations of an oil lamp hanging from the apex.



**Figure 11-02.** Crescents at a *Mosque* in *Egypt*. This is a beam molding at '*Amr Mosque*, *Egypt* (dated 827 AD).<sup>4020</sup>

### Two-dimensional *Mihrabs* from Early *Islamic* Centuries

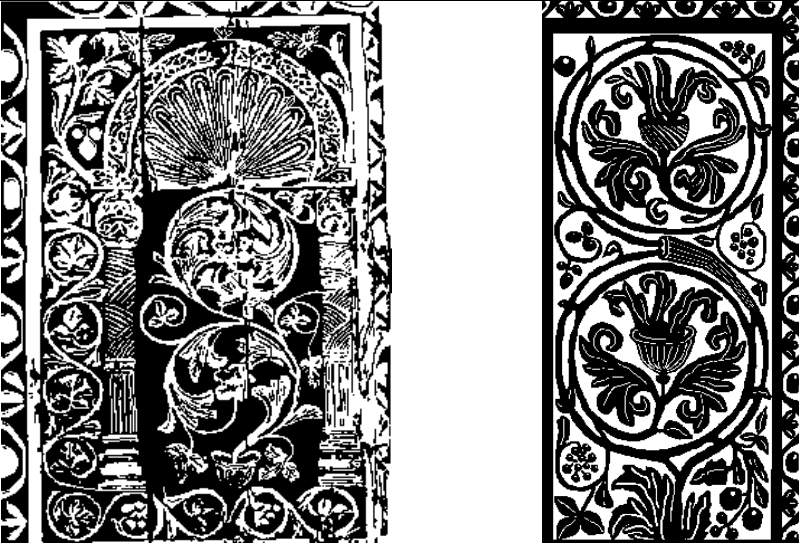
The above beam molding from the *Mosque* of '*Amr* in *Egypt* (dated 827 AD) clearly shows a center strip with crescent and Venus orb couplets. The *Fleur-de-lis* between the couplets represents another artistic form of the crescent and Venus orb couplet. The same applies to the acanthus leaves on the top and the scrolling and undulating vines on the bottom. The curved vine represents the horns of the crescent-moon and the leaf or circular bloom in the center represents the Venus orb.

K.A.C. Creswell connects the beam molding from the *Mosque* of '*Amr* in *Egypt* with earlier wood carved panels and friezes in the *Dome of the Rock* and *Aqsa Mosque* on the temple mount.<sup>4021</sup> *Mihrab* wall panels from *Aqsa Mosque* from 780 AD are illustrated below.

<sup>4019</sup> Rogers. *Spread*, p. 32.

<sup>4020</sup> Creswell. *Architecture*, pp. 244-245 and plate 46.

<sup>4021</sup> "The woodwork was decorated as follows: The side of the beam was covered by a thin strip of wood on which was carved a flowing acanthus frieze (Plate 46), which instantly recalls a whole series of similar ornament, beginning with the sixth century at *Al Bara*, *Mijlayya*, the Golden Gate of *Jerusalem*, and the cornices of the dome piers in the *Dome of the Rock* (Plate 3) and several wall-plates of AD 780 in the *Aqsa Mosque* (Plate 42)" (Creswell. *Architecture*, p. 244).



**Figures 11-03 and 11-04.** These early *Islamic* crescent-and-orb motifs decorated *Mihrab*-like wall panels (dated 780 AD) in the *Aqsa Mosque*, Temple Mount.<sup>4022</sup>

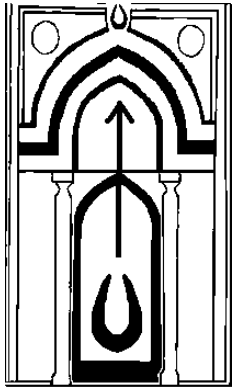
Notice the crescent and Venus orb couplets and the *Fleur-de-lis* between the couplets that represent an artistic form of the crescent and Venus orb couplet. The crescent and Venus orb couplets on *Mihrab* panels show that the early *Muslims* understood the *Mihrab* to be a Venus-moon altar and the *Mosque* to be a moon-god worship center.



**Figure 11-05.** An early *Islamic* crescent-and-orb motif at the temple mount. The *Mihrab*-like wall panel is from *Aqsa Mosque* (780 AD). “It is attributed to a restoration by the *Abbasid Caliph Al Mahdi*, who visited the city [Jerusalem] in 780 [AD]” (Nuseibeh & Grabar. *Dome*, p. 140).

Note: Rotate book to view upright.

<sup>4022</sup> Creswell. *Architecture*, p. 244 and plate 42.



**Figure 11-06.** This is an illustration of a crescent found near the top of the *Mihrab* in the Egyptian *Mosque of Ibn Tulun*. This illustration shows just the outline of the *Mihrab* structure, which is filled with *Koranic* inscriptions of hundreds of Arabic letters in the typical *Islamic horror vacui* style.

The large crescent and arrow (see inset) merely point the reader to the top of the illustration where the actual crescent is found on the *Mihrab*.

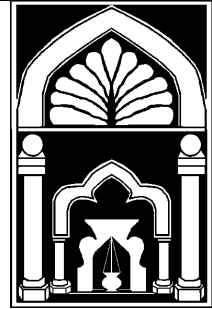
The *Mihrab* is datable to 1094 AD. Michael Rogers' caption under the source picture reads: "*Mosque of Ibn Tulun, Mihrab of Al Afdal Shahinshah* (datable 1094 AD)" (Rogers. *Spread*, p. 75).

### Two-dimensional *Mihrabs* from Later *Islamic* Centuries

Note how these various kinds of two-dimensional *Mihrabs* below have representations of an oil lamp hanging from the apex:



**Figure 11-07.** This is a *Fatimid*-era (909–1171 AD) *Mihrab*-like panel in the grotto under the Rock of *Ibrahim* in the Dome of the Rock.<sup>4023</sup>



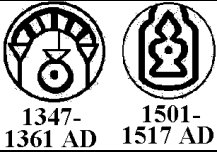
**Figure 11-08.** *Mihrab* with hanging lamp twelfth-century stele. "Stele in the Form of a Prayer Niche or *Mihrab*: *Seljuk Iran*, late twelfth-century CE" (Blair & Bloom. *Paradise*, p. 96, figure 32).



**Figure 11-09.** *Mihrab* or Prayer Niche with hanging lamp luster tiles (1309-1310 AD).<sup>4024</sup> This illustration shows just the outline of the *Mihrab*-like tile, which is filled with *Koranic* inscriptions of hundreds of Arabic letters in the typical *horror vacui* style.

<sup>4023</sup> Nuseibeh & Grabar. *Dome*, pp. 135, 140.

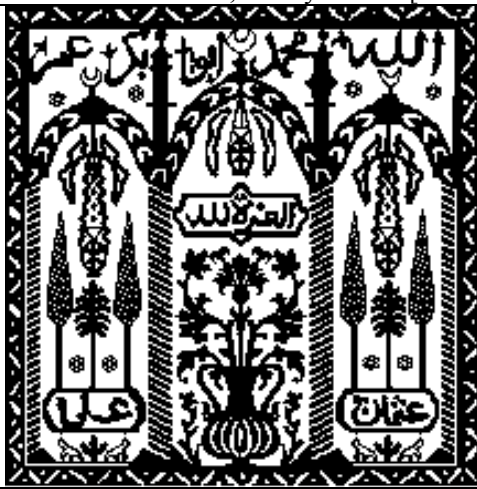
<sup>4024</sup> Blair. *Inscriptions*, p. 157, figure 11.67.



**Figure 11-10.** These are fourteenth-and-sixteenth-century *Mamluk* coins with *Mosque* lamps in *Mihrabs*.<sup>4025</sup>

Sheila Blair wrote about how a tile (illustrated below) with three *Mosque* lamps hanging in three arches was inspired by those hanging in the seventeenth-century Grand *Mosque* in *Makka*:

Small panels of tiles as these made in Damascus were probably designed either as wall decorations for *Mosques* or as ornaments for private dwellings. Both panels show a triple-arched gateway, a depiction of the heavenly gate, which probably owes its origin to the [fifteenth-century *Mamluk*] triple-arched gateway that once adorned the enclosure of the *Kaaba* in *Makka*. Within its openings are three hanging lamps and in the side apertures date-palm trees and tall, pointed cypresses, both symbols of the heavenly garden in *Islamic* art. In the center, a vase of carnations recalls both the water and the flowers promised in Paradise. The panels were made for orthodox *Muslims*, as their inscriptions list the names of the first four ‘rightly guided’ *Caliphs*, *Abu Bakr*, Umar, Uthman and ‘Ali, in addition to the names of God and *Muhammad*. The inscriptions in the center reads, ‘Glory to God [*Allah*].’<sup>4026</sup>



**Figure 11-11.** Seventeenth-century tile inspired by *Mosque* lamps hanging from arches at the Grand *Mosque* at *Makka*. Notice the plant and plaque lol *Allah* motif and the crescents.

“Tile Panel Depicting the Gateway to Paradise, *Ottoman* Syria, ~1600 CE. Colors on white slip on white siliceous ceramic body, covered with clear glaze.”<sup>4027</sup>

### Sublimated Crescent and Venus Orb Representations

In later centuries the crescent and Venus orb couplet became more sublimated in *Mosque* art, mostly using the lol *Allah* style that is also called the high-low-high

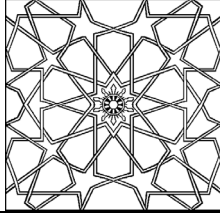
<sup>4025</sup> *Mihrab* with rounded arch on capitals of columns with *Mosque* lamp coin: ANS Accession No.: 1971.89.1; region: Syria; denomination: *fals*; period 1347-1361 AD; Publications: B.374A, and see Khoury paper, 1990; *Sultan*: *Al Malik Al Nasir Hasan*; dynasty: *Mamluk*; mint: *Hamah (Hims)*. *Mihrab* with pointed arch with *Mosque* lamp coin: ANS Accession No.: 1972.209.11; denomination: *fals*; date: 1501-1517 AD; ruler: Qansuh *Al Ghuri*; dynasty: *Mamluk*; publication: NC 1962, no. 25; Balog 901; reference: B.901.

<sup>4026</sup> Blair & Bloom. *Paradise*, pp. 88-89.

<sup>4027</sup> Panel (27.5 x 29 inches). Museum of Fine Arts, Boston Venues: DC, AS” (Blair & Bloom. *Paradise*, p. 88, figure 22a).

style. The crescent by itself of course became more visible, probably out of need to stress monotheism since a star-and-crescent couplet smacks of polytheism.

One way the crescent-and-star motif remains but in a sublimated way, is in starburst patterns. In many starburst patterns one can identify angular-looking crescents and *Mihrab*-looking brackets with stars or orbs in the middle.



**Figure 11-12.** An interlaced starburst ceiling panel at the Dome of the Rock. Note the crescent-and-star motif within the starburst, in other words, the multiple U-arches with an interlocking star in the center.<sup>4028</sup>

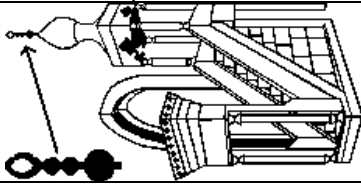
This geometric, interlaced artwork was perfected in *Islamic* times but it began in late antiquity. Even then it was considered an astral religion design, as Goodenough describes:

In the vault of a fourth *Arcosolium* [in Rome] were painted larger and more ornate geometrical units, with rosettes rather than the cruder star or sun symbols within them. Both can be taken to be designs of the starry heaven and to be astral in reference. We see again that since the dome of heaven is interchangeable with the starry ceiling both probably refer to an astral concept of religion.<sup>4029</sup>

Perhaps the interlacing was suggested by star charts that map out constellations. These often connect-the-dots drawings show the imagined form of the constellations such as the Big Dipper, the Ram, the Crab, etc.

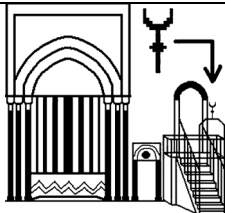
### Crescents over *Minbars* (Elevated Pulpits) in *Mosques*

In an illustration a few pages back there was a crescent over a *Mihrab* in the *Mosque* of *Ibn Tulun* (1094 AD).<sup>4030</sup> Often a crescent on a finial is found over the *Minbar* pulpit either over the gateway at the foot of the stairs, or over the platform roof at the top of the stairs.



**Figure 11-13.** A common style and arrangement of *Minbar* pulpit and *Mihrab* Venus-moon altar found in *Mosques*.

**Note:** Rotate book to view figure upright.



**Figure 11-14.** Yet another crescent at the temple mount in the *Aqsa Mosque*. Pictured here is a set consisting of one *Minbar* pulpit and two *Mihrab* Venus-moon altars.

The inset shows the location of the crescent over the gate to the staircase of the *Minbar*.

<sup>4028</sup> Nuseibeh & Grabar. *Dome*, pp. 69-70.

<sup>4029</sup> Goodenough. *Symbols*, p. 123.

<sup>4030</sup> “*Mosque of Ibn Tulun, Mihrab of Al Afdal Shahinshah* (datable 1094 [AD])” (Rogers. *Spread*, p. 75).



### **Minarets Are Phallic Symbols—Giant Sutra Poles**

*Minarets* are the tall towers next to *Mosques* from where the *Muezzin* used to call out the *Adhan*, the Call to Prayer. There are zero to four *Minarets* per *Mosque* and sometimes more. Nowadays, the *Muezzin* has largely been replaced by loudspeakers mounted on the *Minaret*, connected to a tape recorder on a timer.

The fact that *Muslims* used *Mihrabs* and *Sutra* poles as phallic symbols was discussed in this chapter on *Mosques* and in the chapter on Venus altars. That *Mihrabs* were Venus altars suggests that *Minarets* are in fact just giant phallic symbols used to attract the attention of *Allah* to worshippers in *Mosques*. This is just what Moshan Fani wrote in *The Dabistan* (~1645 AD):

Another man among them said that as the just-named place [the *Mihrab*] emblems the *Bhaga* [vulva], the *Minar[et]* or turret of the *Mosque* represents the *Linga* [phallic symbol]; on which account both are found together [as a *Lingam* and *Yoni*].<sup>4031</sup>

These assertions are supported by the fact that the first *Minarets* that *Muslims* used were at Damascus. As soon as *Muslims* conquered Damascus, the Call to Prayer was chanted out from four phallic symbol towers that had surrounded a pagan temple there.<sup>4032</sup> From this time on, *Minarets* became a universal feature in *Islam*.

If *Muslim* scholars did not think that *Muhammad* had used *Minarets* or something like *Minarets*, they would have questioned the use of *Minarets*. There is no record that anyone disputed whether *Muhammad* used *Minarets*.

Some historians say that the Call to Prayer was first called out from the roofs of houses, which may have been true at first until *Minarets* were built. Such talk about there being no *Minarets* early on in *Islam* is probably just an effort to distance *Muhammad* and early *Islam* from pre-*Islamic* pagan practices—as much as historians felt it was possible to do. As Carleton Coon wrote:

*Muslims* are notoriously loath to preserve traditions of earlier paganism and like to garble what pre-*Islamic* history they permit to survive in anachronistic terms.<sup>4033</sup>

In fact, there are *Hadiths* that mention *Minarets*. *Muhammad* spoke of a *Minaret* in Damascus (*Sahih Muslim*, bk. 41, no. 7015) and one in *Madina* (*Sahih Muslim*, bk. 6, no. 2401).

*Muhammad* spoke of boundary markers as *Minarets* (*Sahih Muslim*, bk. 22, no. 4876). Also, *Muhammad*'s favorite wife, A'isha, spoke of *Minarets* in a story about *Muhammad* (*Malik's Muwatta*, bk. 19, no. 19.1.3).

<sup>4031</sup> Fani. *Dabistan*, p. 251.

<sup>4032</sup> Creswell. *Architecture*, pp. 14, 58.

<sup>4033</sup> Coon. *Southern*, p. 398.

## Chapter 12: Moon-o-theistic Temples

### Introduction

The early *Muslims* remembered *Allah* as being a pre-*Islamic* moon-god as is evidenced by some of the early coinage, the *Kaaba*, the Dome of the Rock and the *Muslim*-built *Haranian* moon temple.<sup>4034</sup>

Some early *Caliphs* including those under whose auspices the *Haran* and Dome of the Rock moon-god temples were built, had crescents on their coinage. Coins depicted *Caliphs* holding scepters with crescents atop, holding an orb with a cross surmounted by a crescent and the like.<sup>4035</sup>

### The *Kaaba* Today is Similar to How It Was in *Muhammad's* Time

The permanent parts of the *Kaaba* are the Black Stone representing Venus, the cube itself representing the sun and the crescent-shaped *Hatim* Wall representing the moon-god.

In pre-*Islamic*, patriarchal Arabia, only one of the just-mentioned deities was considered male and a high god—the moon-god. Therefore, the *Kaaba* was a moon-god shrine by default. Since tradition says it was *Allah's* house, *Allah* was the name of the moon-god.

F. E Peters wrote about the rebuilding of the *Kaaba* during *Muhammad's* lifetime:

In 605 AD...the *Quraysh* decided to rebuild the *Kaaba* when the Apostle was 35 years of age.<sup>4036</sup>

...sometime before *Muhammad's* first revelations *Muhammad* himself had participated in the reconstruction of the *Kaaba* [*Kaaba*]...The *Haram* [sacred area] has been remodeled many times, most recently and massively by the *Saudis* in 1957; but the *Kaaba* in its midst, what the nineteenth-century Dutch Orientalist Snouck Hurgronje called 'a monument of old Arabia preserved with antiquarian solicitude [i.e. extreme care employed to preserve an antiquity],' remain much the same structure it became when *Muhammad* assisted in its construction.<sup>4037</sup>

Gibb and Kramers wrote:

The building [the *Kaaba*], in keeping with the wish of the *Umayyads* [dynasty 661–750 AD], thus practically received its pre-*Islamic* form again and this form has survived to the present day. The piety of the populace has always resisted any considerable innovations.<sup>4038</sup>

There are even accounts of *Muhammad* refereeing (or coaching) the building of the *Kaaba* by the subtribes of the *Kuraish*:

The tribes of the *Quraysh* gathered stones for the building, each tribe collecting them and building by itself until the building was finished up to the Black Stone where controversy arose, each tribe wanting to lift it to its place,

<sup>4034</sup> *Haran* spelled with two r's (*Harran*) reflects the Arabic spelling. The Hebrew has one "r" and so do most English Bible translations (NIV, KJV, RSV, YLT). The *Septuagint* uses two r's to spell the name of the city *Harán* (*Charron*) (Gen 11:31), and, interesting, the name of Abraham's brother *Harán* (*Arran*) (Gen 11:26).

<sup>4035</sup> Illustrations of *Caliph* coins with crescents can be found by looking at the Thumbnail Gallery.

<sup>4036</sup> Peters. *Origins*, p. 138.

<sup>4037</sup> Peters. *Hajj*, pp. 61-69.

<sup>4038</sup> Gibb & Kramers. *Encyclopedia*, p. 193, *Kab'ah* entry.

until they went their several ways, formed alliances and got ready for battle....A traditionalist alleged that *Abu Umayya Ibn Al Mughira*, who was at the time the oldest man of the *Quraysh*, urged them to make the first man to enter the gate of the *Mosque* umpire in the matter of the dispute. They did so and the first one to come in was the Apostle of God. When they saw him they said ‘This is the trustworthy one. We are satisfied. This is *Muhammad*.’ When they came to him and informed him of the matter, he said ‘Give me a cloak,’ and when they brought it to him, he took the Black Stone and put it inside it and said that each tribe should take hold of an end of the cloak and they should lift it together. They did this so that when they got it into position, he placed it with his own hand, and then building went on above it.<sup>4039</sup>

### The *Kaaba* Is Similar To Its Pre-Islamic Appearance

The *Kaaba* that *Muhammad* helped to construct was built using alternating courses of stone and wood. During the *Umayyad* period, the *Kaaba* burned down. The *Kaaba* was rebuilt without the wood courses since these were deemed a fire hazard.

The same-layered look was carved into the monolithic pillars of the moon-god *Mahram* who happened to be the *Abyssinian* national god of war. *Mahram*’s stone slabs were topped by a crescent, and the stone slabs were made to look like houses just like the *Kaaba* is called *Allah*’s House.

The cube of the *Kaaba* was once constructed like *Mahram*’s monolith with a crescent finial, suggesting that *Allah* was a war-and-moon-god. Creswell wrote:

They [monolithic pillars at *Aksum*] are of oblong cross-section...carved to resemble houses of many stories, and the technique just described is counterfeited on the stone. The largest, now fallen and broken, measured 33.3 meters (109 feet) in height, tapered upward and ended in a crescent-shape which was the symbol of *Mahram*, the *Abyssinian* God of war.<sup>4040</sup>

### The Crescent-shaped Decorations in the Islamic *Kaaba*

The main decoration at the *Kaaba* in *Islamic* times was the crescent and no solar decorations were mentioned. This fact and the crescent-shaped *Hatim* Wall outside the *Kaaba* suggest that the *Kaaba* was a moon-god temple even during *Islamic* times, as Oleg Grabar wrote:

In *Islamic* times a new series of objects was brought into the holy place. Umar [the second Orthodox *Caliph* (634-644 AD)] hung there two **crescent**-shaped ornaments taken from the capital city of the Persians. [*Umayyad Caliph*] Yazid I [680-683 AD] gave two ruby-encrusted **crescents** belonging to a Damascene church, together with two cups. [*Caliph*] *Abd Al Malik* [685–705 AD] sent two necklaces and two glass cups, [*Caliph*] *Al Walid I* [705-715 AD] two cups, [*Caliph*] *Al Walid II* [743-744 AD] a throne and two **crescent**-shaped ornaments with an inscription, and [*Abbasid Caliph*] *Al Saffah* [750-754 AD] a green dish.<sup>4041</sup>

<sup>4039</sup> Ishaq. *Sirat*, pp. 84-85, as quoted in Peters. *Origins*, p. 140.

<sup>4040</sup> Creswell. *Architecture*, pp. 2-3.

<sup>4041</sup> Grabar. *Art*, pp. 56-57.

### The Crescent-shaped *Hatim* Wall

The *Hatim* Wall was freestanding at least since the time of *Muhammad*, if not before. There are mentions of people standing and sleeping in the *Hijr* area during *Muhammad*'s lifetime in order to receive dreams in a rite called "incubation."

Pre-Islamic access to the *Hijr* area suggests that the *Hijr* wall was never attached to the *Kaaba* directly. Moreover, the Arabic word *Hatim* meaning "the broken,"<sup>4042</sup>  
<sup>4043</sup> probably in the sense of "detached." That the *Hatim* Wall was detached means it always looked like a crescent-moon altar and was not just a semi-circular wall connected to the *Kaaba* for keeping sacrificial animals penned.

In the past, acaDhimmis have missed the fact that the *Hatim* Wall was a crescent-shaped altar. This was the case even though this symbol of the moon-god was several meters long, a meter and a half high and weighed several tons. F. E. Peters wrote:

It seems equally certain that *Allah* was not merely a god in *Mekka* but was regarded as the 'high god,' the chief of the chief and head of the entire *Makkan* pantheon, whether this was the result, as has been argued, of a natural progression toward henotheism [the belief in one god without denying the existence of others], or of the growing influence of Jews and Christians in the peninsula. The most convincing piece of evidence that it was the latter [Jews and Christians] at work is the fact that of all the gods of *Makka*, *Allah* alone was not represented by an idol.<sup>4044</sup>

The crescent-shaped *Hatim* Wall and the crescent decorations in the *Kaaba* ought to be considered idols or images of *Allah*. The *Hatim* Wall was the biggest idol at the *Kaaba*!

Some scholars have presumed the *Hatim* Wall was only a desk for closing contracts, a wall for enclosing a pen for sacrificial animals or a place for sleeping to receive dreams (ritual incubation).

The main purpose of the *Hatim* Wall however was as a crescent-shaped altar used for sacrifices to the moon-god *Allah*. The second purpose was as a desk for signing contracts since moon-gods such as *Sin* were guardians of contracts.<sup>4045</sup> Carl Brockelmann wrote: "*Allah* was actually the guardian of contracts..."<sup>4046</sup>

To conclude this section, the *Kaaba* no doubt conforms to the beliefs of the pre-Islamic *Kuraish* who built it—including the pre-Islamic beliefs of *Muhammad*. This would include the astral triad. The Black Stone represented Venus (*Uzza*), the cubic *Kaaba* represented the sun-goddess (*Allat*) and the *Hatim* Wall represented the moon-god (*Allah*).

### The *Haranian* Moon Temple

Tamara Green wrote:

In 1081 CE, *Haran* was occupied by the *Bedouin* Sharaf *Al* Dawlah, an ally of the *Seljuk* Turks, who installed as governor his supporter, Yahya *Ibn* *Al* Shatir, a man said to have once been the slave of a Numayrid. According to *Ibn* Shaddad, it was *Al* Shatir who destroyed the moon temple that had been built for

<sup>4042</sup> Hughes. *Dictionary*, *Ka'bah* entry, p. 257, left column, bottom.

<sup>4043</sup> "'The broken (wall)' from *Hatim*=breaking. It fences the *Hijr* or space where Ishmael is buried (vol. vi:205); and I have described it in *Pilgrimage* iii, 165" (Burton. *Nights*, vol. 7, fn. 271).

<sup>4044</sup> Peters. *Origins*, p. 107.

<sup>4045</sup> Combe. *Culte du Sin*, p. 61, as quoted in Green. *Moon*, p. 35.

<sup>4046</sup> Brockelmann. *Peoples*, p. 9.

the *Sabians* by the *Muslim* conqueror of the city, *Ibn Ghanam*, in the 7<sup>th</sup> century.<sup>4047</sup>

Significantly, though *Haran* is a small city in a remote area with limited resources, an early *Muslim Caliph* made it his capital. His palace would have been within a few hundred yards of the moon temple since *Haran* was not a large town. Besides, the famous moon temple was probably the reason the *Caliph* relocated to *Haran* anyway. Tamara Green wrote:

But, in 744 CE, Marwan II, the last of the *Umayyad Caliphs*, made *Haran* not only the site of his court, but the administrative center of the *Caliphate* as well...It was from *Haran* in 750 CE that Marwan [Marwan II (744–750 AD)] set out to meet the ‘*Abbasid* army, and the historian Tabari (839–923 AD) records that after his defeat the palace that he had built at *Haran* was looted and destroyed by the victors.

Despite the fact that *Haran* was so closely identified with the last of the *Umayyads*, the ‘*Abbasid Caliph*, *Abu Ja’far Al Mansur* (754-775 CE), clearly did not hold a grudge. By his order the walls of all the cities of northern Mesopotamia were torn down; only *Haran* and *Maipherqat* to the east were spared. Soon after, the *Caliph Harun Al Rashid* (786-809 CE) constructed a canal from the *Jullab* River to *Haran* in order to insure an adequate water supply.<sup>4048</sup>

The *Haran* lunar temple no longer stands. A tour of the eighth-century Dome of the Rock in Jerusalem however gives an idea of what the seventh-century *Muslim*-built lunar temple at *Haran* would have looked like.

The moon-god decorative features in the Dome of the Rock would have been more subdued than those at the *Muslim*-built *Haran* lunar temple. At least, one would expect this to be the case since *Haran* was known as “The City of the Moon (God).” In contrast, Jerusalem is the spiritual capital of two world religions, and Judaism and Christianity are not moon-god religions.

The *Khuzistani Chronicle* may refer to a *Muslim Haranian* moon temple. Hawting wrote:

The earliest external source to associate the sanctuary of the Arabs with Abraham seems to be the so-called *Khuzistani Chronicle*, probably dating from around AD 660-670. That refers to the Dome of *Ibrahim* at which the Arabs worshipped but does not say where it was.<sup>4049</sup>

The *Khuzistani Chronicle* was written two decades before 691 AD when the Dome of the Rock was completed. The *Kaaba* does not have a dome, so the chronicle may have referred to a *Muslim Haranian* moon temple.

The Dome of *Ibrahim* probably was a moon temple in *Haran* that *Muslims* built when they conquered *Haran* in 639 AD, considering the above information and what *Al Kindy* wrote in his *Apology* around 830 AD:

We know from the *Book of Genesis* that Abraham lived with his people four-score years and ten, in the land of *Harrân*, worshipping none other than *Al Ozza* [*Uzza*], an idol famous in that land and adored by the men of *Harrân* under the

<sup>4047</sup> Green. *Moon*, p. 97.

<sup>4048</sup> Green. *Moon*, p. 95.

<sup>4049</sup> Hawting. *Idolatry*, p. 39, note 46.

name of the moon [actually, *Uzza* is Venus, not the moon] which same custom prevails among them to the present day.<sup>4050</sup>

The Dome of *Ibrahim* seems to have lasted until the tenth century AD:

*Al Mad'udi* remarks that this is the only temple of the *Haranians* which remained until his time (10th century AD) and that it is the temple of *Azar* [*Terah*], Abraham's father. Moreover, he narrates from '*Ibn 'Ishun Al Harani Al Qadi* that there were four underground corridors for various idols representing heavenly bodies, i.e. planets [Venus, for instance] and saints [*Ibrahim* and *Terah*, for instance].<sup>4051</sup>

### **Islam's Connection to the Dome of the Rock**

The Dome of the Rock was completed in 691 or 692 AD, about sixty years after *Muhammad* died and about fifty-four years after *Muslims* conquered Palestine in 638 AD (17 AH). Tradition has it that *Muhammad* ascended from the temple mount during his "celebrated Night Journey."

According to tradition, the first leg of *Muhammad's* "Night Journey" began at "the Sacred *Mosque*," the *Kaaba* at *Makka*. There was a layover at the Dome of the Rock before the second leg of his flight to the Seven Heavens to meet *Allah*. The Dome of the Rock corresponds to "the furthest *Mosque*" mentioned in *K* 017:001.

There are other candidates for the "furthest *Mosque*" such as a *Mosque* on the outskirts of *Makka* and a *Mosque* in *Madina*. Perhaps *Muhammad* was referring to an Ibrahimic moon temple in *Haran*, southeast Turkey, "the City of the Moon." The Dome of the Rock is by far the strongest candidate even though the *Koran* never mentions Jerusalem by name:

- ⊕ A few verses after mentioning "the furthest *Mosque*" (*K* 017:001), *Muhammad* mentioned the twice-destroyed Jerusalem temple, calling it a *Mosque* (*K* 017:007). The real reason *Muslims* do not say these two *Mosques* (in verses 1 and 7) are the same is for political reasons. *Muslims* want to deny any Jewish connection to the temple mount in order to deny Jews possession of the temple mount. Consistent with their claim, *Muslims* do not even call the temple mount "the temple mount" (see the Irredentist Turf section of the Khidr-Second Lamech Logic Table).
- ⊕ A while before coming to *Madina*, *Muhammad* customarily prayed so that he would face both the Black Stone and Jerusalem at the same time.<sup>4052</sup>
- ⊕ *Muhammad* referred to Palestine as "the Holy Land" (*K* 005:021).
- ⊕ The temple mount *Mosque* seems to have been named *Al-Aqsa* ("The Furthest") at least from 691 AD when the Dome of the Rock was built.
- ⊕ The temple mount was the *Kiblah* toward which *Muslims* prayed for seventeen months after coming to *Madina* in 622 AD. Then the *Muslims* turned their backs on Jerusalem and prayed toward the *Kaaba* at *Makka* (*K* 002:142-145).<sup>4053</sup>
- ⊕ *Muhammad* mentioned few, if any, Biblical cities by name in the *Koran*, so it would be surprising for him to mention Jerusalem by name.

<sup>4050</sup> *Al Kindy. Apology*, p. 17.

<sup>4051</sup> *Gunduz. Life*, p. 149.

<sup>4052</sup> *Ishaq. Sirat*, pp. 157-158.

<sup>4053</sup> *Peters. Jerusalem*, p. 181.

There likely was no structure at all on the temple mount during *Muhammad's* time. The stones of the last Roman temple had been reused in churches some distance from the temple mount but *Muhammad* probably did not know this.

The fact that there was no building on the Mount is of no concern since even a line of rocks in the desert sand often delineated a *Mosque* or prayer ground (*Musalla*) for *Muslims*, especially for travelers and *Bedouin Muslims*.<sup>4054</sup>

Cyril Glassé reports “*Mosques* in the *Sahara* are often no more than a half circle of stones.”<sup>4055</sup> The half-circle brings to mind a crescent. These half circles of stone often have a notch to represent the Venus-altar *Mihrab*.

*Muhammad*, during the Night Journey, was a traveler, therefore the furthest *Mosque* or *Musalla* could have been the Rock of *Ibrahim*. The half-circle of stones would correspond to the Rock of *Ibrahim* directly under the dome of the Dome of the Rock.

The *Kaaba* area is mostly open air, as one would expect astral temple complexes to be. For instance, the *Ziggurats* at *Ur* and the *Mahram Bilqis* moon-god temple in *Marib, Yemen*, were mostly open-air complexes. The *Ziggurat* at *Ur* allowed priests to get above the smoke of campfires and fog. The outer walls at the *Marib* temple did not hold up a roof but merely “defined” the space, and kept out the blowing sands and light from campfires.

Open air spaces accommodated astral worship and astrological observations of the sky, as Udi Levy wrote:

...there is a place of sacrifice...on a mountain south of the valley of *Petra* where there are indications that mysteries and sacrificial rituals were celebrated in the open air. The spiritual beings who were venerated here are manifested in the celestial bodies: sun, moon and stars...Whereas only a limited amount of the sky is visible at the bottom of the valley in which the city of antiquity lies hidden, we see the whole of the heavenly vault from the summit...there is an unhindered view to the horizon in all directions.<sup>4056</sup>

The temple mount in Jerusalem is mostly open air. During the *Islamic* period the temple mount served as a sort of second *Kaaba* complete with circumambulation (inside the halls of the Dome of the Rock). There were other rites as well.

### The Caliph Who Built the Dome of the Rock

Most scholars say the Dome was completed in 691 or 692 AD (72 AH). A few scholars say 691 or 692 AD was the year that *Abd Al Malik* ordered the Dome be built.<sup>4057</sup> The consensus view is that *Abd Al Malik* (ruled 684-705 AD) was the *Caliph* who had the Dome built.

*Abd Al Malik* was from the *Umayyad* dynasty. Some say that the *Umayyad Caliphs* (661–750 AD), who ruled out of Damascus were “**Arabs** first and *Muslims* second.” Oleg Grabar states:

But its [the *Umayyad* Empire’s] political and administrative organization and its ethos were still very much those of what has been called an ‘Arabian kingdom.’<sup>4058</sup>

<sup>4054</sup> Glassé. *Encyclopedia*, p. 391, illustration and caption.

<sup>4055</sup> Glassé. *Encyclopedia*, p. 276 *Mosque* entry.

<sup>4056</sup> Levy. *Lost*, p. 69, and figure 8, p. 68.

<sup>4057</sup> Blair. *Inscriptions*, p. 40.

<sup>4058</sup> Grabar. *Shape*, p. 111.

This affects our study of the Dome because someone might say the Dome is an Arab construction rather than a *Muslim* construction.

That the *Umayyads* were “more Arab than *Muslim*” can partly be discounted as mere *Abbasid* propaganda. The *Umayyads* who ruled out of Damascus and *Haran* were virtually wiped out in 750 AD by the *Abbasids* who ruled from *Baghdad*. As happened many times before and since, the victor’s propaganda became accepted as historical truth.

Despite the generalization made about *Umayyad* dynasty noted above, the *Umayyad Caliph* who built the Dome of the Rock definitely was “**Muslim** first and Arab second.” *Abd Al Malik* (~646–705 AD) reflected the religious beliefs of *Madina* and *Makka*. The *Encyclopædia Britannica* notes:

‘*Abd Al Malik* spent the first half of his life with his father, *Marwan Ibn Al Hakam*, fourth *Umayyad Caliph*, in *Madina*, where he received religious instruction and developed friendly relations with the pious circles of that city that were to stand him in good stead in his later life. At the age of 16, he was entrusted by his kinsman, the *Caliph Mu’awiyah*, with administrative responsibilities. He remained at *Madina* until 683, when he and his father were driven out of the city by *Medinese* rebels in revolt against the central government in Damascus.

In general, *Umayyad* rule was greatly strengthened by ‘*Abd Al Malik*, who enjoyed good relations with the *Medinese* religious circles, an element with considerable moral influence in the *Islamic* world. ‘*Abd Al Malik* was more pious than any of his *Umayyad* predecessors. His long sojourn in *Madina* [thirty-seven years] had enabled him to know the sentiments of *Medinese* religious scholars. As *Caliph*, he treated them respectfully and his private life was close to their ideals. As a result, many were to abandon their earlier opposition to *Umayyad* rule.<sup>4059</sup>

*Abd Al Malik* was no friend to non-*Muslims* either. Daniel Sahas wrote:

...the last years of ‘*Abd Al Malik*’s reign (684-705 AD) and the reign of his successors was a particularly intolerant and hostile period for Christians.<sup>4060</sup>

Many *Muslims* admire *Abd Al Malik* for his *Islamic* reforms, for building the Dome of the Rock and for his Arabization of the government bureaucracy:

It was the *Caliph* ‘*Abd Al Malik* (684-705 AD) who first introduced reforms in the administration, imposed the use of Arabic as the official language of the government and minted new coins which, unlike the ones that had been used until then, bore no images but only inscriptions from the *Quran*.<sup>4061</sup>

The long inscription in the Dome of the Rock also makes it clear that the Dome is a *Muslim* shrine. The inscription draws on many polemical passages in the *Koran* and chides Christians for believing in the Trinity.<sup>4062</sup>

### The Astral Imagery on the Outside of the Dome of the Rock

The large crescent finial above the dome means the Dome of the Rock is a temple to a moon-god *Allah*. Also, the crescent finials on the nearby *Al-Aksa Mosque* show that *Muslims* think the temple mount is sacred to a moon-god. One of the

<sup>4059</sup> *EB*, accessed 1 Nov 2001, “‘*Abd Al Malik*’ entry.

<sup>4060</sup> Sahas. *Heresy*, p. 44.

<sup>4061</sup> Sahas. *Heresy*, p. 46.

<sup>4062</sup> Grabar. *Shape*, pp. 58-61.



finals even has the Arabic for *Allah* in the crescent, as illustrated on the title page of *Moon-o-theism*.

*Al-Aksa* means “the furthest” and refers to “the furthest *Mosque*” where *Muhammad* began his ascent into heaven after having made the Night Journey from *Makka* to Jerusalem—or so *Muslims* teach (*K* 017:001). *Muhammad* ascended to the eight levels of heaven that were identified with the moon, the planets and the stars.

The octagonal shape of the outside wall and the outer arcade in the ambulatory shows the Dome to be a moon-god temple. This feature was copied from the lunar temples at *Haran*. The historian Masudi (896-956 AD) wrote in the *Golden Meadows*:

The *Haranian Sabians* have temples according to the names of the intellectual substances and the stars...(The temple) of Saturn is hexagonal; of Jupiter, triangular; of Mars, long (rectangular); the sun square; that of Venus, a triangle in a quadrangle; that of Mercury, a triangle inside an elongated quadrangle, and that of the moon, octagonal.<sup>4063</sup>

The bottom half of the outside wall is marble but the upper half of the wall has blue tiles and an *Ottoman* Empire Era inscription from *K* 036, the *Ya Sin* chapter. *Ya Sin* is Arabic for “O *Sin*,” a reference to *Allah*, a.k.a. the moon-god *Sin*.

The neck below the dome structure has a strip with an *Ottoman* Empire-era inscription from *K* 017, the chapter entitled “The Night Journey,” or “The Children of *Israel*.”<sup>4064</sup>

*Muhammad* supposedly ascended to the heavens from the Rock of *Ibrahim* on the temple mount. During the Night Journey and during his Ascent to Heaven, *Muhammad* was said to have visited eight levels of heaven. Each heaven was associated with a planet, the moon or the stars. Thus one can see that given this bit of mythology, both the *K* 017 “Night Journey” and the *K* 036 *Ya Sin* inscriptions are quite appropriate for an astral temple.

### ***Allah* Motifs Found in the Dome of the Rock**

*Allah* motifs are artistic adaptations of the ancient orb and crescent symbol. *Allah* motifs can be found in most of the illustrations in this chapter. These tall-short-tall (lol) *Allah* motifs, along with other evidence, show that the Dome of the Rock is a temple to a moon-god—that being *Allah*. *Allah* motifs are discussed in more detail in a later chapter.

The *Allah* tall-short-tall (lol) motifs include the following numbered symbols as seen in the illustration immediately below:

1. A star in a crescent.
2. A square in between two vertical lines, which is an abstract squared crescent-and-orb.
3. An orb in between two vertical lines connected at the bottom somewhat like a flat-bottomed U.
4. A lotus blossom that sits in a canoe-like crescent formed by two leaves.
5. A tulip blossom with two crescent horns formed by two offshoot petals.
6. Orbs in crescents in a row with three-bladed, sprig *Fleur-de-lis* decorations interspersed.

<sup>4063</sup> Green. *Moon*, p. 71.

<sup>4064</sup> Juferi, Mohd Elfie Nieshaem. “The Dome of The Rock (*Qubbat as-Sakhrā*),” bismikaAllahuma.org, accessed 11 Mar 2004.

7. Orbs in crescents in a row with orbs interspersed.
8. A grapevine that both scrolls around and undulates between the orbs.
9. Interconnected crescents that form a wave (undulating) pattern with orbs in the curved triangular space called “spandrels” formed by the horns of the crescents.
10. A star in the center of an interlocking crescent motif that forms a daisy flower or *Shamsa* (sunburst) medallion pattern. The crescents in these *Shamsas* are of the squared *Mihrab* Venus-altar type.



**Figure 12-01.** Tall-short-tall (lol) *Allah* motifs in the Dome of the Rock.<sup>4065</sup>

### The Dome of the Rock Floor Plan and Inner Space Plan

The floor plan of the Dome of the Rock includes an outer octagonal wall, an inner octagonal arcade and an inner circular arcade. The octagonal shape shows that the Dome of the Rock is a moon-god temple, as the historian *Masudi* (896-956 AD) wrote in the *Golden Meadows*:

The *Haranian Sabians* have temples according to the names of the intellectual substances and the stars... (The temple) of Saturn is hexagonal; of Jupiter, triangular; of Mars, long (rectangular); the sun square; that of Venus, a triangle in a quadrangle; that of Mercury, a triangle inside an elongated quadrangle, and that of the moon, octagonal.<sup>4066</sup>

The innermost arcade that surrounds the Rock of *Ibrahim* is circular. The circular arcade supports a drum (neck) that in turn supports the dome. Both the octagonal and circular arcades consist of arches resting on a combination of piers and columns.

The Rock of *Ibrahim* in the center is in the form of a crescent that is oriented the way it would look in the sky from the temple mount, meaning that the horns are oriented north and south. A crescent was commonly found in the hubs of zodiac wheels in ancient times.

Each of the twelve columns in a circular arcade represents a zodiac constellation. Between each of the four sets of three columns is a pier. Each three-column set represents three months and a pier represents a season—either spring, summer, winter or fall (see the Thumbnail Gallery).

Above each of the four piers in the neck (drum) of the dome, there is a solid black square within a golden square frame. Squares are four-sided of course and this reminds the viewer that there are four seasons (or Seasons).

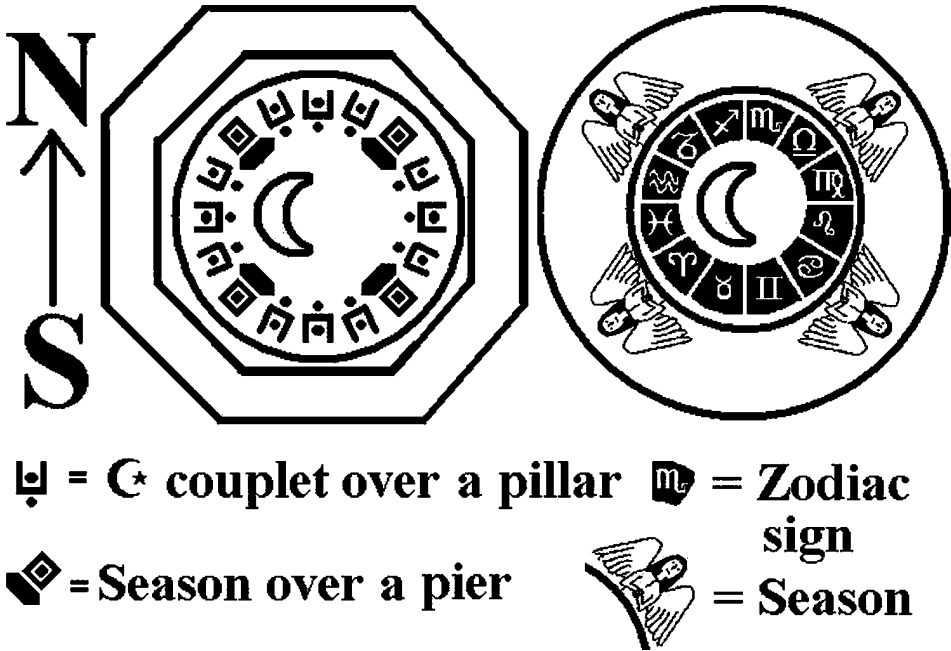
The reason for the square-within-a-square is that each set is an abstract representation of one of the Seasons—either spring, summer, winter or fall. In pre-*Islamic* zodiacs, the Seasons’ busts would be placed in four niches or carved into the stone face if the zodiac was in relief.

The reason for the squared, abstract representations of the Four Seasons above the piers, and also the dozen moon-Venus couplets above the pillars, has to do with

<sup>4065</sup> Grabar. *Dome*, pp. 64-65, 110-117, and in Grabar. *Shape*, pp. 74-75. The small squares (instead of the normal circles) between the upright *Lams* can be seen on Grabar. *Dome*, pp. 65, 67 and 141.

<sup>4066</sup> Green. *Moon*, p. 71.

artistic taste. Moreover, the situation in seventh-century Jerusalem called for subdued astral worship because Jews and Christians would jeer at blatant astral paganism. Moreover, there were plenty of Jewish, Christian and *Muslim* iconoclasts who would object to such symbols.



**Figure 12-02.** A comparison of the Dome of the Rock floor plan to a typical zodiac circle with the Four Seasons.

One can see that the Dome of the Rock was built with the astral Byzantine-era synagogue zodiac mosaics in mind, as well as pagan astral temples where the worshippers ambulated around a central sacred stone. In synagogues the zodiacs were placed on the floor in the center of the building, and often there was a crescent-moon in the hub of the zodiac.

The Dome of the Rock was based on a *Muslim* artist’s conception of the Solomonic temple. The artist may have formed this conception based on the *Haranian* moon-temple dedicated to *Ibrahim* and his father and synagogues with zodiac circles.

In the Dome of the Rock, above each of the twelve inner columns is a squared crescent-and-orb. This symbol is similar to some of the lunar cipher symbols. See the Thumbnail Gallery to find the charts “Alphabet of the Moon” and the “Alphabet of *Cancer*, Under the Influence of the Moon” illustrated in a later chapter.

The idea expressed by the just-mentioned twelve crescent-and-orb symbols is this: as the moon and planets make their way through the twelve constellations (or “houses”) of the zodiac, they exert different influences on nature and humans depending on which zodiacal constellation they cross.

The supposed different influences of the constellations, especially during a transit of the sun and moon, were what Isaiah referred to when he said that astrologers made their predictions month by month (Isa 47:13).

In ancient times the moon was often found in the hub of zodiac circles. Not only was this because of the crescent's moon-god association but there was a time element too. After all, zodiacs doubled as calendars. The sun remained in each zodiacal constellation approximately one lunar month. By contrast, the moon, in the course of one lunar month, passes through all the zodiacal constellations.

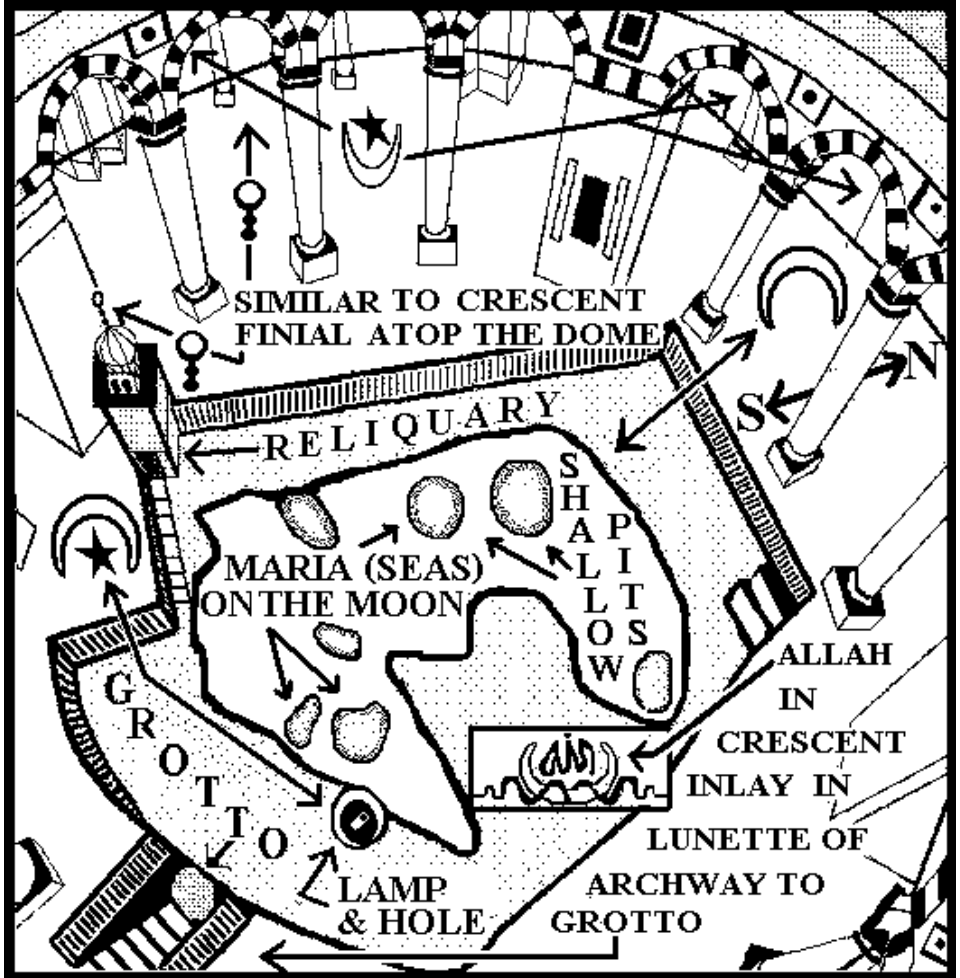


Figure 12-03. View of the Rock of *Ibrahim* at the Dome of the Rock.<sup>4067</sup>

Due to its swiftness, it was thought that the moon affected humans the most of all the heavenly objects. It was known that the ebb and flow of the tides, the cycle of ocean life and the menstrual cycle could be gauged by the phase of the moon.<sup>4068</sup> The

<sup>4067</sup> This picture was drawn from Landay. *Rock*, pp. 72-73 (large picture). A capitals-level view (pp. 112-113) and a standing-level view (pp. 114-115) of the rock can be seen at Nuseibeh & Grabar. *Dome*.

<sup>4068</sup> 'We see...that certain things are increased or diminished in size by the waxing and waning of the moon...the wonderful ocean-tides' (*Augustine Civ. Dei* 5.6 (*Migne, Patr. Lat.* 41.146))' (Wedel. *Attitude*, p. 24). Also see pp. 5, 8 where *Ptolemy* quotes *Posidonius* who recognizes the moon's effect on the oceans.

seasonal harvests of the ocean and land affected the Mideast populations greatly (Deu 33:14; Psa 104:19).

The moon was thought to have maximum effect when it was in its own “house,” the constellation called *Cancer*.<sup>4069</sup> T. Wedel wrote:

Among the greatest of Arabian astrologers was *Abu Mashar* who studied at *Baghdad* in the 9th century (AD) and formulated the doctrine that the more rapidly and erratically a body in the heavens moves, the more influence it will exert on things below. The moon being the swiftest object in the heavens thusly exerts the greatest effect on human affairs.<sup>4070</sup>

What *Abu Massar* did was put into writing what had been believed in the Mideast since ancient times.

### The Dome of the Rock’s Lunar Religious Calendar Décor

The idea of using an arch to show time is an ancient one. Often the arch over a niche with a god such as *Mithras* doubled as a zodiac belt.<sup>4071</sup> A circular or oval frame (cartouche) around portraits of deities was in fact a zodiac circle. Each sign indicated a month-long period of a season—the time the sun took to transverse one zodiacal constellation.

The Dome of the Rock is different from the just-mentioned zodiacs in that the arches represent the phases of the moon and the pillars represent the constellations of the zodiac.

The black and white marble facing tiles on the arches indicate moon phases. The tiles do not have actual pictures of the moon because there have always been iconoclastic currents that ran deep in *Islam*. Many of *Islam*’s early converts were even Jewish converts from *Muhammad*’s stay in *Madina*.

That black marble tiles in the Dome of the Rock had significance beyond themselves is not surprising since more than one rock in *Islam* holds great meaning, for instance:

- ☉ The Black Stone.
- ☉ The *Hatim* Wall.
- ☉ The individual building blocks of the *Kaaba*.
- ☉ The ubiquitous stone *Mihrab* Venus altars that *Muslims* pray toward, even in the Dome of the Rock (see the chapter on Venus altars where it is shown the *Kaaba* and the Dome of the Rock are giant Venus altars).
- ☉ The Rock of *Ibrahim* in the Dome of the Rock.
- ☉ The Black Paving Stone in the Dome of the Rock that is an imitation of the Black Stone at the *Kaaba*. The Paving Stone is discussed elsewhere.

The reflection and sheen seen on the polished marble reminded Mideast pagans of Venus or the moon, as was discussed about betyls in a previous chapter. This accounts for the traditions dating from the late eighth, tenth and fourteen centuries that say people prayed to *Allah* facing a black paving stone at the Dome of the Rock.<sup>4072</sup> This strengthened the association among the black tiles, the phases of the moon and *Allah* the moon-god.

<sup>4069</sup> Ma’shar. *Astrology*, p. 5.

<sup>4070</sup> Ma’shar. *Albumasaris*, as cited by Wedel. *Attitude*, pp. 56-57, cited in turn by Spengler & Sayles. *Turkoman*, p. 22.

<sup>4071</sup> Goodenough. *Symbols*, figure 81.

<sup>4072</sup> Elad. *Jerusalem*, pp. 79-80.

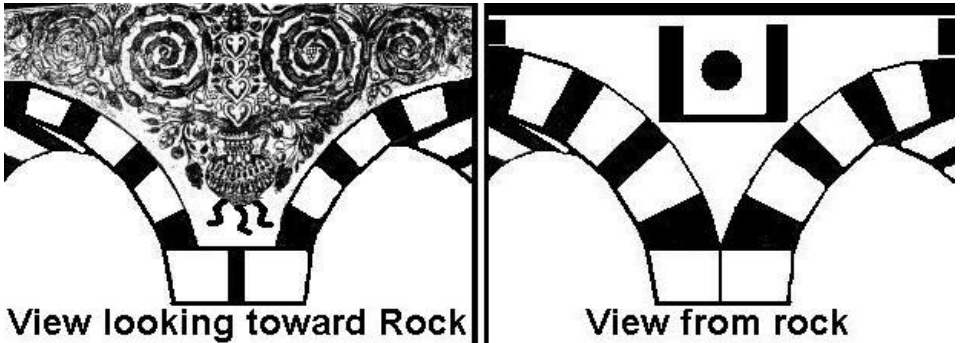
Most of the archways in the Dome incorporate seven black plates. Some smaller arched windows have only five black tiles. The window arches with five black tiles indicate five moon phases: 1 + 2) the waxing and waning crescents, 3 + 4) the half-moons and 5) the full-moon. The archways with seven black tiles indicate the previously mentioned phases, as well as the waxing and waning gibbous moons.

In desert-dry areas with sparse cloud cover and little fog, it is possible to view the moon twenty-eight days a month, at least for a few minutes each night. Each night the moon shows an incremental change in its phases and is striped black and white except when the moon is full.

Earthshine (earthlight) revealed to the ancients that the entire moon existed each night but that it was partially lit. Earthshine is moonlight that reflects from the earth back to the moon.

The fact that the moon-god's main symbol is striped most of the month combined with *Islam's* strain of iconoclasm led to *Islam's* trademark striped architectural design.

The stripes honor the moon's incremental changes. Striped arches honor the moon's waxing and waning and the arches themselves honor the moon's path along the arched ecliptic. In contrast, *Islam's* signature geometric designs seem to be inspired by connecting the dots of astrological star charts and zodiacs.



**Figure 12-04.** This is the inner circular arcade that surrounds the Rock of *Ibrahim*. The acanthus plant and vase and orb and crescent are two sets of fertility symbols.

The lunar association of the arches is indicated by the squared crescent and Venus orb couplets seen above the four sets of triple arches. These squared couplets help to indicate that each pillar and arch combination represents a month.

That the squared crescent-and-orb couplet is in fact a fertility symbol is shown by how on the opposite side of the arch there is another obvious fertility symbol: a three-legged vase with an acanthus plant. A *Muslim* circumambulating just outside the inner arcade would see both the several crescent and Venus orb couplets on the far side and on the near side the acanthus plants.

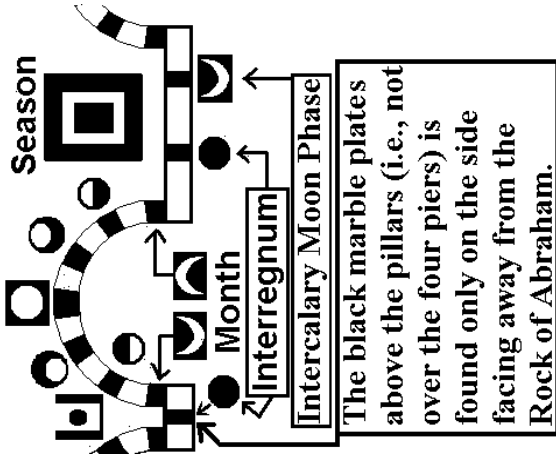
The inner circular arcade around the Rock of *Ibrahim* forms a complete calendar for one lunar year, if one only counts one arch for each of the twelve pillars.

The reason for the discrepancy in the number of arches is whenever architects built a circular arcade mimicking a lunar calendar they realized that the combinations that were architecturally possible were eleven pillars and twelve arches, or twelve pillars and thirteen arches.

Consequently, the architect determined that there would be a pillar for each month or zodiac constellation and four piers for the seasons probably because twelve columns and four piers was the bare minimum needed to hold up the dome.

Structural demands meant that there would be four extra arches connecting the pillars and piers. In other words, the décor in the Dome of the Rock would represent a lunar clock but not actually function as one unless one mentally omitted some arches. Other moon-temples surely had functional clocks since they did not have such a lofty dome.

**Figure 12-05.** A segment of the lunar clock in the Dome of the Rock. Each



archway in the inner arcade around the Rock of *Ibrahim* indicates one lunar month.

The black tiles indicate the incremental moon phases. The squared crescent-and-orb (left) represent the common astral fertility symbol: Ⓒ

A square-within-a-square above the pier represents a season. The two black panels below the square represent two moon phases necessary for intercalation in terms of lunar calendrical reckoning.

Each archway shows seven stages of the moon on the side facing the Rock of *Ibrahim*. Having a lunar religious calendar was early *Islam*'s highest form of worship for *Allah* the moon-god and it assisted *Muslims* in regulating their religious activities.

The lunar religious calendar décor in the Dome reminded *Muslims* to start looking for a crescent marking the beginning of the next month. Even today, most *Muslim* jurists consider it an act of worship to watch for the crescent-moon that marks the start of a new month. Abdulkader Tayob wrote:

The basic forms of *Islamic* worship were also determined by God, in the *Quran*, as well as by the Prophet *Muhammad*'s example. This means that, in many cases, the forms were regarded as ends in themselves. Riding a camel to *Makka* would be regarded as a means to an end but *Mufti* Shafi, like most other contemporary jurists, regards watching the crescent of the new-moon to signal the change of month as an end in itself. Unlike riding a camel, watching the new-moon is an act of worship.<sup>4073</sup>

The fact that watching for a moon was religious worship shows that it was entirely appropriate for the lunar religion of *Islam* to have a lunar religious calendar décor in the Dome of the Rock shrine.

The fact that the décor in the Dome was modeled on a lunar clock makes one wonder what the dome looked like originally. Due to a fire and probably rain damage, the decoration of the inside of the dome no longer exists. It may have been

<sup>4073</sup> Tayob. *Islam*, p. 27.

astral-based like some domes that still exist from the thirteenth and fourteenth centuries. Astral decorations transform the dome into a celestial sphere.<sup>4074</sup>

### How the Lunar Clock in the Dome Shows the Interregnum Phase

#### *The Tiles Above the Pillars*

The base of the arches resting on pillars shows a black tile for the interregnum period but only on the side facing away from the Rock of *Ibrahim*. Evidently, each of the squared moon and Venus couplets on the side facing the Rock took the place of a black tile that would have indicated the moon's dark interregnum period. It just would not do to have two symbols, a couplet and a black tile, for the same interregnum period.

The arrangement with one black tile on the side opposite the Rock of *Ibrahim* can be seen in an illustration above. The tile is in the spandrel area of the arch below a vase and an acanthus plant. In passing, moonless nights during the interregnum period are called the Ebony Moon—ebony being the color black. Therefore, a black tile is quite appropriate for the interregnum period.

The fact that the tile is on the side away from the Rock of *Ibrahim* suggests it represents the interregnum phase. This phase occurs when the moon is traveling through the underworld from east to west where it reappears as a waxing crescent near the setting sun.

The interregnum phase is shown as a black tile beneath a potted acanthus plant, as shown in the illustration above. This arrangement indicates a belief that the interregnum period was especially fertile for the earth's plant and animal life. Alternatively, the arrangement may have meant that during the Interregnum period the moon was in the underworld where it recharged itself with life-giving forces.

### Why Seven Phases of the Moon Are Shown in the Dome Décor

Probably a major reason that only seven phases are shown on each arch is that *Muslims* once circumambulated in the Dome of the Rock just as they still do at the *Kaaba* at *Makka* in seven-lap cycles. The tiles served as a mnemonic aid in that the worshipper felt that each lap around the Dome honored one of *Allah* the moon-god's phases, and seven laps honored the moon-god *Allah*'s monthly cycle.

St. Clair-Tisdall wrote:

Herodotus (*Herodotus*, III:8) mentions the use of seven stones by the Arabs when taking solemn oaths. The honor, almost amounting to worship, still paid by *Muslim* pilgrims to the famous meteoric *Hajaru'l Aswad* or Black Stone, which is built into the wall of the *Kaaba*, is one of the many *Islamic* customs which have been derived from those of the Arabs who lived long before *Muhammad*'s time.<sup>4075</sup>

*Muslims* also carry on the tradition of sevens by throwing stones at the *Jamara* pillars in multiples of seven, thereby showing the oath aspect of this ritual.

The number seven was sacred to *Semites* from ancient times. In Hebrew *Sheba* (*Strong's* no. 07614) means "seven" or "oath." Interestingly, the country of *Sheba* is in Southern Arabia, the same place where *Sabeanism* was rife. That *Makka* is not far

<sup>4074</sup> Baer. *Ornament*, pp. 98-102.

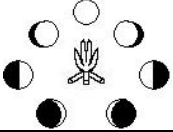
<sup>4075</sup> St. Clair-Tisdall. *Sources*, Ch. 2.



up the spice road from *Sheba* suggests that the oath ritual of throwing seven stones and other rituals in *Islam* come from *Sabeanism*.

It has been theorized that the number seven was sacred because there are five visible planets along with the sun and moon. Perhaps another reason is that there were seven moon phases that especially interested the ancients:

1) The waxing crescent-moon started the month, 2 + 3) half-moons marked the end of the first and third weeks and 4) the waning crescent and 5) interregnum period marked the end of the month. The 6 + 7) waxing and waning gibbous moons suggested pregnancy and thus fertility.



**Figure 12-06.** Seven round rocks around a campfire can reproduce seven moon phases when one looks from outside the circle of rocks. Perhaps this was the origin of the ubiquitous rock circles used in the Mideast and elsewhere for taking oaths.

Seven visible moon phases could easily be reproduced by seven stones and a source of light such as a campfire. The Arabs used circles of stones when they enacted oaths, as was noted above. The moon-god *Sin* was a guardian of contracts.<sup>4076</sup> It is not surprising that *Semites* used stones when enacting oaths.

Notably, *Allah* was a moon-god and a guardian of contracts too.<sup>4077</sup> In fact, much of the *Koran* and *Islamic Sharia* law read as though they were merely contract law rather than, say criminal law.

The seven stones that ancients used for oath taking may have been circumambulated during the oath ceremony. If so, circumambulating at the *Kaaba* may be a form of oath taking to *Allah* the moon-god.

The Bible indicates that moon-god worshippers used a pile of stones and even circles of stones for oath taking. Laban lived near *Haran*, the City of the Moon. Laban and Jacob enacted an oath around a pile of stones (Gen 31:46, 48, 51, 52).

The book of *Joshua* speaks about how an oath was taken at *Gilgal*. *Gilgal* means “sacred circle of stones” and evidently was a place that moon-god worshippers, such as those at nearby *Jericho* (meaning “His Moon”), enacted oaths and circumambulated. *Joshua* records that *Gilgal* was on the east border of *Jericho* (Jos 04:19). *The 1911 Encyclopedia* states:

Jerome (*Onomasticon*, s.v. [Latin: *sub verba*, meaning see “under the word”] *Galgal*) places *Gilgal* 2 Roman miles from *Jericho* and speaks of it as a deserted place held in wonderful veneration (Latin: *Miro Cultu*) by the natives.<sup>4078</sup>

Instead of the seven stones that pagan *Semites* used for oaths, *Joshua* had twelve stones brought up from the Jordan River (Jos 04:19-20). The reason river stones were used was not only to commemorate the crossing of the Jordan on its dry river bottom but brook stones are generally rounded and smooth. The light falling on rounded stones reproduced the phases of the moon. This is illustrated above.

This variance in the procedure of taking an oath mocked the local moon-god religions. This is similar to how marching around *Jericho* thirteen times in seven days mocked *Jericho*’s moon-god religion. The *Israelites* circumambulated *Jericho* six times in six days and seven times on the seventh day and thus mocked the pagan ritual of circumambulating moon-god shrines in multiples of seven (Jos 06:03-04).

<sup>4076</sup> Combe. *Culte du Sin*, p. 61, as quoted in Green. *Moon*, p. 35.

<sup>4077</sup> Brockelmann. *Peoples*, p. 9.

<sup>4078</sup> *The 1911 Encyclopedia*, 1911encyclopedia.org, *Gilgal* entry.

### Description of the Lunar Clock Décor in the Dome of the Rock

So putting all the above information together, one can see that the décor of the inner arcade of the Dome of the Rock was inspired by a one-year lunar calendar and zodiac circle which suggests that the Dome of the Rock was modeled after Mideast moon-god temples.

Together the inside and outside face of each arch indicated a complete lunar month. The black stone at the top of each arch indicates the full-moon. The black tile on the side facing away from the rock indicates the interregnum moon.

The square-in-the-rectangular-frame symbols on the piers indicate the Seasons. The four Seasons were commonly found on zodiac circles, which were used both as perpetual calendars and for making astrological predictions.

The seasons did not factor into the official *Islamic* religious lunar calendar but did for the civic solilunar calendar used for government, agriculture and such. The calendar at the Dome of the Rock could easily be used as both a lunar and solar calendar by following or ignoring the extra black intercalation panels found above the piers that represented the seasons.

There are two black tiles under each of the four square season symbols. One tile indicates an interregnum phase of the moon. The second tile indicates an intercalary phase of the moon that could either be ignored for purely lunar calculations or incorporated for solilunar calculations. History shows, by the way, that many people kept track of solar, solilunar and lunar calendars simultaneously.<sup>4079</sup>

The lunar year is slightly more than eleven days short of a solar year. Eleven days is equal to about four of the eight phases depicted in the Dome of the Rock say, 1) the Interregnum, 2) waxing crescent, 3) half-moon and 4) the waxing gibbous moon.

Thus the lunar calendar that inspired the Dome's décor accounts for ninety-six phases of the moon per lunar year, or eight phases per lunar month. The breakdown, as can be seen in the illustration above, is thus  $(84 + 8 + 4 = 96)$ :

☾ Seven phases represented by seven tiles on each of the twelve arches (84).

☾ A phase represented by a tile above each of the eight pillars (8).

☾ A phase represented by one of the two tiles above each of the four piers (4).

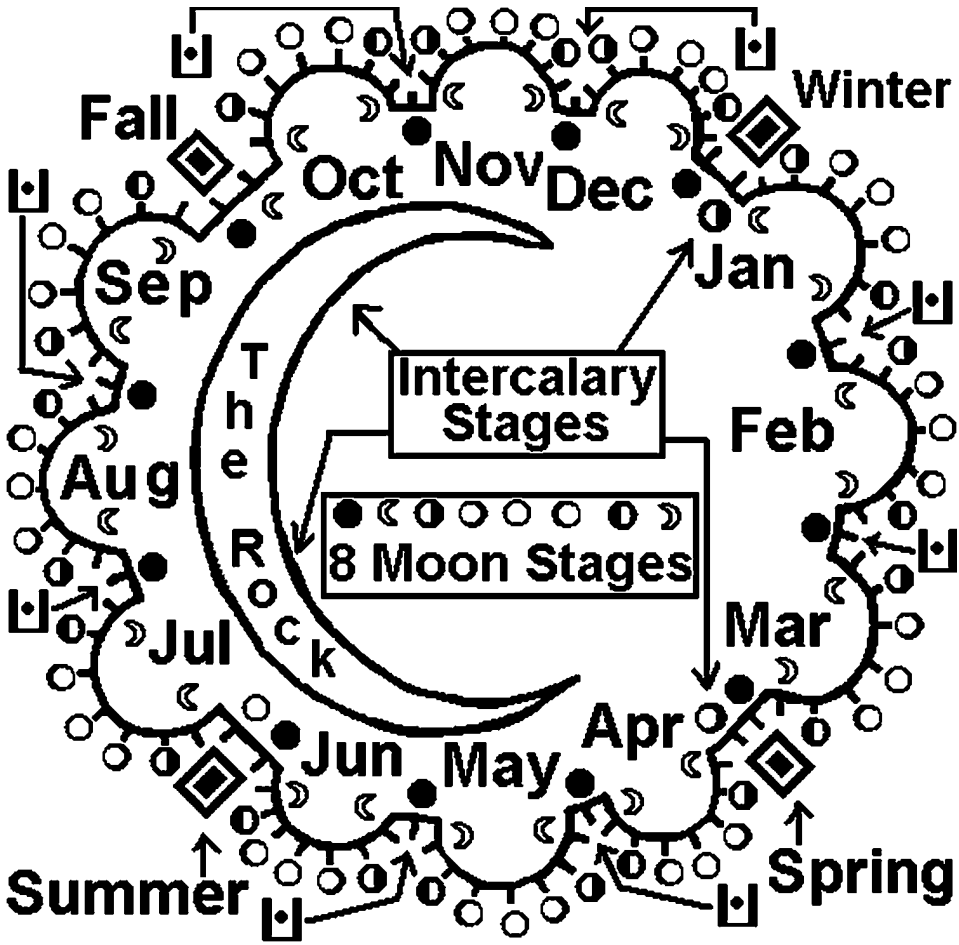
In addition, the second of the two tiles above each of the four piers represents a phase of the moon, amounting to about eleven days. These four extra tiles means the calendar which inspired the décor in the Dome could track both the 354-day lunar year and the 365-day solar year.

Despite the presence of intercalary tiles, the calendar on which the décor in the Dome was based was in keeping with *Muhammad's* dictum against intercalation (*K* 009:036). When the religious *Hegira* lunar date was calculated, the intercalary tiles were ignored. When the solilunar calendar was computed, the intercalary tiles were incorporated into the calculations.

The Dome's lunar religious calendar's four additional intercalary phases of the moon account for the seasons. Thus a purely lunar calendar works. A solilunar calendar would show undue deference to the sun or the Four Seasons. This was in keeping with *Muhammad's* dictum that the moon could be used to account for the seasons:

They ask thee, (O *Muhammad*), of new moons, say: 'They are fixed seasons for humanity and for the pilgrimage' (*Pickthall K* 002:189).

<sup>4079</sup> Blair. *Inscriptions*, pp. 23, 49, 158, 217-220.



**Figure 12-07.** This is an illustration of the lunar calendar that may have inspired the décor in the Dome of the Rock around the Rock of *Ibrahim*. Lunar calendars like this may have been common in Mideast moon-god temples but it is speculative since only scattered stones of such temples remain today—not counting the ziggurats, of course.

The black and white tiles on the inside and outside faces of the arcade that circles the Rock of *Ibrahim* are features copied from a lunar calendar for one annum. Each tile represents one moon phase: waxing or waning crescent, waxing or waning half-moon, waxing or waning gibbous, full or interregnum period.

**The Idea of the Moon Marking Seasons**

The link between stones, the moon and the seasons was not new to *Muhammad*. Since the moon is roughly on the same ecliptic as the sun, it rises high in the sky in summer and is low in winter. Spotting and measuring the position of the moon is much easier than looking at the blinding sun. Ancient stone circles are found throughout Europe. John Michell wrote:

Stones within and beyond the circles lined up to indicate a natural or artificial mark on the horizon where the moon or sun reached one of the extreme positions in their cycles, as at a solstice.<sup>4080</sup>

In the *Lascaux* caves in France, the lines of dots interspersed with squares seem to indicate the stages of the moon.<sup>4081</sup> The fact that many of the dots are next to painted game animals suggests that already then the moon cycle was connected to fertility, meaning the prehistoric hunters thought the moon made the animals plentiful.

The cave dwellers probably noticed that the moon was lowest in winter and highest in the sky during the fall breeding and spring calving season. Cave dwellers also noticed that the human menstrual cycle occurred monthly. Therefore, the moons were painted next to painted game animal in the hopes of increasing their fertility.

### What the Lunar Religious Calendar Décor in the Dome of the Rock Meant

The lunar religious calendar décor goes well with the *Koranic* inscription displayed in Arabic that circumscribed the entire Dome of the Rock. The epigraphy uses *Koranic* language to voice anti-Trinitarian assertions and to say that *Muhammad* was *Allah's* prophet.<sup>4082</sup>

*Muhammad* thought that Jews believed that Ezra was a sun-god and he thought the Christians believed that Jesus was a sun-god. The pro-lunar, anti-solar inscription paralleled the circular lunar religious calendar like two concentric circles at the center of which was the crescent-shaped Rock of *Ibrahim*.

Using and displaying the lunar religious calendar décor in such a grandiose form around the crescent-shaped Rock of *Ibrahim* along with the mosaic message constituted a witness against:

- ☉ *Muhammad's* mistaken idea that Christians thought Jesus was a sun-god.
- ☉ The solar calendar used by Christians since Roman times.
- ☉ The solilunar calendar of the Jews.

### The *Allah* Motifs on the Inner Side of the Octagonal Arcade

The inner circular arcade has a thin crossbeam. The octagonal arcade however has a large, decorative crossbeam. The inner face of the crossbeam of the octagonal arcade has an ornate entablature. A very long *Koran*-based inscription is found on both the inner and outer faces of the octagonal arcade near the ceiling.

The crossbeam entablature on the inner face of the octagonal arcade has several tall-short-tall (lol) *Allah* motifs just like those discussed elsewhere:

- ☉ The top cornice has interconnected crescents with orbs in the spandrels formed by the horns of the crescents.
- ☉ At the top of the frieze just below the cornice, are orbs between vertical lines.
- ☉ In the top middle of the frieze are lotus blossoms that sit in canoe-like crescents formed by two leaves.

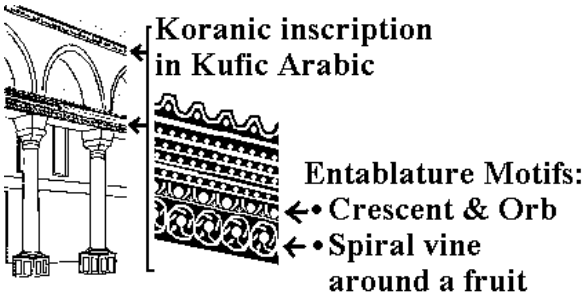
<sup>4080</sup> Michell, John. "Sacred Science & The Megaliths," *Earth Mysteries* britannia.com/wonder, 2001, excerpted from Michell, John. *The Traveller's Guide to Sacred England*. Gothic Image, United Kingdom, 1996.

<sup>4081</sup> "Oldest lunar calendar identified," *BBC*, [bbc.co.uk](http://bbc.co.uk), 16 Oct 2000.

<sup>4082</sup> An English translation of the 240-meter long inscription can be found in Nuseibeh & Grabar. *Dome*, pp. 106-109.

- Ⓒ The bottom middle of the frieze has orbs in crescents with three-bladed, sprig *Fleur-de-lis* interspersed.
- Ⓒ The bottom architrave has a grapevine scrolling around orbs.

**Figure 12-08.** The inner face of the octagonal arcade that rings the Dome. In the background is the inside of the outer octagonal wall of the Dome of the Rock.



The arcade has an ornate crossbeam with several tall-short-tall (lol) crescent-derived *Allah* motifs. Also, on the arcade is a *Koranic* inscription found near the ceiling (see inset for exactly where).<sup>4083</sup> Note the connection made between the crescent-based *Allah* motifs and the *Koran*.

The crossbeam is supported on both columns and piers. Whenever the crossbeam of the octagonal arcade rests on a pier, a large molding with arches and a floral motif is added just below the crossbeam entablature (see the illustration below).



لااله الا الله  
لا = "Lā" = "There is no"  
اله = "ilah" = "god"  
الا = "illā" = "except"  
الله = "Allah" = "Allah"

**Figure 12-10.** This is the start of the lengthy inscription that wraps right to left around the interior of the Dome of the Rock.

**Figure 12-09.** This is a common entablature at the Dome of the Rock. Notice the four *Allah* motifs (from top to bottom): 1) The lotus flower in a crescent canoe-like boat (inset is enlarged detail), 2) the crescent-and-orb, 3) the undulating vine and 4) the acanthus plant with the tall-short-tall (lol) crescent-derived *Allah* pattern.

This is the inner side of the octagonal arcade. The top half is the entablature on the crossbeam. The bottom half is molding on a pier beneath the crossbeam.<sup>4084</sup>

The *Koranic* inscription near the ceiling is 240 meters long and runs on both sides of the outer octagonal arcade.<sup>4085</sup> The ornate entablature runs along the inner

<sup>4083</sup> Peters. *Jerusalem*, p. 56.

<sup>4084</sup> Grabar. *Shape*, p. 58, figure 23.

<sup>4085</sup> Grabar. *Shape*, p. 56.

side of the octagonal arcade. This means the crossbeam and inscription run together for 120 meters.

The pairing of inscriptions and frieze seems to associate the *Koran* and *Allah* with the crescent-based *Allah* motifs on the crossbeam. The *Koranic* inscription encircles most of the Dome of the Rock complex and thus associates the *Koran* and *Allah* with all the other *Allah* motifs and crescents found in the entire Dome.

The *Allah* motifs of course are derived from the orb and crescent symbol. This indicates *Allah*'s moon-god origin. The crossbeam with *Allah* motifs and *Koranic* inscription together are the longest and most massive piece of evidence showing that *Allah* is a moon-god. The two other contenders will be discussed later in this chapter.

### The *Allah* Motifs on Ceiling Panels

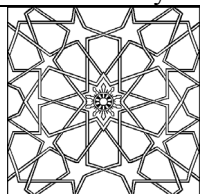
Even the ceiling panels of the Dome have *Allah* motifs. One panel has a design with a sunburst or daisy flower in the middle with interlaced stars on the perimeter.

Unlike nearly all of the other decorations in the Dome, this sunburst ceiling panel design is not part of the original artwork. Geometric patterns did not become popular in *Islam* until about the eleventh century. Since late medieval times, the sunburst design has been used everywhere in *Islam*. Sheila Blair wrote:

The same [sunburst] symbolism is inherent in the medallions known as *Shamsa* (Arabic meaning “sun”) that appear so frequently in *Islamic* art. They are found on illuminated pages in manuscripts...on carpets and on the interiors of domes over *Mosques* and tombs where they symbolize the vault of heaven and the central unity of God.<sup>4086</sup>

Sunbursts are actually *Allah* motifs in disguise. The outline of each daisy petal is actually a crescent in the shape of a flat-bottomed U—a shape common in *Allah* motifs. The flat-bottomed U-crescent and the star in the center form ten interlocking star-and-crescent symbols.

The eight stars around the perimeter serve to emphasize the astral significance of the design. The design indicates that *Allah* is a moon-god and is surrounded by stars that are actually astral spirits or angels.



**Figure 12-11.** A sunburst pattern at Dome of the Rock. This is a ceiling panel with an interlocking crescent-and-star lol *Allah* motif.<sup>4087</sup>

### The Star-and-crescent Symbol on the Octagonal Arcade

One of the arches of the octagonal arcade on the north side has a mosaic crescent-and-star on the underside of the arch—the *intradós* or soffit. The crescent star is located underneath the keystone. The crescent-and-star symbol is located in a pear, pomegranate and leaf mosaic.

The star and crescent on the soffit in the octagonal arcade reminds one of the images of the sun and moon decorating the Gate of the Prophet. These decorations are found on the outside and in the internal ceiling of the Gate of the Prophet.<sup>4088</sup> This gate is on the south side of the *Haram*—the temple mount in Jerusalem.

<sup>4086</sup> Blair & Bloom. *Paradise*, p. 93.

<sup>4087</sup> Nuseibeh & Grabar. *Dome*, pp. 69-70.

<sup>4088</sup> Elad. *Jerusalem*, p. 99.

*Muhammad* was said to have walked through the Gate of the Prophet on his Night Journey. This suggests that the astral character of *Muhammad's* religion was well-known to those who built the gate.



**Figure 12-12.** Crescent-and-star mosaic on the peak of the soffit (underside) of an arch of the octagonal arcade in the Dome of the Rock.<sup>4089</sup> The mosaic on the haunches of the arch consists of pears, pomegranates and leaves.

### The *Allah* Motifs Found in the Neck (Drum) Above the Rock of *Ibrahim*

In the drum underneath the Dome is a border of orbs in crescents along with an occasional tulip. This associates tulips with the crescent-and-orb symbol. The outline of a tulip blossom has similarities to a crescent or half-moon. Tulips occur elsewhere on the flanks of piers<sup>4090</sup> and on the soffits of cross beams.<sup>4091</sup>

Another chapter of this book discusses how the tulip is a Turkish and Persian *Allah* motif. A later chapter also discusses how the tulip (Turkish: *Laleh*) is, so to speak, metathetically related to the word *Allah*. Since the tulip is a Turkish and Persian *Allah* motif, tulip decorations are a later addition to the Dome.

The drum area where several tulip mosaics occur probably was damaged during the dome fire of 1448 AD.<sup>4092</sup> Instead of just repairing a damaged mosaic, an artist employed his artistic license to replace a crescent-and-orb symbol with a tulip, an equivalent symbol.



**Figure 12-13.** A tulip mosaic representing *Allah* the moon-god in the dome at the Dome of the Rock.<sup>4093</sup>

### Crescents in Crown Jewelry

The Dome's mosaics mainly consist of vases and cornucopias with extruding, stylized grapevines and acanthus plants. The same vine may bear a combination of pomegranates, grapes and jewels. Eva Baer wrote about the Dome of the Rock's plant vases:

In a recent article, I drew attention to a group of relatively cheap pottery vessels that were decorated with ornaments that gave them a precious appearance and 'transformed' these artifacts into 'living things' by using for their embellishment ornaments that imitated **jewelry** which was normally worn by men. These 'transformations' were achieved first by employing precious metal techniques like twisted wire and granulation [rough surface] and using base material, barbotine [a paste of clay used in decorating coarse pottery in relief] and other cheap pottery techniques instead of gold and silver. Secondly, they imitated necklaces and other jewelry like pendants [ornament on necklace], brooches [decorative pins] or earrings and applied them to the neck, foot or shoulder of the inanimate objects as if they were men. The earliest realization of

<sup>4089</sup> Nuseibeh & Grabar. *Dome*, p. 85.

<sup>4090</sup> Creswell. *Architecture*, plate 9.

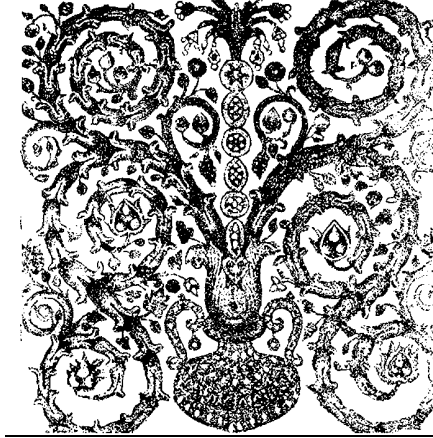
<sup>4091</sup> Creswell. *Architecture*, plate 10.

<sup>4092</sup> Landay. *Rock*, p. 107.

<sup>4093</sup> The tulip is a tall-short-tall (lol) *Allah* motif (Grabar. *Shape*, p. 80, figure 30).

the latter—anthropomorphic—notion appears in the mosaics of the Dome of the Rock...where the artists laid jeweled breastplates around the neck of an amphora, and attached earrings with one or three suspended pearls to the S-shaped handles of the vase.<sup>4094</sup>

The anthropomorphized vases probably all represented the Venus angel, especially the vase mosaics in the Dome of the Rock.



**Figure 12-14.** A typical, bejeweled acanthus plant in a vase mosaic with jewelry analogous to earrings, neck and chest jewelry. This anthropomorphizes the vase as the Venus angel.

The S-shaped arms of the vase with earrings and the neck for the lol pattern representing the Venus orb and crescent-moon. The center bejeweled stem and vines (off to the left and right sides of the vase) form a lol pattern. Moreover, the vines scrolling around the pomegranate pods represent a crescent-and-orb pattern.

### Bejeweled Vases in the Dome of the Rock Represented the Male Venus Angel

Elsewhere it was discussed how lamps in Venus-altar *Mihrabs* and vases on prayer rugs represent Venus. The bejeweled, anthropomorphized vases in the Dome of the Rock represent the male Venus angel too. The crescent-shaped rock of *Ibrahim* and the bejeweled vases together form Venus-moon symbols.

Why would Venus be wearing jewelry? The *Dabistan* notes that the Venus angel was beautiful and he denoted gladness and festivity.<sup>4095</sup> Besides, early *Muslim* males wore jewelry and earrings. For instance, the illustrator Angus McBride depicts the *Abbasid Caliph* Mutawakkil (ruled 847-861 AD) with a trident-like crescent-and-star earring.<sup>4096</sup> David Nicolle wrote:

Some of the *Umayyad* elite certainly wore jewelry and even *Kohl* eye shadow—though this certainly did not reflect any effeminacy.<sup>4097</sup>

The jewelry probably was crescent-shaped just as Angus McBride drew them, and such jewelry honored *Allah* the moon-god. This is similar to how camels were decorated with crescent ornaments in honor of a moon-god (Jdg 08:21, 26).

It was noted in a previous chapter that the *Mihrab* prayer niche with its bulbous *Mosque* lamp came to be artistically represented on prayer rugs as a flowerpot underneath an arch. It is worthwhile to repeat one quote here:

The *Mosque* lamps suspended in the *Mihrab*-like arches of prayer carpets are perhaps best-known examples...They originally reflected verse 35 of *Sura* xxiv [K 024:035]...Later on the light-carrying lamp became a flower vase [note that *Mosque* oil lamps resemble vases] and it was eventually placed on a saucer at the bottom of the arch. What is remarkable about the *Allah*-derived motif is the fact

<sup>4094</sup> Baer. *Ornament*, pp. 105-106, 108.

<sup>4095</sup> Fani. *Dabistan*, pp. 398, 404.

<sup>4096</sup> Nicolle. *Conquest*, Plate H.

<sup>4097</sup> Nicolle. *Conquest*, p. 40, describing a figure on plate E1: “*Umayyad* Governor of *Balkh* (circa 700 AD).”



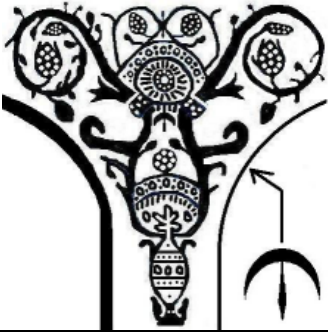
that it preserves a certain innate power which gave it a magic, apotropaic [intended to ward off evil] quality.<sup>4098</sup>

The vases, with and without crown jewels, are associated with the crescent-shaped Rock of *Ibrahim*. Not only do they ring the Rock by being on the inner arcade of the Dome but the plants with crown jewels all happen to face the Rock of *Ibrahim*, as Oleg Grabar wrote:

The [crown] jewel decoration [on vases and plants] does not appear uniformly throughout the building but almost exclusively on the inner face of the octagonal colonnade and of the drum....It may rather be suggested that these actual crowns, bracelets and other [royal] jeweled ornaments were meant to surround the central holy place toward which they face, and it is in this sense that they contrast with the purely decorative gemlike fragments throughout the building.<sup>4099</sup>

There are vase and vine mosaics on both the outer and inner walls of the arcades. However, the vases and vines that are decorated with crowns and royal jewelry tend to face the Rock of *Ibrahim*. This also means the crescent decorations found on the vases and vines tend to face the Rock of *Ibrahim*.

The Rock of *Ibrahim* is connected with *Allah* in various *Muslim* traditions. So it would be natural that the vases and vines decorated with crescent jewels are personalized to represent *Allah* the moon-god.



**Figure 12-15.** Typical crowned plant located on a spandrel and impost at the Dome of the Rock. Note the crescent-and-star hanging jewel pendant (see inset and arrow for exact location).

The plants and vases and vases with crowns and royal jewelry typically face the Rock of *Ibrahim*.

### The Crescents Surrounding the Rock of *Ibrahim*

As Oleg Grabar noted above, the most notable, bejeweled decorations are on the inner face of the octagonal arcade and in the drum area. Many of these mosaics have crescent-and-star jewelry and they tend to face the Rock of *Ibrahim*.

Additionally, on the inner wall of the circular arcade is a series of mosaic arches. Suspended from the relatively small mosaic arches are crescent, half- and full-moon jewelry mosaics (illustrated below). As was noted in a previous chapter, the arch represented the crescent-moon in early *Islam* and this strengthened the association.

This arcade mosaic motif seems to have been the original motif that encircled the lower part of the drum just over the circular arcade. In places however the original mosaic motif has been repaired and replaced with geometric design mosaics typical of a later era.

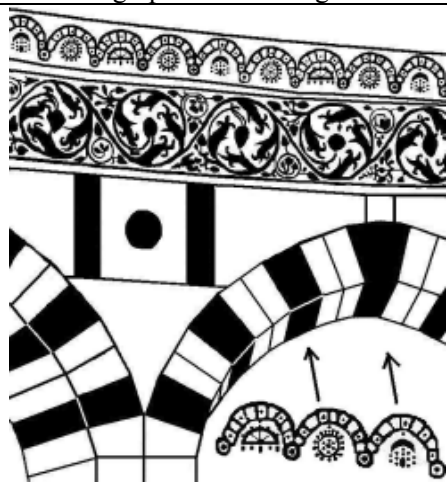
Still, it is notable that the crescent-shaped Rock of *Ibrahim* was encircled with real arches and mosaic arches, as well as crescent, half- and full-moon jewelry. These honored the moon-god *Allah*.

Other *Allah* motifs that surround the Rock of *Ibrahim* include:

<sup>4098</sup> Ettinghausen. *Kufesque*, pp. 43-45.

<sup>4099</sup> Grabar. *Art*, p. 55.

- ⊕ Orbs between two vertical lines in the spandrels. This is an example of the tall-short-tall (lol) *Allah* motif crescent-derived pattern.
- ⊕ Some of the vertical lines are connected at the bottom like a flat-bottomed U, which form a squared crescent-and-orb.
- ⊕ A grapevine scrolling and undulating around orbs.



**Figure 12-16.** This is one spandrel of the inner circular arcade facing the Rock of *Ibrahim* at the Dome of the Rock.<sup>4100</sup>

Note the crescent, half-moon and full-moon jewelry mosaics. The vine scrolling and undulating around grape clusters and the acanthus pods form artistic crescent-and-orb symbols.

The black facing marble forms an orb in a flat-bottomed U, which is another crescent-and-orb symbol.

All these symbols associate the moon with the crescent-shaped Rock of *Ibrahim* that lies below.

### The Entrance to the Grotto

There is a cave beneath the Rock of *Ibrahim* that is commonly called the “Well of Souls” (see the illustration below). In front of the marble steps that lead down into the grotto is an arch with a flat lunette on two pillars. The arched entrance resembles a *Mihrab* prayer niche. As was discussed in a previous chapter, arched *Mihrabs* associate *Allah* with the crescent-moon.

Significantly, the grotto itself contains two *Mihrab* prayer niches dating back to medieval times.<sup>4101</sup> One of the grotto’s *Mihrabs* from the *Fatimid*-era (909–1171 AD) is illustrated in a previous chapter along with even older *Mihrab* panels from the *Al-Aksa Mosque* (see the Thumbnail Gallery). Incidentally, Michael Rogers says a *Mihrab* may have been placed in the grotto when the Dome of the Rock was first built.<sup>4102</sup>

In the lunette of the archway entrance is a canoe-like (boat-like) crescent. In this crescent is the word *Allah*. This *Mihrab* associates *Allah* with the crescent-moon. In fact, this reminds one of how the ancient steles show a male moon-god rowing a crescent boat through the night sky. The artwork of course was based on popular myths about the moon-god. The *Allah* in a boat crescent shows that *Allah* was a moon-god.

The *Mihrab* also seems to emphasize that the Rock of *Ibrahim*, as seen through the entrance, is in the form of a crescent. The Rock is further associated with *Allah* by the fact that at the level of the Rock of *Ibrahim* over the cave opening itself is a blue plaque of recent origin that says “*Bismillah ir Rahman ir Rahim*” meaning “In the Name of *Allah* the Merciful, the Compassionate.”

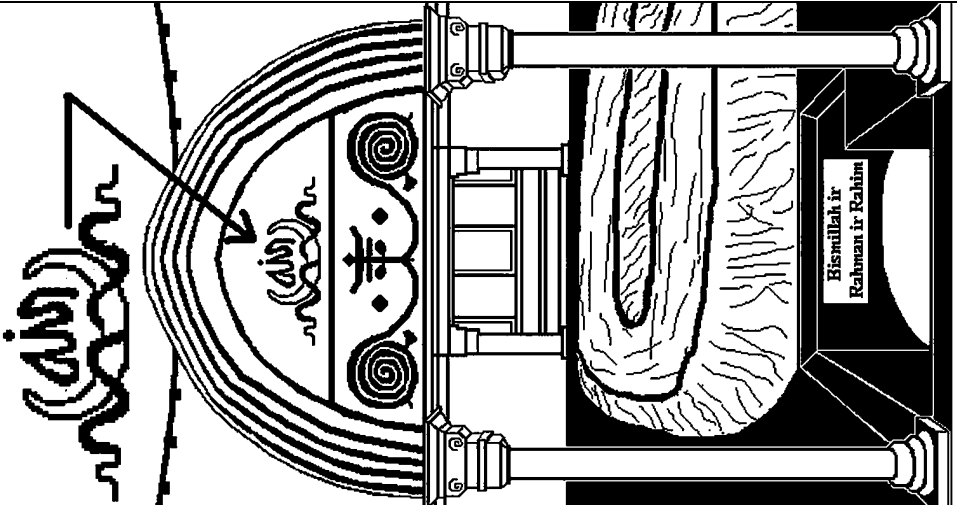
The shape of the word *Allah* in the moon-boat deserves discussion. The word *Allah* normally looks like *aUl* but the *Allah* in the lunette looks like the English word

<sup>4100</sup> Nuseibeh & Grabar. *Dome*, p. 116.

<sup>4101</sup> Nuseibeh & Grabar. *Dome*, pp. 135, 140.

<sup>4102</sup> Rogers. *Spread*, p. 84, left column.

“air” in cursive English script (see the illustration above). The dot above the *Lam* (ل) (i.e. the “i” in “air”) is not a vowel but an accent mark.



**Figure 12-17.** Archway entrance to the grotto under the crescent-shaped Rock of Ibrahim. Note the *Allah* in the *Thuluth* calligraphy style in the crescent boat that looks like the cursive English word: *air* (see the inset and arrow). Also note the crescent-and-orb-derived pattern consisting of a stem and scrolling ribbon on the stem’s right and left.<sup>4103</sup> **Note:** Rotate book to view figure upright.

**Figure 12-18** is located at the Title Page (see Figure 00-01).

The word *Allah*’s transliteration looks like “air” in the lunette because it is written in the calligraphy style called *Thuluth* which happens to mean “a third,” for some reason. The *Thuluth* script was first formulated in the seventh century during the *Umayyad Caliphate*.

The *Thuluth* script was refined until the ninth century. To the present day, *Thuluth* remains a popular Arabic script for use on monuments. In fact, the *Thuluth* calligraphy style is so well known among *Muslims* that in the mid-1990’s, *Muslim* protests forced the shoe company *Nike* to redesign its logo on its *air*<sup>TM</sup> brand.<sup>4104</sup> The reason given was the cursive *air*<sup>TM</sup> logo looked like *Allah* in the *Thuluth* style.

When exactly the archway came into existence is hard to know based on the evidence available to this author. The *Thuluth* calligraphy could have been produced anywhere from the eighth century AD onward. Whoever built the grotto entrance seems to have known that *Allah* was a moon-god.

### The Shrine to the Prophet Muhammad

Close to the Rock of Ibrahim is a wooden reliquary with a ring-shaped crescent atop (the *Qubbat Al Nabi*). The reliquary is depicted in the Rock of Ibrahim drawing earlier in this chapter. The caption of a picture on the reliquary reads:

<sup>4103</sup> Illustration was drawn from an as yet unpublished photograph. One can see just a part of the arch of the grotto entrance in Nuseibeh & Grabar. *Dome*, p. 74, fig. 25.

<sup>4104</sup> “*Nike* and *Islamic* group [CAIR] end logo logjam,” CNN.com, 21 Nov 1998.

A shrine to the Prophet *Muhammad* is said to contain a piece of the Rock [of *Ibrahim*] with a footprint of *Buraq*, the winged steed who, as told in the *Koran*, carried the Prophet during his Ascension from the Rock through the Seven Heavens to ‘the Lote-tree [lotus tree] of the utmost boundary (*K* 053:014).<sup>4105</sup>

Since some traditions say *Muhammad* saw *Allah* on his trip to heaven, the crescent above the reliquary would seem to associate *Allah* with the crescent-moon. The same could be said for the *Alam* crescent finial atop the Dome of the Rock, which sits far above the Rock of *Ibrahim*.

### The Crescent in the Grotto Vent Lighting Effect

A vent hole was drilled from the top of the Rock straight down through the ceiling of the grotto below. Interestingly, the fourth-century Anonymous Pilgrim of Bordeaux mentions that:

...the Jews came annually to Jerusalem to mourn the destruction of the

Temple and that their ceremonies center around a ‘pierced rock.’<sup>4106</sup>

The “pierced rock” may refer to either the grotto cave itself or to the grotto vent hole.

Apparently, a *Muslim* noticed that if a candle or lamp were placed into the vent hole, the illuminated side of the hole appears to be a crescent when viewed from the dome above. The lamp or candle represents a star and the illuminated side of the hole viewed from an oblique angle forms a crescent.

The hole may have been drilled so that people looking down from the dome would see the crescent lighting effect and then notice the general crescent shape of the Rock of *Ibrahim*.

To see the star and crescent, the hole must be viewed off-center, or else the lighted side of the hole would appear as a ring and not as a crescent. This is not a concern since people are not allowed to walk on the rock anyway. Also, the balcony in the dome above only allows for an off-center view of the vent hole.

This lighting effect appeared from at least the mid-sixteenth century AD, if not from the building of the Dome of the Rock in the eighth century AD. A *Muslim* wrote in his mid-sixteenth century AD guide to the Dome of the Rock:

The hole in the center of the cave. There one finds a big candle, lit day and night.<sup>4107</sup>

Photographs show this lighting effect still existed in about 1972 AD.<sup>4108</sup> The crescent-and-star lighting effect is reproduced earlier in this chapter—in the drawing of the overhead view of the Rock of *Ibrahim*.

Sometime after 1972 AD, the lantern that hung in the hole was replaced with a beige glass *Mosque* lamp.<sup>4109</sup> The source of light no longer is a well-placed “star” in the hole but a *Mosque* lamp that hangs below the vent hole.

Currently, the side of the hole is less illuminated than before. Also, the bulbous lamp is almost the same size as the hole. This means there is no dark space between

<sup>4105</sup> Nuseibeh & Grabar. *Dome*, p. 68.

<sup>4106</sup> Peters. *Jerusalem*, p. 196.

<sup>4107</sup> “This guide was written by Nasir *Al Din*, *Muhammad b. Khidr Al Rumi* (mid-16<sup>th</sup> century), and is included in his book *Al Mastaqsa fi Fadail Al Masjid Al-Aqsa*, which is still in manuscript form” (Elad. *Jerusalem*, pp. 164, 167).

<sup>4108</sup> Landay. *Rock*, pp. 72-73. The photo shows a point of light and a crescent illuminated on side of hole when the hole is viewed from an angle.

<sup>4109</sup> Nuseibeh & Grabar. *Dome*, p. 135 (photo).

the side of the hole and the lamp to form a well-formed crescent-and-star projection that can be seen from above.

That a crescent-and-star was projected to viewers in the dome's balcony for a period of centuries was meant to show the Dome of the Rock was a moon-god temple. It was also a subtle way to tell the viewer to look for the crescent shape in the Rock of *Ibrahim*.

The horns of the Rock of *Ibrahim* and the horns of the crescent projection in the hole both point to the east. The star and crescent projection and crescent-shaped rock were meant to communicate *Allah*'s presence at the Rock of *Ibrahim*, as Amikam Elad wrote:

Early traditions of this kind, in praise of the Rock on the *Haram* [sacred area], relate that when *Allah* went up from the Rock to heaven, He said to the Rock: 'This is the place of my abode and the place of my throne on the Day of Resurrection of the dead and the [in]gathering of my servants, and this is the place of my Paradise to the right [of the Rock].' And, in another tradition, when He is on the Rock, *Allah* says, 'This is my Paradise to the west and this is my fire to the east.'<sup>4110</sup>

### The Koranic Inscriptions and Their Connection to Circumambulation

An author wrote of a pre-*Islamic* Arab temple—the type of which must have inspired the design of the Dome of the Rock:

The great Temple of the Winged Lions, overlooking the northern bank of the Wadi *Musa*, was so named because of the feline decorations on its Corinthian capitals. The main section is a large altar platform bordered by twelve columns at the center of a square *Cella* [holy room] surrounded by a portico intended for the ritual ceremony of walking around an idol [circumambulation]...The foundation of the temple has been dated to AD 27.<sup>4111</sup>

A *Cella* is an inner room or sanctuary of an ancient temple where the statue of the god was located. A portico is a porch walkway supported by columns. The Temple of the Winged Lions had twelve columns, probably standing for the twelve constellations since most Arabian temples were astral in nature. Leo the Lion is one of the twelve zodiacal constellations.

The crescent-shaped Rock of *Ibrahim* in the center of the Dome is comparable to the statue of the deity usually found in the *Cella* of astral temples like the Temple of the Winged Lions. The crescent-shaped Rock constitutes a statue of the moon-god or at least his abode and main sign.

The Temple of the Winged Lions had twelve columns and the circular arcade of the Dome of the Rock around the Rock of *Ibrahim* has twelve columns in addition to four piers. The columns must represent the twelve constellations of the zodiac and twelve lunar months and the four piers represent the Four Seasons.

Like the portico at the Temple of the Winged Lions, the two ambulatories in the Dome of the Rock allowed for circumambulation around the Rock of *Ibrahim*. K. A. C. Creswell wrote:

<sup>4110</sup> Elad. *Jerusalem*, p. 78.

<sup>4111</sup> Aube & Dentzer. *Petra*, p. 78.

The two concentric ambulatories...thus formed [by two arcades] were of course intended for the *Tawwaf* [or *Tawaf*], or ceremonial circumambulation of the sacred object, the Rock.<sup>4112</sup>

The Dome's two ambulatories could be considered a covered portico. The circumambulation at the Dome of the Rock evidently began at the south entrance—at the start of the lengthy *Koranic* inscription that rings the Dome of the Rock. At the Dome the southerly direction happens to be the *Kiblah*, the direction towards *Makka*. Sheila Blair wrote:

On the Dome of the Rock, for example, the *Bismalla* [invocation in Arabic meaning “in the name of *Allah*”] shows that both inner and outer bands of inscription begin on the south or *Qibla*, side.<sup>4113</sup>

Arabic is read from right to left, opposite to the way English is read. The *Koranic* inscription runs on both sides of the octagonal arcade. Therefore, a person in the outer ambulatory must walk clockwise around the Rock of *Ibrahim* to read the inscription. A person in the inner ambulatory must walk counterclockwise to read the inscription.<sup>4114</sup> Evidently, this was how circumambulation was conducted in medieval times—people just followed the text around.

The circular inscription and circumambulation gave the effect as though the worshippers were in the stars praising *Allah* the moon-god along with the astral angels.

Eva Baer wrote about “whirling” inscriptions in *Islamic art*:

Whirling rosettes in the center of a radiating *Naskhi* inscription figure again on the walls of the base made for Hugh IV de Lusignan [French noble family]. Here too the inscription, which in addition is framed by circles of flying birds, informs us about the owner of the basin...The integration of whirling rosettes and a radiating—in this case *Quranic*—inscription features also on the top of the lid of the plated *Quran* box in *Cairo*...The inscription, *Sura* LIX, 23 [K 059:023], which praises God as the ‘Holy King, the Giver of Peace...the Powerful... the most High, the Haughty,’ is set in a twelve-lobed frame which is attached by four whirling rosettes to the lobed triangular cartouches at the sides. It looks as if the whole composition wanted to create the notion that the *Quranic* inscription was ‘hooked up’ and moving in an orbit...All these ‘wheel’ ornaments shared a number of features. One was that by their revolving movement they became associated with stellar bodies with which they were actually merged in east *Iranian* ornament in which palmettes and half-palmettes circulated round a central star.<sup>4115</sup>

At the *Kaaba* two parallel bands of gold-embroidered inscription encircle the *Kaaba*. The upper band is solid while the lower band has spaced medallions and rectangular pieces. Similarly, two mosaic inscriptions encircle the Dome of the Rock near the ceiling on either side of the octagonal arcade. These inscriptions are like the whirling *Koranic* inscription that Eva Baer spoke about.

The whirl effect is caused by the fact that:

☉ These inscriptions encircle the Dome of the Rock and the *Kaaba*.

<sup>4112</sup> Creswell. *Architecture*, pp. 19-20.

<sup>4113</sup> Blair. *Inscriptions*, p. 30.

<sup>4114</sup> Nuseibeh & Grabar. *Dome*, p. 74.

<sup>4115</sup> Baer. *Ornament*, pp. 122-123.

C Pilgrims circumambulate the inscriptions as they circumambulate the Rock and the *Kaaba*.

Like the whirling *Koranic* inscription that Eva Baer wrote of, the inscriptions at the Dome of the Rock and *Kaaba* are put into “orbit” and are “associated with stellar bodies.” The bands on either side of the octagonal arcade at the Dome of the Rock represent the Milky Way and the zodiacal constellations along the ecliptic.

The solid upper band at the *Kaaba* may represent the Milky Way. The rectangular pieces of the lower bands may represent the zodiacal constellations and the medallions may represent the sun and moon.<sup>4116</sup>

In addition, the entire silk *Kiswa* upon which the gold letter is stitched is comprised of subdued, black on black *Koranic* quotations. This can only be seen in photos where the weave of the fabric is visible.<sup>4117</sup>



**Figure 12-19.** Part of the *Koranic* inscription that encircles *Kaaba*. The embroidering is gold calligraphy lettering on black silk.

The *Koranic* inscriptions “written into the stars” complement the crescent-shaped Rock of *Ibrahim* and the *Hatim* Wall. It is as though the *Hatim* Wall and the Rock of *Ibrahim* were about to rise into the starry heavens. This contrasts with how *Muhammad* thought that the sun set into a muddy puddle (*K* 018:086). Thus the astral inscriptions are appropriate decorations for lunar temples which of course the *Kaaba* and Dome of the Rock are.

It was noted near the start of this chapter that the twelve pillars and four piers in the Dome of the Rock represent the twelve months. Above the four piers are squares that represent the Seasons and the Rock of *Ibrahim* in the center represents the moon.

So a *Muslim* who circumambulated around the Dome of the Rock navigated as though going through the zodiacal constellations. He or she also symbolically passed through a consecutive lunar month. The moon of course in the period of one lunar month passes through all the zodiacal constellations.

### The Crescent-shaped Rock of *Ibrahim*

The exposed sandstone called the Rock of *Ibrahim* is 17.7 meters long north to south, 13.5 meters wide east to west and 1.5 meters tall at the highest point. The rock has a relief portion that resembles a crescent. This raised portion of the rock is roughly comparable to the size of the crescent-shaped *Hatim* Wall by the *Kaaba*.

*Muhammad* is said to have made his Night Journey from *Makka* to the temple mount in Jerusalem and made his ascent into the heavens from the Rock of *Ibrahim*.

In the Night Journey, each of the eight heavens is associated with the planets and the moon. Thus the crescent-shaped Rock of *Ibrahim* was an appropriate spot for *Muhammad* to make his ascent.

That *Muhammad*'s journey to the heavens occurred at night shows the lunar and astral significance of the Rock of *Ibrahim*. The Night Journey also suggests that *Islam* is an astral religion since similar events in the Bible always occur during the

<sup>4116</sup> Nasr & Nomachi. *Makka*, pp. 7, 37, 44-45, 49, 53.

<sup>4117</sup> Nasr & Nomachi. *Makka*, p. 51.

daytime, e.g. Moses and Elijah meeting *Yahveh* on Mount Sinai, Elijah and Jesus' ascents to heaven, Jesus' Transfiguration.

That the sandstone Rock of *Ibrahim* was shaped and carved can be seen from looking at pictures and reading the literature. Scholars have speculated that the long straight trench near the border of the rock was once a wall of the Holy of Holies. Other indentations were thought to hold an altar and other furnishings.

Scholars generally assume the rock was shaped for the purposes of Jewish temple worship while the crusaders installed some steps leading to an altar. The crusaders also found it necessary to marble over the stone and install iron gates to keep souvenir hunters from chipping the stone down to nothing.

In order to consider the possibility that *Muslims* altered the Rock of *Ibrahim*, one would need to think of a reason and motive for *Muslims* doing so. No one has given any thought to the idea that *Muslims* altered the rock to form a crescent because few have seriously researched the subject of *Islam* being a moon-god religion.

Because of PC-AIDS and PC-ASS and the constant threat of harassment and violence, no aca*Dhimmi* has speculated that the Rock of *Ibrahim* may have been chiseled out during *Islamic* times. It has been wrongly assumed that *Muslims* have esteemed the rock too much to alter it.

To dismiss this notion that *Muslims* would not touch the Rock, one need only think of how *Ibrahim's* footprints have been carved into a rock placed only a few meters from the *Kaaba* to fool gullible pilgrims. The place is called the Standing Place of *Ibrahim* (K 002:125; 003:097). F. E. Peters says the Standing Place of *Ibrahim* (K 002:125; 003:097) was a notable pre-*Islamic* feature of the *Kaaba*.<sup>4118</sup> In fact, *Ibn Ishaq* (704-773 AD) quotes a poem from *Muhammad's* time that suggests the carvings were recent even though *Ibrahim* lived 2,500 years before *Muhammad*:

By Abraham's footprint in the rock still fresh, with both feet bare, without sandals.<sup>4119</sup>

### Who May Have Carved the Crescent-shaped Rock of *Ibrahim*

Admittedly, the rock may have taken on its lunar shape in pre-*Islamic* times. At that time the moon-god worshipping *Muslims* may have become instantly fond of the rock due to its readymade lunar form.

In Old Testament times, the starry hosts were worshipped in the temple (2Ki 23:04). Antiochus Epiphanes rededicated the Temple of *Yahveh* at Jerusalem to "Olympian *Zeus*" (2Ma 06:02). The second time the temple mount was dedicated to *Zeus-Jupiter* was when the Roman Emperor Hadrian built a temple to Jupiter. By the way, Hadrian also built a temple to Venus over the site of Jesus' crucifixion.

Hadrian's temple lasted from 132 to 326 AD when Constantine's mother, St. Helena, used the pagan temple as building material for the Churches of the Nativity and Holy Sepulcher. Perhaps the rock crescent now known as the Rock of *Ibrahim* was carved in honor of Jupiter's wife, *Juno*, who was a moon-goddess.<sup>4120</sup>

Someone might ask "What does *Zeus* have to do with a crescent?" *Zeus* supposedly appeared as a white bull to seduce the *Phoenician* princess *Europa*. The horns of the crescent-moon probably inspired the white bull imagery and this may be why a crescent was carved into the rock.

<sup>4118</sup> Peters. *Origins*, p. 165.

<sup>4119</sup> Ishaq. *Sirat*, p. 123.

<sup>4120</sup> *Heritage*, *Juno* entry.



Josephus and Philo record that Jews imported astrological elements into the Second Temple and synagogues. The crescent altar that became the Rock of *Ibrahim* may have been carved during any one of these periods.

It is interesting to note that the temple mount has been the location of astral temples longer than it has been the location of three temples to *Yahveh*: Solomon, Zurubabel and Herod's. Hadrian's temple to Jupiter lasted from 132 to 326 AD. The current Dome of the Rock moon-god shrine (691 AD to the present) was once a full-fledged moon-god temple complete with sacrifices. The *Adha* sacrifices like those at *Makka* were performed at the Dome into the seventeenth century.<sup>4121</sup>

Notwithstanding all these other astral temples on temple mount, it likely was the crescent-loving, semi-pagan *Muslims* who stealthily carved out a crescent-shaped *Hatim* Wall for the Dome of the Rock that is now known as the Rock of *Ibrahim*. *Muslims* were already in a habit of creating moon-shaped worship areas on the ground, as Cyril Glassé reports:

*Mosques* in the *Sahara* are often no more than a half circle of stones.<sup>4122</sup>

When the Dome of the Rock was just built, the Rock was anointed with “all kinds of perfume,” some of which may have been oily and acidic. The perfume may have been meant specifically to smooth over and hide fresh chisel marks in the sandstone surface.<sup>4123</sup>

The Rock of *Ibrahim* would look more like the moon in the sky than the stylized *Hatim* Wall at the *Kaaba*. That the Rock of *Ibrahim* was indeed meant to resemble the *Hatim* Wall is suggested by the many other architectural and ceremonial features at the Dome that obviously are copied from the *Kaaba*. The Rock of *Ibrahim* also looks rather realistic when compared to the moon—complete with craters and Mares.

The trench in the Rock of *Ibrahim* that certain scholars speculate served as a foundation for a wall for the Holy of Holies is in fact the back of the crescent. The dimples and pits in the rock were not to hold ancient altars but were meant to mimic the *Maria* seas on the moon.

The lunette look of the rock when viewed from certain angles may have suggested to some that the Rock of *Ibrahim* was like the lunette of a *Mihrab*. Amikam Elad wrote:

Hamilton proposed that for [*Caliph*] ‘*Abd Al Malik* [ruled 685-705 AD] the Rock served as a symbol of Solomon's Temple, or of the *Mihrab Dawud*.<sup>4124</sup>

The crescent-shape of the Rock of *Ibrahim* is harder to see from ground level due to the low wall around the Rock and the columns and piers of the circular arcade. Oleg Grabar wrote:

The Rock projects about 5 feet (1.5 meters) above the level of the building floor, but it is hardly visible upon entering the building, as it is surrounded by a low wooden screen the contemporary shape of which follows late twelfth-century models. A reliquary of relatively recent vintage is found at one corner of the Rock.<sup>4125</sup>

The balustrade around the Rock may not be as recent as Grabar supposes since Elad says that there was an ebony balustrade already during ‘*Abd Al Malik*'s day.<sup>4126</sup>

<sup>4121</sup> Elad. *Jerusalem*, pp. 52, 58.

<sup>4122</sup> Glassé. *Encyclopedia, Mosque* entry, p. 276.

<sup>4123</sup> Elad. *Jerusalem*, p. 51.

<sup>4124</sup> Elad. *Jerusalem*, p. 161.

<sup>4125</sup> Nuseibeh & Grabar. *Dome*, p. 22.

<sup>4126</sup> Elad. *Jerusalem*, p. 51.

The early *Muslim* carvers of the Rock of *Ibrahim* did not dare carve the crescent to perfection. They had to create and maintain the illusion that *Muslims* found the rock in its present crescent shape. The origins of the Rock of *Ibrahim* at least had to be as mysterious as the “black paving stone” installed at the Dome. The paving stone was said to have come down from heaven. The paving stone is discussed later in this chapter.

*Muslim* tradition said the Rock of *Ibrahim* and the temple mount was visible since the time of Adam. Therefore, the rock had to appear as though it weathered the Great Flood and thousands of years of rain. The Rock also had to look as though it had survived once being a threshing floor (1Co 21:18-28). Moreover, the rock had to look like it had survived the destruction of the temples of Solomon, Zurubabel, Herod and the Romans.

Since *Muslims* put their finishing touches on the Rock of *Ibrahim* in the seventh century AD, souvenir hunters have chipped away at the crescent for over a millennium. In fact, to protect the rock, the crusaders had to marble over the rock and install an iron partition and gate after conquering Jerusalem in 1087. Part of what is said to be the Crusader’s iron fence is displayed in the *Islamic Museum* on the temple mount near the *Aqsa Mosque*.

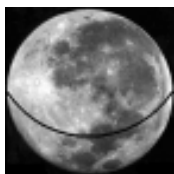
The crusaders installed an altar on the rock and steps were carved into the rock so priests could access the altar. The chipping away at the rock by the souvenir hunters, Crusaders and others, means that the crescent shape formed by the ridge of the rock is now harder to see, especially at eye-level.

*Muslim* carvers seem to have had the *Hatim Wall* at the *Kaaba* in mind when they determined what the height of the Rock of *Ibrahim* crescent would be. Both the *Hatim Wall* and the Rock of *Ibrahim* are about five feet high. The natural features of the monolithic rock however helped to determine what the other dimensions of the crescent would be.

The view of the Rock from above (see the illustration earlier in this chapter) shows that the carvers used the waxing crescent-moon with its dark lava *Maria* seas as the model for dimpling the rock. Making the rock look like the crescent-moon would give the rock an ancient, rough look, the look that moon-god worshippers were after.

Carving *Maria* into the crescent-moon is similar to how footprints were carved into the Rock of *Ibrahim* and at a stone in a station near the *Kaaba*. Various accounts by travelers recount that the footprints were those of *Ibrahim*, *Muhammad*, *Gabriel* and the horse-like creature *Baraq* that *Muhammad* rode during his Night Journey. The Rock was even said to have the footprints of *Allah*!

To conclude this section, one can see that the Rock of *Ibrahim* is the second largest piece of known “*Allah* is a moon-god” evidence. The crescent-laden crossbeam and *Koranic* inscription of the octagonal arcade in the Dome of the Rock definitely are longer than the Rock of *Ibrahim*. In its entirety, at least, the Rock of *Ibrahim* surely outweighs the *Hatim Wall* at the *Kaaba* and perhaps the crossbeam of the Dome’s octagon arcade too.



**Figure 12-20.** The dark *Maria* (lava seas) of the moon and craters from a portion of the moon seem to have been copied and carved into the Rock of *Ibrahim*. That particular portion is the lower half of this photo. Incidentally, the crescent in the Mideast nearer the equator is positioned more like a U, while the upper and lower latitudes see the moon more like a C.

Therefore, there was another reason for circumambulation at the Dome of the Rock and at *Makka*. The crescent-shaped *Hatim* Wall at the *Kaaba* serves as a betyl indicating *Allah* the moon-god's presence, as was discussed in a previous chapter.

As was noted in the quote of Amikam Elad above, *Allah* was thought to be present at the Rock of *Ibrahim*. Consequently, the crescent-shaped Rock of *Ibrahim* served the same purpose as the *Hatim* Wall to denote the moon-god's presence.

In addition to the crescent-shaped Rock of *Ibrahim*, the numerous crescents located around the Dome of the Rock provided good crescent-sighting opportunities while *Muslims* circumambulated. Moon-god worshippers did not need to wait until the start of the new month to see the crescent or wonder whether the weather would permit seeing the crescent.

### The Lunar Connection Between the Dome of the Rock and the *Kaaba*

The *Koran* associates *Ibrahim* with the moon-god. That *Muslims* believe *Ibrahim* was both at the temple mount and at the *Kaaba* suggests that *Muslims* viewed the *Hatim* Wall at the *Kaaba* and the Rock of *Ibrahim* at the Dome to be crescents. *Muhammad* said that *Ibrahim* rejected the stars (K 006:076) and the sun (K 006:078) but referred to the moon as his Lord who guided him (K 006:077).

There is literary evidence that early *Muslims* thought of the *Kaaba* and the Dome of the Rock as temples to *Allah* the moon-god. That the buildings were temples to a moon-god would also indicate *Muslims* knew the Rock of *Ibrahim* and the *Hatim* Wall were oversized crescents. For instance, Amikam Elad wrote:

Particularly notable are the placing within the Dome of the Rock the Black Paving Stone and the horns of a ram sacrificed by Abraham (which, according to tradition, were removed from the *Kaaba*)...<sup>4127</sup>

The Ram's horns, like the curved horns of gazelles and *Ibexes*, were moon-god symbols. *Ibex* horns were discussed in a previous chapter. A *Muslim* tradition says *Abd Al Muttalib* found a golden gazelle along with swords (probably curved) while uncovering the *Zamzam* well and these were placed inside the *Kaaba*.<sup>4128</sup> Ram's horns were also found in the *Kaaba* at *Makka*.<sup>4129</sup>



**Figure 12-21.** Ram horns were curved moon-god symbols.<sup>4130 4131</sup>

There is another instance of literary evidence that shows early *Muslims* thought of the *Kaaba* and the Dome of the Rock as moon-god temples. Oleg Grabar wrote:

Most of the decorative themes of the mosaics consist of vegetal [plant] motives [motifs] interspersed with vases, cornucopias and what have been called 'jewels.' All these elements, except the 'jewels,' are common enough and their significance in late-seventh-century art is primarily stylistic; but the 'jewels' present peculiarities that may help to explain the meaning of the structure.

The jewel decoration does not appear uniformly throughout the building but almost exclusively on the inner face of the octagonal colonnade and of the drum. Although it has been suggested that this is so the decoration will appear more

<sup>4127</sup> Elad. *Jerusalem*, p. 160.

<sup>4128</sup> Peters. *Makka*, p. 38.

<sup>4129</sup> Grabar. *Art*, p. 56.

<sup>4130</sup> Moon-god worshippers thought curved horns of a ram to be moon-god symbols.

<sup>4131</sup> See the marble frieze that alternates the crescent-and-Venus orb symbol with *Ibexes*: Doe. *Arabia*, p. 36, plate 10.

brilliant when seen against the light coming from the windows, it can be shown that the difference between this part of the mosaic decoration and the rest of it lies not in a jewel-like effect but in the type of jewels used. Had the intended effect been purely formal, gems and mother-of-pearl, as used elsewhere in the building, would have served equally well here. It may rather be suggested that these actual crowns, bracelets and other jeweled ornaments were meant to surround the central holy place toward which they face and it is in this sense that they contrast with the purely decorative gemlike fragments throughout the building.

Although in most cases the jewels have been adapted to the vegetal basis of the decorative scheme, they are identifiable. There are crowns, either diadems with hangings and encrusted precious stones and in many cases topped with triangular, oval or arched forms, or diadems surmounted by wings and a crescent. There is also a variety of breastplates, necklaces, pins and earrings, almost all of which are set with precious stones as incrustations or as hangings.

A fascinating document is provided by the list of objects sent to *Makka* [*Makka*] and kept there in the *Kaaba*. This list can be made up from different authors, especially from *Al Azraqi* whose early date (ninth century) is of particular significance to us...In pre-Islamic times the *Makkan* sanctuary had contained paintings and sculptures, which were destroyed on the Prophet's order. Apparently until the time of *Ibn Al Zubayr* the shrine also kept the two horns of the ram which had [supposedly] been sacrificed by Abraham and other prophets; when he destroyed the *Kaaba*, *Ibn Al Zubayr* reached for them but they crumbled in his hands. In Islamic times a new series of objects was brought into the holy place. Umar [the second Orthodox *Caliph* (634-644 AD)] hung there two crescent-shaped ornaments taken from the capital city of the Persians. [*Umayyad Caliph*] *Yazid I* [680-683 AD] gave two ruby-encrusted crescents belonging to a Damascene church, together with two cups. [*Caliph*] *Abd Al Malik* [685-705 AD] sent two necklaces and two glass cups, [*Caliph*] *Al Walid I* [705-715 AD] two cups, [*Caliph*] *Al Walid II* [743-744 AD] a throne and two crescent-shaped ornaments with an inscription, and [*Abbasid Caliph*] *Al Saffah* [750-754 AD] a green dish.<sup>4132</sup>

Thus crescent jewels were placed in the Dome of the Rock and in the *Kaaba*.

That there were so many crescents and swords in the *Kaaba* suggests the *Kaaba* was the temple for a war-god who also was a moon-god. Warlike moon-gods were common in the Mideast but especially in South Arabia, as Hans Kraus wrote:

...the main god, the national god of war...this is in all South Arabian, yes, nearly in all Semitic monuments, a sure identifying mark of the moon-god.<sup>4133</sup>

Creswell wrote that the first *Kaaba* was built using a building technique used on the pillars of monumental size at *Aksum* (*Axum*), *Abyssinia*:

They [monolithic pillars at *Aksum*] are of oblong cross-section and are carved to resemble houses of many stories, and the technique just described is counterfeited on the stone. The largest, now fallen and broken, measured 33.3 meters (109 feet) in height, tapered upward and ended in a crescent-shape, which was the symbol of *Mahram*, the *Abyssinian* God of war.<sup>4134</sup>

<sup>4132</sup> Grabar. *Art*, pp. 55-57.

<sup>4133</sup> Nielsen. 1912. pp. 593-594, as translated in Krause, "*Haram-Harimat*."

<sup>4134</sup> Creswell. *Architecture*, pp. 2-3.

Not only is *Mahram* a war-god like *Allah* but the monumental pillars with a crescent at the top remind one immediately of the *Muslim Minarets* with their crescent finials. In fact, there are several pairs of *Minaret*, all with crescent finials, at *Makka*.



**Figure 12-22.** Caricature. This is an FSB (Russian Intelligence) photograph of the Arabian war-and-moon-god *Allah*.

To *Allah*'s right and left are pairs of phallic symbol *Minarets*. The *Islamic Minaret* topped with crescent finials are like the pillars of monumental size found at *Aksum* in *Abyssinia*. These phallic symbols were topped with crescents in honor of the *Abyssinian* war-and-moon-god *Mahram*.

FSB's Camera-in-a-Koran™ captures *Allah* leading the *Muslim Hajjis* in a ...<sup>4135</sup>

The *Hajj*-like rituals at the Dome of the Rock showed that the Dome and the *Kaaba* were moon-god temples. That *Hajj* rituals were based on a lunar religion was discussed in previous chapters.

In the early *Islamic* centuries, *Hajj*- and *Umra*-like ceremonies occurred at the Dome of the Rock. In 1189 AD, *Saladin* sacrificed at the Dome for *Eid Al Adha* at the conclusion of the *Hajj* there.<sup>4136</sup> Many rituals were held at the Dome well into the fourteenth century.<sup>4137</sup> Amikam Elad wrote about the *Umayyad* period:

During the season of the *Hajj*, the same ritual ceremonies were held on the *Haram* [sacred area] as in the *Makka*. . . . At the same time, religious ceremonies and rituals, identical to those held at *Makka* during the *Hajj*, were also performed within the Dome of the Rock and outside it.<sup>4138</sup>

Sibt B. *Al Jawzi* (1186-1256 AD) wrote in *Mir'at Al Zaman*:

<sup>4135</sup> Cartoon caption, continued: . . . "follow-the-bouncing-ball" *Karaoke* session where they learn the *Adhan* "Call to Worship."

The *Muezzins* in the nearby *Minarets* help *Allah* lead the congregation. The cubic *Kaaba* serves as a bass sub-woofer speaker in *Allah*'s sound system. The underside of the moon ship serves as a stadium-sized big-screen, and shows a ball bouncing from Arabic scribble word to scribal word.

In a related story, the FBI said it could now close many "*X-Files*" since it has determined that most UFO sightings are actually just "The Two-horned Crusader," a.k.a. "Alien" *Allah*, flitting hither and yon on his superhero moon ship.

The weird sounds that come from UFO's is actually "Golden Oldie" *Muezzin* calls emanating from *Allah*'s moon ship over loudspeakers, combined with the Doppler Effect.

*Allah* also reportedly likes the *Iranian* rap artists songs that are censored by "the ministry of *Islamic* guidance and culture." These songs are so bad that plants just wither and die, causing those mysterious crop circles associated with UFOs ("Baby Got *Burqa*," CoxandForkum.com, 11 Jun 2004).

<sup>4136</sup> Elad. *Jerusalem*, p. 62.

<sup>4137</sup> Elad. *Jerusalem*, p. 62.

<sup>4138</sup> Elad. *Jerusalem*, pp. 52, 58.

They used to stand by the Rock and circumambulate it as they used to circumambulate the *Kaaba* and slaughter beasts on the day of the feast [i.e. '*Id Al Adha*'].<sup>4139</sup>

Amikam Elad wrote:

Additional testimonies on the performance of the *Wuquf* ceremonies [mimics the “Standing” ceremony at Mount Arafat near *Makka*] in Jerusalem on the *Haram* [sacred area] come from later periods. Nasir-i-Khusraw, who visited Jerusalem in the year 1047 [AD], describes the performance of *Al Ta'rif* opposite the Rock on the *Haram*, the offering of the '*Id Al Adha*' sacrifice on the *Haram* by those *Muslims* who were unable to make the pilgrimage to *Makka*. *Al Turtushi*, who was in Jerusalem during the last decades of the 11<sup>th</sup> century, notes that on the day of *Arafat*, in the *Mosque* of Jerusalem, the people from Jerusalem and the neighboring villages stood in prayer, with their faces turned to *Makka*, raising their voices in the *Du'a'* (prayers of request, invocation) as though they were standing before Mount '*Arafat*' in *Makka*. In the year 1189, *Salah Al Din* traveled from *Safad* to Jerusalem for the explicit purpose of celebrating the holiday of the sacrifice there. *Ibn Taymiya* (died 1328 AD) also tells of the existence of the *Wuquf* custom in Jerusalem. Towards the middle of the 14<sup>th</sup> century '*Ala Al Din, Abu Al Hasan* composed a poem (*Qasida*), whose verses blatantly condemn a number of the rituals which were held in Jerusalem and which were related to the Holy Rock and other places on the *Haram*...*Muslims* from Jerusalem and adjacent areas and pilgrims from all over the *Muslim* world most certainly took part in the rituals held on the *Haram* in the course of their visit to the holy places in the city.<sup>4140</sup>

Just as the *Kaaba* has the Standing Place of *Ibrahim* complete with his footprints, so the Rock of *Ibrahim* at the Dome had footprints ascribed variously to the Prophet, *Gabriel* and the horse-like creature *Baraq* that *Muhammad* rode during his Night Journey. The Rock was even said to have the footprints of *Allah*!

The *Kaaba* had paintings until a fire at the end of the eighth century, and the Dome of the Rock had pictures of the *Sirat* sword bridge to paradise and the Gate of Paradise, at least during the *Umayyad* period.<sup>4141</sup>

The Dome of the Rock even had a black paving stone that was equated with the Black Stone in the southeast corner of the *Kaaba*. Amikam Elad wrote:

Found within the Dome of the Rock was a black Paving Stone (*Al Balata Al Sawda*), also sometimes called the Black Marble Paving Stone (*Al Rukhama Al Sawda*)...Though the stone's existence is not noted in traditions dealing with the construction of the Dome of the Rock, other traditions, transmitted by *Al Wasiti* and *Ibn Al Muraja*, relate that this Paving Stone existed at least in the year 130 [AH]/748 [AD] towards the end of the *Umayyad* rule...*Ibn 'Abd Rabbihi* (early 10<sup>th</sup> century) describes this Paving Stone as follows...At the beginning of the 14<sup>th</sup> century *Ibn Fadl Allah Al Umari* referred to the Black Paving Stone thus...The Black Paving Stone is also mentioned by the author of *Muthir Al Gharam* (mid-14<sup>th</sup> century) and by [the author] *Mujir Al Din*, who copies him. *Abd Al Ghani Al Nabulsi*, who visited Jerusalem in 1689, describes it as green and thought that it was termed “black” since the term *Sawad, Aswad* at time

<sup>4139</sup> Elad. *Jerusalem*, p. 53.

<sup>4140</sup> Elad. *Jerusalem*, pp. 61-62.

<sup>4141</sup> Elad. *Jerusalem*, p. 58.

refers to a shade of green as well....The constructors of the Dome of the Rock were presumably aware of the parallel sought between *Al Balata Al Sawda* [the Black Paving Stone at the Dome] and *Al Hajar Al Aswad*, the Black Stone in the *Kaaba*. The installation of the Black Paving Stone in the Dome of the Rock reinforces and adds a further stratum to the theory put forward by Goldziher, Wellhausen and others...and attests to a tendency [for the Dome of the Rock] to compete with the *Kaaba* and the holy center in *Makka*...a tradition...states that it [the Black Stone of the *Kaaba*] came down from Paradise or that it belongs to Paradise—exactly like the traditions of the Black Paving Stone in the Dome of the Rock.<sup>4142</sup>

### Other Similarities Between The *Kaaba* and the Dome of the Rock

There are enough similarities between both the building and usage of the *Kaaba* and the Dome of the Rock that it has gone way beyond the realm of imitation and into the area of competition.

The *Umayyads* were trying to enhance the spiritual status of Jerusalem versus that of *Makka*. The *Umayyads* were not trying to enhance the political status of Jerusalem since that intercity rivalry was between Damascus and *Madina*. The *Umayyads* transferred *Muhammad's* *Minbar* pulpit which doubled as a throne, to Damascus.

The *Umayyad* capital of the empire was in Damascus and briefly in *Haran*. Even the provincial capital of Palestine was not Jerusalem but was at the city of *Ramlah* (modern *Ramallah*) founded in 715 AD.<sup>4143</sup> *Ramallah* was where Arafat had his headquarters for several years and where he was buried in 2004.

*Ram-Allah* means “High Place or Hill of *Allah*.” The name *Ramallah* is derived from the fact that during Biblical times the site was *Nob*, a city for priests (1Sa 22:19). In Hebrew *Nob* means “High Place.” Also, *Ramath* in Hebrew means “height.” When *Muslims* came to *Nob*, the name was changed to *Ram-Allah*.

This history of *Ramallah* makes one wonder why in modern times the Palestinians want Jerusalem as their capital. Jerusalem never was a *Muslim* capital even during the centuries when the entire Mideast was under *Muslim* control.

With the exception of only a few decades out of the last fourteen centuries, *Muslim* rulers were Jerusalem’s absentee slumlords.<sup>4144</sup> Even the Dome of the Rock and the temple mount were left in a decrepit state since the 1600’s when pilgrimages and sacrifices there for the most part ceased.

The Palestinian *Muslims* ought to put their national capital (if they ever get their own state) in *Ramallah* just as the medieval provincial capital was in *Ramallah*. Since *Ramallah* means “High place of *Allah*,” it would be appropriate to dismantle the Dome of the Rock moon-god shrine on the temple mount and put it in *Ramallah* too (Joh 02:15). Another idea was suggested by Baruch *Ben-Yosef*, a member of the temple mount Faithful, who says the *Mosques* on the temple mount should be “moved to *Makka* where they should be...”<sup>4145</sup>

The details on how the *Kaaba* and the Dome of the Rock were constructed have a familiar ring:

<sup>4142</sup> Elad. *Jerusalem*, pp. 78-80.

<sup>4143</sup> Grabar. *Shape*, p. 112.

<sup>4144</sup> Pipes, Daniel. “The *Muslim* Claim to Jerusalem,” *Middle East Quarterly*, Sep 2001, *DP*.

<sup>4145</sup> Katz, Yaakov. “US politician hopes to speed building of third temple,” *jpost.com*, 25 Jan 2005.

- Ⓒ A *Copt* (Egyptian) carpenter helped rebuild the *Kaaba* in 605 BC<sup>4146</sup> and another *Copt* artist named Baqum or Pachomios painted the interior of the *Kaaba*.<sup>4147</sup> Likely, many *Copts* worked to construct the Dome of the Rock. It is commonly said in histories that the tax levied on Egypt for seven years paid for the construction of the Dome of the Rock.
- Ⓒ The *Kaaba*'s roof and inside pillars were built from a ship that ran aground near *Jedda* on the eastern side of the Red Sea.<sup>4148</sup> The ship was probably *Copt*-built. Notably, the two dome shells (inside and outside) at the Dome of the Rock were built of interlocking beams and a shell or skin, which reminds one of ship construction.

### The Outside Silhouette of the Dome of the Rock

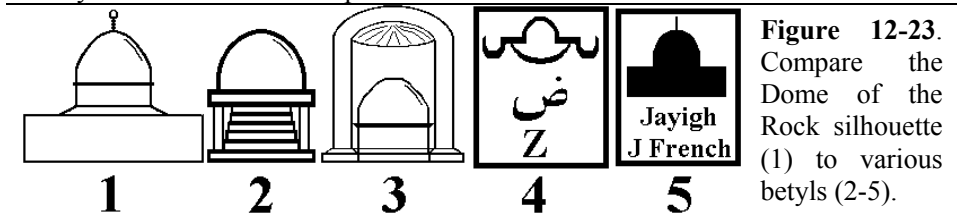
What inspired the design of the dome of the Dome of the Rock? The Dome was completed in 691 AD, only about sixty years after *Muhammad* died. Therefore, many of *Muslims* alive at that time were once polytheistic sun and moon-god worshippers, or at least their parents had been polytheistic sun and moon-god worshippers.

That sun-god symbolism would survive in early *Islam* is not surprising since other pagan symbols and practices were not extirpated upon the arrival of *Islam*. Samuel Zwemer wrote that even many Animistic practices were not abolished. Zwemer gives an astral pagan example here:

‘The Hand of *Fatima* [*Muhammad*'s daughter],’ says Tremearne, ‘is a great favorite in *Tunis* and one sees it above the great majorities of doorways; in *Tripoli* there is hardly one and this is only to be expected, since the sign is an old Carthaginian one, representing not the Hand of *Fatima* at all but that of *Tanith* [*Venus*]. It has been thought however that the amulet is so curiously similar to the thunderbolt of *Adad* [a storm god], worn in the necklet of the *Assyrian* kings along with emblems for the sun, the moon and *Venus*, that it may be a survival of that.’<sup>4149</sup>

In *Tunis* the most common amulets are little leather bags in which are sewn written charms, bits of incense, white caraway seeds, also shells of snails and ‘*Fatima*'s hand’; the latter being often hung round the neck of cows or donkeys to keep them from disease. One also sees the tails of fish over house doors and the skull and horns of cattle.<sup>4150</sup>

A period painting of a Moorish army shows the Hand of *Fatima* was used on an infantryman's shield even in *Spain*.<sup>4151</sup>



**Figure 12-23.** Compare the Dome of the Rock silhouette (1) to various betyls (2-5).

<sup>4146</sup> Lings. *Sources*, p. 41.

<sup>4147</sup> Hastings. *Ethics*, “Arabs (Ancient)” entry, p. 667, bottom of the right column.

<sup>4148</sup> Lings. *Sources*, p. 41.

<sup>4149</sup> Zwemer. *Animism*, ch. 4.

<sup>4150</sup> Zwemer. *Animism*, ch. 10.

<sup>4151</sup> Nicolle. *Moors*, pp. 38-39 (see the caption and painting).



*The First Line Drawing in the Accompanying Illustration*

The first pictured outline depicts the Dome of the Rock with its *Alam* crescent finial.

*The Second Line Drawing in the Accompanying Illustration*

The second pictured outline is a *Nabatean Dushara* betyl on a platform with stairs. The betyl is depicted on coins from the Roman Province of Arabia, which province included *Petra* and *Damascus*.<sup>4152</sup>

Significantly, some coins show betyl rocks with bulbous finials made of rocks with flat surfaces stacked on each other like pancakes. The stacked rocks represent the orbs of the planets. The Dome of the Rock and most *Mosque* domes have finials with bulbous stems topped by a crescent just like those seen on domical (hemispheroidal) stone betyls.

*The Third Line Drawing in the Accompanying Illustration*

The third outline is the outline of a *Dushara* betyl carved into a niche in a sandstone wall at *Petra*, Jordan.<sup>4153</sup> A similar domical betyl in a niche carved into a sandstone wall is found in the *Nabatean Mada'in Salih* ruins in the northwestern Arabia peninsula. An eagle however surmounts this niche. Also, two owls apparently roost over the pillars (imposts) on the right and left sides of the niche.<sup>4154</sup>

The owl, understandably enough, is a moon-god symbol since an owl is a nocturnal creature. Perhaps the niche was built for the north Arabian moon-god *Shaj Al Qaum* (also spelled *Sahj el-Qaum*). The eagle is a sun-god symbol, as J. Spencer Trimmingham wrote:

The sun-god *Shamash* figures as its [the Aramean-Arab *Hatra* state in Mesopotamia] principal deity. *Nasr*, the Eagle-god, is distinctly Arab and a symbol of the sun.<sup>4155</sup>

*Abdullah Yusuf Ali* wrote:

Further, it may be that *Nasr* (the vulture, falcon, hawk or eagle, the Egyptian *Horus*) also represents a solar myth, mixed up with the cult of the planets. These crosscurrents of astro-mythological mixtures of cults are well known to students of ancient popular religions.<sup>4156</sup>

<sup>4152</sup> Coins 1130-1131 from *Adraa* near *Damascus*: “Obverse: laureate bust of M. Aurelius (AD 161-180) with Greek legend: “*Aut[okrator]* (Emperor) *M[arcos]* (Marcus) *Au[relios]* (Aurelius) *Antoninoc* [Antoninus].” Reverse: Dome-shaped betyl on altar with steps with the legend “*DOYCARHC THEOCADRAHNWN*.” The legend transliterated into *Latin* is: “*DOUSARES* (the *E* is in this case an *Eta*) *THEOS ADRAENON* (the *O* is an *Omega*)” and means “god of the *Adraeni*.” *Adraenon* is a plural genitive describing the inhabitants of the city *Adraa*. Coin 1135: “Gallienus (AD 253-68)...Dome-shaped betyl on altar.” Coins 1215-1216 from *Bostra* in the *Decapolis* area: “Elagabalus (AD 218-22)...Betyl of *Dusares* between two uncertain objects on a small base; all on altar with staircase.” Coins 1252-1253 from *Bostra* in the *Decapolis* area: “Trajan Decius (AD 249-51)...Stepped altar, upon which betyl surmounted by seven flat objects; flanked by two small betyls” (*Sylloge*, plates 38, 41-42).

<sup>4153</sup> Auge & Dentzer. *Petra*, p. 48.

<sup>4154</sup> Nasr & Nomachi. *Makka*, p. 169.

<sup>4155</sup> Trimmingham. *Arabs*, p. 20.

<sup>4156</sup> *Yusuf Ali. Holy*, p. 1622, App. XIII.

The *Nabateans* comprised most of the early Arab population in and around Palestine and the population at Damascus. As far back as the first century AD, Josephus considered even the Transjordan to be part of Arabia.<sup>4157</sup>

The Dome was built only fifty-six years after Bishop Sophronius surrendered Jerusalem to *Caliph* Omar in 636 AD. Therefore, *Muslim* moon-god worship along with *Nabatean* sun and moon-god worship would have influenced the design and decoration of the Dome of the Rock.

Arab names for their sun and moon-gods varied. The *Nabatean* high god was the sun-god *Dushara*. The *Nabateans* worshipped the moon extensively, as evidenced by carvings and inscriptions. The *Nabateans* were traders and were in contact with the Egyptians and other sun worshippers.

These non-Semitic cultural influences are why the *Nabateans* are the exception to the rule that *Semitic* peoples generally worshipped the moon as the high god over the sun-god. Likely the view was not unanimous since some *Nabateans* would have preferred the moon-god to the sun-god.

*Dushara* is also spelled *Dusares*, *d(h)u-Shara* and *Duchares*. *Dushara* means “Lord of *Shara*,” a reference to the reddish mountains overlooking *Petra*. The association with the color red may have led to *Dushara*’s association with the sun or perhaps it was the other way around. Rod and Joy Baird wrote:

Ancient authors tell us explicitly that the *Nabateans* worshipped the sun-god *Dushara*, whose symbol was an uncut black stone [perhaps of volcanic or meteoritic origin]. *Allat*, the great mother goddess of Arabia, was his mother and consort. All over *Petra* we see carved niches containing pillars or large separate monoliths representing *Dushara*. These were placed near graves, along roadways, in temples, up steep stairways.<sup>4158</sup>

*Allat* was *Allah*’s consort or daughter (*K* 053:019-020, 049 and the Satanic Verses). That *Allat* was also *Dushara*’s consort suggest there was some syncretism between *Dushara* and *Allah* worship even in pre-*Islamic* times. Surely, this encouraged further syncretism when *Islam* took over *Nabatean* lands.

The *Nabatean* sun-god connection may explain why the outline of the Dome of the Rock has similarities to a *Dushara* betyl on a platform. Besides, most Arabs were worshipping and circumambulating around betyls in pre-*Islamic* times.

That the dome represents a betyl would explain the color of the Dome. Betyls represented the sun, moon, planets and stars. The copper covering or gold gilding, made the dome look like the sun—at least when the dome was first built. After a while copper oxidizes to green and gold leaf flakes away.

The Dome of the Rock then is a throwback to the pre-*Islamic* days when betyl shrines would compete for pilgrims. The shrine custodians would shape ever-larger boulders into sun betyls and then build ever-larger platforms to accommodate the domical rocks. The look and size of the Dome of the Rock would greatly impress former sun-god worshipping *Nabateans* since they never saw a representation of the sun so large and dazzling in the sunlight.

The decorations in the Dome of the Rock also seem to have been affected by the syncretism between *Dushara* and *Allah* worship. *Dushara* was both a sun-god and a god of vines and was represented by rock betyls. *Nabateans* would surely find the

<sup>4157</sup> Dearman. *Mesha*, p. 26.

<sup>4158</sup> [ancientroute.com/cities/Petra.htm](http://ancientroute.com/cities/Petra.htm), accessed 20 Nov 2001.

crescent-shaped Rock of *Ibrahim* betyl of interest since it would indicate *Allah* the moon-god’s presence.

The *Dushara-Allah-Venus* angel syncretism also explains why the Dome of the Rock is covered in vines. In southern Arabia, vines are found carved into ancient moon-god altars but nowhere near the extent found in the Dome of the Rock where whole walls are covered with vines. *Dushara* however was associated with thick vegetation.

In keeping with the *Islamic* prohibition, of course there is a conspicuous absence of birds, animals and people in the vine art of the Dome of the Rock. Udi Levy wrote:

*Sharay* [the *Nabatean* gods’ heavenly home] is ‘a place with dense vegetation where wild animals graze,’ a kind of paradise. *Dushara*, the name of the main *Nabatean* god, means ‘Master of *Sharay*.’ Stephen of *Byzantium* explains that *Aara* is the name of a rock which was named after this God. *Shara* is also the name for the *Edom* mountains. *Dushrat* or *Dushara* (*Dusares* in Greek) was no longer expressly a sun-god,<sup>4159</sup>

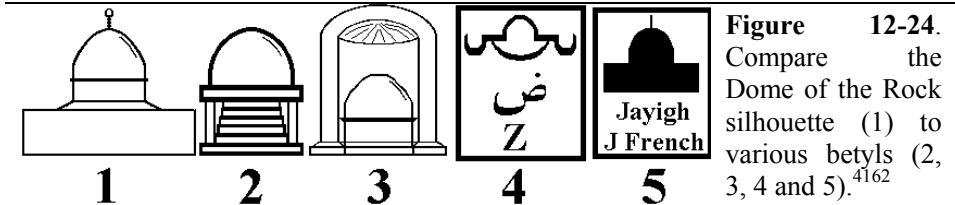
...vines are characterized by their great capacity to survive and their vitality. These life forces were supposed to be transferred to the participants in the religious act...As the life-giving god, *Dushrat* now also became the god of the vine.<sup>4160</sup>

Memorials to *Dushrat* have also been found in *Avdut* [town in the *Negev*]. Here in the *Negev*, as well as in central Arabia, he was venerated as the god of growth and plants, and stone steles were erected to him which were set up in niches.<sup>4161</sup>

Some authors have noted that other ancient temples and bathhouses had mosaics and stone relief vines. Few buildings however used vine art as extensively as the Dome of the Rock. Also, no other buildings personified their vines with jewelry, earring and crowns. So it seems the *Dushara-Allah-Venus* angel syncretism explains why the inside of the Dome of the Rock is covered in vines.

The outside of the Dome may have originally been covered with vines too. The outside of the Dome of the Rock currently has geometric patterns and *Koranic* inscriptions composed out of tiles fired and installed during the *Ottoman* era.

The syncretism between *Allah* and *Dushara* worship likely explains how in *Islamic* art the “Venus angel is a lamp in a niche” theme (*K* 024:035) merged with vine art to become the “Venus angel is a plant in a vase on a sill under an arch” theme. These themes were discussed in a previous chapter in reference to prayer rugs and *Mihrabs*.



**Figure 12-24.** Compare the the Dome of the Rock silhouette (1) to various betyls (2, 3, 4 and 5).<sup>4162</sup>

<sup>4159</sup> Levy. *Lost*, pp. 67-68.

<sup>4160</sup> Levy. *Lost*, p. 76.

<sup>4161</sup> Levy. *Lost*, p. 77.

<sup>4162</sup> The previous illustration is repeated here for sake of convenience.

It should be mentioned that the Dome of the Rock surely was instrumental in spreading the “Venus angel is a vine in a vase on a sill under an arch” motif throughout *Islam*, along with other architectural designs and interior décor ideas.

#### *The Fourth Line Drawing in the Accompanying Illustration*

The fourth outline is a cipher symbol from the “Alphabet of the Moon,” as compiled by the early ninth-century *Muslim* researcher Ahmad Bin Abubekr Bin Wahshih.<sup>4163</sup> These cipher alphabets that Wahshih provides purportedly predate *Islam*.

The ciphers were said to have been used by Greek philosophers and others who predated *Islam* such as the *Sabeans*, *Nabateans*, *Chaldeans* and the *Hermesians*. The *Hermesians* were Gnostics whose mythical leader was *Hermes Trismegistos* (meaning “Mercury, the Thrice Great”).

The cipher symbol dome and platform likely are a sun betyl on a platform altar. There also is a large crescent-moon beneath the platform and a crescent on either side of the platform. These must be crescents since this is a cipher symbol from the “Alphabet of the Moon”!

Perhaps these crescents were three crescent-shaped walls like the *Hatim Wall* at the *Kaaba* at *Makka*. Otherwise, the three crescents might be carved into the hillside like the crescent-shaped Rock of *Ibrahim*.

An artist’s conception of the outline of the Dome of the Rock could very well be similar to this cipher symbol from this “Alphabet of the Moon.” The dome would be a sun betyl, the octagonal base is the betyl altar platform and the Rock of *Ibrahim* is the large crescent below the dome. This cipher symbol from the “Alphabet of the Moon” further strengthens the case that the Dome of the Rock is a moon-god temple since it is patterned after moon-god betyls on platforms.

#### *The Fifth Line Drawing in the Accompanying Illustration*

The fifth silhouetted outline is a cipher symbol from the *Shimshim* alphabet of the *Hermesians*. Wahshih wrote:

It [the *Shimshim* alphabet] was **inspired** by divine revelation and varied in four different manners by the people who used it, viz. [namely] the *Hermesians*, the *Nabatheans* [*Nabateans*], the *Sabeans* and the *Chaldeans*.<sup>4164</sup>

Wahshih then lists the *Hermesian* version of the *Shimshim* alphabet.

It is interesting that *Muslims* like Washih considered the cipher designs to be “**inspired**.” Since Wahshih was a *Muslim*, this means that early *Muslims* thought astral texts were inspired. Moreover, Washih thought that the moon-god who had inspired the alphabet was *Allah*. Therefore, the Dome of the Rock may have been based off a design that was considered inspired by *Allah* the moon-god himself.

The religious groups that Wahshih said used the *Shimshim* alphabet were polytheistic astral worshippers. This explains why the fifth silhouetted outline has a stem on top.

The stem likely represents a bulbous finial with each ball on the spike representing a planet. The Dome of the Rock and most *Mosques* have similar finials with bulbous stems topped by a crescent.

<sup>4163</sup> Wahshih. *Hieroglyphic*, pp. 10, 53.

<sup>4164</sup> Wahshih. *Hieroglyphic*, pp. 43, 46.

That the people who used the *Shimshim* alphabet were polytheistic astral worshippers strengthens the assumption that the *Shimshim* cipher symbol was a silhouette of a sun betyl on a platform. The *Shimshim* name reminds one of various Semitic names for the sun such as *Shemesh*, *Shamash*, *Shamsa* and *Shams*.

### The Crescent Symbol Atop the Dome of the Rock

A *Muslim* coin that dates to 738 AD and features a *Menorah* on one side and a crescent finial on a *Mosque* dome on the other may have been issued at Jerusalem. It may have depicted a contemporary crescent finial on the Dome of the Rock. This coin is discussed in the numismatic appendix.

There is a curious story that may indicate the Dome of the Rock had a crescent finial before the tenth century AD. Mujir a-*Din* and *Ibn Askar* were tourists to Jerusalem. They praised the banana, which was a fruit new to them.

They remarked that eating a banana in the shade of the Dome of the Rock symbolizes the good life in both worlds.<sup>4165</sup> They may have been alluding to how a gold gilded crescent on a finial, or its shadow, might look like a banana.

It is not farfetched however to think there may have indeed been a banana-looking crescent over the Dome of the Rock. Muqaddasi (985 AD) wrote that the finial over the Damascus Great *Mosque* displayed a golden orange and pomegranate, which may have symbolized a full-moon.<sup>4166</sup> The dome would have looked like many pre-*Islamic* betyls with bulbous rocks on spikes representing the sun, moon and stars.

Fruit may have been used in the first centuries of *Islam* to camouflage astral worship. Similarly, Jewish coins in the centuries leading up to the destruction of the temple had a crescent-and-star symbol that consisted of a double cornucopia with a pomegranate orb on a stem between the horns of plenty.<sup>4167</sup>

When some historians discuss the crusaders taking Jerusalem in 1099 AD, they sometimes mention replacing the crescent with a cross atop the Dome of the Rock. Likewise, historians mention *Saladin* replacing the cross with a crescent when he retook Jerusalem in 1187 AD.

Historians add these details because this is what usually happened in later times when land was conquered or reconquered. These details might be anachronistic because it is not known exactly when a crescent finial was first placed on the dome of the Dome of the Rock.

There is little record of extensive use of crescent finials on *Mosques* until the eleventh century.<sup>4168</sup> This may be a gap in the historical record. Otherwise, it reflects reality and in the first few centuries of *Islam*'s existence the crosses on churches came down when *Muslims* converted churches to *Mosques* but no crescent finial went up in the crosses' place.

This seems to be the case in Jerusalem since we do know that *Saladin* had a *Minbar* pulpit installed in the *Al-Aksa Mosque* after he conquered Jerusalem.<sup>4169</sup> There is no record of *Saladin* installing a crescent finial, however.

<sup>4165</sup> The New Jerusalem Mosaic. The Tower of David Museum, jeru.huji.ac.il/ee41.htm, accessed Nov 2001.

<sup>4166</sup> Creswell. *Architecture*, p. 52.

<sup>4167</sup> Meshorer. *Coinage*, vol. i, pp. 67-68 & plates 08-55 have cornucopias, especially coins Jc1-Jc7.

<sup>4168</sup> Newby. *Encyclopedia*, p. 81, *Hilal* entry.

<sup>4169</sup> Landay. *Rock*, pp. 134-135.

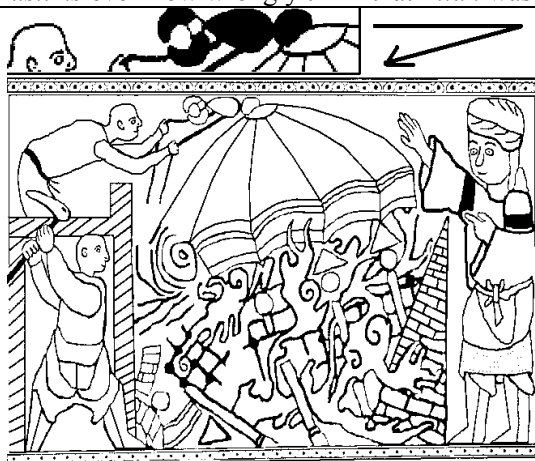
In passing, *Saladin's* pulpit no longer exists since a Christian fanatic torched it in 1969 AD. That arson led to a great loss of life in India due to mob violence, or more accurately, the arson was used as a flimsy pretext for *Muslims* to act on the 164 ethnic-cleansing and war verses in the *Koran*. The incident also led to the formation of the Organization of *Islamic* Conference (OIC).<sup>4170</sup>

We do know *Saladin* ordered the cross on the Dome of the Rock be taken down. Since contemporaries mention other acts *Saladin* accomplished in Jerusalem, a contemporary would surely have mentioned *Saladin* installing a crescent finial on the Dome of the Rock if he had done so.

A manuscript copied in 1307 AD has a miniature that depicts the destruction of the Jewish temple. The artist's conception of the Jewish temple has a crescent finial. Notice that the temple looks like a domical tent even though Solomon's temple was rectangular. This may be a composite drawing of the tent tabernacle of Hebrew scripture merged with the octagonal Dome of the Rock.

The artist would have been familiar with the Dome. The Dome of the Rock purportedly stands on the site of Solomon's temple and was euphemistically dubbed "Solomon's temple" by the crusaders.

Therefore the crescent finial on the 1307 AD manuscript pictured below suggests that in 1307 AD or before, there was a crescent finial on the Dome of the Rock. The crescent finial also suggests that the *Muslim* artist knew *Allah* to be a moon-god since *Muslims* even now wrongly think that *Allah* was *Yahveh* of the Old Testament.



**Figure 12-25.** A *Muslim* depiction of the destruction of Solomon's Temple. The person on the right represents *Nebuchadnezzar*.

The miniature is from a 1307 AD (707 AH) copy of a book by *Al Biruni* entitled *Abu Al Raiha* (973-1048 AD).<sup>4171</sup>

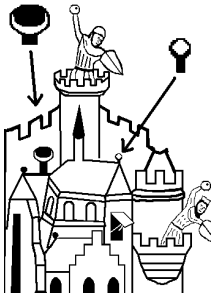
Note that the *Muslim* artist thought that there was a crescent finial atop Solomon's temple (see inset with arrow line).

A miniature in Jacob Van Maerlant's *Revenge of Jerusalem* (1332 AD) seems to show two crescent finials in Jerusalem in 1099 AD. The large crescent finial could not be mistaken for anything else. For instance, it would be anachronistic to think that early fourteenth-century Jerusalem had eighteenth or nineteenth-century chimneys that could be mistaken for crescent finials.

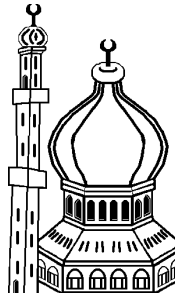
In 1187 AD when *Saladin* conquered Jerusalem, he may not have installed a crescent finial. This drawing suggests that by 1332 AD however the crescent finial was a common feature of *Muslim* architecture in Jerusalem.

<sup>4170</sup> Pipes, Daniel. "Who Set Fire to *Al-Aqsa* Mosque in 1969?," *DP*, 21 Aug 2004.

<sup>4171</sup> *Chronology of the World (circa 1030 AD)*, Edinburgh University Library, Edinburgh, United Kingdom, MS 161, Folio 134v. The manuscript is reproduced in Landay. *Rock*, pp. 45, 169.



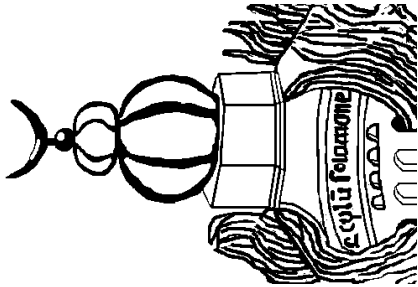
**Figure 12-26.** Muslims defending Jerusalem against Crusaders. This scene depicts 1099 AD. There seem to be two crescent finials (see insets).<sup>4172</sup> From *The Revenge of Jerusalem* (1332 AD).



**Figure 12-27.** Fifteenth-century artist's depiction of the Dome of the Rock.<sup>4173</sup> Note the crescents atop the dome and *Minaret*. From *Passages d'Outremer* (1454-1459 AD).

By the fifteenth century, there are plenty of drawings of the Dome of the Rock with crescent finials. The *Nuremberg Chronicles* (1493 AD) contains a composite drawing of the six destructions of Jerusalem that illustrate what the text describes.

The building with the inscription “Temple of Solomon” has similarities to the Dome of the Rock, which was once nicknamed “The Temple of Solomon.” It also has a crescent finial. The dome fire that occurred at the Dome of the Rock in 1448 AD might have inspired the flames and smoke in this picture.<sup>4174</sup>



**Figure 12-28.** Hartmann Schedel (1440-1514 AD) produced this hand-colored woodcut of the Dome of the Rock entitled *DESTRVCCIO IHEROSOLIME* (“Destruction of Jerusalem”), from the *Liber Cronicarum Nuremberg*, meaning “The Nuremberg Chronicles Book,” Osher Collection, 1493 AD.

**Note:** Rotate book to view image.

**Europeans in 1625 AD Knew That Allah Was a Moon-god**

The Frenchman Michel Baudier knew that *Muslims* worshipped *Allah* the moon-god. He even printed an artist's conception of *Muslim* heaven in 1625. One of his illustrations is reproduced below which has *Muslims* worshipping the Man-in-the-Moon using the Sign of *Tanit*.

The *Dabistan* (~1645 AD) describes *Muslims* in heaven thus:

There are eight gradations, or steps, in heaven...the highest of blessing is the sight of God, the Almighty, whom the good behold as the moon of fourteen nights. This is upon the authority of the lord Mulana *Abd-ul* Rahmen Jami.<sup>4175</sup>

A manuscript illumination from a thirteenth-century manuscript of William of Tyre's *Histoire d' Outremer* (*Historia Rerum in Partibus Transmarinis Gestarum*) shows *Muslims* worshipping a naked idol on a pedestal in the Dome of the Rock. Evidently, this idol represents *Allah*, the Man-in-the-Moon, because the text of the illuminated manuscript says “the *Saracens* revered *Muhammad* as a prophet and rejected worship of idols.”<sup>4176</sup>

<sup>4172</sup> Excerpt of miniature in Van Maerlant, Jacob. *Revenge of Jerusalem* (1332 AD), University Library, Groningen, Netherlands, as reproduced in Rogers. *Spread*, p. 25.

<sup>4173</sup> Excerpt of miniature of pilgrims entering Jerusalem from *Passages d'Outremer*, *Bibliothèque Nationale*, Paris, 1454-1459 AD, Manuscript France 9087, Folio 85v, as reproduced in Landay. *Rock*, p. 12.

<sup>4174</sup> Landay. *Rock*, p. 107.

<sup>4175</sup> Fani. *Dabistan*, p. 321.

<sup>4176</sup> Baltimore Art Gallery manuscript 10137.f.1r (Tolan. *Saracens*, pp. 131-132).



**Figure 12-29.** A Frenchman’s 1625 AD depiction of *Muslims* worshipping *Allah* the moon-god, here seen as “the Man-in-the-Moon.”<sup>4177</sup>

The *Muslims* are raising their hands, which act is the first part of the *Rakah* prostration—part of the five daily prayers that *Muslims* must perform. The raising of the hands transforms their heads and turbans into Venus orbs and their arms into crescents. This forms G couplets.

A critic, who is overly sympathetic to *Islam*, had this comment about Michel Baudier’s frontispiece showing *Allah* as “the Man-in-the-Moon”:

Christians persistently misunderstood the nature of the pleasures promised *Muslims* in Paradise, depicting it as a place of licentiousness. The frontispiece to a volume on the *Ottoman* Empire published in 1625 by the Frenchman Michel Baudier... shows an invidious contrast between Christian and ‘*Islamic*’ concepts of heaven, including depictions of *Muslims* bathing and supposedly worshipping the moon. It perpetuated centuries-old slanders on *Islam* at a time when wiser and more evenhanded Europeans had already begun to realize how much the two religions shared in their vision of a more perfect life after death.<sup>4178</sup>

The above quote states that Michel Baudier’s publication was slanderous, despite the fact that his illustrations were and still are entirely accurate.

### Defending the Earlier European Perception of *Islam* as Being Accurate

#### *The Count of Slander Concerning Houris*

The above quote alludes to Michel Baudier’s depiction of the banquet table in heaven with *Muslim* men reveling with naked *Houris*. *Houris* are nymph nymphomaniacs.

Saying that something is slander does not automatically make it so. Many millions of non-*Muslims* did indeed die, and others suffered terribly, just so *Muslim* terrorists and *Jihadists* could caress their six-dozen *Houris*. To deny this fact would be as shameful as saying that millions of Jews were not killed due to anti-Semitism.

It is an insult to the victims of *Jihad* to say that *Jihadists* had some lofty, Platonic goals or that they were fighting a “just war”—even by any stretch of the imagination. Besides, saying that the *Houris* are a mental abstraction does not help *Islam*’s image much since lusting mentally is a sin (Mat 05:28).

#### *The Count of Slander Concerning Allah Being a Moon-god*

In the above quote, the critic says that Europeans in 1625 AD and after were abandoning centuries-old beliefs about *Islam*, such as the belief that *Allah* was a moon-god.

The critic asserts that Europeans were coming to appreciate the commonalities between *Islam* and Christianity but of course no names are provided. The critic is making a lame attempt to extend delusional multicultural ideas into the distant past.

<sup>4177</sup> Frenchman’s art of *Muslims* praying to the Man-in-the-Moon in *Muslim Heaven*, published 1625 AD (Frontispiece to Michel Baudier, *Histoire general de la Religion des Turcs*, Paris, 1625 AD, found in Blair & Bloom. *Paradise*, p. 43, fig. 15).

<sup>4178</sup> Blair & Bloom. *Paradise*, p. 43.



The fact is that if one were looking for the most informed judgment about the nature of *Islam*, one would accept the centuries-old belief that *Allah* was a moon-god. That is because Europeans were more knowledgeable about *Islam* before 1625 AD than after—at least until the nineteenth century when Western scholars reacquainted themselves with the very earliest *Islamic* sources in Arabic.

Between 1625 and the nineteenth century AD, Europeans knew less about *Allah's* moon-god origins because:

- ☉ *Muslims* had been forced out of Spain by 1502 and 1570 AD.
- ☉ The Crusaders had been forced out of the Mideast for the most part by the thirteenth century. The Crusaders of course had seen the inside the Dome of the Rock moon-god temple.
- ☉ *Muslim* rituals at the Dome of the Rock that suggested *Allah* was a moon-god may have been curtailed around the fourteenth century.<sup>4179</sup>
- ☉ 1625 AD was during the Thirty-Years War (1618-1648) and wartime is nearly always a low-point for academic pursuits.
- ☉ Eastern Christianity's scholarship collapsed because of the intensive *Jihad* campaigns that occurred after *Saladin's* victories. Christians became fewer and their *Dhimmi* lot went from being intolerable to unbearable. There were also plenty of martyrdoms, pogroms and mobs that Christians had to contend with, and it was all they could do to survive and hang onto their religion.
- ☉ *Muslim* scholarship and the knowledge of *Islam's* pagan origins had been in serious decline ever since the tenth century AD and especially after the *Mongol* invasions around 1260 AD. *Muslims* tended to follow *Muhammad's* advice about not asking hard questions lest one lose his or her faith (*K* 005:101-102). Since *Muslim* literalism did not become dominant before the tenth century, it is not surprising that only early *Islamic* scholars spoke of:
  - ★ The astral character of the *Kaaba* (*Masudi* (896-956 AD)).<sup>4180</sup>
  - ★ The idols that were once in the *Kaaba* (*Ibn Al Kalbi* (died 821-822 AD/206 AH)).
  - ★ By 1645 AD, when the *Muslim Sufi* Moshan Fani reported that only “the learned” *Muslims* still knew that the *Kaaba* and the *Zamzam* well by the *Kaaba* were emblems of the sun.<sup>4181</sup>

The nadir in knowledge about *Islam's* origins between the Crusades and the nineteenth century means that any new conclusions drawn during this period are suspect, especially the conclusion that *Islamic* monotheism is like Christian monotheism. The reason for this is that in the absence of knowledge people today make the false multiculturalist assumption that other people are like them or that all religions are alike.

Unfortunately, conclusions drawn in an earlier period cannot be easily discarded, especially if these uninformed opinions are considered “enlightened” or “politically correct.” For instance just as the idea that *Islam* was a moon-god religion was mostly abandoned so also the notion that *Islam* is a religion of war was suppressed in favor of the idea that “*Islam* is a Religion of Peace.”™ Now however the West is reluctantly relearning what the Crusaders and Byzantines knew—that *Islam* is both a war-and-moon-god religion!

<sup>4179</sup> Elad. *Jerusalem*, p. 62.

<sup>4180</sup> Ruthven. *World*, p. 18; Gibb & Kramers. *Encyclopedia*, p. 198, *Kab'ah* entry.

<sup>4181</sup> Fani. *Dabistan*, p. 394.

Just to show how uninformed Europeans had become about *Islam* between the end of the Crusades and the nineteenth century, one need only read a little history. For instance, after the crusaders were expelled from Jerusalem in 1187 AD, it was 1855 AD before the next non-Arab glimpsed inside the Dome of the Rock.<sup>4182</sup>

*Makka* and *Madina* largely remained a mystery until the nineteenth century AD. The famous British historian Edward Gibbon (1737-1794 AD) wrote in his chapter on “Arabia and Mahomet”:

Our notions of *Makka* must be drawn from the Arabians [Arabs], as no unbeliever [non-Muslim] is permitted to enter the city, our travelers are silent; and the short hints of [the author] Thevenot are taken from the suspicious mouth of an African *Renegado* [a renegade].<sup>4183</sup>

Isabel Burton, wife of Sir Richard Burton (1821–1890 AD), wrote about Richard Burton’s trip to *Makka* and *Madina*:

For those who may not know the import of *A Pilgrimage to Al Madinah and Makkah*, in 1853 AD, they will not take it amiss when I say that there are holy shrines of the *Muslim* world in the far-away desert, where no White man, European or Christian, could enter (save as a *Muslim*) or even approach, without certain death. They are more jealously guarded than the ‘Holy Grail,’ and this work narrates how this pilgrimage was accomplished.<sup>4184</sup>

In 1855 AD, Thomas Wolley wrote in the preface to Richard Burton’s book on *Makka* and *Madina*:

The interest just now felt in everything that relates to the East would alone be sufficient to ensure to the author of ‘*El Madinah and Makkah*’ the favourable consideration of the Reading Public. But when it is borne in mind that since the days of William Pitts of Exeter (AD 1678-1688) no European travelers, with the exception of Burckhardt and Lieutenant Burton, have been able to send us back an account of their travels there, it cannot be doubted but that the present work will be hailed as a welcome addition to our knowledge of these hitherto mysterious penetralia of *Mohammedan* superstition. In fact, *El Madinah* may be considered almost a virgin theme; for as Burckhardt was prostrated by sickness throughout the period of his stay in the Northern *Hejaz* [*Hijaz*], he was not able to describe it as satisfactorily or minutely as he did the Southern country, —he could not send a plan of the *Mosque*, or correct the popular but erroneous ideas which prevail concerning it and the surrounding city.<sup>4185</sup>

---

<sup>4182</sup> “1855 [AD]: Duke of Brabant becomes [the] first non-Arab to tour [the] Dome since [the] expulsion of the Crusaders” (Landay. *Rock*, p. 163).

<sup>4183</sup> Gibbon’s footnote 18 reads: “Our notions of *Makka* must be drawn from the Arabians (D’Herbelot, *Bibliothèque Orientale*, pp. 368-371. Pocock, *Specimen*, pp. 125-128. Abulfeda, pp. 11-40). As no unbeliever [non-Muslim] is permitted to enter the city, our travelers are silent; and the short hints of Thevenot (*Voyages du Levant*, part i, p. 490) are taken from the suspicious mouth of an African *renegado*. Some Persians counted 6,000 houses [in *Makka*] (Chardin, tome iv. p. 167)” (Gibbon, Edward. *The Decline and Fall of the Roman Empire*, vol.: “Fall of the Roman Empire in the East,” Ch. 50: “Arabia & Mahomet,” section: “Description of Arabia and its Inhabitants,” fn. 18).

<sup>4184</sup> Burton. *Narrative*, p. xvii.

<sup>4185</sup> Burton. *Narrative*, p. xxv.

### Why Was It Possible For Many to Forget That *Allah* Was a Moon-god?

Information that is damaging to *Islam* is suppressed for generations until at some point the vast majority of *Muslims* refuse to believe the word of “the learned” who still have a record of the detrimental knowledge.

It is fair to ask “What made Michel Baudier vulnerable to the accusation of slander for stating the obvious—that *Allah* is a moon-god?” The application of the principle of monotheism in *Islam* tended to make many *Muslims* forget that *Allah* was a moon-god. After awhile it became easy to plausibly deny that *Allah* had been a pre-*Islamic* moon-god. In ancient Egypt, the application of the principle of dualism and other historical factors had similar effects, as Egerton Sykes notes:

The application of the principle of Dualism however caused his [*Set*’s] original position as a sky and sun-god to be forgotten and for him to degenerate into the chief of the powers of evil, as manifested in the serpent, *Apep*...*Set* was also a chief god of the *Hyksos* [invaders of Egypt], which explains why—after their departure—he was degraded to the position of lord of the powers of evil and had his name erased from many monuments.<sup>4186</sup>

Until recently, Christians only knew what *Muslims* wanted to divulge about *Allah*’s pre-*Islamic* history which was not much. Even in modern times, ancient sites in the Arabian Peninsula have either been destroyed or largely have escaped the archeologist’s spade. This is due to the reticence on the part of religious authorities to let others know the pre-*Islamic* past, as Carleton Coon wrote:

*Muslims* are notoriously loath to preserve traditions of earlier paganism and like to garble what pre-*Islamic* history they permit to survive in anachronistic terms.<sup>4187</sup>

This reticence to know about pre-*Islamic* times goes back to early *Islam*. F. E. Peters wrote about *Muhammad*’s leading the *Hajj* of 630 AD (9 AH):

The presence of pagans at a *Hajj* in which *Muhammad* himself led the *Muslim* contingent doubtless troubled many of the ancient authorities who preferred to keep the Prophet far from any taint of paganism.<sup>4188</sup>

This reticence to talk about pre-*Islamic* paganism is evident in a book written by Hisham *Ibn Al Kalbi* (died 821-822 AD/206 AH). Although *Al Kalbi* wrote about many idols in his *Book of the Idols*, he did not discuss any “*Allah*” idols, nor *Allah*’s association with the crescent-moon.

It seems inconceivable that in all of *Allah*’s long history at the *Kaaba* that only the crescent was used and that no one ever associated an anthropomorphized idol with *Allah* himself. That there was no idol to *Allah* is about as implausible as the notion that the Arabs had no real false gods but only avatars of *Allah*. Of course if this were true, than one could say *Allah*’s avatars were moon-gods, solar-gods, rain gods and the like.

Almost nothing was written about pre-*Islamic* paganism until modern times. What has been written is mainly by Western scholars who managed to gain limited access to Arabia’s archeological treasures still buried under the sand. The *Muslim Yusuf Ali* wrote in 1946 AD that even though *Muslim* scholars walked among ancient ruins and walked over buried history all the time:

<sup>4186</sup> Sykes. *Mythology*, *Set* entry, pp. 188-189.

<sup>4187</sup> Coon. *Southern*, p. 398.

<sup>4188</sup> Peters. *Origins*, p. 251.

Our doctors of religion [*Islam*] have evinced no interest in the study of ancient cults or in comparative religion and most of them had not before them the results of modern archeology.<sup>4189</sup>

*Ibn Warraq* wrote:

It was not until the nineteenth century once again that a *Muslim* country took an interest in her pre-*Islamic* past. In 1868 *Sheikh Rifa Al Tahtawi*, the Egyptian man of letters, poet and historian, published a history of Egypt giving full attention to her pharaonic past. Up to then of course histories of Egypt had begun with the Arab conquest...*Al Tahtawi* sought to define Egyptian identity in national and patriotic terms—not in terms of *Islam* or Pan-*Arabism*. Perhaps for the first time in *Islamic* history, someone tried to see his country has having a ‘living, continuing identity through several changes of language, religion and civilization.’<sup>4190</sup>

Pre-*Islamic* history was covered up because many early *Islamic* scholars knew that *Allah* is a rehabilitated Pre-*Islamic* moon-god. *Muslims* knew their competitors, the Christians and Jews, would mock *Muslims* if Christians and Jews could prove *Allah* was a moon-god. *Muslim* scholars knew that if people started comparing *Islam* to pre-*Islamic* astral paganism they would realize that *Islam* is mostly recycled paganism.

Nabih Amin Faris wrote about *Al Kalbi*’s experience. This account goes a long way in explaining why Westerners need thick volumes to prove that *Allah* is a moon-god, even though this fact seems obvious. Nabih Amin Faris wrote:

...the desire of official *Islam* to stamp out all that belonged to the pagan days of Arabia discouraged learned men from the pursuit of studies which related to the so-called *Jahiliyah* [Arabic: ignorance] days. According to the traditionists, who were then in full control of the intellectual life of the community, *Muhammad* once said ‘*Islam* destroys all that preceded it.’ The Prophet, undoubtedly, had in mind the pagan religions of his country; but his followers, in their zeal to establish the new faith, set out to eradicate everything which had its roots in the old order. Consequently, the historians (*Akhbariyun*), whose work was to record the past and preserve its glories, were without honor in the *Muslim* community, particularly during the early period of *Islam*. The great Arab historians flourished during a later period. These too placed their emphasis on the *Muslim* era and treated the pre-*Islamic* days in a cursory manner. What is more, the word historian (*Akhbari*) acquired a bad meaning and became an epithet of near-contempt. It was applied to *Ibn Al Kalbi* as well as to any learned man who dared dwell upon Arab history before the ‘*Am Al Fil*.’ But no historian was attacked more virulently than *Ibn Al Kalbi*, probably because he addressed himself to the study of those things which *Islam* was determined to obliterate, namely the pagan religions and practices of Arabia. Thus *Al Baghdadi* preserves a saying current among the students of the *Hadith* concerning *Ibn Al Kalbi*’s alleged lack of veracity. To them he was but an amateur genealogist and a storyteller whose word no one would either accept or quote. *Al Isfahani* too despite his dependence upon *Ibn Al Kalbi*, attacks him in at least two places and asserts that everything which he had quoted in his authority was false. *Al Sam’ani* is still more outspoken. In his *Ansab* he dismisses *Ibn Al Kalbi* with the

<sup>4189</sup> *Yusuf Ali. Holy*, p. 1623, App. XIII.

<sup>4190</sup> *Warraq. Why*, p. 207.

following sentence, ‘He....used to relate odd and strange things and events none of which had any foundation.’ Another *Muslim* writer who disparages *Ibn Al Kalbi* is *Al Dhahabi*. Besides calling him a *Rafidi*, he says, ‘He was not reliable...but merely an historian (*Akhbari*).’ *Ahmad Ibn Hanbal* deemed it necessary to say of him, ‘I do not think anyone would quote him as an authority.’ All these attacks were undoubtedly motivated by fanaticism on the part of the traditionists and the *Koran* readers. For his part, *Ibn Al Kalbi* had little respect for them and for their studies and did not commit the *Koran* to memory except under the pressure of criticism.

But *Ibn Al Kalbi* was not without his stout champions. Foremost among those were *Al Masudi* and *Yaqt*. The former lists him among the best authorities and acknowledges his indebtedness to him. The latter actually defends him against the vilifications of the traditionists. Discussing a controversial point in which *Ibn Al Kalbi* was pitted against the other authorities, *Yaqt* accepts his report and says, ‘This, therefore, confirms the statement of *Abu Al Mundhir Hisham Ibn Muhammad Al Kalbi*. Bless his soul! Never have the learned men disagreed on any point without finding his word the final authority. Yet despite all that, he is unjustly treated and greatly maligned.’ But his vindication has come from modern scientific research and archeology, which have confirmed the greater part of his statements [about pre-Islamic paganism] and supported him against the fanatical criticism of his coreligionists.<sup>4191</sup>

So *Al Kalbi* was vindicated by archeology and modern studies concerning the idols of Arabia. In a similar fashion, *Michel Baudier* has been vindicated against the charge of slander. *Allah* really is a moon-god. Now, Christians can both state the obvious and back it up with many clear proofs and much circumstantial evidence: “*Allah* is indeed a moon-god.”

---

<sup>4191</sup> *Al Kalbi. Idols*, pp. viii-x.

## Chapter 13: Moon-o-theistic Pilgrimages

### Intercalation Myths

Lunar calendars are the simplest kind. There are approximately twelve new-moons for each year as judged by the seasons. Unfortunately the lunar year is slightly over eleven days short of a solar year, so each lunar month cycles through the seasons. The interregnum moon cannot be seen for three days each month during the new-moon conjunction.

When calendar keepers want to associate the same set of months with particular seasons year after year, intercalation is employed. A solilunar calendar has the crescent-moon marking the start of each month and a thirteenth leap month is added about every three years so each month stays in the same season.

By contrast, solar calendars like the Gregorian calendar do not add a thirteenth month but merely adds one or more days at the end of each of the twelve months. The phases of the moon are not taken into account in a solar calendar, so a waxing crescent can appear on any day of the month and sometimes twice in one month.

The fact that the moon no longer mattered in purely solar calendars is why they did not catch on in the Mideast since the *Semites* held the moon in high regard. Even solilunar calendars were probably seen as a necessary evil where agriculturalists needed to peg certain months to certain seasons. The solilunar calendar was kept in addition to the official religious lunar calendar.

In places nearer the equator the seasons mattered less since there is less precipitation except in rain forests, and no frost or snow except on mountains. *Makka*'s elevation is only 909 feet (277 meters) above sea level. The surrounding mountains (*Jabal*) are also low: *Ajyad*, 1,332 feet; *Abu Qubays*, 1,220 feet; *Qu'ayq'an*, 1,401 feet; *Hira*, 2,080 feet; *Thawr*, 2,490 feet.<sup>4192</sup> The *Koran* only mentions hail (*K* 024:043), while the Bible was written in a higher latitude and mentions frost and snow many times.

Since there is less seasonal agriculture and more herding, fishing and hunting nearer the equator, solilunar calendars may have been perceived as an unnecessary slight to the male moon-god of *Makka*. This slight that had to be atoned for like other acts of perfidy, especially if the solilunar calendar started to replace the official religious lunar calendar.

In contrast, though Latin and Greek cultures were as patriarchal as *Semitic* cultures, implementing a solar calendar was not a concern. This is because in the Romance (Latin) and Greek languages and mythology, the gender of the sun just happens to be masculine and the moon feminine. This is the reverse of the arrangement in the Semitic language and mythology.

The Latin word for sun is *Sol* and the word for moon is *Luna*. In Greek the word for sun is *helios* and the word for the moon is *selene*. In a sun-based calendar, the moon would just have to accommodate the sun.

In pagan societies, intercalation needed to be explained through myths since the sun and moon were deities. Here, by way of example, is an intercalation myth from Egypt. Egerton Sykes wrote:

Frazer attributes a lunar origin to *Osiris*, as did *Plutarch*. This might explain the violence of the fight with *Set*...Before the birth of *Osiris* [moon-god], *Ra* [sun-god] was so infuriated at the faithlessness of *Nut* that he decreed that her

<sup>4192</sup> EB, *Makka* entry, accessed 22 Dec 2004.

children should not be born in any month of the year. *Thoth* [moon-god] however gambled with the moon for a seventy-second part of the day and eventually won five days, which were added to the Egyptian lunar year of 360 days, thus enabling not only *Osiris* but his four brothers and sisters to be [re]born out[side] of any month. The addition of these days, known as the *Epact*, to the year in connection with the [re-]birth of *Osiris*, shows that it was at this time [4231 BC] that the adjustment of the calendar took place.<sup>4193</sup>

We do not know the intercalation myths of *Makka* but history is clear that intercalation was used at *Makka*. Even the names of the months speak of intercalation: *Ramadan* means “the scorcher” and refers to the hot Arabian summers, and *Rabi’a* means “Spring.”<sup>4194</sup> The intercalation myth at *Makka* likely involved some jockeying between *Allah* the moon-god and *Allat* the sun-goddess.

### Tracking the Sun and Moon Equals Worship

As was mentioned in the previous chapter, *Muhammad* often spoke against partnering gods with *Allah* in the *Koran*. *Muhammad* thought that people who used solilunar calendars were polytheistic since they tracked both the sun and moon.

To *Muhammad*, tracking astral bodies was worship. Even today, most *Muslim* jurists consider it an act of worship to watch for the crescent-moon to mark the start of a new month, as Abdulkader Tayob wrote:

The basic forms of *Islamic* worship were also determined by God, in the *Quran*, as well as by the Prophet *Muhammad*’s example. This means that, in many cases, the forms were regarded as ends in themselves. Riding a camel to *Makka* would be regarded as a means to an end but *Mufti* Shafi, like most other contemporary jurists, regards watching the crescent of the new-moon to signal the change of month as an end in itself. Unlike riding a camel, watching the new-moon is an act of worship.<sup>4195</sup>

In *Muhammad*’s mind, following a lunar religious calendar was an act of worship to *Allah* the moon-god. Interestingly, one of the moon-god *Sin*’s titles was “lord of the calendar and of wisdom.”<sup>4196</sup> *Muhammad* without a doubt considered *Allah* the moon-god to be “lord of the calendar,” too. This strengthens the connection between *Allah* and the moon-god *Sin*.

### Solar, Solilunar and Lunar Calendars

The modern world generally uses solar calendars, and solilunar calendars have always been the calendar of choice. Lunar calendars’ main purpose in history has been setting the routine for monotheistic moon-god religions like *Islam*.

The reason that solar calendars are dominant is that while the moon has an effect on the tides, the sun affects the seasons. Everyone is affected by the seasons but tides only matter to fishermen and other seafarers who, incidentally, are as interested in tracking seasons as they are in keeping track of tidal conditions.

The solar year is about 365 days long whereas the lunar year is about 354 days long. The difference between a solar and lunar year is about eleven days, or about one month every three years.

<sup>4193</sup> Sykes. *Mythology*, *Osiris* entry, pp. 162-164; see also pp. 71-72, *Epact* entry.

<sup>4194</sup> Ishaq. *Sirat*, p. 405, note 2.

<sup>4195</sup> Tayob. *Islam*, p. 27.

<sup>4196</sup> *CEE*, *Sin* entry.

In the Gregorian solar calendar, the months are between twenty-eight and thirty-one days long. In solar calendars a crescent-moon does not mark the start of the month but appears at any time during the month. In solar calendars, a moon phase such as a waxing crescent-moon or a full-moon will often appear twice in one month.

In a solilunar calendar each month starts with the sighting of the crescent-moon. In a solilunar calendar, the solar and lunar cycles are usually reconciled by having a thirteenth lunar month every third year.

### **Muhammad Spoke Against Intercalation**

The traditions and the *Koran* mention that *Muhammad* spoke against solilunar intercalation where “they were wont [i.e. accustomed] to intercalate a month every third year.”<sup>4197</sup> The *Koran* says:

Surely the number of months with *Allah* is twelve months in *Allah*'s ordinance since the day when He created the heavens and the earth, of these four being sacred; that is the right reckoning; therefore be not unjust to yourselves regarding them and **fight the polytheists** all together as they fight you all together; and know that *Allah* is with those who guard (against evil). Postponing (of the sacred month) is only an addition in unbelief, wherewith those who disbelieve are led astray, violating it one year and keeping it sacred another, that they may agree in the number (of months) that *Allah* has made sacred and thus violate what *Allah* has made sacred; the evil of their doings is made seemingly fair to them; and *Allah* does not guide the unbelieving people (*K* 009:036-037).

Notice in the above quotation that *Muhammad* mentions fighting **polytheists** right in the midst of his discussion of intercalary days and months (*K* 009:036).

The Arabic word translated “polytheists” in *Koran* 009:036 is the word *Almushrikeena*. This word is related to the Arabic word *Shirk*. “*Shirk*” in English means “to avoid or neglect a duty or responsibility.” In *Islam* and Arabic, however *Shirk* means “to associate a partner god with *Allah*,” or “directing any form of worship to other than *Allah*.”

When *Ibrahim* told the *Haranians* that they were wrong to associate the sun with *Allah*, he referred to the *Haranians* as *Almushrikeena* (polytheists) (*K* 006:078-079). *Almushrikeena* is a form of the Arabic word for *Shirk*.

So the fact that *Muhammad* mentions polytheism and intercalation together, and his assertion that lunar calendars constitute monotheistic worship, implies that *Allah* was a moon-god. If intercalation implies sun- and moon-god worship, then a purely lunar calendar implies lunar monotheism, or moon-o-theism.

### **Praying at Sunrise and at High Noon Taboo**

Note that the *Koran* has the sun setting into a mud puddle in the *Koran* (*K* 018:086) but no mention is made of where the moon sets. This is a case even though the moon-god was considered the high god and was the most popular Mideast cult.

This shows that *Muhammad* was a monotheistic moon-god prophet in a religious war with a sun-goddess. Samuel Zwemer wrote:

The noonday prayer is never held at high noon but a short time after the sun reaches the meridian. Wensinck points out that this is due to the belief that the sun-god is really a demon and must not be worshiped by the monotheist. According to *Al Bokhari* [*Al Bukhari*] the Prophet postponed the noonday prayer

<sup>4197</sup> Zwemer. *Animism*, ch. 1.



until after high noon for ‘the greatest heat of the day belongs to the heat of hell.’ Nor is it permitted to pray shortly after sunrise for ‘the sun rises between the horns of the devil.’<sup>4198</sup>

### Lunar Pilgrimages

The moon of course was not the only celestial object worshipped at the pre-Islamic Kaaba with its 360 idols. Some *Hajj* rites were solar and were, apparently, imported from India. *Al Kindy* wrote to a *Muslim* around 830 AD:

Knowest thou not that the same is the practice of the sun-worshippers and *Brahmas* in India at the present day? They make the circuit of their idol temples, with just these ceremonies, shaved and naked, or with the dress they call *Ihrâm*. The only difference is that ye perform it once in the year at a movable season while they do it twice at certain solar conjunctions, one in the spring when the heat begins, the other in autumn when the cold sets in. Such is the origin of these idolatrous customs. Thou well knowest that the Arabs practiced them from the foundation of the *Kâaba*; and thy Master continued the same, with only this alteration, that on account of the distance and labor of travel, he limited the [main] Pilgrimage to one period of the year and abolished what was indecent in the pilgrim dress. Thus that [pilgrimage] which ye perform [now] in nothing [in no way] differs from the idolatrous ceremonies of the sun-worshippers and idolaters of India.<sup>4199</sup>

Wherry wrote about the Arab-Indian religious connection:

The ancient Arabians [Arabs] and Indians, between which two nations was a great conformity of religions, had seven celebrated temples, dedicated to the seven planets; one of which in particular, called *Bait Ghumdan*, was built in *Sanaa*, the metropolis of *Yaman*, by *Dahaq*, to the honour of *Al Zuharah* or the planet Venus, and was demolished by the *Khalifah* Othman [*Caliph* Uthman]; by whose murder was fulfilled the prophetic inscription set, as is reported, over this temple, viz. [namely], ‘*Ghumdan*, he who destroyeth [destroys] thee shall be slain.’ The temple of *Makkah* is also said to have been consecrated to *Zuhal*, or *Saturn*.<sup>4200</sup>

The Saturn association (just mentioned) is explained elsewhere.

It should be noted that while some of the *Hajj* rites may have originally come from India by way of *Yemen*. Ryckmans wrote in the 2004 *Encyclopedia Britannica* that *Hajj*-like pilgrimages were common in pre-Islamic Arabia:

The rites included purification and the wearing of ritual clothing, sexual abstinence, abstention from shedding blood and circuits performed (*Tawaf*, *Dawar*) around the sacred object; they were concluded by the slaughter of animals, which were eaten in collective feasts. Today such practices still form the core of the *Islamic* pilgrimage to *Makka*. The classical, *Nabataean*, *Lihyanite* and *Sabaeen* sources mention pilgrimages....The slaughter of animals as a sacrifice of expiation or of thanksgiving was probably, as in the *Islamic* cult, an individual rite performed by the faithful himself. But collective sacrifices too place in accordance with the pilgrimages [like as in *Islam’s Hajj*].<sup>4201</sup>

<sup>4198</sup> Zwemer. *Animism*, ch. 3.

<sup>4199</sup> *Al Kindy*. *Apology*, pp. 92-93.

<sup>4200</sup> Wherry. *Commentary*, vol. i, section i, p. 38.

<sup>4201</sup> Ryckmans, Jacques. *EB*, “Arabian Religions,” 2004.

In 1992 Ryckmans wrote about South Arabian rites similar to those in *Islam*:

The sanctuaries consisted essentially of a sacred open precinct (*haram* or *mahram*) accessible only on conditions of ritual purity. Expiatory confessions inform us as to the details of those rules. Women accuse themselves of having entered the temple during their menses. Men confess having had sexual relations with menstruating women, or women in childbirth, or of having omitted the ritual washing after sexual relations. Such rules, borne out by inscriptions several centuries older than the birth of *Islam* but using technical terms identical or very close to those of the *Muslim* jurisprudence, obviously were part of an ancient common Semitic heritage. There is therefore no reason to assume—as some *Islamologists* have done—that the similar *Islamic* rules were borrowed from the Jews in *Madina*, instead of being a mere survival of pre-*Islamic* Arabian usages.<sup>4202</sup>

Today there are *Hajj* and *Umra* manuals like *Shaykh Al Albani's Rites of Hajj and Umrah* (1975 AD), as was the case in pre-*Islamic Yemen*. Simpson wrote:

Pilgrimage played an important part in South Arabian religious life (fig. 59).<sup>4203</sup> A large third-century BC inscription from the highland site of *Riyam* contains precise prescriptions as to when and how the pilgrimage to *Ta'lab* of *Riyam* should be fulfilled, how many animals should be slaughtered during the days of pilgrimage and what should be done in which temple.<sup>4204</sup>

The *Encyclopedia Britannica* also states that in *Al-Jawf* of northern *Yemen*, there is a 3.7-mile-long processional way that connects two temples, one at the foot and one at the summit of a 3,000 foot-high mountain. This reminds one immediately of the long pilgrim circuit through the mountains east of *Makka*.<sup>4205</sup>

The *Koran* indicates that the two yearly pilgrimages, the *Umra* and *Hajj*, had once been spring and fall harvest festivals (*K* 106:002). *K* 106 speaks of how *Allah* had fulfilled his promises to *Ibrahim*. *Allah* promised *Ibrahim* that though *Makka* was situated in a barren land, *Allah* would cause pilgrims to bring sustenance to *Ibrahim's* descendants who tended the *Kaaba* (*K* 002:126; 014:035-037; 028:057). This suggests that the original pilgrimages were spring and fall harvest festivals, as F. E. Peters wrote about *K* 106:

Not everyone reads [understands] the 'two journeys,' which God had 'eased' and to which the prosperity of the *Quraysh* was linked, as an expanded opportunity for trade [meaning spring and fall caravans to Syria]. *Al Razi* for one thought that the 'journey of winter and of summer' referred to the traveling of pilgrims to *Makka*, the one referring to the *Umra* of the month of *Rajab* and the other to the *Hajj* of the month *Dhu Al Hijja*. If it was a guess, it was an inspired one. *Muslim* commentators, who lived in an era and a society without intercalation and so without seasonal festivals, would have difficulty in imagining seasonal pilgrimages, as all such were in pre-*Islamic* days.<sup>4206</sup>

*Muhammad* thought that making pilgrimages seasonal suggested a solar rite. The Bible writers saw it differently however and said "The moon marks off the seasons," especially growing seasons (*Deu* 33:14; *Psa* 104:19). Of course the moon and months

<sup>4202</sup> Ryckmans. *Anchor*, v. 6, p. 173.

<sup>4203</sup> "Figure 59: Dedicatory stela describing a pilgrimage to the temple of 'Almaqah, Marib (cat. 206)" (Simpson. *Sheba*, p. 164).

<sup>4204</sup> Simpson. *Sheba*, p. 165.

<sup>4205</sup> Ryckmans, Jacques. *EB*, "Arabian Religions," 2004.

<sup>4206</sup> Peters. *Origins*, pp. 92-93.

only mark off the seasons accurately when intercalation is implemented, when one lunar month is inserted every three years. *Muhammad* ended this practice.

The pre-*Islamic* Arabs also thought the moon and months marked out the seasons because they used intercalation. This is why the month *Ramadan* means “the scorcher” and refers to the hot Arabian summers. The month *Rabi’a* means “spring.”<sup>4207</sup>

Since the lunar year is eleven days short of a solar year, in a lunar calendar with intercalation, the lunar months cycle through the seasons. *Rabi’a* no longer just occurs during spring, and *Ramadan* no longer occurs during the summer.

That the seasons were marked off by the moon and months was not good enough for *Muhammad*. *Muhammad* was a monotheistic moon-god worshipper, so every easily recognized vestige of solar rites had to be extirpated.

*Muhammad* also wanted to guarantee that the *Hajj* occurred when the moon was waxing or full. If however the pilgrimages coincided with the equinoxes, the moon might be in its waning phase. So *Muhammad* put this verse in the *Koran*:

They ask you concerning the new-moon. Say: They are times appointed for (the benefit of) men and (for) the pilgrimage (*K* 002:189).

In this way *Muhammad* rescheduled the fall harvest festival *Hajj* so that it begins in the twelfth and last month of the lunar year—the *Dhu Al Hijjah* month [i.e. *Zulhijjah*]. This lunar month occurs eleven days earlier each solar year, so the *Hajj* quickly and permanently lost its seasonal aspect.

The spring *Umra* minor harvest festival also immediately lost its seasonal aspect. Since *Muhammad*'s reforms, the *Umra* pilgrimage can be done at any time and even in conjunction with the *Hajj*.

*Muhammad*'s religious calendar reform was formalized a few years after *Muhammad* went to hell (~632 AD). In 638 AD the second *Caliph*, Umar (592-644 AD), implemented the *Hijri* lunar religious calendar. 622 AD, the year that *Muhammad* fled from *Makka* to *Madina*, was used as Year One of the *Hijri* calendar. The abbreviation used after *Hijri* dates is AH.

### The Lunar *Hajj*

*Muhammad* was not satisfied with just having pilgrimages follow the lunar religious calendar. The *Hajj* already had lunar rite aspects but *Muhammad* made it more so. As was noted at the start of the chapter, *Islamic* jurists consider watching for the sliver of the crescent-moon to be an act of worship.

Crescent sighting is what the first stage of *Hajj* is mainly about. The second stage of *Hajj* is about basking in the moonlight while the moon phases go from half full (first quarter) to nearly full.

If a pilgrim stays the entire time, the *Hajj* lasts twelve days. One might think that a lunar-oriented pilgrimage would last crescent to full-moon, which is thirteen to fourteen days long. However, the *Hajj* is a rather onerous duty, so the days were probably cut short. There were other considerations, however:

- ☉ Twelve is a good number for the days of the *Hajj* since that is the number of zodiac constellations.
- ☉ The lunar calendar year is slightly over eleven days short of the solar calendar each year.

<sup>4207</sup> Ishaq. *Sirat*, p. 405, note 2.

These last few facts may seem like trivia but these realities were important to the priests at the *Kaaba* whose job it was to intercalate. *Muhammad* said that the number of lunar months in a year was twelve by the decree of *Allah* (K 009:036).

Many *Hajj* pilgrims do the *Hajj* events out of order, so their activities do not match the moon phases. Some pilgrims do only part of *Hajj*. Others manage to trim a few days off the *Hajj* at the start or end or both. *Encyclopaedia Britannica* states:

The pattern of pilgrimage rites was established by the Prophet *Muhammad* but variations have arisen in it and the stringent formal itinerary is not strictly adhered to by the mass of pilgrims, who frequently visit the various *Makkan* sites out of their proper order.<sup>4208</sup>

These shortcuts and variations are only a peripheral issue in this discussion, however.

### The First Stage of the *Hajj*

*Muhammad* scheduled the *Hajj* to begin at the start of the lunar month *Dhu Al Hijjah* [*Zulhijjah*]. During this week the pilgrim enters the holy areas around *Makka* (the *Mawaqit* and *Haram*), consecrates himself or herself, puts on pilgrim clothing (the *Ihram*) and states his intentions to *Allah*.<sup>4209</sup>

As during any time of the year, a pilgrim may circumambulate the *Kaaba*. Sometime before the end of the seventh day of *Dhu Al Hijjah*...

...He [the pilgrim] enters *Makka* and walks seven times around the sacred shrine called the *Kaaba*, in the Great *Mosque*, kisses or touches the Black Stone (*Hajar Al Aswad*) in the *Kaaba*, prays twice in the direction of the *Maqam Ibrahim* and the *Kaaba* and runs seven times between the minor prominences of Mount *Safa* and Mount *Marwah*.<sup>4210</sup>

While the pilgrim does the above rituals, the phase of the moon goes from a crescent to nearly half full (first quarter).

The moon rises and sets at varying times due in part to the elliptical orbit of the moon. The following chart gives an approximate idea of the moon rise and set times during the first stage of the *Hajj* at *Makka*:



Figure 13-01. The typical moon phases of the first stage of *Hajj*—week one. The half-moon signals the end of the first stage of *Hajj*.

Day of <i>Hajj</i>	Day 01	Day 02	Day 03	Day 04	Day 05	Day 06	Day 07
<b>Moon Rise</b>	06:12 AM	07:11 AM	08:12 AM	09:15 AM	10:17 AM	11:17 AM	12:17 PM
<b>Moon Set</b>	20:07 PM	21:03 PM	21:54 PM	22:40 PM	23:23 PM	00:04 AM	00:04 AM

The crescent-moon phase is appropriate since circumambulation around the *Kaaba* involves crescent-moon sighting. Circumambulation around the *Kaaba* is mainly about watching for the crescent-shaped *Hatim* Wall as it appears while the pilgrim rounds the corner of the *Kaaba*.

The large black silk *Kiswa* cover over the *Kaaba* represents the starry night sky. The band of gold Arabic calligraphy embroidered on the *Kiswa* represents the stars

<sup>4208</sup> *EB*, accessed 22 Jun 2002, *Hajj* entry.

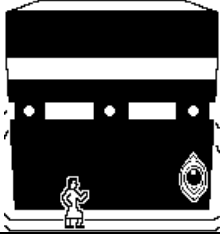
<sup>4209</sup> Glassé. *Encyclopedia, Hajj* illustration, pp. 444-445.

<sup>4210</sup> *EB*, accessed 22 Jun 2002, *Hajj* entry.

and the Milky Way. The Arabic writing is from the *Koran*, so it is as though the *Koran* is written across the starry skies.

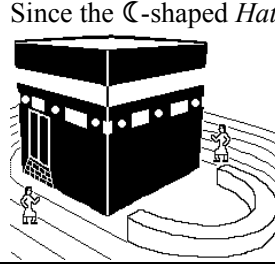
The *Hatim Wall* is on the northwest side of the *Kaaba*, so while the pilgrim is on the southeast side of the *Kaaba*, the *Kiswa* blocks the *Hatim Wall* from view. The *Hatim Wall* being out of view represents the new-moon conjunction phase when the moon is dark for three days each month. After the conjunction, of course the crescent-moon appears. Just as one can see a lot of stars especially on nights with no moon, one sees the “starry” *Kiswa* when one cannot see the *Hatim Wall* crescent.

**Figure 13-02.** The *Kaaba* as seen from the SE (Mount *Safa*). From Mount *Safa* the Black Stone is visible but the



☾-shaped *Hatim Wall* is hidden. This represents the interregnum dark conjunction phase of the moon.

**Figure 13-03.** Walkers by the *Kaaba* as seen from the NE (Mount *Marwa*).



Since the ☾-shaped *Hatim Wall* is visible, this constitutes a waxing crescent-moon sighting.

As was noted above, *Islamic* jurists consider sighting the crescent-moon to be an act of worship. So walking around the *Kaaba* and spotting the crescent-shaped *Hatim Wall* seven times constitutes seven acts of worship to *Allah* the moon-god.

The attraction of crescent-moon sighting at the *Kaaba* of course is that these seven acts of worship only take a few minutes to complete. Otherwise, making seven crescent-moon sightings, each marking the start of a month, would require seven lunar months to complete.

Circumambulating the *Kaaba* is not the only crescent watching activity that occurs during the first stage of the *Hajj*. There also is the activity called the *Sa'y*, the running seven times between the minor prominences called *Safa* and *Marwa*. Scholars have realized that this is just a straight-line version of circumambulating the *Kaaba*.

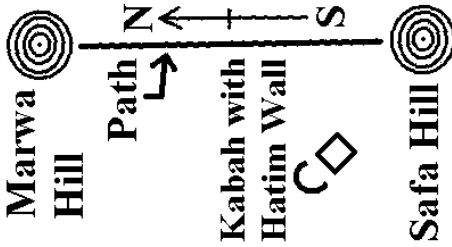
The pilgrim is supposed to climb Mounts *Safa* and *Marwa* high enough to see the *Kaaba*. Mount *Safa* is about 200 meters southeast of the *Kaaba*, while Mount *Marwa* is about 425 meters due north of Mount *Safa*.

The way the *Kaaba* and the crescent-shaped *Hatim Wall* and two hills are positioned, the viewer on *Marwa* makes a crescent sighting, while the viewer on *Safa* experiences the new-moon conjunction phase.

During the *Hajj* while the pilgrim makes his crescent-moon sightings from Mount *Marwa* of the *Hatim Wall*, the moon in the sky appears as a crescent to nearly half full (first quarter). This is because the *Hajj* starts on the first week of the lunar month when the moon goes from crescent to half moon.

The *Sa'y* is straight-line circumambulation between Mounts *Safa* and *Marwa*. This involves watching for the crescent-moon (the *Hatim Wall*) at *Allah* the moon-god’s shrine. Due to the *Sa'y*’s lunar connection, *Muhammad* said in the *Koran*:

Surely the *Safa* and the *Marwa* [Mounts] are among the signs appointed by *Allah*; so whoever makes a pilgrimage to the House [the *Kaaba*] or pays a visit (to it), there is no blame on him if he goes round them both [i.e. circumambulates the *Kaaba* and runs between Mounts *Safa* and *Marwa*]; and whoever does good spontaneously, then surely *Allah* is Grateful, Knowing (*K* 002:158).



**Figure 13-04.** *Marwa* is to the northeast of the *Kaaba* and *Safa* is to the southeast of the *Kaaba*.

A *Muslim* can see the crescent-shaped *Hatim Wall* from the *Marwa* prominence, but a *Muslim* on the *Safa* Hill finds that the *Hatim Wall* is hidden from view by the tall cubic *Kaaba*.

Note: Rotate book to view image.

Of course since *Muhammad's* time, the *Grand Mosque* building around the *Kaaba* has been built up so much that it now encloses Mounts *Safa* and *Marwa*. There are even escalators up the mounts. The modern building makes seeing the crescent-shaped *Hatim Wall* from the *Marwa* prominence nearly impossible. *Shaykh Al Albani* wrote in his *Hajj* guide:

Then he [the pilgrim] begins with *as-Safaa*—climbing upon it until he can see the *Kaaba*...It is not easy these days to see the *Kaaba* except from certain points on *as-Safa*; it can be seen from the pillar which supports the second story of the *Mosque*, so he who is able to do so has attained the *Sunnah* [sacred tradition], and if not then let him try his best and there is no harm.

Then he walks up to *Marwah* and ascends it and does upon it as he did upon *as-Safaa*—facing the *Qiblah* [the direction of the *Kaaba*], saying *Takbeer* and *Tahleel* and making *Du'aa*...As for seeing the *Kaaba*—it is not possible now because of the building between it and the *Kaaba*—so [he] should try his best to face the *Kaaba* and not do as the confused people do, who raise up their eyes and hands to the sky!<sup>4211</sup>

This shows that the traditional circumambulation of the *Kaaba* involves the sighting of the *Kaaba* and the crescent-shaped *Hatim Wall*, and that the *Hatim wall* has always been considered a part of the *Kaaba*.

## The Second Stage of the *Hajj*

### *Many Rites Occur at Night as One Would Expect for a Moon-god Religion*

When the second stage of the *Hajj* begins, the moon is a little over half full (first quarter). The second stage of *Hajj* begins on the eighth day of the lunar month *Dhu Al Hijjah* month, which starts after the sighting of the crescent-moon.

As one might expect, when the moon in the sky no longer appears as a crescent, pilgrims leave off crescent sighting at the *Kaaba*. Then they head toward the outskirts of *Makka*.

Moshan Fani (1615-1670 AD) notes in *The Dabistan* that the *Hajj* really is thought of in terms of the moon. The “day of *Arirfah* [at Mount *Arafat*]” is called the “the ninth day of the moon.”<sup>4212</sup> The annotator states:

This mountain [*Arafat*], in the pilgrimage to *Makka*, is one of the principal sacred stations, which the pilgrims cannot enter without having taken the *Ihram*,

<sup>4211</sup> *Al Albani. Rites*, in the section “*Sa’ee* Between *Safaa* and *Marwah*.”

<sup>4212</sup> Fani. *Sufis*, p. 53.

or ‘penitential veil,’ on the first day of the moon *Zilhajah* (the last lunar month of the Arabian year).<sup>4213</sup>

The second and last stage of the *Hajj* ends on the twelfth day of the lunar month *Dhu Al Hijjah* when the moon is nearly full. The *Encyclopedia Britannica* states:

On the 7th of *Dhu Al Hijjah* the pilgrim is reminded of his duties. At the second stage of the ritual, which takes place between the 8th and the 12th days of the month, the pilgrim visits the holy places outside *Makka*—*Jabal ar-Rahmah*, *Muzdalifah*, *Mina*.

At the second stage of the ritual, the pilgrim proceeds from *Makka* to *Mina*, a few miles away; from there he goes to ‘*Arafat*, where it is essential to hear a sermon and to spend one afternoon. The last rites consist of spending the night at *Muzdalifah* (between *Arafat* and *Mina*).

The moon is in the sky in the evenings when *Muslims* move between mountains around *Makka* since the *Hajj* occurs during the first twelve days of the lunar month. Thus the second half of *Hajj* is similar to the first half in that the moon guides the pilgrim all the way.

The crescent-shaped *Hatim* Wall is visible during the circumambulation around the *Kaaba* and during the *Sa’y* straight-line circumambulation between Mount *Safa* and *Marwa*.

Thus during both the first and second week of *Hajj*, the moon guides the pilgrims around the mountains of *Makka*. This is similar to how both *Ibrahim* (*K* 006:077) and *Muhammad* were guided by the moon (*K* 053:002, 004-005, 007, 013; 081:022-023).

*Ibn Warraq* wrote about how *Muhammad* turned the second half of *Hajj* into an anti-solar rite:

The *Muslim* rites of running between *Arafat* and *Muzdalifah* and between *Muzdalifah* and *Mina*, had to be accomplished after sunset and before sunrise. This was a deliberate change introduced by *Muhammad* to suppress this association with the pagan solar rite.<sup>4214</sup>

*Zwemer* also wrote about the anti-solar aspect of the *Hajj*:

As soon as the sun was visible, the *Ifada* to *Mina* used to begin in pre-*Islamic* times. *Mohammed* therefore ordained that this should begin before sunrise; here again we have the attempt to destroy a solar rite. In ancient times they are said to have sung during the *Ifada*: *Ashrik Thabir Kaima Nughir*. The explanation of these words is uncertain; it is sometimes translated: ‘Enter into the light of morning *Thabir*, so that we may hasten.’<sup>4215</sup>

The trip between *Muzdalifah* and *Mina*, especially as revised by *Muhammad*, especially illustrates the new lunar orientation of the *Hajj*.

Many Arabs were happy to embrace moon monotheism too—not so much because they liked the idea of monotheism—but because the number two deity in the sky, the sun, was associated with the oppressive heat in Arabia. *Armstrong* wrote:

The *Hajj* itself was originally an Autumn[al] rite apparently persecuting the dying sun to bring on the winter rains.<sup>4216</sup>

<sup>4213</sup> Fani. *Sufis*, p. 53, fn.

<sup>4214</sup> Warraq. *Why*, p. 40.

<sup>4215</sup> Zwemer. *Animism*, ch. 8.

<sup>4216</sup> Armstrong. *Biography*, p. 62.

In nineteenth century American, Mark Twain said “Everybody talks about the weather but nobody does anything about it.” By contrast, in ancient Arabia, the dominant pagan religion was based on doing something about the weather! Rain clouds block out the sun and cool the sun’s heat, making rain-inducing ceremonies into anti-solar events.

Rain-inducing ceremonies of the pre-*Islamic Hajj* were pro-lunar events, as one can tell from a similar ceremony. Werner Daum wrote about how the *Ibex* hunt was meant to induce rain and Jacques Ryckmans wrote that this *Ibex* hunt rain rite is still being preformed in modern times in the *Hadramawt* in Southern Arabia.<sup>4217</sup> On a related note, Jacques Ryckmans wrote:

*Istisqa’*, a collective rogation [i.e. prayer] for rain with magical rites, in times of acute drought, is mentioned by the *Muslim* tradition and in two *Sabaeen* texts. The rite is still part of the *Islamic* ritual.<sup>4218</sup>

It seems that the main event of the *Hajj* in Pre-*Islamic* times was the ritual *Ibex* hunt. *Makka* still has a large *Haram* sacred area around it where hunting is forbidden. This is a remnant of the time when the *Ibex* were spared during the rest of the year so that hunts during pilgrimage times would be successful. In pre-*Islamic* times the pilgrimages occurred during the Spring and Fall Equinox festivals—the planting (*Umra*) and harvest (*Hajj*) festivals.

Nowadays the *Makkan* desert would not support many *Ibex*, but the Arabian Desert used to be a wetter place. The entire Mideast used to be wetter. Egypt and the plains of Jordan (not just the valleys) were well-watered (Gen 13:10). Even the *Sahara* Desert was a savanna and cave dwellers painted trees and carved giraffes.

The Arabian Desert was wetter as is evidenced by animal bones left in caves, cave drawings, and dry river beds and lakes. “Fossil” springs—dry springs that once had provided nearby towns with water for many centuries as evidenced by the ruins, *tells* and artifacts. Breton wrote that the common construction technique once used to build houses, towerhouses and temples in *Yemen* speaks of wetter times:

The walls were (curiously) made of wood...The framework of wooden beams was filled with unfired bricks and earth...This method of construction may seem a bit strange for a country that is now almost entirely deforested. It is definitely tempting to infer the existence of ancient forests from the use of wood in buildings over the millennia.<sup>4219</sup>

Breton wrote that jujube and locust trees were used in construction, but now...

A rare locust, myrrh tree or tamarisk will be found here and there, but the mature standing forests praised by ancient writers have entirely vanished. The deforestation is not limited to the areas around the cities of the lowlands; the same fate has befallen the mountains of *Yemen*...junipers [there] now grow only in rare patches...<sup>4220</sup>

Roman writers called southern Arabia “Happy Arabia” (*Felix Arabia*), a name no longer befitting the hot climate. The ancients who wrote of forests (besides the frankincense and myrrh groves) include Theophrastus of *Eresos* (372-287 BC) who said the mountains are “lofty” and “forest-covered,” and Agatharchides (flourished

<sup>4217</sup> Daum. *Ursemitische*, pp. 76-78; Ryckmans, Jacques. *EB*, “Arabian Religions,” 2004.

<sup>4218</sup> Ryckmans, Jacques. *EB*, “Arabian Religions,” 2004.

<sup>4219</sup> Breton. *Felix*, p. 82.

<sup>4220</sup> Breton. *Felix*, p. 22.



120-110 BC) who said the forests are “dense” and the timbers “grow very tall.”<sup>4221</sup> Simpson wrote about weather conditions across the Red Sea from *Mekka*:

According to Strabo, South Arabian ‘houses in the mode of binding the timbers together, are like those of Egypt.’ Although it may seem strange, excavations in the 1940s revealed that *Ptolemaic* houses in the Nile or in the *Fayum* oasis used large timber framing. Some of these dwellings are similar to [*Yemeni*] tower-houses and are sometimes depicted in the ‘*Nilotic* landscape’ mosaics from Egypt. On the western side of the Red Sea in *Tigray* it was common to use wooden posts and frames before the sixth century BC, as recorded in *Grat Be’al Gebri*, and some centuries later [Ethiopian] *Aksumite* palaces continued to require large quantities of wood for their walls.<sup>4222</sup>

*Mekka* was as fertile as the surrounding region once was, as F.E. Peters wrote:

The Arab tradition asserted that when the *Jurhum* came to *Makka*, ‘they saw a town blessed with water and trees and, delighted with it, they settled there.’ The tradition even recalls the presence of trees in the valley bottom of *Makka* in more recent times...but, given the unvarying climate of *Makka*, it is unlikely the trees were much more than scrub [i.e. a straggly, stunted tree or shrub].<sup>4223</sup>

The *Ibex* hunt explains why the sacred grounds of *Makka* are set back in some low mountains rather than in a more accessible plain. In former times when the area was wetter, the area around *Makka* would have been prime *Ibex* habitat. The *Ibex* hunt explains why the *Hajj* involves long hikes through the valley and low mountains east of *Makka*: Mounts *Marwa*, *Safa*, *Muzdalifa* and *Arafat*.

The pilgrims who went on the *Ibex* Hunt may also have gathered seeds and fruit that grew wild around *Makka*, and also gathered resin from wild frankincense and myrrh trees. The resin would have been collected for use at the *Kaaba* and part of it would have been sold to merchants and caravaners who annually attended the *Umra* and *Hajj* at *Makka*.

Also interesting is the fact that frankincense grows wild in Somalia and parts of southern Arabia, and wild “myrrh trees are apparently scattered all over South Arabia, usually in the high hills and mountains.” Frankincense trees grow wild “at elevations from 600 to 760 meters” and “myrrh trees grow wild in Arabia from about 600 to 1500 meters.”<sup>4224</sup> The *Encyclopedia Britannica* relates:

*Makka* is situated at an elevation of 909 feet (277 meters) above sea level in the dry beds of the *Wadi Ibrahim* and several of its short tributaries. It is surrounded by the *Sirat* Mountains, the peaks of which include *Jabal Ayyad*, which rises to 1,332 feet, and *Jabal Abu Qubays*, which attains 1,220 feet, to the east and *Jabal Qu’ayq’an*, which reaches 1,401 feet, to the west. *Jabal Hira’* rises to 2,080 feet on the northeast...<sup>4225</sup>

The above information helps to explain *Koran* 106 which, like several other *Suras* and stories in the *Koran*, is moon-god literature that predates *Islam*. *Koran* 106 talks about how *Allah* provided the *Kuraish* with food and caravans at the winter and summer equinoxes so they were free to worship *Allah* at the *Kaaba*.

<sup>4221</sup> Breton. *Felix*, pp. 54-55.

<sup>4222</sup> Simpson. *Sheba*, pp. 144-145.

<sup>4223</sup> Peters. *Makka*, p. 21.

<sup>4224</sup> Bowen & Albright. *Arabia*, pp. 61-62.

<sup>4225</sup> *EB*, “*Makka*” entry, accessed 4 Feb 2005.

By *Muhammad's* time of course *Makka* had dried up, the *Ibex* hunt was abandoned for lack of game animals, and the caravans passing through *Makka* were less frequent because demand for frankincense and myrrh were at historic lows. The Fertile Crescent and Mediterranean religions burned much less incense and embalmed fewer bodies.

Originally, the *Ibex* that had been hunted during *Hajj* would have been prepared and eaten during *Eid ul-Adha*. Since however not many game animals roamed near *Makka* perhaps hundreds of years before *Muhammad's* time, the *Ibex* was replaced by domesticated animals raised by ranchers with access to *Wadis*, oasis and wells: camels, cattle, sheep and goats.

*Muhammad* then heard about *Ibrahim*, Isaac and the ram caught in the thicket (Gen 22). *Muhammad* said this event occurred at *Makka* and that this was the beginning of the *Eid ul-Adha* ceremony.

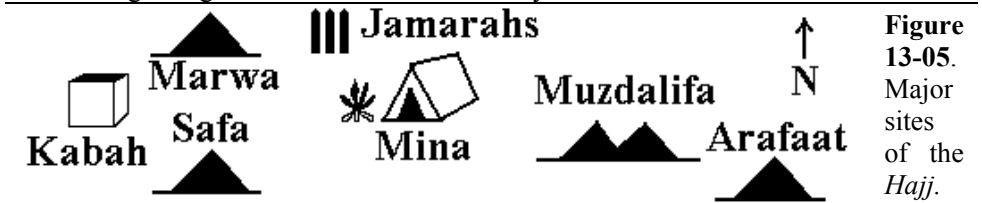


Figure 13-05. Major sites of the Hajj.

### *The Stoning of the Pillars*

While the pilgrim is encamped at *Muzdalifa* overnight, he or she is supposed to gather up chickpea-sized pebbles. Just how many pebbles is open to interpretation but the figure commonly advised is seven.<sup>4226</sup>

Some authorities suggest the pebble count should be a multiple of seven: seven, forty-nine, sixty-three or seventy. Some authorities suggest collecting extra pebbles in case one loses a few. Some authorities say that not all the pebbles need to be collected at the *Muzdalifah* site.

The pilgrim then leaves *Muzdalifa* before daybreak and travels to the plain of *Mina* to stone the three nearby *Jamara* pillars. These pillars are called the “Great Devil,” the “middle pillar” and the “first one.”<sup>4227</sup> The pillars are also collectively known as “three Satans.”

There are three pillars because, according to *Islamic* tradition, Satan tempted *Ibrahim* three times in three places. The pillars must be stoned only during the daytime. *Shaykh Al Albani* wrote:

And he [the pilgrim] does not perform this stoning until after sunrise, even the women or weak who were allowed to leave *Muzdalifah* after half the night [to avoid the pressing or stampeding crowds], as this [leaving] is one thing and the stoning is something else.<sup>4228</sup>

The stoning of the pillars likely had its own significance before it was *Islamized*. That *Muhammad* enjoined *Muslims* to stone the pillars only during the daylight however adds meaning. This shows *Muhammad's* contempt for the sun and his preference for the moon. *Zwemer* wrote:

...we know from statements in *Ibn Hisham* [died 828 or 833 AD/213 or 218 AH]...that the stone throwing only began after the sun had crossed the meridian

<sup>4226</sup> *Zwemer. Animism*, ch. 8.

<sup>4227</sup> *Zwemer. Animism*, ch. 8.

<sup>4228</sup> *Al Albani. Rites*, section “The Stoning (*Ar-Ramee*).”

[at noon hour]. Houtsma has made it probable that the stoning was originally directed at the sun demon...<sup>4229</sup>

During the stoning, the pilgrim is supposed to say prayers to *Allah*. The way this rite was reformed and brought into *Islam*, it is subtly saying that the pre-*Islamic* sun-god is really Satan. The rite also hints that *Allah* the moon-god is so powerful that even little pebbles bathed in moonlight and gathered at Mount *Muzdalifa* can dispel Satan the sun-god.

The reason that the stoning starts in the afternoon is that in the morning the moon will often be visible. At noon however the sun is so bright that the moon is never visible except during an eclipse. So the sun is most devilish at noon, and stoning the solar demon hurries it along to sunset where it falls into a muddy puddle every evening (*K* 018:086).

#### *Why the Stoning of the Pillar is the Climax of the Hajj*

The Stoning of Satan is the rite that finally releases the pilgrim from all sin so he stands to receive a reward in paradise. One pilgrim stated his understanding of the ritual:

I was throwing stones at the devil because through that we cleanse ourselves of sin.<sup>4230</sup>

The only rites after the stoning ritual are circumambulating the *Kaaba* one last time and the *Eid Al Fitr* sacrifice. *Muslims* do not consider any sacrifice to be propitiatory. The *Eid Al Fitr* sacrifice merely celebrates how *Ibrahim* nearly sacrificed Ishmael—at least according to the *Muslim* version of Gen 22.

Shortly after the Stoning of Satan ritual, the pilgrim is free to remove the *Ihram* outfit and wear normal clothing, and he or she can resume sexual relations.<sup>4231</sup> *Al Albani* wrote in his *Hajj* guide:

...after this *Tawaaf* [circumambulation of the *Kaaba* after the Day of Sacrifice] everything again becomes lawful for him that became unlawful due to *Ihraam* [holy state]—even the woman (sexual intercourse).<sup>4232</sup>

The reason the pilgrim is done with the *Hajj* shortly after the *Stoning of the Pillars* is because this rite is the main anti-Solar rite of the several anti-solar rites in the *Hajj*. Stoning Satan, whom *Muhammad* considered to be a sun-god, was the ultimate rejection of the sun-god. Using the pebble bathed in moonlight to dispel the sun demon was the ultimate affirmation of moon monotheism.

Rejection of polytheism may not sound like it ought to be the climax of the *Hajj* since monotheism comes naturally to Christians and Jews. This, unfortunately, is the nature of *Islam*, which legalizes much immorality while presenting as lofty goals things that are either immoral or trivial or both. The result is that *Muslims* have the attitude that they are morally superior to others because they hold to certain distinctive doctrines and practices of *Islam*, even though these distinctives do not impress others.

<sup>4229</sup> Zwemer. *Animism*, ch. 8.

<sup>4230</sup> “Many Pilgrims Stone ‘Devil’ Bush in Hajj Ritual,” reuters.com, 21 Jan 2005, *JW*.

<sup>4231</sup> Glassé, *Encyclopedia*, p. 445, Appendix B: “*Makka* and the *Hajj*” entry.

<sup>4232</sup> *Al Albani*. *Rites*, “The Sacrifice,” point 114.

### Overview of the Second Stage of the Hajj

The reform of the *Hajj* rite parallels the calendar reform mentioned earlier in this chapter. *Muhammad* redirected toward the moon any act that might be interpreted as solar worship. So during the second stage of the *Hajj*, pilgrims climb moonlit mountains.

While performing rituals and camping and hiking to and fro in the outskirts of *Makka*, pilgrims bask in the glory of the moon-god *Allah*. It seems appropriate to ask “What else but moon-god worship would require crowds to climb mountains at night”—exactly the time when climbing is most dangerous.

The *Hajj* ends once the moon is nearly full on day twelve. This is convenient because in pre-*Islamic* times, the moon was nearly in its glory when pilgrims made their way home from day thirteen through say, day sixteen.

During the first stage of the *Hajj*, the crescent-moon rises in the morning and sets in the evening. This is appropriate for crescent watching at the *Kaaba*. By day eight, the moon is at first quarter and provides enough light for climbing mountains and camping by moonlight in the outskirts of *Makka*.



**Figure 13-06.** The typical moon phases of the second stage of *Hajj*—days eight through twelve. The nearly full-moon signals the end of *Hajj*.

<i>Hajj</i> Day	Day 08	Day 09	Day 10	Day 11	Day 12
<b>Moon Rise</b>	13:16 PM	14:16 PM	15:17 PM	16:19 PM	17:22 PM
<b>Moon Set</b>	00:43 AM	01:22 AM	02:03 AM	02:47 AM	03:35 AM

The moon rises and sets at varying times due to the elliptical orbit of the moon. The above chart gives an idea of the moon’s rising and setting times during the second stage of the *Hajj* at *Makka*.

So here is the essence of the *Hajj*:

- ☉ Pilgrimage at the end of the month when the moon is not visible prepares one to worship *Allah* the moon-god at the *Hajj* when the moon reappears at the beginning of the lunar month.
- ☉ Participating in various lunar rites during the day, camping out in the evening to witness *Allah*’s moon symbol growing in glory from a crescent to nearly a full-moon, and by traveling between mountains and climbing mountains by moonlight.
- ☉ Traveling from the *Hajj* to go home while basking under the light of a full-moon after the *Hajj* ends. (Traveling during the daytime in Arabia during much of the year was hard due to the oppressive heat.)

### A Religious Lunar Calendar Suggests Moon-god Worship

*Muslims* have stated that *Muhammad* went to a lunar religious calendar to suppress pagan sun worship. Lunar worship however was more prevalent in the Mideast during *Muhammad*’s day than solar worship. Instituting a lunar religious calendar would be seen as promoting moon-god worship at the expense of solar-god worship, which of course was exactly the case.

If *Muhammad* had really wanted to strike a blow at the prevalent form of paganism—moon-god worship—he would have instituted a solar calendar such as the Julian. The Julian calendar had been instituted by Julius Caesar and was used until the Gregorian calendar (1582 AD) corrected it. Besides, only a solar calendar

keeps track with the seasons. A solar calendar would be in keeping with *Muhammad's* dictum that the number of months be twelve only.

Intercalation in a solar calendar only involves adding a day here and there. Note that Moses had to deal with pagan moon and solar worship too, but Moses still instituted a solilunar calendar and not a lunar calendar, which would please moon-god worshippers. This will be discussed shortly.

The difficulty of maintaining a religion and society by a lunar calendar just is not worth the effort, unless of course one's god is a moon-god. For instance, *Muslims* must verify the appearance of the crescent-moon before each lunar month can officially begin, so one reads in the newspapers:

The *Islamic* calendar follows the movements of the moon, making the beginnings of the months and holidays fluid. As of Thursday afternoon, the *Muslim* community was unsure if *Ramadan* would start Friday or Saturday. A sighting of the new crescent moon by the *Islamic Shura* Council of North America determined *Ramadan* started Friday. The last day of *Ramadan* will be decided in the same manner.<sup>4233</sup>

The same calendar scenario occurs throughout the world, even in *Israel*, despite the *Muslims* who argue that astronomical computer software ought to be used rather than naked-eye observation.<sup>4234</sup>

So a *Muslim's* schedule is tenuous until the crescent-moon makes its appearance each month. This led many *Muslims* to keep a second calendar—a seasonal calendar, as Sheila S. Blair wrote:

Foundation inscriptions, particularly on religious buildings, and chronicles [histories], are usually dated in the *Muslim* year to show the piety and official nature of the record, but commemorative texts show us that several calendars were used concurrently during medieval times, probably for agricultural activities, religious festivals and other seasonal events.<sup>4235</sup>

The fact that *Muslims* used the lunar calendar to show their piety, but otherwise used solar calendars, shows that *Islam* is a moon-god religion.

<sup>4233</sup> Trier, Maddie. "Religious revelation: Local *Muslims* gather to honor holy month," *The State News*, statenews.com, 19 Oct 2004.

<sup>4234</sup> Ettinger, Yair & Jackie Khoury. "Israeli Arab leaders disappointed by turnout at Arafat memorial," *haaretz.com*, 13 Nov 2004.

<sup>4235</sup> Blair. *Inscriptions*, p. 49.

## Chapter 14: Moon-o-theistic Prophet

### *Muhammad's Call to Prophethood according to Muslim Traditions*

At first glance, the *Koran* seems ambiguous about who appeared to *Muhammad* and issued *Muhammad* his call. The *Koran* says:

- ☛ *Allah* appeared to *Muhammad* (K 053:002-018; 081:019-024).
- ☛ *Gabriel* appeared to *Muhammad* (K 002:097-098).
- ☛ *Muhammad* received his revelation from the spirit of *Allah* (K 016:102; 026:192-194).

These facts have led scholars to conclude that there are several versions of *Muhammad's* call. Watt wrote about *Muhammad's* call to prophethood:

Unfortunately there are several alternative versions of these events.<sup>4236</sup>

*Ibn Warraq* wrote:

Though *Muslim* and sympathetic Western commentators deny it, it is clear that *Muhammad* himself thought he had seen God Himself in person, as in *Sura* 53.2-18.<sup>4237</sup>

F. E. Peters also agrees the *Koran* says *Muhammad* thought he saw *Allah* in K 053, though Peters notes that the traditions contradict this obvious conclusion:

This tradition too is exegetical, assuring the *Muslim* that the unidentified presence in *Sura* 53:5-10, which is obviously the inspiration for this story, was not God, as we have reason to suspect, but *Gabriel*, as *Muhammad* later asserted and as the entire *Muslim* tradition after him maintained.<sup>4238</sup>

Notably, there is a way to reconcile the information found in the *Koran* and in the traditional accounts. For instance, the references to the spirit of *Allah* can be explained. *Muhammad* dabbled in Jewish theology as proven by the fact that the *Koran* and the traditions mentions the *Sakina*, the Arabic translation of the Hebrew *Shekinah*. *Sakina* is translated as “tranquility” in K 002:248; 009:026, 040; 048:004, 018, 026 or as “the Spirit of Peace.”<sup>4239</sup> So surely *Muhammad* thought of the spirit of *Allah* as Jews did, either as:

- ☛ An impersonal force from *Allah*, or
- ☛ The angel *Gabriel* since after all, angels are spirits.

The seeming discrepancy about whether *Muhammad* saw *Allah* or *Gabriel* is resolved if one takes into account that *Allah* is a moon-god. For example, here is a summation of the traditional accounts of *Muhammad's* call by the *Islamic* historian Mumtaz Sadik Ali Tajddin. Several paragraphs are given here rather than just short excerpts, because the rest of this chapter will refer to this Tajddin's account often:

Always tormented by and concerned with the sinful and blasphemous pursuits of his native fellows, *Muhammad* kept pondering over the reforms of their ethnic beliefs and savage character. Even when his people were steeped in vices and immoralities of the worst type, he was straight with pure and stainless soul. His soul could not be satisfied with its milieu. Thomas Carlyle writes, ‘From of old, a thousand thoughts, in his pilgrimages and wanderings, had been in this man: What am I? What is this unfathomable thing I live in, which men name universe? What is life; what is death? What am I to believe? What am I to do? The grim

<sup>4236</sup> Watt. *Makka*, pp. 54-68.

<sup>4237</sup> Warraq. *Why*, p. 129.

<sup>4238</sup> Peters. *Origins*, p. 149.

<sup>4239</sup> Lings. *Sources*, p. 255.

rocks of Mount *Hira* [outside *Makka*], of Mount *Sinai*, the stern solitudes answered not. The great heavens rolling silent overhead, with its blue-glancing stars, answered not. There was no answer. The man's own soul, and what of God's inspiration dwelled there, had to answer, ' [*Muhammad* thought] (Carlyle, Thomas. *Heroes and Hero-Worship*, London, 1850, pp. 63-64 [online]). It was indeed the spiritual self of *Muhammad* that solved all the problems which his thinking and inquisitive soul put to him. He had prepared his soul by years of exercises, introspection and communion to give the answer.

For years after his marriage, *Muhammad* would frequently take a provision of dates and oatmeal for food and retire for days into a cave he had found at the top of a cone-shaped mountain, called *Hira*, some three miles from *Makka*. He used to spend night after night in that solitary cave far away from all the worldly turmoil. Here he eagerly pondered and contemplated in long and lonely vigils to search after One and Only God. His periods of loneliness became more frequent and his vigils lengthened. He prayed ardently, opening his whole heart to his Creator Whom his soul longed to meet. He became so fully absorbed in the ecstasy of his devotions that he would remain for days in the mountain cavern. Often his beloved wife [Khadijah] brought him food. This went on for a considerable length of time, till at last, in his fortieth year, a great unseen was revealed to him. The light of God was fully reflected in *Muhammad*. He had reached the stage of self-elevation when duality becomes nonexistent and only One remains.

The earliest sources relate that the moon on that day of the eve of *Ramadan* enraptured *Hira*. The birds were still in their nests and not a sound or movement disturbed this heavy quiet. It was as though everything was pegged to its place and nothing existed save the heavens and the earth. Tonight, a few roaming shepherds had seen *Muhammad* go there. Now there was no one else, only the sky and the earth and the crescent-moon between them [i.e. between "the earth and the sky"], rising sometimes aloft and sinking to the edge of the horizon. Stricken with panic, *Muhammad* came home from *Hira* on that morning, strangely troubled, his great eyes dilated in wonder. 'Cover me up, Khadija, cover me up!' he said in feverish agitation. After awhile, he became calmer and spoke thus 'A strange vision appeared to me in the cave of *Hira* tonight. The vision said 'I am the angel *Gabriel*, sent by God.'<sup>4240</sup>

So *Muhammad* saw *Allah* the moon-god in the sky. Tamara Green describes what *Ibrahim* saw:

The Man-in-the-Moon is seen not merely because human features can be discerned, but because the moon, more than any other of the heavenly bodies, is alive; he comes to life, he grows and then begins to disappear from the visible heavens, only to be recreated anew.<sup>4241</sup>

### **Why *Muhammad* Could See Only the Moon in the Night Sky and Why It Was Moving**

As to the supposed movements on the moon, thinking that astral objects are alive due to the interaction of atmospheric and psychological phenomena is not unknown

<sup>4240</sup> Tajddin. *Ismailis*.

<sup>4241</sup> Green. *Moon*, p. 24.

even in modern times, as James Taranto of *The Wall Street Journal Opinion Journal* wrote:

[Former President] Jimmy Carter's Love Goddess: Yesterday we noted that Jimmy Carter claimed to have seen a flying saucer in 1969. It turns out UFO [Unidentified Flying Object] skeptic Robert Sheaffer debunked Carter's claim in the July/August 1977 issue of *The Humanist*:

The incident occurred in Leary, Georgia, about forty miles from Plains, on the evening of January 6, 1969. Mr. Carter was the local district governor of the Lion's Club and had come to Leary to boost the local chapter. While standing outdoors at approximately 7:15 pm, waiting for the Lion's Club meeting to begin, Mr. Carter reported seeing a single 'self-luminous' object, 'as bright as the moon,' which reportedly approached and then receded several times. Mr. Carter reports that his 'UFO' was in the western sky, at about 30 degrees elevation. This almost perfectly matches the known position of Venus, which was in the west-southwest at an altitude of 25 degrees. Weather records show that the sky was clear at the time of the sighting.

No other object generates as many UFO reports as the planet Venus. Venus is not as bright as the moon, nor does it actually approach the viewer, or change size and brightness, but descriptions like these are typical of misidentifications of a bright planet. Every time Venus reaches its maximum brilliance in the evening sky, hundreds of 'UFO sightings' of this type are made. At the time of the Carter UFO sighting, Venus was a brilliant evening star, nearly one hundred times brighter than a first-magnitude star.

Sheaffer notes that 'Mr. Carter is in good company in misidentifying Venus as a UFO.' Indeed, 'during World War II, US aircraft tried to shoot down Venus on numerous occasions.' If only they had succeeded, the ex-Prez [short for ex-President] from Plains would have been spared some embarrassment.<sup>4242</sup>

There are many explanations as to why *Muhammad* could see the moon and no other object in the sky. Perhaps:

- ☉ The sky became hazy, a halo appeared around the moon and the light from other astral objects was diffused,
- ☉ *Muhammad* developed a case of "tunnel vision" by staring at the moon too long and too intently, or
- ☉ *Muhammad* lost his "night vision" by staring at his campfire too long.

Having seen a strange atmospheric phenomenon, his drug-influenced thinking then led *Muhammad* to think that the moon was jumping up and down on the horizon. He then hallucinated about the angel *Gabriel* choking him.

### ***Muhammad* Thought His Moon Experience to be Monotheistic**

According to Tajddin's account of the call (quoted earlier in this chapter), there was no other astral object in the sky besides the crescent-moon. This fact indicated to *Muhammad* that he had experienced a monotheistic moon-god vision.

*Muhammad* trusted the guidance of the moon, which was the abode of his god. The *Sufi* Martin Lings wrote about the *Hijri* migration, an event that occurred a few years later:

On one of their first evenings, looking [West] across the water towards the *Nubian* Desert, they saw the new-moon of the month of *Rabi'al-Awwal*. 'O

<sup>4242</sup> "Jimmy Carter's Love Goddess," OpinionJournal.com, 25 Oct 2002.



crescent of good and of guidance, my faith is in Him who created thee.’ This the Prophet would say when he saw the new [crescent] moon.<sup>4243</sup>

The crescent-moon’s “rising sometimes aloft and sinking to the edge of the horizon” signaled to *Muhammad* that *Allah* the moon-god had sent the angel *Gabriel*. *Allah*’s signaling just above the horizon meant *Muhammad* could be confident that *Gabriel* was not some demon in disguise.

That *Muhammad*’s message is valid because *Allah* signaled to him from above the horizon is reflected in the *Koran*:

I [*Allah*] swear by the star when it goes down, your companion [*Muhammad*] does not err, nor does he go astray, nor does he speak out of desire, it is naught but revelation that is revealed, The Lord of Mighty Power [*Allah*] has taught him, one vigorous; and he [*Allah*] grew clear to view, while He [*Allah*] was on the highest part of the horizon (*K* 053:001-007).

(O people!) your companion [*Muhammad*] is not one possessed. Surely, he beheld Him [*Allah*] on the clear horizon, neither doth he withhold grudgingly knowledge of the unseen, nor is this the utterance of Satan worthy to be stoned (*K* 081:022-025).

So taking all the data into consideration, one can say that *Muhammad* thought *Allah* appeared to him from the moon and also had sent *Gabriel* to *Muhammad*. This is consistent with how the angel *Gabriel* met *Muhammad* at a later time at the crescent-shaped *Hatim* Wall that borders the *Hijr* area by the *Kaaba*.

Not surprisingly, *Allah* the moon-god interacted with many people at the crescent-shaped *Hatim* Wall, as F. E. Peters wrote:

As the *Hijr* is portrayed in *Muhammad*’s day, it was a place of common assembly where political matters were discussed or people prayed, or as it appears, slept. The sleepers in the *Hijr* are generally dreamers and their dreams have a divine purport: *Abd Al Muttalib* [*Muhammad*’s grandfather] was inspired to discover the *Zamzam* [well] while sleeping there, the mother [Amina] of the Prophet had a vision of her greatness, and *Muhammad* was visited by *Gabriel* there before beginning his celebrated Night Journey—all commonplace examples of inspiration in the course of an incubation, that is, sleeping in a sacred place...Ishmael [*Ibrahim*’s son by Hagar] too the *Muslims* claimed, had been promised by God that a gate into heaven would be opened for him in the *Hijr*.<sup>4244</sup>

In respect to dreams and other functions, *Allah* was like other moon-gods. The *Encyclopedia Britannica* states:

Among the many other forms of divination known from pre-*Islamic* Arabia, only oneiromancy, or divination by means of dreams (possibly after incubation in the temple), is well attested in *Sabaeen* texts.<sup>4245</sup>

Tamara Green wrote that the moon-god *Sin* also was a giver of oracles:

The political prominence of *Haran* in the *Assyrian* period was due in large measure to its protecting deity: *Sin*, the god of the moon, giver of oracles, guardian of treaties, whose eye sees and knows all.<sup>4246</sup>

<sup>4243</sup> Lings. *Sources*, p. 120.

<sup>4244</sup> Peters. *Hajj*, pp. 15-16.

<sup>4245</sup> Ryckmans, Jacques. *EB*, “Arabian Religions,” 2004.

<sup>4246</sup> Green. *Moon*, p. 21.

### **Muhammad Was Known as a Moon-god Prophet**

At *Makka Muhammad* the moon-god prophet was associated with the moon. Ka' b b. Malik, said:

Like the full-moon that cannot lie, when he [*Muhammad*] appeared [like the full-moon], we followed him and held him true.<sup>4247</sup>

Similarly, the *Muslim* named Hassan said (as reported in poetic form):

The day that God's apostle came to them [the *Makkans*] [was] like a brilliant moon...<sup>4248</sup>

A famous *Muslim*, Ka' b b. Malik, recounted a conversation with *Muhammad*:

[*Muhammad* said] Good news to you! I said 'From you or from God?' 'From God of course' he said. When he told good news [from *Allah* the moon-god] his face used to be like the moon, and we used to recognize it.<sup>4249</sup>

At *Madina*, early in *Muhammad*'s career, *Muhammad* was known as a moon-god prophet. This fact can be ascertained from the words of *Muhammad*'s captured Jewish bride Safia, as Muir wrote:

It is related that she [Safia] bore the mark of a bruise upon her eye; when the Prophet asked her tenderly the cause, she told him [i.e. lied under duress] that while yet Kinana's [Kinana was Safia's husband whom *Muhammad* tortured and beheaded] bride, she saw in a dream as if the moon had fallen from the heavens into her lap; and that when she told Kinana [whom *Muhammad* had just tortured to death], he struck her violently, saying: 'What is the dream but that thou covetest [covet] this king of the *Hejaz* [*Hijaz*], the Prophet, for thy husband!' The mark of the blow [the bruise] was the same which Mahomet saw.<sup>4250</sup>

Here is the *Sufi* Martin Lings' version of the above account which associates the moon both with *Muhammad* and *Madina*:

Soon after her [Safia's] marriage, and not long before the Prophet arrived in front of *Khaybar*, she had had a dream. She saw a brilliant moon hanging in the sky and she knew that beneath it lay the city of *Madina*. Then the moon began to move towards *Khaybar*, where it fell into her lap. When she woke she told Kinanah what she had seen in her sleep, whereupon he struck her a blow in the face and said: 'This can only mean that thou desirest [desire] the King of the *Hijaz*, *Muhammad*.' The mark of the blow was still visible when she was brought as captive to the Prophet.<sup>4251</sup>

That Safia dreamt the moon fell into her lap is similar to this *Shiite* anti-solar rite, as related by Bess Allen Donaldson in 1937 AD:

At the vernal equinox, which is the Persian New Year, one should have a *Koran* in his lap when the sun gives the signal that 'the year has changed.' This gives him good luck for the coming year. But this blessing may be increased if he has learning, for by reading the *Sura Ya Sin*, this time, he is given the assurance that he will remain secure in his employment for the whole year.<sup>4252</sup>

<sup>4247</sup> Ishaq. *Sirat*, p. 422.

<sup>4248</sup> Ishaq. *Sirat*, p. 480.

<sup>4249</sup> Ishaq. *Sirat*, p. 613.

<sup>4250</sup> Muir. *Life*, vol. 4, pp. 70-71.

<sup>4251</sup> Lings. *Sources*, p. 268.

<sup>4252</sup> Donaldson, Bess Allen. "The *Koran* as Magic," *The Muslim World* (1937 AD), vol. 27, pp. 254-266, answering-*Islam.org*.

So while a *Shia* observes the sun, he or she holds dear the *Koran* because it is moon-god literature, especially the *YaSin* chapter, which *Muhammad* called “the heart of the *Koran*,”<sup>4253</sup> and shows that *Allah* is *Sin* the moon-god.

Incidentally, the moon and *Koran* are connected in *K* 054:001 and *K* 059:021 in that the moon was said to have split and went behind two mountains, whereas the *Koran* would split if it descended from heaven on to a mountain.

### ***Muhammad's Astral Call to Prophethood As Expressed by the Koran***

#### *Koran 053 entitled “The Star”*

001. I [*Gabriel*] swear by the star when it goes down,
002. Your companion [*Muhammad*] does not err, nor does he go astray,
003. Nor does he speak out of desire,
004. It is naught but revelation that is revealed,
005. The Lord of Mighty Power [*Allah*] has taught him,
006. One vigorous; and he [*Allah*] grew clear to view,
007. While He [*Allah*] was on the highest part of the horizon [a silhouetted mountain seen from Mount *Hira*],
008. Then He [*Muhammad*] drew near, then he [*Muhammad*] bowed,
009. So he [*Muhammad*] was the measure of two bows [arrow shots?] or nearer still [to *Allah*],
010. And He [*Allah*] revealed to His servant what He revealed,
011. The heart [of *Muhammad*] in no way falsified that which he saw,
012. What! do you [the *Makkans*] then dispute with him as to what he saw?
013. And certainly he [*Muhammad*] saw Him [*Allah*] in another descent,
014. At the farthest *Lote* [lotus] tree,
015. Near which is the garden, the place to be resorted to,
016. When that [the moon] which enshrouds [i.e. silhouettes] enshrouded [silhouetted] the *Lote* [lotus] tree,
017. [*Muhammad's*] sight never swerved, nor did it go wrong [i.e. lose focus]!
018. Certainly he saw of the greatest signs [the Moon Illusion] of his Lord.

#### *Koran 054 entitled “The Moon”*

001. The hour drew nigh and the moon did rend asunder,
002. And if they see a miracle they turn aside and say: ‘Transient magic.’

#### *Koran 081 entitled “The Rending Asunder [of the Moon]”*

022. (O people!) your companion [*Muhammad*] is not one possessed,
023. Surely he beheld Him [*Allah*] on the clear horizon,
024. Neither doth he withhold grudgingly knowledge of the unseen,
025. Nor is this the utterance of Satan worthy to be stoned.

#### *Overview*

*Allah* guided *Muhammad* and *Ibrahim* by stellar objects in the sky (*K* 002:144; 006:075, 077). *Muhammad* said that *Allah* told him:

<sup>4253</sup> Maududi. *Meaning, Ya Sin Sura* Introduction.

We [*Allah*] see the turning of thy face (for guidance) to the heavens: now shall We turn thee to a *Qibla* that shall please thee. Turn then Thy face in the direction of the sacred *Mosque* (K 002:144).

The two moon sightings mentioned in the traditions and in the *Koran* (K 053 and 081) collectively describe the two visions that constituted *Muhammad's* prophetic call. *Koran* 054 describes yet a later third moon sighting that supposedly validated *Muhammad's* prophethood to the *Makkans*.

#### *Allah's Initial Appearance* (K 053:001-012 and 081:022-025)

In the *Koranic* chapters just cited, several well-known optical illusions involving different phases of the moon occurred. The initial appearance probably involved a crescent-moon when *Muhammad* experienced a Moon Illusion and tunnel vision.

*Koran* 053:001-012 and 081:022-025 seem to be describing the same initial appearance since K 053:007 mentions the highest part of the horizon, and K 081:023 mentions a “clear horizon.” In contrast, during the second appearance called “another descent” (K 053:013), the moon is obscured by a *Lote* [lotus] tree (K 053:014)—definitely not a “clear horizon.”

The first few verses of the *Koran* were delivered during “The Night of Power” (K 044:002-004; 097:001-005) during the lunar month of *Ramadan* (K 002:185). *Bukhari's Hadith* says The Night of Power occurred on an odd night during the last week of *Ramadan*, but other *Hadith* writers say the Night of Power was on the first, seventeenth or twenty-first night of *Ramadan*.<sup>4254</sup>

So exactly what moon phase *Muhammad* saw on The Night of Power is uncertain, but a waxing or waning crescent phase is most likely. In *Tajddin* account (quoted earlier in this chapter), he mentions that there was a crescent-moon on the eve of *Ramadan*.

#### *Allah's Second Appearance* (K 053:013-018)

During the “second descent,” *Muhammad* experienced a Moon Illusion while viewing the full-moon (K 053:013-018). The *Koran* refers to this as “another descent” (K 053:013). The moon phase must have been full since the moon seemed to cover or “enshroud” a *Lote* [lotus] tree (K 053:014).

#### *Allah's Third Appearance* (K 054:001-002)

*Muhammad* experienced a lack of depth perception, or perhaps double vision (*diplopia*) of an unspecified moon phase. Unlike the other illusions that *Muhammad* saw while he was at Mount *Hira*, a crowd supposedly saw this illusion just outside of *Makka* (K 054:001-002). All these illusions are discussed in further detail next.

### **The Double Image of the Moon As Described in K 054**

*Muhammad's* only miracle described in the *Koran* is called the *Shaqq Al Qamar*, the Splitting of the Moon:

The hour drew nigh and the moon did rend asunder. And if they [non-*Muslim Makkans*] see a miracle they turn aside and say: ‘Transient magic’ (K 054:001-002).

<sup>4254</sup> Shafaat, Dr. Ahmad. “Message of *Islam* to Humankind: The Night of Power,” *Al-Ummah*, Montreal, Canada, 1987.

Tradition says the Splitting of the Moon miracle took place while *Muhammad* and some *Makkans* were at Mount *Mina* near *Makka*. The moon was said to be over Mount *Abu Qubais*, a prominence southeast of the *Kaaba*. The miracle supposedly happened five years before the *Hijra* when *Muhammad* left *Makka* for *Madina*.

Incidentally, the *Koran* seems to indicate that *Muhammad* did not perform any miracles (K 017:090-098), so some *Muslims* disregard tradition and speculate that the Splitting of the Moon verse (K 054:001) is a prophecy of an End Time event.

Whether the miracle of the Splitting of the Moon supposedly occurred in *Muhammad's* day, or will be near the End, does not matter. The fact that *Muhammad's* only miracle mentioned in the *Koran* involves the moon suggests that *Muhammad* was a prophet of the moon-god *Allah*.

*Muhammad* admitted that not all people saw the moon split when he said “If they see it...” (K 054:002). Surely, if the moon had split, medieval astronomers and writers around the world would have recorded this very ominous event. However, no record of the phenomenon exists outside the *Koran* and the traditions. The *Dabistan* (~1645 AD) records:

The *Mussulman* said: ‘From his miracles, one of which is the dividing of the moon.’ The Nazarene [Christian] observes upon this: ‘If the dividing of the moon has taken place, the inhabitants of the world must have seen it, and the recorders of extraordinary things in all countries, and the historians of all nations, would have written it down with the pen of truth. Now none, except *Mussulmans*, give any information of it.’<sup>4255</sup>

There are ways that the moon could appear to split in a localized area and these deserve examination. *Muhammad* said that those who saw the miracle were not impressed. They said it was merely “transient magic.” This suggests that *Muhammad* used hypnosis to induce a group hallucination.

*Muhammad's* biographer *Ibn Ishaq* relates that at another time *Muhammad* sprinkled dust on the heads of his *Mekkan* opponents by putting them in a trance state using hypnosis while reciting K 036:001-008, starting with “*Ya Sin*, by the Wise *Quran*.”<sup>4256</sup>

Interestingly, *Ya Sin* refers to the moon-god *Sin* which point is discussed elsewhere in this book. *Sura* 036 is entitled *Ya Sin* and the miracle of the splitting of the moon is recorded in K 054:001, which *Sura* is entitled “The Moon.”

That the *Mekkans* called the splitting of the moon “transient magic” may indicate that the miracle involved a type of ephemeral optical illusion that occurs once in a while.

Some scholars would like to say that the *Koran* never claims that the Splitting of the Moon occurred during *Muhammad's* time but would be merely a sign of the End Times. The fact that the crowd said it was “transient magic” seems to indicate that the miracle supposedly occurred during *Muhammad's* lifetime. Otherwise, why would skeptics say “Transient magic” about a prophesied End Time event?

So perhaps the *Makkans* saw the crescent-moon rising behind a distant mountain peak, with the moon partially obscured by the peak. Some of them were spooked and did not interpret the distance and visual cues properly. Their excitement and lack of depth perception would have caused them to momentarily think that the moon had

<sup>4255</sup> Fani. *Dabistan*, p. 361.

<sup>4256</sup> Wakidi (W.), 51, as reference by Margoliouth. *Rise*, p. 154 & fn. 3; also see *Ishaq. Sirat*, p. 222, where *Ishaq* says *Muhammad* said “*Ya Sin*,” and sprinkled dust.

split, especially if *Muhammad* had suggested this was the case. People are highly suggestible in certain circumstances, especially when they find a leader to be charismatic.

The *Sufi* Martin Lings wrote that there was a mountain involved in the Splitting of the Moon miracle:

On one occasion, a night of the full-moon, not long after it had risen, when it was to be seen hanging in the sky above Mount Hira, a body of disbelievers approached the Prophet and asked him to split the moon in two as a sign that he was indeed the Messenger of God...all eyes were turned toward the luminary. Great was their amazement to see it divide into two halves which drew away from each other until there was half-moon shining brightly on either side of the mountain.<sup>4257</sup>

**Figure 14-01.** “The crescent-moon behind the mountain peak” explanation of the Splitting of the Moon so-called miracle (K 054:001-002)



explanation. Here *Muhammad* is preaching at the mouth of a cave in a mountain near *Makka*. His belt holds a sword and marijuana pouch. This illustration shows the dark portion of the crescent-moon being illuminated by earthshine (earthlight). **Note:** Rotate book to view figure upright.

*Al-Bukhari* wrote in several *Hadith* about the Splitting of the Moon miracle:

The moon was split (into two pieces) while we were with the Prophet in *Mina*<sup>4258</sup>....During the lifetime of *Allah's* Apostle the moon was split into two parts; one part remained over the [*Hiram*<sup>4259</sup>] mountain and the other part went beyond the mountain. On that, *Allah's* Apostle said ‘Witness this miracle.’<sup>4260</sup>

The details about the Splitting of the Moon suggest that the *Makkans* may have seen an optical illusion—a double image of the moon. The moon phase is not specified, so a double image of a crescent-moon could be mistaken for the moon “splitting” more readily than a double image of a full-moon. In fact, a double image of a full-moon would look more like the moon had just doubled rather than was being “rent asunder.”

A double image of a crescent-moon could have been caused by: 1) Atmospheric conditions, 2) Crossing one’s eyes or 3) Double vision (*diplopia*).

### Why the *Makkans* Were Unimpressed by *Muhammad's* Moon Miracle

That the moon might temporarily appear as two moons would not seem very spectacular to the *Makkans*. The *Makkans* were desert dwellers acquainted with mirages. During the warm and hot seasons, *Makkans* daily saw shimmering, blurry images created by thermals rising off the desert roads and dunes.

<sup>4257</sup> Lings. *Sources*, p. 68.

<sup>4258</sup> *Sahih Bukhari*, vol. 5, bk. 58, no. 209.

<sup>4259</sup> *Sahih Bukhari*, vol. 5, bk. 58, no. 208.

<sup>4260</sup> *Sahih Bukhari*, vol. 6, bk. 60, no. 387.

The *Makkans* were also acquainted with other atmospheric phenomena such as rainbows, twinkling stars, halos around the moon, and sundogs and halos (aureole) circling the sun. These were considered ephemeral or “transient” magic (*K* 054:002).



**Figure 14-02.** Caricature. This is a *Mossad* (Israeli Intelligence) photograph of the Arabian war-and-moon-god *Allah*. Here “*Kung Fu*” *Allah* shows the *Hajjis* at *Makka* how he “split the moon asunder” with his two swords and then quickly superglued the moon back together before anyone but a few *Muslims* noticed. This feat is alluded to in the *Sura* named “The Moon” (*K* 054:001).

All these visual phenomena occurred but meant nothing—at least nothing that all the *Makkans* could agree on. This meant that the moon appearing as two moons probably meant nothing too. If it meant anything, it meant they had been bewitched—perhaps even by *Muhammad*:

They would only say: ‘Our eyes have been intoxicated: Nay, we have been bewitched by sorcery’ (*K* 015:015).

### Why the Moon May Have Appeared as Two Moons: An Atmospheric Phenomenon

While standing next to a body of water, a person can see a double image of the moon: one image of the moon itself and one image reflected off the water. A similar effect can be replicated in the atmosphere but the effect in the atmosphere is produced by refraction rather than reflection.

Occasionally, the moon’s light is refracted through two layers of air that have noticeably different indices of refraction due to differences in residual desert heat after sunset or other factors. This causes viewers on earth to see two moons as though the moon had split.<sup>4261</sup>



**Figure 14-03.** Illustration of the atmospheric refraction explanation of Splitting of the Moon. A crescent and full-moon as seen through two layers of air with different indices of refraction.

Refraction is usually illustrated by placing a pencil or a pole partway into water. The observer notes that below the surface of the water, the pencil or pole appears bent relative to the portion above the water.

The object appears bent because air and water have different indices of refraction. The object above water can also appear to be nearer the observer than the object under the water, depending on the viewing angle.

Two layers of air may have noticeably different indices of refraction. The cause is a difference in temperature that condenses or expands the gases. Furthermore, the atmosphere is not a consistent mix of all the elements. Since some gasses are heavier

<sup>4261</sup> Double images of the crescent-moon are discussed in: 1) Miles, Bob (with credit to D. K. Hackett). *Double Image of Crescent-Moon*, Teknowledgey Press, 1989, and in 2) Corliss, William R. *Science Frontiers*, no. 68, Mar-Apr 1990.

than others, there may be differing concentrations of gasses such as water vapor and carbon dioxide between layers of air due to gravity.

The differing concentrations may be anywhere in the atmosphere between the observer and the moon. Just as fog can form even when the skies are clear, greater concentrations of carbon dioxide settle into lower elevations when there is little wind. For instance, the Dead Sea area experiences higher concentrations of carbon dioxide, which helps irrigated crops grow faster.

### A Double-vision Phenomenon

The right eye and left eye gather in slightly different images to produce stereoscopic vision. Normally, the eyes work together and focus on one point. Usually the images forwarded to the brain are nearly identical. The “mind’s eye” combine the two similar images into one image through neural processing.

When eye muscles relax, the eyes do not aim at the same focal point. With the muscles relaxed, the images gathered in by each eye become very different. The brain cannot seamlessly converge two noticeably different images into one image, so the “mind’s eye” sees two images with an overlap.

A moon gazer merely needs to learn how to relax his eyes and he or she can see a double image of the moon. Since the background sky is black, the overlapping images are not noticeable.

One could even imagine that the crescent-moon “split.” The reader can induce this double-vision phenomenon the next time the moon is visible. Hold a finger up so it appears next to the moon. Focusing on the moon yields two images of a finger and focusing on a finger yields two images of the moon.

*Muhammad* was talented at making the mundane seem miraculous. He was able to convince others he was heaven-sent, that the *Koran* was inspired, and that his dream of heaven was really a Night Journey and Ascent. Likewise, *Muhammad* was able to convince those who saw a double image of the crescent-moon that the moon had indeed momentarily split merely by having them induce double vision. Double vision can be induced by an illusionist, or one can focus on their finger pointed at the moon.

*Muhammad* said that there were people who did not see the miracle since he said “If they see it...” (*K* 054:002). *Muhammad* was able to convince some of those who did not experience double vision that they had just missed a stupendous miracle by looking the wrong way at just the wrong time. *Muhammad* undoubtedly enlisted the help of those who saw the double image to convince those who did not see the “miracle” that it had indeed taken place.



**Figure 14-04.** The double-vision explanation of Splitting of the Moon.

These are the crescents and full-moons one would see if one experienced double vision (*diplopia*).

### The Physics of the Moon Illusions Described in *K* 053 and 081

The Moon Illusion occurs when a viewer thinks that the moon on the horizon is larger than it ought to be. In other words, the viewer expects the moon to appear smaller than it does, leading the viewer to conclude that he or she is experiencing a Moon Illusion.

That *K* 053:001-012 describes the Moon Illusion is suggested by details such as how *Allah* the moon-god was seen:

☉ On “the clear horizon” (*K* 081:023).



☉ On “the highest part of the horizon” (K 053:007).

The “highest part of the horizon” and the “clear horizon” probably refers to the hilltops around *Makka* that rise two hundred feet or more. *Makka* is situated in a valley.

The second sighting of the moon (K 053:013-018) was also at the horizon, but not a high location since the moon was said to have silhouetted or “enshrouded” a lotus tree (K 053:014, 016). Trees around the desert of *Makka* do not grow on hilltops but rather in *Wadis*.

K 053:013 talks about *Muhammad*’s second moon sighting as being “another descent.” The “another” contrasts the second sighting with the first moon sighting mentioned in K 053:001-012. So both moon sightings must have been a “descent” of sorts.

The “descent” refers to how the moon is perceived to be much closer during the Moon Illusion. Logically, this makes sense since any object that appears larger than one would expect must also be closer than one would expect—hence, the moon and moon-god must have moved closer.

That the first sighting of *Allah* involved the moon being perceived as being close is confirmed by how *Muhammad* moved toward the moon by two-arrow shots (K 053:008-009). If *Muhammad* thought the moon had stayed distant, he would not have bothered to walk toward it.

The descent at the second sighting (K 053:013-018) also involved the perception that the moon moved closer. This is confirmed by how *Muhammad* marveled at how the moon moved so close and appeared to be so bright that it silhouetted an entire lotus tree (K 053:016).

Religious frenzy and a drug- or superstition-crazed imagination came into play so that a silhouette seemed to *Muhammad* like it was enshrouding. That the moon silhouetted the tree is evident from how the landscape was illuminated from horizon to horizon, as the *Islamicist*, Martin Lings, wrote:

According to the commentary, the Divine Light descended upon the *Lote* [lotus] tree and enshrouded it and all else beside, and the eye of the Prophet beheld it without wavering and without turning aside from it. Such was the answer—or one of the answers—to the supplication implicit in his words: ‘I take refuge in the Light of Thy Countenance.’<sup>4262</sup>



**Figure 14-05.** *Muhammad* felt the moon came so close that *Allah* the moon-god was only two arrow shots away (K 053:008-009).

That K 053 describes two instances of the Moon Illusion is further indicated by how *Muhammad* was said to be staring and did not lose focus:

[*Muhammad*’s] sight never swerved, nor did it go wrong! (K 053:017).

Staring and not losing focus would induce the Moon Illusion since such a viewer would lose perspective altogether.

It is interesting that during the first sighting, *Muhammad* moved toward the moon a distance of “two bows.” The “two bows” likely means a distance of two arrow shots (K 053:008-009). That a crescent-shaped archery bow was used as a unit of distance between *Muhammad* and *Allah* may suggest that:

☉ The moon was in crescent phase as the *Muslim* traditions confirm.

<sup>4262</sup> Lings. *Sources*, p. 102.

- ⊙ *Allah* is a moon-god since a curved bow in the ancient Mideast probably was considered moon-god paraphernalia.

### Why the Moon Illusion Was Thought to be an Important Proof of Prophethood

One of *Muhammad*'s early followers, Ka'b b. Malik, said:

Like the full-moon that cannot lie, when he [*Muhammad*] appeared [like the full-moon], we followed him and held him true.<sup>4263</sup>

So for *Muhammad* to be completely trustworthy, not only would he need to communicate with the moon but he must also say he was in closer proximity to the moon than anyone else. The same reasoning led *Muhammad* to concoct the Night Journey and Ascent tale.

To get such a close look at the moon, *Muhammad* stayed in the Mount *Hira* cave as long as a month at a time. He saw *Allah* the moon-god on the "highest part of the horizon" (K 053:007). This meant over a mountain range near *Makka*. Because the moon appeared over a mountain range, there was no obscuring fog between *Allah* the moon-god and *Muhammad*. That is why the horizon is mentioned as being "clear" (K 081:023).

Because he had such a good look at the moon-god, *Muhammad* showed himself to be a moon-god **prophet** rather than just another moon-god **follower**. To add icing to the cake, *Muhammad* said that the moon-god even came closer to him, meaning he experienced the Moon Illusion (K 053:008-009, 013-018).

*Muhammad* thought that the moon seemed to enshroud a Lotus tree (K 053:016). *Muslims* believe that the Lotus tree is the same species as Moses' burning bush, and *Muslims* believe the Tree of Life in heaven is a Lotus tree. Because of these epiphanies of the moon-god, the *Koran* says *Muhammad* was as trustworthy as the moon-god (K 053:001-007; 081:015-023).

Parallel passages in the *Koran* also show that, in order to establish that he was a legitimate prophet of the moon-god *Allah*, *Muhammad* had to claim *Allah* the moon-god's guidance and endorsement. *Ibrahim* was so authoritative among *Muslims* because he was allegedly guided by the moon-god's use of the moon:

Then when he [*Ibrahim*] saw the moon rising, he said: "Is this my Lord?" So when it set, he said: "If my Lord [*Allah* the moon-god] had not guided me I should certainly be of the erring people" (K 006:077).

*Muhammad* was as trustworthy as *Ibrahim* because he was guided by the moon-god's use of the moon:

- ⊙ "Your companion [*Muhammad*] does not err, nor does he go astray...It is naught but revelation that is revealed...The Lord of Mighty Power has taught him...And he [*Allah* the moon-god] is in the highest part of the horizon...and certainly he saw him [*Allah* the moon-god] in another descent" (K 053:002, 004-005, 007, 013).
- ⊙ "Your companion [*Muhammad*] is not gone mad. Of a truth he saw him [*Allah* the moon-god] on the clear horizon" (K 081:022-023).
- ⊙ "*Ya Sin* [meaning "O moon-god *Sin*"]. By the wise *Quran*. Surely you [*Muhammad*] are among those sent on a straight path. A revelation of the Mighty, the Compassionate" (K 036:001-005).

<sup>4263</sup> Ishaq. *Sirat*, p. 422.

### The Moon Illusion Explained

The apparent size of the moon is a matter of physics and neural processing in the brain—the “mind’s eye.” Physics is a factor because the moon follows an elliptical orbit.

The moon is 356,000 KM distant at perigee and 407,000 KM at apogee. This means the distance of the moon from the earth varies by 12.5 percent. Due to the Inverse-Square law which states that the radius squared equals the area, the apparent size of the moon varies by 31 percent.<sup>4264</sup>

The variable size of the moon probably accentuates the Moon Illusion since the mind is left with conflicting memories as to the “correct” size of the moon. The mind must also factor in the different moon phases.

When the moon is at perigee (nearest), a person with decent vision can make out features such as the starburst crater and the lava seas. The moon was exceptionally clear to the naked eye back before the Industrial Age era when air pollution was low and light pollution was non-existent. When the moon is at apogee (furthest away), the moon appears featureless and chalky.

The elliptical orbit of the moon is only 29.5 days long, so if the moon appears close and detailed one night, within two weeks the moon will appear far and featureless.

The *Britannica Encyclopedia* comments on the Moon Illusion:

There is a well-known apparent difference in the size of the moon when it is at the horizon and when it is fully risen. The horizon moon, though it is actually farther away from the observer, looks much larger than it does when it is high in the sky and closer. Physicist S. Tolansky explained this phenomenon:

...we are expecting, like all other objects, that its size should diminish as it nears the horizon. This does not happen. So because it does not get smaller, as we expect, it therefore appears larger than it should be...The Moon Illusion remains a paradox since, although the retinal images (in the eye) of the high moon and the horizon moon are about the same, the perceived size differs **grossly**.<sup>4265</sup>

That the retinal image of the moon is the same can be confirmed using a simple procedure. Many people will find that a quarter held at arm’s length will exactly eclipse the moon whether the moon is on the horizon or at zenith.

One might ask “What did the *Encyclopedia Britannica* contributor mean by the word ‘grossly,’ above?” Most people think the moon along the horizon is thirty percent larger than it ought to be. Some people however think the moon along the horizon is 80 to 180 percent larger than the moon they remember and expect to see.



**Figure 14-06.** During Moon Illusions, the moon is perceived to be 80 to 180 percent larger than what viewers think it ought to be.

One might ask “Where does the under-expectation of the moon’s size on the horizon originate?” That the retinal image of the moon does not change when the moon is at zenith or on the horizon is an important clue. This means that the Moon

<sup>4264</sup> Radius A is 356,000 km and Radius B is 407,000 km, or if Radius A is 1 then Radius B is 1.14. The square of 1 is 1, and the square of 1.14 is 1.307, meaning the area of the moon at Radius B is 30.7 percent larger than at Radius A. Turning this geometric construct around mentally indicates the moon is 30.7 percent larger when it is closer (Radius A) than when it is at its farthest (Radius B).

<sup>4265</sup> EB, accessed 27 Jun 2002, Illusion entry.

Illusion probably has nothing to do with optics or *oculomotor micropsia*, a visual disorder.

The “mind’s eye” must create the Moon Illusion. One can prove this to one’s own satisfaction by taking a coin and holding it out to the moon on the horizon until one sees the moon eclipsed. Then, later that night when the moon is well off the horizon, hold out the same coin the same distance to produce the same eclipse effect. The moon is no bigger than the quarter each time.<sup>4266</sup>

The Moon Illusion apparently results from a simple error in judging depth, i.e. perceived distance. Depth perception is gained in two ways. For objects close by, the mind processes two slightly different images from each eye to create stereoscopic vision. Differences in the angle of view allow for depth perception of close objects.

The eyes however cannot gain different angles of view on distant objects. Faraway objects can only be judged by distance cues and by relying on memory of past sightings. Distance cues include how an object appears to relate to foreground and background objects.

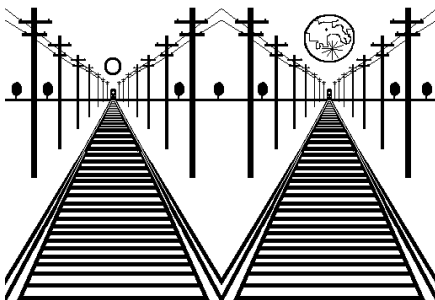
The moon at zenith has no distance cues based on foreground or background objects. Therefore, the “mind’s eye” automatically assumes the moon must be near. To the “mind’s eye,” the moon resembles a close object because close objects usually have no foreground objects.

Most of the sky has no distance cues, except for the sky near the horizon. Thus the mind operates on the assumption that the sky is a huge, oblate hemispheroid or a shallow dome. In other words, the sky above is perceived to be near, while the sky on the horizon is perceived to be far.

The mind expects that as the moon moves from the “close” zenith towards the “far” horizon, the moon will get smaller just as overhead planes and birds appear smaller as they fly toward the horizon.

The moon does not get smaller, but impresses the viewer by remaining large and dwarfing what the viewer knows are large, distant objects such as houses, trees, power line poles, railroad trains and whatnot.

**Figure 14-07.** The Moon Illusion. Just as power line poles, trees, trains and train tracks appear smaller as they near the horizon, people expect the moon to appear smaller as it nears the horizon. Instead,



the moon stays the same size and dwarfs distant objects.

Viewers expect to see the small, featureless moon shown on the left, but instead see the large moon with striking visible features shown on the right. This leads people to think the moon is either nearer or larger than normal, or both nearer and larger than normal.

### **Muhammad’s “Burning Bush”**

The Jewish influence on *Muhammad* led to *Muhammad* meeting *Allah* the moon-god when *Allah* was in a bushy Lotus tree (*K* 053:014, 016).

Emanuel Deutsch commented on why the *Koran* is full of references to Bible personages and Jewish theological constructs:

<sup>4266</sup> “Why does the moon look so big now?” news.bbc.co.uk, 24 Jun 2005.

It seems as if he [*Muhammad*] had breathed from his childhood almost the air of contemporary Judaism, such Judaism as is found by us crystallized in the *Talmud*, the *Targum* and the *Midrash*.<sup>4267</sup>

*Ibn Warraq* wrote about what other scholars have noted before:

...*Islam* emerged only when it came into contact with and under the influence of *Rabbinic Judaism*, ‘that *Islamic* doctrine generally, and even the figure of *Muhammad*, were molded on *Rabbinic Jewish* prototypes.’<sup>4268</sup>

Moses was one of *Muhammad*’s prophetic role models. Thus it is not surprising that while receiving revelation, *Muhammad* “habitually wore a veil.”<sup>4269</sup> This is a clear allusion to how Moses occasionally wore a veil until the afterglow of the glory of the Lord had passed from Moses’ face (Exo 34:33, 35; 2Co 03:13).

Naturally, *Muhammad*’s call would need to be similar to the call that his prototype Moses had received from *Yahveh*. *K* 053:001-018 seems to represent *Muhammad*’s interpretation of the “burning bush” episode of Exo 03. Moses saw a bush that was not consumed by fire on Mount *Sinai*. *Yahveh* and the Angel of *Yahveh* were in the same bush (Exo 03:02, 04).

*Muhammad* thought *Allah* was “at the farthest Lotus tree” (*K* 053:014) and *Allah* enshrouded the Lotus tree (*K* 053:016). Then the angel *Gabriel* appeared to *Muhammad*. So *Allah* the moon-god and the angel *Gabriel* appeared in the same bush similar to how *Yahveh* and the Angel of *Yahveh* appeared in the same bush (Exo 03:02, 04).

*Muslims* seem to have associated Moses with the Lotus tree species. For instance, there is more than one story mentioning Moses and a Lotus tree. *Muhammad*’s biographer, *Ibn Ishaq*, mentions an incident where *Muhammad* speaks of Moses and a Lotus tree at Mount *Sinai*:

As we were going with the apostle we saw a great *Lote* [lotus] tree and we called out to the apostle from the sides of the way, ‘Make us a tree to hang things on such as they have.’ He said ‘*Allah Akbar!* By Him who holds my life in His hand, you have said what Moses’ people said to him: ‘Make us a god even as they have gods.’ He said ‘You are an ignorant people. You would follow the customs of those who were before you.’<sup>4270</sup>

The *Sufi* Martin Lings, in his narrative history of *Muhammad*, also connects *Muhammad*, Moses and a Lotus tree:

At the *Lote* tree [lotus tree in *Muslim* heaven] the Prophet received for his people the command of fifty prayers a day; and it was then that he received the Revelation which contains the creed of *Islam*...They made their descent through the Seven Heavens even as they had ascended. The Prophet said: ‘On my return, when I passed Moses...’<sup>4271</sup>

*Muhammad* may have been convinced that *Allah* the moon-god appeared to him by a Lotus tree because Paul said that Mount *Sinai* was in Arabia (Gal 04:25). The place Paul called “Arabia” likely encompassed both the *Sinai* and Arabian peninsulas. So Mount *Sinai* is likely located in the *Sinai* Peninsula, though some argue for Arabian Peninsula locations.

<sup>4267</sup> Warraq. *Why*, p. 54.

<sup>4268</sup> Warraq. *Why*, p. 73.

<sup>4269</sup> Margoliouth. *Rise*, pp. 88-89, 104-106, as quoted in Warraq. *Why*, p. 91.

<sup>4270</sup> Ishaq. *Sirat*, pp. 568-569.

<sup>4271</sup> Lings. *Sources*, pp. 102-103.

*Muhammad* would have been helped along in his belief that *Allah* was in the bush, not only by Moses' burning bush account, but by the fact that ancient Near East astral deities had a habit of inhabiting bushes. Zwemer wrote:

The *Ashera* [Venus] or sacred poles (trees) were connected with idolatrous and orgiastic worship of the *Baalim*. Egyptologists speak of *Osiris* [moon-god] as a tree-god with tree-demons and on *Babylonian* cylinders [with astral deities, no doubt] we find pictures of sacred trees.<sup>4272</sup>

Guillaume wrote about Arabia in *Muhammad's* time:

Trees were also regarded as sacred because a deity inhabited them...<sup>4273</sup>

The *Encyclopedia Britannica* states:

The secret name of the *Lihyanite* god nicknamed *Dhu Ghabat*, 'the One of the thicket,' is unknown.<sup>4274</sup>

The *Lihyans* "were located in and around *Dedan*."<sup>4275</sup> "*Dedan*, or *Dodanim*, is the Bible's "eponym of a people apparently occupying Arabia S[outh] of Palestine."<sup>4276</sup>

Zwemer likewise wrote of how many groves with deities were reinterpreted after the advent of *Islam*:

In *Nagran* [*Najran*] a date palm served as god. A number of sacred trees or groves between *Makka* and *Madina* which formerly were idol temples, are now visited because 'Mohammed resided there, prayed there, or had his hair cut under them (see Bokhari [Bukhari]1:68-3:36).<sup>4277</sup>

An umbrageous [shady] tree in *Wadi Ul-Sirar*, not far from [the astral worship center of] *Makka*, which used to be worshiped in pre-*Islamic* ages, is adored as the one under which seventy prophets had their umbilical cords severed (*Al Muwatta* II, p. 284; *Yakut* III, p. 75). The *Abbasid Abd-ul-Samad-Ibn-Ali*, Governor of *Makka*, built a *Mosque* at this place.<sup>4278</sup>

That the "enshrouded" Lotus tree was far off suggests that *Muhammad* saw both the lotus tree and *Allah* the moon-god on the horizon. *Makka* is situated in a valley, so anywhere far off on the horizon must be on one of the tall hills surrounding *Makka*. These hills have been called "mountains," which is a slight misnomer.

Some of the hills, like *Arafat*, have springs that quench the thirst of *Hajj* pilgrims. These springs and wells must have been used to irrigate gardens and lotus trees in *Muhammad's* day.<sup>4279</sup> Apparently, this was before the gradual climate change made *Makka* into the desert-dry moonscape we see today. So it seems *Muhammad's* bush was situated on an elevated place just as Moses' bush was, and not in a low place such as in a greener *Wadi*, as it would have to be today.

Just as Moses' "burning bush" did not burn up (Exo 03:02-03), so *Muhammad's* "enshrouded" lotus tree did not burn from being silhouetted by the moon. The species and genus of Moses' burning bush was not specified in the Biblical account.

*Muhammad* may have thought that Moses' "burning bush" was an "enshrouded" lotus tree. Lotus trees are deciduous and are found in the Mediterranean and Arabian

<sup>4272</sup> Zwemer. *Animism*, ch. 11.

<sup>4273</sup> Guillaume. *Islam*, p. 9.

<sup>4274</sup> *EB*, "Arabian Religions" entry, accessed 2 Oct 2002.

<sup>4275</sup> *EB*, "Arabian Religions" entry, accessed 2 Oct 2002.

<sup>4276</sup> *CEE*, *Dedan* entry.

<sup>4277</sup> Zwemer. *Animism*, ch. 8.

<sup>4278</sup> Zwemer. *Animism*, ch. 11.

<sup>4279</sup> Wherry. *Commentary*, vol. i, section i, p. 17.

regions. They vary from the size of a shrub to a medium-sized tree and nearly always have several main branches.



**Figure 14-08.** *Muhammad's* “burning bush” was a lotus tree “enshrouded” or silhouetted by the moon (*K* 053:014-016).

Of course the *Makkan* version of a lotus tree would likely be more shrub than tree, which would strengthen the connection between Moses’ bush and *Muhammad's* so-called tree. F. E. Peters wrote:

The Arab tradition asserted that when the *Jurhum* came to *Makka*, ‘they saw a town blessed with water and trees and, delighted with it, they settled there.’

The tradition even recalls the presence of trees in the valley bottom of *Makka* in more recent times...but, given the unvarying climate of *Makka*, it is unlikely the trees were much more than scrub [i.e. a straggly, stunted tree or shrub].<sup>4280</sup>

In the “burning bush” account, Moses was tending a flock of sheep (*Exo* 03:01). The traditions say that some shepherds saw *Muhammad* on his way to the Mount *Hira* cave. *Muhammad* believed that Moses talked to an angel and saw *Yahveh* at the “burning bush” (*Exo* 03:02). Similarly, *Muhammad* saw *Allah* the moon-god at the “enshrouded” lotus tree and *Allah* sent an angel to meet *Muhammad*.

Moses went over to see *Yahveh* (*Exo* 03:03) and the *Koran* says that *Muhammad* approached *Allah* by two bowshots (*K* 053:009). Evidently, the Moon Illusion made the “enshrouded” lotus tree as mysterious to *Muhammad* as the “burning bush” was to Moses.

*Muhammad* referred to the Moon Illusion as one of *Allah's* “greatest signs” (*K* 053:018). Apparently, *Muhammad* thought that he and Moses had the same Moon Illusion experience. *Muhammad* evidently thought the reason Moses’ bush did not burn up was the “fire” was really just the moon silhouetting the “burning bush.”

Later evidence suggests the lotus tree that *Muhammad* saw at his call to prophethood was a real tree, as Zwemer wrote:

Abbe Barges tells of a lotus-tree in the garden of an Arab in *Jaffa* to which special veneration was offered. From the branches of the tree depended [hung] lamps and strips of cloth of a variety of colors. The proprietor, explaining the strange worship, said that the seed of the tree had descended from heaven. That was why it was dedicated to the Prophet who visited the tree from time to time in the shades of the night. All good *Mohammedans* show the same awe-struck respect for a holy tree.<sup>4281</sup>

Someone might ask why *Muhammad* did not step to one side or the other to see that the moon was not enshrouding a lotus tree anymore than any other object on the horizon, as the *Koran* says: *Muhammad* “drew near...his sight never swerved, nor went out of focus” (*K* 053:008, 017). One must remember that *Muhammad* was a moon-god worshipper, so naturally the Moon Illusion left him stunned. Moreover, this sight of the moon behind a lotus tree was exactly what he expected an epiphany

<sup>4280</sup> Peters. *Makka*, p. 21.

<sup>4281</sup> Zwemer. *Animism*, ch. 11.

of the moon-god would look like since *Muslims* believe there is a lotus tree in heaven. Zwemer wrote:

It [the lotus-tree of Paradise] is said to be at the extremity or on the most elevated spot in Paradise, and is believed by *Muslims* to have as many leaves as there are living human beings in the world; and the leaves are said to be inscribed with the names of all those beings; each leaf bearing the name of one person and that of his father and mother. This tree, *Muslims* believe, is shaken on the *Laylat Al Qadr* (Night of Destiny [see K 097]) a little after sunset; and when a person is destined to die in the ensuing year, the leaf upon which his name is written, falls off on this occasion; if he is to die very soon his leaf is almost wholly withered, a very small portion only remaining green; if he is to die later on in the year, a larger portion remains green; according to the time he has yet to live, so is the proportion of the part of the leaf yet green. This therefore is a very awful night to the serious and considerate *Muslims*, who, accordingly, observe it with solemnity and earnest prayer. A whole world of superstition and tradition is connected with this tree of Paradise and pictures of it are sold as amulets in *Cairo*. It is also common to find the genealogy of the Prophet *Mohammed* traced back to Adam and forward to the saints of *Islam* depicted as a sacred tree.<sup>4282</sup>

The *Sufi* Martin Lings adds:

The summit of his ascent was the *Lote* tree of the Uttermost End [lotus tree in *Muslim* heaven]. So it is named in the *Koran* and, in one of the oldest commentaries, based on the saying of the Prophet, it is said: ‘The *Lote* tree is rooted in the Throne, and it marks the end of the knowledge of every knower, be he Archangel or Prophet-Messenger. All beyond it is a hidden mystery, unknown to any save God alone. At this summit of the universe *Gabriel* appeared to him in all his archangelic splendor, even as he was first created. Then, in the words of Revelation: ‘When there enshrouded the *Lote* tree that which enshroudeth [enshrouds], the eye wavered not nor did it transgress. Verily he beheld, of all the signs of his Lord, the greatest. According to the commentary, the Divine Light descended upon the *Lote* tree and enshrouded it and all else beside, and the eye of the Prophet beheld it without wavering and without turning aside from it. Such was the answer—or one of the answers—to the supplication implicit in his words: ‘I take refuge in the Light of Thy Countenance.’<sup>4283</sup>

---

<sup>4282</sup> Zwemer. *Animism*, ch. 11.

<sup>4283</sup> Lings. *Sources*, p. 102.



## Chapter 15: Moon-o-theistic Drug

### The Real Reason *Muhammad* Thought He Was a Prophet

*Muhammad* thought that it was significant that *Gabriel* appeared while a crescent-moon jumped up and down on the horizon (K 053:001-007; 081:022-025). To a monotheistic moon-god worshipper like *Muhammad*, this proved *Gabriel* was not a demon in disguise but was sent by *Allah* the moon-god. This point was discussed in a previous chapter. Here however the following questions will be discussed:

- ☉ What **really** caused *Muhammad* to think that *Allah* the moon-god was talking to him?
- ☉ What **really** caused *Muhammad* to see an angel?
- ☉ What **really** caused the moon to jump around on the horizon that night?

*Muhammad* was a moon-god worshipper, so a Moon Illusion naturally would be more interesting to *Muhammad* than to non-moon worshippers. There were however many moon-god worshippers in the Mideast to whom Moon Illusions were a religious experience but none except *Muhammad* thought they had received a call to a prophet.

The night *Muhammad* received his call, no medieval astronomer or astrologist made a notation saying the moon had jumped around on the horizon. So it is safe to assume that nothing can fully account for the phenomenon observed during *Muhammad's* call except for disturbances in *Muhammad's* mind. It is only fair to ask "What caused these mental disturbances?"

There are many accounts that describe the symptoms *Muhammad* exhibited during his revelatory process. *Muhammad* is described as exhibiting a few symptoms already on the first night of his calling, while other symptoms are mentioned concerning his later revelatory activity. Margoliouth wrote concerning *Muhammad's* revelation experience:

The process of revelation was so suspicious that one of the scribes employed to take down the effusions became convinced that it was imposture [i.e. was faked] and discarded *Islam* in consequence.<sup>4284</sup>

Several Orientalists have read all the accounts and have concluded that *Muhammad's* career started out somewhat innocently, but as Buhl wrote:

The supposition is forced upon us that the earlier form of revelation may now have been [an] artificial means for keeping alive his reputation and that in reality he may often consciously have been guilty of pious fraud.<sup>4285</sup>

Tisdall wrote:

The *Quran* breathes the air of the desert, it enables us to hear the battle-cries of the Prophet's followers as they rushed to the onset [of battle], it reveals the working of *Muhammad's* own mind and shows the gradual declension [sinking] of his character as he passed from the earnest and sincere though visionary enthusiast into the conscious impostor and open sensualist.<sup>4286</sup>

Margoliouth wrote:

As the Prophet more and more identified himself with his part [i.e. moon-god prophet] he endeavored to live up to it. It is said that he habitually wore a

<sup>4284</sup> Margoliouth. *Rise*, pp. 88-89, 104-106, as quoted in Warraq. *Why*, p. 90.

<sup>4285</sup> *Muslim World*, vol. i, 1911, pp. 356-364, as quoted in Warraq. *Why*, p. 89.

<sup>4286</sup> St. Clair-Tisdall, William. *Sources*, Ch. 1: "Introductory."

veil and this practice may have begun at the time of these mysterious trances, of which it served to enhance the solemnity.<sup>4287</sup>

Quickly, the amateur became a seasoned professional medium who knew how to cheat. MacDonald in his *Aspects of Islam* states:

...how he [*Muhammad*] passed over at last into turpitude is a problem again for those who have made a study of how the most honest trance mediums may at any time begin to cheat.<sup>4288</sup>

Cheating could mean, among other things, faking epileptic symptoms.

Apparently, the genuine symptoms are those *Muhammad* experienced during his first vision. Some of the later symptoms appear to have been just a part of *Muhammad's* Shamanistic, ecstatic state. One must separate the real drug-induced symptoms from the faked symptoms that were just part of his prophetic act.

*Muhammad's* contemporaries were in fact able to distinguish the marijuana-induced symptoms from the faked, more bizarre symptoms. The *Sufi* Martin Lings wrote:

...there came over the Prophet a state which was comparable to that of receiving a Revelation but which left him in full possession of his faculties. He gave instructions to one of his Companions, who thereupon went through the camp proclaiming: ‘The Holy Spirit hath descended upon the Messenger and commandeth [commands] allegiance...The descent of the *Sakina* [Hebrew: *Shekinah*; translated as “tranquility” in *K* 002:248; 009:026, 040; 048:004, 018, 026], the Spirit of Peace...<sup>4289</sup>

The faked symptoms should be considered part of *Muhammad's* other chicanery such as wearing a veil while prophesying as though he were Moses (2Co 03:13). The faked symptoms should not be considered manifestations of a drug-induced brain chemical imbalance or a psychological problem. These theatrics were faked in order to enchant his followers so as to save, maintain or enhance his prophetic reputation—*Muhammad* claimed that he:

- ☉ Was spoken to by food, urine, feces, trees and stones addressed him.
- ☉ Saw an angelic army with three thousand angels at the Battle of *Badr* (*K* 003:013, 123-125).<sup>4290</sup>
- ☉ Saw a roomful of seated angels and two *Houris* (*nymph* nymphomaniacs),
- ☉ Preached to and converted *Jinn* (spirits) (*K* 046:029-035; 072:001-028).
- ☉ Fought *Jinn* in *Mosques*.
- ☉ Was bothered by an *Afreet* (also spelled *Afrit*—a powerful evil spirit or gigantic and monstrous demon in Arabian mythology).
- ☉ Saw a person's *Doppelgänger* (evil twin) (Arabic: *Qarina*).
- ☉ Practiced necromancy (talking to the dead) in cemeteries and at battlefield graves (e.g. the Well at *Badr* that *Muslims* stuff full with the *Mekkan* dead).
- ☉ Continually saw Paradise.

These are all discussed in further detail below.

<sup>4287</sup> Margoliouth. *Rise*, pp. 88-89, 104-106, as quoted in Warraq. *Why*, p. 91.

<sup>4288</sup> MacDonald. *Aspects of Islam*, quoted in Jeffery. *Quest*, p. 336, cited by Warraq. *Why*, p. 90.

<sup>4289</sup> Lings. *Sources*, p. 255.

<sup>4290</sup> Peters. *Origins*, pp. 214-215.

### Details on *Muhammad's* Theatrics

**Concerning *Muhammad's* hearing food speak, 'Abdullah reported:**

I saw the water flowing from among the fingers of *Allah's* Apostle and no doubt, we heard the meal glorifying *Allah*, when it was being eaten (by him).<sup>4291</sup>

After *Muhammad* captured *Khaybar*, a Jewish woman tried to poison him—or so the story goes. *Muhammad* said:

Hold off your hands! This shoulder [of lamb] proclaimeth unto [proclaims to] me that it is poisoned.<sup>4292</sup>

These stories remind one of children's cartoons called *Veggie Tales* (bigidea.com).

**Concerning *Muhammad* hearing trees and stones hail him, Ali Dashti wrote:**

...whenever *Muhammad* walked beyond the houses of *Makka* to relieve nature's demands...a voice saying 'Peace upon you, O Apostle of God!' rang out from every rock and tree that he passed.<sup>4293</sup>

*Muhammad* said that the Black Stone used to pay him salutations when he was a pagan.<sup>4294</sup> *Muhammad* even thought that trees told him about the supernatural *Jinn* converting to *Islam*. *K* 072 is entitled "The *Jinn*" and is about the *Jinn* converting after hearing *Muhammad* teach (*K* 046:029-032; 072:001, 005, 006). Here is a *Hadith* is about the supposed incident:

'I asked Masruq, 'Who informed the Prophet about the *Jinns* at the night when they heard the *Quran*?' He said 'Your father 'Abdullah informed me that a tree informed the Prophet about them.'<sup>4295</sup>

More ominously, *Muhammad* thought trees would incite *Muslims* to murder Jews:

The last hour would not come unless the *Muslims* will fight against the Jews and the *Muslims* would kill them until the Jews would hide themselves behind a stone or a tree and a stone or a tree would say: '*Muslim*, or the servant of *Allah*, there is a Jew behind me; come and kill him;' but the tree *Gharqad* [box-thorn or salt-bush] would not say [it], for it is the tree of the Jews.<sup>4296</sup>

Ali Dashti also notes that the *Andalusian Qadi* (*Qadi* is Arabic for "jurist") 'Iyad (1088-1149 AD) wrote in *Ketab Osh-shefa Be-ta'rif Hoquq Mostafa* that the Prophet's urine and feces spoke and stated that...

...in the opinion of certain 'olama [Arabic meaning "legal scholars"; also spelled *Ulema*, plural of *Alim*], they were nonpollutant.

...when the Prophet went out of *Makka* to relieve his bowels, the stones and trees walked up and formed a hedge around him so that he would not be seen.<sup>4297</sup>

It is interesting that the above-mentioned hallucinations occurred when *Muhammad* was "answering the call of nature," since the *Encyclopedia Britannica* states:

Occasionally drug [ab]use is accompanied by nausea and an urge to urinate or defecate.<sup>4298</sup>

<sup>4291</sup> *Sahih Bukhari*, vol. 4, bk. 56, no. 779.

<sup>4292</sup> Lings. *Sources*, p. 268.

<sup>4293</sup> Dashti. *Career*, p. 26; see also Ishaq. *Sirat*, p. 105.

<sup>4294</sup> *Sahih Muslim*, bk. 30, no. 5654.

<sup>4295</sup> *Sahih Bukhari*, vol. 5, bk. 58, no. 199.

<sup>4296</sup> *Sahih Muslim*, bk. 041, nos. 6981-6985; also see *Sahih Muslim*, bk. 041, nos. 6981-6985, as well as *Sahih Bukhari*, vol. 4, bk. 52, nos. 176-177, and *Sahih Bukhari*, vol. 4, bk. 56, no. 791.

<sup>4297</sup> Dashti. *Career*, p. 67.

<sup>4298</sup> *EB*, accessed 28 Jun 2002, "Drug use" entry.

The drug abuse would also explain why tradition has it that stones and bushes had to form a hedge to save passersby from seeing *Muhammad* disrobe and defecate (quoted above).

**Concerning** *Muhammad* seeing angels and *Houris* at a wake, Margoliouth wrote:

In an empty room he [*Muhammad*] professed to be unable to find a sitting place—all the seats being occupied by angels. He turned his face away modestly from a corpse, out of regard for the two *Houris* who had come from heaven to tend their [newfound] husband [who had just died].<sup>4299</sup>

There also is a *Hadith* where *Muhammad* and his wife Aisha meet *Gabriel*, except Aisha does not see *Gabriel*:

Narrated ‘Aisha: *Allah*’s Apostle said ‘O ‘Aisha! This is *Gabriel* sending his greetings to you.’ I said ‘Peace and *Allah*’s Mercy be on him (*Gabriel*). You see what we do not see’ (She [Aisha] was addressing *Allah*’s Apostle) (*Sahih Bukhari*, vol. 8, bk. 74, no. 266).

**Concerning** *Muhammad*’s preaching to and converting *Jinn*, Normal Geisler wrote:

In addition to angels God created other spiritual beings called *Jinn*. The *Quran* declares, ‘We created...the *Jinn* race, We had Created before, from the fire of a scorching wind’ (K 015:026-027)...it is commonly believed that they [*Jinns*] are powerful, intelligent creatures who possess freedom of choice. Therefore, some are good and some are evil (confer K [046:029-032;] 072:011). They seem to be halfway between men and angels...There are several *Quranic* passages that describe their activities—such as *Jinn* listening to the recitation of the *Quran* and being converted to *Islam* or being obedient servants to King Solomon (see *Koran* [034:012;] 046:029ff.; 072:001-002). And in later *Islamic* theology and culture they play an even more prominent role.<sup>4300</sup>

**Concerning** the conversion of *Jinn*, the *Sufi* Martin Lings wrote:

...while he was standing in prayer at *Nakhla*, a company of the *Jinn* passed by—seven *Jinn* from *Nasibin*—and they stopped spellbound by the words he was reciting from the *Koran*. The Prophet knew that he had not been sent to the world of men only. The Revelation had recently affirmed: ‘We sent thee not save as a mercy for the worlds [K 021:107]; and one of the earlier *Suras* [K 055:033] is addressed to the *Jinn* as well as to men, warning them both of hell as a punishment for evil and promising Paradise to both as a reward for piety.<sup>4301</sup>

**Concerning** *Muhammad*’s preaching to the *Jinn*, Samuel Zwemer wrote:

...the Prophet replied, ‘A caller of the *genii* came to me, so I went away with him and recited the *Koran* to them.’ He then went away with us and showed us the traces of their fires; they (the *genii*) then asked him for traveling provisions and he said (to them), ‘For you is every bone over which the name of God has been taken (at the time of slaughtering), which you may take and which will fall into your hands with the largest quantity of flesh (over it) and all the globular dung as fodder for your animals.’ The Prophet then said (to us [*Muslims*]), ‘Do

<sup>4299</sup> Margoliouth. *Rise*, pp. 88-89, 104-106, as quoted in Warraq. *Why*, p. 90.

<sup>4300</sup> Geisler & Saleeb. *Answering*, p. 36.

<sup>4301</sup> Lings. *Sources*, pp. 99-100.

not clean yourselves with them [bones and dung] for they are the food of your brethren [i.e. the *Jinn* and their animals].<sup>4302</sup>

Mustafa Fahmi explains what *Muhammad* meant by “clean yourselves”:

...at times the *Jinn* take the form of dogs and such, for dogs find pleasure in eating bones. So the Apostle of *Allah*—upon whom be *Allah*’s blessing and peace—forbade the use of bones and bits of dung when wiping oneself after natural evacuations [defecations], saying: ‘These are the food of our brethren the *Jinn*.’<sup>4303</sup>

**Concerning *Muhammad*’s fighting *Jinn* and *Afrits* in *Mosques*,** Samuel Zwemer wrote:

There are many traditions concerning *Mohammed*’s struggle with *Afrits* [giant spirits] and *Jinn* in a *Mosque*. The most interesting one is given in *Muslim* (vol. i, p. 204): ‘Said the Apostle of God (on him be prayers and peace): ‘A certain demon of the *Jinn* attacked me yesterday in order to stop my prayers, but, verily, God gave me victory over him. I was about to tie him to the side of a pillar of the pillars of the *Mosque* so that ye might get up in the morning and behold him, all of you, when I remembered the prayer of my brother Solomon: ‘O Lord, forgive me and give me a dominion such as no one ever had,’ and after that God set the demon free!’<sup>4304</sup>

Actually, Solomon prayed for uncommon wisdom, not for a great kingdom, which was an unsolicited gift from *Yahveh* (2Ch 01:10-12). This shows that *Muhammad*’s spiritual role models were badly warped and this explains a lot about *Muhammad* and *Islam*.

**Concerning *Muhammad* being bothered by an *Afreet*,** Samuel Zwemer wrote:

Here [*Al Razi*, vol. viii, pp. 559-564] we also learn that an *Afrit* [*Afreet*] used to tease *Mohammed*, so *Gabriel* taught him to repeat this chapter [*K* 113] at bedtime. It was also given him as a charm against the evil eye.<sup>4305</sup>

**Concerning seeing a person’s “evil twin” (*Qurana*),** Samuel Zwemer wrote:

The *Qurana* (plural of *Qarina* [a familiar spirit]) come into the world from the *Alalam ul Barzakhia* [*Hades*] at the time the child is conceived before it is born; therefore during the act of coition [*Coitus*], *Muslims* are told by their Prophet to pronounce the word ‘*Bismillah*’ [In the name of *Allah*]. This will prevent the child from being overcome by its devil and turned into an infidel or rascal. The *Qarina* exists with the fetus in the womb. When the child is born the ceremony of pronouncing the creed in its right ear and the Call to Prayer [the *Adhan*] in the left is to protect the child from its mate [its familiar ‘evil twin’ spirit]. Among the charms used against *Qurana* are portions of the *Koran* written on leaden images of fish or on leaden discs. The *Qurana* are invisible except to people who are idiots and to the prophets [like *Muhammad*, “the Last Prophet”]. These often have ‘second’ vision [i.e. “second sight” or clairvoyance].<sup>4306</sup>

<sup>4302</sup> *Sahih Muslim*, bk. 4, no. 0903; *Sunan Abu-Dawud*, bk. 1, no. 0039, as quoted in Zwemer. *Animism*, ch. 7.

<sup>4303</sup> Fahmi, Mustafa. *Asrar Al Jinn*. Cairo, 1354 AH/1935 AD, pp. 22-28, as quoted in Jeffery. *Islam*, p. 121.

<sup>4304</sup> Zwemer. *Animism*, ch. 3.

<sup>4305</sup> Zwemer. *Animism*, ch. 9, fn. 9.

<sup>4306</sup> Zwemer. *Animism*, ch. 6.

The idea of there being an “evil twin” may come from double vision (induced or not), or from autoscopy (not to be confused with otoscopy) out-of-body experiences or visions.

**Concerning Muhammad** practicing necromancy, Norman Geisler wrote:

Another characteristic often associated with occult ‘revelation’ is contact with the dead (cf. Deut. 18:09-14). Haykal relates an occasion when ‘the *Muslims* who overheard him [*Muhammad*] asked, ‘Are you calling the dead?’ and the Prophet answered, ‘They hear me no less than you do, except that they are unable to answer me.’ According to Haykal, on another occasion *Muhammad* was found ‘praying for the dead buried in that cemetery.’<sup>4307</sup>

The *Hadiths* also record *Muhammad* talking to the dead on the battlefield:

Anas b. Malik reported that *Allah’s* Messenger...let the dead bodies of the unbelievers who fought in *Badr* (lie unburied) for three days. He then came to them and sat by their side and called them and said: O *Abu Jahl b. Hisham*, O *Umayya b. Khalaf*, O *Utba b. Rab’ila*, O *Shaiba b. Rabi’a*, have you not found what your Lord had promised with you to be correct? As for me, I have found the promises of my Lord to be (perfectly) correct. Umar listened to the words of *Allah’s* Apostle...and said: *Allah’s* Messenger, how do they listen and respond to you? They are dead and their bodies have decayed. Thereupon he (the Holy Prophet) said: ‘By Him in Whose Hand is my life, what I am saying to them, even you cannot hear more distinctly than they but they lack the power to reply.’ Then he commanded that they should be buried in the well of *Badr* (*Sahih Muslim*, Bk. 40, No. 6869).

Blair and Bloom summarize the *Islamic* doctrine concerning the dead, which explains why *Muhammad* thought he could talk to the dead:

At death, after the inquisition by the angels *Munkar* and *Nakr*, all but martyrs [martyrs supposedly go to heaven right away] repose in their graves, the virtuous in a peaceful sleep [soul sleep], the wicked nightmarishly pressed by the earth around them and tortured by visions and portents of their fate. The ordinary world and the repose of the dead is brought to an end by the cataclysm of the Judgment [when many *Muslims* go to Purgatory before going to heaven]...<sup>4308</sup>

*Muhammad* believed that people were tortured in their graves even for minor infractions:

Once the Prophet went through the graveyards of *Madina* and heard the voices of two humans who were being tortured in their graves. The Prophet said ‘They are being punished, but they are not being punished because of a major sin, yet their sins are great. One of them used not to save himself from (being soiled with) the urine, and the other used to go about with calumnies (*Namima*).’ Then the Prophet asked for a green palm tree leaf and split it into two pieces and placed one piece on each grave, saying ‘I hope that their punishment may be abated as long as these pieces of the leaf are not dried.’<sup>4309</sup>

The idea that there are tens of millions of unbelievers suffering in graves all around Arabia must have been psychologically damaging to *Muslims*. This reminds one of Corporal Adolph Hitler, whose formative years were warped by his time in the open graveyards that were the “no-man’s land” battlefields of WWI.

<sup>4307</sup> Haykal. *Life*, pp. 231, 496, quoted in Geisler & Saleeb. *Answering*, pp. 155-156.

<sup>4308</sup> Blair & Bloom. *Paradise*, p. 15.

<sup>4309</sup> *Sahih Bukhari*, vol. 8, bk. 73, nos. 78+81.

**Concerning** *Muhammad's* continually seeing paradise, the *Sufi* Martin Lings wrote:

The Prophet continually spoke of Paradise and when he did so it was as a man who sees what he describes. This impression was confirmed by many other signs, as for example when he once stretched out his hand as if to take something and then drew it back. He said nothing, but some of those who were with him noticed his action and questioned him about it. 'I saw Paradise,' he said 'and I reached out for a cluster of grapes. Had I taken it, ye would have eaten of it as long as the world endureth [endures].'<sup>4310</sup>

### ***Muhammad's* Artificially Produced Symptoms**

*Ibn Warraq* wrote:

The *Muslim* sources are full of references to the "strange fits" to which the Prophet was subject, particularly at the time of the revelations he periodically received. Here is how Margoliouth describes them:

The notion...that he was subject to epilepsy finds curious confirmation in the notices recorded of his experiences during the process of revelation—the importance of which is not lessened by the probability that the symptoms were often artificially produced. The process was attended by a fit of unconsciousness, accompanied (or preceded) at times by the sound of bells in the ears [*Tinnitus*] or the belief that someone was present: by a sense of fright, such as to make the patient burst into perspiration; by the turning of the head to one side; by foaming at the mouth; by the reddening or whitening of the face; by a sense of headache.<sup>4311</sup>

Note that Margoliouth said "the process of revelation was so suspicious" and that it was probable the "symptoms were often artificially produced." These conclusions seem logical because untreated epilepsy often is debilitating or progressively becomes so. *Muhammad* likely would not have been able to carry on as he did right up to the bitter end if he had untreated epilepsy.

Real epilepsy would not be conducive to any sort of prophetic experience. During and after a real epileptic attack like the ones that supposedly affected *Muhammad's* whole body, *Muhammad* would have been exhausted. *Muhammad* likely would not have been able to produce cogent *Koranic* prophecy, either in prose or poetic form, had the epileptic seizure been real.

*Muhammad* did not compose verse, according to traditions associated with *Koran* 036:069.<sup>4312</sup> Scribes molded some of *Muhammad's* pronouncements into *Koranic* poetry, while leaving a lot of it in prose form.

<sup>4310</sup> Lings. *Sources*, p. 337.

<sup>4311</sup> Margoliouth. *Rise*, pp. 88-89, 104-106, as quoted in Warraq. *Why*, p. 89.

<sup>4312</sup> Margoliouth wrote: "*Ibn Hisham's* note in which *Sura* 36.69 is quoted rests on the absurd statement of an anonymous traditionist that *Muhammad* was so ignorant of verse that he could not recognize rhyme when he heard it, a poor compliment to the greatest Arab of all time. Here, for want of a better place, I cite *Ibn Ishaq* from *Al Zuhri* via Yunus (*Sura* 36.69): 'We have not taught him verse. That does not benefit him.' The meaning is 'What We have taught him is not verse. It is not fitting that he should bring verse from Us.' The apostle only uttered verse which had been spoken by others before him' (*Akhbaru '-l-Nahwiyin Al Basriyin*, by *Al Sarafi*, ed. F. Krenkow, Beirut, 1936, pp. 72f, as quoted in *Ishaq. Sirat*, p. 595, note 2).

*Muhammad's* epileptic symptoms likely were “artificially produced” because *Muhammad* knew the Arabs had a longstanding belief that epileptic symptoms were a sign of an otherworldly encounter, as Robert Morey wrote:

What must be remembered is that in the Arab culture of *Muhammad's* day, epileptic seizures were interpreted as a religious sign of either demonic possession or divine visitation.<sup>4313</sup>

*Muhammad* knew the Arabs were conditioned to think this way because he lived in *Makka* near the *Kaaba*. There, divination and other tomfoolery occurred on a daily basis. Tamara Green wrote that “daily miracles” were common at...

...places all over the ancient world...numerous accounts attest to the ingenious mechanical devices which allowed statues of the deities to move, talk and then disappear in clouds of steam.<sup>4314</sup>

Evidently, *Muhammad* was familiar with talking idols since he mentions that the Golden Calf that Aaron made moored (*K* 007:148; 020:088).

### ***Muhammad as a Shaman***

Drug-induced channeling likely occurred on a daily basis. The *Kaaba* undoubtedly had its *Shamans*, especially considering *Makka's* proximity to the Indian trade route that plied the coasts of the Red Sea. Also, Africa has many *Shamans*. Africa borders the narrow Red Sea on the west coast and *Makka* is forty-five miles inland from the Arabian coast of the Red Sea.

The Red Sea is only 225 miles (362 KM) wide<sup>4315</sup> and *Makka* was distant only 508 miles (818 KM) from *Aksum*, the ancient capital of *Abyssinia*. At the south end of the Red Sea, Arabia is about twenty miles from modern *Djibouti* and *Eritrea*, Africa, with an island stop in between.<sup>4316</sup> Thus African *Shamanism* was well known at *Makka*.

The *Encyclopedia Britannica* states:

It is generally agreed that *Shamanism* evolved before the development of class society in the Neolithic Period (New Stone Age) and the Bronze Age, that it was practiced among peoples living in the hunting-and-gathering stage, and that it continued to exist, somewhat altered, among peoples who had reached the animal raising and horticultural stage.

*Muhammad* learned how to easily reach an ecstatic state from the other *Shamans*. The *Encyclopedia Britannica* states:

Since ecstasy is a psychosomatic phenomenon that may be brought about at any time by persons with the ability to do so, the essence of *Shamanism* lies not in the general phenomenon but in specific notions, actions and objects connected with the ecstatic state.<sup>4317</sup>

*Muhammad's* method of reaching the state of ecstasy likely involved the use of drugs. The *Encyclopedia Britannica* states:

In mysticism, [ecstasy is] the experience of an inner vision of God or of one's relation to or union with the divine. Various methods have been used to achieve ecstasy, which is a primary goal in most forms of religious

<sup>4313</sup> Morey. *Invasion*, p. 51.

<sup>4314</sup> Green. *Moon*, p. 215.

<sup>4315</sup> CEE, “Red Sea” entry, accessed 16 Sep 2003.

<sup>4316</sup> *Perim* (Arabic: *Barim*) Island, *Yemen*, is by the SW Arabian Peninsula in the *Bab el Mandeb* strait. *Perim* is about 5 miles<sup>2</sup> (13 KM<sup>2</sup>), at 12° 39' 33N 43° 24' 56 E.

<sup>4317</sup> *EB*, accessed 12 Jul 2002, *Shamanism* entry.



mysticism...dancing (as used by the *Mawlawiyah*, or whirling dervishes, a *Muslim Sufi* sect); the use of sedatives and stimulants (as utilized in some Hellenistic mystery religions); and the use of certain drugs, such as peyote, mescaline, *Hashish*, LSD and similar products (in certain *Islamic* sects and modern experimental religious groups)...In primitive religions, ecstasy was a technique highly developed by *Shamans*, religious personages with healing and psychic-transformation powers, in their ‘soul,’ or ‘spirit,’ flights...The goal of ecstasy and its effects however are best known from the writings and activities of the mystics of the world’s great religions.<sup>4318</sup>

### **Muhammad’s Upbringing Groomed Him to be a Shamanistic Prophet**

*Muhammad* had plenty of time to learn *Shamanistic* techniques. To start with, *Muhammad*’s mother Amina was involved in the pagan occult:

*Muhammad*’s mother, Aminah, was of an excitable nature and often claimed that she was visited by spirits, or *Jinns*....She also at times claimed to have visions and religious experiences. *Muhammad*’s mother was involved in what we call today the ‘occult arts,’ and this basic orientation is thought by some scholars to have been inherited by her son.<sup>4319</sup>

Examples of Amina’s mysticism include how Amina saw a white light like a crystal ball that appeared to her during her pregnancy. In the light she could see the castles of Syria.<sup>4320</sup>

According to tradition, *Muhammad* as a child experienced events that sound like *Shamanistic* initiation rites.<sup>4321</sup> For some time *Muhammad* lived with the *Bedouin* as an orphan.

It is easy to imagine that in the medieval pagan context in and around *Makka*, there were plenty of spooky occult activities that kept the natives in a restless state. Also, one must consider the drug-induced hallucinations. For instance, *Muhammad* told his *Bedouin* guardian:

Two men in white raiment came and threw me down and opened up my belly and searched therein for I know not what.<sup>4322</sup>

*Muhammad* said that a similar *Shamanistic* surgery occurred on his Night Journey. The angel *Gabriel* slit *Muhammad*’s abdomen and removed his heart. Then an assistant brought two basins filled with “faith” and *Zamzam* water and washed *Muhammad*’s heart. After *Muhammad* was sewn up, he rode a steed named *Buraq* to Jerusalem.<sup>4323</sup>

*Muhammad* likely had daily contact with the *Kaaba* for almost fifty-two years before he left *Makka* for *Madina* in 622 AD. *Muhammad* was so involved with the *Kaaba* that a few years before becoming a prophet, he refereed (coached) the placement of the Black Stone into the corner of the *Kaaba* in 605 AD.<sup>4324</sup>

<sup>4318</sup> *EB*, accessed 12 Jul 2002, Ecstasy entry.

<sup>4319</sup> McClintock, John and James Strong. *Cyclopedia of Biblical, Theological and Ecclesiastical Literature*. Baker Book House, Grand Rapids, Michigan, USA, 1981, 6:406, as quoted in Morey. *Invasion*, p. 71.

<sup>4320</sup> Ishaq. *Sirat*, p. 72.

<sup>4321</sup> Stortroen. *Makka*, pp. 99-130, Ch. 6: “*Muhammad* the *Shaman*.”

<sup>4322</sup> Ishaq. *Sirat*, p. 72.

<sup>4323</sup> *Al Baghawi. Masabih as-Suna*. Khairiyya Edition, *Cairo*, 1900 AD/1318 AH, vol. ii, pp. 169-172, as translated in Jeffery. *Islam*, pp. 35, 40.

<sup>4324</sup> Peters. *Origins*, p. 140.

*Muhammad's* family lived in *Makka* for generations and his family life centered on the *Kaaba*. *Muhammad's* grandfather even inherited the right to provide water to pilgrims at the *Kaaba*. *Muhammad's* grandfather had custody of *Muhammad* when *Muhammad* was six to eight years old. *Ibn Ishaq* wrote:

*Hashim Ibn Manaf* [*Muhammad's* great-grandfather] died in *Gaza* in the land of Syria while traveling with merchandise, and *Abd Manaf's* son *Al Muttalib* [*Muhammad's* grandfather] assumed the right of feeding and watering the pilgrims. He was younger than *Abd Shams* and *Hashim*, but he was held in high esteem among his people, who called him *Al Fayd* on account of his liberality and high character.<sup>4325</sup>

While living at *Makka*, *Muhammad*, his grandfather *Muttalib* and *Muhammad's* mother *Amina*, all dreamt dreams while sleeping next to the crescent-shaped *Hatim* Wall:

As the *Hijr* is portrayed in *Muhammad's* day, it was a place of common assembly where political matters were discussed or people prayed or as it appears, slept....The sleepers in the *Hijr* are generally dreamers and their dreams have a divine purport: *Abd Al Muttalib* [*Muhammad's* grandfather] was inspired to discover the *Zamzam* [well] while sleeping there, the mother [*Amina*] of the Prophet had a vision of her greatness, and *Muhammad* was visited by *Gabriel* there before beginning his celebrated Night Journey—all commonplace examples of inspiration in the course of an incubation, that is, sleeping in a sacred place...*Ishmael* too the *Muslims* claimed, had been promised by God that a gate into heaven would be opened for him in the *Hijr*.<sup>4326</sup>

So at the *Kaaba* *Muhammad* learned the “trade” and the “art” well. Epileptic symptoms were likely a part of well-rehearsed, crowd-pleasing act performed at the *Kaaba* countless times. The symptoms exhibited included unconsciousness, convulsive muscle spasms, jerky head movements and foaming at the mouth.

The foam from the mouth was likely just worked-over spittle, phlegm or some preparation. Concoctions have long been used by mediums, as well as stage acts, such as tomato catsup standing in for blood.

*Muhammad's* symptoms either were faked or they were caused either by a purposeful abuse or intentional non-lethal overdose of a drug, depending on the symptom in question.

Before investigating what drug *Muhammad* used in his act, it should be mentioned that mediums in the ancient world often took drugs or inhaled fumes to induce a *Shamanistic*, ecstatic state.

The drug of choice was seen as a facilitator drug that would alter the mental state, put the person in touch with the “other side” and loosens the lips of the revelator. Additionally, the drug would often produce mysterious symptoms affecting the body that were convincing to onlookers. A case study seems appropriate here.

### Exactly What Drug Loosened the Lips of Other Revelators?

The *Encyclopedia Britannica* states:

Though the idea may be strange to most modern worshippers, drugs have played an important role in the history of religions...Modern studies of the hallucinogenic drugs have indicated that such drugs, in certain persons under

<sup>4325</sup> *Ibn Ishaq. Sirat*, pp. 58-59, as quoted in Peters. *Origins*, p. 59.

<sup>4326</sup> Peters. *Hajj*, pp. 15-16.

certain conditions, release or bring about what those persons claim to be profound mystical and transcendental experiences, involving an immediate, subjective experience of ultimate reality, or the divine, resulting from the stirring of deeply buried unconscious and largely non-rational reactions. Modern students of pharmacological cults who have participated in cultic drug ceremonies and used the drugs themselves have been astonished at the depth of such experiences.<sup>4327</sup>

Adherents and mediums in many pagan religions induce a trance, or an altered state of mind, through the use of drugs. These abnormal states of mind were thought to facilitate communication with the gods, nature or spirits. AmerIndians, for example, make dried *mescal* buttons from the Peyote cactus. Peyote produces the hallucinatory effects that are mistaken for genuine revelatory visions.

In modern times even non-religious persons use drugs for quasi-spiritual experiences that “expand the consciousness.” They attempt to break down the barrier between their conscious and subconscious mind so they can dream and think irrational thoughts while wide awake. They also seek to confuse their imagination with their memory.

In ancient Greece, the female *Pythia* mediums at the Oracle at *Delphi* breathed in natural gas fumes that still percolate through the water in the area in modern times. The *Pythia* channeled for the god *Apollo*. The Oracle at *Delphi* was active from 1400 BC to 381 AD when it was closed down by a decree of a Christian emperor.

In the following descriptions of how the Oracle at *Delphi* operated, note that an underground chamber was dug to trap and concentrate the natural gas fumes. Likely, during the halcyon days, the chamber was not needed to gain the desired trance state. Later, when the natural gas vein became weaker, a pit became necessary to trap the gasses. *National Geographic* reports:

Ancient legend suggests that the concentration of the vapors became weaker—possibly because the absence of a major earthquake failed to keep Earth’s narcotic juices flowing.<sup>4328</sup>

The *Encyclopedia Britannica* comments on the Oracle at *Delphi*:

The *Pythia* (priestess) of the Greek oracle at *Delphi* often went into an ecstatic state during which she uttered sounds revealed to her by the python (the snake, the symbol of resurrection), after drinking water from a certain spring. Her “words” were then interpreted by a priest to help a suppliant find a way to avoid calamities, especially death.<sup>4329</sup>

The *Pythia* and her consultants first bathed in the *Castalian* spring; afterward, she drank from the sacred spring *Cassotis* and then entered the temple. There she apparently descended into a basement cell, mounted a sacred tripod and chewed leaves of the laurel, *Apollo*’s sacred tree. While in her abnormal state, the *Pythia* would speak, intelligibly or otherwise. Her words however were not directly recorded by the inquirer; instead they were interpreted and written down by the priests in what was often highly ambiguous verse.<sup>4330</sup>

<sup>4327</sup> *EB*, accessed 3 Jul 2002, “Drug cult” entry.

<sup>4328</sup> Roach, John. “Delphic Oracle’s Lips May Have Been Loosened by Gas Vapors,” *National Geographic News*, news.nationalgeographic.com, 15Aug 2001.

<sup>4329</sup> *EB*, accessed 12 Jul 2002, Ecstasy entry.

<sup>4330</sup> *EB*, accessed 29 Jun 2002, Oracle entry.

That the priestesses vocalized while others took dictation reminds one of how parts of the *Koran* were reportedly given after *Muhammad* was affected by his “strange fits.” *Muhammad* spoke and others wrote down or memorized the message sent to *Muhammad* by *Allah*. *National Geographic* continues their report:

According to traditional explanations, the *Pythia* derived her prophecies in a small, enclosed chamber in the basement of the temple. De Boer said that if the *Pythia* went to the chamber once a month, as tradition says, she could have been exposed to concentrations of the narcotic gas that were strong enough to induce a trance-like state.<sup>4331</sup>

Philip Ball wrote:

The Greek writer *Plutarch*, who, in the first century AD, served as a high priest of the temple, left clear records of how the oracle worked. It was spoken by a local woman—the *Pythia*—who entered a trance inside a small chamber, called the *Adyton*. These trances occasionally deepened into delirium, even death....The newfound fault crosses the long-known *Delphi* fault, apparently right below the temple. This crossing makes the bitumen-rich limestone there more permeable to gases and groundwater. Seismic activity on the faults could have heated up these deposits, releasing light hydrocarbon gases, the researchers speculate. Indeed, water from a spring northwest of the temple contains methane, they report—and, even more intriguingly, traces of ethylene...Ethylene, a sweet-smelling gas, stimulates the central nervous system—it was once used as an anesthetic. Although fatal in large quantities, small doses produce a floating sensation and euphoria. In other words just what an oracle needs to start having visions.<sup>4332</sup>

The *Pythia* who reportedly died might have expired for the same reason that a small percentage of patients in modern hospitals never wake up after anesthetization, due to an unexpected reaction to measured dosages. Another possibility is that the adytum chamber may not have been properly vented and the gases became too concentrated.

The flow of underground gas might have increased dramatically due to seismic activity, but *Pythia* were unaware of that fact since gas detection was unknown. In more modern times caged canaries been used in coalmines to detect methane gas—canaries are more sensitive to methane than humans.

The *Pythia* might have died of asphyxiation—a lack of oxygen. Many people die of asphyxiation each year when they enter enclosed spaces such as sewers, cisterns, grain silos and mines. In these enclosed spaces, fermenting or rotting vegetation gives off methane.

Air is seventy-eight percent nitrogen and only twenty-one percent oxygen. The introduction of methane further thins the oxygen. Some people become trapped in enclosed spaces because lack of oxygen causes them to become muddleheaded or even unconscious. Even those alerted to the danger might find themselves too weak to climb the ladder or stairs to safety due to hypoxia.

The enclosed space of the *Kaaba* at *Makka* is similar to the adytum chamber at *Delphi*. The *Kaaba* is shut tight and the one door most often is closed. The *Kiswa* blanket over the *Kaaba* does go back to pre-*Islamic* times as *Zwemer* points out:

<sup>4331</sup> Roach, John. “Delphic Oracle’s Lips...” *Op. Cit.*

<sup>4332</sup> Ball, Philip. “Oracle’s secret fault found: Ancient prophesies made at Delphi may have been inspired by natural gas.” *Nature News Service, Macmillan Magazines*, nature.com, 17 Jul 2001.

The *Ka'aba* itself in its plan and structure is a heathen temple. The covering of the *Ka'aba* goes back to old heathenism. The Temple was the Bride and she received costly clothing.<sup>4333</sup>

The *Kiswa* blanket also served to keep out sunlight that would bother eyes sensitized by drug abuse and irritating smoke. The *Kiswa* blanket draped over the door of the *Kaaba* would help keep drug fumes in and sunlight out.

The *Kiswa* blanket may have been a pre-Islamic attempt to hermetically seal the *Kaaba*, as *Muhammad's* experience at the caves of Mount *Hira* and *Thawr* suggest. These cave experiences will be discussed shortly.

### Early Islam as a Pharmaceutical Cult

The *Dabistan* states that the *Parsees* (Zoroastrians) served up myrobalan and gum Arabic at some of their temples.<sup>4334</sup> What was the drug of choice at the *Kaaba*?

Some *Hindus* were familiar with *Muhammad's* teachings and history and in their considered opinion it was *bhanga*, also spelled, *bang*. David Shea and Anthony Troyer note that:

*Bhang* is an inebriating, maddening draught, made of hemp-leaves, henbane [Nightshade], opium or masloe.<sup>4335</sup>

The *Dabistan* records:

There is a class among the *Hindus* who give themselves the term of *Musulman-Sofis* [*Muslim-Sufis*] and really agree in several tenets and opinions with the *Sufis*. . . they relate that one day the Prophet was taking a pleasure-walk under the guidance of *Jabril* [the *Muslim* angel *Gabriel*] and came to a place where a great tumult was heard. *Jabril* said 'This is the threshold of pleasure; enter into the house.' The Prophet consented to go in and there he saw sitting forty persons as naked as they came from their mother and a band busy serving; but whatever service the Prophet requested them. . . to do, they did not comply, until the moment to grind *bhanga* arrived. When they had ground it, they had no cloth through which they could stain and purify it; then the prophet, having taken his turban from his hand, purified through it the juice of the *bhanga*, the color [green] of which [the *bhanga*] remained on the turban; whence the garment [heraldry] of the *Bini Hashem* [*Muhammad's* sub-tribe] is green. When the prophet rendered them this service, they were glad and said among themselves, 'Let us give to this messenger of God, who is always running to the door of the ignorant, a little of the *bhanga*, that he may obtain the secrets of the Almighty power.' So they gave the remains of the juice to the prophet. When he had drunk it he became possessed of the secrets of the Angel of Destiny, and whatever men heard from him came through the means of this bounty.<sup>4336</sup>

Another drug that may have been used is opium. Opium has the effect of creating fantasies. In fact, opium smoked in pipes was where the phrase "pipe dream" originated in the late 1800's.<sup>4337</sup> Tradition records yet another drug was used at the *Kaaba*:

<sup>4333</sup> Zwemer. *Animism*, ch. 8.

<sup>4334</sup> Fani. *Sufis*, pp. 22, 25.

<sup>4335</sup> Fani. *Sufis*, p. 278, fn.

<sup>4336</sup> Fani. *Sufis*, pp. 277-278.

<sup>4337</sup> Ammer, Christine. *The American Heritage Dictionary of Idioms*, 1997, Houghton Mifflin Company, "Pipe dream" entry.

Anas said ‘Some people of ‘*Ukl* or ‘*Uraina* tribe came to *Madina* and its climate did not suit them. So the Prophet ordered them to go to the herd of (milk) camels and to drink their milk and urine (as a medicine). So they went as directed and...became healthy...’<sup>4338</sup>

To help the ill person stomach the urine, marijuana or *Hashish* may have helped the medicine go down and stay down. That marijuana was served up at the *Kaaba* is apparent from traditions—judging from this account about how *Al Tufayl* saw light hallucinations but was still able to function. *Ibn Ishaq* relates that *Al Tufayl* saw *Muhammad* standing by the *Kaaba* and said:

O prophet of God, I am a man of authority among my people and when I go back and call them to *Islam*, pray to God to give me a sign which will help me when I preach to them.’ He [*Muhammad*] said ‘O God, give him a sign.’ So I went back to my people and when I came to the [mountain] pass which would bring me down to the settlement a light like a lamp played between my eyes and I said ‘O God, not in my face! For I fear that they will think that a dire punishment has befallen my face because I have left their religion.’ So the light moved and lighted on the top of my whip. The people began to look at that light attached to my whip like a candle while I was coming down from the pass to them.<sup>4339</sup>

The *Koran* and the traditions speak of other visual hallucinations such as:

- ☉ “They bewitched the people’s eyes” (*K* 007:116).
- ☉ The moon appeared to split into two and it was called transient magic (*K* 054:001-002).
- ☉ Pharaoh’s magicians caused their staffs to only appear as though they were crawling like snakes (*K* 020:066).
- ☉ *Muhammad* often confused his imagination with his memory, as his favorite wife ‘Aisha related:
 

Magic was worked on *Allah*’s Apostle so that he began to imagine that he had done something [i.e. have sex] although he had not (*Sahih Bukhari*, vol. 7, bk. 71, no. 661; vol. 8, bk. 75, no. 400).
- ☉ *Muhammad*’s drug-induced, out-of-body experiences such as his Night Journey to Jerusalem and his Ascent to Heaven (*K* 017).

### Marijuana at the *Kaaba*

Marijuana at the *Kaaba* would fit the drug’s historical timeline as the *Encyclopedia Britannica* states:

*Cannabis* is an ancient plant in terms of use, having been known in central Asia and China as early as 3,000 BC and in India and the Near East shortly thereafter. Its introduction to Europe and the Western Hemisphere was probably by way of Africa.<sup>4340</sup>

Duncan Campbell notes that Jews, with whom *Muhammad* had plenty of contact, used marijuana:

‘There can be little doubt about a role for *Cannabis* in Judaic religion,’ Carl Ruck, professor of classical mythology at Boston University said. Referring to the existence of *Cannabis* in anointing oils used in ceremonies, he added:

<sup>4338</sup> *Sahih Bukhari*, vol. 1, bk. 4, no. 234; also see vol. 2, bk. 24, no. 577; vol. 9, bk. 83, no. 37, etc.

<sup>4339</sup> *Ishaq. Sirat*, p. 176.

<sup>4340</sup> *EB*, accessed 4 Jul 2002, “Drug cult” entry.

‘Obviously the easy availability and long-established tradition of *Cannabis* in early Judaism...Although most modern people choose to smoke or eat pot, when its active ingredients are transferred into an oil-based carrier, it can also be absorbed through the skin.’<sup>4341</sup>

*Muhammad* may have applied marijuana or *Hashish*-laced ointment since there are records of *Muhammad* rubbing other men. A *Hashish*-laced ointment would have been more potent than an ointment laced with marijuana.

*Ibn Ishaq* records how *Muhammad* rubbed or massaged people during discussions. *Muhammad* perhaps prayed while placing his hands on the unwary in imitation of the legitimate New Testament practice (Mat 19:13; Act 06:06; 13:03; 28:08). Tradition records show how:

☉ A Muslim recounted meeting *Muhammad* at the *Kaaba*, saying “Then he [*Muhammad*] rubbed my breast [i.e. chest] and prayed that I might be steadfast.”<sup>4342</sup>

☉ *Muhammad* stroked *Abu Baker*’s father’s “chest and asked him to accept *Islam* and he did so.”<sup>4343</sup>

*Muhammad* may have practiced hypnosis at the same time he rubbed men’s chests, for *Muhammad* was said to have sprinkled dust on the heads of his *Mekkan* opponents by putting them in a trance state using hypnosis while reciting *K* 036:001-008, starting with “*Ya Sin*, by the Wise *Quran*.”<sup>4344</sup>

It is interesting to speculate that *Muhammad* may have gained converts through this marijuana-laced ointment. Significantly, *Muhammad* said that a person guided by *Allah* trembled and had a heartwarming experience (*K* 039:023). *Muhammad* of course knew that the application of the marijuana-laced ointment was “*Allah*’s guidance” in a bottle—*Allah*’s guidance in liquid form.

Those coming to the *Kaaba* may have not thought it unusual to be anointed, or to smoke various plants. During this period, priests were the pharmacists and *Shamanistic* healers and they dispensed drugs and ointments.

Worshippers at the *Kaaba* may have been drugged involuntarily just by being in a smoky room. Kate Seredy reports being drugged from leaves tossed on a brazier; and such an incident was recorded in *Sherlock Holmes*’ “Case of the Greek Interpreter.”

*Muhammad* could have easily applied an ointment in wide swaths since the pilgrims coming to the *Kaaba* would have been dressed either in a scanty *Ihram* cloth or other airy clothing, or been nude during the pre-*Islamic* period. It was not until *Muhammad*’s Farewell Pilgrimage right before his death that *Muhammad* imposed the *Ihram* dress code, as the *Sufi* Martin Lings wrote:

He was also to make it clear that no one after that year would be allowed to go round the Holy House naked and that idolaters were making the Pilgrimage for the last time.<sup>4345</sup>

One seems to read about *Muhammad* rubbing other men only when he wants to convince them of the truth of *Islam*. The chroniclers of *Muhammad*’s life perhaps would rather we not know about the other times *Muhammad* did this.

<sup>4341</sup> Campbell, Duncan. “Jesus healed using *Cannabis*,” *The Guardian*, guardian.co.uk, 6 Jan 2003.

<sup>4342</sup> Ishaq. *Sirat*, p. 158.

<sup>4343</sup> Ishaq. *Sirat*, p. 549.

<sup>4344</sup> Wakidi (W.), 51, as reference by Margoliouth. *Rise*, p. 154 & fn. 3; also see Ishaq. *Sirat*, p. 222, where Ishaq says *Muhammad* said “*Ya Sin*,” and sprinkled dust.

<sup>4345</sup> Lings. *Sources*, p. 323.

After either smoking marijuana with *Muhammad*, or after *Muhammad* applied the ointment, the person affected felt an abnormal peace come over him, saw a hallucination or dreamt psychedelic dreams. Of course this is what was supposed to happen at a pagan shrine and place of oracle like the *Kaaba*, as the *Encyclopædia Britannica* notes:

One of the most common methods was incubation, in which the inquirer slept in a holy precinct and received an answer in a dream.<sup>4346</sup>

The drug-induced psychedelic experience then convinced the person of the truth of *Islam*. *Muhammad* may have gained dozens of converts using this chemical means of persuasion. Perhaps this is what happened to *Al Tufayl* who traveled to the *Kaaba* and when he returned home he saw a light at the end of his whip.<sup>4347</sup>

Marijuana use can easily explain most of what passes for *Muhammad*'s religious experiences and that of some of his followers too:

☉ *Muhammad*'s "Night Journey" from *Makka* to Jerusalem to heaven and back. Yoav Ben-Dov wrote about a similar Hashish-induced experience:

'After consuming too much *Hashish* in Damascus, Taylor Bayard, a nineteenth-century traveler, sees himself in two places at once: in his real life surroundings but also flying over the Egyptian pyramids.'<sup>4348</sup>

☉ *Muhammad* being able to convince himself and his followers that seventy-two nymph nymphomaniac *Houris* awaited each *Jihadist* in a whorehouse heaven, for other religious leaders did the same thing using *Hashish*:

...in Marco Polo's tale of the Assassins and the Old Man of the Mountain, who conjured up a *Muslim* paradise for his disciples with the help of *Hashish*. With such imagery, it is not difficult to understand why their experiences were so different from those who smoke grass today, who have only childish pothead humor or subversive sites on the Internet to stimulate their imagination.... But a report of the Indian Hemp Drugs Commission in 1894 states that *Hashish* was given to *Hindu* soldiers to make them more fearless on the battlefield (as in the story of the *Assassins*).<sup>4349</sup>

☉ *Muhammad*'s world that was filled with *Jinn* and other spirits. Louisa May Alcott (1832–1888) wrote about Hashish in one of her stories:

*Hashish* affects different people in different ways, and during a single trip a marvelous spectacle of light and joy can suddenly become a menacing world filled with frightening creatures. As Louisa May Alcott puts it in one of her short stories ["Perilous Play" (1869)], *Hashish* produces 'a heavenly dreaminess. [One moves] as if on air. Everything is calm and lovely...' But there are also 'phantoms, frenzies and a touch of nightmare, which seems to last a thousand years.'<sup>4350</sup>

The *Encyclopedia Britannica* states that marijuana is nearly ubiquitous:

Probably the most widespread plant having psychedelic properties and used in cults is Indian hemp, *Cannabis Sativa*, which grows all over the world except

<sup>4346</sup> *EB*, accessed 29 Jun 2002, Oracle entry.

<sup>4347</sup> The account *Al Tufayl* and the light on the end of his whip is found a few pages back.

<sup>4348</sup> Ben-Dov, Yoav. "Pot Luck," *haaretz.com*, 23 May 2003, extracted from Daor, Dan (editor). *Dapei Esev: Hashish Besifrut Ha'olam, Antalogia* (translated as *Grass Files: Anthology*), Hargol Books, Israel, 2003.

<sup>4349</sup> Ben-Dov, Yoav. "Pot Luck," *Ha'aretz*, *Idem*.

<sup>4350</sup> Ben-Dov, Yoav. "Pot Luck," *Ha'aretz*, Op. Cit.



in very cold climates. It is used in religious practices in India and Africa (and probably elsewhere) and is also sometimes used illicitly in the US and Europe.<sup>4351</sup>

*Muhammad* would have had access to nearly any product grown in India and even China since the Arabs were the middlemen between the Orient and the Mediterranean and Fertile Crescent markets. The traditions even recount *Muhammad's* recommending herbal medicine from India:

I heard the Prophet saying ‘Treat with the Indian incense ([*Ud Al Hindi* aloeswood], for it has healing for seven diseases; it is to be sniffed by one having throat trouble, and to be put into one side of the mouth of one suffering from pleurisy.’ Once I went to *Allah's* Apostle with a son of mine who would not eat any food, and the boy passed urine on him whereupon he asked for some water and sprinkled it over the place of urine.<sup>4352</sup>

As early as the fifth to second century BC, marijuana use had spread to *Scythia*, as evidenced by unearthed “censers for burning hemp seeds found in the frozen tombs at *Pazyryk* in the *Altai* Mountains.”<sup>4353</sup> *Muhammad* knew of the *Zoroastrians*, and they had a psychedelic *Haoma* drink concocted with unknown ingredients. “Allusions to the twigs and branches of *Haoma*...suggest...perhaps, hemp.”<sup>4354</sup>

Of course the marijuana used at the *Kaaba* was either locally grown or came by way of India since it is known that rites celebrated at the *Kaaba* were copied from India. *Al Kindy* wrote to a *Muslim* around 830 AD:

Knowest thou not that the same is the practice of the sun-worshippers and *Brahmas* in India at the present day? They make the circuit of their idol temples, with just these ceremonies, shaved and naked, or with the dress they call *Ihrâm*. The only difference is that ye perform it once in the year at a movable season while they do it twice at certain solar conjunctions, one in the spring when the heat begins, the other in autumn when the cold sets in. Such is the origin of these idolatrous customs. Thou well knowest that the Arabs practiced them from the foundation of the *Kâaba*...Thus that which ye perform in nothing differs [i.e. differs not at all] from the idolatrous ceremonies of the sun-worshippers and idolaters of India.<sup>4355</sup>

All these facts suggest that marijuana use in the *Kaaba* at *Makka* in pre-Islamic times would be neither anachronistic, out of place, nor unexpected.

Whether *Hashish* was used in addition to marijuana is another question altogether. *Hashish* is made from the *Cannabis* plant resin and so has a higher concentration of THC than marijuana. In modern times, most *Hashish* comes from the Middle East, Nepal and other Asian countries, as well as from Latin America.<sup>4356</sup> Schultes and Hoffman wrote:

The Indian *Vadas* [or *Vedas*, written 1500 to 500 BC] sang of *Cannabis* as one of the divine nectars, able to give man anything from good health and long life to visions of the gods. The *Zend-Avesta* of 600 BC mentions an intoxicating

<sup>4351</sup> *EB*, accessed 3 Jul 2002, “Drug cult” entry.

<sup>4352</sup> *Sahih Bukhari* vol. 7, bk. 71, no. 596; also see 611, 613 and 616, and *Sahih Muslim*, bk. 26, nos. 5487 & 5488.

<sup>4353</sup> *EB*, accessed 6 Jul 2002, “Drug cult” entry.

<sup>4354</sup> *EB*, accessed 6 Jul 2002, “Drug cult” entry.

<sup>4355</sup> *Al Kindy. Apology*, pp. 92-93.

<sup>4356</sup> *EB*, accessed 4 Jul 2002, *Hashish* entry.

resin, and the *Assyrians* used *Cannabis* as incense as early as the ninth century BC<sup>4357</sup>

Before the *Islamic* ban on alcohol, there was less of a demand for *Hashish* in the Mideast. This may explain why widespread, heavy use of *Hashish* did not occur until immediately after the advent of *Islam*. During *Muhammad's* time in Arabia, well-off persons such as *Muhammad* probably had access to *Hashish* from India.

The *Arabian Nights* series has two tales about *Hashish* users. Samuel Zwemer says “The *Arabian Nights*...gives us a faithful picture of popular *Islam*.”<sup>4358</sup> The “traditional” *Hashish* tale is about two *Hashish* users, one of whom was a common fisherman.<sup>4359</sup>

The *Arabian Nights* collection purportedly was compiled during the reign of *Harun Al Rashid* (786-809 AD). By 900 to 1000 AD, *Hashish* use became pervasive in Arabia. *Hashish* was heavily used in the rest of the Mideast by 1200 AD.

Marijuana was likely smoked in the *Kaaba* and the *Kaaba* probably smelled of fragrant marijuana incense. Gibb and Kramers wrote about an act that may have been caused by marijuana-induced carelessness:

When *Muhammad* reached a man's estate, the fire of a woman incensing [perhaps with marijuana incense] the *Kaaba* is said to have caught the building and laid it waste.<sup>4360</sup>

Gibb and Kramers also noted:

According to some traditions, even the Prophet had incense [perhaps with marijuana incense] burned in the *Mosque* (Tirmidhi, I. 116; see Lamens, *Mo'awia*, p. 367, note 8).<sup>4361</sup>

Since the *Kaaba* was the “House of *Allah*” and *Allah* is a moon-god, the main ceremonies in the *Kaaba* surely occurred at night. Besides, as with many drugs, the most graphic hallucinations occur at night when people are apt to daydream and can't see reality clearly.

Pilgrims and shrine custodians would inhale the concentrated smoke in the *Kaaba*. Pilgrims may have smoked marijuana in a water pipe (a *Narghile* or *Hookah*). After reaching a trance state or at least a state of reverie, they would exit the *Kaaba*. Upon exiting the *Kaaba*, pilgrims would perhaps circumambulate the *Kaaba* to clear their eyes, breathe some fresh air and complete some crescent sightings.

If the moon were not visible in the sky, at least they could see the crescent-shaped *Hatim* Wall. Then another round of marijuana smoking would begin either in the *Kaaba* or by the *Hatim* Wall.

As the pilgrims watched clouds drift by the moon, they would inhale more marijuana fumes. Then they would drift off to sleep to await further hallucinations from *Allah* the moon-god, as F. E. Peters wrote:

As the *Hijr* is portrayed in *Muhammad's* day, it was a place of common assembly where political matters were discussed or people prayed or as it appears, slept....The sleepers in the *Hijr* are generally dreamers and their dreams

<sup>4357</sup> Schultes, Richard Evans and Albert Hoffman. *Plants of the Gods—Their Sacred, Healing and Hallucinogenic Powers*. Healing Arts Press, Vermont, 1992, Ch.: “The Nectar of Delight.”

<sup>4358</sup> Zwemer. *Animism*, ch. 1.

<sup>4359</sup> Burton. *Nights*, “The Tale of Two *Hashish*-Eaters” and “The Tale of King Omar *Bin Al Nu'uman* and his Sons *Sarrkan* and *Zau Al Makan*.”

<sup>4360</sup> Gibb & Kramers. *Encyclopedia*, p. 193, *Kab'ah* entry.

<sup>4361</sup> Gibb & Kramers. *Encyclopedia*, p. 346, *Masjid* entry.

have a divine purport: *Abd Al Muttalib* [*Muhammad's* grandfather] was inspired to discover the *Zamzam* [well] while sleeping there, the mother [*Amina*] of the Prophet had a vision of her greatness, and *Muhammad* was visited by *Gabriel* there before beginning his celebrated Night Journey—all commonplace examples of inspiration in the course of an incubation, that is, sleeping in a sacred place...*Ishmael* too the *Muslims* claimed, had been promised by God that a gate into heaven would be opened for him in the *Hijr*.<sup>4362</sup>

It is worth noting that nowadays, police would immediately suspect that any building closed up like the “House of *Allah*” was in fact a “drug house”—especially considering how hot the climate is in *Makka*. The *Kaaba* however seems not to have been the only place on the *Hajj* circuit with a drug history.

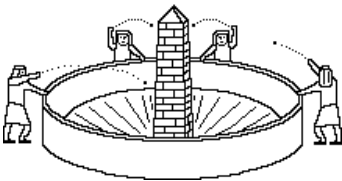
### The Stoning of Satan Ritual

Scholars have wondered what the pre-*Islamic* Stoning of Satan ceremony was all about. Not only did *Muhammad* reform and reinterpret these pagan ceremonies but the pagans themselves may have forgotten the true meaning. *Zwemer* quoted *Wensinck* as saying:

‘...the significance of the religious ceremonies had even then lost its meaning for the people.’ Nevertheless the significance of the various rites and ceremonies, although no longer understood clearly, point to a pagan origin.<sup>4363</sup>

The current version of the Stoning of Satan ritual begins while the pilgrim is encamped at *Muzdalifa*. There he or she gathers up chickpea-sized pebbles overnight.<sup>4364</sup> The pilgrim then leaves *Muzdalifa* before daybreak and hikes to the plain of *Mina* to stone the three nearby *Jamara* pillars. These pillars are commonly called the “three Satans.”

The three pillars are spaced apart to represent the three times Satan tempted *Ibrahim* in three different places. Of course the pre-*Islamic* rite had no real connection to the biblical Abraham.



**Figure 15-01.** The “Stoning of Satan” *Hajj* ritual at *Mina Hill*. Here pilgrims in scanty *Ihram* clothes throw pebbles at three pillars (*Jamara*). The funnel pit is meant to catch the millions of pebbles thrown. Because 244 people were trampled near these pillars in 2004, they were replaced with billboard-size walls with long catchment pits for the 2005 *Hajj*.

Richard Burton wrote:

Finding an opening, we approached within about five cubits of the place, and holding each stone between the thumb and forefinger of the right hand, we cast it at the pillar, exclaiming, ‘In the name of *Allah* and *Allah* is Almighty! (I do this) in Hatred of the Fiend [*Satan*] and to his Shame.’<sup>4365</sup>

*Shaykh Al Albani* wrote in his *Hajj* guide about the Stoning of Satan ritual:

Then he stones it with seven small stones, like the Stones of *Khadhf*—which are slightly longer than the chickpea. And he recites *Takbeer* while throwing

<sup>4362</sup> Peters. *Hajj*, pp. 15-16.

<sup>4363</sup> *Zwemer*. *Animism*, ch. 8.

<sup>4364</sup> *Al Albani*. *Rites*, the section on “The Stoning (*Ar-Ramee*).”

<sup>4365</sup> *Zwemer*. *Animism*, ch. 8.

each stone. And he ceases reciting *Talbiyyah* when throwing the last stone....So when he has stoned the *Jamrah* everything becomes lawful for him again except women, even if he has not sacrificed or shaved his head—so he may wear his clothes and use perfume. However, he should perform *Tawaaf-ul-Ifaada* on the same day (before *Maghrib*) if he wishes to continue in his state of having left *iHraam* [or *Ihram*]<sup>4366</sup>—otherwise, if he has not made *Tawaaf* before the evening (before *Maghrib*) then he returns to the state of *iHraam* as he was before the stoning—so he should remove his clothes and put on *iHraam* according to the Prophet’s saying: ‘Verily on this day has been allowed for you, when you have stoned the *Jamrah*, that was prohibited for you except women (sexual intercourse). Verily on this day everything that you were prohibited from (by *iHraam*) has been allowed for you, when you have stoned the *Jamrah*, except the women (sexual intercourse)—so if evening comes upon you before you have made *Tawaaf* of this House then you revert to the state of *iHraam* as you were before stoning the *Jamrah*—until you make the *Tawaaf*.’<sup>4366</sup>

Notice that the Stoning of Satan ritual mostly releases the pilgrim from the sacred state of *Ihram* that was entered into at the start of *Hajj*. This is the case even though the *Hajj* is not quite over. *Muhammad* said about the *Hajj*:

And the prophet said: ‘He who performs *Hajj* and does not speak obscenely or commit evil then he returns from his sins just as the day his mother gave birth to him, and if he did so then his *Hajj* would be accepted...The accepted *Hajj*—there is no less a reward for it than Paradise.’<sup>4367</sup>

One pilgrim stated his understanding of the ritual:

I was throwing stones at the devil because through that we cleanse ourselves of sin.<sup>4368</sup>

Malise Ruthven wrote:

Here [at *Muzdalifa*] two evening prayers, the *Maghrib* and ‘*isha*, are performed together: the pilgrims, now cleansed of sin, are expected to purge themselves of all resentments against others. The narrowness of the passage makes it densely crowded. At *Muzdalifa*—’the place where one makes oneself agreeable’—the pilgrims collect the small pebbles, 49 in all, to be used in the most complicated and arcane of the *Hajj* ceremonies, the ritual stoning of the three pillars, or *Jamarat*, at *Mina*.<sup>4369</sup>

### ***Minarets and the Three Jamara Pillars are Asherah Poles***

What the pre-*Islamic* ceremony of Stoning the Devil will be discussed shortly. What *Muhammad* came to think of the ceremony can be ascertained from several similar traditions of which Samuel Zwemer provides an example:

A curious tradition is given by *Abu Dawud* on the authority of *Ibn Abbas* who said ‘I think the Apostle of God said ‘If one of you prays without a *Sutra* (a thing set up by a praying person) before him, his prayer is apt to be annulled by a dog or an ass or a pig or a Jew or a *Magi* or a menstruating woman; if they pass

<sup>4366</sup> *Al Albani. Rites*, in the section “The Stoning (*Ar-Ramee*).”

<sup>4367</sup> “That an accepted *Hajj* is rewarded by paradise is reported by Bukharae, Ahmad, An-nasaaiie & *Ibn Maajah* from *Abu Hurairah*. See ‘*Silsilat-ul-Ahadeeth-us-Saheehah*’ (no. 1200) and ‘*Al Irwaa*’ (no. 769)” (*Al Albani. Rites*, in the section “Advice for those about to perform *Hajj*”).

<sup>4368</sup> “Many Pilgrims Stone ‘Devil’ Bush in *Hajj* Ritual,” reuters.com, 21 Jan 2005, *JW*.

<sup>4369</sup> Ruthven. *World*, p. 22.

before him [a *Muslim* praying] they ought to be punished on that account; with the pelting of stones.’<sup>4370</sup>

Another *Hadith* says *Muhammad* said:

When any one of you prays he should not let anyone pass in front of him (if there is no *Sutra*), and should try to turn him away as far as possible, but if he refuses to go, he should turn him away forcibly for he is a devil.<sup>4371</sup>

Before, during and after the stoning ceremony, the pilgrim is supposed to pray.

*Al Albani* says that the pilgrim...

...recites *Takbeer* while throwing each stone...and he ceases reciting *Talbiyyah* when throwing the last stone.<sup>4372</sup>

The Three *Jamara* Pillars, like *Muhammad's Sutra*, are three phallic symbols—large *Asherah* poles. The idea behind the stoning ceremony is that the continual pelting of the pillars drives away any devils or *Jinn* who might block the prayer from reaching the pillar.

Apparently, it was thought if the pilgrims' prayers reached the pillar, it would reach heaven without fail. Zwemer wrote that at *Mina* “during the devil-stoning” ceremony is one of the fifteen places, “all of them connected...with the old idolatry of Arabia,” where prayer was granted.<sup>4373</sup>

Tradition indicates that *Ibrahim* pelted a demon with stones until the demon fled. So the continual barrage of stones at the Three *Jamara* pillars means no demon can possibly intercept the pilgrims' prayers, as Zwemer wrote:

Houtsma has made it probable that the stoning was originally directed at the sun demon...<sup>4374</sup>

The fact that *Muhammad* considered the demon who was pelted during the Stoning of Satan ceremony was a sun-god is discussed in a previous chapter. Also discussed at the same spot is how the several pebbles that pilgrims threw came to have power to dispel the sun demon from the Venus *Asherah* poles (the Three *Jamara* pillars). The pebbles had been bathed in moonlight the night before and moonlight dispels the sun demon.

*Minarets*, like *Muhammad's Sutra* pole and the three *Jamaras*, are giant *Asherah* poles. *Mosques* are often walled enclosures with four *Minaret* towers. The *Minarets* and walls constitute a step up from *Asherah* poles. The *Minaret* and walls doubly assure *Muslims* that no non-*Muslim* can come between *Muslims* and *Allah* and thus block a *Muslim's* prayer.

*Muslims* like to say that the *Minaret* came from towers on the corners of the temple square in Damascus, but these pre-*Islamic* towers probably served the same purpose as *Minarets*—they were *Asherah* poles! Thus *Minarets* are just one more piece of pre-*Islamic* paganism to which *Muslims* adhere.

### The Pre-Islamic Origin of the Three *Jamaras* Ceremony

In *Islamic* times, the Stoning of Satan ritual seems to be the real endpoint and goal of the *Haji*. This fact provides a clue as to the pre-*Islamic* origin and purpose of the ritual. The *Encyclopedia Britannica* states:

<sup>4370</sup> Zwemer. *Animism*, ch. 3 + fn 15: “Ad-Damiri’s *Hayat Al-Hayawan*, 3, v. i, p. 708.”

<sup>4371</sup> *Sahih Muslim*, bk. 4, no. 1023.

<sup>4372</sup> *Al Albani. Rites*, in the section “The Stoning (*Ar-Ramee*).”

<sup>4373</sup> Zwemer. *Animism*, ch. 8.

<sup>4374</sup> Zwemer. *Animism*, ch. 8.

Along with the sacramental function of the drug cults is the concept of purification through drug [ab]use. This may take the form of certain ritualistic preparations for the ceremony or the observing of certain taboos for days before it, or may be a part of the ceremony itself. Many psychedelic drugs produce nausea and the consequent vomiting may be looked on as a purging of faults. In more advanced cults the purification may be seen as the pure and ethical living that should both precede and follow the ceremony.<sup>4375</sup>

The Stoning of Satan shows all hallmarks of once having been a purgative purification rite that incorporated the use of drugs:

- ☉ The *Hajj* events constitute the “ritualistic preparations for the ceremony.”<sup>4376</sup>
- ☉ The *Ihram* state is “the observing of certain taboos for days before it [the purification event].”<sup>4377</sup>
- ☉ The release from most of the *Ihram* state, the canceling out of sins and the promised reward of heaven show that the Stoning of Satan ritual purifies and purges the participant of sin.
- ☉ The chickpea-sized pebbles likely represent the nauseating drug taken in pre-*Islamic* days.
- ☉ Gathering the pebbles before leaving *Muzdalifa* reflects the time it would take for the nauseating drug to work. If a pilgrim took the right dosage at *Muzdalifa*, he or she would be nauseated by the time he or she reached the plain of *Mina*.
- ☉ That the participant “recites *Takbeer* while throwing each stone...and he ceases reciting *Talbiyyah* when throwing the last stone”<sup>4378</sup> suggests that the pre-*Islamic* ritual involved hurling something out of the pilgrim’s mouth.
- ☉ The pebble thrown at the pillar represents the projectile vomit that once helped to rid oneself of sin in pre-*Islamic* days in a purgative ritual. The pillars were installed so:
  - ★ Everyone hurled vomit at a central point and not accidentally at each other.
  - ★ Everyone need not watch his step.<sup>4379</sup>

<sup>4375</sup> *EB*, accessed 3 Jul 2002, “Drug cult” entry.

<sup>4376</sup> *EB*, accessed 3 Jul 2002, “Drug cult” entry.

<sup>4377</sup> *EB*, accessed 3 Jul 2002, “Drug cult” entry.

<sup>4378</sup> *Al Albani. Rites*, in the section “The Stoning (*Ar-Ramee*).”

<sup>4379</sup> Many were mystified as to why the World Trade Towers held so much attraction for *Muslims* since many Americans never heard of the skyscrapers before *Muslims* bombed them in 1993, and then hurled planes into both towers in a suicidal attack on September 11<sup>th</sup>, 2001.

The “Stoning of Satan” rite may go a long way to psychologically explain the target selection. *Muslims* hurl projectiles at three pillars (now replaced with walls for crowd control reasons) called the “three Satans” at *Mekka*. Many, if not most, *Muslims* consider the U.S. to be the “Great Satan.” Evidently, *Muslims* considered the World Trade Center Twin Towers to be the penultimate symbol of the “Great Satan.” This surmise seems all the more plausible since:

- ☉ Prior to 2005, graffiti denouncing Bush was daubed on the pillars” (“Many Pilgrims Stone ‘Devil’ Bush in *Haj* Ritual,” reuters.com, 21 Jan 2005, *JW*), and
- ☉ *Hezbollah* has one tall and one short square pillars side-by-side on Lebanon’s southern border representing the Great Satan (U.S.) and the Little Satan (Israel) (picture at Totten, Michael J. “The Lebanese/Israeli Border,” michaeltotten.com, 29 Nov 2005) (cont’d...)

Also interesting is the fact that there is the tradition that *Muhammad* said a sign of the end of the world would be excessively tall buildings (Lings. *Sources*, pp. 330-331). So there may also be an eschatological side to the 9/11 attacks.

If the drug in question did not induce nausea, perhaps it was an expectorant. Moshan Fani (1615-1670 AD) was a *Sufi* and the author of *The Dabistan* (~1645 AD). Fani says that the cult of the Persians believed that the *Kaaba* at *Makka* was once a Zoroastrian fire temple.<sup>4380</sup>

Notably, fire temples distributed drugs like myrobalan and gum Arabic.<sup>4381</sup> Myrobalan (*Fructus Chebulae*) is known as “*Buddha’s Chosen Herb*” and has many medical purposes including as an expectorant. An expectorant of course results in spit. So the pre-*Islamic* purgative rite may have involved spitting in addition to vomiting. *Muslim* tradition suggests that spitting was an important pre-*Islamic* rite. Zwemer wrote:

A young mother yet a slender girl, brought her wretched babe and bade me spit upon the child’s sore eyes; this ancient *Semitic* opinion and custom I have afterward found wherever I came in Arabia. *Meteyr* nomads in *el-Kasim* have brought me, some of them bread and some salt, that I should spit in it for their sick friends...when I blamed their superstition they answered simply, that ‘such was the custom here from time out of mind.’

In regard to blowing and spitting as methods of healing or conferring a blessing, it is important to note the Arabic distinction between *Nafakha* and *Nafatha*, the latter means to blow with spittle. A *Muslim* correspondent in *Yemen* points out this distinction and says that there is no real healing power or hurting power in the dry breath. It is the spittle or soul-stuff that transfers good or ill.<sup>4382</sup> The transference of “ill” from the body to the pillars made the pre-*Islamic* ritual into a purgative ritual. Zwemer also wrote in regard to spitting (note: readers of sensitivity are strongly urged not to read the following quote):

The Rev. Edwin F. Calverley tells this story: ‘What do you suppose I have just seen?’ exclaimed an excited Jew to a Christian in a *Muslim* city of Arabia. ‘What was it? Where did you see it?’ ‘There was a whole group of Arab women standing outside the big door of the *Mosque* and they all had cups or glasses in their hands.’ ‘Oh they were beggars and they were waiting for the men to get through reciting their prayers.’ ‘But no, they were not beggars, because I saw the beggars at another door and besides, I watched the men as they came out of the *Mosque* and, it is hard to believe it, they spat right into the cups and glasses and bowls that the women and children and even men held out to them. Some of the *Muslims* spat into one cup after another—into every cup that was put near them. I never saw the like in all my life!’ ‘That is indeed most strange and revolting! What were they doing it for? I’m sure I don’t know. Why don’t you go and ask some *Muslim* about it?’

Soon he came back, utterly disgusted. Did you find out what the purpose is?’ ‘Yes, and that is the most repulsive thing of all! I wouldn’t have believed it about them if anybody but one of their own religion had told it to me. Those people with the cups and bowls have some friend or some one in their family who is sick and they are collecting the spittle of the men who have just finished their prayers for their sick ones at home.’

My *Muslim* friends could not give me the religious authority supporting their unhygienic custom, but such authority exists nevertheless. *Al Bukhari* (*Sahih VII*,

<sup>4380</sup> Fani. *Dabistan*, p. 29.

<sup>4381</sup> Fani. *Dabistan*, pp. 22, 25.

<sup>4382</sup> Zwemer. *Animism*, ch. 9.

p. 150) gives two traditions reporting *Mohammed's* sanction for the practice. After recording the usual 'chain of witnesses, *Al Bukhari* relates that 'Aisha...said that the Prophet...told a sick man, 'In the name of *Allah* the earth of our land and the saliva of some of us cure our sick, by the permission of our Lord.<sup>4383</sup>

Another purification ritual involving the mouth that still survives and is popular among *Muslims* is saying *Koranic* verses into cupped hands and then passing the hands over an object or one own body to impart the blessing.

The next event after pilgrims Stone the Pillars at *Mina* is the Day of Sacrifice at *Mina* when whole camels and other animals are sacrificed and eaten. Also, to remove lice, pilgrims can get their heads shaved. One is also free to remove the *Ihram* outfit and wear normal clothing and one can resume sexual relations,<sup>4384</sup> as *Al Albani* also wrote:

...after this *Tawaaf* [circumambulation of the *Kaaba* after the Day of Sacrifice] everything again becomes lawful for him that became unlawful due to *IHraam* [holy state]—even the woman (sexual intercourse).<sup>4385</sup>

This suggests that in pre-*Islamic* times the pilgrim would spit, and also purge his stomach of its contents at the phallic pillars of *Mina* and then clean up a bit by changing clothes and cutting off lousy hair. The pilgrim would then gorge himself on a ritual sacrifice on the Day of Sacrifice and then he would participate in a ritual orgy.

So one can see that the pre-*Islamic Hajj* was an astral fertility rite where pilgrims would abstain from sex for a while and purge themselves of sin by spitting and vomiting. Then, having been purified, the pilgrim would feast on sacred food and would join a sacred orgy.

### **What Drug Artificially Produced Symptoms In, and Loosened the Lips of, Muhammad**

A study of the genuine symptoms attendant to *Muhammad's* initial revelation is useful in figuring out his drug of choice. Right after his initial call, *Muhammad* felt no pressure from the crowd to embellish the symptoms that were induced by drug abuse with additional faked symptoms of epilepsy. The *Islamic* historian Mumtaz Sadik Ali Tajddin wrote about *Muhammad's* initial call:

The earliest sources relate that the moon on that day of the eve of *Ramadan* enraptured [Mount] *Hira*...there was no one else, only the sky and the earth and the crescent-moon between them [the earth and the sky], rising sometimes aloft and sinking to the edge of the horizon. Stricken with panic *Muhammad* came home from *Hira* on that morning, strangely troubled, his great eyes dilated in wonder. 'Cover me up, Khadija, cover me up!' he said in feverish agitation. After awhile, he became calmer and spoke thus 'A strange vision appeared to me in the cave of *Hira* tonight. The vision said 'I am the angel *Gabriel*, sent by God.'<sup>4386</sup>

<sup>4383</sup> Zwemer. *Animism*, ch. 9.

<sup>4384</sup> Glassé, *Encyclopedia*, p. 445, Appendix B: "Makka and the Hajj" entry.

<sup>4385</sup> *Al Albani. Rites*, "The Sacrifice," point 114.

<sup>4386</sup> Tajddin. *Ismailis*.



Norman L. Geisler wrote about *Muhammad*'s initial call:

During his call he [*Muhammad*] was choked by an angel. *Muhammad* himself said of the angel, 'He choked me with the cloth until I believed I should die. Then he released me and said 'Recite!' (*Iqra*).' When he [*Muhammad*] hesitated, he received 'twice again the repeated harsh treatment.'<sup>4387</sup>

*Ibn Ishaq* wrote about *Muhammad*'s initial call:

I thought, 'Woe is me poet or possessed—Never shall *Quraysh* say this of me! I will go to the top of the mountain and throw myself down that I may kill myself and gain rest. So I went forth to do so and then when I was midway on the mountain, I heard a voice [*Gabriel*] from heaven...'<sup>4388</sup>

M. H. Haykal wrote about *Muhammad*'s initial call:

Stricken with panic, *Muhammad* arose and asked himself, 'What did I see? Did possession of the devil which I feared all along come to pass?' *Muhammad* looked to his right and his left but saw nothing. For a while he stood there trembling with fear and stricken with awe. He feared the cave might be haunted and that he might run away still unable to explain what he saw.<sup>4389</sup>

William Muir wrote about *Muhammad*'s prophethood:

The Prophet was of a high-strung and nervous temperament. So afraid was he of darkness, that, on entering a room at night, he would not sit down [un]till a lamp had been lighted for him; and *Al Wakidi* adds that he had such a repugnance to the form of the cross that he broke everything brought into the house with the figure upon it.<sup>4390</sup>

Margoliouth wrote about *Muhammad*'s prophethood:

Scrupulous care was bestowed by him [*Muhammad*] on his person: every night he painted his eyes and his body was at all times fragrant with perfumes. His hair was suffered to grow long till it reached his shoulders; and when it began to show signs of gray, these were concealed with dyes.<sup>4391</sup>

The dye was reddish-orange or reddish-brown *Henna*. Even with all this hair care, *Muhammad* contracted lice.<sup>4392</sup>

The following list of symptoms is compiled from the above descriptions of *Muhammad*'s calling, his lifestyle and his "strange fits." The few, probably faked, epileptic symptoms have been excluded because they were likely faked. *Muhammad*:

- ☉ Grew his hair long.
- ☉ Exhibited feverish, agitated behavior, was "strangely troubled" and suicidal.
- ☉ Perspired abnormally.
- ☉ Had alternately a flushed-red and pale-white face.
- ☉ Was irrationally frightened (paranoid) and panicky.
- ☉ Had visual hallucinations (an angel appeared, moon bounced around) and auditory hallucinations (heard bells).
- ☉ Lost interest in honest work and sex and preferred to either meditate in a dark cave, or cavort with women.
- ☉ Used cosmetics on the eyes, perhaps to cover up the sunken eye look common to drug abusers.

<sup>4387</sup> Geisler & Saleeb. *Answering*, p. 154.

<sup>4388</sup> Ishaq. *Sirat*, p. 106.

<sup>4389</sup> Haykal. *Life*, p. 74, as quoted in Geisler & Saleeb. *Answering*, p. 155.

<sup>4390</sup> Muir. *Life*, vol. iii, ch. 10, p. 61; see also fn. 46.

<sup>4391</sup> Margoliouth. *Rise*, pp. 88-89, 104-106, as quoted in Warraq. *Why*, p. 91.

<sup>4392</sup> Bukhari, vol. 9, no. 130, as quoted in Trifkovic. *Sword*, pp. 45-46.

- ☉ Had dilated eyes and dilated pupils. That *Muhammad* felt most comfortable hanging out in the dimly lit Mount *Hira* cave for days at a time suggests that his pupils were dilated and his eyes were sensitized to light. Staying in a cave until his marijuana “stash” ran out and the symptoms subsided was easier than squinting all day.
- ☉ Used perfume and incense, possibly to cover up the peculiar smell of smoked marijuana.
- ☉ Wrongly sensed that someone else (*Gabriel*, angels, demons, *Jinn*, spirits of the dead) was present.
- ☉ Heard a bell ringing in his ears (tinnitus) when *Koran* verses were revealed.<sup>4393</sup> Marijuana is known to make pre-existing tinnitus worse.
- ☉ Suffered from a headache.

Parents with teenagers with the above symptoms and lifestyle would rightly suspect tetrahydrocannabinol (THC) abuse.

THC is a mild euphoriant, as well as an intoxicating hallucinogen.<sup>4394</sup> THC is the primary intoxicant in *Ganja*, *Hashish* and marijuana, all of which are prepared from various parts of the *Cannabis* plant.

The Bible is another source of evidence of *Muhammad*'s drug abuse. Scholars have amply demonstrated the Bible's influence, albeit belated influence, on *Muhammad* and on the *Koran*. It seems the “official” version of *Muhammad*'s call has uncanny parallels to *Muhammad*'s unique interpretation of Isa 29:09-12:

Be stunned and amazed, blind yourselves and be sightless; be drunk, but not from wine, stagger, but not from beer. *Yahveh* has brought over you a deep sleep; He has sealed your eyes (the prophets); he has covered your heads (the seers). For you this whole vision is nothing but words sealed in a scroll. And if you give the scroll to someone who can read and say to him, ‘Read this, please,’ he will answer, ‘I cannot; it is sealed.’ Or if you give the scroll to someone who cannot read and say ‘Read this, please,’ he will answer, ‘I don’t know how to read.’

*Muhammad* stayed in a dark cave at Mount *Hira* to, in a sense, blind himself. He used marijuana to “be drunk, but not from wine,” and to “stagger, but not from beer.” *Muhammad* slept and that “sealed his eyes.”

That the angel *Gabriel* choked *Muhammad* with a cloth may have been *Muhammad*'s interpretation of Isaiah's “he has covered your heads.” Isaiah says both the learned and unlearned could not read a scroll. This reminds one of how the Angel *Gabriel* showed *Muhammad* a scroll three times and said “Recite,” but each time *Muhammad* said that he was illiterate.

THC is not chemically addictive but THC can create a strong psychological dependence. In fact, a psychological dependence can become as controlling as a chemical addiction. The whole lifestyle of a THC user may revolve around marijuana.

Marijuana is quite addictive psychologically. A US federal government National Survey on Drug Use and Health survey revealed that 15 percent of people who have ever sampled marijuana in the US reported using marijuana in the last month. This is higher than the sample/addiction rates of other illegal drugs: meth (five percent), heroin (three percent), crack (eight percent) and painkillers (ten percent).

<sup>4393</sup> Montecroce. *Crucible*, p. 92.

<sup>4394</sup> EB, *Marijuana* entry.

Incidentally, the sample/use rates for legal drugs were: cigarettes (37 percent) and alcohol (60 percent), but 27 of the 60 percent abused alcohol in the prior month by drinking five or more drinks on one occasion.<sup>4395</sup>

One symptom of psychological dependence is that irrational thinking suddenly makes sense. One can be sure the psychological dependence is doing the talking when marijuana users say:

- ☉ “Marijuana ought to be legalized even though THC saps users’ motivation. Never mind the fact that many users who could have achieved a profession and became upstanding citizens only end up with menial jobs, and sometimes do jailtime or end up on welfare.”
- ☉ “Alcohol and cigarettes already cause many people to die prematurely, so there is no reason not to legalize yet another habit-forming, carcinogenic drug like marijuana.”

Such crazy talk statements reminds one of many statements in the traditions attributed to *Muhammad*.

Compare *Muhammad*’s symptoms to the side effects of THC as listed by the *Encyclopedia Britannica*:

Perceptual distortions may also occur, involving space, time, sense of distance and sense of the organization of one’s own body image (i.e. depersonalization). Thought processes may also become disorganized, with fragmentation, disturbances of memory and frequent shifts of attention acting to disrupt the orderly flow of ideas...undesired subjective experiences include fear, anxiety or panic.<sup>4396</sup>

The perceptual-distortion effect involving space and distance may have made the Moon Illusion seem much more awe-inspiring to *Muhammad*. The “perceptual distortion” involving the “sense of organization of one’s own body image” might explain why *Muhammad* fancied that he was possessed by a demon. Clearly, *Muhammad* felt fear, anxiety and was panicky.

*Encyclopedia Britannica* elsewhere states other negative side effects of THC:

Marijuana...is more apt to produce effects at the opposite or mild end of the continuum from those of LSD. When smoked, physiological manifestations are apparent within minutes. These include dizziness, lightheadedness, disturbances in coordination and movement, a heavy sensation in the arms and legs, dryness of mouth and throat, redness and irritation of the eyes, blurred vision, quickened heartbeat, tightness around the chest, and peculiarities in the sense of hearing such as ringing, buzzing, a feeling of pressure in the ears or altered sounds.

Occasionally drug abuse is accompanied by nausea and an urge to urinate or defecate. There is also a feeling of hunger that may be associated with a craving for sweets. Toxic manifestations are rare and include motor restlessness, tremor, ataxia [lacking coordination], congestion of the conjunctivae of the eye, abnormal dilation of the pupil, visual hallucinations and unpleasant delusions. Marijuana is not a drug of addiction. Use does not lead to physical dependence and there are no withdrawal symptoms when the drug is discontinued. Psychological dependence does occur among certain types of users. Infrequently, a ‘*Cannabis* psychosis’ may occur, but generally this type of psychiatric reaction is associated only with heavy, long-term use of *Hashish*, such as in India and

<sup>4395</sup> Tierney, John. “Debunking the Drug War,” nytimes.com, 9 August 2005.

<sup>4396</sup> *EB*, accessed 28 Jun 2002, “Drug use” entry.

*Morocco*. Other effects of chronic *Hashish* use are a debilitation of the will and mental deterioration.

Psychological manifestations are even more variable in response to *Cannabis*. Alterations in mood may include giggling, hilarity and euphoria. Perceptual distortions may also occur, involving space, time, sense of distance and sense of the organization of one's own body image. Thought processes may also become disorganized with fragmentation, disturbances of memory, and frequent shifts of attention acting to disrupt the orderly flow of ideas. One may also experience some loss of reality contact in terms of not feeling involved in what one is doing; this may lead to considerable detachment and depersonalization. On the more positive side, there may be an enhancement in the sense of personal worth and increased sociability. Undesired subjective experiences include fear, anxiety or panic. These effects vary considerably with practice and with the setting in which the drug is taken.<sup>4397</sup>

*Muhammad* was said to experience ringing in the ears (*Tinnitus*) during his "strange fits," which is a symptom of THC use. The visual hallucination symptom would explain *Gabriel's* appearing to *Muhammad*. Perhaps the dizziness and the hallucination side effect together explain why *Muhammad* saw the moon jump up and down on the horizon.

The *Arabian Nights* series has two tales about *Hashish* use. The traditional tales of the *Arabian Nights* collection purportedly was compiled less than two centuries after *Muhammad*, who died in about 632 AD. One traditional tale even concerns a *Hashish* user and the moon.

This traditional tale (more like real-life account of a wacky drug-trip) of "Two *Hashish* Eaters" excerpt will give the reader pause concerning *Muhammad's* hallucination involving the moon. On the 797<sup>th</sup> night, Scheherazade spoke:

There was once, my lord...a man in a certain city, who was a fisherman by trade and a *Hashish*-eater by occupation. When he had earned his daily wage, he would spend a little of it on food and the rest on a sufficiency of that hilarious herb [*Cannabis*]. He took his *Hashish* three times a day: once in the morning on an empty stomach, once at noon and once at sundown. Thus he was never lacking in extravagant gaiety. Yet he worked hard enough at his fishing, though sometimes in a very extravagant fashion.

On a certain evening for instance, when he had taken a larger dose of his favorite drug than usual, he lit a tallow [i.e. fat-based] candle and sat in front of it, asking himself eager questions and answering with obliging wit. After some hours of this delight, he became aware of the cool silence of the night about him and the clear light of a full-moon above his head, and exclaimed affably to himself: 'Dear [imaginary] friend, the silent streets and the cool of the moon invite us to a walk. Let us go forth, while all the world is in bed and none may mar our solitary exaltation.'

Speaking in this way to himself, the fisherman left his house and began to walk towards the river; but, as he went, he saw the light of the full-moon lying in the roadway and took it to be the water of the river. 'My dear old [imaginary] friend the fisherman,' he said 'get your line and take the best of the fishing, while your rivals are indoors.' So he ran back and fetched his hook and line and cast into the glittering patch of moonlight on the road.

---

<sup>4397</sup> *EB*, accessed 28 Jun 2002, "Drug use" entry.

Soon an enormous dog, tempted by the smell of the bait, swallowed the hook greedily and then, feeling the barb, made desperate efforts to get loose. The fisherman struggled for some time against this enormous fish [really, a dog], but at last he was pulled over and rolled into the moonlight. Even then he would not let go his line but held on grimly, uttering frightened cries. ‘Help, help, good *Mussulmans!*’ he shouted. ‘Help me to secure this mighty fish, for he is dragging me into the deeps! Help, help, good friends, for I am drowning!’ The guards of that quarter ran up at the noise and began laughing at the fisherman’s antics; but when he yelled: ‘*Allah*, curse you...! Is it a time to laugh when I am drowning?’ they grew angry and, after giving him a sound beating, dragged him into the presence of the *Kadi* [judge].<sup>4398</sup>

*Muhammad* received his call at age forty or so. *Muhammad*’s prolonged use of marijuana and *Hashish* likely did take its toll on *Muhammad*’s mental faculties. *Encyclopedia Britannica* states:

A hallucinogenic drug may lead to experiences that resemble psychoses, in which case it is called psychotomimetic; under other circumstances it may cause a quasi-mystical or psychedelic, experience.<sup>4399</sup>

Prolonged use would have contributed to *Muhammad*’s experience at the Mount *Hira* cave, but it was the immediate use of marijuana at the cave that led to the hallucination of the moon jumping around on the horizon and the angel *Gabriel* choking him.

The mediums at the Oracle at *Delphi* breathed in concentrations of hydrocarbons in an enclosed space and suffered from hypoxia. Likewise, the Mount *Hira* cave was an enclosed space and the campfire reduce the available oxygen. The resultant hypoxia enhanced the hallucinatory effects of being alone while breathing in THC. The thinner atmosphere at the Mount *Hira* cave had its effect too—as *Haaretz* reported:

...divine revelations take place at relatively low altitudes, it is safe to assume...sufficiently high to arouse similar experiences in individuals who, in any case, tended toward mystical experiences. Altitude sickness can occur at low altitudes. It is interesting to note that, although autoscopy [an out-of-body experience] is more frequently encountered among pilots of jet planes flying at high altitudes, it also occurs among helicopter pilots flying at altitudes of between 1,500 and 3,000 meters.<sup>4400</sup>

The idea of a cave appealed to *Muhammad* because he knew caves were where drug-induced religious experiences often occurred. Cave art and artifacts suggest that caves have been a poor-man’s cathedral since prehistoric times.

The cave reminded *Muhammad* of the enclosed space of the *Kaaba*. The *Kaaba*, with its thick stone walls, may have been modeled on caves that it replaced. In fact, the *Kiswa*, the black silk drop cloth over the *Kaaba*, is embroidered with verse from “The Cave” *Sura* of the *Koran* (*K* 018).<sup>4401 4402</sup> The “Cave” chapter is so named because it contains the story of the “Sleepers in the Cave” (*Ashab-i-Kahf*) (*K* 018: 008-026).

<sup>4398</sup> Burton. *Nights*, “The Tale of Two *Hashish*-Eaters” and “The Tale of King Omar *Bin Al* Nu’uman and his Sons Sarrkan and Zau *Al* Makan.”

<sup>4399</sup> *EB*, accessed 3 Jul 2002, “Drug cult” entry.

<sup>4400</sup> Arzy, Shahar & Moshe Idel & O. Blanke. “Magical mystery tours,” *haaretz.com*, 26 Aug 2005.

<sup>4401</sup> Hughes. *Dictionary, Kiswah* entry, p. 280, left column.

<sup>4402</sup> Zwemer. *Animism*, ch. 8.

So it would seem that the *Kaaba* was popular because travel to this man-made cave was more convenient than trudging to nearby glens for drug rituals in smoky caves. *Ibn Ishaq* relates that *Muslims* first worshipped in the glens around *Makka*.<sup>4403</sup> Its many caves may be why the spiritual center of *Makka* came to exist in a desolate desert in a dry wadi prone to flash flooding.<sup>4404</sup>

*Makka* surely did not come to prominence as the traditions say. *Makka* was not a major caravansary, and *Makka* was not rich and prosperous. F. E. Peters wrote:

The center of town was wrapped in ‘suffocating heat, deadly wind, clouds of flies,’ as an Arab geographer later described it, while the so-called outskirts were little more than mud huts clinging to the slopes of the inhospitable mountains.<sup>4405</sup>

The *Sayl* is the torrential flooding that has plagued *Makka* for most of its history and has succeeded in leveling the most substantial of structures, to say nothing of the humble abodes of the fifth- and sixth-century *Quraysh*.<sup>4406</sup>

Attempts to explain *Makka*’s past prosperity are misguided and uninformed since *Makka* never was prosperous until modern times. F. E. Peters wrote:

*Makka*, it is often said in an attempt to explain its prosperity or simply why people chose to settle there in the first place, stood at the nexus of natural trade routes. In fact, it does not. The natural route between *Yemen* and the north lies well east of *Makka* and caravans going there obviously made a detour. There were many places in the near vicinity of *Makka*, *Ta’if*, for example, with better soil, more water and a better climate. What *Makka* possessed and they did not, though we cannot explain how or why, was an intrinsic holiness.<sup>4407</sup>

Perhaps pre-*Islamic Makka* was holy because of the many caves for drug ceremonies. Marijuana users are known for their lack of ambition and initiative. In the deserts of *Makka* no one would nag marijuana users to plow a field, hoe a row, pick a crop, pay taxes or enlist in an army. In short, the wastelands and caves of *Makka* were a marijuana users’ paradise just as modern out-of-the-way-places are.

Just as the Greeks initiated the Olympics in honor of the high god *Zeus*, so the pre-*Islamic Hajj* was created in honor of the high god *Allah*. Of course this Olympics was created by and for drug abusers. So instead of a track and stadium, there is nude circumambulation around the drug house *Kaaba*, camping at *Muzdalifa* and purgative ceremonies at *Mina*.

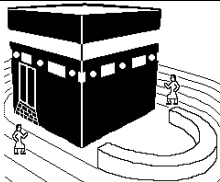


Figure 15-02. *Muslims* circumambulating the *Kaaba*.

*Muhammad* attended rituals at the *Kaaba* and sought out the Mount *Hira* cave for the same reason that marijuana smokers commonly smoke in small rooms, walk-in closets and in automobiles with tinted glass. The enclosed, small spaces trap and concentrate marijuana smoke and also shut out sunlight.

Sunlight is uncomfortable to drug abusers because some drugs dilate the pupils and smoke irritates the eyes. Both the *Kaaba* and the Mount *Hira* cave were

<sup>4403</sup> Ishaq. *Sirat*, p. 118.

<sup>4404</sup> Peters. *Makka*, p. 24.

<sup>4405</sup> Peters. *Makka*, p. 22.

<sup>4406</sup> Peters. *Makka*, p. 24.

<sup>4407</sup> Peters. *Makka*, p. 22.

hermetically sealed except for the entrance. Like the black *Kiswa* blanket at the *Kaaba*, *Muhammad* may have put a blanket over the cave entrance to keep marijuana smoke in and sunlight out.

From the early sources, we know that *Muhammad* rushed home and told his wife, *Khadija*, to cover him up. So the night of *Muhammad*'s call was cold. This meant that *Muhammad* likely had a blanket over the cave entrance for keeping out the cold air.

*Muhammad* surely made a campfire on such a cold night. As it burned down to embers it removed oxygen from the air and replaced it with carbon dioxide and monoxide, making *Muhammad* lightheaded and enhancing the symptoms of THC intoxication.

In the Mount *Hira* cave *Muhammad* may have eaten *Hashish*, smoked marijuana or burned it as incense. Breathing in concentrated marijuana smoke has nearly instantaneous effects on the brain, while eating *Hashish* has more prolonged, powerful effects.

So it would seem that *Muhammad*'s call at the Mount *Hira* cave likely was caused by an extra-heavy dose. Like other would-be mediums in medieval Arabia, *Muhammad* probably used drugs to induce revelations.

This interpretation of *Muhammad*'s Mount *Hira* cave experience is supported by the fact that a few years later in another cave in Mount *Thawr*, *Muhammad* felt the "peace" or "tranquility" (Arabic: *Sakina*) of God descend on him and his companion (K 009:040). Notably, the mouth of the Mount *Thawr* cave is reported as being somewhat blocked up, trapping some of the marijuana smoke inside, as Karen Armstrong wrote:

God had sent down His *Sakina* once before, when *Abu Bakr* and *Muhammad* had hidden for three days in the Cave outside *Makka*, despised and rejected by their kinsmen and facing the possibility of imminent, pointless death. The *Sakina* [K 002:248; 009:026, 040; 048:004, 018, 026], it will also be recalled, seems to have been related to the Hebrew *Shekinah*, the term for God's presence in the world.<sup>4408</sup>

The *Sufi* Martin Lings wrote how the entrance was blocked up:

...the Prophet and *Abu Bakr* went to the mouth of the cave. There in front of it, almost covering the entrance, was an acacia tree, about the height of a man, which [supposedly] had not been there that morning; and over the gap that was left between the tree and the wall of the cave a spider had woven its web.<sup>4409</sup>

Evidently, marijuana use made *Muhammad* believe the tree grew up overnight.

Shorosh wrote:

Miracles were reported to have happened there. Allegedly, a spider wove her web across the mouth of the cave and branches sprouted over it on which wild pigeons settled as camouflage.<sup>4410</sup>

The *Sakina* induced a feeling of unnatural peace—like the peace after marijuana use (K 002:248; 009:026, 040; 048:004, 018, 026). Amerindian chiefs use to smoke peace pipes (calumets) to achieve a similar effect with tobacco.

The description of the *Sakina* seems to have been a hallucination inspired by the serpentine wafting of marijuana smoke. Gibb and Kramers wrote:

<sup>4408</sup> Armstrong. *Biography*, p. 224.

<sup>4409</sup> Lings. *Sources*, p. 119.

<sup>4410</sup> Shorosh. *View*, p. 57.

The patriarch [*Ibrahim*] came to Arabia led by the *Sakina*, which had the shape of a stormy wind with two heads; it is also described as having a snake's head. When it reached the site of the *Kaaba*, it wound itself round the foundation and said 'Build on me.' According to others, *Ibrahim* built on its [the snake's] shadow.<sup>4411</sup>

What was different about the night of *Muhammad's* initial call in the Mount *Hira* cave is that *Muhammad* experienced a "bad trip" (a negative hallucination). *Muhammad* was likely accustomed to positive hallucinations after using marijuana. He probably was unaware that his surroundings might bring about negative hallucinations, as the *Encyclopedia Britannica* states about THC:

These effects vary considerably with practice and with the setting in which the drug [*Cannabis*] is taken.<sup>4412</sup>

*Muhammad* evidently thought that the Mount *Hira* cave might be haunted even before having his negative hallucination. The cave seemed especially spooky at night and *Muhammad* feared he was possessed by a demon.

*Muhammad's* fears not only affected the content and tone of the hallucination but also his interpretation of the hallucination, as the *Encyclopedia Britannica* states:

...more than 100 plants known to have properties that affect the mind [and are used in religious ceremonies]...Though these drugs vary greatly in composition, their effects tend to be similar. Such factors as the personality, mood, expectation of the user, the setting, the nature of those in charge, and the interpretation of the experience may have a more significant effect on the experience than do the specific properties of the drug.<sup>4413</sup>

*Muhammad* may also have felt ill from a THC non-lethal overdose, which made him think that he might be possessed by a demon, as the *Encyclopedia Britannica* states:

At other times illness may be interpreted as the result of possession by evil spirits.<sup>4414</sup>

Hallucinations often occur when a marijuana user is sleepy or dozes off. *Ibn Ishaq* notes that *Muhammad*, during his initial call, was asleep when the angel *Gabriel* came and choked him three times.<sup>4415</sup> 'Ali Dashti also relates a tradition where *Muhammad's* revelatory state is described as sleep:

A state of inspiration came over the Prophet. 'Omar signaled to Ba'li to come in. Ba'li went in and saw the Prophet looking like someone asleep, snoring and with his blessed complexion flushed.<sup>4416</sup>

When a person is tired or asleep, the subconscious wells up in the form of irrational thinking and dreams. So *Muhammad's* tiredness and his fears combined and led to the negative hallucination of the angel *Gabriel* choking him.

After being choked three times, it took *Muhammad* a long while to convince himself that *Gabriel* was an angel rather than a demon. Saint Paul said that Satan masquerades as an angel of light but evidently does not put on a very convincing performance every time (2Co 11:14). So it seems eating *Hashish* and using

<sup>4411</sup> Gibb & Kramers. *Encyclopedia*, p. 195, *Kab'ah* entry.

<sup>4412</sup> *EB*, accessed 28 Jun 2002, "Drug use" entry.

<sup>4413</sup> *EB*, accessed 3 Jul 2002, "Drug cult" entry.

<sup>4414</sup> *EB*, accessed 3 Jul 2002, "Drug cult" entry.

<sup>4415</sup> *Ishaq. Sirat*, p. 106.

<sup>4416</sup> *Dashti. Career*, p. 59.



marijuana in a relatively enclosed space may have been a main cause of *Muhammad's* first prophetic experience.

There are however other indications that *Muhammad* used marijuana and *Hashish*. For instance, *Muhammad* banned the drinking of alcohol (K 002:219; 004:043; 005:090). The prohibition of drinking in *Islam* occurred on 4 AH/625 AD. That many *Muslims* did not abandon *Islam* immediately due to this prohibition of wine indicates the availability of other intoxicants such as marijuana, *Hashish* and opium, as the *Encyclopedia Britannica* states:

In *Islam*, which prohibits use of alcohol, there has been much more general use of *Cannabis*. The fanatical sect known as the Assassins, founded in the eleventh century, used *Hashish*; their name is derived from an Arabic word denoting a consumer of *Hashish*.<sup>4417</sup>

The history of marijuana, *Hashish* and opium poppies in Arabia likely pre-dates *Islam* by centuries or even millennia. Morphine and heroin were unheard of in medieval Arabia because they are modern laboratory derivatives of opium. That the early *Muslims* used *Hashish* is suggested by the fact that wherever *Muslims* conquered, widespread *Hashish* use ensued.

Also interesting is the fact that vegetal motifs in early *Islamic* art were the norm until the eleventh century, as though plants with drug properties were an integral part of early *Islam*. The most famous example is the interior of the Dome of the Rock.

Starting in the eleventh century, geometric patterns became the dominant *Islamic* art form. Perhaps early *Islamic* plant art was alluding to how certain hallucinatory plants were instrumental in the formation of *Islam*.

So it is plausible that *Muhammad* knew that he and his followers could afford to give up one of their many vices. Giving up alcohol would make *Muhammad* and *Muslims* feel at least a semblance of religiosity, especially when compared to their fellow pagan Arabs. Giving up alcohol would still leave *Muhammad* and *Muslims* free to enjoy THC and opium, as well as all the other vices that *Islam* legalizes such as polygyny and easy divorce.

After *Muhammad's* initial call, he did not receive another revelation for some time, so he contemplated suicide.<sup>4418</sup> That *Muhammad* considered suicide during the “intermission” (Arabic: *Fatrah*) between his revelatory activities is well documented by Bukhari, *Ibn Ishaq*, *Ibn Sa'd*, Tabari (839–923 AD) and others.<sup>4419</sup>

Tabari even wrote that *Muhammad* sporadically took steps to commit suicide throughout the rest of his career as a prophet:

Narrated ‘Aisha: But after a few days [the reportedly Christian] Waraqa died and the Divine Inspiration was also paused for a while and the Prophet became so sad as we have heard that he intended several times to throw himself from the tops of high mountains. Every time he went up the top of a mountain in order to throw himself down, *Gabriel* would appear before him and say ‘O *Muhammad*! You are indeed *Allah's* Apostle in truth,’ whereupon his heart would become quiet and he would calm down and would return home. And whenever the period of the coming of the inspiration used to become long, he would do as before, but

<sup>4417</sup> *EB*, accessed 3 Jul 2002, “Drug cult” entry.

<sup>4418</sup> Muir. *Life*, vol. 2, ch. 3.

<sup>4419</sup> Silas. “*Muhammad's* Suicide Attempts,” and “Comments on a ‘Response to *Muhammad's* Suicide Attempts,’” Answeringislam.org, accessed 26 Sep 2003.

when he used to reach the top of a mountain, *Gabriel* would appear before him and say to him what he had said before.<sup>4420</sup>

Norman Geisler also wrote about *Muhammad's* suicidal thoughts:

Also clouding the alleged divine origin of his message is the fact that after this there was a long period of silence, which according to some accounts lasted about three years, during which time *Muhammad* fell into the depths of despair, feeling forsaken by God and even entertaining thoughts of suicide. These circumstances strike many as uncharacteristic of a divine call.<sup>4421</sup>

This indicates that after his frightful hallucinations of an angel choking him, *Muhammad* likely reduced his consumption of THC. Because *Muhammad* did not overdose during this period, he did not hallucinate and so he received no further revelation during this “intermission.”

*Muhammad* reminisced about the euphoria and favorable hallucinations of the earlier, heavier drug abuse that he felt he had to swear off. In other words, *Muhammad* suffered from a psychological dependence to THC use. The disappointment of not receiving further revelations (i.e. hallucinations) after his initial call and his psychological dependence to THC, led to thoughts of committing suicide.

Marijuana may also help explain *Muhammad's* surprising lack of offspring—considering how many wives and concubines *Muhammad* had. *Muhammad* had no surviving male heir.

The *Muslim* scholar and statesman, Ali Dashti lists twenty-three women in *Muhammad's* life, which averages out to one intimate woman for each year of *Muhammad's* twenty-three-year prophethood:

1. Khadija 2. Sawda 3. Aesha [Aisha] 4. *Omm [Umm]* Salama 5. Hafsa 6. Zaynab I [former wife of prophet's adopted son Zayd] 7. Jowayriya [Juwayriyah] 8. *Omm [Umm]* Habiba 9. Safiya [Jewess and widow of Kinana, whom *Muhammad* had tortured to death and decapitated<sup>4422</sup>] 10. Maymuna I 11. *Fatima* I 12. Hend 13. Asma I 14. Zaynab II 15. Habla 16. Asma II 17. *Fatima* II 18. Mariya the *Copt* (a Christian) 19. Rayhana (Jewess who was widowed when 600 to 900 men of the Jewish *Kurayza* tribe were beheaded in one day<sup>4423</sup>) 20. *Omm [Umm]* Sharik 21. Maymuna II 22. Zaynab III 23. Khawla.<sup>4424</sup>

Of these twenty-three women, two were concubines: Mariya the Christian *Copt* and Rayhana the Jewess. Robert Morey points out that:

The last four women were neither wives nor slaves [concubines] but devout *Muslim* women who ‘gave’ themselves to satisfy *Muhammad's* sexual desires.<sup>4425</sup>

Worth noting is the tradition that says that during *Muhammad's* Night Journey, he married three additional women in heaven: 1) Mary, the mother of Jesus, 2) the sister of Moses and 3) the wife of Pharaoh. Salman Hassan Jabbaar wrote:

When he [*Muhammad*] returned to earth from that trip [Night Journey] he was unable to hide the fact from his first wife, Khadija - the eldest. He told her as she lay dying: ‘Oh Khadija, know that God has wedded me to Mary, Christ’s

<sup>4420</sup> *Sahih Bukhari*, vol. 9, bk. 87, no. 111.

<sup>4421</sup> Geisler & Saleeb. *Answering*, p. 156.

<sup>4422</sup> Ishaq. *Sirat*, p. 515.

<sup>4423</sup> Ishaq. *Sirat*, p. 466.

<sup>4424</sup> Dashti. *Career*, pp. 123-125.

<sup>4425</sup> Morey. *Invasion*, p. 86.

mother in paradise' [which information surely hurried her along to the grave]. He repeated this story to his favorite wife, Aiysha, after the *Hejira*, saying: 'Oh Aiysha, didn't you know that God Almighty in heaven wedded me to Mary the daughter of Imran, to Kulthum, Moses' sister and to Assiya, wife of the Pharaoh.'<sup>4426</sup>

Ali Dashti wrote on the subject of *Muhammad's* celestial marriages:

According to the *Cambridge Tafsir* [commentary on the *Koran*], the word *Thayyibat* (widows or divorcees) refers to Pharaoh's wife Asiya, and the word virgins (*Abkar*) refers to Jesus' mother Mary, both of whom are waiting to be married to the Prophet *Muhammad* in heaven.<sup>4427</sup>

*Muslims* like to excuse *Muhammad* for having so many intimates by advancing the suspect assertion that "most" of the women were widows. One must never forget that *Muhammad's* *Jihad* made many women into widows and slaves. At least two of *Muhammad's* wives were made into widows by *Jihad* (as was noted above). More of *Muhammad's* wives and sex-slaves were widows of husbands who were either on the giving or receiving end of *Jihad*. Moreover, *Muhammad* made around twenty-three women into widows when he himself died—another one of the cruelties of polygyny.

### Marijuana and Gonorrhea Rendered *Muhammad* Heirless

*Muhammad* apparently was sexually impotent for a whole year. Gordon Newby wrote:

During *Muhammad's* lifetime, Jewish magicians are supposed to have cast a spell on *Muhammad*, rendering him impotent or in pain for a period of time.<sup>4428</sup>

*Muhammad's* biographer, *Ibn Ishaq* wrote about *Muhammad's* impotence:

From B. Zurayq [a Jewish tribe at or near *Madina*]: Labid *b. A'sam* who bewitched the apostle of God so that he could not come at his wives.<sup>4429</sup>

Michael Lecker wrote that the witchcraft's desired effect was:

...harming the Prophet's sexual potency. This is expressly said in the sources...<sup>4430</sup>

Guillaume wrote:

In commenting on this [*Muhammad's* impotence] Suhayli [died 1185 AD/581 AH] asserts that the tradition is sound and is accepted by the traditionalists. He found in the *Jami'* of *Mu'ammara b. Rashid*...the statement that the spell lasted for a year. He adds that the *Mu'tazili* and Modernists rejected the tradition on the ground that prophets could not be bewitched otherwise they would commit sin and that would be contrary to the word of God 'And God will protect them from men' (*Sura* 5.71). He [Suhayli] finds the tradition unassailable. It is properly attested and intellectually acceptable. The prophets were not preserved from bodily afflictions in which category sorcery falls.<sup>4431</sup>

Because *Muhammad* thought a certain Jew bewitched him and caused his year long impotency, he wrote two *Koranic* chapters:

Commentators on the *Koran* relate that the reason for the revelation of the chapter quoted above [*K* 113] was that a Jew named Lobeid [or Labid] had, with

<sup>4426</sup> Jabbaar, Salman H. "The Place of Women in Christianity & Islam," Answeringislam.org, 1994.

<sup>4427</sup> Dashti. *Career*, p. 138.

<sup>4428</sup> Newby. *Arabia*, p. 73.

<sup>4429</sup> Ishaq. *Sirat*, p. 240, in the section "The Names of the Jewish Adversaries."

<sup>4430</sup> Lecker. *Arabia*, XII:563.

<sup>4431</sup> Ishaq. *Sirat*, p. 240, fn. 1.

the assistance of his daughters, bewitched *Mohammed* by tying eleven knots in a cord which they hid in a well. The Prophet falling ill in consequence, this chapter [K 113] and that following it [K 114] were revealed; and the angel *Gabriel* acquainted him with the use he was to make of them [K 113-114] and told him where the cord was hidden. The [later] *Khalif* Ali fetched the cord and the Prophet repeated over it these two chapters; at every verse, a knot was loosed until, on finishing the last words, he was entirely freed from the charm.<sup>4432</sup>

It must have been psychologically painful for *Muhammad* when he was unable to satisfy himself at the expense of his beautiful wives and sex-slaves. Moreover, *Muhammad* had no surviving male heir and could not even hope for one as long as he was bewitched and impotent.

It seems that *Muhammad's* sterility problem caused him to increase his THC intake. Not only did the THC ameliorate his just-described psychological discomfort, but apparently, marijuana had sexual side effects on *Muhammad*. First, marijuana took away what few inhibitions about sex that *Muhammad* had and second, stimulated *Muhammad's* sex libido. Examples of *Muhammad's* loosened inhibitions include:

☉ When *Muhammad* visited the house of his adopted son, *Zayd*, he saw “*Zaynab* unveiled and was enamored by her beauty.” *Zayd* divorced *Zaynab* and *Muhammad* married her despite the scandal caused by marrying his son-in-law’s wife (K 033:037).<sup>4433</sup> Regarding this and similar scandals, *Muhammad's* wife *Aisha* then said: “*Allah* was quick to fulfill his desires” (*Suyuti's Asbab Al-Nuzul* comments on K 033:049).

☉ *Muhammad* married and had sex with *Safiya* on the very night that her husband *Kinana* was tortured and beheaded on *Muhammad's* orders.<sup>4434 4435</sup>

☉ *Aisha* recounted what she thought when she first saw *Juwayriyah*, that is, shortly before *Muhammad* proposed to *Juwayriyah* and married her:

She [*Juwayriyah*] was a woman of great loveliness and beauty...when I saw her at the door of my room I was filled with misgivings, for I knew that the Prophet would see in her what I saw.<sup>4436</sup>

☉ *Muhammad's* satyriasis was so severe that he commanded that women show only their face and hands in public so he could control himself (K 004:034; 033:059; *Sunan Abu-Dawud* 32:4092).

☉ *Serge Trifkovic* wrote how *Muhammad* came to have about two dozen sexual contacts with only some being “regulars”:

...as for the women, ‘whenever *Muhammad* took a woman as a captive, if he imposed the veil on her, *Muslims* would say he took her as a wife, but if he left her unveiled they would say ‘He owned her as a slave;’ that is, she became a property of his right hand.’<sup>4437</sup>

Marijuana can either depress or stimulate the sex drive. *Yoav Ben-Dov* wrote:

For astronomer *Carl Sagan*, jazz clarinet player *Milton Mezzrow* and others, *Cannabis* arouses sensual feelings and enhances sexual pleasure. But *Gautier*

<sup>4432</sup> Zwemer. *Animism*, ch. 9.

<sup>4433</sup> Shamoun, Sam. “Revisiting *Muhammad's* Marriage to His Adopted Son’s Divorcee, *Zaynab Bint Jash*,” answering-Islam.org, accessed 28 Sep 2005.

<sup>4434</sup> Ishaq. *Sirat*, p. 515.

<sup>4435</sup> Muir. *Life*, vol. 4, pp. 70-71.

<sup>4436</sup> Lings. *Sources*, pp. 241-242.

<sup>4437</sup> Trifkovic. *Sword*, p. 127.

claims that it depresses the sex drive altogether. ‘A *Hashish* user would not lift a finger for the most beautiful woman in Verona,’ he writes.<sup>4438</sup>

Marijuana must have stimulated *Muhammad*’s sex drive. Serge Trofkoic wrote about *Muhammad*’s unusual sexual symptoms:

According to Bukhari, *Muhammad* sometimes had sex with all his wives in one night, and at that time he had nine wives, and he once said of himself that he had been given the power of forty men [*Sahih Bukhari*, vol. i, bk. 5, no. 268; vol. vii, *Hadith* no. 142].<sup>4439</sup>

Hamdun Dagher wrote:

A tradition says: ‘The Messenger of God said ‘*Gabriel* met me with a pot, of which I ate and I was given the *Kafit* [sexual ability] of forty men’ (‘*Tabaqat Ibn Sa’d*, 8:192). Another tradition has it that *Muhammad* was given the strength of thirty men, as *Al Tabarani* mentioned (*Al Anwar Al Muhammadiyya Min Al Mawahib Al ‘adunniyya*, Beirut, 1892, p. 261) and *Al Bukhari*: ‘The Prophet used to visit all his wives in a round, during the day and night and they were eleven in number. I asked Anas, ‘Had the Prophet the strength for it?’ Anas replied, ‘We used to say that the Prophet was given the strength of thirty men’ (‘*Ghusl* 12 [*Sahih Bukhari*, vol. 1, bk. 5, no. 268]). *Salma* narrated: ‘In one night, the Prophet had intercourse with his nine wives (who were to outlive him). When he would come out each time he would say ‘Pour water for me.’ He would wash before having sex with the following one. I asked him ‘Oh Messenger of God, isn’t one time of washing enough for you?’ The Prophet replied, ‘This is purer and better’ (‘*Tabaqat Ibn Sa’d*, 8:193). *Al Qadi ‘Iyad* said that the Messenger of God was given enough strength to have intercourse with all his wives (*Al Shifa Fi Sifat Al Mustafa*, Beirut, 1980, 1:195).<sup>4440</sup>

*Muhammad* said in the above quote, “*Gabriel* met me with a pot, of which I ate and I was given the *Kafit* [sexual ability] of forty men” (*Tabaqat Ibn Sa’d*, 8:192). This story is *Muhammad*’s way of alluding to *Hashish* as though it were a heaven-sent drug. So THC may explain a lot of *Muhammad*’s excesses, both violent and sexual.

Notably, nudity and frolicking at night are main story elements in the two *Arabian Nights* tales about *Hashish*: “The Tale of the *Hashish* Eater” and the “traditional” “Tale of the Two *Hashish* Eaters.”

That *Muhammad* was able to have sex with nine or eleven women in a short period of time and not impregnate any sexual partner is consistent with marijuana use. Marijuana users often report sexual dysfunction, including the inability to achieve orgasm after arousal. So *Muhammad* likely faked an orgasm and then moved on to the next wife or concubine, repeating the process until he cycled through all his wives.

The inability to reach orgasm meant *Muhammad* found sexual satisfaction elusive. So *Muhammad* collected twenty-four women like other people might collect menageries in the forlorn hope that the next pretty woman would bring him instant satisfaction and a male heir.

<sup>4438</sup> Ben-Dov, Yoav. “Pot Luck,” haaretz.com, 23 May 2003, extracted from Daor, Dan (editor). *Dapei Esev: Hashish Besifrut Ha’olam, Antologia* (translated as “Grass Files: Anthology”), Hargol Books, Israel, 2003.

<sup>4439</sup> Trifkovic. *Sword*, p. 163.

<sup>4440</sup> Dagher, Hamdun. *The Position of Women in Islam*. Excerpt from Ch. 23, “The Prophet *Muhammad* and his Wives,” and footnotes 13 and 14, light-of-life.com.

*Muhammad* was not always impotent and all his sexual partners could not have been infertile. Tradition says that *Muhammad* did have a few children but the males all died in their infancy. Of the daughters who survived into adulthood, only *Fatima* outlived *Muhammad*. One however could imagine *Muhammad* having dozens of children given all his female acquaintances and his reportedly insatiable sex drive.

*Muhammad's* household may have used drugs, which may explain why the few children *Muhammad* sired did not survive to adulthood. Studies have found that when either the man or women uses marijuana, the couple is significantly less fertile and their newborns weigh less.<sup>4441</sup> The *Columbia Electronic Encyclopedia* states:

Marijuana lowers testosterone levels and sperm counts in men and raises testosterone levels in women. In pregnant women, it affects the fetus and results in developmental difficulties in the child.<sup>4442</sup>

Another reason *Muhammad* collected wives may have been the hope that the next woman would be fertile enough to make up for his lack of potency. Certainly it was a stigma in medieval Arabian culture to have such a large *Harem* and so few offspring.

The *Encyclopedia Britannica* mentions these symptoms arising from THC use:

Thought processes may also become disorganized, with fragmentation, disturbances of memory and frequent shifts of attention acting to disrupt the orderly flow of ideas.<sup>4443</sup>

Many infertility problems involve more than one factor and it seems as though *Muhammad's* involved both marijuana and a venereal disease (VD). Very likely, *Muhammad* gave his twenty-three sexual partners gonorrhea, a disease that causes miscarriages and infertility.

*Muhammad's* case is similar to that of England's Charles VIII, who remained heirless because he gave his six wives syphilis. Incidentally, *Muhammad* would not have had syphilis since that disease was only known in Europe after 1492 AD.

The *Clinical Microbiology Review* publication states:

It was not until AD 130 that [Roman physician] Galen, who mistakenly confused the purulent discharge associated with gonococcal urethritis with semen, introduced the term gonorrhea, i.e. 'flow [*rhoe*] of seed [*gonos*].'<sup>4444</sup>

The "discharge" is actually pus from the mucous membrane infection in the genital and urinary tracts. The purulent discharge is often called the "gonorrhea drip" which occurs any time during the day or night. Untreated gonorrhea leads to sterility in both men and women.

The *Hadith* suggest that *Muhammad* had the "gonorrhea drip" and that *Muhammad* and his wives mistook the pus for semen (Arabic: *Janaba*). This was in accord with the common ancient misunderstanding that the pus was semen, as noted above:

Narrated 'Aisha: 'I used to wash the semen off the clothes of the Prophet and even then I used to notice one or more spots on them' (*Sahih Bukhari*, vol. 1, bk. 4, no. 233).

<sup>4441</sup> "Smoking pot thwarts fertility treatments," msnbc.com, 31 Mar 2006.

<sup>4442</sup> *CEE*, Marijuana entry.

<sup>4443</sup> *EB*, accessed 28 Jun 2002, "Drug use" entry.

<sup>4444</sup> Edwards, Jennifer L. & Michael A. Apicella. "The Molecular Mechanisms Used by *Neisseria gonorrhoeae* To Initiate Infection Differ between Men and Women," *Clin Microbiol Rev.* 2004 October; 17(4), pp. 965–981, pubmedcentral.nih.gov.

Narrated 'Aisha: 'I used to wash the traces of *Janaba* (semen) from the clothes of the Prophet and he used to go for prayers while traces of water were still on it (water spots were still visible)' (*Sahih Bukhari*, vol. 1, bk. 4, no. 229).

The *Clinical Microbiology Review* publication states that gonorrhoea was known as a venereal disease (VD) long before *Muhammad's* time:

[Greek physician] Hippocrates referred to acute gonorrhoea as 'strangury' obtained from the 'pleasures of Venus' in the fourth and fifth centuries BC.<sup>4445</sup>

That *Muhammad* thought the pus was an over-abundance of semen and a gift from *Allah* delivered by the male Venus angel, is suggested by what the Spaniard Alvarus Paulus (flourished 854 AD) wrote about *Muhammad's* "gonorrhoea drip":

...In their disturbing teachings, these ones [that is, the *Muslims*] recount and babble, as if proclaiming something noble, that this pimp of theirs, preoccupied with the activity of seduction, had obtained the power of *Aphrodite* [the Greek **Venus**] in excess of other men; that he had received, as a gift from his god [*Allah*], a more abundant 'will of **Venus**' than others; that he had a **greater quantity of [seminal] liquid** for his foul activities than the rest; that **he could distribute this fluid with less effort** [very descriptive of gonorrhoea drip] than could other [uninfected] men; and that he had been given the endurance in *Coitus* and indeed the abundance of more than forty men for exercising his lust for women. The foul, fertile abundance of his rank loins [came] not from God, the begetter of all things, as this most evil robber dreamed, but from **Venus**, the ridiculous mate of *Vulcan*, that is, from the wife of fire. She is called *Afrodin* [*Aphrodite*] on account of this foamy liquid [**Venus** was thought to have been born of sea-froth and semen] and it is to her that venereal activity is ascribed. This shameless one [*Muhammad*] called her *Alkaufeit*. Excellent praise indeed! What an elegant gift of great carnality.<sup>4446</sup>

*Muhammad's* men also seem to have had the "gonorrhoea drip." That *Muhammad* mistook the pus for semen is suggested by the fact that he gave *Muslims* permission to do the *Hajj* in this condition "forever" afterward, as the *Hadith* record:

Narrated *Ibn 'Abbas*:...*Jabir* said surprisingly, 'Shall we go to *Mina* [at *Mekka* during the *Hajj*] while semen is dribbling from our male organs?'...When this news reached the Prophet he delivered a sermon...At that *Suraqa Bin Malik* stood up and asked 'Oh *Allah's* Apostle! Is this permission for us only or is it forever?' The Prophet replied, 'It is forever' (*Sahih Bukhari*, vol. 3, bk. 44, no. 683; also see vol. 9, bk. 92, no. 464).

By contrast, *Yahveh* told Moses that anyone with a continuous discharge was unclean and would have to remain outside the camp of Israel (Lev 15:03, 25, 26).

When *Muhammad* said that he was able to make the round of all his wives in one night (quoted above), this probably means he mistook the pus for semen each time. When he said he had the strength of thirty or forty men (quoted above), he probably thought the "gonorrhoea drip" was a continual flow of semen, as went the ancient misunderstanding. When *Muhammad* said men in *Muslim* heaven (*Janna*) would be given the strength of a hundred men (quoted above), he meant they would all have the "gonorrhoea drip."

<sup>4445</sup> Edwards, Jennifer L. & Michael A. Apicella. "The Molecular Mechanisms Used by *Neisseria* gonorrhoeae To Initiate Infection Differ between Men and Women," *Clin Microbiol Rev.* 2004 October; 17(4), pp. 965–981, pubmedcentral.nih.gov.

<sup>4446</sup> Wolf. *Antichrist*, p. 9.

### The *Koran* Itself Evidences *Muhammad's* Drug Abuse

The *Koran* itself evidences that the above symptoms occurred in *Muhammad*. Carlyle wrote:

It is as toilsome reading as I ever undertook, a wearisome, confused, jumble, crude, incondite [badly constructed]. Nothing but a sense of duty could carry any European through the *Koran*.<sup>4447</sup>

W. Montgomery Watt criticized the *Koran* for its “disjointedness.”<sup>4448</sup> The Arabic literary scholar R. A. Nicholson wrote that the *Koran* is...

...obscure, tiresome, uninteresting; a farrago [i.e. mix] of long-winded narratives and prosaic exhortations.<sup>4449</sup>

C. C. Torrey adds the following comments about the *Koran*:

His characters [e.g. the *Muslim* Noah, *Ibrahim* and Moses] are all alike and they utter the same platitudes. He is fond of dramatic dialogue but has very little sense of dramatic scene or action. The logical connection between successive episodes is often loose, sometimes wanting; the points of importance, necessary for the clear understanding of the story, are likely to be left out. There is also the inveterate habit of repetition and a very defective sense of humor....In *Sura* 11:27-51 is given a lengthy account of Noah's experiences....It contains very little incident, but consists chiefly of the same religious harangues which are repeated scores of time throughout the *Koran*, uninspired and uniformly wearisome. We have the feeling that one of Noah's contemporaries who was confronted with the prospect of forty days and forty nights in the ark would prefer to take his chances with the deluge [i.e. the Flood].<sup>4450</sup>

*Muslim* manufactured traditions to discredit criticisms of the *Koran's* glaring deficiencies. The tradition that *Muhammad* was an illiterate is an attempt to shift blame to others. That *Muhammad* was illiterate is less than likely given that *Muhammad* was a:

- ☉ Member of a revered clan, the *Hashimites*, of a respected tribe, the *Kuraish*.
- ☉ Man from a family that was heavily involved with pre-*Islamic* religion that was based mainly on Arabic poetry. Poetry was hung around the *Kaaba* in pre-*Islamic* times along with pictures of idols and cultic symbols. Notably, some of the poetry was allowed to remain hung on the walls of the *Kaaba* even after *Muhammad* purged the *Kaaba* of idols.<sup>4451</sup>
- ☉ Businessman who occasionally traveled. *Muhammad* also descended from a family of businessmen who sometimes traveled.

<sup>4447</sup> Quote of Carlyle in Geisler & Saleeb. *Answering*, p. 189.

<sup>4448</sup> Watt & Bell. *Introduction*, p. 22.

<sup>4449</sup> Nicholson, Reynold A. *A Literary History of the Arabs*, Cambridge University Press, Cambridge, United Kingdom, 1969, p. 161.

<sup>4450</sup> Torrey. *Foundations*, p. 108, as quoted in Warraq. *Why*, p. 55.

<sup>4451</sup> “But Arabic literature did not begin with the *Quran*. In the *Ka'aba* there were a number of poems ‘hanged’ [hung] on the walls. Some of these ‘hanged [hung] poems’ were allowed to remain after the *Muslim* order was established. They allow us some insight into the literature of pre-*Islamic* Arabia.” These included the poems of Imru-*Ul-Quais*, Antar and Zuhair (*Medieval Sourcebook: Pre-Islamic Arabia: The ‘Hanged’ Poems, before 622 CE*, fordham.edu/halsall/source/640hangedpoems.html).



- ☉ Husband of a rich woman, Khadija, who had been widowed. She surely would have been discriminating in her choice of a husband and a prerequisite would be that he could read.

Some traditions say the entire *Koran* was pieced together after *Muhammad's* death from memory and from scattered notes. One wonders what *Muhammad's* scribes, who are mentioned in *Muhammad's* biographies and in *Islamic* traditions, were doing while *Muhammad* was alive!

The *Koran* has *Allah* saying he provided a “**Koran**,” a “book,” not just scattered notes. The *Koran* says:

- ☉ I swear by the *Koran* full of wisdom (K 036:002).
- ☉ I swear by the *Koran*, full of admonition (K 038:001).
- ☉ I swear by the **Book** that makes things clear: Surely We [*Allah*] have made it an Arabic *Koran* that you may understand. And surely it is in the original of the **Book** with Us, truly elevated, full of wisdom (K 043:002-004).
- ☉ I swear by the **Book** that makes manifest (the truth). Surely We [*Allah*] revealed it on a blessed night... Therein every wise affair is made distinct (K 044:002-004).
- ☉ I swear by the glorious *Koran* (K 050:001).

If the truth were told about the *Koran*, it would probably be that the scribes edited and edited, but there was only so much the scribes could do with such sorry, psychedelic material. Not even Rumpelstiltskin could have spun such straw into gold.

So it seems that even after extensive scribal editing, the *Koran* is a monument to *Muhammad's* scattered thinking. This supports the hypothesis that *Muhammad* habitually used marijuana and hashish, especially just prior to his public revelatory episodes.

Unfortunately, this psychedelic literature is far from harmless. The *Koran* seems to exhibit the same faults as psychedelic experiences in general. The *Encyclopedia Britannica* states:

The literal meaning of the term psychedelic (“mind-manifesting”) suggests the vast amount of material (feelings, images, etc.) released by these drugs from the unconscious. This material, related as it is to the psychological needs and history of the person, is viewed as both uplifting and creative and, on the other hand, **frightening** and **destructive**.<sup>4452</sup>

As far as the *Koran* is concerned, more descriptive words than these could hardly be found!

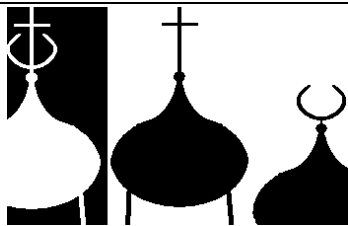
<sup>4452</sup> *EB*, accessed 3 Jul 2002, “Drug cult” entry.

## Chapter 16: Moon-o-theistic Religious Culture

### Deconstructing the Myth that *Islam* Borrowed the Crescent From Christianity

Gullible nineteenth-century aca*Dhimmis* believed uninformed *Muslims* who said that *Allah* and *Islam* had nothing to do with the crescent symbol. In the nineteenth century, many *Muslims* assumed that the Turks introduced the crescent symbol into the rest of *Islamdom* as late as the fifteenth century AD.

The crescent was used in the Roman and Byzantine Empires, leading some nineteenth-century aca*Dhimmis* to assume the Turks inherited the crescent from Constantinople. Some onion domes of some Orthodox churches still have crescents with crosses in modern times.



**Figure 16-01.** Illustration of crosses above crescents that are still seen above some Orthodox Church “onion” domes in southeastern Europe that celebrate the throwing off of *Islam*’s shackles. Left: the cross and crescent are on a single onion dome; right: the cross is on a taller dome and the crescent is on a shorter dome.

*Hughes Dictionary* (1885 ed.) speculates on the origin of the *Islamic* crescent:

Crescent...this figure however did not originate with the Turks, but it was the symbol of sovereignty in the city of *Byzantium* previous to the *Muslim* conquest, as may be seen from the medals struck in the honor of Augustus Trajan [reigned 98–117 AD] and others...It must have been adopted by *Muhammadans* for the first time upon the overthrow of the Byzantine Empire by *Muhammad II* and it is now generally used by the Turks as the insignia of their creed.<sup>4453</sup>

*Ibn Warraq* quoted the *Muslim* myth about the origin of *Islam*’s crescent:

The crescent, the emblem of *Islam*, was originally the symbol of sovereignty in the city of *Byzantium*.<sup>4454</sup>

Note how similar the above quotation is to the *Muslims*’ debatable contentions that the veil came from the Persians, iconoclasm came from Christianity and the *Koran*’s errors about Christianity worshipping Mary (*K* 072:003) and Jews worshipping Ezra (*K* 002:259-260; 009:030) came from sects that *Muhammad* knew of (all subjects discussed elsewhere).

The *Encyclopedia Britannica* notes that the myth about the origin of *Islam*’s crescent does not align well with history:

Later it [the crescent] became the symbol of the Byzantine Empire, supposedly because the sudden appearance of the moon saved the city of *Byzantium* ([later called] Constantinople [but now called *Istanbul*]) from a surprise attack. It once was thought that the *Ottoman* Turks adopted the crescent for their own flags after capturing Constantinople in 1453, but in fact they had been using the symbol for at least a century before that, for it appeared on the standards of their infantry under *Sultan* Orhan (~1324 to ~1360). In that case however the crescent may have been of different origin...<sup>4455</sup>

<sup>4453</sup> Hughes, *Dictionary*, p. 63, Crescent entry.

<sup>4454</sup> Warraq. *Why*, p. 194.

<sup>4455</sup> *EB*, accessed 22 Jun 2003, Crescent entry.

Similarly, Clare Gibson notes an even earlier Turkish use of the crescent well before Constantinople fell:

*Sultan* Osman had a vision of a crescent-moon before his conquest of the lands now known as Turkey in 1299 [AD] and it [the crescent] became the emblem of his dynasty, to whose scion, Mehmed II, Constantinople fell in 1453.<sup>4456</sup>

Early Byzantine crescent usage is discussed in the section on the Mary Orant icon (see the Index). Later cross-over-crescent usage on top of Orthodox Church onion domes (illustrated above) could conceivably be related to Mary symbolism (Rev 12:01), but probably is the Christian answer to earlier *Muslim* practices:

☉ Some early *Muslim* coins had a crescent over a cross and even sliced into a cross. These coins are discussed in an earlier chapter (see *Caliph coins* the Index).

☉ Since the eleventh century or before, *Muslims* put a crescent over a cross whenever they conquered a church or replaced the cross with a crescent.<sup>4457</sup> So when a church was regained from the *Muslims*, the Christians replaced the crescent with a cross or put a cross over the crescent. In at least one case a statue of the Virgin Mary still standing on a crescent was placed on top of a *Minaret* that the *Muslims* had built by a baroque-style church—at the castle-cathedral of Peter & Paul in *Kamyanets-Podilsky, Ukraine*.

Historians remark about the cross-over-the-crescent atop St. Dmitrii in the town of *Vladimir*, which is east of Moscow. This church was built between 1193-1197 AD by Vsevolod (also spelled Vsyevolod) III, who ruled 1176-1212 AD:

The cupola of Saint Dmitrii Cathedral has preserved to the present day its *Byzantine*, helmet-like shape. Its top is crowned with an old open-work gilded copper cross, which has a dove vane on its top and a crescent at the bottom, symbolizing the invincibility of the Orthodox faith and the victory of Christianity over *Islam*. It appears that the crescent was on the top of the cross during the [*Muslim*] *Tatar* [also *Tartar*] occupation of Russia [thirteenth to fourteenth centuries].<sup>4458</sup>

### Crescent Finials on Mosques Show that Allah was a Moon-god

Historically the crescent atop a pole has always stood for a moon-god. The war-and-moon-god *Mahram*'s pillars of monumental size in *Aksum, Abyssinia*, have a crescent atop, as discussed elsewhere (see *Aksum* in the Index). Bernard Goldman wrote:

The crescent on a pole, the symbol of the lunar god, is found in the ancient Orient [i.e. the Near East] and persists in later, *Nabataean* art where it crowns columns.<sup>4459</sup>

The crescent atop a *Mosque* finial stands for the war-and-moon-god *Allah*. Clare Gibson wrote:

...the symbol most closely associated with *Islam* today is the *Hilal*, or star and crescent, which represents sovereignty and **divinity**...<sup>4460</sup>

<sup>4456</sup> Gibson. *Symbols*, p. 109.

<sup>4457</sup> Newby. *Encyclopedia*, p. 81, *Hilal* entry.

<sup>4458</sup> "Russian Art and Architecture Through the Centuries: Cathedral of St. Dmitrii," Xenophone Group Internatinol, xenophongi.org/rushistory/artandarch/stdmitrii.htm; picture at: ar.utexas.edu/courses/glossary/building/list.html, accessed 29 Jan 2005.

<sup>4459</sup> Goldman. *Portal*, p. 108.

Cyril Glassé wrote similarly:

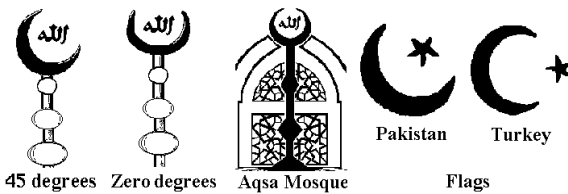
Moon... a crescent [finial] on the cupolas of *Mosques* is used to indicate the *Qiblah* (direction of *Makka*). Often three golden balls are placed below the crescent [see illustration, below]; traditionally they stand for the Material [*Nasut*], Subtle [*Malakut*] and Angelic [*Jabarut*] worlds (see “Five Divine Presences”) and **the crescent then symbolizes the world of Being** [*Lahut*].<sup>4461</sup>

Five Divine Presences... a metaphysical doctrine of the degrees of reality of which there are different versions. The following schema, according to the terminology of *Abu Talib Al Makki* (died 386 AH/996 AD), is the most systematic: in descending order, the five are: *Hahut*, Ipseity [selfhood], the Godhead, the Essence, Absolute Reality; ***Lahut*: the Reality of Being, namely the Divinity or Personal God**; *Jabarut*, the world of Angels; *Malakut*, the subtle world; and *Nasut*, the corporeal or human world... ***Lahut*: from the word *Al Ilah* [*Al Ilah* is abbreviated as *Allah*], or ‘Divinity.’ *Lahut* is Being and ‘Personal God’; or as Plato says, ‘the One Who Is.’**<sup>4462</sup>

So we can see from the above encyclopedic entries that the crescent stands for *Lahut* and *Lahut* comes from the word *Al Ilah*, meaning “the god.” *Allah* is an Arabic contraction for “the god” (*Al Ilah*), as F. E. Peters wrote:

The cult of the deity termed simply ‘the god’ (*Allah* < *Al Ilah*) was known throughout southern Syria and northern Arabia, and was obviously of central importance in *Makka* where the building called the *Kaaba* was indisputably his [*Allah*’s] house.<sup>4463</sup>

So from the above we see that crescent = *Lahut* = *Al Ilah* = *Allah*, which shows that *Allah* is a moon-god.



**Figure 16-02.** Examples of crescents used on finials and flags of *Islamic* countries.<sup>4464</sup> The round balls on the staff and the *Allah* (*aUI*) in the crescents are discussed in this section.

That *Allah* is represented by the crescent is especially apparent since:

- ☉ Some *Mosque* finials have the name *Allah* (*aUI*) inside the horns of the crescent.
- ☉ Many early coins have the name *Allah* (*aUI*), or the dedicatory abbreviation “to / for *Allah*” (*aU* = *Li-'llah*), inside the horns of the crescent.

*Abu Talib Al Makki* (quoted above) associated *Allah* with crescents in print sometime before his death in 996 AD. This explains why the name *Allah* is found in crescents on coins, over the grotto archway in the Dome of the Rock and over an entrance to the *Aqsa Mosque* (see the Thumbnail Gallery).

The crescent symbol is ubiquitous in *Islam* because *Allah* was an Arabian moon-god and the symbol naturally carried over into *Islam*. Gordon Newby pointed out:

<sup>4460</sup> Gibson. *Symbols*, p. 109.

<sup>4461</sup> Glassé. *Encyclopedia*, p. 274, Moon entry.

<sup>4462</sup> Glassé. *Encyclopedia*, p. 128, “Five Divine Presences” entry.

<sup>4463</sup> Peters. *Origins*, p. 107.

<sup>4464</sup> For more info on the association of the name *Allah* with crescent finials, see *Lahut* in the Index.

The crescent [Arabic: *Hilal*] or new-moon, it has become the symbol of *Islam*. . . . The crescent-moon began to appear, usually accompanied by a five- or six-pointed star, in the first *Islamic* century as a symbol on coins and decorations. By the fifth/eleventh century [AH/AD], the crescent was used to replace the cross when churches were converted to *Mosques*. In *Ottoman* times, the crescent and the star became emblems on *Muslim* battle flags and royal standards. In the twentieth century these symbols became the flag of the Republic of Turkey when it was declared in 1923. *Pakistan* also adopted it, as have a number of *Muslim* countries around the world.<sup>4465</sup>

That *Allah* was a moon-god explains why the word *Allah* (*aU*) and the abbreviation “to / for *Allah*” (*aU* = *Li-'llah*) can be found in crescents on coins, in inscriptions in the lunettes of archways, atop finials on the domes of *Mosques* and elsewhere in *Islam*.

In the chapter on moon-god temples, a crescent with the word *Allah* in it was discussed in connection with the Dome of the Rock. In the lunette of the archway entrance to the grotto under the Rock of *Ibrahim* is a canoe-like crescent with the word *Allah*. Similarly, a crescent finial over the *Aqsa Mosque* has the word *Allah* inside the crescent (see the Thumbnail Gallery).

### The Pantheon Hierarchy Common in the Mideast Shows *Allah* was a Moon-god

*Islam*'s atavistic crescent symbol for *Allah* stems from pre-*Islamic* times when the moon-god was the high astral god. *Ibn Warraq* wrote:

The worship of the moon is also attested by the proper names of people such as *Hilal*, a crescent, *Qamar*, a moon and so on.<sup>4466</sup>

It was common around the pagan world to think of the sun and moon as being spouses even in the New World. The *Pawnee* AmerIndian tribe called the moon-god *Pah* and his sun-goddess consort *Shakaru*.

Most gods in ancient times were thought to have consorts. Most often the sun and moon were thought to be each other's mate, so if the sun were male, the moon would be female, as is the case with *Apollo* the sun-god and *Luna* the lunar goddess.

In Arabia the gender role was reversed from the norm found in most places. *Allat*, meaning “the goddess,” was a title for the sun deity. *Allah* is the masculine form of the word *Allat*.

Some scholars in the past have thought that *Allat* might be a moon-goddess because it was thought her sign was a crescent-and-orb.<sup>4467</sup> However, the crescent in the couplet represents the male moon-god and it is only the sun orb that represents *Allat* the sun-goddess.

There is little doubt that in Arabia, *Allat* was an appellation for the sun-goddess. *Ibn Warraq* wrote:

The goddess *Al Lat* is also sometimes identified with the solar divinity.<sup>4468</sup>

*Yusuf Ali* wrote about the daughters of *Allah*:

<sup>4465</sup> Newby. *Encyclopedia*, p. 81, *Hilal* entry.

<sup>4466</sup> Warraq. *Why*, p. 40.

<sup>4467</sup> Levi illustrates a *Nabatean* “rock stèle of the Goddess *Allat* near *Ein esh-Shellaleh*.” It shows a primitive orb and crescent symbol formed using two ox horns and a rounded post. Levi thinks the post and orb are a rough anthropomorphism of the *Allat* “sun disc,” and he points out that the crescent-shaped bull horns have a “chalice” form (Levy. *Lost*, p. 75, fig. 13; also see p. 65).

<sup>4468</sup> Warraq. *Why*, p. 40.

They were all female goddesses. *Lât* almost certainly represents another wave [popular variety] of sun worship: the sun being feminine in Arabic and in Semitic languages generally.<sup>4469</sup>

Egerton Sykes wrote:

*Allat(u)*...Female counterpart of *Allah* from the pre-Islamic pantheon condemned by the *Koran*: ‘What think ye then of *Al Lat*?’ She is considered to have been the solar-goddess *Samas* [or *Shams*].<sup>4470</sup>

That *Allah* was the moon-god and *Allat* was the sun-goddess squares with other linguistic evidence:

- ☉ According to the *Encyclopædia Britannica*, the etymological origin of *Allah*’s name can be traced back to the earliest Semitic writings in which the word for god was *Il* or *El*.<sup>4471</sup>
- ☉ Carleton Coon wrote: ‘The god *Il* or *Ilah* was originally a phase of the moon-god, but early in Arabian history the name became a general term for god...under *Mohammed*’s tutelage, the relatively anonymous *Ilah*, became *Al Ilah*, The God, or *Allâh*, the Supreme Being.’<sup>4472</sup>
- ☉ Egerton Sykes wrote that *Ilah* was the ‘moon-god of the southern Semites, similar to *Ilmaqah*.’<sup>4473</sup> Egerton Sykes wrote that *Ilmaqah* was the:

Semitic moon-god, predecessor of *Allah*, in [the] pre-Islamic pantheon. He had a privileged place in the astral trinity [*sic*; actually, a triad], *Ilmaqah*, *Sams* and *Atter*, being a [grouping of] god[s] common to Semitism...In this particular pantheon the moon was masculine and the sun feminine, giving an indication of its great age...He [*Ilmaqah*] may have been equated to *Il* or *Ilah*.<sup>4474</sup>

So *Il* the moon-god = *El* the moon-god = *Ilah* the moon-god = *Ilmaqah* the moon-god = *Al Ilah* the moon-god, and later the contracted form, *Allah* the moon-god.

### The Grammatical Gender of the Moon Shows That *Allah* was a Moon-god

The grammatical gender of the word moon was one reason the moon was considered the high god in Arabian patriarchal societies. In Arabic, the usual words involving the moon are masculine: *Qamar* (moon), *Badr* (full-moon) and *Hilal* (crescent-moon).

The word for sun in Semitic languages is feminine.<sup>4475</sup> The *Encyclopedia Britannica* states ‘The word ‘sun’ is feminine in Arabic.’<sup>4476</sup> *Yusuf Ali* states:

...the Moon was a male divinity in ancient India; it was also a male divinity in ancient Semitic religion, and the Arabic word for the moon (*Qamar*) is of the masculine gender. On the other hand, the Arabic word for the sun (*Shams*) is of

<sup>4469</sup> *Yusuf Ali. Holy*, p. 1623, App. XIII.

<sup>4470</sup> Sykes. *Mythology, Allat(u)* entry, p. 7.

<sup>4471</sup> *EB*, accessed 21 Sep 2001, *Allah* entry.

<sup>4472</sup> Coon. *Southern*, p. 399.

<sup>4473</sup> Sykes. *Mythology*, p. 102, *Ilah* entry.

<sup>4474</sup> Sykes. *Mythology*, p. 102, *Ilmaqah* entry.

<sup>4475</sup> Hebrew, like Arabic, is a Semitic language. In Hebrew, the moon (*Yareach*) and crescent (*Saharon*) are masculine, a star (*Kowkab*) is masculine, and the sun (*Shemesh*) is considered either masculine or feminine. Greek by contrast is an Indo-European language where the sun (*Helios*) is masculine, the moon (*Selene*) is feminine, and a star (*Astron*) is neuter.

<sup>4476</sup> *EB*, ‘Arabian Religions’ entry, accessed 20 Nov 2001.

the feminine gender. The pagan Arabs evidently looked upon the sun as a goddess and the moon as a god.<sup>4477</sup>

Unfortunately, *Koran* translations most often do not follow the Arabic conventions concerning the gender of the sun and moon. In determining the gender of the sun and moon in translation, scholars generally follow the ancient mythology of the locale. So English translations use masculine pronouns for the sun and feminine pronouns for the moon (or neuter for both the sun and moon). Take for instance the English translation of K 091:001-002:

- ☉ Both the *Yusuf Ali* and *Pickthall* English translations have the sun as masculine (his, him) and the moon as feminine (she).
- ☉ The *Shakir* English translation uses the neuter (its) for both the sun and moon.

Changing the genders of the sun and moon in the *Koran* obscures the *Koran's* origin in astral triad worship. An interesting parallel is found in Arabic erotic poetry where both the lover and the beloved are male. By merely changing a few pronouns in the translation, the poetry is transformed from homoerotic to heteroerotic poetry, as Stephen Murray wrote:

The famed medieval poets who wrote in Persian or Turkish all wrote poems about desired boys. Indeed, not only in poetry, but all genres were written about men, by men, and for exclusively male audiences. Often, its pederastic content has been obscured in translation with female pronouns.<sup>4478</sup>

### ***Islam's Moon-god Religion Elements Show That Allah Was a Moon-god***

That *Muhammad* was a moon-god worshipper for the first forty years of his life explains why moon-god elements appear in *Islam*. For instance, *Ramadan*, one of the sacred months, is meant to honor the month in which the *Koran* was revealed (K 002:185-187). The angel *Gabriel* supposedly first appeared to *Muhammad* a few miles from *Makka* at Mount *Hira*, on a night with a crescent-moon.<sup>4479</sup>

Rather than celebrate for a period of time marked by the sun, such as a day or a week, *Ramadan* and the sacred months (K 009:002, 005, etc.) are marked by one cycle of the moon's phases from crescent to crescent.<sup>4480</sup>

The *Koran* demands that, during the lunar month of *Ramadan*, *Muslims* fast and abstain from sexual intercourse during daylight hours (K 002:187). This means the *Koran* wants followers to yearn for and be loyal to the god who rules the night.

*Ramadan* is a pro-lunar, anti-solar rite, where the moon-god monopolizes all worship to himself. Having sex and feasts only at night during the lunar month of *Ramadan* shows *Islam* to be an astral fertility religion.

That *Allah* wants his followers to revere his realm of the night can be ascertained especially from "the Night of Power" (*Laylat ul-Qadr*), which night occurs near the end of the month of *Ramadan*. Worship and work during this night are said to carry more value than the worship and works of one thousand months (K 097:003). This hyperbole seems to imply that forgiveness or intercession by another god or goddess besides *Allah* is no longer needed.

<sup>4477</sup> *Yusuf Ali. Holy*, p. 1621, App. XIII.

<sup>4478</sup> Murray. *Culture*, pp. 132, 136.

<sup>4479</sup> Tajddin. *Ismailis*.

<sup>4480</sup> *Hadith*: "Do not fast unless you sight the crescent, and do not break your fast till you sight the (following) crescent" (*Al Bukhari*, vol. 3:130).

“The Night of Power” occurs during the month of *Ramadan* when angels are said to descend by the decree of *Allah* (K 002:185; 044:001-006). The angels descend from the moon since this is considered the gate to the First Heaven, as made clear in various renditions of *Muhammad’s* Night Journey.<sup>4481</sup>

During “the Night of Power” (*Laylat ul-Qadr*) *Muslims* stay awake all night reading and studying the *Koran*, listening to religious addresses and performing *Salat*. The *Koran* tells believers to pray and worship at night:

Remember the name of our Lord morning and evening; in the nighttime worship Him: praise Him all night long (K 076:023; see also K 017:078).

Many *Muslims* celebrate *Laylat ul-Qadr* on the twenty-seventh night of *Ramadan*, a month that is about thirty days long. This means many *Muslims* celebrate “The Night of Power” when the sliver of the waning crescent-moon can be seen right before the three-day new-moon conjunction, or interregnum, is about to begin.

The activities that take place and the timing of the Night of Power near the end of the lunar month of *Ramadan*, are especially interesting when one notes what the *Encyclopædia Britannica* has to say about moon-god worship:

The mythology of the moon emphasizes especially those periods when it disappears—the three days of darkness in the lunar cycle and eclipses...The interregnum is interpreted as an evil period necessitating strict taboos against beginning any new or creative period (e.g. planting or sexual intercourse). In some areas loud noises are part of a ritual activity designed to scare off the moon’s assailant.<sup>4482</sup>

### The Arabic Alphabet Shows that *Allah* Was a Moon-god

The *Ugaritic* alphabet had thirty letters—one letter per day of the soli-lunar month, as Finn Rasmussen wrote:

The Ugaritic alphabet is a poem...The alphabet is invented in a *Canaanite* temple. We can expect that the subject of the poem is essential religious ideas and rituals. The religious life was ruled by the lunar calendar and the lunar phases....The assumption will be that the 30 letters is a list of the days in the month. This idea was proposed by Moran and Kelley (Moran and Kelley 1969).<sup>4483</sup>

Interestingly, “the South-Arabic alphabet has 29 letters,”<sup>4484</sup> again indicating a lunar orientation. With this information in mind, the fact that the *Koran* has twenty-nine *Suras* prefixed by mystical characters and twenty-nine mentions of the moon (see tables in each case) can only indicate the lunar orientation of the *Koran*.

The astral orientation of the twenty-nine characters seems to be confirmed by the fact that the *Shias* call the mystical characters “light-possessing, light-giving” and “the bright ones.”<sup>4485</sup>

Due to his limited exposure to the world, *Muhammad* thought that the Arabic language somehow confirmed the authenticity of his message better than would Hebrew, Greek, Syriac or Aramaic (K 016:103; 026:195; 046:012). That *Muhammad*

<sup>4481</sup> Fani. *Sufis*, p. 45.

<sup>4482</sup> *EB*, accessed 15 Oct 2001, “Moon Worship” entry.

<sup>4483</sup> Rasmussen. Letter.

<sup>4484</sup> Rasmussen. Letter.

<sup>4485</sup> Donaldson, Bess Allen. “The *Koran* as Magic,” *The Muslim World* (1937 AD), vol. 27, pp. 254-266, answering-*Islam.org*.



thought a moon-god revealed the alphabet and pen helps to explain how Arabic came to have such a curvy form.

<b>The <i>Koran's</i> Seemingly Nonsensical Letters (Detailed)</b> (Found at the Start of Twenty-Nine Chapters)		
No.	Seemingly Nonsensical Letter(s) at the Start of <i>Suras</i>	Mention of Verse, Book, <i>Koran</i> , Pen, Etc., Mostly at Start of <i>Sura</i>
1	002:001 <i>Alif Lam Mim</i>	002:002 Book
2	003:001 <i>Alif Lam Mim</i>	003:003 Book, <i>Torah</i> and Gospel
3	007:001 <i>Alif Lam Mim Sad</i>	007:002 Book
4	010:001 <i>Alif Lam Ra</i>	010:001 Verses, Book
5	011:001 <i>Alif Lam Ra</i>	011:001 Book
6	012:001 <i>Alif Lam Ra</i>	012:001 Book; 012:002 “Arabic <i>Koran</i> ”
7	013:001 <i>Alif Lam Mim Ra</i>	013:001 Book
8	014:001 <i>Alif Lam Ra</i>	014:001 Book
9	015:001 <i>Alif Lam Ra</i>	015:001 Book, <i>Koran</i>
10	019:001 <i>Kaf Ha Ya Ain Sad</i>	019:012 Book; 019:016 Book
11	020:001 <i>Ta Ha</i>	020:002 <i>Koran</i>
12	026:001 <i>Ta Sin Mim</i>	026:002 Verses, Book
13	027:001 <i>Ta Sin</i>	027:001 <i>Koran</i> , Book
14	028:001 <i>Ta Sin Mim</i>	028:002 Verses, Book
15	029:001 <i>Alif Lam Mim</i>	029:027 Book
16	030:001 <i>Alif Lam Mim</i>	030:058 <i>Koran</i>
17	031:001 <i>Alif Lam Mim</i>	031:002 Verses, Book of Wisdom
18	032:001 <i>Alif Lam Mim</i>	032:002 Book
19	036:001 <i>Ya Sin</i>	036:002 <i>Koran</i>
20	038:001 <i>Sad</i>	038:001 <i>Koran</i>
21	040:001 <i>Ha Mim</i>	040:002 Book
22	041:001 <i>Ha Mim</i>	041:002 Revelation; 041:003 Book 041:003; Book, Arabic <i>Koran</i>
23	042:001 <i>Ha Mim</i> ; 042:002 <i>Ain Sin Qaf</i>	042:007 Arabic <i>Koran</i>
24	043:001 <i>Ha Mim</i>	043:002 Book; 043:003 Arabic <i>Koran</i> ; 043:004 Book
25	044:001 <i>Ha Mim</i>	044:002 Book
26	045:001 <i>Ha Mim</i>	045:002 Revelation, Book
27	046:001 <i>Ha Mim</i>	046:002 Revelation, Book; 046:012 Book, Arabic Language
28	050:001 <i>Qaf</i>	050:001 <i>Koran</i>
29	068:001 <i>Nun</i>	068:001 Pen, What Angels Write

*Muhammad* believed that one of the angels' main activities was writing with pens (K 068:001). *Muhammad* thought *Allah* was never at a loss for words either. *Muhammad* said that if every tree on earth was made into a pen and there were seven oceans of ink, they would not be able to write all that *Allah* has to say (K 031:027).

*Muhammad* believed that *Allah* taught humans how to write (K 096:004). Evidently, *Muhammad* thought that the Arabic letters were divinely inspired too. The reason this inference can be made is that twenty-nine chapters of the *Koran* begin

with seemingly nonsensical Arabic letters, as though the Arabic letters were as inspired as the *Koran's* content itself. The letter names, as opposed to the letters' sounds, are read or recited.

Near the very start of all but three (*K* 019, 029, 030) of these twenty-nine chapters with seemingly nonsensical Arabic letters (*Muqattaat*, meaning "Disjointed letters"), there is a mention of the "*Koran*," or "Book," or "Pen."

In the three chapters just mentioned (*K* 019, 029, 030), the word "*Koran*," or "Book," or "Pen," is found later in the chapter. This seems to confirm that *Muhammad* was saying that *Allah* equally inspired both the Arabic letters and text.<sup>4486</sup>

The moon may have influenced the direction that Semitic languages are written. The moon was often associated with wisdom and scribal gods attended the moon in mythology just as *Nabu* (or *Nebo*) attended the moon-god *Sin*.

Originally the languages were written both ways. In *Boustrophedon* writing, the alternate lines of script run right-to-left and then left-to-right. Semitic scribes, who tended to be moon-god priests, noticed that:

- ☉ The moon swept from east to west through the night sky but never west to east (*K* 002:258).
- ☉ *Muhammad* said that the fact that sun rose toward the right and set to the left showed *Allah's* guidance (*K* 018:017).
- ☉ In the northern hemisphere the moon is lit first on the right side at the beginning of the lunar month and on the left side at the end of the month.

Accordingly scribes, whose scribal god *Nabu* was an associate of the moon-god *Sin*, decided that writing from right to left was preferable.

After an initial period of development, the alphabets of the Mideast generally became squared and rectilinear. Once moon-god monotheism became dominant, the moon-god culture influence the shapes of the alphabet. Several of the resultant letters combined with pointing strongly resemble the star-and-crescent couplet ☉.

The squared *Kufic* and *Naskhi* scripts of pre-*Islamic* and early *Islamic* centuries steadily became decidedly curvy and crescent-moon shaped as the *Islamic* centuries progressed.

Other later Arabic scripts, especially calligraphy, took on an even curvier, ropy look. For instance, the *Maghrebi* Arabic writing style found in northwest Africa looks even more "moon-like" than *Naskhi* script. It is interesting to note that the descendants of *Islamic* slaves taken from Africa, perhaps from where the *Maghrebi* script was used, "remembered them as worshippers of the sun and moon."<sup>4487</sup>

Modern *Naskhi* Arabic letters given in the chart below are mostly in the final form, rather than the medial or initial form. The final form of most letters is curvier than the medial or initial form. The reason is that crescent shapes are easier to form at the end of a word than at the start or in the middle of a word.

That most Arabic letters were modified to have a curvy shape presented some problems. There are only so many distinctive letters that can be formed with one, two or three curves. *Ibn Warraq* wrote about the original Arabic *Koran*:

<sup>4486</sup> Asad agrees with this observation, though he does not mention specifics (Asad, *Message*, App. II, p. 992).

<sup>4487</sup> Pipes, Daniel. Book review of "*Servants of Allah: African Muslims Enslaved in the Americas* by Sylviane A. Diouf," *Middle East Quarterly*, DP, Dec 2000.

Uthman’s codex was supposed to standardize the consonantal text; yet we find that many of the variant traditions [i.e. different readings] of this consonantal text survived well into the fourth *Islamic* century [300-400 AH/912-1009 AD]. The problem was aggravated by the fact the consonantal text was unpointed, that is to say, the dots that distinguish, for example, a ‘b’ from a ‘t’ or a ‘th,’ were missing. Several other letters (f and q; j, h and kh; s and d; r and z; s and sh; d and dh; t and z) were indistinguishable. As a result, a great many variant readings were possible according to the way the text was pointed (had dots added). The vowels presented an even worse problem. Originally, the Arabs had no signs for the short vowels—these were only introduced at a later date. The Arabic script is consonantal.<sup>4488 4489</sup>

Most of the letters that *Ibn Warraq* mentions in the above quote have crescent shapes as can be seen in the accompanying tables on Arabic letters.

ENGLISH	ʾ	b	g	d	h	w	z	ḥ	ṭ	y	k
HEBREW	א	ב	ג	ד	ה	ו	ז	ח	ט	י	כ
5th Century C. E. Kufic	Ⲁ	Ⲃ	Ⲅ	Ⲇ	ⲈⲀ	Ⲋ	Ⲍ	Ⲏ	Ⲑ	Ⲓ	Ⲕ
7th Century C. E. Naskhi	ا	ب	ج	د	ه	و	ز	ح	ط	ي	ك
ARABIC	ا	ب	ج	د	ه	و	ز	ح	ط	ي	ك
ENGLISH	l	m	n	ṣ	ʿ	p	ṣ	q	r	s	t
HEBREW	ל	מ	נ	ס	ע	פ	צ	ק	ר	ש	ת
5th Century C. E. Kufic	Ⲍ	Ⲏ	Ⲑ	Ⲓ	Ⲕ	Ⲗ	Ⲙ	Ⲛ	Ⲝ	Ⲟ	Ⲡ
7th Century C. E. Naskhi	ل	م	ن	س	ع	و	ز	ح	ط	ي	ك
ARABIC	ل	م	ن	س	ع	و	ز	ح	ط	ي	ك

Figure 16-03. Comparison of some rather squared Hebrew and the increasingly crescent-shaped Arabic script.<sup>4490</sup>

*Ibn Warraq* demonstrated that several sets of characters look very much alike.<sup>4491</sup> One set of similar-looking letters looks like the first *Alif* (l) of the word *Allah* (aUl), except for a squiggle: Cutting *Hamza*, ‘*Alif Madda* and the Joining *Hamza*.

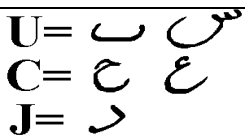
*Allah* the moon-god is associated with the crescent-moon and the middle part of the word *Allah* (aUl) looks like a crescent, so even the first letter *Alif* in the archaic Arabic alphabet came to have a lunar association on account of its being the first letter in the word *Allah*.

<sup>4488</sup> Warraq. *Why*, p. 108.

<sup>4489</sup> Richard Plant gives a list of indistinguishable *Kufic* letters (Plant, *Coins*, p. 32).

<sup>4490</sup> “Appendix H: A Comparative Table of Syriac, Hebrew, and Arabic Scripts,” and “Appendix I: A Comparative Table of Nabataean and Arabic (adapted from *Dictionnaire de la Bible*, vol. i, Paris, 1895)” (Warraq. *What*, pp. 768-769).

<sup>4491</sup> Warraq. *What*, “App. L: A Dot or Two Can Make All the Difference,” p. 775.



**Figure 16-04.** U, C and J-shaped crescent letters. These basic crescent patterns were adapted to create most of the letters of the Arabic alphabet.

Other sets of similar-looking characters have a more direct lunar association:

- ☉ One set of letters looks like a U-crescent-moon, except for a dot or a squiggle: *b, t, th, ba, bu, bi, b, bb, s* (with and without the dot below), *sh/s* and *d*.
- ☉ Another set of letters looks like a C crescent-moon, except for a dot or a squiggle: *j/g, h, kh/h, ‘ayn* and *gh/g*.
- ☉ Another set of letters looks like a J-crescent-moon, except for a dot or a squiggle: *d, dh/d, r* and *z*.

The above data indicate that even though several sets of similar-looking crescent-shaped letters caused endless confusion, they were pressed into service for *Allah* the moon-god anyway.

*Ibn Rawandi* wrote about the unpointed text of early *Korans*:

...finding the originally intended sequence of consonants...becomes something of a lottery.<sup>4492</sup>

G. R. Puin of the University of *Saarland*, the scholar who discovered early *Koran* manuscripts in the wall of a *Mosque* in *San ‘a, Yemen*, found that...

...every fifth sentence or so simply doesn’t make sense...a fifth of the *Koranic* text is just incomprehensible.<sup>4493</sup>

Arabic letters each have three forms: initial, medial and final. As though the confusion were not enough, even the Arabic letters that do not have a basic crescent shape in their initial or medial form often have crescent-shaped tails in their final form.

The final letterform occurs when the letter is at the end of a word. Sheila Blair called the tails of Arabic final letters “crescent or shovel-shaped.”<sup>4494</sup> Letters with a crescent-shaped final form include: *Jim, Ha, Kha, Sin, Shin, Sad, Dad, ‘ayn, Ghayn, Qaf, Kaf, Lam, Nun, Waw* and *Ya*.<sup>4495</sup>

A system of diacritical marks eventually came into use to differentiate the letters of the Arabic alphabet. Dots were also used to indicate the various vowels. Perhaps dots were introduced instead of additional vowel letters since still more crescent-shaped letters would have been even more confusing.

The diacritical dots looked like stars and an asterism (i.e. a small group of stars), so many letters were made to appear like crescent-and-star symbols. The dots also made the *Koran* look as though it were written in a field of stars. A line of the Arabic *Koran* looks like a swatch of the Milky Way. A page of the *Koran* looks like a starry night with lines indicating the constellations.

Arabic script looks like so many crescent-moons and constellations among a field of stars (diacritical marks). On account of its moon-god symbolism, Arabic script was considered too sacred for infidels to use. Bat Yeor wrote:

<sup>4492</sup> Warraq. *What*, Ch. 8.3: “On Pre-Islamic Christian Strophic Poetical Texts in the *Koran*: A Critical Look at the Work of Gunter Luling,” p. 656.

<sup>4493</sup> Warraq. *What*, p. 121.

<sup>4494</sup> Blair. *Inscriptions*, pp. 166-167.

<sup>4495</sup> Warraq. *What*, “Appendix K: The Arabic Alphabet,” p. 774.

In fact, this *Arabization* was imposed on the *Dhimmis* by *Caliph Abd Al Malik* (ruled 685-705 AD) who ordered the *Arabization* of the whole administration of the Byzantine and *Sassanid* territories occupied by the conquering Arabs. All *Dhimmis*, and not only the Christians of Palestine, were forced to accept this *Arabization*, although they were forbidden to use the Arabic alphabet, considered too sacred for infidels.<sup>4496</sup>

Still today in Egypt:

A Christian may not teach Arabic, because this material is linked to the teaching of the *Islamic* religion.<sup>4497</sup>

In Copenhagen, Denmark, *Muslims* took umbrage when a teacher quoted the *Koran*:

He was leaving the Theology department in the middle of the city when he was being brutally beaten up by five men whom he did not know. Allegedly they kicked and hit him because he has quoted from the *Qur'an* during a lecture. They told him that an infidel was not allowed to do that.<sup>4498</sup>

Because of Arabic script's moon-god symbolism, for a long while the practice of adding diacritical marks to the text was resisted. Since in former times the stars were considered gods and goddesses, adding star-like dots to Arabic script's crescent-shaped letters was considered tantamount to polytheism—"adding partners to *Allah*." *Ibn Rawandi* wrote about how the badly needed pointing of the *Koranic* text was resisted for centuries:

Every Arabic text today, as for the past fourteen or fifteen centuries, consists of three different layers. First, the basic letter shape or drawing (*Rasm*). Second, the diacritical points (*Nuqat*), the function of which is to differentiate the otherwise similar letters of the *Rasm*. And third, the strokes for the vowels (*Harakat*), which are not shown in the basic consonantal text of the *Rasm*. The crucial point here is that in pre-*Islamic* and early *Islamic* times the diacritical points were not set at all in everyday writing, because they were not yet known or not commonly accepted. In the *Koran* text, at least during the first century of its existence, diacritical points were even forbidden, ostensibly out of pious reverence for the holy text. All the older *Koran* codices that have come down to us display the text without diacritical points and signs, not to speak of the strokes for the vowels, which were introduced even later. This means that finding the originally intended sequence of consonants, and hence the originally intended meaning of the text, becomes something of a lottery, often determined by the preconceptions of the redactor as to what the text ought to mean.<sup>4499</sup>

Alphabets of other languages are more rectilinear and have fewer crescent-shaped letters than Arabic. This may be a reason why *Muslims* disdain translations of the *Koran*. This is as plausible a reason as the one commonly given—that the poetic "ring" of the *Koran* is not reproducible in translation.

<sup>4496</sup> Yeor. *Dhimmitude*, p. 370.

<sup>4497</sup> "The [Coptic] Humiliation Continues: An interview with Youssef Sidhom, director of 'Watani,' *Il Regno*" (biweekly of the Sacred Heart congregation of *Bologna*), Chiesa.com, 15 Sep 2003; also see Adelman, Jonathan & Agota Kuperman. "The Christian Exodus from the Middle East," *copts.net*, 2001.

<sup>4498</sup> Spencer, R. "Jewish teacher attacked in Copenhagen—for quoting *Qur'an*," *DW*, 12 Oct 2004.

<sup>4499</sup> Warraq. *What*, Ch. 8.3: "On Pre-*Islamic* Christian Strophic Poetical Texts in the *Koran*: A...Look at the Work of Gunter Luling," by *Ibn Rawandi*, pp. 655-656.

As *Islamic* centuries rolled by, the script became ever more curvy. A motivation for this development is that the crescent-moon script added veracity to the text in the eyes of moon-o-theists, as one of *Muhammad's* followers, Ka'b b. Malik, said:

Like the full-moon that cannot lie, when he [*Muhammad*] appeared [like the full-moon], we followed him and held him true.<sup>4500</sup>

Out of a mere twenty-eight letters in the squared Arabic alphabet, a surprising number have crescent shapes. *Encyclopædia Britannica* states that even the Arabic letters derived from earlier alphabets did not retain their initial form but were arced into curvy shapes:

Twenty-two of the letters are those of the *Semitic* alphabet from which it [*Arabic*] descended, modified only in letter form, and the remaining six letters represent sounds not used in the languages written in the earlier alphabet.<sup>4501</sup>

ع	ى	ب	ض	د	ف	گ	غ
ain	alef	beh	dad	dal	feh	gaf	ghain
maksura							
ح	ج	ژ	ك	ك	خ	ل	ى
hah	jeem	jeh	kaf	keheh	khah	lam	maksura
ن	پ	ق	ر	ص	س	ش	چ
noon	peh	qaf	reh	sad	seen	sheen	tcheh
ت	ذ	ث	و	ي	ز	٢	٤
teh	thal	theh	waw	veh	zain	two	four

Figure 16-05. Sample of Arabic letters and numerals that incorporate crescent shapes.

### Criticisms of the Idea That the Arabic Alphabet Was Inspired by the Moon

It could be argued that there are several moon-shaped letters in the English alphabet. This is to be expected because the English alphabet was derived mostly from the Latin alphabet. The Latin alphabet was in turn derived from the Greek alphabet, and the source of the Greek alphabet was the *Phoenician* alphabet.

Romans, Greeks and *Phoenicians* all worshipped the moon. Romans worshipped the goddess *Luna*, Greeks worshipped the goddess Selene and *Phoenicians* worshipped the male West *Semitic* moon-god *Yarikh* (also spelled *Yerah* and *Yareach*).<sup>4502</sup>

The *Phoenicians* borrowed many of their alphabet letters from *Canaanites* like the moon worshippers of *Ugarit*. Finn Rasmussen wrote about the *Ugaritic* alphabet:

It's a common mistake that alphabets are constructed just to have one symbol for each phoneme. *Ugaritic* has 30 symbols [only] because the [lunar] month has 30 days. Some of the 30 letters are unnecessary. The two letters *s* and *š* probably had the same pronunciation in *Ugaritic*. The two letters *q* and *k* also have the same pronunciation. Even in *Ugaritic* there was some confusion about which of them to use....The alphabet poem gives a very precise description of the sphere of authority of the principle gods. Now we are able to have a better

<sup>4500</sup> Ishaq. *Sirat*, p. 422.

<sup>4501</sup> *EB*, accessed 15 Nov 2001, "Arabic alphabet" entry.

<sup>4502</sup> *EB*, accessed 24 Jun 2003, *Yarikh* entry.

understanding of the significance of the moon in Prehistoric Times. The alphabet poem was invented in some *Canaanite* temple...<sup>4503</sup>

Rasmussen also wrote that other *Ugaritic* letters have moon-god connections:

- ☉ A (*Alfu*), meaning cattle, probably with crescent-shaped horns.
- ☉ B (*Bet*) stands for a temple, probably a moon-god temple.
- ☉ The third *Ugaritic* letter is named “the crescent” (*Gamlu*).
- ☉ The thirtieth letter is named “the moon” (*Shri*).
- ☉ Each *Ugaritic* letter consists of little wedge marks made in clay. Finn Rasmussen writes that a single wedge mark is the symbol of the moon-god, and his wedge mark is found in letters 3 (crescent), 27 (“turn,” i.e. to the dark new-moon phase), 28 (*Ibbu* moon-goddess) and 29 (light).
- ☉ Rasmussen theorizes that the twenty-eight *Ugaritic* letter “I” (*Ib*) comes from *Ibbu*, the moon-goddess who was married to the moon-god *Yarikh*.
- ☉ The thirteenth and fourteenth letters are named “shine” and “flame,” respectively. They are so named because the full-moon shines all night on the thirteenth and fourteenth nights of the lunar calendar, and these were the favored nights for parties lit by torches and bonfires. In this connection it is worth noting, “In the Arabian moon-calendar, these are the two full-moon days.”<sup>4504</sup>

Someone might say there is no evidence that moon worshippers who passed down what has become the English alphabet had any affect on the alphabet. Thus someone will contend that the curvy letters of the Arabic alphabet likewise were not affected by their moon-god origins.

The English letter C initially came from the *Phoenician* letter *Gimel* or *Gaml*, meaning a “camel” or a “throw stick.”<sup>4505</sup> The “throw stick” refers to a crescent-shaped boomerang. Both the camel and a boomerang were associated with the crescent-moon (Jdg 08:21, 26). Finn Rasmussen explains the moon-god connection with the letter *Gimel*:

We don’t know the meaning of the Hebrew letter name *Gimel* but with the same root *gml* we have *Gàmal* = ‘camel.’ It’s a common belief that the early letter name means ‘camel,’ and this could explain the Proto-*Canaanite* pictogram, but it doesn’t explain the *Ugaritic* pictogram. The word for ‘camel’ is *Udr* in *Ugaritic* (KTU. 1.4, V, 17). The first textual evidence to the word ‘camel’ appears in *Assyrian* records in the ninth century BC of a battle in North Syria against some Arab nomads (Schwartz<sup>4506</sup>). It is possible that a word with the root *gml* means ‘divine’ because it is made by the two Hebrew words *Gam* = ‘also, as’ and *El* = ‘God.’ Then we have to look for another divine creature than the camel. Albright (Albright 1966) has proposed the meaning ‘throw-stick’ because *Gaml* means ‘throw-stick’ in Ethiopian. Throw-sticks and camels are not mentioned in *Ugaritic*. In the *Ugaritic* poem about the marriage of the moon-god we have the name *Gml* = ‘sickle’ in the context. ‘*Hilal*, master of the sickle’ (KTU, 1.24:41).

<sup>4503</sup> Rasmussen. Letter.

<sup>4504</sup> Daum. *Ursemitische*. p. 60.

<sup>4505</sup> *Heritage*, “Development of the Alphabet” table.

<sup>4506</sup> *Civilizations of the Ancient Near East*, vol. i. Edited by Jack M. Sasson *et al.* New York, 1995, article by Schwartz, Glenn. M., p. 256.

*Hilal* means ‘the shining one’ in Hebrew and Arabic and in Ethiopian it means ‘moon-crescent.’ He is a moon-god. In *Akkadian* we have the word *Gamlu* = ‘scimitar,’ a sword in sickle form, symbol for the Mesopotamian moon-god *Sin* (*Assyrian Dictionary*, 1956, 5.35). In the Stone Age and Bronze Age the sickle was made of stone and looked like the crescent of the moon. The Proto-*Canaanite* pictogram is probably a crescent and the same thing can be said of the South-Arabic letter symbol. The *Ugaritic* pictogram is a straight vertical wedge, but it is acceptable as a picture of the crescent since it is impossible to carve bent curves with a single wedge. The early letter name in *Ugaritic* is *Gml*. As to the pronunciation, the *Akkadian* and Ethiopian are more original than the Hebrew and I [Rasmussen] will choose *Gamlu*. In Bronze Age *Canaan* crescents are depicted on steles (Keel and Uehlinger, 1992) and on a cylinder seal, where the crescent is placed on top of a standard beside a god (Parker 1949, no. 190). The meaning ‘crescent’ of the letter name [g] could be an icon in the temple, or it could be the moon-crescent.<sup>4507</sup>

One can see from the development of the letter C that the Romans must have known the letter C honored the moon-god. At first the letter was angular, but under the tutelage of the moon-worshipping Romans, the letter C came to resemble the moon.

DEVELOPMENT OF THE ALPHABET									
PROTO-CANAANITE		SEMITIC		PHOENICIAN	EARLY GREEK	GREEK		ETRUSCAN	CLASSICAL ROMAN
		Names	Sounds			Names	Sounds		
c. 1500 B.C.				c. 1000 B.C.	c. 800 B.C.			c. 500 B.C.	
L	7	gaml	gamel	lgl	7	gamma	lgl	7	C
		"throwstick"							

Figure 16-06. How the ancient *Gimel* letter developed into the Roman Letter C.<sup>4508</sup>

The Romans derived the letter G from the letter C, so G is a second English letter derived a moon-god symbol. *The American Heritage Dictionary* states:

Our modern [English] letters derive from the Romans, who adapted the *Etruscan* script for monumental inscriptions and wrote from left to right. Because *Etruscan* writing did not distinguish between the sounds c and g [the *Etruscans* used c for both the c and g phonemes], the Romans created the new letter G by adding a [vertical] stroke to C.<sup>4509</sup>

The Latin D was derived from the Greek letter *Delta*, which looked like a triangle. The fact that the crescent-shaped C preceded D in the alphabet might explain how D eventually received the half-moon shape since the half-moon phase occurs after a waxing crescent phase.

The O and Q letters may have come to represent the full-moon to the Greeks or Romans, but not to the *Phoenicians* for whom the O meant “eye” and Q “monkey.”

What is significant is that after Christianity arrived, the letters received from the Romans did not become significantly curvier. By contrast, the early *Muslims* took an essentially squared alphabet and rounded it out to create many crescent shapes. The

<sup>4507</sup> Rasmussen. Letter.

<sup>4508</sup> Excerpt from *Heritage*, “Development of the Alphabet” table. In case the scan above is hard to read, here is the text typed out: Proto-Canaanite, Semitic Names/Sounds, Phoenician, Early Greek, Greek Names/Sounds, Etruscan, Classical Roman, ~1500 BC, ~1000 BC, ~800 BC, ~500 BC, *gaml*, *gamel*, g, throwstick, *gamma*, g.

<sup>4509</sup> *Heritage*, “Development of the Alphabet” table.



monotheism of Christianity does not revolve around the moon, but this suggests that *Islam* is all about moon-god monotheism.

Someone might say that in these Mediterranean cultures (*Phoenician*, Greek and Roman) the moon-god was a minor deity, so the moon's corresponding effect on the alphabet would be small. This however disregards the evidence that full- and crescent-moon symbols were ubiquitous in these cultures. There is no reason to suppose that the moon would affect the overall set of symbols, but not the symbol subset called the alphabet.

It is easy for moderns to underestimate the influence that the moon had on the imagination of Roman pagans. Moderns generally do not invest as much time in religion and superstition as the ancient pagans did. Many pagans paid more attention to minor deities each day than many modern monotheists spend in religious thought all week.

The Ancients' great devotion to minor gods is reflected in how the moon exercised its hold on the pagan imagination for quite some time, as Ramsay MacMullen points out concerning the former Western Roman Empire:

...fears that the moon would disappear for good: to an eclipse or the end of the month, the response that we hear about from the western provinces [of what was the Roman Empire] was to make a great racket with horns and bells. The bishops from the fifth century [AD] on called the practice sacrilege, the Devil's work, and tried to end it by their conciliar [church council] legislation on solemn occasions and by their preaching far more often; but it persisted till the ninth century [AD].<sup>4510</sup>

So what was a minor deity in the West had a disproportionate effect on the pagan mind and on Mediterranean symbols and alphabets. This prompts the question: "How would a lunar high god, or monotheistic moon-god, affect alphabets in the Mideast?" One need just look at the curvy Arabic alphabet for the answer!

That *Muslims* recognized the curvy letters as crescents can be illustrated from various sources. Robert Plant wrote about an issue of *Safavid* coins from 1719 AD (1132 AH). Plant's illustration shows a coin with three crescent-shaped letters in the center of the reverse side:

We see the three crescents [UUU] they liked to put in the center of the design—formed by the *-dah* of *bandah*...the...*n* of *Husain* and the final ...*n* of *Irvan*.<sup>4511</sup>

*Muslim* calligraphists inserted dots into crescent-shaped letters—even when the letters were in miniature form—to create star and crescent patterns. Robert Plant wrote about a coin similar to the *Safavid* coin described just above:

This is the obverse [side] of a [Persian '*Qajar*' dynasty] silver coin of Fateh Ali...Here is the favorite three-crescent pattern again, formed of the final *n*'s of the *Sultan* [mentioned twice] and the *n* of *Ibn* [Arabic meaning "son"]. Placing the *Alefs* inside the crescents is a new, but growing habit [meaning that letters were combined in inscriptions to create a crescent-and-star symbol].<sup>4512</sup>

<sup>4510</sup> MacMullen. *Eighth*, p. 70.

<sup>4511</sup> Plant. *Coins*, pp. 100-101.

<sup>4512</sup> Plant. *Coins*, p. 107.

Crescent-shaped tails were added to letters to the point where inscriptions became unreadable. Sheila Blair wrote:

In the eleventh century, *Tiraz* inscriptions became shorter and more decorative with the introduction of non-historical texts that repeated a single word or phrase such as ‘blessing’ (*Baraka*) or ‘good fortune’ (*Al Yumn*). The crescent or shovel-shaped tails of the letters were extended below the baseline. In pieces made for the *Caliph Al Zahir* (ruled 1020-1035 AD), the terminals are still attached correctly to descending letters...but gradually the large endings were applied at regular intervals and attached indiscriminately to any letter, thereby obscuring the text and making it more difficult to read.<sup>4513</sup>

Eva Baer wrote about the same phenomenon on attaching crescents to letters:

Letters, which originally finished below the baseline, were applied with upward-curving lines or rising tails....<sup>4514</sup>

*Muslims* recognized that the entire Arabic alphabet was *Allah’s* moon-god alphabet and not just the letters with crescent curves. It could be no other way since *Muslims* believe that *Allah* speaks Arabic. *Muslims* even believe that *Allah* produced the Arabic *Koran* in eternity in heaven and then delivered it to *Muhammad*.

This explanation helps to solve another mystery—that of the “mystic characters” or “mystic symbols” at the start of many *Koranic* chapters. For instance, *K* 002:001 and *K* 003:001 begin with the Arabic letters “*Alif Lam Mim*,” and *K* 027:001 begins “*Ta Sin*.” So for *Muhammad* to preface the *Koran* chapters with a few of *Allah’s* moon-god symbols served to dedicate the chapter to *Allah* the moon-god. See the ToC for the discussion of the Mysterious Letters at the head of *Suras*.

**Metathetical Words Show That Allah Was a Moon-god**

Pre-Islamic Arabian paganism revolved, and *Islam* revolves, around two consonantal sounds (*h*, *l*). These are used mostly in trilateral (three-consonantal) roots of special words. In the following words, the “h” sound is either hard or soft.

NAMES		NABATAEAN					ARABIC				
		Palmyrene	Ḥaurān	Abu Shadir	Petra	Sinai	Kufic	Naskhī	Kufic (Middle Ages)	NASKHĪ (modern)	NAMES
		2nd.C C.E.	1st.C C.E.	4th.C C.E.	1st.C C.E.	5th.C C.E.	5th.C C.E.	7th.C C.E.			
Ḥē	𐤇𐤁	𐤇𐤁	𐤇𐤁	𐤇𐤁	𐤇𐤁	ح	ح	ح	ح	ح	Ḥāʾ

Adapted from *Dictionnaire de la Bible*, vol. 1, Paris, 1895.  
**Figure 16-07.** The Arabic Letter *Ha* has at least one crescent shape. See the far right character in the “*Naskhī (modern)*” column (above). *Naskhī* is a major script used to write Arabic since the seventh century AD, as noted in the above chart.<sup>4515</sup>

<sup>4513</sup> Blair. *Inscriptions*, pp. 166-167.

<sup>4514</sup> Baer. *Ornament*, p. 62.

The hard “h” sound is represented by the Arabic letter *Hah*, the 6<sup>th</sup> letter of the Arabic alphabet. In transliterations, the *Hah* letter is represented by an “h” or “ha” with a dot underneath the “h”.

The dot below an Arabic letter shows it is aspirated. “Aspiration” means to roughen a sound or make it uneven. More than one version of the letter *Hah* has a crescent form, as can be seen in the two tables (above) that list crescent-shaped Arabic letters.

The soft “h” sound is represented *Ha*, the 25<sup>th</sup> letter of the Arabic alphabet. In transliterations, the letter *Ha* is represented by an “h” or “ha” without a dot. *Ha* has at least one crescent shape in *Naskhi*, as shown the above graphic.

### A Representative Sample of Metathetical Words Based on the Letters *llh*

#### ☉ *llh*

- ★ *Allah* = “the God” (because *Allah* is a contraction of two words, the hard-vowel *Alif* happens to be prefixed to the *llh*)<sup>4516</sup>
- ★ *Laleh* = a tulip (a Turkish word and a symbol for *Allah*)

#### ☉ *hll*

- ★ *Halal* (or *Halaal*) (*Ha* with a dot) = the *Islamic* version of *Kosher* food
- ★ *Halala* = a *Saudi Arabian* coin
- ★ *Halla* = “to appear (the moon)”
- ★ *Hilal* = the crescent-moon (*Ha* **without** a dot)
- ★ *Hilal* [plural of *Hilla*<sup>4517</sup>] (*Ha* **with** a dot) = “dwelling,” another name for the *Kaaba*
- ★ *Hulul* (*Ha* with a dot) = an indwelling or incarnation of *Allah* in *Sufism*
- ★ *Ihlal* (*Ha* with a dot) = pre-*Islamic* ceremony around the *Kaaba* similar to the *Ihram* purification rite. This ceremony and the *Hajj* were done also at the Dome of the Rock in the early *Islamic* centuries.<sup>4518</sup>

#### ☉ *Hlh*

- ★ *Hilah* (*Ha* with a dot) = a legal stratagem to circumvent the *Sharia* law

#### ☉ *Hl*

- ★ *Hal* (*Ha* with a dot) = a *Sufi* mental condition

#### ☉ *Kh-l-l*

- ★ *Khalil* = “friend” (Arabic and Turkish) (the letter *Kha*)

<sup>4515</sup> This illustration is two juxtaposed excerpts of a table that shows that the Arabic letter *Ha* has at least one crescent shape in *Naskhi* (Warraq. *What*, p. 769).

<sup>4516</sup> *Alif* is not a vowel, but rather it is a typical Semitic-language semi-vowel. *The 1911 Encyclopedia*, 1911encyclopedia.org, states under the entry for “A”:

In Phoenician, a, like the symbols for e and for o, did not represent a vowel, but a breathing; the vowels originally were not represented by any symbol. When the alphabet was adopted by the Greeks it was not very well fitted to represent the sounds of their language. The breathings which were not required in Greek were accordingly employed to represent some of the vowel sounds, other vowels, like i and u, being represented by an adaptation of the symbols for the semi-vowels y and w. The Phoenician [letter] name, which must have corresponded closely to the Hebrew *Aleph*, was taken over by the Greeks in the form *Alpha* (A/a).

<sup>4517</sup> Another definition for “*Hilla*” is: “marry someone else other than his husband” (Sarker, Rafique. “Family flees Home for *Fatwa*,” vol. 5, no. 131, 4 Oct 2004, *DW*).

<sup>4518</sup> Elad. *Jerusalem*, p. 64.

## What Metathesis Is

Arabic is based mainly on trilateral (three-consonantal) roots, if one excludes the vowels. The short vowels were not written in Arabic text before the eighth century. The short vowels are represented by dots called diacritical marks.

Diacritical marks are placed on the periphery of the consonants, so the short vowels do not much affect the spacing of the Arabic. That the vowels letters were only added in later Arabic partly explains why variants of Arabic words differ in vowel letters more than they do in consonants, such as *Mohamed*, *Muhammad*, *Muhammed*, *Mahomet* and so forth.

Often in Semitic languages the trilateral consonants are retained or rearranged, and vowels are changed, to create new words such as *Halal* (allowed) and *Haram* (forbidden).

The three-consonantal *hrm* root is used to form new words by substituting different vowels and by changing the letter order of *hrm*. For instance, these *hrm* words all have the sense of “forbidden” or “sacred,” with additional meanings in parenthesis:

- ☪ *Haruma* or *Harima*
- ☪ *Haram*, plural: *aHram*
- ☪ *Hurma*, plural: *Huram* or *Hurum*
- ☪ *Haram*, plural: *Huram*
- ☪ *Muharram* (a *Mosque*)
- ☪ *HarIm*, plural: *Hurum* (a sanctum)
- ☪ *MaHram*, plural: *MaHrim*
- ☪ *Ihram* (a state of ritual consecration of the *Makkan* pilgrim)
- ☪ *MuHarram* (forbidden, or the name of the first *Islamic* month)
- ☪ *MuHrim* (a *Makkan* pilgrim who entered state of ritual consecration)<sup>4519</sup>
- ☪ *Mahram* (“The Holy One,” title of the *Abyssinian* moon-god)

Ditlef Nielsen elucidates the etymological connection between *Mahram* the moon-god of the *Abyssinians*, with the word *Haram*, meaning “sacred” or “holy.”<sup>4520</sup> That *Haram*, meaning “sacred” or “forbidden,” is connected to the name of a moon-god, *Mahram*, suggests that *Halal* (*Kosher*) and *Hilal* (crescent) could also be connected to the name of a moon-god, namely *Allah*.

Metathesis in linguistics is described as a transposition of letters, sounds or syllables within a word. The *Encyclopedia Britannica* states “Metathesis...the transposition of sounds...”<sup>4521</sup> The changes usually occur in pronunciation first, and then the change is reflected in the spelling, as *The American Heritage Book of English Usage* states:

Two historical examples of metathesis are Modern English *bird* and *horse* from Old English *Brid* and *Hros*. Over time the metathesized pronunciations became standard and the spellings were changed to conform to the new pronunciations.<sup>4522</sup>

<sup>4519</sup> Wehr, Hans. *Dictionary of Modern Written Arabic*, 1979, pp. 201-202, as referenced in translation in Krause, “*Haram–Harimat*.”

<sup>4520</sup> Nielsen, 1912, pp. 591-592, as translated in Krause, “*Haram–Harimat*.”

<sup>4521</sup> *EB*, accessed 17 Jun 2003, “*Dravidian languages*” entry.

<sup>4522</sup> *The American Heritage Book of English Usage: A Practical and Authoritative Guide to Contemporary English*, 1996, bartleby.com, “7. Pronunciation Challenges: Confusions and Controversy, § 131. Metathesis.”

Alfred Guillaume provides another example of metathesis:

*Arab*, a metathetical form of *Abir* is ‘nomad.’ This identification is supported by the meaning which the plural *A’rab*=nomads often has in the *Quran* and in the inscriptions found in South Arabia which mention *Bedouin*.<sup>4523</sup>

Similarly, the words in the above *hll* and *hrm* root-word lists are all metathetically related (in the loosest sense) in that they all use certain letters (or sounds) in various arrangements to describe religious matters. The reason that some of the *hll* words use a hard “h” and others a soft “h” may be due to a drift in the pronunciation, or the words may have started out that way.

These same reasons may be why the words *Kiblah* and *Kaaba* are often found together. The *Kiblah* is an imaginary line that runs through the *Kaaba*’s Black Stone from any point on earth. *Kiblah* and *Kaaba* probably have no etymological connection, but the similarity in sounds between words cannot always be explained as mere coincidence.

The drift is inevitable because these words were thought up in one moon-god worshipping culture in the Fertile Crescent and transferred over many miles and centuries to other moon-god worshipping cultures.

The situation pertaining to the hard and soft “h” in related Arabic words is similar to how:

- Ⓒ In English *Hanukah*, the Hebrew “Festival of Lights,” is also transliterated *Chanukah*.
- Ⓒ In English, *Haim*, meaning “life” in Hebrew, is also transliterated *Chaim*.
- Ⓒ During the time of the *Judges*, the majority of *Israelites* said “*Shibboleth*” to describe an ear of grain or wheat, but the Transjordan tribes said “*Sibboleth*” (Jdg 12:06).

The Arab’s drift from soft “h” to hard “h” in the *hll* list may have been an unconscious attempt to differentiate several similar sounding words in speech, and in writing and inscriptions. In other words, only so many words could be formed from one trilateral root without confusion arising, so a hard “h” was substituted for a soft “h.”

The drift in pronunciation of Arabic words may also have been an attempt to make them easier to pronounce. Richard Burton (1821–1890 AD) relates that the first letter of the word *Sirat*—*Islam*’s Sword Bridge—changed twice in less than thirteen hundred years: from *Sin* to *Sad* to *Za*. Burton wrote in 1885 AD:

The word [*Sirat*] was originally written with *Sin* but changed for easier articulation to *Sad*, one of the four *Huruf al-Mutabbakat*, ‘the flattened,’ formed by the broadened tongue in contact with the palate. This *Sad* also by the figure *Ishmam* (=conversion) turns slightly to a *Za*, the intermediate between *Sin* and *Sad*.<sup>4524</sup>

The words in the above *Hll* list are not necessarily related etymologically to the word *Hilal*, meaning “the crescent-moon.” The list merely reflects how words with “l” and “h” sounds, whether hard (aspirated) or soft, gained currency in religious matters merely because words with “l” and “h” appealed to the sensibilities of moon-god worshippers.

Many of the metathetical-like words listed above rhyme with *Halil*, meaning “crescent.” This is certainly the case with *Khalil*, which is spelled with the *Kha* letter

<sup>4523</sup> Guillaume. *Islam*, p. 2.

<sup>4524</sup> Burton. *Nights*, vol. 4, fn. 318.

and means “friend.” *Kha* is related to the Hebrew *Kaf*. *Khalil* rhymes with *Halil*. *Khalil* often refers to *Ibrahim* being a “friend” with *Allah* the moon-god, who is represented by the great *Halil* crescent in the sky.

If the metathetical-like words did not rhyme, then they were adopted for pre-Islamic moon-god liturgy based on their assonance or alliteration with *Halil*. Assonance refers to the same vowel sounds being used in successive words that do not necessarily rhyme. An example of *hll* assonance (not rhyme) can be seen in this word definition given by Jeffery (note *Tahlil*, *Hallel*):

*Tahlil*, to raise the *Hallel*, i.e. to praise *Allah* by using the formula:  
‘There is no deity save *Allah*.’<sup>4525</sup>

Words that merely sound similar to a sacred word are sometimes held to be sacred. A case in point is the *Shiite Ashurah* festival in *Iraq*. The *Ashurah* festival supposedly is derived from an Arabic word for “ten.” The festival begins on the tenth day of the lunar month, *Muharram*, and some participants fast for ten days.

The *Ashurah* festival is officially tied to the death of *Husayn bin Ali*, the grandson of *Muhammad* who was killed by *Umayyad* forces at the Battle of *Karbala* (680 AD). Scholars however think that the rite actually comes from ancient *Baal* and *Asherah* rites in which they used swords and whips for self-cutting and self-flagellation (e.g. 1Ki 18:28).

*Asherah* was the Mother goddess in early mythology but then was associated with *Venus*. The death and rebirth cycle of *Asherah* mythology fits in well with the *Shiite* commemoration of *Husayn*’s death since the cycle infuses (false) hope.

The festival could have had many different names, but the fact that the name *Ashurah* was chosen indicates that in the spirit of syncretism, the ancient *Asherah* rite was cleverly incorporated into the *Shiite* brand of *Islam*.

The name of the festival, *Ashurah*, was chosen mainly because of its similarity to the name of the goddess *Asherah*, and secondly because *Ashurah*’s meaning of “ten” conveniently matches the day on which *Huseyn* died. Thus this example shows how words which merely sound similar to a sacred word, can be deemed sacred by association.

### Words Often Change Via a Vowel Substitution Process

The phenomenon can be seen in the Hebrew Scriptures where different vowels are substituted so that the three or four written consonants become a different word. For instance, the consonants for *Yahveh* (*YHVH*) were written with the vowels for *Adonai*, meaning “Lord.” This is how *Yahveh* mistakenly came to be called *Jehovah* in some circles during medieval times.

The *Canaanite* idol “*Melek*” came to be called *Molech* through a vowel substitution process similar to the *Yahveh*-*Jehovah* transformation. *Melek* means “King,” but scribes substituted the vowels for those of the word *Bosheth*, meaning “Shame” in Jer 11:13 and Hos 09:10.<sup>4526</sup>

The *ISBE*’s article on “*Molech/Moloch*” states:

The use of *Basileus* [Greek for “king”] and *Archon* [Greek for “ruler”] as a translation of the name [*Molech*] by the *Septuagint* suggests that it may have

<sup>4525</sup> Jeffery. *Islam*, p. 247.

<sup>4526</sup> Similarly, Hebrew scribes changed *Eshbaal*, meaning “Man of *Baal*” (1Ch 08:33; 09:39) to *Ishbosheth*, meaning “Man of Shame” (2Sa 02:08). Also, scribes rendered *Jerub-baal*, meaning “Let *Baal* contend” (Jdg 06:32), with *Jerub-besheth*, meaning “Shame will contend” (2Sa 11:21).

been originally the Hebrew word for ‘king,’ *Melekh*. *Molech* is obtained from *Melekh* by the substitution of the vowel points of Hebrew *Bosheth*, signifying “Shame.”

Even an instance of using *hll* words with different vowels to mimic the Aramaic word for the moon-god can be found in the Bible. Isaiah wrote an ode to the downfall of “the king of *Babylon*.” Isaiah compared the king of *Babylon* to Lucifer and “the Morning Star, the Son of the Dawn” (Isa 14:12).

The astral imagery that is used to describe Satan’s predicament is fitting because the Old Testament prophets recognized that it was demons who animated the astral religions of their surrounding enemies (Deu 32:17; Psa 106:37).

Elsewhere the Bible borrows astral imagery to mock enemies of *Israel* who believed in such notions, such as when Deborah said the stars and a river fought against the pagan Sisera (Jdg 05:20-21). Ezekiel, in a passage similar to Isa 14:12, says that Satan was thrown down from heaven even though he had walked among the “fiery stones” (Eze 28:14, 16). The “fiery stones” likely refer to the stars.

Isaiah seems to have had a male *Semitic* Venus-god in mind in Isa 14:12. Isaiah said that this Venus-god said in his heart:

I will ascend into heaven; I will exalt my throne above the stars of God...I will ascend above the heights of the clouds; I will be like the most High (Isa 14:13-14).

Isaiah mentions that Hebrew women who dabbled in paganism wore crescent ornaments (Isa 03:18). The writer of *Judges* notes that the Ishmaelites used crescents on their camels (Jdg 08:21, 26).

The *Assyrians* were known for their prominent use of the crescent and Venus symbol, and more often than not their high god was the moon. In fact, the *Assyrian* king that concerned Isaiah most was *Sennacherib* (2Ki 18:13; 19:09, 16, 20, 36; 2Ch 32:01-02, 09-10, 16, 22; Isa 36:01; 37:09, 17, 21, 37). *Sennacherib* means “*Sin* (the moon-god) multiplied brothers.”

In Semitic (not Greco-Roman) mythology, Venus was considered to be the offspring of the moon. Since Venus was the offspring of the moon and wanted to ascend to be “like” the moon, Isaiah called Venus *Helel* (or *Heylel*).

The word Hebrew word *Helel* is similar to the Arabic word for crescent-moon (*Hilal*), and probably was similar to the Aramaic word that meant “crescent” as spoken in *Assyria*. Finn Rasmussen wrote that an *Ugaritic* text called the moon-god “*Hilal*, master of the sickle.”<sup>4527</sup> Rasmussen also wrote:

*Hilal* means ‘the shining one’ in Hebrew and Arabic, and in Ethiopian it [*Hilal*] means ‘moon-crescent.’

So in Isa 14:12-14, Isaiah was saying that the deity *Helel* (Venus) wanted to be like the Aramean high god, *Hilal* (the moon-god). Without vowel pointing the word that Isaiah used for Venus would be the same as the consonants for “the crescent-moon,” in other words: *hll* wanted to be like *hll*. So this example suggests that the metathetical-like words in the above list really do have significance in the discussion of whether *Allah* was a moon-god or not.

<sup>4527</sup> *KTU* 1.24:41, as quoted in Rasmussen. Letter.

### Discussion of Words Metathetically Related (in the Loosest Sense) to *Hilal* (*hll*)

#### C *Allah* = “the God”

In pre-*Islamic* Safaitic inscriptions (1<sup>st</sup> century B.C.—4<sup>th</sup> century A.D.), *Allah* was spelled *Hallah* and *Alaha*, both meaning “the god.”<sup>4528</sup> Note that the form *Hallah* need not come through Hebrew however “since the demonstrative element *Ha* is so pervasive in all *Semitic* speech.”<sup>4529</sup>

Scholars have supposed that *Al Ilah* (“the god”) was contracted to *Allah* due to frequency of use. It is however easy to see that the real reason why the contraction *Allah* became popular as an appellation for *Allah* the moon-god. The reason is that *Allah* (*llh*) is metathetically related (in the loosest sense to the word) to *Hilal* (*hll*), meaning “the crescent-moon.” Also, the word *Allah* is only one syllable different from the word *Ahillah* (new-moons, crescents). *Ahillah* is the plural of *Hilal* (crescent-moon). Perhaps *Allah* is a contraction of *Ahillah* (“crescents”) rather than *Al Ilah* (“the god”).

#### C *Laleh* = “a **tulip**” (a symbol for *Allah*)

Eva Baer wrote about roses and **tulips** in *Islamic art*:

It goes without saying that, in countries with a dry climate, flowering gardens were regarded with high esteem. We also know the preoccupation of *Islamic* literature and particularly of Persian and Turkish poetry, with paradise, where flowers like roses and **tulips** were endowed with symbolic attributes and used as a metaphor for Divine Beauty.<sup>4530</sup>

Stephen O. Murray wrote about roses and **tulips** (as previously quoted):

The famed medieval poets who wrote in Persian or Turkish all wrote poems about desired boys. Indeed, not only in poetry but all genres were written about men, by men, and for exclusively male audiences. Often, its pederastic content has been obscured in translation with female pronouns. As Baraheni notes, one aspect of this poetry ‘is the difficulty in deciding whether the poet is addressing himself to a man or a woman. Generally, the beloved has all the characteristics of a beautiful male with some feminine qualities’...Lying, ogling and promiscuously giving favors to rivals are not plausible attributes of an omnipotent, omniscient God. In much poetry I am convinced that the rose, a recurrent metaphor for the beloved object of the yearning poet’s phallic nightingale, is ‘really’ God and not a boy’s anus (the **tulip** similarly figures as a metaphor for a vagina). In a way ecstasy is ecstasy is ecstasy, and perhaps a rose is not a rose is not a rose—if a rose is sometimes a metaphor for the gateway to sexual pleasure (a *Zina*) and at other is a synecdoche for the glory of divine creation, and if contemplation of beauty is a gateway to union with the Creator of all beauty. The metaphor, to put it mildly, is over determined. Poetry in general is polysemous [i.e. characterized by having many meanings], and *Islamic* poetry may carry more than one of these meanings, while sexual acts are never explicitly mentioned...<sup>4531</sup>

Louis Crompton confirms that even in *Islamic Spain* the poetry was homoerotic:

<sup>4528</sup> Hastings. *Ethics*, “Arabs (Ancient)” entry, p. 664, right column.

<sup>4529</sup> Torrey. *Foundations*, p. 20.

<sup>4530</sup> Baer. *Ornament*, p. 95.

<sup>4531</sup> Murray. *Culture*, pp. 132, 136.



Almost any collection of Hispano-Arabic poetry yields a plethora of love poems by men to or about other males. Erotic poetry first flourished in *Andalusia* at *Cordoba* under ‘*Abd Al Rahman II* (822-852).<sup>4532</sup>

The connection between the moon and **tulips** is made based on several factors. The moon has been called “the “eternally fruiting orb,” which refers to the recurrent cycle of moon phases.”<sup>4533</sup> The silhouette of a **tulip** flower has the rough outline of a crescent-and-star symbol. The Moon is a fertility symbol, as Leo Dubal states:

The moon is the matrilineal symbol *par excellence* as the full-moon provides the basic timing for the menstrual cycle.<sup>4534</sup>

In the drum underneath the dome of the Dome of the Rock is a border of orbs in crescents along with an occasional **tulip**. The **tulips** have a pistil that serves as the orb and two extended petals serve as horns of a crescent-moon. This border seems to reveal the association between **tulips** and the crescent-and-orb symbol. Later in this chapter there is a discussion on how the **tulip** is a Turkish and Persian *Allah* motif.



Figure 16-08. Tulip mosaics in the Dome of the Rock.<sup>4535</sup>

☪ *Halal* = “the *Islamic* version of *Kosher* food”

The symbol for *Halal* (*Kosher*) food is stamped onto *Halal* foods. The sign is often a large crescent. Sometimes it takes the form of a large U-like crescent with the word *Halal* on a billboard-like sign hung on a *Minaret* that is topped by a crescent.<sup>4536</sup>

Animals used to prepare *Halal* meat are killed with a curved knife. The connection between curved knives and moon-god religions will be discussed later in this chapter.

There is a moon-god religion connection between the *Islamic* diet and the moon. All *Islamic* festivals, some of which involve fasting or feasting, are scheduled using the lunar calendar. *Ramadan* is a month-long partial fast, which starts and ends with crescent-moons.

It is known that pre-*Islamic* moon-god worshippers in *Haran* and *Yemen* and other places had fasts timed by the *Hilal* crescent-moon phase. A case in point is that William St. Clair-Tisdall quoted early *Islamic* authorities who said:

The connexion with their fast they [the *Sabians*] observed the festivals of *Fitr* (breaking the fast at the end of the lunar month) and *Hilal* (new-moon [meaning the “crescent-moon”]) ‘in such a way that the festival of *Fitr* occurred when the sun entered *Aries*...[i.e. during a certain month’s time].<sup>4537</sup>

☪ *Halala* = a *Saudi* Arabian coin

☪ *Halla* = “to appear (of the moon)”

☪ *Hilal* = “the crescent-moon”

<sup>4532</sup> Murray. *Culture*, p. 152.

<sup>4533</sup> “*Sin (Nannar)* with the three muses and the ‘Eternally Fruiting Orb’ [i.e. moon phases], *Ur-Nammu*” (Maspero. *Dawn*, p. 655).

<sup>4534</sup> Dubal. *Riddle*.

<sup>4535</sup> The Tulip tall-short-tall (lol) mosaic in the drum that supports the dome at the Dome of the Rock (Grabar. *Shape*, p. 80, figure 30).

<sup>4536</sup> Chebel. *Symbols*, pp. 96-97, picture.

<sup>4537</sup> St. Clair-Tisdall. *Sources*, ch. 2, pp. 52-53.

C *Halla* = “to appear (the moon)”

*Halala* is a Saudi coin derived from the word *Hilal*, meaning “crescent-moon,” and *Halla*, meaning “to appear (of the moon).”<sup>4538</sup> Since the start of *Islam* to the present, many *Islamic* coins have featured a crescent.

The *Muslim* religion follows a lunar calendar, so *Ramadan* and the *Hajj* and other festivals and fasts begin with sightings of the crescent-moon. In the case of *Ramadan*, the month-long feast ends with the sighting of the crescent-moon.

C *Hawl* = Jacques Ryckmans wrote:

In *Hadramawt*, *Hawl* was probably a moon-god; his name apparently alludes to the lunar cycle.<sup>4539</sup>

C *Khalil* = friend

That *Allah* is a moon-god explains this common Turkish *Blessing* that refers to *Allah* the moon-god being the friend (*Khalil*) of *Ibrahim*:

May the moon shine in front of you. | May the moon-god | Protect you and us. | I saw the moon, oh God. | May the months be auspicious. | I saw the moon | I saw light, | I saw *Khalil Ibrahim*, | I gave thanks | And forswore my sins, | Thanks be to God.<sup>4540</sup>

*Khalil* means “friend.” So in this just-quoted blessing, *Allah* the moon-god is called a “Friend of *Ibrahim*.” *Muslims* calling *Allah* “the friend of *Ibrahim*” mirrors how in the Old Testament and New Testament, Abraham is called a “Friend of God.”<sup>4541</sup>

Incidentally, many *Mosques* with crescent finials are named “*Khalil Ibrahim*.” This goes back to how *Haran*, the City of the Moon was, and still is, an ancient *Ibrahamic* pilgrimage site.

The metathetical-like aspect of *Khalil* being Arabic for “friend” can be traced back to *Islamic* times, if not thousands of years earlier than *Islamic* times. The connection between this Turkish *Blessing* and *Ibrahim* and K 006 was discussed in a previous chapter.<sup>4542</sup> The Turks and other *Muslims* believed that *Ibrahim* called the moon-god *Allah* his lord in K 006.

The word *Khalil* (friend) was coined based on its metathetical-like connection to the crescent-moon (*Hilal*). The moon was always thought of as a trusted friend in the Mideast, especially for camel caravaners who traveled at night, as well as shepherds and travelers.

The *Gilgamesh Epic* provides an ancient example of how the moon was thought of as a friend. The traveling hero, *Gilgamesh*, prayed to *Sin* the moon-god as though *Sin* were a trusted friend. The moonlight helped *Gilgamesh* fend off lions at night.<sup>4543</sup>

## Discussion of the List of Words Metathetically Related (in the Loosest Sense) to *Allah*

C *Hilal* [(rough breathing “h,” plural of *Hilla*] = dwellings, or another name for the *Kaaba*

<sup>4538</sup> *Heritage*, App. II, Semitic Roots, *hll* entry.

<sup>4539</sup> Ryckmans, Jacques. *EB*, “Arabian Religions” entry, 2004.

<sup>4540</sup> Turkey Ministry of Culture and Tourism, Culture > Stereotypical Expressions > Prayers–Blessings > m kultur.gov.tr/portal/kultur\_en.asp?belgeno=5598, “Moon,” accessed 13 Nov 2003.

<sup>4541</sup> “Friend of God”: Hebrew: *‘ahab Yahveh* (2Ch 20:07; Isa 41:08); Greek: *Philos Theou* (Jam 02:23).

<sup>4542</sup> Cross-reference “K 006” and *Halil* and *Khalil* in the Index for more on Abraham and the moon.

<sup>4543</sup> Anonymous. *Gilgamesh*, “The Search for Everlasting Life.” Also, Pritchard. *Ancient*, I:62, middle of Tablet IX.

*Abdu'l-Muttalib, Muhammad's grandfather* prayed concerning the *Kaaba*:

O God, a man protects his dwelling, so protect Thy dwellings [*Hilal*].<sup>4544</sup>

Notice that the plural form *Hilal*, meanings “dwellings,” is very close to “*Hilal*,” meaning “the crescent-moon.” The two words are differentiated by the fact that “dwellings” has a rough breathing mark on the “h” while the “h” for “crescent” is smooth. This fact seems pertinent since a *Hatim* crescent-shaped wall is part of the *Kaaba*.

C *Hulul* = *alighting, or an incarnation of Allah in a Sufi*<sup>4545</sup>

*Sufis* thought that they could become infused with *Allah*, perhaps by looking at the moon. In a previous chapter it was discussed how a *Sufi Muslim*, Awhad *Al Din Kirmani* (died 1237 AD), admired *Allah* the moon-god in a reflection on water:

[Upon] being asked by *Shams-i-Tabriz* what he was doing, he replied, ‘I am contemplating the moon in a bowl of water,’ meaning the Beauty of the Creator in the beauty of the creature; to which *Shams-i-Tabriz* replied, ‘Unless you are afflicted with a carbuncle [a severe boil] on the back of your neck, why do you not look at the moon in the sky?’<sup>4546</sup>

The *Sufi* dervish *Al Hallaj* was condemned for blasphemy and crucified in 922 AD for claiming “I am God—I am the Truth.”<sup>4547</sup> Guillaume wrote:

He [*Hallaj*] used the term *Hulul*, meaning “indwelling,” a word that is associated in *Muslim* literature with the Christian doctrine of the incarnation.<sup>4548</sup>

The name *Hallaj* means “cottonseed processor” and is spelled with a *Ha* with a dot. *Hulul* also is spelled with a *Ha* with a dot. It seems that the name *Hallaj* is metathetically related (in the loosest sense) to the word *Allah*, or the pre-*Islamic Hallah* of the Safaitic Inscriptions (see the Index). With a seemingly theophoric name like *Hallaj*, this helps to explain how *Hallaj* concluded that he was *Allah*, or that he was indwelt by *Allah*.

C *Ihlal* = pre-*Islamic* ceremony around the *Kaaba*

The *Kuraish* had a ceremony next to the *Kaaba* and crescent-shaped *Hatim* Wall called the *Ihlal*. William St. Clair-Tisdall wrote:

And *Ibn Ishaq*, the earliest biographer of *Muhammad* of whose work any certain remains have come down to us, is quoted by *Ibn Hisham* as stating that the tribes of *Kinana* and *Quraish*, when performing the religious ceremony known as the *Ihlal*, used to address the Deity in such words as these: ‘*Labbaika, Allahumma!*’—‘We are present in Thy service, O God; we are present in Thy service! Thou hast no partner, except the partner of Thy dread’ . . . *Ibn Ishaq* uses much the same language as *Abu'l Fida*, but adds that the customs which he mentions, including that of the *Ihlal* had been retained from *Ibrahim's* time.<sup>4549</sup>

That a ceremony was called the *Ihlal*, a metathesis of *Hilal*, meaning “the crescent-moon,” is significant since the ceremony was conducted next to the crescent-shaped *Hatim* Wall. Moreover, it is known that the moon was worshipped at *Makka*, as *Ibn Warraq* wrote:

<sup>4544</sup> Ishaq. *Sirat*, p. 26 & fn. 1.

<sup>4545</sup> Hughes. *Dictionary*, p. 184, *Hulul* entry.

<sup>4546</sup> Murray. *Culture*, p. 118.

<sup>4547</sup> Ali. *Spirit*, p. 141.

<sup>4548</sup> Guillaume. *Islam*, p. 146.

<sup>4549</sup> St. Clair-Tisdall. *Sources*, ch. 2.

The worship of the moon is also attested by proper names of people such as *Hilal*, a crescent, *Qamar*, a moon, and so on.<sup>4550</sup>

☉ *Hal* = a *Sufi* mental condition

The definition of *Hal* reminds one of *Hulul* meaning “indwelling” (as mentioned above). Gibb and Kramers wrote:

In mysticism a *Hal* is a mental condition, given immediately and momentarily by divine grace, not to be gained by application or effort, consisting of joy, sorrow, depression, exaltation, etc. It passes when the powers of the *Nafs* get the upper hand, but may be followed immediately by another *Hal*.<sup>4551</sup>

☉ *Hilah* = a legal stratagem to circumvent the *Sharia* law

Cyril Glassé wrote:

*Hilah* (literally “ruse”...): A legal stratagem to circumvent the intentions of the *Sharia* (*Islamic* law), without technically breaking it. Such stratagems came into use in the ‘*Abbasid Caliphate* chiefly among the *Hanafis*, but were adopted to a lesser degree by the other schools when they offered solutions to otherwise difficult social problems, and were not intended merely to circumvent the law.<sup>4552</sup>

### Curved Knives as Moon-god Religion Paraphernalia

As was noted above, *Halal* and *Allah* are metathetical-like forms of *Hilal*, meaning “crescent-moon.” *Hilal* seems to have been a name or title of the *Ugaritic* moon-god.<sup>4553</sup> Indeed, moon-gods over the entire Mideast were probably called by the appellation *Hilal* or some variant of *Hilal*.

Most of these moon-god religions came with special diets, and in some places the food approved by the moon-god priest probably was called *Halal*, which means “allowed.” Appropriately, *Halal* food is stamped with a crescent symbol. *Halal* meats are associated with the name *Allah* and the curved knives used for *Halal* sacrifice or butchery. CAB International reported on the *Dhabh* method of slaughter:

Any *Muslim* may slaughter an animal while invoking the name of *Allah*....Observations of *Halal* cattle slaughter without stunning done by a *Muslim* slaughterman with a large, curved skinning knife resulted in multiple hacking cuts. Sometimes there was a vigorous reaction from the animal.<sup>4554</sup>

That *Islamic Halal* knives are curved cannot be traced back to either Jewish *Kashruth-Kosher* or *Hasidic Glatt-Kosher* laws. This is the case, despite the fact that *Muslims* sometimes claim that “The Jewish method of slaying animals (*Shehita* or *Shechita*)—is identical with the method of *Dhabh*...”<sup>4555</sup> The knife used by Jewish ritual slaughters (*Shohet*) for the ritual slaughter (*Shechita*) are straight butcher knives (*Chalaf*) that have no curve.<sup>4556 4557</sup>

<sup>4550</sup> Warraq. *Why*, p. 40.

<sup>4551</sup> Gibb & Kramers. *Encyclopedia*, p. 127, *Hal* entry.

<sup>4552</sup> Glassé. *Encyclopedia*, p. 157, *Hilah* entry.

<sup>4553</sup> Rasmussen. Letter.

<sup>4554</sup> “Religious slaughter and animal welfare,” *Meat Focus International*, Mar 1994, pp. 115-123, published by CAB International, grandin.com & colostate.edu.

<sup>4555</sup> Khan. *Al-Dhabh*, p. 42; also, see p. 38.

<sup>4556</sup> For *Kosher* questions, see the Orthodox Union (ou.org).

<sup>4557</sup> Bauske, Gloria. “Where’s the beef?,” jpost.com, 21 Mar 2004, picture of knife.

In passing, the knives that *Shias* traditionally used during the bloody, self-flagellation *Ashura* ritual were not scimitars since these would kill rather than just wound. Pictures show the knives were generally short, wide and curved single-blade cutlasses or machetes.<sup>4558</sup>

Nowadays, weapons are imported from outside the Mideast, so photos of the bloody *Ashura* ceremony in *Iraq* mostly show slightly curved sabers and tapered daggers. However, one nineteenth-century drawing of the *Ashura* festival *Ta'ziya* Passion play shows a full-length scimitar.<sup>4559</sup>

During the *Ashura* parade and spectacle, the *Shias* call on *Allah* and cut their foreheads with a sword so that blood runs down their entire front side. Self-slashing and self-flagellation was a pagan practice described and forbidden in the Bible (Lev 19:28; Deu 14:01; 1Ki 18:28).

Self-flagellation was one of the many widespread pagan practices in the ancient world—another one being the use of prayer beads. The “rosaries (strings of beads) and chaplets (circular strings of beads)” are used “in *Hinduism*, *Buddhism*, *Islam*, *Roman Catholicism*, *Eastern Orthodoxy* and *Judaism*.”<sup>4560</sup>

Christian monks, including Martin Luther on occasion, self-flagellated. Self-flagellation reportedly is still practiced by some Catholic monks in the Philippines and among members of the Catholic *Illuminati* order. Christian self-flagellation probably was never as bloody an affair as the *Shiite Ashura* ceremony.

The *Koran* states that *Muslims* must pronounce the name of *Allah* over an animal before eating it (*K* 005:005-006). The phrase most used is called the *Takbir*: “*Allah* is (Most) Great” (*Allahu Akbar*).<sup>4561</sup> Another phrase is called the *Tasmiyah-Takbir*: “In the name of God, God is Most Great” (*Bismillah Allahu-Akbar*).<sup>4562</sup>

While slaughtering during the *Hajj* on the Day of Sacrifice, *Muslims* are supposed to make the animal face the *Kiblah* toward the *Makkan Kaaba* with its crescent-shaped *Hatim* Wall. This further connects the pre-*Islamic Halal* rite to a moon-god religion, as *Al Albani* wrote:

...he should make the animal face the *Qiblah* when slaughtering, making it lie down on its left side and putting his right foot upon its right side. As for the camel then he should slaughter it by means of *Nahr*,<sup>4563</sup> while it is standing having its left leg tied [up] standing on its [three] others with its face towards the *Qiblah*.<sup>4564</sup>

Tradition also has *Muhammad* associating the name *Allah* with the *Halal* form of slaughter:

...the Prophet replied, ‘A caller of the *Genii* [*Jinn*] came to me, so I went away with him and recited the *Koran* to them.’ He then went away with us and showed us the traces of their fires; they (the *Genii*) then asked him for traveling provisions and he said (to them), ‘For you is every bone over which the name of God has been taken (at the time of slaughtering), which you may take and which

<sup>4558</sup> Bürgel, J. C. & F. Allemann. *Symbolik des Islam (Symbolism of Islam)*, Hiersemann Vlg., Stuttgart, 1975, p. 113 (illustration), as is discussed in Krause, Hans. *Ancient Arabia and its Religion* (hanskrause.de), “Ch. 3: Sacrifice in Ancient Arabia,” accessed Feb 2004.

<sup>4559</sup> Blair & Bloom. *Paradise*, p. 43, figure 15, p. 29, figure 2.

<sup>4560</sup> EB, accessed 16 Apr 2006, “Ceremonial object” entry.

<sup>4561</sup> Hughes. *Dictionary*, “*Allahu Akbar*” entry, p. 14.

<sup>4562</sup> Gilchrist. *Approach*, Ch. 6: “The *Halaal* Symbol—Token of a Sacrifice?”

<sup>4563</sup> *Nahr* slaughter is described in Khan. *Al-Dhabh*, p. 20.

<sup>4564</sup> *Al Albani*. *Rites*, “The Sacrifice,” points 98-99.

will fall into your hands with the largest quantity of flesh (over it) and all the globular dung [e.g., sheep dung] as fodder for your animals.’ The Prophet then said (to us [*Muslims*]), ‘Do not clean yourselves with them [bones and dung] for they are the food of your brethren [i.e. the *Jinn*].’<sup>4565</sup>

The just-mentioned tradition make it clear that if *Muslims* do not eat *Halal* food, then the *Muslim Jinn* will either starve, or they will be forced to eat unclean infidel food! Note also how *Muslims* believed the *Muslim Jinn* must congregate and live near *Muslims* since infidels do not have any *Halal* food for the *Jinn*!

The religious connection between *Halal* meat and the name of *Allah* is not just a forgotten rule in a book, but it is put into practice, as this human-interest story shows:

Only then did Mr. Olgun stride toward the steer, with a 22-inch butcher knife tucked behind his back. ‘In the name of *Allah*, *Allah* is great,’ Mr. Olgun whispered in Arabic. The razor-sharp edge of his knife flashed as it arced through the air. ‘In the name of *Allah*, *Allah* is great,’ he whispered again. In one swift motion, Mr. Olgun slit the steer’s throat. ‘In the name of *Allah*, *Allah* is great,’ he said a third time.

Mr. Olgun stood still as the slaughtered steer was clamped into a harness and raised about 10 feet above the floor by a winch. Except for wiping his knife clean, he didn’t move for the eight minutes it took for the blood to drain from the carcass [from ten feet up!].

Among *Muslims*, Mr. Olgun is considered holy. Like every *Halal* butcher interviewed, *Mohamed Soliman*, who owns *Halal Meat Market* on Atlantic Avenue in Brooklyn, said that meat is only as pure as the heart of the one who slaughtered the animal.<sup>4566</sup>

Another ritual cutting in *Islam* is accomplished with a curved blade. *Muslim* physicians report that in circumcisions, the prepuce is lopped off with a curved scalpel blade. *Muslim* tradition reports that *Ibrahim* used an adze, an ax-like tool with a curved blade, to circumcise himself and the males of his family.<sup>4567</sup>

Unfortunately, many non-*Muslims* have had their private parts cut and even excised by moon-god adherents bearing moon-god knives. For centuries *Muslims* have used forced circumcision to “convert” populations to *Islam*.<sup>4568</sup> The precedent for this practice goes back to *Muhammad*’s time.

The *Muslim Sultan Tipu* (1753-1799 AD), who undoubtedly associated *Allah* with a sharp pointy crescent, had this to say about the forced circumcision of tens of thousands of Indian Christian men who managed to survive a 210-mile forced march:

A swift punitive action would allow a total uprooting, transportation and induction of the community into the followers of the Prophet, to be sealed by the eternal proselytizing blade of *Islam*.<sup>4569</sup>

*Muslim* militias still carry out this strange form of terrorism. *Muslims* with assault rifles and machetes surround entire non-*Muslim* villages, and each villager

<sup>4565</sup> *Sahih Muslim*, bk. 4, no. 0903; *Sunan Abu-Dawud*, bk. 1, no. 0039, as quoted in Zwemer. *Animism*, ch. 7.

<sup>4566</sup> O’neill, Molly. “The New Neighborhood Butcher in an Old-Fashioned Way,” *The New York Times*, library.cornell.edu/colldev/mideast/halalb.htm, 2 Jun 1999.

<sup>4567</sup> *Sahih Bukhari*, vol. 4, bk. 55, nos. 575 & 576; vol. 8, bk. 74, no. 313.

<sup>4568</sup> Bubesi, Sibusiso. “Children kidnapped and mutilated,” *Sunday Times*, suntimes.co.za, 14 Mar 1999. Also, do a web search on “forced circumcision.”

<sup>4569</sup> Lobo, Joe. “*Sarasvati’s Children*” Indian Catholic Association of Florida, Inc. The article is based on the book *Sarasvati’s Children*.

was forced to undergo circumcision or FGM. This occurs in Indonesia and *Malaysia* and the surrounding islands as late as 2004.<sup>4570</sup>

Curved knives have long been associated with moon-god religions. Finn Rasmussen wrote:

In *Akkadian* we have the word *Gamlu* = ‘scimitar,’ a sword in sickle form, symbol for the Mesopotamian moon-god *Sin* (*Assyrian Dictionary*, Chicago, 1956, 5.35).<sup>4571</sup>

The *Mahram Bilqis* in *Yemen* was not very far from *Makka* and was a moon-god pilgrimage site as late as 550 AD. This is a mere twenty years before the traditional date of *Muhammad*’s birth.<sup>4572</sup> Wendell Phillips wrote:

I was particularly struck by a [curved] sheathed dagger or *Jambiya* fastened in the man’s belt. It was similar to those used today [in *Yemen*], twenty-five centuries after the time of the statue, except that it was straight at the end where those of this time have points that turn up abruptly...An inscription ran from the shoulders to the bottom of the skirt, ending at the right knee. It told us this statue of ‘*Ma’adkarib*’ was dedicated to the moon-god, *Ilumquh*.<sup>4573</sup>

Notice that the sword got even more curvy over twenty-five centuries on account of *Islam* being a monotheistic moon-god religion.

### **Halal Food is Food Sacrificed to Demons**

As was noted above, *Halal* food was sacrificed to *Allah* using curved knives—just as it had been done from hoary pagan times for all the south Arabian moon-gods.

In pre-*Islamic* times when there was a sacrifice, it was not just for the human partakers and the god named in the dedicatory. Sacrifices were banquets for the human realm and for the spirit realm too. The ancients thought that gods, sprites, *nymphs* and even the souls of their dead ancestors could eat food, especially if the spirits assumed animal form.

The spirit realm was invoked to explain the evaporation of libation offerings and why food offerings quickly dehydrated and shrank. Of course what often happened was that a priest, bird or animal would carry the food off when no one was looking.

*Muhammad* taught that there was only one god and all the rest of the spirit beings were angels or *Jinn*. Though *Muslims* would not sacrifice to other gods besides *Allah* anymore, *Muhammad* still wanted to have a communal meal with the spirit realm. This is why *Muhammad* told the *Jinn* that they could partake of *Halal* food (as quoted previously):

‘For you is every bone over which the name of God [*Allah*] has been taken (at the time of slaughtering), which you may take and which will fall into your hands with the largest quantity of flesh (over it) and all the globular dung as fodder for your animals.’ The Prophet then said (to us [*Muslims*]), ‘Do not clean yourselves with them [bones and dung] for they are the food of your **brethren** [i.e. the *Jinn*].’<sup>4574</sup>

Notice that in the above quotation, *Muhammad* called the *Jinn* the “**brethren**” of *Muslims*, meaning that *Muslims* are in league with demons and Satan.

<sup>4570</sup> Bubesi, Sibusiso. *Op. Cit.*

<sup>4571</sup> Rasmussen. Letter.

<sup>4572</sup> Graveland. *Queen*.

<sup>4573</sup> Phillips. *Sheba*, p. 287.

<sup>4574</sup> *Sahih Muslim*, bk. 4, no. 0903; *Sunan Abu-Dawud*, bk. 1, no. 0039, as quoted in Zwemer. *Animism*, ch. 7.

The *Jinn* to which *Muhammad* refers are demons, such as surely as *Allah* the moon-god is a demon. Eating *Halal* food, then, is being in fellowship with demons, as Saint Paul wrote:

Do I mean then that a sacrifice offered to an idol is anything, or that an idol is anything? No, but the sacrifices of pagans are offered to demons, not to God, and I do not want you to be participants with demons. You cannot drink the cup of the Lord and the cup of demons too; you cannot have a part in both the Lord's Table and the table of demons. Are we trying to arouse the Lord's jealousy? Are we stronger than he? (1Co 10:19-22).

In the quotation of *Muhammad* above, recall that *Muhammad* told *Muslims* not to use bones and dung to wipe themselves after defecation because the bones and dung were food for the *Jinn* and the *Jinn*'s imaginary animals. The bones were *Halal* because the name of *Allah* was pronounced during its slaughter.

*Muhammad*'s belief about the *Jinn* and bones and dung may explain why he wants *Muslims* to use only water and their left hand in order to wipe themselves after a bowel movement. Nowadays, *Muslims* often use a toilet and sprayer on the end of a hose or they use a bidet. Evidently, *Muhammad* thought that if they used plant leaves or whatever, then the *Jinn* and their imaginary animals would be deprived of food—or worse—actually eat the used leaves.

An incident illustrates how *Muslims*, in keeping with *Muhammad*'s just-mentioned dictum, keep the *Halal* food, their offerings to demons, separate from non-*Halal* food. A *Malaysian* newspaper reported that in their capital, *Kuala Lumpur*, a *Muslim* schoolmaster sent out a directive:

Zainal's letter, dated July 14, sent to parents and guardians of students, read: 'Please be informed that non-*Muslim* students are altogether forbidden from bringing non-*Halal* food to school, forbidden from using canteen utensils, for example forks and spoons, and from throwing rubbish into rubbish bins.'<sup>4575</sup>

To conclude this section, one can see that *Muhammad* was a real sorcerer and that *Muslims*, especially *Muslim* butchers and cooks, are real sorcerer's apprentices.

### The *Bakhkh* Moon-god Religion Symbol

Another piece of data relevant to the discussion of the connection between scimitars, curved *Jambiya* daggers and moon-gods concerns the *Bakhkh* symbol found on *Sabean* and *Islamic* coins. The *Bakhkh* scimitar-like *Tamga* symbol means "Glory be to *Allah*."

The appendix on coins has a section discussing the *Bakhkh* symbol, and a *Saba* coin with the *Bakhkh* symbol is illustrated in the section "Critique of the Revisionist View on the Sun- and Moon-gods in Southern Arabia" in this Moon-o-theism book.

### Swords Were Among the Moon-god Paraphernalia at the *Kaaba*

*Abd Al Muttalib* was the grandfather of *Muhammad*. He slept in the *Hijr* area of the *Kaaba*. He dreamt that *Allah* told him where to find a well that had been covered up in a previous age.<sup>4576</sup> While uncovering the well, *Abd Al Muttalib* purportedly found a golden gazelle and swords and these were placed in the *Kaaba*.<sup>4577</sup>

<sup>4575</sup> Jason, Roshan. "Parents question no 'non-*Halal*' food in school order," *malaysiakini.com*, 23 Jul 2004, *DW*, 26 Jul 2004.

<sup>4576</sup> Peters. *Hajj*, p. 15.

<sup>4577</sup> Peters. *Makka*, p. 38.

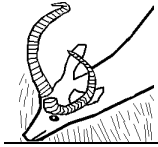


Peters wrote: “In 605 AD...the *Quraysh* decided to rebuild the *Kaaba* when the Apostle was 35 years of age.”<sup>4578</sup> *Al Azraqi* wrote:

The ‘golden gazelle’ and treasures which were kept in the house of *Abu Talha* during the reconstruction and the idols, stored in the *Zamzam* [well], were returned to their accustomed places inside the *Kaaba*.<sup>4579</sup>

Because the curved or curled horns of bulls, rams, gazelles and *Ibexes* reminded the ancients of the crescent-moon, they were used as symbols of moon-gods. “In most [gazelle species] the horns are heavily ringed and curve backward and inward in the form of a lyre.”<sup>4580</sup> Thus *Muhammad’s* grandfather associated *Allah* with a moon-god when he put the golden gazelles in the *Kaaba*.

That the gazelle is a moon-god symbol is interesting in light of the fact that the gazelle is a *Sufi* symbol both of *Muhammad*<sup>4581</sup> and “the beauty of” *Allah*.<sup>4582</sup> This means the *Sufis* believed *Muhammad* was a prophet of a moon-god.



**Figure 16-09.** Typical gazelle with curved horns. The gazelle was a moon-god symbol in southern Arabia.

Gazelles are a type of antelope. Certain antelope species such as *Ibex* have especially curved horns and the “Scimitar” *Oryx* has slightly curved horns that look like its namesake. Reliefs from southern Arabia show that *Ibexes* were moon-god symbols.



**Figure 16-10.** Frieze with *Ibex* and crescent-and-orb motif.<sup>4583</sup> *Ibex* were moon-god symbols in southern Arabia on account of their curved horns.

Besides a golden gazelle, *Abd Al Muttalib*, *Muhammad’s* grandfather, also found swords in the *Zamzam* well. Ancient sources that mention swords generally are silent about sword specifics, but since *Muttalib* found these particular swords:

- ☉ In proximity to a moon-god shrine
- ☉ In a well along with a gazelle, which is a symbol of a moon-god
- ☉ Based on directions he received in a dream while sleeping next to the crescent-shaped *Hatim* Wall

Thus there is a good chance these swords were curved sabers or scimitar swords.<sup>4584</sup>

<sup>4578</sup> Peters. *Origins*, p. 138.

<sup>4579</sup> *Al Azraqi*, 1858, pp. 108-109 is quoted in Peters. *Origins*, p. 140.

<sup>4580</sup> *CEE*, Gazelle entry.

<sup>4581</sup> *Al Farid. Poems*, p. 53, note 27 (referring to Poem II. 13, p. 28).

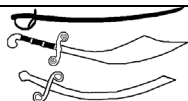
<sup>4582</sup> “The gazelle, favorite simile of the early Arab poets for the slender, shy young beloved, with the *Sufis* becomes a symbol of the elusive beauty of God, identified by *Ibn Al Farid*, as we see in lines 37-38, with the Prophet *Muhammad*. The image passed over into Persian mystical poetry in the form of the *Ahu-yi Vahshi* of *Hafiz*, see for example my *Fifty Poems of Hafiz*, 131-4” (*Al Farid. Poems*, p. 32, note 13, referring to Poem II. 13, p. 28).

<sup>4583</sup> “A portion of a marble entablature, or frieze, probably from *Marib*, has the crescent-and-Venus orb as a central motif flanked by crouching *Ibexes*” (Doe. *Arabia*, p. 36, fig. 10).

<sup>4584</sup> A scimitar (also spelled cimeter and scymetar) is a shorter crescent-shaped sword known for flexibility and for slashing at close range. Straight, long swords are better for thrusting and fencing.

Arabian crescent-shaped swords are usually called scimitars. The Persian and *Turkish* crescent-shaped sabers are usually referred to as scimitars or *Kilij*, while Indian crescent-shaped sabers are referred to as *Shamshirs*.

The defining difference between a *Kilij* and a *Shamshir* is that a *Shamshir* is closer to the arc of a circle and uses a closed scabbard (sheath), while a *kilij* starts almost straight near the handle



**Figure 16-11.** A slightly curved saber (top) and two types of curved scimitars (middle and bottom). Scimitars were moon-god symbols in the Mideast East since ancient times.

It is anachronistic to think that most swords owned by early *Muslims* were scimitars. Scimitars did not become a *Muslim* trademark until the fifteenth century.

The fact that southern Arabians [Arabs] have sported *Jambiya* daggers from ancient times to the present suggest that the only reason *Muslims* did not carry scimitars from the earliest times is that most swords were made outside the Mideast in Germany or India. *Ibn Ishaq* wrote that *Muhammad*'s men had "fine polished Indian swords" in 629 AD.<sup>4585</sup> It seems the famous *Damascene* swords were in short supply due to lack of iron and wood in the Mideast. David Nicolle wrote:

Indian steel blades were still sought after, though by the ninth century they seem to have taken a back place to those from the Rhineland [Germany]...Bronze was used to a much greater extent [in the Mideast] than in Europe presumably because of the shortage of iron in the *Islamic* world.<sup>4586</sup>

So while the moon-god armies of *Islam* preferred scimitars, they used straight swords mostly because *Muslims* bought most of their swords from India and Europe.

Some early *Muslim* armies did use slightly curved sabers, as was noted in previous chapters. It was also noted that some twelfth-century *Islamic* coins depicted scimitars (see the Index entries for saber and scimitars).

Though scimitars did not become a *Muslim* trademark until later centuries, the fact that there were legends about *Muhammad* owning scimitars suggests that *Muslims* knew *Islam* was a moon-god religion.

According to legend, *Muhammad*'s sword was a scimitar that came from his share of the spoils after the Battle of *Bakr*. *Bakr*, by the way, means "full-moon," which suggests the sword was a crescent-shaped scimitar. *Muhammad*'s scimitar was named the *Dhu'l-Fiqar*, meaning the "The Trenchant," i.e. "the Cutter."<sup>4587</sup>

Also, according to legend, *Muhammad*'s sword was brandished by one named *Ali* in early *Islamic* battles such as *Khaybar* and the Battle of the Trench. Another legend says:

When your Prophet led the first great battle in the month of *Ramadan*, in the second year of the *Hegira*, he stuck his scimitar into a staff and had it carried as a standard. It led them to victory and was adopted as the battle standard henceforth. From that time the curved scimitar changed into the crescent, [and] has been the universal symbol of *Islam*.<sup>4588</sup>

Some historians note that scimitars were rare in *Islam* before the 14<sup>th</sup> century AD and then assert that the legends and historians speak anachronistically whenever *Islam* is associated with scimitars before the 14<sup>th</sup> century. However, since scimitars were invented in the Mideast earlier than 2,000 BC, there is a good chance that the legends and historians are correct in associating scimitars with *Islam* since *Islam*'s inception.

---

then curves. A *kilij* requires a scabbard with an open back for the first few inches starting at the handle end.

<sup>4585</sup> Ishaq. *Sirat*, p. 588, Chapter "The Capture of *Al-Taif*", 8 AH.

<sup>4586</sup> Nicolle, David. *Armies of the Caliphates*, 862-1098, Men-at-Arms Series, Osprey Publishing, Oxford, 1998, p. 16.

<sup>4587</sup> Brewer. *Fable*, "Fakâr (*Dhu'l*)" entry.

<sup>4588</sup> May, Karl. *Jack Hildreth on the Nile*, translator Marion Ames Taggart, Benzinger Brothers Publishers, 1899 AD

### Esoteric Script and Inscriptions Show that *Allah* was a Moon-god

Scholars like to talk about how *Muslims* decorated their script and inscriptions in order to impart some esoteric meanings but they often leave the reader guessing what the esoteric meaning is.

It is true that some decoration was meaningless artistry and calligraphy but it is obvious that some artists were making crescent-and-orb symbols. This was noted in connection to coins earlier in this chapter.

It has already been noted in this chapter that many Arabic letters had curves similar to crescents and the diacritical marks were similar to stars and asterisms (i.e. a small groups of stars).

With curvy letters it was especially easy to make crescent-and-star decorations out of Arabic script. Because iconoclasm ebbed and flowed over the centuries, there was an incentive for artists to produce subtle crescent-and-star symbols in script and inscription form.

*AcaDhimmis* do not come right out and say that early *Islamic* artists were creating crescent-and-orb symbols out of script. Perhaps they fear the repercussions of saying the obvious. So they talk about how the tall-short-tall (lol) pattern of calligraphy script indicates *Allah*—yet without mentioning the crescent-and-orb pattern.

*AcaDhimmis* also talk about the “esoteric meaning” of the *Alif* and *Lam* ornamentation. *Alif* (*A*) and *Lam* (*L*) are the first two letters of the word *Allah* (*aUl*). The fact that the tall-short-tall (lol) pattern is derived from the horns of the crescent and middle orb is never mentioned.

In her book *Islamic Inscriptions*, Sheila Blair mentioned several times how calligraphists gave special attention to the decoration of *Alifs* or *Lams*.<sup>4589</sup> Sheila Blair wrote:

She [Bierman, 1989, 1997] connected the elaboration of script to *Isma'ili* symbolism and other popular beliefs, suggesting, for example, that the interlaced *Lam-Alif* reflects the interior (*Batin*) hidden or esoteric meaning behind the outside (*Zahir*) appearance.<sup>4590</sup>

Sheila Blair wrote:

Ettinghausen (1976) noticed that one group of inscriptions in pseudo-*Kufic* is composed of two framing uprights set to the right and left of an arched unit. He suggested that this tall-short-tall (lol) pattern had evolved from the word *Allah*, which was often embellished with a bump between the two *Lams* on tombstones from ninth-century Egypt. The meaning of the design [crescent-and-orb] had been lost [or rather, became an open secret among *Muslims*] and this simple and pleasing pattern was repeated on a number of buildings and objects where the use of the name of God [*Allah*] would have been particularly inappropriate. These include not only Christian monuments, such as the marble cornice of the church at Hosias Loukas, but also other types of *Islamic* objects, notably ceramics, textiles and glassware.<sup>4591</sup>

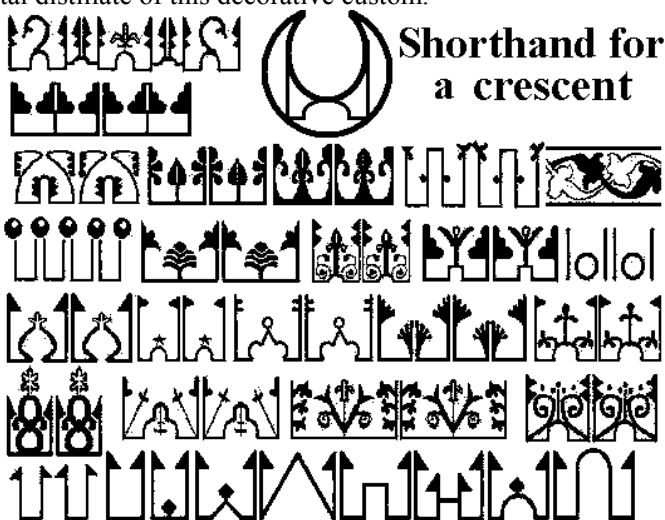
<sup>4589</sup> Blair. *Inscriptions*, pp. 57, 80, 104, 149, 151, 169, 178.

<sup>4590</sup> Blair. *Inscriptions*, p. 57.

<sup>4591</sup> Blair. *Inscriptions*, p. 80.

Ettinghausen even wrote:

Obviously, the *Islamic* custom was to stress and beautify the word *Allah* in one way or another in building inscriptions just as in some early *Koran* manuscripts the word *Allah* was rendered in gold, while the rest of the text was written in black ink. The tall-short-tall (lol) syndrome in East and West is the ornamental distillate of this decorative custom.<sup>4592</sup>



**Figure 16-12.** These are tall-short-tall (lol) crescent-based *Allah* motifs. They are shorthand for a crescent as shown at the top of this illustration where a basic *Allah* motif fits into a crescent.

Twenty-four examples as well as a chart of tall-short-tall syndrome examples are covered in the article by Ettinghausen (*Kufesque*, pp. 28-47).

Also see the illustration of *Allah* motifs decorating the Dome of the Rock in the moon-god temples chapter (see the thumbnail gallery).

*Allah* looks like *aUl* in Arabic. The calligraphists using the tall-short-tall (lol) pattern and sometimes dropping characters managed to make the word *Allah* look more like a crescent (e.g. l\_l), or like a crescent-and-orb (e.g. ln\_l, lol and l|l). Ettinghausen gives the specifics on how this was done:

The ordinary form of two uprights which closely reproduce the unadorned center of the word *Allah* is correctly rendered by first presenting the initial *Lam*, while in the case of the second *Lam*, the connecting line to the final *Ha* has been omitted, so that it looks like an *Alif*...a quasi-*Alif*.<sup>4593</sup>

Ettinghausen notes when the tall-short-tall (lol) pattern is first evidenced in *Islamic* inscriptions:

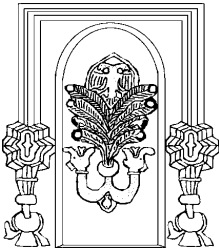
...particularly in the introductory *Basmala* formula. It occurred first in a marble tombstone of 191 AH/AD 807...and is then found in other *stelae* [stone slabs] of the ninth century. The first further elaboration of the motif is found in the tombstone of 208 AH/AD 823, where a small star is fixed to the top of the rounded arch...More elaborate is the example of 224 AH/AD 839, where the medial section is a tripartite arch, the center of which is pointed and topped by a small circle, while the side units are round...A stone of 243 AH/857 AD has not

<sup>4592</sup> Ettinghausen. *Kufesque*, p. 39.

<sup>4593</sup> Ettinghausen. *Kufesque*, p. 37.

only beautifully raised *Kufic* with arabesque endings for the tall letters but also shows a high, polylobed arch for the center section...On the other hand, in two other *stela*e [stone slabs] of the same year the center of the word *Allah* is rendered several times by a high, pointed, horseshoe arch in double outline while the crest is decorated with a small *Fleur-de-lis*...The two most elaborate versions of the ninth century are found in yet another stone of the year 243 AH/858 AD showing a high polylobed arch which is filled with a flower, and in one of 245 AH/860 AD where the fleuron above the pointed arch is higher than the framing *Lams*.<sup>4594</sup>

Other tall-short-tall (lol) patterns include the sunburst patterns ubiquitous in *Islam*. An example of pseudo-*Kufic* with sixteen *Fleur-de-lis* (fleurons) between sixteen pair of *Lams* (e.g. 181) is the marble sixteen-point star or sunburst on the wall of the *Aqsa Mosque* on the temple mount in Jerusalem, as was pictured in a previous chapter (see the Thumbnail Gallery).<sup>4595</sup> Another sixteen-point sunburst is found on a *Mamluk Koran* frontispiece from about 1370 AD.<sup>4596</sup>



**Figure 16-13.** Tall-short-tall (lol) ornamentation. This is an example of the tall-short-tall (lol) crescent-derived ornamentation meaning “Allah,” combined with a *Mihrab*-like frame.

Bear wrote: “Palm leaves carved in stone, next to monumental portal of the *Cifte Minare Medrese, Erzerum*, ~mid-thirteenth century” (Baer. *Ornament*, p. 91, figure 106).

Another example of the tall-short-tall (lol) pattern is the crescent-and-orb and three-sprigged *Fleur-de-lis* carvings ubiquitous in early *Mosques* and the Dome of the Rock.<sup>4597 4598 4599</sup> Examples of such wood panels and entablatures are illustrated in a previous chapter (see the thumbnail gallery).

Another example of a rounded unit between two *Lams* given by Ettinghausen is a picture of a tenth-century slip-painted piece of pottery from *Nishapur, Iran*. The tall-short-tall *Allah* motif looks like lol and is repeated all around the edge of the dish like lollllol.<sup>4600</sup>



**Figure 16-14.** Some *Allah* motifs used in the Dome of the Rock as discussed in detail in the moon-god temples chapter. Also, see the Thumbnail Gallery.

<sup>4594</sup> Ettinghausen. *Kufesque*, p. 35, and fig. 15 on p. 36.

<sup>4595</sup> Nuseibeh & Grabar. *Dome*, p. 157.

<sup>4596</sup> “Frontispiece from *Mamluk Quran*, circa 1370, detail. *Cairo National Library* 54, folio IR. From *Mosque of Mustafa Chorbaji Mirza*” (Baer. *Ornament*, color plate B). “The [book] cover illustration shows a detail from a frontispiece to a *Quran* written and illuminated for Arghun *Shah*, circa 770-790 AH/1368-1388 AD, now in the National Library, *Cairo*.”

<sup>4597</sup> Grabar. *Dome*, pp. 57-58, 60-61, 114-117, with a close-up on p. 71.

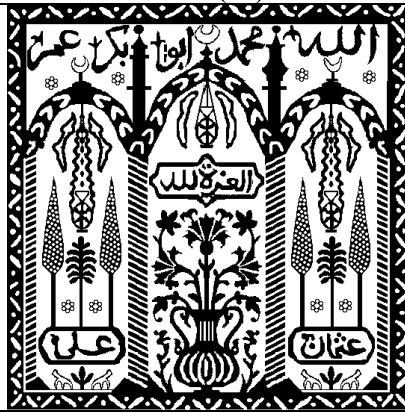
<sup>4598</sup> The “ball in hammock” motif in the Dome of the Rock’s upper drum is pictured in Grabar. *Dome*, pp. 119-121, 128-129, 132-133, and in Grabar. *Shape*, pp. 78, 80.

<sup>4599</sup> Grabar. *Dome*, p. 140.

<sup>4600</sup> Ettinghausen. *Kufesque*, pp. 32-33.

Twelve lol ornaments of inlaid marble, each perhaps greater than two feet square, can be seen in the white marble above the circular arcade of pillars facing “The Rock of *Ibrahim*” in the Dome of the Rock.

### The Tall-short-tall (lol) *Allah* Motif’s Connection to the *Kaaba* at *Makka*



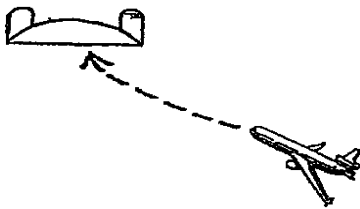
**Figure 16-15.** Seventeenth-century tile inspired by *Mosque* lamps hanging from arches at the *Grand Mosque* at *Makka*. Notice the plant and plaque lol *Allah* motif and the crescents.

“Tile Panel Depicting the Gateway to Paradise, *Ottoman* Syria, ~1600 CE. Colors on white slip on white siliceous ceramic body, covered with clear glaze. Panel (27.5 x 29 inches). Museum of Fine Arts, Boston, Venues: DC, AS” (Blair & Bloom. *Paradise*, p. 88, figure 22a).

A lol *Allah* motif is found on a seventh-century tile (see illustration above). The many three-entryway gates at *Makka* inspired the pattern on the tile. The arches of these gates had lamps hanging from the apex in the fashion of a *Venus Mihrab* altar.

Such gates ringed the *Kaaba* area and were present for several centuries when the *Ottoman* Turks still controlled Arabia. That there were such doors at the *Kaaba* indicates that *Allah* is a moon-god and the *Kaaba* is a moon-god shrine.

### The Tall-short-tall (lol) *Allah* Motif as Used by Modern *Jihadists*



**Figure 16-16.** In 2004 a *Jihadist* used the tall-short-tall balloon-letter-styled *Allah* motif symbol. The picture shows a passenger jet flying up toward a symbol of *Allah* in the heavens, a symbol that has similarities to a stylized moon crescent. Some *Allah* motif symbols are symbols of martyrdom.

On 3 Aug 2003, Northeastern Intelligence Network posted the above picture with this write-up:

This morning analysts have forwarded to law enforcement a posting from an Arabic language *Jihadi* board containing the above image. The heading of the post says [in Arabic], ‘The *Islamic Airlines*.’ The posting urges: ‘By *Allah*, do not underestimate us.’ The flight is described as ‘The Flight with No Destination.’ The posting closes with the statement: ‘There is no life but in the hereafter.’ Analysts have found no clues in the post that indicates what the image is. It clearly shows an airliner headed towards some sort of targets.<sup>4601</sup>

The “targets,” however are just a modern version of the tall-short-tall lol *Allah* symbol, as shown in the illustration above. This would explain why the plane is flying up toward heaven and toward *Allah* rather than down toward the ground.

The above drawing is saying that a suicide-bombing using a plane is a ticket to paradise where *Allah* resides. This interpretation agrees with the sordid text that went

<sup>4601</sup> “*Islamic Airlines; Flight to No Destination*,” homelandsecurityus.com, 3 Aug 2004.

along with the drawing, as quoted above, and it agrees closely with the *Muslim Brotherhood's* slogan as found on their Web home page:

*Allah* is our objective. The messenger is our leader. *Koran* is our law. *Jihad* is our way. Dying in the way of *Allah* is our highest hope.<sup>4602</sup>

Notice that the symbol that the terrorist drew for *Allah* in the heavens has some abstract similarities to the two-horned smiling crescent-moon as seen in the Mideast. Besides being similar to several tall-short-tall lol *Allah* motif symbols, the symbol is very similar to the “F” cipher in the Alphabet of *Cancer*—Under the Influence of the Moon, which is illustrated later in this chapter.

The tall-short-tall lol *Allah* motifs have a history of being used as a symbol of martyrdom. *Allah* motifs are commonly found on grave markers and *Mosque* inscriptions. In fact, the earliest instance of an *Allah* symbol is on a tombstone, as was discussed earlier in this chapter.<sup>4603</sup>

The *Iranian* flag has a tall-short-tall lol *Allah* symbol that looks like a crescent and tulip-shape all at once. This *Iranian* symbol has definitely come to signify martyrdom, or may always have signified martyrdom. This *Iranian* symbol will be discussed and illustrated shortly.

### An Allah Motif As a Symbol for Lebanon



**Figure 16-17.** This tall-short-tall symbol for *Allah* was found on a Christian Lebanese “Cedar Land” web site ([cedarland.org](http://cedarland.org), accessed 1 Sep 2004).

The web site discussion board explained that the symbol was from the Arabic or Lebanese and it meant “Lebanon.” This derivation may or may not explain some of the minor shapes involved, but the symbol’s main shape and first and basic meaning is that *Allah* is a moon-god.

The fact that the tall-in-one-tulip-crescent on *Iran's* flag is a martyr symbol and the fact that other tall-short-tall *Allah* motifs serve as martyr symbols, may mean that this is “Lebanese” tall-short-tall *Allah* motif is a *Muslim* martyr symbol too.

### A Tulip is used as an Allah Motif in the Iranian Flag



**Figure 16-18.** The tall-short-tall tulip symbol for *Allah* found in the center of an *Iranian* flag is formed by four parenthesis-like crescents. These are positioned to suggest a large crescent abstractly like the one at the lower-left bottom of this illustration.

The upright sword between the horns of the large “suggested” crescent turns the symbol into a tulip with pistil. The *Tashdid* (W) character at the top of the sword looks like an open *Koran*, or a sword hilt and hand guard.

Christiane Bird wrote about the tulip in the *Iranian* flag:

The dome was topped with the cupped logo of the *Islamic Republic of Iran*, which is a sword bracketed with four crescent-moons that stand for the unity and oneness of God:

<sup>4602</sup> *Muslim Brotherhood Movement*, [ummah.org.uk/ikhwan](http://ummah.org.uk/ikhwan), accessed 27 Mar 2005.

<sup>4603</sup> Ettinghausen. *Kufesque*, p. 35 and fig. 15 on p. 36.

Unto *Allah* belong the East and the West and whithersoever ye turn, there is *Allah's* countenance...read the *Qor'an* (2:115).<sup>4604</sup>

It is worth noting how matter-of-factly Christiane Bird says that each of the four crescents represents *Allah* and she even associates this idea with the *Koran*. Apparently, this is conventional wisdom that no *Iranian* would dispute. The real reason, though, that the stylized Tulip looks like the word *Allah* in Arabic is the tall-short-tall (lol) pattern that represents *Allah* as an orb-and-crescent-moon.

The *Flags Of The World* (FOTW) web site has some interesting information about the *Iranian* flag. The tri-color flag is green, standing for *Islam*, white, standing for peace, and red, standing for courage. The *Takbir* phrase, *Allahu Akbar*, meaning “*Allah* is great!” is embroidered twenty-two times on the flag. Harald Müller stated:

The four crescents are meant to stand for the word *Allah* (there is indeed some resemblance to the Arabic writing of it).<sup>4605</sup>

In Arabic calligraphy, letters are often eliminated, or moved in front or in back of the next letter or letters. Thus the tulip is formed by moving the initial *Alif* (*I*) letter of the word *Allah* (*aUI*) to the middle between the pair of *lam* (*I*) letters and by dropping the final *Ha* (*a*) letter.

A contributor identified only as M. N. wrote in *Flags of the World* (FOTW) web site:

The shape of the [*Iranian* flag] emblem is chosen to remind [one of] a Tulip...In recent years it is considered as the symbol of martyrdom.<sup>4606</sup>

In 1991 Blair and Bloom wrote that at Tehran...

...a fountain in the cemetery spews forth red water as a graphic symbol of martyrs' blood. Friends and family cluster around the individual graves, the women in their black veils grieving and leaving red gladioli and tulips...<sup>4607</sup>

Since *Iranian Mullahs* believe in suicide-bombing, have long-range missiles and may have nuclear weapons in several years' time, it is sobering to know that the main symbol on their flag stands for martyrdom! Instead of personal suicide-bombing, they may try national suicide-bombing.

Based on the information given so far, one can conclude that the *Iranian* flag emblem is another example of the tall-short-tall (lol) *Allah* motif. Also, the flag's logo shows the connection between the tulip, the crescent, *Allah* and the *Koran*.

The *Iranian* flag also has other interesting aspects. Harald Müller stated:

The symbol consists of four crescents and a sword. The four crescents are meant to stand for the word *Allah* (there is indeed some resemblance to the Arabic writing of it). The five parts of the emblem symbolize the five principles of *Islam*. Above the sword (central part) is a *Tashdid* (W [or aW]) [*Tashdid* is also called the *Shadda*] character. In Arabic writing this is used to double a letter, here it doubles the strength of the sword.<sup>4608</sup>

The *Tashdid* (W) character looks a lot like an open *Koran* on top of a sword, or a sword hilt and hand guard. When Harald Müller says “five principles of *Islam*,” he is referring to the Five Pillars of *Islam*: 1) Faith (Creed: One God, *Muhammad* is His

<sup>4604</sup> Bird, Christiane. *Neither East Nor West: One Woman's Journey Through the Islamic Republic of Iran*. Washington Square Press, 2002.

<sup>4605</sup> Bottasini, Giuseppe *et al.* *Flags of the World*, flagspot.net, contributor Harald Müller, 14 May 1996.

<sup>4606</sup> Bottasini, Giuseppe *et al.* *Flags of the...*, *Idem.* Contributor N. M., 7 Jun 1999.

<sup>4607</sup> Blair & Bloom. *Paradise*, p. 29.

<sup>4608</sup> Bottasini, Giuseppe *et al...*, *Idem.* contributor Harald Müller, 14 May 1996.



Prophet), 2) Prayer, 3) Charity (*Zakat*), 4) Fasting during *Ramadan* and 5) Pilgrimage (*Hajj* once in a lifetime).

The sword is “doubled” by the *Tashdid* character that looks like the sword’s hilt and hand guard, or an open *Koran*. This seems to be an allusion to the Sixth Pillar of *Islam*, namely *Jihad*, which Pillar is firmly grounded in the *Koran* and *Hadith*. So taking the doubling effect of the *Tashdid* character into account, the tulip emblem stealthily represents the Six Pillars of *Islam*, not just five.

So the *Iranian* flag is like many other *Islamic* flags in that it has *Koranic* quotations, a crescent and a sword. This indicates that the country is founded as an *Islamic* theocracy and also is a promoter of *Jihad*, both in principle and in practice.

The association between the sword and *Jihad* on flags is strengthened by calligraphy, a feature often found on *Islamic* flags. Calligraphists have long formed the first letter of the *Islamic* profession of faith “There is no god but *Allah*,” as a sword, as Seyyed Hossein Nasr noted:

The very form of the first witness (*La Ilaha Illa’ Lla-h* in Arabic) when written in Arabic calligraphy is like a bent sword.<sup>4609</sup>

That the long-time state sponsor of terrorism, *Iran*, has a sword representing *Jihad* seems entirely appropriate but is evil at the same time. The flag and emblem were adopted in 1980 AD, the year after *Ayatollah* Khomeini took power after the *Shah* of *Iran* abdicated in the face of revolution. Khomeini is also the founder of *Islamic Jihad*, a.k.a. *Hezbollah*, literally meaning “Party of *Allah*.”

Another interesting aspect of the *Iranian* flag is that The *Shah* of *Iran*’s flag had a centerpiece which...

...comprised a lion with a sword standing before a rising sun, with a crown above, but all traditional flags and banners were abolished after the abdication of The *Shah* in 1979.<sup>4610</sup>

Here is how *Iran* came to have its current flag. The exiled *Ayatollah* Khomeini (1900-1989), an *Islamic* radical who briefly sheltered in Paris (1978-1979) [or *Paristanbul*], came as the envoy of the moon-god *Allah*. He and his fellow moon-god clerics “saved” *Iran* from the pro-Western *Shah*, whose favorite symbol was the sun. The official astral emblem of *Iran* was then switched from the sun to the moon when *Iran* officially became an *Islamic* moon-god theocracy.

The common symbol of Persia was the lion and the sun, but the *Draphshe* was the royal crescent of ancient Persia and this symbol may have been found onto ancient flags.<sup>4611</sup> Davood N. Rahni states that at first *Iranian Muslim* flags were aniconic but these two rulers used the moon symbol:

*Sultan* Mahmoud Ghaznavi, the founder of the first Persian dynasty after the Arab invasion[, was the ruler] who reinstated the use of symbolic expressions on the *Iranian* flag. This solid rectangular black flag had in its center inscribed a golden moon.... Among the *Safavid* kings...*Shah* Esmail’s flag was triangular green with a moon on top...<sup>4612</sup>

<sup>4609</sup> Nasr, Seyyed Hossein. “The Spiritual Significance of *Jihad*,” *Al-Serat*, vol. IX, no. 1, *Al-Islam.org/Al-serat/Jihad-nasr.htm*, accessed 5 May 2004.

<sup>4610</sup> Shaw, Carol P. *Collins Gem Flags*. Harper Collins, Glasgow, United Kingdom, 1994, as quoted in Bottasini, Giuseppe *et al. Flags of the World*, flagspot.net, contributor Carlos de Noronha, 28 Mar 1998.

<sup>4611</sup> “Persan Royalists took by storm the Triumphal Arch,” Altermedia.info, 14 Jun 2006, *JW*.

<sup>4612</sup> Rahni, Davood N. “Persian Parade *Iranian* Flag: A National Historical Perspective,” payvand.com, dr Rahni.com, 10 Jan 2005.

That the moon finally replaced the sun on the *Iranian* flag is reminiscent of how the *Koran* is an anti-solar, pro-lunar screed.

### Crescent-and-star Shapes Found on Early *Islamic* Coins

What is true about early *Islamic* inscriptions is also true concerning epigraphic coins, even though the script on coins is less decorated than in inscriptions. Ettinghausen wrote:

The importance accrued to the middle portion of the word *Allah* and the tendency to decorate it become evident even when no actual ornamentation is physically applied to the *Kufic* letters.<sup>4613</sup>

*Islamic* coins minted in the first several centuries after the inception of *Islam* often have the *Kalima* written in *Kufic* or *Naskhi* script. The obverse (front side) of the coin commonly has the first part of the *Kalima* as reproduced below. The transliteration and translation read line by line:

Ⓒ *La Ilah Illah...* (There is no god except...)

Ⓒ *Allah Wahduhu...* (*Allah*, He is alone...)

Ⓒ *La Sherik Lahu* (There is no partner to Him (“Him” refers to “*Allah*”))

<p><b>Kufic</b> <b>Kalima</b> لا اله الا الله وحده لا شريك له</p>	<p><b>Naskhi</b> <b>Kalima</b> لا اله الا الله وحده لا شريك له</p>	<p><b>Figure 16-19.</b> On many coins the word “god” (<i>aJl</i>) with a “pellet” (a numismatic term) forms a crescent-and-star (illustrated here). On other coins (illustrated elsewhere) a star-and-crescent couplet is formed by placing a dot above the <i>aU</i> (meaning “to / for <i>Allah</i>.”)</p>
---	--	--

Note that the *aJl* (god) in the illustration above has a dot to make a crescent-and-star symbol. That this is the intended symbol is made obvious by the fact that other symbols such as stars appear above words referring to *Allah* (*aJl*, *aU*, *aUl*). Sometimes crescent-scepters that look like modern tuning forks appear in words referring to *Allah*. These all signify that *Allah* was known to be a moon-god (see the appendix and the illustration below).

<p><b>Kalima</b> <b>Creed on</b> <b>Coins</b> لا اله الا الله وحده لا شريك له</p>	<p><b>Allah Lunar Symbols on Coin</b> "To Allah" (<i>aU</i>): لله "to him" (meaning Allah) (<i>aJ</i>) له لله لله لله "Allah" (<i>aUl</i>): الله الله الله الله</p>	<p><b>Figure 16-20.</b> Early <i>Islamic</i> coins with crescents. Notice especially the crescent on a pole in 1) the <i>aU</i> (meaning “to / for <i>Allah</i>”) and in 2) the <i>aJ</i> (meaning “god”).</p>
---	---	--

The last word of the excerpt of the *Kalima* on the obverse side of the coin looks like *aJ* in Arabic. The English transliteration of *aJ* is *Lahu* and means “to him.” *aJ* is often translated as “god” when the context indicates that the “Him” refers to *Allah*.

In the *Kalima* creed and in early *Islamic* literature, such as *Ibn Ishaq*’s biography of *Muhammad*, *Allah* was often called “Him” (*aJ* = *Lahu*).<sup>4614</sup> Also, the context and

<sup>4613</sup> Ettinghausen. *Kufesque*, p. 38.

<sup>4614</sup> Ishaq. *Sirat*, pp. 99, 123, 127, 600, 608, 682.

parallel passages show that the *Koran* refers to *Allah* as “Him” (*aJ* = *Lahu*) hundreds of times.<sup>4615</sup>

It seems one reason a well-used appellation for *Allah* the moon-god was the pronoun “Him” (Arabic: *aJ*; pronounced *Lahu*) is that *aJ* looks somewhat like a crescent. *aJ* (Him) also looks much like the crescent-shaped *aJl*, Arabic meaning “god,” and like *aU*, an abbreviation meaning “to / for *Allah*.”

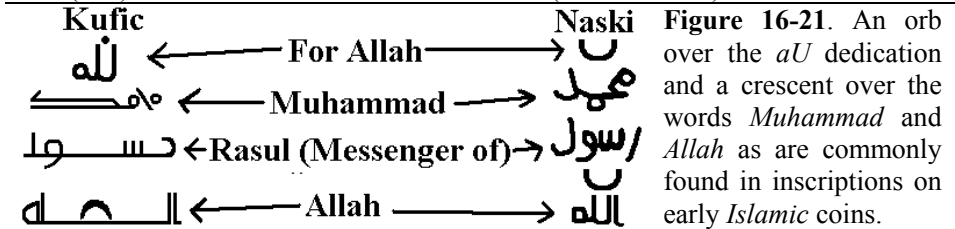
The English transliteration of *aU* is *Li-'llah*. *Li-'llah* is a contracted form of *li-Allah*, meaning “to *Allah*,” or “for *Allah*.” All these words signifying *Allah*, along with moon-god symbols, are often found together on coins, as discussed in the appendix on *Islamic* coins.

The reverse side of *Islamic* coins often has a crescent or *aU* (“to” or “for *Allah*”) at the top and the three-word, three-line appellation: “*Muhammad, Rasul Allah*” (meaning “*Muhammad*, Apostle of *Allah*”). A tradition suggests the wording on the coin was inspired by *Muhammad*'s signet ring:

Narrated Anas Bin Malik: *Allah*'s Apostle wanted to write a letter to a group of people or some non-Arabs. It was said to him, ‘They do not accept any letter unless it is stamped [sealed].’ So the Prophet had a silver ring made for himself and on it was engraved: ‘*Muhammad*, the Apostle of *Allah*’...as if I am now looking at the glitter of the ring on the finger (or in the palm) of the Prophet.<sup>4616</sup>

So many of these “*Muhammad, Rasul Allah*” coins had crescents that it seems likely *Muhammad*'s signet ring had a crescent mounted at the top, or a crescent over the engraved wording as is found on the coins. On coins, the bottom word *Allah* often had a crescent over it, or the word *Allah* was elongated and a crescent was positioned within the word *Allah* itself.

At the top of many coins a crescent substitutes for the dedicatory “to / for *Allah*” (*aU* = *Li-'llah*). An orb or crescent is often found between the *Lams* (*ll*) of both *Allah* (*aUl*) and the “to / for *Allah*” abbreviation (*aU* = *Li-'llah*).



**Cryptographic Alphabets Show That *Allah* was a Moon-god**

The early ninth-century *Muslim* researcher Ahmad Bin Abubekr Bin Wahshih compiled cipher symbol alphabets that reportedly predated *Islam*. Greek philosophers, *Sabeans*, *Nabateans*, *Chaldeans* and *Hermesians* were said to have used the ciphers.

The *Hermesians* were *Gnostics* whose mythical leader was *Hermes Trismegistos* (“*Mercury-god*, the *Thrice Great*”). Notice how the Arabic alphabet has more crescent-moon shapes than even this *Hermesian* “*Alphabet of the Moon*”!

<sup>4615</sup> K 029:065, the well-known “ship and land” passage, has “*Allah*,” but its clone in K 017:067 has “*He*” or “*Him*,” depending on the English translation. If the reader wants to find other instances where “*Him*” and “*He*” refers to *Allah*, do a case-sensitive, “match whole word only” search in an online English *Koran* translation.

<sup>4616</sup> *Sahih Bukhari*, vol. 7, bk. 72, no. 761.

Alphabet of the Moon

Cipher											
Arabic	\ (Alef)	ع (Ayn)	ب	د	ف	غ	ه (Soft)	ح (Hard)	ج	ك	
English	A	A	B	D	F	GH	h	H	J	K	
	ق	ك	ل	م	ن	ر	س	ش	ص	ش	ط
	K	K	L	M	N	R	S	S	S	SH	T
	و	ي	ذ	ز	ظ	ض					
	W or V	Y	Z	Z	Z	Z					

Figure 16-22. Cipher Alphabet of the Moon. 4617

Here is what the Alphabet of the Moon cipher symbols look like. The:

- Crescent (Alef (A), D, J, K, T, W (or V) and four Z characters represent crescents.
- 'ayn (A) looks like a crescent finial atop a dome and the second Z looks like a crescent finial.
- B looks like the *Maria* (seas) of the lunar surface.
- “Soft h” looks like the crescent-and-orb symbol.
- “Hard H” looks like a full-moon and orb on a post or scepter.
- K looks like a stack of betyls on a post, a common sight both in ancient times and during the *Islamic* period, i.e., the finials atop *Mosques* often have a stack of five orbs under the crescent that stand for the five visible planets and the moon (as is discussed elsewhere in this chapter).
- L looks like the outline of a *Mosque* lamp.
- SH and Y represent the tall-short-tall (lol) pattern that represents a crescent-and-orb symbol and by extension *Allah*—as was noted above.
- Y tall-short-tall (lol) pattern (two vertical bars with an orb in the middle) is found above the arcade facing the Rock of *Ibrahim* at the Dome of the Rock. This particular tall-short-tall (lol) pattern is larger than two feet square and is repeated twelve times in the Dome of the Rock. The pattern is discussed elsewhere in this *Moon-o-theism* book and is pictured in a few illustrations.
- The first Z cipher reminds one of a crescent on a *Mosque* dome.
- The last Z looks like the outline of the Dome of the Rock with a crescent shape for the crescent-shaped Rock of *Ibrahim* (as is discussed elsewhere).
- Other symbols have moon-like curves and shapes as the name of the cipher set implies, specifically, Alphabet of the Moon.

Alphabet of the Moon

Allah

Cipher				
Arabic	\ (Alef)	ل	ل	ه (Soft)
English	A	L	L	h (Soft)

Hilal, Arabic for "crescent"

Cipher			
Arabic	ه (Soft)	ل	ل
English	h (Soft)	L	L

Figure 16-23. Allah and Hilal in the Alphabet of the Moon cipher code.

An interesting fact to note is that the cipher characters that make up *Allah's* name are symbols commonly found in *Islam*: A (crescent), L (*Mosque* lamp), H

(crescent-and-orb) (see illustration, below). The same could be said for the characters of *Hilal* (HLL), meaning “the crescent-moon” (see illustration above).

<b>Alphabet of Cancer, Under the Influence of the Moon</b>									
<b>Cipher</b>	⋈	⋈	⋈	⋈	⋈	⋈	⋈	⋈	⋈
<b>Arabic</b>	ا	ع	ب	د	ف	غ	ح	ه	ج
<b>English</b>	A (Alef)	A (Ayn)	B	D	F	GH	H	h	J
						(Hard)	(Soft)		
	⋈	⋈	⋈	⋈	⋈	⋈	⋈	⋈	⋈
	ك	ك	ك	ل	ن	ن	ر	س	ص
	K	K	K	L	N	N	R	S	S
	⋈	⋈	⋈	⋈	⋈	⋈	⋈	⋈	⋈
	ت	و	ي	ظ	ض	ز	ذ	ط	
	T	W or Y	Y	Z	Z	Z	Z	T	

**Figure 16-24.** The “F” cipher is similar to some tall-short-tall *Allah* motif symbols discussed and illustrated elsewhere in this chapter.  
4618

The cipher “Alphabet of *Cancer*, Under the Influence of the Moon” is of interest too because—as *Abu Mashar* wrote:

*Cancer* is the House of the Moon and the exaltation of Jupiter is in the 15th degree...It has three decans [subdivision of the astrological sign/constellation]: the first belongs to Venus, the second to Mercury, the third to the moon.<sup>4619</sup>

So in astrology the moon basically owns the constellation Cancer (how ironic).

T. Wedel mentions the moon and *Abu Mashar* (just quoted) in this passage:

Among the greatest of Arabian astrologers was *Abu Mashar* who studied at *Baghdad* in the 9th century (AD) and formulated the doctrine that the more rapidly and erratically a body in the heavens [night sky] moves, the more influence it will exert on things below. The moon being the swiftest object in the heavens thusly exerts the greatest effect on human affairs.<sup>4620</sup>

What *Abu Mashar* wrote in the ninth century was already widely believed for centuries, as suggested from this quote of *Baqir Sharif Al Qarashi*, an *Imam* who was born in 655 AD:

The following is his supplication when he looked at the new crescent-moon:

‘O obedient creature, speedy and untiring, frequenter of the mansions of determination, moving about in the sphere of governance!<sup>4621</sup>

The F cipher symbol of “The Alphabet of *Cancer* Under the Influence of the Moon” is of interest because it is a squared crescent-and-orb symbol much like the tall-short-tall (lol) symbols mentioned earlier in the chapter. *Richard Ettinghausen* concluded that these tall-short-tall (lol) symbols stood for *Allah*.

<sup>4618</sup> Wahshih. *Hieroglyphic*, pp. 11, 57.

<sup>4619</sup> Ma’shar. *Astrology*, p. 5.

<sup>4620</sup> Ma’shar. *Albumasaris*, as cited by Wedel. *Attitude*, pp. 56-57, cited in turn by Spengler & Sayles. *Turkoman*, p. 22.

<sup>4621</sup> *Al Qarashi*, *Baqir Sharif. The Life of Imam Zayn Al 'Abidin (Born 655 AD/34 AH)*, rafed.net/books/other-lang/zain-alabiden, pp. 457-458.

Several of the symbols in “The Alphabet of *Cancer* Under the Influence of the Moon” resemble Arabic letters in certain respects (D, J, K, N, W and Z). The last Z cipher symbol (*aJ* = *Lahu*) is the same as the Arabic for the pronoun “him.” It was already noted above that the *Kalima* creed on the obverse side of early *Islamic* coins has “Him” (*aJ* = *Lahu*) as the last word, and in the *Koran* the “Him” pronoun (*aJ*) is commonly understood to refer to *Allah*.

So to conclude this section, it is clear that the “Alphabet of *Cancer* Under the Influence of the Moon” cipher constitutes more evidence that *Allah* is a moon-god.

### Moon-god Monotheism in Early *Islam*

Besides all the other evidence tying *Islam* to moon-god worship, *Muslims* have always had a fond attachment to the moon. The sun is very hot in the desert but the moon is always a pleasant sight. As was noted earlier in this *Moon-o-theism* book, Abdulkader Tayob wrote:

Unlike riding a camel, watching the new-moon is an act of worship.<sup>4622</sup>

Early *Muslim* literature and traditions is peppered with moon metaphors, comparisons to the moon and allusions to the moon. This shows that *Islam* is not very far removed from the moon-god religion that *Muhammad* practiced and believed for the first two-thirds of his life. Baqir Sharif *Al Qarashi* provides an example from an *Imam* who was born in 655 AD:

The following is his supplication when he looked at the new **crepuscular-moon**:  
 ‘O obedient creature, speedy and untiring, frequenter of the mansions of determination, moving about in the sphere of governance! I have faith in Him [*Allah*] who lights up darkness through you [moon], illuminates jet-black shadows by you [moon], appointed you [moon] one of the signs of His kingdom and one of the marks of His [*Allah*’s] authority, and humbled you [moon] through increase and decrease, rising and setting, illumination and eclipse. In all of this you [moon] are obedient to Him [*Allah*], prompt toward His will. Glory be to Him! How wonderful is what He has arranged in your [moon’s] situation! How subtle what He [*Allah*] has made for your [moon’s] task! He [*Allah*] has made you [moon] the key to a new month for a new situation. So I ask *Allah*, my Lord and your [moon’s] Lord, my Creator and your [moon’s] Creator, my Determiner and your [moon’s] Determiner, my Form-giver and your [moon’s] Form-giver, that He [*Allah*] bless *Mohammed* and his Household and appoint you [the moon] a **crepuscular** of blessings not effaced by days and of purity not defiled by sins; a **crepuscular** of security from blights and of safety from evil deeds; a **crepuscular** of auspiciousness containing no misfortune, of prosperity accompanied by no adversity, of ease not mixed with difficulty, of good unstained by evil; a **crepuscular** of security and faith, favor and good-doing, safety and submission!

O *Allah*, bless *Mohammed* and his Household, place us among the most satisfied of those over whom the **crepuscular** has risen, the purest of those who have looked upon it [the moon], the most fortunate of those who have worshipped you under it [the moon]; give us the success during (the new [lunar] month) to repent...<sup>4623</sup>

<sup>4622</sup> Tayob. *Islam*, p. 27.

<sup>4623</sup> *Al Qarashi*, Baqir Sharif. *The Life of Imam Zayn Al 'Abidin (Born 655 AD/34 AH)*, rafed.net/books/other-lang/zain-alabiden, pp. 457-458.

### Lunar Art in Islam Shows That Allah Was a Moon-god

Besides the crescent artwork that has been ubiquitous in the Mideast since ancient times, there are other forms of lunar art. Eva Baer wrote:

The motif of animal heads joined together into a swastika-like designs of real or imaginary creatures which are linked by one of their organs to form a wheel, goes back to remote antiquity, and after Pharaonic Egypt it continued to be used by the *Skythians* [*Scythians*], in *Buddhist* Central Asia, the lands of *Islam* and medieval Europe. In the *Islamic* world it was adopted about the tenth century for the decoration of metal and ceramic wares, first in *Khurasan*, and between the later twelfth and the fourteenth century in Mesopotamia, Syria and Egypt.<sup>4624</sup>

All these ‘wheel’ ornaments shared a number of features. One was that by their revolving movement they became associated with stellar bodies, with which they were actually merged in the east *Iranian* ornament, in which palmettes and half-palmettes circulated round a central star.<sup>4625</sup>

The animal wheels are therefore not an isolated phenomenon. They are part of an ornamental language which at least in general terms had cosmic connotations. In fact, as early as 1957 [AD] Richard Ettinghausen showed convincingly that the idea of revolving birds and fishes as well as their solar significance goes back to prehistoric times, and was taken up by *Muslim* artists who had been aware of the ancient meaning of these designs....Ettinghausen has also established the decorative and solar function of the sphinx wheel in Persian and Syro-Mesopotamian art. He also assumed that in view of the ancient lunar significance of the hare the revival of this motif in the form of wheels should be interpreted in the same traditional sense....in the center of a round brass tray...three hares joined by their long ears are framed by an epigraphic frieze which is broken by copper-inlaid moon crescents into four sections. Similar crescents are relatively common decorative device. Whether they were charged with lunar connotations, comparable to the astrological symbols of *Luna* or *Cancer*, is questionable. Be this as it may, revolving hares, like sphinx, bird and fish wheels, were extremely attractive ornaments which spread from eastern *Iran* westwards, and enjoyed relative popularity between the mid-twelfth and thirteenth centuries. By that time, *Islamic* artists had gradually lost interest in figural signs altogether and animal wheels were replaced by other designs.<sup>4626</sup>

### The Crescent is an Official Symbol of Islam

The *Catalan* map drawn up around 1375 AD shows a flag for *Cairo* with a crescent.<sup>4627</sup> A painting of *Saladin*'s army made in 1337 AD shows the horses with

<sup>4624</sup> Baer. *Ornament*, pp. 118-119.

<sup>4625</sup> Baer. *Ornament*, p. 123.

<sup>4626</sup> Baer. *Ornament*, p. 124.

<sup>4627</sup> The *Catalan Atlas* (BNF, Esp. 30;

bnf.fr/enluminures/texte/manuscrit/aman6.htm) is the finest work to come from the *Majorcan* cartographic school of the fourteenth century. Most probably produced in 1375 [AD], which is the date that appears on the perpetual calendar accompanying the maps. The map is attributed, though without certainty, to Cresques Abraham. The atlas was already recorded in Charles V's library, in the inventory drawn up by Gilles Malet and copied by Jean Blanchet in 1380 [AD] (“une quarte de

crecents and stars. Other later maps of *Islamic* lands and paintings of *Islamic* armies continue to associate crecents with *Muslims*.

---



**Figure 16-25.** *Saladin's* army with crecents (on the lead horse's blanket covering or plated-armor covering).<sup>4628</sup>

---



**Figure 16-26.** Crusaders versus *Muslims* riding horses sporting crecents, from a fourteenth-century painting.<sup>4629</sup>



**Figure 16-27.** Crescent on seventeenth-century map of the Turkish Empire, London ~1627 AD, John Speed (1552-1629).<sup>4630</sup>

---

*mer en tableaux faicte par maniere de unes tables, peinte et ystoriee, figuree et escripte et fermant a iiii fermoers*" ).

<sup>4628</sup> Drawing of excerpt of reproduction. Miniature from Roman. *Bibliothèque Nationale*, Paris, France, Ms. fr. 22495, folio 229.

<sup>4629</sup> Roman de Godfrey de Bouillon, *Bibliothèque Nationale*, Paris, Ms. Fr. 22495, folio 265v. *bataille de damiette* (1218/1219) *guillaume de tyr, historia (et continuation)*, 14th century.

Drawing of excerpt of copy in Landay. *Rock*, p. 101.

<sup>4630</sup> Speed. *A Prospect of the Most Famous Parts of the World*, as excerpted in "16th - 17th Century Maps," [turkeyinmaps.com/Sayfa2.html](http://turkeyinmaps.com/Sayfa2.html), accessed 2004.



## Appendix: Moon-o-theistic Coins

### Index

- I. Introduction
- II. Crescents Appeared on Early *Islamic* Coins
- III. The Significance of Crescent Artwork and Mintmarks on Coins
- IV. Some Coins and Coin Weights With Symbols of Especial Interest
- V. Crescent Use On Early *Islamic* Coins, Coin Weights and Vessel Stamps (by Dynasty)
- VI. Dating *Islamic* Coins, Coin Weights and Vessel Stamps
- VII. Early Arab *Islamic Caliphates*
- VIII. Some *Islamic* Numismatic Abbreviations and Terminology
- IX. Selected *Islamic* Coin References

### I. Introduction

This list of early *Islamic* items incorporating the crescent and other symbols is not exhaustive by far but is merely a representative sample. The emphasis on “crescent(s)” and “star(s)” is the author’s Yoel Natan’s and any comments in square brackets [ ] are Yoel Natan’s.

The reader who is unfamiliar with *Islamic* history or coin collecting may want to skip down to the end of the appendix to read these minor sections:

- ☉ An explanation of the different calendars used in the dating of *Islamic* coins.
- ☉ A list of rulers and a brief history of early Arab *Islamic* dynasties.
- ☉ A list of *Islamic* coin references.
- ☉ Abbreviations used in numismatics.

### II. Crescents Appeared on Early *Islamic* Coins

Gordon Newby wrote:

*Hilal* (Arabic: crescent): The crescent or new-moon, it has become the symbol of *Islam* because of its association with the sighting of the new-moon at the start and finish of the holy month of *Ramadan*. It is important in *Islamic* religious law (*Sharia*), because the *Muslim* calendar is lunar and the beginning of festivals are determined by the sightings of the new-moon. The details of such sightings vary from one legal school (*Madhhab*) to another. The crescent-moon began to appear, usually accompanied by a five- or six-pointed star, in the first *Islamic* century on coins and decorations. By the fifth [AD]/eleventh [AH] century, the crescent was used to replace the cross, when churches were converted to *Mosques*. In *Ottoman* times, the crescent and the star became emblems on *Muslim* battle flags and royal standards. In the twentieth century, these symbols became the flag of the Republic of Turkey when it was declared in 1923. *Pakistan* also adopted it, as have a number of *Muslim* countries around the world...the crescent has become the official symbol for deceased *Muslims* in the US military, parallel to the cross for Christians and the star of David for Jews.<sup>4631</sup>

<sup>4631</sup> Newby. *Encyclopedia*, pp. 81-82, *Hilal* entry.

### III. The Significance of Crescent Artwork and Mintmarks on Coins

Ya'akov Meshorer wrote:

On coins of the ancient world there are various marks, single letters, monograms, as well as other signs and symbols in the field of the coin. Some of these refer to the name and site of the mint...Most cities had their own symbols or mintmarks which were struck on the coins. The symbols were generally associated with the characteristic cult of the city (such as the club of *Heracles-Melqart* on the coins of *Tyre*, or the dove of *Aphrodite-Atargatis* on the coins of *Ascalon*) or with the name of the city (such as the symbol of the pomegranate on the coins of *Side* in *Pamphylia*, which is the meaning of the city's name, or the palm-tree on the coins of *Phoenicia-Tyre*, or the symbol of the rose of the coins of Rhodes and so on).<sup>4632</sup>

Alice Muehsam wrote that a dot was used on Roman coins to indicate the god and these coins were minted in Rome as well as in the east part of the empire. This technique avoided the need to widen the central columns of a temple in order to depict the statue of the god or goddess inside.<sup>4633</sup> The dot or orb was entirely appropriate given the fact that many of these gods and goddesses were associated with astral bodies.

Dan Barag wrote:

Stars, pentagrams, crescents and similar representations on coins contemporary with candlestick coins (8<sup>th</sup> century AD) may all have direct or indirect religious connotations.<sup>4634</sup>

The points or orbs are stars and planets associated with various male angels who guard heaven and throw meteoroids at invading or eavesdropping *Jinn* (K 041:012; 072:008-009). This and other evidence indicates that the crescent on *Islamic* coins, whether incorporated in the artwork or as a mintmark, is a symbol of *Allah* the moon-god.

### IV. Some Coins and Coin Weights With Symbols of Especial Interest

*Coins with the Bakhkh Symbol That Means "Glory be to Allah."*



**Figure A-01.** The *Bakhkh* scimitar-like symbol.

The *Bakhkh* scimitar-like *Tanga* symbol means "Glory be to Allah."<sup>4635</sup> While the *Bakhkh* symbol looks like a tilted, backwards "J," often the symbol is depicted on coins in a nearly horizontal fashion and could be mistaken for a scimitar.

The *Bakhkh* symbol is found on *Sabean* bucraneum coins between the early 2<sup>nd</sup> and mid-third centuries AD when *Saba* stopped issuing coins altogether. The word *Bakhkh* is mentioned in the *Arabian Nights*<sup>4636</sup> and the *Bakhkh* symbol is found on

<sup>4632</sup> Meshorer. *Nabatean*, p. 27 & fn.

<sup>4633</sup> Muehsam. *Temple*, p. 59, right column.

<sup>4634</sup> Barag, Dan. "The *Islamic* Candlestick Coins of Jerusalem," *Barag. Balog*, p. 46.

<sup>4635</sup> A piece of information that may be related is *Bakh-Bakh* (word repeated twice) is said to express admiration of something, or to praise it, or be proud of it (*Muhit-Al Muft Dictionary*).

<sup>4636</sup> From a footnote concerning the words translated: "Bravo! Bravo" in the fable told on the Two Hundred and Eightieth Night, which is "The Story of Isaac of *Mosul*": "The Syriac is '*Bakhkh-un-Bakhkh-un*,' meaning 'well done.' It is the *Pers Aferin* and means 'all praise be to him [*Allah*]' or 'Glory be to Allah'" (Burton. *Nights*, vol. 4, fn. 178).

coins from the same period in which the *Arabian Nights* was compiled. In fact, the *Bakhkh* symbol is found on coins that mention *Caliph Harun Al Rashid*, the *Caliph of Arabian Nights*' fame. Examples include:

- ☉ Bucraneum *Saba* coin series with *Bakhka* symbol. See the illustration and discussion in the section "Critique of the Revisionist View on the Sun- and Moon-gods in Southern Arabia" in this Moon-o-theism book (see the ToC).
- ☉ Ilisch. *Palastina*, coins 96-102 (217 AH/832 AD *Abbasid*).
- ☉ Arab-*Sassanian* coin, *Abbasid* governors of *Tabaristan*, anonymous coinage, Tabari *Dirham* 134 PYE = 169 AH/785 AD, *Tabaristan*. Conventional post-*Sassanian* type with *Afzut* (also spelled "Abzud," a word meaning "increase") instead of governor's name and double Arabic *Bakhkh* symbols. Walker p. 156 O. 10. 1.94 gram.
- ☉ *Abbasid Dirham* coin, 167 AH/783 AD, *Sijistan*. Rev. name of *Caliph (Al Mahdi Muhammad, 158-169 AH/775-785 AD)* and double Arabic *Bakhkh* symbols. Lowick/Savage 2357; Slg. Konsul Meyer 5786, variant 2.71 gram, coin 1502.
- ☉ *Abbasid Dirham*, 182 AH/798 AD, *Madinat Zaranj*. With the names of the *Caliph*, the governor of the East 'Ali Ibn 'Isa and the provincial governor Humam (*Ibn Salama*). Arabic *Bakhkh* symbol. Lowick/Savage 2430; Tiesenhausen 1323; Klukowicz Hd. 12. 2.79 grams.
- ☉ *Abbasid Dirham* from 174 A.H., *Sijistan*. With the names of the *Caliph (Harun Al Rashid, 170-193 AH/786-809 AD)* and the governor ('Uthman Ibn 'Umar) *Ibn Hurraym (Al Muzani, 172-176 AH)*. Reverse below field and a dot, a point and *Bakhkh*. Lowick/Savage 2378 variant; Lavoix 800; Baldassari collection 407 variant, 2.88 gram, coin 1507.



**Figure A-02.** *Bakhkh* symbol in *aU* ("to Allah" or "for Allah").

There are many coins with *Bakhkh*-like symbols but only a few references call the symbol by its name. Most *Islamic* coin references list the *Bakhkh* symbol as an ornament, mintmark, or the Arabic letter *hah* that looks somewhat like "p".

Few numismatists have been able to make any sense of these symbols or pellets, or most other *Islamic* coin symbols, except for saying that they are mintmarks. The *Bakhkh* symbol on these coins is listed as being the Arabic letter *hah*: Treadwell. *Buyid*, coin Sh408a (1/R1-4/R5).



**Figure A-03.** *Bakhkh* symbol in *aJl* (god = *Ilah*).

- ☉ Treadwell. *Buyid*, coin Fa408 (R1...4).



**Figure A-04.** *Bakhkh* symbol over *aJl* (god = *Ilah*).

- ☉ Treadwell. *Buyid*, coin J1362.1/2/3, J1365.1, J1368.1, Ba385.1-5, 10, Ms382G.1, Ms383Ga.1, Isa 393G.1, Qa 393G.1, Am341G.1

### Coins with Crescents



**Figure A-05.** *aU* in Crescent (to / for *Allah*).

- ☉ Ilisch. *Nord*, coins 400 (415 AH/1024 AD Binkat) and coin 453 (390 AH/1000 AD *Huganda*).



**Figure A-06.** Crescent in *aU* (to / for *Allah*).

- ☉ Treadwell. *Buyid*, coin Mb370G (1/R1), Mb371 (1/R1), Mb372 (1/R1 & R1/2 (catalogue p. 189)), Ms383Gb.2.



**Figure A-07.** Inverted crescent in *aJl* (god = *Ilah*).

- ☉ Castan, Carlos and Juan Cayon. *Las Monedas Hispano Musulmanas y Cristianas, 711-1981 [AD]*, ISBN: 84-85329-12-0. Madrid, Spain, 1981, (*Dinar Cece Zaragoza*, 503 AH/1109 AD, p. 44, photograph 81).



**Figure A-08.** Crescent in *aJl* (god = *Ilah*).

- ☉ Ilisch. *Nord*, coins 401-402 (415 AH/1024 AD Binkat).



**Figure A-09.** Crescent on a stick (like a tuning fork) in *aJl* (god = *Ilah*). This phrase means “There is no god but...”

- ☉ Treadwell. *Buyid*, p. 216, coins Mu403.1 and Mu403.2, plate 155.

### Coins with Pellets



**Figure A-10.** Pellet under *aU* (“to *Allah*” or “for *Allah*”) centered on coin face.

- ☉ Ilisch. *Palastina*, coins 563 (725-750 AD *Umayyad*).



**Figure A-11.** Crescents(s) next to *aJl* (god = *Ilah*).

- ☉ Treadwell. *Buyid*, coins Fa410, Sh390b (1/R1), Sh391b (1/R1-5/R5), Sh392 (1/R1).

Perhaps excepting those few coins that have crescent motif around the entire margin, coin Sh391b (1/R1-5/R5) may have the most crescents (nine) of any *Islamic* coin from early *Islam*:

3 crescents on the obverse [side] and four small crescents within a pointilate circle round reverse field...single crescent to either side of *aU* on reverse [side]. Similarly, Um391G has two crescents on the obverse side and six on the reverse field for a total of eight.



**Figure A-12.** Pellet in *aJl* (god = *Ilah*).

- ☉ Ilisch. *Palastina*, coins 124 (332 AH/944 AD *Ikhshidid*)
- ☉ Ilisch. *Nord*, coins 8-9 (65x AH/1252-62 AD *Otrar*), coin 130 (402 AH/1011 AD, *Balasagun*)
- ☉ Treadwell. *Buyid*, coins Ar354.9, Di375.1, Di377.1/2, Mb372.R2



**Figure A-13.** Pellet and star in *aJl* (god = *Ilah*).

- ☉ Treadwell. *Buyid*, coin Sh395a (1/R1-3/R?)



**Figure A-14.** Pellet(s) in *aUl* (*Allah*).

- ☉ Treadwell. *Buyid*, coin Sh331 (6/R2 in obverse margin, catalogue p. 37).



**Figure A-15.** Pellet(s) or Orb(s) in crescent(s).

- ☉ Ilisch. *Palastina*, coins 64-78 (120 AH/738 AD *Umayyad*), 411-412 (200 AH/816 AD *Abbasid*), 231-235 (80 AH/699 AD *Umayyad*), 571 (725-750 AD *Umayyad*)
- ☉ Ilisch. *Nord*, coin 606 (409 AH/1018 AD *Naukat*)

- Ⓒ Balog. *Glass*, coin weights 81-82 (*Umayyad*) and coin weight 753 (end of second century AH or later/816+ AD *Abbasid*)
- Ⓒ Treadwell. *Buyid*, coins Fa381 (2/R2 & 5/R4), Fa382, Fa385.2, Ja336.R1, Ja344.R1, Sh323, Sh324, Sh331, Sh336c.R1, Sh340.R1, Sh360.2, Sh381a22/23, Sh381b.1/3 & Sh381a.R28, Sh382.1/2/3/4/5/7/8/9, Sh383.1, Sh385.4/5, Ay334.R1, Ay338.R1, Ay349.R1, Ra344.R1, Ra 349.R5/6, Ra350.R1, Rh332.R2, Su334.R2, Su337.R2, Su338.R2, Su341.R3, Su344.R1/2/4/5, Sr346.R1, Su370.R1, Tu334a.R1/2, Tu334b.R1, Tu337.R2, Tu339.R1/2, Tu340a.R4, Tu340a.R6, Tu342.R1/2, Tu 343.R1, Tu350.R1, Tu356.R1, Tu374.R1/2, Ma372.4



**Figure A-16.** Pellet centered over crescent.

*Coins with Crescents Pairs with Other Symbols*

- Ⓒ Treadwell. *Buyid*, coin Br384, Br484, Fa381.2, Fa383.1-2, Kr382.1-2, Kr383.1, Kr383G.1, Kz383.1-2, Kz397.R1, Sh423a.R1, Br382.3, Br384.1, Rd382.2, Sr382.1.



**Figure A-17.** Crescent(s) next to star(s).

- Ⓒ Ilisch. *Palastina*, coin 245 (198 AH/814 AD *Abbasid*). The crescents and star combination is like this: U \* U
- Ⓒ Balog. *Glass*, coin weight 77 (*Umayyad*), Vessel Stamps 632, 672-673, 677 (*Abbasid*), 803, 806, 816-818 (Anonymous)
- Ⓒ Sanchez, R. Frochoso. *Los Feluses de Al Andalus*. Editor: *Numismatica Cordoba*. Madrid, Spain, 2001, p. 19, group I, type IIA. The crescents and star combinations are like this: ( \* ) at the top and bottom of the coin face
- Ⓒ Milstein, Rachel. “A Hoard of Early Arab Figurative Coins” as found in Barag. *Balog*, plate 3, coin 132. On such coins the crescents and stars are found in various places in and around the “M” denomination mark (as shown in the illustration at the start of this section)



**Figure A-18.** Monarch holding a cross affixed onto an orb with a crescent sliced into the top of the cross.

- Ⓒ Ilisch. *Palastina*, coin 517 (70 AH/689 AD *Umayyad*)



**Figure A-19.** Star-and-crescent couplet positioned over a cross affixed atop an orb.

- Ⓒ Ilisch. *Palastina*, coin 521 (70 AH/689 AD *Umayyad*)



**Figure A-20.** Crescent over scepter.

- Ⓒ Milstein, Rachel. “A Hoard of Early Arab Figurative Coins” as found in Barag. *Balog*, plate 6, coins 21 and 22. Some of these coins have crescent on lower reverse.



**Figure A-21.** Inverted Crescent with Pendant.

☉ Treadwell. *Buyid*, coin Si337a



**Figure A-22.** Star(s) in crescent (s).

☉ Balog. *Glass*, coin weight 635 (*Abbasid*) and Treadwell. *Buyid*, coin SH350 (1/R1)

#### *Coins with Fleur-de-lis (ψ)*



**Figure A-23.** *Fleur-de-lis* (ψ) in aJl (god = Ilah).

☉ Treadwell. *Buyid*, coin Mu 347c.1, Sh423b.1, Ak334a.1, Ak334b.1/2, Ha372.1, Is369.5/6/7/8, Is372.1, Mu347c.1, 361a.2 (Stp), Mu361a.2 (Moscow), Mu362a.3, Mu363a.1, Mu363b.1, Mu366.1, Mu367a.1, Mu367c.3/4, Mu368.4, Mu371.2, Mu393G.2, Mu394G.1/2, Qa371.1, Qu348G.1, Am387.1, Ab372.1, Ab385.1, Sy371b.1, Sy372.1



**Figure A-24.** *Fleur-de-lis* (ψ) in crescent.

☉ Ilisch. *Palastina*, coins 529-530 (725-750 AD *Umayyad*). Ilisch. *Nord*, coins 403-404 (416 AH/1025 AD Binkat), 522 (412 AH/1021 AD Taraz).



**Figure A-25.** *Fleur-de-lis* (ψ) next to a Crescent.

☉ Balog. *Glass*, coin weights 757-758-759 (*Abbasid*)

## V. Crescent Use On Early Islamic Coins, Coin Weights and Vessel Stamps (by Dynasty)

### *Introduction*

Below are *Islamic* coins, coin weights and vessel stamps with crescents and stars found in various books but also on the Internet. The user should be able to find these and similar coins, coin weights and vessel stamps on the web by using specific terms from the coin descriptions along with the word “crescent.”

General search parameters such as “early *Islamic*” and “coin” will not narrow the search results down to web pages with coins with crescents, but including the early *Islam* dynasty name (*Umayyad*, *Abbasid*, etc.) will help.

There are also ANS coins, coin weights and vessel stamps listed below that can be found by entering the ANS accession number (for example, 1991.3.168) in the ANS search form ([amnumsoc.org/search/](http://amnumsoc.org/search/)). One can also append the accession number to a URL address in the web browser’s address field like so: [amnumsoc.org/lookup.cgi?string=0000.999.37488](http://amnumsoc.org/lookup.cgi?string=0000.999.37488).

### *Arab Sassanian Coins With Crescents*

The last ruler of the Persian *Sassanian* Empire was *Yazdegird* III (632–651 AD). Most *Sassanian* coins had a crescent since a crescent was a common symbol among night god worshippers and Persian Zoroastrians.

After *Muslims* conquered Persian lands, *Muslims* only modified the coin designs somewhat because the crescents and stars found on Persian Zoroastrian coinage initially were in accord with early *Islamic* sensibilities. That early *Islamic* coins were similar to *Sassanian* coinage is why some of the following *Muslim* coins are called “*Yazdegird* type” coins.

<b>Description</b>	Coin: Anonymous <i>Yazdegird</i> III type, AR <i>Drachm</i> , Mint: BN
<b>Period</b>	651-665 AD
<b>Reverse</b>	Fire altar; two attendants holding swords (left-handed), facing. $\text{C}$ to left, star to right (reversed). Four $\text{C}$ s containing stars outside triple border. Mint name to right (BN= <i>Veh-Ardashir</i> in <i>Kirman</i> ); year 20 (frozen) to left.
<b>Reference</b>	As given on the web site: Album 2; Mitchiner ACW; Mitchiner WOI; Nikitin/Roth NC 155 no. 9 (same dies)
<b>Coin Date</b>	“Frozen Year” 20 YE/29 AH. These types bear the immobilized “Year 20” of <i>Yazdegird</i> III (“ <i>Yazdegird</i> Era” year 20 = 651 AD = 31 AH), though this issue was probably struck for 15 years. This is the earliest dated <i>Islamic</i> coin.

<b>Description</b>	Coin: Anonymous <i>Khosrou</i> II type, AR <i>Drachm</i> , Mint: BYSh
<b>Period</b>	653-670 AD
<b>Obverse</b>	Bearded bust right wearing headdress with two turrets; pair of wings topped by star in $\text{C}$ , above. Diadem ends floating upward, left and right. $\text{C}$ s on shoulders and star behind bust. $\text{C}$ containing star in right field. Three $\text{C}$ s containing stars outside double border. <i>Pahlavi</i> legend; <i>Bismillah</i> in margin. <i>Bactrian</i> word ‘ <i>CLOGO</i> ’ (?) in 1st quadrant (position 8h) and 3rd quadrant (position 1h).
<b>Reverse</b>	Fire altar; two attendants holding swords, facing. Star to left, $\text{C}$ to right. Four $\text{C}$ s containing stars outside triple border. Mint name to right ( <i>BYSh</i> = <i>Bishapur</i> in <i>Fars/Bishapur</i> district); (blundered; ‘ <i>Yazdegird</i> Era’) to left.
<b>Reference</b>	As given on the web site: Album 4; Mitchiner ACW 1344v.; Mitchiner WOI 24v. Gobl Hunnen Countermark 38 (x2).
<b>Coin Date</b>	25 YE/34 AH

<b>Description</b>	Coin: <i>Abd Allah Ibn Khazim</i> , AR <i>Drachm</i> , Mint: APRShT
<b>Period</b>	682-692 AD
<b>Obverse</b>	Triple pellets on either side of star and $\text{C}$ at 6h. <i>Pahlavi</i> legend; ‘ <i>Bismillah</i> ’ in margin; breast ornament: three pellets.
<b>Reverse</b>	Mint name to right (APRShT); year 69 AH to left.
<b>Reference</b>	As given on the web site: Album 19 type; Walker 157; Mitchiner ACW; Mitchiner WOI
<b>Coin Date</b>	69 AH

<b>Description</b>	Coin: ‘ <i>Umar Ibn ‘Ubayd Allah Ibn Mi’mar</i> , AR <i>Drachm</i> , Mint: WYHC
<b>Period</b>	686-689 AD
<b>Obverse</b>	Four pellets to right and single pellet to left of star and $\text{C}$ at 6h. Arabic legend; ‘ <i>lillah Al Hamd</i> ’ in margin; breast ornament: pellet within annulet.
<b>Reverse</b>	Mint name to right (WYHC) with pellet to either side; year 68 AH to left. Pellet to either side of altar at bottom.
<b>Reference</b>	As given on the web site: Album 21 type; Walker B.35 (year 69); Mitchiner ACW; Mitchiner WOI
<b>Coin Date</b>	687 AD, 68 AH

<b>Description</b>	Coin: 'Umar b. 'UbaydAllah b. Mi'mar, Governor of Fars, Ardashir-Khurra mint
<b>Period</b>	686-689 AD
<b>Obverse</b>	Within two concentric circles is a bust with a crown. From the crown rises a pole with wings on the bottom, ☪ in the middle and a star on top. ☪s with stars on shorter poles are at the three other cardinal points so that horns of ☪s face north, south, east and west.
<b>Reverse</b>	Various objects are within three concentric circles with four ☪s and stars arranged as on obverse, but all are on short poles.
<b>Comments</b>	This particular variety is especially interesting since it is inscribed with the name 'AbdAllah' to the left of the bust in <i>Pahlavi</i> script. This name refers to 'AbdAllah b. Al Zubayr, who was accepted as <i>Caliph</i> in Arabia, Iraq, Egypt and parts of Syria in the 680s but was defeated in 692 by his <i>Umayyad</i> rival, <i>Caliph</i> 'Abd Al Malik (685-705 AD).
<b>Coin Date</b>	69 AH

<b>Description</b>	'Abd Al Malik Ibn Marwan, 65-86 A.H./684-705 AD <i>Drachm</i>
<b>Obverse</b>	Conventional post- <i>Sassanian</i> type with <i>Bismillah</i> in margin, group of three dots left and right of the lower ☪ on obverse, one dot over the other ☪s.
<b>Reverse</b>	One dot in margin beside the upper ☪. Walker S. 28 c.
<b>Coin Date</b>	60 YE/72 AH

### *Umayyad Caliphate Coins, Coin Weights and Vessel Stamps With Crescents*

After the fourth and last Orthodox *Caliph* ruled in *Madina* and *Makka*, the *Umayyads* took over the *Caliphate* after a civil war. The *Umayyads* ruled from *Damascus* (661–750 AD). The *Umayyads* are known for building the:

- ☪ *Umayyad Mosque*, called “the Great *Mosque* of *Damascus*.” This *Mosque* was completed in 715 AD but only remnants have survived to the present
- ☪ The *Dome of the Rock* in *Jerusalem* completed 691 AD. The *Dome* was never destroyed but has been extensively renovated several times

The *Abbasids*, who ruled from *Baghdad* (749/750–1258 AD), massacred almost the entire royal house of the *Umayyads* in 750 AD, except for one *Umayyad* who traveled to *Spain* to rule there (see next page for *Umayyad* coin descriptions).



<b>Description</b>	These <i>Islamic</i> imitations of Byzantine Constantine II type coins have an obverse that depicts an emperor holding in his left hand a cross on an orb ( <i>Globus Cruciger</i> ), sometimes with the ☩ over the cross. In the emperor's right hand is a cruciform scepter. A chain that rests in front of the emperor apparently links the orb and cruciform scepter. The reverse has a cross over an M that stands for the value, sometimes underneath script that mentions "to / for Allah (aU = Li-llah), but sometimes the cross is replaced with a ☩.
<b>Comment</b>	Coin 517: Around 70 AH/689 AD. This coin has a ☩ over the cross on the orb ( <i>Globus Cruciger</i> ) on the obverse, while on the reverse there is text that mentions "to / for Allah (aU = Li-llah) over the cross over the valuation mark M. "Av. Constans II. Mit Kreuzstab in der Rechten und Kreuzglobus in der Linken von vorn stehend. Rev. m unter Kreuz uber Abschnittsleiste, darunter "aU..." Coin 517: "Av. Halbmond uber Kreuzglobus." Coin 521: About third quarter of first century AH (650-675 AD). This coin has a ☩ and star over the cross on the orb ( <i>Globus Cruciger</i> ) on the obverse. "Av. Constans II. Mit unberproportioniertem Kopf mit Kreuzstab in der Rechten und Kreuzglobus unter Halbmond und Stern in der Linken von vorn stehend, darum Kreis. Rev. m unter Kreuz uber Abschnittsleiste."
<b>Reference</b>	Ilisch. <i>Palastina</i> , page 44, plate 17.

<b>Description</b>	Coin 3, AE, 6h
<b>Period</b>	Abpit 74-77 AH/693-696 AD
<b>Comment</b>	"Standing <i>Caliph</i> " coin. ☩ situated over or under "M" denomination mark on reverse.
<b>References</b>	Ilisch. <i>Palastina</i> , page 10, plate 1. On the obverse of "Standing Emperor" and "Standing <i>Caliph</i> " imitative coins, the cruciform scepter is morphed into T-shaped stand that has either a "bird, a palm branch, a star and crescent or no symbol at all" (Bates. <i>Innovation</i> , p. 21).

<b>Description</b>	" <i>Mihrab</i> " Coin 1944.100.612, ANS, dated 695/698 AD, Arab- <i>Sassanian</i> , <i>Umayyad</i> dynasty. The reverse middle says " <i>Nasara/Caliphate/Allah</i> " next to the <i>Mihrab</i> . The coin is found in publications: BMC Arab-Sas ANS.5; IC.4.3 & c; D. and J. Sourdel, <i>La civ. de l'Islam classique</i> , fig. 21 (reverse only), ANS, accessed 18 Mar 2003. Also, " <i>Mihrab</i> " coins are discussed and pictured in this <i>Moon-o-theism</i> book.
--------------------	---

<b>Description</b>	Coin: Anonymous, AE <i>Fals</i> , Mint: <i>Jund Hims</i> (Ilisch 10a, Walker 801; coin: Bones 7.2b); <i>Jund Filastin</i> (Arabic for "Philistine / Palestine District") (Copper <i>Fals</i> : SNAT 69-70; coin: SNAT 74-75).
<b>Period</b>	698-750 AD
<b>Obverse</b>	Arabic legend around circle containing pellet
<b>Reverse</b>	Arabic legend around ☩ containing pellet
<b>Reference</b>	Walker 801; Album 177

<b>Description</b>	Coin: Anonymous, AE <i>Fals</i> , Mint: <i>Al Ramla</i>
<b>Period</b>	698-750 AD
<b>Obverse</b>	Palm tree within beaded circle; Arabic legend around.
<b>Reverse</b>	☾ within beaded circle; Arabic legend around.
<b>Reference</b>	Walker 855; Album 185 (?)

<b>Description</b>	Coin: AE false, without mint name, candelabra or <i>Menorah</i>
<b>Period</b>	699–750 AD



**Figure A-26.** *Menorah* and “crescent finial on dome” coin.

Stephen Album wrote:

Turned upside-down, this design resembles the dome of a *Mosque*, which may have been the engraver’s intention. The type, normally found in Palestine or southern Syria, is nonetheless in great demand from collectors of Judaica.<sup>4637</sup>

That the engraver meant the candelabrum to morph into a *Mosque* finial crescent when it was rotated is indicated by the fact that another coin from the same period has an *amphora* cleverly drawn so that when turned upside down it resembles a poppy.<sup>4638</sup> (An *amphora* was a two-handled jar with a narrow neck used for carrying wine or oil.)

Josephus and Philo relate that the lamps atop the *Menorah* in the *Herodian* temple represented the seven planets, i.e. the sun, moon and five visible planets. Knowing this and seeing the relief of the *Menorah* (70 AD war spoils from Jerusalem) on Titus’ arch in Rome reveals that the two branches of the *Menorah* were meant to look like two crescents on a stem. This is discussed previously in this *Moon-o-theism* book.

Some have stated that these coins could not depict an astral type *Menorah* but plausible alternative explanations are hard to come by. One reason given is that the temple *Menorah* had six branches and a center stem, with seven lights atop. The coins however commonly only have four branches. Also, some coins have a bipedal base and others have tripodal bases. This objection has an answer, however.

Bernard Goldman quotes a Rabbinic text that shows that the bases of *Menorahs* outside of the temple actually ought to have fewer branches than seven, meaning that the three and five branched *Menorah* coins may in fact represent *Menorahs*. Goldman wrote:

A man may not make...a candelabrum after the design of its [the temple’s] candelabrum. He may however make one with five, six or eight branches, but with seven he may not make it even though it be of other metals (‘*Abodah Zerah* 43a).<sup>4639</sup>

Numismatists note that The *Shahada*, the short statement of *Islamic* faith, tends to start at the bottom of the dome on these *Menorah* coins. The orientation of marginal inscriptions sometimes indicates the intended orientation of the coin. The coin issue may commemorate how the Dome of the Rock—as represented by the

<sup>4637</sup> Album. *Checklist*, p. 22, Coin 163.

<sup>4638</sup> Album. *Checklist*, p. 22, Coin 159.

<sup>4639</sup> Goldman. *Portal*, p. 151.

crescent finial—was built over the spot where the Jewish temple—as represented by the Menorah—used to be.

Michael Bates of the American Numismatic Society wrote:

Looking at the only examples I have here [at the American Numismatic Society, New York], I would say that the figure is not a cross. The ‘arms’ on all the examples in the *Tuebingen Sylloge* slant downwards—slightly in some cases, more steeply in others [as though they were a finial crescent]. [Lutz] Ilisch [leading *Islamic* coins scholar] in the *Tuebingen Sylloge* has noted several instances of die-linkage between this obverse and another *Umayyad* series with a pentagram.<sup>4640</sup> He dates both of them ~120 H. [738 AD] and lists them under the mint Jerusalem.

He [Lutz Ilisch] aligns the coin photos as if the image in question is a *Menora*....In response to the query, ‘Did *Mosques* have domes when the issue was struck?’ The answer is, ‘Of course! That’s why we call it the Dome of the Rock.’ That structure was started, or probably finished, in 692 [AD].

If the issue can be said to depict the Dome of the Rock, that would be very plausible...If the issue has a *Menora* or the Dome of the Rock, then it is probably from *Iliya*, Jerusalem. But otherwise, it could be from anywhere. So far as I know, there is no other evidence for its location.<sup>4641</sup>

The die-linkage between the pentagram and the *Menorah-Mosque* dome with finial crescent is significant since the Dome of the Rock was thought of as being a recreation of Solomon’s temple. While the six-pointed star was the Star of David, the five-pointed pentagram star was the sign of Solomon.<sup>4642</sup> Dan Barag wrote:

Stars, pentagrams, crescents and similar representations on coins contemporary with candlestick coins (8th century AD) may all have direct or indirect religious connotations.<sup>4643</sup>

So the pentagram coin and *Menorah*-dome with finial crescent coin may both indeed commemorate the Dome of the Rock. This interpretation is buttressed on the fact that the find spot for most of the *Menorah*/dome with crescent finial coins is around Jerusalem. Also, there were few Jews living in *Umayyad* Jerusalem in accordance with *The Pact of Umar* (635 AD) agreement struck between *Muslims* and *Jerusalemites* early in the *Muslim* conquest.<sup>4644</sup> So the coin would most likely commemorate the Dome of the Rock rather than say, any *Muslim*-Jewish solidarity and friendship.

<b>Description</b>	Coin: Post reforms <i>fals</i> , 3,04 g (lot 784)
<b>Obverse</b>	<i>La Ilah / Illah Allah / Wahdahu</i> Circular Legend: <i>Bismillah</i>
<b>Reverse</b>	<i>Muhammad / Rasul / Allah</i> (☪ appears over <i>Muhammad</i> ); Circular Legend: <i>Zuriba haza Al fal[s sana]t tis` wa tis`in</i>
<b>Comments</b>	Though without a mint-name, this coin was certainly struck at one of the more important Syrian mints (Damascus, <i>Aleppo</i> or <i>Hims</i> ) during the reign of Suleyman (96-99 AH/715-717 AD).

<sup>4640</sup> Ilisch. *Palastina*, pp. 10 & plate 1, coins 23-31

<sup>4641</sup> Bates, Michael. Post 10022, Subject: *Menora*/Dome/Goblet Coin, Yahoo’s *Islamic* Coins Group, groups.yahoo.com/group/*Islamic\_coins*/message/10022, Sunday, 12 Oct 2003, 11:24 AM.

<sup>4642</sup> *EB*, “David, Star of” entry, accessed 28 Aug 2003.

<sup>4643</sup> Barag, Dan. “The *Islamic* Candlestick Coins of Jerusalem,” *Barag. Balog*, p. 46.

<sup>4644</sup> About the coin find location and the fact that few Jews lived in *Umayyad* Jerusalem, see: Ilisch, Lutz. Post 10036, Subject: *Menora*/Dome/Goblet Coin, Yahoo’s *Islamic* Coins Group, groups.yahoo.com/group/*Islamic\_coins*/message/ 10036, 13 Oct 2003, 12:08 PM.

<b>Description</b>	Coin: Contemporary north African imitation of a <i>Wasit</i> 93 AH (712 AD) <i>Umayyad Dirham</i> . <i>Wasit</i> was established in 702 AD in what now is modern <i>Iraq</i> by <i>Umayyad Caliphate Abd Al Malik</i> (reigned 685-705 AD). <i>Wasit</i> declined and disappeared in the fifteenth century when there was a shift in the course of the <i>Tigris</i> River and scholars still debate the exact location of the city.
<b>Comment</b>	Such imitations of <i>Wasit</i> 93 A.H. <i>Dirhams</i> are well attested in major collections by the typical marks (star, ☪ or groups of dots) above or below the reverse field, which together with a low weight standard around 2.6 g often indicate their North African origin.
<b>Reverse</b>	Star (top) and ☪ (bottom)

<b>Description</b>	Coins 231-235, AE
<b>Period</b>	About the time of <i>Caliph Hisam</i> , 105-125 AH/723-743 AD
<b>Comment</b>	☪ in reverse
<b>References</b>	Ilisch. <i>Palastina</i> , page 26, plate 8.

<b>Description</b>	Coins 23-26, AE
<b>Period</b>	About 120 AH/738 AD
<b>Comment</b>	Reverse has pentagram and ☪.
<b>References</b>	Ilisch. <i>Palastina</i> , p. 10, plate 1.

<b>Description</b>	Coin 29, AE, 5h, 3.04g
<b>Period</b>	About 120 AH/738 AD
<b>Comment</b>	“Candelabrum” coin. Candelabrum on obverse, ☪ and the words “ <i>Muhammad Rasul Allah</i> ” on reverse.
<b>References</b>	Ilisch. <i>Palastina</i> , p. 10, plate 1.

<b>Description</b>	Coins 64-78
<b>Period</b>	About 120 AH/738 AD
<b>Comment</b>	These coins have a ☪ in a circle in the middle of the obverse.
<b>References</b>	Ilisch. <i>Palastina</i> , p. 14, plate 3.

<b>Description</b>	Coins 529-530, AE, 3.07g
<b>Period</b>	725-750 AD
<b>Comment</b>	The obverse of the coin depicts a three-petal flower in a ☪-shaped chalice.
<b>Reference</b>	Ilisch. <i>Palastina</i> , page 44, plate 17.

<b>Description</b>	Coin 531, AE, 12h, 2.05g
<b>Period</b>	725-750 AD
<b>Comment</b>	The obverse depicts a ☪ over the head of a flying bird
<b>Reference</b>	Ilisch. <i>Palastina</i> , page 44, plate 17.

<b>Description</b>	Coins 571-572
<b>Period</b>	725-750 AD
<b>Comment</b>	The obverse of the coin depicts a pellet in a ☪.
<b>Reference</b>	Ilisch. <i>Palastina</i> , page 46, plate 18.

<b>Description</b>	Glass Weights or Vessel Stamps with a star and ☪: 77		
<b>Description</b>	Glass Weights or Vessel Stamps with ☪s: 79-80, 151		
<b>Description</b>	Glass Weights or Vessel Stamps with pellets in ☪s: 81-82		
<b>Period</b>	661-750 AD	Reference	Balog. <i>Glass</i> .

ANS Acc. No.	Crescent Info	Reference	Date AD
1991.3.256	Coin: Reverse	BMC <i>Arab</i> Sas. I.22	661/662
margin has point left of top star and ☪ like M.27			
1956.137.72	Coin: 6-pointed star left of reverse; 12 o'clock ☪ and star	BMC <i>Arab</i> Sas Cam. 15 var.	686/687
1954.112.9	Coin: Standing emperor with horizontal ☪ and star on a T-stand	BMC <i>Arab</i> Byz. 22var	692/694
1970.107.24 1971.316.1195	Coin: Standing emperor with horizontal ☪ holding star on a T-stand. ANS coin 1970.107.24 and 1971.316.1195 were struck with the same die (BMC <i>Arab</i> Byz. 7var; Year: 692/694).		
1991.3.168	Coin: Six-rayed star above <i>Muhammad</i> ; ☪ above <i>Allah</i>	BMC <i>Arab</i> Byz. 666	697/750
1997.98.1	Coin: Obverse: Bust in circle, ☪s in margin; Reverse: inscription in circle, ☪s in margin	Curiel/Gyselen.114	699/709
1971.316.1533 1971.89.120	Coin: ☪ with flower bud above	BM. 596/7	699/750
1998.25.152	Coin: Legend with ☪. This is the "candlestick" coin.	BMC <i>Arab</i> Byz. 605	699/750
1998.25.153 1998.25.154	Coin: Legend with ☪	BMC <i>Arab</i> Byz. P.114 (p. 206)	699/750
1998.25.184	Coin: Obverse: Six-pointed star in circle center, Reverse: ☪	BMC <i>Arab</i> Byz?	699/750
1998.25.306- 1998.25.310	Coin: ☪ in circle	BMC <i>Arab</i> Byz. 855-859	699/750
1998.25.311	Coin: ☪ in circle	BMC <i>Arab</i> Byz. 856	699/750
1998.25.312 1998.25.313, 1998.25.315	Coin: ☪ in circle	BMC <i>Arab</i> Byz. 857-860	699/750
1998.25.316	Coin: ☪ in circle	BMC <i>Arab</i> Byz. 869	699/750
1998.25.317	Coin: ☪ in circle	BMC <i>Arab</i> Byz. 863; Album FPL 32, no. 391	699/750
1988.86.28	Coin: <i>Shahada</i> ; large ☪ with dot below <i>Rasul</i>		700/710
1971.316.1249	Coin: Pellet with ☪?	BM. 869. variant	700/750
1971.316.1120	Coin: Reverse star above, inverted ☪ below		711/712
1953.123.4	Coin Weight	EIGS.37-39, CAM.29	725/734
Obverse: ☪ with dot pointing downwards under last line.			

<b>1974.268.29</b>	Coin Weight	EIGS.40, B.77	725/734
Eight-rayed asterisk and increasing ☉ at bottom			
<b>1974.268.30</b>	Coin Weight	EIGS.37-39, B.79	725/734
☉ with dot pointing upwards over first line			
<b>1949.120.2</b>	Coin Weight	EIGS.74-76, EAGS.8	734/742
Raised circle, sometimes beaded, around border; ☉ pointing up with dot in center after isolated <i>Alif</i>			
<b>1954.168.2</b>	Coin Weight	EIGS.73, CAM.52	734/742
☉ pointing up with dot in center at end of line 3			
<b>1974.268.429</b>	Vessel Stamp	B.203	739/740
Obverse: Star and ☉. Reverse: asterisk and decreasing ☉ after “ <i>mi'a</i> ”			

### *Abbasid Coins and Coin Weights With Crescents*

The *Abbasid Caliphate* ruled from *Baghdad* starting in 749 AD. The *Abbasids* almost completely wiped out the *Umayyad Caliphate* in 750 AD but was in turn wiped out by the *Seljuk Turks* in 1258 AD.

The *Abbasid* dynasty was named after *Al Abbas* (566?–652 AD), a paternal uncle of the prophet *Muhammad*.

<b>Description</b>	Coin: <i>Al Mahdi</i> , AV <i>Dinar</i> , without mint name
<b>Reverse</b>	“A few varieties have a symbol (☉, three dots, etc.) below or above the reverse field.”
<b>Reference</b>	Album. <i>Checklist</i> , p. 26, coin 214.
<b>Coin Date</b>	775-785 AD/158-169 AH

<b>Description</b>	Coin 82, AE, 6h, 2.20g
<b>Comment</b>	☉ at bottom of reverse.
<b>References</b>	Ilisch. <i>Palastina</i> , p. 14, plate 3.
<b>Date</b>	About 190 H/806 AD

<b>Description</b>	Coins 245-246, AE
<b>Period</b>	<i>Al Mamun</i> , Als <i>Gegenkalif</i> 195-198 AH/811-814 AD, and <i>Ibn Surayh</i> , <i>Unbekannter Funktionar</i> (translation: unknown official)
<b>Comment</b>	Four ☉s set inside obverse.
<b>References</b>	Ilisch. <i>Palastina</i> , p. 26, plate 8.
<b>Date</b>	About 198 H/814 AD

<b>Description</b>	Coins 411-412, AE
<b>Period</b>	End of the village wars around the successors of <i>ar-Rasids</i> , <i>Ibrahim Ibn Humran</i> , <i>Unbekannter Autonomer Furst</i> (tr.: unknown autocrat)
<b>Comment</b>	☉ at bottom of obverse
<b>References</b>	Ilisch. <i>Palastina</i> , p. 38, plate 14.
<b>Date</b>	About 200 H/816 AD

<b>Description</b>	Coin 96, AE, 2h, 2.88g
<b>Comment</b>	☪ at bottom of obverse.
<b>References</b>	Ilisch. <i>Palastina</i> , p. 14, plate 3.
<b>Date</b>	About 217 H/832 AD

<b>Description</b>	Coin 32, AE, 11h, 2.14g, 217 AH/832 AD Coin 33, AE, 7h, 2.25g, 219 AH/834 AD
<b>Comment</b>	Perhaps two ☪s at bottom of reverse.
<b>References</b>	Ilisch. <i>Palastina</i> , p. 10, plate 1.

<b>Description</b>	Coin: <i>Al Muqtadir</i> (295-320 AH/908-932 AD) from the <i>Madinat Al Salam</i> (meaning “City of Peace” = <i>Baghdad</i> ) mint
<b>Reference</b>	The author owns two of these coins.
<b>Coin Date</b>	300 AH/913 AD and 301/914 AD

<b>Description</b>	Coin: <i>Al Radi bi'llah</i> , 322-329 AH/934-940 AD; gold <i>Dinar</i> ; mint: <i>Madinat Al Salam</i> ; 2.96 gram
<b>Comment</b>	☪ above obverse and annulet below reverse fields
<b>Coin Date</b>	327 AH

<b>Description</b>	Glass Weights or Vessel Stamps with star and ☪s: 635, 672-673, 677
<b>Description</b>	Glass Weights or Vessel Stamps with ☪s: 279-284, 354, 422-423, 458-459, 609, 613, 615-616, 632, 692-696
<b>Period</b>	749-1258 AD
<b>Reference</b>	Balog. <i>Glass</i> .

ANS Accession	Crescent Info	Reference	Date
<b>1974.268.73</b>	Coin Weight:	Morton, EIGS, p 82f	750/751
Obverse: ☪ facing up above first line. Obverse legend: “ <i>Bism Allah / amara A (Sic) Muhammad / mithqal thulth dinar waf</i> ”			
<b>1974.268.76</b>	Coin Weight:	Morton, EIGS, p 82f, B.282	750/751
Obverse: ☪ facing up above first line. Obverse Legend: “ <i>Bism Allah / amara Al Muhammad / mithqal Dirham / thalatha `ashara kharr / uba waf</i> ”			
<b>1975.93.1056</b>	Coin Weight: First	B.753	750/850
line: ☪ with tiny circle in center, 3 tiny circles, ☪ with tiny circle in center			
<b>1991.3.643</b>	Coin Weight: Line	B.753   Fahmy, p. 8 and 68.52	750/868
over legend: ☪ facing up with pellet in center, three pellets, ☪ facing up with pellet in center			
<b>1974.268.82</b>	Coin Weight: ☪ facing up above first line	B.354	754/775
<b>1974.268.103</b>	Coin Weight:	EIGS.188	760/762
Obverse: Half ☪ facing up under <i>ya</i> ’ of <i>Dinar</i> . Obverse legend: “ <i>Bism Allah amar[a / a]l-amir Humayd [b.] / Qahtaba mithq[a] / l thulth dinar w / af</i> ”			

<b>1956.163.765</b>	Coin Weight: Two Cs	EIGS.249	762/764
facing down over first line, three dots on right side and at bottom, annulet on left side			
<b>1956.8.19</b>	Coin Weight: Dots at	CAM.145	762/764
ends of some letters; 2 small Cs facing down over first line; C facing left and 6-rayed asterisk over last line; three dots forming triangle facing up under last line; raised dotted circle along border			
<b>0000.999.23357</b>	Coin Weight	EIGS.241, EAG.77	762/769
Raised circle around inscription; C facing up above first line, C facing down under last line			
<b>1972.79.584</b>	Coin: C below		777/778
<b>1002.1.44</b>	Coin: C above field point below <i>Rasul</i> point below B of <i>Saba'</i>	SEAD.58	783/784
<b>1952.125.1</b>			
<b>1971.49.65</b>			
<b>1971.49.66</b>	Coin: C above field point below <i>Rasul</i>	SEAD.x	784/785
<b>1971.49.67</b>			
<b>1973.187.3</b>	Coin: Small circle or C under <i>Al Ma'mun</i> ; same		824/825
reverse die as 1971.49.227 of 208, later die state			
<b>1917.216.254</b>	Coin: C below obverse	T.2849	832/833
<b>1956.8.176</b>	Coin Weight: 2 Cs above first line	CAM.214	800/850

<b>1973.37.285</b>	Coin: This coin does NOT have Cs. The		910/911
C-shaped forms around the edge are the dangling curved "tails" of various Arabic letters in the marginal inscription. There is a similar curved tail on one of the letters of the second word on the reverse. This <i>Dirham</i> coin was minted at <i>Makka</i> in 298 AH.			

#### *Abbasid Governors of Tabaristan Coins With Crescents*

*Tabaristan* was an *Abbasid* province on the southern border of the *Caspian Sea*. *Tabaristan* was ruled on and off from 759 AD to 928 AD when the *Ziyarids* conquered *Tabaristan*.

<b>Description</b>	Coin: Umar <i>Al 'Ala</i> , AR <i>Hemidrachm</i> , Mint: TPWRSTAN
<b>Period</b>	771-780 AD
<b>Obverse</b>	Bust right, breast ornament: three pellets. Name in Arabic.
<b>Reverse</b>	Fire altar with two attendants; star left and C right of flames. <i>Pahlavi</i> date to the left, mint name to the right 'TPWRSTAN' ( <i>Tabaristan</i> ).
<b>Reference</b>	As given on the web site: Album 56
<b>Coin Date</b>	122 PYE/151 AH

<b>Description</b>	Coin: Anonymous, Half <i>Dirham</i> , silver, 23 mm
<b>Obverse</b>	The word " <i>Afzul</i> " is right of portrait.
<b>Comments</b>	On both the obverse and reverse is one or more concentric circles with Cs with stars on poles at all four cardinal points with the horns of Cs facing north, south, east and west.
<b>Coin Date</b>	130 PYE, 165 AH



<b>Description</b>	Coin: Sulayman, Half <i>Dirham</i> , silver, 23 mm
<b>Period</b>	784-788 AD
<b>Obverse</b>	Head represented by a diamond
<b>Comments</b>	On both the obverse and reverse is one or more concentric circles with $\text{C}$ s with stars on poles at all four cardinal points with the horns of $\text{C}$ s facing north, south, east and west.
<b>Coin Date</b>	137 PYE, 172 AH

<b>Description</b>	Coin: <i>Hani</i> , Half <i>Dirham</i> , silver, 23 mm
<b>Period</b>	788-789 AD
<b>Comments</b>	On both the obverse and reverse is one or more concentric circles with $\text{C}$ s with stars on poles at all four cardinal points with the horns of $\text{C}$ s facing north, south, east and west.
<b>Coin Date</b>	138 PYE, 173 AH

<b>Description</b>	Coin: <i>Muqatil</i> , Half <i>Dirham</i> , silver, 23 mm
<b>Period</b>	780-790 AD
<b>Comments</b>	On both the obverse and reverse is one or more concentric circles with $\text{C}$ s with stars on poles at all four cardinal points with the horns of $\text{C}$ s facing north, south, east and west.
<b>Coin Date</b>	139 PYE, 174 AH

*Abbasid Coins With Crescents Minted in the Two Abbasid Caucasus Mints*

<b>Description</b>	<i>Arminiya</i> (Armenia)
<b>Coin Date</b>	Most years between 140-149 (757-766 AD), as well as 150-151 AH (767-768 AD) and 161-162 AH (777-778 AD).

<b>Description</b>	<i>Arran</i>	Coin Date	147 AH/764 AD
<b>Reference</b>	<i>Qatar</i> no. 1394		

*Tulunid Governor of Egypt Coins with Crescents*

Egypt drifted out of the Arabian *Abbasid* dynasty's control in 868 AD while under *Tulunid* governors. Egypt was again under *Abbasid* control in 906 AD when the *Abbasids*, whose capital was in *Baghdad*, experienced a resurgence of power.

<b>Description</b>	Glass Weights or Vessel Stamps with star and $\text{C}$ s: 759
<b>Description</b>	Glass Weights or Vessel Stamps with $\text{C}$ s: 751-752, 765-766, 773, 791
<b>Description</b>	Glass Weights or Vessel Stamps with pellets in $\text{C}$ s: 753, 757-758
<b>Period</b>	868-906 AD
<b>Reference</b>	Balog. <i>Glass</i> .

*Buyid Coins with Crescents*

The *Shiite Islamic* dynasty of North Persian descent that controlled *Iraq* and *Persia* from 945 to 1060 AD. The *Buyids* captured the *Abbasid* capital of *Baghdad* in 945 AD. The *Sunni Abbasid Caliphs* lost their temporal power but retained some nominal spiritual authority. The *Buyids* conquered *Oman*, *Tabaristan* and *Jorjan*.

Tughril Beg, a *Seljuk* Turk, conquered most *Buyid* territory in 1060 AD. *Buyid* coins with crescents include:

Treadwell. *Buyid*, coins Ad332, Ar364a, Ay334, Bm362, Bm367b, Bm384, Br382.3, Br384, Br384.1, Br392, Br484, Fa335b.R1-2, Fa381, Fa382, Fa383, Fa385, Fa391, Fa410, Fa423, Fa436, Ha370, Ji381, Ka366, Ka370, Kr354, Kr355, Kr356G, Kr357G, Kr362, Kr362G, Kr363, Kr380, Kr381, Kr382, Kr382G, Kr383, Kr383G, Kz383.1-2, Kz397.R1, Ma372, Mb370G, Mb370a, Mk366, Mu344Gc, Mu349, Mu351G, Mu362a, Mu377b, Mu387c, Mu397G, Mu403G, Qa411, Qu360, Rd382, Rd382.2, Sa349G, Sh327, Sh331, Sh333, Sh350, Sh360, Sh366b, Sh380, Sh381a, Sh381b, Sh382, Sh383, Sh384, Sh385, Sh386, Sh390a, Sh390b, Sh391a, Sh391b, Sh392, Sh395a, Sh408a, Sh416a, Sh423a, Sh435G, Sh436, Sh438, Si337a, Sr361, Sr362, Sr363, Sr366, Sr382.1, Sr382, Sr383, Su369, Um362Ga, Um363, Um364G, Um362-4, Um364a, Um364b, Um365, Um366, Um367b, Um367Ga, Um367Gb, Um368, Um370, Um381a, Um381d, Um383, Um391G, Um362b, Ju386.

*Idrisid* (also spelled “*Al Idrisiyun*”) under *Abbasid* Governors Coin With a Crescent

The *Idrisids* were an Arab Muslim dynasty that ruled in the Berber areas of Morocco from 789 until 921 AD. The *Abbasid* Caliphate broke up in the ninth and tenth centuries AD, but retained nominal authority over the *Idrisid*, *Aghlabid*, *Tulunid* and *Ikhshidid* dynasties in northern Africa.

The *Idrisids* were eventually crushed between the *Umayyad* Caliphs of Cordoba and the *Fatimids* of Cairo. The last *Idrisid* ruler was killed while a prisoner of the *Cordoba Umayyads* in 985 AD.

ANS Accession No.	Crescent Info	Date AD
1964.7.1	Coin: Palm above field and above line 2; ☾ with dots between lines 2 and 3	789/796

*Sana* Coin With Crescent Minted in Arabia

<b>Description</b>	Coin 215, AR, 10h, 1.32g	
<b>Period</b>	<i>Abbasid</i> , <i>Al Rashid</i> , 170-193 AH/786-809 AD, with Hammad <i>Al Barbari</i>	
<b>Comment</b>	“...small ☾...in reverse field”	Coin Date
<b>Reference</b>	Album. <i>Ashmolean</i> , Plate 10.	191 AH/807 AD

*Baysh* Coin With Crescent Minted in Arabia

<b>Description</b>	Coins 41, 41A, 42, 43 and 44, AV	
<b>Period</b>	<i>Abbasid</i> , <i>Al Muti</i> , 334-363 AH/945-974 AD	
<b>Reference</b>	Album. <i>Ashmolean</i> , Plate 2.	
<b>Comment</b>	“Group IV has no mintmark on the obverse but a small ☾ below the reverse.”	
<b>Coin Date</b>	342-343 AH/953-954 AD	

*Athar Coin With Crescent Minted in Arabia*

<b>Description</b>	Coins 312, 314-328, 330-335, AV
<b>Period</b>	<i>Abbasid</i> , <i>Al Muti</i> , 334-363 AH/945-974 AD
<b>Comment</b>	Reverse has small C
<b>Reference</b>	Album. <i>Ashmolean</i> , Plate 15.
<b>Coin Date</b>	337-347 AH/948-958 AD

*Uman Coin With Crescent Minted in Arabia*

<b>Description</b>	Coin 465, AR, 3.93g
<b>Period</b>	Buwayhid, <i>Al Marzuban</i> ( <i>Sharaf Al Dawla</i> ), as governor in <i>Kirman</i> , ~361-372 AH (972-982 AD)
<b>Comment</b>	“C above and x below obverse.”
<b>Reference</b>	Album. <i>Ashmolean</i> , Plate 22.
<b>Coin Date</b>	363 AH/974 AD

*Huganda Coin with Crescent Minted in North or East Central Asia*

<b>Description</b>	Coin 453, AE, 8h, 1.75g
<b>Period</b>	<i>Nasr Ibn Ali Karachanide</i> , <i>Nachgewiesen</i> [proven] (383-403 AH/993-1012 AD), <i>Ahmad Ibn Ali Karachanide</i> , <i>Nachgewiesen</i> [proven] (384-405 AH/994-1014 AD).
<b>Comment</b>	Reverse has a <i>Mzz.</i> (“ <i>munzzeichen</i> ” = “mintmark”) a U-positioned C under “ <i>aU</i> ” (“ <i>lillah</i> ,” meaning “to / for <i>Allah</i> ”)
<b>Reference</b>	<i>Ilisch. Nord</i> , p. 56, plate 22.
<b>Coin Date</b>	390 AH/1000 AD

*Qarakhanid (Ilak Khans) Coins with Crescents*

The *Qarakhanids* (or Black Khans) are a Turkish people whose ancestors converted to *Islam* in 960 AD. *Bokhara* fell to them in 999 AD and the rest of the *Transoxanian* region shortly thereafter. These *Qarakhanid* conquests and the *Ghaznavid* expansion into *Buyawid* territory left the east marches of Persia under Turkish domination. *Khwarazm Shah Ala'ad Din Muhammad* defeated the *Qarakhanids* in 1211 AD, and that dynasty was extirpated.

<b>Description</b>	Coin: EA <i>Fals</i> , <i>Akhsikath</i> , from Lots 356-373
<b>Period</b>	1012 AD
<b>Reference</b>	Kochnev 302
<b>Description</b>	As given on web site ( <a href="http://russian-coins.net/auc7tob4.htm">russian-coins.net/auc7tob4.htm</a> ): Reverse: <i>Allah</i> in C above central legend. <i>Al Malik Al `adl khan</i> . In margin: <i>Al Amir Al sayid Ahmad Ibn `Ali</i>
<b>Coin Date</b>	403 AH/ 1012 AD

*Naukat Coin with Crescent Minted in North or East Central Asia*

<b>Description</b>	Coin 606, AE, 9h, 2.35g
<b>Period</b>	Mansur <i>Ibn</i> Ali, <i>Karachanide</i> , <i>Nachgewiesen</i> (404-415 AH/1013-1024 AD). Bori Tegin.
<b>Comment</b>	“ <i>Av...: ein gleichseitiges Liniendreieck, an den Seitmitten jeweils eine Mondsichel mit drei Punkten im Innern.</i> ” A loose translation of the German: “Obverse:...there is an equilateral line triangle. At the middle of each side is a moon ☾ with three points inside.”
<b>Reference</b>	Ilisch. <i>Nord</i> , p. 72, plate 30.
<b>Coin Date</b>	409 AH/1018AD

*Binkat Coins with Crescents Minted in North or East Central Asia*

<b>Description</b>	Coin 400, BI, 3h, 4.47g: Reverse has a U-positioned ☾ mintmark under (or within) the word “ <i>aU</i> ,” meaning “to / for <i>Allah</i> .” Coin 401, BI, 10h, 2.90g: Avers (obverse) Mzz.(“ <i>munzzeichen</i> ” = “mintmark”) U-positioned ☾
<b>Period</b>	Binkat, Ali <i>Ibn</i> Al Hasan, <i>Karachanide</i> , <i>Nachgewiesen</i> [“proven”] (411-426 AH/1020-1035 AD), <i>Muhammad Ibn</i> Al Hasan, <i>Karachanide</i> , <i>Nachgewiesen Mit Unterbrechungen</i> [“proven with interruptions”] (399-440 AH/1009-1048 AD), Kalif <i>Al</i> Quadir Billah
<b>Reference</b>	Ilisch. <i>Nord</i> , p. 50, Plate 19.
<b>Coin Date</b>	415 AH/1024 AD

*Ghaznavid Coin With Crescent*


The *Ghaznavids* (977–1186 AD) were a *Muslim* Turkish dynasty that ruled in *Khorasan* in northeast *Iran*, *Afghanistan* and northern *India*. Mahmud (ruled 998–1030 AD) was an especially devout *Muslim* and reshaped the *Ghaznavids* from their pagan Turkic origins into an *Islamic* dynasty and expanded the frontiers of *Islam*.

Little survives of *Ghaznavid* art, but the period is important for its influence on the *Seljuk* Turks in *Iran* and on later *Islamic* art in *India* (*EB*, accessed 13 Sep 2001, “*Ghaznavid*”).

ANS Accession No.	Crescent Info	Date AD
1993.40.7	Coin: Small ☾ above s of <i>Rasul</i>	1039/1040

*Seljuk Coins With Crescent*

The *Seljuks* were a *Muslim* dynasty that ruled Mesopotamia, Syria, Palestine and most of *Iran* from their remote homelands north of the Caspian and *Aral* Seas from 1038 to 1077 AD. Then the *Seljuk* Empire split into different principalities. The *Seljuks* mark the beginning of Turkish power in the Middle East.

	<b>Figure A-27.</b> Fitial crescent coin (ANS Accession No. 0000.999.37488).
<b>Crescent Info/ANS Accession No.</b>	<b>Date AD</b>
Coin: The obverse of the coin illustrated above may depict a <i>Mosque</i> finial ☾ according to the ANS, whose database of coins has the entry “ <i>Mosque</i> finial crescent?” (Accessed Sep 2001). Gordon Newby wrote: “By the fifth [AD]/eleventh [AH] century, the crescent was used to replace the cross, when churches were converted to <i>Mosques</i> .” <sup>4645</sup>	1072/1100
The ☾ is rather large as far as ☾s on coins go and is mounted on a smaller globe. It is not strange that a finial ☾ would appear on money since paper money 2000.7.52 and 2000.7.53 also depict <i>Mosque</i> finial ☾s, but they were minted hundreds of years later (1991/1999 AD) in <i>Tatarstan</i> , an autonomous republic of west-central Russia.	
Kaykhusraw II (1236-1245 AD), AR <i>Dirham</i> of <i>Sivas</i> mint, 640 AH, the common “lion and sun” type sometimes has a star to the left of the sun (top center), as well as a star (left) and ☾ (right) between the legs of a lion walking and facing right (reference A-1218).	1242 AD

*Adan Coin With Crescent Minted in Arabia*

<b>Description</b>	Coin: 418, AV, 11h, 2.48g
<b>Period</b>	Sulayhid, <i>Al Mukarram Ahmad</i> , 473-484 AH/1080-1091 AD
<b>Comment</b>	☾ above reverse
<b>Reference</b>	Album. <i>Ashmolean</i> , Plate 19.
<b>Coin Date</b>	484 AH/1091 AD

*Fatimid Coin Weight With Crescent*

The *Fatimid* dynasty was named after *Fatima*, a daughter of *Muhammad*.

Said *Ibn* Husayn of northeast Syria managed to conquer most of northern Africa starting in 893 AD. The fourth *Fatimid Caliph*, Moizz (953–975 AD) conquered Egypt, Palestine, part of Syria and western Arabia and then moved his capital to *Cairo* in 973 AD.

*Saladin* invaded Egypt in 1169 AD and by 1171 AD had suppressed the *Fatimids* and united Egypt with the *Abbasid Caliphate*.

<b>ANS Accession No.</b>	<b>Crescent Info</b>	<b>Reference</b>	<b>Date AD</b>
1991.3.674	Coin Weight: ☾ moon around inscription	B.428.2?, M.116	1160/1171

<sup>4645</sup> Newby. *Encyclopedia*, pp. 81-82, *Hilal* entry.

*Zangid (also spelled "Zengid") Coins With Crescents*

The *Zangids* were mid- to late-twelfth and early thirteenth-century successors (along with the *Artukids* and others) of the *Seljuk* Turks. The *Zangid Islamic* kingdom was based out of the region between the Tigris and *Euphrates* rivers, north of *Baghdad* and south of Lake *Van* in modern *Iraq* and east Turkey.

The *Zangi* and his son *Nur Al Din* took a prominent role in the *Muslim* counter-offensive against the Crusaders in the mid-1100's and, in the process, created for themselves a large state extending from northern *Iraq* and Syria down into Egypt.

The *Zangids* eventually lost a lot of their territory to one of their successor states that was run by the *Ayyubids*. A *Zangid* expedition led by the brother of a Kurd named *Ayyub* conquered *Fatimid* Egypt in 1169 AD. *Ayyub* died immediately after the victory, but his son, known to the Western world as *Saladin* (1137-1193 AD), created the *Ayyubid* state of Egypt.

*Saladin* remained vassal to the *Zangids* until the death of his sponsor, *Nur Al Din* (died 1174 AD), but then promptly took over much *Zangid* territory. *Saladin* suppressed the *Fatimids* and united Egypt with the *Abbasid Caliphate* in 1171.

*Saladin* recaptured almost all Crusader fortifications in Palestine and Syria by 1187 AD. This necessitated the Third Crusade (1189 AD), headed by the kings of France and England, who defeated *Saladin* and captured *Acre* in 1191 AD.

*Saladin* is known for his combating Richard the Lion-Hearted of England (ruled 1189-1199 AD). *Saladin* signed the Peace of *Ramla* (1192 AD) that left the Palestinian coast in control of the crusaders and permitted Christians to visit the holy places of Jerusalem.

<b>Description</b>	Coin: AE <i>Dirham</i> , seated figure holding large ☪, struck at <i>Al Mawsil</i> (SS63)
<b>Reference</b>	Album. <i>Checklist</i> , p. 93, Coin 1863.2
<b>Coin Date</b>	585-587 AH (1189-1191 AD)

<b>Description</b>	Coin: <i>Al Mu'azzam Mahmud</i> , AE <i>Dirham</i> , crowned facing bust behind huge ☪, <i>Al Jazira</i> , 606-618 (2 variants, SS87-88)
<b>Period</b>	605-648 AH (1208-1251 AD)
<b>Reference</b>	Album. <i>Checklist</i> , p. 94, Coin 1883

<b>Description</b>	Coin: <i>Mu'izz Al din Mahmud Ibn Sinjar</i> , <i>Al Jazira</i> mint, copper <i>Dirham</i> , 16.74 grams
<b>Period</b>	605-618 A.H./1209-1221 AD
<b>Obverse</b>	Bust holding ☪
<b>Reference</b>	BMC 645 ff.; Mitchiner 1114.
<b>Coin Date</b>	618 AH

ANS Acc. No.	Crescent Info	Reference	Date AD
1991.3.561	Coin: Seated figure holding ☪	BMCOr. 3.567	1229/1230

<b>Description</b>	Coin: AE <i>Dirham</i> , seated figure holding ☪, struck at <i>Al Mawsil</i>
<b>Reference</b>	Album. <i>Checklist</i> , p. 93, Coin 1870.2. Also, Mitchiner 1129 and SS67.
<b>Coin Date</b>	627 AH / 1230 AD

*Lu'lu'id Coins With Crescents*

Lu'lu was a slave of the *Zangids* but later became a successor of the *Zangids* at *Mosul (Al Mawsil)*.

<b>Description</b>	Coin: AE <i>Dirham</i> , seated figure holding ☪
<b>Reference</b>	Album. <i>Checklist</i> , p. 93, Coin 1874.2
<b>Coin Date</b>	654-655 AH (1256-1257 AD)

*Artukid (also spelled "Artuqid" and "Urtuqid") Coin With Crescent*

The *Artukids* (1102-1234 AD) were the successors of the *Seljuk* Turks and struck vast numbers of coins. The *Artukids* were based mainly in *Mardin* in east Turkey. The *Artukids* were conquered first by the Arab *Muslim Ayyubids* and then the *Mongols*.

ANS Accession No.	Crescent Info	Date AD
1971.76.1733	Coin: Dies J-a; reverse die fresh, so there is no crack at the ☪	1250/1251

*Ilkhanid Coins With Crescents*

The *Mongols* under Genghis Khan swept into *Iran*, the *Caucasus* and southern *Russia* (1220-1222 AD) and his successors attacked *Persia* (1231 AD), *East Europe* (1236-41 AD) and *Iraq* and the *Caucasus* (1245-1253 AD). They finally sacked *Baghdad* (1258 AD), bringing an end to the *Abbasid Caliphate*.

The *Mongol* territories were divided among the sons and grandsons of Genghis. One of Genghis Khan's sons was *Tuluy*, the father of the famous ruler of China, *Kublai Khan*, and also of *Hulagu*, first of the *Ilkhanid* rulers of *Persia*.

The *Ilkhanid* possessions included *Georgia*, a special region that was allowed to issue coins with Christian inscriptions and other distinctive features.

The *Ilkhanid* state in *Persia* collapsed in 1353 AD after decades of turmoil. The western portion was taken over by the "Black Sheep" Turks (*Qara-Qoyunlu*) and the "White Sheep" Turks (*Aq-Qoyunlu*).

ANS Accession No.	Crescent Info	Reference	Date AD
1998.25.692	Coin: Hare facing left; ☪	BMCOrVI. 32	1256/1265
1917.215.1861	Coin: Seated figure holding ☪; stars to right and left of head		1265/1281
1917.216.820- 1917.216.822, 1959.165.285	Coin: Seated figure holding ☪		1281/1282

<b>Description</b>	Coin: AE <i>fals</i> , seated figure holding ☪. <i>Al Mawsil</i> mint.
<b>Period</b>	1256-1297 AD, for example, <i>Gaykhatn</i> (1291-1295 AD)
<b>Reference</b>	Album. <i>Checklist</i> , p. 105, Coin 2131.2

*Unidentified Islamic Dynasty*

ANS Accession No.	Crescent Info	Date AD
1966.126.111	Coin: The reading <i>Qazan</i> (for <i>Ghazan</i> )	1300/1350
Mahmud (1295-1304 AD), <i>Ilkhanid</i> ruler of <i>Mongol Persia</i> , has been suggested, but as GC points out, the coin has <i>QRA</i> for <i>Qara Mahmud</i> . What seems to be a dislocated <i>nun</i> (a letter) is actually a schematic ☪. Obverse: lion right, star and ☪		

*Rasulid (Yemen)*

<b>Description</b>	Coin: Silver, seated figure in a large $\text{C}$ holding a $\text{C}$ . Type: <i>Al Ashraf Isma'il I</i> , Type: A-1110, Mint: <i>Al Mahjam</i> , administrative capitol of the <i>Rasulid (Yemenis)</i> dynasty. Date: 799 AH/1396 AD. Of interest is the fact that the Nuetzel says a twelfth-century <i>Rasulid (Yemenis)</i> <i>Dirham</i> coin depicts three scimitars (Nützel 38, Zabid 783 H). The scimitar coin has no $\text{C}$ s but the scimitars may have stood for $\text{C}$ s.
<b>Period</b>	1376-1400 AD

*Ottoman Caliphate Coins and Coin Weights With Crescents*

The *Ottomans* were a Turkish *Sultanate* founded in the thirteenth century by Osman I. The *Ottomans* steadily expanded their thirteenth-century AD holdings in western Turkey until by 1699 AD, the *Ottomans* held all the lands previously controlled by the Byzantine Empire, plus Mesopotamia and the coastal lands of Arabia along the Red Sea and upper Persian Gulf.

In 1687 AD, the *Ottoman* Empire adapted a European style of currency. The *Ottoman* Empire steadily lost lands from 1807 to 1924 AD when Kemal Atatürk overthrew the last *Sultan*.

The most notable event in *Ottoman* history was the taking of Constantinople in 1453 AD. This event occasioned the conversion of *Hagia Sophia* into *Aya Sofia Mosque*. *Minarets* and a *Mihrab*, the niche indicating the direction to *Makka*, were added later.

In 537 AD, Emperor Justinian completed the *Hagia Sophia* cathedral in Constantinople. *Hagia Sophia* means “Holy Wisdom.” Emperor Constantius (son of Constantine) built the first church on the location of the *Hagia Sophia* in 360, but it was destroyed in 404. The second church on that spot was completed in 415 by Emperor Theodosius, but it was destroyed in 532.

Constantinople is now known as *Istanbul* and the population is mostly *Muslim*. The *Hagia Sophia* has been a museum of Byzantine art since 1935. What remains of the original decorations has been restored but the finial crescent remains atop the highest dome.

<b>ANS Accession No.</b>	<b>Crescent Info</b>	<b>Date AD</b>
<b>1973.7.35</b>	Coin Weight: $\text{C}$ on hollowed out background, central lathe-hole, inscribed circle 10 mm.	1574/1639
<b>1973.7.9</b>	Coin Weight: Obverse: $\text{C}$ left of legend on obverse. Obverse Legend: “ <i>Muhammad</i> ”	1594/1687
<b>1973.7.45</b>	Coin Weight: Obverse: $\text{C}$ on obverse. Obverse legend: “ <i>Muhammad</i> ”	1594/1687
<b>1917.215.2088</b>	Coin: <i>Tughra</i> with $\text{C}$ at right above	1786/1787

**VI. Dating Islamic Coins, Coin Weights and Vessel Stamps**

The discussion of the dates of *Islamic* coins usually uses AD or AH dates. However, some *Islamic* coins are dated based on different calendars such as YE = *Yazdegird* Era (Year 1 = 631 AD) and PYE = Post *Yazdegird* Era (Year 1 = 651 AD). See the Abbreviations section at the front of this book for a comparison of AH and AD dates.



## VII. Early Arab Islamic Caliphates

### *The Orthodox Caliphate*

The Orthodox *Caliphate* (also called the *Rashidun* (“Correctly Guided”) *Caliphs*) ruled from 632 to 661 AD from *Makka* and *Madina* in *Saudi Arabia*. The four Orthodox *Caliphates* were *Abu Bakr* (632-634 AD), *Omar* (634-644 AD), *Uthman* (644-656 AD) and *Caliph Ali* (656-661 AD).

The first Orthodox *Caliph* was *Abu Bakr*, who lived from 573–634 AD, was the first *Caliph*. *Abu Bakr* was the father-in-law and successor of *Muhammad* and was probably *Muhammad*’s first convert. During *Abu*’s critical two-year *Caliphate* (632–634 AD), *Islam* began the phenomenal growth that was to make it a world religion.

The second Orthodox *Caliph* was *Umar* (also spelled “*Omar*”) (634-644 AD). *Umar* was the father of *Hafsa*, one of *Mohammed*’s wives. *Umar* conquered the Persian capital of *Ctesiphon* (637 AD), which was ruled by *Yazdegird III* (632–651 AD), the last ruler of the *Sassanian Empire* (224-651 AD).

*Yazdegird III* fled the country when Arab *Muslims* overran it and spent his last days fleeing towards Central Asia. *Umar* also conquered *Syria* (636 AD) and *Alexandria* (641 AD). A Persian slave assassinated *Umar* in *Madina*.

The third Orthodox *Caliph* was *Uthman* (also spelled “*Osman*”) (644-656 AD). During his reign, the official text of the *Koran* was established in 651–52 AD (30 AH).

The fourth and last Orthodox *Caliph* was *Ali* (656-661 AD). The *Caliphate* eventually was split between the *Umayyads* who ruled from *Damascus* and the *Abbasids* who ruled from *Baghdad*.

The *Abbasids* massacred the *Umayyads* in 750 AD, but one member escaped to *Spain* where he established the Western *Caliphate* (the *Caliphate of Cordoba*), which lasted until 1031 AD.

A third *Caliphate*, established by the *Fatimid* sect in *Africa*, lasted from 909 to 1171 AD. After the rise of the *Ottoman Turks*, the *Sultans* assumed the title of *Caliph*. The title lapsed in 1926 AD after the end of the *Ottoman* rule in *Turkey*.

### *The Umayyad Caliphate*

Arab *Umayyad Caliphate* ruled from *Damascus* from 661 AD until the *Umayyad* was massacred by the *Abbasid Caliphate* in 750 AD. *Umayyad Caliphs* were: *Mu’awiya I* (661–680 AD), *Yazid I* (680–683), *Mu’awiya II* (683–684 AD), *Marwan I* (684–685 AD), *Abd Al-Malik* (685–705 AD), *Al-Walid I* (705–715 AD), *Suleyman* (715–717 AD), *Umar II* (717–720 AD), *Yazid II* (720–724 AD), *Hisham* (724–743 AD), *Al-Walid II* (743–744 AD), *Yazid III* (744 AD), *Ibrahim* (744 AD) and *Marwan II* (744–750 AD).

### *The Abbasid Caliphate*

The Arab *Abbasid Caliphate* ruled from *Baghdad* from 749 AD until 1258 AD when they were overthrown by the *Seljuk Turks*. The *Abbasid Caliphs* were: *Abu Al Abbas Al Saffah* (750–754 AD), *Al-Mansur* (754–775 AD), *Al-Mahdi* (775–785 AD), *Al-Hadi* (785–786 AD), *Harun Al-Rashid* (786–809 AD), *Al-Amin* (809–813 AD), *Al-Mamun* (813–833 AD), etc.

VIII. Some *Islamic* Numismatic Abbreviations and Terminology

Numismatic Metal Abbreviations		
<b>AE</b>	Copper	Refers to both relatively pure copper and copper mixed with other base metals. Other common abbreviations for copper are C or Cu.
<b>AR</b>	Silver	Although early <i>Islamic</i> coinage was relatively pure (90-99+ percent), by the fourth AH/tenth century AD, silver was often debased, especially during the years 350-620 AH/960-1225 AD
<b>AU</b> or <b>AV</b>	Gold	This refers normally to fine gold, usually 90 percent or better. Lighter gold is known as pale gold. The term “electrum” is not usually used in <i>Islamic</i> numismatics (at least yet).
<b>B</b>	Brass	Brass was used only by a few relatively late mints, such as the coins of <i>Harar</i> in Ethiopia.
<b>BI</b>	Billon	Debased silver, normally 20-60 percent fine. The symbol “AR” is used for silver coins roughly 60 percent or better. Billon <i>jitals</i> are usually much less than 20 percent fine. Billon is an alloy of gold or silver used for making coins, while bullion refers to refined gold or silver in the form of ingots.
<b>BR</b>	Bronze	A copper-tin alloy. AE and BR are interchangeable because collectors assume older copper coins (AE) are in fact Bronze (BR), or else the coin would have corroded beyond recognition.
<b>EL</b>	Electrum	Silver-gold alloy.
<b>NI</b>	Nickel	Nickel.
<b>Pb</b>	Lead	Lead was alloyed with gold, silver and copper to produce coins. Pure lead was sometimes heated and poured to form coins and seals.

Other Numismatic Abbreviations					
<b>Ch</b>	Choice	<b>C/M</b>	Counter-marked	<b>Cr</b>	Crude
<b>D/M</b>	Date Missing	<b>D/S</b>	Double struck	<b>Lt</b>	Light
<b>T/M</b>	Test-mark	<b>M/M</b>	Mint Missing	<b>N/D</b>	No Date
<b>N/M</b>	No mint	<b>Nr</b>	Near(ly)	<b>M/R</b>	Mount removed
<b>1h,</b> <b>12h,</b> <b>etc.</b>	Coin die position using the clock-face hour positions: When looking at the obverse, one can flip a US coin vertically to look at the reverse. Thus US coins have a die position of 6h (six o'clock). A coin minted so that one must flip the coin horizontally to see the reverse right side up would have a die position of 12h (12 o'clock). Hand-minted coins most often follow no such convention so die positions can be anywhere from 1h to 12h.				

**IX. Selected Islamic Coin References**

The ANS ([amnumsoc.org/search](http://amnumsoc.org/search)) has a library of coin references. Searching on the references below should bring you to web pages with extensive bibliographies.

<b>Selected Islamic Coin References</b>	
Album	Album, Stephen. <i>A Checklist of Popular Islamic Coins</i> , 2 <sup>nd</sup> Edition, Album, California, 1998
Album SI 21	Album, Stephen. <i>An Arab-Sassanian Dirham Hoard From the Year 72 Hijri</i> , <i>Studia Iranica</i> 21, 1992
Gobl Hunnen	Gobl, Robert. <i>Dokumente Zur Geschichte Der Iranischen Hunnen In</i>
Mitchiner ACW	Mitchiner, Michael. <i>Oriental Coins, the Ancient and Classical World</i> , Hawkins Publications, London, 1978
Mitchiner WOI	Mitchiner, Michael. <i>Oriental Coins, the World of Islam</i> , Hawkins Publications, London, 1977
Walker AB	Walker, John. <i>A Catalogue of the Arab-Byzantine Coins (BMC)</i> , British Museum, London, 1956
Walker AS	Walker, John. <i>A Catalogue of the Arab-Sassanian Coins (BMC)</i> , British Museum, London, 1941

## Back Matter

<b>18 Ethnic-cleansing Verses in the <i>Koran</i></b>	
<b><i>Sura</i> &amp; <i>Period</i></b>	Note: The ethnic-cleansing verses in this table are also found in the list of 164 War verses <b>except</b> K 007:004, 074; 014:013-014; 021:044b & 033:060.
<b>002:191</b> <i>Madinan</i>	“Kill them [non- <i>Muslims</i> ] wherever you find them and <b>drive them out</b> ” [in order to leave an area entirely free of non- <i>Muslims</i> ].
<b>004:089</b> <i>Madinan</i>	...take not from among them [non- <i>Muslims</i> ] friends <b>until they fly</b> (their homes) in <i>Allah</i> ’s way [ <i>Sher Ali</i> : “ <b>until they emigrate</b> ”, <i>Palmer</i> : “ <b>until they flee</b> ”]; but if they turn back [to their homes], then seize them and kill them wherever you find them ( <i>Shakir</i> ).
<b>004:094</b> <i>Madinan</i>	O you who believe! <b>When you go forth (to fight)</b> in the way of <i>Allah</i> , <b>be careful to discriminate</b> and say not unto one who offers you peace: “You are not a believer [a <i>Muslim</i> ],” seeking the chance profits of this life (so that you may despoil him) ( <i>Pickthall</i> ). [In other words, <i>Muslims</i> ought to be careful to kill and plunder only non- <i>Muslims</i> .]
<b>004:104</b> <i>Madinan</i>	<b>Slacken not in following up the enemy</b> [as non- <i>Muslims</i> retreat]: If you [ <i>Muslims</i> ] are suffering hardships, they are suffering similar hardships; but you have hope from <i>Allah</i> , while they have none [i.e. it is not enough to fight and beat non- <i>Muslims</i> in battle but one must also not stop chasing them out of the area.]
<b>005:033</b> <i>Madinan</i>	The punishment of those who wage war against God and His Apostle... is execution or crucifixion or the cutting off of hands and feet from opposite sides or <b>exile from the land</b> [ <i>Yusuf Ali</i> : “ <b>exile from the land</b> ” <i>Pickthall</i> : “ <b>be expelled out of the land</b> ”] [ <i>Muslims</i> are to kill or cripple or drive out non- <i>Muslim</i> who try to defend themselves from the ravages of <i>Jihadist</i> driven on by the murderous <i>Koran</i> ].
<b>007:004,</b> <b>074</b> <i>Makkan</i>	How many townships have We [ <i>Allah</i> ] destroyed! <b>As a raid by night</b> , or while they slept at noon [a <i>siesta</i> ], Our [ <i>Allah</i> ’s] terror came unto them ( <i>Pickthall</i> )... <b>Remember how He</b> [ <i>Allah</i> ] <b>made you inheritors after the ‘Ad people</b> [a mythical pre- <i>Islamic</i> Arabian tribe] and gave you habitations in the land ( <i>Yusuf Ali</i> ) [i.e. pre- <i>Islamic</i> peoples were murdered at night and terrorized during the day all at <i>Allah</i> ’s behest, so that the survivors would flee and leave their land to <i>Makkans</i> (see K 014:013-014, below).]
<b>009:005</b> <i>Madinan</i>	Slay the idolaters <b>wherever you find them</b> and take them captives and besiege them and <b>lie in wait for them in every ambush</b> [in order to render an area pagan-free (compare with K 002:191)].
<b>009:029</b> <i>Madinan</i>	Fight those...who have been given the Book [Jews and Christians], <b>until they pay the</b> [ <i>Jizya</i> ] <b>tax</b> in acknowledgment of [ <i>Muslim</i> ] superiority and they are in a state of subjection. [These measures would tend to make Christians either emigrate or convert to <i>Islam</i> .]
<b>009:123</b> <i>Madinan</i>	O you [ <i>Muslims</i> ] who believe! Fight those of the <b>disbelievers who are near to you and let them find harshness in you</b> , and know that <i>Allah</i> is with those who keep their duty unto Him. [These measures would tend to make Christians either emigrate or convert to <i>Islam</i> . Verses about how <i>Muslim</i> ought to be harsh to non- <i>Muslims</i> include K 009:073, 123; 048:029; 066:009.]

<p><b>014:013-014</b> <i>Makkan</i></p>	<p>We [<i>Allah</i>] will settle you [i.e. the followers of the <i>Muslim</i> Prophet <i>Nuh</i> (Noah), Prophet <i>Salih</i> of the <i>Samood</i> tribe (<i>K</i> 007:073), Prophet <i>Hud</i> of the <i>Ad</i> tribe (<i>K</i> 007:065)] and other legendary <i>Muslim</i></p>
<p>prophets] in the land after them [unbelievers] [<i>Muhammad</i> said that <i>Muslims</i> were not the first followers of a <i>Muslim</i> prophet to receive land from a people who were exterminated or chased out (see <i>K</i> 007:004, 074, above)].</p>	
<p><b>021:044b</b></p>	<p>See they not that We [<i>Allah</i>] gradually reduce the land (in their control) from its outlying borders? Is it then they who will win? [<i>Islamic</i>-style conquering and ethnic cleansing is <i>Razzia</i> raids and a war of attrition in the form of terrorism].</p>
<p><b>033:026-027</b> <i>Madinan</i></p>	<p>He [<i>Allah</i>] took down the followers of the Book [<i>Jews</i>]...from their fortresses and He cast awe into their hearts; some you killed [<i>Muhammad</i> had between 700 and 900 Jewish men of the third <i>Madinan</i> <i>Kurayza</i> tribe butchered in cold blood after they surrendered (see <i>K</i> 059:002, below)] and you took captive another part [<i>Muhammad</i> had the <i>Kurayza</i> women and children sold as slaves]. He [<i>Allah</i>] made you [<i>Muslims</i>] heirs of their [the Jew's] lands, their houses and their goods and of a land which you had not frequented before [because the <i>Madinan</i> <i>Muslims</i> were formerly <i>Makkan</i> <i>Muslims</i>].</p>
<p><b>033:060</b> <i>Madinan</i></p>	<p>We [<i>Allah</i>] will certainly urge you [<i>Muslims</i>] against them [non-conforming <i>Muslims</i>], and then they will not dwell with you therein as neighbors but for a short while.</p>
<p><b>059:002</b> <i>Madinan</i></p>	<p>He [<i>Allah</i>] it is Who caused those who disbelieved of the followers of the Book [the first two <i>Madinan</i> Jewish tribes that <i>Muhammad</i> banished, the <i>Nadir</i> and <i>Kuynuqa</i> (see 033:026-027, above)] to go forth from their homes at the first banishment. You did not think that they would go forth, while they were certain that their fortresses would defend them against <i>Allah</i>; but <i>Allah</i> came to them whence they did not expect and cast terror into their hearts [meaning <i>Jews</i> and <i>Muslims</i> decided on surrender terms whereby <i>Jews</i> vacated <i>Madina</i>]; they demolished their houses with their own hands [meaning <i>Jews</i> took their ornate lintels with them into exile<sup>4646</sup>] and the hands of the believers [<i>Muslims</i> demolished the vacated houses so <i>Jews</i> would not come back]; therefore take a lesson, O you who have eyes! [Yes, <i>Muhammad</i>, we are taking note of your evil!]</p>
<p><b>059:005</b> <i>Madinan</i></p>	<p>Whatever palm-tree you cut down or leave standing upon its roots, it is by <i>Allah</i>'s command, and that He may abase the Transgressors [During the siege of the Jewish tribe, the <i>Nadir</i>, <i>Muhammad</i> started to cut down all the palm trees.<sup>4647</sup> When <i>Jews</i> saw this, they decided to surrender even though it meant exile since no one can live at a desert oasis without palm trees for food. So threatening to cut down the palm trees was a way to ethnically cleanse <i>Madina</i> of <i>Jews</i>. Today, this would be called environmental and economic terrorism.]</p>

<sup>4646</sup> Ishaq. *Sirat*, p. 437.

<sup>4647</sup> Ishaq. *Sirat*, p. 437; *Muslim* nos. 4324-4326; *Abu Dawud* no. 2609.

## The *Koran's* 164 War verses (Detailed)

I. Horizontal List of Verses .....	p. 1068
II. Vertical List of Verses .....	p. 1069
III. Excerpts of Verses.....	p. 1070
IV. Full-text of Verses (With Bolding).....	p. 1079

### I. Introduction

#### A. War verse Selection Criteria

Each of the 164 War verses in this list was selected based on how clearly and directly it spoke about *Jihad*, at least when considered in its immediate context. Most of the listed passages mention a military expedition, fighting or distributing war spoils. Verses NOT generally listed are those that speak about aspects of *Jihad* other than raiding, fighting and looting, such as:

- ☉ *Muhammad's* poor opinion of those who did not go on *Jihad*, even though they were able-bodied and able financially (such in some verses in *K* 009:081-096).
- ☉ The heavenly rewards for *Jihadists*.
- ☉ The many generic mentions of “victory” found in the *Koran*.

Such omitted verses can readily be found in proximity to the War verses listed below.

#### B. Related Issues

Abrogation is a reoccurring topic whenever verses of the *Koran* are discussed. As a rule, later verses counseling Holy War, such the Sword Verse (*K* 009:005), abrogate earlier verses counseling tolerance and peace, such as *K* 002:256. The Sword Verse is just one of the 164 War verses listed below. It follows that not many, if any, of the Holy War verses in this list are abrogated.

The list gives the verses in the order they occur in the *Koran*, but this is not the chronological order the verses were written. To gain a deeper understanding of the verses, one can study these verses in chronological order and also consult articles and commentaries for the historical context. A good place to start is Rev. Richard P. Bailey's article “*Jihad: The Teaching of Islam From Its Primary Sources—The Quran and Hadith.*”<sup>4648</sup>

---

<sup>4648</sup> This list was compiled based on the examination of similar lists, the major ones being: 1) Richardson, Don. *Secrets of the Koran*. Regal, Venture, California 2003, Appendix B, p. 254, “The *Koran's* 109 War Passages,” 2) Winn, Craig. “What did *Muhammad* have to say about...,” ProphetOfDoom.net, accessed 3 May 2004, 3) Bailey, Rev. Richard P. “*Jihad: The Teaching of Islam From Its Primary Sources—The Quran and Hadith,*” Answeringislam.org/Bailey/Jihad.html, accessed 4 May 2004 and 5) various chapters of Goel, Sita Ram. *The Calcutta Quran Petition*, Voice Of India, New Delhi 1999, 3rd edition (voi.org/books).

## I. Horizontal List of Verses

*In text-only format*

**The Koran's 164 War verses:** **K 002:**178-179, 190-191, 193-194, 216-218, 244; **003:**121-126, 140-143, 146, 152-158, 165-167,169, 172-173, 195; **004:**071-072, 074-077, 084, 089-091, 094-095,100-104; **005:**033, 035, 082; **008:**001, 005, 007, 009-010, 012, 015-017, 039-048,057-060, 065-075; **009:**005, 012-014, 016, 019-020, 024-026, 029,036, 038-039, 041, 044, 052, 073, 081, 083,086, 088, 092, 111, 120, 122-123; **016:**110; **022:**039, 058, 078; **024:**053, 055; **025:**052; **029:**006, 069; **033:**015, 018, 020, 023, 025-027, 050; **042:**039; **047:**004, 020, 035; **048:**015-024; **049:**015; **059:**002, 005-008, 014; **060:**009; **061:**004, 011, 013; **063:**004; **064:**014; **066:**009; **073:**020; **076:**008

*In table format*

Ch.	The Koran's 164 War verses	# per Sura	Running Count
002	178-179, 190-191, 193-194, 216-218, 244	10	10
003	121-126, 140-143, 146, 152-158, 165-167, 169, 172-173, 195	25	35
004	071-072, 074-077, 084, 089-091, 094-095, 100-104, 141	18	53
005	033, 035, 082	3	56
008	001, 005, 007, 009-010, 012, 015-017, 039-048, 057-060, 065-075	34	90
009	005, 012-014, 016, 019-020, 024-026, 029, 036, 038-039, 041, 044, 052, 073, 081, 083, 086, 088, 092, 111, 120, 122-123	27	117
016	110	1	118
022	039, 058, 078	3	121
024	053, 055	2	123
025	052	1	124
029	006, 069	2	126
033	015, 018, 020, 023, 025-027, 050	8	134
042	039	1	135
047	004, 020, 035	3	138
048	015-024	10	148
049	015	1	149
059	002, 005-008, 014	6	155
060	009	1	156
061	004, 011, 013	3	159
063	004	1	160
064	014	1	161
066	009	1	162
073	020	1	163
076	008	1	164

## II. Vertical List of Verses

The *Koran's* 164 War verses

<b>1</b>	2:178	<b>26</b>	3:156	<b>51</b>	4:103	<b>76</b>	8:57	<b>101</b>	09:029	<b>126</b>	29:69
<b>2</b>	2:179	<b>27</b>	3:157	<b>52</b>	4:104	<b>77</b>	8:58	<b>102</b>	09:036	<b>127</b>	33:15
<b>3</b>	2:190	<b>28</b>	3:158	<b>53</b>	4:141	<b>78</b>	8:59	<b>103</b>	09:038	<b>128</b>	33:18
<b>4</b>	2:191	<b>29</b>	3:165	<b>54</b>	5:033	<b>79</b>	8:60	<b>104</b>	09:039	<b>129</b>	33:20
<b>5</b>	2:193	<b>30</b>	3:166	<b>55</b>	5:035	<b>80</b>	8:65	<b>105</b>	09:041	<b>130</b>	33:23
<b>6</b>	2:194	<b>31</b>	3:167	<b>56</b>	5:082	<b>81</b>	8:66	<b>106</b>	09:044	<b>131</b>	33:25
<b>7</b>	2:216	<b>32</b>	3:169	<b>57</b>	8:001	<b>82</b>	8:67	<b>107</b>	09:052	<b>132</b>	33:26
<b>8</b>	2:217	<b>33</b>	3:172	<b>58</b>	8:005	<b>83</b>	8:68	<b>108</b>	09:073	<b>133</b>	33:27
<b>9</b>	2:218	<b>34</b>	3:173	<b>59</b>	8:007	<b>84</b>	8:69	<b>109</b>	09:081	<b>134</b>	33:50
<b>10</b>	2:244	<b>35</b>	3:195	<b>60</b>	8:009	<b>85</b>	8:70	<b>110</b>	09:083	<b>135</b>	42:39
<b>11</b>	3:121	<b>36</b>	4:071	<b>61</b>	8:010	<b>86</b>	8:71	<b>111</b>	09:086	<b>136</b>	47:04
<b>12</b>	3:122	<b>37</b>	4:072	<b>62</b>	8:012	<b>87</b>	8:72	<b>112</b>	09:088	<b>137</b>	47:20
<b>13</b>	3:123	<b>38</b>	4:074	<b>63</b>	8:015	<b>88</b>	8:73	<b>113</b>	09:092	<b>138</b>	47:35
<b>14</b>	3:124	<b>39</b>	4:075	<b>64</b>	8:016	<b>89</b>	8:74	<b>114</b>	09:111	<b>139</b>	48:15
<b>15</b>	3:125	<b>40</b>	4:076	<b>65</b>	8:017	<b>90</b>	8:75	<b>115</b>	09:120	<b>140</b>	48:16
<b>16</b>	3:126	<b>41</b>	4:077	<b>66</b>	8:039	<b>91</b>	9:05	<b>116</b>	09:122	<b>141</b>	48:17
<b>17</b>	3:140	<b>42</b>	4:084	<b>67</b>	8:040	<b>92</b>	9:12	<b>117</b>	09:123	<b>142</b>	48:18
<b>18</b>	3:141	<b>43</b>	4:089	<b>68</b>	8:041	<b>93</b>	9:13	<b>118</b>	16:110	<b>143</b>	48:19
<b>19</b>	3:142	<b>44</b>	4:090	<b>69</b>	8:042	<b>94</b>	9:14	<b>119</b>	22:039	<b>144</b>	48:20
<b>20</b>	3:143	<b>45</b>	4:091	<b>70</b>	8:043	<b>95</b>	9:16	<b>120</b>	22:058	<b>145</b>	48:21
<b>21</b>	3:146	<b>46</b>	4:094	<b>71</b>	8:044	<b>96</b>	9:19	<b>121</b>	22:078	<b>146</b>	48:22
<b>22</b>	3:152	<b>47</b>	4:095	<b>72</b>	8:045	<b>97</b>	9:20	<b>122</b>	24:053	<b>147</b>	48:23
<b>23</b>	3:153	<b>48</b>	4:100	<b>73</b>	8:046	<b>98</b>	9:24	<b>123</b>	24:055	<b>148</b>	48:24
<b>24</b>	3:154	<b>49</b>	4:101	<b>74</b>	8:047	<b>99</b>	9:25	<b>124</b>	25:052	<b>149</b>	49:15
<b>25</b>	3:155	<b>50</b>	4:102	<b>75</b>	8:048	<b>100</b>	9:26	<b>125</b>	29:006	<b>150</b>	59:02

<b>151</b>	59:05
<b>152</b>	59:06
<b>153</b>	59:07
<b>154</b>	59:08
<b>155</b>	59:14
<b>156</b>	60:09
<b>157</b>	61:04
<b>158</b>	61:11
<b>159</b>	61:13
<b>160</b>	63:04
<b>161</b>	64:14
<b>162</b>	66:09
<b>163</b>	73:20
<b>164</b>	76:08



## III. Excerpts of Verses

## The Koran's 164 War verses

Translation used: *M. H. Shakir*, published by Tahrike Tarsile *Quran*, Inc., 1983, unless otherwise indicated.

Set	Count	Citation	Excerpt
Set 1	Count 1+2	K 002:178-179	[002:178]...retaliation is prescribed for you in the matter of the slain...[002:179]...there is life for you in (the law of) retaliation, O men of understanding, that you may guard yourselves.
Set 2	Count 3+4	K 002:190-191	[002:190]...fight in the way of <i>Allah</i> with those who fight with you...[002:191] And kill them wherever you find them and drive them out from whence they drove you out, and persecution is severer than slaughter, and do not fight with them at the Sacred <i>Mosque</i> until they fight with you in it, but if they do fight you, then slay them; such is the recompense of the unbelievers.
Set 3	Count 5+6	K 002:193-194	[002:193]...fight with them...[002:194]...whoever then acts aggressively against you, inflict injury on him according to the injury he has inflicted on you...
Set 4	Count 7-9	K 002:216-218	[002:216] Fighting is enjoined on you...[002:217]...fighting in it. Say: Fighting in it is a grave matter...persecution is graver than slaughter...[002:218]...strove hard [Arabic: <i>wajahadoo</i> ] in the way of <i>Allah</i> ...
Set 5	Count 10	K 002:244	...fight in the way of <i>Allah</i>
Set 6	Count 11-16	K 003:121-126	[003:121]...to lodge the believers in encampments for war...[003:122] When two parties from among you had determined that they should show cowardice [about war]...[003:123]... <i>Allah</i> did certainly assist you at [the Battle of] <i>Badr</i> ...[003:124]...[003:125] Yea! if you remain patient and are on your guard and they come upon you in a headlong manner, your Lord will assist you with five thousand of the havoc-making angels. [003:126]...victory is only from <i>Allah</i> ...
Set 7	Count 17-20	K 003:140-143	[003:140] If a wound has afflicted you (at [the Battle of] <i>Uhud</i> ), a wound like it has also afflicted the (unbelieving) people; and We bring these days to men by turns, and that <i>Allah</i> may know those who believe and take witnesses from among you...[003:141]...that He [ <i>Allah</i> ] may purge those who believe and deprive the unbelievers of blessings. [003:142] <i>Yusuf Ali</i> : Did ye think that you would enter heaven without God testing those of you who fought hard (in His Cause) [Arabic: <i>wajahadoo</i> ] and remained steadfast? [003:143] <i>Pickthall</i> : And verily ye used to wish for death before ye met it (in the field). Now ye have seen it [death] with your eyes!
Set 8	Count 21	K 003:146	<i>Yusuf Ali</i> : How many of the prophets fought (in <i>Allah's</i> way) [war], and with them (fought) large bands of godly men? But they never lost heart if they met with disaster in <i>Allah's</i> way [in a battle], nor did they weaken (in will) or give in.

Set 9	Count 22-27	K 003:152-157
<p>[003:152]...you slew them by His [<i>Allah's</i>] permission [during a battle]...[003:153] <i>Pickthall</i>:...the Messenger, in your rear, was calling you (to fight)...that which ye missed [war spoils]...[003:154]...They say: Had we any hand in the affair, we would not have been slain here [in a battle]. Say: Had you remained in your houses, those for whom slaughter was ordained [in a battle] would certainly have gone forth to the places where they would be slain...[003:155] (As for) those of you who turned back on the day when the two armies met...[003:156] O you who believe! be not like those who disbelieve and say of their brethren when they travel in the earth or engage in fighting: Had they been with us, they would not have died and they would not have been slain...[003:157]...if you are slain in the way of <i>Allah</i>...mercy is better than what they amass [what those who stay home from war receive—no loot on earth and no perks in heaven].</p>		
Set 10	Count 28-30	K 003:165-167
<p>[003:165]...you [<i>Muslims</i>] had certainly afflicted (the unbelievers) with twice as much [in a battle]...[003:166]...when the two armies met ([the Battle of] <i>Uhud</i>)...[003:167]...Come, fight in <i>Allah's</i> way, or defend yourselves...If we knew fighting, we would certainly have followed you...</p>		
Set 11	Count 31	K 003:169
<p>...reckon not those who are killed in <i>Allah's</i> way as dead; nay, they are alive (and) are provided sustenance from their Lord [banquets in heaven];</p>		
Set 12	Count 32+33	K 003:172-173
<p>[003:172] ...those who responded (at [the Battle of] <i>Uhud</i>) to the call of <i>Allah</i> and the Apostle after a wound had befallen them...shall have a great reward. [003:173] Those to whom the people said: Surely men have gathered against you [in battle], therefore fear them, but this increased their faith and they said: <i>Allah</i> is sufficient for us and most excellent is the Protector.</p>		
Set 13	Count 34	K 003:195
<p>...who fought and were slain...I will most certainly make them enter gardens beneath which rivers flow; a reward from <i>Allah</i>, and with <i>Allah</i> is yet better reward.</p>		
Set 14	Count 35+36	K 004:071-072
<p>[004:071]...go forth in detachments or go forth in a body [to war]. [004:072]...hang back [from war]...not present with them [in war].</p>		
Set 15	Count 37-40	K 004:074-077
<p>[004:074] Therefore let those fight in the way of <i>Allah</i>, who sell this world's life for the hereafter; and whoever fights in the way of <i>Allah</i>, then be he slain or be he victorious, We shall grant him a mighty reward. [004:075]...fight in the way of <i>Allah</i>...[004:076] Those who believe fight in the way of <i>Allah</i> and those who disbelieve fight in the way of the Satan. Fight therefore against the friends of the Satan...[004:077]...when fighting is prescribed for them...Our Lord! why hast Thou ordained fighting for us?...</p>		
Set 16	Count 41	K 004:084
<p>Fight then in <i>Allah's</i> way...rouse the believers to ardor maybe <i>Allah</i> will restrain the fighting of those who disbelieve...</p>		

Set 17	Count 42-44	K 004:089-091	
[004:089]...if they turn back [to their homes], then seize them and kill them wherever you find them...[004:090] <i>Allah</i> has not given you a way against them [ <i>Allah</i> supposedly does not allow <i>Muslims</i> to fight people friendly to <i>Muslims</i> ]. [004:091]...seize them and kill them wherever you find them...			
Set 18	Count 45+46	K 004:094-095	
[004:094]...when you go to war in <i>Allah's</i> way...[004:095]...those who strive hard [ <i>waalmujahidoona</i> ] in <i>Allah's</i> way with their property and their persons are not equal... <i>Allah</i> shall grant to the strivers [Arabic: <i>almujahideena</i> i.e. <i>Jihadist</i> ] above the holders back a mighty reward.			
Set 19	Count 47	K 004:100	
...whoever flies in <i>Allah's</i> way [forsakes his home to fight], he will find in the earth many a place of refuge and abundant resources, and whoever goes forth from his house flying to <i>Allah</i> and His Apostle and then death overtakes him, his reward is indeed with <i>Allah</i> ...			
Set 20	Count 48	K 004:102	
...let them take their arms...let them take their precautions and their arms...there is no blame on you, if you are annoyed with rain or if you are sick, that you lay down your arms...			
Set 21	Count 49	K 004:104	
...be not weak hearted in pursuit of the enemy...			
Set 22	Count 50	K 005:033	
The punishment of those who wage war against <i>Allah</i> and His apostle and strive to make mischief in the land is only this, that they should be murdered or crucified or their hands and their feet should be cut off on opposite sides or they should be imprisoned [ <i>Pickthall</i> and <i>Yusuf Ali</i> have “exiled” rather than “imprisoned”]			
Set 23	Count 51	K 005:035	
...strive hard [Arabic: <i>wajahidoo</i> ] in His way that you may be successful.			
Set 24	Count 52	K 005:082	
...you will find the most violent of people in enmity for those who believe (to be) Jews [compare with “whenever Jews kindle fire for war, <i>Allah</i> [ <i>Muslims</i> ] puts it out” (K 005:064)] and those who are polytheists [while they are converted to <i>Islam</i> on pain of death]...			
Set 25	Count 53	K 008:001	
<i>Pickthall</i> :...the spoils of war...The spoils of war belong to <i>Allah</i> and the Messenger			
Set 26	Count 54	K 008:005	
Even as your Lord caused you to go forth from your house with the truth, though a party of the believers were surely averse;			
Set 27	Count 55	K 008:007	
... <i>Allah</i> promised you one of the two (enemy) parties, that it should be yours: You wished that the one unarmed should be yours, but <i>Allah</i> willed to justify the Truth according to His words and to cut off the roots of the Unbelievers.			
Set 28	Count 56	K 008:009	
...I will assist you [in war] with a thousand of the angels following one another [see K 008:012].			

Set 29	Count 57	K 008:012
...make firm those who believe. I will cast terror into the hearts of those who disbelieve. Therefore strike off their heads and strike off every fingertip of them.		
Set 30	Count 58-59	K 008:015-017
[008:015]...when you meet those who disbelieve marching for war, then turn not your backs to them. [008:016]...for the sake of fighting...[008:017] So you did not slay them, but it was <i>Allah</i> Who slew them, and you did not smite when you smote (the enemy), but it was <i>Allah</i> Who smote [ <i>Allah</i> gets the credit for war]...		
Set 31	Count 60-70	K 008:0390-48
[008:039] <i>Shakir</i> :...fight with them until there is no more persecution and religion should be only for <i>Allah</i> ...[008:040] <i>Yusuf Ali</i> : If they [unbelievers] refuse [to stop fighting], be sure that God is your Protector...[008:041] <i>Shakir</i> :...whatever thing [loot] you gain, a fifth of it is for <i>Allah</i> and for the Apostle...the day on which the two parties met [in a battle]...[008:042]... <i>Allah</i> might bring about a matter which was to be done, that he who would perish might perish by clear proof [bring success to <i>Muslims</i> engaged in robbing a caravan near <i>Badr</i> against all the odds]...[008:043]... <i>Allah</i> showed them [the <i>Makkans</i> ] to you in your dream as few [fighters]; and if He had shown them [the <i>Makkans</i> ] to you as many [fighters] you would certainly have become weak-hearted [i.e. hearts. See the similar discussion in K 002:249 about how a smaller army can defeat a larger army]...[008:044]...when you met, as few [fighters] in your eyes and He made you to appear little [few fighters] in their eyes, in order that <i>Allah</i> might bring about a matter which was to be done [a battle entered into on account of overconfidence on each side]...[008:045]...when you meet a party [in battle], then be firm...[008:046]...obey <i>Allah</i> and His Apostle and do not quarrel for then you will be weak in hearts [demoralized] and your power [to execute war] will depart...[008:047]...be not like those [ <i>Makkans</i> ] who came forth from their homes [to fight <i>Muslims</i> ]...[008:048]...when the two parties [ <i>Muslims</i> versus <i>Makkans</i> ] came in sight of each other he [Satan] turned upon his heels...		
Set 32	Count 71-74	K 008:057-060
<i>Pickthall</i> : [008:057] If thou come on them in the war, deal with them so as to strike fear in those who are behind them, that haply they may remember. [008:058] <i>Khalifa</i> : When you are betrayed by a group of people, you shall mobilize against them in the same manner. GOD does not love the betrayers. [008:059] <i>Shakir</i> :...let not those who disbelieve think that they shall come in first; surely they will not escape. [008:060] And prepare against them what force you can and horses tied at the frontier, to frighten thereby the enemy of <i>Allah</i> and your enemy and others besides them, whom you do not know (but) <i>Allah</i> knows them; and whatever thing you will spend in <i>Allah's</i> way [for war]...		

Set 33	Count 75-85	K 008:065-075
<p>[008:065] O Prophet! urge the believers to war; if there are twenty patient ones of you they shall overcome two hundred, and if there are a hundred of you they shall overcome a thousand of those who disbelieve, because they are a people who do not understand [in other words, “do not understand totalitarian ideologies like <i>Islam</i>”]. [008:066]...if there are a hundred patient ones of you they shall overcome two hundred, and if there are a thousand they shall overcome two thousand by <i>Allah's</i> permission...[008:067] It is not fit for a prophet that he should take captives unless he has fought and triumphed in the land; you desire the frail goods [i.e. ransom money] of this world...[008:068]...ransom...[008:069] Eat then of the lawful and good (things) which you have acquired in war [war spoils]...[008:070] O Prophet! say to those of the captives [non-<i>Muslims</i>] who are in your hands: If <i>Allah</i> knows anything good in your hearts, He will give to you better than that which has been taken away from you [in war]...[008:071] <i>Yusuf Ali</i>: But if they have treacherous designs against thee, (O Apostle!)...He [<i>Allah</i>] given (thee) power over them...[008:072] <i>Yusuf Ali</i>: Those who ...fought for the Faith, with their property and their persons, in the cause of God...[008:073] <i>Yusuf Ali</i>: The Unbelievers are protectors, one of another: Unless ye do this, (protect each other), there would be tumult and oppression on earth and great mischief. [008:074] <i>Yusuf Ali</i>:...fight for the Faith...[008:075] <i>Yusuf Ali</i>: ...fight for the Faith...</p>		
Set 34	Count 86	K 009:005
<p>...slay the idolaters wherever you find them...take them captives and besiege them and lie in wait for them in every ambush...</p>		
Set 35	Count 87-89	K 009:012-014
<p>[009:012]...fight the leaders of unbelief...[009:013] What! will you not fight a people...[009:014] Fight them, <i>Allah</i> will punish them by your hands and bring them to disgrace, and assist you against them and heal the hearts of a believing people.</p>		
Set 36	Count 90	K 009:016
<p>...those of you who have struggled hard [<i>Arabic: jahadoo</i>]</p>		
Set 37	Count 91+92	K 009:019-020
<p>[009:19]...strives hard in <i>Allah's</i> way [<i>Arabic: wajahada</i>]?...[009:20]...strove hard in <i>Allah's</i> way [<i>wahajaroo wajahadoo</i>] with their property and their souls...</p>		
Set 38	Count 93-95	K 009:024-026
<p>[009:024]...striving in His way [<i>Arabic: wajihadin</i>], then wait till <i>Allah</i> brings about His command [to go to war]:...[009:025] Certainly <i>Allah</i> helped you in many battlefields and on the day of [the Battle of] <i>Hunain</i>, when your great numbers made you vain...[009:026]...chastised those who disbelieved [<i>Muhammad</i> gives credit to angels and <i>Allah</i> for the actions of <i>Jihadists</i>]...</p>		
Set 39	Count 96	K 009:029
<p>Fight those who do not believe in <i>Allah</i>...nor follow the religion of truth, out of those who have been given the Book, until they pay the tax in acknowledgment of superiority and they are in a state of subjection.</p>		
Set 40	Count 97	K 009:036
<p>...fight the polytheists all together as they fight you all together...</p>		

Set 41	Count 98+99	K 009:038-039	
[009:038]...Go forth in <i>Allah's</i> way [to war]... [009:039] If you do not go forth [to war], He will chastise you with a painful chastisement and bring in your place a people other than you [to go to war]...			
Set 42	Count 100	K 009:041	
Go forth light [lightly armed] and heavy [heavily armed], and strive hard in <i>Allah's</i> way [Arabic: <i>wajahidoo</i> ] with your property and your persons...			
Set 43	Count 101	K 009:044	
...striving hard [Arabic: <i>yujahidoo</i> ] with their property and their persons [in war]...			
Set 44	Count 102	K 009:052	
... <i>Allah</i> will afflict you with punishment from Himself or by our hands...			
Set 45	Count 103	K 009:073	
...strive hard [Arabic: <i>jahidi</i> ] against the unbelievers and the hypocrites and be unyielding to them...			
Set 46	Count 104	K 009:081	
...they were averse from striving in <i>Allah's</i> way [Arabic: <i>yujahidoo</i> ] with their property and their persons and said: Do not go forth [to war] in the heat...			
Set 47	Count 105	K 009:083	
...shall you fight an enemy with me [in war]...			
Set 48	Count 106	K 009:086	
...strive hard [Arabic: <i>wajahidoo</i> ] along with His Apostle			
Set 49	Count 107	K 009:088	
...strive hard [Arabic: <i>jahadoo</i> ] with their property and their persons...			
Set 50	Count 108	K 009:092	
<i>Yusuf Ali</i> : Nor (is there blame) on those who came to thee to be provided with mounts [i.e. camels, horses, mules], and when thou said "I can find no mounts for you," they turned back, their eyes streaming with tears of grief that they had no resources wherewith to provide the expenses [to go to war].			
Set 51	Count 109	K 009:111	
...they fight in <i>Allah's</i> way, so they slay and are slain...			
Set 52	Count 110	K 009:120	
<i>Yusuf Ali</i> :...whether they suffered thirst or fatigue or hunger in the cause of <i>Allah</i> [while on a march to war], or trod paths to raise the ire of the Unbelievers [invade their territory], or received any injury whatever from an enemy [during a battle]...			
Set 53	Count 111+112	K 009:122-123	
[009:122] <i>Pickthall</i> :...the believers should not all go out to fight. Of every troop of them, a party only should go forth...[009:123]...fight those of the unbelievers who are near to you and let them find in you hardness...			
Set 54	Count 113	K 016:110	
<i>Yusuf Ali</i> :...who thereafter strive and fight [Arabic: <i>jahadoo</i> ] for the faith and patiently persevere...			
Set 55	Count 114	K 022:039	
Permission (to fight) is given to those upon whom war is made...			
Set 56	Count 115	K 022:058	
<i>Sher Ali</i> :...those who leave their homes for the cause of <i>Allah</i> and are then slain or die, <i>Allah</i> will surely provide for them a goodly provision...			

Set 57	Count 116	K 022:078	
...strive hard [Arabic: <i>wajahidoo</i> ] in (the way of) <i>Allah</i> , (such) a striving [Arabic: <i>jihadihi</i> ] is due to Him...			
Set 58	Count 117	K 024:053	
...they would certainly go forth [to war (see K 024:055)]...			
Set 59	Count 118	K 024:055	
<i>Allah</i> has promised to those of you who believe and do good that He will most certainly make them rulers in the earth [as a reward for going to war (see K 024:053)]...			
Set 60	Count 119	K 025:052	
<i>Palmer</i> :...fight strenuously with them in many a strenuous fight.			
Set 61	Count 120	K 029:006	
...whoever strives hard [Arabic: <i>jahada</i> ], he strives [Arabic: <i>yujahidu</i> ] only for his own soul...			
Set 62	Count 121	K 029:069	
...(as for) those who strive hard [Arabic: <i>jahadoo</i> ] for Us...			
Set 63	Count 122	K 033:015	
<i>Pickthall</i> :...they had already sworn unto <i>Allah</i> that they would not turn their backs (to the foe) [in battle]...			
Set 64	Count 123	K 033:018	
...they come not to the fight [in war] but a little...			
Set 65	Count 124	K 033:020	
...they would not fight save a little [in war].			
Set 66	Count 125	K 033:023	
<i>Pickthall</i> :...Some of them [ <i>Jihadists</i> ] have paid their vow by death (in battle) and some of them still are waiting...			
Set 67	Count 126-128	K 033:025-027	
[033:025]... <i>Allah</i> succided the believers in fighting... [033:026]...some [Jews] you killed and you took captive another part. [033:027]...He made you heirs to their [Jewish] land and their dwellings and their property and (to) a land which you have not yet trodden...			
Set 68	Count 129	K 033:050	
...those [captive women] whom your right hand possesses [i.e. by virtue of the sword used in battle] out of those whom <i>Allah</i> has given to you as prisoners of war...			
Set 69	Count 130	K 042:039	
<i>Salé</i> :...and who, when an injury is done them, avenge themselves...			
Set 70	Count 131	K 047:004	
...when you meet in battle those who disbelieve, then smite the necks until when you have overcome them, then make (them) prisoners, and afterwards either set them free as a favor or let them ransom (themselves) until the war terminates...(as for) those who are slain in the way of <i>Allah</i> ...			
Set 71	Count 132	K 047:020	
[047:020]...fighting is mentioned therein...			

Set 72	Count 133	K 047:035	
<i>Rodwell</i> : Be not fainthearted then; and invite not the infidels to peace when ye have the upper hand: for God is with you and will not defraud you of the recompense of your works.			
Set 73	Count 134-136	K 048:015-017	
[048:015] <i>Pickthall</i> :...when you set forth to capture booty [loot]...[048:016]...You shall soon be invited (to fight) against a people possessing mighty prowess; you will fight against them until they submit...[048:017] <i>Pickthall</i> : There is no blame...for the sick (that they go not forth to war). And whoso obeys <i>Allah</i> and His messenger [by going to war], He will make him enter Gardens underneath which rivers flow; and whoso turns back [from battle], him will He punish with a painful doom.			
Set 74	Count 137	K 048:022	
...if those who disbelieve fight with you, they would certainly turn (their) backs...			
Set 75	Count 138	K 048:024	
And He [ <i>Allah</i> ] it is Who held back...your hands from them [in battle] in the valley of <i>Makka</i> ...			
Set 76	Count 139	K 049:015	
<i>Sale</i> :...true believers...employ their substance and their persons in the defense of God's true religion...			
Set 77	Count 140	K 059:002	
...they [Jews] demolished their houses with their own hands and the hands of the believers [i.e. <i>Muslims</i> demolished Jewish homes]...			
Set 78	Count 141-144	K 059:005-008	
<i>Pickthall</i> : [059:005] Whatsoever palm-trees you cut down or left standing on their roots [during a siege of Jews at <i>Madina</i> ], it was by <i>Allah's</i> leave, in order that He might confound the evil-livers [Jews]. [059:006]...that which <i>Allah</i> gave as spoil unto His messenger from them, you urged not any horse or riding-camel for the sake thereof, but <i>Allah</i> gives His messenger lordship over whom He will...[059:007] That which <i>Allah</i> gives as [war] spoil unto His messenger from the people of the townships [Jews], it is for <i>Allah</i> and His messenger...whatsoever [spoils] the Messenger gives you, take it...[059:008]...who seek bounty [war spoils] from <i>Allah</i> ...			
Set 79	Count 145	K 059:014	
They will not fight against you in a body save in fortified towns or from behind walls...			
Set 80	Count 146	K 060:009	
<i>Allah</i> only forbids you respecting those who made war upon you on account of (your) religion [no fraternizing with the enemy]...			
Set 81	Count 147	K 061:004	
... <i>Allah</i> loves those who fight in His way in ranks as if they were a firm and compact wall.			
Set 82	Count 148	K 061:011	
...struggle hard in <i>Allah's</i> way [Arabic: <i>watujahidoona</i> ] with your property and your lives...			
Set 83	Count 149	K 061:013	
...victory [in battle] near at hand...			



Set 84	Count 150	K 063:004	
...they think every cry to be against them. They are the enemy, therefore beware of them; may <i>Allah</i> destroy them, whence are they turned back? [This verse speaks of internecine fights against <i>Muslims</i> deemed infidels or “hypocrites.”]			
Set 85	Count 151	K 064:014	
...surely from among your wives and your children there is an enemy to you; therefore beware of them [collaborators with the enemy, especially if the women were once war spoils]...			
Set 86	Count 152	K 066:009	
O Prophet! strive hard against the unbelievers and the hypocrites and be hard against them...			
Set 87	Count 153	K 073:020	
...others who fight in <i>Allah's</i> way...			
Set 88	Count 154	K 076:008	
And they [ <i>Muslims</i> ] give food out of love for Him [ <i>Allah</i> ] to...the captive [of battle]...			

## IV. Full-text of Verses (With Bolding)

The *Koran's* 164 War verses

Translation used: *M. H. Shakir*, published by *Tahrike Tarsile Quran, Inc.*, 1983, unless otherwise indicated.

Set	Count	Citation	Full-Text
Set 1	Count 1+2	K 002:178-179	<p>[002:178] O you who believe! <b>retaliation is prescribed for you in the matter of the slain</b>, the free for the free, and the slave for the slave, and the female for the female, but if any remission is made to any one by his (aggrieved) brother, then prosecution (for the blood-wit) should be made according to usage, and payment should be made to him in a good manner; this is an alleviation from your Lord and a mercy; so whoever exceeds the limit after this he shall have a painful chastisement. [002:179] <b>And there is life for you in (the law of) retaliation, O men of understanding, that you may guard yourselves.</b></p>
Set 2	Count 3+4	K 002:190-191	<p>[002:190] <b>And fight in the way of Allah with those who fight with you</b>, and do not exceed the limits surely <i>Allah</i> does not love those who exceed the limits. [002:191] <b>And kill them wherever you find them and drive them out from whence they drove you out, and persecution is severer than slaughter, and do not fight with them at the Sacred Mosque until they fight with you in it, but if they do fight you, then slay them; such is the recompense of the unbelievers.</b></p>
Set 3	Count 5+6	K 002:193-194	<p>[002:193] <b>And fight with them</b> until there is no persecution and religion should be only for <i>Allah</i>, but if they desist, then there should be no hostility except against the oppressors. [002:194] The Sacred month for the sacred month and all sacred things are (under the law of) [or demand] retaliation; <b>whoever then acts aggressively against you, inflict injury on him according to the injury he has inflicted on you</b> and be careful (of your duty) to <i>Allah</i> and know that <i>Allah</i> is with those who guard (against evil).</p>
Set 4	Count 7-9	K 002:216-218	<p>[002:216] <b>Fighting is enjoined on you</b>, and it is an object of dislike to you; and it may be that you dislike a thing while it is good for you, and it may be that you love a thing while it is evil for you, and <i>Allah</i> knows while you do not know. [002:217] They ask you concerning the sacred month about <b>fighting in it</b>. Say: <b>Fighting in it is a grave matter</b>, and hindering (men) from <i>Allah's</i> way and denying Him, and (hindering men from) the Sacred <i>Mosque</i> and turning its people out of it, are still graver with <i>Allah</i>, and <b>persecution is graver than slaughter</b>; and they will not cease fighting with you until they turn you back from your religion, if they can; and whoever of you turns back from his religion, then he dies while an unbeliever—these it is whose works shall go for nothing in this world and the hereafter, and they are the inmates of the fire; therein they shall abide. [002:218] Surely those who believed and those who fled (their home) and <b>strove hard in the way of Allah</b> [Arabic: <i>wajahadoo</i>] these hope for the mercy of <i>Allah</i> and <i>Allah</i> is Forgiving, Merciful.</p>
Set 5	Count 10	K 002:244	<p><b>And fight in the way of Allah</b> and know that <i>Allah</i> is Hearing, Knowing.</p>

Set 6	Count 11-16	K 003:121-126
<p>[003:121] And when you did go forth early in the morning from your family to lodge the believers in encampments for war and <i>Allah</i> is Hearing, Knowing. [003:122] When two parties from among you had determined that they should show cowardice [about war], and <i>Allah</i> was the guardian of them both, and in <i>Allah</i> should the believers trust. [003:123] And <i>Allah</i> did certainly assist you at [the Battle of] <i>Badr</i> when you were weak; be careful of (your duty to) <i>Allah</i> then, that you may give thanks. [003:124] When you said to the believers: Does it not suffice you that your Lord should assist you with three thousand of the angels sent down? [003:125] <b>Yea! if you remain patient and are on your guard and they come upon you in a headlong manner, your Lord will assist you with five thousand of the havoc-making angels.</b> [003:126] And <i>Allah</i> did not make it but as good news for you, and that your hearts might be at ease thereby, and <b>victory is only from <i>Allah</i>, the Mighty, the Wise.</b></p>		
Set 7	Count 17-20	K 003:140-143
<p>[003:140] <b>If a wound has afflicted you (at [the Battle of] <i>Uhud</i>), a wound like it has also afflicted the (unbelieving) people; and We bring these days to men by turns, and that <i>Allah</i> may know those who believe and take witnesses from among you; and <i>Allah</i> does not love the unjust.</b> [003:141] And that He [<i>Allah</i>] may purge those who believe and deprive the unbelievers of blessings. [003:142] <i>Yusuf Ali</i>: <b>Did ye think that ye would enter heaven without God testing those of you who fought hard (in His Cause) [Arabic: <i>jahadoo</i>] and remained steadfast?</b> [003:143] <i>Pickthall</i>: <b>And verily ye used to wish for death before ye met it (in the field). Now ye have seen it [death] with your eyes!</b></p>		
Set 8	Count 21	K 003:146
<p><i>Yusuf Ali</i>: <b>How many of the prophets fought (in <i>Allah</i>'s way) [war] and with them (fought) large bands of godly men? But they never lost heart if they met with disaster in <i>Allah</i>'s way [in battle], nor did they weaken (in will) or give in. And <i>Allah</i> loves those who are firm and steadfast [in battle].</b></p>		
Set 9	Count 22-28	K 003:152-158
<p>[003:152] And certainly <i>Allah</i> made good to you His promise when <b>you slew them by His [<i>Allah</i>'s] permission</b> [during a battle], until when you became weak-hearted and disputed about the affair and disobeyed after He [<i>Allah</i>] had shown you that which you loved; of you were some who desired this world and of you were some who desired the hereafter; then He [<i>Allah</i>] turned you away from them that He might try you; and He has certainly pardoned you, and <i>Allah</i> is Gracious to the believers. [003:153] <i>Pickthall</i>: <b>When ye climbed (the hill) and paid no heed to anyone, while the Messenger, in your rear, was calling you (to fight).</b> Therefore He rewarded you grief for (his) grief, that (He might teach) you not to sorrow either for <b>that which ye missed</b> [war spoils] or for that which befell you. <i>Allah</i> is informed of what ye do. [003:154] Then after sorrow He sent down security upon you, a calm coming upon a party of you, and (there was) another party whom their own souls had rendered anxious; they entertained about <i>Allah</i> thoughts of ignorance quite unjustly, saying: We have no hand in the affair. Say: Surely the affair is wholly (in the hands) of <i>Allah</i>. They conceal within their souls what they would not reveal to you. <b>They say: Had we any hand in the affair, we would not have been slain here</b> [in battle]. <b>Say: Had you remained in your houses, those for whom slaughter was ordained</b> [in battle] <b>would certainly</b></p>		

**have gone forth to the places where they would be slain**, and that *Allah* might test what was in your breasts and that He might purge what was in your hearts; and *Allah* knows what is in the breasts. [003:155] **(As for) those of you who turned back on the day when the two armies met**, only the Satan sought to cause them to make a slip on account of some deeds they had done, and certainly *Allah* has pardoned them; surely *Allah* is Forgiving, Forbearing. [003:156] **O you who believe! be not like those who disbelieve and say of their brethren when they travel in the earth or engage in fighting: Had they been with us, they would not have died and they would not have been slain**; so *Allah* makes this to be an intense regret in their hearts; and *Allah* gives life and causes death and *Allah* sees what you do. [003:157] **And if you are slain in the way of Allah** or you die, certainly forgiveness from *Allah* and **mercy is better than what they amass** [what those who stay home from war receive—no loot and no perks in heaven]. [003:158] **And if indeed you die or you are slain, certainly to Allah shall you be gathered together.**

Set 10

Count 29-31

K 003:165-167

[003:165] What! when a misfortune befell you, and **you had certainly afflicted (the unbelievers) with twice as much** [with war], you began to say: Whence is this? Say: It is from yourselves; surely *Allah* has power over all things. [003:166] **And what befell you on the day when the two armies met** ([the Battle of] *Uhud*) was with *Allah's* knowledge, and that He might know the believers. [003:167] **And that He might know the hypocrites; and it was said to them: Come, fight in Allah's way, or defend yourselves.** They said: **If we knew fighting, we would certainly have followed you.** They were on that day much nearer to unbelief than to belief. They say with their mouths what is not in their hearts, and *Allah* best knows what they conceal.

Set 11

Count 32

K 003:169

**And reckon not those who are killed in Allah's way as dead; nay, they are alive (and) are provided sustenance from their Lord** [heavenly banquets];

Set 12

Count 33+34

K 003:172-173

[003:172] **(As for) those who responded (at [the Battle of] Uhud) to the call of Allah and the Apostle after a wound had befallen them**, those among them who do good (to others) and guard (against evil) **shall have a great reward.** [003:173] **Those to whom the people said: Surely men have gathered against you [in battle], therefore fear them, but this increased their faith and they said: Allah is sufficient for us and most excellent is the Protector.**

Set 13

Count 35

K 003:195

So their Lord accepted their prayer: That I will not waste the work of a worker among you, whether male or female, the one of you being from the other; they, therefore, who fled and were turned out of their homes and persecuted in My way and **who fought and were slain**, I will most certainly cover their evil deeds, and **I will most certainly make them enter gardens beneath which rivers flow; a reward from Allah, and with Allah is yet better reward.**

Set 14

Count 36+37

K 004:071-072

[004:071] **O you who believe! take your precaution, then go forth in detachments or go forth in a body** [to war]. [004:072] **And surely among you is he who would certainly hang back** [from war]! If then a misfortune befalls you he says: '*Allah* conferred a benefit on me that I was **not present with them.**'

Set 15	Count 38-41	K 004:074-077
<p>[004:074] <b>Therefore let those fight in the way of Allah, who sell this world's life for the hereafter; and whoever fights in the way of Allah, then be he slain or be he victorious, We shall grant him a mighty reward.</b> [004:075] And what reason have you that you should not <b>fight in the way of Allah</b> and of the weak among the men and the women and the children, (of) those who say: Our Lord! cause us to go forth from this town whose people are oppressors, and give us from Thee a guardian and give us from Thee a helper. [004:076] <b>Those who believe fight in the way of Allah and those who disbelieve fight in the way of the Satan. Fight therefore against the friends of the Satan;</b> surely the strategy of the Satan is weak. [004:077] Have you not seen those to whom it was said: Withhold your hands and keep up prayer and pay the poor-rate; but <b>when fighting is prescribed for them,</b> lo! a party of them fear men as they ought to have feared <i>Allah</i>, or (even) with a greater fear and say: <b>Our Lord! why hast Thou ordained fighting for us?</b> Wherefore didst Thou not grant us a delay to a near end? Say: The provision of this world is short and the hereafter is better for him who guards (against evil); and you shall not be wronged the husk of a date stone.</p>		
Set 16	Count 42	K 004:084
<p><b>Fight then in Allah's way;</b> this is not imposed on you except in relation to yourself, and <b>rouse the believers to ardor maybe Allah will restrain the fighting of those who disbelieve</b> and <i>Allah</i> is strongest in prowess and strongest to give an exemplary punishment.</p>		
Set 17	Count 43-45	K 004:089-091
<p>[004:089] They desire that you should disbelieve as they have disbelieved, so that you might be (all) alike; therefore <b>take not from among them friends until they fly (their homes) in Allah's way; but if they turn back [to their homes], then seize them and kill them wherever you find them,</b> and take not from among them a friend or a helper. [004:090] Except those who reach a people between whom and you there is an alliance, or who come to you, their hearts shrinking from fighting you or fighting their own people; and if <i>Allah</i> had pleased, He would have given them power over you, so that they should have certainly fought you; therefore if they withdraw from you and do not fight you and offer you peace, then <b>Allah has not given you a way against them</b> [<i>Allah</i> supposedly does not allow <i>Muslims</i> to fight people friendly to <i>Muslims</i>]. [004:091] You will find others who desire that they should be safe from you and secure from their own people; as often as they are sent back to the mischief they get thrown into it headlong; therefore if they do not withdraw from you and (do not) offer you peace and restrain their hands, then <b>seize them and kill them wherever you find them;</b> and against these We have given you a clear authority.</p>		
Set 18	Count 46+47	K 004:094-095
<p>[004:094] O you who believe! <b>when you go to war in Allah's way,</b> make investigation, and do not say to any one who offers you peace: You are not a believer. Do you seek goods of this world's life! [Meaning that <i>Muslim</i> ought not say someone is a non-<i>Muslim</i> just to plunder him.] But with <i>Allah</i> there are abundant gains; you too were such before, then <i>Allah</i> conferred a benefit on you; therefore make investigation; surely <i>Allah</i> is aware of what you do. [004:095] The holders back from among the believers, not having any injury, and <b>those who</b></p>		

**strive hard** [Arabic: *waalmujahidoona*] **in Allah's way with their property and their persons are not equal**; *Allah* has made the strivers [Arabic: *almujahideena*] with their property and their persons to excel the holders back a (high) degree, and to each (class) *Allah* has promised good; and ***Allah* shall grant to the strivers** [Arabic: *almujahideena*, i.e. *Jihadists*] **above the holders back a mighty reward:**

Set 19	Count 48-52	K 004:100-104
--------	-------------	---------------

[004:100] **And whoever flies in Allah's way** [forsakes his home to fight in war], **he will find in the earth many a place of refuge and abundant resources**, and **whoever goes forth from his house flying to Allah and His Apostle, and then death overtakes him, his reward is indeed with Allah** and *Allah* is Forgiving, Merciful. [004:101] *Rodwell*: **And when ye go forth to war in the land, it shall be no crime in you to cut short your prayers, if ye fear lest the infidels come upon you; Verily, the infidels are your undoubted enemies!** [004:102] **And when you are among them and keep up the prayer for them, let a party of them stand up with you, and let them take their arms**; then when they have prostrated themselves let them go to your rear, and let another party who have not prayed come forward and pray with you, and **let them take their precautions and their arms**; (for) those who disbelieve desire that you may be careless of your arms and your luggage, so that they may then turn upon you with a sudden united attack, and **there is no blame on you, if you are annoyed with rain or if you are sick, that you lay down your arms** and take your precautions; surely *Allah* has prepared a disgraceful chastisement for the unbelievers. [004:103] *Khalifa*: **Once you complete your Contact Prayer (Salat), you shall remember GOD while standing, sitting, or lying down. Once the war is over, you shall observe the Contact Prayers (Salat)**; the Contact Prayers (*Salat*) are decreed for the believers at specific times. [004:104] **And be not weak hearted in pursuit of the enemy**; if you suffer pain, then surely they (too) suffer pain as you suffer pain, and you hope from *Allah* what they do not hope; and *Allah* is Knowing, Wise.

Set 20	53	K 004:141
--------	----	-----------

*Sher Ali*: Those who await your ruin. **If you have a victory** [in war] **from Allah**, they say 'Were we not with you?' And if the disbelievers have a share of it, they say to them, 'Did we not on a previous occasion get the better of you and save you from the believers?' *Allah* will judge between you on the Day of Resurrection; and *Allah* will not grant the disbelievers a way to prevail against the believers.

Set 21	Count 54	K 005:033
--------	----------	-----------

**The punishment of those who wage war against Allah and His apostle and strive to make mischief in the land is only this, that they should be murdered or crucified or their hands and their feet should be cut off on opposite sides or they should be imprisoned** [*Pickthall* and *Yusuf Ali* have "exiled" rather than "imprisoned"]; this shall be as a disgrace for them in this world and in the hereafter they shall have a grievous chastisement.

Set 22	Count 55	K 005:035
--------	----------	-----------

O you who believe! be careful of (your duty to) *Allah* and seek means of nearness to Him and **strive hard** [Arabic: *wajahidoo*] **in His way that you may be successful.**

Set 23	Count 56	K 005:082
Certainly <b>you will find the most violent of people in enmity for those who believe (to be) Jews</b> [compare with “whenever Jews kindle fire for war, <i>Allah</i> puts it out” (K 005:064)] <b>and those who are polytheists</b> [while they are converted to <i>Islam</i> on pain of death]...		
Set 24	Count 57	K 008:001
<i>Pickthall</i> : They ask thee (O <i>Muhammad</i> ) of <b>the spoils of war</b> . Say: <b>The spoils of war belong to Allah and the Messenger</b> , so keep your duty to <i>Allah</i> and adjust the matter of your difference, and obey <i>Allah</i> and His messenger, if ye are (true) believers.		
Set 25	Count 58	K 008:005
<b>Even as your Lord caused you to go forth from your house with the truth, though a party of the believers were surely averse;</b>		
Set 26	Count 59	K 008:007
<i>Yusuf Ali</i> : Behold! <i>Allah</i> promised you one of the two (enemy) parties, that it should be yours: <b>Ye wished that the one unarmed should be yours, but Allah willed to justify the Truth according to His words and to cut off the roots of the Unbelievers;</b>		
Set 27	Count 60+61	K 008:009-010
When you sought aid from your Lord [at the Battle of <i>Badr</i> ], so He answered you: <b>I will assist you [in war] with a thousand of the angels following one another</b> [see K 008:012]. [008:010] <b>And Allah only gave it as a good news and that your hearts might be at ease thereby; and victory is only from Allah; surely Allah is Mighty, Wise.</b>		
Set 28	Count 62	K 008:012
When your Lord revealed to the angels: I am with you, <b>therefore make firm those who believe. I will cast terror into the hearts of those who disbelieve. Therefore strike off their heads and strike off every fingertip of them.</b>		
Set 29	Count 63-65	K 008:015-017
[008:015] O you who believe! <b>when you meet those who disbelieve marching for war, then turn not your backs to them.</b> [008:016] And whoever shall turn his back to them on that day—unless he turn aside <b>for the sake of fighting</b> or withdraws to a company—then he, indeed, becomes deserving of <i>Allah</i> 's wrath and his abode is hell; and an evil destination shall it be. [008:017] <b>So you did not slay them, but it was Allah Who slew them, and you did not smite when you smote (the enemy), but it was Allah Who smote</b> [ <i>Allah</i> gets the credit for battles], and that He might confer upon the believers a good gift from Himself; surely <i>Allah</i> is Hearing, Knowing.		
Set 30	Count 66-75	K 008:039-048
[008:039] <i>Shakir</i> : And <b>fight with them until there is no more persecution and religion should be only for Allah</b> ; but if they desist, then surely <i>Allah</i> sees what they do. [008:040] <i>Yusuf Ali</i> : <b>If they [unbelievers] refuse [to stop fighting], be sure that God is your Protector</b> —the best to protect and the best to help. [008:041] <i>Shakir</i> : And know that <b>whatever thing [loot] you gain, a fifth of it is for Allah and for the Apostle</b> and for the near of kin and the orphans and the needy and the wayfarer, if you believe in <i>Allah</i> and in that which We revealed to Our servant, on the day of distinction, <b>the day on which the two parties met</b> [in battle]; and <i>Allah</i> has power over all things. [008:042] When you were on the		

nearer side (of the valley) and they were on the farthest side, while the caravan was in a lower place than you [the *Makkan* caravan the *Muslims* robbed]; and if you had mutually made an appointment, you would certainly have broken away from the appointment, but—in order that **Allah might bring about a matter which was to be done, that he who would perish might perish by clear proof** [bring success to *Muslims* engaged in robbing a caravan near *Badr* against all the odds], and he who would live might live by clear proof; and most surely *Allah* is Hearing, Knowing; [008:043] When **Allah showed them** [the *Makkans*] **to you in your dream as few** [fighters]; and if He had shown them [the *Makkans*] **to you as many** [fighters] **you would certainly have become weak-hearted** [i.e. hearts. See the similar discussion in *K* 002:249 about how a smaller army can defeat a larger army] and you would have disputed about the matter, but *Allah* saved (you); surely He is the Knower of what is in the breasts. [008:044] And when He showed them to you, **when you met, as few** [fighters] **in your eyes and He made you to appear little** [few fighters] **in their eyes, in order that Allah might bring about a matter which was to be done** [a battle brought on by overconfidence in each side], and to *Allah* are all affairs returned. [008:045] O you who believe! **when you meet a party** [in battle], **then be firm** and remember *Allah* much that you may be successful. [008:046] And **obey Allah and His Apostle and do not quarrel for then you will be weak in hearts** [demoralized] **and your power** [to execute war] **will depart**, and be patient; surely *Allah* is with the patient. [008:047] And **be not like those** [*Makkans*] **who came forth from their homes** [to fight *Muslims*] in great exultation and to be seen of men, and (who) turn away from the way of *Allah*, and *Allah* comprehends what they do. [008:048] And when the Satan made their works fair seeming to them, and [Satan] said [to the *Makkans*]: No one can overcome you this day, and surely I [Satan] am your protector: but **when the two parties** [*Muslims* versus *Makkans*] **came in sight of each other he** [Satan] **turned upon his heels**, and [Satan] said: Surely I am clear of you [the *Makkans*]; surely I see what you do not see [*Allah's* angels]; surely I fear *Allah*; and *Allah* is severe in requiting (evil).

Set 31

Count 76-79

K 008:057-060

*Pickthall*: [008:057] **If thou come on them in the war, deal with them so as to strike fear in those who are behind them, that haply they may remember.** [008:058] *Khalifa*: **When you are betrayed by a group of people, you shall mobilize against them in the same manner. GOD does not love the betrayers.** [008:059] *Shakir*: **And let not those who disbelieve think that they shall come in first; surely they will not escape.** [008:060] **And prepare against them what force you can and horses tied at the frontier, to frighten thereby the enemy of Allah and your enemy and others besides them, whom you do not know (but) Allah knows them; and whatever thing you will spend in Allah's way [for war], it will be paid back to you fully and you shall not be dealt with unjustly.**

Set 32

Count 80-90

K 008:065-075

[008:065] **O Prophet! urge the believers to war; if there are twenty patient ones of you they shall overcome two hundred, and if there are a hundred of you they shall overcome a thousand of those who disbelieve, because they are a people who do not understand** [i.e. do not understand totalitarian ideologies like *Islam*]. [008:066] For the present *Allah* has made light your burden, and He knows that there is weakness in you; so **if there are a hundred patient ones of**



**you they shall overcome two hundred, and if there are a thousand they shall overcome two thousand by Allah's permission, and Allah is with the patient.** [008:067] **It is not fit for a prophet that he should take captives unless he has fought and triumphed in the land; you desire the frail goods** [i.e. ransom money] **of this world,** while Allah desires (for you) the hereafter; and Allah is Mighty, Wise. [008:068] Had it not been for a previous ordainment [i.e. the revelation of K 008:067] from God, a severe penalty would have reached you for the (ransom) that you took [or better, “would have taken”]. [008:069] **Eat then of the lawful and good (things) which you have acquired in war** [war spoils], and be careful of (your duty to) Allah; surely Allah is Forgiving, Merciful. [008:070] **O Prophet! say to those of the captives** [non-Muslims] **who are in your hands: If Allah knows anything good in your hearts, He will give to you better than that which has been taken away from you** [in war] and will forgive you, and Allah is Forgiving, Merciful. [008:071] *Yusuf Ali:* **But if they have treacherous designs against thee, (O Apostle!),** they have already been in treason against God, and so hath [has] He [Allah] given (thee) power over them. And God is He Who hath (full) knowledge and wisdom. [008:072] *Yusuf Ali:* **Those who believed and adopted exile and fought for the Faith, with their property and their persons, in the cause of God,** as well as those who gave (them) asylum and aid, these are (all) friends and protectors, one of another. As to those who believed but came not into exile, ye owe no duty of protection to them until they come into exile; but if they seek your aid in religion, it is your duty to help them, except against a people with whom ye have a treaty of mutual alliance. And (remember) God seeth [sees] all that ye do. [008:073] *Yusuf Ali:* **The Unbelievers are protectors, one of another: Unless ye do this, (protect each other), there would be tumult and oppression on earth and great mischief.** [008:074] *Yusuf Ali:* Those who believe and adopt exile and **fight for the Faith** in the cause of God as well as those who give (them) asylum and aid, these are (all) in very truth the Believers: for them is the forgiveness of sins and a provision most generous. [008:075] *Yusuf Ali:* And those who accept Faith subsequently, and adopt exile, and **fight for the Faith** in your company,—they are of you. But kindred by blood have prior rights against each other in the Book of God. Verily God is well acquainted with all things.

Set 33	Count 91	K 009:005
--------	----------	-----------

So when the sacred months have passed away, then **slay the idolaters wherever you find them, and take them captives and besiege them and lie in wait for them in every ambush,** then if they repent and keep up prayer and pay the poor-rate, leave their way free to them; surely Allah is Forgiving, Merciful.

Set 34	Count 92-94	K 009:012-014
--------	-------------	---------------

[009:012] And if they break their oaths after their agreement and (openly) revile your religion, then **fight the leaders of unbelief**—surely their oaths are nothing—so that they may desist. [009:013] **What! will you not fight a people who broke their oaths and aimed at the expulsion of the Apostle, and they attacked you first; do you fear them?** But Allah is most deserving that you should fear Him, if you are believers. [009:014] **Fight them, Allah will punish them by your hands and bring them to disgrace, and assist you against them and heal the hearts of a believing people.**

Set 35	Count 95	K 009:016
<p>What! do you think that you will be left alone while <i>Allah</i> has not yet known <b>those of you who have struggled hard</b> [Arabic: <i>jahadoo</i>] and have not taken any one as an adherent besides <i>Allah</i> and His Apostle and the believers; and <i>Allah</i> is aware of what you do.</p>		
Set 36	Count 96+97	K 009:019-020
<p>[009:019] What! do you make (one who undertakes) the giving of drink to the pilgrims and the guarding of the Sacred <i>Mosque</i> like him who believes in <i>Allah</i> and the latter day and <b>strives hard in Allah's way</b> [Arabic: <i>wajahada</i>]? They are not equal with <i>Allah</i>; and <i>Allah</i> does not guide the unjust people. [009:020] Those who believed and fled (their homes), and <b>strove hard</b> [Arabic: <i>wahajaroo wajahadoo</i>] <b>in Allah's way with their property and their souls</b>, are much higher in rank with <i>Allah</i>; and those are they who are the achievers (of their objects).</p>		
Set 37	Count 98-100	K 009:024-026
<p>[009:024] Say: If your fathers and your sons and your brethren and your mates and your kinsfolk and property which you have acquired, and the slackness of trade which you fear and dwellings which you like, are dearer to you than <i>Allah</i> and His Apostle and <b>striving in His way</b> [Arabic: <i>wajihadin</i>], <b>then wait till Allah brings about His command</b> [to go to war]: and <i>Allah</i> does not guide the transgressing people. [009:025] <b>Certainly Allah helped you in many battlefields and on the day of</b> [the Battle of] <i>Hunain</i>, <b>when your great numbers made you vain</b>, but they availed you nothing and the earth became strait to you notwithstanding its spaciousness, then you turned back retreating. [009:026] Then <i>Allah</i> sent down His tranquility upon His Apostle and upon the believers, and sent down hosts which you did not see, and <b>chastised those who disbelieved</b> [<i>Muhammad</i> gives credit to angels and <i>Allah</i> for the actions of <i>Jihadists</i>], and that is the reward of the unbelievers.</p>		
Set 38	Count 101	K 009:029
<p><b>Fight those who do not believe in Allah</b>, nor in the latter day, nor do they prohibit what <i>Allah</i> and His Apostle have prohibited, <b>nor follow the religion of truth, out of those who have been given the Book, until they pay the tax in acknowledgment of superiority and they are in a state of subjection.</b></p>		
Set 39	Count 102	K 009:036
<p>Surely the number of months with <i>Allah</i> is twelve months in <i>Allah's</i> ordinance since the day when He created the heavens and the earth, of these four being sacred; that is the right reckoning; therefore be not unjust to yourselves regarding them, and <b>fight the polytheists all together as they fight you all together</b>; and know that <i>Allah</i> is with those who guard (against evil).</p>		
Set 40	Count 103+104	K 009:038-039
<p>[009:038] O you who believe! What (excuse) have you that when it is said to you: <b>Go forth in Allah's way</b> [to war], you should incline heavily to earth; are you contented with this world's life instead of the hereafter? But the provision of this world's life compared with the hereafter is but little. [009:038] <b>If you do not go forth</b> [to go to war], <b>He will chastise you with a painful chastisement and bring in your place a people other than you</b> [to go to war], and you will do Him no harm; and <i>Allah</i> has power over all things.</p>		

Set 41	Count 105	K 009:041
<b>Go forth lightly</b> [lightly armed] <b>and heavy</b> [heavily armed], <b>and strive hard in Allah's way</b> [Arabic: <i>wajahidoo</i> ] <b>with your property and your persons</b> ; this is better for you, if you know.		
Set 42	Count 106	K 009:044
They do not ask leave of you who believe in <i>Allah</i> and the latter day (to stay away) from <b>striving hard with their property and their persons</b> [Arabic: <i>yujahidoo</i> ], and <i>Allah</i> knows those who guard (against evil).		
Set 43	Count 107	K 009:052
Say: Do you await for us but one of two most excellent things? And we await for you that <i>Allah</i> will afflict you with punishment from Himself or by our hands. So wait; we too will wait with you.		
Set 44	Count 108	K 009:073
O Prophet! <b>strive hard</b> [Arabic: <i>jahidi</i> ] <b>against the unbelievers and the hypocrites and be unyielding to them</b> ; and their abode is hell and evil is the destination.		
Set 45	Count 109	K 009:081
Those who were left behind were glad on account of their sitting behind <i>Allah's</i> Apostle and <b>they were averse from striving in Allah's way</b> [Arabic: <i>yujahidoo</i> ] <b>with their property and their persons and said: Do not go forth</b> [to war] <b>in the heat</b> . Say: The fire of hell is much severe in heat. Would that they understood (it).		
Set 46	Count 110	K 009:083
Therefore if <i>Allah</i> brings you back to a party of them and then they ask your permission to go forth, say: By no means shall you ever go forth with me and by no means <b>shall you fight an enemy with me</b> [in war]; surely you chose to sit the first time, therefore sit (now) with those who remain behind.		
Set 47	Count 111	K 009:086
And whenever a chapter is revealed, saying: Believe in <i>Allah</i> and <b>strive hard</b> [Arabic: <i>wajahidoo</i> ] <b>along with His Apostle</b> , those having amplexness of means ask permission of you and say: Leave us (behind), that we may be with those who sit.		
Set 48	Count 112	K 009:088
But the Apostle and those who believe with him <b>strive hard</b> [Arabic: <i>jahadoo</i> ] <b>with their property and their persons</b> ; and these it is who shall have the good things and these it is who shall be successful.		
Set 49	Count 113	K 009:092
<i>Yusuf Ali</i> : <b>Nor (is there blame) on those who came to thee to be provided with mounts</b> [i.e. camels, horses, mules], <b>and when thou said "I can find no mounts for you," they turned back, their eyes streaming with tears of grief that they had no resources wherewith to provide the expenses</b> [to go to war].		
Set 50	Count 114	K 009:111
Surely <i>Allah</i> has bought of the believers their persons and their property for this, that they shall have the garden; <b>they fight in Allah's way, so they slay and are slain</b> ; a promise which is binding on Him in the <i>Taurat</i> and the <i>Injeel</i> and the <i>Quran</i> ; and who is more faithful to his covenant than <i>Allah</i> ? Rejoice therefore in the pledge which you have made; and that is the mighty achievement.		

Set 51	Count 115	K 009:120
<p><i>Yusuf Ali:</i> It was not fitting for the people of <i>Madina</i> and the <i>Bedouin</i> Arabs of the neighborhood, to refuse to follow <i>Allah's</i> Messenger, nor to prefer their own lives to his: because nothing could they suffer or do, but was reckoned to their credit as a deed of righteousness,- <b>whether they suffered thirst, or fatigue, or hunger, in the cause of Allah</b> [while on a march to battle], <b>or trod paths to raise the ire of the Unbelievers</b> [invade their territory], <b>or received any injury whatever from an enemy</b> [during a battle]: for <i>Allah</i> suffers not the reward to be lost of those who do good;</p>		
Set 52	Count 116+117	K 009:122-123
<p>[009:122] <i>Pickthall:</i> And the believers should not all go out to fight. Of every troop of them, a party only should go forth, that they (who are left behind) may gain sound knowledge in religion, and that they may warn their folk when they return to them, so that they may beware. [009:123] O you who believe! <b>fight those of the unbelievers who are near to you and let them find in you hardness</b>; and know that <i>Allah</i> is with those who guard (against evil).</p>		
Set 53	Count 118	K 016:110
<p><i>Yusuf Ali:</i> But verily thy Lord,- to those who leave their homes after trials and persecutions,- and <b>who thereafter strive and fight for the faith</b> [Arabic: <i>jahadoo</i>] <b>and patiently persevere</b>. Thy Lord, after all this is oft-forgiving, Most Merciful.</p>		
Set 54	Count 119	K 022:039
<p><b>Permission (to fight) is given to those upon whom war is made</b> because they are oppressed, and most surely <i>Allah</i> is well able to assist them;</p>		
Set 55	Count 120	K 022:058
<p><i>Sher Ali:</i> And <b>those who leave their homes for the cause of Allah and are then slain or die, Allah will surely provide for them a goodly provision</b>. And surely <i>Allah</i> is the Best of providers.</p>		
Set 56	Count 121	K 022:078
<p>And <b>strive hard</b> [Arabic: <i>wajahidoo</i>] <b>in (the way of) Allah, (such) a striving</b> [Arabic: <i>Jihadihi</i>] <b>a is due to Him</b>; He has chosen you and has not laid upon you a hardship in religion; the faith of your father <i>Ibrahim</i>; He named you <i>Muslims</i> before and in this, that the Messenger may be a bearer of witness to you, and you may be bearers of witness to the people; therefore keep up prayer and pay the poor-rate and hold fast by <i>Allah</i>; He is your Guardian; how excellent the Guardian and how excellent the Helper!</p>		
Set 57	Count 122	K 024:053
<p>And they swear by <i>Allah</i> with the most energetic of their oaths that if you command them <b>they would certainly go forth</b> [to battle (see K 024:055)]. Say: Swear not; reasonable obedience (is desired); surely <i>Allah</i> is aware of what you do.</p>		

Set 58	Count 123	K 024:055	
<i>Allah</i> has promised to those of you who believe and do good that He will most certainly make them rulers in the earth [as a reward for going to war (see K 024:053)] as He made rulers those before them, and that He will most certainly establish for them their religion which He has chosen for them, and that He will most certainly, after their fear, give them security in exchange; they shall serve Me, not associating aught with Me; and whoever is ungrateful after this, these it is who are the transgressors.			
Set 59	Count 124	K 025:052	
<i>Palmer</i> : So obey not the unbelievers and <b>fight strenuously with them in many a strenuous fight.</b>			
Set 60	Count 125	K 029:006	
And <b>whoever strives hard</b> [Arabic: <i>jahada</i> ], <b>he strives</b> [Arabic: <i>yujahidu</i> ] <b>only for his own soul</b> ; most surely <i>Allah</i> is Self-sufficient, above (need of) the worlds.			
Set 61	Count 126	K 029:069	
And <b>(as for) those who strive hard</b> [Arabic: <i>jahadoo</i> ] <b>for Us</b> , We will most certainly guide them in Our ways; and <i>Allah</i> is most surely with the doers of good.			
Set 62	Count 127	K 033:015	
<i>Pickthall</i> : And verily <b>they had already sworn unto Allah that they would not turn their backs (to the foe)</b> [in battle]. An oath to <i>Allah</i> must be answered for.			
Set 63	Count 128	K 033:018	
<i>Allah</i> knows indeed those among you who hinder others and those who say to their brethren: Come to us; and <b>they come not to the fight but a little,</b>			
Set 64	Count 129	K 033:020	
They think the allies are not gone, and if the allies should come (again) they would fain [gladly] be in the deserts with the desert Arabs asking for news about you, and if they were among you <b>they would not fight save a little.</b>			
Set 65	Count 130	K 033:023	
<i>Pickthall</i> : Of the believers are men who are true to that which they covenanted with <i>Allah</i> . <b>Some of them have paid their vow by death (in battle) and some of them still are waiting</b> ; and they have not altered in the least.			
Set 66	Count 131-133	K 033:025-027	
[033:025] And <i>Allah</i> turned back the unbelievers in their rage; they did not obtain any advantage, and <i>Allah</i> <b>sufficed the believers in fighting</b> ; and <i>Allah</i> is Strong, Mighty. [033:026] And He drove down those of the followers of the Book who backed them from their fortresses and He cast awe into their hearts; <b>some</b> [Jews] <b>you killed and you took captive another part.</b> [033:027] And <b>He made you heirs to their</b> [Jewish] <b>land and their dwellings and their property and (to) a land which you have not yet trodden</b> , and <i>Allah</i> has power over all things.			
Set 67	Count 134	K 033:050	
O Prophet! surely We have made lawful to you your wives whom you have given their dowries, and <b>those</b> [captive women] <b>whom your right hand possesses out of those whom Allah has given to you as prisoners of war</b> , and the daughters of your paternal uncles and the daughters of your paternal aunts, and the daughters of your maternal uncles and the daughters of your maternal aunts who fled with you; and a believing woman if she gave herself to the Prophet, if the Prophet			

desired to marry her—specially for you, not for the (rest of) believers; We know what We have ordained for them concerning their wives and those whom their right hands possess in order that no blame may attach to you; and <i>Allah</i> is Forgiving, Merciful.		
Set 68	Count 135	K 042:039
<i>Sale</i> :...and who, when an injury is done them, avenge themselves...		
Set 69	Count 136	K 047:004
So when you meet in battle those who disbelieve, then smite the necks until when you have overcome them, then make (them) prisoners, and afterwards either set them free as a favor or let them ransom (themselves) until the war terminates. That (shall be so); and if <i>Allah</i> had pleased He would certainly have exacted what is due from them, but that He may try some of you by means of others; and (as for) those who are slain in the way of <i>Allah</i> , He will by no means allow their deeds to perish.		
Set 70	Count 137	K 047:020
And those who believe say: Why has not a chapter been revealed? But when a decisive chapter is revealed and <b>fighting is mentioned therein</b> you see those in whose hearts is a disease look to you with the look of one fainting because of death. Woe to them then!		
Set 71	Count 138	K 047:035
<i>Rodwell</i> : <b>Be not fainthearted then; and invite not the infidels to peace when ye have the upper hand: for God is with you and will not defraud you of the recompense of your works.</b>		
Set 72	Count 139-148	K 048:015-024
[048:015] <i>Pickthall</i> : Those who were left behind will say, “ <b>When ye set forth to capture booty</b> [loot]: Let us go with you.” They fain would change the verdict of <i>Allah</i> . Say (unto them, O <i>Muhammad</i> ): Ye shall not go with us. Thus hath <i>Allah</i> said beforehand. Then they will say: Ye are envious of us. Nay, but they understand not, save a little. [048:016] <i>Shakir</i> : Say to those of the dwellers of the desert who were left behind: <b>You shall soon be invited (to fight) against a people possessing mighty prowess; you will fight against them until they submit; then if you obey, Allah will grant you a good reward</b> [loot]; and if you turn back as you turned back before, He will punish you with a painful punishment. [048:017] <i>Pickthall</i> : There is no blame for the blind, nor is there blame for the lame, nor is there blame for the sick (that they go not forth to war). And whoso obeyeth <i>Allah</i> and His messenger [by going to war], He will make him enter Gardens underneath which rivers flow; and whoso turneth back [from battle], him will He punish with a painful doom. [048:018] Certainly <i>Allah</i> was well pleased with the believers when they swore allegiance to you under the tree, and He knew what was in their hearts, so He sent down tranquility on them and rewarded them with a near victory, [048:019] And much booty [loot] that they will capture. <i>Allah</i> is ever Mighty, Wise. [048:020] <i>Allah</i> promised you many acquisitions which you will take, then He hastened on this one for you and held back the hands of men from you, and that it may be a sign for the believers and that He may guide you on a right path. [048:021] <i>Sale</i> : And [he also promiseth you] other [spoils], which ye have not [yet] been able [to take]: But now hath God encompassed them [for you]; and God is almighty. [048:022] And if those who disbelieve fight		

**with you, they would certainly turn (their) backs, then they would not find any protector or a helper. [048:023] Such [i.e. the battle mentioned the previous verse] has been the course [practice] of Allah that has indeed run before, and you shall not find a change in Allah's course. [048:024] And He [Allah] it is Who held back their hands from you and your hands from them [in battle] in the valley of Makka** after He had given you victory over them; and *Allah* is Seeing what you do.

Set 73

Count 149

K 049:015

*Sale:* Verily the **true believers** [are] those only who believe in God and his apostle, and afterwards doubt not; and **who employ their substance and their persons in the defense of God's true religion:** These are they who speak sincerely.

Set 74

Count 150

K 059:002

He it is Who caused those who disbelieved of the followers of the Book to go forth from their homes at the first banishment you did not think that they would go forth, while they were certain that their fortresses would defend them against *Allah*; but *Allah* came to them whence they did not expect, and cast terror into their hearts; **they [Jews] demolished their houses with their own hands and the hands of the believers** [i.e. *Muslims* demolished Jewish homes]; therefore take a lesson, O you who have eyes!

Set 75

Count 151-154

K 059:005-008

*Pickthall:* **[059:005] Whatsoever palm-trees you cut—cut down or left standing on their roots** [during a siege of Jews at *Madina*], **it was by Allah's leave, in order that He might confound the evil-livers [Jews]. [059:006] And that which Allah gave as spoil unto His messenger from them, you urged not any horse or riding-camel for the sake thereof, but Allah gives His messenger lordship over whom He will. Allah is Able to do all things. [059:007] That which Allah gives as [war] spoil unto His messenger from the people of the townships [Jews], it is for Allah and His messenger** and for the near of kin and the orphans and the needy and the wayfarer, that it become not a commodity between the rich among you. And **whatsoever [spoils] the Messenger gives you, take it.** And whatsoever he forbids, abstain (from it). And keep your duty to *Allah*. Lo! *Allah* is stern in reprisal. **[059:008] And (it is) for the poor fugitives who have been driven out from their homes and their belongings, who seek bounty [war spoils] from Allah** and help *Allah* and His messenger. They are the loyal.

Set 76

Count 155

K 059:014

**They will not fight against you in a body save in fortified towns or from behind walls;** their fighting between them is severe, you may think them as one body, and their hearts are disunited; that is because they are a people who have no sense.

Set 77

Count 156

K 060:009

**Allah only forbids you respecting those who made war upon you on account of (your) religion** [i.e. no fraternizing with the enemy], and drove you forth from your homes and backed up (others) in your expulsion, that you make friends with them, and whoever makes friends with them, these are the unjust.

Set 78	Count 157	K 061:004	
Surely <i>Allah</i> loves those who fight in His way in ranks as if they were a firm and compact wall.			
Set 79	Count 158	K 061:011	
You shall believe in <i>Allah</i> and His Apostle, and <b>struggle hard in <i>Allah's</i> way</b> [Arabic: <i>watujahidoona</i> ] <b>with your property and your lives</b> ; that is better for you, did you but know!			
Set 80	Count 159	K 061:013	
And yet another (blessing) that you love: help from <i>Allah</i> and a <b>victory</b> [in battle] <b>near at hand</b> ; and give good news to the believers.			
Set 81	Count 160	K 063:004	
And when you see them, their persons will please you, and if they speak, you will listen to their speech; (they are) as if they were big pieces of wood clad with garments; <b>they think every cry to be against them. They are the enemy, therefore beware of them; may <i>Allah</i> destroy them, whence are they turned back?</b> [This verse speaks of internecine fights against <i>Muslims</i> deemed infidels or “hypocrites.”]			
Set 82	Count 161	K 064:014	
O you who believe! <b>surely from among your wives and your children there is an enemy to you; therefore beware of them</b> [collaborators with the enemy, especially if the women were once war spoils]; and if you pardon and forbear and forgive, then surely <i>Allah</i> is Forgiving, Merciful.			
Set 83	Count 162	K 066:009	
<b>O Prophet! strive hard against the unbelievers and the hypocrites and be hard against them</b> ; and their abode is hell; and evil is the resort.			
Set 84	Count 163	K 073:020	
Surely your Lord knows that you pass in prayer nearly two-thirds of the night, and (sometimes) half of it, and (sometimes) a third of it, and (also) a party of those with you; and <i>Allah</i> measures the night and the day. He knows that you are not able to do it, so He has turned to you (mercifully), therefore read what is easy of the <i>Quran</i> . He knows that there must be among you sick, and others who travel in the land seeking of the bounty of <i>Allah</i> , and <b>others who fight in <i>Allah's</i> way</b> , therefore read as much of it as is easy (to you), and keep up prayer and pay the poor-rate and offer to <i>Allah</i> a goodly gift, and whatever of good you send on beforehand for yourselves, you will find it with <i>Allah</i> ; that is best and greatest in reward; and ask forgiveness of <i>Allah</i> ; surely <i>Allah</i> is Forgiving, Merciful.			
Set 85	Count 164	K 076:008	
And <b>they</b> [ <i>Muslims</i> ] <b>give food out of love for Him</b> [ <i>Allah</i> ] <b>to the poor and the orphan and the captive</b> [of battle]...			



## Abbreviations

### Bible Book Name Abbreviations

#### *Conventions*

All Bible book name abbreviations are three-lettered. This citation method has advantages over other abbreviation systems. The three-letter abbreviations are the same as the first three letters of the English Bible book name, except in these few cases:

- ☆ *Judges* (Jdg) is differentiated from *Jude* (Jud).
- ☆ *Philemon* (Phm) is differentiated from *Philippians* (Phi).
- ☆ *Song of Solomon* is abbreviated “Sol” to avoid confusion with the word “Son.”

For the most part, all three-lettered book name abbreviations sort just as their corresponding book names would in search engines and indexes. The exceptions are *Judges* (Jdg) and the one-chapter book called *Jude* (Jud).

#### *Old Testament (Old Testament)*

1. Gen: *Genesis*; 2. Exo: *Exodus*; 3. Lev: *Leviticus*; 4. Num: *Numbers*; 5. Deu: *Deuteronomy*; 6. Jos: *Joshua*; 7. Jdg: *Judges*; 8. Rut: *Ruth*; 9. 1Sa: 1 *Samuel*; 10. 2Sa: 2 *Samuel*; 11. 1Ki: 1 *Kings*; 12. 2Ki: 2 *Kings*; 13. 1Ch: 1 *Chronicles*; 14. 2Ch: 2 *Chronicles*; 15. Ezr: *Ezra*; 16. Neh: *Nehemiah*; 17. Est: *Esther*; 18. Job: *Job*; 19. Psa: *Psalms*; 20. Pro: *Proverbs*; 21. Ecc: *Ecclesiastes*; 22. Sol: *Song of Solomon*; 23. Isa: *Isaiah*; 24. Jer: *Jeremiah*; 25. Lam: *Lamentations*; 26. Eze: *Ezekiel*; 27. Dan: *Daniel*; 28. Hos: *Hosea*; 29. Joe: *Joel*; 30. Amo: *Amos*; 31. Oba: *Obadiah*; 32. Jon: *Jonah*; 33. Mic: *Micah*; 34. Nah: *Nahum*; 35. Hab: *Habakkuk*; 36. Zep: *Zephaniah*; 37. Hag: *Haggai*; 38. Zec: *Zechariah*; 39. Mal: *Malachi*.

#### *New Testament (New Testament)*

40. Mat: *Matthew*; 41. Mar: *Mark*; 42. Luk: *Luke*; 43. Joh: *John*; 44. Act: *Acts*; 45. Rom: *Romans*; 46. 1Co: 1 *Corinthians*; 47. 2Co: 2 *Corinthians*; 48. Gal: *Galatians*; 49. Eph: *Ephesians*; 50. Phi: *Philippians*; 51. Col: *Colossians*; 52. 1Th: 1 *Thessalonians*; 53. 2Th: 2 *Thessalonians*; 54. 1Ti: 1 *Timothy*; 55. 2Ti: 2 *Timothy*; 56. Tit: *Titus*; 57. Phm: *Philemon*; 58. Heb: *Hebrews*; 59. Jam: *James*; 60. 1Pe: 1 *Peter*; 61. 2Pe: 2 *Peter*; 62. 1Jo: 1 *John*; 63. 2Jo: 2 *John*; 64. 3Jo: 3 *John*; 65. Jud: *Jude*; 66. Rev: *Revelation*.

### Citation Convention for the Bible and the *Koran*

All the chapter and verse Bible citations are two-digit, for example, Mat 01:01, except for *Psalms*, which has three-digit chapter references. Leading zeroes are used when necessary, for example, Psa 001:01. This method of citation means that the chapter and verse citations sort numerically in search engines and indexes.

All the chapter (*Sura*) and verse (*Ayat*) citations for the *Koran* are three-digit (K 009:005). “*Sura(h)*” is Arabic and refers to the 114 chapters of the *Koran*.

A quirk involving *Koran* citation is that some translations break down the verses differently. Hughes wrote that Arabic versions follow five different numbering systems 6,239 in the *Kufa* version, 6,204 in the *Basra* version, 6,225 in the *Shami* version, 6,219 in the *Makka* version and 6,211 in the *Madina* version.<sup>4649</sup>

<sup>4649</sup> Hughes. *Dictionary*, p. 489, *Qur'an* entry, right column, bottom.

Translation citation systems vary too. A case in point is Rodwell's English translation of the *Koran* has 6,151 verses.<sup>4650</sup> A verse citation in one version may be plus one verse or minus one verse in a different edition.<sup>4651</sup> This book uses the verse citation system commonly used in the online English translations of the *Koran*.

Just as the *Koran* has different versifications, so do different *Hadith* collections. This authors uses the citation scheme found in the online MSA-USC *Hadith* Database. A few quotations found in this book use the citation as given by the quoted author, which may not match the online citation system.

#### *Bible Version Abbreviations*

- † *KJV: King James Version of the Bible* (English)
- † *LXX: The Septuagint*
- † *MT: The Masoretic Text* (Old Testament Hebrew and Aramaic)
- † *NIV: New International Version*, 1984 (US English Bible)
- † *RSV: Revised Standard Version*, 1952 (English Bible)
- † *YLT: The English Young's Literal Translation of the Holy Bible*, 1862/1887/1898, by J. N. Young

#### **Date Abbreviations**

Jan: January; Feb: February; Mar: March; Apr: April; May: May; Jun: June; Jul: July; Aug: August, Sep: September; Oct: October; Nov: November; Dec: December.

<b>Other References</b> (Also see the Selective Bibliography)	
2Ma	Second Maccabees (Intertestamental apocryphal book)
ANS	American Numismatic Society, 96 Fulton Street (Lower Manhattan), New York, <a href="http://amnumsoc.org/search">amnumsoc.org/search</a>
<i>Adam Clarke Commentary</i>	<i>Adam Clarke Commentary on the Bible</i> , Hunt & Eaton, Vancouver, BC, Canada, 1884 (online).
<a href="http://AnsweringIslam.org">AnsweringIslam.org</a>	Answering <i>Islam</i> ministry
<i>Arutz-Sheva</i>	<i>Arutz-Sheva</i> ( <a href="http://Israelnationalradio.com">Israelnationalradio.com</a> )
CCC	<i>Catechism of the Catholic Church</i> : <a href="http://sborromeo.org/ccc.htm">sborromeo.org/ccc.htm</a> , <a href="http://christusrex.org">christusrex.org</a> , etc.
CEE	<i>Columbia Electronic Encyclopedia</i>
C&R	<i>Clarity &amp; Resolve</i> web blog by Patrick O'Brien
CNN.com	Cable News Network
DP	Daniel Pipes' articles & web blogs are at <a href="http://DanielPipes.org">DanielPipes.org</a> . <a href="http://Meforum.org">Meforum.org</a> and <a href="http://campuswatch.org">campuswatch.org</a> . are related sites.
DSS	Dead Sea Scrolls (from the <i>Qumran</i> Caves)
DW	<a href="http://DhimmiWatch.org">DhimmiWatch.org</a> (Robert Spencer's web site)
EB	<i>Encyclopedia Britannica</i>
FPM	<i>Front Page Magazine</i> ( <a href="http://FrontPageMag.com">FrontPageMag.com</a> )
<a href="http://Haaretz.com">Haaretz.com</a>	<i>Ha'aretz</i> (Israeli newspaper)
<i>Hadith</i>	Report of the sayings or actions of <i>Muhammad</i> or his

<sup>4650</sup> Robertson. *Secrets*, p. 92.

<sup>4651</sup> Warraq. *What*, Appendix B: "Converting Flugel *Koran*ic Verse Numbers Into Standard Egyptian," p. 751-752.

companions, together with the tradition of its chain of transmission. Individual reports are called *aHadith*. The plural is either *Hadith* or *Hadiths*. The *Hadiths* are also called *Sunna*. Searchable *Hadith* collections can be found online, for example, at: [usc.edu/dept/MSA/fundamentals/HadithSunnah/](http://usc.edu/dept/MSA/fundamentals/HadithSunnah/).

<i>IMRA</i>	Independent Media Review Analysis ( <a href="http://imra.org.il">imra.org.il</a> )
<i>ISBE</i>	<i>International Standard Bible Encyclopedia</i> , James Orr (editor), Wm. B. Eerdmans Publishing Company, 1934 (online).
Jpost.com	<i>The Jerusalem Post</i> .
<i>JW</i>	<i>JihadWatch.org</i> (Robert Spencer's web site)
<i>K</i> or <i>Koran</i>	The sacred text of <i>Islam</i> , considered by <i>Muslims</i> to contain the revelations of God to <i>Muhammad</i> . Also spelled <i>Alcoran</i> and <i>Quran</i> .

With at least 164 War verses mentioning expeditions, fighting and plunder, the *Koran* is incitement to violence. Many *Muslim* view the *Koran* as being their license to kill infidels. In fact this is why (as *Islam-Online.net* reported)...

...the religious administration of the *Muslims* of *Dagestan*, a republic of the

Russian Federation, has decided to ban circulation of the Russian versions of the holy *Qur'an*, as well as...books of prophetic *Sunna* (Tradition) as well as some *Islamic* books...due to its keenness on 'fighting terrorist and fanatic ideas...' <sup>4652</sup>

For more on how the *Koran* was written to turn *Muslims* into terrorists, see the Khidr-Second Lamech Logic table.

Major translations of the *Koran* can be found online, as at *Quranbrowser.com*, one can search on these translations: Sher Ali, *Khalifa*, Palmer, *Pickthall*, Rodwell, George Sale, Shakir, Yusuf Ali, the Transliterated Arabic and others beside.

The content of the *Koran* seems to go back to *Muhammad* but it is clear that the *Koran* has been collated and edited. The text has been reworked and updated somewhat to bring the language up to date, and vowels were added.

There are a lot of anachronisms in the *Koran* but no anachronisms involving events after *Muhammad's* lifetime. The *Koran's* contents are entirely consistent with the accepted idea that *Muhammad* wrote the *Koran* in *Makka* and *Madina* between 610 and 632 AD.

There are no early sources saying the *Koran* was concocted at a later date. The *Shias* however allege that one chapter laudatory of Ali is missing, and some say a precept for stoning adulterers was removed from the *Koran*. This precept is found in *Sharia* law and many *Hadiths*.

The Arab Christian, John of Damascus (~675 to ~749 AD), received an *Islamic* education until age twelve. He learned "the books of the *Saracens*," which has been taken to mean "memorizing the *Quran* and the *Hadith* literature as well as Arabian poetry." <sup>4653</sup>

John was age twelve in 687 AD, a mere 55 years after *Muhammad* died. One would think that he would have known whether the *Koran* was a forgery or not. Yet he says that *Muhammad* even gave the titles to all 114 *Suras*:

This *Muhammad*...composed many idle tales, on each of which he prefixed a title, like for example the discourse of *The Woman* [really, *The Women* (*K* 004)]...*The Camel* [*K* 007:077; 091:014]...*The Table* [(*K* 004)] ...*The Heifer* [(*K* 002)]. <sup>4654</sup>

<sup>4652</sup> Ahmed, D. "Dagestan Bans Russian Versions Of *Qur'an*," *Islam-online*, 17 May 2004, *DW*.

<sup>4653</sup> Sahas. *Heresy*, p. 40.

<sup>4654</sup> Sahas. *Heresy*, pp. 137-141; see also p. 90-93.

The Dome of the Rock, built in 691 AD, has a long inscription that paraphrases or echoes the *Koran* throughout. Thus all the evidence seems to indicate that at least the bulk of the *Koran* came from *Muhammad's* own mouth.

<i>LGF</i>	<i>Little Green Footballs</i> , by Charles Johnson. <i>LGF</i> is a web blog ( <a href="http://littlegreenfootballs.com/weblog">littlegreenfootballs.com/weblog</a> ) in the web blogosphere that documents the ongoing <i>Islamic</i> hatefest targeting <i>Israel</i> , the West and all things deemed un- <i>Islamic</i> .
MEMRI	Middle East Media Research Institute ( <a href="http://memri.org">memri.org</a> ).
<i>NRO</i>	<i>National Review Online</i> ( <a href="http://nationalreview.com">nationalreview.com</a> )
New Testament	New Testament. The original was written in <i>Koine</i> Greek.
Nypost.com	<i>The New York Post</i> .
Nytimes.com	<i>The New York Times</i> .
Opinion Journal.com	<i>Wall Street Journal</i> , Editorial Page, <i>Opinion Journal</i> . Often refers to James Taranto's weblog: "Best of the Web Today."
Old Testament	Old Testament (Jewish <i>Tanakh</i> ). The original was written mostly in Hebrew but some later chapters were written in Aramaic.
<i>Pickthall</i>	<i>Pickthall, Mohammad</i> Marmaduke. <i>The Meaning of the Glorious Quran</i> , London, 1930 AD. This is a translation of the <i>Koran</i> , despite its being entitled as though it were a commentary.
<i>Shakir</i>	<i>Shakir, M. H.</i> <i>Holy Quran</i> , New York, 1982 AD.
<i>Sunna(h)</i>	The way of life prescribed as normative in <i>Islam</i> , based both on the teachings and practices of <i>Muhammad</i> as recorded in the <i>Hadiths</i> , the <i>Koran</i> , and in less authoritative books that record traditions.
<i>TSK</i>	<i>The Treasury of Scriptural Knowledge</i> , by Canne, Browne, Blayney, Scott, <i>et al.</i> , ~1880 AD, with introduction by R. A. Torrey.
Washpost.com	<i>The Washington Post</i>
Washtimes.com	<i>The Washington Times</i>
Wnd.com	<i>World Net Daily</i>
<i>Yusuf Ali</i>	See the Selective Bibliography to find bibliographical entries on <i>Yusuf Ali's Quran</i> translation and commentaries.

### Finding References and Books Online

For books, check online library catalogues and online libraries such as:

The US *Library* of Congress ([loc.gov](http://loc.gov)), COPAC ([copac.ac.uk/copac](http://copac.ac.uk/copac)), the British *Library* ([bl.uk](http://bl.uk)), [libdex.com](http://libdex.com), [sunsite.berkeley.edu/Libweb](http://sunsite.berkeley.edu/Libweb), Google Book Search and Amazon's Search Inside.

## Glossary

*General Notes*

The reason that there are many spellings of *Islamic* words is not due to sloppiness on anyone's part. Many older spellings are of Turkish origin but modern spellings reflect the Arabic. Moreover, many spellings have been passed down from Medieval times through Western languages—all of which have changed over time.

The definitions of words and abbreviations not listed below can be found on web sites such as: Britannica.com™, Infoplease.com™, GuruNet.com.™ and Internet search engines such as *Google.com*.™

Italics as used in this book tend to highlight titles of books and publications, as well as transliterated foreign words, foreign place names and the like.

Any bolding in quotations in this book is Yoel Natan's way of emphasizing certain text to make a point. The bolding is not found in the original source.

Square brackets [ ] in quotations indicate Yoel Natan's comments, unless otherwise noted. Any braces { } or parentheses ( ) in quotations represent punctuation found in the original quotation in the cited source, and are not Yoel Natan's comments.

English-Arabic Who's Who			
English	Transliteration	English	Transliteration
Aaron	<i>Harun</i>	John (any John)	<i>Yahya</i>
Abel	<i>Habil</i>	Jonah	<i>Yunus</i>
Abraham	<i>Ibrahim</i>	<i>Joshua</i>	<i>Yusha</i>
Adam	<i>Adam</i>	Joseph	<i>Yusuf</i>
The Antichrist	<i>Dajjal</i>	Korah	<i>Qarun</i>
Cain	<i>Qabil</i>	Lot	<i>Lut</i>
David	<i>Daud/Dawood</i>	Mary	<i>Marium</i>
Elijah	<i>Elias/Ilyas/ Ilyasin/Alyasa</i>	Michael	<i>Mikail</i>
Enoch	<i>Idris</i>	Miriam	<i>Kulthum</i> <sup>4655</sup>
Ezra	<i>Uzair</i>	Moses	<i>Musa</i>
<i>Gabriel</i>	<i>Jibril</i>	Noah	<i>Nuh</i>
<i>Gog and Magog</i>	<i>Yajuj and Majuj</i>	Pharaoh	<i>Firaun/Firon</i>
Goliath	<i>Jalut</i>	Saul	<i>Talut</i>
Hagar	<i>Hajar</i>	Solomon	<i>Sulaiman</i>
Isaac	<i>Ishaq</i>	<i>Terah</i>	<i>Azar</i>
Ishmael	<i>Ismail</i>	Jesus, <i>Yeshua</i>	<i>Isa</i>
Jacob	<i>Yacub</i>	Zechariah	<i>Zakariya</i>
Job	<i>Aiyub</i>		

<sup>4655</sup> *Miriam* (Arabic: *Kultham*) is found in *Islamic* traditions, but not in the Arabic *Koran*. The *Koran* records how *Muhammad* thought that Mary and Miriam were one person, i.e. *Muhammad* thought the Virgin Mary was the sister of Moses and Aaron.

<b>English-Arabic Glossary Index</b>
--------------------------------------

**Glossary Entry (page number):** & Symbol (1099); 9/10 (1100); 9/11, or 9/11/2001 (1100); 24-7-365 (1100); 'Abd (1101); Abrogation (1101); Abu (1101); Abdullah (1101); AcaDhimmi (1101); AD/AH Dates (1102); Adhan (1103); aJ (1103); aJl (1103); a.k.a. (1103); Alam (1103); Alhamdulillah (1103); Allah (1103); Al-Qaeda (or Al-Qaida) (1103); Arafat (1103); AS or S (1103); aU (1104); aUl (1104); Ayat (1104); BH or BAH (1104); Bakhkh (1104); b. (Ibn/Bint) (1104); Bait (1104); Bismillah (1104); bk. (1104); Burk(h)a (1104); CAIR (1104); ch. (1105); Circa (1105); Dar Al Harb (1105); Dar Al Islam (1105); Dawa(h) (1105); Dhabh (1105); Dhimmi (1105); Din (1108); Eid Al Fitr (1108); Eid Al Adha (1108); En masse (1108); et al. (1108); Etc. (1108); Eurabia; (1108); Fatwa (1109); FGM (1109), Fn. (1110); Giaour (1110); Hajj or Haj (1110); Hajji (1110); Halal (1110); Hanif (1110); Hatim (1110); Henotheism (1110); Heylel (1110); Hijab (1110); Hijr (1110); Hijri (1110); Hilal (1110); Houris (1110); Hudna (1110); Iblis (1110); Idem (1111); I.e. (1111); Iftar (1111); Ihram (1111); Ilah (1111); Imam (1111); Injeel (1111); InshAllah (1111); In toto (1111); Islam (1111); Islamism (1112); Islamist (1112); Islamo-Christian (1112); Islamophobia (1113); Isnad (1116); Jamara (1116); Jihad (1116); Jinn (1117); Jizya (1117); Kaaba (1118); Kafir (1118); Kaffiya (1118); Kalima (1118); Khalifa (1118); Khalifat (1118); Khatib (1118); Khuṭba (1118); Kibla(h) or Qibla(h) (1118); Kiswa (1118); Kitman (1119); Koran (1119); Kufic (1119); Laicist (1120); Madrasa/Madrassah (1120); Mahdi, The (1120); Maksura (1120); Mansukh (1120); Maqam (1120); Masjid (1120); Massiah Ad-Dajjal (1120); Makka(h) (1120); Metathesis (1120); Mihrab (1120); Miraj (1120); Minaret (1120); Minbar/Mimbar (1120); Moderate Muslims (1120); Monolatry (1120); Mosque (1120); Mumin (1120); Muezzin (1120); Mujahid (1120); Muqattaat (1120); Muslim (1121); Nasi (1121); Nasikh (1121); Naskhi (1121); Nymphomania (1121); no. (1121); para. (1121); PC-AIDS/PC-ASS (1121); PBUH (1121); Purgatory (1134); Qarina (1134); Raka (1134); Ramadan (1134); Rasul (1134); Sae'e (1134); Salaam (1134); Salat (1134); Sakina (1134); Satyriasis (1135); SAW (1135); Shahada (1135); Shahid (1135); Sharia law (1136); Sheikh or Shaykh (1137); Shirk (1137); Sic (1137); Sira/Sirat/Seerat (1137); Sqq. (1137); Suicide-bombing (1138); Sujud (1142); Sunni(te) (1142); Sura(h) (1142); Sutra (1142); SWT (1142); Tafsir (1142); Takbir (1142); Takfir (1142); Takiya (1142); Tasbih (1143); Taurat (1143); Tawaf (1143); Tu Quoque (1143); Turnspeak (1143); Ulama (1143); Umma (1143); Umra (1143); V./Vss. (1143); Vice versa/ vv. (1143); vol./Vols. (1143); WMD (1143); WoT (1143); WWMD? (1143); Wudu (1143); Yahveh (1143); Yeshua (1143); Zakat (1143); Zamzam (1143)

<b>English-Arabic Glossary</b>	
--------------------------------	--

&	Ampersand conjunction meaning “and”
9/10	Used as an adjective, as in “9/10 thinking.” A 9/10 politician

believes that terrorism is a matter for law enforcement rather than for the intelligence services and the military. A 9/10 politician believes in the old style of defense where a nation attacks only when there is an imminent threat, or one has already been attacked.<sup>4656</sup>

<sup>4656</sup> Pipes, Daniel. “9/10 vs. 9/12 on 11/2 [election day],” *DP*, 26 Oct 2004.

9/11, or 9/11/2001	On this date, terrorists destroyed the twin towers of the World Trade Center skyscrapers in New York while <i>Muslims</i> around the world cheered and then named their newborns Usama. 9/11 was an infomercial showing that <i>Islam</i> was really a suicide/killing cult whose members gleefully end the lives of non-believers—all this despite its claims to being a Religion of Peace.™
-----------------------	---

Before 9/11, Khidr-Second Lamech Logic terrorism was considered a law enforcement matter. The scale of the 9/11 attack necessitated the Global War on Terror (GWOt, or often just WoT) and the involvement of entire governments and their militaries.<sup>4657</sup> In 2006 Donald Rumsfeld started saying “The Long War.”<sup>4658</sup>

9/11 was the date that Americans found out that many *Muslims* cheered the attack. The footage of cheering crowds really was shot on 9/11 and was not recycled from a previous date as some *Muslims* claimed.<sup>4659</sup> Many Americans asked “Why do they hate us?” but few people ask this question after familiarizing themselves with the *Koran, Hadith, Sira, Fatwas* and such.

9/11 has become a synonym for mega-terror attacks. Since *Israel* is so small, each time a miniskirt-chasing suicide-bomber kills several people, it is said to proportionally feel like a 9/11. *Bali* experienced its “9/11” attack on 12 October 2002 when 202 people, many of them Australians, died in an attack on night clubs.

Russia has experienced two instances of terrorist attacks that were said at the time to be Russia’s 9/11. In one week in 2002, 33 terrorists and 128 hostages died in a Moscow theatre. In one week in 2004, two female suicide-bombers felled jets south of Moscow, a suicide-bomber blew herself up in Moscow, and about 331 people died after being taken hostage at an elementary school in *Beslan*, Russia.

Spain and some say “Old” Europe, experienced its 9/11 two and a half years after 11 Sep 2001. On 11 March 2004, several bombs exploded in commuter trains in *Madrid*, killing about 200 people. The *Madrid* attack in 2004 is now called 3/11. On 7 July 2005 suicide-bombers struck London’s “Tube” subway and a double-decker bus, killing over fifty people. This is called 7/7.

Daniel Pipes, quoting from the 9/11 Commission report issued on 22 July 2004, wrote that the committee determined...

...the enemy is ‘*Islamist* terrorism... not just ‘terrorism,’ some generic evil’...*Islamist* terrorism is ‘the ‘catastrophic threat’ facing the US’...[the] US strategy, therefore, must be to dismantle *Al-Qaeda*’s network and prevail over ‘the ideology that gives rise to *Islamist* terrorism.’ In other words, ‘the US has to help defeat an ideology, not just a group of people’...[*Islamists*]...have ‘hostility toward us and our values [that] is limitless,’ and that their goal, based on a ‘long tradition of extreme intolerance’ was ‘to rid the world of religious and political pluralism.’<sup>4660</sup>

*AcaDhimmis* were partly responsible for the fact that 9/11 came as a shock to most Westerners rather than as an anticipated event (see the *acaDhimmi* definition).

24-7-365	24 hours per day, seven days a week, 365 days per year.
----------	---

<sup>4657</sup> Pipes, Daniel. “Democrats Unlearn 9/11,” *DP*, 7 Jan 2004.

<sup>4658</sup> “Rumsfeld: Pentagon preparing for ‘The Long War,’” *jpost.com*, 2 Feb 2006.

<sup>4659</sup> “CNN used old footage...false,” *Urban Legends*, *snopes.com*, 23 Sep 2001.

<sup>4660</sup> Pipes, Daniel. “The 9/11 Report’s Straight Shooting on *Islamist* Terror,” *FPM*, 27 Jul 2004; and “Weblog: Calling *Islamism* the Enemy,” *DP*, 29 Jan 2004.

<i>'Abd</i>	<i>'Abd</i> means “servant” or “slave.” Other forms are <i>'Abda</i> , <i>'Abdu</i> .
Abrogation	Arabic: <i>Naskh</i> . There are contradictory verses in the <i>Koran</i> , such as those few verses that call for peace and tolerance of other faiths versus the many verses that call for <i>Jihad</i> warfare and intolerance of other faiths. <i>Muhammad</i> was aware of this and stipulated that later verses ( <i>Nasikh</i> ) always abrogate the earlier verses ( <i>Mansukh</i> ) ( <i>K</i> 002:106; 017:086; 016:101). Earlier tolerance verses are automatically considered <i>Makkan</i> and later War verses are automatically considered <i>Madinan</i> .

Incredibly, *Muslim* tradition relates that a goat abrogated two verses:

The verse[s] of stoning [an adulterer], and of suckling an adult ten times [sic ?!], were revealed, and they were (written) on a paper and kept under my bed. When the Messenger of *Allah*...expired and we were preoccupied with his death, a goat entered and ate away the paper.<sup>4661</sup>

The reason the goat is introduced in tradition seems to be the existence of a *Hadith* that says that the punishment for stoning is found in the *Koran* (which, by the way, is not the case):

Stoning is a duty laid down in *Allah*'s Book for married men and women who commit adultery when proof is established, or if there is pregnancy or a confession (*Sahih Muslim*, bk. 17, ch. 4, no. 4194).

<i>Abu</i>	<i>Abu</i> means “father.” <i>Abi</i> is the genitive and <i>Aba</i> is accusative.
<i>Abdullah</i>	Common name meaning “son (or slave) of <i>Allah</i> .”
<i>AcaDhimmi</i>	An academic, often a tenured aphid on collegiate ivy, who is a

*Dhimmi*. See the *Dhimmi* definition. *AcaDhimmis* are to *Dhimmitude* what Holocaust Deniers are to the Holocaust.

If there were awards for the *AcaDhimmi* category, they would be: Outstanding *Jihad* Apologist, Outstanding Counter-terrorism Sabotager, Outstanding Media Manipulator and Outstanding *Dhimmitude* Advocate.<sup>4662</sup> *AcaDhimmis* were largely responsible for 9/11 and for US foreign policy failures because they mischaracterized to the public and leaders the true nature of *Islam* and *Jihad*.<sup>4663</sup>

*AcaDhimmis* like to say things like “*Islamophobes*' demonization of *Islam* may lead to a genocide just as the demonization of the Jews led to the Holocaust” (see *Islamophobia* in this Glossary). The *acaDhimmis* know this last statement is poppycock since, for starters, the *Nazis* were genetic racists with a twisted morality, while *Islam*'s critics merely attack *Islam*'s murderous, supremacist ideology (*K* 003:139; 005:056; 008:030; 009:029, 033; 048:028; 061:009). Besides, *Islam* is not a race. One can change his mind after hearing valid criticism of an ideology but one cannot readily change his or her DNA.

*AcaDhimmis*' avoidance of controversial issues is a survival mechanism in today's intolerant, shuttered, one-party system educational establishments. Professors must also watch out for *Muslim* student spies and thought-police recruited by *Muslim* organizations who:

☪ Try to get the professor fired if the course is not “taught in a pious, Sunday-school manner.”

<sup>4661</sup> Musnad Ahmad Bin Hanbal. vol. 6. p. 269; Sunan Ibn Majah, p. 626; Ibn Qutbah, Tawil Mukhtalafi 'l-Hadith (Cairo: Maktaba Al-Kulliyat Al-Azhariyya. 1966) p. 310; As-Suyuti, ad-Durru 'l-Manthur, vol. 2. p. 13; and Ishaq. *Sirat*, pp. 684-685.

<sup>4662</sup> Pipes, Daniel. “I Am a Runner-up for an ‘*Islamophobia*’ Award, *DP*, 26 Jun 2004.

<sup>4663</sup> Phares, Walid. “9/11: A Failure of Academia,” *FPM*, 28 Jul 2004.



- ☉ Ensure that “courses serve *Dawa* purposes, namely that they attract converts to *Islam*.”
- ☉ Enforce “incipient *Dhimmitude*, a state in which (among other features) non-*Muslims* [teachers and students] dare not say anything critical about *Islam* and *Muslims*.”<sup>4664</sup>

Daniel Pipes lists some traits by which aca*Dhimmis* can be identified:

- ☉ *Incompetent*: They consistently get the basics wrong. Militant *Islam* they portray as a democratizing force. Osama *Bin Laden* and *Al-Qaeda* they dismiss as irrelevant. The Palestinian Authority they predict to be democratic. So consistently wrong are the academics that government officials have largely stopped asking them for advice.
- ☉ *Adversarial*: Many aca*Dhimmis* are hostile to US national interests. Thus the Middle East Studies Association (MESA) board has recommended that its members ‘not seek or accept’ US government funded scholarships. That three specialists were recently indicted on terrorism charges caused no alarm among their colleagues.
- ☉ *Intolerant*: The field is hobbled by political uniformity and an unwillingness to permit alternate viewpoints. In one infamous case at Berkeley, the section leader of a course on Palestinian poetics made this bias explicit in the course catalog (‘Conservative thinkers are encouraged to seek other sections’).
- ☉ *Apologetic*: Specialists generally avoid subjects that reflect poorly on their region, such as repression in Saddam Hussein’s *Iraq*, *Muslim* anti-Semitism and chattel slavery in *Sudan*. The MESA president recently discouraged studying what he called ‘terrorology.’ Specialists sometimes actively deceive, for example, by denying that *Jihad* historically has meant offensive warfare.
- ☉ *Abusive*: Specialists too often coerce students into regurgitating a party line and penalize freethinkers with lower grades.<sup>4665</sup>

Students may one day realize that the just-so stories their professors spoon fed them are mostly bunk:

They [students] were simply told so by a professor they trusted. Ultimately, these students must face the fact that they have been personally betrayed by professors and other academics who don’t really care about them at all and have misled them on a whole host of issues—including probably everything political.<sup>4666</sup>

AD/AH Dates	Early <i>Islamic</i> coins are often dated by the <i>Hijri</i> (AH) calendar (also spelled <i>Hegira</i> , <i>Hejira</i> and <i>Hijrah</i> ). The Latin <i>Anno Hijri</i> is abbreviated “AH.” The AH abbreviation is similar to the AD abbreviation. AD is the abbreviation for the Latin <i>Anno Domini</i> , meaning “Year of our Lord.” BH or BAH, meaning “Before AH” is similar to BC, meaning “Before Christ.” BH is before Year One (622 AD) of the <i>Hijri</i> religious calendar, and BC is before Year One of the Gregorian secular calendar.
-------------	---

The *Islamic* Era year AH Year One is 622 AD, the year *Muhammad* fled from *Makka* to *Madina*. Since the *Islamic* religious calendar is based on the lunar year, it is eleven days shorter than the solar year. This fact causes the *Islamic* month of

<sup>4664</sup> Pipes, Daniel. “Islamists Police the Classroom,” *WND*, DP, 2 Jan 2004.

<sup>4665</sup> Pipes, Daniel. “Saving Mideast Studies,” *DP*, 18 Sep 2003.

<sup>4666</sup> Bruce, Tammy. “My Brush with the Campus Thought Police,” *FPM*, 2 Dec 2003.

*Ramadan* to drift through the West's solar calendar, and the seasons to drift through the *Hijri* religious calendar.

To roughly determine the AD date from the AH date, multiply the AH date by 0.97 and then add 622 years. To figure the approximate AH date from the AD date, subtract 622 from the AD date and then multiply the result by 1.03. There are web sites that convert *Hijri* to Gregorian dates and *vice versa*.

<i>Adhan</i>	Call to Prayer voiced from <i>Minarets</i> by <i>Muezzin</i> (Arabic: <i>Muadhdhin</i> ). Also spelled <i>Athan</i> or <i>Azan</i> .
--------------	--

<i>aJ</i>	<i>aJ</i> is a representation of an Arabic word using English letters. The English transliteration of <i>aJ</i> is <i>Lahu</i> , meaning "to him," or "to Him," with <i>Allah</i> usually being understood when "Him" is capitalized. See <i>aJl</i> , <i>aU</i> and <i>aUl</i> . These Arabic words are listed in the vocabulary section of Plant's book on <i>Coins</i> .
-----------	---

<i>aJl</i>	This is a representation of an Arabic word using English letters. The English transliteration of <i>aJl</i> is <i>Ilah</i> , meaning "god." See <i>aJ</i> .
------------	---

a.k.a.	Also known as
--------	---------------

<i>Alam</i>	A sign. There are many signs of <i>Allah</i> , including the crescent. For more information on the association of the name <i>Allah</i> with crescent finials, see especially the <i>Lahut</i> and Turkish <i>Blessing Index</i> entries.
-------------	---

<i>Alhamdulillah</i>	"Praise be to God."
----------------------	---------------------

<i>Allah</i>	In its common usage <i>Allah</i> is an abbreviation meaning "the God," and is formed from the Arabic: <i>Al Ilah</i> . In its common usage <i>Allah</i> <b>cannot</b> stand for small "g" god(s), but theologically speaking, <i>Allah</i> is a demonic moon-god and the <i>Allah</i> of the <i>Koran</i> is by no means the God of the Bible. The <i>Allah</i> demon said "I will make myself <b>like</b> the Most High," and those who are perishing, because they refuse to love the truth and so be saved, say that <i>Allah</i> <b>is</b> the Most High (Isa 14:14; 1Co 01:18; 2Co 04:03; 2Th 02:10).
--------------	--

<i>Al-Qaeda</i> (or <i>Al-Qaida</i> )	A global <i>Islamist</i> terrorist group. <i>Al-</i> is Arabic for "the," and <i>Al-Qaeda</i> is Arabic for "the camp." <i>Al-Qaeda</i> 's godfather and mentor is Usama <i>Bin Laden</i> (UBL).
---------------------------------------	--

<i>Arafat</i> , Mount	Mountain outside of <i>Makka</i> visited by <i>Hajjis</i> on the major annual <i>Hajj</i> pilgrimage. <i>Yasar Arafat</i> was a PLO terrorist.
-----------------------	--

AS or S	Abbreviation for "' <i>Alaihi Salaam</i> ," which means " <b>Peace be upon him</b> (PBUH)." AS and PBUH are synonymous abbreviations that <i>Muslims</i> write after the name <i>Muhammad</i> , Christ and other religious notables. PBUH means " <b>Peace be upon him</b> ." Sometimes the AS is abbreviated to just S, for example, <i>Muhammad</i> (S).
---------	--

AS is slightly different from the traditional *Muslim* greeting between *Muslims* "Peace be with you" (*as-Salamu 'alaykum*). SWS is a similarly used, but less common, abbreviation found after the name of *Muhammad*.

Other less common similar abbreviations used after the mention of *Muhammad*'s Companions are RTA and RAA, meaning "May *Allah* be pleased with him" (Arabic: *Radhi Allah 'Anhu*).

The practice of using the blessing after a name may have paralleled the Jewish practice of using a curse after certain names, as in Hitler (*Yimach Shmo Ve-zichro*), meaning "May his name and memory be forgotten (or obliterated)."

Since *Muhammad* was a mass murderer and his *Koran*-inspired *Jihad*'s have murdered millions, the reader may wish to substitute "a **pox be upon him**" for PBUH, and pray that *Muhammad*'s rule from the grave ends soon.

<i>aU</i>	This is a representation of an Arabic abbreviation using English letters. The English transliteration of <i>aU</i> is <i>Li-'llah</i> . <i>Li-'llah</i> is a contracted form of <i>Li-Allah</i> , meaning “to <i>Allah</i> ” or “for <i>Allah</i> .” See <i>Allah</i> and <i>aJ</i> .
<i>aUl</i>	This is a representation of the Arabic word for <i>Allah</i> using English letters. See <i>aJ</i> and <i>Allah</i> .
<i>Ayat</i>	A verse in a chapter ( <i>Sura</i> ) of the <i>Koran</i> . See <i>Sura</i> .
BH or BAH	Before AH. See “AD/AH Dates” for an explanation.
<i>Bakhhk</i>	A backwards J symbol that means “Glory be to <i>Allah</i> .” See the coins appendix for a discussion and illustrations.
<i>b. (Ibn/Bint)</i>	<i>Ibn</i> means “son,” and <i>Bint</i> means “daughter.” Similarly, the Hebrew for son is <i>Ben</i> and daughter is <i>Bat</i> .
<i>Bait</i>	House, temple, shrine. <i>Bait</i> is related to the word <i>betyl</i> .
<i>Bismillah</i>	Expression meaning “In the Name of <i>Allah</i> .”
bk.	Abbreviation meaning “book.”
<i>Burka</i>	An enveloping robe or amorphous sack that <i>Muslim</i> women

often wear for enforced, excessive modesty and for personal safety. Since women are second-class citizens in *Islamic* countries, they need to protect themselves from ogling since women barely have any recourse to the law under *Sharia* law in case they are raped or sexually assaulted. In fact women who are raped are often punished for fornication or adultery if they report the rape to the police.

Since women in many *Islamic* countries are sequestered indoors and otherwise wear concealing clothing outside, they often suffer from soft bones brought on by a Vitamin D deficiency. Vitamin D is produced by sunlight hitting bare skin.

In Egypt, a veil cloth covering the face from the eyes down is called *Niqab*. A full body wrap except for the eyes is called an *Abaya* in *Saudi Arabia*, but a *Chador* in *Iran*, *Pakistan*, *Afghanistan* and *India*.

Some *Muslim* women in or from *Pakistan* and *India* wear a *Sari* (or *Saree*), which is a long wide cloth first wrapped around the lower half of the body to create a skirt. The remainder is draped over the shoulder and sometimes covers one arm or the head.

The color of baggy *Burka*-like sacks in *Saudi Arabia* is mostly black, but blue in *Afghanistan*. The *Burkas* most often have a head covering that is one piece with the robe or gown. The head covering has a netted screen for viewing purposes. *Burka* is also spelled *Burqa* and *Burkha*. Another style of dress for women is the *Jilbab*, an ankle-length gown that covers the entire body but not the face and hands.

*Muslim* men often wear a *Galabiyya* (also spelled *Djellaba(h)*, *Jellaba*). The *Galabiyya* is a loose, hooded and long (often ankle-length) garment with full-length sleeves. Another popular garb is the white *Dishdash(eh or as)* tunic, but persons of stature (e.g. the wealthy, officials, clerics) often wear flowing robes or Western clothing.

Some accessories that *Muslims* wear are sandals or flip-flops and skullcaps. The round knitted skullcap or tuque that *Muslim* men wear, a *Kufi*, is worn like the Jewish *Kippa* or *Yarmulke*, but is often as large as a cereal bowl.

CAIR	Council on American-Islamic Relations poses as <i>Islam</i> 's public relations firm and has staff that pose as civil rights activists, but Daniel Pipes states:
------	--

‘...CAIR, with *Saudi* financing, is the attack dog of *Islamist* institutions in the United States. CAIR has two primary goals: to help build *Hamas* against

*Israel* and to promote militant *Islam*'s agenda here. Its people are all over the place, extremely active, but they are the totalitarians among us, the front for the enemy in this country, and they should be shunned, as David Duke or Louis Farrakhan is shunned.<sup>4667</sup> In fact three CAIR staff members...have been convicted on mail fraud and terrorism-related charges.<sup>4667</sup>

CAIR was named as a defendant in a 9/11 terror lawsuit in late 2004.<sup>4668</sup>

ch.	Abbreviation for "chapter."
<i>Circa</i>	<i>Circa</i> (or ~) is used with dates and means "approximately."
<i>Dar Al Harb</i>	"Abode of War" where non- <i>Muslims</i> rule.
<i>Dar Al Islam</i>	"Abode of <i>Islam</i> " where <i>Muslims</i> rule, <i>Sharia</i> law is imposed and <i>Islamic</i> terrorists are trained and harbored. One could also say it is the Abode of the Devil.
<i>Dawa(h)</i>	<i>Dawa</i> is <i>Islamic</i> proselytizing. <i>Muslims</i> are supposed to call people to <i>Islam</i> before initiating <i>Jihad</i> but this is not absolutely necessary. The <i>Sunni Hanafi</i> school states:

If a *Muslim* attack infidels without previously calling them to the faith, he is an offender, because this is forbidden; but yet if he does attack them before thus inviting them and slay them and take their property, neither fine, expiation, nor atonement are due [from the offending *Muslim*], because that which protects (namely, *Islam*) does not exist in them, nor are they under protection by place [meaning they are not 'protected' *Dhimmi*s because they are not in *Muslim* lands].<sup>4669</sup>

If a *Muslim* attack infidels without previously calling them to the faith, he is an offender, because this is forbidden; but yet if he does attack them before thus inviting them and slay them and take their property, neither fine, expiation, nor atonement are due [from the offending *Muslim*], because that which protects (namely, *Islam*) does not exist in them, nor are they under protection by place [meaning they are not 'protected' *Dhimmi*s because they are not in *Muslim* lands].<sup>4669</sup>

<i>Dhabh</i>	<i>Dhabh</i> (or <i>Dhabiha</i> ) the cutting the veins at the top of the neck using a knife, whereas <i>Nahr</i> is cutting the veins lower down in the neck by stabbing with a spear. <i>Dhabh</i> is the more common method but camels are slaughtered using the <i>Nahr</i> method. See <i>Halal</i> , which is the <i>Islamic</i> version of <i>Kosher</i> .
--------------	---

*Dhimmi* means "protected one." *Muhammad* describes *Dhimmi*s as Christians and Jews who must pay a *Jizya* poll tax, acknowledge the superiority of *Islam* and are in a state of subjection to *Muslims* (K 009:029). *Muhammad* commanded *Muslims* to be kind to *Muslims* and harsh to non-*Muslims* (K 009:073, 123; 048:029; 066:009).

*Abu Khawla* explains how *Muslims* classify and treat people differently according to their religion:

"Why did these fundamentalist havens try to hide the truth about the *Darfur* massacre? For starter, we should notice that the matter wouldn't have raised an eyebrow among *Muslim* public opinion had the slaughter targeted non-*Muslims*. Fighting infidels until they either convert to *Islam* or submit to *Muslims* as *Dhimmi*s, i.e. citizens of second class status under *Islamic* rule, and pay the *Jizya* (a poll tax), is still considered by *Islamists* to be a religious duty. And the above-mentioned status of *Dhimmitude* is exclusive to the 'peoples of the book,' namely Christians and Jews. Animists, *Hindus* and other 'heretics,' are all considered *Najus* (filthy), i.e. fit for extermination. Today's animists in Southern

<sup>4667</sup> Tassel, Janet. "Militant about 'Islamism'" harvardmagazine.com, Jan-Feb 2005, vol. 107, no 3, p. 38, *LGF*.

<sup>4668</sup> "Weblog: CAIR named as a defendant in 9/11 terror lawsuit," *DP*, 30 Dec 2004.

<sup>4669</sup> Hughes. *Dictionary*, p. 245, right column, *Jihad* entry.

*Sudan* as well as *Bah'ai* and *Ismailite* [*Shiite*] sects in most *Islamic* countries are learning about it the hard way.<sup>4670</sup>

Many provisions of *Dhimmitude* may be relaxed in these modern times on account of Western pressure, but still the conditions are hard enough that *Dhimmis* have emigrated *en masse* out of all *Muslim* countries. Furthermore, not paying the *Jizya* tax means that *Dhimmis* are in more danger because *Islamists* feel justified in attacking *Dhimmis*.

As Bat Yeor, Habib Malik and others have pointed out, the most debilitating aspects of *Dhimmitude* is not the constant discrimination, which are terrible in and of themselves, but the constant physical insecurity of the person and family, and the very real fear that the non-*Muslim* community will cease to exist due to conversion-to-*Islam* pressures, emigration, mob violence, ethnocide, genocide and such.

*Dhimmis* have good cause for thinking that their lives are always in peril. They live under the discriminatory, medieval *Sharia* law that imposes draconian punishments. *Dhimmis* never know when they will be falsely accused of crimes which carry fines, jail time, amputations or the death sentence.

Even where the government does not enforce *Sharia* law, individual *Muslims* may take it upon themselves to enforce the provisions of *Sharia* law. For instance, *Iraq* was officially a secular state both under Saddam Hussein and afterward. But *Muslims* would firebomb and spray with bullets any Christian place of business that sold wine and pork, as well as those businessmen's homes, because Christians and Jews "are forbidden to openly display wine or pork" (*Umdat Al-Salik*, o11.4(6)).

In just one of many instances of *Sharia*-related killings, two Assyrian Christian children were killed after...

...the family received a photocopied death threat. 'We are warning you, the enemies of God and *Islam*, from selling alcohol again, and unless you stop we will kill you and send you to hell where a worse fate awaits you,' reads the warning, signed by *Harakat Ansar Al-Islam*, the Partisans of *Islam* Movement.<sup>4671</sup>

A pogrom or mob action by *Muslims* is possible at any time due to some perceived or imagined slight. Rebecca Bynum wrote:

The fear of this kind of mob violence is so strong that *Muslim* parents condition their children from an early age never to criticize *Islam*. This is a mental conditioning so extensive that not only *Muslims*, but also Christians, Jews and others living in any proximity to *Muslims* are likewise so conditioned. Thus wherever *Islam* holds power, it goes un-criticized and therefore, unreformed.<sup>4672</sup>

Examples of mobs and pogroms include:

- ☉ "In *Pakistan* in 1997, *Shantinagar*, a Christian town of some 10,000 people, was burned to the ground after a man there was accused of tearing pages from a *Koran*,"<sup>4673</sup>
- ☉ In 2005 in *Pakistan* 200 Christian homes and a *Hindu* temple in a few locations were burned down and three men were beaten, after a *Pakistani*

<sup>4670</sup> "The Arab Silence on *Darfur*," *MEMRI*, No.835, 28 Dec 2004, *DW*.

<sup>4671</sup> Ciezadlo, Annia. "*Iraq*'s Christians consider fleeing as attacks on them rise," *csmonitor.com*, *DW*, 13 Jul 2004.

<sup>4672</sup> Bynum, Rebecca. "Moral Clarity and *Islam*," *JW*, 23 Apr 2005.

<sup>4673</sup> Marshall, Paul. "Deadly Mistake," *nationalreview.com*, 16 May 2005.

army officer told an illiterate Christian to burn some paper. *Muslim* witnesses claimed that *Koran* verses were written on the paper,<sup>4674</sup>

- ⊕ In *Pakistan*, after a man was accused of being disrespectful to a *Koran*, he went into hiding on a Monday, 18 April 2005, but was spotted on Wednesday, 20 April 2005:

Witnesses said the man was chased through fields and climbed a tree to get away from an angry crowd of up to 500 men. When he refused to come down, someone shot him dead, they said.<sup>4675</sup>

- ⊕ In 2005 in *Sudan*, crowds demanded that an *Islamist* journalist associated with the *Muslim* brotherhood, who was being tried for slighting *Muhammad*, be handed over to the crowd to be murdered.<sup>4676</sup>
- ⊕ In *Nigeria*, a Christian trader, Gideon Akaluka, was accused of tearing pages out of a *Koran* in December 1994. He was rescued by police but was jailed for two years in *Bompai* prison. On 26 December 1996 a mob stormed the jail, beheaded Akaluka and paraded the head on a pike through the streets of *Kano*.<sup>4677</sup>

In 2005, in the midst of deadly global anti-American protests that ensued after a retracted *Newsweek* article cited an unnamed source who claimed *Guantanamo* Bay interrogators flushed a killing manual, the *Koran*, down the toilet, cleric Hafiz Hussain Ahmad in *Islamabad, Pakistan*, incited his parishioners during a fiery sermon with these words:

By insulting the *Koran*, they have challenged our belief. We are hurt...If we don't rise against Americans, if we don't give them a strong message today, they will do it again.<sup>4678</sup>

Any statement that puts *Islam* in a negative light can be deemed blasphemy, thereby subjecting a *Dhimmi* or a *Muslim* to a death sentence meted out by mobs or *Sharia* courts, as Robert Spencer wrote:

A cardinal principle of *Dhimmi* laws is that the 'protection' of the *Dhimmis* is canceled if a *Dhimmi* 'mentions something impermissible about *Allah*, the Prophet or *Islam*' (*Umdat Al-Salik*, 011.10 (5)).<sup>4679</sup>

Often the *Dhimmis* did not actually make a blasphemous statement at all, but *Muslims* falsely charge the *Dhimmis* with blasphemy since *Muslims* know that *Dhimmis* are nearly helpless and friendless in the Mideast.

Some *Muslim* public-relations (PR) spokespersons may say that *Muslim* societies are democratic and culturally pluralistic. The PR spokespersons even cite examples of supposed inter-religious harmony such as in Nazareth and Bethlehem which cities have in fact been steadily *Islamized* in recent decades.

Closer inspection reveals that everywhere *Muslims* are in the majority, *Muslims* engage in bullying of Christians, Jews, *Hindus* and all non-*Muslims*. In fact the bullying is far worse and more persistent than what criminal *Mafia*-style gangs dish out.

Without exception, Christian communities in the Mideast are being driven toward extinction. In 2001, a mere twelve million Christians lived in the Mideast and

<sup>4674</sup> “*Muslim* mobs burn Christian homes,” *WND*, 30 Jun 2005, *DW*.

<sup>4675</sup> “Man Accused of Blasphemy Shot Dead,” news.yahoo.com, 20 Apr 2005.

<sup>4676</sup> “*Sudan* editor denies Prophet slur,” news.bbc.co.uk, 6 May 2005.

<sup>4677</sup> Okonkwo, Rudolf O. “Worshipping the *Koran*, flushing reason,” kwenu.com, 1 Jun 2005, *DW*.

<sup>4678</sup> “Protests spread in *Afghanistan* over *Koran* desecration,” jpost.com, 13 May 2005.

<sup>4679</sup> Spencer, Robert. *DW*, 3 Apr 2004; see the *Sharia* Law entry about *Al-Salik*.

by 2020, only six million will live in the Mideast if current trends continue. Even in Turkey, which is officially secular by its constitution, Christians number only in the thousands. Daniel Pipes wrote:

In Turkey, Christians constituted a population of two million in 1920 but now only some thousands remain.<sup>4680</sup>

The population of Constantinople was fifty percent Christian as late as 1914 but in 2005 it is about one percent.<sup>4681</sup>

The last Orthodox seminary was closed in 1971 and was only reopened in 2004 in Turkey's bid to become part of the European Union. Under Turkish law "the Ecumenical Patriarch of Constantinople must be a Turkish citizen, born and raised in Turkey."<sup>4682</sup> Turks protested the reopening of the seminary, as *EU Business* reported:

Nearly 1,000...stone-throwing...protesters marched to the headquarters of the Greek Orthodox Church in *Istanbul* on Sunday and burned an effigy of the Ecumenical Patriarch Bartholomew I.<sup>4683</sup>

Bat Yeor, Robert Spencer (*DhimmiWatch.org*) and others discuss *Dhimmitude* in books and on web sites. In the *Ottoman Empire*, *Dhimmis* were called *Gavours* and *Rayas*, among other terms.

<i>Dhimmi</i> , NOT under <i>Sharia</i> law	Western <i>Dhimmis</i> are non- <i>Muslims</i> who are naïve or are in denial, about <i>Islam's</i> pernicious religious ideology.
---	--

Western *Dhimmis* consciously or unconsciously accept a diminished social and religious status in deference to *Muslims'* supersessionist (*K* 003:067) and supremacist (*K* 003:139; 005:056; 008:030; 009:029, 033; 048:028; 061:009) beliefs, demands and veiled threats of terrorism.

Western *Dhimmis*, particularly politicians and academics, accede to *Islamists* rhetoric and demands in order not to seem politically incorrect or racist. They also hope to: 1) not become a terrorist assassination target, 2) spare their countries some terrorism and 3) gain the goodwill and gratuities from oil *emirs* and petrol sheikhs.

<i>Din</i>	Faith, usually a reference to <i>Islam</i> .
<i>Eid Al Fitr</i>	<i>Eid Al Fitr</i> means "Feast of breaking the fast." <i>Eid Al Fitr</i> marks the end of the lunar month of <i>Ramadan</i> , when the crescent-moon marking the start next lunar month appears. See <i>Iftar</i> .
<i>Eid Al Adha</i>	<i>Eid Al Adha</i> means "Feast of the Sacrifice." This feast occurs on the tenth day of the <i>Hajj</i> , which is the tenth day of the lunar month of <i>Zulhijjah</i> , which is the twelfth month of the <i>Islamic</i> lunar year.
<i>En masse</i>	French: In one group or body; all together.
<i>et al.</i>	Latin: <i>Et alii</i> , meaning "and others."
<i>Etc.</i>	Latin: <i>Et Cetera</i> , meaning "And the like."
<i>Eurabia</i>	The term was coined in the 1970's as the title of a magazine but

Bat Yeor popularized the term.<sup>4684</sup> *Eurabia* denotes how Western Europe has been invaded by *Muslims*, most of whom came legally or illegally to the European Union states starting in the mid-1950's. Due to graying and shrinking indigenous

<sup>4680</sup> Pipes, Daniel. "Disappearing Christians in the Middle East," *Middle East Quarterly*, Winter 2001, *DP*.

<sup>4681</sup> Hugh, Fitzgerald. "*Muslims* in the West," *DW*, 26 Aug 2005.

<sup>4682</sup> Spencer. "Turkey: violent protests against Greek Orthodox patriarchate, *DW*, 6 Sep 2004.

<sup>4683</sup> "Greece condemns Turkish protests outside Greek Orthodox..." *Idem*.

<sup>4684</sup> Bernhard, Brendan. "The Fallaci Code," *laweekly.com*, 15 Mar 2006.

populations and young and burgeoning *Muslim* populations, Bernard Lewis stated that trends indicate that...

...Europe will be *Islamic* by the end of the century,” meaning by 2100 AD.<sup>4685</sup>

<i>Fatwa</i>	An edict issued by a <i>Muslim</i> cleric such as a <i>Mufti</i> or a <i>Muftia</i> , a woman cleric.
FGM	Female Genital Mutilation, a.k.a., female circumcision. The US

State Department web site states that there are four types of FGM, as does the National Organization of Circumcision Information Resource Centers (nocirc.org).

The first three types of FGM are progressively worse, while the fourth pales in comparison to the first three types. Most often no anesthesia and no antiseptics are used, and the cutting instrument can be scalpels, knives, broken glass, used razor blades or whatever is available. The four FGM types are:

- ☉ FGM Type I: Clitoridectomy (cutting out the clitoris and sometimes the clitoral hood).
- ☉ FGM Type II: Excision (removing both the clitoris, clitoral hood and inner vaginal lips).
- ☉ FGM Type III: Infibulation (excision of the clitoris, as well as the inner and outer vaginal lips, and the stitching together of the vaginal opening, except for tiny holes to release urine and menses).
- ☉ FGM Type IV: Pricking, piercing and incising (the organs may heal or scar, depending on the severity of the Type IV abuse).

The U.N.'s World Health Organization (WHO) Study Group on Female Genital Mutilation and Obstetrical Outcome found that...

The minor forms of mutilation caused about a 20 percent rise in death rates, while extensive procedures caused rises of over 50 percent. By almost all measures studied by the WHO, a history of genital mutilation put both mother and baby at risk. Mothers who had had the procedure had longer hospital stays, experienced more blood loss and were more likely to need a Caesarean section. Babies were nearly twice as likely to require resuscitation. Worse still, the researchers noted, the study almost certainly underestimates the potential for death and damage, since it only included women who delivered their babies in hospitals. Many women in the African nations where genital mutilation is practiced deliver their babies at home, where medical complications like severe bleeding cannot be treated and an ailing newborn cannot be resuscitated. Although the exact reason for the rise in mortality was not clear, the researchers noted that it made anatomical sense: Genital mutilation results in severe scarring of the vagina and surrounding area, so it might make it more difficult for babies to emerge.<sup>4686</sup>

The US State Department reports on FGM in Africa, Indonesia and *Yemen* (state.gov/g/wi/rls/rep/crfgm), but does not mention its presence in other Arab countries, nor in the *Muslim* diaspora in Europe and the United States. FGM is practiced extensively throughout *Islamdom*, however. For instance, *The Christian Science Monitor* reported that a Kurdish cleric said:

<sup>4685</sup> Pipes, Daniel. "The *Islamic* States of America?" *DP*, 23 Sep 2004.

<sup>4686</sup> Rosenthal, Elisabeth. "Study tracks genital cutting's deadly legacy," *International Herald Tribune*, iht.com, 2 Jun 2006.



According to the *Shafi'i* school, which we Kurds belong to, circumcision is obligatory for both men and women. The *Hanbali* [school] say it is obligatory only for men.<sup>4687</sup>

The *Wikipedia* entry on *Shafi'i* states:

*Shafi'i* [school] is practiced throughout the *Ummah*, but is most prevalent in Egypt, Indonesia, Thailand, Singapore and the Philippines, and is the school of thought officially followed by the government of *Brunei Darussalam* and *Malaysia*. It is followed by approximately 15 percent of *Muslims* worldwide [i.e. 195 million *Muslims*].

That the *Shafi'i* school is both widespread and promotes FGM explains why...

...the practice is known to exist throughout the Middle East, particularly in northern *Saudi Arabia*, southern Jordan and *Iraq*. There is also circumstantial evidence to suggest it is present in Syria, western *Iran* and southern Turkey.<sup>4688</sup>

*Muhammad* endorsed FGM in one of the six major *Hadith* collections:

A woman used to perform circumcision in *Madina*. The Prophet...said to her: Do not cut severely as that is better for a woman and more desirable for a husband (*Sunan of Abu Dawud*, bk. 41, no. 5251),

<i>Fn.</i>	Footnote.
<i>Giaour</i>	Pronounced “jour.” A <i>Kafir</i> . An infidel.
<i>Hajj</i> or <i>Haj</i>	The major annual (based on the lunar calendar) pilgrimage at <i>Makka</i> . The <i>Hajj</i> occurs during the twelfth month, <i>Dhu-Hijjah</i> , of the <i>Islamic</i> lunar year.
<i>Hajji</i>	Pilgrim who is performing the <i>Hajj</i> , or has completed the <i>Hajj</i> .
<i>Halal</i>	The <i>Islamic</i> version of <i>Kosher</i> food. See <i>Dhabh</i> .
<i>Hanif</i>	Pre- <i>Islamic</i> monotheistic worshipper of <i>Allah</i> and adherent to the informal, loosely organized Religion of <i>Ibrahim</i> . Tradition suggests that <i>Hanifs</i> lived and traveled throughout the Mideast.
<i>Hatim</i>	The low, semi-circular freestanding wall on the northwest side of the <i>Kaaba</i> .
Henotheism	English: Serving one god without denying the existence of others (Greek: <i>heno</i> =“one”+ <i>theo</i> =god+ <i>ismos</i> ). Same as “Monolatry.”
<i>Heylel</i>	Hebrew word used to designate Venus in Isa 14:12-14.
<i>Hijab</i>	A <i>Hijab</i> is a <i>Muslim</i> woman’s headscarf. A man’s headscarf is called a <i>Kaffiya</i> or <i>Ghutra</i> . The head cloth with cords is called an <i>Akal</i> . <i>Salafi</i> literalists and other <i>Muslims</i> claim that <i>Sharia</i> law dictates that women wear the <i>Hijab</i> , and this religious duty is called <i>Fard Dinee</i> .
<i>Hijr</i>	The <i>Kaaba</i> and the <i>Hatim</i> Wall border the <i>Hijr</i> area.
<i>Hijri</i>	The <i>Islamic</i> lunar religious calendar. See “AH” in this Abbreviations section for further explanation.
<i>Hilal</i>	The crescent-moon.
<i>Houris</i>	<i>Houris</i> are <i>nymph</i> nymphomaniacs awaiting <i>Muslims</i> in <i>Muslim</i> heaven ( <i>Janna</i> ). See the Khidr-Second Lamech Logic table.
<i>Hudna</i>	<i>Hudna</i> means truce or cease-fire. A <i>Tahdiya</i> (or <i>Tahidiya(h)</i> ) means “lull” or “calm” in Arabic.
<i>Iblis</i>	Satan. The Devil.

<sup>4687</sup> Birch, Nicholas. “Female circumcision surfaces in *Iraq*,” news.yahoo.com, 10 Aug 2005, *DW*.

<sup>4688</sup> Birch, Nicholas. “Female circumcision surfaces in *Iraq*,” news.yahoo.com, 10 Aug 2005, *DW*.

<i>Idem</i>	Latin: Something that has been mentioned previously.
I.e.	Latin: <i>id est</i> , meaning “that is,” or “in other words.”
<i>Iftar</i>	Meal of dates that breaks the <i>Ramadan</i> fast at sunset each day of the lunar month. See <i>Eid Al Fitr</i> .
<i>Ihram</i>	A holy state entered into during the <i>Hajj</i> and <i>Umra</i> pilgrimages at <i>Makka</i> where <i>Muslims</i> wear a scanty, white wrap.
<i>Ilah</i>	<i>Ilah</i> is the generic Arabic term for “god.” <i>Allah</i> is sometimes called <i>Ilah</i> : “ <i>Allah!</i> There is no God [ <i>Ilah</i> ] save him... <i>Allah</i> is only one God [ <i>Ilah</i> ]” (K 002:255...004:171).
<i>Imam</i>	Literally “leader.” A <i>Muslim</i> prayer leader or community leader.

Among the *Shias* though an *Imam* has the same status as a *Caliph* among the *Sunni*.

*Imams* or *Khatibs*, preach from the *Koran* with its 164 War verses, and throughout most of the history of *Islam* preached with a sword in hand.<sup>4689</sup> *Imams* encourage murder via their *Fatwas* and sermons, and *Imams* often are the purveyors of terrorism, riots, pogroms, genocides and ethnocides.

The *Koran* encourages the killing of pagans and the fighting and conquering of Jews and Christians. The Bible needs no hate-law exemption since nowhere does it suggest that Jews or Christians fight and kill peoples that exist. The *Koran* says to ambush and kill pagans (K 009:005) and fight and conquer Jews and Christians (K 009:029), in other words practically all non-*Muslims* and heretical *Muslims*.

Since *Imams* preach from the *Koran*, many *Imams* really are just preachers of hate, inciters of murder, and cheerleaders and promoters of *Jihad*, as Swank wrote:

The world right now is being threatened by a religion of hell. Its deity is the devil. Its holy book is unholy. Its clerics are not clergy persons of the revealed truth. They are agents of murdering schemes. That is it. If you don't believe it, read the paper, listen to the news. And if you still reach the conclusion that *Islam* is a peace religion, God help your brain cells.<sup>4690</sup>

*The New York Times* opined about *Imams*' sermons:

While such a sermon may be incitement, recruitment takes a more shadowy course and is hard to detect, a senior antiterrorism official said. ‘Believers are appealed to in the *Mosques*, but the real conversations take place in restaurants or cafes or private apartments,’ the official said.<sup>4691</sup>

There may be one *Imam* for every fifty *Muslims* since many *Mosques* are small. The guesstimated 24 million *Imams* constitute the priests and officer corps of *Islam*. Since *Islam* is a war-god religion, its 1.2 billion adherents constitute the largest mix of standing army and camp followers in history.

<i>Injeel</i>	Arabic for Gospel, referring to the four New Testament Gospels.
<i>InshAllah</i>	Arabic expression meaning “If <i>Allah</i> wills it.”
<i>In toto</i>	Latin meaning “Totally; altogether.”
<i>Islam</i>	<i>Islam</i> is a Bilibicized Arabian war-and-moon-god religion that has

become a world religion second only to Christianity in terms of number of adherents.

Since *Islam* is a war-god religion, its 1.2 billion adherents constitute the largest mix of standing army and camp followers in history.

<sup>4689</sup> Zwemer. *Heirs*, ch. 4, pp. 42-43.

<sup>4690</sup> Swank, J. Grant J. “Do I Spew Hate When Revealing *Koran* Killing Passages,” *michnews.com*, 23 Apr 2004.

<sup>4691</sup> Tyler, Patrick E. “Militants in Europe Openly Call for *Jihad* and the Rule of *Islam*,” *New York Times*, *nytimes*, 26 Apr 2004.

<i>Islamism</i>	The pure form of <i>Islam</i> that tends to follow the 164 War verses.
<i>Islamist</i>	An <i>Islamist</i> is different from an <i>Islamicist</i> , i.e. an <i>Islamologist</i> .

An *Islamist* is a *Muslim* who seeks to establish a worldwide *Caliphate* through violent means. *Islamists* are just *Muslims* who take the *Koran's* commands to fight and conquer more seriously than the average *Muslim*. *Islamists* are by-the-book *Muslims*, the book being the *Koran*, as well as the *Hadith* and the *Sharia* law code.

*Islamists* are in many ways like fascists. The socialist and communist fascists promised a workers' materialistic paradise on earth and no afterlife. "No afterlife" is a "good afterlife" if one's morality is based on "the ends justifies the means," and "the good of the many outweighs the good of the few." Similarly, *Islamists* are promised a work-free warriors' paradise on earth, or a work-free warriors' afterlife if they are killed during *Jihad*.

A major way *Islamism* is set off from other forms of totalitarianism is *Islamism* is more artistic—no gray impersonal clothing and soulless concrete-gray or white-marble monumental buildings that exude power but no warmth.

<i>Islamo-Christian</i>	<i>Islamo-Christians</i> are a subset of <i>Islamo-infidels</i> and are Christians or former Christians, often Arab Christians, who mischaracterize and minimize the malevolent motivations and goals of <i>Islamists</i> . Some <i>Islamo-Christians</i> are Hanan Ashrawi, Fawaz Gerges, Rami Khoury and Edward Said. Some <i>Islamo-Christians</i> eventually convert to <i>Islam</i> . Hugh Fitzgerald coined and the defined the term <i>Islamo-Christians</i> :
-------------------------	---

Any *Islamo-Christian* Arab who promotes the *Islamic* agenda, by participating in a campaign that can only mislead Infidels and put off their understanding of *Jihad* and its various instruments, is objectively as much part of the problem as the *Muslim* who knowingly practices *Takiya* in order to turn aside the suspicions of non-*Muslims*. Whoever acts so as to keep the unwary infidel unwary is helping the enemy.<sup>4692</sup>

[*Islamo-Christians*] lie on behalf of *Islam*—some out of fear, some out of an ethnocentric identification...some out of venality (if Western diplomats and journalists can be on the Arab take, why not Arabs themselves?), some out of careerism (if you want to rise in the academic ranks and your field is the Middle East, unless you are a real scholar—Cook or Crone or Lewis—better to parrot the party line, which costs you nothing and gains you friends in tenure-awarding, grant-giving, reference-writing circles.<sup>4693</sup>

While there is a whole spectrum of activities and arguments that *Islamo-Christians* engage in, an example would be what Hugh Fitzgerald wrote about:

[One] who wishes to prevent inquiry into the origins of the *Koran*—or to prevent philological study (of, for example, Aramaic and other loan-words)...and one whose unwillingness to encourage such study is...a fervent Defender of the [*Islamic*] Faith.<sup>4694</sup>

Other litmus tests for *Islamo-Christians* is if their heroes are *Muslims* and if they are offended at anyone who criticizes or pokes fun at *Muhammad*. *Haaretz* reported:

Bishara doesn't like talking about being a Christian. He sees such discussions as manipulative and an attempt to stir up discord in Arab society. This time, he finishes the question himself. 'What are you asking? If I'm going

<sup>4692</sup> Fitzgerald, H. "Ten Things to Think When Thinking of *Muslim* 'Moderates,' *JW*, 25 Nov 2004.

<sup>4693</sup> Fitzgerald, Hugh. "The Elusive Moderate *Muslim*," *JW*, 24 Nov 2004.

<sup>4694</sup> Fitzgerald, H. "Ten Things to Think When Thinking of *Muslim* 'Moderates,' *JW*, 25 Nov 2004.

out of my way to be pro-*Islamic* because I'm a Christian?' he says, with a big laugh. 'I try not to turn the fact that I'm a Christian into an agenda. Actually, I was born into an *Islamic* milieu and I'm part of an *Islamic* culture. The heroes of *Islam* are my heroes. I live among *Muslims* and I don't set myself apart, but I don't kowtow either. All members of *Balad*, whether they are *Druze* or *Muslim Sheikhs*, were upset about the cartoons mocking the Prophet Mohammed.'<sup>4695</sup>

**Islamophobia** Islamophobia is the catchall term for a basketful of **alleged** phobias such as: *Jihado-phobia*, *Shahido-phobia* (i.e. miniskirt-chasing suicide-bomber-phobia), *Sharia-phobia* and Terroristo-phobia.<sup>4696</sup> A phobia is an irrational fear of something, but what is not rational about fearing *Islam*?

People who warn about *Islamism* are concerned about their society's self-preservation in the face of a fascist threat. Warners about *Islamism* are like Churchill who voiced his concerns about the Nazis and fascists though this message was not well received at first. Churchill's critics counseled that the vast majority of Germans did not support Naziism and today people say the same regarding *Muslims* and *Islamists*.

Those who slap the *Islamophobe* label on non-*Muslims* who pay heed to what *Islamists* are actually saying are themselves deceived about the true nature of *Islam*, or they are intent on deceiving others about *Islam*'s true nature.

Some critics say that so-called *Islamophobes* who call terrorists "*Jihadists*" ought not to do so because that legitimizes terrorists.<sup>4697</sup> *Muslims*, however, call those terrorists who kill *Muslims Takfiris* after the terrorists' habit of declaring *Muslims* to be non-*Muslims*, yet no one says that *Muslims* calling terrorists *Takfiris* legitimizes those particular terrorists. Besides, the fact that terrorists kill hoping to advance *Islam* means that infidels ought not let terrorists think they can kill all they want because the foolish infidels will never fail to sing the praises of *Islam* (e.g. *Islam* is a religion of peace™) even as they are assaulted daily. Moreover, *Muslims* ought not to think they can say and do little to nothing about *Islamists* in their midst without *Islam*'s reputation suffering as a result because Westerners do not, or ought not, mind being killed off one-by-one or *en masse*.<sup>4698</sup> Surely, the meager efforts that *Muslims* put into squashing *Islamic* terrorism is not worthy of infidels entrusting their civilization and placing their very lives in the hands of moderate *Muslims*.

The Grand *Mufti* of *Bosnia*, Mustafa Ceric, "expressed concern about the rise of anti-*Islamic* hysteria in the West" and "he added that there was 'no such thing as *Islamic* terrorism.'<sup>4699</sup> Even if it were true that terrorists misunderstand *Islam* and there is no such thing as *Islamic* terrorism, is it not right to fear the prevalence and resist the spread of any doctrine—no matter how benign—when that doctrine is so readily misunderstood in such violent ways? Therefore, one ought to call terrorists "*Islamic*" terrorists even if terrorists are *Islamic* heretics, especially since *Jihadists* are not excommunicated, but are widely heralded by *Muslims* as heroes and martyrs.

<sup>4695</sup> Galili, Lily. "A Green Line runs between them," haaretz.com, 23 Feb 2006.

<sup>4696</sup> Isshaytan, Uhler. Comment on "D.C. Watson: A Call To...", *DW*, 18 Dec 2004.

<sup>4697</sup> Garamone, Jim. "Loosely Interpreted Arabic Terms Can Promote Enemy Ideology," defenseink.mil, 22 Jun 2006, *JW*.

<sup>4698</sup> Scheherezade, Faramarzi. "*Muslims* address silence on Europe attacks," news.yahoo.com, 24 Jun 2006, *LGF*.

<sup>4699</sup> Gorin, Julia. "In Birmingham, the benevolent face of *Jihad*," jewishworldreview.com, 26 Apr 2006, *DW*.

The *Islam*-Sirens who use the *Islam*phobia slur are akin to those who said in the past that the West had nothing to fear from Naziism and Communism. Fools and the self-deceived have never been in short supply anywhere.

*Islam*-Sirens may be cynically tricking the public, or they may be sincere in what they are saying. Cynical *Islam*-Sirens think of themselves as being advisers like Hushai the *Arkite* (2Sa 15:33-35; 17:07-14). *Islam*-Sirens think that infidels are all Absaloms whom they must mislead in order to re-establish the *Caliphate* and save the faith—that being *Islam*.

Infidels who rely on moderate *Muslims* for their opinion of *Islam* are the blind leading the blind because even moderate *Muslims* do not see the threat of *Islamism* coming (Mat 15:14). For instance, in 2006 *Shia Muslims* were surprised that sectarian strife arose in New York when their twentieth annual *Shiite* religious procession ran into the *Sunni Islamic* Thinkers Society. They were yelling “*Kafir!*” and were carrying placards saying “*Enemies of Islam!*” “*Shia* are NOT *Muslims!*” and “*Shia* is made of superstitious elements of Judaism.” Police had to break up the shoving match. Naqvi, president of *Shah E Najaf Islamic* Center in Brentwood, said:

We never thought it could happen in New York... In other countries, yes.

But not here...It is very worrying.<sup>4700</sup>

A lack of fear is the opposite of a phobia but a lack of fear does not necessarily equal courageousness. People who lack a healthy fear of say, heights, are prone to falling from heights. The *Dodo* bird had a lack of fear of both man and introduced predators, and for this it went extinct. (*Dodo* means “fool” in Portuguese.)

The *Warrarh*’s scientific name is *Dusicyon australis*, which means “foolish dog of the south.” This refers to the *Warrarh*’s lack of fear of man that made it easy for sheepherders to liquidate them. An infidel’s lack of fear of *Islamists* leads to *Islamization*, beheadings, amputations, whippings and lack of free speech.

*Islam*-Sirens serve up multicultural pipe dreams and prescriptions, and they use platitudes and bromides to numb the minds of infidels whose cultures and religions they wish to destroy incrementally. For instance, at an international conference...

...political figures from *Islamic* countries, including the presidents of *Iraq* and Afghanistan, argued that it should never be labeled ‘*Islamic*’ or ‘*Muslim*’ terrorism because *Islam* is based on peace, dialogue and tolerance.<sup>4701</sup>

Anyone linking *Islam* to terrorism draws criticism from *Islam*-Sirens and *Islam*-baiters, who often are the same people:

Ⓒ *Islam*-Sirens call *Islamic* scholars and *Islamic* terrorists who link *Islam* with terrorism “fundamentalists,” “*Wahhabis*,” “extremists,” “heretics” and *Takfiris* (or *Takfireen*), after their habit of justifying the killing of fellow *Muslims* by declaring them non-*Muslims*.<sup>4702</sup>

Ⓒ *Islam*-baiters call non-*Muslims* who link *Islam* and terrorism “ignorant” and “*Islamophobes*” as though:

★ *Islam* is so sublime and nuanced that even many learned *Muslims* misunderstand *Islam* and become terrorists, or terrorist supporters. Thus no non-*Muslim* has a chance of fathoming, or even getting the gist of, what *Islam* is all about—no matter how many books they read.

<sup>4700</sup> Eisenberg, Carol. “We never thought it could happen in NY,” newsday.com, *JW*.

<sup>4701</sup> Eggleston, Roland. “Vienna Conference on *Islam* Ends With Appeals For Understanding, Tolerance,” payvand.com, 17 Nov 2005.

<sup>4702</sup> “*Sunnis* and *Sadr*’s *Shiites* make peace,” theaustralian.news.com.au, 26 Feb 2006.

- ★ The vast majority of *Muslims* subscribe to a traditional, mainstream school of moderate *Islam*, so *Muslim* schools and *Madrasas* are stocked with creedal statements and tomes that read just like the books of Western apologists for *Islam* (e.g. Karen Armstrong, John Esposito).

*Islamophobes* are in actuality *Islam*-realists who do not respond to the Pied Piper calls issued by *Islam*-Sirens, nor are *Islam*-realists intimidated by attempts to ban or criminalizing their fact-based opinions about *Islam*—a scorched-earth propaganda trick. *Islam*-realists realize that if too many infidels are cowed into kidding themselves about the true nature of *Islam*, they might personally experience *Islam* in its full-bodied form rather than just reading about it.

Until just recently, *Islamic* terrorists often rejected the “*Islamic* terrorist” label since it made for bad publicity, but now they often embrace the label. For instance:

- ☉ *Sheikh* Abed al-Qadr bin Abed al-Aziz, the mentor for Ayman Al-Zawahiri, the No. 2 man in *Al-Qaeda*, asserted:

Terror is from *Islam* and anyone who denies this is a heretic.<sup>4703</sup>

- ☉ *Time* magazine reported: “Unlike many other insurgents, who reject the terrorist label and call themselves freedom fighters or holy warriors, Marwan embraces it. ‘Yes, I am a terrorist,’ he says. ‘Write that down: I admit I am a terrorist. [The *Koran*] says it is the duty of *Muslims* to bring terror to the enemy, so being a terrorist makes me a good *Muslim*.’ He quotes lines from the *Surah* known as *Al-Anfal*, or the Spoils of War: ‘Against them make ready your strength to the utmost of your power, including steeds of war, to strike terror into the enemy of *Allah* and your enemy’ [K 008:060]... ‘It doesn’t matter whether people know what I did,’ he says. ‘The only person who matters is *Allah*—and the only question he will ask me is ‘How many infidels did you kill?’”<sup>4704</sup>

- ☉ In 2005, *Umm* Nidal, mother of three *Hamas* “martyrs,” said on PA TV:

I am proud and honored to be a terrorist for the sake of *Allah*...[here she quoted K 008:060]. I am happy to implement this *Koranic* verse myself and to be a terrorist for the sake of *Allah*.<sup>4705</sup>

- ☉ In 2005 the Chechnyan terrorist Basayev “admitted that he was ‘a bad guy, a bandit...Ok, so I’m a terrorist, but what would you call them (the Russians)?”<sup>4706</sup>

- ☉ In 2005, one Jordanian terrorist said:

You are the real criminals. *Islam* will prevail...If you consider the *Jihad* to be terrorism, then, I declare that we are proud to bring terror to your very hearts. The word terrorism is a medal of honour for us.<sup>4707</sup>

Terrorists are now responding to those who deny the connection between *Islam* and terrorism, saying that the *Islam*-Sirens are apostates and heretics, for instance:

- ☉ UK-based *Al-Ghurabaa Islamists* issued a statement saying: “Any *Muslim* that denies that terror is a part of *Islam* is *Kafir* [an unbeliever].”<sup>4708</sup>

<sup>4703</sup> Ein-Gil, Ehud. “The roots of *Jihad*,” haaretz.com, 19 Mar 2006.

<sup>4704</sup> Ghosh, Aparisim. “Inside the Mind of an *Iraqi* Suicide Bomber,” time.com, 26 Jun 2005, JW; also see Spencer, Robert. “Yes, I am a Terrorist,” *FPM*, 29 Jun 2005, JW.

<sup>4705</sup> “Palestinian Legislative Council...” Special Dispatch 1063, MEMRI.org, 4 Jan 2006, JW.

<sup>4706</sup> “Basayev broadcast enrages Russia,” news.bbc.co.uk, 29 Jul 2005.

<sup>4707</sup> “Zarqawi death-sentence sought,” news.com.au, 28 Nov 2005, C&R.

<sup>4708</sup> “Battle for the heart of *Islam*,” timesonline.co.uk, 24 Jul 2005.

Ⓒ "...*al-Qa'ida* leader Mahfouz Walad *al-Walid* has cited this very verse [K 008:060] as a justification for terrorism, in an interview for *Al Jazeera* on November 30, 2001: 'This terrorism is a divine commandment. *Allah* has said...[here *al-Walid* quotes K 008:060]. Striking horror, panic and fear in the hearts of the enemies of *Allah* is a divine commandment and the *Muslim* has in this matter two choices: Either he believes in these verses, which are clear, or he denies these verses and [becomes] an infidel. The *Muslim* has no other option."<sup>4709</sup>

Some *Islamo-Sirens* and *Islamo-baiters*, who are not necessarily *Muslim*—want to increasingly use anti-vilification, anti-hate laws and civil rights laws against *Islamo-realists*, several of whom have been fined and jailed right in the West.

Some *Islamo-Sirens* and *Islamo-baiters* are not satisfied with just toying with *Islamo-realists*, but want to punish *Islamo-realists* and increase censorship of the press. For instance, Turkish President Erdoğan said "*Islamic-phobia*" and "*anti-Islamism* must [both] be treated as a crime against humanity just like anti-Semitism."<sup>4710</sup> Daniel Pipes. Pipes explains why *Islamists* find these labels necessary:

In addition to terrorism and other forms of violence, the current war also involves a battle of ideas, with *Islamist* totalitarians on one side and their opponents on the other. To convince the undecided, each side tries to discredit the other. This is a battle I am intensely engaged in to show the true nature of the *Islamist* organizations.<sup>4711</sup>

*Muslims* should dispense with this discredited term [*Islamophobia*] and instead engage in some earnest introspection. Rather than blame the potential victim for fearing his would-be executioner, they would do better to ponder how *Islamists* have transformed their faith into an ideology celebrating murder (*Al-Qaeda*: "You love life, we love death") and develop strategies to redeem their religion by combating this morbid totalitarianism.<sup>4712</sup>

<i>Isnad</i>	Chain of authorities who supposedly handed down a tradition. The traditions' provenance.
<i>Jamara</i>	Three pillars that <i>Hajjis</i> stone at <i>Mina</i> outside of <i>Makka</i> .
<i>Jihad</i>	There are several types of <i>Jihad</i> : Defensive ( <i>Fard Ayn</i> ), Offensive ( <i>Fard Kifaya</i> ), <i>Jihad</i> of the Tongue ( <i>Al-Jihad bil-Lisan</i> ), <i>Jihad</i> of the Pen ( <i>Al-Jihad bil-Qalam</i> ) and Checkbook <i>Jihad</i> ( <i>Al-Jihad bil-Mal</i> ).

*Islamic* jurists state that offensive *Jihad* is the responsibility of the entire *Muslim* community (the *Umma*), but Defensive *Jihad* is incumbent upon each individual *Muslim*.

Here is what *Jihad* and *Islam* are really all about:

*Islam* = *Jihad* = Legalized terrorism + Loot + (Sex)slaves + *Houris* + Paradise

Majid Khadduri wrote that *Islam* is *Jihad*:

<sup>4709</sup> Durie, Mark. "Anti-dhimmitude...the theological roots of *Islamic* terror," *JW*, 10 Nov 2005.

<sup>4710</sup> "Anti-*Islamism*": Albayrak, Mukremin & Nuri Imre. "Erdoğan Asks *Islamic* Leaders to Explain *Islam* in the Best Way," zaman.com, 6 Sep 2005, *Islamonline.net*, *DW*; "*Islamic-phobia*": Ser, Sam. "Turkey's chief rabbi attends 'Meeting of Civilizations,'" jpost.com, 30 Sep 2005.

<sup>4711</sup> Pipes, Daniel. "Weblog: I Am a Runner-Up for an '*Islamophobia*' Award," *DP*, 26 Jun 2004.

<sup>4712</sup> Pipes, Daniel. "*Islamophobia*?" *FPM*, 25 Oct 2005, *DW*.

The universality of *Islam*, in its all embracing creed, is imposed on the believers as a continuous process of warfare, psychological and political if not strictly military.<sup>4713</sup>

*Jihad* literally means “struggle” and is said to apply to an inner spiritual Struggle, but *Jihad* most often is rightly translated “Holy War.” Whether there really is a personal spiritual “struggle” for sanctification type of *Jihad* is debatable (see the Table of Contents for the *Jihad* “Sham” sections). The reason that *Muhammad* chose an ambiguous term for Holy War is revealed in the *Koran*:

When a decisive chapter is revealed and fighting is mentioned therein, you see those in whose hearts is a disease look as though they were swooning at the approach of death (*K* 047:020; see also 002:216; 004:077; 009:086; 033:010-012).

Using an ambiguous term like “struggle” means *Muslims* who are averse to fighting can claim that *Jihad* means “self-improvement,” while those enthusiastic about terrorism and fighting can interpret *Jihad* as meaning Holy War.

Using an ambiguous term means *Muslims* can dupe non-*Muslims* into thinking that *Islam* is a peaceful religion. *Muslims* can convince non-*Muslims* that the *Koran*’s 164 War verses threatening death to non-*Muslims* are really just self-help advice in the form of bogus death threats against non-*Muslims*.

Some *Muslims* claim that *Jihad* war is called only for self-defense but history shows that most *Islamic* Holy Wars have been offensive in nature. For instance, it is hard to make the case that the Byzantine and Persian Empires threatened the desert kingdoms of *Makka* and *Madina* at all. The French, Indians, Armenians and others posed no threat to the *Muslims* who attacked them. In fact when the *Muslims* came slaughtering, most non-*Muslims* were unprepared for any type of war, much less an ideological and religious war.

<i>Jinn</i>	Mischievous spirits, not quite demons.
<i>Jizya</i>	<i>Jizya</i> is the poll tax that <i>Dhimmis</i> living under <i>Sharia</i> law must

pay. *Muhammad* describes *Dhimmis* as Christians and Jews who must pay a *Jizya* poll tax, acknowledge the superiority of *Islam* and are in a state of subjection to *Muslims* (*K* 009:029). *Jizya* is all about *Muslims* living off the labors of others.

Since colonial times *Sharia* law has not been fully enforced in *Islamdom* in that infidels have not paid the *Jizya* tax—at least in name. There are many discriminatory laws and taxes that infidels must pay in *Muslim* lands where they are second-class citizens.

Much Western foreign aid to *Islamic* countries could easily be considered a *Jizya* tax. The *Bumiputra* (Sons of the Soil) system in *Malaysia* could be considered a *Jizya* tax since it requires every non-*Muslim* firm to have silent partners—*Malay Muslims* who often contribute nothing but take a share of the profit.<sup>4714</sup>

Some apologists for *Islam* try to say that it was fair that Christians paid the *Jizya* tax because *Muslims* had to serve in the military. This however was no bargain because this arrangement left the Christians without training in arms. This led to the utter domination of Christians at the hands of *Muslims* resulting in many genocides and ethnic cleansings.

<sup>4713</sup> Khadduri, Majid. *War and Peace in the Law of Islam*, 1955, Richmond, Virginia, pp. 63-64, as quoted in Boston, Andrew G. “John Quincy Adams Knew *Jihad*,” *FPM*, 29 Sep 2004.

<sup>4714</sup> “Discrimination against non-*Muslims* in Malaysia,” biography.ms, *DW*, 8 Jun 2005.



In early *Islam* when *Dhimmis* were plentiful, the *Muslim* soldiers were paid very well. David Nicolle wrote:

The lure of wealth and promotion even led men from beyond *Islam*'s frontiers to volunteer as *Ghulams* or *Mamluks*—soldiers of slave origin...There were even cases of voluntary castration since a eunuch's prospects were brighter—at least in career terms....The early 'Abbasid military structure was in fact exceptionally expensive...The payment of troops became the main consideration for governments in almost every corner of the world.<sup>4715</sup>

So *Muslims* kept Christians out of a profitable occupation and made Christians pay the *Jizya* tax besides, which is hardly fair.

Some *Muslim* apologists argue that the *Jizya* poll tax was equal to the *Zakat* charity tax that *Muslims* paid. However, the *Zakat* tax rate is only 2.5 percent for most *Muslims*, the *Zakat* was for the most part voluntary and so went largely unpaid throughout most of *Islamdom* from *Islam*'s inception.<sup>4716</sup>

As a rule, non-*Muslims* were made to pay two or more times as much tax as *Muslims* and in fact as much as Christians could bear and then some. There are many, many accounts of Christians and Zoroastrians and others being whipped to death in order to extort more silver and gold *Dinars*. Sometimes even their pet dogs were whipped along with their *Dhimmi* masters.<sup>4717</sup>

Many *Dhimmis* either converted to *Islam*, or hid from the tax collector, or tried to flee to non-*Muslim* lands, because they were dirt-poor and knew that facing the tax collector would mean certain death. They knew that they could not produce the demanded-*Dinars* even under torture and whipping.

The *Muslim* tax collectors were merciless because the *Jizya* tax was the only thing that separated non-*Muslims* from death at the hands of *Muslims* in accordance with *Muhammad*'s directive (*K* 009:029). Thus it made sense for tax collectors to kill and torture a few non-*Muslims* in order to extract the tax, because if the tax was not forthcoming, the *Dhimmis* would be killed or sold into slavery anyway.

<i>Kaaba</i>	<i>Kaaba</i> is also spelled “ <i>Kaba(h)</i> ,” “ <i>Kaaba(h)</i> ” and “ <i>Caaba(h)</i> .”
	<i>Kaaba</i> refers to the cubic shrine at <i>Makka</i> .
<i>Kafir</i>	An unbeliever. Infidel. Also spelled <i>Kaffir</i> , <i>Kufar</i> , <i>Kuffaar</i> , etc.
<i>Kaffiya</i>	See <i>Hijab</i> .
<i>Kalima</i>	Short <i>Islamic</i> creed professing monotheism. Also called The <i>Shahada</i> .
<i>Khalifa</i>	A <i>Caliph</i> is a ruler said to be a successor to <i>Muhammad</i> .
<i>Khalifat</i>	A <i>Caliphate</i> . An evil empire run by a <i>Caliph</i> who imposes <i>Sharia</i> law on the populace and engages in state-sponsored <i>Jihad</i> against non- <i>Muslim</i> states.
<i>Khatib</i>	<i>Mosque</i> preacher, often called an <i>Imam</i> , who gives the <i>Khutba</i> sermon in the Friday main <i>Mosque</i> .
<i>Khutba</i>	A sermon given on Fridays at the Friday (i.e. main) <i>Mosque</i> .
<i>Kibla(h)</i> or <i>Qibla(h)</i>	Direction of prayer toward <i>Makka</i> . In <i>Mosques</i> , the <i>Kiblah</i> is indicated by a <i>Mihrab</i> , and outside by a <i>Sutra</i> pole.
<i>Kiswa</i>	The embroidered fabric covering for the <i>Kaaba</i> .

<sup>4715</sup> Nicolle. *Caliphates*, pp. 6, 11.

<sup>4716</sup> Spencer, Robert. “*IslamOnline: Jizya* is ‘fair,’” *DW*, 20 Sep 2004.

<sup>4717</sup> Boyce, M. A Persian Stronghold, pp. 141-142, as quoted by Bostom, Andrew G. “The Real Roots of *Muslim* Hatred,” *FPM*, 3 Jun 2004.

<i>Kitman,</i> <i>Takiya,</i> <i>Tu Quoque,</i> <i>Turnspeak</i>	<i>Kitman</i> is also spelled <i>Kithman</i> . <i>Takiya</i> is also spelled with one k and two y's, and with a q or q's instead of a k or k's. <b><i>Kitman</i></b> is religiously sanctioned dissembling, feigning by using false pretenses and telling subtle half-truths in order to deceive. A half-truth is often more beguiling than a bold-faced lie just as the proverbial wolf with a sheepskin will nab more sheep than one without.
---	--

An example of a *Kitman* half-truth is for *Muslims* to say that *Jihad* only means “an inner spiritual struggle” like quitting smoking, even though *Jihad* also means violently fighting so-called oppression via physical means.

***Takiya*** is religiously-sanctioned outright deception. *Kitman* and *Takiya* are also referred to as “Holy Hypocrisy” and “*Islamic* outwitting.” *Takiya* is discussed further in the Khidr-Second Lamech Logic table in the section on deception.

***Tu Quoque*** is Latin meaning “you also” and refers to the *Ad Hominem* “You do it too” argument of accusing a critic of the same offense or behavior being criticized. A related argument is the “they, also” argument, where *Muslims* argue that a third-party engages in the same objectionable behavior, so why single *Islam* out? The implication of the “they, also” argument is that the critic just hates *Islam*.

An example of the “you do it too” fallacy is when someone points out that *Islam* is violent, *Muslims* often bring up the Crusades.<sup>4718</sup> Another example is when Christians criticize *Muslims* for slavery, *Muslims* point out that 150 years ago whites enslaved Blacks.

An example of the “they, also” argument is when Christians criticize *Muslims* for some aspect of *Sharia* law (e.g. *Takiya*, treatment of women and *Dhimmis*, death penalty for homosexuality or not attending *Mosque*, etc.), *Muslims* will point out that primitive tribal laws, Catholic canon law or Jewish *Talmudic* or *Halakhic* rules are similar.<sup>4719</sup>

***Turnspeak*** is inverting reality on its head. *Turnspeak* is similar to George Orwell’s “*Newspeak*” where “war is peace” and “freedom is slavery.” *Turnspeak* changes the “bad guys” into “good guys.” *Muslims* use *Turnspeak* to say that their offensive acts are defensive, to say that an opponent’s police action is aggression, and to say that an opponent’s armed retaliation is just a land grab.

Orwell’s 1984 had the Ministry of Truth, and the USSR had *Pravda*, whose name meant “truth” but whose content was lies. So *Jihadists* have outlets that publish their *Turnspeak*: *Hezbollah*’s *Al-Manar* Satellite TV, *Al-Jazeera*, otherwise known as *Jihad* TV, and thousands of Web sites such as *Jihad Unspun*.

<i>Koran</i>	Literally “the recitation,” a.k.a. “unholy writ from the pit.”
--------------	--

*Muhammad*’s *Koran* ought to be called “*Mein Koran*” after Hitler’s *Mein Kampf*.

The *Koran* is both motivational reading for *Islam*-fascists and *Islam*’s manual for war against the enemies of the war-and-moon-god *Allah*. The *Koran* is a license to kill and a hit list with five billion names—all the non-*Muslims* on the globe. *Muslims* are allowed however to leave Christians and Jews unconverted to *Islam* as long as they submit as *Dhimmis* and pay the *Jizya* tax. Otherwise, *Muslims* are to kill even the Christians and Jews.

<i>Kufic</i>	An early Arabic script that is squarish, while the later <i>Naskhi</i> script is cursive (i.e. curvy or curlicue)
--------------	---

<sup>4718</sup> Fitzgerald, Hugh. “*Islam* and NPR, Part I: *Taqiyya* and *Tu-Quoque*,” *JW* 13 Jan 2005.

<sup>4719</sup> “Robert Spencer and the Boston Anti-*Islamic* Controversy,” *JW*, 10 Mar 2005.

Laicist	French: <i>laïcité</i> . Laicists are militant secularists who believe in strict separation of church and state. Secularists, but not Laicists, might blur the separation when it comes to <i>Islam</i> by: 1) reasoning that <i>Muslims</i> do not worship in churches and therefore do not fall under the “church” versus state paradigm and by 2) promoting the study of <i>Islam</i> as culture or as politics rather than as a religion, but in a propogandistic way that leaves students with a very positive impression of <i>Islam</i> .
---------	--

<i>Madrasa/ Madrassa(h)</i>	A school or boarding school- <i>Mosque</i> complex where the <i>Koran</i> is memorized and taught, either as the sole subject of study, or as part of a curriculum. Instruction progresses from the <i>Koran</i> to the <i>Hadiths</i> , theology, religious law and other subjects.
-----------------------------	--

The *Madrasa* label applies to schools attended by boys and girls, as well as to seminaries attended by men. Some *Madrastas* can be compared to Jewish *Yeshivas* where the *Talmud* is taught extensively, or even to the exclusion of all other subjects. In Indonesia a *Madrasa* is called a *Pesantren*.

<i>Mahdi</i> , The	A messianic figure prophesied to return before the Last Day with <i>Isa</i> (Jesus). They will together defeat the one-eyed Antichrist ( <i>Dajjal</i> ).
<i>Maksura</i>	Space by <i>Mihrab</i> partitioned by a low wall or screen.
<i>Mansukh</i>	<i>Koranic</i> verse abrogated and nullified by a <i>Nasikh</i> verse.
<i>Maqam</i>	Standing place for prayer and reflection.
<i>Masjid</i>	A <i>Mosque</i> . The <i>Islam</i> version of a synagogue or church.
<i>Massiah Ad-Dajjal</i>	Literally “Messiah, the Liar,” meaning the Antichrist.
<i>Makka</i>	Also spelled <i>Mekka(h)</i> and <i>Mecca</i> . The city in the Arabian Peninsula where the <i>Kaaba</i> is located.
<i>Mihrab</i>	Concave niche in a <i>Mosque</i> that indicates the <i>Kiblah</i> .
Metathesis	Adjective: Metathetic. Linguistics: The transposition within a word of letters, sounds or syllables, as in the change from Old English <i>brid</i> to modern English <i>bird</i> or... <i>modren</i> for modern ( <i>American Heritage Dict.</i> ).
<i>Miraj</i>	Literally “a ladder.” The Ascent of <i>Muhammad</i> .
<i>Minaret</i>	Arabic: <i>Manarah</i> . The phallic-symbol towers beside <i>Mosques</i> from which <i>Muezzins</i> call the <i>Adhan</i> .
<i>Minbar/Mimbar</i>	Elevated pulpit reached by a set of stairs.
Moderate Muslim	“A <i>Muslim</i> who accepts the nation-state system,” <sup>4720</sup> and a law code, social order and culture not dictated according to <i>Sharia</i> law.
Monolatry	Serving one god without denying the existence of others.
<i>Mosque</i>	The <i>Islamic</i> version of a synagogue or church. Arabic: <i>Masjid</i>
<i>Mumin</i>	A <i>Muslim</i> believer.
<i>Muezzin</i>	A <i>Muslim</i> who calls out the Call to Prayer ( <i>Adhan</i> ). This was formerly done from a <i>Minaret</i> , but now a pre-recorded <i>Adhan</i> is broadcast over loudspeakers, so loudly in fact, that the <i>Adhan</i> can be heard for kilometers.
<i>Mujahid</i>	A <i>Jihadist</i> . <i>Mu-</i> means “one who” and <i>-jahid</i> means <i>Jihad</i> . Plural: <i>Mujahideen</i> , meaning “ <i>Jihadists</i> .”
<i>Muqattaat</i>	Disjointed letters that prefix thirty-four chapters of the <i>Koran</i> .

<sup>4720</sup> Bay, Austin. “Dire Straits: The war on terror’s Singapore front,” *weeklystandard.com*, 3 Mar 2003, vol. 8, issue 24.

<i>Nasi</i>	Intercalation.
<i>Muslim</i>	One who has been hijacked by <i>Islam</i>
<i>Nasikh</i>	Later <i>Koranic</i> verse that abrogates a <i>Mansukh</i> verse.
<i>Naskhi</i>	Later Arabic script more curvilinear than the earlier <i>Kufic</i> script.
Nymphomania	Excessive sexual desire in a woman. See Satyriasis.
no.	Number. The plural “numbers” is abbreviated “nos.”
para.	Paragraph.
PBUH	See AS.
PC-AIDS & PC-ASS	David Brooks of <i>The New York Times</i> wrote in his article “War of Ideology”:

Simply put, the unapologetic defenders of America often lack the expertise they need. And scholars who really know the *Islamic* world are often blind to its pathologies. They are so obsessed with the sins of the West, they are incapable of grappling with threats to the West.<sup>4721</sup>

It is about time that someone puts a label to these two syndromes rather than just talk in generic descriptive terms. These terms (coined by this writer, Yoel Natan) are **PC-ASS** (Political Correctness—Acquired Self-debasement Syndrome) and **PC-AIDS** (Political Correctness—Acquired Intellect Deficiency Syndrome).

### The Five Stages of the Dreaded PC-AIDS and PC-ASS Diseases

**Introduction:** PC-AIDS and PC-ASS are deadly intellectual diseases—especially in the later stages. Liberals and leftists who say that *Islam* is a Religion of Peace™ are apologists for *Islam* and are guilty of aiding and abetting a totalitarian religion that has killed millions and enslaved millions, and will kill more (Mat 23:35; Luk 11:51).

Leftists and *Islamists* defend terrorism and insurgencies, at least in principle, using many ruses. One ruse is claiming that all terrorism and insurgencies are merely defensive and retaliatory in nature. Even Usama *bin* Laden characterizes all of his acts, including 9-11, as being solely defensive and retaliatory in nature.<sup>4722</sup>

Liberals and leftists who want to kill a country start by attacking its morality, patriotism and religion. They teach that right and wrong is bipolar thinking fit only for the unsophisticated. They teach that pride in being a Brit, American, German or Frenchman is nationalistic chauvinism simply because they want capitalistic states to fail.<sup>4723</sup> For the same reason they teach that taking prudent security measures proportionate to the terrorist threat is in fact giving in to terrorists and becoming a police state, and they publish state secrets regardless of the security implications.

Secularists teach that pride in one’s religion is really bigotry and all religions are alike. Secularists teach that one must have a hands-off or kid-glove approach to another’s religion even though *Islam* is the most political religion, even though *Islamists* want to terrorize and conquer the world and even while *Islamists* gather nuclear weapons.

While the West enjoyed its Enlightenment period centuries ago, multiculturalists say *Islam* must develop along its own timeline and on its own terms. This is a

<sup>4721</sup> Brooks, David. “War of Ideology,” nytimes.com, 24 Jul 2004.

<sup>4722</sup> Spencer, Robert. “Esmay’s dismay, and his response,” *JW*, 17 May 2006.

<sup>4723</sup> Pipes, Daniel. “Great Britain—Worth Saving?” *DP*, 14 Jul 2005.

centuries-long project at best, but the West, at least as we know it, may not survive that long if *Islam* does not engage in serious reform now.

Multiculturalists say we must leave our fate in the able hands of a tiny minority of moderate *Muslim* reformers. It is they who will save the day by tinkering with *Islam*'s internal logic even though *Muslim* moderates are powerless, are shunned by mainstream *Muslims*, and have no track record of bringing about long-lasting reform. For instance:

☉ “*Rabbi* Michel Serfaty, from the Jewish-*Muslim* friendship association, said [he] believes that press drawings of biblical figures or Jesus Christ can be printed, but not *Muslim* caricatures. ‘The Christians and us are used to this...We’ve been living in this free speech environment for centuries. They’ve just arrived. We don’t care about these caricatures but they get hurt...the important issue now is to reach civilian peace. **We must let *Muslims* develop their own self-criticism by themselves.**”<sup>4724</sup>

☉ *The Jerusalem Post* editorialized in 2006 that we must entrust our fate to *Islam*'s own reformers and we only “need to welcome voices of reason and encourage *Muslim* theologians willing to engage Westerners in a spirit of mutual respect...**It is for *Muslims* themselves to determine whether their faith**, in this century, will be shaped by the likes of *Iranian* President Mahmoud Ahmadinejad and *Al-Qaida*'s fanaticism, or whether moderate views gain a hearing.”<sup>4725</sup>

Liberals then push for liberal abortion laws, loose drug and immigration laws, and euthanasia legalization. First, unrestrictive abortion laws lead to a labor shortage since laborers are aborted, and many workers are rendered unfit for work by recreational drugs. This leads to *Muslim* immigration to fill the vacuum.

When *Muslims* inside a country turn radical (and there are always at least a few), the government must respond to the *Islamist* siege from within and without. Governments raise taxes and/or cut services in order to pay for more security, prosecuting terrorists, monitoring thousands of *Mosques* and for identifying potential terrorists. Hugh Fitzgerald's signature paragraph on the subject reads:

The large-scale presence of *Muslims* in the Western countries has led to a situation that is more unpleasant, more expensive and more physically dangerous for the indigenous infidels than it would be without that large-scale presence.<sup>4726</sup>

Examples of how security costs have escalated ever since the *Muslim* presence in the West ballooned and became radicalized—both starting in the 1990s—include:

☉ How high-profile sports venues now must have “airport” security, and of course “airport” security came about due to *Islamic* terrorists hijacking planes in the 1970s. Franz Beckenbauer recalled how lax sport security was before before 9-11, and before the terrorism at the 1972 Munich Olympics:

‘I remember the 1966 World Cup in England. There were very few policemen there. The only ones I saw were directing traffic. It was the same in 1970 in Mexico. There was one policeman on duty, wearing a sombrero and clutching an ancient machine-gun. During the siesta period, he fell asleep.’ Germany has not had police on the streets since

<sup>4724</sup> “Jewish dignitaries condemn *Muhammad* cartoon,” ynetnews.com, 2 Feb 2006.

<sup>4725</sup> “Message of the *Haj*,” jpost.com, 9 Jan 2006.

<sup>4726</sup> Spencer, Robert & Hugh Fitzgerald. “FrontPage Symposium on death penalty for apostasy,” *JW*, 28 Apr 2006.

Hitler was vanquished in 1945 and it would be a very large *Rubicon* to cross if they were deployed in this World Cup, requiring an instant change to the nation's constitution. But Interior Minister Schaeuble has vowed such measures if a terror strike makes it necessary.<sup>4727</sup>

- ⊕ With 1.6 million *Muslims* to monitor, the UK security establishment could not even spare the man-hours for a public investigation of the 7/7 bombings, nor could it retroactively increase awards for 7/7 victims since there was no monies available. Why? Within one year of 7/7, there was one copycat subway bombing attempted, three foiled *Al-Qaeda* attacks, twenty “‘major conspiracies’ uncovered by the security services” and in 2006 “1,200 potential terrorist suspects may now be in the UK.”<sup>4728</sup>

Sadly, after *Islamic* terrorist attacks, the infidels' military and contractors are sent to fight in *Islamdom* to protect and shower infidel treasures on—you guessed it—*Muslims*. How ironic! Even in the West and in *Islamdom*, the police are sent to protect *Islamists* at their protests marches. The police also protect *Mosques* everywhere from any backlash they might encounter after an *Islamic* terrorist attack. All this occurs while infidel nations' ports and borders go mostly unguarded and unfenced!

While *Islamists* receive police protection, they intimidate into silence any news outlet that may not be pro-*Muslim*, and then the government does nothing to protect the press. When *Islamists* effectively silenced the free press with threats—as during the 2006 Danish cartoon protests—a UK magazine, *The Liberal*, was told that it was not guaranteed police protection if it printed the *Muhammad* cartoons since there were only “‘finite resources’ for the protection of journalists.”<sup>4729</sup> Yet:

- ⊕ Only a few days later “the police provided 500 officers to protect a ‘peaceful’ *Muslim* protest in *Trafalgar Square*” over the same cartoons.<sup>4730</sup>
- ⊕ “The British police...regularly provide protection for *Mosques* (as they did after the 7/7 bombs).”<sup>4731</sup>

Due to lost productivity and because so many *Muslims* are on the dole, military budgets are cut in order to save the social safety net from bankruptcy. For instance, after 9/11, EU military budgets dropped to 1.8 of GDP.<sup>4732</sup> Also, more countries legalize euthanasia to save money for nationalized healthcare.

Not surprisingly, “the euthanasia debate is strong” in the very countries that decided to commit national suicide via abortion and mass *Muslim* immigration: Netherlands, Belgium, France, Australia and Britain.<sup>4733</sup> A health minister in the Netherlands even suggested forced abortions for “*Antillean* teenage mothers; drug addicts and people with mental handicaps.”<sup>4734</sup> The Netherlands *Antilles* Islands are 92 percent Christian according to the *CIA World Factbook 2006*.

<sup>4727</sup> Hall, Allan & Michael Lynch. “On the defensive,” theage.com.au, 19 May 2006.

<sup>4728</sup> Foggo, Daniel & David Leppard. “MI5 at full stretch as 20 *Islamist* terror plots revealed,” *Sunday Times*, timesonline.co.uk, 28 May 2006, *JW*.

<sup>4729</sup> “UK mag will not publish cartoons,” manchesteronline.co.uk, 9 Feb 2006

<sup>4730</sup> Murray, Douglas. “We should fear Holland's silence,” *The Sunday Times*, timesonline.co.uk, 26 Feb 2006, *JW*.

<sup>4731</sup> Murray, Douglas. “We should fear Holland's silence,” *The Sunday Times...Idem*.

<sup>4732</sup> Dunn, J.R. “Prospects of Terror: An Inquiry into...(2),” americanthinker.com, 22 Mar 2006.

<sup>4733</sup> “Dutch legalise euthanasia,” news.bbc.co.uk, 1 Apr 2002.

<sup>4734</sup> “Mandatory abortion proposed in Holland,” WND.net, 21 Feb 2006, jacklewis.net.

Secularists have perverted priorities and worry more about preserving: 1) their pipe dream of a multicultural society and hedonism, 2) exaggerated civil rights that were not envisioned until recently, 3) loose immigration laws and 4) strict anti-discrimination laws, all to the detriment of the security of the populace against: a) *Islamic* terrorists and b) *Islamists* who would ethnically cleanse neighborhoods and cities and *Islamize* the nation.<sup>4735</sup>

Secular academics are some of the worse *Dhimmi* collaborators with *Islamists*, as Bruce Thornton wrote:

The eagerness of Western intellectuals to betray their professional duty to seek truth, and their zeal for idealizing a culture which wouldn't tolerate their existence for five seconds, are both from the perspective of the *Jihadists* evidence that the West is a spiritually bankrupt *Dhimmi* culture ripe for submission to *Islamic* hegemony.<sup>4736</sup>

Liberal and leftist delusions about *Islam* being peaceful will eventually prove to be as lethal to Westerners and Western civilization as the idea that the lifestyle of a mother cannot be put on hold for a few months so her unborn child can be adopted though most industrialized countries are predicted to have population implosions. For instance, Australia may become *Muslim* in fifty years because...

...there are 250,000 children born each year...There are 100,000 abortions and [only] 70 adoptions. Termination is more acceptable than adoption.<sup>4737</sup>

Secularists believe that the **lifestyle** of *Muslims* is more important than the **lives** of non-*Muslims*, tens of millions of people may die and many will lose their limbs before the West either fights off or surrenders and succumbs to *Islamization*.

Soon, a lot more of us may be ethnically cleansed right out of our own neighborhoods, or will find ourselves jumping out of burning skyscrapers without a parachute like occurred on 9/11.

It is a statistical certainty that in any *Muslim* population, many will become radicalized if they are not already, and will engage in assassinations, riots and Pocketbook *Jihad* that finances terrorism at home and proxy *Jihad* abroad. For instance, a moderate *Muslim*, Sheikh Prof. Abdul Hadi Palazzi, left Rome for *Cairo* in 1980 and upon returning in 1984, he found the community had been radicalized.

Palazzi was and still is shunned by Orthodox *Muslims* for saying that Israel has a right to a homeland. Raphael Israeli, a Mideast studies professor, said of Palazzi:

Not many *Muslims* are paying attention to him. *Islamic* fundamentalism is the winning direction. Maybe there are other *Muslim* intellectuals who think like him but they are not heard. Maybe they are afraid to speak. If he lived in an *Islamic* country, he would have been killed long ago. But he is in the West, so he can speak.

There never was an insignificant minority of *Muslim* extremists—if being pro-*Jihad* and pro-*Sharia* law defines extremism. Increasingly, there is only a tiny minority of *Muslim* Moderates.

Liberals and leftists should have known that allowing *Muslims* to immigrate would result in more people dying at home and abroad while either fending off or succumbing to *Islamization*.

<sup>4735</sup> Pipes, Daniel. "Balancing Liberties, Security," *DP*, 1 Mar 2005.

<sup>4736</sup> Thornton, Bruce. "The Myth of *Islam* Busted," victorhanson.com, 6 Aug 2005.

<sup>4737</sup> Peatling, Stephanie. "Abortion will lead to *Muslim* nation: MP," *Sydney Morning Herald*, smh.com.au, 14 Feb 2006.

Liberals and leftists should be blamed now for all the recent deaths from *Jihad* and for many of those who will inevitably die at the hands of *Islamists*. Liberals and leftists are already the Judas Iscariots and Benedict Arnolds who betrayed millions of non-*Muslims* to *Jihadists* and figuratively put a knife to the neck of every Westerner.

Here is the usual course of the pair of diseases:

**Stage 1 (Travel in Islamdom):** Naïve tourists, business travelers and foreign workers blithely wonder about *Islamdom* not knowing that they are abduction and terrorist targets, and that they may be prosecuted under *Sharia* law for things that are not even a crime in the West. PC-ASS and PC-AIDS sufferers should feel blessed by *Yahveh* for having gone where angels fear to tread (i.e. the Mideast (Dan 10:13, 20)) without having been stabbed, held hostage, whipped, tortured, jailed, shot or beheaded. Once one reads *Islamic* literature, one realizes that *Muslims* see non-*Muslims* like *Nazis* viewed Jews.

**Stage 2 (Muslims Immigrate to the West):** Multiculturalists preach that everyone ought to “feel good” about other cultures, yet many multiculturalists hardly know anything about these other cultures other than what one might find in travel-agency brochures.

Most multiculturalists are totally satisfied with having read “about” other religions, but have never actually read the contents of the primary texts of the religions. Surely they have read nothing that would ever challenge their assumption that all religions are alike.

Multiculturalists like to make charges for which they have no facts to back them up, and they hope the listener does not know any better. Multiculturalists often say that they can find passages in the Bible like those in the *Koran* and *Hadith*, but they cannot, for there are no passages in the Bible that:

- ☉ Tell all believers of all times to subdue or kill non-believers (*K* 009:005, 029).
- ☉ Say to make Judaism or Christianity superior to all other religions though non-believers resist (*K* 003:139-140; 005:056; 008:030; 009:029, 033; 048:028; 061:009).

Multiculturalists like to limit the terror threat to “a tiny minority of extremists” and they call anyone who says that *Muslims* are the problem racists and bigots. Polls however show that many *Muslims* are *Islamists* or *Islamist* sympathizers, and *Muslims* consistently elect parliamentarians with *Islamist* leanings in relatively fair-and-free elections (see the Lamech’s Logic Table).

Many people with PC-AIDS suppose that being in the West moderates *Muslims*’ attitudes, as did the *Israelis* concerning their Arab-*Israeli* residents. When given the opportunity in 2006 however East Jerusalem *Muslims* overwhelmingly voted for *Hamas* rather than for *Fatah*, the lesser of the two terrorist organizations. *The Jerusalem Post* reported:

The landslide vote cast doubt on long-standing *Israeli* beliefs that the 230,000 Arab residents of Jerusalem were more moderate than the Palestinians in the West Bank, having grown acclimated to the economic benefits of living under *Israeli* sovereignty.<sup>4738</sup>

<sup>4738</sup> Lefkovits, Etgar. “Capital’s Arabs vote *Hamas*,” jpost.com, 27 Jan 2006.



The US and Israel misread just how radicalized *Israeli* Arabs and Palestinians were and assumed *Fatah* would win until after the votes were counted.<sup>4739</sup> This of course is just a snapshot of the West's misreading of *Muslim* attitudes and beliefs in general.

Sympathizers with *Islam* call anti-*Jihadists* racists, bigots and *Islamophobes* even though *Islamists* come in all colors and ethnicities. This parallels how fascist- and communist-sympathizers once mislabeled anti-Nazis as anti-German racists, and smeared anti-communists as anti-Russian racists.

While color and ethnicity are not dangerous to others, ideology is. Unfortunately, there is no surefire way to tell an *Islamist* from a Moderate *Muslim*, and no way to tell whether a Moderate *Muslim* or his kids will stay Moderate *Muslims* for life.

There is no mainstream traditional school of moderate *Islam*. *Muslims* whom multiculturalists would call “moderate” are usually called heretics worthy of death by *Muslims* themselves. Most *Muslims* believe, at least in principle, in using *Jihad* to eventually impose *Sharia* law across the entire world.

Multiculturalists' hope in moderate *Islam* springs eternal because they flip reality on its head: there is no tiny minority of extremists on the fringes of *Islam*, as multiculturalists would have us believe. The tiny minority on the fringes of *Islam* is the moderates, not the extremists.

Naïve citizens and their politicians allow more or less motivated totalitarians to immigrate into their countries though they adhere to texts that speak of violence against others (e.g. 164 War verses in the *Koran*), or terrorizing others (e.g. *K* 008:067), or call for the fighting of, the subduing of, or the killing of, **during this present age**, whole existing religious classes of people such as pagans, Christians, Jews (e.g. Hitler's *Mein Kampf*, *Koran* 009:005, 029), heretics, apostates (*Sahih Al Bukhari* vol. 4, bk. 52, no. 260; vol. 9, bk. 84, no. 57) and “blasphemers” of a mere man such as *Muhammad* (*Sahih Muslim*, bk. 19, ch. 41, no. 4436; *Sahih Bukhari*, vol. 3, ch. 45, no. 687; vol. 4, bk. 52, no. 270; vol. 5, bk. 59, no. 369).

### Stage 3 (Being Stubbornly Wrong About Multiculturalism and *Islam*):

When non-integration and terrorism make it apparent that allowing *Muslim* immigration was not such a wise idea, the issue becomes taboo in the mainstream media—a regular “elephant in the room” situation. “Better dead than rude,” as John Derbyshire phrased it.

It is true that the media will talk about agents of terrorism as being *Al-Qaeda* or another terrorist group, youths, gangs, tribes, factions, sects, etc., but will tiptoe around any in-depth discussion of *Islamism* to keep their multicultural credentials intact and not risk being called *Islamophobic*. The media also has a longstanding aversion to being seen on the same side of any issue as the Religious Right.

Even hardnosed police are cowed into feigned ignorance about *Islam* as in 2006, after arresting seventeen bearded *Muslims* for plotting to bomb buildings, a Canadian police commissioner said:

They represent the broad strata of our society. Some are students, some are employed, some are unemployed.

Likewise, the Toronto Police Chief said:

I would remind you that there was not one single reference made by law enforcement to *Muslim* or [the] *Muslim* community.<sup>4740</sup>

<sup>4739</sup> Katz, Yaakov. “Red-faced IDF misread the ‘street,’” *jpost.com*, 27 Jan 2006.

<sup>4740</sup> Spencer, Robert. “*Jihad* Denial in Toronto,” *FPM*, 7 Jun 2006.

No matter how much evidence mounts up that a *Jihadist* was motivated by *Koranic* dictates and teachings, the media refused to acknowledge the *Jihad* motivation. Why? The media and the elite are mostly atheistic or agnostic evolutionists so they are not impressed when Christians argue that the *Koran* inspires killing by dehumanizing non-*Muslims* as pigs and apes. After all, evolution dehumanizes humanity even more, and evolution in its short history has been married up to Naziism and Communism, and has been behind the killing of many times more people than all those who died in religious wars over the millennia.

The Judeo-Christian tradition condemns murder because of verses like Gen 09:06 which says that humans are made in the image of God and demands capital punishment for premeditated murder. Gen 09:06 means nothing to evolutionists who often do not believe in God, much less that humans are made in the image of God. They also do not believe that capital punishment does justice nor deters crime.

Evolutionists have only one law regarding killing: one must not violate the survival of the fittest doctrine either by killing off the fittest, or by reducing the diversity of the gene pool. After all, the fittest can only improve and prove themselves to be the fittest in the context of diversity.

Evolutionary logic explains why Hitler is excoriated while by comparison Stalin and Mao get a pass even though Stalin and Mao killed more people than Hitler did. Even Hitler gets a pass for that portion of his killing that was more in keeping with Darwin's survival of the fittest and Nietzschean philosophy. Hitler's untold victims include: the unborn, the retarded, the aged, the infirm, Russian soldiers, Gypsies, homosexuals and others.

Hitler's anti-Semitism led him to try to reduce diversity in the human gene pool by killing off a race, something Stalin and Mao did not do. Evolutionists reckon that Hitler's killing of his untold victims did not significantly affect the survival of the fittest paradigm or the diversity of the human gene pool.

Reasons evolutionists cannot condemn Hitler too loudly without seeming hypocritical include:

- ⊙ Environmental activists nearly all believe in evolution and they want to reduce the human population to a sustainable two billion people using a few of the methods that Hitler employed: eugenics, abortion, and euthanasia.
- ⊙ Evolutionists would rather have millions of people die each year from malaria rather than use DDT. Why? Because these chemicals reduce the diversity of wildlife, the human race is not pruned of people with weak immune systems, and evolutionists think there are too many people anyway.
- ⊙ Evolutionists would rather have millions of people die each year from AIDS than pay for abstinence or safe-sex campaigns, condoms, anti-viral drugs and other treatments. Why? Because the human race is culled of people not resistant to AIDS, and they think there are too many people anyway.

Evolutionists often do not condemn terrorism but instead blame the victim, and in fact, many Leftist groups are comprised of evolutionists who engage in terrorism. Evolutionists find that terrorism is by definition random, so terrorism does not affect the survival of fittest paradigm much. Conversely, evolutionists are against capital punishment, private gun ownership and wars because these negatively affect the survival of the fittest of certain races. War merits special condemnation because the physically fittest humans are selected to be soldiers thereby stunting evolution.

Evolutionists condemn so-called *Islamophobia* because evolutionists:

- ☉ Have dehumanized and killed so many “capitalist pigs” and “enemies of the state” and such that they feel any singling out an ideology for criticism is like handing out a license to kill.
- ☉ Perceive fear of *Islam* is racism, and in the nuclear age *Islamophobia* could conceivably skew the survival of fittest paradigm for Arabs, Persians<sup>4741</sup> and Indonesians—just as anti-Semitism adversely affected the survival of fit Jews during WWII.

The courts restrict police profiling since if “such measures became publicly known, they could ‘reinforce prejudices and stigmatize the affected social groups in the perception of the public.’”<sup>4742</sup> By contrast Christianity is better represented among all races, so criticism of Christianity could not affect the survival of the fittest paradigm like criticism of *Islam* conceivably could.

Since criticism of *Islam* is not allowed under the survival of the fittest law, all sorts of excuses are extended to explain behavior easily explained by referring to the *Koran*. For instance:

- ☉ When Shahawar Matin Siraj was convicted in 2006 for plotting to blow up a New York subway, a *New York Times* article delved into the issue of whether he was entrapped by a police informant and only alludes to the mound of evidence that says otherwise. The *Koran* is never mentioned except to say his mother read it while waiting outside the courtroom.<sup>4743</sup>
- ☉ After the Washington DC Snipers were arrested in 2002, though there was a mountain of evidence that they were freelance *Islamic* terrorists, the media played up the fact that:
  - ★ John Allen (Williams) *Muhammad* was a divorced, disgruntled father and the John Lee (Boyd) Malvo came from broken home.
  - ★ Their motivation was a 10 million USD extortion plot against the US federal government<sup>4744</sup> even though they were planning to spend the money to “establish a Canadian commune to train 140 homeless children in terrorist shooting and bombings to ‘continue the mission’ in other cities” and “shut things down.”<sup>4745</sup>
  - ★ Poorly enforced gun-control laws allowed the duo to obtain a weapon.<sup>4746</sup>
  - ★ Playing violent video “games both broke down his inhibition to kill and gave him [Malvo] incredible shooting skills” as though the *Koran* has never by itself broken down anyone’s inhibition to kill.<sup>4747</sup>

Hollywood has been capitulating to *Islamists* at least since 1977. Out of deference to *Muslims*, the movie *Mohammad: Messenger of God* never showed *Muhammad’s* face. Then a dozen *Hanifi Muslims* took 149 hostages in a 39-hour

<sup>4741</sup> Guttman, Nathan. “Israeli Vice Premier Shimon Peres: ‘[*Shia*] *Iran* can also be wiped off the map,’” jpost.com, 8 May 2006.

<sup>4742</sup> “German court bans data tawl for *Qaeda* ‘sleepers,’” reuters.co.uk, 23 May 2006, *DW*.

<sup>4743</sup> Rashbaum, William K. “Guilty Verdict in Plot to Bomb Subway Station,” nytimes.com, 25 May 2006.

<sup>4744</sup> “Beltway sniper attacks,” wikipedia.com, accessed 26 May 2006.

<sup>4745</sup> Manning, Stephen. “Malvo says *Muhammad* planned extortion,” crisscross.com, 24 May 2006.

<sup>4746</sup> “Beltway sniper attacks,” wikipedia.com, accessed 26 May 2006.

<sup>4747</sup> Thompson, Jack. “Beltway Sniper Trained on Sniper Video Game,” fradical.com, 14 Dec 2002, stopkill.com; “Beltway sniper attacks,” wikipedia.com, accessed 26 May 2006.

terrorist stand-off at the *B'nai B'rith* center in Washington DC. The *Washington Post* recounted twenty-five years later in 2002:

The *Hanafi Muslims* also killed and maimed to stop the showing in America of the movie *Mohammad, Messenger of God* on the grounds that it was sacrilegious.<sup>4748</sup>

Since 1977, Hollywood has suffered from Stockholm Syndrome and has made movies sympathetic to *Islam* that are steeped in false moral equivocation. The rule is that “self-flagellation and self-loathing pass for complexity and moral seriousness in Hollywood.”<sup>4749</sup>

Then in 2006, all but a few newspapers and TV news show refused to show twelve tame *Muhammad* caricatures—though the widespread *Muslim* riotous protests and boycott of Danish products were major news events, and they carried big implications for the future.

Most of mass media is pro-*Muslim* and anti-Christian, so they blamed the cartoonists for the ruckus. The media did not print the actual cartoons because then the viewers would have seen that: 1) the cartoonists were not to blame for drawing such tame cartoons, 2) *Islam* is a long way from being Westernized despite what all the would-be reformers of *Islam* say and 3) the media is as willing to give up its free speech rights to *Islamists* as they are willing to give up their right to bear arms.

Initially only two newspapers stated that they wanted to print the cartoons but were honest enough to say they could not due to safety concerns.<sup>4750</sup> The bottom line is that Western democracy was diminished because newspapers gave in to the same anti-democratic forces that have kept true democracies from forming in *Islamdom*.<sup>4751</sup>

When more people die and enough property goes up in smoke, the topic cannot be avoided any longer. Even then, politicians deny the obvious and say that poverty and lack of integration, not *Islamism*, is the cause of the conflagration, as with the French *Muslim* riots of 2005.<sup>4752</sup>

Professors, journalists and others who cherished the “received wisdom” about *Islam* will attack the skeptics, Jeremiahs and Cassandras. Today, the situation is not unlike the battle between reporters Duranty and Muggerridge during the Stalin era. One must search the Web to find out the truth, much like Soviets had to seek out *Samizdat* literature during the Cold War period.

Media news fails to report on much news-worthy *Islamist* violence and they choose commentators who blame *Islamic* violence on non-*Muslims* being racists, or on *Muslims* being kept poor by non-*Muslims*, or on anything other than the actual cause, that being *Islam*.

To blame the violence on poverty or racism strengthens the hand of the left who specialize in multiculturalism and counter-productive anti-poverty programs. To blame the violence on *Islam* works against the left since the multiculturalists on the left would be blamed for their having allowed decades of *Muslim* immigration. For instance:

<sup>4748</sup> “25th Anniversary of Terror,” *washpost.com*, 9 Mar 2002.

<sup>4749</sup> Krauthammer, Charles. “Oscars for Osama,” *washingtonpost.com*, 3 Mar 2006, *coxandforkum*.

<sup>4750</sup> Papers that wanted to print the cartoons but did not due to safety concerns: 1) *The Phoenix* of Boston (Jacoby, Jeff. “When fear crows the media,” *Boston Globe*, *boston.com*, 19 Feb 2006); and 2) *The Liberal* (“UK mag will not publish cartoons,” *manchesteronline.co.uk*, 9 Feb 2006).

<sup>4751</sup> Prager, Dennis. “American news media: little courage...honesty,” *townhall.com*, 14 Feb 2006.

<sup>4752</sup> Pipes, Daniel. “Further Thoughts on the First French Intifada,” *DP*, 8 Nov 2005.

- ⊕ In 2003 *CNN* admitted that it did not report on the *Iraqi* regime's murders and torturing for a "dozen years" for the sake of continued access to *Iraq* and to ensure the safety of its staff and informants.<sup>4753</sup>
- ⊕ In 2005 billionaire *Saudi* Prince *al-Walid bin Talal*, a shareholder in *Fox News*, called Rupert Murdoch and complained about the "*Muslim Riots*" news banner, and within half hour the news banner said "Civil Riots,"<sup>4754</sup>
- ⊕ During the French *Muslim* riots of 2005, the director-general of the French news station LCI, told a broadcasters' conference in Amsterdam: "Politics in France is heading to the Right and I don't want rightwing politicians back in second or even first place because we showed burning cars on television,"<sup>4755</sup>
- ⊕ In 2005, 5,000 Australian beachgoers were tired of: 1) losing compatriots to suicide-bombers in *Bali* and 2) the Lebanese gangs that intimidated beachgoers, beat up lifeguards and raped Aussie women. When the surfing community rioted, the media made the Bra Boys surf club members out to be a "gang." The media suggested that Neo-Nazis and Skinheads organized the riots, as though it were responsible journalism to tar anyone who has legitimate concerns about multiculturalism and mass-immigration policies with the dreadful Neo-Nazi and Skinhead labels. Meanwhile, *Muslims* gathered at a large *Mosque* at *Lakemba* to be incited by *Mufti Al-Hilaly*, from whence dozens of carloads of *Muslims* traveled to and trashed a Sydney suburb near a beach. The media did not call this racist violence, but merely retaliatory or revenge attacks, even though text messages said:

All Arabs unite as one...The Aussie will feel the full force of the Arabs as one 'brothers in arms.' Unite now lets show them who's boss. Destroy everything. Gather at *Cronulla*...<sup>4756</sup>

Not only does mainstream media not report accurately, but anyone who would tell the media the truth about *Islamists* is called a racist and threatened with lawsuits, as when a French-Jewish philosopher opined on the French *Muslim* riots of 2005, people "felt Finkelkraut had slipped up by mentioning the ethnic identity of the rioters—he had described them as Blacks, Arabs and *Muslims*" with the result that "a powerful 'civil rights' organization"<sup>4757</sup> "threatened to sue him for racism."<sup>4758</sup>

Book publishers also do not deliver the facts due to lawsuits, Pryce-Jones wrote:

When the outspoken French novelist Michel Houellebecq pronounced *Islam* to be hateful, stupid and dangerous, *Muslim* organizations and the League for the Rights of Man took him to court just as the Italian writer Oriana Fallaci was sued for her book tying the 9/11 attacks to the teachings of *Islam*. Although both writers won their cases, **the chilling effect was unmistakable.**<sup>4759</sup>

<sup>4753</sup> Jordan, Eason. "The News We Kept To Ourselves," 11 Apr 2003, nytimes.com, imra.org.il.

<sup>4754</sup> "Saudi prince gives Sharon 'benefit of the doubt' for peace," middle-east-online.com, 5 Dec 2005, *DW*, *C&R*.

<sup>4755</sup> Steyn, Mark. "France's *Muslim* future," jpost.com, 20 Nov 2005.

<sup>4756</sup> McIlveen, Luke. "Young Arabs call for revenge attacks as hate groups gloat," theadvertiser.news.com.au, 13 Dec 2005.

<sup>4757</sup> Pipes, Daniel. "Explaining the French Intifada," *DP*, 8 Nov 2005.

<sup>4758</sup> Ben Simon, Daniel. "France's Sarkozy backs beleaguered Finkelkraut over *Muslim* riot comments," haaretz.com, 6 Dec 2005.

<sup>4759</sup> Pryce-Jones, David. "The *Islamization* of Europe?" commentarymagazine.com, Dec 2004.

*Muslims* and their allies in the left never let up, so Fallaci was again prosecuted in 2005 in Italy for another book, *The Force of Reason* (2004).<sup>4760</sup>

When it finally becomes widely apparent that multicultural fascists have made a mistake by allowing those who adhere to a totalitarian ideology to immigrate into a democratic country, PC-AIDS and PC-ASS adherents, in a bid to end discussion and debate, say their critics are insensitive, racists, bigots and *Svengalis*, i.e. a persuasive but evil person.

In order to make their mistake appear less grave, multicultural fascists start dividing the totalitarians into extremists and moderates. The extremists are totalitarians who are willing to use or encourage violence, while the moderates are totalitarians not willing to use or encourage violence.

Unfortunately, the uncommitted and unmotivated totalitarians and their children and converts may become committed and motivated at a later date, especially if the number of totalitarians increases overall. Thus unmotivated and uncommitted totalitarians are smiling tigers that just need an incentive to become terrorists or a fifth-column for terrorists.

PC-AIDS and PC-ASS sufferers always understate the *Islamic* terrorism threat to their own country and try to exonerate *Muslims* at large, and *Islam* itself, from any involvement in terrorism and violence. Why? Many people are filled with a legion of propagandistic arguments, so the spirit of multiculturalism cannot be exorcised no matter how many facts are thrown at it. The propaganda includes:

- ☉ The un-killable opinion that *Islam* is a Religion of Peace™ that rejects terrorism.
- ☉ A foreign terrorist group such as *Al-Qaeda* ordered the attack and they follow a perverted form of *Islam* recently born under authoritarian rule and poverty. Then when the foreign connection proves tenuous, it is said that *Al-Qaeda* inspired the act and wrote the *Jihadist* literature and the How-To manual for bomb-making. Then when this is ruled out, it is said that homegrown *Jihadists* were just amateurs who copycatted *Al-Qaeda*.
- ☉ Groups of suicide-bombers who blow up together must have been duped and they all really were not so single-minded in their hatred of the West as to choose to die while taking infidels with them. For instance:
  - ★ After 9/11, it was theorized that only the terrorist pilots knew it was a suicide mission until it was revealed that each man of the cell was handpicked and trained for carrying out a suicide mission.
  - ★ After the 7/7 London bombing, it was theorized that the four *Muslims* carrying the rucksacks were only planning to plant or transport the bombs and not blow themselves up. Then however the bombs were found to be of the toggle button type and where not set off by timers or by remote control (i.e. cell phone).<sup>4761</sup>

Interestingly, denial of *Islam*'s close connection to terrorism does not necessarily depend on familiarity with *Muslims* or *Islam*, even though terrorism follows wherever *Muslims* go, and most terrorists are *Muslim*. For instance:

---

<sup>4760</sup> Parker, Kathleen. "Outrage to Religion: Let insults flourish; see alternative," *The Sun*, myrtlebeachonline.com 28 May 2005, *DW*.

<sup>4761</sup> Dodd, Vikram & Rosie Cowan. "Suicide bombs breakthrough gives police vital clues," *guardian.co.uk*, 24 Aug 2005.

- ☉ Though there are 5+ million *Muslims* in France, President Chirac and the media blamed the *Muslim* riots of 2005 not on *Islam*, but on the French for not practicing multiculturalism, inclusion and integration enough.<sup>4762</sup>
- ☉ Though London is eight to ten percent *Muslim*, after the 7/7 attacks in 2005, the Mayor “Red” Ken Livingstone “blamed Britain for having practiced ‘double standards’ in its foreign policy which had helped drive young British *Muslim* men to murder their fellow citizens.”<sup>4763</sup>
- ☉ Though 1) *Bangladesh* is 83 percent *Muslim* according to the *CIA Factbook* of 2005, 2) there are “31 *Islamic* militant outfits...operating in *Bangladesh* targeting non-*Muslims* and seeking to establish a ‘greater *Islamic* nation,’”<sup>4764</sup> and 3) The *Islamist* group *Jama’atul Mujahideen* left notes by all 350+ exploded bombs that called for the imposition of *Sharia* law and the deportation of Americans and Brits from *Muslim* countries, the government “has repeatedly rejected any suggestion that there could be a problem with *Islamic* extremists,”<sup>4765</sup> “Intelligence officials...said...the recent [7/7] London bombings had inspired the blasts,” and the Home Minister suggested the opposition party, the *Awami* League, was responsible and said that police should avoid raiding *Mosques* if possible.<sup>4766</sup>

So if one were to believe the mayor of London, then the 7/7 bombing was caused by British foreign policy, and if one were to believe *Bangladesh* intelligence, the mega-attack there was inspired by the 7/7 attack in London.

**Stage 4 (Dhimmification Via Legislation):** Officials, legislators, judges and educators with PC-AIDS and PC-ASS start the *Dhimmification* and *Islamification* process by enforcing political correctness and anti-vilification laws.

Western legislators know that the *Koran* constitutes hate-literature since they often insert exemption clauses for the *Koran* whenever they draft hate-speech legislation. This expands the existing double standard of excusing leftist speech that calls for or excuses terrorism while prosecuting everyone else. Why is this done? Because if one prosecuted *Muslims* for calls for terrorism, one would have to start prosecuting leftists under those same laws, too.

Even if some laws regulating speech do not explicitly exempt any religion, the double standard becomes apparent when police enforce the laws and courts interpret the laws. For instance, in Australia two pastors were condemned for telling the truth about *Islam*, yet vile *Islamist* and *Jihadist* literature is found to be perfectly legal.

- ☉ Two pastors, Daniel Scot and Danny Nalliah, gave an accurate seminar on *Islam*. Later however Judge Higgins of the Victoria state court concluded that the seminar constituted religious vilification. In 2004 Judge Higgins...  
...ordered the two Daniels to publish a statement in major newspapers where they would be forced to condemn themselves as having ‘no credibility’ and that they did not act ‘in good faith.’ Judge

<sup>4762</sup> Marrin, Minette. “*Muslim* apartheid burns bright in France,” *The Sunday Times*, timesonline.co.uk, 13 Nov 2005.

<sup>4763</sup> Phillips, Melanie. “Weasel words on terror,” *JewishWorldReview.com*, 22 Jul 2004.

<sup>4764</sup> “*Bangladesh* now has 31 *Islamic* militant groups,” news.newkerala.com, 20 Jan 2005, *JW*.

<sup>4765</sup> Pipes, Daniel. “350 Bombs in an Hour—A Vision of the Terrible Future?” *DP*, 18 Aug 2005.

<sup>4766</sup> “Analysts: Khaleda Zia govt can’t ignore fundamentalism,” newkerala.com, 19 Aug 2005, *DP*.

Higgins has also placed an Australia-wide ban on both of them speaking about the *Koran* or the *Islamic* religion or they will be charged again.<sup>4767</sup>

- C *The Daily Telegraph* reported in 2006 on *Islamist* books that are sold in *Islamic* book shops. The Commonwealth Director of Public Prosecutions and Australian Federal Police found that the books were completely legal:

Books of hate promoting suicide bombings, anti-Australian conspiracies and racism can be freely sold in the *Muslim* community after a ruling that they don't breach sedition laws....One of the books, *Defence of the Muslim Lands* [Robert Spencer notes: authored by *Sheikh* Abdullah Azzam, cofounder of *Al-Qaeda*], carried an endorsement from Osama bin Laden on its back cover and promoted 'wiring up one's body' with explosives for 'martyrdom or self-sacrifice operations.' *The Criminal West*, written by Australian *Muslim* Omar Hassan, claimed to be called 'Australian' was something to be ashamed of and Western culture is the culture of wolves, injustice and racism. It also claims Australian police are rapists who bash young boys and spoke of a conspiracy involving politicians to turn young *Muslims* into drug addicts. *The Ideological Attack* claims there was a barbaric onslaught against *Muslims* by Jews, Christians and atheists.<sup>4768</sup>

During the Cartoon Riots of 2006, many observers were dismayed to see how few major newspapers reprinted caricatures of *Muhammad* out of fear of *Muslim* protestors and shakedown tactics, i.e. boycotting advertizers in the print media. As expected, the *BBC* did not print the cartoons. Diana West wrote:

...on the *BBC* Web site, a religion page about *Islam* presents the angels and revelations of *Islamic* belief as historical fact, rather than spiritual conjecture (as is the case with its Christianity Web page); plus, it follows every mention of *Mohammad* with '(pbuh),' which means 'peace be upon him'—'as if,' writes Will Wyatt, former *BBC* chief executive, in a letter to *The Times of London*, 'the corporation itself were *Muslim*.'<sup>4769</sup>

Then the situation worsened when the government stepped in to squash what little there was of acts of anti-*Dhimmitude* and standing up for freedom of the press. The US State Department, Whitehall, the Vatican, the U.N. president and other past and present world leaders condemned the cartoons and apologized to *Muslims*. Sweden shut down websites that posted *Muhammad* cartoons citing national security concerns.<sup>4770</sup> That is a trade-off many citizens would not like to make since who values national security if one can no longer freely speak one's mind?

There was talk in the EU of setting up voluntary media standards, but what remained unsaid was many advertizers and the government probably would not advertize in any news outlet that did not abide by the guidelines.<sup>4771</sup> In Canada,

<sup>4767</sup> "No justice for two Daniels," Christian Democratic Party, [christiandemocratic.org.au](http://christiandemocratic.org.au), 24 Jun 2005; also see Spencer, Robert. "Australia: Judge's decision," *DW*, 17 Dec 2004.

<sup>4768</sup> Bissett, Kelvin & Angela Kamper. "*Muslim* 'books of hate' get OK," *The Daily Telegraph*, [news.com.au](http://news.com.au), 15 May 2006, *DW*.

<sup>4769</sup> West, Diana. "Cartoon rage," [washingtontimes.com](http://washingtontimes.com), 10 Feb 2006, [michelemalkin.com](http://michelemalkin.com).

<sup>4770</sup> Holender, Robert. "*Muhammedteckningar borta efter Säposamtal*," *Dagens Nyheter*, [dn.se](http://dn.se), 10 Feb 2006, [spectator.se](http://spectator.se), [instapundit.com](http://instapundit.com), [michellemalkin.com](http://michellemalkin.com), [mypetjawa.mu.nu](http://mypetjawa.mu.nu).

<sup>4771</sup> "European Union mulls media code after cartoon protests," 9 Feb 2006, [newkerala.com](http://newkerala.com), [michellemalkin.com](http://michellemalkin.com).



campus police confiscated 2,000 student newspapers with cartoon reprints.<sup>4772</sup> In South Africa, a judge banned the publication of the cartoons there.<sup>4773</sup>

So, astute observations and debates about religion are no longer protected as free speech, but are punished under anti-racism and anti-religious vilification laws—even though *Islam* is a religious and political ideology and not a race. The misguided thinking goes that racism, not *Islam* itself, gives rise to *Islamic* terrorism. So-called racism must be punished so the country does not become a favorite terrorist target. Free speech and other freedoms must be traded in for security. Since free speech is labeled racism and is restricted or abolished, no one can warn against indiscriminate immigration, or issue any jeremiads. The sheep dogs are muzzled while *Islamist* and *Jihadist* wolves and bears circle the flock. A nation that restricts Biblical Christianity stores up swift punishment for itself.

**Stage 5 (Sovereignty and Territorial Concessions to *Islamists*):** *Muslims* create autonomous infidel-free zones where they implement *Sharia* law. Through immigration and demographic growth, *Islamists* take over street corners, neighborhoods, suburbs and cities, and then they partition the nation *a la Pakistan*.

The preachers who drive and motivate *Islamists* are largely immune to prosecution and deportation. Even after the 9/11, 3/11 and 7/7 bombings, and after the French *Muslim* riots of 2005, few radical *Muslims* had been deported, as Daniel Pipes wrote at year's end, 2005:

Germany topped the list, having thrown out at least 20...Spain, Italy and France each deported 4. Holland 3. And the UK [and US & Canada] zero.<sup>4774</sup>

Before a PC-AIDS and PC-ASS nation knows it, it finds itself on the lips of *Islam* and then in *Islam's* gut. Samuel Huntington described the process: "*Islam's* borders are bloody and so are its innards."<sup>4775</sup> See the Irredentist Turf section in the Khidr-Second Lamech Logic table.

Purgatory	See the Plenary Absolution section in the Khidr-Second Lamech Logic table.
<i>Qarina</i>	Plural: <i>Qurana</i> . A person's evil twin in spirit form.
<i>Raka</i>	A prostration. A step in a <i>Salat</i> series of actions.
<i>Ramadan</i>	Ninth month of the <i>Islamic</i> lunar year. One of the five pillars of <i>Islam</i> is the <i>Sawm</i> fast from dawn to sunset during the month of <i>Ramadan</i> .
<i>Rasul</i>	Messenger or Apostle.
<i>Sae</i>	Straight-line circumambulation between the summits of <i>Safa</i> and <i>Marwa</i> hills that are near the <i>Kaaba</i> . See <i>Tawaf</i> .
<i>Salaam</i>	Expression meaning "Peace." The words <i>Salaam</i> and <i>Islam</i> are etymologically related, but <i>Islam</i> means "submission."
<i>Salat</i>	A set number of <i>Rakas</i> constitute a <i>Salat</i> session—usually an odd number such as five.
<i>Sakina</i>	Arabic transliteration of the Hebrew: <i>Shekinah</i> , meaning "presence, peace." Mentioned in the traditions and in <i>K</i> 002:248; 009:026, 040; 048:004, 018, 026.

<sup>4772</sup> Day, Jim. "UPEI [University of Prince Edward Island] snatches newspapers with *Muhammad* cartoons," *The Guardian*, theguardian.pe.ca, 9 Feb 2006.

<sup>4773</sup> Reid, Rowan. "Court's Outlawing Prophet Cartoons Seen as Threat to S. African Press Freedom," voanews.com, 8 Feb 2006, michellemalkin.com.

<sup>4774</sup> Pipes, Daniel. "How Many 'Hate Preachers' Expelled?" *DP*, 29 Dec 2005.

<sup>4775</sup> Huntington. *Clash*, p. 258.

SAW	<i>Sallallahu Aleyhi Wasallam</i> is Arabic for “May God bless him and grant him [ <i>Muhammad</i> ] peace.” SAW is an abbreviation used after the name <i>Muhammad</i> , based on <i>K</i> 033:056. See AS and SWT.
Satyriasis	English: Excessive sexual acting out in a man. The word Satyriasis is derived from classical mythology. Satyrs were part-man and part-goat and were famous for chasing <i>nymphs</i> . See Nymphomania.
<i>Shahada</i>	See <i>Kalima</i> .
<i>Shahid</i>	Arabic for “a witness.” A <i>Muslim</i> so-called martyr.

Christian martyrs are those who die either in defense of their faith, or die under torture rather than renounce their faith. A *Muslim* martyr, more often than not, is a *Jihadist* who dies while trying to murder infidels. A significant number of *Muslim* martyrs die after setting out on suicidal-murder missions.

*Muslims* are considered martyrs even if they are just involved in a nationalist war or a non-religious property dispute. The reason is that, while the Great Commission for Christians is to preach the gospel to every nation (Mat 28:19), *Islam*’s Great Commission is to conquer all nations until all religion be for *Allah* (*K* 002:193) by *Jihad* or by immigration (*K* 004:097). Because the mere holding on to property is paramount in *Islam*, *Muhammad* said:

He who is killed while protecting his property is a martyr and he who is killed while defending his family or his blood or his religion is a martyr (*Sunan Abu Dawud*, bk. 40, no. 4754; also see no. 4754; *Sahih Bukhari*, vol. 3, bk. 43, no. 660; and *Sahih Muslim*, bk. 1, no. 0260).

Many *Muslim* martyrs start out as *Jihadists* who do not intend to die but are rather looking for loot. *Muhammad* even says as much when he told his troops, “You people want casual gain,” referring to ransom payments for abductees (*K* 008:067). *Al-Kindy* in his *Apology* (830 AD) contrasted the *Muslim* notion of warrior martyrs to Christian truly holy martyrs who generally do not die in battle.<sup>4776</sup>

Most *Muslim* martyrs are not moral purists. Since *Muslims* believe that martyrdom wipes away all sin, why should terrorists bother trying to keep pure in this life? *Muslim* martyrs look forward to eating from the banquets in heaven and acting out their sex addiction to the seventy-two *Houris*.

It is known from surveillance footage that some of the nineteen 9/11 miniskirt-chasing suicide-bomber hijackers spent their last night on earth drinking alcohol, smoking and watching lap dancers in a strip club. They were not studying the *Koran* to become more pious, or praying for the purity of their souls.

Terrorist “handlers” try to spiritualize suicide-bombing by having the would-be bomber write about, or make a video proclaiming, their spiritual intentions. Further research shows that many of these *Muslim* martyrs could care less about *Islam*, except of course for *Islam*’s promises of sex and feasting in heaven:

- ☉ Some are forced into suicide-bombing because they “desecrated family honor” and would otherwise be the victim of a family honor-killing,<sup>4777</sup>
- ☉ One *Jihadist* decided to commit murder-suicide by fighting to the death with the Indian army because he flunked out of second-year medical school,<sup>4778</sup>
- ☉ Others have not reached “the age of informed consent,” meaning they are easily manipulated boy-bombers and girl-bombers under the age of eighteen.

<sup>4776</sup> *Al Kindy. Apology*, pp. 103-104.

<sup>4777</sup> Rabinovich, Abraham. “Atoning for adultery with ‘martyrdom,’” *Washtimes.com*, 20 Jan 2004.

<sup>4778</sup> Connolly, E. & L. Kennedy. “Fed up with West, I’m off to *Jihad*,” *smh.com.au*, 30 Apr 2004.

There are many child militias fighting suicidal battles in *Islamdom* and during *Intifada* II (2000-2004) thirty-one *Muslim* suicide-bombers were children.<sup>4779</sup>

Evidently, race has more to do with who becomes a *Shahid* than does religion. *Muslims* recently claimed that an Arab Christian, who was killed because he was mistaken for a Jew, was a martyr. Right during the eulogy his mother objected to the *Shahid* label and said he was an angel instead, which label ought not be taken literally.<sup>4780</sup>

So one can see that the three criteria for being a *Shahid* are: 1) dying in the pursuit of 2) sex and 3) food. By this loose definition, billions of insects are made *Shahids* daily since they martyr themselves on high-voltage bug zappers in their pursuit of sex and food. Also spelled *Shaheed*.

**Sharia law** A body of religious laws enforced on both *Muslims* and non-*Muslims* from medieval times to the present wherever *Muslims* are in control. *Sharia* law flatly contradicts the constitutions of every democracy on the planet. True, Turkey is a democracy of sorts, but while secularism is imperfectly enforced, *Sharia* law still rears its ugly head enough that most Christians and Jews have been chased out of Turkey.

*Sharia* law is highly discriminatory against women and non-*Muslims* to the point where in many ways *Sharia* law puts every non-*Muslim*'s life in jeopardy, as well as the lives of *Muslim* women. For instance:

- ☉ In modern *Iran* *Sharia* law has been re-imposed, so now the life of a *Muslim* woman is worth half that of a *Muslim* man and the life of a non-*Muslim* is worth only twelfth that of a *Muslim* man.<sup>4781</sup>
- ☉ In *Saudi Arabia* the situation is similar. If someone kills another person the compensation (blood-money) that must be paid is: 1) 100,000 *Riyals* if the victim is a *Muslim* man, 2) 50,000 *Riyals* if a *Muslim* woman or a Christian man, 3) 25,000 *Riyals* if a Christian woman, 4) 6,666 *Riyals* if a *Hindu* man and 5) 3,333 *Riyals* if a *Hindu* woman.<sup>4782</sup> Thus a *Muslim* woman or a Christian man has half the worth of a *Muslim* man, a *Hindu* man is worth fifteen times less than a *Muslim* man and a *Hindu* woman is worth thirty-three times less than a *Muslim* man.

Ali Sina of FaithFreedom.com stated:

Let us see what the *Koran* says about women. It says, 'men have a degree (of advantage) over them' (*K* 002:228); that the witness of woman is worth half of that of man (*K* 002:282); that women inherit half of their male siblings (*K* 004:011-012); that a man can marry two or three or four women (*K* 004:003); that if a woman becomes captive in a war, her *Muslim* master is allowed to rape her (*K* [023:005-006;] 033:050); that if a woman is not totally submissive to her husband she will enter hell (*K* 066:010); that women are 'tilth' [tillage] for their husbands (to cultivate...) (*K* 002:223); that men are in charge of women, as if women were imbeciles or minors who could not take care of themselves; that

<sup>4779</sup> "Israel: Use of Palestinian Children Bombers Barbaric," Israelnewsagency.com, 25 Mar 2004.

<sup>4780</sup> Abu Toameh, K. "My son is an angel, not a *shaheed*," jpost.com, 21 Mar 2004.

<sup>4781</sup> "Iran: Christian life worth only a twelfth that of a *Muslim*," Pakistanchristianpost.com, 5 Nov 2004, *DW*, 4 Nov 2004.

<sup>4782</sup> *The Wall Street Journal*, April 9, 2002, as quoted in Glazov, Jamie. "Symposium: Gender Apartheid and *Islam*," *FPM*, 31Dec 2004.

they must be obedient to their husbands or be admonished (verbally abused), banished from the bed (psychologically abused) and beaten (physically abused) (K 004:034).<sup>4783</sup>

Women also have unequal divorce rights (K 002:229) and must wear veils (K 033:032-033, 053, 059).

Basically, *Sharia* law is derived from the *Koran* and is another tool used for ethnic cleansing (see the ToC for the *Koran*'s ethnic-cleansing passages). *Sharia* law is also the kind of unfair law code that Cain's descendant Lamech would have devised (see the Khidr-Second Lamech Logic table). Lamech was the first polygynist recorded in history, incidentally.

*Sharia* law is an umbrella term for jurisprudence manuals that delineate crimes and punishments, mandate *Jihad* and the *Jizya* tax on non-*Muslims* and specify government and social policy.

Robert Spencer's books *Islam Unveiled* and *Onward Muslim Soldiers* quote from the *Sharia* manual *Umdat Al-Salik* (died 769 AH/1368 AD), published in English as *Reliance of the Traveler*—a *Sunni* manual of the *Shafi'i* school of jurisprudence.

*Sharia* law is the main tool used to bring whole societies into conformity with *Islamic* sensibilities. *Sharia* law makes *Islam* the dominant religion though people of other faiths may be in the majority and may be averse to *Islam* (K 009:033).

The provisions of *Sharia* law are myriad and reduce non-*Muslims* to a second-class citizen status, impose many hardships and indignities on women and non-*Muslims* and offer few legal protections to anyone other than *Muslim* men. For instance, *Muslims* can maliciously accuse non-*Muslims* of blasphemy and the accused has little choice other than to convert to *Islam* or be killed since a *Dhimmi*'s testimony is not accepted in court, or it does not carry any weight.

*Sharia* law imposes many draconian punishments even for petty theft and other misdemeanors. *Sharia* law encourages vile, criminal acts against non-*Muslims*, as well as *Muslim* women and girls, as with FGM.

*Sharia* is also spelled *Shariah*, *Syariah* and *Sheri*.

<i>Sheikh or Shaykh</i>	Literally "Old man with gray hairs." Professor, teacher.
<i>Shirk</i>	In Arabic, <i>Shirk</i> means "partnering divine persons with <i>Allah</i> ," which is a violation of the central doctrine of <i>Islam</i> , namely <i>Tawhid</i> —the oneness or unity of <i>Allah</i> , i.e. <i>Islamic</i> monotheism. The unrelated English word "shirk" means "to avoid or neglect a duty or responsibility."
<i>Sic</i>	Latin: thus, so. <i>Sic</i> is used when the reader might otherwise think that the author inadvertently made a typographical error when in fact the author only copied someone else's mistake "as is."
<i>Sira(h)/Sirat/Seerat</i>	<i>Sira</i> literally means "a path." <i>Sira</i> can mean "biography," or <i>Sirat</i> can refer to the sword bridge between Purgatory and <i>Muslim</i> heaven. <i>Muhammad</i> taught that everyone except martyrs would enter hell to "taste fire." <sup>4784</sup> After the <i>Muslim</i> was purified by fire, he or she would walk across the <i>Sirat</i> to paradise. <i>Sira(t)</i> is sometimes confused with <i>Sura</i> —the chapters of the <i>Koran</i> .
<i>Sqq. or ff.</i>	Sequential, meaning "the following [things]."

<sup>4783</sup> Glazov, Jamie. "Symposium: Gender Apartheid and *Islam*," *FPM*, 31Dec 2004.

<sup>4784</sup> See the Glossary for information on *Islam*'s version of Purgatory.

**Suicide-bombing** *Muslims* like to say that the *Koran* forbids suicide (Rodwell *K* 004:029), but many other verses in the *Koran* show that suicide-bombing of infidels is highly esteemed by *Allah*. This is merely another instance of *Takiya* where *Muslims* lie to infidels whenever *Muslims* think that lying helps *Islam* more than does telling the truth.

When the numbers are tallied, suicide-bombing, like terrorism in general, is far more prevalent in *Islamdom* than in any other culture. For instance, the Dutch newspaper *NRC Handelsblad* reports that in the period between 11 Sep 2001 and 15 April 2004, *Islamic* terrorists have killed at least 7,085 people and wounded 10,132 in 393 attacks around the world.<sup>4785</sup>

In *Iran*, between 2004 and 2005, 40,000 *Islamists* volunteered to be suicide-bombers virtually overnight to carried out attacks for the Committee for the Commemoration of Martyrs of the Global *Islamic* Campaign. The targets include US and UK troops, *Israelis* and the author Salman Rushdie.<sup>4786 4787</sup>

In *Kashmir*, a 2,000-member squad was easily recruited by the *Lashker-e-Taiba* organization from the ranks of seminary students. Thus there is no arguing that the recruits did not know their *Koran* well enough! “The *Lashker* claims to have orchestrated around 200 suicide attacks between 1999 and 2002.”<sup>4788</sup>

Daniel Pipes notes that the *NRC Handelsblad* list is “severely incomplete” and even misses widely reported and deadly terrorist incidents such as “the LAX (Los Angeles airport) Murders” and “the Beltway Snipers.”<sup>4789</sup>

It seems that there is no comprehensive list of terrorist acts. Even the “Patterns of Global Terrorism 2003” put together by the US government “is by no means comprehensive,” according to *Hindustan Times*.<sup>4790</sup>

These terrorism watch lists probably do not include the hundreds of incidences each year of *Muslim* militias attacking Christian villages and churches, nor *Muslim* gang attacks and pogroms on Jews, Christians, *Hindus* and others.

There are a number of ingredients to making a suicide-bomb. The main ingredient of course is the 164 War verses found in the *Koran*.<sup>4791</sup> Other ingredients include the *Fatwas* that approve of suicide-bombings and the promise of seventy-two *Houris* in heaven. Yet another ingredient is the fact that *Islam* presents no truly worthy reason not to commit suicide, as Samuel Ives Curtiss wrote in 1902:

*Islam* is in no sense the product of a development from ancient Semitism.

On the contrary, it is still fettered by a compromise with old heathenism, by the adoption of the ancient rites at its pilgrim festival and kissing of the stone at the *Kaaba*. It is bound by fate; it presents no worthy aim in life, woman’s face is veiled that man may not lust after the beauty of his neighbor’s wife; continence is secured through license, which is legalized immorality; the zeal of the faithful

<sup>4785</sup> *NRC Handelsblad*, nrc.nl, LGF, “Jihad Death Count,” 17 Apr 2004.

<sup>4786</sup> Parinoosh, Arami. “Thousands of *Iranians* ready for suicide raids,” *Reuters.co.uk*, 5 Jun 2004, *JW*, 7 Jun 2004.

<sup>4787</sup> *Al-Arabiya* TV Report: *Iranian* Volunteer Suicide Bomber Organization of 40,000 ‘Time Bombs’ Recruited to Target Americans in *Iraq* and *Israel*,” *Memri.org*, #929, 6 Jul 2005, *JW*.

<sup>4788</sup> “*Pakistan*-based *Lashker* raises suicide squads in *Iraq*,” *newindpress.com*, 14 Jun 2004, *JW*.

<sup>4789</sup> Pipes, Daniel. “Weblog: *Jihad*’s Total Fatalities since 9/11,” *DP*, 16 Apr 2004.

<sup>4790</sup> Rajagopalan, S. “*India* was worst victim of terror in 2003: U.S. report,” *Hindustantimes.com*, 30 Apr 2004.

<sup>4791</sup> See the Contents section to locate the table on the *Koran*’s 164 War verses.

is stimulated by prospects of plunder; converts are made by the sword; and paradise consists of a garden of sensual delights. This the mass of *Muslims* believe...<sup>4792</sup>

*Islam* did not invent the concept of Holy War but borrowed it from Jews. Of course Holy War itself is not new, but pairing Holy War up with rewards in the afterlife came from the Intertestamental Jews, which rewards will be discussed in a moment. Examples of Holy War that are **not** explicitly connected to rewards in the afterlife include:

- ☉ The *Pentateuch* encourages Holy War so *Israel* could have a homeland.
- ☉ The Bible mentions that the god *Kemosh* gave an *Ammonite* king some *Israeli* land (Jdg 11:24).
- ☉ Genghis Khan (1162?–1227) set out to conquer the world in obedience to revelations from his god *Tengiri*.<sup>4793</sup>
- ☉ “Manifest destiny” is a Holy War concept that may have been a distortion of Act 17:26 where it says God determined the times and places where every nation would live.
- ☉ Modern Zionists carried out Holy War since they sought to obtain land based on *Yahveh*’s promises to the *Israelites* in the *Pentateuch*.

*Islam* also did not invent the idea of rewards in the afterlife for carrying out suicidal mission in a complete vacuum. The idea of carrying out suicidal missions for heavenly reward originally comes from ancient Jews, which is not to say that modern Jews hold to these same beliefs. The Roman historian Tacitus (~55 AD to ~120 AD) wrote:

They [Jews] hold that the souls of all who perish in battle or by the hands of the executioner are immortal. Hence a passion for propagating their race and a contempt for death.<sup>4794</sup>

Intertestamental Jewish warriors seem to have believed that if they were killed in battle, or singly after carrying out an assassination or suicidal mission, that they would be immortalized in the afterlife. They believed their reward would somehow be greater than what others receive.

The flip side of the belief that dying in battle is glorious is *Din Rodef*, the Jewish belief that anyone who gives up land that Jews have captured can be killed with impunity.<sup>4795</sup> *Din Rodef* also covers killing those who besmirch *Yahveh* or endanger his people.

Many Jews still believe in *Din Rodef* and the *Israeli* Prime Minister Yitzhak Rabin was assassinated in 1995 on account of *Din Rodef*. Jews who want to give up land are sometimes referred to as the spies who spread the evil report during the *Exodus* (Num 13:32; 14:37).<sup>4796</sup>

Before Rabin’s assassination, a *Rabbi* performed the *Pulsa De Nura* (Lashes of Fire) *Kabalistic* ritual putting a deadly curse on Rabin.<sup>4797 4798</sup> Kahanists credit the

<sup>4792</sup> Curtiss. *Primitive*, p. 240.

<sup>4793</sup> Goel. *Calcutta*, ch. 10.

<sup>4794</sup> MacMullen & Lane. *Sourcebook*, p. 162.

<sup>4795</sup> Gilbert, Nina *et al.* “Knesset debates *Din Rodef*,” jpost.com, 6 Jul 2004. The *Din Rodef* is based on the idea that anyone who is about to murder, or cause the wrongful death of another person, can be killed with impunity.

<sup>4796</sup> Gutman, Matthew. “Gaza settlers start pro-evacuation group,” jpost.com, 25 Aug 2004.

<sup>4797</sup> “Rabbi says would hold *Kabbalah* ritual calling for PM’s death,” haaretz.com, 15 Sep 2004.

<sup>4798</sup> Ilan, Shahr. “The original *Pulsa Denura*,” haaretz.com, 5 May 2005.

*Pulsa* ritual performed before the Disengagement in 2005 with Prime Minister Ariel Sharon's debilitating stroke in January 2006.<sup>4799</sup>

*Muslims* and Jews to some extent share these two doctrines, which are different faces on the same coin. This makes both *Muslims* and many *Israelis* into ardent irredentists who are loath to cede any land whatsoever.

The doctrine of immortality for dead warriors did not arise from the Old Testament prophets. It did not arise from Intertestamental prophets either since there were no Intertestamental prophets (*Prayer of Azariah* 01:15; 1 *Maccabees* 09:27).

It should be noted that the Intertestamental Jews were motivated to Holy War by feelings of nationalism and tribalism, rather than by the Old Testament. There is no hint in the New Testament that anyone was made to feel shame and guilt for not joining the Zealots or the *Sicari*. In contrast to those Jews who were not willing to share the Holy Land, Jesus was willing to share the temple. He quotes Isaiah and says the temple is the house of prayer for all nations (Mar 11:17; Isa 56:07).

The topic of "freedom fighting" never comes up in the New Testament even though Simon the Zealot was one of Jesus' disciples (Mat 10:04). Nor is there any discussion of whether *Sicari* methods were *Kosher*. The name *Sicari* comes from the Latin word, *Sica*, which refers to the "small dagger" the Jewish Zealots used to assassinate Romans and collaborators.

There was no commandment that Jews fight a Holy War against the Romans—an "obligatory warfare" (*Milchemet Mitzvah*). In contrast with Judaism, *Islam* has 164 War verses mixed in with a lethal combination of other types of verses:

- ☉ Promising fleshly rewards in the afterlife if *Muslim* go on *Jihad*.
- ☉ Threatening hellfire if able-bodied *Muslims* do not go on *Jihad*.
- ☉ Teaching the attitude that this mortal life is a mere "sport" and "play."

The "immortalization of dead warriors" idea can be quite a powerful incentive to engage in Holy War. This idea probably motivated the Zealots and the *Sicari*, who specialized in suicidal assassinations and risky rebellions that had little chance of any strategic success against the Roman Empire.

Immortalization was probably what drove the *Maccabeans* to forcefully convert many peoples in Galilee and *Idumea*. John Hyrcanus (134-104 BC) and his son, Alexander Janneus (103-176 BC) forcefully converted those they conquered. The *Herodian* dynasty was of *Idumean* descent.<sup>4800</sup> The *Idumeans* were forced to practice Judaism by John Hyrcanus in 130 BC.

The immortalization of dead warriors concept probably led to the people to try to make Jesus into their bread-king or at least resistance leader (Joh 06:15; 12:13). Caiaphas knew of the mindset of the people and figured that Jesus had to be killed before he would become the next Spartacus (died 71 BC) (Joh 11:50). In the end, Jesus' trial before Pilate centered on his being a king (Joh 18:33, 36, 39; 19:03, 12, 14, 19, 21).

The "immortalization of dead warriors" concept led to the Judean province being virtually ungovernable for the Romans, which eventually led to Jews' loss of their homeland. It seems logical that soldiers could not be motivated to fight the mighty Roman Empire for material gain, so they must have been promised heavenly rewards instead.

<sup>4799</sup> Katz, Yaakov. "Extremists boast they cursed Sharon," jpost.com, 6 Jan 2006.

<sup>4800</sup> Josephus, *Antiquities of the Jews*, bk. 14, ch. 1, section 3.

Jews in southern Arabia seemed to have employed Holy War under King *Dhu Nuwas*, whose real name was Yusuf As'ar Yath'ar<sup>4801</sup> (died 525 AD). The senseless slaughters of Christians that brought the wrath of the Byzantines and *Abyssinian* Christians may have been the result of failed forced conversion policies or ethnic cleansings. Significantly, *Muhammad's* biographer Ishaq, mentions King *Dhu Nuwas*, as though he were a precursor to *Muhammad*.<sup>4802</sup>

The idea of heavenly rewards for *Jihad* spread throughout *Islamdom*, so that *Muslim* rulers must constantly be on vigil to repress terrorism, and true democracy is nearly impossible to implement.<sup>4803</sup> Unfortunately, *Muslim* rulers are glad to let would-be martyrs go after Christians and other non-*Muslims* so that *Islamists* do not feel the need to attack *Muslim* governments.

Someone might argue that Jews did not engage in suicidal warfare or attacks and that Josephus' account of the suicidal end at *Masada* is not borne out by archaeology. Doubts about Josephus' account are speculative. Anyway, the whole idea of taking on the ancient Roman Empire time and again was suicidal, as the High Priest Caiaphas admitted (Joh 11:50).

Some of the same beliefs and attitudes that made many ancient Jews perpetrate suicidal attacks infect *Muslims* still today. These beliefs are mentioned by the Roman historian Tacitus (~55 AD to ~120 AD):

...among themselves [Jews] they are inflexibly honest and ever ready to shew [show] compassion, though they regard the rest of mankind with all the hatred of enemies.<sup>4804</sup>

Similarly, *Muhammad* commanded *Muslims* to be kind to *Muslims* and harsh to non-*Muslims* (*K* 009:073, 123; 048:029; 066:009) and kill pagans on sight (*K* 009:005). The *Koran* says that unbelievers are "enemies" (*K* 002:098; 008:060; 009:114; 041:019, 028), "vile animals" (*K* 008:022, 055), cattle (*K* 007:179) and are unclean and must be kept away from *Makka* (*K* 009:017-018, 028).

The Roman historian Tacitus wrote:

Things sacred with us [Romans], with them [Jews] have no sanctity, while they allow what with us is forbidden...Circumcision was adopted by them as a mark of difference from other men...Those who come over to their religion adopt the practice and have this lesson first instilled into them, to despise all gods, to disown their country and set at naught parents, children and brethren.<sup>4805</sup>

All the above could be said about *Islam*, for instance:

- *Islam's* polygamous marriage laws and temporary (*Muta*) marriage laws are iniquitous.
- That the *Koran* sanctions non-consensual sex between a master and slave is wicked.
- John of Damascus (~675 to ~749 AD) noted that the *Halal* list of foods is different from the list of *Kosher* foods that Moses gave, and the list of disallowed foods is different too.<sup>4806</sup>

<sup>4801</sup> Ryckmans, Jacques. *EB*, "Arabian Religions" entry, 2004.

<sup>4802</sup> Ishaq. *Sirat*, p. 13-14.

<sup>4803</sup> Pipes, Daniel. "A Strongman for Iraq?" *New York Post*, 28 Apr 2004, *DP*.

<sup>4804</sup> Tacitus, *Histories*, 5.3ff, as excerpted from *Tacitus, Histories*, translated by A. J. Church & W. J. Brodribb, 1888, reprinted in Modern Library, New York, 1942, as quoted in MacMullen & Lane. *Sourcebook*, p. 161.

<sup>4805</sup> Tacitus, *Histories*, 5.3ff, *Idem*.

<sup>4806</sup> Sahas. *Heresy*, p. 141, App. I, M.P.G., XCIV:773.



☉ *Islamists* teach their followers to not hold allegiance to any nation but only to *Islam* and a future *Caliphate*.

All the above cultural differences drive the wedge deeper between *Muslims* and non-*Muslims* and make it easier for *Muslims* to kill non-*Muslims*.

Concerning propagation of the Jewish race, the Roman historian Tacitus wrote:

It is a crime among them to kill any newly born infant. They hold that the souls of all who perish in battle or by the hands of the executioner are immortal. Hence a passion for propagating their race and a contempt for death.<sup>4807</sup>

The ancient Jews believed that they and their children would be immortalized in heaven, so they were more likely to have children and not to abort them, nor kill them at birth. Jews also were not afraid to die and face the afterlife, whereas other cultures at the time were less than hope-filled about their prospects in the afterlife.

*Muslims* believe that if they perpetrate a suicide-bombing, they will become *Shahids* and they will immediately receive banquets and 72 virgins in heaven.

The non-martyr *Muslims* will need to soul sleep after they die until the Last Day when they will go to Purgatory for their “taste of fire.”<sup>4808</sup> *Muslim* martyrs however will be able to intercede for seventy relatives to get them out of Purgatory.

Similarly, *Muhammad* thought it a shame that Arabs buried baby girls (gendercide), mainly because this would mean there would be fewer *Muslim* warriors who would be immortalized in heaven (K 016:058-059). Thus *Muhammad* may have believed in the propagation of his race for the same reasons as the ancient Jews did.

It is not surprising, given these beliefs, that many *Muslim* women are glad to have plenty of children, and even happier if one or more of their children “martyr” themselves.<sup>4809 4810</sup> Just as many find that children are the best social security insurance policy on earth, children will also help parents get out of Purgatory sooner in the afterlife (Purgatory is discussed in the Khidr-Second Lamech Logic table).

<i>Sujud</i>	The place where <i>Rakas</i> are performed.
<i>Sunni</i>	90 percent of <i>Muslims</i> are <i>Sunni</i> and 10 percent are <i>Shia</i> . <i>Shias</i> are mostly Persian who have introduced newer traditions and beliefs.
<i>Sura(h)</i>	There are 114 <i>Suras</i> , or chapters, of the <i>Koran</i> . An <i>Ayat</i> is an individual verse. <i>Sura</i> is sometimes confused with <i>Sira</i> —the biographies of <i>Muhammad</i> , and <i>Sirat</i> —the bridge over <i>Muslim</i> hell.
<i>Sutra</i>	An object a praying <i>Muslim</i> places to mark the <i>Kiblah</i> .
SWT	<i>Subhanahu Wa Ta'ala</i> is Arabic for “Glorified is He and Exalted,” used after the name <i>Allah</i> . See also AS and SAW.
<i>Tafsir</i>	A commentary on the <i>Koran</i> .
<i>Takbir</i>	The formula “ <i>Allah Akbar</i> ,” literally meaning “ <i>Allah</i> is greater!”
<i>Takfir</i>	The practice of a <i>Muslim</i> condemning another <i>Muslim</i> as an infidel over some doctrinal disagreement. Those deemed to be infidels can be killed, especially during time of insurgency and during acts of terrorism. <sup>4811</sup>
<i>Takiya</i>	Also spelled <i>Taqiyya</i> . See <i>Kitman</i> .

<sup>4807</sup> Tacitus, *Histories*, 5.3ff, *Op. Cit.*

<sup>4808</sup> See the Glossary for information on *Islam*’s version of Purgatory.

<sup>4809</sup> “Palestinian mother proud of two sons killed on *Hamas* missions,” Jpost.com, 19 Feb 2003.

<sup>4810</sup> Daraghmeh, Mohammed. “Suicide-bomber was apprentice lawyer scarred by her brother’s killing,” *The Associated Press, New Jersey News*, nj.com, 4 Oct 2003.

<sup>4811</sup> Nordland, Rod & Babak Dehghanpisheh. “Rules of Engagement,” msnbc.com, 29 Nov 2004, Backspin, 22 Nov 2004.

<i>Tasbih</i>	The formula “Glory be to <i>Allah</i> .”
<i>Taurat</i>	<i>Torah</i> . The <i>Pentateuch</i> . Sometimes <i>Torah</i> is shorthand for the entire body of Jewish religious law and learning.
<i>Tawaf</i>	Circumambulation around the <i>Kaaba</i> . Also see <i>Sae</i> .
<i>Tu Quoque</i>	See <i>Kitman</i> .
Turnspeak	See <i>Kitman</i> .
<i>Ulama</i>	Religious instructor. Theologian. Divine.
<i>Umma</i>	The <i>Muslim</i> community.
<i>Umra</i>	Literally “visitation.” The minor annual pilgrimage at <i>Makka</i> .
<i>V./Vss.</i>	Verse and Verses.
<i>Vice versa</i>	Latin for “Reversed order or circumstances.”
vol./vols.	Contraction meaning “volume.” “Vols.” stands for “volumes.”
WMD	“ <b>W</b> eapons of <b>M</b> ass <b>D</b> estruction,” i.e. Nuclear-Chemical-Biological
WoT	War on Terror. Also Global War on Terror (GWOt). See 9/11.
WWMD?	Abbreviation for “ <b>W</b> hat <b>W</b> ould <i>Muhammad</i> <b>D</b> o?” or “What Would <i>Muslims</i> Do?”, based on the WWJD abbreviation for “ <b>W</b> hat <b>W</b> ould <i>Jesus</i> <b>D</b> o?” Note that WWMD and WMD are eerily similar.
<i>Wudu</i>	Water or sand ablution before prayers.
<i>Yahveh</i>	The German transliteration of the Hebrew word <i>Yahveh</i> is <i>Yahweh</i> ,

but is still pronounced *Yahveh* since the “w” in German is pronounced like an English “v”.

In many English Bibles, *Yahveh* is commonly translated as “LORD,” but sometimes as GOD (note the all-capital letters). *Yahveh* is translated as *Kurios*, meaning “Lord,” in the Greek *LXX*. The *LXX* was translated in the third to second centuries BC.

<i>Yeshua</i>	<i>Yeshua</i> is Aramaic meaning “Jesus.” Jesus in Arabic is <i>Isa</i> , though <i>Isa</i> originally may have referred to <i>Esau</i> . Perhaps Arab Jews after the time of Christ labeled Jesus <i>Isa</i> in a derogatory sense (see <i>Esau</i> in a Bible dictionary).
<i>Zakat</i>	Alms. Charity. One of the five pillars of <i>Islam</i> .
<i>Zamzam</i>	The well dug during pre- <i>Islamic</i> times by the <i>Kaaba</i> . Sometimes spelled <i>Zemzem</i> and also as two words: <i>Zem Zem</i> .

## Selective Bibliography

(Also see the Other References section under Abbreviations)

**Note 1:** Some references can be found at the end of the Coins Appendix in the section “Selected *Islamic* Coin References.” Standard reference books such as *Koran* and Bible versions can be found in the “Other References” section at the start of this book.

**Note 2:** If the footnote contains the full bibliographical citation, the entry for the work is not repeated in the Selective Bibliography.

**Note 3: Bolded** words in the titles below relate to the abbreviated citations found in the footnotes.

- ☉ *Abu-Dawud*, Sulaiman Bin Al Aash'ath Al Azdi as-Sijistani (817-888 AD/202-275 AH). *Translation of Sunan Abu-Dawud* (partial). Translated by Professor Ahmad Hasan (online).
- ★ *Abu Khalil*, As'ad. “A note on the study of homosexuality in the Arab/*Islamic* civilization.” *Arab Studies Journal*, 1993, vol. 1(2):32-34, 48.
- ★ Ahmad, Imad-ad-Dean. ***Signs in the Heavens: A Muslim Astronomer's Perspective on Religion and Science***. Writers' Inc., International, Beltsville, Maryland, USA, 1992.
- ★ *Al Albani*, Muhammad Naasir-ud-Deen (*Shaykh*). ***Rites of Hajj and Umrah, Quran & Sunnah*** Society Publishers, Damascus, 1395 AH (1975 AD) (online).
- ★ *Al Farid*, Ibn. *Chester Beatty Monograph no. 6: The Mystical Poems of Ibn Al Farid*, A. J. Arberry (translator, annotator), Emery Walker, Limited, St. Margaret's, Donnybrook, Dublin, Ireland 1956.
- ★ *Al Kalbi*, Hisham (died 821-822 AD/206 AH). *Book of the Idols* [Arabic: *Kitab Al-Asnam*]. Introduction and notes by Nabih Amin Faris (translator), Princeton University Press, Princeton, New Jersey, USA, 1952 (online).
- ★ *Al Kindy*. ***The Apology of Al Kindy in Defence of Christianity Against Islam*** (written ~830 AD). Foreword by Sir William Muir, 2<sup>nd</sup> Edition, London Society for the Promotion of Christian Knowledge (SPCK), E. & J. B. Young & Company, New York, 1887 (online).
- ★ *Al-Misri*, Ahmad Ibn Naqib (died 769 AH/1368 AD). ***Reliance of the Traveller: The Classic Manual of Islamic Sacred Law ('Umdat Al-Salik)***. Compiled by. Translated by Ahmad Ibn Lulu Ibn Al-Naqib & Noah Ha Mim Keller. Amana Publishing, Beltsville, Maryland, 1994 (*Al-Azhar Seminary*, Cairo, approved).
- ★ *Al Saeh*, Khairt. ***Fabled Cities, Princes & Jinn from Arab Myths and Legends***, Schocken Books, New York, 1985.
- ★ *Al-Salik'*, Umdat (see *Al-Naqib. Reliance*, which is a manual of *Sharia* law).
- ★ *Al Tabari* (839–923 AD). ***The History of Al Tabari, vol. i, General Introduction and from the Creation to the Flood***. Franz Rosenthal (translator), State University of New York Press, 1989.
- ★ Albright, W. F. *The Proto-Sinaitic Inscriptions and their Decipherment*. *Harvard Theological Studies* xxii, Cambridge, Massachusetts, 1966.
- ★ Album, Stephen. ***A Checklist of Popular Islamic Coins***, 2<sup>nd</sup> Edition, Album, California, 1998.
- ★ Album, Stephen. *Sylloge of Islamic Coins in the Ashmolean*, vol. 10, Arabia and East Africa, Ashmolean Museum, Oxford, 1999.

- ★ Ali, Syed Ameer. The **Spirit** of *Islam*: A History of the Evolution and Ideals of *Islam* with a Life of the Prophet. Low Price Publications, *Delphi*, 1923.
- ★ *American Heritage Dictionary of the English Language, The*, 4<sup>th</sup> Edition, Houghton Mifflin Company, 2003 (online).
- ★ Anonymous. *Gilgamesh, King of Uruk: The Epic of Gilgamesh*, ~7th Century BCE.
- ★ Armstrong, Karen. *Muhammad: A Biography of the Prophet*. HarperSanFrancisco, San Francisco, California, USA, 1993.
- ★ Asad, *Muhammad*. *The Message of the Quran*. Dar Al-Andalus Limited, 3 Library Ramp, Gibraltar, Spain, reprint 1993.
- ★ *Assyrian Dictionary, The*. vol. 5. Oriental Institute of the University of Chicago, Chicago, Illinois, USA, 1956.
- ★ Auge, Christian & Jean-Marie Dentzer. *Petra: Lost City of the Ancient World*. Harry N. Abrams (translator), Abrams, New York, 2000.
- ★ Avakian, Lindy V. *The Cross and the Crescent*, 3<sup>rd</sup> Edition. Golden West Publishers, Unlimited, Fresno, California, USA, 1998.
- ♣ Baer, Eva. *Islamic Ornament*. New York University Press, New York, 1998.
- ★ Balog, Paul. *Umayyad, Abbasid and Tulunid Glass Weights and Vessel Stamps*. The American Numismatic Society, New York, 1976.
- ★ Barag, Dan (editor). *Studies in Memory of Paul Balog*. The Israel Numismatic Society, Jerusalem, 1991. The article was also published in *Israel Numismatic Journal*, Israel Numismatic Society, vol. 10, 1988-1989.
- ★ Barber, Allen H. *Celestial Symbols: Symbolism in Doctrine, Religious Traditions and Temple Architecture*, Horizon Publishers, Bountiful, Utah, USA, 1989.
- ★ Bates, Michael L. "The Arab-Byzantine Bronze Coinage of Syria: An **Innovation** by 'Abd Al Malik," found in *A Colloquium in Memory of George Carpenter Miles (1904-1975)*, The American Numismatic Society, New York, 1976.
- ★ Blair, Sheila S. *Islamic Inscriptions*. New York University Press, New York, 1998.
- ★ Blair, Sheila S. & Jonathan M. Bloom (editors). *Images of Paradise in Islamic Art*. Hood Museum of Art, Dartmouth College, Hanover, New Hampshire, USA, 1991.
- ★ Bowen, Richard L., Jr., & Albright, Frank P. *Archaeological Discoveries in South Arabia*. The Johns Hopkins Press, Baltimore, Maryland, USA, 1958.
- ★ Breton, Jean-Francois. *Arabia Felix From the Time of The Queen of Sheba: Eight Century BC to First Century AD*. Translated by Albert LeFarge. U. of Notre Dame Press, Notre Dame, Indiana, 1999.
- ★ Brockelmann, Carl. *History of the Islamic Peoples* (1939). Joel Carmichael and Moshe Perlmann (translators). Capricorn Books, New York, 1960.
- ★ Brewer, E. Cobham (1810–1897 AD). *Dictionary of Phrase and Fable*. Henry Altemus, PhilaDelphia, 1898 AD, ISBN: 1-58734-094-1 (online).
- ★ Brighton, Louis A. *Revelation*. Concordia Publishing House, Saint Louis, Missouri, 1999.
- ★ Brown, Matthew B. and Paul Thomas Smith. *Symbols in Stone: Symbolism on the Early Temples of the Restoration*. Covenant communications, Inc., American Fork, Utah, USA, 1997.
- ★ Budge, E. A. Wallis. *Osiris: The Egyptian Religion of Resurrection*. University Books, New Hyde Park, New York, 1961.

- ★ Bukhari, *Abu Abdullah Muhammad Bin Ismail Bin Ibrahim Bin Al Mughira Al Ja'fai* (809-869 AD/194-256 AH). *Translation of Sahih Bukhari*. Translated by M. Muhsin Khan (online).
- ★ Burton, Sir Richard Francis (1821-1890 AD) (translator). *The Book of the Thousand Nights and a Night*, 1885 (online).
- ★ Burton, Sir Richard Francis. "Terminal Essay, Section D: **Pederasty**," from his translation of *Nights* (online).
- ★ *Burton, Sir Richard Francis. City of the Saints, and across the Rocky mountains to California*. New York, Harper & brothers, 1862.
- ★ Burton, Sir Richard Francis. *Personal Narrative of a Pilgrimage to Al Madinah and Makkah*, vol. i, 10<sup>th</sup> edition, Isabel Burton (widow & editor), United Kingdom, 1893 (online).
- ☛ Caner, Ergun Mehmet & Emir Fethi Caner. **Unveiling Islam: An Insider's Look at Muslim Life and Beliefs**. Kregel Publications, Grand Rapids, Michigan, 2002.
- ★ Cashford, Jules. *The Moon: Myth and Image*. Four Walls Eight Windows, New York, 2003.
- ★ Chebel, Malek. **Symbols of Islam**. Editions Assouline, Paris, France, 1997.
- ★ Ciolek, T. Matthew. **Old World Trade Routes (OWTRAD): Gazetteer of geo-referenced nodes of long-distance communication routes** (version 7.1). Research School of Pacific and Asian Studies, Australian National University, Canberra, Australia (ciolek.com).
- ★ Clapp, Nicholas. **Sheba: Through the Desert in Search of the Legendary Queen**. Houghton Mifflin Company, Boston, 2001.
- ★ *Columbia Electronic Encyclopedia, The (CEE)*. Columbia University Press, 1999 (online).
- ★ Coon, Carleton Steven (1904-1981). **Southern Arabia**, Smithsonian, Washington D.C., 1944, pp. 398-399, as quoted in Morey. *Invasion*, Appendix C: "The Moon-god and Archeology," pp. 213, 215, 217 & footnotes 8, 13, 14.
- ★ Corbin, Henry. *Creative Imagination in the Sufism of Ibn 'Arabi*. Princeton University Press, Princeton, 1969.
- ★ Cragg, Kenneth. **Jesus and the Muslim**. George Allan and Unwin, London, 1985.
- ★ Creswell, K. A. C. *A Short Account of Early Muslim Architecture*, Penguin Books, Baltimore, Maryland, 1958.
- ★ Christys, Ann. *Christians in Al Andalus (711-1000)*. Curzon Press, Richmond, Surrey, United Kingdom, 2002.
- ★ Curtiss, Samuel Ives. **Primitive Semitic Religion Today: A Record of Researches, Discoveries and Studies in Syria, Palestine and the Sinaitic Peninsula**, Revell, Chicago, Illinois, USA, 1902, as quoted in *Hans Krause's Research Reports: Ancient Arabia and its Religion 1*.
- ★ Curtiss, Samuel Ives. **Ursemitsche Religion im Volksleben des heutigen Orients: Forschungen und Funde aus Syrien und Palästine**. Leipzig, Germany, 1903, as translated from German to English in *Hans Krause's Research Reports: Ancient Arabia and its Religion 1*, hanskrause.de, Chapter 5: Modern Baal Worship, accessed Feb 2004.
- ☛ Darnell, Charles E. *The Illustrated Guide To The Tribe of the Quraish*, 1998, ISBN 1-889949-02-7, VisionQuest Publishing, Louisville, Kentucky, family tree compiled from *History of Muhammad (The Prophet) & Glubb, Sir John Bagot (1897-1986 AD), The Life and Times of Muhammad*. J.B.G., Madison Books, 1998.

- ★ Dashti, Ali. *Twenty-Three Years: A Study of the Prophetic Career of Mohammad*. F. R. C. Bagley (translator). Mazda Publishers, Costa Mesa, California, USA, 1994.
- ★ Daum, Werner. *Ursemitische Religion* (meaning “Primeval Semitic Religion”). Kohlhammer, Stuttgart, Germany, 1985, as translated from German to English in *Hans Krause’s Research Reports: Ancient Arabia and its Religion 1, 2 and 3* (hanskrause.de), accessed Feb 2004.
- ★ De Rosa, Giuseppe (S. I.) “**Christians** in Islamic Countries,” *La Civiltà Cattolica*, no. 3680, 18 Oct 2003, as translated in Magister, Sandro. “The Church and Islam: *La Civiltà Cattolica* Breaks the Ceasefire,” *Chiesa* (online), Oct 2003.
- ★ Dearman, Andrew (Editor). *Studies in the Mesha Inscription and Moab*, Scholars Press, Atlanta, Georgia 1989.
- ★ Dietrich, M.; Lorentz, O.; and Sanmartín, J. *The Cuneiform Alphabetic Texts from Ugarit, Ras Ibn Hani and Other Places*. Münster, 1995, or *Die Keilalphabetische Texte aus Ugarit (KTU): Alter Orient und Altes Testament (KTU)*, 24. Kevelaer, 1976.
- ★ Doe, Brian. *Southern Arabia: New Aspects of Antiquity*. McGraw-Hill Book Company, New York, 1971.
- ★ Dubal, Léo. “The **Riddle** of the Protective Crescent in Punic Votive Art,” *IV Congresso Internacional de Estudios Fenicios y Púnicos Cadiz*, 2-6 Octubre 1995, Sec. F: Religiòn y culto (archaeometry.org/cdz.htm), accessed 18 Mar 2003.
- C Edwardes, Marian & Lewis Spence. *A Dictionary of Non-Classical Mythology*. Ernest Rhys (editor). Everyman’s Library, no. 632, E. P. Dutton, New York, 1923 (2<sup>nd</sup> Edition).
- C Eisler, Robert, 1909, as quoted in *Hans Krause’s Research Reports: Ancient Arabia and its Religion, Part 3*, “Ch. 3: The Goddess *Ka’abah*” (hanskrause.de), accessed Feb 2004.
- ★ Elad, Amikam. *Medieval Jerusalem and Islamic Worship: Holy Places, Ceremonies, Pilgrimage*. E. J. Brill, New York, 1995.
- ★ Eliade, Mircea (Editor). *Encyclopedia of Religion*. MacMillan Publishing House, New York, 1987.
- ★ Elias, Jamal J. and Nancy D. Lewis. *The Pocket Idiot’s Guide to Islam*. Alpha Books, 2002.
- ★ *Encyclopædia Britannica (EB)*, Britannica.com.
- ★ Ettinghausen, Richard. “**Kufesque** in Byzantine Greece, the Latin West and the Muslim World,” pp. 28-47, as found in *A Colloquium in Memory of George Carpenter Miles (1904-1975)*, The American Numismatic Society, New York, 1976.
- C Fallaci, Oriana. *The Rage and the Pride*. Rizzoli, New York, 2001.
- ★ Fallaci, Oriana. *The Strength of Reason* (Italian: *La Forza della Ragione*), 2004.
- ★ Fani, Moshan [also spelled Mohsin] (1614-1670 AD). *Oriental Literature (or The Dabistan)* (1645 AD). David Shea and Anthony Troyer (translators). Tudor Publishing Co, New York, 1937.
- ★ Fani, Moshan (also spelled “Mohsin”). *The Religion of the Sufis*. David Shea and Anthony Troyer (translators). The Octagon Press, London, 1979.
- ★ Farah, Caesar E. *Islam: Beliefs and Observances* (5<sup>th</sup> Edition), Baron’s Education Series, 1994.

- ★ Felter, M.D., Harvey Wickes, and John Uri Lloyd, Phr. M., Ph. D. *King's American Dispensatory* (two volumes), 8<sup>th</sup> Edition. 3<sup>rd</sup> Revision, Ohio Valley Company, Cincinnati, Ohio, USA, [ibiblio.org](http://ibiblio.org), 1898.
- ★ Fletcher, Richard. *Moorish Spain*. University of California Press, Berkeley, Los Angeles, California, 1992.
- ★ Freedman, David Noel (editor). *Anchor Bible Dictionary*, New York, 1992, entry Ryckmans, Jacques. "South Arabia, Religion of," v. 6, pp. 171-176.
- ★ Fregosi, Paul. *Jihad in the West*. Prometheus Books, Amherst, New York, 1998.
- ★ Geisler, Norman L. & Abdul Saleeb. *Answering Islam: The Crescent in the Light of the Cross*. Baker Books, Grand Rapids, Michigan, USA, 1993.
- ★ Ghosh, A. *The Koran and the Kafir, Islam and the Infidel: All That an Infidel Needs to Know about the Koran but Is Embarrassed to Ask*. 1983.
- ★ Gibb, H. A. R. *Mohammedanism: A Historical Survey*. Oxford University Press, New York, 1953.
- ★ Gibb, H. A. R. & J. H. Kramers. *Concise Encyclopedia of Islam*, Brill Academic Publishers, Boston, 2001.
- ★ Gibson, Clare. *Sacred Symbols: A Guide to the Timeless Icons of Faith and Worship*. Barnes and Noble Books, New York, 1998.
- ★ Gilchrist, John. *Muhammad and the Religion of Islam*, MERCESA, Claremont/Cape Town, South Africa, 1986 (online).
- ★ Gilchrist, John. *Muhammad: The Prophet of Islam*, MERCESA, Claremont/Cape Town, South Africa, 1994 (online).
- ★ Gilchrist, John. *Our Approach to Islam: Charity or Militancy?* MERCESA, Claremont/Cape Town, South Africa, 1990 (online).
- ★ Glassé, Cyril. *The Concise Encyclopedia of Islam*. HarperCollins Paperback Edition, 1991.
- ★ Glueck, Nelson. *Deities and Dolphins: The Story of the Nabataeans*. Cassell, London, 1966.
- ★ Goel, Sita Ram. *Hindu Temples: What Happened to Them* (Vols. I & II). Voice of India, New Delhi, 1993 (online: [voi.org/books](http://voi.org/books)).
- ★ Goel, Sita Ram. *The Calcutta Quran Petition*, Voice Of India, New Delhi 1999, 3rd edition (online: [voi.org/books](http://voi.org/books)).
- ★ Goldman, Bernard. *The Sacred Portal: A Primary Symbol in Ancient Judaic Art*. Wayne State University, 1966.
- ★ Goodenough, Erwin R. *Jewish Symbols in the Greco-Roman Period* (abridged). Jacob Neusner (editor). Princeton University Press, Princeton, New Jersey, 1988.
- ★ Grabar, Oleg. *The Formation of Islamic Art*. Yale University Press, New Haven, Connecticut, 1973.
- ★ Grabar, Oleg. *The Shape of the Holy: Early Islamic Jerusalem*. Princeton University Press, Princeton, New Jersey, 1996.
- ★ Graveland, Bill. "Queen of Sheba's temple found: University of Calgary professor directs team that finds 3,000 year old temple in Yemen," *The Canadian Press* ([canoe.ca](http://canoe.ca)), 12 Sep 2000.
- ★ Green, Tamara M. *The City of the Moon-god: Religious Traditions of Harran*. E. J. Brill, New York, 1992.
- ★ Grunebaum, G. E. von. *Muhammadan Festivals*. Henry Schuman, Inc., New York, 1951.
- ★ Guillaume, Alfred. *Islam*. Penguin Books, New York, 1956 (second edition).

- ★ Gunduz, Sinasi. *The Knowledge of Life: The Origins and Early History of the Mandaeans and Their Relation to the Sabians of the Quran and to the Haranians*. Oxford University Press, United Kingdom, 1994.
- ★ Gutmann, Joseph. *The Dura-Europos Synagogue: A Reevaluation (1932-1972)*. University of Montana, Missoula, Montana, 1973.
- ☉ *Hadith* (see the listings for Bukhari, *Muslim*, *Abu-Dawud*, and Malik. Also, see the online editions at:
- ☉ [usc.edu/dept/MSA/fundamentals/HadithSunnah/](http://usc.edu/dept/MSA/fundamentals/HadithSunnah/).
- ★ Hastings, James (editor). *Encyclopedia of Religion & Ethics*, Clark, Edinburgh, England, 1908, vol. i, Part 2 (2), Apaches-Art, pp. 659-673, “Arabs (Ancient).” Reprinted by Elibron Classics, elibron.com.
- ★ Hazm, *Ibn*. *A Book containing the Risala known as the Dove’s neck-ring about love and lovers*. Translated by A. R. Nykl. Paul Geuthner (press), Paris, 1931.
- ★ Hawting, G. R. *The Idea of Idolatry and the Emergence of Islam: From Polemic to History*. Cambridge University Press, Cambridge, United Kingdom, 1999.
- ★ Haykal, Muhammad Husayn. *The Life of Muhammad*. Ismail Ragi A. Al Faruqi (translator), North American Trust Publication, 1976.
- ★ Heritage (see American **Heritage** Dictionary).
- ★ Hislop, Alexander. *The Two Babylons, Or, the Papal Worship Proved to Be the Worship of Nimrod and His Wife*. Loizeaux Brothers, Inc. New York, 1945.
- ★ Hughes, Thomas Patrick. *Dictionary of Islam*. Munshiram Manoharlal Publishers, New Delhi, India, 1885 (reprint 1999; also online).
- ★ Huntington, Samuel P. *The Clash of Civilizations and the Remaking of World Order*. Simon & Schuster, New York, 1997.
- ☉ Ilisch, Lutz. *Sylogie Numorum Arabicorum Tubingen: Nord- und ostzentrasian XVb Mittelasien II*, Ernst Wasmuth Verlag, Tubingen, 1998.
- ★ Ilisch, Lutz. *Sylogie Numorum Arabicorum Tubingen: Palastina IV a Bilad as-Sam I*, Ernst Wasmuth Verlag, Tubingen, 1993.
- ★ Ishaq, *Muhammad Ibn* (704-773 AD/85-151 AH). *Sirat Rasul Allah* (Editor and annotator *Ibn Hisham* (died in 828 or 833 AD/213 or 218 AH). Translated and further annotated by Alfred Guillaume under the title *The Life of Muhammad*. Pakistan Branch, Oxford University Press, Karachi, 1955.
- ★ *Israeli*, Raphael. *Islamikaze—Manifestations of Islamic Matryrology*. Frank Cass, London, 2003, 494 pages.
- ☉ Jeffery, Arthur (editor). *Islam: Muhammad and His Religion*. vol. 137 in “The Library of Liberal Arts,” The Bobbs-Merrill Company, New York, 1958.
- ★ Jeffery, Arthur. *The Foreign Vocabulary of the Quran*. Oriental Institute, Baroda, India, 1938.
- ★ Jeffery, Arthur, “The **Quest** for the Historical Muhammad.” *Muslim World*, vol. 16, no. 4, Oct 1926.
- ★ Jenkins, Philip. *The Next Christendom: The Coming of Global Christianity*. Oxford University Press, 2002.
- ★ Jeremias, Joachim. *Infant Baptism In the First Four Centuries*. Translated by David Cairns. Wipf & Stock Publishers, Eugene, Oregon, 1960.
- ★ Johnson, Eric. *Joseph Smith & Muhammad: A characteristic comparison between the leaders of Mormonism and Islam*. Mormonism Research Ministry, mrm.org, El Cajon, California, USA, 1998.



- ★ Jubayr, *Ibn. The Travels of Ibn Jubayr*. R. J. C. Broadhurst (translator), Jonathan Cape, London, 1952, pp. 75-105 “*Ibn Jubayr Arrives in Makka, 1183 AD*” (online).
- ☛ Kaegi, Walter E. *Byzantium and the Early Islamic Conquests*. Cambridge University Press, Cambridge, United Kingdom, 1992.
- ★ Katt, Krass. *Joseph Smith: Man, Yes; Myth, Maybe; Prophet, NEVER!* cDe Publications, 1994, cultdeadcow.com.
- ★ Khan, Ghulam Mustafa. *Al-Dhabh: Slaying Animals for Food the Islamic Way*. Abul-Qasim Bookstore, Jiddah, Saudi Arabia, 1991.
- ★ Koelle, S. W. *Mohammed and Mohammedanism*. Fulham, London, 1889 (online).
- ★ *Koran* (online).
- ★ Krause, Hans (see Nielsen, Ditlef).
- ★ *KTU* (see Dietrich, M. *et al.*).
- ★ Kuban, Dogan. *Muslim Religious Architecture, Part I: The Mosque and its Early Development*. E. J. Brill, Leiden, 1974.
- ☛ Landay, Jerry M. *Dome of the Rock*. Newsweek Book Division, New York, 1972.
- ★ *Larousse Encyclopedia of Mythology*. Prometheus Press, New York, 1960.
- ★ Larson, Charles M. *By his own hand upon papyrus: a new look at the Joseph Smith papyri*. Institute for Religious Research, Grand Rapids, Michigan, USA, 1992.
- ★ Lecker, Michael. *Jews and Arabs in Pre- and Early Islamic Arabia*. Ashgate Variorum, Brookfield, USA, 1998.
- ★ Levy, Udi. *The Lost Civilization of Petra*. Floris Books, Edinburgh, England, 1999.
- ★ Lewcock, Ronald. *The Old Walled City of San'a.*, United Nations Educational Scientific and Cultural Organization (UNESCO), Paris, 1986 (online).
- ★ Lewis, B. (Editor) V. L. Menage, Ch. Pellat and J. Schacht. *The Encyclopedia Of Islam*, New Edition, 1971.
- ★ Lindner, Manfred. *Petra: und das Konigreich der Nabataer*. Delp'sche Verlagsbuchhandlung, Munchen und Bad Windsheim, 1970.
- ★ Lings, Martin (a Muslim Sufi). *Muhammad: His Life Based on the Earliest Sources*. Inner Traditions International, Rochester, Vermont, USA, 1983.
- ★ Lovette, James B. *Biblical-Related Coins (including both the Old Testament and New Testament)*, Little Rock, Arkansas, 1996.
- ☛ MacMullen, Ramsay. *Christianity & Paganism in the Fourth to Eighth Centuries*. Yale University Press, New Haven, Massachusetts, 1997.
- ★ MacMullen, Ramsay. *Christianizing the Roman Empire: AD 100-400*. Yale University Press, New Haven, Connecticut, USA, 1984.
- ★ MacMullen, Ramsay & Eugene N. Lane (editors). *Paganism and Christianity: 100-425 CE: A Sourcebook*. Fortress Press, Minneapolis, Minnesota, USA, 1992.
- ★ Maimonides, Moses (1138–1204 AD). *The Guide for the Perplexed*. Translated from Arabic by M. Friedlander, Ph.D. 2<sup>nd</sup> Edition, 1904 (online).
- ★ Makiya, Kanan. *The Rock: A Tale of Seventh-century Jerusalem*. Pantheon Books, New York, 2001.

- ★ Malik, Bin Anas Bin Malik Bin Abu Amir Al Asbahi (711-795 AD/93-179 AH). *Translation of Malik's Muwatta*. Translated by `A'isha `AbdaRahman at-Tarjumana and Ya`qub Johnson (online).
- ★ Malkin, Michelle. *In Defense of Internment: The World War II Round-Up and What It Means for America's War on Terror*, Regnery Publishing, Inc., 2004.
- ★ Margoliouth, D. S. *Mohammed and the Rise Of Islam*. New York and London, 1905 (online).
- ★ Margoliouth, D. S. "Some Additions to Professor Jeffery's *Foreign Vocabulary of the Quran*," *JRAS (Journal of the Royal Asiatic Society)*, 1939:53-61, as reprinted in Warraq. *What*, pp. 193-200.
- ★ Margoliouth, D.S., *The Relations Between Arabs and Israelites Prior to the Rise of Islam*, The Schweich Lectures of 1921, Oxford University Press, London, England, 1924.
- ★ Marks, Tracy. "**Makeda**, Queen of Sheba," windweaver.com, 1990.
- ★ Mashar, Abu (787-886 AD). *The Abbreviation of the Introduction to Astrology*. Charles Burnett, translator and editor, ARHAT Publications, 1994.
- ★ Mashar, Abu. *Introductorium in Astronomiam Albumasaris Abalachi, octo Continens Libros Partiales*, Augsburg, 1489 AD.
- ★ Maspero, Gaston. *The Dawn of Civilization*, MacMillan, New York, 1922.
- ★ Maududi, Sayyid Abul A'la (1903-1979 AD; founder of the *Pakistani Jamaat-e-Islami (Islamic Party)*; envisioned a *Caliphate*). *The Meaning of the Quran*, "Chapter Introductions to the *Quran*" (online). Published between 1974 and 1977. Translated from the *Urdu* by Ch. Muhammad Akbar and Edited by A. A. Kamal. Lahore, *Pakistan: Islamic Publications*, 1985.
- ★ Meshorer, Ya'akov. *Ancient Jewish Coinage*, 2 Volumes. Amphora Books, New York, 1982.
- ★ Meshorer, Ya'akov. *Nabatean Coins. Qedem: Monographs of the Institute of Archaeology*, The Hebrew University, Jerusalem, 1975.
- ★ Meyendorff, John. *The Byzantine Legacy in the Orthodox Church*. St. Vladimir's Seminary Press, Crestwood, New York, 1982.
- ★ Meyerson, Mark D. & Edward D. English (editors). *Christians, Muslims and Jews in medieval and Early Modern Spain: Interaction and Cultural Change*. University of Notre Dame Press, Notre Dame, Indiana, 2000.
- ★ Montecroce, Riccoldo da (1242-1320 AD). *Contra Legem Sarracenorum*, written in 1300 AD. Translated into German by Martin Luther (1492-1546 AD), as *Verlegung des Alcoran Bruder Richardi, Prediger Ordens*, 1542 AD (WA 53:272-396) (Translation: Refutation of the *Koran* by Brother Richard, Preaching Order, 1542 AD). Foreword and Conclusion by Martin Luther. Translated from German to English as *Islam in the Crucible: Can it pass the test?* by Thomas C. Pfothenauer. Lutheran News (684 Luther Lane, New Haven, Missouri, 63068), 2002.
- ★ Morey, Robert A. *The Islamic Invasion: Confronting the World's Fastest Growing Religion*. Christian Scholars Press, Las Vegas, Nevada, USA, 1992.
- ★ Muhsam, Alice. *Coin and Temple: A Study of the Architectural Representation on Ancient Jewish Coins*. Leeds University Oriental Society, Leeds, 1966.
- ★ Muir, William. *The Life of Mahomet* (4 volumes), Smith, Elder, & Co., London, 1858-1861 (online).
- ★ Muller, Herbert J. *The Loom of History*. University Press, New York 1966.

- ★ Murray, Stephen O., *et al. Islamic Homosexualities: Culture, History and Literature*. New York University Press, New York, 1997.
- ★ *Muslim*, Abul Husain Muslim Bin Al Hajjaj Al Nisapuri (817-874 AD/202-261 AH). *Translation of Sahih Muslim*. Translated by Abdul Hamid Siddiqui (online).
- ☛ Nasr, Seyyed Hossein & Ali Kazuyoshi Nomachi. *Makka the Blessed and Madina the Radiant: The Holiest Cities of Islam*. Odyssey Books, Hong Kong, 1997.
- ★ Natan, Yoel. *The Jewish Trinity*. Aventine Press, San Diego, California, 2003.
- ★ Natan, Yoel. *The Jewish Trinity Sourcebook*. Lulu Press, Raleigh, USA, 2003.
- ★ Nehls, Gerhard & Walter Eric. *Christians Answer Muslims*. Life Challenge, Cape Town, Republic of South Africa, 1980 (online).
- ★ Nehls, Gerhard & Walter Eric. *Islam: As It Sees Itself, As Others See It, As It Is*. Life Challenge Africa, Nairobi, Kenya, 1996 (online).
- ★ Ness, Lester. *Written in the Stars: Ancient Zodiac Mosaics*. Marco Polo Monographs, Shangri-La Publications, Warren Center, Pennsylvania, 1999.
- ★ Ness, Lester. “Astrology and Judaism in Late Antiquity,” The doctoral dissertation of Lester Ness, Miami University, 1990 (online).
- ★ Newby, Gordon Darnell. *The Concise Encyclopedia of Islam*. OneWorld, Oxford, England, 2002.
- ★ Newby, Gordon Darnell. *A History of the Jews of Arabia: From Ancient Times to Their Eclipse Under Islam*. University of South Carolina Press, Columbia, South Carolina, U.S.A., 1988.
- ★ Nicolle, David. *The Armies of Islam 7th-11th Centuries*, Men-at-Arms, vol. 125, Osprey Publishing, Oxford, 1982.
- ★ Nicolle, David. *Armies of the Caliphates, 862-1098*, Men-at-Arms, vol. 320, Osprey Publishing, Oxford, 1998.
- ★ Nicolle, David. *Armies of the Muslim Conquest*, Men-at-Arms, vol. 255, Osprey Publishing, Oxford, 1993.
- ★ Nicolle, David. *The Moors: The Islamic West 7th-15th Centuries AD*, Men-at-Arms, vol. 348, Osprey Publishing, Oxford, 2001.
- ★ Nicolle. *Saladin and the Saracens*. Men-at-War-Series, vol. 171. Osprey Publishing, Oxford, 1986.
- ★ Nielsen, Dr. Christian Ditlef (1874-1949 AD), Copenhagen, Denmark, 1912, as translated by Hans Krause from German to English in: *Hans Krause's Research Reports* (hanskrause.de), “Ancient Arabia and its Religion, Part 3,” Chapter 2: “*Haram–Harimat*: The Old Arabian Sanctuary, God and Goddess,” , accessed Feb 2004.
- ★ Nuseibeh, Said & Oleg Grabar. *The Dome of the Rock*. Rizzoli International Publications, New York, 1996.
- ☛ Peters, F. E. *Jerusalem: The Holy City in the Eyes of Chroniclers, Visitors, Pilgrims, and Prophets from the Day of Abraham to the Beginning of Modern Times*. Princeton University Press, Princeton, New Jersey, USA, 1985.
- ★ Peters, F. E. *Makka: A Literary History of the Muslim Holy Land*. Princeton University Press, Princeton, New Jersey, 1994.
- ★ Peters, F. E. *Muhammad and the Origins of Islam*. State University of New York Press, Albany, New York, 1994.
- ★ Peters, F. E. *The Hajj: The Muslim Pilgrimage to Makka and the Holy Places*. Princeton University Press, Princeton, New Jersey, 1994.

- ★ Peters, Rudolph. *Jihad in Classical and Modern Islam*. Princeton, New Jersey, USA, 1996.
- ★ Phillips, Wendell. *Qataban and Sheba: Exploring the Ancient Kingdoms on the Biblical Spice Routes of Arabia*. Harcourt, Brace and Company, New York, 1955.
- ★ Pipes, Daniel. *Militant Islam Reaches America*. W.W. Norton & Company, USA, 2002.
- ★ Pipes, Daniel. *In the Path of God: Islam and Political Power*. Transaction Publishers, USA, 2002.
- ★ Plant, Richard. *Arabic Coins and How to Read Them*, 2<sup>nd</sup> Edition, University Press, Cambridge, 1980.
- ★ Pritchard, James B (editor). *The Ancient Near East: A New Anthology of Texts and Pictures* (2 Vols.). Princeton University Press, Princeton, New Jersey, USA, vol. i: 1958, vol. ii: 1975.
- C Rasmussen, Finn. “Early **Letter** Names,” Denmark web site, [hjem.get2net.dk/finn\\_rasmussen/MANUS.htm](http://hjem.get2net.dk/finn_rasmussen/MANUS.htm), accessed 26 Jun 2003.
- ★ *Reliance of the Traveller* (see *Al-Naqib*)
- ★ Rice, Edward. *Captain Sir Richard Francis Burton: The Secret Agent Who Made the Pilgrimage to Makka, Discovered the Kama Sutra, and Brought The Arabian Nights to the West*, Charles Scribner’s Sons, New York, 1990.
- ★ Richardson, Don. *Secrets of the Koran*. Regal, Venture, California 2003.
- ★ Ritter, Hellmut. *Das Meer der Seele*. Brill, Leiden, 1955.
- ★ Ritter, Hellmut. “*Philologika II: Über einige Koran- und Hadith-betreffende Handschriften hauptsächlich Stambuler Bibliotheken.*” *Der Islam*, 1928, 17:249-57.
- ★ Rogers, Michael. *The Spread of Islam*. Elsevier-Phaidon Press, Limited, New York, 1976.
- ★ Ryckmans, Jacques (see Freedman, David Noel. *Anchor Bible Dictionary*).
- ★ Ruthven, Malise. *Islam in the World*, 2<sup>nd</sup> Edition. Oxford University Press, 2000.
- C Sahas, Daniel J. *John of Damascus [~675 to ~749 AD] on Islam: The Heresy of the Ishmaelites*. Leiden, E. J. Brill, 1972.
- ★ Sarwar, Hafiz Ghulam. *Muhammad: The Holy Prophet*. Lahore, Pakistan, 1980.
- ★ Schimmel, Annemarie. *As Through a Veil: Mystical Poetry in Islam*. Columbia University Press, New York, 1982.
- ★ Schmidt, Alvin J. *The Great Divide: The Failure of Islam and the Triumph of the West*. Regina Orthodox Press, Boston, Massachusetts, 2004.
- ★ Schmidt, Alvin J. *The Menace of Multiculturalism: Trojan Horse in America*. Praeger Publishers, Westport, Connecticut, 1997.
- ★ Schmidt, Alvin J. *Under the Influence: How Christianity Transformed Civilization*. Zondervan Publishing House, Grand Rapids, Michigan, 2001.
- ★ Segal, J. B. *The Sabian Mysteries in Vanished Civilizations*. Edited by Edward Bacon, Thames & Hudson, London, 1963.
- ★ Sell, Rev. Edward (1869-1932 AD), *The Historical Development of the Quran*, 4th Ed., London, 1923, facsimile by People International, Tunbridge Wells, England, 1989 (online).
- ★ Shorosh, Anis (former Palestinian Muslim-turned-Christian). *A. Islam Revealed: A Christian Arab’s View of Islam*. Thomas Nelson Publishers, Nashville, Tennessee, USA, 1988.

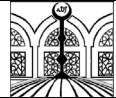



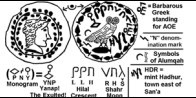
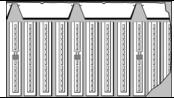
- ★ Siddiqui, Abdul Hameed. *The Life of Muhammad*. Library of Islam, Chicago, Illinois, USA, 1991 (online).
- ★ Simpson, St. John (editor). *Queen Of Sheba: Treasures From Ancient Yemen*. The British Museum Press, London, 2002.
- ★ Spencer, Neil. *True as the Stars Above*. Orion, London, 2000.
- ★ Spencer, Robert. *Islam Unveiled: Disturbing Questions about the World's Fastest-Growing Faith*. Encounter Books, San Francisco, USA, 2002.
- ★ Spencer, Robert. *Onward Muslim Soldiers: How Jihad Still Threatens America and the West*. Regnery Publishing, Washington, D.C., USA, 2003.
- ★ Spengler, William F. & Wayne G. Sayles. *Turkoman Figural Bronze Coins and Their Iconography, vol. ii—The Zengids*, Clio's Cabinet, Lodi, Wisconsin, 1996.
- ★ St. Clair-Tisdall, William (1859-1928). *The Original Sources of the Quran*. Society for Promoting Christian Knowledge (SPCK), E. S. Gorham, New York, 1905 (online).
- ★ St. Clair-Tisdall, Rev. William. *The Religion of the Crescent, or, Islam: Its Strength, Its Weakness, Its Origin, Its Influence*. Society for Promoting Christian Knowledge (SPCK), London, England, 1895 (online).
- ★ Stortroen, Brett Marlowe. *Makka and Muhammad: A Judaic-Christian Documentation of the Islamic Faith*. Edited by Dr. Joseph Buitrago. Church of PhilaDelphia of the Majority Text (Magna), Inc., Publishing, Queen Creek, Arizona, USA, 2000.
- ★ Swinton, Heidi S. *Sacred Stone: The Temple of Nauvoo*. Covenant Communications, Inc., American Fork, Utah, 2002.
- ★ Sykes, Egerton. *Everyman's Dictionary of Non-Classical Mythology*. E. P. Dutton & Co, New York, 1952.
- ★ *Sylloge Nummorum Graecorum: The Collection of the ANS, Part 6, Palestine-South Arabia*, American Numismatic Society, New York, 1981.
- ☉ Tajddin, Mumtaz Sadik Ali. *Ismailis Through History*. Islamic Book Publisher, Karachi, Pakistan, January 1997 (online).
- ★ Tameanko, Marvin. *Monumental Coins: Building & Structures on Ancient Coinage*. Krause Publications, Iola, Wisconsin, USA, 1999.
- ★ Tayob, Abdulkader. *Islam: A Short Introduction*, Oneworld Publications, Ltd; ISBN: 1851681922, 1999.
- ★ Thompson, Caton G. *The Tombs and Moon Temple of Hureidha (Hadhramaut)*. Reports of the Research Committee of the Society of Antiquaries of London XIII, Oxford, 1944.
- ★ Tolan, John Victor. *Saracens: Islam in the medieval European Imagination*. Columbia University Press, New York, 2002.
- ★ Torrey, Charles Cutler. *The Jewish Foundations of Islam*. Ktav Publishing House, Inc., New York, 1933.
- ★ Treadwell, Luke. *Buyid Coinage: A Die Corpus (322-445 AH [934-1053 AD])*, Ashmolean Museum, Oxford, 2001.
- ★ Trifkovic, Serge. *The Sword of the Prophet: The Politically Incorrect Guide to Islam*. Regina Orthodox Press, Inc., Boston, Massachusetts, U.S., 2002.
- ★ Trimmingham, J. Spencer. *Christianity Among the Arabs in Pre-Islamic Times*. Longman Group Limited, London, 1979.
- ★ Tritton, Arthur Stanley. *The Caliphs and their Non-Muslim Subjects: A Critical Study of the Covenant of Umar*. Frank Cass, London, 1930 (reprint 1970).






- C Wahshih, Ahmad Bin Abubekr Bin. *Ancient Alphabets and Hieroglyphic Characters Explained* (214 AH/829-830 AD). Joseph Hammer, translator. The first half of the book is the English translation, and the second half is the Arabic original. W. Bulmer and Co, London, 1806. Reprinted by Wizards Bookshelf, San Diego, California, USA, 2002.
- ★ Walker, John. "A New Type of South Arabian Coinage", *The Numismatic Chronicle and Journal of The Numismatic Society*, 1937, volume 17 (XVII), series 5 (V), pp. 260-279 + plate 33 (XXXIII).
- ★ Walker, John. "The Moon-god on Coins of the *Hadramaut*," *Bulletin of the School of Oriental & African Studies of London*, v. 14, no. 3, 1952, pp. 623-626.
- ★ Warraq, Ibn (editor and translator). *What the Koran Really Says: Language, Text and Commentary*. Prometheus Books, Amherst, New York, 2002.
- ★ Warraq, Ibn. *Why I Am Not a Muslim*. Prometheus Books, Amherst, New York, 1995.
- ★ Warraq, Ibn (editor). *The Quest for the Historical Muhammad*. Prometheus Books, Amherst, New York, 2000.
- ★ Watt, William Montgomery. *Muhammad at Makka*. Clarendon Press, Oxford, United Kingdom, 1953.
- ★ Watt, William Montgomery. *Muhammad: Prophet and Statesman*. Oxford University Press, New York, 1961.
- ★ Watt, William Montgomery (reviser). (Richard) Bell's *Introduction to the Quran*, Edinburgh University Press, Edinburgh, 1970 (online).
- ★ Wedel, Theodore Otto. *The Medieval Attitude Toward Astrology—Particularly in England*. Yale University Press, New Haven, Connecticut, USA, 1920.
- ★ Wherry, E. M. *A Comprehensive Commentary on the Quran: Comprising Sale's Translation and Preliminary Discourse, with Additional Notes and Emendations Together with a Complete Index to the Text, Preliminary Discourse and Notes*, London, Trubner & Co., Ludgate Hill, 1882 (online).
- ★ Wilson, Ian. *The Mysterious Shroud*. Doubleday & Company, Inc., Garden City, New York, 1986.
- ★ Wilson, Peter Lamborn, and Bernd Manuel Weischer. *Heart's Witness: The Sufi Quatrains of Awhaduddin Kirmani*. Imperial Iranian Academy of Philosophy, Tehran, 1978.
- ★ Wise, Michael, Martin Abegg & Edward Cook. *The Dead Sea Scrolls: A New Translation*. HarperCollins, New York, 1999.
- ★ Wolf, Kenneth Baxter. "Muhammad as Antichrist in Ninth-century Cordoba," pp. 3-19, as found in Meyerson & English. *Spain*.
- ★ Wollaston, Arthur N. *Muhammad: His Life and Doctrines with Accounts of his Immediate Successors*, W.H. Allen & Company, London, 1904 (reprint of *Half Hours with Muhammad*, 1886).
- C Yeor, Bat (Hebrew pseudonym meaning "Daughter of the River," referring to the Nile where Bat Yeor grew up as a Jewish girl). *Eurabia: The Euro-Arab Axis*, Fairleigh Dickinson University Press, 2005.
- ★ Yeor, Bat. *Islam and Dhimmitude: Where Civilizations Collide*. Associated University Press, Cranbury, New Jersey, 2002 (Dhimmi.org).
- ★ Yeor, Bat. *The Decline of Eastern Christianity Under Islam: From Jihad to Dhimmitude—Seventh to Twentieth Century*. Associated University Press, London, 1996.

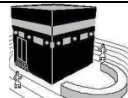



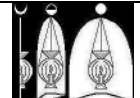
- ★ Yeor, Bat. *The **Dhimmi**: Jews and Christians Under Islam*. Fairleigh Dickinson University Press, Toronto, 1985.
- ★ Yusuf Ali, Abdullah. *The **Holy** Quran, Text, Translation and Commentary*, Lahore, Pakistan, 1946 AD, 1,815 pages.
- ★ Yusuf Ali, Abdullah. *The **Meanings** of The Illustrious Quran*. Alminar Publications, New York, 1934 (reprinted 1997), 520 pages.
- ☉ Zwemer, Samuel Marinus (1867-1952 AD). ***Dynamic** Christianity and the World Today*. The Inter-Varsity Fellowship of Evangelical Unions, 1939, pp. 81-94, as found in Zwemer. *Selections*.
- ★ Zwemer, Samuel. ***Heirs** of the Prophets: An Account of the Clergy and Priests of Islam, the Personnel of the Mosque, and 'Holy Men,'* Moody Press, Chicago, 1946 (online).
- ★ Zwemer, Samuel. *The Influence of **Animism** on Islam: An Account of Popular Superstitions*. The Macmillan Company, New York, 1920 (online).
- ★ Zwemer, Samuel. *Islam and the **Cross**: Selections from 'The Apostle to Islam.'* Roger S. Greenway (editor), P&R Publishing, Phillipsburg, New Jersey, USA, 2002.
- ★ Zwemer, Samuel. *The Muslim Doctrine of God: An **Essay** on the Character and Attributes of Allah According to the Koran and the Orthodox Tradition*. American Tract Society, New York, 1905 (online).
- ★ Zwemer, Samuel. *The Muslim **Christ**: An Essay on the Life, Character, and Teachings of Jesus Christ According to the Koran and Orthodox Tradition*, Oliphant, Anderson & Ferrier, Edinburgh and London, 1912 (online).





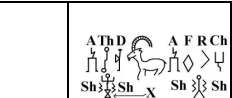
Thumbnail Gallery


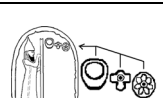



Note: Yoel Natan produced all the illustrations and adaptations in this book.

					
Figure 00-01	Figure 00-02	Figure 00-03	Fig. 02-01	Fig. 02-02	Fig. 02-03
Page 1	P. 5	P. 6	P. 347	P. 348	P. 351
Lahut finial	M.E. Map	M.E. Map	Sabean C-Coin	Sabean C-Coin	Sabean C-Temple

				
Fig. 02-04	Fig. 02-05	Figure 03-01	Fig. 03-02	Fig. 03-03
P. 353	P. 354	Page 392	P. 393	Page 394
Syn C-Coins	Syn C-Eagle Coin	Allah C-god	Islamic nuke	3 totalitarian ideologies trashed

				
Fig. 04-01	Fig. 04-02	Figure 04-03	Fig. 04-04	Figure 04-05
Page 431	Page 441	Page 444	Page 445	Page 448
Kaaba+Hatim	Various C	Zulqarnain	Zulqarnain	C + niche

				
Fig. 04-06	Fig. 04-07	Figure 04-08	Figure 04-09	Fig. 04-10
Page 453	Page 470	Page 477	Page 478	Page 497
Yemeni C	C + Ibexes	Persian C	C-god Sin	C-god art

				
Fig. 05-01	Fig. 05-02	Fig. 06-01	Fig. 06-02	Fig. 06-03
Page 520	Page 527	Page 572	Page 577	Page 607
Haran C	Nabonidus	Isis & Horus	Anhk-cross	Apis/Osiris





			
Figure 07-01	Figure 07-02	Figure 07-03	Figure 08-01
Page 616	Page 617	Page 628	Page 629
Jewish Coin	Titus Arch	Zodiac Wheel	Zodiac Hub



Figure 08-02	Fig. 08-03	Fig. 08-04	Figure 08-05
Page 633	Page 709	Page 709	Page 730
<i>Sin + Muses</i>	Waning ☾	Waxing ☾	<i>Caliph Coins</i>





Fig. 09-01	Figure 09-02	Fig. 09-03	Fig. 09-04	Figure 09-05
Page 753	Page 759	Page 766	Page 767	Page 767
Black Stone	<i>Kaaba + Hatim</i>	<i>Makka</i>	<i>Kaaba</i>	<i>Kaaba + Hatim</i>





Fig. 09-06	F. 10-01	10-02	Fig. 10-03	10-04	F. 10-05
Page 767	P. 776	P. 779	Page 780	P. 784	P. 786
<i>Muhammad and 360 idols</i>	<i>Mihrab + Minbar</i>	<i>Ankh-cross</i>	<i>Spear in Mirab x 2</i>	<i>Kaaba &amp; Hatim</i>	<i>Dome of the Rock</i>


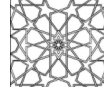


F. 10-06	Figure 10-07	Figure 10-08	Figure 10-09	Fig. 10-10
Page 788	Page 790	Page 791	Page 793	Page 798
<i>Dome of the Rock</i>	<i>Mihrab lamp</i>	☉ coins	<i>Mosque Orb</i>	<i>Muhammad</i>




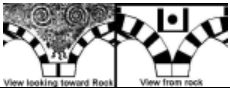

Fig. 10-11	Figure 10-12	Figure 10-13	Figure 10-14	Figure 10-15
Page 800	Page 800	Page 802	Page 806	Page 808
<i>Sign of Tanit</i>	<i>Mihrab lamp</i>	<i>Sign of Tanit</i>	<i>Sign of Tanit</i>	Black Stone

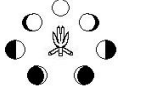

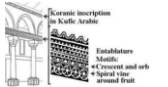


Figure 10-16	Figure 10-17	Figure 10-18	Fig. 11-01	Figure 11-02
Page 836	Page 836	Page 841	Page 857	Page 857
<i>Caliph Coin</i>	<i>Caliph Coin</i>	<i>Muhammad</i>	<i>Mihrab</i>	☉ Panel






			
Figure 11-03	Figure 11-04	Fig. 11-05	Fig. 11-06
Page 858	Page 858	Page 858	Page 859
☉ Panel	☉ Panel	☉ Panel	☾ in Mihrab



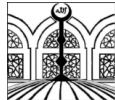


			
Figure 11-07	Figure 11-08	Figure 11-09	Figure 11-10
Page 859	Page 859	Page 859	Page 860
Lamp in Mihrab	Lamp in Mihrab	Lamp in Mihrab	Lamp in Mihrab






			
Figure 11-11	Figure 11-12	Figure 11-13	Figure 11-14
Page 860	Page 861	Page 861	Page 861
Lamp in Mihrab	Starburst	Mihrab + Minbar	Mihrab + Minbar





				
Fig. 12-01	Fig. 12-02	Fig. 12-03	Figure 12-04	Fig. 12-05
Page 871	Page 872	Page 873	Page 875	Page 876
Allah motifs	Zodiac ☉	Rock of Ibrahim	Dome of Rock Arcade	Lunar clock






				
Fig. 12-06	Figure 12-07	Figure 12-08	Fig. 12-09	Figure 12-10
Page 878	Page 880	Page 882	Page 882	Page 882
7 Stones show the lunar phases	Dome of the Rock lunar clock	Dome of Rock arcade	Dome of the Rock entablature	Dome of the Rock inscription







				
Fig. 12-11	Figure 12-12	Figure 12-13	Fig. 12-14	Fig. 12-15
Page 883	Page 884	Page 884	Page 885	Page 886
Starburst	☉ Dome of the Rock	Dome of Rock mosaic	Plant and vase mosaic	Crown mosaic

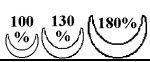


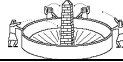

				
Fig. 12-16	F. 12-17	Fig. 12-18	Figure 12-19	Fig. 12-20
Page 887	P. 888	Page 888	Page 892	Page 895
C Dome of the Rock	Grotto archway	Lahut finial	Kiswa at the Kaaba	Maria (seas) on the moon




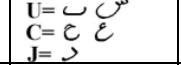

				
Figure 12-21	Figure 12-22	Figure 12-23	Figure 12-24	Fig. 12-25
Page 896	Page 898	Page 901	Page 904	Page 907
C symbol	Allah C-god	Betyls	Betyls (repeat)	Temple

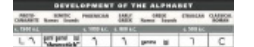




			
Figure 12-26	Figure 12-27	Figure 12-28	Figure 12-29
Page 908	Page 908	Page 908	Page 909
C finials in Jerusalem	C on Dome of the Rock	C on Dome of the Rock	Muslim C-god worship






				
Figure 13-01	Figure 13-02	Fig. 13-03	F. 13-04	Fig. 13-05
Page 921	Page 922	Page 922	P. 923	Page 927
Hajj Moons – Week One	Kaaba + Black Stone	Kaaba + Hatim	Kaaba, Safa + Marwa	Hajj Sites at Makka




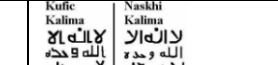
					
F. 13-06	F. 14-01	Fig. 14-02	F. 14-03	F. 14-04	Fig. 14-05
Page 929	P. 939	Page 940	Page 940	Page 941	Page 942
Hajj moons	Split-moon miracle	Split-moon miracle	Split-moon miracle	Split-moon miracle	2 arrows shots to C

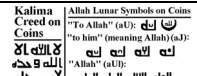
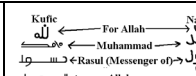

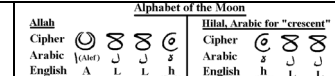
				
Fig. 14-06	Fig. 14-07	Fig. 14-08	Figure 15-01	Fig. 15-02
Page 944	Page 945	Page 948	Page 968	Page 979
C illusion	C illusion	C behind lotus tree	3 Jamarat pillars	Kaaba + Hatim

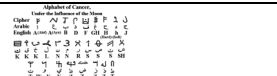



				
Figure 16-01	Figure 16-02	Figure 16-03	Fig. 16-04	Figure 16-05
Page 991	Page 993	Page 1000	Page 1001	Page 1003
† above ☾	Lahut finials	☾ Arabic	☾ Arabic	☾ Arabic

				
Fig. 16-06	Fig. 16-07	Figure 16-08	F. 16-09	Fig. 16-10
Page 1005	Page 1007	Page 1014	P. 1022	Page 1022
☾ English	☾ Arabic	Dome of the Rock mosaic	Gazelle	☾ + Ibexes

				
Figure 16-11	Fig. 16-12	Fig. 16-13	Fig. 16-14	Fig. 16-15
Page 1023	Page 1025	Page 1026	Page 1026	Page 1027
Scimitars	Allah motifs	Allah motif	Allah motifs	Allah motif



			
Figure 16-16	Figure 16-17	Figure 16-18	Figure 16-19
Page 1027	Page 1028	Page 1028	Page 1031
Allah motif martyr	Allah motif	Allah motif	Kufic/Naskhi

			
Fig. 16-20	Figure 16-21	Fig. 16-22	Figure 16-23
Page 1031	Page 1032	Page 1033	Page 1033
☾ on coins	☾ on coins	☾ cipher	Allah cipher

			
Figure 16-24	Figure 16-25	Figure 16-26	Figure 16-27
Page 1034	Page 1037	Page 1037	Page 1037
Cancer-☾ cipher	Saladin's army with ☾	Muslim army with ☾	☾ on map of Turkey

Coins with Crescents and Other Moon-god Symbols

See pages 1039 through 1043 for illustrations of more than two dozen representative samples of crescent coins, plus these pages:

	
Figure A-26	Figure A-27
Page 1047	Page 1058

## About the Book Cover

### Front Cover

The front book cover illustration approximates ancient depictions of Mideast moon-gods like *Sin*, who rowed across the sky in his moon boat, wore a crescent crown and was associated with scimitars.<sup>4812</sup>

This book's illustration of *Allah*, a.k.a. *Sin*, is shown holding two scimitars—one scimitar for each role *Allah* plays: war-and-moon-god. South Arabian moon-gods were also war-gods.<sup>4813</sup>

The colors most associated with *Sin* were azure blue or *lapis-lazuli*, which is blue, violet-blue or greenish-blue.<sup>4814</sup> The *Encyclopedia Britannica* says that...

...from being depicted as a bull or boat, because of his crescent emblem, he came to be represented as a cowherd or boatman. *Sin* was represented as an old man with a flowing beard—a wise and unfathomable god—wearing a headdress of four horns surmounted by a crescent moon.<sup>4815</sup>

The illustration also approximates *Allah* the war-and-moon-god, whose religion is associated with scimitars and the crescent-moon. *Allah* is also said to have:

- ☉ A golden or greenish robe, a golden crown on his head and sandals on his feet<sup>4816</sup>
- ☉ A face (*K* 055:026-027; *Sahih Al-Bukhari* 9:503)
- ☉ A hand (*K* 048:010; *Sahih Al-Bukhari* 9:508)
- ☉ Fingers (*Sahih Al-Bukhari* 9:510, 511) with which he writes in a book (*Sahih Al-Bukhari* 9:501)
- ☉ An eye (*K* 020:036-039)
- ☉ A shin (lower leg) (*K* 068:042; *Sahih Al-Bukhari*, vol. 6, bk. 60, no. 441; and vol. 9, bk. 93, no. 532s)
- ☉ Mounted a throne (*K* 057:004) that is borne by angels (*K* 069:017), on which he will appear at the end of the world (*K* 089:021-023)
- ☉ Appeared on the clear horizon and came closer to *Muhammad* (*K* 053:001-010; 081:019-027)
- ☉ Descended, and still descends, every night to the nearest heaven (*Sahih Al-Bukhari* 2:246)<sup>4817</sup>
- ☉ Europeans sometimes depicted *Allah* as a man or as “the Man-in-the-Moon such as in illustrations from the thirteen century and 1625 AD”<sup>4818 4819</sup>

### Back Cover

This is a typical *Assyrian* cylinder showing the moon-god *Sin* with three female muses and the “Eternally Fruiting Orb,” which refers to the recurrent cycle of moon phases.<sup>4820</sup>

<sup>4812</sup> *Larousse*, *Sin* entry, p. 56.

<sup>4813</sup> Nielsen, 1912, pp. 593-594, as translated in Krause, “*Haram–Harimat.*”

<sup>4814</sup> *Larousse*, *Sin* entry, p. 56.

<sup>4815</sup> *Encyclopedia Britannica*, *Sin* entry, accessed 16 Aug 2004.

<sup>4816</sup> Ritter, Hellmut 1928:257; Corbin, Henry 1969:272; Schimmel, Annemarie 1982:67-68.

<sup>4817</sup> Shamoun, Sam. “*Allah*—an Immaterial Entity or an Invisible Man?” AnsweringIslam.org, accessed 10 Aug 2004.

<sup>4818</sup> Baltimore Art Gallery manuscript 10137.f.1r (Tolan. *Saracens*, pp. 131-132).

<sup>4819</sup> Blair & Bloom. *Paradise*, p. 43, figure 15.

<sup>4820</sup> Maspero. *Dawn*, p. 655; *Larousse*, p. 55, picture.

## Index

- 1Ch, 29, 589, 717, 832, 1011, 1094  
 1Co, 21, 183, 275, 364, 400, 430, 434, 594,  
     598, 602, 605, 644, 646, 650, 660, 664,  
     895, 1021, 1094, 1103  
 1Jo, 34, 367, 407, 1094  
 1Ki, 78, 323, 330, 335, 336, 410, 415, 416,  
     420, 430, 452, 476, 620, 756, 758, 770,  
     778, 801, 811, 812, 830, 1011, 1018, 1094  
 1Pe, 400, 618, 1094  
 1Sa, 52, 78, 367, 476, 787, 818, 900, 1094  
 1Th, 400, 540, 712, 1094  
 1Ti, 34, 78, 125, 314, 364, 381, 400, 407, 409,  
     432, 598, 730, 801, 1094  
 2Ch, 29, 52, 335, 452, 552, 756, 758, 778, 801,  
     954, 1012, 1015, 1094  
 2Co, 21, 32, 105, 362, 424, 437, 602, 713, 854,  
     946, 951, 981, 1094, 1103  
 2Jo, 34, 366, 599, 1094  
 2Ki, 51, 78, 250, 323, 424, 434, 503, 525, 529,  
     544, 566, 589, 603, 620, 631, 725, 726,  
     746, 758, 762, 773, 778, 813, 893, 1012,  
     1094  
 2Ma, 893, 1095  
 2Pe, 400, 401, 407, 602, 603, 1094  
 2Sa, 594, 603, 680, 843, 1011, 1094, 1114  
 2Th, 78, 364, 384, 407, 417, 1094, 1103  
 2Ti, 400, 407, 1094  
 3Jo, 1094  
 Aaron, 128, 133, 217, 234, 235, 242, 244, 289,  
     313, 314, 494, 583, 584, 632, 957, 1098  
 Abbas, 90, 118, 173, 222, 225, 240, 251, 316,  
     510, 612, 636, 704, 750, 752, 757, 782,  
     828, 848, 969, 988, 1051, 1062  
 Abbasid, 276, 556, 581, 723, 838, 858, 864,  
     866, 869, 885, 897, 947, 1017, 1040, 1041,  
     1042, 1043, 1045, 1051, 1053, 1054, 1055,  
     1056, 1058, 1059, 1060, 1062, 1118, 1145  
 Abdullah, 22, 46, 99, 118, 157, 159, 173, 174,  
     339, 370, 486, 494, 552, 571, 590, 594,  
     678, 682, 695, 696, 731, 795, 848, 902,  
     952, 1099, 1101, 1133, 1146, 1156  
 Abel, 41, 115, 170, 1098  
 Abraham, 17, 51, 52, 85, 240, 242, 327, 328,  
     334, 336, 337, 360, 366, 380, 430, 431,  
     432, 438, 443, 445, 448, 449, 450, 452,  
     457, 461, 462, 467, 468, 469, 470, 471,  
     472, 473, 474, 476, 478, 482, 483, 484,  
     495, 496, 501, 502, 503, 508, 509, 510,  
     511, 512, 513, 514, 517, 518, 519, 520,  
     521, 522, 523, 524, 525, 529, 530, 531,  
     535, 536, 537, 538, 539, 542, 544, 546,  
     558, 562, 563, 564, 565, 566, 571, 572,  
     576, 580, 589, 590, 603, 610, 611, 618,  
     620, 623, 624, 638, 643, 662, 664, 677,  
     682, 683, 684, 701, 713, 720, 749, 750,  
     763, 766, 768, 776, 789, 793, 804, 822,  
     832, 856, 859, 863, 866, 867, 868, 870,  
     871, 872, 873, 874, 875, 876, 877, 880,  
     881, 884, 885, 886, 887, 888, 889, 890,  
     891, 892, 893, 894, 895, 896, 897, 899,  
     904, 905, 917, 919, 924, 927, 928, 932,  
     934, 943, 968, 970, 981, 989, 994, 1011,  
     1015, 1016, 1019, 1027, 1033, 1036, 1098,  
     1110, 1135, 1152, 1159  
 Abrogation, 88, 1067, 1099, 1101  
 Abu Bakr, 192, 203, 265, 402, 704, 737, 762,  
     849, 860, 980, 1062  
 Abu Khalil, 276, 705, 1144  
 Abu-Dawud, 33, 46, 78, 83, 87, 88, 90, 102,  
     143, 173, 174, 197, 203, 206, 241, 250,  
     266, 271, 368, 410, 423, 442, 487, 639,  
     641, 654, 705, 706, 707, 821, 848, 954,  
     985, 1019, 1020, 1144, 1149  
 Abyssinian, 26, 325, 326, 332, 333, 345, 359,  
     423, 504, 519, 532, 536, 567, 582, 694,  
     724, 864, 897, 898, 1009, 1141  
 AcaDhimmi, 1099, 1101  
 acanthus, 344, 857, 875, 877, 882, 884, 885,  
     887  
 Achaemenid, 477, 529, 607  
 acid, 106, 205, 245, 312, 506  
 Act, 8, 50, 51, 78, 155, 158, 206, 266, 308,  
     332, 381, 383, 394, 400, 407, 409, 435,  
     437, 479, 502, 537, 538, 545, 557, 559,  
     575, 605, 609, 616, 620, 621, 671, 680,  
     697, 752, 770, 779, 964, 1094, 1139  
 Adad-Guppi, 362, 477, 529, 531  
 Adam, 165, 166, 242, 272, 382, 407, 408, 430,  
     431, 432, 445, 451, 493, 503, 508, 509,  
     513, 538, 540, 546, 581, 590, 617, 659,  
     738, 742, 818, 895, 949, 1095, 1098  
 Adan, 1058  
 Adhan, 90, 219, 220, 221, 223, 225, 231, 250,  
     296, 315, 386, 410, 412, 413, 419, 423,  
     468, 717, 794, 806, 862, 898, 954, 1099,  
     1103, 1120  
 Adonis, 779  
 Aesha, 983  
 Afghanistan, 32, 36, 62, 75, 76, 83, 114, 159,  
     165, 166, 169, 176, 221, 226, 250, 262,  
     273, 293, 308, 376, 387, 395, 409, 411,  
     455, 651, 1057, 1104, 1107, 1114  
 Ahab, 410, 415, 770  
 Ahmad, 63, 83, 132, 165, 170, 199, 208, 221,  
     234, 262, 313, 371, 411, 494, 590, 703,  
     744, 784, 806, 848, 849, 905, 914, 937,  
     969, 1032, 1056, 1058, 1101, 1107, 1144,  
     1153, 1155  
 Ahura Mazda, 366, 384, 444, 561, 565, 630

- Aisha, 88, 107, 250, 495, 595, 612, 654, 662, 663, 702, 737, 738, 750, 821, 822, 827, 828, 829, 830, 839, 842, 843, 844, 845, 846, 849, 953, 963, 973, 982, 983, 985, 987, 988
- Aiysha, 583, 984
- Aiyub, 1098
- aJ, 1031, 1032, 1035, 1099, 1103, 1104
- aJl, 1031, 1032, 1040, 1041, 1043, 1099, 1103
- Akkadian, 8, 355, 384, 456, 643, 722, 723, 798, 812, 1005, 1020
- Aksa, 1, 221, 222, 389, 776, 787, 856, 869, 870, 887, 906
- Aksum, 7, 16, 323, 325, 326, 332, 333, 504, 567, 864, 897, 898, 957, 992
- Aksumitic, 326
- Al Albani, 752, 757, 761, 765, 919, 923, 927, 928, 968, 969, 970, 971, 973, 1018, 1144
- Al Farid, 704, 705, 1022, 1144
- Al Kalbi, 348, 425, 429, 443, 562, 576, 679, 698, 746, 749, 761, 769, 770, 772, 777, 789, 910, 912, 913, 914, 1144
- Al Kindy, 503, 518, 519, 520, 559, 571, 670, 677, 702, 721, 722, 739, 740, 749, 866, 867, 918, 966, 1135, 1144
- Al Saeh, 769, 1144
- Al Tabari, 440, 448, 474, 482, 564, 604, 635, 639, 665, 669, 714, 745, 748, 777, 793, 1144
- Alam, 889, 902, 1099, 1103
- Albright, 343, 345, 607, 791, 926, 1004, 1144, 1145
- Album, 444, 1044, 1046, 1047, 1050, 1051, 1053, 1055, 1056, 1058, 1059, 1060, 1064, 1144
- Allah motif, 344, 860, 870, 871, 881, 882, 883, 884, 886, 887, 1014, 1025, 1026, 1027, 1028, 1029, 1034, 1159, 1161
- Allahu Akbar, 141, 147, 179, 412, 413, 423, 496, 687, 725, 749, 799, 806, 807, 808, 833, 1018, 1029
- Allat, 8, 330, 334, 335, 447, 454, 458, 472, 527, 532, 533, 535, 540, 567, 590, 628, 630, 632, 633, 634, 635, 701, 711, 746, 747, 754, 756, 759, 760, 761, 762, 763, 766, 767, 768, 770, 771, 774, 789, 792, 799, 865, 903, 916, 994, 995
- Almaqah, 26, 27, 326, 330, 331, 333, 335, 338, 339, 340, 341, 342, 343, 344, 345, 346, 347, 348, 353, 354, 355, 358, 359, 453, 454, 459, 496, 497, 919
- Al-Naqib, 1144, 1153
- Alphabet, 498, 872, 905, 997, 1001, 1003, 1004, 1005, 1028, 1032, 1033, 1034, 1035
- Alvarus, 221, 385, 386, 414, 830, 850, 851, 852, 988
- Alyasa, 1098
- Ambrose, 239, 284
- Ameer Ali, 270, 441, 442, 565, 575, 578, 579, 607, 631, 700, 750, 756, 768, 820, 831
- Amm, 16, 333, 338, 350, 495, 532, 537, 561, 597
- Ammonite, 720, 1139
- Amo, 8, 51, 545, 620, 671, 1094
- Anbay, 333, 338, 356, 532, 537, 561
- Andalusia, 60, 213, 226, 236, 380, 523, 557, 1014
- Andrew, 36, 48, 49, 50, 54, 59, 79, 96, 98, 113, 114, 116, 141, 161, 162, 163, 166, 168, 175, 191, 197, 198, 204, 208, 209, 213, 228, 239, 258, 268, 269, 276, 287, 308, 312, 361, 365, 370, 389, 396, 404, 405, 415, 426, 680, 718, 805, 903, 1117, 1118, 1147
- Anhk, 1157
- Annunciation, 202, 233, 234, 237, 313
- Antichrist, 83, 221, 368, 385, 414, 417, 427, 438, 443, 638, 831, 850, 851, 852, 988, 1098, 1120, 1155
- anti-solar, 17, 18, 24, 441, 462, 490, 531, 670, 671, 672, 673, 697, 768, 807, 881, 924, 925, 928, 935, 996, 1031
- Aphrodite, 8, 383, 455, 532, 557, 701, 748, 749, 765, 779, 808, 830, 852, 988, 1039
- Apis, 579, 607, 671, 1157
- Apollo, 8, 363, 367, 401, 464, 562, 603, 604, 621, 625, 638, 817, 960, 994
- Aqsa, 1, 54, 133, 199, 227, 242, 243, 244, 268, 389, 736, 786, 857, 858, 861, 867, 889, 895, 907, 993, 994, 1026
- Aquarius, 674, 700
- Arabian Nights, 391, 444, 546, 809, 967, 977, 986, 1039, 1153
- Arafat, 61, 117, 120, 127, 137, 198, 217, 226, 235, 243, 264, 268, 297, 307, 314, 374, 389, 393, 403, 475, 547, 554, 671, 690, 735, 736, 814, 899, 900, 923, 924, 926, 930, 947, 1099, 1103
- Ares, 8, 325, 326, 345, 519, 532
- Aries, 619, 657, 674, 679, 702, 1014
- Armstrong, 24, 25, 687, 704, 924, 980, 1115, 1145
- Artemis, 8, 325, 464, 479, 559, 569, 752, 779, 802
- Artukid, 1060
- Asad, 8, 488, 496, 498, 822, 999, 1145
- Asaf, 579, 702, 765, 766
- Ascension, 231, 712, 889
- Asherah, 520, 758, 770, 778, 780, 781, 782, 799, 812, 832, 839, 841, 969, 970, 1011
- Ashtaroth, 8
- Ashurah, 1011
- Asma, 109, 371, 399, 574, 663, 983
- Assyria, 323, 355, 384, 652, 1012

- Assyrian, 28, 245, 312, 327, 339, 355, 363,  
424, 457, 464, 478, 503, 545, 633, 643,  
666, 723, 755, 901, 934, 1004, 1005, 1012,  
1020, 1106, 1145, 1162
- Assyrian Dictionary, 643, 723, 1005, 1020,  
1145
- Astarte, 8, 78, 804
- Astron, 566, 995
- Atargaris, 480, 779, 782
- Athanasius, 729
- Athar, 358, 497, 1056
- aU, 597, 993, 994, 1031, 1032, 1040, 1041,  
1046, 1056, 1057, 1099, 1103, 1104
- Auge, 701, 890, 902, 1145
- Augustine, 404, 557, 576, 750, 873
- Augustus, 606, 991
- aUl, 1, 596, 856, 887, 993, 994, 1000, 1024,  
1025, 1029, 1031, 1032, 1041, 1099, 1103,  
1104
- Aurangzeb, 644
- Aurelian, 604, 606
- Aurelius, 902
- Avakian, 1145
- Axum, 333, 897
- Ayat, 1094, 1099, 1104, 1142
- Ayatollah, 30, 86, 98, 132, 134, 158, 160, 161,  
215, 267, 308, 315, 320, 1030
- Azar, 64, 68, 208, 209, 265, 508, 511, 518,  
683, 867, 1098
- Azraqi, 474, 571, 572, 580, 769, 897, 1022
- Aztec, 676
- B'nai B'rith*, 1129
- Baal, 8, 330, 356, 366, 367, 410, 415, 416,  
592, 593, 594, 595, 597, 725, 750, 757,  
768, 769, 770, 771, 773, 774, 810, 811,  
812, 826, 831, 1011, 1146
- Baal Shamin, 773
- Baalzebub, 382, 415
- Babylonia, 323, 522, 528, 545
- Badr, 12, 160, 197, 240, 267, 337, 370, 410,  
499, 546, 572, 685, 716, 833, 951, 955,  
995, 1070, 1073, 1080, 1084
- Baer, 543, 877, 884, 885, 891, 892, 1007,  
1013, 1026, 1036, 1145
- Baghdad, 77, 132, 152, 200, 208, 216, 224,  
228, 245, 270, 293, 312, 361, 391, 409,  
445, 446, 469, 512, 567, 626, 679, 685,  
691, 707, 724, 760, 823, 869, 874, 1034,  
1045, 1051, 1052, 1054, 1059, 1060, 1062
- Bakhkh, 347, 1021, 1039, 1040, 1099, 1104
- Balog, 689, 724, 730, 791, 835, 836, 860,  
1039, 1042, 1043, 1048, 1050, 1052, 1054,  
1145
- baptism, 368, 650, 801, 806
- Baqum, 580, 901
- Barag, 689, 724, 730, 791, 835, 836, 1039,  
1042, 1048, 1145
- Barber, 1145
- Bates, 1046, 1048, 1145
- Baudier, 455, 908, 909, 912, 914
- Baysh, 1055
- Bedouin, 180, 243, 293, 323, 439, 518, 690,  
695, 740, 745, 749, 769, 780, 865, 868,  
958, 1010, 1089
- behead, 52, 66, 83, 207, 230, 437, 680, 684,  
685
- beheaded, 76, 127, 175, 201, 240, 270, 275,  
385, 408, 684, 685, 686, 687, 688, 712,  
822, 829, 837, 843, 850, 935, 983, 985,  
1107, 1125
- Bel, 8, 525, 531, 592, 770, 773, 774
- Belshazzar, 522, 525, 526, 528, 538
- Beth Alpha, 627, 628, 629, 632
- Beth Yerah, 7, 16, 323, 327, 475
- Bhaga, 753, 862
- Big Dipper, 472, 474, 475, 675, 861
- Bilal, 220, 221
- Billon, 1063
- Bilqis, 27, 333, 334, 335, 339, 341, 343, 458,  
459, 461, 469, 868, 1020
- Binkat, 1040, 1041, 1043, 1057
- bisexual, 373, 374, 547, 659, 703, 704, 736
- bisexuality, 374, 438, 659, 702, 703, 705, 706,  
707, 775
- Bizbat, 740
- Blair, 91, 106, 112, 122, 129, 134, 226, 250,  
259, 418, 523, 554, 596, 689, 690, 722,  
776, 783, 792, 793, 794, 838, 856, 859,  
860, 868, 879, 883, 891, 909, 930, 955,  
1001, 1007, 1018, 1024, 1027, 1029, 1145,  
1162
- Book of Mormon, 588, 589
- Bosphorus*, 803
- Bostom, 36, 48, 49, 50, 54, 59, 67, 141, 161,  
162, 163, 166, 168, 175, 191, 197, 198,  
204, 208, 209, 213, 228, 239, 258, 268,  
269, 276, 287, 312, 361, 365, 370, 389,  
396, 405, 426, 680, 718, 1117, 1118
- Boustrophedon, 999
- Brahma, 384, 782
- Brewer, 811, 1023, 1145
- Brockelmann, 104, 401, 456, 512, 550, 622,  
677, 772, 830, 865, 878, 1145
- Brown, 249, 273, 307, 469, 796, 1145
- Budge, 59, 581, 607, 608, 1145
- Bukhari, 31, 33, 34, 45, 46, 52, 54, 78, 83, 84,  
85, 87, 88, 90, 99, 101, 102, 105, 108, 122,  
134, 142, 150, 164, 172, 173, 174, 181,  
183, 184, 193, 194, 196, 197, 199, 203,  
208, 212, 220, 223, 239, 241, 245, 250,  
251, 255, 258, 259, 260, 261, 267, 271,  
273, 276, 278, 279, 281, 282, 288, 360,  
368, 391, 399, 401, 406, 408, 410, 412,  
421, 443, 452, 455, 481, 504, 505, 517,



- 551, 552, 553, 555, 592, 595, 606, 613,  
614, 637, 639, 641, 643, 648, 654, 662,  
667, 672, 683, 684, 698, 699, 702, 703,  
704, 705, 713, 727, 728, 732, 735, 736,  
738, 749, 750, 752, 758, 780, 781, 792,  
793, 806, 813, 814, 816, 821, 826, 828,  
829, 830, 834, 838, 839, 840, 842, 843,  
846, 848, 849, 853, 917, 937, 939, 947,  
952, 953, 955, 963, 966, 972, 974, 982,  
983, 986, 987, 988, 996, 1019, 1032, 1126,  
1135, 1146, 1149, 1162
- Burka, 244, 747, 762, 1104
- Burton, 8, 185, 339, 357, 375, 430, 444, 494,  
546, 550, 587, 705, 709, 710, 727, 746,  
747, 762, 774, 775, 865, 911, 967, 968,  
978, 1010, 1039, 1146, 1153
- Buyid, 723, 1040, 1041, 1042, 1043, 1054,  
1055, 1154
- Byzantine, 17, 43, 270, 302, 323, 327, 332,  
333, 369, 395, 397, 425, 443, 444, 449,  
455, 507, 514, 535, 544, 554, 565, 566,  
568, 569, 587, 600, 603, 617, 624, 626,  
658, 701, 740, 748, 749, 790, 797, 802,  
803, 804, 805, 836, 872, 991, 992, 1002,  
1046, 1061, 1064, 1117, 1145, 1147, 1151
- Byzantium, 48, 104, 333, 418, 729, 802, 803,  
804, 904, 991, 1150
- Caesar, 96, 147, 258, 386, 402, 425, 432, 444,  
504, 620, 629, 737, 929, 1147
- Cain, 41, 115, 170, 173, 1098, 1137
- Caliph Ali, 613, 1062
- Caliph coin, 730, 836, 863, 992
- Canaanite, 8, 241, 243, 476, 997, 1004, 1005,  
1011
- Cancer, 374, 674, 872, 874, 1028, 1034, 1035,  
1036, 1161
- Caner, 255, 256, 399, 401, 541, 555, 663, 829,  
851, 1146
- Capricorn, 674, 1145
- Caracalla, 569
- Carrhae, 327, 512, 520
- Cashford, 327, 607, 1146
- catacombs, 619, 801, 803
- Catalan, 1036
- Catechism, 599, 804, 1095
- Catholic, 23, 125, 160, 194, 233, 236, 237,  
247, 248, 266, 270, 313, 319, 378, 426,  
540, 599, 655, 774, 804, 1018, 1019, 1095,  
1119
- Catholicism, 309, 1018
- Caucasus, 291, 315, 1054, 1060
- Chebel, 403, 806, 1014, 1146
- Chi-Rho, 604
- Chosroes, 258, 425, 737, 855
- Christys, 185, 727, 1146
- Ciolek, 7, 1146
- clitoridectomy, 642, 757
- clitoris, 131, 555, 757, 785, 1109
- Col, 646, 1094
- Collyridian, 575
- Constantine, 567, 604, 605, 606, 748, 749,  
779, 803, 804, 893, 1046, 1061
- Constantinople, 83, 565, 722, 730, 802, 803,  
804, 991, 992, 1061, 1108
- Constantius, 450, 1061
- Convivencia, 303, 319
- Coon, 694, 778, 842, 852, 862, 912, 995, 1146
- Coptic, 235, 236, 288, 315, 574, 577, 580, 581,  
582, 655, 663, 733, 800, 1002
- Copts, 107, 236, 241, 302, 313, 315, 548, 577,  
580, 581, 582, 779, 901
- Corbin, 481, 1146, 1162
- Cordoba, 29, 185, 222, 236, 258, 380, 426,  
556, 724, 726, 1014, 1042, 1055, 1062,  
1155
- cornucopia, 476, 544, 616, 906
- Corpus Christi*, 307
- Cosmas, 385
- Covenant of Security, 97, 320, 321
- Cragg, 573, 574, 1146
- Cranes, 633, 635
- crescent finial, 1, 25, 231, 473, 744, 776, 806,  
864, 869, 889, 898, 902, 906, 907, 908,  
993, 994, 1015, 1033, 1047, 1048, 1103
- Creswell, 325, 385, 504, 567, 724, 776, 789,  
852, 853, 854, 857, 858, 862, 864, 884,  
890, 891, 897, 906, 1146
- Crusade, 77, 824, 1059
- Curtiss, 667, 1138, 1139, 1146
- curvy letters, 596, 1004, 1006, 1024
- Dabistan, 259, 473, 479, 482, 483, 484, 517,  
551, 561, 563, 595, 651, 679, 701, 722,  
746, 750, 751, 753, 776, 777, 778, 783,  
789, 790, 815, 819, 827, 852, 855, 862,  
885, 908, 910, 923, 938, 962, 972, 1147
- Dajjal, 83, 368, 417, 443, 638, 1098, 1099,  
1120
- Dan, 65, 90, 111, 248, 255, 293, 294, 295, 307,  
368, 415, 418, 476, 524, 525, 526, 538,  
566, 725, 965, 986, 1039, 1048, 1094,  
1125, 1145
- Daniel, 20, 21, 22, 52, 54, 60, 63, 64, 65, 66,  
67, 69, 70, 71, 76, 77, 87, 91, 96, 106, 108,  
113, 115, 117, 119, 120, 121, 122, 123,  
125, 127, 128, 142, 147, 148, 149, 154,  
177, 181, 198, 208, 214, 215, 223, 225,  
226, 235, 238, 242, 243, 244, 246, 249,  
250, 263, 264, 269, 272, 273, 276, 277,  
280, 284, 285, 286, 287, 288, 291, 292,  
295, 299, 303, 304, 307, 310, 313, 315,  
316, 320, 321, 362, 369, 372, 373, 374,  
391, 395, 401, 417, 422, 507, 522, 524,  
525, 546, 547, 549, 566, 594, 641, 642,  
653, 699, 734, 735, 808, 851, 853, 869,

- 900, 907, 999, 1094, 1095, 1099, 1100,  
 1101, 1102, 1104, 1108, 1109, 1116, 1121,  
 1123, 1124, 1129, 1130, 1132, 1133, 1134,  
 1138, 1141, 1153  
 Dante, 710, 712, 813  
 Darnell, 612, 614, 1146, 1152  
 Darwin, 377, 1127  
 Dashti, 22, 209, 370, 371, 373, 451, 463, 585,  
 589, 641, 663, 727, 738, 740, 752, 820,  
 821, 831, 842, 843, 844, 845, 952, 981,  
 983, 984, 1147  
 Daud, 494, 1098  
 Daum, 331, 339, 340, 453, 459, 487, 496, 497,  
 674, 925, 1004, 1147  
 David, 32, 34, 48, 57, 71, 91, 110, 115, 132,  
 150, 152, 157, 177, 202, 206, 217, 220,  
 224, 231, 232, 233, 234, 235, 237, 239,  
 240, 241, 242, 243, 251, 261, 273, 275,  
 294, 298, 300, 303, 304, 310, 316, 321,  
 361, 404, 411, 433, 434, 446, 491, 544,  
 545, 553, 556, 587, 589, 620, 624, 625,  
 630, 631, 649, 662, 717, 723, 728, 786,  
 787, 824, 836, 843, 885, 906, 962, 1023,  
 1038, 1048, 1098, 1105, 1118, 1121, 1123,  
 1130, 1147, 1148, 1149, 1152, 1153  
 Dawa, 42, 52, 82, 134, 166, 171, 203, 219,  
 263, 264, 309, 318, 320, 360, 397, 398,  
 412, 422, 1099, 1102, 1105  
 Dawood, 204, 276, 1098  
 De Rosa, 237, 1147  
 death-cult, 548, 550, 733, 743  
 Decius, 568, 902  
 Delphi, 270, 369, 381, 382, 417, 960, 961, 978,  
 1145  
 Demeter, 634  
 Demetrius, 381, 537, 559, 770  
 Deu, 32, 51, 52, 171, 177, 183, 364, 366, 367,  
 388, 401, 403, 407, 415, 417, 430, 432,  
 434, 437, 438, 467, 475, 529, 539, 557,  
 594, 598, 602, 620, 632, 643, 646, 665,  
 674, 721, 725, 758, 778, 810, 874, 919,  
 1012, 1018, 1094  
 Dhabh, 682, 683, 684, 720, 1017, 1018, 1099,  
 1105, 1110, 1150  
 Dhimmi, 22, 46, 64, 116, 123, 154, 160, 162,  
 163, 169, 175, 176, 215, 239, 259, 276,  
 287, 289, 302, 333, 361, 365, 394, 395,  
 408, 409, 411, 452, 910, 1099, 1101, 1105,  
 1107, 1108, 1118, 1124, 1132, 1137, 1155,  
 1156  
 Dhimmification, 259, 1132  
 Dhimmitude, 28, 48, 91, 125, 213, 231, 232,  
 235, 237, 267, 287, 288, 303, 304, 306,  
 307, 310, 311, 313, 319, 390, 394, 395,  
 396, 397, 400, 717, 718, 1002, 1101, 1102,  
 1105, 1106, 1108, 1133, 1155  
 Dhu Nuwas, 536, 567, 1141  
 Dhu Shanatir, 710, 726, 767  
 Dhul-Hijja, 667, 668, 674, 750, 828  
 Dhul-Qada, 667, 674  
 Diana, 8, 150, 247, 269, 282, 479, 569, 802,  
 1133  
 Dietrich, 1147, 1150  
 Din Rodef, 1139  
 Dinar, 78, 88, 401, 443, 1041, 1051, 1052  
 Diocletian, 606  
 Dirham, 443, 516, 724, 1040, 1049, 1052,  
 1053, 1054, 1058, 1059, 1060, 1061, 1064  
 Disjointed, 488, 496, 498, 999, 1120  
 Ditch, 197, 483  
 Doe, 7, 328, 331, 333, 336, 344, 347, 348, 350,  
 352, 353, 354, 355, 356, 453, 470, 475,  
 478, 537, 591, 790, 791, 896, 1022, 1147  
 Double Predestination, 450, 646, 647, 648,  
 649, 650, 717, 742  
 Dubal, 763, 800, 1014, 1147  
 Dushara, 591, 902, 903, 904  
 Ea, 8  
 Eastern Christianity, 910, 1155  
 Eastern Orthodox Church, 801  
 Ebony, 877  
 Ecc, 633, 677, 850, 958, 1094  
 Edwardes, 390, 575, 583, 1147  
 Egeria, 501, 507, 508, 512  
 Eisler, 574, 575, 747, 765, 810, 1147  
 El, 8, 50, 73, 98, 99, 104, 127, 151, 155, 162,  
 204, 205, 226, 227, 278, 288, 290, 313,  
 356, 370, 386, 399, 454, 594, 739, 818,  
 911, 995, 1004, 1149  
 Elad, 313, 562, 787, 874, 883, 889, 890, 894,  
 896, 898, 899, 900, 910, 1008, 1147  
 Eliade, 816, 817, 1147  
 Elias, 456, 494, 501, 503, 597, 1098, 1147  
 Elijah, 410, 415, 494, 501, 503, 525, 597, 631,  
 811, 812, 893, 1098  
 Elom, 469  
 Enki, 8  
 Enoch, 566, 610, 622, 626, 630, 631, 632, 633,  
 1098  
 Enuma Elish, 324, 479, 747, 768  
 Eph, 183, 417, 424, 432, 538, 540, 646, 712,  
 732, 1094  
 Ephesus, 409, 576, 752, 779, 804  
 Epiphanius, 805  
 Esarhaddon, 362, 477  
 Est, 588, 639, 711, 1094  
 Eternally Fruiting Orb, 633, 743, 1014, 1162  
 ethnic cleanse, 215, 415  
 ethnic cleansing, 52, 73, 82, 107, 123, 124,  
 125, 127, 128, 163, 187, 191, 208, 215,  
 229, 259, 314, 415, 416, 426, 645, 1066,  
 1117, 1137, 1141  
*ethnically cleanse*, 218, 240, 269, 311, 312,  
 415, 416, 1066, 1124

- ethnically cleansed*, 218, 240, 311, 312, 415, 1124
- Ettinghausen, 543, 799, 802, 856, 886, 1024, 1025, 1026, 1028, 1031, 1034, 1036, 1147
- Euphrates, 325, 337, 475, 511, 516, 560, 695, 769, 1059
- Europa, 96, 383, 893
- Eusebius, 604, 779
- evolution, 42, 303, 376, 377, 433, 439, 1127
- evolutionism, 376, 433
- evolutionist, 378
- excommunication, 101, 102
- Exo, 29, 31, 52, 105, 382, 387, 401, 403, 417, 432, 435, 466, 467, 529, 535, 542, 566, 582, 583, 589, 594, 612, 618, 721, 758, 778, 801, 946, 947, 948, 1094
- Ezana, 325, 567
- Eze, 51, 105, 323, 363, 364, 415, 417, 503, 541, 800, 830, 835, 838, 1012, 1094
- Ezr, 567, 589, 631, 633, 801, 1094
- Ezra, 17, 51, 105, 366, 372, 416, 457, 464, 531, 567, 573, 584, 588, 591, 592, 604, 610, 615, 625, 628, 629, 630, 631, 632, 633, 636, 638, 658, 659, 660, 665, 668, 881, 991, 1094, 1098
- Fallaci, 214, 215, 637, 1108, 1130, 1131, 1147
- Fani, 259, 473, 479, 483, 517, 551, 561, 563, 595, 636, 651, 666, 679, 701, 712, 722, 746, 750, 751, 753, 776, 777, 782, 783, 789, 790, 797, 815, 819, 827, 838, 852, 855, 862, 885, 908, 910, 923, 924, 938, 962, 972, 997, 1147
- Farah, 127, 386, 1147
- fascism, 107
- fatalism, 308, 557, 617, 650, 651, 692, 694
- Fatiha, 486, 498, 685
- Fatima, 40, 613, 653, 663, 755, 901, 983, 987, 1058
- Fatimid*, 231, 239, 523, 855, 859, 887, 1058, 1059, 1062
- Fatwa, 41, 63, 73, 96, 102, 103, 113, 114, 116, 117, 118, 130, 131, 135, 137, 138, 139, 140, 142, 150, 156, 159, 164, 179, 200, 206, 398, 409, 411, 599, 708, 1008, 1099, 1109
- Felter, 845, 1148
- FGM, 68, 104, 106, 107, 128, 145, 372, 410, 440, 553, 555, 642, 643, 644, 834, 1020, 1099, 1109, 1110, 1137
- Fingers, 1162
- Finial crescent, 1058
- Firaun, 1098
- Firon, 457, 1098
- Fitzgerald, 157, 160, 178, 196, 260, 302, 306, 311, 312, 315, 395, 515, 1108, 1112, 1119, 1122
- Fletcher, 152, 426, 804, 1148
- Fleur-de-lis, 857, 858, 870, 882, 1026, 1043
- Fregosi, 54, 310, 315, 395, 516, 517, 1148
- fruit that grows by itself, 743
- Gabriel, 34, 39, 78, 368, 409, 429, 448, 464, 481, 551, 552, 554, 564, 578, 602, 635, 712, 713, 732, 733, 832, 848, 895, 899, 931, 932, 933, 934, 936, 946, 949, 950, 953, 954, 958, 959, 962, 968, 973, 974, 975, 977, 978, 981, 982, 985, 986, 996, 1098
- Gaia, 384
- Gal, 400, 433, 618, 624, 715, 775, 804, 946, 1094
- gamlu, 643, 723
- gazelle, 896, 1021, 1022
- Geisler, 79, 183, 250, 368, 410, 573, 638, 712, 716, 732, 734, 744, 796, 797, 953, 955, 974, 983, 989, 1148
- Gemini, 556, 627, 674, 675, 702
- Gen, 78, 105, 170, 171, 177, 266, 275, 293, 318, 331, 336, 337, 364, 382, 407, 408, 430, 431, 432, 437, 438, 452, 466, 469, 473, 511, 522, 523, 525, 529, 538, 541, 542, 544, 551, 566, 567, 569, 588, 589, 590, 602, 613, 620, 631, 638, 640, 644, 662, 665, 682, 684, 709, 713, 720, 731, 766, 804, 818, 832, 863, 878, 925, 927, 928, 1094, 1127
- genii, 477, 953
- George, 52, 58, 100, 106, 205, 223, 410, 446, 454, 589, 656, 737, 740, 1096, 1119, 1145, 1146, 1147
- Gerizim, 559
- Geta, 791
- Ghaznavid, 1056, 1057
- Ghosh, 209, 263, 277, 390, 402, 424, 428, 1115, 1148
- Gibb, 24, 32, 76, 83, 84, 109, 117, 120, 136, 139, 152, 172, 180, 330, 352, 369, 402, 403, 407, 441, 453, 503, 507, 521, 561, 570, 658, 660, 677, 679, 717, 722, 723, 747, 768, 769, 778, 781, 794, 806, 827, 839, 841, 849, 855, 863, 910, 967, 980, 981, 1017, 1148
- Gibson, 446, 475, 722, 730, 992, 993, 1148
- Gilchrist, 491, 586, 601, 829, 1018, 1148
- Gilgamesh, 29, 105, 345, 362, 442, 451, 489, 493, 726, 1015, 1145
- Glassé, 7, 50, 83, 84, 708, 762, 772, 781, 799, 806, 809, 810, 827, 868, 894, 921, 928, 973, 993, 1017, 1148
- Glueck, 7, 344, 629, 634, 800, 1148
- Gobl, 1044, 1064
- Goel, 31, 32, 37, 38, 43, 48, 54, 118, 142, 164, 276, 282, 311, 390, 401, 533, 852, 853, 1067, 1139, 1148
- Gog and Magog, 443, 638, 1098

- Goldman, 449, 476, 477, 544, 576, 616, 619, 626, 628, 629, 630, 632, 634, 729, 785, 798, 817, 992, 1047, 1148
- Goliath, 589, 1098
- Goodenough, 127, 200, 562, 566, 611, 616, 617, 619, 621, 622, 624, 625, 626, 627, 631, 632, 654, 664, 790, 861, 874, 1148
- Grabar, 1, 365, 397, 478, 581, 730, 785, 786, 787, 788, 858, 859, 861, 864, 868, 869, 871, 873, 881, 882, 883, 884, 886, 887, 888, 889, 891, 894, 896, 897, 900, 1014, 1026, 1148, 1152
- Graveland, 334, 458, 1020, 1148
- Green, 200, 290, 295, 296, 324, 448, 452, 464, 465, 466, 476, 477, 481, 482, 503, 510, 511, 512, 518, 519, 520, 521, 522, 526, 529, 530, 550, 569, 593, 610, 622, 633, 666, 677, 714, 725, 748, 759, 760, 761, 768, 814, 817, 865, 866, 870, 871, 878, 932, 934, 957, 1097, 1113, 1148
- Gregory, 740, 805
- Grunebaum, 46, 71, 749, 750, 820, 833, 1148
- Guillaume, 8, 37, 102, 175, 330, 368, 454, 518, 536, 560, 563, 575, 576, 578, 609, 611, 615, 632, 633, 634, 635, 662, 676, 683, 698, 703, 712, 754, 762, 769, 771, 826, 840, 847, 848, 849, 947, 984, 1010, 1016, 1148, 1149
- Gunduz, 451, 452, 457, 465, 477, 484, 507, 509, 512, 513, 517, 518, 527, 528, 529, 531, 569, 592, 593, 644, 725, 740, 784, 817, 867, 1149
- Gutmann, 587, 625, 649, 664, 1149
- Ha, 40, 488, 489, 492, 493, 636, 721, 769, 965, 986, 998, 1001, 1007, 1008, 1013, 1016, 1025, 1029, 1095, 1144, 1153
- Hab, 587, 1094
- HaBaal, 330, 356, 456, 769
- Habiba, 983
- Habil, 1098
- Habla, 983
- Hadad, 755
- Hadith, 20, 41, 42, 46, 47, 52, 76, 78, 83, 88, 90, 99, 100, 105, 115, 118, 121, 130, 143, 164, 172, 184, 187, 188, 194, 195, 208, 212, 220, 239, 255, 258, 259, 260, 261, 269, 273, 275, 287, 303, 370, 399, 400, 408, 410, 412, 421, 442, 481, 510, 516, 517, 546, 549, 553, 555, 583, 592, 603, 641, 642, 643, 644, 662, 667, 683, 684, 706, 708, 711, 728, 738, 758, 780, 781, 797, 805, 806, 813, 814, 828, 838, 845, 849, 851, 913, 937, 939, 952, 953, 970, 986, 987, 988, 996, 1030, 1067, 1095, 1096, 1100, 1101, 1110, 1112, 1125, 1149, 1153
- Hadiths, 20, 24, 40, 46, 52, 83, 87, 100, 105, 107, 142, 164, 172, 173, 250, 281, 368, 373, 375, 386, 416, 443, 502, 551, 703, 737, 796, 806, 839, 841, 845, 848, 862, 955, 1096, 1097, 1120
- Hadramawt, 331, 333, 338, 341, 342, 344, 345, 346, 349, 350, 351, 352, 353, 354, 355, 356, 357, 358, 359, 478, 494, 785, 925, 1015
- Hadramis, 330, 333, 537
- Hadrian, 520, 893, 894
- Hafsa, 983, 1062
- Hag, 617, 1094
- Hagar, 431, 461, 503, 513, 538, 539, 544, 546, 576, 624, 662, 677, 678, 701, 749, 750, 764, 766, 804, 822, 934, 1098
- Hagia Sophia, 48, 241, 271, 1061
- Hajar, 705, 752, 755, 757, 762, 900, 921, 1098
- Haji, 6, 12, 18, 24, 25, 44, 46, 71, 178, 208, 285, 324, 331, 334, 335, 385, 386, 440, 463, 502, 505, 512, 519, 559, 571, 575, 579, 618, 650, 661, 666, 668, 669, 670, 671, 672, 673, 674, 675, 682, 689, 690, 691, 692, 693, 694, 697, 698, 699, 701, 702, 748, 749, 750, 752, 755, 757, 759, 764, 765, 769, 771, 772, 774, 777, 778, 795, 820, 828, 833, 863, 898, 912, 918, 919, 920, 921, 922, 923, 924, 925, 926, 927, 928, 929, 934, 947, 959, 968, 969, 970, 971, 973, 979, 988, 1008, 1015, 1018, 1021, 1030, 1099, 1103, 1108, 1110, 1111, 1144, 1152, 1160
- Halal, 52, 102, 117, 136, 137, 139, 141, 153, 193, 194, 201, 258, 260, 263, 272, 278, 279, 281, 283, 287, 320, 408, 414, 558, 559, 561, 596, 643, 666, 679, 681, 683, 684, 685, 686, 689, 1008, 1009, 1014, 1017, 1018, 1019, 1020, 1021, 1099, 1105, 1110, 1141
- Halil, 473, 1010, 1011, 1015
- Hallah, 1013, 1016
- hallucination, 414, 809, 933, 938, 965, 977, 978, 980, 981
- Haman, 588
- Hammurabi, 384
- Hand of Allah, 752, 755, 808, 819, 820
- Hand of Fatima, 755, 901
- Hanif, 73, 366, 503, 509, 510, 521, 529, 538, 540, 558, 559, 563, 591, 602, 606, 668, 669, 770, 1099, 1110
- Hanifs, 17, 52, 407, 452, 503, 507, 508, 509, 510, 513, 521, 522, 527, 535, 537, 538, 539, 540, 558, 559, 563, 564, 591, 600, 669, 1110
- Haram, 16, 26, 38, 101, 116, 117, 118, 136, 137, 139, 260, 326, 328, 341, 345, 352, 359, 380, 414, 462, 473, 519, 532, 563,

- 597, 650, 693, 711, 716, 722, 724, 728,  
773, 787, 834, 863, 883, 890, 897, 898,  
899, 921, 925, 1009, 1152, 1162
- Haran, 7, 16, 17, 18, 323, 325, 327, 328, 336,  
337, 356, 362, 366, 432, 441, 451, 452,  
469, 475, 477, 478, 484, 496, 501, 503,  
507, 508, 510, 511, 512, 513, 514, 518,  
519, 520, 521, 522, 523, 525, 527, 528,  
529, 530, 531, 544, 553, 565, 593, 610,  
620, 623, 644, 666, 671, 677, 714, 725,  
728, 784, 791, 817, 863, 865, 866, 867,  
869, 870, 878, 900, 934, 1014, 1015, 1157
- Harem, 52, 189, 255, 258, 515, 540, 547, 653,  
655, 663, 703, 727, 775, 795, 830, 834,  
836, 987
- harpies, 628, 635
- Harun, 361, 866, 967, 1040, 1062, 1098
- Haruspex, 604
- Harut, 323, 445, 447
- Hashish, 958, 963, 964, 965, 966, 967, 975,  
976, 977, 978, 980, 981, 982, 986
- Hastings, 496, 534, 580, 591, 592, 602, 676,  
702, 770, 807, 815, 817, 901, 1013, 1149
- Hatim, 25, 329, 430, 431, 535, 621, 622, 623,  
677, 678, 682, 683, 719, 720, 722, 747,  
748, 759, 761, 763, 766, 767, 784, 785,  
787, 815, 863, 864, 865, 874, 892, 894,  
895, 896, 905, 921, 922, 923, 924, 934,  
959, 967, 1016, 1018, 1022, 1099, 1110,  
1157, 1158, 1160
- Hawting, 484, 485, 519, 534, 536, 636, 711,  
771, 866, 1149
- Haykal, 250, 410, 712, 744, 955, 974, 1149
- Hazna, 258, 426, 510, 513, 610, 707, 1149
- Hazor, 7, 16, 323, 328, 345
- Heb, 476, 538, 618, 1094
- Hecate*, 802, 804
- Helil, 8
- Helios, 8, 448, 465, 501, 502, 503, 576, 591,  
597, 603, 621, 626, 627, 629, 631, 632,  
668, 669, 679, 817, 995
- Hend, 983
- Henotheism, 1099, 1110
- Henotheistic, 520
- Hera, 383
- Hercules, 382, 618, 700
- Hermes, 8, 51, 383, 445, 479, 610, 633, 816,  
817, 905, 1032
- Herod, 50, 620, 894, 895
- Herodian, 545, 616, 621, 1047, 1140
- Heyl, 363, 1012, 1099, 1110
- Hierapolis, 480, 779, 782
- Hijab, 70, 88, 90, 104, 205, 413, 414, 446, 652,  
847, 1099, 1110, 1118
- Hijr, 678, 756, 759, 783, 784, 815, 865, 934,  
959, 967, 1021, 1099, 1110
- Hijri, 9, 381, 712, 920, 933, 1064, 1099, 1102,  
1103, 1110
- Hilal, 104, 165, 169, 208, 213, 346, 347, 348,  
349, 354, 363, 384, 452, 594, 596, 597,  
644, 652, 666, 683, 724, 729, 744, 819,  
906, 992, 994, 995, 1004, 1005, 1008,  
1009, 1010, 1012, 1013, 1014, 1015, 1016,  
1017, 1033, 1034, 1038, 1058, 1099, 1110
- Himyarite, 347, 348, 350, 354, 769
- Hira, 12, 480, 535, 558, 712, 732, 744, 915,  
926, 932, 936, 937, 939, 943, 948, 962,  
973, 975, 978, 979, 980, 981, 996
- Hislop, 363, 496, 1149
- Hollywood, 307, 372, 455, 1128, 1129
- Homer, 382, 383, 384, 671
- homosexual, 375, 555, 556, 702, 706, 707,  
708, 709
- homosexuality, 52, 255, 375, 556, 659, 702,  
703, 705, 706, 707, 708, 709, 1119, 1144
- honor-killings, 78, 88, 145, 178, 181, 185, 186,  
187, 189, 190, 192, 193, 195, 372, 446,  
641, 681
- Horovitz, 294
- Horus, 17, 327, 472, 572, 573, 574, 578, 579,  
580, 581, 582, 586, 587, 591, 603, 607,  
608, 729, 790, 902, 1157
- Hos, 567, 583, 594, 810, 811, 1011, 1094
- Houri, 255, 659, 705, 795, 826, 828, 851
- Howdah, 579, 842
- Hubal, 8, 329, 330, 334, 348, 356, 425, 455,  
456, 476, 493, 571, 572, 579, 580, 765,  
768, 769, 770, 771, 772, 774, 795
- Hudaybiya, 12, 107, 117, 197, 198, 320, 735
- Hudna, 78, 110, 198, 744, 1099, 1110
- Huganda, 1040, 1056
- Hughes, 47, 52, 54, 83, 84, 118, 164, 208, 209,  
236, 373, 404, 496, 517, 572, 752, 754,  
755, 757, 781, 799, 865, 978, 991, 1016,  
1018, 1094, 1105, 1149
- Hulul, 596, 1008, 1016, 1017
- human sacrifice, 415, 518, 571, 676, 677, 678,  
679, 680, 681, 682, 683, 684, 685, 686,  
692, 720, 795
- Huntington, 27, 249, 745, 1134, 1149
- Huraidah, 7, 16, 323, 328, 475
- Huraydah, 7, 16, 323, 328, 359, 475
- Husayn, 474, 1011, 1058, 1149
- Ibex, 331, 343, 344, 453, 459, 469, 470, 496,  
497, 896, 925, 926, 927, 1022
- Ibexes, 331, 332, 343, 344, 459, 470, 896,  
1022, 1157, 1161
- Iblis, 659, 1099, 1110
- Ibrahim, 17, 23, 24, 51, 61, 90, 114, 117, 120,  
162, 222, 223, 229, 235, 240, 264, 318,  
334, 336, 360, 366, 380, 407, 443, 445,  
448, 449, 457, 461, 462, 467, 468, 469,  
470, 471, 472, 473, 474, 476, 478, 482,

- 483, 484, 494, 495, 496, 502, 503, 508,  
509, 510, 511, 512, 513, 514, 517, 518,  
519, 520, 521, 522, 524, 529, 530, 531,  
535, 536, 537, 538, 556, 558, 562, 563,  
564, 571, 572, 576, 580, 589, 590, 611,  
618, 624, 638, 643, 662, 664, 684, 713,  
749, 750, 763, 764, 768, 776, 785, 787,  
789, 793, 795, 820, 829, 856, 859, 866,  
867, 868, 870, 871, 872, 873, 874, 875,  
876, 877, 880, 881, 884, 885, 886, 887,  
888, 889, 890, 891, 892, 893, 894, 895,  
896, 899, 904, 905, 917, 919, 921, 924,  
926, 927, 928, 932, 934, 936, 943, 968,  
970, 981, 989, 994, 1011, 1015, 1016,  
1019, 1027, 1033, 1051, 1062, 1089, 1098,  
1110, 1146, 1159
- Idris, 1098
- Idrisid, 1055
- Idumean, 1140
- Ifada, 672, 924
- Iftar, 100, 1099, 1108, 1111
- Ihram, 692, 700, 704, 750, 828, 921, 923, 928,  
964, 968, 969, 971, 973, 1008, 1009, 1099,  
1111
- Il, 330, 356, 386, 459, 494, 497, 532, 533, 995,  
1002
- Ilah, 330, 356, 386, 454, 455, 533, 534, 592,  
593, 599, 993, 995, 1013, 1031, 1040,  
1041, 1043, 1048, 1099, 1103, 1111
- Ilisch, 730, 1040, 1041, 1042, 1043, 1046,  
1048, 1049, 1050, 1051, 1052, 1056, 1057,  
1149
- Ilkhanid, 1060
- Ilmuqak, 335
- Illumquh, 16, 26, 330, 331, 333, 335, 336, 338,  
340, 347, 359, 366, 532, 537, 561, 630,  
632, 670, 674, 723, 1020
- Ilyas, 82, 362, 494, 1098
- IIYaSin, 8, 494, 495, 1098
- Imam, 31, 40, 49, 52, 59, 69, 70, 71, 75, 88,  
90, 99, 111, 112, 115, 120, 121, 134, 139,  
144, 145, 151, 153, 159, 162, 172, 181,  
189, 200, 207, 212, 220, 224, 225, 226,  
227, 258, 266, 268, 269, 270, 281, 288,  
310, 315, 321, 371, 397, 412, 418, 424,  
494, 679, 680, 707, 724, 727, 793, 832,  
833, 834, 835, 836, 837, 848, 1034, 1035,  
1099, 1111, 1118
- Imapagan, 381, 382, 383
- impinge, 397
- Inana, 8
- Inferno, 106, 710, 712, 813
- Injeel, 570, 584, 1088, 1099, 1111
- Inquisition, 514
- inscriptions, 27, 222, 230, 323, 326, 328, 330,  
339, 341, 342, 347, 348, 353, 356, 357,  
358, 381, 384, 484, 496, 527, 528, 533,  
534, 535, 576, 592, 601, 621, 676, 754,  
762, 773, 780, 859, 860, 869, 870, 883,  
891, 892, 903, 904, 919, 930, 994, 1005,  
1006, 1007, 1010, 1013, 1024, 1025, 1028,  
1031, 1032, 1047, 1060
- invert, 703
- Invisible Man, 1162
- Iqbal, 90, 113, 124, 139, 158, 194, 213, 275,  
644, 724, 744
- Isa, 29, 78, 83, 105, 323, 360, 361, 363, 364,  
367, 369, 384, 386, 424, 503, 523, 525,  
552, 554, 566, 569, 570, 574, 594, 643,  
644, 652, 738, 789, 801, 805, 824, 872,  
975, 1012, 1015, 1040, 1094, 1098, 1103,  
1110, 1120, 1140, 1143
- Isaac, 336, 360, 519, 538, 567, 590, 591, 611,  
624, 682, 684, 822, 927, 1039, 1098
- Ishaq, 8, 12, 13, 29, 35, 37, 38, 40, 79, 100,  
107, 109, 136, 151, 153, 163, 173, 174,  
175, 180, 184, 188, 192, 197, 201, 227,  
240, 251, 258, 265, 276, 277, 325, 330,  
334, 337, 368, 369, 370, 371, 398, 399,  
421, 425, 438, 441, 442, 445, 450, 459,  
474, 479, 480, 481, 483, 490, 495, 503,  
504, 505, 509, 530, 535, 536, 537, 538,  
540, 556, 558, 560, 561, 562, 563, 568,  
572, 579, 586, 590, 600, 603, 606, 611,  
612, 613, 614, 634, 635, 636, 641, 642,  
654, 669, 676, 682, 694, 696, 698, 700,  
701, 702, 703, 704, 710, 712, 715, 716,  
719, 720, 722, 727, 736, 737, 739, 744,  
748, 749, 754, 756, 757, 762, 763, 765,  
766, 767, 768, 769, 771, 772, 787, 794,  
795, 797, 805, 808, 809, 814, 819, 821,  
822, 826, 827, 829, 830, 840, 841, 842,  
843, 845, 846, 847, 848, 853, 854, 864,  
867, 893, 916, 920, 935, 938, 943, 946,  
952, 956, 958, 959, 963, 964, 974, 979,  
981, 982, 983, 984, 985, 1003, 1016, 1023,  
1031, 1066, 1098, 1101, 1141, 1149
- Ishmael, 240, 336, 361, 431, 461, 479, 501,  
502, 503, 513, 517, 538, 576, 590, 611,  
624, 677, 678, 679, 684, 713, 764, 783,  
818, 822, 865, 928, 934, 959, 968, 1098
- Ishtar, 8, 323, 356, 431, 527, 569, 652, 778,  
798
- Isis, 17, 327, 453, 472, 572, 573, 574, 575,  
576, 578, 579, 580, 581, 582, 583, 584,  
586, 587, 591, 607, 608, 628, 634, 710,  
729, 760, 790, 1157
- Islamization, 30, 58, 69, 259, 287, 307, 318,  
1114, 1124, 1130
- Islamofascist, 375, 709, 1119
- Ismail, 111, 126, 419, 479, 651, 1098, 1146,  
1149
- Isnad, 1099, 1116

- Israeli, 65, 79, 87, 103, 106, 110, 114, 119, 128, 137, 140, 145, 146, 149, 150, 151, 152, 156, 158, 165, 166, 170, 190, 195, 198, 199, 216, 217, 233, 234, 239, 250, 261, 262, 264, 269, 275, 281, 289, 291, 293, 294, 295, 300, 302, 303, 313, 315, 374, 389, 390, 396, 399, 426, 432, 439, 493, 541, 547, 560, 650, 651, 680, 682, 721, 930, 940, 971, 1095, 1124, 1125, 1126, 1128, 1139, 1149
- Istanbul, 48, 83, 234, 271, 351, 516, 802, 991, 1061, 1108
- Jacob, 271, 360, 431, 507, 512, 525, 572, 590, 620, 626, 662, 794, 818, 832, 878, 907, 908, 1098, 1148
- Jacobites, 361
- Jahiliya, 672, 852
- Jalut, 1098
- Jam, 78, 183, 275, 407, 410, 646, 970, 1015, 1094
- Jamara, 503, 755, 877, 927, 968, 969, 970, 1099, 1116, 1160
- Jambiya, 27, 682, 720, 723, 1020, 1021, 1023
- Janissaries, 733
- Janissary, 145, 516
- Jannah, 47
- Jdg, 78, 323, 367, 387, 388, 404, 409, 416, 457, 511, 523, 592, 674, 720, 721, 726, 829, 885, 1004, 1010, 1011, 1012, 1094, 1139
- Jeffery, 323, 381, 383, 392, 443, 445, 446, 474, 483, 485, 491, 496, 533, 534, 622, 623, 649, 697, 951, 954, 958, 1011, 1149, 1151
- Jellaba, 1104
- Jenkins, 249, 310, 317, 395, 579, 745, 1149
- Jer, 51, 78, 323, 325, 366, 406, 417, 567, 589, 594, 620, 732, 804, 830, 1011, 1094
- Jerah, 469, 514, 523
- Jericho, 7, 16, 217, 242, 323, 328, 329, 475, 476, 627, 878
- Jerome, 703, 878
- Jerusalem, 1, 7, 83, 90, 123, 146, 151, 152, 166, 169, 170, 176, 190, 192, 195, 213, 217, 220, 221, 222, 231, 232, 235, 236, 239, 241, 242, 243, 244, 250, 262, 265, 268, 269, 295, 297, 300, 304, 308, 323, 324, 328, 330, 335, 336, 345, 374, 382, 406, 413, 415, 423, 424, 433, 454, 456, 478, 501, 519, 541, 547, 555, 557, 559, 562, 563, 566, 567, 615, 616, 617, 620, 631, 642, 650, 651, 686, 688, 729, 735, 756, 773, 774, 776, 787, 788, 822, 826, 827, 853, 857, 858, 866, 867, 868, 870, 872, 874, 882, 883, 889, 890, 892, 893, 894, 895, 896, 898, 899, 900, 903, 906, 907, 908, 910, 911, 958, 963, 965, 1008, 1026, 1039, 1045, 1047, 1048, 1059, 1096, 1122, 1125, 1145, 1147, 1148, 1150, 1151, 1152, 1160
- Jesus, 17, 32, 33, 34, 51, 78, 83, 105, 125, 132, 187, 205, 241, 264, 271, 307, 314, 330, 360, 361, 363, 366, 367, 369, 378, 388, 391, 400, 403, 407, 408, 409, 410, 413, 415, 417, 424, 427, 430, 432, 442, 443, 445, 449, 464, 471, 496, 504, 514, 531, 539, 541, 551, 554, 559, 566, 567, 569, 570, 571, 572, 573, 574, 575, 576, 577, 578, 579, 580, 582, 583, 584, 587, 590, 594, 598, 603, 604, 605, 606, 609, 621, 628, 630, 632, 636, 637, 638, 646, 659, 663, 665, 668, 713, 720, 721, 729, 738, 740, 779, 787, 801, 803, 804, 881, 893, 964, 983, 984, 1098, 1120, 1122, 1140, 1143, 1146, 1156
- Jibril, 1098
- Jihad Fard Ayn, 1116
- Jihad Fard Kifaya, 1116
- Jinn, 78, 183, 255, 264, 276, 429, 471, 509, 540, 541, 554, 555, 710, 717, 731, 788, 794, 796, 806, 951, 952, 953, 954, 965, 970, 975, 1018, 1019, 1020, 1021, 1039, 1099, 1117, 1144
- Jinni, 710
- Jizya, 28, 36, 45, 52, 78, 87, 115, 149, 150, 153, 164, 176, 214, 235, 250, 263, 264, 269, 274, 278, 279, 285, 287, 289, 302, 368, 391, 403, 420, 485, 510, 514, 559, 638, 1065, 1099, 1105, 1106, 1117, 1118, 1119, 1137
- Job, 78, 105, 407, 419, 501, 529, 731, 801, 811, 1094, 1098
- Joe, 118, 135, 152, 153, 588, 589, 655, 697, 1019, 1094
- Joh, 78, 183, 187, 364, 365, 366, 407, 415, 424, 432, 433, 445, 540, 559, 605, 630, 712, 717, 721, 732, 740, 741, 900, 1094, 1140, 1141
- John of Damascus, 336, 454, 503, 582, 642, 644, 701, 748, 749, 755, 765, 766, 808, 820, 852, 1096, 1141, 1153
- John the Baptist, 21, 501, 508, 589
- Johnson, 40, 96, 680, 692, 1097, 1149, 1151
- Jon, 21, 1094
- Jonah, 21, 1094, 1098
- Jos, 329, 469, 475, 476, 511, 518, 523, 544, 620, 721, 810, 878, 1094
- Joseph, 126, 127, 128, 230, 242, 243, 379, 464, 465, 555, 566, 567, 572, 574, 583, 587, 588, 589, 620, 625, 678, 679, 737, 739, 787, 804, 1098, 1149, 1150, 1154, 1155
- Josephus, 513, 544, 545, 615, 616, 617, 621, 631, 894, 903, 1047, 1140, 1141

- Joshua, 206, 415, 476, 518, 583, 620, 721, 740, 878, 1094, 1098
- Josiah, 603, 773
- Jowayriya, 983
- Jubayr, 580, 699, 755, 756, 783, 809, 815, 818, 834, 835, 1150
- Jubilees, 513
- Jud, 401, 409, 557, 602, 1094
- Judaism, 19, 25, 36, 83, 85, 243, 303, 304, 341, 360, 361, 364, 366, 367, 379, 382, 383, 401, 404, 410, 415, 416, 423, 424, 438, 466, 467, 502, 503, 509, 526, 531, 536, 538, 544, 545, 546, 558, 565, 566, 592, 599, 606, 609, 611, 615, 616, 617, 618, 619, 621, 624, 625, 626, 630, 631, 632, 643, 818, 836, 866, 946, 964, 1018, 1114, 1125, 1140, 1152
- Jude, 557, 1094
- Jumada I, 667, 674
- Jumada II, 667, 674
- Juno, 383, 804, 893
- Jupiter, 8, 51, 324, 325, 329, 334, 350, 367, 382, 383, 441, 470, 478, 479, 482, 526, 527, 528, 531, 671, 747, 764, 768, 772, 773, 774, 831, 870, 871, 893, 894, 1034
- Justinian, 1061
- K 001, 486, 498
- K 002, 12, 17, 20, 24, 26, 27, 28, 29, 32, 33, 35, 39, 41, 45, 51, 52, 54, 68, 75, 83, 85, 87, 88, 105, 111, 117, 120, 126, 129, 131, 132, 133, 136, 149, 154, 164, 180, 182, 183, 184, 187, 191, 192, 193, 201, 208, 212, 214, 221, 223, 241, 250, 255, 257, 259, 266, 268, 271, 276, 281, 320, 323, 360, 364, 366, 368, 370, 380, 401, 402, 407, 408, 416, 418, 421, 438, 444, 445, 447, 451, 456, 457, 462, 463, 464, 465, 468, 481, 493, 499, 502, 503, 506, 509, 510, 513, 521, 531, 537, 549, 550, 552, 555, 563, 564, 567, 569, 584, 585, 588, 589, 591, 594, 598, 600, 609, 610, 615, 625, 630, 635, 636, 638, 640, 648, 660, 661, 667, 677, 685, 720, 721, 726, 727, 735, 743, 764, 823, 824, 826, 839, 846, 853, 867, 879, 893, 919, 920, 922, 931, 936, 937, 951, 980, 982, 991, 996, 997, 999, 1007, 1065, 1067, 1068, 1070, 1073, 1079, 1084, 1096, 1101, 1111, 1134, 1135, 1136, 1137, 1141
- K 003, 28, 29, 38, 39, 41, 45, 50, 52, 85, 86, 87, 95, 107, 117, 120, 121, 123, 126, 131, 149, 199, 201, 240, 254, 258, 259, 265, 266, 275, 276, 282, 302, 315, 320, 364, 370, 407, 417, 420, 425, 443, 471, 499, 504, 510, 521, 570, 583, 618, 647, 648, 787, 820, 951, 1007, 1070, 1071, 1080, 1081, 1101, 1108, 1125
- K 004, 12, 27, 29, 32, 41, 42, 43, 45, 47, 51, 52, 68, 69, 72, 78, 81, 82, 87, 88, 90, 95, 96, 100, 102, 107, 109, 111, 114, 117, 118, 122, 123, 124, 125, 126, 149, 172, 182, 184, 185, 193, 196, 202, 206, 208, 241, 245, 250, 254, 255, 257, 258, 259, 265, 268, 276, 281, 282, 288, 314, 362, 366, 372, 400, 401, 408, 417, 420, 422, 423, 427, 506, 517, 569, 570, 585, 590, 622, 630, 640, 641, 647, 648, 651, 657, 660, 663, 714, 735, 760, 775, 833, 834, 985, 1071, 1072, 1081, 1082, 1083, 1096, 1135, 1136, 1138
- K 005, 17, 20, 28, 32, 42, 45, 52, 85, 88, 90, 107, 109, 120, 129, 130, 131, 132, 133, 135, 138, 147, 148, 149, 151, 152, 154, 155, 156, 157, 158, 160, 161, 163, 164, 165, 166, 167, 168, 170, 172, 173, 174, 177, 178, 182, 185, 187, 191, 192, 194, 195, 196, 265, 267, 278, 279, 315, 335, 365, 367, 370, 401, 406, 408, 415, 418, 419, 420, 423, 451, 471, 531, 549, 574, 576, 578, 582, 592, 595, 609, 628, 637, 643, 668, 675, 717, 731, 812, 824, 867, 910, 1018, 1072, 1083, 1084
- K 006, 8, 24, 82, 86, 107, 276, 334, 363, 365, 430, 440, 445, 448, 450, 462, 467, 468, 469, 470, 471, 472, 473, 476, 481, 482, 484, 494, 495, 508, 511, 518, 520, 529, 563, 571, 576, 582, 585, 590, 664, 669, 676, 677, 758, 793, 824, 839, 896, 917, 924, 943, 1015
- K 007, 266, 269, 270, 276, 419, 438, 442, 450, 452, 457, 502, 506, 509, 535, 539, 540, 581, 584, 587, 588, 589, 590, 635, 664, 682, 706, 717, 720, 734, 742, 747, 795, 957, 963, 1065, 1066, 1096, 1141
- K 008, 28, 38, 52, 100, 117, 138, 153, 198, 208, 214, 250, 266, 275, 276, 335, 406, 422, 423, 427, 438, 506, 679, 682, 712, 717, 719, 720, 722, 727, 740, 1072, 1073, 1074, 1084, 1085, 1115, 1116, 1126, 1135, 1141
- K 009, 12, 17, 28, 32, 33, 35, 42, 43, 52, 61, 64, 69, 71, 78, 90, 115, 125, 129, 132, 138, 143, 149, 150, 152, 153, 154, 163, 164, 165, 196, 197, 208, 215, 221, 236, 250, 265, 266, 268, 269, 273, 276, 283, 289, 372, 380, 390, 401, 403, 404, 408, 410, 416, 419, 422, 427, 438, 463, 464, 466, 506, 514, 526, 531, 534, 559, 573, 584, 592, 601, 604, 615, 622, 628, 630, 638, 655, 664, 665, 666, 667, 668, 669, 673, 675, 677, 704, 708, 716, 720, 727, 768, 834, 879, 917, 921, 980, 996, 1065, 1067, 1074, 1075, 1086, 1087, 1088, 1089, 1094, 1105, 1111, 1117, 1118, 1125, 1137, 1141



- K 010, 82, 448, 457, 468, 472, 482, 564, 584,  
 585, 587, 609, 610, 630, 658, 665, 668  
 K 011, 131, 408, 587, 588, 706  
 K 012, 36, 151, 407, 535, 555  
 K 013, 281, 418, 666, 758  
 K 014, 590, 648, 691, 1065  
 K 015, 940, 953  
 K 016, 36, 37, 38, 39, 41, 117, 120, 136, 184,  
 192, 196, 308, 384, 403, 471, 472, 584,  
 587, 716, 722, 758, 796, 846, 931, 997,  
 1075, 1089, 1142  
 K 017, 172, 187, 189, 250, 364, 535, 587, 600,  
 601, 635, 711, 712, 738, 767, 777, 842,  
 867, 870, 938, 963, 997, 1032  
 K 018, 12, 24, 142, 143, 144, 145, 147, 148,  
 151, 187, 330, 331, 408, 440, 442, 443,  
 444, 457, 463, 468, 503, 568, 582, 584,  
 587, 637, 714, 715, 793, 813, 817, 892,  
 917, 928, 978, 999  
 K 019, 259, 491, 551, 554, 574, 576, 583, 589,  
 758, 999  
 K 020, 40, 488, 492, 493, 587, 963, 1162  
 K 021, 275, 457, 587, 589, 601, 625, 711, 731,  
 953  
 K 022, 117, 362, 402, 438, 451, 476, 564, 597,  
 635, 637, 638, 648, 714, 716, 1075, 1076,  
 1089  
 K 024, 72, 81, 88, 105, 182, 184, 188, 193,  
 196, 420, 421, 448, 470, 564, 618, 641,  
 654, 662, 782, 792, 798, 799, 807, 818,  
 846, 854, 855, 856, 885, 904, 915, 1076,  
 1089, 1090  
 K 025, 39, 46, 468, 471, 601, 610, 711, 1076,  
 1090  
 K 026, 372, 493, 498, 503  
 K 027, 330, 331, 336, 430, 453, 456, 458, 461,  
 462, 493, 567, 587, 632, 665, 670, 788,  
 796, 1007  
 K 028, 365, 462, 493, 588, 589  
 K 029, 39, 41, 334, 458, 569, 677, 691, 771,  
 1032, 1076, 1090  
 K 030, 28, 85, 276, 323, 360, 365, 368, 408,  
 411, 417, 452  
 K 031, 498, 998  
 K 033, 12, 35, 85, 87, 90, 107, 154, 202, 250,  
 254, 257, 265, 266, 404, 589, 641, 660,  
 661, 684, 735, 736, 738, 833, 844, 846,  
 985, 1076, 1090, 1135, 1137  
 K 034, 334, 459, 460, 461, 462, 637, 695, 788  
 K 036, 8, 38, 255, 330, 331, 406, 441, 488,  
 490, 491, 492, 493, 494, 495, 585, 758,  
 870, 938, 943, 964, 990  
 K 037, 255, 471, 490, 494, 590, 770, 771  
 K 038, 530, 535, 600, 787, 990  
 K 039, 406, 449, 471, 964  
 K 040, 276  
 K 041, 362, 471, 589, 710, 792, 794, 1039  
 K 042, 39, 407, 584, 609, 1076, 1091  
 K 043, 335, 430, 590, 602, 990  
 K 044, 221, 255, 937, 990  
 K 046, 78, 183, 567, 796, 951, 952  
 K 047, 12, 265, 1076, 1077, 1091, 1117  
 K 048, 35, 85, 173, 203, 404, 419, 570, 1077,  
 1091, 1162  
 K 049, 1077, 1092  
 K 050, 385, 807, 990  
 K 052, 255  
 K 053, 330, 335, 385, 406, 430, 453, 472, 480,  
 495, 527, 535, 540, 572, 633, 634, 635,  
 639, 647, 663, 668, 760, 789, 792, 793,  
 794, 796, 808, 889, 903, 924, 931, 934,  
 937, 941, 942, 943, 945, 946, 948, 950,  
 1162  
 K 054, 329, 369, 417, 441, 490, 499, 738, 758,  
 936, 937, 938, 939, 940, 941, 963  
 K 055, 255, 554, 622, 851, 953, 1162  
 K 056, 268, 430, 668  
 K 057, 716, 1162  
 K 058, 182, 204, 276  
 K 059, 276, 329, 891, 936, 1066, 1077, 1092  
 K 060, 52, 185, 192, 1077, 1092  
 K 061, 29, 52, 61, 208, 250, 276, 281, 425,  
 590, 1077, 1093  
 K 062, 401  
 K 063, 143, 196, 275, 1078, 1093  
 K 064, 143, 275, 1078, 1093  
 K 065, 661, 825, 844  
 K 066, 373, 588, 834, 1078, 1093, 1136  
 K 068, 998, 1162  
 K 069, 758, 1162  
 K 071, 171, 329, 350, 462, 476, 602  
 K 072, 17, 264, 531, 576, 710, 952, 953, 991  
 K 073, 37, 38, 39, 498, 1078, 1093  
 K 074, 276, 424, 430, 499, 668, 742  
 K 076, 39, 997, 1078, 1093  
 K 078, 255  
 K 080, 196  
 K 081, 472, 480, 495, 653, 794, 934, 937, 941,  
 943  
 K 084, 430, 668  
 K 085, 430, 668  
 K 089, 430, 1162  
 K 091, 430, 996  
 K 093, 12  
 K 096, 12, 733, 998  
 K 097, 464, 949, 996  
 K 105, 268, 462, 488, 635, 694  
 K 106, 488, 559, 666, 919  
 K 108, 820, 830, 831  
 K 110, 398, 421, 422  
 K 111, 572  
 K 113, 487, 488, 848, 954, 984  
 K 114, 487, 848, 985

- Kaaba, 18, 25, 29, 30, 129, 141, 202, 208, 213,  
 240, 242, 250, 329, 334, 335, 363, 367,  
 369, 392, 423, 429, 431, 450, 456, 459,  
 462, 463, 473, 474, 475, 476, 478, 482,  
 483, 499, 500, 502, 503, 509, 512, 515,  
 517, 519, 535, 536, 537, 540, 556, 558,  
 559, 561, 562, 563, 564, 571, 572, 574,  
 577, 579, 580, 588, 592, 601, 610, 621,  
 622, 623, 634, 635, 644, 669, 673, 675,  
 676, 677, 678, 679, 682, 689, 691, 693,  
 695, 696, 699, 700, 702, 703, 704, 719,  
 723, 724, 746, 747, 748, 749, 750, 752,  
 753, 754, 756, 757, 759, 761, 762, 763,  
 764, 765, 766, 767, 768, 769, 771, 772,  
 774, 776, 777, 778, 783, 784, 785, 787,  
 788, 793, 798, 808, 809, 810, 812, 815,  
 816, 817, 819, 826, 827, 834, 835, 839,  
 860, 863, 864, 865, 866, 867, 868, 874,  
 877, 878, 891, 892, 893, 894, 895, 896,  
 897, 898, 899, 900, 901, 905, 910, 912,  
 918, 919, 921, 922, 923, 924, 926, 928,  
 929, 934, 938, 957, 958, 959, 961, 962,  
 963, 964, 965, 966, 967, 968, 972, 973,  
 978, 979, 981, 989, 993, 1008, 1010, 1015,  
 1016, 1018, 1021, 1022, 1027, 1099, 1110,  
 1118, 1120, 1134, 1138, 1143, 1157, 1158,  
 1160  
 Kaba, 748, 1118  
 Kabbalah, 545, 1139  
 Kaegi, 729, 1150  
 Kaiwan, 8, 545  
 Kalima, 734, 1031, 1035, 1099, 1118, 1135  
 Kamikazes, 254, 387  
 Kamyanets-Podilsky, 992  
 Katabanians, 333  
 Katt, 1150  
 Kemosh, 404, 415, 720, 726, 1139  
 Khadija, 244, 583, 595, 612, 932, 973, 980,  
 983, 990  
 Khafre, 49  
 Khalifa, 30, 42, 131, 1073, 1083, 1085, 1096,  
 1099, 1118  
 Khalil, 125, 126, 288, 473, 705, 1008, 1010,  
 1015, 1144  
 Khan, 50, 78, 81, 90, 99, 100, 114, 178, 250,  
 261, 275, 287, 404, 465, 553, 683, 684,  
 686, 1017, 1018, 1060, 1139, 1146, 1150  
 Khatib, 31, 49, 834, 835, 836, 837, 1099, 1118  
 Khawla, 983, 1105  
 Khaybar, 197, 549, 704, 736, 850, 935, 952,  
 1023  
 Khazar, 243, 502  
 Khusrau, 508, 565  
 Khutba, 48, 724, 835, 836, 1099, 1118  
 Khuzistani Chronicle, 519, 866  
 Kiblah, 30, 695, 723, 756, 776, 780, 781, 785,  
 788, 793, 799, 826, 827, 835, 839, 867,  
 891, 1010, 1018, 1118, 1120, 1142  
 Kinana, 107, 136, 173, 184, 334, 568, 571,  
 586, 771, 829, 843, 935, 983, 985  
 King Hassan, 710, 726, 767  
 Kismet, 650  
 Kiswa, 746, 747, 753, 754, 756, 761, 762, 892,  
 921, 922, 961, 962, 978, 980, 1099, 1118,  
 1160  
 Kitman, 73, 196, 201, 255, 735, 1099, 1119,  
 1142, 1143  
 Kiyyun, 8  
 Koelle, 197, 606, 614, 727, 1150  
 Korah, 1098  
 Kowkab, 995  
 Kramer, 70, 109, 113, 152, 172, 180, 402, 403  
 Krause, 16, 26, 38, 255, 256, 326, 341, 345,  
 352, 359, 380, 497, 519, 532, 542, 597,  
 711, 716, 722, 773, 897, 1009, 1018, 1146,  
 1147, 1150, 1152, 1154, 1162  
 Kronos, 8  
 Kuban, 793, 794, 853, 855, 1150  
 Kufic, 508, 999, 1000, 1024, 1026, 1031,  
 1099, 1119, 1121, 1161  
 Kulthum, 583, 984, 1098  
 labia majora, 756, 785  
 labia minora, 785  
 Lahdi, 854, 857  
 Lahut, 1, 993, 1103, 1157, 1160, 1161  
 Laicist, 1099, 1120  
 Laleh, 884, 1008, 1013  
 Lam, 105, 488, 489, 492, 597, 888, 998, 1001,  
 1007, 1024, 1025, 1094  
 land claims, 213, 720, 725, 726  
 Landay, 231, 873, 884, 889, 906, 907, 908,  
 911, 1037, 1150  
 Larousse, 332, 335, 441, 444, 478, 633, 643,  
 778, 817, 838, 1150, 1162  
 Larson, 1150  
 Lecker, 613, 614, 758, 839, 847, 984, 1150  
 Leo, 523, 674, 763, 804, 890, 1014  
 Leonids, 556  
 Lev, 31, 171, 432, 438, 466, 467, 552, 559,  
 605, 988, 1018, 1094  
 Levy, 453, 532, 591, 634, 701, 733, 816, 854,  
 868, 904, 994, 1150  
 Lewcock, 335, 593, 1150  
 Lewis, 183, 303, 456, 476, 515, 575, 692, 755,  
 770, 774, 1109, 1112, 1147, 1150  
 Li-'llah, 597, 993, 994, 1032, 1046  
 Libra, 627, 657, 674, 700  
 Light Verse, 448, 618, 782, 792, 798, 818, 853,  
 855, 856  
 Lindner, 149, 220, 282, 412, 572, 634, 1150  
 Lingam, 753, 754, 755, 756, 757, 758, 779,  
 782, 783, 826, 832, 838, 840, 841, 842, 862

- Lings, 6, 77, 83, 174, 196, 201, 202, 206, 220,  
221, 320, 324, 331, 369, 370, 371, 373,  
427, 449, 483, 493, 504, 512, 515, 516,  
538, 539, 546, 559, 571, 572, 580, 590,  
601, 622, 654, 682, 695, 696, 698, 703,  
704, 705, 711, 712, 720, 738, 740, 741,  
767, 807, 808, 817, 821, 827, 828, 832,  
834, 837, 850, 853, 901, 931, 933, 934,  
935, 939, 942, 946, 949, 951, 952, 953,  
956, 964, 971, 980, 985, 1150
- Lot, 588, 706, 717, 1098
- Lotus, 870, 881, 882, 889, 936, 937, 942, 943,  
945, 946, 947, 948, 949, 1160
- Lovette, 520, 1150
- Lucian, 480, 779, 782, 811
- Lucifer, 789, 1012
- Luk, 21, 78, 125, 132, 177, 281, 330, 364, 366,  
368, 381, 408, 409, 415, 471, 509, 540,  
559, 561, 566, 583, 584, 589, 602, 603,  
605, 606, 615, 621, 637, 713, 804, 1094,  
1121
- Lullayy, 770, 774
- Luna, 8, 325, 367, 569, 670, 802, 915, 994,  
1003, 1036
- Lut, 1098
- Luther, 1018, 1151
- Lutheran, 1, 515, 1151
- Lyrids, 556
- Maccabean, 544, 616
- Macedon*, 802
- MacMullen, 332, 343, 464, 517, 573, 576, 577,  
578, 579, 580, 603, 604, 605, 618, 634,  
671, 751, 800, 803, 1006, 1139, 1141, 1150
- Madina, 9, 12, 35, 37, 39, 40, 43, 83, 100, 131,  
180, 197, 201, 239, 240, 250, 267, 308,  
320, 324, 337, 370, 381, 382, 398, 429,  
481, 483, 500, 502, 504, 512, 523, 549,  
552, 558, 563, 590, 606, 611, 612, 613,  
614, 644, 694, 695, 696, 704, 707, 708,  
712, 738, 739, 741, 758, 795, 821, 826,  
833, 838, 839, 841, 842, 845, 847, 850,  
852, 853, 854, 855, 862, 867, 869, 874,  
900, 911, 919, 920, 935, 938, 947, 955,  
958, 963, 984, 1045, 1062, 1066, 1077,  
1089, 1092, 1094, 1096, 1102, 1110, 1117,  
1152
- Madrassa, 376, 857, 1099, 1120
- Maghrebi, 999
- Magians, 444, 458, 520, 564, 600
- Mahram, 16, 325, 326, 333, 334, 335, 339,  
343, 345, 359, 458, 459, 504, 532, 597,  
724, 864, 868, 897, 898, 992, 1009, 1020
- Maimonides, 64, 671, 811, 812, 1150
- Makiya, 752, 1150
- Makka, 6, 7, 9, 16, 24, 30, 35, 37, 38, 39, 40,  
43, 46, 71, 78, 320, 323, 324, 329, 333,  
334, 336, 337, 357, 363, 369, 370, 371,  
379, 381, 382, 385, 386, 392, 398, 399,  
416, 421, 429, 431, 443, 451, 452, 454,  
456, 460, 461, 462, 463, 464, 475, 478,  
480, 482, 484, 487, 488, 499, 502, 503,  
505, 508, 509, 511, 512, 519, 526, 535,  
536, 537, 539, 552, 556, 558, 559, 561,  
562, 563, 568, 571, 572, 573, 575, 576,  
578, 579, 580, 581, 583, 586, 588, 590,  
592, 595, 600, 601, 614, 615, 622, 623,  
630, 635, 642, 644, 648, 650, 652, 669,  
670, 676, 678, 679, 683, 685, 689, 690,  
691, 693, 694, 695, 696, 697, 698, 699,  
700, 701, 702, 703, 704, 712, 714, 717,  
722, 723, 724, 728, 733, 737, 739, 741,  
746, 747, 748, 749, 750, 753, 757, 771,  
772, 774, 776, 777, 784, 787, 788, 789,  
795, 797, 798, 806, 808, 809, 810, 812,  
814, 815, 817, 818, 819, 820, 826, 828,  
833, 834, 844, 853, 854, 855, 857, 860,  
865, 867, 869, 870, 876, 877, 891, 892,  
894, 896, 897, 898, 899, 900, 902, 905,  
911, 915, 916, 918, 919, 920, 921, 923,  
924, 925, 926, 927, 928, 929, 931, 932,  
935, 937, 938, 939, 940, 942, 943, 947,  
948, 952, 957, 958, 959, 961, 965, 966,  
968, 972, 973, 979, 980, 993, 996, 1016,  
1020, 1021, 1027, 1045, 1053, 1061, 1062,  
1077, 1091, 1094, 1096, 1099, 1102, 1103,  
1110, 1111, 1116, 1117, 1118, 1120, 1141,  
1143, 1150, 1152, 1153, 1154, 1155, 1158,  
1160
- Mal, 603, 606, 1094, 1116
- Malik, 40, 46, 78, 118, 174, 197, 205, 208,  
260, 281, 430, 478, 480, 551, 581, 586,  
590, 606, 614, 637, 703, 704, 706, 708,  
724, 725, 727, 750, 780, 787, 791, 794,  
797, 828, 835, 836, 838, 860, 862, 864,  
868, 869, 894, 897, 935, 943, 955, 988,  
1002, 1003, 1032, 1045, 1049, 1056, 1062,  
1106, 1145, 1149, 1151
- Maliki, 184, 185, 204, 267, 276, 555, 659, 707,  
708, 726, 775, 838
- Mamluks, 241, 556, 1118
- Mamun, 739, 1051, 1062
- Manat, 330, 335, 472, 527, 535, 540, 590, 628,  
630, 633, 634, 635, 711, 756, 760, 761,  
762, 763, 789, 792
- Mandaean, 240
- Man-in-the-Moon, 385, 450, 455, 476, 477,  
478, 480, 481, 607, 710, 760, 908, 909,  
932, 1162
- Mansukh, 742, 1099, 1101, 1120, 1121
- Manuel, 481, 805, 1155
- Maqam, 921, 1099, 1120
- Mar, 7, 16, 21, 22, 26, 27, 34, 48, 53, 54, 60,  
61, 64, 65, 66, 67, 69, 72, 73, 78, 79, 82,  
98, 103, 107, 125, 131, 135, 144, 145, 150,

- 152, 155, 156, 158, 159, 160, 162, 165,  
169, 183, 184, 185, 186, 189, 190, 193,  
198, 199, 203, 206, 208, 209, 215, 217,  
218, 219, 221, 222, 223, 224, 225, 226,  
229, 231, 234, 236, 240, 243, 244, 250,  
259, 260, 262, 263, 265, 266, 268, 271,  
272, 274, 275, 282, 285, 293, 303, 304,  
307, 308, 311, 313, 314, 316, 323, 324,  
332, 333, 334, 335, 337, 341, 344, 345,  
356, 357, 358, 359, 366, 378, 381, 384,  
388, 393, 398, 399, 401, 403, 406, 408,  
409, 410, 413, 415, 416, 426, 430, 432,  
439, 458, 459, 460, 461, 462, 465, 470,  
478, 496, 502, 511, 515, 528, 539, 541,  
553, 575, 579, 597, 604, 615, 621, 631,  
640, 642, 643, 645, 647, 678, 679, 686,  
695, 708, 713, 724, 733, 734, 738, 756,  
775, 780, 795, 800, 804, 846, 847, 868,  
870, 919, 940, 987, 1017, 1019, 1022,  
1028, 1030, 1046, 1094, 1095, 1108, 1115,  
1119, 1120, 1123, 1124, 1129, 1136, 1140,  
1147
- Marduk, 8, 324, 325, 334, 441, 479, 525, 526,  
527, 528, 531, 671, 747, 768, 773, 774
- Margoliouth, 38, 83, 203, 441, 483, 490, 510,  
601, 780, 811, 826, 938, 946, 950, 951,  
953, 956, 964, 974, 1151
- Marib, 7, 16, 27, 323, 324, 332, 333, 334, 335,  
341, 344, 345, 356, 357, 358, 359, 458,  
459, 460, 461, 462, 470, 695, 868, 919,  
1022
- Marijuana, 939, 951, 963, 964, 965, 966, 967,  
975, 976, 978, 979, 980, 981, 982, 983,  
984, 985, 986, 987
- Mariolatry, 575, 579
- Marium, 569, 574, 1098
- Mariya, 582, 983
- Mark Twain, 925
- Marks, 523, 674, 1151
- Mars, 8, 35, 325, 326, 345, 381, 479, 519, 532,  
639, 711, 747, 764, 870, 871
- Marut, 323, 445, 447
- Marwa, 474, 475, 483, 690, 764, 765, 766,  
767, 922, 923, 924, 926, 1134, 1160
- Mary, 17, 51, 76, 105, 156, 207, 307, 366, 367,  
372, 407, 408, 415, 416, 433, 531, 551,  
554, 567, 569, 570, 572, 573, 574, 575,  
576, 578, 579, 580, 582, 583, 584, 586,  
587, 589, 591, 592, 595, 603, 607, 609,  
630, 632, 637, 663, 729, 787, 795, 801,  
802, 803, 804, 805, 983, 984, 991, 992,  
1098
- Mary Orant, 801, 802, 803, 804, 805, 992
- Masada, 1141
- Masjid, 271, 352, 658, 723, 778, 827, 839,  
855, 889, 967, 1099, 1120
- Maspero, 633, 743, 1014, 1151, 1162
- Massiah Ad-Dajja, 1099, 1120
- Masudi, 561, 675, 747, 748, 870, 871, 910, 914
- Mat, 21, 33, 34, 61, 78, 96, 132, 171, 205, 264,  
330, 364, 366, 369, 400, 403, 409, 415,  
417, 423, 424, 430, 431, 432, 433, 435,  
444, 502, 514, 538, 539, 566, 567, 568,  
570, 583, 584, 597, 609, 615, 621, 624,  
637, 646, 650, 663, 720, 721, 734, 740,  
775, 804, 909, 964, 1094, 1114, 1121,  
1135, 1140
- Maududi, 9, 10, 11, 37, 38, 82, 362, 494, 495,  
499, 574, 672, 682, 848, 936, 1151
- Maymuna, 830, 983
- Mein Kampf, 42, 264, 318, 376, 1119, 1126
- Mein Koran, 42, 1119
- Menorah, 616, 617, 618, 790, 906, 1047, 1048
- Mercury, 8, 51, 338, 383, 479, 482, 562, 633,  
747, 764, 817, 870, 871, 905, 1032, 1034
- Merrikh, 8
- Mesha, 404, 415, 903, 1147
- Meshorer, 544, 545, 616, 906, 1039, 1151
- Mesopotamia, 7, 337, 356, 358, 415, 449, 475,  
494, 497, 511, 512, 520, 524, 526, 528,  
529, 533, 569, 579, 587, 620, 625, 721,  
740, 743, 769, 770, 788, 866, 902, 1036,  
1058, 1061
- messianic, 532, 738, 1120
- metathesis, 597, 643, 1009, 1010, 1016
- metathetical, 1010, 1011, 1012, 1015, 1017
- Meyendorff, 553, 554, 748, 749, 802, 805,  
1151
- Meyerson, 221, 385, 414, 1151, 1155
- Mic, 343, 1094
- Michael, 67, 73, 74, 99, 103, 108, 144, 155,  
156, 157, 159, 208, 209, 298, 388, 389,  
390, 392, 409, 436, 522, 524, 550, 614,  
682, 719, 737, 786, 796, 804, 847, 853,  
855, 859, 887, 971, 984, 987, 988, 1048,  
1064, 1098, 1123, 1145, 1150, 1153, 1155
- Midrash, 611, 675, 946
- Mihrab, 18, 25, 30, 31, 49, 352, 479, 483, 554,  
563, 635, 722, 723, 753, 776, 778, 780,  
781, 782, 783, 784, 785, 786, 787, 788,  
789, 790, 791, 792, 793, 794, 795, 797,  
798, 799, 800, 807, 808, 809, 810, 818,  
819, 825, 826, 827, 830, 832, 835, 839,  
841, 851, 852, 853, 854, 855, 856, 857,  
858, 859, 860, 861, 862, 868, 871, 874,  
885, 887, 894, 1026, 1027, 1046, 1061,  
1099, 1118, 1120, 1158, 1159
- Mikail, 1098
- Milchemet Mitzvah, 1140
- Milstein, 689, 730, 836, 1042
- Mina, 475, 503, 671, 672, 690, 691, 693, 699,  
750, 755, 758, 828, 924, 927, 938, 939,  
968, 969, 970, 971, 973, 979, 988, 1116
- Minaeans, 329, 333, 476, 495, 537

- Minaret, 225, 231, 235, 237, 243, 273, 385, 419, 666, 775, 862, 898, 908, 970, 992, 1014, 1061, 1099, 1120
- Minbar, 31, 49, 227, 776, 793, 794, 797, 798, 834, 835, 836, 837, 838, 853, 861, 900, 906, 1099, 1120, 1158, 1159
- Minotaur, 383
- Miriam, 307, 575, 582, 583, 584, 589, 1098
- misappropriate, 241
- Mitchiner, 444, 1044, 1059, 1064
- Mithras, 605, 874
- Mongol, 59, 276, 325, 327, 507, 910, 1060
- Monolatry, 1099, 1110, 1120
- Moon-o-theism, 20, 22, 24, 50, 329, 856, 870, 1033, 1035, 1046, 1047
- Morey, 51, 358, 456, 478, 494, 523, 539, 594, 623, 624, 737, 850, 957, 958, 983, 1146, 1151
- Mormon, 588, 589, 598
- MormonIslam, 544, 598
- Mormonism, 419, 544, 1149
- Moses, 45, 85, 142, 143, 144, 147, 148, 151, 153, 170, 360, 407, 415, 416, 417, 430, 432, 434, 437, 438, 442, 457, 466, 467, 493, 494, 501, 529, 539, 541, 550, 559, 575, 582, 583, 584, 585, 588, 589, 598, 602, 603, 609, 610, 615, 618, 619, 620, 621, 630, 631, 632, 633, 636, 637, 664, 671, 675, 720, 721, 740, 797, 810, 811, 816, 824, 893, 930, 943, 946, 947, 948, 951, 983, 984, 988, 989, 1098, 1141, 1150
- Mosul, 152, 242, 512, 1039, 1060
- Muehsam, 1039, 1151
- Muezzin, 90, 220, 221, 231, 234, 250, 385, 412, 414, 423, 717, 806, 834, 862, 898, 1099, 1103, 1120
- Muharram, 409, 411, 534, 667, 672, 674, 1009, 1011
- Muir, 10, 11, 66, 285, 392, 404, 429, 495, 570, 586, 613, 703, 729, 808, 809, 843, 935, 974, 982, 985, 1144, 1151
- Mujahid, 40, 263, 541, 1099, 1120
- Mujahideen, 41, 62, 136, 244, 250, 261, 296, 320, 685, 724, 1120, 1132
- Muller, 34, 640, 1151
- Muqattaat, 488, 999, 1099, 1120
- Murray, 184, 185, 255, 256, 267, 375, 481, 546, 547, 551, 553, 555, 556, 644, 659, 703, 705, 706, 707, 708, 709, 775, 837, 838, 996, 1013, 1014, 1016, 1123, 1152
- Musa, 133, 208, 250, 281, 493, 584, 609, 664, 890, 1098
- Muttalib, 558, 571, 590, 612, 613, 614, 615, 677, 678, 682, 696, 700, 703, 754, 795, 896, 934, 959, 968, 1016, 1021, 1022
- Muzdalifah, 671, 814, 924, 927
- Mystical, 491, 492, 1144, 1153
- Nabataean, 534, 592, 616, 629, 634, 729, 769, 918, 992, 1000
- Nabatean, 344, 532, 613, 614, 634, 902, 903, 904, 994, 1039, 1151
- Nabonidus, 325, 337, 356, 362, 477, 482, 507, 508, 513, 522, 523, 524, 525, 526, 527, 528, 529, 531, 1157
- Nabu, 8, 338, 346, 356, 479, 525, 633, 725, 999
- Nadir, 175, 614, 850, 1066
- Nah, 1094
- Najran, 197, 536, 947
- Nanna, 8, 324, 337, 760, 798
- Nasi, 463, 665, 701, 1099, 1121
- Nasikh, 742, 1099, 1101, 1120, 1121
- Naskhi, 891, 999, 1007, 1008, 1031, 1099, 1119, 1121, 1161
- Nasr, 8, 54, 131, 149, 165, 350, 588, 603, 693, 700, 892, 902, 1030, 1056, 1152
- Nativity, 195, 223, 232, 234, 235, 410, 411, 566, 570, 573, 574, 576, 587, 779, 893
- Naukat, 1041, 1057
- Nauvoo, 737, 1154
- Nazareth, 190, 202, 232, 233, 234, 237, 313, 521, 637, 1107
- Nazi, 123, 156, 162, 208, 303, 378, 399, 436, 1130
- Naziism, 394, 435, 1113, 1114, 1127
- Nebo, 8, 329, 337, 356, 404, 415, 475, 725, 999
- Negev, 293, 296, 439, 532, 854, 904
- Negus, 325, 332, 449, 504, 505, 537, 567, 574, 582, 737
- Neh, 337, 356, 457, 467, 588, 589, 1094
- Nehls, 39, 64, 1152
- Nemesis, 634
- Nephalim, 541, 551
- Nergal, 8, 479
- Ness, 8, 478, 479, 507, 508, 565, 603, 604, 609, 610, 616, 625, 627, 628, 629, 631, 658, 674, 675, 700, 747, 768, 773, 797, 1152
- Nestor, 803
- Nestorians, 361
- Newby, 6, 104, 626, 631, 632, 676, 710, 729, 758, 767, 847, 906, 984, 992, 993, 994, 1038, 1058, 1152
- Nicholas Mysticus, 802
- Nicolle, 29, 48, 213, 222, 380, 405, 491, 505, 523, 556, 722, 723, 724, 728, 793, 833, 836, 885, 901, 1023, 1118, 1152
- Nielsen, 16, 26, 38, 326, 339, 340, 341, 345, 352, 359, 380, 519, 532, 597, 711, 716, 722, 773, 897, 1009, 1150, 1152, 1162
- Night Journey, 242, 429, 479, 517, 534, 563, 583, 622, 623, 636, 651, 712, 789, 794,

- 867, 868, 870, 884, 892, 895, 899, 934,  
941, 943, 958, 959, 963, 965, 968, 983, 997  
Night of Power, 464, 465, 466, 481, 744, 937,  
996, 997  
Nike, 888  
Nilus, 807  
Ninib, 8  
Ninurta, 8, 479  
Noah, 367, 407, 462, 541, 570, 587, 588, 602,  
989, 1066, 1098, 1144, 1153  
Noeldeke, 9, 37, 38  
Nöldeke, 9, 10, 11  
Nonsensical, 492, 493, 998  
Nostra Aetate, 599, 805  
Nuh, 570, 1066, 1098  
Num, 52, 328, 366, 401, 444, 475, 518, 566,  
582, 583, 612, 671, 725, 810, 865, 1094,  
1139  
Nur Al Din, 546, 1059  
Nuseibeh, 1, 231, 365, 478, 785, 786, 787,  
858, 859, 861, 873, 881, 883, 884, 887,  
888, 889, 891, 894, 1026, 1152  
nymph, 255, 540, 625, 679, 826, 909, 951,  
965, 1110  
nymphomania, 825  
nymphomaniac, 965  
Oba, 494, 594, 1094  
Omar, 76, 83, 84, 99, 121, 129, 139, 148, 155,  
164, 207, 213, 226, 231, 260, 266, 269,  
270, 296, 308, 320, 321, 421, 679, 903,  
967, 978, 981, 1062, 1133  
orans, 790, 800  
orant, 578, 790, 799, 800, 801, 802, 803  
Orionides, 556  
Orthodox Church of America, 803, 805  
Oryx, 1022  
Osiris, 16, 327, 472, 477, 572, 577, 578, 579,  
580, 581, 582, 591, 607, 608, 633, 634,  
671, 729, 790, 915, 916, 947, 1145, 1157  
Ottomans, 52, 729, 1061  
Pachomios, 580, 901  
Pahlavi, 350, 1044, 1045, 1053  
Palamas, 740  
PBUH, 1099, 1103, 1121  
PC-AIDS, 90, 687, 688, 893, 1099, 1121,  
1125, 1131, 1132, 1134  
PC-ASS, 90, 687, 688, 893, 1099, 1121, 1125,  
1131, 1132, 1134  
pearls, 255, 540, 541, 542, 736, 885  
pedophile, 548  
pedophilic, 621  
Pentecostal, 801  
Perseids, 556  
*Persephone*, 802  
Persia, 158, 240, 369, 397, 418, 443, 445, 483,  
556, 563, 588, 611, 708, 776, 790, 852,  
1030, 1054, 1056, 1060  
Peters, 6, 153, 231, 324, 334, 429, 450, 462,  
484, 488, 509, 512, 513, 518, 523, 537,  
538, 556, 558, 559, 562, 571, 574, 575,  
576, 579, 580, 588, 590, 592, 601, 611,  
615, 644, 665, 666, 669, 673, 678, 679,  
680, 693, 694, 696, 702, 728, 749, 757,  
763, 764, 765, 769, 771, 772, 774, 776,  
777, 795, 809, 818, 844, 853, 855, 863,  
864, 865, 867, 882, 889, 893, 896, 912,  
919, 926, 931, 934, 948, 951, 958, 959,  
967, 968, 979, 993, 1021, 1022, 1152, 1153  
phallic, 363, 364, 503, 542, 577, 750, 753, 755,  
757, 759, 766, 767, 778, 779, 780, 781,  
782, 788, 830, 831, 832, 833, 834, 835,  
836, 837, 838, 839, 840, 841, 851, 862,  
898, 970, 973, 1013, 1120  
Pharaoh, 49, 74, 417, 457, 472, 529, 535, 583,  
587, 588, 589, 823, 963, 983, 984, 1098  
Phi, 1015, 1094  
Phillip, 90, 91, 166, 167, 185, 187, 249, 263,  
268, 273, 299, 317, 370, 440, 549, 579,  
773, 802, 961, 1149  
Phillips, 23, 27, 71, 332, 337, 340, 341, 345,  
348, 357, 458, 461, 591, 674, 723, 789,  
1020, 1132, 1153  
Phm, 1094  
Pipes, 20, 21, 22, 34, 52, 54, 60, 63, 64, 65, 66,  
67, 69, 70, 71, 76, 77, 87, 91, 96, 106, 108,  
113, 115, 117, 119, 120, 121, 122, 123,  
125, 127, 128, 142, 147, 148, 149, 154,  
177, 181, 198, 208, 214, 215, 223, 235,  
238, 241, 242, 243, 246, 249, 250, 263,  
264, 269, 272, 273, 276, 277, 280, 284,  
285, 286, 287, 288, 291, 292, 295, 299,  
303, 304, 307, 309, 310, 313, 314, 315,  
316, 320, 321, 362, 372, 373, 374, 390,  
391, 395, 401, 422, 547, 549, 594, 641,  
642, 653, 699, 734, 735, 851, 900, 907,  
999, 1095, 1099, 1100, 1101, 1102, 1104,  
1108, 1109, 1116, 1121, 1124, 1129, 1130,  
1132, 1134, 1138, 1141, 1153  
Pisces, 657, 674  
Plant, 1000, 1006, 1103, 1153, 1159  
polygamy, 128, 171, 179, 515, 795, 822, 824  
polygyny, 107, 179, 372, 373, 431, 432, 515,  
538, 539, 544, 545, 546, 554, 558, 613,  
641, 662, 760, 823, 824, 832, 982, 984  
pope, 237, 579, 733  
Potiphar, 555, 588  
Pritchard, 239, 284, 345, 358, 359, 362, 442,  
451, 489, 493, 523, 527, 572, 798, 1015,  
1153  
Pro, 78, 121, 271, 306, 320, 374, 400, 403,  
437, 439, 670, 712, 1094, 1124  
Psa, 32, 90, 364, 366, 367, 407, 424, 430, 437,  
523, 557, 594, 598, 602, 623, 646, 725,  
801, 810, 811, 874, 919, 1012, 1094

- Pulsa De Nura, 1139  
 Purgatory, 83, 84, 259, 260, 261, 271, 554,  
 623, 689, 712, 715, 736, 955, 1099, 1134,  
 1137, 1142  
 Pyramid of the Moon, 676  
 pyramids, 472, 676, 965  
 Qabil, 1098  
 Qamar, 499, 594, 937, 994, 995, 1017  
 Qarakhanid, 1056  
 Qarina, 717, 951, 954, 1099, 1134  
 Qarnaw, 16, 323, 329, 333, 336, 355  
 Qarun, 1098  
 Qatabanians, 333, 537  
 Qibla, 805, 853, 891, 937, 1099, 1118  
 Queen of Heaven, 447, 454, 804  
 Qurayza, 30, 614, 850, 1066  
 Quynuqa, 614, 850, 1066  
 Rabia I, 667, 674  
 Rabia II, 667, 674  
 Rahman, 69, 144, 145, 165, 330, 381, 427,  
 428, 491, 535, 556, 600, 601, 711, 835,  
 887, 1014  
 Rajab, 667, 669, 672, 673, 674, 919  
 Rakah, 764, 799, 802, 806, 807, 809, 811, 813,  
 827, 841, 909  
 Ramadan, 75, 96, 98, 119, 134, 198, 220, 262,  
 307, 308, 452, 464, 465, 466, 481, 512,  
 549, 610, 650, 661, 666, 667, 670, 674,  
 681, 712, 713, 740, 744, 795, 916, 920,  
 930, 932, 937, 973, 996, 997, 1014, 1015,  
 1023, 1030, 1038, 1099, 1103, 1108, 1111,  
 1134  
 RamAllah, 560, 682, 900  
 Ramazan, 666  
 Ramla, 1047, 1059  
 Rasmussen, 723, 997, 1003, 1004, 1005, 1012,  
 1017, 1020, 1153  
 Rasul, 8, 330, 769, 1032, 1048, 1049, 1050,  
 1053, 1057, 1099, 1134, 1149  
 Rasulid, 724, 1061  
 Rayhana, 983  
 Rephan, 8, 545, 616, 620  
 Resheph, 8  
 Rev, 78, 364, 366, 382, 386, 401, 407, 496,  
 566, 592, 602, 603, 697, 732, 804, 810,  
 972, 987, 988, 992, 1040, 1046, 1067,  
 1094, 1153, 1154  
 revert, 52, 122, 201, 276, 360, 365, 403, 452,  
 521, 969  
 Rice, 63, 109, 223, 1153  
 Richardson, 125, 265, 315, 391, 401, 456, 457,  
 462, 506, 644, 645, 715, 823, 824, 825,  
 851, 1067, 1153  
 Ritter, 481, 705, 1153, 1162  
 Rogers, 776, 780, 781, 786, 794, 853, 855,  
 857, 859, 861, 887, 908, 1153  
 Rom, 33, 34, 183, 187, 431, 433, 540, 566,  
 646, 649, 650, 730, 734, 739, 1094  
 Rome, 83, 106, 237, 270, 303, 304, 418, 577,  
 579, 603, 616, 618, 629, 649, 652, 728,  
 738, 801, 803, 861, 1039, 1047, 1124  
 Rut, 1094  
 Ruthven, 470, 561, 689, 690, 747, 768, 774,  
 811, 910, 969, 1153  
 Sabeian, 26, 27, 326, 330, 331, 335, 345, 346,  
 347, 348, 349, 351, 354, 359, 366, 450,  
 451, 452, 453, 457, 459, 460, 461, 482,  
 497, 503, 510, 567, 597, 610, 671, 694,  
 695, 783, 795, 811, 1021, 1039, 1157  
 saber, 31, 723, 724, 1023  
 Saece, 766, 1099, 1134, 1143  
 Safa, 474, 475, 483, 690, 764, 765, 766, 767,  
 921, 922, 923, 924, 926, 1134, 1160  
 Safa Inscriptions, 496, 1016  
 Safar, 667, 674  
 Safiya, 495, 586, 829, 843, 983, 985  
 Sagittarius, 627, 674, 700  
 Sahar, 347, 348, 469, 523  
 Saharon, 337, 995  
 Sahas, 336, 385, 503, 583, 642, 644, 701, 748,  
 749, 765, 766, 808, 819, 820, 826, 840,  
 852, 869, 1096, 1141, 1153  
 Sahih Muslim, 33, 42, 46, 52, 54, 78, 83, 84,  
 85, 86, 88, 90, 100, 102, 105, 107, 108,  
 118, 122, 134, 150, 153, 154, 173, 184,  
 196, 197, 203, 206, 208, 212, 239, 240,  
 241, 245, 250, 251, 259, 260, 261, 267,  
 271, 273, 276, 279, 281, 282, 288, 360,  
 368, 400, 402, 403, 408, 410, 447, 452,  
 495, 592, 595, 606, 613, 614, 637, 639,  
 648, 649, 662, 667, 684, 705, 727, 735,  
 741, 752, 757, 758, 780, 805, 813, 814,  
 816, 832, 834, 846, 853, 854, 862, 952,  
 954, 955, 966, 970, 1019, 1020, 1101,  
 1126, 1135, 1152  
 Sakina, 704, 931, 951, 980, 981, 1099, 1134  
 Salaam, 44, 205, 1099, 1103, 1134  
 Saladin, 18, 75, 231, 232, 233, 237, 293, 457,  
 546, 547, 548, 556, 723, 724, 780, 791,  
 898, 906, 907, 910, 1036, 1037, 1058,  
 1059, 1152, 1161  
 Salafi, 1110  
 Salafist, 193, 203, 226, 645  
 Salama, 150, 226, 983, 1040  
 Salat, 52, 90, 173, 201, 515, 618, 660, 781,  
 801, 802, 806, 826, 827, 997, 1083, 1099,  
 1134  
 Samas, 497, 995  
 Samin, 592  
 Samosata, 480, 779, 782  
 Sana, 26, 159, 313, 324, 333, 335, 459, 537,  
 1055  
 Sanhedrin, 45, 513, 620, 810

- Sarwar, 97, 329, 602, 603, 678, 1153  
 Sassanian, 28, 206, 302, 350, 443, 444, 445,  
     565, 780, 781, 855, 1040, 1043, 1045,  
     1046, 1062, 1064  
 Satanic Verses, 130, 134, 139, 162, 167, 334,  
     335, 384, 527, 586, 591, 628, 630, 633,  
     635, 636, 638, 659, 665, 746, 777, 797, 903  
 Saturn, 8, 479, 482, 484, 508, 517, 545, 563,  
     711, 747, 764, 870, 871, 918  
 Satyriasis, 850, 1099, 1121, 1135  
 Saul, 589, 1098  
 Sawda, 373, 663, 827, 839, 899, 983  
 Sayin, 333, 338, 342, 346, 355, 356, 358  
 Schimmel, 481, 708, 1153, 1162  
 Schmidt, 124, 212, 213, 227, 287, 288, 304,  
     319, 370, 398, 545, 605, 606, 642, 654,  
     832, 845, 1153  
 scimitar, 29, 187, 398, 437, 450, 564, 585, 643,  
     682, 709, 710, 711, 715, 716, 719, 720,  
     722, 723, 743, 744, 745, 1005, 1018, 1020,  
     1021, 1022, 1023, 1039, 1061, 1162  
 Scorpio, 674  
 Seerat, 716, 1099, 1137  
 Segal, 345, 452, 520, 1153  
 Selena, 8  
 Selene, 325, 479, 569, 995, 1003  
 Seljuk, 518, 793, 859, 865, 1051, 1055, 1057,  
     1058, 1059, 1060, 1062  
 Sell, 9, 10, 11, 457, 588, 1153  
 semen, 274, 551, 749, 750, 827, 828, 831, 839,  
     987, 988  
 Sepulcher, 231, 232, 239, 893  
 Serapean, 579  
*Serene*, 256, 401, 541, 555, 802, 829, 851  
 serving boys, 255, 541, 542, 548, 659, 705,  
     736  
 Set, 25, 247, 299, 327, 472, 573, 586, 671,  
     907, 912, 915, 921, 929, 1070, 1071, 1072,  
     1073, 1074, 1075, 1076, 1077, 1078, 1079,  
     1080, 1081, 1082, 1083, 1084, 1085, 1086,  
     1087, 1088, 1089, 1090, 1091, 1092, 1093  
 Shaban, 667, 674  
 Shabwa, 16, 323, 327, 333, 336, 351, 352, 355,  
     561  
 Shahada, 76, 275, 365, 618, 687, 692, 733,  
     1047, 1050, 1099, 1118, 1135  
 Shahid, 261, 547, 736, 1099, 1135, 1136  
 Shamash, 8, 442, 497, 527, 617, 798, 902, 906  
 Shamoun, 368, 417, 488, 590, 846, 985, 1162  
 Shams, 8, 338, 339, 342, 356, 462, 496, 497,  
     591, 593, 676, 761, 906, 959, 995, 1016  
 Shapash, 8  
 Sharia, 20, 23, 28, 30, 31, 44, 48, 50, 52, 66,  
     69, 70, 74, 76, 82, 83, 85, 88, 90, 95, 96,  
     99, 100, 107, 108, 109, 115, 116, 117, 121,  
     127, 130, 141, 144, 145, 148, 149, 150,  
     156, 158, 178, 179, 180, 181, 187, 188,  
     189, 190, 191, 192, 193, 194, 195, 196,  
     212, 213, 214, 215, 240, 245, 247, 250,  
     265, 273, 279, 281, 282, 299, 300, 303,  
     308, 314, 319, 320, 373, 393, 396, 400,  
     401, 403, 409, 410, 415, 418, 420, 421,  
     427, 434, 437, 438, 446, 506, 577, 653,  
     662, 663, 684, 685, 720, 730, 742, 743,  
     844, 847, 851, 878, 1008, 1017, 1038,  
     1096, 1099, 1104, 1105, 1106, 1107, 1108,  
     1110, 1112, 1113, 1117, 1118, 1119, 1120,  
     1124, 1125, 1126, 1132, 1134, 1136, 1137,  
     1144  
 Shariah, 642, 1137  
 Sharik, 983  
 Shawwal, 667, 670, 674  
 Shaykh, 35, 118, 164, 206, 281, 282, 409, 411,  
     551, 919, 923, 927, 968, 1099, 1137, 1144  
 sheath, 758, 832, 839, 1022  
 Sheba, 26, 27, 28, 330, 331, 332, 333, 334,  
     335, 336, 337, 339, 340, 341, 342, 343,  
     344, 345, 346, 347, 348, 349, 350, 351,  
     352, 353, 354, 357, 442, 450, 456, 457,  
     458, 459, 460, 461, 462, 469, 495, 503,  
     511, 567, 591, 632, 670, 674, 723, 761,  
     789, 837, 877, 919, 926, 1020, 1145, 1146,  
     1148, 1151, 1153, 1154  
 Shekinah, 566, 931, 951, 980, 1134  
 Shemesh, 8, 356, 617, 906, 995  
 Shewel, 666  
 shin, 1162  
 Shirk, 100, 510, 917, 1099, 1137  
 Shorrosh, 386, 739, 980, 1153  
 Sicari, 1140  
 sickle-dagger, 213, 398, 644, 724, 744  
 Siddiqui, 8, 1152, 1154  
 Silas, 174, 188, 371, 982  
 Sin, 8, 16, 24, 26, 29, 38, 202, 323, 325, 327,  
     328, 329, 330, 331, 332, 333, 334, 335,  
     337, 339, 345, 351, 353, 355, 356, 357,  
     358, 359, 362, 366, 384, 429, 441, 442,  
     448, 451, 454, 456, 463, 464, 465, 466,  
     469, 475, 477, 478, 489, 490, 491, 492,  
     493, 494, 495, 496, 498, 499, 500, 519,  
     520, 521, 522, 523, 525, 526, 527, 528,  
     529, 531, 532, 537, 549, 550, 569, 593,  
     597, 622, 629, 633, 643, 666, 671, 672,  
     677, 723, 725, 726, 743, 760, 772, 785,  
     786, 788, 798, 814, 838, 865, 870, 878,  
     916, 934, 936, 938, 943, 964, 998, 999,  
     1001, 1005, 1007, 1010, 1012, 1014, 1015,  
     1020, 1157, 1158, 1162  
 Sinai, 16, 133, 290, 302, 323, 337, 529, 552,  
     671, 721, 725, 807, 893, 932, 946  
 Sirah, 27, 1099, 1137  
 Sirat, 8, 12, 13, 29, 35, 37, 38, 40, 79, 100,  
     107, 109, 136, 151, 163, 173, 174, 175,  
     180, 184, 188, 192, 197, 201, 227, 240,

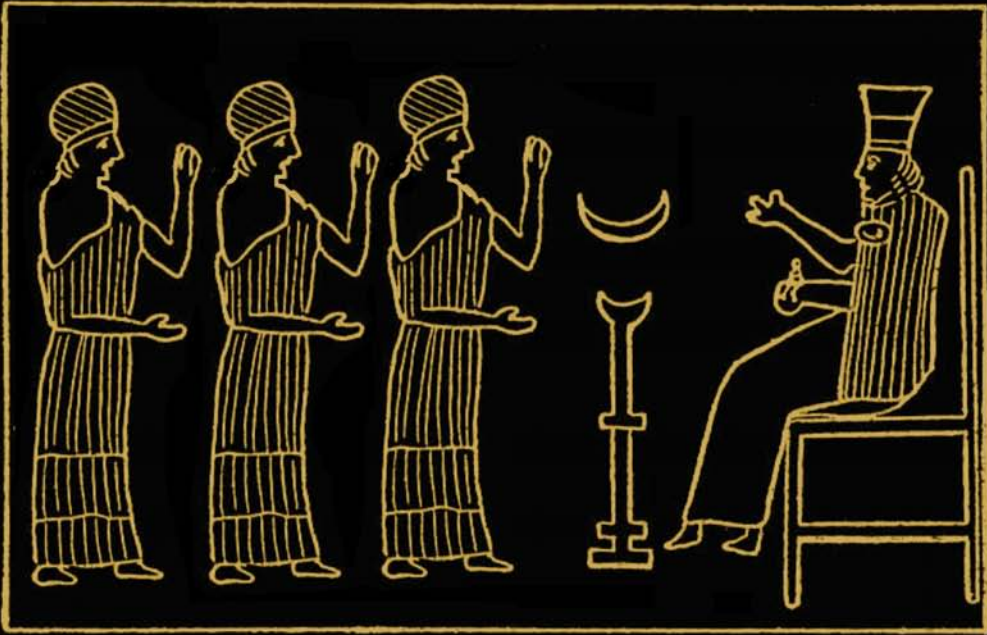


- 251, 258, 260, 265, 277, 325, 330, 334, 337, 357, 368, 369, 370, 371, 399, 421, 425, 438, 441, 442, 445, 450, 459, 474, 479, 480, 481, 483, 490, 494, 495, 503, 504, 505, 509, 530, 535, 536, 537, 538, 540, 556, 558, 561, 562, 563, 568, 572, 579, 586, 600, 603, 606, 611, 612, 613, 614, 635, 641, 642, 654, 669, 676, 682, 694, 696, 698, 700, 701, 702, 703, 704, 710, 712, 715, 716, 719, 720, 727, 736, 737, 739, 744, 748, 749, 754, 756, 762, 763, 765, 766, 767, 769, 771, 772, 787, 794, 795, 797, 805, 808, 809, 814, 819, 822, 826, 827, 829, 830, 841, 842, 843, 845, 846, 847, 848, 853, 854, 864, 867, 893, 899, 916, 920, 926, 935, 938, 943, 946, 952, 956, 958, 959, 963, 964, 974, 979, 981, 983, 984, 985, 1003, 1010, 1016, 1023, 1031, 1066, 1099, 1101, 1137, 1141, 1142, 1149
- Sirius, 335, 453, 471, 472, 482, 540, 572, 573, 575, 583, 607, 608, 627, 628, 630, 633, 634, 635, 657, 663, 710, 760, 762, 763
- Sirwah, 326, 332, 333, 335, 343, 575, 595
- Siva, 753, 782, 783
- Siva-Linga, 753, 782, 783
- sodomy, 185, 374, 555, 706, 707, 708, 709, 726, 775
- Sol, 8, 105, 603, 604, 627, 803, 915, 1094
- Sol Invictus, 604, 627, 803
- Solis Invicti, 606
- Solomon, 32, 240, 242, 243, 330, 335, 336, 430, 450, 452, 457, 458, 461, 469, 473, 544, 553, 566, 567, 587, 620, 621, 624, 637, 650, 662, 788, 796, 832, 843, 894, 895, 907, 908, 953, 954, 1048, 1094, 1098
- Son of Slaughter, 740
- Sophronius, 729, 903
- spadix, 758, 759, 761, 839
- spear, 30, 31, 352, 587, 679, 685, 689, 722, 723, 729, 778, 780, 781, 832, 841, 1105
- Spencer, 21, 22, 36, 41, 46, 48, 53, 54, 60, 67, 84, 87, 103, 110, 113, 122, 126, 135, 143, 156, 166, 177, 182, 183, 184, 200, 204, 205, 207, 209, 214, 215, 216, 218, 221, 240, 241, 245, 246, 259, 263, 268, 269, 271, 281, 282, 286, 287, 288, 290, 296, 309, 315, 318, 370, 376, 383, 390, 391, 393, 394, 400, 402, 412, 417, 432, 447, 558, 637, 640, 643, 646, 648, 657, 661, 718, 824, 825, 834, 846, 847, 902, 1002, 1095, 1096, 1107, 1108, 1115, 1118, 1119, 1121, 1122, 1126, 1133, 1137, 1154
- Spengler, 281, 282, 469, 760, 800, 809, 874, 1034, 1154
- sperm, 378, 750, 758, 839, 987
- Sphinx, 49, 273, 459
- St. Clair-Tisdall, 323, 392, 452, 499, 541, 568, 828, 877, 950, 1014, 1016, 1154
- Standing emperor, 1050
- Standing Place of Abraham, 509, 537, 893, 899
- Stephen, 48, 58, 59, 128, 184, 185, 200, 249, 255, 267, 286, 298, 321, 375, 378, 435, 545, 546, 551, 555, 557, 616, 620, 621, 659, 705, 706, 707, 709, 775, 837, 904, 996, 1013, 1047, 1064, 1128, 1144, 1152
- Stonehenge, 784, 785
- Stortroen, 46, 71, 456, 635, 648, 749, 750, 812, 816, 817, 818, 820, 833, 958, 1154
- Suen, 8
- Su-en, 333, 355, 356, 357, 494, 532
- Sufi, 36, 44, 47, 48, 49, 52, 54, 161, 191, 198, 206, 208, 220, 224, 273, 361, 405, 427, 449, 516, 572, 596, 601, 695, 696, 703, 705, 707, 711, 718, 740, 767, 807, 808, 821, 827, 828, 837, 850, 853, 910, 933, 935, 939, 946, 949, 951, 953, 956, 958, 964, 972, 980, 1008, 1016, 1017, 1022, 1150, 1155
- Suicide-bombing, 388, 389, 409, 1099, 1138
- Sujud, 799, 811, 827, 1099, 1142
- Sulaiman, 1098, 1144
- Sumerian, 8, 241, 324, 384, 431, 497, 528, 725, 759, 785, 788
- Sunna, 83, 102, 137, 148, 152, 153, 245, 393, 728, 1096, 1097
- Sunnah, 116, 188, 218, 764, 765, 919, 923, 1144
- Sunnat, 762
- Sura, 9, 10, 12, 14, 15, 36, 38, 39, 42, 258, 264, 323, 367, 429, 445, 462, 463, 468, 487, 488, 489, 490, 491, 492, 493, 494, 495, 499, 517, 570, 573, 574, 601, 661, 672, 682, 720, 732, 738, 742, 799, 809, 814, 820, 821, 844, 846, 847, 855, 856, 885, 891, 931, 935, 936, 938, 940, 956, 978, 984, 989, 998, 1065, 1068, 1094, 1099, 1104, 1137, 1142
- Sutra, 31, 90, 723, 778, 780, 781, 782, 795, 799, 832, 839, 841, 862, 969, 970, 1099, 1118, 1142, 1153
- Swinton, 544, 1154
- Sykes, 26, 330, 333, 347, 454, 459, 469, 472, 518, 523, 586, 591, 597, 671, 674, 912, 915, 916, 995, 1154
- Syn, 16, 333, 338, 339, 340, 341, 342, 345, 346, 349, 350, 353, 354, 355, 356, 357, 358, 359, 478, 494, 1157
- synagogue, 18, 81, 216, 217, 334, 399, 405, 449, 537, 544, 573, 587, 588, 603, 610, 611, 617, 619, 625, 626, 627, 628, 629, 631, 658, 664, 665, 713, 790, 872, 1120
- Ta Sin, 331, 493, 998, 1007

- Taala, 8, 453, 496  
 Tabari, 64, 69, 86, 87, 151, 276, 370, 440, 448,  
     474, 481, 482, 564, 604, 635, 639, 665,  
     669, 714, 745, 748, 769, 777, 792, 793,  
     794, 866, 982, 1040, 1144  
 Tabaristan, 1040, 1053, 1054  
 Tacitus, 343, 344, 517, 618, 671, 1139, 1141,  
     1142  
 Tajddin, 931, 932, 933, 937, 973, 996, 1154  
 Takbir, 496, 765, 799, 805, 1018, 1029, 1099,  
     1142  
 Takfir, 101, 283, 1099, 1142  
 Takiyya, 40, 42, 47, 201, 735, 742, 1099,  
     1119, 1138, 1142  
 Taliban, 36, 44, 59, 65, 76, 145, 166, 176, 221,  
     263, 273, 376, 411, 455  
 Talmud, 45, 306, 513, 566, 611, 626, 946,  
     1120  
 Talmudic, 610, 617, 706, 797, 1119  
 Talut, 1098  
 Tameanko, 545, 1154  
 Tanit, 750, 755, 790, 799, 800, 801, 805, 806,  
     807, 827, 841, 908, 1158  
 Tarana e malli, 644, 724, 744  
 Tasbih, 1099, 1143  
 Taurat, 584, 1088, 1099, 1143  
 Taurids, 556  
 Taurus, 619, 669, 674  
 Tawaf, 561, 747, 764, 765, 766, 891, 918,  
     1099, 1134, 1143  
 Tawhid, 213, 279, 288, 1137  
 Tayob, 464, 480, 797, 798, 876, 916, 1035,  
     1154  
 Teima, 522, 523  
 Tema, 7, 16, 323, 327, 337, 356, 522, 523  
 Temple Mount, 1, 118, 221, 243, 268, 562,  
     563, 650, 776, 857, 858, 861, 867, 868,  
     869, 870, 871, 883, 892, 893, 894, 895,  
     896, 900, 1026  
 Terah, 469, 508, 511, 514, 518, 520, 523, 544,  
     620, 683, 867, 1098  
 Tertullian, 605  
 Testament of Abraham, 539, 623  
 Thamudenic, 769  
 Thawr, 704, 915, 962, 980  
 THC, 966, 975, 976, 977, 978, 980, 981, 982,  
     983, 985, 986, 987  
 The Seasons, 626, 627, 634  
 Theodosius, 568, 1061  
 Theophanes, 397  
 Theotokos, 575, 609, 802, 803, 804, 805  
 Thoth, 586, 633, 916  
 three muses, 633, 743, 1014  
 Thuluth, 888  
 Tiesenhausen, 1040  
 Timna, 16, 323, 333, 337, 345, 607  
 Tit, 400, 432, 499, 1094  
 Titus, 615, 616, 617, 1047, 1094, 1157  
 Tolan, 455, 701, 748, 908, 1154, 1162  
 Torrey, 360, 367, 392, 489, 570, 584, 611, 769,  
     770, 989, 1013, 1097, 1154  
 Treadwell, 723, 1040, 1041, 1042, 1043, 1055,  
     1154  
 Trifkovic, 122, 130, 184, 189, 241, 245, 255,  
     256, 288, 303, 310, 319, 375, 395, 398,  
     444, 455, 516, 542, 555, 564, 565, 639,  
     641, 648, 698, 736, 739, 740, 830, 833,  
     834, 847, 974, 985, 986, 1154  
 Trimmingham, 385, 430, 480, 501, 502, 503,  
     512, 575, 594, 595, 596, 597, 611, 612,  
     778, 779, 782, 807, 902, 1154  
 Tritton, 1154  
 Trojan Horse, 160, 1153  
 Tubba, 330, 442  
 Tulunid, 1054, 1055, 1145  
 Turkish Blessing, 1, 473, 1015, 1103  
 Tyche, 629, 634  
 Ugaritic, 997, 1003, 1004, 1005, 1012, 1017  
 Uhud, 12, 76, 197, 250, 276, 347, 425, 493,  
     590, 639, 701, 716, 744, 768, 769, 771,  
     773, 850, 1070, 1071, 1080, 1081  
 Ulama, 145, 1099, 1143  
 Uman, 1056  
 Umar, 40, 118, 174, 203, 229, 504, 580, 699,  
     702, 727, 741, 749, 756, 780, 826, 832,  
     840, 849, 852, 853, 854, 860, 864, 897,  
     920, 955, 1040, 1044, 1045, 1048, 1053,  
     1062, 1154  
 Umayyad, 30, 319, 581, 689, 729, 730, 780,  
     787, 788, 835, 836, 855, 864, 866, 868,  
     869, 885, 888, 897, 898, 899, 900, 1011,  
     1041, 1042, 1043, 1045, 1046, 1048, 1049,  
     1051, 1055, 1062, 1145  
 Umma, 64, 78, 121, 123, 180, 216, 312, 418,  
     420, 554, 648, 706, 1099, 1116, 1143  
 Umra, 669, 670, 672, 673, 675, 750, 828, 898,  
     919, 920, 925, 926, 1099, 1111, 1143  
 uplifted, 578, 790, 810  
 Ur, 7, 16, 323, 325, 327, 328, 332, 336, 337,  
     356, 358, 366, 384, 432, 469, 475, 478,  
     508, 511, 520, 523, 525, 526, 528, 633,  
     671, 695, 725, 743, 788, 789, 868, 1014  
 Urban, 1100  
 Uthman, 486, 487, 853, 860, 918, 1000, 1040,  
     1062  
 Utu, 8, 324  
 Uzair, 592, 625, 636, 1098  
 Uzza, 8, 330, 334, 335, 429, 443, 447, 455,  
     472, 493, 503, 504, 518, 519, 520, 527,  
     532, 535, 540, 562, 576, 590, 591, 628,  
     630, 633, 634, 639, 676, 677, 678, 679,  
     701, 711, 722, 749, 751, 756, 759, 760,  
     763, 770, 771, 789, 792, 795, 797, 826,  
     865, 866

- Vasiliev, 803  
 Vatican, 233, 237, 376, 721, 804, 1133  
 Venus, 8, 18, 25, 30, 78, 323, 326, 329, 334, 335, 338, 339, 340, 341, 342, 344, 346, 348, 351, 356, 358, 359, 363, 383, 384, 391, 429, 444, 445, 447, 449, 450, 453, 455, 468, 470, 471, 472, 479, 483, 497, 504, 508, 509, 517, 518, 519, 520, 521, 527, 532, 534, 540, 541, 542, 544, 545, 551, 552, 554, 557, 562, 563, 572, 575, 576, 578, 591, 607, 616, 624, 628, 630, 633, 634, 635, 639, 640, 646, 651, 652, 653, 654, 657, 676, 677, 678, 679, 692, 701, 702, 711, 722, 746, 747, 748, 749, 750, 751, 752, 754, 755, 757, 758, 759, 761, 762, 763, 764, 765, 766, 767, 776, 777, 778, 779, 781, 783, 784, 785, 786, 789, 790, 791, 792, 793, 795, 796, 797, 798, 799, 800, 801, 804, 806, 807, 808, 809, 810, 818, 819, 820, 826, 827, 830, 832, 839, 841, 850, 851, 852, 853, 855, 856, 857, 858, 860, 861, 862, 863, 865, 867, 868, 870, 871, 874, 875, 877, 885, 893, 896, 901, 904, 905, 909, 918, 933, 947, 970, 988, 1011, 1012, 1022, 1027, 1034, 1110  
 Venus altars, 18, 25, 351, 449, 450, 479, 554, 778, 783, 785, 786, 791, 795, 819, 852, 853, 862, 874  
 Vespasian, 604  
 Virgo, 627, 657, 674, 699  
 Vulgate, 496  
 vulva, 635, 752, 753, 754, 755, 756, 757, 758, 761, 762, 766, 767, 779, 784, 785, 792, 820, 826, 827, 832, 862  
 vulviform, 363, 577, 699, 755, 762, 767, 779, 783, 799, 810, 820, 826, 827, 840, 841  
 Wadd, 16, 329, 333, 338, 350, 358, 476, 495, 532, 537, 561, 597, 603, 774  
 Wahhabi, 82, 227, 244, 285  
 Wahshih, 905, 1032, 1033, 1034, 1155  
 Walker, 44, 217, 346, 349, 350, 351, 352, 353, 354, 355, 356, 1040, 1044, 1045, 1046, 1047, 1064, 1144, 1155  
 Waraqa, 595, 612, 982  
 Warraq, 22, 76, 88, 90, 91, 104, 158, 163, 203, 227, 361, 370, 393, 398, 463, 483, 508, 533, 535, 556, 582, 594, 596, 600, 611, 614, 635, 641, 660, 671, 672, 690, 706, 729, 752, 761, 764, 765, 814, 816, 822, 913, 924, 931, 946, 950, 951, 953, 956, 974, 989, 991, 994, 999, 1000, 1001, 1002, 1008, 1016, 1017, 1095, 1151, 1155  
 Watermelon-eater, 791  
 Watt, 12, 737, 931, 989, 1155  
 Wedel, 469, 557, 558, 625, 626, 646, 702, 760, 796, 873, 874, 1034, 1155  
 Wherry, 8, 392, 453, 476, 496, 517, 556, 557, 579, 670, 765, 768, 774, 918, 947, 1155  
 Wilson, 145, 255, 481, 581, 582, 603, 604, 1155  
 Wise, 490, 522, 524, 566, 804, 938, 964, 1080, 1083, 1084, 1085, 1091, 1155  
 Wolf, 221, 385, 414, 831, 850, 851, 852, 988, 1155  
 Wollaston, 533, 1155  
 Wudu, 117, 136, 1099, 1143  
 Xerxes, 588  
 Ya Allah, 489, 493  
 Ya Sin, 38, 330, 331, 429, 441, 488, 489, 490, 491, 492, 493, 494, 495, 498, 672, 870, 935, 936, 938, 943, 964, 998  
 Yacub, 1098  
 Yahveh, 16, 29, 31, 33, 34, 51, 52, 78, 85, 96, 170, 266, 275, 279, 330, 331, 333, 335, 344, 362, 363, 364, 365, 366, 367, 380, 381, 382, 383, 384, 385, 386, 388, 400, 403, 410, 415, 424, 429, 430, 431, 435, 437, 457, 461, 466, 469, 476, 485, 494, 496, 502, 514, 523, 526, 529, 534, 535, 538, 539, 541, 542, 544, 559, 564, 566, 569, 577, 587, 590, 591, 592, 593, 594, 595, 596, 597, 598, 599, 600, 601, 602, 607, 610, 614, 618, 630, 632, 643, 648, 650, 671, 688, 717, 720, 721, 726, 731, 756, 770, 800, 810, 811, 893, 894, 907, 946, 948, 954, 975, 988, 1011, 1015, 1099, 1125, 1139, 1143  
 Yahya, 87, 172, 424, 518, 865, 1098  
 Yajuj and Majuj, 1098  
 Yamin Allah, 752, 755  
 Yarah, 8  
 Yareach, 8, 475, 995, 1003  
 Yareah, 8  
 YaSin, 8, 221, 489, 490, 493, 494, 495, 651, 672, 734, 936  
 Yathrib, 483, 523, 559, 611, 614, 615, 696  
 Yazdegird, 1043, 1044, 1061, 1062  
 Yeor, 48, 64, 91, 213, 231, 232, 239, 267, 276, 302, 304, 310, 312, 313, 319, 390, 395, 396, 408, 452, 718, 1001, 1002, 1106, 1108, 1155, 1156  
 Yerach, 523  
 Yeshua, 1098, 1099, 1143  
 Yom Kippur, 75, 198, 667  
 Yoni, 753, 754, 755, 756, 757, 758, 779, 826, 832, 838, 840, 841, 842, 862  
 Yunus, 822, 956, 1098  
 Yusha, 1098  
 Yusuf, 9, 10, 11, 14, 37, 41, 42, 45, 46, 64, 96, 109, 159, 190, 260, 268, 281, 339, 415, 440, 450, 451, 453, 458, 470, 478, 486, 488, 489, 493, 494, 495, 499, 518, 527, 532, 555, 578, 589, 592, 633, 634, 638,

- 653, 665, 770, 771, 788, 812, 817, 842,  
902, 912, 913, 994, 995, 996, 1065, 1070,  
1072, 1073, 1074, 1075, 1080, 1083, 1084,  
1085, 1088, 1089, 1096, 1097, 1098, 1141,  
1156
- Yusuf Ali, 9, 10, 11, 14, 37, 41, 42, 45, 46, 64,  
109, 268, 415, 440, 450, 451, 453, 458,  
470, 478, 486, 488, 489, 493, 494, 495,  
499, 518, 527, 555, 578, 589, 592, 633,  
634, 638, 653, 665, 770, 771, 788, 813,  
817, 842, 902, 912, 913, 994, 995, 996,  
1065, 1070, 1072, 1073, 1074, 1075, 1080,  
1083, 1084, 1085, 1088, 1089, 1096, 1097,  
1156
- Zakariya, 172, 1098
- Zakat, 37, 38, 97, 150, 153, 250, 251, 402,  
403, 618, 1030, 1099, 1118, 1143
- Zamzam, 250, 430, 556, 644, 679, 815, 834,  
896, 910, 934, 958, 959, 968, 1022, 1099,  
1143
- Zangi, 1059
- Zangid, 1059
- Zayd, 562, 613, 660, 770, 843, 846, 983, 985
- Zaynab, 613, 660, 663, 843, 846, 983, 985
- Zec, 78, 388, 407, 437, 636, 1094
- Zechariah, 636, 787, 1094, 1098
- Zem Zem, 746, 815, 1143
- Zep, 1094
- Zeus, 8, 51, 350, 367, 382, 383, 479, 564, 604,  
752, 773, 774, 779, 893, 979
- Zilhijah, 666
- Zin, 16, 323, 337, 356, 725
- Zodiac, 610, 616, 619, 629, 634, 657, 658,  
659, 660, 661, 662, 663, 668, 669, 673,  
674, 763, 1152, 1157, 1159
- Zoroastrian, 36, 88, 268, 269, 366, 443, 444,  
564, 565, 708, 972, 1043
- Zuhai, 8, 918
- Zuharah, 8, 918
- Zuhra, 8, 445, 447, 613, 614
- Zulhijjah, 674, 920, 921, 1108
- Zulkadah, 674
- Zulqarnain, 24, 330, 331, 440, 441, 442, 443,  
444, 445, 457, 503, 568, 582, 1157
- Zurubabel, 894, 895
- Zwemer, 28, 31, 49, 90, 257, 329, 332, 381,  
386, 392, 474, 483, 514, 551, 554, 575,  
590, 592, 595, 603, 638, 672, 678, 690,  
702, 707, 713, 717, 730, 731, 732, 735,  
742, 747, 749, 755, 762, 764, 774, 778,  
780, 782, 795, 796, 798, 807, 809, 811,  
813, 815, 825, 834, 835, 836, 837, 838,  
839, 841, 848, 849, 853, 854, 901, 917,  
918, 924, 927, 928, 947, 948, 949, 953,  
954, 961, 962, 967, 968, 969, 970, 972,  
973, 978, 985, 1019, 1020, 1111, 1156

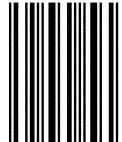


**Yoel Natan writes  
about Mideast Moon  
God Religions**

ISBN 1-4116-1765-7



90000



9 781411 617650